









126  
76 559

PROCEEDINGS

OF THE

AMERICAN PHILOSOPHICAL SOCIETY

HELD AT PHILADELPHIA

FOR

PROMOTING USEFUL KNOWLEDGE.

---

VOL. XLIII.

JANUARY TO DECEMBER,

1904.

---

66425  
1819/05

PHILADELPHIA :  
THE AMERICAN PHILOSOPHICAL SOCIETY.  
1904.

Q

11

P5

v. 43

PROCEEDINGS  
OF THE  
AMERICAN PHILOSOPHICAL SOCIETY  
HELD AT PHILADELPHIA  
FOR PROMOTING USEFUL KNOWLEDGE

---

VOL. XLIII.

JANUARY, 1904.

No. 175.

---

*Stated Meeting, January 1, 1904.*

President SMITH in the Chair.

A communication was received from the Société Nationale des Antiquaires de France, announcing that it would celebrate its centenary on April 11, 1904, and inviting the Society to appoint a delegate to represent it on this occasion. The invitation was accepted, and the President subsequently appointed the Marquis de Nadaillac to represent the Society at the celebration.

The Judges of the Annual Election of Officers and Councillors reported that an election had been held on the afternoon of this day, and that the following named persons had been elected to be the Officers for the ensuing year:

*President*

Edgar F. Smith.

*Vice-Presidents*

George F. Barker, Samuel P. Langley, William B. Scott.

*Secretaries.*

I. Minis Hays, Edwin G. Conklin, Arthur W. Goodspeed,  
Morris Jastrow, Jr.

*Treasurer.*

Henry LaBarre Jayne.

*Curators.*

Charles L. Doolittle, William P. Wilson, Albert H. Smyth.

*Councillors to serve for three years.*

Richard Wood, Henry Carey Baird, Samuel G. Dixon,  
J. G. Rosengarten.

---

*Stated Meeting, January 15, 1904.*

President SMITH in the Chair.

The decease was announced of Alfred R. C. Selwyn, LL.D., at Vancouver, B. C., on October 18, 1902, æt. 78.

The following papers were read:

“On the Phylogeny of the Edentata,” by Prof. William B. Scott.

“Herder and Franklin,” by Prof. M. D. Learned.

“The Main Facts in Regard to the Cellular Basis of Heredity,” by Prof. Thomas H. Montgomery, Jr.

## THE MAIN FACTS IN REGARD TO THE CELLULAR BASIS OF HEREDITY.

(Contributions from the Zoological Laboratory of the University of Texas, No. 56.)

BY THOMAS H. MONTGOMERY, JR.

(Read January 15, 1904.)

### I.

Under heredity we understand the transference to the offspring of qualities of the parent or parents. The interpretation of the phenomena involved constitutes one of the broadest problems in the field of Biology, and has for centuries been the theme of eager discussion. Yet only in the past forty years has there come out any positive knowledge upon the subject, except the making known of certain cases of parthenogenesis and of the occasional difference of reciprocal crosses.

There are obviously two methods of determining the facts of heredity. First, by the intercrossing of different varieties or species, and the determination of the relative influences of the parents upon the offspring. The first fundamental work in this line was done by Mendel in 1865 (*Versuche über Pflanzenhybriden*), who determined a large series of facts for the plant genus *Pisum*, and from the data established a mathematical law for this genus as to the inheritance of parental qualities by the hybrids. This memoir, only some three years ago resurrected from its long obscurity, is to-day occupying the attention it deserves, and has stimulated much work along the same line. De Vries' magnificent work, *Die Mutationstheorie*, demands as well recognition in this respect. But it is clear that such experimental intercrossing, in so far as only the end results of the crosses are considered, can do no more than state the degrees of resemblance of the offspring to the parents, and decide the questions as to the fertility of the hybrids. Important and necessary as it is, it does not go to the root of the matter, and cannot present any empirical analysis of the underlying factors.

For an understanding of these we must turn to the second method, to the examination and interpretation of the intimate structural and growth phenomena of the germ cells themselves, that is, to the

cellular basis. All explanations must remain purely hypothetical until this is done. And here I would call attention, as briefly and concisely as possible, to certain positive results that have been won in the study of the germ cells, and disregard the many fascinating but purely hypothetical views as to the process of heredity.

## II.

The statement of the problem must be a very broad one. The fertilized egg gradually cleaves into many cells. These progressively arrange themselves into tissues, and these form organs. By continuing cell division, by change of position and infolding of cells, and particularly by a differentiation of the cells as the development proceeds, the adult organism eventuates. Then from the body of this adult comes an egg, and it repeats the whole involved process. Here are two great fundamental problems: the one, why the offspring resembles the parent? the other, what are the factors of differentiation? On the answer to these problems depends to great extent the explanation of how variations arise and how they are promulgated, that is, the explanation of descent with modification, broadly called evolution. The very subsidiary question of the determination of sex is necessarily also connected with these problems. And all of these questions are inseparable from the one: How far is the adult preformed or prelocalized in the germ cells?

What interests us immediately are the two points: First, has there been empirically determined a particular cellular substance, most intimately connected with the transmission of hereditary growth energies? And second, if such a substance is known, does its behavior during the process of development of the embryo throw any light upon the processes of heredity?

## III.

To make the following argument clear, we must call to mind the structure of the mature germ cells and the process of cell division.

The maternal germ cell, the ovum, appears much like any large, unspecialized cell. We distinguish in it a central rounded body, the nucleus, with its surrounding cytoplasm. In the cytoplasm there is a living substance, the protoplasm proper, and various deutoplasmic substances, such as yolk, which serve mainly for the nourishment of the cell. The nucleus is more complex. Travers-



ing the thinly fluid nuclear sap, which fills it, is a delicate network or meshwork of linin threads, and supported upon or imbedded in them masses of a substance called chromatin. In the nuclear sap may be suspended also one or many large rounded bodies, the nucleoli, and numerous minute lanthanin granules. The whole is enclosed by a nuclear membrane.

The paternal germ cell, the spermatozoon, has a very different appearance, and in volume is exceedingly smaller than the ovum. In the case of the sea-urchin, Wilson (*The Cell in Development and Inheritance*) has computed it to be about one half-millionth the volume of the egg, and the difference is many times greater than this in the case of the bird. The history of its formation shows it to be a highly specialized cell with regard to its cytoplasm, which is generally modified to form a locomotory flagellum. But its amount of chromatin is the same as that in the egg cell, though contained in a very condensed form (composing the head of the spermatozoon). At the junction of the flagellum and head there is frequently found a mid-body, a metamorphosed centrosome. Thus there is a division of labor between the two germ cells: the ovum is large to provide the necessary cytoplasm and nourishment for the embryo; the spermatozoon minute and motile in order to reach the ovum.

All cell reproduction is by division of the cell, and the mode of division, which differs very notably from a mere constriction into two, may be briefly recalled. The nucleus of the cell increases in volume, and its scattered chromatin masses group themselves evenly along the linin threads, so that eventually the chromatin seems to be arranged in the form of a long, continuous loop. In the cytoplasm at one side of the nucleus appears a minute body, the centrosome. This divides into two centrosomes, and they wander apart from each other, each through an angle of  $90^{\circ}$ , to opposite sides of the nucleus. These centrosomes are the dynamic centres of the cell division and exert an influence upon the surrounding cytoplasm, as shown by systems (asters) of cytoplasmic rays converging upon them. Within the nucleus, meanwhile, the chromatin loop has become split through its entire length by an exact halving of each of its larger chromatin masses, and has also broken transversely into a fixed number of segments, the chromosomes, which now are connected together only by linin threads. Then the nuclear membrane dissolves away and a dicentric figure appears

with a centrosome, the centre of an aster, at each pole, the chromosomes grouped together in a plane midway between the poles and with the long axis of each chromosome coinciding with this plane. Then begins the separation from each other of the halves of each longitudinally split chromosome and to opposite poles, probably due to the contraction of linin fibres that connect the chromosomes with the centrosomes. Their separated halves come to lie in two groups, one near each centrosome. Finally, each centrosome loses its influence upon the cytoplasm, the radiations around it disappear, each group of chromosomes forms again a rounded nucleus, the cell body constricts between them to form two cells, and as a result there are two cells each with its own nucleus. The remarkable accomplishment is an exactly equal distribution of the chromatin mass to the daughter cells by a very complex mechanical process.

#### IV.

Now is there any particular one of these structures that can be determined as the bearer of hereditary qualities? No one has advocated that it might be a centrosome, and, indeed, there is no reason for considering a centrosome to be any other than a dynamic centre. Such a substance must then be in either the cytoplasm or the nucleus.

The earlier views were that this particular substance was located in the cytoplasm (Lankester, 1877; Whitman, 1878; Flemming, 1882; Van Beneden, 1883). But these were hypothetical assumptions and employed not so much to show a special hereditary substance, as rather to explain the progressive specialization of the cleavage cells. Hereditary traits cannot, moreover, be transmitted by the cytoplasm of the spermatozoon, for in some cases (Echinoderms) the whole cytoplasmic flagellum of the spermatozoon is left outside the egg, and only the head and midbody of the spermatozoon penetrate the egg in fertilization. There is also the decisive experiment of Boveri, to which we shall recur, showing that the cytoplasm of the egg cell also does not transmit hereditary traits.

Accordingly the hereditary substance must have its seat in the nucleus, and there is now practically positive evidence that such a germ plasm is the chromatin. The main reasons are as follows:

(1) The exact distribution of the chromatin in cell division, so that each daughter cell receives just half the amount of chromatin

of the mother cell. The longitudinal splitting of the chromosomes is an autonomous act, whereby each small chromatin mass composing the chromosome (though not the smallest visible granules or microsomes) divides exactly into halves, and the whole complex series of changes leading to the dicentric division figure seem to have been evolved simply to effect the equal distribution of the daughter chromosomes to the daughter cells. Whether the cytoplasm divides equally or unequally, the chromatin is always divided and distributed equally. This fact alone has seemed sufficient to most workers to mark the chromatin as the hereditary substance.

(2) The fact that the chromosomes, the accumulations of chromatin during cell division, are fixed in number for all the cell generations of a species. And the strong probability, amounting almost to a fact, that the chromosomes preserve their individual continuity from generation to generation, notwithstanding their great chemical and structural changes during the rest stage of the cell.

(3) The fact that the spermatozoon, in most respects the very antithesis of the ovum, on entering the egg in fertilization brings in just the same amount of chromatin as that contained in the egg. Not only is this so, but Van Beneden demonstrated as long ago as 1883 (*Recherches sur la maturation de l'œuf*) that the spermatozoon brings into the egg just as many chromosomes as are contained in the latter. Since we know that the two parents have an approximately equal influence upon the offspring, and since the chromatin is a substance contributed in equal amount by the two germ cells, it is logical to conclude that this substance is the seat of the hereditary growth energies.

(4) The fact that, despite considerable differences in other respects in their cell divisions, animals and the higher plants show essentially the same behavior of the chromosomes.

(5) The experiment, first made by Boveri, 1895 (*Ueber die Befruchtungs- und Entwicklungsfähigkeit kernloser Seeigel-Eier*), of fertilizing with a spermatozoon the cytoplasm of an egg cell deprived of its nucleus. Such a fertilized egg fragment develops, but shows purely parental characters, probably because all maternal chromatin had been eliminated. And two recent papers by Boveri (*Ueber mehrpolige Mitosen*, etc., 1902; *Ueber den Einfluss der Samenzelle auf die Larvencharaktere*, 1903) have shown, with

their keen critical analysis of the experiments, that the chromatin alone can be considered the bearer of the hereditary traits.

From all these results it is concluded that the chromatin is the seat of the hereditary growth energies.<sup>1</sup>

And from another point of view this is rendered probable. The microchemical study of the cell has shown that the chromatin is the most active substance concerned in cellular metabolism; and experimental work, particularly that of Verworn, shows that a cell deprived of its nucleus, and hence of its chromatin, is unable to build up new substances. The chromatin accordingly, as it is transmitted from generation to generation, carries with it certain definite metabolic energies characteristic of the species. And from this view there is good reason to consider the idea of Delage (*La structure du protoplasma et les theories sur l'Heredité*, 1895) to be in the main correct, namely, that the offspring is like the parent because it has similar metabolic energies.

## V.

There is another series of facts known about the behavior of the chromatin, the hereditary substance, in the germ cells, and a few of them will be touched upon. Oscar Hertwig showed, in 1875 (*Beiträge zur Kenntniss der Bildung, etc., des tierischen Eies*), that the fertilized egg cell contains two nuclei, one belonging to the egg cell itself and one introduced by the spermatozoon. Then Van Beneden (*l. c.*) demonstrated that the spermatozoon brings in just

<sup>1</sup> It has been argued by an English writer whose name escapes me, as does the title and date of his paper, that the linin is the hereditary substance. Active chromatin is never disassociated from linin, but there is always a substratum of linin in each chromosome, and in the rest stage the chromatin is always supported upon linin strands. Hence it was argued that the linin is likewise equally distributed in cell division. This is a good point, but there is a strong objection to it. When the daughter chromosomes separate, in the anaphase, the linin becomes pulled out between every two corresponding chromosomes as a connective fibre, and in the reconstruction of the daughter nuclei the greater portion of such a fibre is not taken up again into the nuclei. And this fact cannot be used in favor of the intracellular pangensis theory of de Vries, whereby pangenes are hypothetically supposed to wander out of the nucleus and so determine the differentiation of the cleavage cells, for the connective fibres appear to behave alike in all cell divisions. Thus of the two constituents of the chromosomes, at each cell division some of the linin becomes displaced into the cytoplasm, but all the chromatin passes into the nucleus.

as many chromosomes, and that their mass is the same, as those contained in the egg. Further, it is proved that in normal fertilization only one spermatozoon enters the egg, and that when more than one enters the development is abnormal. The proof that both egg chromosomes and sperm chromosomes have an approximately equal rôle in determining the growth of the embryo has been shown by Boveri (*l. c.*) by crossing different species of sea-urchins, and by analyzing the results of fertilizing an egg with two or more spermatozoa.

Now each act of fertilization would necessarily double the normal number of chromosomes, since the spermatozoon introduces as many as are already present in the egg, were there not some process to obviate this. There is such a process, and it is known as the "reduction in number of the chromosomes." The last two divisions of the germ cells, preceding the act of fertilization and preparing them for it, are known as the maturation divisions; and it has been known for some fifteen years past that in these divisions each germ cell has only one-half the normal number of chromosomes. It is also proven that the ripe egg cell, as well as the ripe spermatozoon, has only one-half the number of chromosomes characteristic of the species. It is further known (since the work of Henking and of O. Hertwig, in 1890) that the processes involved in producing this result are essentially the same in both germ cells. Accordingly, by this preliminary halving of the number in each germ cell before fertilization, the germ cells on conjugation each contribute only one-half the normal number, with the result that the normal number is restored. But this preliminary reduction in number has a broader meaning than this.

Before the first maturation division of the germ cell is accomplished there takes place a pairing of the chromosomes, so that instead of, *e.g.*, four single (univalent) chromosomes there are two double (bivalent) ones (Montgomery, *Spermatogenesis of Peripatus*, 1899). These become so arranged that one of the two maturation divisions results in separating chromosomes that are split longitudinally, just as in any other cell division; but the other maturation division removes entire chromosomes from each other by separating the two chromosomes of each pair, and thereby reduces the number of the chromosomes to one-half. That is definitely known for certain species.

But how account for the preliminary pairing of the chromosomes? It is apparent that each spermatozoon may be called paternal, but not male, and each egg cell maternal, but not female, for the following reason: We have seen that each organism formed by fertilization has a fixed number of chromosomes, half of which were derived from the spermatozoon and half from the egg cell. The germ cells that develop within that organism, be they spermatozoa or egg cells, accordingly have an equal number of chromosomes from each parent. Therefore, the spermatozoon contains maternal as well as paternal chromosomes, and the egg cell paternal as well as maternal chromosomes. And, therefore, each germ cell has in equal measure the hereditary substance of both its parents.

Now the process of pairing of the chromosomes, which we found to be an initial step to their reduction in number, has been proved to be a pairing of paternal with maternal chromosomes (Montgomery, *A Study of the Chromosomes of the Germ Cells of the Metazoa*, 1901). In a particular generation of the sperm cell it was demonstrated (and not merely "surmised," as stated by another worker) that paternal chromosomes pair with maternal ones, forming thus double rods instead of single ones; it is probable, but not yet demonstrated, that likewise in each egg cell, of the corresponding generation, paternal chromosomes pair with maternal. Thus in the reduction division, which displaces the two elements of a pair, a maternal chromosome separates from a paternal in each pair, but not so that all the paternal chromosomes pass into one cell and all the maternal into another.

These facts which we have learned about the chromatim lead to a conclusion that for its probability approaches a fact. That is, that the different chromosomes in a germ cell have each their particular values. Roux (*Ueber die Bedeutung der Kerntheilungsfiguren*, 1883) was the first to postulate that the chromatin cannot be hereditarily the same throughout the length of a chromosome, for otherwise its equal longitudinal splitting would be without meaning. In other words, each particular portion of a chromosome would represent a particular hereditary value. Not only is this probable, but it is also probable that one chromosome has hereditary values not found in the others. For we have seen that each germ cell has a set of maternal and a set of paternal chromosomes, and that in a particular generation those of the one set pair with those

of the other (Montgomery, *l. c.*; Sutton, *The Chromosomes in Heredity*, 1903). The two that pair are of corresponding volume (as brought out especially by Sutton), and sometimes of corresponding form (Montgomery, in a paper now in press). Because they are thus similar in volume and form, it is at least possible that they are similar in hereditary value. So Sutton has ably argued that when the two of a pair, a maternal and paternal chromosome of corresponding volume, separate from each other in the reduction division, chromosomes of like hereditary quality become separated into separate cells, so that no mature germ cell shall contain before fertilization two chromosomes having similar hereditary values. And this is the best reason yet given in explanation of the peculiar reduction division.

## VI.

Finally, we may ask how far these facts agree with the germ-plasm theory of Weismann.

Some eighteen years ago, Carnoy (*La cytodièrese chez les arthropodes*, 1885) showed, and he was the first to do so, that two kinds of cell division occur, namely, a transverse splitting of the chromosomes and a longitudinal splitting. That transverse splittings of chromosomes should occur was directly opposite to the prevalent view of the time, to the effect that only longitudinal divisions take place. Carnoy was far ahead of his day, and while this most important memoir of his then and for years afterwards met with only rather scornful criticism, we must now grant him his proper place as the discoverer of the reduction divisions.

Weismann, in 1887 (*Ueber die Zahl der Richtungskörper und ueber ihre Bedeutung für die Vererbung*), prophesied, clearly without knowledge of Carnoy's work, and in conformity with the ideas of Roux (1883, *l. c.*), that in addition to the longitudinal splitting of the chromosomes, the "hereditary equal division," there would be found to occur in certain generations of the germ cells a "hereditary unequal division," either by a transverse division of the chromosomes or by a separation of entire chromosomes from each other. A number of the students of the maturation phenomena of the germ cells have empirically demonstrated this. Weismann's reduction division is the one where entire chromosomes become separated from each other. Equally, confirmation has been brought of another of his cardinal postulates, the con-

tinuity of the germ plasm. To be sure it is known that the germ plasm, the chromatin, is not an eternally unchangeable substance, as Weismann at first postulated. But the chromatin persists from generation to generation; the continuity of the germ plasm is what to-day is being termed the continuity of the chromosomes, and these continue from generation to generation, maintaining their individuality, just as much as a particular cell of one generation may be said to be represented by a particular cell of another.

Only some half dozen years ago, in the course of the conflict over the germ-plasm theory of Weismann, no workers upheld the occurrence of the reduction division except the school at Freiburg and one or two others. There even appeared a paper, presuming to be decisive, entitled "The Facts of Chromosome Reduction *versus* the Postulates of Weismann" (J. E. S. Moore, 1897). Since that time there has been much new research and by the comparative method, perhaps the safest of all methods, and the mass of evidence is now strongly corroborative of Weismann's two cardinal postulates. So to-day Weismann can point to the actual confirmation of the fundamental portion of his germ-plasm theory.

---

*Stated Meeting, February 5, 1904.*

President SMITH in the Chair.

The following papers were read:

"The Babylonian and Hebrew Accounts of the Creation, in the Light of Recent Criticism," by Prof. Morris Jastrow, Jr.

"The Miocene Diabase of the Santa Cruz Mountains in San Mateo County, California," by H. L. Haehl and Ralph Arnold, communicated by Prof. J. C. Branner.





THE MIOCENE DIABASE OF THE SANTA CRUZ MOUNTAINS IN SAN MATEO COUNTY, CALIFORNIA.<sup>1</sup>

BY H. L. HAEHL AND RALPH ARNOLD.

*(Read February 5, 1904.)*INTRODUCTION.<sup>2</sup>

The presence of the basic eruptives in the Santa Cruz Mountains of San Mateo County, California, and portions of Santa Clara and Santa Cruz Counties, was first noted in 1865 by J. D. Whitney. In discussing the geology in the vicinity of Searsville, Whitney says:<sup>3</sup>

“In the bed of the creek (one mile west of the ridge in which the coal mine is situated) were, among the boulders of sandstone, some fragments of syenitic granite and of a basaltic rock, which latter is said to cap a few of the highest points of this ridge.” Whitney's party also passed over the divide from San Mateo to Half-moon Bay, noting the Cretaceous and Miocene strata and the Montara granite exposed along the road, but seem to have overlooked the diabase exposures on the east and south of the granite outcrop.

W. L. Watts in a paper<sup>4</sup> on San Mateo County says: “At some points basaltic rocks have been observed, and on the San Gregorio Rancho the Field Assistant of the Bureau noted and obtained specimens of vesicular dolerite, the vesicles of which were filled with petroleum.”

<sup>1</sup> Published by permission of the Director of the U. S. Geological Survey.

<sup>2</sup> The work of which the results are given in this paper was done while the authors were post-graduate students of geology in Stanford University, under the direction of Dr. J. C. Branner. The authors wish to acknowledge their indebtedness to Dr. Branner for suggestions regarding the field relations, especially of the tuffs and associated rocks, and to Dr. J. P. Smith for suggestions relating to the petrographical work.

The names used in the lists of fossils in this paper are those commonly applied to the respective species by the West Coast paleontologists. Owing to the imperfect state of our knowledge regarding the nomenclature of the California Tertiary fauna, there is a probability that some of the names used are erroneous: the writers, therefore, reserve the privilege of revising any or all of the names if future study shall warrant it.

<sup>3</sup> *Geological Survey of California*, Vol. I, p. 71, 1865.

<sup>4</sup> *Tenth Ann. Rept. Calif. State Mineralogist*, p. 586, 1890.

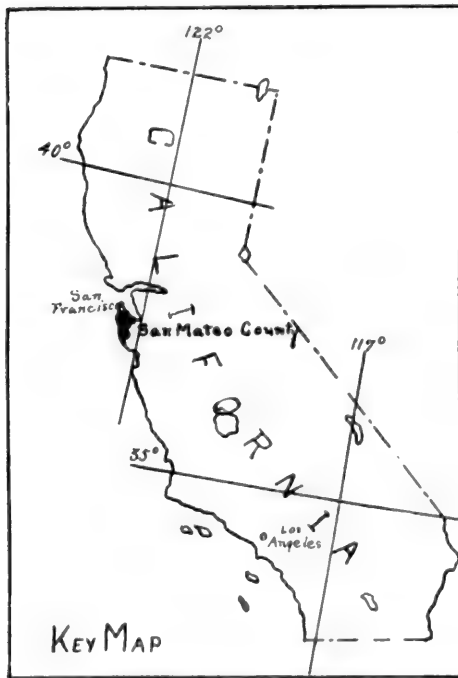

## FIELD RELATIONS.

*General Relations of the Diabase.*

The exposures of the diabase have been traced for a distance of approximately thirty-two miles in a generally southeasterly direction from a point near the San Mateo-Halfmoon Bay road, on Pilarcitos Creek, in San Mateo County, to a point on the headwaters of Lompico Creek, four miles east of the town of Boulder Creek, in Santa Cruz County. There is also a basaltic outflow exposed near Stanford University, which is probably closely related genetically to the diabase. The exposures east and south of those found at the head of Devil's Canyon are not shown on the map, as, with one exception, they are of minor importance. The largest exposed areas of the diabase are in the vicinity of Langley and Mindego Hills east of La Honda, and on the ridges between the headwaters of Pescadero Creek and the San Lorenzo River (the latter being outside of the area shown on the accompanying map).

The whole area presents at the surface a chain of more or less connected patches of diabase, extending approximately parallel to the coast, and also parallel to, but southwest of, the major axis of the Santa Cruz Mountains. The continuity of the patches is hidden by overlying strata and by dislocated masses of country rock and soil to such an extent that the exact relations of the various facies are difficult to ascertain.

It is possible, however, to determine the age of the igneous mass by its relation to the sediments about it. The relations of the stratified rocks of the area under discussion are as follows: <sup>1</sup>

Pliocene	{	Purisima formation with <i>Astrodapsis</i> n. sp., <i>Lucina acutilineata</i> , <i>Nucula castrensis</i> , <i>Pecten</i> 3 n. sp., A, B, and C, <i>Rostellaria undulata</i> and <i>Saxidomus gibbosus</i> .
Miocene	{	Monterey shale with <i>Arca montereyana</i> , <i>Callista angustifrons</i> , <i>Pecten peckhami</i> , and <i>Tellina congesta</i> . Vaquero sandstone with <i>Agasoma barkerianum</i> , <i>A. kernianum</i> , <i>Pecten magnolia</i> , and <i>Turritella hoffmani</i> .

#### *Associated Sedimentary Formations.*

The diabase proper breaks through beds of lower, and perhaps middle, Miocene age; while the associated diabase tuff is interbedded with strata containing a typical lower Miocene fauna and lies below the Monterey shale. The basalt <sup>2</sup> outflow exposed near Stanford University overlies and metamorphoses beds of lower Miocene age, and is overlain by beds containing a fauna very similar to the underlying strata. This evidence indicates the lower Miocene age of the basalt and its probable contemporaneity with the diabase tuffs of Mindego and Langley Hills. Both the intrusive diabase and the tuff are in many places overlain by the Purisima (lower Pliocene) beds, which show a distinct erosion line at their base, and also often a basal conglomerate made up of diabase pebbles.

<sup>1</sup> An uplifted mass of impure stratified limestone, containing a fauna that indicates its probable lower Eocene age, occurs in the diabase area between the headwaters of Pescadero Creek and the San Lorenzo River. This limestone appears to have no visible stratigraphic relations with the Miocene shales surrounding the diabase.

<sup>2</sup> This basalt is the subject of a paper now in course of preparation by Prof. Milnor Roberts, of the University of Washington.

**MIOCENE.**—(1) *The Vaquero Sandstone.* The lower Miocene of the area consists of a series two or three thousand feet thick of massive, coarse, yellowish sandstone layers, interbedded with a few layers of varying thickness of dark-colored argillaceous shale, the whole overlain by three or four hundred feet of thin-bedded siliceous shales. The lower part of this series of beds, including most of the sandstone, appears to have the same fauna and occupy the same stratigraphic position as the Vaquero sandstone of the Salinas Valley.<sup>1</sup> The name "Vaquero" will, therefore, be used to designate the lower Miocene sandstone in the area under discussion. The sandstone and shale series is typically developed in the region between the headwaters of Stevens Creek and the lower portion of Peters Creek. Fig. 1 shows a typical section of this area.

The fauna of the Vaquero sandstone series indicates its lower Miocene age. The following fossils, most of which are characteristic of the lower Miocene, are among others found in the Vaquero sandstone on Mindego Creek, Langley Creek, at the head of Stevens Creek, and at other points in the area under discussion:

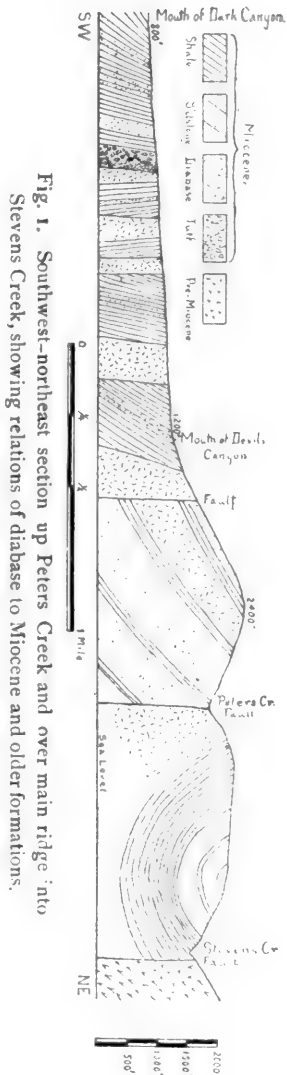

Fig. 1. Southwest-northeast section up Peters Creek and over main ridge into Stevens Creek, showing relations of diabase to Miocene and older formations.

<sup>1</sup> The name for this sandstone was suggested by Mr. Homer Hamlin, and was first used by Dr. Fairbanks in the San Luis folio. This sandstone is typically developed in the Los Vaqueros Valley, near the Salinas Valley, Monterey County.

*List of Vaquero (Lower Miocene) Fossils.*—Those marked with a (\*) are characteristic, so far as known.—

* <i>Agasoma barkerianum</i> Cooper	<i>Lucina richthofeni</i> Gabb
* <i>Agasoma gravida</i> Gabb	<i>Mytilus mathewsonii</i> Gabb
* <i>Agasoma kernianum</i> Cooper	<i>Neverita recluziana</i> Petit
* <i>Arca microdonta</i> Conrad	<i>Ostrea titan</i> Conrad
<i>Balanus estrellanus</i> Conrad	<i>Panopea generosa</i> Gould
* <i>Cardium (Trachycardium) n.</i>	<i>Pecten estrellanus</i> Conrad
sp. A.	* <i>Pecten (Chlamys) n. sp. E.</i>
* <i>Chione mathewsonii</i> Gabb,	* <i>Pecten (Lyropecten) magnolia</i>
<i>Chione n. sp. A. (very large)</i>	Conrad
* <i>Conus n. sp. A.</i>	<i>Pecten (Plagiectenium) n. sp. E.</i>
<i>Crepidula grandis</i> Midd.	* <i>Periploma n. sp. A.</i>
* <i>Cuma buplicata</i> Gabb	<i>Psammobia edentula</i> Gabb
* <i>Dosinia conradi</i> Gabb	* <i>Pyrula (?) sp. A.</i>
<i>Dosinia mathewsonii</i> Gabb	* <i>Pinna alamedensis</i> Yates
* <i>Dosinia cf. montana</i> Conrad	* <i>Sigaretus scopulosus</i> Conrad
<i>Dosinia aff. ponderosa</i> Gray	<i>Solen sicarius</i> Gould
* <i>Galeocerdo productus</i> Agassiz,	* <i>Tivela ineziana</i> Conrad
<i>Galerus cf. excentricus</i> Gabb	* <i>Trochita costellata</i> Conrad
* <i>Glycymeris n. sp. A. (very</i>	* <i>Turritella hoffmani</i> Gabb
large)	* <i>Turritelia ocoyana</i> Conrad
* <i>Lamna clavata</i> Agassiz	* <i>Yoldia n. sp. aff. cooperi</i> Gabb
<i>Lucina acutilineata</i> Conrad	

(2) *The Monterey Shale.* The shales overlying the coarse yellow Vaquero sandstone are in some places thin-bedded, soft and chalky, while in others they are hard, dark colored and somewhat more massive. The white facies of the shale is found overlying the diabase tuff in the region just west of the Langley Hill-Mindego Hill igneous area, while the dark colored facies is found on the northeast slope of the main ridge between the summit and Corte de Madera Creek. These shales represent at least a part of the Monterey series, which is supposed to be of middle Miocene age. The upper part of the Vaquero sandstone series, at least that part showing alternating beds of sandstone and shale with a tendency to grade from the sandstone vertically upward into the shale, may be the inshore equivalent of some of the Monterey shale found at the typical locality in the region around Monterey. This

theory is supported by the fact that, where typically developed, the Monterey shale is between twenty-five hundred and three thousand feet thick and rests on a comparatively thin layer of sandstone, while, in the area under discussion, the relative proportions of shale and sandstone are exactly the reverse. The harder, more flinty shales which appear along the coast are not found in the vicinity of the diabase.



Fig. 2. View on the Searsville-La Honda road three-fourths mile south of summit, looking east, showing the Miocene shale beds resting against the diabase which has intruded them in sill-like dikes. The man points at the contact. Photograph by Ralph Arnold.

The following species of fossils have been found in the Monterey shale within the diabase area :

*List of Fossils from the Monterey Shale (Miocene).*—Those marked (\*) are characteristic, so far as known.—

- |  |   |
|--|---|
| * <i>Arca montereyana</i> Osmond                 | * <i>Leda</i> sp. A. and B.             |
| <i>Callista angustifrons</i> Conrad              | <i>Pecten peckhami</i> Gabb             |
| <i>Chione mathewsonii</i> Gabb                   | <i>Pecten (Plagiocentrum)</i> n. sp. E. |
| * <i>Corbula</i> sp. A.                          | * <i>Semele</i> n. sp. A.               |
| <i>Cylichna</i> cf. <i>petrosa</i> Conrad        | <i>Siliqua</i> sp. A.                   |
| <i>Cythera</i> cf. <i>vespertina</i> Conrad      | * <i>Tellina congesta</i> Conrad        |
| * <i>Diplodonta</i> n. sp. aff. <i>serricata</i> |   |
| Reeve  |   |

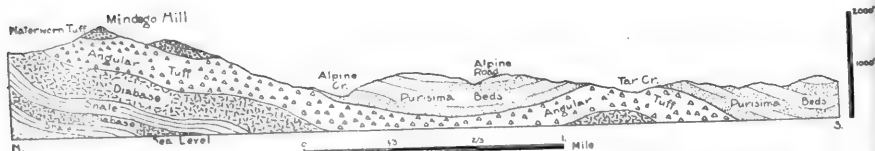

Fig. 3. North-south section from Mindogo Hill to Tar Creek, showing the relation of the diabase tuffs to the overlying Purisima beds.

**PLIOCENE.**—*The Purisima Formation.* Within the area under discussion is an extensive series of conglomerates, fine-grained sandstones and shales for which the writers propose the name "Purisima formation."<sup>1</sup> This name has been chosen because of the typical development of the formation in the vicinity of Purisima Creek, San Mateo County. The Purisima beds lie unconformably upon the Vaquero sandstone and Monterey shale, and at the top grade into beds having a fauna somewhat similar to that of the Merced formation. Its upper limit may be defined as the base of the Merced. In age the Purisima probably represents the lower, and perhaps middle, Pliocene. The individuality of the fauna, stratigraphy and lithology of this formation appears to warrant the application of a new and distinctive name. Fig. 4 shows a typical section of the Purisima formation in the area.

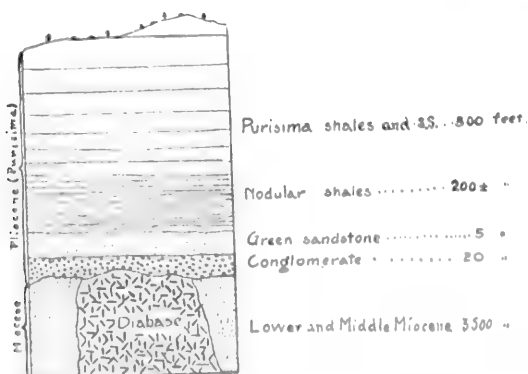

Fig. 4. A typical section in the diabase area.

Stratigraphically the Purisima formation presents a uniform cross

<sup>1</sup> The junior author now has in course of preparation a paper giving in detail the characteristics and faunal relations of this formation.



section throughout nearly the whole diabase area. At its base is the conglomerate, consisting of water-worn diabase pebbles cemented by a more or less siliceous sand. In some places, however, the amount of diabase is so great that it is difficult to distinguish the beds, where badly weathered, from the diabase tuff.

The presence of barnacles (*Balanus*) and of a single specimen of *Pecten* afford the best evidence of the sedimentary nature of the deposit, and fix its origin as marine. The conglomerate is not always of this nature, however. South of the Alpine schoolhouse the base of the Purisima consists of a rather incoherent shale breccia, which had its origin in a talus slope. Part of a *Balanus* was found in this breccia, showing that at least part of the deposit was laid down under water. In places fragments of the Miocene shale, together with hardened sandstone and chert, make up the greater portion of the basal layers, indicating possibly that the Purisima coast line lapped over the intruded area and obtained its materials, not from the diabase area, but from beds to the east of them. The total thickness of the Purisima formation is probably about seven hundred feet. As a rule the conglomerate beds are thin; the thickest of them are about twenty feet in thickness. At some localities, notably at a place a quarter of a mile southwest of the Alpine schoolhouse, the base of the Purisima consists of shale, which rests unconformably upon the diabase.

Above the conglomerate is a thin bed (four or five feet) of soft green sandstone, stained by the chloritic weathering products of the diabase. It contains bones and sharks' teeth and, in some localities, a rich marine invertebrate fauna. Over the green sandstone is a bed of an unfossiliferous, nodular shale of perhaps two hundred feet in thickness.

On the top of the unfossiliferous shale are sandy shales and fine sandstones probably five or six hundred feet thick. While these may readily be distinguished by their lithology, they are also characterized by numerous fossils which are in a fair state of preservation. The following species were gathered from the Purisima beds in different parts of the area under discussion:

*List of Fossils from the Purisima (Pliocene) Formation.*—Those marked with a (\*) are characteristic, so far as known.—

- \* *Arca canalis* Conrad  
*Arca trilineata* Conrad  
\* *Astrodapsis* n. sp. Merriam  
*Astyris richthofeni* Gabb  
*Balanus estrellanus* Conrad  
\* *Buccinum* n. sp. A.  
\* *Calliostoma* n. sp. A.  
*Callista angustifrons* Conrad  
\* *Cancellaria* n. sp. A.  
*Cardium meekianum* Gabb  
\* *Cardium meekianum* n. var. A.  
*Chrysodomus liratus* Martyn  
*Chrysodomus tabulatus* Baird  
\* *Chrysodomus* n. sp. aff. *tabulatus*  
*Crepidula grandis* Midd.  
*Crepidula rugosa* Nuttall  
\* *Cryptomya* n. sp. aff. *californica*  
\* *Dolichotoma* n. sp. aff. *carpenteriana*  
*Drillia incisa* Carpenter  
*Galerus mammillaris* Broderip  
*Glottidia albida* Hinds  
\* *Lævicardium* n. sp. aff. *substriatum*  
*Leda* cf. *fossa* Baird  
*Leda taphria* Dall  
*Lucina acutilineata* Conrad  
*Lunatia lewisii* Gould  
*Macoma inquinata* Deshayes  
*Macoma nasuta* Conrad  
*Maetra californica* Conrad  
*Maetra falcata* Gould  
*Modiolus rectus* Conrad  
*Mytilus mathewsonii* Gabb  
*Nassa californiana* Conrad  
\* *Neptunea humerosa* Gabb  
*Nucula castrensis* Hinds  
*Olivella intorta* Carpenter  
*Olivella pedroana* Conrad  
*Panomya ampla* Dall  
*Panopea generosa* Gould  
*Pecten expansus* Dall  
*Pecten hastatus* Sby. (smooth var.)  
\* *Pecten* n. sp. aff. *expansus*  
\* *Pecten* n. sp. aff. *dilleri* Dall  
\* *Pecten* n. sp. aff. *parmeleci*  
\* *Priene oregonensis* Redfield (n. var. ?)  
*Purpura crispata* Chemnitz  
*Rostellaria indurata* Conrad  
*Saxidomus gibbosus* Gabb  
*Scutella interlineata* Stimpson  
*Siliqua patula* Dixon  
*Solariella peramabilis* Carpenter  
*Tapes staleyi* Gabb  
*Tapes tenerrima* Carpenter  
*Tellina* aff. *congesta* Conrad  
*Tresus nuttalli* Conrad  
\* *Voluta* n. sp.

## RELATION OF THE DIABASE TO THE ASSOCIATED SEDIMENTARIES.

The masses of diabase follow the bedding, particularly in the shale of the lower Miocene series, and it is in between shale beds that most of the diabase exposures occur. Fig. 2 shows some shale beds resting against a large diabase dike which crosses the Searsville-La Honda road near the summit of the Santa Cruz range. The diabase dike in this case was intruded between and followed

the bedding planes of the shale in the form of a sheet. There are some very striking exceptions to the sheet-like occurrences of the diabase, but in general the ready cleavage of the shale along the bedding planes seems to have offered the line of weakness which the intrusive rock followed. Fig. 5 shows a characteristic case of the diabase breaking through the Miocene shales and sandstones. The shale in the middle of the dike in this exposure is slightly darker colored and somewhat harder than the shale beneath the diabase. The sandstone was not affected by the intrusive rock.

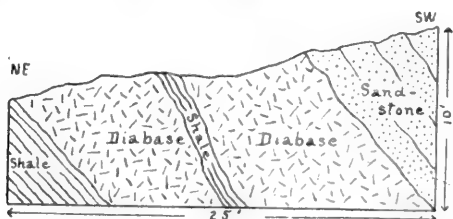

Fig. 5. Vertical section exposed in small ravine on Dornberger's ranch, near the Page Mill road summit, showing diabase intrusive in shale and between shale and sandstone.

Inclusions of sandstone and shale are plentiful and vary from the size of a walnut to masses of hundreds of tons, but no evidence of the alteration of the sandstone has been noted, except in the case of the underlying beds of the basalt near Stanford University. Some well-preserved vertebrate bones and teeth (*Oxyrhina tumula* Agassiz) were found in a sandstone inclusion two feet in diameter about one-half mile north of the Alpine schoolhouse. Fig. 6 shows an inclusion of light yellow sandstone found near the edge of a large diabase dike on the Searsville-La Honda road. Neither the intruded sandstone, which is seen in the upper right-hand corner of the picture, nor the inclusion is in the least altered.

The inclusions of shale are usually somewhat metamorphosed, but the metamorphism is not radical, changes in color and texture being the chief phenomena. An inclusion of shale four inches thick metamorphosed to a hard, brittle flint was found in the diabase on Oil Creek. Similar occurrences were noted at several other localities in the area under discussion. Fig. 7 shows a shale layer which has been slightly hardened by an intrusion of diabase. This is an example of a somewhat common phenomenon.

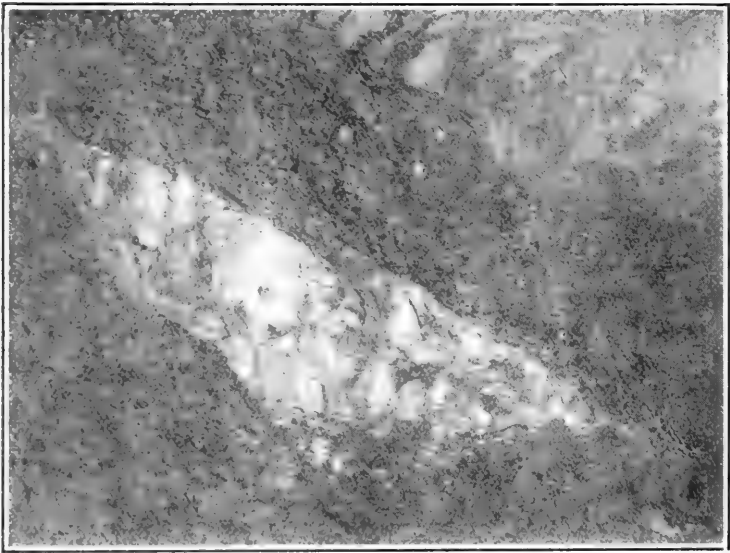

Fig. 6. Inclusion of sandstone in diabase dike seen in vertical cut beside the Searsville-La Honda road three miles north of La Honda. Photograph by Ralph Arnold.

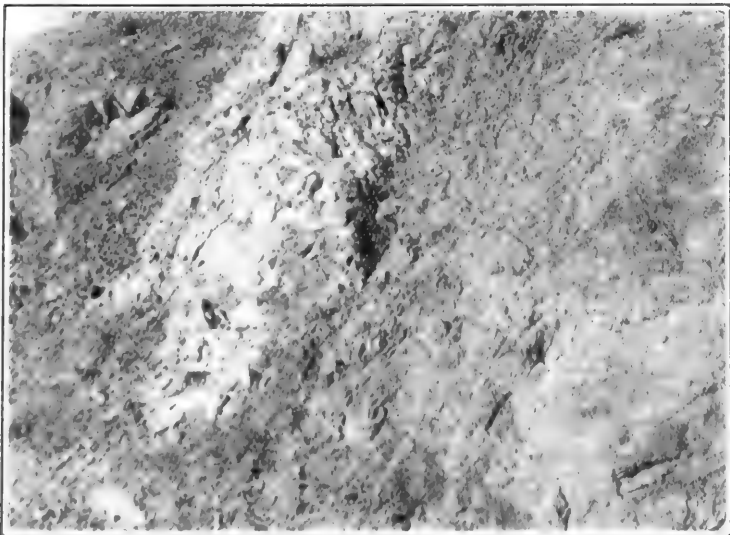

Fig. 7. View on the Page Mill road two hundred yards south of the summit, looking northeast, showing shale layer slightly hardened at the contact with the diabase dike. Photograph by Ralph Arnold.

An interesting section (shown in Fig. 8) is exposed beside an old road one-half mile north of the Langley ranch house. The diabase at that place breaks through the Miocene shales, following the bedding planes in a general way, but sometimes breaking through the beds. Small inclusions of the shale are found in the diabase, but no alteration of either the inclusions or beds thus intruded was noticed.

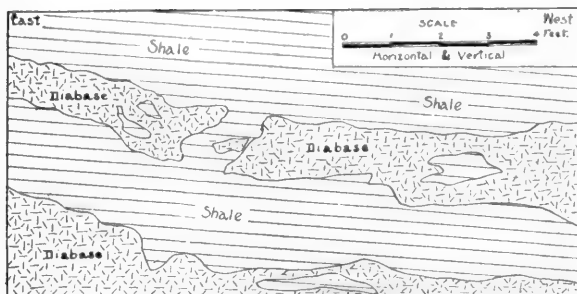

Fig. 8. Vertical section of bank on south side of road one-half mile north of Langley's ranch house, showing diabase intrusion in shale. The shale, which is unaltered, dips into the bank at an angle of  $35^{\circ}$ .

The Purisima beds (Pliocene) which cover large areas of the diabase are not penetrated by the diabase. This may explain the presence of only small, isolated patches of the diabase along the northern end of the area. Either the Miocene or post-Miocene denudation over the northern end of the diabase area must have been great, or else the Monterey shale must be represented by sandstone over that territory, for there, wherever the diabase is exposed, it is in the Vaquero sandstones, while the Monterey shale appears to be almost lacking. Over this tract a deposition of the Purisima sediments took place after the denudation and covered large areas of the eroded surface of the diabase. At the base of the Purisima beds are conglomerates made up largely of diabase pebbles, and these conglomerates are now exposed in the canyons together with small areas of the diabase in place. The presence of the diabase conglomerate at the base of the Purisima formation, together with the fact that the diabase is intrusive in the Miocene, establishes the time of at least the greater part of the igneous intrusions as later than the middle Miocene (Monterey), and before the Pliocene (Purisima). It is noticeable that the exposures of diabase in sev-

eral instances are low down on the south-facing slopes of the ridges next to the creek beds, but are not visible on the north-facing slopes. This seems to be more than a mere coincidence. The difference of exposure on the two sides of the canyon may be due partly to the thick vegetation and partly to the depth of decomposition and the admixture of organic matter in the formation of the soil on the north-facing slopes.

In general the Miocene shales near the diabase dip away from the intrusion as if it were the axis of an anticline. (See Fig. 2.) This may be due to a lifting action of the diabase upon nearly horizontal strata, or possibly to the fact that a pre-existing axis presented the line of weakness along which the intrusion was made. There are instances of sill-like intrusions or sheets between the sedimentary beds of this area. The evidence of oil well records is available in some instances to show the presence of such sheets. At well No. 1, on San Gregorio Creek near the mouth of Harrington Creek, the San Mateo Oil Company put down a test hole, and a sheet of diabase was encountered at a depth of one hundred feet. A hundred feet deeper the drill passed through the diabase and again entered the shale. This well is about a quarter of a mile from the igneous outcrop on Harrington Creek. Mr. Bell, on whose property another well was bored about ten years ago, is authority for the statement that no diabase was encountered in sinking that well, which is about four hundred yards west of San Mateo Oil Company's well No. 1, and away from the diabase.

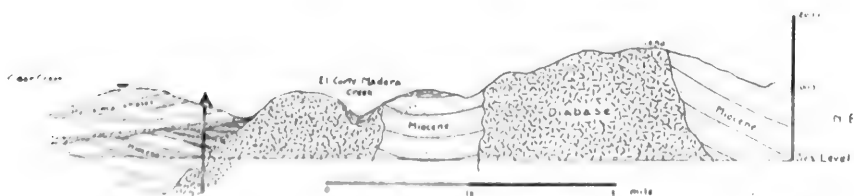

Fig. 9. Northeast-southwest section through the Bella Vista oil well, San Mateo County. Photograph by Ralph Arnold.

The well sunk by the Bella Vista Oil Company on the Bella Vista ranch, north of El Corte Madera Creek, encountered, according to the report of the driller, a fifty-foot stratum of diabase at a depth of four hundred and fifty feet; the drill then passed into shale for another hundred feet, after which it again passed through diabase

for fifty feet and again entered the shale. After passing through a few hundred feet of the shale the well entered the diabase again, and was still in the igneous rock when discontinued. Microscopic slides of the diabase encountered in this well showed it to be very similar to the exposure a quarter of a mile to the east, except that the rock was badly blackened with carbonaceous matter.

### *The Tuff.*

The tuffs associated with the diabase are confined to the Langley Hill-Mindego Hill igneous area, of which they form the major portion. Within this area are also found diabase both of the diabasic and basaltic types, limestone beds, limestone dikes or intrusions, shale and sandstone. It is to be regretted that all of the rocks within this area cannot be differentiated on the map, as their areal distribution would throw much light on the structure of the territory within which they occur. Beds of sandstone containing a typical lower Miocene fauna (given on a previous page) are found between layers of the tuff, while the shales containing *Pecten peckhami*, when associated with the tuffs, are always found above them. This places most of the tuffs in the lower Miocene, with a possibility of their extending into the middle Miocene. Layers of one of the basaltic facies of the diabase are found in such relation to the tuff as would indicate the contemporaneity of the two. This theory is strengthened by the fact that this characteristic basaltic facies, with the exception of the outflow near Stanford University, has been found so far only within the Langley Hill-Mindego Hill igneous area, to which the tuff is confined. The true diabase is later than the basaltic facies and associated tuffs, as it is intrusive both in the tuffs and in shale beds overlying them. The Purisima formation overlies unconformably both the tuffs and their overlying shale beds. (See Fig. 3.)

The tuffs vary in composition from solid masses of basaltic diabase fragments to almost pure limestone, sandstone and shale, depending on the conditions under which they were formed. It is a significant fact that the fragments of igneous rock in the tuff are, in all cases so far noticed, composed of the basaltic facies of the diabase. This is to be expected, as the extrusive forms of the rock would naturally be finer grained than the intrusive ones. The material in which the fragments of igneous rock are imbedded is generally more or less limy, thus showing that the fragments were de-

posited in water at least deep enough to be the habitat of lime-forming organisms. The theory that most of the tuffs were deposited in comparatively deep water is strengthened by the fact that the fragments in most of the beds are angular, which would not be the case had the tuffs been deposited near enough the surface of the water to be affected by the action of the waves.

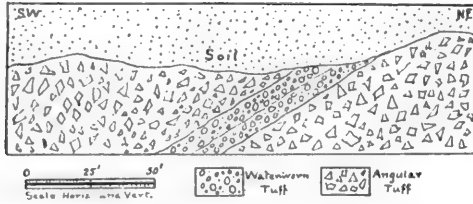

Fig. 10. Section exposed along the Searsville-La Honda road one-fourth mile north of La Honda, showing water-worn tuff interbedded between massive angular tuff.

Fig. 10 shows a section which is exposed along the Searsville-La Honda road a quarter of a mile north of La Honda. Interbedded with the angular tuff is a layer of water-worn tuff about twenty feet thick. The angular tuff appears to have been deposited in the sea in successive layers until it reached near enough the surface of the water to be affected by the wearing action of the waves, when the water-worn layer was formed of the fragmental material. After a time a submergence took place and the top of the deposit was again lowered to such a depth as to be unaffected by the waves, or else the volcanic ejectamenta filled up the shallow sea quite above the water level.

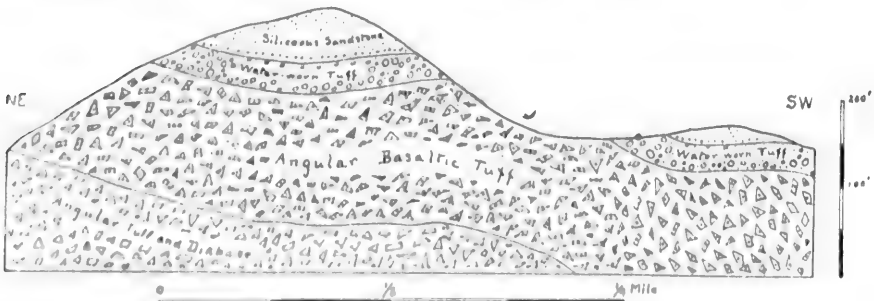

Fig. 11. North-east-southwest section through the top of Mindego Hill, showing the relations of the different tuffs exposed on it.



Another interesting example of the relation between different facies of the tuff is shown in Fig. 11, which represents a section through the top of Mindego Hill. Here the angular tuff is overlain by a water-worn tuff, which in turn grades by easy stages into a siliceous sandstone. The line of demarkation between the angular and water-worn tuffs is very distinct, the former being dark colored and grading into an almost massive basalt below, while the latter is composed of well-worn fragments of light-colored weathered amygdaloidal basaltic diabase. The water-worn layer grades into a tuff, which is composed of fragments of rock replaced by chalcedony, and then into a fossiliferous sandstone in which some of the fossils and much of the rock have been replaced by chalcedony. Chalcedony and quartz veins and chalcedony-lined cavities are common in the beds above the typical water-worn tuff.

A peculiar tuff, composed of water-worn pebbles of the basaltic diabase imbedded in a fine, brown, ash-like matrix, is exposed on the Searsville-La Honda road just south of the mouth of Langley Creek. Where weathered this tuff so much resembles a true diabase containing pebbles of basalt that at first its origin was quite

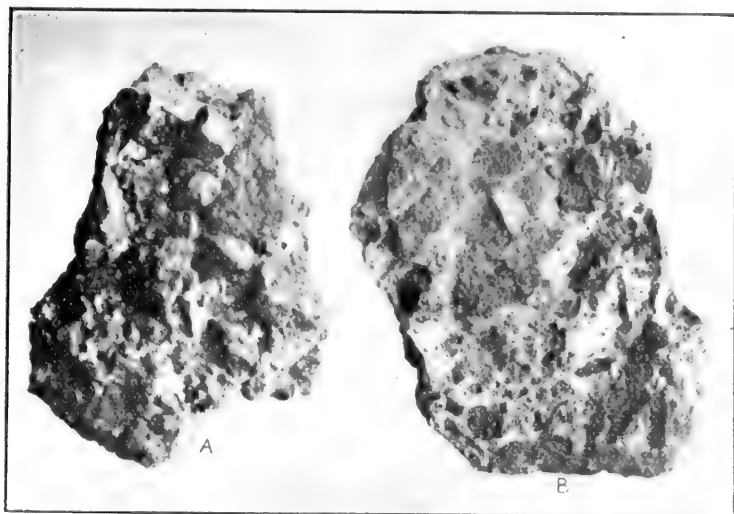

Fig. 12. (a) Showing weathered and (b) fractured surface of the typical 'imy tuff from the hill north of the Langley ranch house. Reduced one-half. Photograph by Ralph Arnold.

puzzling. The layer is interbedded between shale layers and at first was thought to be intrusive in the shale, but a later examination showed its true relation to the shales and its clastic origin.

The typical tuff is found in thick beds all along the southwestern and part of the northeastern side of the Langley Hill-Mindegog Hill igneous area. Fig. 12*a* is a photograph of a hand-specimen showing a weathered surface of the tuff, while 12*b* shows a freshly fractured surface. The fragments composing the tuff are of dark-colored basaltic diabase, angular in outline and varying in size from the smallest grains to large masses weighing several hundred pounds. The slides of these fragments show them to be badly weathered, a few feldspars, a little augite and the magnetite and ilmenite being the only recognizable original constituents. The fragments are imbedded in a limy matrix, varying in composition from pure lime to a limy shale. Spheroidal weathering of the tuffs was noticed in one or two instances. Small organic remains are often found associated with the rock fragments in some of the more limy tuffs. Much, and sometimes all, of the lime occurs in a secondary form, as veins of calcite surrounding the fragments or cutting through the tuff. Pure calcite crystals weighing several ounces are sometimes found in the tuff. This calcite is derived principally from the original lime beds in which the tuff was deposited, but a little

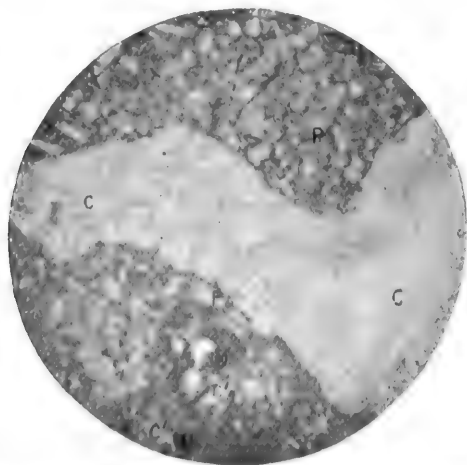

Fig. 13. Thin section of diabase tuff, showing secondary calcite vein, (C); patches of secondary calcite, (C'); feldspar, (F); magnetite, (M).  $\times 20$ . Photograph by Ralph Arnold.

of it may come from a weathering of the feldspars of the basaltic fragments. Patches of isolated calcite are also found in most of the slides of both the basaltic and diabasic rocks. Fig. 13 shows a slide of diabase tuff from the hill east of the Langley ranch house. A secondary calcite vein (C) and small isolated patches of calcite (C') are seen in this slide. Veins of chalcedony and limestone dikes or intrusions are also common in the tuffs.

#### *Limestone Dikes.*

One of the most interesting phenomena met with in a study of the Langley Hill-Mindego Hill igneous area is the occurrence of limestone dikes or intrusions in the tuff beds. The best exposures of these dikes are found in the ridge to the north of the Langley ranch house. Figs. 14 and 15 show transverse and longitudinal sections of this ridge, respectively. Similar dikes occur in the tuff

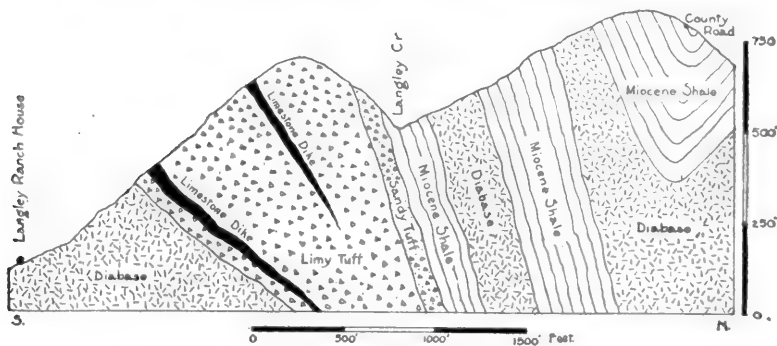

Fig. 14. North-south section through the Langley ranch, showing the stratigraphic relations of the tuffs which contain the limestone dikes.

which makes up the ridge running southeast from the top of Langley Hill, and also in the tuff exposed along the Searsville-La Honda road north of La Honda.

Fig. 15 shows the relative position and size of the principal dikes exposed in the ridge north of the Langley ranch house. These dikes are composed of a more or less pure limestone, in which are generally imbedded fragments of the tuff of varying sizes. The clastic origin of these dikes is shown by their gross structure, their petrographical character and the occurrence of organic remains in nearly all of them. The dikes vary in width from a fraction of an

inch to over thirty feet, and from a few inches to at least one hun-

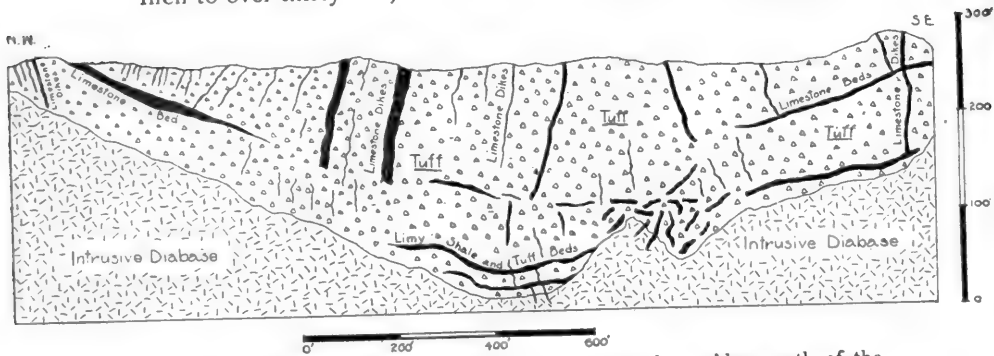

Fig. 15. Northwest-southeast vertical section exposed on ridge north of the Langley ranch house, showing limestone layers interbedded with, and limestone dikes intrusive in, the diabase tuff.

dred and fifty feet in length. Some of them show a kind of flow structure; and a few of them show two systems of joint planes at right angles to each other and both perpendicular to the surfaces

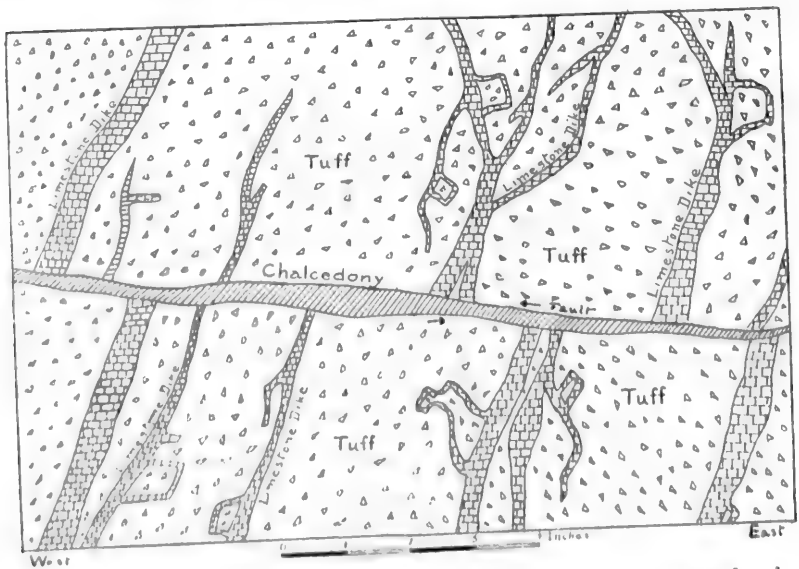

Fig 16. Vertical section showing detail of tuff containing limestone dikes, found on the ridge north of the Langley ranch house. Taken from sketch made in the field.

of the dikes. The surfaces of the dikes are quite irregular, giving a more or less wavy line in section, but the planes of contact of most of the dikes are approximately perpendicular to the bedding planes of the tuff and interbedded limy layers. Some of the dikes extend into the diabase which has intruded the tuff beds. Chalcedony, quartz and calcite form veins and fill cavities all through the tuff, limy tuff beds and the limestone dikes. The minerals deposited from solution are of later origin than the limestone dikes. Fig. 16 shows in detail a small section of the tuff exposed on the side hill north of the Langley house. The chalcedony was deposited along a fault line developed after the intrusion of the limestone into the tuff. Fig. 17 is a photograph taken on the Searsville-La Honda road a quarter of a mile north of La Honda, and shows the tuff cut by limestone dikes and calcite veins.

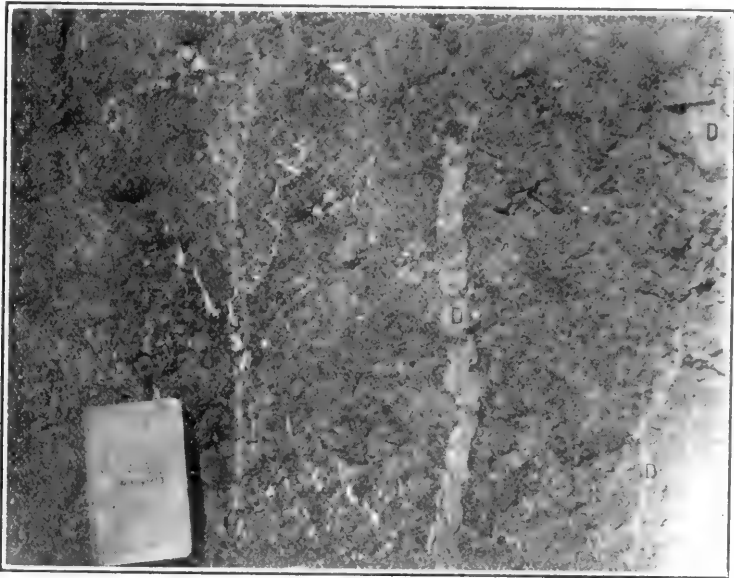

Fig 17. Vertical section along the Searsville-La Honda road one fourth mile north of La Honda, showing limestone dikes (D) and secondary calcite veins (V) in the diabase tuff. Photograph by Ralph Arnold.

The origin of the limestone dikes is easily accounted for when the relations of the containing and associated terranes is consid-

ered. The series of beds in which the dikes occur north of the Langley house have an upward sequence of sandstone, tuff, limy shales, and then alternating thick beds of tuff, comparatively thin beds of limestone and limy tuff, the whole capped by sandy tuff, above which are shale and sandstone beds (see Fig. 14.) Soon after the deposition of this series, and before the tuffs and limestones had become very coherent, diabase was intruded between the lower sandstone layer and the overlying tuffs. The intruded bed fractured the tuff along lines approximately perpendicular to the bedding planes of the series, and the unconsolidated ooze and limy tuff of the interbedded layers flowed into the fissures, thus forming the dikes.

#### *The Diabase.*

Studied in the field the diabase presents two facies. One will be termed the diabasic, the other the basaltic. The distinction is made purely on the physical appearance of the two. No great chemical difference exists, but the crystallization, color, texture and manner of weathering are so radically different that, while no differentiation is attempted on the map, a distinction is necessary in describing the rocks microscopically. Secondary dikes of small proportions were found in the diabasic type, and will be briefly described under that head.

*The diabasic facies.*—The diabasic type seems to be confined to the masses which make the north and east boundaries of the area between the south fork of Tunitas Creek on the north and Langley Hill on the south. In all cases it lies along the crest of the range, making the highest peaks and giving them a peculiar rounded outline that is readily distinguishable at a distance. The rock is well exposed near the summit of the ridge, on the road which crosses the range two and one-half miles south of Sierra Morena. Here the course of the dike is plainly marked by the large rounded boulders on the hillsides. The rocks weather in such a way here as to give particular prominence to the feldspars, thus giving the mass the appearance of a gabbro. The soil derived from its disintegration closely resembles granitic soil. It is made up of granular particles with a slight reddish cast, and varying in size from a diameter of one quarter to one-sixteenth of an inch.

Macroscopically the rock is a medium grained, light gray, crystalline aggregate, in which three components are very readily dis-

tinguishable. One, augite, is present in dark patches intruded by the others, and showing distinct glistening cleavages. Magnetite can be detected in large flat plates and smaller grains, dark and lustrous. Separated with a knife-blade, small portions can be picked up readily with a magnet. The most evident component is the feldspar. It occurs in long white rod-like crystals sometimes as much as two inches in length, giving a reticulated appearance to the mass; it is banded and contains inclusions of magnetite and augite. Fig. 18*b* is a photograph of the typical diabasic facies, being specimen No. 24, the analysis of which is given as I in a following paragraph.

Fresh specimens showing but slight kaolinization are readily obtained. Occasionally a crystal is seen to contain a few clear, glassy spots quite easily distinguishable with a hand lens. They are probably analcite.

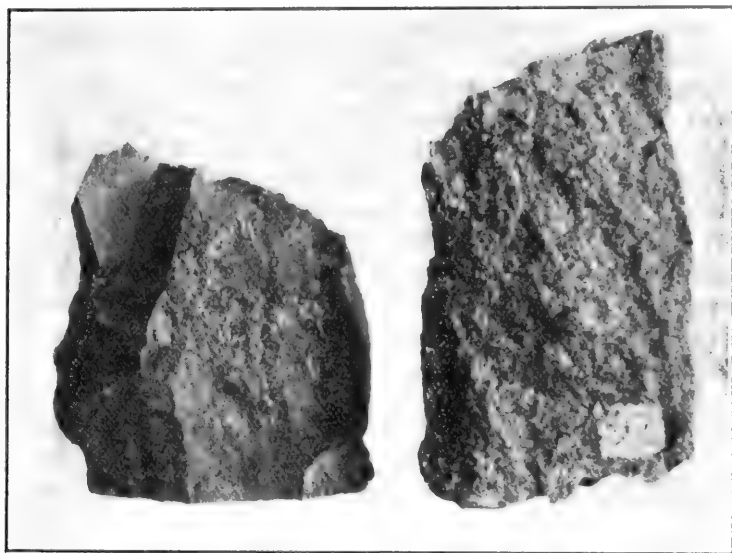

Fig. 18. (a) Showing the basaltic (specimen 38) and (b) true diabasic (specimen 24) facies of the diabase. Reduced one-half. Photograph by Ralph Arnold.

On the stage road from Redwood City to La Honda, at a point on the west side of the summit, about one-half mile from the Summit

House, the road cuts across the contact of the diabase with the lower Miocene sediments in a small canyon, so that a good cross section is exposed (see Fig. 2). The sediments here dip at an angle of sixty degrees south, twenty degrees west, and the diabase, which is of the coarse variety and rather badly weathered, follows the bedding planes. Within the diabase, running exactly parallel to the contact and dipping with the sediments, are a number of coarsely crystalline secondary dikes, varying in width from one inch to six inches and standing out hard and fresh in the darker decomposed diabase. Figure 2 is a photograph of this dike. The secondary dikes may be seen to the left of the man in the figure.

Macroscopically this rock is medium grained, light colored and with a rather mottled appearance, due to the uneven distribution of the more basic constituents. Augite, plagioclase and magnetite are the chief components. The augites are large and tend to segregate in spots, often with a poikilitic structure; the feldspars being included in the augites and giving a mottled appearance to the rock. The feldspars are long and narrow, somewhat kaolinized and show banding. Clear patches of analcite are frequently included in them. Magnetite is very plentiful in long irregular blades which stand out prominently and often reach a length of half an inch.

A few small cavities in the rocks are filled with a mass of rather flexible, fine, acicular crystals matted together indiscriminately. The crystals are usually light colored, although a few are discolored, evidently by weathering products. Such small amounts were obtained that it was impossible to determine them accurately. Before the blowpipe they are infusible and they are not acted upon by acids.

*The basaltic facies.*—It is thought best to treat all the fine-grained dark varieties which make up the remaining portion of the area under the head of basaltic facies. These in turn could be readily separated into at least two general types, differing in the coarseness of their crystallization and weathering products, but such a classification would be tedious and will not be attempted. It is necessary to state, however, that those portions of the area which are made up of smaller dikes are almost universally of a coarser texture than the larger masses and exhibit spheroidal weathering in a very striking way. Figure 19 illustrates a typical example of the spheroidal weathering of the medium grained diabase. The basaltic facies differ from the diabasic facies in that they are dark, show-





Fig. 19. Spheroidal weathering of the diabase exposed beside the Page Mill road, one-half mile east of the summit.  $\times \frac{1}{10}$ . Photo. by R. Arnold.

ing the white feldspars but indistinctly, the predominating crystals being augites and olivines. The finer grained varieties make up the larger masses, such as the tuffs and some of the dikes of the Langley Hill-Mindego Hill igneous area, and are often amygdaloidal, weathering into a compact adobe soil. Amygdaloidal cavities of great size are frequently encountered. One cavity filled with quartz measured four inches along its greatest diameter. Calcite, chalcedony and serpentine fill the cavities in many instances, and on Bogess and Harrington Creeks diabase in place was found with its vesicles filled with petroleum. Perhaps the most interesting occurrence is the presence in many places of nests of glassy analcite crystals, filling the amygdaloidal cavities and joints and seams in the rock. Almost perfect icositetrahedrols were obtained. Qualitative tests showed the presence of Al, Na and  $\text{SiO}_2$ . The mineral is fusible before the blowpipe and soluble in hydrochloric acid, yielding no jelly, however; in this particular agreeing with the observation made by Lawson and Palache<sup>1</sup> on

<sup>1</sup>"The Berkeley Hills," *Bull. Dept. Geol. Univ. Cal.*, Vol. II, p. 418, Berkeley, 1902.

analcite from the andesites in the Berkeley Hills. At several points in the area small irregular aggregates, varying in size from one-tenth to one-half of an inch in diameter, made up of fan-shaped growths of slightly clouded, white crystals, were found in the weathered diabase. When tested before the blowpipe these crystals were found to be natrolite, and a thin section cut from one of the small bodies showed the angular centre area between the natrolite crystals to be filled with analcite (see Fig. 25). Calcite veins of considerable size were found in the mass in some places.

Macroscopically the rock is fine grained and dark. Augite and olivine crystal are readily detected in most specimens, sometimes in crystals large enough to be porphyritic. Plagioclase feldspar and magnetite are also present, and pyrite has been found in a few places. The augite is dark and lustrous and usually quite fresh. The olivine, however, is generally somewhat weathered to serpentine, which often fills the crystal cavity completely and gives the rock a greenish tint. Another weathering product of the olivine was found quite plentifully in thin scales of light brown color. Chemical tests showed the presence of Na, Ca, Fe and Mg. The mineral is hydrous and infusible. Treated with hydrochloric acid, it becomes lighter in color and gives up its iron. These, together with its optical properties, which will be mentioned, make it possible that it is the mineral described by Lawson<sup>1</sup> as iddingsite. The feldspars in this facies are almost universally microlitic. An occasional phenocryst is seen. Magnetite is present in small grains, barely visible to the unaided eye. The basaltic facies usually has a very distinct, coarse, conchoidal fracture. Figure 18*a* is a photograph of specimen No. 38, a piece of the typical basaltic facies, the analysis of which is given as II on a following page.

#### MICROSCOPIC PETROGRAPHY.

The petrographic discussion contained herein is based upon the study of about one hundred and thirty slides, cut from the rocks collected over the diabase area and examined under the microscope. In thin section the eruptive presents two facies. Both are holocrystalline and contain about the same minerals, but the one presents a rather granular structure under the microscope, just as it does in the hand specimen; the other a finely crystalline, aphanitic

<sup>1</sup>"The Geology of Carmelo Bay," *Bull. Dept. Geol. Univ. Cal.*, Vol. I, p. 31.

structure with smaller individuals, yet of nearly the same chemical composition. While no separation of the two has been attempted in mapping in the field, they will be treated under separate heads in dealing with their microscopic character. In describing their field relations the first has been called the diabasic, the latter the basaltic facies. It is not intended that these terms shall be used to designate two distinct series of rocks, but rather in the sense of a convenient classification of two facies of the same magma.

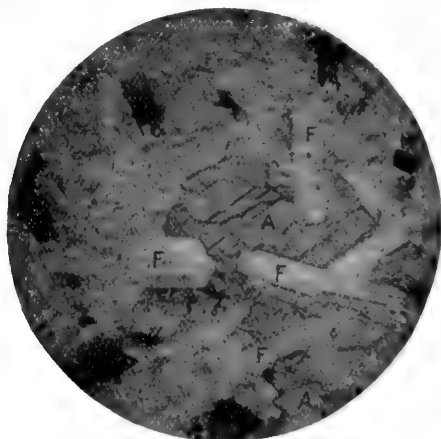

Fig. 20. Thin section of the diabase facies (specimen 24), showing the typical diabase structure. (A), augite; (F), feldspar; (M), magnetite.  $\times 20$ . Photograph by Ralph Arnold.

### *The Diabasic Facies.*

Considering the general tendency of the eruptive to disintegrate, the diabasic type is usually remarkably fresh and clear in thin sections. The slides show the following principal constituents, given in the order of their crystallization: magnetite, ilmenite, apatite, olivine, feldspar, augite and analcite. The last is never present as an original constituent, so far as could be determined, but is certainly in many cases, and probably in all cases, a secondary product. Of the secondary minerals, serpentine, chlorite, iron ores, calcite and natrolite have been noted.

Plagioclase.—The feldspar is generally present in the diabasic facies in rather stout, lath-shaped forms with an average length of two millimeters, twinned according to the Albite and Carlsbad laws



Fig. 21. Twinned crystal of labradorite, showing cleavage.  $\times 60$ .

(see Fig. 21). Of the two, the Albite twinning predominates and is usually polysynthetic, and occasionally combined with the Pericline. Crystals cut parallel to the composition plane and showing tabular forms are not infrequent, and in many cases show zonal structure and wavy extinction, indicating a centre more basic than the periphery. Extinction angles were carefully taken and indicate plagioclases of about the order of labradorite with a formula of mixture about  $Ab_3An_4$ .

Decomposition of the feldspars has gone on to a great extent in portions of the mass. Comparatively fresh sections are obtainable, however, in places. Kaolinization is very common in all sections. The most characteristic alteration, however, seems to be that which results in the formation of analcite within the feldspar. Nor does it seem that any one law of decomposition applies to all the cases seen. In one instance a mere patch of an isotropic, clear glassy mineral is found in the centre of a plagioclase. In another the crystal form of the feldspar appears to be filled with the product, except, perhaps, a small fresh patch of the original mineral left in the centre, in just such a position as the analcite held in the first case cited. Occasionally the whole crystal is replaced by the analcite. In the slides examined there seems to be much evidence that the analcite is an alteration product (in these instances) of the feldspars themselves. The problem of the percentage of soda required for the

formation of analcite will be discussed under the head of "Chemical Characters."

Lenses of high powers reveal the presence in the feldspars of many dust-like particles, the nature of which is unknown. Usually they are without definite arrangement. Inclusions of gas bubbles, patches of augite, magnetite, and also serpentine and chlorite are noted.

*Augite.*—Augite is very plentiful in the diabasic facies of the rock, and is usually allotriomorphic with respect to the feldspars. It is of a pale brown color with a tinge of red, probably due to a small percentage of titanium—a supposition which the rock analysis appears to verify. Its pleochroism is faint, changing the shade and not the color. Extinction angles as high as  $53^\circ$  were noted, and zoned crystals with undulatory extinction were occasionally seen. Twinning is not uncommon. Cleavage cracks are very distinct, and the intersecting cleavage lines parallel to the prism of  $87^\circ 6'$  are frequently observed. The augite is remarkably fresh and clear in this rock, having withstood the effects of weathering better than the feldspars. Smaller crystals of augite, occasionally included in the larger phenocrysts, are often almost entirely decomposed into what appears to be a yellowish-brown chlorite, the coloration being due to the iron ores present. Frequent irregular patches of gas and fluid inclusions occur in the phenocrysts, sometimes long and rope-like, and often clustered around smaller included grains of augite. Irregular inclusions of feldspar are often found and are generally much kaolinized. Magnetite and its decomposition products are also present in the phenocrysts.

*Olivine.*—Olivine is not abundant in the slides of the diabasic facies. It would have been possible, however, to so choose the sections as to show considerable of this mineral, as its occurrence seems to be in occasional local patches and segregations. It is present, however, in very small quantity in the typical slides, usually in minute clear patches, making up the centre of a mass of brownish decomposition material, badly discolored by iron and showing no characteristic optical properties. Its crystal form, where disintegration is complete, suggests its origin from olivine. In rare instances, too, this secondary decomposition mass assumes a fibrous structure, strong pleochroism and strong double refraction with bright red and green polarization colors, suggesting iddingsite.<sup>1</sup>

<sup>1</sup> "The Berkeley Hills," by A. C. Lawson and Chas. Palache, *Bull. Dept. Geol. Univ. Cal.*, Vol. II, No. 12, p. 430, Berkeley, 1902.

*Other Minerals.*—Magnetite and some ilmenite are present in the diabase as grains and irregular masses. Grouping is occasionally seen, but for the most part both of these minerals are scattered through the mass without definite position.

Apatite is sparingly present in its usual characteristic clear, long, slender prisms, included by the other constituents.

Of the secondary products analcite is by far the most important. It occurs chiefly in the feldspars in the diabasic facies. In no instance could it be shown that it is other than a secondary product, nor does it indicate an origin other than of an alteration product of the feldspars. Treated with hydrochloric acid it is soluble, but forms no jelly.



Fig. 22. Section of secondary dike. (A), analcite; (P), augite; (F), feldspar.  $\times 30$ .

*The Secondary Dikes.*—In thin sections the rocks of the secondary dikes contain apatite, magnetite, augite, sphene, feldspar, pyrite, analcite and natrolites (see Fig. 22). The sections are particularly clear and fresh.

The feldspars are plagioclases with the composition of labradorite. They are broadly lath-shaped and show Albite twinning. Wavy extinction with a basic interior and more acid periphery is common

Kaolinization is somewhat advanced; dust-like inclusions, together with augite and magnetite, are frequent.

The augites are of the pale purplish-brown variety with slight pleochroism. They make up an unusually small percentage of the rock, however. Basal sections show wavy extinction. Both idiomorphic and allotriomorphic crystals are present. Cleavage is distinct and relief high. Inclusions of feldspar and magnetite are numerous and decomposition very slight.

Magnetite is present in unusual quantities and in very striking, long, slender rods, as well as in its common tabular forms. A few crystals of pyrite were noted, also a wedge-shaped crystal of sphene.

Analcite and natrolite are present in these sections in greater quantity than in those of any other portion of the mass.

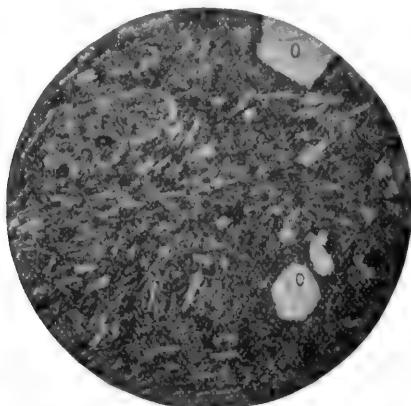

Fig. 23. Section of the basaltic facies (specimen 38), showing basaltic and flow structure. (O), olivine; (O'), olivine weathering to iddingsite; (F), feldspar crystal with etched edges; (A), augite.  $\times 20$ . Photograph by Ralph Arnold.

### *The Basaltic Facies.*

In thin section the basaltic facies of the igneous mass presents a more difficult problem than the diabasic type, because it is universally more weathered. The typical section shows a few phenocrysts of olivine and augite in a fine-grained ground mass of lath-shaped feldspars, microscopic augites and olivines, ilmenite, magnetite, and the secondary products—calcite, serpentine, chlorite, iddingsite, iron oxides, natrolite and analcite.

*Feldspar.*—The feldspars are in two general forms—typical lath-shaped crystals and broader tabular plates with wavy extinction or zonal structure and, usually, an abundance of inclusions. The lath-shaped crystals predominate. As far as it was possible to determine them, both seem to be of the order of labradorite and exhibit the same extinction angles that were characteristic of the plagioclases of the diabasic type. Individual crystals are seldom over one millimetre in length. Twinning is usually polysynthetic according to the Albite law, although Carlsbad twins are frequently noted. Flow structure is often beautifully shown by the arrangements of the lath-shaped microlites in regular courses between the larger crystals of augite or olivine (see Fig. 23). Not infrequently the ophitic structure of the typical diabase is seen, the feldspars radiating, in all cases noted, around the larger crystals of olivine. This is particularly true of the slides cut from the rocks of the narrow dikes. In numerous cases, especially in sections showing flow structure, feldspars are bent and broken and displaced. In many slides the ground mass is badly decomposed and shows practically no optical phenomena, except such as is shown by the feldspar microlites which, in these sections, are so badly etched along the crystallographic outlines that they present rough, saw-like edges (see F, Fig. 23). Feldspars differing from the general type are occasionally found in the slides. Slides from one exposure show feldspars which at first glance might be mistaken for orthoclases, so clear and regular are they and free from banding or twinning. Inclusions are numerous, however, and a closer examination of their optical properties leaves little doubt that they belong to the plagioclases. There is an unusual amount of analcite in these slides, which suggests very strongly that the feldspars may contain a larger percentage of soda. Again some sections show feldspars, the order of whose interference colors borders closely on nepheline, and one slide shows a number of crystals whose optical properties would tend to class them as melilites. In view of these resemblances, tests were made upon the thin sections to determine physically whether the optical properties were true indicators. The results, however, left no doubt that the crystals were simply feldspar. Crystals were also found in these slides, portions of which gave the normal optical phenomena of the feldspars common to the rock. Low order interference colors are frequently met with in the more weathered slides, but in no case could nepheline be positively detected.



The matter of the presence or absence of the nepheline was made the object of particularly careful search, as its presence, if established, would materially assist in accounting for the soda necessary to the formation of analcite, as has been observed by Fairbanks in dealing with a very similar rock in San Luis Obispo County.<sup>1</sup> As shown above, however, it is very doubtful whether any nepheline occurs in either facies of the diabase of the area here under discussion.

*Pyroxene.*—The pyroxenic constituent is usually augite, but enstatite is occasionally noted. The augite occurs, in general, in two ages—a more or less porphyritic series which are occasionally idiomorphic and frequently absent entirely in the slides, and a series of small allotriomorphic grains filling the interstices between the feldspars and olivines of the ground mass. Augites of this latter type are seldom over five-hundredths of one millimetre in diameter, and seem to be identical in composition and optical phenomena with the porphyritic type. No grouping of either type could be detected, the only instance of a perceptible order of arrangement being found in the slides from one small area on Harrington Creek, where porphyritic augites with distinct micropoikilitic structure were observed. The included crystals were particularly fresh plagioclases, which made up about fifty per cent. of the cross section of the pyroxene host. The phenocrysts seldom attained a large size in this facies and were usually broken by mechanical strains or rounded and etched by chemical action. However, elongated crystals with approximately idiomorphic outlines were not uncommon. The augite is of the same pale brown to pinkish tint noted in the diabasic facies. Like it, too, it is but slightly pleochroic, except for some few scattered individuals whose pleochroism is somewhat marked. Polarization colors are very brilliant. Twinning according to the augite law is not uncommon. Only simple twins were noted. Inclusions of glass, gas bubbles and magnetite were noted in the porphyritic crystals.

Enstatite is found in a few instances in irregular plates showing low interference colors. The crystals were in no case large, two-tenths of one millimetre being the greatest diameter measured. The surfaces of the crystals were distinctly pitted, but no distinct

<sup>1</sup>"Analcite Diabase," by H. W. Fairbanks, *Bull. Dept. Geol. Univ. Cal.*, Vol. I, pp. 273-300, Berkeley, 1895.

cleavage was observed. Irregular patches of the enstatite were found included in the feldspars.

On the whole the pyroxenes are remarkably fresh. Many slides show absolutely no decomposition products even where the feldspars are badly weathered. In a few instances slight chloritization was noted, that being practically the only indication of decomposition.

*Olivine.*—The olivine, like the augite, is present in two generations, porphyritic and microlitic. The porphyritic crystals are usually idiomorphic and are among the oldest segregations of the magma. They are usually much fractured and jointed, and rounded or embayed by the corrosive action of the magma. Usually disintegration has gone on to such an extent that only the crystal form remains, filled with the secondary products. Where the original olivine remains it is clear and colorless, with strong double refraction and high relief. It usually includes much magnetite in small grains, some glass and dust particles.

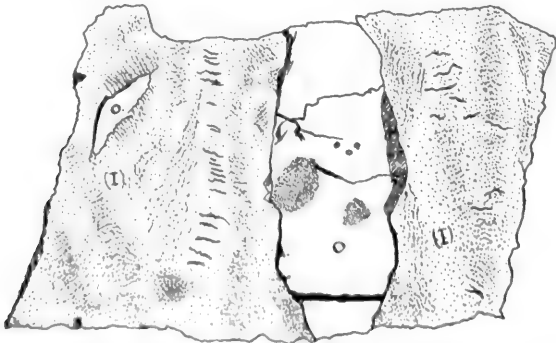

Fig. 24. Phenocryst of olivine (O) weathering to iddingsite (I).  $\times 60$ .

The most common product of decomposition is serpentine, which frequently shows its fibrous character. Alteration begins along the cracks, gradually working inward from them until the crystal is divided into a number of irregular rounded patches of clear olivine separated by fibrous serpentine, the whole making up the complete form of the original crystal. Perhaps fifty per cent. of the phenocrysts studied were completely replaced in this way, the remainder showing various stages of such decomposition or alteration in like manner to the mineral, which is probably iddingsite (see Fig. 24

and  $O^1$ , Fig. 23). It shows high polarization colors and is strongly pleochroic in the green shades, the greatest absorption being parallel to the fibres. It agrees strongly with the mineral described by Iddings<sup>1</sup> from Nevada and afterwards named iddingsite by Lawson. A small amount of chlorite was noted. Calcite is quite abundant in the more weathered portions of the rock. It is usually found filling seams, joints and amygdular cavities.



Fig. 25. Natrolite (N) and analcite (A) between crossed nicols.  $\times 30$ .

*Analcite*.—The most striking product of decomposition is analcite. Its occurrence in the field has been described. In certain areas it is quite plentiful. In thin section it is often found associated with natrolite, fibrous aggregates of which it frequently includes (see Fig. 25). It is isotropic, occasionally showing optical anomalies. It has been observed to occur in five general ways: 1. In irregular patches in the centre of crystals of plagioclase. 2. In a form suggesting a decomposition product of the plagioclases, advancing in irregular lines from the crystal edges inward. 3. Completely filling what seems to have been the rectangular outline of a plagioclase crystal. 4. In irregular patches filling the angular

<sup>1</sup> "Geology of the Eureka District, Nevada," by Arnold Hague, Mon. XX, U. S. G. S., Appendix B, pp. 388-390, Washington, 1892.

spaces between crystals of feldspar. 5. In large irregular patches sometimes two and a half millimetres in diameter, filled with a confusion of microlites of some indeterminable mineral.

#### CHEMICAL CHARACTERS AND ANALYSES.

The writers are indebted to the United States Geological Survey for the analyses (I and II) of the two typical facies. For the purpose of comparison and discussion there have been added analyses of the analcite from Cuyamas<sup>1</sup> (III), the teschenite diabase (IV), plagioclase feldspar (VI) and analcite (VII) from Point Sal,<sup>2</sup> and a typical analysis of labradorite from Dana (V).<sup>3</sup>

	I.	II.	III.	IV.	V.	VI.	VII.
SiO <sub>2</sub> .....	50.12	49.60	50.55	49.61	56.0	52.72	54.40
Al <sub>2</sub> O <sub>3</sub> .....	18.52	16.56	20.48	19.18	27.5	30.46	23.04
Fe <sub>2</sub> O <sub>3</sub> .....	2.47	4.28	2.66	2.12	0.7		
FeO .....	4.11	4.44	4.02	5.01			
MgO .....	2.68	5.38	4.24	4.94	0.1		
CaO .....	8.99	9.22	7.30	10.05	10.1	11.01	0.21
Na <sub>2</sub> O .....	5.22	3.31	8.37	5.62	5.0	3.70	13.33
K <sub>2</sub> O .....	1.46	1.25	2.27	1.04	0.4	0.42	0.19
H <sub>2</sub> O .....	1.64	1.44					
H <sub>2</sub> O .....	3.09	2.58	0.44	Ig 3.55		1.44	8.46
TiO <sub>2</sub> .....	1.33	1.86					
P <sub>2</sub> O <sub>5</sub> .....	0.18	0.30		0.27			
So <sub>3</sub> .....	0.08	0.17		tr.			
Cr <sub>2</sub> O <sub>3</sub> .....	tr.	0.03					
NiO .....	none	none					
MnO .....	tr.	0.08					
BaO .....	0.02	0.06					
	99.91	100.55	100.33	101.39	99.8	99.75	99.63
Sp. Gr. ....	2.732	2.825		2.782			

(I) Diabase (typical diabasic facies), from one mile north of Bella Vista ranch houses, San Mateo County, California. Specimen No. 24. E. T. Allen, Analyst. (U. S. Geological Survey.)

(II) Diabase (typical basaltic facies), from Mindego Hill, San

<sup>1</sup> "Analcite Diabase," by H. W. Fairbanks, *Bull. Dept. Geol. Univ. Cal.*, Vol. I, p. 293, Berkeley, 1895.

<sup>2</sup> "The Geology of Point Sal," by H. W. Fairbanks, *Bull. Dept. Geol. Univ. Cal.*, Vol. II, pp. 1-92, Berkeley, 1896.

<sup>3</sup> *System of Mineralogy*, by J. D. Dana. Sixth edition.

Mateo County, California. E. T. Allen, Analyst. (U. S. Geological Survey.)

(III) Analcite diabase from Cuyamas, San Luis Obispo County, California. V. Lenher, Analyst. (Fairbanks.)

(IV) Augite-teschenite from Point Sal. Santa Barbara County, California. (Fairbanks.)

(V) Labradorite, typical analysis, Dana, System of Mineralogy, Sixth Edition, p. 337.

(VI) Feldspar from Augite-teschenite, Point Sal, Santa Barbara County, California. (Fairbanks.)

(VII) Analcite from Augite-teschenite, Point Sal, Santa Barbara County, California. (Fairbanks.)

The close relation between the two facies, as far as chemical composition is concerned, is very evident. A striking similarity exists also between them and the two analyses of very similar rocks from San Luis Obispo County, described by Fairbanks as analcite diabase and augite-teschenite. Hand specimens and a few slides of these latter rocks which were studied for comparison tend to emphasize this similarity, and to make it reasonably certain that the rocks are very closely related in all their properties. In that connection it seems that the evidence gathered by Fairbanks,<sup>1</sup> in dealing with the probable origin of the analcite in rocks which are of this same type, is particularly applicable here. Fairbanks' analyses both show a slightly greater percentage of soda. Optically his feldspars agree with those encountered here. Chemically they are very like the typical labradorite of Dana (V). Nothing new beyond the data given by Dr. Fairbanks in his discussions was discovered in the examination of the rocks herein described. The conclusions reached by that author, however, are but vaguely substantiated. The presence of nepheline, at some time in the history of the diabase, has not been proven. Aside from the fact that analcite is present, and that the soda necessary to permit of its formation could not have come from a concentration of that element from the feldspars alone, to the extent that the entire rock should show a percentage of soda equal to that of labradorite, there is nothing to suggest the presence of nepheline at any time. The presence of the analcite chiefly within the feldspars themselves would point

<sup>1</sup> "Geology of Point Sal," *Bull. Dept. Geol. Univ. Cal.*, Vol. II, p. 30; and "Analcite Diabase," *Bull. Dept. Geol. Univ. Cal.*, Vol. I, p. 293, Berkeley, 1896.

to its origin as a product of their partial disintegration; while its presence filling angular cavities between crystals of feldspar would indicate that it might have replaced whatever mineral originally filled that area, for it is hardly possible to conceive of that area being left vacant after the magma had cooled and crystallized. Yet, were it conceded that nepheline did occupy these areas, it would still be impossible to believe that it could furnish enough soda for the patches included in the feldspars. This problem remains unsolved.

Titanium is present in some quantity, as shown by the analyses of the rocks discussed in this paper. None, however, is listed from those studied by Fairbanks. It is possible that no determination of that element was attempted by him. The presence of such an amount of titanium, however, suggests that the augite, which is of the pinkish variety both in this occurrence and in those described by Fairbanks, carries some titanium. Ilmenite, which is sparingly present, probably accounts for the remainder.

#### SUMMARY AND CONCLUSION.

Within an area of about three hundred square miles, most of which is shown on the accompanying map, there are exposed about thirty-five square miles of diabase in the form of tuffs, dikes and intrusive sheets. The tuffs are interbedded with lower Miocene strata and overlain by probable middle Miocene shales. The basaltic facies of the diabase is partly contemporaneous with the tuffs and partly of later origin, while the diabase facies is intruded into the tuffs and middle Miocene beds. The igneous rocks under discussion are therefore of lower and middle Miocene ages.

The tuffs are composed of fragments of the basaltic facies, generally angular, but sometimes water-worn. The tuffs are interbedded with limestones, sandstones and shales. Intrusions of limestone derived from the interbedded limy layers have been forced into fissures in the tuff.

Petrographically the diabase is of two general types. One is a light colored, granular rock which is found along the crest of the range north of Langley Hill. The other is a darker, fine grained, basaltic type with occasional phenocrysts of olivine and augite; the latter type makes up the remaining area.

The rock is uniform in its chemical composition, which approxi-

mates that of the typical diabase. The percentages of soda and titanium are large. The former is probably due to the amount of analcite present, and the latter to the character of the augite.

The rocks are closely allied in character and age to those described by Fairbanks from San Luis Obispo and Santa Barbara Counties under the name of augite-teschenite. While analcite is present in considerable quantity and is one of the most interesting features of the rocks, it is also found in basic rocks in several instances on the Pacific Coast, and its presence, taken in connection with other properties of the rock, is not regarded as sufficient to warrant the substitution of the name augite-teschenite for that of diabase. That name has, therefore, not been retained by the writers.

---

*Stated Meeting, February 19, 1904.*

President SMITH in the Chair.

An invitation was received from the University of Wisconsin to send a representative to the Jubilee of the University, to be held at Madison, commencing June 5, 1904, and the President was, on motion, directed to appoint a delegate.

The donations to the Library were laid on the table and thanks were ordered for them.

The following papers were read:

"Present Aspects and Future Prospects of Forestry in Pennsylvania," by Prof. Joseph T. Rothrock. Discussed by Prof. Haupt, Mr. Stuart Wood, Mr. Richard Wood, Dr. Marshall and Mr. Goodwin.

"Views of Old Philadelphia," by Mr. Julius F. Sachse. Discussed by Mr. Goodwin, Mr. Stuart Wood, Mr. Harrison and Mr. Richard Wood.

"A Method of Controlling the Floods of the Mississippi River," by Prof. Lewis M. Haupt. (See page 71.)

*Stated Meeting, March 4, 1904.*

President SMITH in the Chair.

A communication was received from the Committee of Organization of the Fourteenth Congrès Internationale des Orientalistes, announcing that the Congress will be held in Algiers, in Easter week in 1905, and inviting the Society to send delegates. On motion, the President was authorized to appoint delegates.

A list of donations to the Library was laid on the table and thanks were ordered for them.

The following papers were read:

“Literary Remuneration in the Eighteenth and Nineteenth Centuries,” by Prof. Albert H. Smyth.

“Uranium Minerals and their Photographic Action,” by Prof. George F. Barker.

“The Native Tribes of Victoria: Their Languages and Customs,” by R. H. Mathews.

---

## THE NATIVE TRIBES OF VICTORIA: THEIR LANGUAGES AND CUSTOMS.

BY R. H. MATHEWS, L.S.

(*Read March 4, 1904.*)

**SYNOPSIS.**—Prefatory. Orthography. Dhauhurtwürru Language and Vocabulary. Initiation Ceremonies. Folklore. Sociology.

The object of the present short paper is to supply some missing links in the literature of the aborigines of Victoria. For a number of years past I have devoted a portion of the leisure of a busy professional man to taking special journeys among the remnants of the Victorian tribes, for the purpose of adding to our knowledge of their languages, ceremonies, sociology and customs generally. When first entering upon this congenial task I found that little or



nothing had been done to record and preserve the native languages of Victoria, and also that the rites and customs of the people had not received the attention which their importance deserved.

Perhaps it should be mentioned that in 1898 I contributed to the Anthropological Society at Washington a paper dealing with the initiation ceremonies and divisional systems of the Victorian aborigines.<sup>1</sup> In 1902 I read another paper on the aboriginal languages of Victoria before the Royal Society of New South Wales.<sup>2</sup> On the present occasion it is intended to supply further information not included in my former memoirs. The whole of this article has been prepared by me from notes written down by myself from the lips of the aboriginal speakers. When the difficulties encountered in obtaining such particulars from an uncultivated race are taken into consideration, I feel sure that all necessary allowances will be made for any imperfections of my work.

In all the aboriginal languages of Victoria the pronouns and pronominal affixes have two forms in the first person of the dual and plural—one of which includes, and the other excludes, the party spoken to. Again, inflection for person and number is not confined to the pronouns and verbs, but extends to many of the nouns, prepositions, adverbs and interjections. I was the first author to report, in any of the Australian languages, the important grammatical forms referred to in this paragraph.<sup>3</sup>

The items of folklore show the proclivity of the native mind to account for any specialties of animal structure, or remarkable formations in hills, trees, lakes and the like. Under the head of "Sociology," although the names of the phratries have been known for some time, yet many new and important details have been gathered and reported in this article.

The natives of the southwestern portion of Victoria have a habit of distinguishing the neighboring tribes by means of the second personal pronoun, "thou," of their respective dialects. For example, the Dhauhurtwürru are known as the *Ngutuk* people, the Būngandity as the *Nguro* people, and so on. A more widely prevalent practice is to name the dialect of a tribe by the lip, which is symbolical of speech. For this purpose they suffix to the name of the tribe the native word, würru, lip; or its possessive form, würrung,

<sup>1</sup>*American Anthropologist*, Vol. xi, pp. 325-343, with map of Victoria.

<sup>2</sup>*Journ. Roy. Soc. N. S. Wales*, Vol. xxxvi, pp. 71-106.

<sup>3</sup>*Ibid.*, Vol. xxxv, p. 127.

lip of (someone). In other districts the equivalent of our negative adverb, "No," is used, with the suffix *würru*, as, Woi-würru, meaning the No-lip, or Woi-speaking, people.

#### ORTHOGRAPHY.

Eighteen letters of the English alphabet are sounded, comprising thirteen consonants—b, d, g, h, k, l, m, n, p, r, t, w, y—and five vowels—a, e, i, o, u.

The system of orthoepy adopted is that recommended by the Royal Geographical Society, London, but a few additional rules of spelling have been introduced by me, to meet the requirements of the Australian pronunciation.

As far as possible, vowels are unmarked, but in some instances the long sound of *a*, *e*, *o* and *u* are indicated thus, *ā*, *ē*, *ō*, *ū*. In a few cases, to prevent ambiguity, the short sound of *u* has been marked thus, *ū*.

It is frequently difficult to distinguish between the short sound of *a* and that of *u*. A thick sound of *i* is occasionally met with, which closely resembles the short sound of *u* or *a*.

*G* is hard in all cases. *W* always commences a syllable or word.

*Ng* at the beginning of a word or syllable has a peculiar nasal sound, which can be obtained by adding together the two English words "hang up," making "hangup"; then assume this divided into two syllables, thus, "ha-ngup." By pronouncing this so that the two syllables melt into each other, the *ng* of "-ngup" will represent the aboriginal sound. At the end of a syllable, *ng* has the sound of *ng* in "sing."

At the beginning of a word or syllable, the sound of the Spanish *fi* is given by *ny*, but when terminating a word, the Spanish letter is used.

*Dh* is pronounced nearly as *th* in "that," with a slight sound of *d* preceding it. *Nh* has also nearly the sound of *th* in "that," but with an initial sound of the *n*.

A final *h* is guttural, resembling *ch* in the German word *joch*.

*T* is interchangeable with *d*, *p* with *b*, and *g* with *k*.

*Ty* and *dy* at the commencement of a word or syllable have nearly the sound of *j* or *ch*, thus, *tyu*, in the name of Tyu-ron, closely resembles *chu* or *ju*. But at the end of a word or syllable *ty* or *dy* is sounded as one letter; thus, *raty*, the last syllable of

barraty, can be pronounced exactly by assuming *e* to be added to the *y*, making it rat-ye. Then commence articulating the word, including the *y*, but stopping short without sounding the added *e*.

#### THE DHAUHURTWÜRRU GRAMMAR.

The Dhauhurtwürru language is spoken in the country about Portland and Lake Condah, in the State of Victoria, but it is representative of the native speech from the Glenelg to the Gellibrand river, and reaching inland about fifty miles or more.

#### ARTICLES.

The place of the English article is supplied by the various forms of the demonstratives, representing "this" and "that."

#### NOUNS.

Nouns have number, gender and case.

*Number.*—Mär, a man. Mārara, a couple of men. Māraban, several men.

*Gender.*—Sex in the human family is distinguished by different words, as, mär, a man; dhunnumbur, a woman. Wurren, a boy; barraty, a girl.

Among animals gender is denoted by the addition of words signifying "male" and "female," as, warrun mamung, a male bandicoot; warrun ngerang, a female bandicoot. The females of certain animals have a name which distinguishes them without stating the sex, as, ngerangyer, a female dog; murrin, a female kangaroo. The corresponding male names are gal and gorañ. Many of the male animals likewise have a distinguishing name.

*Case.*—The cases are indicated by inflections, the following being the principal:

*Nominative:* This case merely names the subject at rest, as, gal, a dog; kunna, a yamstick; mär, a man; dher, a spear. Mutyir or kurkin, a tomahawk.

*Causative:* This represents the subject acting, as, mārra guramuk burtan, a man an opossum killed; dhunnumburra gal yilpan, a woman a dog flogged; galla guramuk bündan, a dog an opossum bit.

*Instrumental:* This case takes the same affix as the causative, as, mārra kalngun maiangan dherra, a man my dog speared (or pierced)

with a spear. Sometimes the first affix is omitted in such a sentence as this.

Genitive: A peculiarity of the genitive case, which I was the first author to report in Australian languages,<sup>1</sup> is that the property and the possessor each take an affix, but the former affix differs from the latter—*marnгат lettalettimyung*, a man's boomerang; *dhunnumburnгат kannanyūng*, a woman's yamstick; *wurrangат kurkinyung*, a boy's tomahawk.

Every object or article over which ownership can be exerted is subject to inflection<sup>2</sup> for person and number, as, *kurkinгun*, my tomahawk; *kurkinгу*, thy tomahawk; *kurkinung*, his tomahawk; and so on through the dual and plural, which also contain "inclusive" and "exclusive" forms in the first person.

Accusative: This case is the same as the nominative.

The other cases will be passed over.

#### ADJECTIVES.

Adjectives follow the nouns which they qualify, and are subject to similar declensions for number and case:

Nominative: *Mār muryarrung*, a man large. *Gal lēnggin*, a dog large. *Dhunnumbur dhugai-muruk*, a little woman.

It is not thought necessary to illustrate the other cases.

Comparison: *Din ngutyung—dinnung ngummindyar*, this is good—that is bad. *Din karpung karpung*, this is the best.

In the declensions of all the cases of nouns, and of their qualifying adjectives, there are modifications in the affixes, depending upon the termination of the word declined. Sometimes the affix of the noun is omitted, sometimes that of the adjective; this rather being regulated by the euphony of the sentence.

#### PRONOUNS.

Pronouns are inflected for number, person and case, and contain two forms of the first person of the dual and plural, marked "inclusive" and "exclusive," respectively.

<sup>1</sup> "The Gundungurra Language," *PROC. AMER. PHILOS. SOC.*, Philadelphia, Vol. xi, p. 143.

<sup>2</sup> "The Thoorga Language," *Queensland Geographical Journal*, Vol. xvii, p. 53.

The following is a full table of the nominative pronouns :

Singular . . . . .	$\left\{ \begin{array}{l} \text{1st Person} \dots\dots\dots \text{I} \\ \text{2d} \quad \text{"} \quad \dots\dots\dots \text{Thou} \\ \text{3d} \quad \text{"} \quad \dots\dots\dots \text{He} \end{array} \right.$		Ngutthuk
			Ngutuk
			Nung
Dual . . . . .	$\left\{ \begin{array}{l} \text{1st Person} \dots\dots\dots \left\{ \begin{array}{l} \text{We, inclusive} \\ \text{We, exclusive} \end{array} \right. \\ \text{2d} \quad \text{"} \quad \dots\dots\dots \text{You} \\ \text{3d} \quad \text{"} \quad \dots\dots\dots \text{They} \end{array} \right.$		Ngutthungul
			Ngutthungullin
			Ngutuwal
Plural . . . . .	$\left\{ \begin{array}{l} \text{1st Person} \dots\dots\dots \left\{ \begin{array}{l} \text{We, inclusive} \\ \text{We, exclusive} \end{array} \right. \\ \text{2d} \quad \text{"} \quad \dots\dots\dots \text{You} \\ \text{3d} \quad \text{"} \quad \dots\dots\dots \text{They} \end{array} \right.$		Dilakal
			Ngutthungan
			Ngutthungannin
			Ngutuwan
			Dilakanda

There is a sort of trial number, which is formed by the addition of the word *balinia* to the plural, as, Ngutthangan *balinia*, we three, and so on for the remaining numbers. I am inclined to believe, however, that this added word merely serves the purpose of a numeral, and is copied from the Wuddyawürru tribes on the east, and the Tyattalli on the north, among whom I reported a trial number last year.<sup>1</sup>

The following are examples in the singular number of the possessive case :

Singular . . . . .	$\left\{ \begin{array}{l} \text{1st Person} \dots\dots\dots \text{Mine} \\ \text{2d} \quad \text{"} \quad \dots\dots\dots \text{Thine} \\ \text{3d} \quad \text{"} \quad \dots\dots\dots \text{His} \end{array} \right.$		Ngutthungat
			Ngutungat
			Nungat

And so on through the remaining numbers.

The full forms of the pronouns given above are mainly used in replying to a question. In ordinary conversation the natives use the pronominal affixes illustrated under the head of "Verbs."

The accusative pronouns, me, thee, him, etc., are not found separately, like the nominative and possessive, but consist wholly of the pronominal suffixes to verbs, nouns or other parts of speech, as in the following example :

1st Person . . . . .	(Some one)	beats me	Burtangun
2d " . . . . .	"	beats thee	Burtangu
3d " . . . . .	"	beats him	Burtanung

And so on through all the numbers. See also the example under the heading "Prepositions."

Demonstratives: The demonstratives in this language, by the

<sup>1</sup> *Journ. Roy. Soc. N. S. Wales*, Vol. xxxvi, pp. 77-86.

combination of simple root-words, can be made to indicate position, distance, direction, number, person, movement, etc. Want of space precludes more than this brief reference to them at present.

Interrogatives: Who, winya. What, nganya. How many, nummia.

#### VERBS.

Verbs have the same numbers and persons as the pronouns, and also the "inclusive" and "exclusive" forms. The principal moods are the indicative, imperative and conditional. Person and number are indicated by pronominal affixes to the root of the verb, as in my Būngandity grammar.<sup>1</sup> In the following conjugation of the verb, burte, "to beat or kill," the present tense is given in full, but the singular number of the past and future is considered sufficient.

#### *Indicative Mood—Present Tense.*

Singular....	{	1st Person.....	I beat	Burtu
		2d " .....	Thou beatest	Burtangin
		3d " .....	He beats	Burta
Dual.....	{	1st Person.....	{ We, incl., beat	Burtangul
			{ We, excl., beat	Burtangullin
		2d " .....	You beat	Burtawul
3d " .....	They beat	Burtakal		
Plural.....	{	1st Person.....	{ We, incl., beat	Burtangan
			{ We, excl., beat	Burtangannin
		2d " .....	You beat	Burtawan
3d " .....	They beat	Burtakanda		

#### *Past Tense.*

Singular....	{	1st Person.....	I beat	Burtanu
		2d " .....	Thou beatest	Burtanyin
		3d " .....	He beat	Burtan

#### *Future Tense.*

Singular....	{	1st Person.....	I shall beat	Burtugu
		2d " .....	Thou shalt beat	Burtuhu
		3d " .....	He shall beat	Burtuk

Imperative: Beat, Burtē.

<sup>1</sup> "Language of the Būngandity Tribe, South Australia," *Journ. Roy. Soc. N. S. Wales*, Vol. xxxvii, pp. 59-75.

There are conditional, reflexive and reciprocal moods, similar in principle to those shown in my Kamilaroi grammar.<sup>1</sup> There are also modifications of the verbal suffixes of the past tense to indicate the immediate past, the recent past, and the remote past. Similar modifications exist for the proximate, or more or less distant future. There are likewise forms of the verb to express repetition or continuance of the act described, and many other complexities, which need not be detailed in the present brief paper.

## ADVERBS.

Following are a few examples in this part of speech :

Yes, ko. No, bangat. To-day, thinggatbe. Yesterday, ngagat. To-morrow, tungatti. By and by, kalu. Recently, wuluba. Long ago, mulkaiu. All the time (doing something), girtnabe. All the time (resting), girtitbe. Where, wunda. Where art thou, wundayin. Where are you two, wundawar. Where are you all, wundawan.

## PREPOSITIONS.

Here, dinnu. There, dinnunung. These, with numerous modifications, are also used as demonstratives.

In front, gullingat. Behind, wurtgat. On the right, dumbitgat. On the left, warumgat. Inside, gunni. Outside, gunna. Between, bukkargat. This side, yukkai-gatthung. Other side, kunninung. Down, wēnyu. Up, gunnu. Underneath, wenyanu. Through, yunyin.

Many prepositions admit of inflection for person and number, as in my "Thurrawal Language":<sup>2</sup>

Singular . . . . .	$\left\{ \begin{array}{l} \text{1st Person} \dots\dots\dots \text{Behind me} \\ \text{2d} \quad \text{"} \quad \dots\dots\dots \text{Behind thee} \\ \text{3d} \quad \text{"} \quad \dots\dots\dots \text{Behind him} \end{array} \right.$	Wurtganhūn
		Wurtganhu
		Wurtganhung

And so on through the remaining numbers and persons.

## NUMERALS.

One, kaiappa. Two, bulattya. Several, bōrtung.

<sup>1</sup> *Journ Anthropol. Inst.*, July-December, 1903.

<sup>2</sup> *Journ. Roy. Soc. N. S. Wales*, Vol. xxxv, p. 148.

## VOCABULARY.

This vocabulary contains about 260 of the most commonly-used words in the Dhauhurtwürru language, every word having been noted down by myself from old men and women in the native camps.

*The Family.*

A man	mār
Old man	ngurram
Youth	nguin-nguin- mār
Boy	wurran
Elder brother	wartai
Younger brother	koko
Father	pipai
Mother	ngerang
Mother-in-law	nullinyur
A woman	dhunnumbur
Old woman	ngurramdyar
Girl	barraty
Child (neuter)	tukui
Elder sister	kukkai
Younger sister	kokodyar

*The Human Body.*

Head	pim
Forehead	mittin
Hair of head	ngarat
Beard	ngarañi
Moustache	munūtyir
Eye	mirng
Eyebrow	tharruing mirng
Nose	kapping
Ear	wirng
Mouth	ngulang
Lips	wuru
Teeth	thūngang
Mammæ	murtung

Umbilicus	rikut
Abdomen	thukung
Tongue	thallan
Chin	buluñ
Back	wirk
Arm	würk
Shoulder	pakkuran
Elbow	thalling
Hand	marang
Thigh	wurkarriman
Knee	purrañi
Foot	thinnang
Blood	kerik
Fat	pippul
Bone	bukkan
Penis	wirring
Scrotum	burung
Vulva	mulun
Urine	kirng
Excrement	gunang

*Inanimate Nature.*

Sun	thirring
Moon	dhenget
Stars	kukkadhing
Thunder	murndal
Lightning	murthung
Rain	murriang
Rainbow	dhārnt-burru
Fog	wallat
Frost	mikkur
Hail	puttirang
Water	purrity



Ground	miring
A Stone	murrai
Sand	kulak
Light (of day, etc.)	nēanan
Darkness	burun
Heat	kalluñ
Coldness	bullabety
Camp	wurn
Camping place	limbity
Fire	wien
Smoke	thueng
Food	mutthal
Day	dhinggatmirring
Night	burun
Dusk	burunggittian
Hill	kang
Sandhill	pangat
Grass	kariwan
Leaves of trees	dhirrang
Bird's nest	wurnung
Egg	mirkinyung
Honey	wirraty
Path	dhā-urn
Shadow	ngakuyung
Tail of animal	wirranjung
Summer	kalluñ
Winter	pullapity

*Mammals.*

Native bear	winggil
Dog	gal
Wild dog	burnang
Opossum	guramuk
Kangaroo-rat	barrut
Native cat	kuppung
Bandicoot	warrun
Water-rat	murung
Porcupine	willangalak

Kangaroo	gurañ
Platypus	ngullirtil
Flying squirrel	wéthity
Small squirrel	ngundaty
Ringtail opos- sum	wiyan
Bat	ngunni-ngun- nity

*Birds.*

Laughing jack- ass	gunit
Crow	wang
Curlew	wiruk
Plain turkey	burriam
Native-compan- ion	kurun
Pelican	kurtpirrap
Swan	kunuwar
Wood-duck	ngawurk
Quail	ngarēn
Eagle-hawk	ngianggara
Emu	kampirng
Common mag- pie	kirre
Black magpie	munyukil
Black-duck	dhurbang
Mopoke	mūmgaty
Bronze-wing pigeon	gure
Rosella parrot	kurtkurty
Parroquet	yukuty
Kingfisher	bunbungwarpit
Peewee	thulirm
Plover	pitthirrit
Corella	kurogity
White cockatoo	ngaiyuk
Woodpecker	dindēn
Mountain parrot	kalingai
Small nightjar	yerradhaer

Crane	kukap
Black cockatoo	willan

*Fishes.*

Black fish	yim-yim
Trout	dhurkurt
Eel	kuyang
Frog	dhiamp

*Reptiles.*

Sleepy lizard	yuruk
Carpet-snake	kurang
Black-snake	muwang
Tiger-snake	wangaluk
Jew-lizard	wirinyurn
Small lizard	mūnni
Whip-snake	kirdök

*Invertebrates.*

Locust	billirt
Blow-fly	wurul
Louse	barum
Nit of louse	lirt
Bulldog ant,	
black	wulakai
Bulldog ant,	
red	kumal
Centipede	thirrimbangarak
Jumper ant	birpirk
Maggot	thirtui
House fly	minnik
Grasshopper	nger-nger
Spider	buñ-buñ
Mosquito	murukar
March fly	murun
Mussel	thalup

*Trees and Plants.*

Ti-tree	kūrang
Wattle	karrang
Pine	murrung
Oak	ngēring
Cherry tree	pallat
Red gum	bial
White gum	lēng
Honeysuckle	wirraty
Bullrushes	burtity
Yam	gērang
Broom	bunung
Blackwood tree	mūtthang
Peppermint	wurut
Stringybark	marafi
Box tree	karran
Ironbark	yirip
Bush tree	wirriks

*Weapons, etc.*

Tomahawk	mutyir
Koolamin, wood	bupir
Koolamin for	
grubs	yurom
Yamstick	kunnak
Jagged spear	dhuluwarn
Hunting spear	dēr
Reed spear	ngiren
Fishing spear <sup>1</sup>	koyōt
Spear lever	ngarrung
Spear shield	kirram
Waddy shield	mulkar
Fighting club,	
bent	murduang
Hunting club	bippin
Club, with knob	munup
Boomerang	lettalettim

<sup>1</sup> There is a bone spike, called *killip*, fastened to the striking end of the *koyōt* or fishing spear.

Plaything		Drink	thathin
(wooden)	wity-wity	Sleep	yuin
Net bag	kurēra	Stand	kartan
Canoe	dhurung	Sit	nginggan
Belt	murum	Talk	lakan
Kilt	burrandity	Tell	kuyin
	<i>Adjectives.</i>	Walk	yanmin
Alive	boandian	Run	karkurtmin
Dead	kulpiran	Bring	wambakē
Large	muryarrung	Take	wambaku
Small	gurnung	Break	yēnhin
Long	wurumbēt	Strike	burte
Short	mulubēt	Arise	mirtako
Good	ngutyung	See	nakin
Bad	ngummindyar	Hear	wangin-mirri
Thirsty	kurangan	Listen	wangity
Red	gerrigerrigund- ity	Give	woke
White	ngapORITY	Sing	litbity
Black	miñ	Weep	lumin
Quick	wungura	Steal	kurunmin
Slow	gurpippa	Ask	kuemin
Blind	kundity	Climb	kurwurniñ
Strong	ngarakithung	Conceal	yunbin
Afraid	kuninbity	Jump	wurnbin
Tired	barbangan- mirringa	Laugh	wiakan
Hot	kalluñ	Scratch	wirrinity
Cold	pullapety	Send	yumbin
Angry	watthanlingan	Swim	yawin
Sleepy	wandyangan	Spit	thukipin
Greedy	murkappu	Throw	yarndin
Sick	ngullarwano	Whistle	dhēginrin
Stinking	wumbity	Vomit	kurnan
Pregnant	karrawian	Dance	kūrwin
	<i>Verbs.</i>	Go	yanmin
Die	kalpirmity	Come	kaka
Eat	thakian	Burn	bawa
		Bite	būndin
		Fly	mirtan

## INITIATION CEREMONIES OF VICTORIAN TRIBES.

Under this heading it will be sufficient to mention that I have elsewhere described some important ceremonies of initiation in use among the native tribes of Victoria. I have given full details of the Wonggumuk ceremony, which is in force over the central and northern portions of that State. I have likewise reported the Kannety initiation ceremony, practiced by the tribes inhabiting the southwestern districts of Victoria. Other inaugural ceremonies used in eastern Victoria and elsewhere are described by me in a contribution to the Anthropological Society at Washington, already referred to in this paper.

## FOLKLORE.

The following stories were told me by some old aboriginals of the Hopkins and Eumeralla rivers in western Victoria, and as I have never seen them in print, they are included in this paper.<sup>1</sup>

*Tyuron, the Eel Spearer.*—Tyu-ron, a man of the Kappaty phratry, was a notable ancestor of the plovers. He carried a fish-spear on each shoulder when he went fishing, because he was equally dexterous with both hands. He frequented swamps and shallow streams where eels were plentiful, and never hunted for any other kind of food. He was a very agile fellow, and kept a sharp lookout along the margin of the water. When he saw an eel, he struck at it with one of his spears, and threw it out on the bank. He then ran along the edge of the water, and stood a little while looking for his favorite fish. If none were visible, he again ran on, and stood watching. He continued running up and down the stream, or around the margin of the lagoon, until he had caught as many eels as he required.

Tyuron used to paint his breast and the under sides of his arms with pipe-clay, so that the eels would not readily observe him, and sang at intervals, "Pittherit, pittherit." This is why the plover still carries the point of a fish-spear on either shoulder, and likes to remain near water. He also continues his old habit of running a little way and standing still, then running on again. And he still sings his old song, from which he has received his onomatopœic name of *pittherit*.

*Mirkupang and Mount Shadwell.*—Among the remote ancestors

<sup>1</sup> See my *Folklore of the Australian Aborigines* (Sydney, 1899).

of the Girriwürru tribe there was a man of great stature, named Mürkupang, whose body was covered with hair. He dwelt in a cave on the Hopkins river, in the vicinity of Maroona. His *mul-lanyurung*, or mother-in-law, resided near him, and one day she sent her two grandchildren to see Mürkupang and ask him for some food, because according to tribal custom she could not herself approach her son-in-law. As he had not been successful in the chase for a day or two, he killed the children and ate them.

Fearing the retribution of his mother-in-law's friends, Mürkupang left his habitation at dawn next morning and journeyed down the Hopkins river to a place near Wickliffe, where he tried to make a cave in a rock by pulling loose pieces off with his hands, but he did not succeed. He next went on to Hexham, and saw in the distance Mount Shadwell, with its rocky sides. He approached it and saw a suitable cave in one side near the top. Being a great conjurer or sorcerer, he commenced "bouncing" or scolding the mountain, and commanded the portion containing the cave to come down nearer to the plain on which he was standing. He stamped his feet and made passes or signs with his hands while he sang a magical song, and presently a large piece of the mountain containing the cave parted from the rest of the hill.<sup>1</sup> Mürkupang ran away across the plain, and shouted to the fragment of mountain to follow him. After a while, when he thought he had reached a good camping place, he turned round, stamping his feet and using other menaces which caused the mountain fragment to stop. It then settled down and became what is now known as Flat-top Hill.

Mürkupang then selected a place sheltered from the weather by an overhanging rock—a sort of cave—and made his camp there. In a few days' time his mother-in-law tracked him to this retreat. She had with her two young fighting men of the Gurogity phratry, who were clever "doctors" and had some knowledge of magic. While Mürkupang was out hunting, these warriors hid themselves near the cave entrance, one on each side. They covered their bodies with stringybark, softened by beating, so that they could roll it around their bodies. This was done to prevent Mürkupang's dogs from scenting them. After a time the hunter returned, carrying a large kangaroo which he had caught. As soon as he went

<sup>1</sup> The natives point out a depression in one side of Mcunt Shadwell from which Flat-top was disrupted.

into the cave, the warriors emerged from their hiding-place and walked to the entrance, with their weapons ready for an attack. When Mürkupang saw them, he went through some very obscene antics,<sup>1</sup> in the hope of throwing them off their guard, so that he might get a chance to strike one or both of them, but all to no purpose. The warriors divested themselves of their stringybark coverings, with which they stopped up the mouth of the cave. A fire was then applied to this inflammable material, which made a great flame and suffocated Mürkupang. His spirit flew out of the cave and became a Mopoke, called by the natives *mümgüty*, a bird which goes about at night.

#### SOCIOLOGY.

In a former article published in 1898,<sup>2</sup> I gave a short description of the social organization of the tribes occupying the southwestern districts of Victoria, but since then I have again visited the natives of those localities and obtained further information which will now be briefly stated.

If we assume an approximate line drawn on the map of Victoria from Geelong *via* Castlemaine to Pyramid Hill; thence *via* Lake Tyrrell to a point on the boundary between Victoria and South Australia where the thirty-fifth parallel of latitude intersects it; thence along that boundary southerly to the ocean; and thence by the seacoast easterly to the point of commencement at Geelong. Then the people composing all the tribes within the region thus described are divided into two phratries, called respectively Gurogity and Gamaty, or dialectic variations of these names. But upon making a closer examination of the constitution of these phratries, we discover that the details of their composition among the tribes in the northern portion of the above region differ from those in the southern or coastal portion. I will first deal with the tribes occupying the country north of the main dividing range, where the rules of intermarriage of the phratries and the descent of the progeny are as under:

<sup>1</sup> "The Nguttan Initiation Ceremony," PROC. AMER. PHILOS. SOC., Philadelphia, Vol. xxxvii, pp. 69-73.

<sup>2</sup> "The Victorian Aborigines: Their Initiation Ceremonies and Divisional Systems," *American Anthropologist*, Vol. xi, pp. 325-343, with map of Victoria.

Table No. 1.

<i>Phratry.</i>	<i>Husband.</i>	<i>Wife.</i>	<i>Son.</i>	<i>Daughter.</i>
A.....	Gurogity	Gamatygurk	Gamaty	Gamatygurk
B.....	Gamaty	Gurogitygurk	Gurogity	Gurogitygurk

All creation, animate and inanimate, is divided into Gamaty and Gurogity. Attached to each of these phratries are groups of totems, consisting of animals, plants, the heavenly bodies, the elements, etc., lists of a number of which were given in my former treatise.<sup>1</sup>

There is a further subdivision of each phratry into what may be called clans or sections, with distinctive names, taken in some instances from animals and in others from inanimate nature. Each subdivision comprises a number of families bearing different totem names. That is, all the totems of a phratry are apportioned among the sections, some sections (or clans) possessing a certain aggregate of totems and some another. Every individual of a tribe claims some animal or inanimate object as his totem.

Again, each of these clans has its own spirit-land, called *mi'-yur*, to which the shades of all its members depart after death. The miyur of a clan is located in a certain fixed direction from the present hunting grounds of the tribe, but the direction of the miyur of each clan differs from that of the others. It may be situated far out in the desert country of the mallee-scrubs, or away towards the setting sun, or in the distant rocky mountains, or elsewhere.

When a member of a clan dies and is buried, the body is laid horizontally, face upwards, with the head placed towards the part of the horizon which leads to the miyur or spirit-land of the clan to which the deceased belongs. These miyurs are divided into the same two phratries as the people of the tribe. The spirit of a Gurogity man or woman goes to a Gurogity miyur, and a Gamaty spirit travels away to a Gamaty resting-place, conformably to the spirit-home of his clan.

Each spirit-land has its own description of water. For example, in one miyur the water is gray, in another sparkling, in another reedy, in another dark blue, in another reddish, and so on.

Between the main dividing range and the seacoast the phratry

<sup>1</sup> *American Anthropologist*, Vol. xi, pp. 333-334.

names and their feminine equivalents are slightly different from those just described, as shown in the following synopsis :

*Table No. 2.*

	<i>Phratry.</i>	<i>Father.</i>	<i>Mother.</i>	<i>Son.</i>	<i>Daughter.</i>
A.....		Gurogity	Kappatyar	Kappaty	Kappatyar
B.....		Kappaty	Gurogityar	Gurogity	Gurogityar

Everything in the universe is divided between these two phratries. Among the totems of Gurogity are included the following : Dog, flying squirrel, small squirrel, pelican, eagle-hawk, white cockatoo, tiger snake, red bulldog ant, red gum tree, oak tree, bloodwood, broom, peppermint, ironbark.

The undermentioned are some of the totems of Kappaty : Native cat, kangaroo, crow, swan, bat, crane, black cockatoo, whipsnake, black bulldog ant, white gum tree, wattle tree, cherry tree, honey-suckle, stringybark, tomahawk, reed spear, boomerang.

The totemic families belonging to Gurogity and Kappaty are subdivided into clans or sections, somewhat similar to those in use among the tribes already described, but not so numerous or elaborate. They likewise have a spirit-home, which some of the tribes call *maioga* and others *mungo*. Every individual, when buried, is placed with the head pointing in that direction, and all the spirits go away to the same resting-place. This is an island, called by the white people Lady Julia Percy Island, situated off the coast of Victoria, about halfway between Warnnambool and Portland. On the shore of the mainland there are some rocks like stepping-stones stretching out into the sea towards the island. These rocks, some old black fellows told me, were purposely placed in that position, in the far away past, by the spirits of clever men, to enable their fellow-countrymen to reach their *maiogo*. The spirit of a deceased person walks on the land to the shore and springs out to a rock, then to another and another rock, and lastly makes a final bound over the intervening sea and alights on Lady Julia Percy Island, the native name of which is *Dænmar*.



## THE MISSISSIPPI RIVER PROBLEM.

BY LEWIS M. HAUPT.

*(Read February 19, 1904.)*

In the economic development of the Federal Domain, the fostering care of a paternal Government has been liberally extended, by Congress, to the granting of homesteads to actual settlers ; to the reclamation of arid lands by irrigation ; to the donation of swamp lands to States for educational purposes ; to the subsidizing of the overland railroads by extensive land grants and to the setting aside of large tracts for the Indian tribes for ranges, and in many other ways has it stimulated the enormous traffic and wealth of the country.

Still there are waste places which may be made to blossom for a relatively small sum of money, but which cannot be rendered habitable at the expense of the individual settler, and undeveloped communities are likewise unable to reclaim extensive tracts from a foe which may attack them from all sides. General defensive works are of paramount importance to protect property and encourage the settlement of the richest land in the world, and it is manifest that the burden of this reclamation should be borne by those who derive the benefits from the increased yield, namely, the consumers as well as the producers.

But there are great and honest differences of opinion as to the methods which should be followed to secure these results.

The local owners and settlers firmly adhere to the reclamation of their land by levees to exclude the water, regardless of the ultimate consequences from confining the floods to a greatly congested bed. They fail to realize that if the fertilizing silt is excluded from the plains it must be dropped in the bed of the river and cause it to rise, and impair navigation as well as increase the menace to property.

The great necessity for reclamation and protection works seems to have beclouded the issue, and undue stress is laid upon that particular phase of the problem, whereas the intention of the Government, as originally proposed, was to open the channel and control the stream for navigation.

These two purposes are so distinct in character as to claim separate jurisdiction under different departments of the Government,

and are both mutually dependent upon Government appropriations for a successful issue. Works built to reclaim land are not generally well adapted to the creation and maintenance of channels, as will appear from the experience cited later in this paper, and hence the demand for a system of levees which shall at the same time protect the land and create a navigable channel is incongruous, and will also be found to be opposed to existing statutes.

Much greater progress in both directions, it is believed, can be made if the two issues are divorced and separate plans be devised for each on its merits.

In this connection it will be found suggestive to note some of the divergent views expressed by the speakers at the Levee Convention, held at New Orleans, October 27-28, 1903.

It was said, but not by engineers, that "protection can come only from a national system of massive dikes . . . the system of reservoirs (is) utterly unfeasible and impossible." . . . "Outlets are not only impracticable but harmful." A distinguished member of the Mississippi River Commission stated: "The progress of levee extension has been a repetition of the early history . . . their upward extension has cut off more and more of the former overflow. . . . The necessary result has been to raise the flood level higher, and so make it necessary to build the levees higher. . . . The last flood has left behind it a record of mingled disaster and success."

On the other hand the Committee on Resolutions reported that the investigations made by the Commission "wholly disproves the notion, which still prevails to a considerable extent, that the immediate effect of levee construction is to cause the bed of the Mississippi river to rise. If this were true it would necessarily follow that the levees would need to be continuously strengthened and elevated, and thus all hope of protection would have to be abandoned." Thus the case is prejudged by its advocates.

But another close observer remarks: "You are not wise if you do not see that the drainage from this vast basin (the Missouri) will flow into your river faster than you can raise your banks, and the levee system will in time prove a failure. . . . If you go on and complete your levee system as you desire to, in less than twenty years you will be clamoring for some system to get the silt from the water back upon your lands for the fertilization of your plantations."

Again it was urged that the confidence inspired by the levees had caused the value of property to advance "all over the alluvial valley, in some places 100 per cent., in some places 200 per cent., in some places 300 per cent."; but a distinguished Senator calls attention to the fact that Congress, "under the Constitution, had no power to appropriate money to protect private property. I want to say to-day that every dollar that has ever been appropriated for levees on the Mississippi river has been on the theory that it would benefit navigation, and we never dared to put it on the ground, up to this day, that it would benefit private landowners, though we knew of course that it was incidental to it."

The success or failure of this improvement must, therefore, hinge upon the ability to prevent the elevation of the bed and its silting up by the larger amount of sediment confined to its channel and the relief of the excessive high stages by other expedients than levees, and it is to the consideration of this question that the following pages are directed.

#### A METHOD OF CONTROLLING FLOODS ON MISSISSIPPI.

Prior to the Louisiana Purchase in 1803, the territory of the United States was limited to the area east of the Mississippi river and north of the Spanish possessions in Florida, giving no independent outlet for the products of the republic other than that across the Appalachian Mountains to the Atlantic Ocean.

By the purchase of the territory extending from the mouth of the river on the Gulf to Puget Sound on the Pacific, the United States came into peaceable possession of the most fertile and productive region within its borders and secured control of the navigation of the greatest river in length on the globe.

Up to the middle of the last century the population was comparatively sparse and the products limited, but after the restoration of peace and the opening of the country by roads and railroads, the development became so rapid as to require a systematic and comprehensive effort to regulate and control its avenues of interstate and foreign commerce under the control of the general Government.

The frequent casualties to the palatial steamers traversing these western waters from snags, bars and shifting channels with insufficient depths finally led to the organization of the Mississippi River

Commission in 1869, for the purpose of permanently improving the stream from the head of the Passes to the headwaters.

The duties of the Commission as set forth in the law of June 28, 1879, read as follows:

“Section 4. It shall be the duty of said Commission to take into consideration and mature such plan or plans and estimates as will correct, permanently locate and deepen the channel and protect the banks of the Mississippi river; improve and give safety and ease to the navigation thereof; prevent destructive floods; promote and facilitate commerce, trade and the postal service; and when so prepared and matured to submit to the Secretary of War a full and detailed report of their proceedings and actions, and of such plans with the estimates of the cost thereof, for the purposes aforesaid, to be by him transmitted to Congress; *provided*, that the Commission shall report in full upon the practicability, feasibility and probable cost of the various plans known as the jetty system, the levee system and the outlet system, as well as upon such others as they deem necessary.”

This was the authority for the subsequent systematic improvement of the river, which has proven to be an impressive object lesson as to the greatness of the problem and the difficulties to be overcome.

After so many years of experience, with a large amount of reliable data at hand, and with the voluminous discussions, more or less acrimonious, between the advocates of various systems, it may be profitable to weigh dispassionately some of the evidence and note where we are trending.

This may be done best by quoting the language of the Commission itself in the Report of 1903, just published:

“Systematic work, which has for its object to permanently locate and deepen the channel, has not been practicable under existing conditions. In the limited extension and repair of bank protection and contraction work the Commission has, however, kept in mind that the permanent improvement of the river is contemplated by the organic act, and experiments are continually being made looking to the best use of available material and the development of appliances and methods which may be economically and effectively employed when Congress shall provide for such a systematic improvement.”

From which it appears that the permanent and systematic plan

is still conditioned upon the results of experiments and further legislative action by Congress.

Prior to the organization of the Commission a Special Board of five United States Engineer officers was appointed July 8, 1878, to report a plan for the Improvement of Low-Water Navigation, and on the 25th of January following, the report was submitted, recommending the general plan of "contracting the channel to an approximate low-water width of 3500 feet by means of dikes of brush, etc., and where the bed of the river is found to be too hard to be worn away by the river currents, dredging, in addition to the reduction of width, to be resorted to."

In this report attention is directed to the fact that "there is an ample depth wherever the thread of the current follows a well-marked concave bank. Also wherever the low-water width does not exceed about 3500 feet," and, conversely, navigation is bad wherever there are straight reaches and the width exceeds this limit. Another element of serious importance is the great instability of the channel, which shifts through a breadth of several miles, due to the caving of the banks, which proceeds "at the rate of 200 to 300 feet a year in certain places, and these amounts are sometimes much exceeded."

As to the available depths at that date, the report states that "there are forty-three places between Cairo and the mouth of the Red river where low-water depths of less than ten feet and thirteen where depths of less than five feet may be found. . . . There were fifty-two days on which the least depth of water between St. Louis and Cairo was less than six feet, and sixty-nine days when it was less than ten feet."

These considerations led the Board to conclude that "protection of caving banks will therefore be needed. . . . To thoroughly regulate the river caving, even in those bends which have deep water below them, should be stopped. . . . The protection of these caving banks can be effected by mattresses. Where the water is deep it will be very expensive." . . . "That such a trial may thoroughly test the practicability and the cost of regulating the river and increasing its low-water depth, one of the worst places on the river should be selected."

Accordingly the Board recommended the appropriation of \$600,000 for revetments on the Plum Point reach, one hundred and sixty miles below Cairo, which was granted and the test made.

Extensive revetments were also applied at Lake Providence and other points on the river, but the difficulty of holding them against the great pressure of the floods and their enormous expense have led to their abolition.

This Board of Engineers also reported on January 25, 1879, upon the effects of a permanent levee system throughout the length of the river below the mouth of the Ohio, not only upon the low-water navigation but also of the benefits it would confer in affording protection and giving needed facilities to shipping, commerce and navigation in the high stages of the river.

The Board found that "levees have no direct action except when the water is high. . . . A glance at the sketches is sufficient to show that levees, even if they come into action every high-water stage instead of only every 'flood,' would have little or no influence on the low-water navigation. They would leave to the river its inordinately great width and area of shifting sands, and exert little or no influence on channel formation. This would be the fact even if they everywhere followed closely the natural banks. . . . Closely adhering levees which in all high stages shall confine the water which now escapes into the swamps would, by an increased current action, accelerate the caving of the banks in the bends and enhance the instability of the bed, which now not only makes the work of navigation improvement so difficult, but is one of the most formidable foes to a permanent levee system. . . . The great obstacle to the improvement of the low-water navigation and to maintaining a levee system is one and the same for both, viz., the instability of the river from the caving of its banks. . . . We believe that the levee system, if undertaken, should be matured and developed in connection with the navigation improvement."

Hence it appears that this Board attached but little importance to the use of levees as an aid to the formation of a navigable channel, although recognizing their value in the reclamation of land.

It relied upon the regulation of the channel by dikes and revetments to correct the evils, but the past experience has destroyed this expectation and compelled a change of policy which it may be well to review as to its consequences.

After the greatest flood to that date, which occurred in 1882, the Commission reported that the controlling depths at low stages between Cairo and Plum Point reach were but five and one-half and six feet; that a large amount of the revetment had been lost, and

that to determine the effect of outlets surveys had been made during and after the large crevasses caused by that flood, from which it was concluded that the relief which might have been anticipated from the decrease of flow below the outlet was not realized, because the water thus released returned to the river lower down and obstructed the discharge at that point, making a water-dam.

It should not be concluded from this fact, however, that outlets are injurious, for it is not proposed to permit the excess of water immediately to flow back to the lower reaches, but to impound it for a considerable time in large reservoirs, thus changing entirely the conditions and removing the objections to the ordinary operation through natural crevasses, which are wholly different from the impounding reservoirs proposed by Mr. Seddon for the relief of the floods.

This Commission reiterates its statement "that for purposes of channel improvements merely, the limit of economy is reached with the confinement of the ordinary flood. The result of this qualification is that the building of levees to the height necessary to protect the alluvial basin from overflow, is not necessary as a part of the logical plan of river improvement." This policy was doubtless reflected in the legislation which followed, making it illegal to appropriate money for protection works unless they were found to be beneficial to navigation.

The Joint Resolution passed March 3, 1891, *re* Mississippi river levees, reads as follows :

*"Resolved, by the Senate and House of Representatives of the United States of America in Congress assembled, That the sum of one million dollars is hereby appropriated, to be paid out of any money in the Treasury not otherwise appropriated, for the improvement of the Mississippi river from the head of the Passes to the mouth of the Ohio river, which sum shall be immediately available and shall be expended under the discretion of the Secretary of War, in accordance with the plans, specifications and recommendations of the Mississippi River Commission ; Provided, That no portion of this appropriation shall be expended to repair or build levees for the purpose of reclaiming lands or preventing injury to lands or private property by overflows ; Provided, however, That the Commission is authorized to repair and build levees, if in their judgment it should be done, as part of the plans to afford ease and safety to the navigation and commerce of the river and to deepen*

the channel ; *Provided, further,* That the office, clerical and traveling expenses and salaries of the Mississippi River Commission may be paid from this appropriation.

“Approved, March 3, 1891.”

From this law it appears that, unless the levees are beneficial to the navigation, there is no warrant for the application of Government funds to their construction and maintenance ; hence it happens that there is great difference of opinion as to the results produced by them, and it is strenuously urged, doubtless in good faith, by those on whom the burden of levee construction falls so heavily, that the river bed is *not* rising, nor is the channel shoaling, while on the contrary the actual and carefully conducted surveys made by the Commission indicate an unmistakable reduction in the depth and area of the low-water channel, and an increase in the caving and instability of the banks with greater flood elevations than before, as will presently appear.

The logical inference from these data would seem to point conclusively to the necessity for a modification of the levee system and a resort to one which will relieve the floods, while at the same time it reduces their height and also maintains a more constant low-water stage, with greater depths for navigation. Under such a system the Government *would* be fully justified in making appropriations for maintaining low levees, supplemented by outlets and receiving basins for storage of the excess of flood waters.

This involves the removal of all bars or obstacles which retard discharge, beginning at the mouths and proceeding up stream ; the readjustment of the alignment at the gorges and the construction of reservoirs in the swamps, especially of the St. Francis basin.

Before leaving the report of the Commission of 1883, it is desirable to state further that, under the views as above outlined, the estimate for the “levees on the Mississippi river at certain grades” aggregated \$11,443,770 ; but it recommended the “closure of the gaps in the existing levees along the Yazoo and Tensas fronts, begun a year ago, as the most economical and shortest method of shutting off the escape of water into those great reservoirs, and securing so far the benefit of the entire discharge in the improvement of the channel. Beyond that the Commission is not prepared at this time to make any specific recommendation for construction of levees as a means of channel improvement, and reserves the subject for further consideration.”



In closing the report the Commission calls attention to the peculiarly favorable conditions of the outlet section of the river in these words :

“ In conclusion of this subject, the Commission considers it necessary to call the attention of Congress to peculiar conditions existing below Red river. This section of the river is in a state of much greater stability than is found in any other part of its course below the junction of the Missouri. At a short distance below Red river it becomes narrower and deeper. It has been leveed throughout for a great many years. No flood complications arise here, as above, from the return of overflow water which has escaped from the river at points higher up. This all reaches the sea through the numerous delta bayous on either side.”

This reach, therefore, furnishes the best object lesson available as to the proper treatment of the river, and is a complete answer to the objections to the use of outlets, for the volume of discharge, when in flood, is only about one-half that of the river above the mouth of the Red, and yet the depths are more than ample, reaching in places to two hundred feet. The escaping waters do not return to the bed but are permanently withdrawn, and there are no such variation of channel widths as are to be found between the lines of levees as constructed in the higher reaches.

The President of the Commission, however, did not coincide with the majority on the question of levees and outlets, with reference to which he said :

“ Considering . . . the probability that the height of floods will increase in the future, it seems proper that in the plan for any general system of levees, if the principle of keeping out all floods, whatever their height, should be surrendered (a step of doubtful advisability), the plan should at least provide for holding a flood like that of 1882. A thorough study of the subject of levees has not yet been made; until then accurate estimates are impossible. . . . Such as they are they make it impossible for me to concur in the estimate of \$11,443,770 as the cost of a general system of levees from Commerce, Mo., to the Forts, adequate to preserve that country from destructive floods.”

From the foregoing records it appears that the Commission, after a careful investigation covering about fourteen years, had little or no confidence in the ability to regulate the river by revetting the

banks, and no faith in high levees to improve the navigation at low stages.

Consideration of the problem continued and many of the most experienced engineers on the works participated in the discussion.

The local Levee Boards of the several States were obliged to continue their protection works, which were assuming greater proportions as the system was extended, and great pressure was brought to bear upon the general Government to aid in the work of defending the arable land from overflow, and thus confine the floods to the narrower channel between the artificial banks.

As a matter of record it is important to note the arguments advanced by the competent and conscientious men in charge of these works.

In November, 1892, the Chief Engineer of the Yazoo Levee Board stated that "the levee system, which is the one now in vogue, has been objected to on several grounds—that it was very costly, that it was very dangerous, and that it exposed the river to deterioration from the confinement of silt, causing the deposition of silt in the bed of the stream."

In reply to these objections he says that up to that time the cost would probably be covered by \$35,000,000, and that to build the levees to a height now (1892) considered sufficient, namely, five feet above the highest recorded floods, would require some \$20,000,000 more. He adds there is no difficulty in making levees that will secure against disaster. The flood of 1892 was one foot higher than ever before, but there was no break along the Yazoo front; and the third objection, as to elevation of bed, he repudiates as opposed to all testimony.

In his report on the flood of 1903, his successor, also an engineer of long experience on the river, states that the present flood reached a stage exactly three feet above that of 1897, and was prevented from reaching a higher point by the two large crevasses which occurred in the St. Francis basin levees two or three days before the culmination of the flood at Memphis. Correcting for this and the lower gauge reading at Cairo, the present rise might have reached an elevation of four feet above that of 1897. Below Burk's Landing, within the next few miles, are four unclosed crevasses that occurred in 1897, aggregating over a mile in width. There was a crevasse at Rescue Landing in 1897, which lowered the stage locally nearly one foot. He suggests that the grade line of 1897,

which was a little under five feet above the flood-plane of that year, should now be raised to five and a half feet. He also foresees the still greater dangers from increased floods, and suggests in places the construction of reserved and subsidiary lines of levees to cover the emergencies arising from the increased caving of the banks.

The report states: "With a considerable addition to the high-water elevation that may be expected in the near future, it may be assumed that the current force and the general difficulties of the situation will be further magnified."

With reference to the dangers from caving banks he reports:

"The situation here (near Rescue) has become still further complicated to a grave degree by the accelerated rate of caving of the river bank opposite the new levee, which threatens its destruction from that source in a comparatively few years. The greatest development is about the middle point of the new levee, where the bank has receded nearly five hundred feet since November, 1898, with less than seven hundred feet remaining to the levee. In order to retire this line to a more secure location it will be necessary to fall back into very low ground, which would still further magnify the difficulties to be encountered. In view of the foregoing facts the conclusion seems inevitable that the maintenance of the front line extension as a permanent feature of our levee system must be abandoned." . . . "Any further effort to hold this levee end will be well-nigh hopeless of good results."

Again he says:

"The instability of the foundations of the Ward Lake line has been very much in evidence already. With an increase of five or six feet of water pressure this evil will be increased to an unknown but undoubtedly great extent, and will probably require a secondary line, in the nature of a sub-levee, throughout most of its length.

"From renewed activity in caving of the bank along the Burk front, it seems now probable that about one and one-half miles, and possibly more, of that levee will have to be renewed within the next few years." The instability of the bed is further shown at the head of Island 63, where the river is returning to the old channel on the Mississippi side. "This development threatens the stability of some three miles of levee above Burk's Landing that was heretofore considered reasonably secure."

"It has been forcibly demonstrated by this high water that one of the greatest problems of the future shall be to combat the dan-

gers arising from defective foundations of the levees ; that is to say, from the permeable and treacherous character of the natural earth foundation, which permits the passage of large volumes of water beneath the levees. This water is forced up by hydrostatic pressure through every aperture or weak place in the crust above. The flow in many cases comes with great freedom, bringing up large quantities of sand and leaving a corresponding displacement of material under ground. . . . This agency will increase in energy as the river goes to higher stages in the future and demands thorough and systematic treatment."

The estimates submitted to the State Board for work of primary importance aggregates \$627,000, of which \$441,000 is for new levees.

From this evidence it appears that there is some "difficulty in making the line secure against disaster," and that large breaches have actually occurred ; also that there is an ever-present danger of failure in the most vital part of every structure, namely, the foundation, from the constantly increasing head due to the concentration of the waters, and that the increasing caving of the banks requires not only new lines but reserved levees, thus greatly adding to the cost.

The estimates previously submitted as being sufficient to complete the system have been several times exceeded, and it is now stated that to bring the levees up to a safe standard will require about forty per cent. more material than has been already put in place.

But there is no well-defined limit to the height or extent of the works, since the river is not controlled nor the erosion reduced.

A distinguished engineer, employed on the river for many years, states : "The uncertainty as to future flood volumes and the stages consequent upon a confined channel are so great, however, that the great devastation from crevasses, caused by the river overtopping the levees, will continue for many years to come. The banks will never be fully protected from caving, and the channel will always be very unstable and will shift more or less in position. . . . The effect of the levees is to increase the height of the bars so long as the very unequal widths are uncorrected, for a confined river means higher flood stages, and the higher the stage the higher the bars are built up in the wide reaches. Therefore, the regulation of the width and the protection of the banks should precede the building

of the levees. But the popular demand for levees has reversed this order."

It would seem, therefore, that in consequence of the instability of the bed and banks with their superimposed levees and the increasing heights of the floods, the question of the ultimate cost is indeterminate but great.

In military practice it is found to be good tactics to disperse an enemy and attack him in detail, but the levee system appears to reverse this mode of procedure and concentrates the energy of the flood for a thousand miles, so that if there be a weak point in the ramparts it will assuredly discover and breach it.

The third point of contention has been discussed *pro* and *con*, but is of such importance that a few citations are deemed necessary to state its status. For example, it is said :

"The cross-section of the river will gradually rise, and has risen *where not leveed*. . . . It is not claimed by the advocates of the levee and contraction system that there will be an appreciable or immediate lowering of the bed of the river. . . . It will take many years. . . . But that the raising of the bed to any measurable amount in centuries to come will take place is not admitted." The writer then cites the Po.

In other words, the levees have no appreciable effect on the elevation or the depression of the low-water, or even on the high-water, channel in any sensible period of time. If so, there is no justification for their construction as aids to navigation, and hence no warrant for the appropriation by the general Government.

The Po, which is so frequently cited as an illustration that the bed is not rising, appears to be much misunderstood.

One of our most distinguished United States Engineer officers is quoted as saying : "The river Po has long been leveed, and it is often stated that its bed has risen largely in consequence of levees. The following data will show how unfounded is the statement that the bed has risen by amounts that are of much importance." He then adduces the data in the form of gauge readings and adds : "The above gauge readings, which have been kept only since 1807, show that there has been no important rise of the river bed (since that could not rise without raising the low-water surface) in the past sixty-eight years."

This testimony, therefore, admits that the bed does rise but minimizes its amount, and falls into the error of assuming that the eleva-

tion of bed is reflected in that of the surface as recorded by the gauges. That the bed may rise and yet the gauge readings diminish, will be apparent when it is remembered that the width may be increased by caving and the area of the cross-section be increased even, with a resulting lower record on the gauges, as has happened in the Mississippi. Moreover, it is admitted that even in a state of nature or without levees the bed will gradually rise. It is, therefore, only a question of degree as to whether the rate of elevation is augmented or not by the levees.

To determine this mooted point as to the elevation of the Po, an American scientist made a personal inspection and reported his observations in 1896.<sup>1</sup> In his description he says, *inter alia*: "Sir Charles Lyell has been frequently quoted as stating, 'At Ferrara the surface of the water has become more elevated than the roofs of the houses.' . . . My visit showed this danger to be less imminent than might be supposed. Its population has dwindled away from 100,000 to less than 30,000, while great stretches of land within its walls are now quite deserted. It is in a great plain only six and a half feet above the sea level. The roads across the plain are raised considerably above the general level, thus keeping them dry.

"In 1847, Lombardini showed by actual measurement that the mean height of the Po only here and there rose above the general level of the plain and was generally considerably below it, and that even during the great flood of 1830 the pavement in front of the Palace was scarcely ten feet below the level of the surface of the water in the river. Since that time, however, these conditions have altered in a marked manner, the more recent investigation of Zollikofer having shown that in the normal condition of the river the surface of the water in the neighborhood of Ferrara is somewhat over eight feet above the surrounding plains, while in flood the water in some places rises from sixteen to nearly twenty feet above the plain on either side.

"The dikes are estimated to be twenty-six feet high, and the crest is cut down somewhat to permit the road to pass through with easier grades, but the cut is closed with a brick wall arranged for stop-planks to exclude the higher floods. Though the danger is not so great as indicated by Lyell, yet the river in flood time hangs suspended, so to speak, over the surrounding plains, and the city of

<sup>1</sup> See *Science* of May 22, 1896.

Ferrara might be subjected to disastrous inundation should the right dike break. This danger is diminished by a secondary series of lateral embankments, placed at a considerable distance back of the dikes, along the whole course of the river below Cremona.

“The Po at this point is two hundred and eighty-five yards wide; has a swift, turbid current, and long sand bars are seen from the top of the dikes in the wide stretches, showing that in flood time a large quantity of sediment too heavy to be carried in suspension is swept along.”

To a disinterested reader this description conveys the idea that the elevation of the surface of the Po has been a very appreciable quantity during the last half century, and that the bar-building forces have not been idle even in a stream of such paltry dimensions as compared with the mighty Mississippi.

L. F. Vernon-Harcourt says that—

“Numerous breaches have occurred in the embankments of the Po, resulting in the devastation of its valley; and the flood level of the Po has been so much raised that it has been decided not to heighten the embankments, for fear of occasioning still greater disasters. . . . Some of the embanked rivers in Japan have their beds as much as 40 feet above the level of the plains above which they flow. . . . They serve as a warning against the extensive raising of embankments to counteract the silting up of a river” (*Enc. Brit., River Eng.*, p. 588).

In his argument against bed elevation the same United States Engineer officer quotes a portion of a letter from another officer as to the condition of the Hoang Ho, who stated that he had crossed the Yellow river and visited the site of the great break, measuring the levees at various points, but that he had no instruments other than a hand-level and tape. “But,” he says, “the conclusion I came to in regard to the influence of the levees upon the bed of the river was that they had nowhere filled it to a higher level than the adjacent country. . . . I cannot but believe that Abbé Huc was entirely mistaken in regard to the silting up of the channel, and that an exhaustive survey would prove beyond doubt that no such silting as to raise any part of the bed above the adjacent country has ever taken place.”

It seems almost superfluous to call attention to the indirect admission that the bed has risen, but not so much as to reach to or above the surrounding country, but it does not state that the flood height

does not reach above this danger line, as the disastrous breaks in late years attest fully. Moreover, no soundings were made and there was no basis for comparison.

But perhaps the most pronounced instance of bed elevation, due to a partial contraction along the banks of a stream near its outlet, and of which there can be no question, is that at the South Pass, where the constant and accurate surveys made since the construction of the two parallel jetties, in 1869, show they have produced an average shoaling along nearly the entire twelve miles of four inches and over per annum.

A recent Southern writer, evidently alive to the situation, stated: "The living generations will have great responsibilities in their treatment of this stalwart river, for it will not do to say that if the practice of building dikes proves ineffectual the true remedy may be applied at a later date. We know absolutely that the practice will prove ineffectual. This much we have already demonstrated in our own experience, even had we not the experience of twenty centuries to aid us in reaching conclusions; and every foot added to the elevation of the Mississippi river will be a measure of peril and perplexity for future generations. The time to apply the remedy is before the mischief is done." . . . There should be no more Congressional appropriations for dike building, but the whole country can very properly be asked to help in providing for the security of future generations.

In the recent discussion before the American Society of Civil Engineers, it was stated that "the levees of the Po formed an immense network of dikes, which has assured the protection of a vast rich territory century after century." Also that "while the combined discharge of all the affluents amounts to 528,000 cubic feet per second, the discharge of the Po during the same period is only 176,000 cubic feet." The writer adds: "That is certainly a remarkable result, and doubtless much of it must be attributed to the fact that the tributaries do not discharge flood waters simultaneously and that the lakes retard the flow to a marked extent." . . . He also adds: "There are, however, very serious drawbacks to levees as a means of preventing inundation, and Belgrand has stated that 'it is plain that even in a country where levees have existed for twelve centuries, where property has been exposed to all the consequences, it has not been clearly demonstrated that the advantages are greater than the inconveniences.' The chief objec-



tions are: (1) That they raise the flood heights; (2) that they break too easily and often; (3) that they cost too much; (4) that they cause the river bed to rise, because they do not permit the escape of sediment over the banks."

Moreover, it is important to note that the physical conditions attendant upon the drainage basin of the Po are wholly distinct from those of the Mississippi, since the Alpine tributaries with their steep decline of over a mile in twenty are checked and regulated by the magnificent and extensive storage and sedimentary basins of Lakes Maggiore, Como, Iseo and Garda, from which the effluent issues comparatively clear and flows 340 miles to the sea, which is about 1260 feet below. The total basin drained by the Po covers but 27,000 square miles, while its mean discharge at the mouth is only 60,745 cubic feet, or about one-eleventh that of the Mississippi.

The benefit of the lakes as sediment basins is in part neutralized by the formation of pools in the bed of the stream, for the levees do not hug the banks closely but are in places miles apart, and they have been "so spaced at and near the mouths of important tributaries that the major bed forms a sort of reservoir, in which is stored not only the floods but still—and to disappear with time—the deposits carried by the affluents."

This disappearance takes place by the receding stage distributing the bars along the bed of the stream, thus causing elevation, as in the Mississippi, where similar pools are found to exist; so that, notwithstanding the great reservoirs on the tributaries of the Po, the defective alignment of the levees has aggravated the shoaling and bed elevation, as shown by the record.

But aside from general observations, the greatest weight should be given to the carefully conducted surveys made by the Mississippi River Commission, covering a reach of two hundred miles from the mouth of the Arkansas river to Vicksburg, and made at an interval of about twelve years, for the purpose of determining this question. The composite cross-sections of this reach show a fouling of the low-water channel to the extent of about four feet, and an enlargement of the area between low and high water amounting to nearly 17,000 square feet, due to the increased caving of the banks from the efforts of the augmented volume to enlarge its bed. This amounts to not less than 206,200,000 cubic yards of eroded material per annum in the reach of seven hundred and fifty miles from

Cairo to the Red river, from whence to the Gulf the volume is divided and the channel relatively permanent and deep. Here, even with a much flatter slope, the river is narrower and much deeper than necessary for the largest vessels, reaching in places two hundred feet and over, and yet it has been seriously proposed by the opponents of outlets to close the entrance into the Achafalaya, for fear lest that steeper and shorter route might ultimately become the main river and "New Orleans be left high and dry." As the city is on a waterway only a few feet above Gulf level, having ample depth except over the bars in the Gulf, there could be no possibility of such a calamity unless the stream were dammed at both extremities and the water pumped out. In fact it is on an arm of the Gulf, and if all the sediment were diverted through another channel it would greatly simplify the opening of the bars at the delta and improve the maritime conditions of the Port of New Orleans, which would soon be without a rival in this country. But, on the other hand, if the escape into the Achafalaya outlet were closed, the next flood would sweep away the city and all its inhabitants. This is the *reductio ad absurdum* to which the opposition to opening the outlets tends.

In short, the weight of the evidence points most emphatically to the conclusion that the building of levees materially increases the rate of shoaling in the bed of the river and the evils resulting therefrom.

From the foregoing citations it is reasonable to conclude that the effect of the levee system, *per se*, upon the navigable channel is at least negative, and hence the Commission has at length been forced to resort to the use of powerful hydraulic dredges for the purpose of temporarily increasing the depths across the bars during the season of low water. But so unstable are these cuts that in some instances they are redredged from three to four times within a few months during the low-water season, and the plant is of little use during the remainder of the year.

Moreover, under the Act of 1891, there would seem to be no authority for Federal appropriations for the levees, unless they are found "to afford ease and safety to the navigation and commerce of the river and to deepen the channel." It would also appear that the transient dredging of the bars does not fall within the requirements of creating a permanent channel, nor does it operate to "prevent destructive floods."

But "self-preservation is the first law of nature," and the local

belief in the efficacy of embankments for "the purpose of reclaiming lands or preventing injury to lands or private property from overflowing" is so innate that the occupants of such tracts are almost a unit in their demands for national aid for protection, and not without reason since they have a right to be protected in their lives, homes and property from the ravages of a common enemy from without. Since, under existing conditions, there appears to be no warrant for the application of the funds to reclamation works pure and simple, the law should be amended and an appropriation should be made directly for this purpose, independently of the commercial or navigation requirements. The lands thus reclaimed are among the most fertile and desirable within the Federal domain, and would become the source of a large volume of staple commodities for manufactures and food products. There is quite as strong an argument for the development of this portion of our territory by the exclusion of floods and their devastations, at the expense of the general Government, as there is for the fertilization of the arid lands of the Western plains by the application of irrigation. While one section has too much water at certain seasons the other has too little, and it is unquestionably the function of a paternal Government to equalize and regulate the distribution of this life-giving element for the general welfare.

To this extent and for this purpose levees are unquestionably useful, yet they are not the only resource of the engineering profession in alleviating floods and reclaiming lands. Drainage is an important factor, and this is based upon the principle of drawing down the water by gravity to lower levels and voiding it as rapidly as the topography will permit; but this important expedient has been vigorously opposed by levee advocates and set aside untried as purely theoretical, hence it is that attention is directed to a few physical facts as to the direct benefits to be derived from the opening of all possible avenues of escape of the flood waters, commonly known as the

#### OUTLET SYSTEM.

There has been much misunderstanding as to the practical application of this system, and erroneous impressions prevail as to its results in consequence of the deductions drawn from natural crevasses.

As the discharge from these openings returns to the main trunk

lower down through the tributaries, where the confluence of waters further obstructs the flow and causes deposits, it is claimed that outlets would be harmful. But this is not the condition which would prevail if properly constructed weirs and regulating works were placed so as to permit the discharge of a portion of the excess of the floods into suitably located impounding reservoirs, remote from the erosive action of the river currents. It is also claimed that the navigable channel would be injured by the reduction of volume below the crevasses and that the bed would rise in consequence thereof. This conclusion does not appear to be sustained either in theory or practice. On this point Generals Humphreys and Abbot state (page 387, *Physics and Hydraulics*), under the head of "Outlets": "This plan consists in reducing the flood discharge by waste-weirs and conveying the surplus water to the Gulf by channels other than that of the main river. The advantages of this system have been stoutly contested by many writers, on the ground that reducing the discharge of the Mississippi will occasion deposits in its channel, and eventually elevate rather than depress the surface of the river." In support of this opinion they have urged first that actual measurements upon the river at certain crevasses prove that deposits are made when the velocity is thus checked, and, second, that theoretical reasoning indicates that such deposits ought to be anticipated.

"Certain operations of this survey were conducted with especial reference to determine the effects of outlets, and they demonstrate, with a degree of certainty rarely to be attained in such investigations, that the opinions advanced by these writers are totally erroneous."

The report then analyzes the two cases cited in proof of the assertion, viz., the Fortier crevasse of April, 1849, and that of Bonnet-Carré of 1850, and shows that the phenomena attributed to the breaches were those ordinarily found to result from bends and straight reaches, and that in fact even in a natural crevasse there was no bar formed below such opening in the banks, and that "the assertions to the contrary are erroneous." They add: "There is no evidence whatever that any filling up of the bed ever did occur in consequence of a high-water outlet, and, moreover, it is impossible that it ever should occur, either from the deposition of sediment held in suspension or drifting along the bottom. The conclusion is then inevitable that, *so far as the river itself is concerned,*

*they are of great utility.* Few practical problems admit of so positive a solution."

Perhaps the best evidence on this much-mooted point will be found in the answer of Nature herself, so that an examination of the bed below the head of the distributaries will throw much light on the subject. Taking that portion of the delta below the Forts, which is in a state of nature and unleveed, it is observed that in the reverse curves swinging around these defenses, where the radii are but two and one and one-half miles, the greatest depths are thirty-one and twenty-nine fathoms respectively, due to the reaction of the sharp concave banks and the reduced width. As the radius lengthens to five miles the thalweg depths shoal to thirteen, twelve and eleven fathoms, and the river also widens gradually to the crevasse known as "The Jump," where the width exceeds a half mile and the depths increase to fifteen fathoms abreast of the opening, and to thirty-nine fathoms and "no bottom" at a quarter of a mile *lower down*, with over fifteen fathoms for several miles.

In this instance, therefore, the depth below the crevasse, instead of being less, is more than twice as great, and it is not due to local curvature but apparently to impact, due to the suction or set of the currents toward the right bank.

Continuing down stream as it widens out to a mile in breadth, the bed shoals to about six fathoms at the head of the Passes, which may be regarded as three crevasses, and yet it will be found that in each one of these distributaries the depths exceed those of the undivided stream. In the Pass à l'Outre it is twelve, in South Pass fifteen, and in Southwest Pass thirteen fathoms, with "no bottom," all at the points of incidence of the divided currents. Again in the Pass à l'Outre at the crevasse which formed in 1891, the depth abreast the opening is thirteen fathoms, and one mile below it is fourteen and one-half. This same stream again divides into two main branches, showing eight and one-quarter fathoms below the point of separation in the more direct channel, and eleven and one-half along the sharper concavity of the Southeast Pass, due to reaction of the bank. Without further elaboration, the same general results may be seen wherever a crevasse occurs, and there is no indication of shoaling due to the escape of the excess of the flood waters or loss of volume. On the other hand there is a very marked benefit observable in the relief afforded to the stream, for these openings enable it to discharge a large portion of its sediment beyond the banks

and out of the highway of commerce, which must otherwise be carried to the Gulf and be dropped directly across the channel, thus extending the trough, reducing the slope and increasing the height of the floods. In fact a former Chief Engineer of the State of Louisiana stated that the reason for selecting the Southwest Pass for improvement was because of its greater general depth, so that the shoaling which must result from the extension of the channel four miles by the two jetties would not so soon affect the navigable depths, in consequence of the contraction of the outlet.

As already stated, similar results have taken place in the South Pass above the jetties, where the fill in one place has exceeded forty feet. But these lateral outlets also play an important part in the reclamation of land, as well as in reducing floods and improving navigation, for by this method of hydraulic grading, without cost, large areas are gradually filled and converted into valuable plantations. The extent of these deposits may be roughly determined by a comparison of the United States Coast Survey charts of 1854 and 1884, from which it appears that the accretion to the land above water in the vicinity of the Bayou Grand Liard, Spanish Pass, Red Pass, Tiger Pass, Grand and William's Passes during the thirty years between the surveys amounted to about 113 square miles, or nearly 75,000 acres. At Cubit's Gap, where the river is straight and wide, the rate of deposit has also been considerable. This breach occurred in 1863, and within a few years an area of about eight square miles was raised above water; while a survey made by a Mr. Chucas Lewis in 1892 showed further deposits covering some forty-two square miles, which is already laid out (on paper), under the Government land system, into townships and sections.

A better idea of the extent of this contribution to the wealth of the nation may be obtained by computing the cost of securing it by the usual method of back-filling by the use of hydraulic dredging at, say, ten cents per cubic yard, and assuming the average depth to be nine feet. On this basis the total fill would aggregate some 400,000,000 cubic yards in the thirty years, or over 13,000,000 cubic yards per year. The total cost of securing this result by dredging, regardless of time, would therefore represent \$40,000,000 for this one crevasse.

At "The Jump," where 113 square miles were reclaimed in about thirty years, the cost would have been \$3,530,000 per annum if attempted by mechanical dredging, or \$105,000,000 for the entire

time (or over \$1,500 per acre), so that the cost would have been prohibitory. This one deposit, withdrawn from the river, averaged about 35,000,000 cubic yards annually; and as the total amount of sediment carried to the Gulf has been estimated by Humphreys and Abbot at 275,000,000 yards, it represents thirteen per cent. of the whole, while the annual deposit at Cubit's Gap is five per cent.,

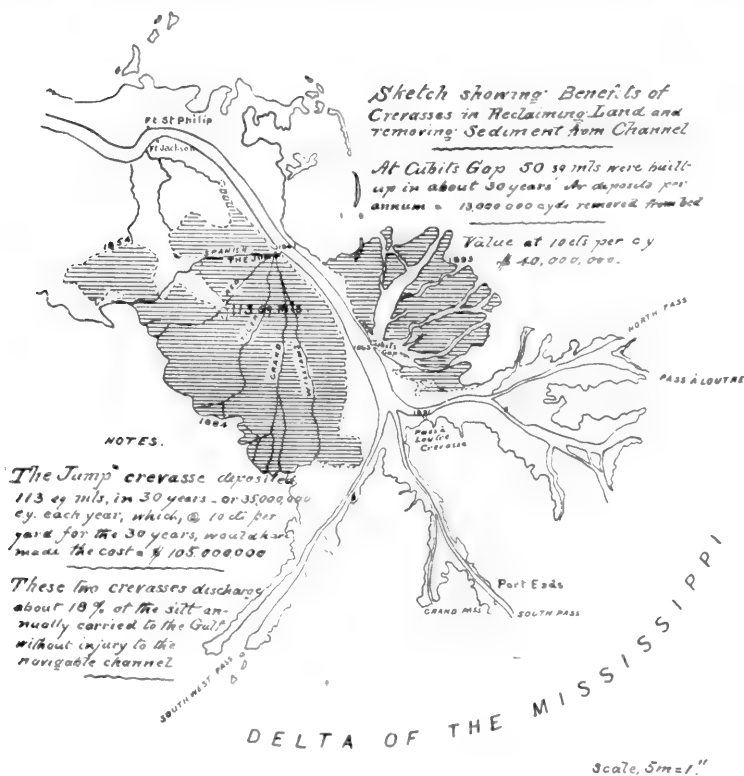

making about one-sixth of the sediment which is thus withdrawn by these crevasse, with consequent benefit to navigation, reduction of flood height and increase of the public domain, all without cost.<sup>1</sup>

It would therefore seem that these *lateral outlets* have very much

<sup>1</sup> The depth of three yards was obtained by taking the average of a number of soundings covering the areas filled up by the crevasse (8.7 ft.).

to commend them to the consideration not only of engineers but of economists, business men, farmers and real estate dealers; and that, so far as the evidence of nature goes, their operation is only beneficial and in no wise injurious. If they were closed and the river leveed, all of the advantages named would be destroyed and the sediment would be carried to the mouth, where it would extend the bars more rapidly, raise the flood plain and require elevation of the entire system of levees along the river banks.

But there is another class of outlets which may be considered in this connection, and that is the bars which obstruct the mouths and thus prevent the free discharge of the fluvial waters. These may be distinguished as *longitudinal outlets*, and their permanent removal is entirely practicable by applying the energy of the river to the work to be done.

It is a well known fact that a sedimentary stream, flowing through a straight reach, seldom maintains a single permanent channel, while in swinging around curves the concave bank, acting as the directrix, causes a reaction which deepens the bed and deposits the silt upon the complementary convex bank which is the resultant of this action.

In this way, by the operation of natural laws, the deposits are removed from the path of navigation and the cross-section is automatically adjusted to the requirements of the river. Instead, therefore, of building two parallel jetties as substitutes for the natural banks, and thus extending the river into the Gulf at the expense of its slope and the reduction of its area of discharge along straight lines, which are unnatural and unfavorable, it will be found more rational to build one curved training wall so placed as to create a head and reaction which will transport the silt to the opposite or convex bank, where it will be deposited without cost, leaving an ample navigable channel and saving the expense of one of the jetties, while it also scours away the bar directly in front of the mouth and affords an open passage for the effluent water.

By thus utilizing the tendency of water to flow in curved lines instead of straight ones half the cost of the jetty works may be saved and a better and more permanent channel be obtained, with a lowering of the flood heights of the river. This result is due to the form of the orifice, and it will be seen that when no such modification is applied the effluent stream is abruptly checked by the inertia of the Gulf water and the sediment thus deposited acts as a



buffer, to divide and deflect the energy into lateral components, which are again subdivided indefinitely, as shown in the typical forms of the deposits at Cubit's Gap; whereas when supported and concentrated by the continuous reaction of a properly placed resisting medium, the activity of the currents thus generated will prevent deposits near the trace of the work and create a neutral zone or counterscarp at some distance therefrom, which will thus become the site for the dump. These features may be observed wherever there are obstacles placed in the path of a current. The best artificial illustration of the efficacy of this principle as applied to a tidal inlet with a feeble tide is to be found at Aransas Pass, Tex.

The lowering of the flood plain by the removal of the barriers to the longitudinal discharge is also well illustrated by the operations on the River Tyne in England, where the flood heights have been reduced from nine to three feet along the stream by the opening of the mouth and removal of the bars from the bed.

Regardless, therefore, of the interests of navigation, it would be of great benefit to the State and nation to open the mouths of all the Passes for drainage and reclamation purposes, and by the use of the proper form of tool this could be accomplished more effectively and at less cost than by the methods now in vogue at the mouths of sedimentary rivers.

In the foregoing analysis it has been the intention to lay particular stress upon the necessity of so regulating the movements of the sediment as to prevent its being deposited in the pathway of the stream, where it may operate to obstruct its flow, causing elevation of bed, banks, levees and greater risks and expense; for it is evident that so long as the commingled earth and water are confined to the channel with no avenues of escape, the deposits must engorge the bed and involve continuous danger and expense.

It would seem that the attention of the engineering profession has been focussed mainly upon the control of the water, apart from its sediment, and with secondary consideration to the evils resulting from failure to separate these two elements, which, it is believed, may be done to great advantage at a number of points *en route* where lands may be reclaimed by the natural process of hydraulic grading, and large tracts of the richest arable land be recovered in a comparatively short time at a cost which will be insignificant as compared with that required to grade and drain it by mechanical means.

It is therefore desired to direct particular attention to the necessity of providing suitable dumping sites for the mud carried seaward by the river in times of flood, where it may be deposited beyond the banks of the stream without injury, through or over suitable weirs, and be retained by impounding dikes in the low swampy regions to their advantage.

The question is similar in its general features and effects to that prevailing at the inlets along alluvial coasts, where it was the practice to attempt the removal of the bars by jetties in pairs, supplemented by dredging; but which method has not been able to meet fully the demands of modern vessels, so that recourse is now being had to the control of the heavier earthy materials which compose these obstructions, in such manner as to protect the channels from their encroachments and cause the single concave jetty to construct and maintain much greater depths than exist in a state of nature.

---

*Stated Meeting, March 18, 1904.*

President SMITH in the Chair.

A letter was read from the Marquis de Nadaillac accepting his appointment as the Society's representative at the celebration of the Centenary of the Société Nationale des Antiquaires de France.

The decease was announced of William Marriott Canby, of Wilmington, Del., on March 10, 1904, æt. 73.

Prof. Felix E. Schelling read a paper on "The Academic Drama in the Age of Elizabeth and James."

PROCEEDINGS  
OF THE  
AMERICAN PHILOSOPHICAL SOCIETY  
HELD AT PHILADELPHIA  
FOR PROMOTING USEFUL KNOWLEDGE

---

VOL. XLIII.

APRIL, 1904.

No. 176.

---

*General Meeting, April 7, 8 and 9, 1904.*

APRIL 7.—MORNING SESSION, 10 A.M.

President SMITH in the Chair.

The President opened the General Meeting with a brief Address of Welcome.

A letter was received from the Committee of Organization of the Fourteenth International Congress of Americanists, to be held in Stuttgart, August 18 to 23, 1904, inviting the Society to be represented at the Congress by a delegate; and

Also from the International Zoological Congress, to be held at Berne, August 14 to 19, 1904, inviting the Society to be represented by delegates at the Congress.

On motion, the President was requested to appoint delegates to these Congresses.

From the President of the American Academy of Political and Social Science, inviting the members to attend the sessions of the Academy on April 8 and 9.

The following papers were read:

"Dimethyl Racemic Acid, Its Synthesis and Derivatives," by Prof. H. F. Keller, of Philadelphia. Discussed by Prof. George F. Barker.

"The Rôle of Carbon," by Prof. Albert B. Prescott, of Ann Arbor, Mich.

"Sources of Error in the Determination of the Atomic Weight of Nitrogen," by Prof. Theodore W. Richards, of Cambridge, Mass. Discussed by the President.

"The Constituents of the Venom of the Rattlesnake," by Prof. John Marshall, of Philadelphia. Discussed by Mr. Joseph Willcox, Prof. William B. Scott and Dr. Marshall.

"Trisulphoxyarsenic Acid," by Prof. LeRoy W. McCay, of Princeton.

"The Atomic Weight of Tungsten," by Prof. Edgar F. Smith and Mr. F. F. Exner, of Philadelphia. Discussed by Prof. Barker and Prof. E. J. Houston.

"The Expansion of Algebraic Functions at Singular Points," by Prof. Preston A. Lambert, of Bethlehem, Pa. Introduced by Prof. C. L. Doolittle.

#### AFTERNOON SESSION, 2 P.M.

Vice-President SCOTT in the Chair.

"The Continuum and the Theory of Masses," by Prof. I. J. Schwatt. Introduced by Prof. C. L. Doolittle.

"An Attempt to Correlate the Marine with the Fresh and Brackish Water Mesozoic Formations of the Middle West," by Prof. John B. Hatcher, of Pittsburg, Pa. Discussed by Profs. Osborn, Scott and Heilprin.

"The Miocene Rodentia of Patagonia," by Prof. William B. Scott, of Princeton, N. J. Discussed by Prof. Osborn.

"Recent Advances in Our Knowledge of the Evolution of the Horse," by Prof. Henry F. Osborn, of New York. Discussed by Profs. Conklin, Heilprin, Scott and Mr. Willcox.

"The Yukaghir Language," by Mr. Waldemar Joehelson, of New York. Introduced by Dr. Franz Boas. Discussed by Dr. Franz Boas.

"The Horizontal Plane of the Skull," by Dr. Franz Boas, of New York.

"The Silurian Fauna of Arkansas," by Mr. Gilbert van Ingen. Introduced by Prof. W. B. Scott.

"Palladium," by Mr. Joseph Wharton, of Philadelphia. Discussed by Mr. Willcox and Prof. Baskerville.

### EVENING SESSION, 8 P.M.

[At the Free Museum of Science and Art, University of Pennsylvania.]

President SMITH in the Chair.

The following paper was read:

"Pompeii and Saint Pierre: An Examination of the Plinian Narration, and Other Studies" (with lantern slide illustrations), by Prof. Angelo Heilprin, of Philadelphia.

### FRIDAY, APRIL 8.—MORNING SESSION, 10 A.M.

Vice-President BARKER in the Chair.

The following papers were read:

"The Reflex Zenith Tube," by Prof. Charles L. Doolittle, of Philadelphia. Discussed by Prof. Snyder and Dr. Brashear.

"Faint Double Stars," by Mr. Eric Doolittle, of Philadelphia.

"On the Spectra and General Nature of Temporary Stars," by Prof. William W. Campbell, of Mt. Hamilton, Cal. Discussed by Dr. Brashear and Dr. Barker.

"Systems of  $n$  Peripleigmatic Orbits," by Prof. Edgar Odell Lovett, of Princeton. Introduced by Prof. C. L. Doolittle.

"Radium from American Ores," by Prof. A. H. Phillips, of Princeton, N. J. Discussed by Mr. Joseph Wharton and Profs. Barker and Phillips.

## EXECUTIVE SESSION, 12.15 P.M.

President SMITH in the Chair.

The report of the Committee appointed to prepare a plan for the appropriate celebration of the bi-centennial of the birth of Benjamin Franklin was presented, and on motion the Committee was continued with power to carry out the plan.

The pending nominations for membership were read and the Society proceeded to an election.

## AFTERNOON SESSION, 2 P.M.

President SMITH in the Chair.

The Tellers reported that the following candidates had been elected to membership:

*Residents of the United States—*

Maurice Bloomfield, Ph.D., LL.D., Baltimore.

Henry Pickering Bowditch, M.D., LL.D., Sc.D., Jamaica Plains, Mass.

Edward Potts Cheyney, A.M., Philadelphia.

Russell H. Chittenden, Ph.D., New Haven.

Frank Wigglesworth Clarke, S.B., Sc.D., Washington.

John Chalmers DaCosta, M.D., Philadelphia.

Kuno Francke, Ph.D., Cambridge, Mass.

Adolphus W. Greely, U.S.A., Washington.

Preston Albert Lambert, Bethlehem, Pa.

Edgar Odell Lovett, Ph.D., LL.D., Princeton.

Edward Leamington Nichols, Ph.D., Ithaca.

Hon. Theodore Roosevelt, Washington.

Samuel W. Stratton, Washington.

Harvey W. Wiley, A.M., M.D., LL.D., Washington.

*Foreign residents—*

Friedrich Delitzsch, Berlin.

Sir Richard C. Jebb, Cambridge.

Ernest Rutherford, Montreal.

Jakob Heinrich Van't Hoff, Berlin.

Wilhelm Waldeyer, Berlin.

The following papers were read:

"A System of Passenger Car Ventilation," by Dr. Charles B. Dudley, of Altoona, Pa. Discussed by Mr. Willcox, Dr. Marshall and Prof. Heilprin.

"Atmospheric Nucleation," by Prof. Carl Barus, of Providence, R. I. Discussed by Profs. Kraemer, Conklin and Snyder.

"On the Classification of Meteorites," by Dr. Aristides Brezina, of Vienna.

"Doliolum and Salpa," by Prof. William Keith Brooks, of Baltimore. Discussed by Prof. Conklin.

"On the Breeding Habits of the Spade-Foot Toad (*Scaphiopus solitarius*)," by Dr. Charles Conrad Abbott, of Trenton, N. J.

"On the Occurrence of Artifacts Beneath a Deposit of Clay," by Dr. Charles Conrad Abbott, of Trenton, N. J.

"The Organization of the Germ Cells and Its Bearings on Evolution," by Prof. Edwin Grant Conklin, of Philadelphia.

"The Origin and Nature of Color in Plants," by Prof. Henry Kraemer, of Philadelphia.

SATURDAY, APRIL 9.—MORNING SESSION, 10 A.M.

President SMITH in the Chair.

"The Establishment of Game Refuges in the United States Forest Reserves," by Mr. Alden Sampson, of Haverford, Pa. Discussed by Profs. Morse and Hewett, Dr. Brashear and the President.

"The Use of the Relative Pronouns in Standard English Writers," by Prof. Waterman T. Hewett, of Ithaca, N. Y.

Discussed by Dr. Brashear, Prof. Morse, Mr. Yarnall and Prof. Hewett.

"The Effect of the American Revolution Upon the English Colonial System," by Mr. Sydney George Fisher, of Philadelphia. Discussed by Mr. Stuart Wood.

"The Hedonic Postulate," by Prof. Lindley M. Keasbey, of Bryn Mawr, Pa. Discussed by Mr. Stuart Wood, Prof. Doolittle, Mr. Richard Wood and Prof. Keasbey.

"Results of the American Ethnographical Survey," by Prof. Marion D. Learned, of Philadelphia. Discussed by Mr. Rosengarten, Mr. Richard Wood and Mr. R. P. Field.

"Regulation of Color-Signals in Marine and Naval Service," by Dr. Charles A. Oliver, of Philadelphia.

"The Ripening of Thoughts in Common," by Prof. Otis T. Mason, of Washington.

---

## THE RÔLE OF CARBON.

BY ALBERT B. PRESCOTT.

(*Read April 7, 1904.*)

It may be said of any one of the chemical elements that it acts a part of its own in the formation of matter and the manifestation of energy in the world. A chemical element taken as it is, aside from questions of its genesis and its decay, stands out before exact measurement as an innate individual factor in the production of things throughout the universe. Whatever there is now being brought to light between matter and the ether or the electrons, at all events the chemical elements taken in their atomic quantities are the present facts upon which further inquiry must rest its advances.

The behavior of an element is an experimental constant, however progressive may be the theories by means of which men of science may pursue their studies. The present is for some reasons a time profitable for us to recount certain of the salient characteristics of that chemical element named at the head of this brief paper.

The registration of carbon compounds in M. M. Richter's *Lexicon*, amounting to 80,000 in the year 1900 and since increased by



the addition of two supplements, presents for our consideration something besides the choice of man in the direction of his chemical research. These advancing thousands of individual combinations, of determinate molecular weight and fixed elemental composition, give us evidence of the chemical productivity of carbon and of its character in relation to the other elements.

We need to keep before us the place of carbon among its relatives in the periodic system. Central as it is in its electric polarity and in the order of its valence, the leading member of a group holding an equilibrium among the other groups, its place is that of a balance of power. But an element, preëminently this element, is more than the occupant of a place, more than a mere number in a progressive system, a mere function of a weight; it is all of these perhaps, but if so it is more: it is an individual. Carbon is not wholly exceptional, however, neither in the sense of an entire lack of the variability of neighboring elements, nor in that of being the only one whose atoms can at all unite to each other in the formation of chains. It is by virtue of both its central position and its independent character that it appears, when in combination, as the element in command.

We must recognize the fact, without explanation, that the unusual ability of carbon to unite its atoms in chains is dependent upon their union with hydrogen, whose aid is thereby indispensable to the organic world. Carbon is formed for complexity only when supported by the unvarying unity of hydrogen, and by this support is provided the great capacity of carbon for extensive molecular structure.

The science of chemistry, and therefrom all physical science, has been enriched by experimental studies of molecular constitution. These are studies of determinate facts, and it is but a consistent expression of these facts that is undertaken in structural formulæ or even in the atomic theory itself, as used in the work of chemists. The several differences, for instance, between dimethyl ether and ethyl alcohol, two individuals of the composition  $C_2H_6O$ , are differences of fact. We give statement in the figurative language of the structural formula and of the atomic theory to the actual nature of the one as an ether and of the other as an alcohol. It is a discovered truth that in the alcohol one-sixth of the hydrogen is united to the oxygen more intimately than the other five-sixths of the hydrogen are united to the oxygen. It is a truth that in the ether

the union of each sixth of the hydrogen to the unit of oxygen is the same. Were chemists to abandon structural formulæ, were they to go further and desert the atomic theory, all the facts heretofore communicated would remain to be told if possible in other terms to the eye and ear.

There has been some reaction against the devotion paid to molecular constitution, and there may well be a protest against certain besetting tendencies in the teaching of this subject. Both teacher and investigator ought to be on guard against the assertiveness of the structural formula. Let us welcome as a corrective the increasing service of empirical formulæ, the appearance of the formula index once a year in the journals, the constant uses of the *Lexicon of Carbon Compounds*, and the adoption of empirical formulæ frequently for summation and comparison as well as for contrast. Of course I refer only to these formulæ when of determined molecular weight, and we must recognize that no small share of the vantage ground in organic chemistry since 1890 is indebted to the new methods of molecular weight determination.

It is the nature of the carbon atom that has made attractive to chemists the work they have done upon molecular structure. It was long ago established that the character of a compound depends partly upon what elements unite to make it and partly upon the order of their union. No atom in a molecule is wholly without influence upon every other however remote. And as to the effect of any element in a compound, it is a fair conclusion that the numbers of its atoms within the molecule count for something, the relative position of its atoms may count for more, the structural concentration of its atoms will count for most.

When the nature of the proteids and other matters manifesting life shall become known we may be sure that molecular constitution will be included in that knowledge. We may be sure that the carbon atom, or some theoretical equivalent of what we now term the atom, will be a very determinate part of the question. This is not to say that chemical synthesis alone can compass vitality, but rather that vitality must still depend upon the chemical constitution of the vitalized material. We cannot speak lightly of the limits of what may come to be defined as the molecule, or count confidently upon future restrictions of its extent. We may well admit, however, that the rim of the molecule wherever placed must continue to bound the province of chemical study.

*Ann Arbor, Mich., March 31, 1904.*

## DIMETHYL RACEMIC ACID: ITS SYNTHESIS AND DERIVATIVES.

BY HARRY F. KELLER AND PHILIP MAAS.

(*Read April 7, 1904.*)

In the course of an investigation on diacetyl, the simplest diketone of the aliphatic series, Fittig<sup>1</sup> and one of us obtained a crystallized acid of the composition  $C_6H_{10}O_6 + H_2O$ , which they recognized as a dimethyl derivative of racemic acid. Continuing the work on diacetyl, we prepared the diketone on a larger scale, and it occurred to us to utilize the accumulated residues for a more extended study of dimethyl racemic acid. In view of the close relationship and the striking resemblance which this compound bears to the tartaric acids, and of certain interesting questions which had been suggested in the original research, it seemed well worth while to take up this line of work. Unfortunately the time we could devote to it has been very limited, so that the results we have to present are somewhat fragmentary, and much remains to be done.

The conversion of diacetyl into the desired acid was effected by the same process as that employed by Strecker in his well-known synthesis of racemic acid, that is by successively treating the diketone with hydrocyanic and hydrochloric acids. Thus

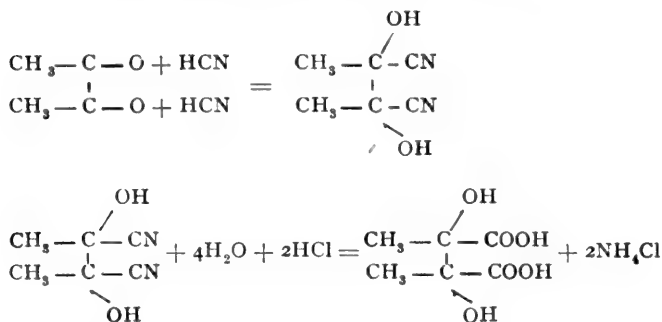

These reactions, consisting in the addition of hydrocyanic acid to an aldehyde or ketone, followed by "saponification" or hydrolysis of the resulting cyanhydrin, are regarded as generally applicable to aldehydes and ketones and are, of course, familiar to every

<sup>1</sup> Liebig's *Annalen der Chemie*, Vol. 249, p. 208.

student of organic chemistry. Nevertheless only meagre descriptions of the manner in which they have been applied in the various cases are to be found in the special literature of the subject, and no little difficulty was experienced in ascertaining the conditions favorable to the formation of the dicyanhydrin of diacetyl and its conversion into dimethyl racemic acid.

Numerous and varied were the attempts to effect a quantitative union of the diketone with hydrocyanic acid, but in no case did the yield of the dicyanhydrin exceed 30% of the theoretical. Large quantities of other products, among them the monocyanhydrin, were always formed. The method generally recommended, that of Wislicenus and Urech,<sup>1</sup> in which the compound containing the ketonic group, CO, is made to react with hydrocyanic acid in the nascent state, gave very poor results, and the only way in which larger quantities of the desired product could be obtained, was that originally used by Fittig and Keller.

It consists in mixing diacetyl with aqueous hydrocyanic acid. The best results were obtained by adhering to the following directions: The diketone in portions of about 20 grammes is gradually added to a 30% solution of hydrocyanic acid, the heat of the reaction being checked by cooling with water. The mixture is then placed into a pressure bottle and heated in the water bath at about 60° for some hours. The product of the reaction may now be extracted with ether (in which it is quite soluble), or it may be directly converted into dimethyl racemic acid by treating the solution with hydrochloric acid. The former seems preferable, since it facilitates the purification of the final product.

The saponification of the crystallized dicyanhydrin presents no difficulties. Recent experiments have shown that it proceeds rapidly and nearly quantitatively, when the substance is heated with ordinary hydrochloric acid *under pressure* at 100°. After removing the excess of hydrochloric acid by evaporation on the water bath, the residue, containing much ammonium chloride and some tarry matter, is dissolved in water, the solution filtered, and the filtrate carefully neutralized with baryta water. It is then boiled with further additions of baryta (to decompose the ammonium chloride), and allowed to stand after having been made slightly acid with acetic acid; barium dimethyl racemate separates as a

<sup>1</sup> Liebig's *Annalen der Chemie*, Vol. 164, p. 255.

characteristic crystalline precipitate. Its separation may be promoted by the introduction of a few particles of the solid salt.

The free acid is readily obtained from this barium salt by means of sulphuric acid. The theoretical quantity of the latter, diluted with water, is added to the finely powdered substance, and the mixture heated with occasional stirring. When the decomposition appears complete, the barium sulphate formed is filtered off, and the filtered solution evaporated to crystallization. The dimethyl racemic acid thus prepared generally forms large transparent crystals, and is easily purified by repeated crystallizations. This process of extracting the dimethyl racemic acid from the products of the action of hydrochloric acid and diacetyl dicyanhydrin, is more convenient and gives a better yield than that described by Fittig and Keller. More than 60 grammes of material have been made by its means.

*Properties of Dimethyl Racemic Acid.*—The physical properties of the acid have been accurately described by its discoverers, and little can be added here to their description. Although remarkably fine crystals have been repeatedly obtained, a definite determination of their form remains to be made. There is reason, however, for believing that racemic acid is *not* isomorphous with its dimethyl derivative. Contrary also to a previous statement, it has been observed that when crystals of dimethyl racemic acid are kept for a long time they *do* effloresce, though far more slowly than those of racemic acid.

The water of crystallization is completely expelled at  $105^{\circ}$ , redeterminations of its amount gave 9.05% and 9.12%; theory requires 9.18%. Above  $110^{\circ}$  there is a further loss of weight, owing no doubt to a slow decomposition of the molecule.

The solution of dimethyl racemic acid in water, like that of other synthetic compounds containing assymetric carbon atoms, is optically inactive.

*Salts of Dimethyl Racemic Acid.*—With the very limited amount of acid at their disposal, Fittig and Keller were able to prepare but a small number of the salts, and three of these only were obtained in a pure state and in quantities sufficient to permit analytical determinations. The data thus secured were, however, sufficient to confirm the composition of their acid, and to establish its close analogy with the tartaric acids. At the same time certain anomalies in the composition and some of the properties of the dim-

ethyl racemates were observed, which rendered a more elaborate study of these salts desirable. This was the object in the experiments recorded on the following pages.

The neutral salts of sodium, potassium and ammonium, which are very soluble in water, were made by neutralizing weighed portions of the acid with calculated quantities of the alkaline carbonates or ammonia, and evaporating to crystallization.

*Sodium dimethyl racemate*,  $C_6H_8O_6Na_2 + 4H_2O$ , forms minute, efflorescent needles. A freshly prepared specimen yielded 23.85% of water, while two others which had been exposed to the air for some time, gave 17.65% and 16.14% respectively. Theory requires 24.48%. The amount of sodium in the anhydrous salt was—

	<i>Required.</i>	<i>Found.</i>
Na.....	20.72%	20.75%

Both the *neutral* and the highly characteristic *acid potassium salt* have been previously described. A new determination of the potassium contents of the latter gave 17.87%, instead of 18.05% required.

The "Rochelle Salt" of dimethyl racemic acid appears to have the composition  $C_6H_8O_6KNa + 2H_2O$ . Its preparation and analysis were attended with many difficulties. On neutralizing the acid potassium salt with sodium carbonate and carefully evaporating the solution, a homogeneous crop of crystals was obtained, but on further evaporation the liquid deposited a mixture of efflorescent prisms and wart-like aggregations of clear anhydrous crystals. An analysis of the first product yielded—

	<i>Required.</i>	<i>Found.</i>
H <sub>2</sub> O.....	13.14%	12.00%
K (calculated for anhydrous compound) .....	16.25 "	16.12 "
Na " " " .....	9.58 "	9.49 "

Unlike the salts of the alkali metals, those of the alkaline earth and heavy metals are insoluble or nearly insoluble in water, though in a few instances they are difficult to precipitate. Many of the insoluble salts contain water of crystallization, which they tenaciously retain at high temperatures. In some cases the composition corresponds to that of the racemate, in others there are notable differences both in composition and properties.

The *calcium salt* which, owing to its great insolubility, was recommended by Fittig and Keller as the most delicate means of

recognizing the presence of dimethyl racemic acid, is at once precipitated when calcium acetate or gypsum solution is added to that of one of the soluble salts. It may be obtained in a crystalline form by dissolving it in hydrochloric acid and reprecipitating with sodium acetate. Its composition varies considerably according to the conditions under which it is formed. The water of crystallization is not completely expelled below  $215^{\circ}$ , a temperature just below incipient decomposition. The following are a few of the analyses made of this salt:

	<i>Required.</i>		<i>Found.</i>		
	1 mol. H <sub>2</sub> O	1½ mol. H <sub>2</sub> O	I.	II.	III.
H <sub>2</sub> O.....	7.65%	11.11%	7.38%	....	11.39%
Ca.....	17.05 "	16.46 "	17.20 "	16.12	16.33 "

The *barium salt*, C<sub>6</sub>H<sub>8</sub>O<sub>6</sub> Ba + 2 H<sub>2</sub>O, shows a remarkable resemblance to the corresponding racemate, from which it differs, however, in that it contains one-half molecule less of water of crystallization. This point has been established by comparative analyses of both compounds. The results were—

	<i>Racemate.</i>		<i>Dimethyl racemate.</i>		
	<i>Required.</i>	<i>Found.</i>	<i>Required.</i>	<i>Found.</i>	
H <sub>2</sub> O ....	13.64%	13.52%	10.32%	10.12%	10.42%
Ba.....	41.40 "	41.10 "	39.25 "	39.14 "	39.16 "

*Magnesium salt*, C<sub>6</sub>H<sub>8</sub>O<sub>6</sub>Mg + H<sub>2</sub>O. A white bulky precipitate. The air-dried substance gave—

	<i>Required.</i>	<i>Found.</i>
H <sub>2</sub> O.....	8.25%	7.06%
Mg.....	11.01 "	10.95 "

*Manganese salt*, C<sub>6</sub>H<sub>8</sub>O<sub>6</sub>Mn + ½H<sub>2</sub>O. Forms a crystalline precipitate having a faint pink tint. The formula is derived from these results:

	<i>Calculated.</i>	<i>Found.</i>
H <sub>2</sub> O.....	3.75%	3.72%
Mn.....	22.91 "	22.97 "

The *zinc salt*, C<sub>6</sub>H<sub>8</sub>O<sub>6</sub>Zn + H<sub>2</sub>O, is obtained as a granular, white precipitate when zinc acetate is added to an alkaline salt of dimethyl racemic acid. It is almost insoluble in water and in dilute acetic acid. Determinations of the water of crystallization

in different preparations of the salt indicate that it can crystallize with either one-half mol. or one mol. of water. One specimen yielded 3.76% and 3.55% H<sub>2</sub>O (3.60% corresponding to ½ mol.), while the analysis of another gave these results :

	<i>Calculated.</i>	<i>Found.</i>
H <sub>2</sub> O .....	6.95%	6.87%
Zn.....	25.18 "	25.26 "

Several attempts to estimate the zinc electrolytically gave lower results, it being found impossible to effect a complete deposition of the metal from a cyanide solution of the salt.

*Cobalt and nickel salts.* A curious difference was repeatedly noticed in the way in which these compounds separated from the solutions in which they were formed. The cobalt salt is invariably precipitated in the cold, and nearly quantitatively, from the liquid, while the solution in which the nickel compound is formed remains perfectly clear for days or weeks even, until it is heated or evaporated; a precipitate or residue is then formed which is about as insoluble as the cobalt compound. Both salts deposit as crystalline crusts; the color of the cobalt salt is a fine purple, that of the nickel salt apple-green. Both contain one molecule of water of crystallization, and their compositions correspond to the formulæ C<sub>6</sub>H<sub>8</sub>O<sub>6</sub>Co + H<sub>2</sub>O and C<sub>6</sub>H<sub>8</sub>O<sub>6</sub>Ni + H<sub>2</sub>O.

	<i>Calculated.</i>	<i>Found.</i>
H <sub>2</sub> O .....	7.11%	6.13% and 6.74%
Co.....	23.72 "	23.09 " 23.34 "
H <sub>2</sub> O .....	7.07 "	6.73 " 6.85 "
Ni.....	23.23 "	23.19 " 22.76 "

The metals were determined both as sulphates and electrolytically.

*Cadmium salt.* This is very similar to the zinc salt, but differs from the latter in being anhydrous. Its weight remains constant to above 160°. Its solution in potassium cyanide was electrolyzed without any difficulty, and the electrolytic determination was checked by one in which the cadmium was weighed as oxide.

	<i>Required.</i>	<i>Found.</i>	
		I.	II.
Cd .....	38.61%	39.20%	38.78%

*Lead salt, C<sub>6</sub>H<sub>8</sub>O<sub>6</sub>Pb + 2H<sub>2</sub>O.* In the earlier part of this investigation, considerable quantities of this compound were obtained as



an intermediate product in the preparation of pure dimethyl racemic acid. Its formation and properties have been described by Fittig and Keller, who were unable, however, to spare any of their material for analysis.

A carefully prepared specimen afforded the following determinations:

	<i>Required.</i>	<i>Found.</i>
H <sub>2</sub> O .....	8.59%	8.52%
Pb .....	49.40"	49.22"

The *copper salt* is anhydrous. When a solution of copper acetate is added to a soluble dimethyl racemate, the liquid remains perfectly clear, but on acidifying it with acetic acid, a light green amorphous precipitate is produced. It is probable, therefore, that this copper compound when first formed exists in the colloidal state. The weight of the air-dry salt remained constant on heating; it yielded—

	<i>Calculated.</i>	<i>Found.</i>
Cu .....	26.39%	26.49%

*Silver salt.* A voluminous and amorphous precipitate, which becomes denser on standing and darkens when exposed to light, results upon addition of silver nitrate to a neutral solution of the sodium salt. It is likewise anhydrous.

	<i>Calculated.</i>	<i>Found.</i>
Ag .....	55.10%	54.76% and 54.92%

When we compare the above results with the composition and properties of the corresponding tartrates, and more particularly the racemates, we are forced to admit that the acid obtained from diacetyl bears the closest resemblance to the group of isomeric compounds, of which it is the dimethyl derivative. Such differences as have been observed between dimethyl racemates and racemates are no greater (if indeed as great) than those known to exist among the salts of the several modifications of tartaric acid.

*Action of Heat upon Dimethyl Racemic Acid.*—It was noticed by Fittig and Keller that when the acid is heated to 178°–179° it melts with partial decomposition, and is completely volatilized, without charring, when the temperature is raised sufficiently.

Experiments, which have thus far been made on a small scale only, indicate the presence of at least one, and probably of two

acids among the volatile decomposition products. In one case a few grammes of the acid, contained in a miniature retort, were slowly heated in the paraffin bath, the volatile products being condensed in well-cooled tubes. Two distinct stages in the decomposition were observed. Just above the melting point the substance began to boil, giving off pungent-smelling vapors. The aqueous distillate had a strongly acid reaction, and on extracting it with ether and evaporating this solvent, a small quantity of needle-like crystals, having acid properties, was obtained. When the residue in the retort was heated to about  $250^{\circ}$ , renewed boiling, and more vigorous than before, took place. The distillate, which was of course separately collected, was oily and viscous, and was found to consist largely of an ether-soluble acid. It has not been prepared in sufficient quantity to permit an analysis. The ammonium salt crystallizes in little prisms, and its solution yields precipitates with calcium, barium, lead and silver salts. The lead salt deposits in beautiful stellated aggregates and seems very characteristic. The study of the decomposition products of dimethyl racemic acid will be continued as soon as enough of the starting material can be procured.

*Central High School, Philadelphia,*

*April 7, 1904.*

## TRISULPHOXYARSENIC ACID.

BY LEROY W. MCCAY.

(*Read April 7, 1904.*)

About eighteen years ago, in order to account for the irregularities accompanying the interaction of sulphuretted hydrogen and arsenic acid, I assumed the existence of three sulphoxyarsenic acids lying between arsenic and sulpharsenic acid:

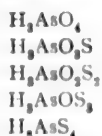

That the monosulphoxyarsenic acid can exist in the free state I showed in 1886. A few months later Preis, of the University of

Prag, established the existence of the disulphoxyarsenic acid, and recently Dr. William Foster, Jr., and I have succeeded in preparing several salts of the trisulphoxyarsenic acid. Ever since Preis discovered the disulphoxyarsenic acid I have been convinced that the trisulphoxy-compound existed, and since it was the only acid necessary to complete the series, a great deal of experimental work was undertaken in order to isolate it.

Dr. Foster<sup>1</sup> published recently the results of an elaborate investigation of the action of magnesium oxide on a mixture of equivalent amounts of arsenic trisulphide and sulphur suspended in water, it being hoped that during the reaction the magnesium salt of the acid would be formed in sufficient amounts to make possible its transformation into the corresponding sodium salt, and the separation of this by means of alcohol. His work has served to clear up many matters bearing on the modes of formation of the sulphoxy-compounds; and although no perfectly consistent results were reached, sodium salts were prepared again and again whose composition approached so closely to one corresponding to the formula  $\text{Na}_3\text{AsOS}_3 + 11\text{H}_2\text{O}$  that I felt convinced the substances were really impure tertiary sodium trisulphoxyarsenate.

A few preliminary experiments having established the fact that freshly precipitated arsenic pentasulphide suspended in water is decomposed far more readily by an excess of magnesium oxide than a mixture of equivalent amounts of arsenic trisulphide and sulphur, I suggested to Dr. Foster that we conjointly make a careful examination of the resulting solution. The proposal was a profitable one, for we find that the solution contains large quantities of magnesium trisulphoxyarsenate.

The magnesium salt of trisulphoxyarsenic acid, then, is formed when magnesium oxide in excess acts upon freshly prepared arsenic pentasulphide suspended in water kept during the entire reaction at  $0^\circ\text{C}$ . The change is rather slow, when the amount of arsenic pentasulphide is large, but it is generally complete in four to five hours.

By precipitating the magnesium in solution by means of sodium hydroxide, as magnesium hydroxide, adding an equal volume of alcohol to the filtrate from the magnesium oxide and hydroxide, and keeping the corked flask and its contents in the ice chest, the

<sup>1</sup> *Z. anorg. Chem.*, 37, 64 (1903).

tertiary sodium salt of the acid commences to separate out in feathery crystals which, in the course of twelve hours, pass over into fine fern-like forms. The compound is purified by recrystallization. The yields are very satisfactory. Thirty grams of  $\text{As}_2\text{S}_5$  yield about thirty grams of the impure salt.

The compound possesses a composition represented by the formula



	<i>Calculated.</i>	<i>Found.</i>
Na.....	15.22%	15.65%
As.....	16.50"	16.84 "
O.....	3.52"	3.45 "
S.....	21.16"	20.74 "
$\text{H}_2\text{O}$ .....	43.60"	43.32 "
	<hr/> 100.00	<hr/> 100.00

The tertiary potassium salt is prepared in an analogous manner. On the addition of the alcohol it separates out in the form of a light yellow oil, which, however, solidifies to a straw-colored, crystalline mass when kept for some hours at  $-20^\circ\text{C}$ .

It crystallizes with seven molecules of water :



By adding an alcoholic solution of strontium chloride to an aqueous solution of the sodium salt, the double trisulphoxyarsenate of sodium and strontium is precipitated in a crystalline condition :



Barium chloride produces in a solution of the tertiary potassium salt a crystalline precipitate of potassium barium trisulphoxyarsenate :



Aqueous solutions of sodium trisulphoxyarsenate are not precipitated by strontium chloride. This reaction has been made use of for separating the small amount of monosulphoxy-salt which is occasionally thrown down along with the trisulphoxy-compound. Barium chloride precipitates both the di- and trisulphoxyarsenic acids, but the barium salt of the latter acid is more soluble than that of the former. The behavior of these two acids toward hydrochloric acid is also a means of distinguishing between them.

If a dilute solution of sodium trisulphoxyarsenate be treated with enough acid to render it strongly acid, then shaken violently and filtered, the filtrate is clear and becomes but faintly turbid on boiling. If a dilute solution of sodium disulphoxyarsenate of the same concentration be tested in a similar way, the filtrate becomes strongly turbid on boiling. When these tests are made in flasks and the flasks, immediately after the addition of the hydrochloric acid, are stoppered, so as to prevent the escape of the sulphuretted hydrogen, at the end of thirty-six hours no smell of the gas can be detected in the flask which contained the disulphoxy-salt, while it is still very pronounced in the one which contained the trisulphoxy-compound. These two reactions have been studied very carefully. It appears that the trisulphoxy-acid breaks down as follows :

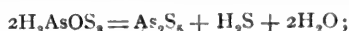

the disulphoxy-compound thus :



The three sulphoxyarsenic acids are not precipitated at once by Weinland's<sup>1</sup> reagent, which fact serves to distinguish them from sulpharsenic acid. All three can be readily separated from arsenic acid by means of magnesia mixture which precipitates only the latter. The formation of these three sulphoxyarsenic acids, their instability and the products of their decomposition, account in a perfectly rational manner for all the irregularities accompanying the interaction of sulphuretted hydrogen and arsenic acid. This is a summary of our work so far as it has thus far progressed.

*Princeton, N. J., April 4, 1904.*

<sup>1</sup> An aqueous solution of tartar emetic and Rochelle salt.

SOURCES OF ERROR IN THE DETERMINATION OF  
THE ATOMIC WEIGHT OF NITROGEN.

(Contribution from the Chemical Laboratory of Harvard College.)

BY THEODORE WILLIAM RICHARDS.

*(Read April 7, 1904.)*

The combining weight of nitrogen presents a problem of unusual interest, because of the uncertainty which still clings to it, in spite of the careful work of some of the most accurate of chemical experimenters. Uncertainty of this kind implies a lack of comprehension of some unknown variable or variables, and it is always possible that the determination of these variables may lead to the discovery of some new important fact or principle. Thus the accurate work of Lord Rayleigh in demonstrating that the less active gases of the atmosphere are somewhat heavier than pure nitrogen, led to the discovery of argon and the other inert gases.

The data for computing the atomic weight of nitrogen are manifold, because nitrogen enters into many well-defined compounds. Unfortunately, however, it is always necessary to find the weight of the nitrogen indirectly. The most extended series of experiments was instituted by the great Belgian chemist Stas, who attacked the problem in various ways, converting silver into the nitrate, converting this nitrate into chloride, converting the nitrates of potassium and sodium into chlorides, and comparing ammoniac chloride and bromide with pure silver. The average results of these experiments have been variously computed, the extreme estimates of the atomic weight of nitrogen ranging between 14.039 and 14.058 if the atomic oxygen is taken as 16.000.<sup>1</sup>

<sup>1</sup> The early work of Stas involving argentic chloride must all be rejected, because insufficient precautions were taken concerning its solubility. Among the other pertinent data obtained by him the following, easily traced in Clarke's convenient *Recalculation of the Atomic Weights* (1897), seem to me the most important.

( $O = 16.000$ ;  $A_g = 107.930$ ;  $Cl = 35.455$ ,  $H = 1.0076$ ,  $Br = 79.955$ )  
 100.000 parts of silver gave 157.478 of its nitrate. . . . .  $N = 14.036$   
 100.000 parts of silver correspond to 49.599 of ammoniac chloride. .  $N = 14.047$   
 100.000 parts of silver correspond to 90.830 of ammoniac bromide. .  $N = 14.048$   
 Difference between molecular weights of alkaline nitrates and  
 chlorides = 26.589. . . . .  $N = 14.043$   
 Marignac's work on argentic chloride and nitrate leads to a much lower value

Stas himself concluded from these results that nitrogen was almost certainly higher than 14.03, and probably about 14.045, basing his conclusion upon a somewhat doubtful application of the theory of least squares.<sup>1</sup>

In spite of the great care taken by Stas in this unusually extended investigation, it is of course not impossible that small constant errors might have existed in parts of the work. Stas was by no means infallible; his long oversight of the solubility of argentic chloride, the uncertainty concerning the amount of oxygen occluded by his silver, and his frequent use of glass vessels somewhat attacked by his reagents for long-continued operations, being among the evidences that he too was mortal. Nevertheless, it is true that Stas was more precise than any one who preceded him; and his results cannot be overthrown without much conclusive experimental evidence.

Three years ago the accuracy of one of these series<sup>2</sup> of experiments made by Stas was impugned by Alexander Scott, namely, the series in which ammoniac bromide was compared with silver. The atomic weight is computed from the result of these experiments by subtracting the weight of the bromine precipitated as silver bromide from the weight of the ammonium bromide, in order to find the weight of ammonium present. Because the bromine is equivalent to the silver, the ammonium previously united to the bromine must also be equivalent, and upon assuming the atomic weight of silver to be 107.93, the molecular weight of ammonium is easily found to be 18.078. Subtracting from this four times the atomic weight of hydrogen, that of nitrogen remains—namely, 14.048—because ammonium consists solely of nitrogen and hydrogen.

Now Scott contended, with plausibility, that this particular specimen of ammonium contained impurities, substances other than nitrogen and hydrogen, because Stas admits that his bromide was not perfectly colorless.

These impurities would all be included in the estimate of the

---

for nitrogen (14.01 to 14.02), a discrepancy which it is not easy to explain, unless the chloride was precipitated from a solution so concentrated as to occlude nitrate. The lack of details in his description makes it impossible to decide this question.

<sup>1</sup> Stas, *Untersuchungen* (Aronstein), p. 322 (1867).

<sup>2</sup> *J. Chem. Soc. Trans.*, 79, 147 (1901).

weight of the nitrogen, since this is merely the remainder left after subtracting that of the bromine and the hydrogen. Hence, Stas's estimate of the atomic weight of nitrogen is probably too high—how much too high it is impossible at once to decide. Some of the possible impurities have so powerful a color that an inappreciable weight of them might darken visibly an otherwise pure sample of salt; but an inappreciable weight could not affect the combining proportion, hence the error may be negligible.

In any case it is obviously well that Stas's experiments on ammoniac bromide should be verified; and the repetition was undertaken by Scott. His ammonium preparation was purified, as he states, by drastic methods, and was beautifully clear and colorless. There is little doubt that, so far as the ammonium was concerned, the salt was purer than Stas's. Unfortunately, however, in his anxiety to purify the ammonium, Scott evidently neglected to purify adequately the bromine which he combined with it. His own results prove this fact indubitably, for he found on the average<sup>1</sup> that 107.93 parts of silver combined with only 79.943 parts of his bromine,<sup>2</sup> a figure perceptibly lower than the most probable value, 79.955. This latter value, computed from Stas's work, has been repeatedly verified in the Chemical Laboratory of Harvard College during the last twelve years with only very slight variations. In order to show how definite the figure is, there is given below a table of all our most refined recent work on this ratio.<sup>3</sup>

<sup>1</sup> Neglecting one imperfect experiment, *J. Chem. Soc. Trans.*, 79, 147 (1901).

<sup>2</sup> Even this weight of bromine may have been too high, since Scott apparently overlooked the danger of the inclusion of water by the argentic bromide (*Proc. Am. Phil. Soc.*, 1903, 28). The fused substance is the only safe standard of reference. In this connection it should be noted that an impurity in Scott's silver would have caused an error in the same direction. Scott seems to have taken more pains with his silver than with his bromine, although indeed he condemns on the basis of a single analysis a method of fusing it which many others have found satisfactory (*J. Chem. Soc. Trans.*, 79, 15, 1901).

<sup>3</sup> Clarke's similar table, *Recalc.*, p. 46 (1897), is necessarily incomplete and includes some imperfect preliminary results, besides containing several minor mistakes in calculation.



Compound containing Bromine analyzed.	No. of experiments.	Analyst.	Reference Proc. Am. Acad.	Per cent. of silver in AgBr.
BaBr <sub>2</sub> .....	Last seven	Richards	28, 28, 29	57.444
SrBr <sub>2</sub> .....	Seven	"	30, 389	57.444
ZnBr <sub>2</sub> .....	Last series	"	31, 178	57.445
NiBr <sub>2</sub> .....	Last seven	Cushman	33, 111	57.444
CoBr <sub>2</sub> .....	Last five	Baxter	33, 127	57.446
UBr <sub>4</sub> .....	Three	Merigold	37, 393	57.447
HBr.....	Two	Richards	28, 17	57.445
".....	One	"	30, 380	57.446
".....	Two	"	31, 165	57.444
".....	One	Cushman	33, 106	57.445
".....	One	Baxter	33, 122	57.444
".....	Two	Baxter	34, 353	57.447
Average.....	.....	.....	.....	57.445 <sup>1</sup>

This percentage of silver in argentic bromide corresponds to an atomic weight of 79.954 for bromine, if silver is taken as 107.93; and in my opinion this value is if anything rather too low than too high, because most of the probable errors tend to diminish it.

This value agrees almost exactly with that of Stas's work, and hence there seems little room for doubt that if silver is 107.93 bromine is between 79.95 and 79.96. Therefore Scott's bromine (79.943) must have been impure, probably containing chlorine, which is not easy to eliminate. It is also possible that the argentic bromide was precipitated from too concentrated a solution and hence contained nitrate. This error would have affected the result in the same way.

If there were no error in determining the amount of silver needed for the precipitation, it would be easy nevertheless to correct for this impurity of the bromine in the following way. Scott found that 107.93 parts of silver corresponded to 97.995 parts of ammoniac halide and 79.943 parts of halogen. By subtracting the last figure from the one preceding it the molecular weight of ammonium is found, independent of the nature of the halogen, to be 18.052, and hence that of nitrogen 14.022. This value is considerably higher than that calculated by Scott on the assumption that his ammoniac bromide was perfectly pure. Unfortunately, however, the presence of chlorine in the salt, by introducing the partly soluble argentic chloride, complicates both the determination of the amount of silver required for the precipitation and the collection of the salt of

silver for weighing. Scott seems to have taken no especial precautions as regards either of these complications, hence the possible error of his work, even when corrected in the manner described above, is as great as the difference between his work and that of Stas. Thus it cannot be said to militate against that work, except in pointing out that it is possible to obtain colorless ammoniac bromide.

Scott also performed two analyses of ammoniac chloride, which gave a result (14.031) more nearly like that of Stas than that from the bromide, but likewise somewhat lower. Since the analyses are hardly numerous enough to be conclusive, and since no especial pains seems to have been taken to prevent the injurious effect of the solubility of argentic chloride or the inclusion of argentic nitrate in the precipitate, no further attention need be given to this result, although it must be considered as more satisfactory than the preceding work on the bromide.

No light is shed upon the doubtful situation by the conclusions of D. Berthelot<sup>1</sup> and of Leduc<sup>2</sup> concerning the density of nitrogen, since they depend upon the precise fulfillment of the rule of Avogadro, a generalization which is undoubtedly only an approximation.<sup>3</sup>

Other recently published results are recorded in the table below.

Thomsen ( <i>Zeitschr. Phys. Chem.</i> , 13, 398, 1894).....	14.021
Hardin ( <i>J. Am. Ch. Soc.</i> , 18, 990, 1896).....	14.01
Hibbs (Thesis, U. of Pa., 1896) .....	14.01
Dean ( <i>J. Chem. Soc. Trans.</i> , 77, 117, 1900).....	14.031
Ramsay and Aston ( <i>Gesell. d. Naturforscher und Aerzte, Allg. Th.</i> (1903) 8).....	13.903
Richards and Archibald ( <i>Proc. Am. Acad.</i> , 38, 469, 1903).....	14.039

Thomsen's result was obtained by weighing the hydrochloric acid and ammonia required to neutralize one another. In my recent experiments on the atomic weight of magnesium, in coöperation with Prof. H. G. Parker, it was found that hydrochloric acid gas is by no means easy to dry thoroughly. It is therefore not impossible that Thomsen weighed some water with his acid, thus causing the weight of ammonia, and hence of nitrogen, to appear too low.

<sup>1</sup> *Comp. Rend.*, 126, 954, 1030, 1415 and 1501 (1898).

<sup>2</sup> Leduc, *Comp. Rend.*, 125, 299 (1897).

<sup>3</sup> Ramsay and Steele, *Phil. Mag.*, Oct., 1903, p. 492.

Among the other investigations those of Hardin and Hibbs were very carefully carried out, but the quantities of material used were so small that these experiments could hardly be expected to determine accurately the second decimal place of the atomic weight. They each weighed portions of substance containing on the average only about 0.05 gram of nitrogen, and hence to be certain of a unit in the second decimal place of the atomic weights the weighing must be certain to within 0.00003 gram. Such precision is almost impossible when one is using a vessel weighing 71 grams, as Hardin did. Moreover, Hardin seems to have made no correction for the trace of electrolyte included in the film of silver which formed one of his standards of reference.

The work of Dean depended upon the volumetric analysis of argentic cyanide. The method of work was too indirect to carry great weight, even if volumetric analysis were at best a process accurate enough for the degree of precision needed.

The work of Sir William Ramsay and Miss Aston is interesting because it involved the analysis of unstable compounds of azoimide. The extraordinarily low result, a whole per cent. less than the usually accepted value, is not easily explained. The authors tentatively suggest once more the revolutionary assumption that the chemical combining proportions are not constant. This idea is by no means a new one, having been seriously advanced by J. P. Cooke in 1855<sup>1</sup> and again by Butlerov in 1882.<sup>2</sup> In both these older cases it is now fairly certain that there is no need of such an iconoclastic assumption; in Cooke's zinc antimonide crystals the solid solution of excess of antimony or zinc in the crystals was probably the cause of the observed irregularities, and in Butlerov's case the analytical data upon which the conclusions rested were probably faulty. Much more recently the experiments of Heydweiler have suggested that possibly a slight change in weight may take place during chemical reaction; but the changes which he observed are so small as to be of entirely another order from this deficiency of a whole per cent. in nitrogen. On studying Ramsay and Aston's work it seems not impossible that the hydrolysis and slightly reducing action of the weak and unstable nitrohydric acid,<sup>3</sup> may have caused a deficiency of nitrogen in the salts which they

<sup>1</sup> *Mem. Am. Acad.*, V, 23 (1855).

<sup>2</sup> *Chem. Centralblatt*, 1882, 740.

<sup>3</sup> Curtius and Radenhausen, *J. Pr. Chem.* (2), 43, 207 (1891).

analyzed, and thus may have led to an underestimate of its atomic weight. Nevertheless, the case is one of those exceptional ones which needs further investigation before it can be cast wholly aside.

At that time, by request of Sir William Ramsay, I made some preliminary experiments upon entirely a new method, namely, the conversion of sodic carbonate into nitrate. These led to a value at least 14.02 for the quantity in question, thus concurring rather with the usually accepted value than with the widely deviant results of the English experimenters. This work has not been completed, and therefore need not receive further discussion.

Still more recently, in connection with Dr. E. H. Archibald, still another method was tried with success.<sup>1</sup> The nitrates of potassium and cæsium were decomposed by finely divided pure silica, the nitric acid being completely expelled. If the atomic weights of these two metals are assumed to be respectively 39.139 and 132.879 (values calculated from other accurate data), that of nitrogen is found to be in the two cases respectively 14.037 and 14.040, in good confirmation of the work of Stas upon the nitrates. Viewed as a means of determining the atomic weight of nitrogen, these analyses must nevertheless be regarded as preliminary, since hardly large enough quantities of material were taken to attain the best results, although indeed the average amount of nitrogen weighed was ten times as great as that weighed by some of the previously mentioned experimenters. The real purpose in this case was to determine the atomic weight of cæsium by a wholly new method, assuming nitrogen to be known.

On considering all these data and their possible errors discussed above it seems probable that the atomic weight of nitrogen is not less than 14.02 and not over 14.04, probably being nearer to the latter value than to the former. The occasional wide deviations are not certain enough to demand the assumption of inconstancy in the atomic weights, or the necessity of disbelieving in the law of the conservation of weight; but the irregularities which exist are enough to point to the desirability of further investigation. Such investigation could hardly fail to yield an interesting outcome, since any uncomprehended relation in nature must be due to some fact or facts not hitherto recognized.

<sup>1</sup> Richards and Archibald, *Proc. Am. Acad.*, 38, 458 (1903).

## THE ATOMIC WEIGHT OF TUNGSTEN.

BY EDGAR F. SMITH AND FRANZ F. EXNER.

(Read April 7, 1904.)

## LITERATURE.

Berzelius, *Pogg. Ann.*, 8, 1 (1826); Schneider, *Jr. prakt. Chemie*, 50, 152 (1850); Marchand, *Ann. Chem. Pharm.*, 77, 261 (1851); Borch, *Jr. prakt. Chem.*, 54, 254 (1851); Riche, *Jr. prakt. Chem.*, 69, 10 (1857); Dumas, *Ann. Chem. Pharm.*, 113, 23 (1860); Bernoulli, *Pogg. Ann.*, 111, 573 (1860); Scheibler, *Jr. prakt. Chem.*, 83, 324 (1861); Roscoe, *Ann. Chem. Pharm.*, 162, 368 (1872); Waddell, *Am. Chem. Jr.*, 8, 280 (1886); Pennington and Smith, *Z. f. anorg. Chem.*, 8, 198 (1895); Smith and Desi, *Z. f. anorg. Chem.*, 8, 205 (1895); Shinn, Thesis, University of Penn'a (1896); Schneider, *Jr. prakt. Chem.*, 53, 283 (1896); Hardin, *Jr. Am. Chem. Soc.*, 19, 657 (1897); *ibid*, 21, 1017 (1899); Thomas, *Jr. Am. Chem. Soc.*, 21, 373 (1899); Taylor, Thesis, University of Penn'a (1901).

The literature pertaining to this subject covers a period of nearly three-quarters of a century. Eight different methods have been used in striving to solve the problem. They are:

## I. REDUCTION OF TUNGSTEN TRIOXIDE.

Berzelius (2).  
 Schneider (5).  
 Marchand (2).  
 Borch (7).  
 Dumas (8).  
 Bernoulli (6).  
 Persoz (2).  
 Roscoe (3).  
 Waddell (5).  
 Schneider (3).  
 Shinn (4).  
 Hardin (29).  
 A total of 78 reductions.

2. OXIDATION OF METAL.

Schneider (3).  
Marchand (2).  
Borch (2).  
Bernoulli (4).  
Roscoe (2).  
Pennington and Smith (9).  
Schneider (3).  
Hardin (37).  
A total of 62 oxidations.

3. WEIGHING THE WATER FROM THE REDUCTION OF TRIOXIDE.

Riche (2).  
Smith and Desi (6).

4. DETERMINATION OF THE WATER CONTENT OF BARIUM METATUNGSTATE.

Scheibler (5).  
Hardin (2).

5. ANALYSIS OF TUNGSTEN HEXACHLORIDE.

Roscoe (2).

6. ANALYSIS OF IRON TUNGSTATE.

Zettnow (4).

7. ANALYSIS OF SILVER TUNGSTATE.

Zettnow.

8. DETERMINATION OF THE WATER IN SODIUM TUNGSTATE.

Thomas (22).

The results obtained by the first and second methods are the most numerous. The frequent employment of these methods would indicate the opinion to be general that they are the most rational. This they are, notwithstanding the want of concordance evident in the work of all chemists who have pursued either one of these methods in the attempt to solve the existing problem. Their sufficiency has been doubted, especially by Hardin, working in this laboratory. He was disposed to attribute the lack of agreement in

his work to volatilization of substance, both in the experiments of reduction of trioxide and in those in which the metal had been oxidized. Hardin adopted the method of purification pursued by Pennington and Smith, and therefore believed that the material with which he operated was pure; hence the errors were the result of imperfections in the method employed.

Pennington and Smith, cognizant of the presence of molybdenum in the tungsten compounds, confirmed by numerous observations of others, were induced to undertake a solution of the difficulty surrounding the atomic weight of tungsten because they noticed in Schneider's communication, that when he reduced tungsten trioxide in a current of hydrogen "ein weissliches Sublimat" appeared on the anterior portion of the reduction tube, which sublimate Schneider thought was tungsten chloride, but which Pennington and Smith, in the light of the discovery of molybdenum in all tungstates, believed was due to the latter element. They accordingly purified a portion of tungsten trioxide by the plan recommended by Schneider and, after eliminating any possible molybdenum content, made tungsten metal and oxidized it. They gave as a result of their labors probably the most concordant series of figures ever published for the constant in question. The other striking feature of this series was their high value, namely 184.921. This was much higher than that generally considered to be the correct value. Its rise was supposed to be due to the complete removal of molybdenum. Let it be noted that Pennington and Smith used tungsten metal from trioxide reduced in a crucible of platinum, and further that they used the second method only.

The work of Smith and Desi, who used the third method, apparently confirmed the conclusions of Pennington and Smith. It may be said that the early work of Schneider, leading to the value 184, had been practically confirmed by subsequent investigators, so that the constant 184 had been looked upon for a period of forty-five years as the accepted atomic weight of tungsten. The experiments of Pennington, Smith and Desi could not fail to be regarded with some question notwithstanding the evident care exercised by them in preparing suitable material for their respective studies, and the conscientiousness to detail exhibited in the experimental work. Schneider was still living on the appearance of the communications just referred to and in letters to one of us, as well as in a public print, naturally took exception, in the most courteous man-

ner, to the methods and to the conclusions of those who advocated the higher value (184.92). It is not necessary here to enter into a detailed review of Schneider's second and later paper. Briefly, he very much doubted whether it was the complete removal of any molybdenum content from the tungstic acid which occasioned the rise in the atomic number. He also entertained grave doubts as to whether, in the methods employed, there were not sources of error which escaped these chemists. The small quantities of material used by Pennington, Smith and Desi were, in the opinion of Schneider, contributory sources of error.

The problem, attracting new attention to itself in this laboratory, led to further studies upon this subject, chief among which were the painstaking investigations of Hardin, extending over several years. Reference to these will show that few points of inquiry escaped this investigator, and one can readily comprehend the spirit which prompted him to say in his final contribution on this subject :

"So far as known there is no perfectly reliable method for the determination of this constant. The method of reduction and oxidation is probably more accurate than any of the other methods which have been employed. The results obtained by it vary about one unit and even more in exceptional cases."

In our frequent discussions on this topic, it did seem as if search for new methods was absolutely required ; that these alone might be expected to settle the difficulty once for all. Taylor, engaged at the time in this laboratory upon the ammonium tungstates, noticed that ignited tungsten trioxide, when dissolved in a solution of pure sodium carbonate, left a white flocculent residue. When dissolved in potassium hydroxide, this residue was not so evident, and in his thesis (University of Penn'a, 1901) he continues :

"On standing a few hours in sodium carbonate, this residue turned reddish-brown. On treatment with hot concentrated hydrochloric acid, it (having been previously washed) broke down into tungstic acid, and the filtrate contained the chlorides of iron and manganese. To ascertain if the original ammonium tungstate would reveal the presence of these impurities, it was dissolved in water, feebly acidulated with hydrochloric acid, and ammonium sulphocyanate added. No coloration was produced. Another portion of the solution was boiled with hydrochloric acid, the tungstic acid precipitated, and now the filtrate easily showed the presence of iron.

"The residue, insoluble in sodium carbonate, appears to be a tungstate of iron and manganese, which probably existed in the



ammonium salt, as an ammonium iron-manganese tungstate. Laurent<sup>1</sup> states that the mother liquor from ammonium tungstate contains such a salt. He ascribed to it the formula:  $[12(\text{NH}_4)_2\text{O}, 6\text{MnO}, 2\text{Fe}_2\text{O}_3, 3\text{H}_2\text{O}, 45\text{WO}_3, 81\text{H}_2\text{O}]$ .<sup>2</sup>

"Borch<sup>3</sup> analyzed this salt with the following results:  $\text{WO}_3$  84.4%,  $(\text{Fe}_2\text{O}_3 + \text{Mn}_2\text{O}_3)$  4.6%,  $\text{NH}_3$  4.0%,  $\text{H}_2\text{O}$  7%. Laurent states that this complex salt is soluble in water and ammonia, and is peculiar in that ordinary reagents do not show the presence of iron, manganese or tungstic acid; further, that the salt is only broken down by prolonged boiling in acids or alkalies, and then the ingredients can be readily detected.

"Schneider<sup>4</sup> recognized the presence of this salt in ammonium tungstate, and stated that it was not removed after five or six recrystallizations. Also that it could not be removed by the ammonium sulphide treatment, for slight amounts of the sulphides of iron and manganese are soluble in the tungsten sulpho-salt. Berzelius<sup>5</sup> stated that the sulphides of tungsten, iron and manganese form a compound which is partly soluble in water.

"To remove this complex salt Schneider, purified his material in the following way: Tungstic acid, obtained from the sulpho-salt of tungsten, was boiled in *aqua regia*, and washed in acidulated water till free from iron. This was dissolved in dilute ammonia, and the solution precipitated by boiling hydrochloric acid, the resulting tungstic acid boiled in *aqua regia* and again washed. This oxide was again dissolved in ammonia and again precipitated. After reprecipitating three times in this manner, tungsten trioxide was obtained free from iron. However, on dissolving the oxide in potassium hydroxide, a slight brown residue remained which had escaped all earlier tests. This he assumed was not enough to affect the result of his work.

"Had he applied the sodium carbonate test, this residue would have been larger. In the recent repetition of his work,<sup>6</sup> he used material purified in precisely the same manner (in fact some of the original material), with the exception of the treatment for the elimination of molybdic acid.

"Borch<sup>7</sup> recognized this complex salt, and tried to remove it by fusion with potassium carbonate.

"Later investigators seem not to have appreciated the difficulty of eliminating it. It crystallizes in part with the ammonium tungstate, and can scarcely be entirely removed by recrystallization.

<sup>1</sup> *J. prakt. Ch.*, 42, 126 (1847).

<sup>2</sup> *Comptes rendus*, 31, 693 (1850).

<sup>3</sup> *J. prakt. Ch.*, 54, 254 (1851).

<sup>4</sup> *J. prakt. Ch.*, 50, 152 (1850).

<sup>5</sup> *Pogg. Ann.*, 8, 279 (1826).

<sup>6</sup> *J. prakt. Ch.*, 161, 288 (1896).

<sup>7</sup> *J. prakt. Ch.*, 54, 254 (1851).

Ignition of the ammonium salt, and resolution in ammonium hydroxide will not eliminate it. Nor will ammonium sulphide remove it. In fact it seems likely that it has never been wholly extracted from any previous material.

"The purification by Pennington and Smith<sup>1</sup> did not remove it, for though closely following the method outlined by Schneider, and adding to it the complete elimination of molybdenum, they omitted the final repeated precipitations with acid.

"To understand the effect of possible impurity, the following table is given. A molecular mixture of tungsten and the impurity is treated as though it were all tungsten, and the resulting atomic weight calculated.

<i>Molecular Mixture.</i>	<i>Reduction Series Atomic Weight.</i>	<i>Oxidation Series Atomic Weight.</i>
W + W .....	184	184
W + Mo .....	140	140
W + 2Fe .....	148	148
W + 3MnO .....	298	298
Loss of Material .....	Low	High

"A consideration of these numbers shows that: molybdenum and iron would produce a low value; manganese a high value; volatility a low value on reduction and a high value on oxidation. The error introduced by manganese is more than three times as costly as that introduced by iron, and more than two and a half times that introduced by molybdenum. These ratios would apply regardless of the proportion of the mixture.

"From these considerations it is believed, that the presence of manganese and iron will account for the high oxidation values, for their presence would affect the result in a twofold manner: Manganese through its inherent molecular changes [ $Mn_2O_4 \leftarrow \rightarrow 3MnO$ ], and iron through its secondary action on the volatility. Further, that the presence of iron, molybdenum, manganese, and volatility will explain the numerous discrepancies noted in the published work on this subject. Again, since iron and molybdenum decrease the value, and manganese and volatility increase the value, and iron and molybdenum influence the volatility, it is quite possible that such a mixture of these factors might occur that the errors would be compensated.

"Viewed in this way there still remains the necessity for determinations with material from which every trace of molybdenum, iron, and manganese, together with other possible impurities, has been removed.

"The method of determining atomic weights from the loss of carbon dioxide has been applied to a number of the elements. Its application to tungsten, and the special modification of the method necessary for accurate determinations has not been before recorded.

<sup>1</sup> *Proc. Am. Philos. Soc.*, 33, 332 (1894).

Svanberg<sup>1</sup> and Struve fused molybdenum trioxide with potassium carbonate and determined the loss in weight. Their value is nearly six units too low and the method must be considered inaccurate. This method was tried with tungsten trioxide and gave values ranging from 160 to 180. The disadvantages of the method are that: the union takes place with considerable spattering; the temperature of fusion is so high that loss by volatility is probable; the alkaline carbonates when held in fusion slowly lose traces of carbon dioxide; and the resulting fusion is extremely hygroscopic.

“These difficulties may be obviated by combining the oxide and sodium carbonate in aqueous solution, and then expelling the water. Operated in this manner the method possesses promising value; and has numerous advantages, among which may be mentioned

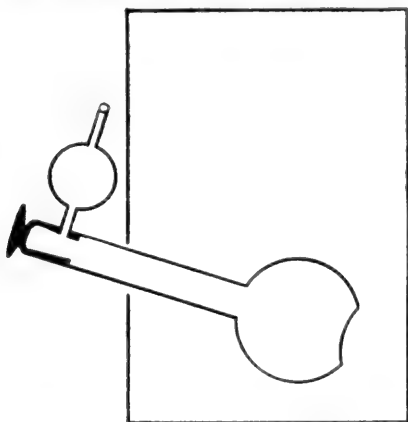

that: carbon dioxide has a molecular weight of forty-four, giving a value for comparison nearly as great as in the simple reduction and oxidation method; the union of sodium carbonate and tungsten trioxide in aqueous solution takes place at a low temperature, and the highest temperature used in the desiccator is a safe distance below the melting point of sodium carbonate, so that there is little chance for volatilization either of sodium carbonate or tungsten trioxide, and in the device used there is no chance for loss by spattering; large quantities of material may be combined with as much ease as small; the method itself would serve for a test of the purity of the material; the presence of chlorides, sulphates, sodium silicate, and potassium carbonate would not affect the result. The presence of alkaline hydroxides would; and to prevent the possibility of this, pure sodium carbonate was saturated in solution with carbon dioxide, and the resulting bicarbonate heated in a vacuum at 300° for three hours.

<sup>1</sup> *J. prakt. Ch.*, 44, 301 (1848).

“The tungsten trioxide and sodium carbonate were combined in a glass bulb as in the sketch. A neutral glass is desirable for this purpose, and the bulb should be made of Jena glass, which will withstand the action of alkaline carbonates better than ordinary glass. If sodium carbonate dissolves the glass no error will be introduced, but if carbon dioxide be liberated through such solution, then the glass cannot be used. To determine this point a blank experiment was made, which showed that the total weight of the bulb and sodium carbonate remained unchanged, while 0.0017 grams of glass were dissolved; hence no appreciable evolution of carbon dioxide occurred. However, to prevent any possibility of such loss, a platinum bulb had better be used.

“It was found that moist sodium carbonate could be heated to a constant weight, by heating for one and a half hours at a temperature of  $300^{\circ}$  in a vacuum; and in this bulb the weight after standing several days remained unchanged. To insure complete desiccation the bulb was always heated double the required length of time. A water pump was used to produce the diminished pressure, and since nothing can be perfectly dried in a vacuum resulting from such a pump, a calcium chloride tower was introduced. But calcium chloride will not perfectly desiccate a gas, so that phosphorus pentoxide had better be used. However, for the preliminary experiments in hand, calcium chloride was sufficient.

“The method of procedure was as follows: some sodium carbonate was introduced into the bulb and heated for three hours at  $300^{\circ}$  in a vacuum. The suction was disconnected, and after cooling, the combined weight of bulb, sodium carbonate, and dry air was obtained. Tungsten trioxide was then introduced through a long funnel, the bulb was exhausted, allowed to fill with dry air and again weighed. This gave the weight of tungsten trioxide. The weight of the sodium carbonate, further than being present in excess need not be known. Water was added and the bulb heated in a glass air bath, so that the course of the reaction could be watched. The mixture slowly effervesced, and when the action had ceased the vacuum apparatus was attached, and the water distilled off. This water was tested and found to be neutral. The calcium chloride tower was now introduced, and the residue, consisting of a mixture of sodium tungstate and carbonate, was heated for three hours at  $300^{\circ}$  in a vacuum. After cooling and thus allowing the bulb to fill with dry air, it was detached and weighed. This loss in weight gave the carbon dioxide evolved. It may be added that the entire bulb should be inside the air bath, until the water has been removed; and then the upper portion be placed outside and the temperature increased to  $300^{\circ}$ . In this way no moisture will condense in the head, and the stopper remaining perfectly dry will not become jammed. The stopper should not be lubricated.

“The following results were obtained, from impure material,

which in the previous experiments in this paper gave values ranging from 182.24 to 184.82, and which was known to contain iron, maganese, and probably molybdcic acid :

	<i>Weight of Na<sub>2</sub>CO<sub>3</sub> grams.</i>	<i>Weight of WO<sub>3</sub> grams.</i>	<i>Weight of CO<sub>2</sub> grams.</i>	<i>Atomic Weight of Tungsten.</i>
(1).....	2.7	2.0802	0.3952	183.60
(2).....	2.3	2.1937	0.4173	183.30
(3).....	3.5	4.0818	0.7762	183.38
(4).....	3.8	3.3629	0.6394	183.41

“These numbers, in that they indicate the atomic weight of tungsten, are worthless ; in that they show promise for the new method, are of value. The presence of impurity would lower the result ; what value the method will give for pure material can only be conjectured.”

Taylor's experience re-emphasized the absolute necessity of satisfying ourselves beyond every reasonable doubt that the material for the atomic weight determinations was pure ; at least as pure as the means at hand would furnish. The admission of Schneider that his purest substance contained traces of impurity, insoluble in caustic potash, and Taylor's discovery that every sample of tungsten trioxide tested by him gave a residue, insoluble in sodium carbonate, made us very solicitous regarding the purity of all material which had been used in any previous investigations, for it will be found upon consulting the literature that almost every experimenter was content to proceed with ammonium paratungstate which was perfectly white in color. Three to five recrystallizations were held to be sufficient to attain that condition.

Our doubts became so overwhelming that it was decided to begin the work anew with the mineral wolframite and to ascertain, once for all, what it contained in order that search might be made for all such constituents, and every effort put forth to insure their perfect removal from the salts which might be experimented upon. Accordingly, in the summer of 1901 large quantities of wolframite, from Lawrence County, S. D., were decomposed and the resulting tungstic acid converted into ammonium paratungstate. The mother liquors from the salt were black in color and gave in due time the interesting compound—ammonium vanadico-phosphotungstate—described by us in the *Jour. American Chemical Society*, 24, 573. Its discovery added, of course, vanadium and phosphorus to the list of possible contaminating substances: columbic oxide, silica,

molybdic oxide, ferric oxide, manganese oxide, etc. Large amounts of ammonium paratungstate were taken for the purification of the tungsten trioxide by methods which may now be presented.

*Method 1.*—This first fraction was collected apart, dissolved in distilled water and recrystallized; the first crystallization was again set aside and dissolved, this operation being repeated ten times. A portion of the sixth crystallization was ignited in a platinum crucible and the resulting oxide was digested on a water-bath with a 2% solution of sodium carbonate free from iron. The oxide dissolved, but its solution was quite turbid. Upon standing, a white residue settled out, which after washing with water and decomposition with a few drops of hydrochloric acid showed tungstic acid and iron. Portions of the tenth recrystallization behaved similarly. The mother liquors, including that from the tenth crystallization, assumed a dark-brown coloration upon concentration, indicating thereby that not only iron, but that also the vanadico-phosphotungstate, already alluded to, continued with the ammonium tungstate. Vanadium too was found in a portion of the tenth crystallization when it was heated in an atmosphere of hydrochloric acid gas. Hence it was concluded that this method was unsatisfactory and it was abandoned. Chemists, who in the past were content to look upon ammonium paratungstate as being very pure when its color was perfectly white (and from published statements most have been content with this criterion), which it is after the third or fourth crystallization, cannot have had pure substance for their investigations, hence the fluctuation in their results is easily comprehended.

*Method 2.*—This may be called the method of Borch. In it the mineral was fused with sodium carbonate, the fusion exhausted with water and after filtration the liquid was precipitated with calcium chloride. The resulting calcium tungstate was filtered, washed and decomposed with hydrochloric acid. The liberated tungstic acid was dissolved in ammonia water and the ammonium salt crystallized out. The method was carried out with rigid adherence to the printed instructions, but it proved entirely unsatisfactory.

*Method 3.*—Solutions of ammonium paratungstate, decidedly brown in color, were boiled with precipitated calcium carbonate. Ammonia and carbon dioxide were evolved, while calcium tungstate was precipitated. The solutions lost nothing in color. After

filtering out and washing the calcium tungstate it was boiled with hydrochloric acid. Tungstic acid of a rich yellow color separated. It was washed and dissolved in ammonia water. There was a very slight bluish-colored residue. The ammonium paratungstate, which crystallized out, was perfectly white in color, but a portion of it ignited and the resulting oxide, digested with a dilute sodium carbonate solution, disclosed the usual white residue in which tungsten and iron were found.

The salt, purified in this way, was fully as free from impurities as a salt which had passed through six crystallizations from water. This fact led us to prepare pure calcium carbonate and hydrochloric acid before repeating the method with another portion of ammonium paratungstate.

Commercial calcium carbonate was boiled with a solution of pure ammonium chloride. Iron and other impurities remained with the excess of calcium carbonate. The filtrate from the latter was precipitated with pure ammonium carbonate. The resulting calcium carbonate was thoroughly washed and then dried.

Ordinary hydrochloric acid was saturated with calcium chloride and after the addition of phosphorus pentoxide was distilled with water. This gave pure acid. With these purified reagents ammonium paratungstate, which had passed through several crystallizations, was subjected to the treatment outlined in the beginning of this section. The purified salt, when tested, showed but traces of impurities and it is very probable that these, after several repetitions, would disappear entirely. The actual trial was not made, because another course seemed to lead to the desired end in a much shorter period. Experience also showed that nitric acid was preferable.

*Method 4.*—In this procedure a boiling solution of ammonium paratungstate was decomposed with hydrochloric acid. The precipitated tungstic acid was again dissolved in ammonia and the decomposition repeated. Repeating this process several times yielded tungstic acid which might be asserted to be quite pure, although when the mother liquors from the several fractions of the ammonium salts were reduced to a small volume the dark color appeared. A white residue, although slight, was also obtained from the ignited tungsten trioxide. Wyman (Thesis, University of Pennsylvania, 1902) found, after twenty-five decompositions with hydrochloric acid, evidences of similar contamination. This

chemist tried seven different schemes in his endeavor to obtain pure tungstic acid without the desired result. Accordingly, on resuming this part of our study in the summer of 1902 we determined to eliminate every possible source of contamination from the various reagents which we proposed using. Thus, fifteen liters of hydrochloric acid were purified as already described. It was free from every impurity, which was proved by carefully repeated tests. Eighteen liters of nitric acid were distilled after the addition of pieces of pumice and some sodium hydrogen phosphate. The product left no ponderable residue when a definite volume of it was evaporated to dryness in a platinum vessel. The sodium carbonate was made pure by fusing it in a platinum vessel and introducing into the molten mass a small quantity of pure, precipitated calcium carbonate which dissolved; the mass being held for five minutes in the liquid state. After cooling, the fusion was allowed to dissolve out in cold water. The calcium carbonate, iron, etc., were filtered off and the solution evaporated to crystallization. The sodium carbonate which separated was recrystallized four times. Platinum vessels were used for the purpose. They are essential. Portions of the purified salt were examined for silica and iron, and their absence demonstrated. There was now every reason to believe that the reagents, including the water (for it had been redistilled), were pure. They contained nothing which would contaminate the tungsten trioxide. Therefore, if the latter left a residue upon digestion with a dilute sodium carbonate solution, that residue plainly came out from the tungstic oxide.

And now we must digress a little. Wyman experienced difficulty and annoyance in his efforts to dissolve tungstic acid in ammonia water. Others have had, doubtless, similar experiences. There invariably remains a bluish-white mass which no amount of ammonia or protracted boiling eliminates. More than a kilogram of this substance had accumulated from Wyman's work and came into our possession. Its bluish-green tint suggested the presence in it of some reduction product, probably occasioned by the hydrochloric acid. We accordingly projected the mass into boiling concentrated nitric acid. A violent evolution of chlorine immediately followed and continued until the material had acquired a rich yellow color. Whence came the chlorine? More of the blue residue was dried at  $100^{\circ}$ , then heated upon a platinum foil. Great volumes of ammonium chloride were expelled, leaving pale-yellow



colored tungsten trioxide. An analysis of a portion of the dry, bluish material was made, when 5.48% of  $\text{NH}_4$  and 9.65% of Cl were found. The presence of this amount of foreign substance could only be accounted for on the assumption that in the liberation of tungstic acid from ammoniacal solutions of ammonium tungstate with hydrochloric acid portions of the latter and of the ammonium chloride were so combined that no amount of washing would remove them. They are retained, and firmly, by the tungstic acid. Let those who question this examine the white, slimy residue which appears on attempting the solution of tungstic acid in ammonia. Most of us have quieted our consciences on this point by asserting that such residues are "those persistently insoluble paratungstates." If the solution from such residues be reprecipitated with hydrochloric acid quantities of insoluble bodies again appear. These are beyond question ammonium chlorinated tungstic acid derivatives which even prolonged boiling with concentrated acids will not change to the yellow acid. They merit further study.

The preceding experience emphasized the necessity of removing all the ammonium chloride in tungstic acid if the precipitation method of purification was to be pursued. This was done in the following way: two to three liters of concentrated nitric acid, diluted with water to half their volume, were heated in a large porcelain dish until it began to fume strongly, when 25cc. of pure hydrochloric acid and three kilograms of dry and fairly pure ammonium tungstate were added. Vigorous action set in and volumes of decomposition gases escaped. The mixture was constantly stirred during the operation. As soon as the action diminished, ten to fifteen cubic centimeters of pure hydrochloric acid were introduced at intervals. As the decomposition approached completion, the yellow tungstic acid lost its porous character and collected as a heavy granular powder upon the bottom of the dish, but it was heated with occasional stirring for a period of from three to four hours. At the expiration of that time, there remained only tungstic acid and nitric acid with traces of chlorine and ammonia. The tungstic acid was washed by decantation with pure distilled water until the tungstic acid suspended in the solution subsided very slowly, and the wash-water from it showed but a faint acid reaction. The subsided yellow-colored acid was placed in a porcelain dish, hot distilled water was poured over it and ammonia was conducted into the solu-

tion. As a rule all of the acid dissolved, and there was at the most a very small residue. Thus forty-five liters of a saturated solution contained a residue which weighed less than two grams.

The ammonium paratungstate separating from such a solution showed the needles and plates characteristic of that salt. Only the first three fractions were preserved. They represented seven-eighths of the entire substance. The other portions were set aside. A second and a third treatment, as outlined above, was given the first three fractions, and when the salt, finally obtained, was subjected to the sodium carbonate test, allowing the solution to stand over night, it remained absolutely clear. The mother liquor from the salt, reduced to five cubic centimeters, remained colorless. One object in this long and baffling study had at last been obtained. We were the possessors of seven hundred grams of pure ammonium paratungstate.

Three kilograms of impure ammonium paratungstate were decomposed by acids as described above, the operation being repeated five times, when the ammonium salt from the last decomposition responded admirably to the crucial tests. This salt disclosed none of the substances which were found accompanying the tungstic acid originally, hence the latter was considered pure and was applied as will appear in subsequent paragraphs. However, before proceeding further it seems proper to direct attention to certain other experiences which possess interest and value.

#### THE RESIDUE OBTAINED BY DIGESTING TUNGSTEN TRIOXIDE WITH SODIUM CARBONATE.

Ammonium paratungstate, after three crystallizations and when quite white in color, was ignited in a platinum crucible. Two hundred grams of oxide were obtained in this way and were digested with a 2% solution of sodium carbonate of excellent commercial quality. Quite a residue appeared. It was washed and dried. A portion, weighing 0.4712 gram, was digested with *aqua regia*. The insoluble part weighed 0.4309 gram, while the solution of the soluble constituents, weighing 0.0403 gram, was reduced to a small volume, diluted with water and precipitated with ammonia. The iron weighed 0.0337 gram as ferric oxide. Manganese and platinum were also found. The tungsten trioxide, when digested with hydrofluoric acid, lost 0.0149 gram, representing silica. Or, if the results be tabulated, they show :

Weight of residue . . . . .	0.4712 gram.	.....
“ “ $\text{WO}_3$ . . . . .	0.4160 “	88.28%
“ “ $\text{SiO}_2$ . . . . .	0.0149 “	3.16 “
“ “ $\text{Fe}_2\text{O}_3$ . . . . .	0.0337 “	7.15 “
Manganese, platinum, etc. . . . .	Undet.	.....
		<hr/>
		98.59%

Even pure sodium carbonate will not remove all of the impurities, although it may serve to test the purity of the oxide as to the iron, etc., which may be present.

#### IGNITION OF AMMONIUM PARATUNGSTATE.

The ignition of this salt in platinum vessels, as ordinarily conducted, contaminates the trioxide with platinum. To minimize this contamination a platinum crucible was fitted tightly two-thirds of its length into an asbestos board. A platinum wire shaped into a tripod was set upon the bottom of the crucible. A smaller platinum crucible was supported by the tripod. Into the latter were introduced from time to time not more than from two to three grams of ammonium tungstate. A red heat was applied to the outer crucible. The ammonia was expelled in the course of half an hour, when the crucibles were covered with an inverted porcelain lid, it being lifted from time to time to admit air. Constant weight was obtained in two hours. This procedure gave the best results which could be gotten by the use of platinum crucibles. While the oxide is cooling it should be protected from all reducing atmospheric dust, because the hot oxide is extremely sensitive to the action of such substances. This is evident from the following: a platinum rod previously heated in a flame and applied to the hot oxide produces no change, but if the rod be touched quickly to the skin and then laid on the hot oxide, a green spot will appear at the point of contact.

The efforts to substitute silver and gold crucibles for those of platinum demonstrated that these metals, too, were appreciably absorbed by the oxide. Porcelain crucibles were used, notwithstanding the absorption of silica, which would of course become greater as the time of ignition was prolonged and as the heat was increased. Further, the oxide in immediate contact with the porcelain invariably showed a green color. The glaze of the crucible always indicated etching. With an unglazed crucible the action was not so evident, hence the contamination was not so great, and the most satisfactory results were gotten by setting the

unglazed porcelain crucible in a platinum crucible and bringing about the ignition of the salt in this double-walled chamber. The coloration of the surface of the oxide was extremely slight. Experience, however, eventually showed that the best course to pursue consisted in digesting the ammonium paratungstate directly in a porcelain casserole with pure nitric acid and a few cubic centimeters of hydrochloric acid until it was completely decomposed, and the ammonia and hydrochloric acid were destroyed. When the tungstic acid was evaporated to complete dryness, it showed a rich orange-yellow color. It was transferred to an unglazed porcelain crucible and there ignited gently for half an hour. This may be done over a direct flame, the crucible being covered with an inverted porcelain lid. Any enclosed nitric acid was expelled by the gentle heat, and the weight soon became constant. The resulting tungstic oxide had a uniform yellow color. Green was absolutely absent. This procedure eliminated the reduction caused by the ammonia, and it may be added that by its use glazed crucibles were employed every day in similar ignitions for several weeks without showing the least etching or corrosion of the surface.

Having at last gotten pure salt and pure oxide, the question arose as to what method should be adopted in the determination of the atomic weight of the metal. The method proposed by Taylor (p. 130) was new. The results he obtained were with material not especially purified, yet their fair agreement pointed to the possibility of arriving at a definite value with the pure substance, such as was now available. Preliminary trials were executed according to Taylor's suggestions, using glass apparatus just as he had done, and drying at  $400^{\circ}$  to constant weight. The weighings were all made on the same day and under uniform conditions. The main purpose was to ascertain whether concordance in results could be realized. The results in the subjoined table show the opposite:

	$Na_2CO_3$	$WO_3$	$CO_2$	<i>At. Weight</i>
1.....	5.9 gm.	2.45645 gm.	.46775 gm.	183.07
2.....	5.6 "	2.72292 "	.51785 "	183.36
3.....	5.5 "	3.32953 "	.63288 "	183.48
4.....	4.7 "	3.96720 "	.75473 "	183.29
5.....	4.0 "	3.44944 "	.65489 "	183.75
6.....	4.1 "	3.41273 "	.64796 "	183.74
7.....	4.8 "	6.10309 "	1.16087 "	183.32
8.....	3.9 "	6.39735 "	1.21644 "	183.39
9.....	3.5 "	2.17450 "	.41332 "	183.48
10.....	3.1 "	1.57903 "	.29966 "	183.85

The trioxide used in experiments 1 to 4, inclusive, was obtained by gently igniting the ammonium salt in a porcelain crucible. That used in experiments 5 and 6 was strongly heated in a porcelain crucible. In 7 and 8 the ammonium tungstate was heated for one hour in a double platinum crucible. The oxide in experiment 7 had been heated two hours in the same kind of crucible, while in experiment 10 the ignition continued for two hours in the double platinum crucible. The gradual rise in the value to 183.85 by protracted heating could surely not be due to the expulsion of volatile matter, for there was no change in weight after the first hour of ignition in the double crucible. Evidently the oxide absorbed impurities which led to the rise in the atomic weight. Accordingly, samples of ammonium paratungstate were ignited under conditions as nearly similar as possible in crucibles of platinum and of porcelain. The values from the oxide in the crucibles of porcelain were higher than those from the oxide made in platinum crucibles, showing in all probability, that the oxide took up more foreign material from the porcelain than from the platinum. Therefore, the mere ignition of the ammonium salt in vessels such as have been described drew in sources of error. These would, of course, have to be eliminated if the method was to be tested upon its own merits. It was sought to accomplish this by igniting thoroughly dry ammonium paratungstate and ascertain the loss (water and ammonia) sustained by different amounts, which resulted in discovering that the percentage of volatile matter could be obtained to within less than 0.01%, which would answer for the purpose of atomic weight determination. And therefore, in the actual experiments, the ammonium paratungstate was weighed out directly into the flask, it being only necessary to make the proper calculations to arrive at the amount of trioxide which was thus used. Six determinations were made; the results in the atomic value varied from 183.4 to 183.81. The early explanation for the lack of concordance, if the method was not faulty, would be to suppose that the action of the soda upon the glass would withdraw varying amounts of silica, and there would follow, of course, the liberation of corresponding amounts of carbon dioxide. If this really occasioned the error, it was hoped that the substitution of a platinum bulb, similar to the glass vessel, would lead to success. This was done. The experiments were performed as before, with slight modifications where it was considered advisable and advantageous. The atomic

values in a series of five trials ranged from 182.85 to 183.64. Patient search was made for the reason, every step being tested repeatedly, until eventually the conclusion was forced upon us that carbon dioxide, in varying amounts, was disengaged through the decomposition of the sodium carbonate in the final drying. Jacquelin (*Jahresb.*, 1860, p. 116; *A. Ch.* [4] 28, 86, and *A. Ch.* [3] 32, 205) showed that this salt loses from 0.03 to 0.05% in weight at 400°, and other observers have shown that the loss continued with the length of the period of ignition and with the temperature. Here, then, was a serious defect in the method which would explain why the values found were low, and why they differed so widely. The attempts to correct this weak point proved futile, so that the method, having had a thorough trying-out, was abandoned after months of arduous work.

It was hoped that perhaps a normal silver tungstate might be made, which after solution in potassium cyanide could be electrolyzed and the value of tungsten obtained from a comparison with the precipitated silver. Fifteen experiments were made. In one series (the best) of five experiments the results varied from 184.00 to 184.39. It was found, after much search, that there could be no certainty as to when a normal salt was really in hand. Washing and drying, even when performed with the utmost care, occasioned a change in the character of the salt. The method was discarded.

An effort was also made to obtain a cadmium salt of definite composition. Much time was given to it, and experiments were made in the electrolysis of bodies believed to be uniform in composition. The atomic values ranged from 181.90 to 185.71.

Having subjected three new methods to vigorous tests in our efforts to solve the problem along new lines, and having found them utterly deficient, the hope still remained that possibly some of the earlier methods might with pure material give satisfactory results. The writers felt, without meaning to reflect in the slightest upon earlier investigators, that their material possessed the merit of superior purity; and if that were really the case, older methods, simple in principle and easy of execution, might well be expected to give concordant values. Of the 175 experiments made by the entire corps of previous investigators, there is but one short series, namely, that of Pennington and Smith, in which there is that degree of concordance which is desirable and necessary in fixing the

atomic value of any element. Splendid as is the work of Schneider, worthy as it is of high praise, there still remains the fact, not to be pushed aside, that between the minimum and maximum values there is a difference of more than a unit. The atomic value given by Schneider, Hardin and others for tungsten is 184—the mean of very widely differing series. Cognizant of these facts, with faith in the greater purity of our material, steps were taken to repeat several older procedures.

#### PREPARATION OF TUNGSTEN HEXACHLORIDE.

Chlorine, free from oxygen and moisture, is absolutely essential to obtain this compound pure and in comparatively large amounts. The product must also be sublimed repeatedly in an atmosphere of chlorine, without exposure to the air. The first condition, although apparently simple, is really very difficult to attain; and after much experimenting, we cannot say that we got chlorine absolutely free from moisture. But the quantity of oxychloride formed along with the hexachloride may be taken as an index of the amount of moisture (also oxygen) in the chlorine.

The generator was charged with material sufficient to yield chlorine an entire day without the addition of acid and consequent introduction of air into the apparatus. When the flow of gas commenced to grow less only the gentlest heat was applied for a few minutes to the generator. The chlorine was most completely dried by conducting it through three six-inch U-tubes connected in series, containing pumice stone saturated with pure concentrated sulphuric acid, and in the bend sufficient acid to fill the bottom of the tubes, thus causing the gas to bubble through the acid before each new preparation. Indeed, it was about every fourth day that a renewal was made. Only traces of oxychloride were observed. The reaction of chlorine and metal took place in a combustion tube of soft glass, 15 to 18 mm. in diameter and  $4\frac{1}{2}$  feet in length. The tube was contracted in two places to the thickness of a lead pencil, thus making three sections, of which the first was 3 feet in length, the second 1 foot and the last  $\frac{1}{2}$  foot. A porcelain boat carried the tungsten metal. The chlorine was passed through the apparatus for two hours before any heat was applied. This was done to expel the air. Then the burners of the furnace (to within three of the boat) were lighted, beginning with those most distant from the boat, the flames being small. The tube beyond the boat

thus reached a temperature of nearly  $350^{\circ}$  C. These burners were then extinguished, while those immediately beneath the boat were lighted, the flames being small. The tube to a length of eight inches beyond the boat was also heated. In a very short time the reaction began, noticeable at first in the yellow vapors which condensed in the colder part of the tube, beyond the furnace, to the light brown oxychloride. This did not continue more than two minutes, when copious reddish-brown vapors appeared and condensed beyond the lighted burners to brilliant blue-black needles. The formation is very rapid. The utmost vigilance is constantly required to the very conclusion of the experiment. In two hours twenty grams of metal may be fully converted into hexachloride. That portion of the combustion tube at which the hexachloride condenses should be kept just hot enough to cause the traces of oxychloride to pass beyond the hexachloride. This can be readily adjusted after a little experience. When working with large amounts the deposits of the hexachloride may obstruct the tube. In that event manipulate a lamp flame with the hand beneath the chloride until it is partially melted. This converts it into a compact solid, requiring less space. Melting and resublimation of the chloride removes every trace of oxychloride. Two sublimations are sufficient for the purpose. The tube can then be sealed off at the contracted points. Perfectly pure hexachloride has a beautiful, brilliant steel-blue color. It can be readily transferred to clean, dry weighing bottles and preserved in them. It has marked stability. There is no perceptible action on bringing the chloride into water at the ordinary temperature even after considerable time. On the application of heat the decomposition does not begin until the temperature of the water reaches  $60^{\circ}$ . The specific gravity of the hexachloride, taken in water at the ordinary temperature, equaled 3.518. After all the weighings were made the water employed for the purpose was tested with litmus; it gave the very faintest acid reaction. Having obtained in the above manner large quantities of the hexachloride, it was decided to change it to trioxide and thus arrive at the atomic weight of the metal. Roscoe had determined the chlorine in this compound. His results were not especially concordant. Perhaps this was due to the involved method or to the presence of traces of oxychloride. However, our thought was to adopt the simplest available course, hence we aimed to convert the chloride into oxide. Roscoe has



stated that when hexachloride is directly decomposed with water and the resulting acid ignited to oxide, the latter will contain chlorine which cannot be expelled by heat. We had hoped to pursue this method, but as it had the condemnation of so high an authority the hexachloride was introduced into freshly distilled ammonia water, contained in a weighed platinum dish, with the expectation of eventually getting ammonium tungstate and chloride which would leave the trioxide upon ignition. Experience showed that the quantity of the resulting ammonium chloride was so great that even with the most careful ignition there was much danger of expelling mechanically appreciable amounts of the oxide. Nor was it forgotten that it is very doubtful whether from such a mixture the chlorine could be completely removed by heat.

The treatment of the hexachloride directly with nitric acid was also found impracticable.

In spite of Roscoe's objection to the decomposition with water it was believed that the transposition could be carried out. Five glazed No. 2 porcelain crucibles of 40cc. capacity were selected, thoroughly cleansed and ignited, allowed to cool in vacuum desiccators and weighed upon a specially constructed Troemner balance, sensitive to  $\frac{1}{10}$  of a milligram. There was next introduced into each one of them tungsten hexachloride from a weighing bottle which was reweighed after the removal of each portion. The crucibles with their chloride content were placed on water-baths and cold distilled water introduced into each. When the volume of water was insufficient for the quantity of chloride sufficient heat was generated by the reaction to make the water boil and spattering followed. At 60° the decomposition proceeded quietly to the hydrated trioxide, which at the beginning had a slight greenish-yellow color, due probably to imperfect decomposition, as mentioned by Roscoe, but this tint disappeared as the hydrochloric acid was expelled. When the mass was perfectly dry a few drops of pure concentrated nitric acid was introduced from a pipette upon the trioxide. Instantly any green tint vanished and was replaced by a rich orange-yellow color. The excess of nitric acid was slowly evaporated away and the oxide assumed a pale yellow hue.

The crucibles were now removed from the water-bath, and after careful drying were ignited for half an hour to a dull red heat, then allowed to cool in the desiccator, and at the expiration of an hour and a half were weighed.

In the calculations the values for oxygen and chlorine were taken at 16 and 35.45 respectively. The specific gravity of tungsten trioxide was found to be 7.157 and that of tungsten hexachloride 3.518.

Seven different series of determinations were made, each from a different sample of hexachloride. The results appear in the sub-joined table :

No. of Exp.	No. of Series.	Wght. of $WCl_6$ Cor. for Vac. in grams.	Wght. of $WO_3$ Cor. for Vac. in grams.	At. Wght. of W.	Means of Series.	Mean of Means.
1	I.	3.18167	1.86085	184.04	184.01	
2		2.66612	1.55903	183.94		
3		3.52632	2.06244	184.05		
4	II.	1.52117	0.88972	184.07	184.04	
5		1.22299	0.71523	184.00		
6		2.28445	1.33603	184.01		
7		3.25404	1.90337	184.10		
8		3.37078	1.97133	184.01		
9	III.	7.76488	4.54082	183.98	183.98	
10	IV.	2.08764	1.22114	184.11	184.08	184.04
11		2.80141	1.63859	184.09		
12		3.24328	1.89681	184.02		
13		4.97975	2.91262	184.06		
14		3.04036	1.77838	184.10		
15	V.	4.31046	2.52133	184.10	184.06	
16		2.21201	1.29381	184.07		
17		2.70368	1.58135	184.06		
18		3.60658	2.10934	184.03		
19		2.63037	1.53835	184.02		
20	VI.	3.41668	1.99808	184.07	184.04	
21		3.49940	2.04675	184.06		
22		3.86668	2.26145	184.05		
23		3.40202	1.98970	184.03		
24		3.20661	1.87533	184.01		
25	VII.	3.26386	1.90909	184.09	184.06	
26		6.73833	3.94031	183.94		
27		7.37889	4.31643	184.14		

It should be mentioned here that at the conclusion of these experiments etching or corrosion of the glaze of the crucibles could not be observed. Nor was there any stain upon them; they looked as if they had been unused.

## METALLIC TUNGSTEN.

It would be superfluous to set forth here the steps taken in procuring the metal. They are familiar to every reader. They were identical with those described by Hardin. One point, however, is worthy of notice. It was discovered that if the trioxide, reduced to metal, had been previously gotten by the ignition of ammonium paratungstate in vessels of platinum, then it might well be expected that after the removal of the tungsten from the reduction boats the latter would show dark spots here and there. This occurred, but uncontaminated trioxide was repeatedly reduced in porcelain by hydrogen without leaving dark stains.

Several experimenters—Riche, Desi, Shinn and Hardin—endeavored to reach the atomic value of tungsten by collecting the water resulting from the reduction of definite amounts of trioxide in hydrogen. Their results were disappointing in the extreme, although the method is surely rational and in some measure ideal. The reasons for its failure have never been satisfactorily explained. We were induced to give it trial. Every attention to detail was scrupulously observed. The results were most disappointing, and yet we cannot give a reasonable explanation for our failure. There seems to be an inherent defect in the method which we were unable to lay bare.

We also reduced definite quantities of trioxide to metal, and from the loss in weight sought to get the atomic value of tungsten. Again the results were discordant. The boats were never stained from the reduction, nor was the porcelain tube in which the reduction took place stained, but on close scrutiny particles of metal could be seen along the sides of the tube. They rested loosely upon it and were removed with ease. This metal, in all probability, was carried out into the tube by the aqueous vapor produced in the reduction. This is, therefore, a serious point in this method.

There remained, finally, only method 2, another time-honored method, upon which much discredit had been cast. Yet with pure material it seemed worth the while to give it further trial. The metal used in this study was made from trioxide obtained from the hexachloride. Portions of it were weighed out into the same crucibles which had been used in the experiments with the hexachloride and gently heated with air contact. The steps in the

ignition were those which any careful analyst would observe, so that they need not be mentioned here. The final oxide was uniformly yellow in color throughout its entire mass.

The weighings here, as in all previous experiments, were reduced to vacuum standard. The value of oxygen was placed at 16. The specific gravity of the oxide was, as before, 7.157, and that of the metal —19.

In the appended table it is to be understood that each single series was made from portions of the same sample of metal. The results are :

No. of Exp.	No. of Series.	Wght. of W. in gms.	Wght. of WO <sub>3</sub> in gms.	At. Wght. of W.	Means of Series.	Mean of Means.
1	I.	2.24552	2.83144	183.96	183.96	
2	II.	1.78151	2.24619	184.07	184.07	
3	III.	1.63590	2.06270	183.98	184.04	
4		1.38534	1.74665	184.04		
5		1.29903	1.63774	184.09		
6	IV.	2.01302	2.53781	184.12	184.09	
7		2.18607	2.75632	184.01		
8		2.36755	2.98478	184.12		
9		1.94958	2.45781	184.12		
10	V.	4.43502	5.59141	184.09	184.10	184.065
11		2.37603	2.99548	184.11		
12		2.58780	3.26260	184.08		
13		2.58503	3.25886	184.14		
14		2.38298	3.00441	184.06		
15	VI.	2.05578	2.59169	184.13	184.11	
16		3.60828	4.54915	184.08		
17		6.22621	7.84949	184.11		
18	VII.	5.28444	6.66239	184.08	184.08	
19	VIII.	3.99095	5.03138	184.12	184.12	
20	IX.	7.30166	9.20647	184.00	184.00	
21	X.	3.44143	4.33870	184.10	184.08	
22		2.67709	3.37541	184.01		
23		4.96735	6.26229	184.13		

In series VII, a very large quantity of oxide was heated in hydrogen from 9 A.M. until 5 P.M. The resulting metal was placed over night in a desiccator, and on the following day a por-

tion of it was weighed out for the eighteenth experiment, the remainder being heated for a day more in hydrogen. After standing over night a second portion was removed and used in experiment 19. The remainder was exposed all of the third day to the action of hydrogen, and was then oxidized for experiment 20. Had not the first reduction been complete, the results would not have agreed so well.

The mean atomic value from the hexachloride is 184.04, that from the oxidation of metal 184.065, or the average of the two independent series is 184.05, which probably approximates the truth very closely and may be safely regarded as the atomic weight of tungsten.

#### SUMMARY.

Our study, extended over so long a period, has revealed—

1. That it is quite doubtful whether any chemists who in the past occupied themselves with a determination of the atomic weight of tungsten have worked with pure substance. Tungstic acid is prone to form "complexes." It was found that if the acid contain no iron, for instance, but be digested with acids, *e.g.*, hydrochloric or nitric acid, in which iron is present, the latter will enter the tungstic acid. Iron and manganese are eliminated from the acid with the greatest difficulty. In the earlier work there is no evidence of their removal. Neither do we discover that vanadium and phosphorus had been considered as present, yet in purifying ammonium paratungstate by recrystallization alone it was found that the tenth recrystallization showed vanadium.
2. The slimy, greenish or bluish-white masses believed to be "paratungstates" because of their great insolubility are probably "complexes."
3. The fourth method of purification can be relied upon to yield pure tungstic acid.
4. The use of pure sodium carbonate (2%) to dissolve tungsten trioxide gives an excellent means of ascertaining when the iron, manganese and silica are fully removed, but that its development into a method for the determination of the atomic weight of tungsten is not at all probable.
5. The plan of digesting pure ammonium paratungstate with nitric acid, then evaporating to complete dryness and gently igniting affords pure oxide.

6. That porcelain vessels are preferable to those of gold, silver or platinum for the ignition of ammonium paratungstate and tungstic acid.

7. That the oxidation of metal (method 2) leads to reliable atomic numbers when the material is pure.

8. That tungsten hexachloride can be completely transposed into pure oxide with water and a little nitric acid.

*The John Harrison Laboratory of Chemistry, University of Penna.*

## THE RIPENING OF THOUGHTS IN COMMON.

“Common Sense is Thoughts in Common.”

BY OTIS T. MASON.

(Read April 9, 1904.)

Those who are entangled in official or commercial life, and, indeed, observant persons generally, will recall many instances in their daily experiences when they have mentioned a name only to see its owner appear. Or they have a friend, say, in the Straits Settlements. After a long silence they begin to worry about him and sit down to write to him. While they are thus engaged the postman hands in an epistle from Singapore signed with his name.

There is, of course, an element of chance in such coincidences. A vast number spring out of deep-seated, normal biological conditions. It is not here denied that many, associated with abnormal or hypersensitive conditions, are so startling in time and detail as to give rise to beliefs in telepathy.

Leaving out the causes just mentioned, this paper will be confined to those artificialities of life called culture, though the natural causes mix freely with these.

The purposeful actions of all humanity have become so artificialized as to make the natural, physical man subservient to the new man, the *Homo sapiens*. Racial activities and community experiences have entirely changed, so that coincidences in speech, manners, customs, and arts, however surprising they may be, are also due to the maturing of thoughts, desires and purposes held in

common. And such agreements are not exceptions but are numberless.

Similarities and simultaneities in actions and thoughts among millions of persons form an unconscious never-ending drill, the activities passing imperceptibly from voluntarism into automatism. The coincidences of which notice is taken are not a drop in the bucket to the whole number.

I shall speak of thoughts in common and the activities linked with them under the heads of *biology, speech, industries, fine art social life, learning and lore, and religion.*

#### BIOLOGY.

To begin with activities that are purely biological, thoughts in common are shared with the animals. The revolution of the earth on its axis, producing day and night, causes nature to awaken in concert in the morning and to fall asleep in unison in the evening. There is no leader to the orchestra in the former, nor authoritative command or lullaby in the latter.

With the change of seasons concerted movements of large masses of insects, fishes, birds, and mammals take place, lasting many days and extending over vast distances and spaces. Under other influences hidden from our knowledge, the whole animate creation seems possessed of individual will only to work in obedience to a common will.

This fact was observed three thousand years ago, for one of the Hebrew proverbs reads, "The locusts have no king, yet they go forth all of them by bands" (Prov. xxx. 27).

This moving in concert has a more complex kind of action still, a sort of international code, existing between creatures of different species, genera, orders, families and even between the kingdoms of nature. It resembles a purposeful selection and is the natural forerunner of altruism in culture. It is the hotbed of suggestion for the whole series of psychical mysteries.

These maturings of thoughts in common are deep-seated in the human frame. "As quick as a wink" does not mean a sudden period of capricious length, but one of duration as regular as the ticking of a watch. The physiologists, with their delicate apparatus, have made wonderful discoveries in this direction. All sorts of clever tricks are played on crowds successfully in the domain of psychology through these uniformities of action in biology.

## SPEECH.

The first and easily overlooked occasion of thoughts in common is speech. Each word or phrase, and even whole sentences, have generic as well as specific meanings. Through the former they have acquired the habit of making like impressions on a multitude of minds or of calling forth identical responses. Through their specific, esoteric meanings they appeal to a smaller following, but more intensively.

Every association or tribe has such formulæ, and their instantaneous power of allaying the individual thought and merging the single into the organized opinion is a matter of common knowledge. Amid the multifarious capabilities of the vocal apparatus a small number of products are chosen, not by a committee, through laborious and purposeful efforts, but by the committee of the whole, which never adjourns.

In some families of tribes, only the easy, musical, phonic elements are picked out; while in others not far away, the harsh or guttural sounds are preferred.

It has often been declared that these subtle combinations of breathings are more persistent than walls of brick and stone. This is not difficult to believe, since the verbal expressions that survive among a people body forth the imperishable thoughts and prejudices that long ago passed from the evanescent stage in the single mind to the fixed stage in the tribal mind. The charge of plagiarism is frequently made by literary critics when the authors were totally unknown to each other.

The great value of this potent *vox populi*, in this case *vox dei* also, for fixing standard vocabulary and grammar cannot be overestimated. It needs no mysterious telepathy to account for such phenomena. They are grounded in the law of association, in the clan organism, and, since biological endurance is a fixed quantity, they ripen together.

## INDUSTRIES.

The common and widespread interests in the activities of life, called industries, give rise to much simultaneity and identity of mental operations. Children go to school in common, the laboring class move to their employments as one.

In the country they have a fashion of cutting a mark in the south kitchen window to note the noon hour. All housewives watch the



shadow of the window frame as it falls there and blow the dinner horn. You can imagine a wave of this joyful sound sweeping across the continent every day from ocean to ocean, and its precisely similar effects on the spirits and bodies of millions on the farms, constituting an aggregate appetite. In precisely the same way the social and political life is agitated, and yet men are amazed to find themselves warming up on the same topics.

In Washington City there are fifty thousand employees. They go to their work at a certain signal. Just at standard noon the whistles blow and they simultaneously and without consultation drop their work. There is a story going around of an old cabinet-maker in one of the Departments, who was so punctual in this regard that once when he was driving a nail and the whistle commenced to blow, he left his hatchet up in the air, like Mohammed's coffin, and went to his lunch.

It is often said that women are governed by instinct, but men by reason. The former share more thoughts in common, they are more conservative, even in savagery. So the actions performed over and over pass into semi-automatism, and without notice the thoughts associated with them arise together in many minds. Even the thoughts go in sets and cliques, and one will awaken the rest by association.

Now and then in the industrial world, through the pleadings of environment, the inspiration of genius, the intense rivalries of trade, new tools, devices, processes and products, and new harness for the forces of nature are devised. The purely original in these are the exceptions, not the rule of action; and, besides, there is more survival than new creation in any one of them, as the suits for interference in the Patent Office will demonstrate.

#### FINE ART.

The æsthetic faculty affords, with its schools and even national styles, most wonderful examples of the force of emotions felt in common. Canons of criticising the methods of appealing to the senses may be defined as expressions of the thoughts which artists of a certain epoch or school have come to hold in association. The same faculty becomes mixed with social life and gives rise to fashions and styles. Hence they say you might as well be out of the world as out of fashion.

It will be asked whether this community among the agents and

agencies of enjoyment accounts for otherwise inexplicable concurrences in art expression. The foundation of art, as of all other human actions, is laid in nature. That artists without consulting one another should copy this or that feature of the world around them is not surprising.

But art is limited in execution. Tennyson's prayer,

"I would that my tongue could utter  
The thoughts that arise in me,"

has been breathed by every artist that ever lived. Fatigued with failure he falls back on his fellow-workers, on the habits of the guild, on conventionalism, which is art-methods in common. It is wonderful how far and wide, and how long these survive. When a student of form in design, familiar with scrolls and frets in Grecian art, discovers the same forms wrought out on Pima Indian basketry and lacework, he lifts his hands with surprise. The ethnologist knows that the Indian woman has not necessarily held converse with the countrymen of Phidias. He realizes that the Pima woman is in the preparatory school, of which the Greek artists were full graduates. Once upon a time Grecian women wove into perishable basketry (*κάναστρα*) forms that have never died and which their descendants fixed imperishably in marble.

Besides the throng of specially endowed creators of art forms coöperating to their origin and perpetuation, there is a united, I almost said organized, admiration-in-common by the enjoyers or consumers of art products. Their habits of judgment, or canons, are intensified and fixed by custom.

#### SOCIAL LIFE.

The phrase "social life" is here used in its most comprehensive sense, taking in the sources of all artificial activities performed by persons working unitedly. Two men managing a canoe down a rapid are intensely social; any rupture in the common thought would be fatal. Social organizations furnish the occasion for growth in what is here under consideration. They are like propagating gardens, farms, or stock ranges, where plants and animals are raised in vastly greater numbers than nature unaided would produce.

It would do no violence to partnerships, corporations, trades unions, and guilds in the industrial world; to secret societies, clubs,

and associations for cultivating the true, the beautiful, and the good, in the moral and intellectual world ; to the family, the clan, the tribe, the state, the nation, in the regulative world, with parliaments, courts, administrations, armies and navies, to characterize them as institutions for creating and preserving mental activities in common—popular legislatures that never adjourn. They afford also fields for their operation. When coincidences occur under their sway, the causes lie in the very nature of society from the beginning.

It is an error to think that social structures and their demands become simplified as one descends from civilization, through barbarism, to savagery. The abundant studies of Major Powell and his colleagues among the tribes of America, and of Morgan among savages in general, teach the contrary. Assuming that social structures and functions among these tribes are in the main types found in all primitive societies in the past, it is not difficult to understand how at the very outset the first society developed a vast number of thoughts in common that have persisted in all ages and areas. To these must be added similar processes originating in races and smaller groups.

Recall how immensely stronger are the character and marks of race than of individuals, how the latter vary in color, stature, viability, number and sex of children, and so on. But the race stature and number of births in males and females, as well as other characteristics of the species, endure.

“ So careful of the type she seems,  
So careless of the single life.”

So long has nature moved by measured steps that there have come about not only cosmic thoughts in common, animal *communis sensus*, anthropic or human rhythm of mental action, but also racial idiosyncrasies, national impulses, civic likenesses, industrial coincidences and inventions, and family likenesses. It is common to hear such expressions as “ the times are ripe,” “ the hour has struck,” for this or that scheme, meaning that thoughts, like heads of wheat in summer time, have simultaneously ripened for the harvest. It accounts for revivals, the singing of masses, the frenzy of crowds, and all such phenomena. The man of old who was wise enough to foresee these maturing of thoughts in common was recognized as a seer. If forceful enough he became a prophet, a leader, a reformer, a culture-hero.

## LEARNING AND LORE.

Lore is the learning of the folk, the philosophy of savages, the survival of old beliefs and customs into enlightenment—old thoughts in common gone to seed. In form, it is the traditions, songs, proverbial philosophies, ceremonies, and real knowledge of peoples. The lore-thoughts of a people are the most deep-rooted and persistent, because indigenous to their minds. It is said that at the battle of Sebastopol the critical charge was incited by the playing of the Marseillaise, which the old soldiers heard for the first time in years. Anyone who has tried to oppose an absurd popular belief, such as that in the hoop-snake, the retiring of the ground-hog at Candlemas, the marvelous doings of the earwig, and a thousand more, will appreciate what is here insisted on, namely, that the holding of a thought in common intensifies its activity, as in a battery of infinite number of cells.

On the intellectual side, lore has become learning and science is slowly permeating the communal mind and becoming the institutional mind. The personal equation of conservatism still acts as a balance-wheel there, as those who worked for uniform time and better nomenclature, and are now laboring for a uniform alphabet and a standard numeral system, will testify.

The sciences began in the individual observation and were perfected one by one in the institutional mind. Since anthropology is a composite science, using and depending on all others, it will be the last to rise to the dignity of a perfected science. The same is true of all its component sciences.

In the museum one sees the botanist returning with his plants from the field. He has been collecting, he is a collector, these are his collections: his work is in the collective stage.

Next, on long tables, he lays them in heaps, according to certain classific concepts in his mind, he is classifying, he is a systematist: this is his classification. Finally he comes to conclusions, will tell you beforehand what to look for in this or that class. He predicts, he is a philosophic botanist: his work is in the predictive stage. But this has been going on for centuries, with fresh returns to the fields, again and again with brighter eyes and larger experience. At last the organized mind takes up the task, so that the work of each must pass the scrutiny of all.

## RELIGION.

So far as it enters the scientific arena, religion has to do with a spirit world and its influence on the world of sense. What is thought in common about that world, its physiography and its inhabitants, especially their activities among men and things, goes by the name of *creed*; what is done in common by men in the organization of society and in conduct responsive to creed is *cult* or *worship*. The most overpowering thoughts in common have belonged to the realm of religion. Things change and thoughts with them, not rapidly but surely. The unseen is not known to change, is believed not to change. The words of Paul, "For the things which are seen are temporal; but the things which are not seen are eternal," embody a thought common to all races and ages, and have held all humanity in lines of conduct more firmly than the teachings of experience.

To sum up, similar words and actions arise among men, spontaneously and incessantly, not so much by reason of similar environments and provocations on the spur of the moment as from a psychological cause, the possession of thoughts in common that have come down through the ages and gathered velocity and impetus as they rolled.

If subtle, telepathic influences exist in spiritual connections, they grow out of common thinking, they are the effect, not the cause, of striking coincidences.

To the educator, the reformer, and the legislator, no less than to the investigator, a constant realization of this fact is necessary to success.

To those who listened to this paper, necessarily brief and general, multitudes of instances will arise where strange coincidences in conduct have expressed themselves in every line of activity. If they were not too busily engaged with the affairs of life they would have noticed many more; because with a normally constituted mind and in a completely organized society they are the rule and not the exception.

RECENT ADVANCES IN OUR KNOWLEDGE OF THE  
EVOLUTION OF THE HORSE.

BY HENRY F. OSBORN.

*(Read April 7, 1904.)*

The American Museum explorations for the development of the horse practically began in 1901 with the first expedition to the Rocky Mountain region in that year, conducted by Dr. J. L. Wortman. By continued exploration and the acquisition of the Cope Collection of fossil vertebrates remains of a large number of fossil horses were secured. In 1901, however, explorations were organized with the particular purpose of securing materials for the further study of the evolution of the horse with the fund donated by the late William C. Whitney. Mr. J. W. Gidley, a graduate of Princeton University, was placed in charge of expeditions sent into Texas, Colorado, South Dakota and Nebraska. The remains of 146 horses were secured, making a total of remains representing this animal in the Museum of upwards of 770.

In the year 1900 the chief discovery was a herd of six Pleistocene horses belonging to the new species *Equus scotti*, giving us for the first time a complete knowledge of the osteology of the American Pleistocene horse—a large-headed, short-limbed animal, proportioned somewhat like the zebra. In 1901, the first year of the Whitney expeditions, *Hypohippus* was discovered in the Upper Miocene, a genus named by Joseph Leidy but hitherto little understood; this animal, although contemporaneous with several highly specialized types of horses, was found to represent a forest-living type, with short crowned teeth and persistent lateral toes. In 1902 the remarkable discovery was made of a new genus and species of horse, *Neohipparion whitneyi*, in the Upper Miocene of western Nebraska. This animal, in contrast with the foregoing, was extremely light limbed, proportioned rather like the deer, with diminutive lateral toes, long crowned teeth, and represented a highly specialized, cursorial type, remotely related to the *Hipparion* of Europe.

Our explorations therefore have demonstrated the existence of two and probably three collateral lines of horses contemporaneous with the *Protohippus* line, which apparently led into the true horse. The early conclusions of Joseph Leidy, based on far less

perfect material, are thus confirmed in the most gratifying manner. Many problems yet remain to be solved, however, especially the osteology of the line leading directly into the modern horse. Explorations will therefore be continued, especially the search for the skeleton of *Protohippus*, with a view to ascertaining whether this is or is not one of the direct ancestors of *Equus caballus*.

*American Museum of Natural History,  
New York, April 7, 1904.*

## RADIUM IN AN AMERICAN ORE.

BY ALEXANDER H. PHILLIPS.

(Read April 8, 1904.)

The work which I have accomplished in the separation of radium, or more exactly the concentration of radium in barium salts, has been carried on entirely with the mineral carnotite.

Carnotite is comparatively a new mineral, having been described by Friedel and Cumenge in July, 1899, and for this reason it is not found in most books on mineralogy, and is therefore but little known to the general prospector. It was first discovered in the western part of Colorado, and occurs in Montrose, San Miguel and Mesa counties of that State and the adjacent counties of Utah.

The theoretical percentage composition as given by Friedel and Cumenge is:

U <sub>3</sub> O <sub>8</sub> .....	63.54%
V <sub>2</sub> O <sub>5</sub> .....	20.12 "
K <sub>2</sub> O .....	10.37 "
H <sub>2</sub> O .....	5.95 "

Results very close to these were obtained in the actual analyses. The mineral formula is given as 2UO<sub>3</sub>, V<sub>2</sub>O<sub>5</sub>, K<sub>2</sub>O, 3H<sub>2</sub>O, or a uranyl potassium vanadate with three molecules of water of crystallization. Hillebrand, after a series of analyses, disputes this composition, and holds that the mineral is probably a mixture to which the above simple formula is not applicable.

Carnotite is a light canary-colored powder disseminated through a fine-grain sandstone. It is easily soluble in acids, and is treated in this way for the commercial production of uranium salts.

In October, 1902, I received twenty-five pounds of this ore from Richardson, Utah. Carnotite occurs here in the usual way; the ore being rather a lean one, no specimens of which carries more than 10% of the mineral carnotite, while the average is greatly below this amount. The percentage content of uranium and vanadium in this ore was not determined, which is to be regretted.

The radio-activity compared to uranium, as determined by G. B. Pegram, of Columbia University, was .40.

After a series of experiments upon a one-pound sample, the remainder of the twenty-five pounds was treated as follows: It was first leached with hydrochloric acid to remove most of the soluble salts; as radium salts are isomorphous with barium salts, and agree very closely in their chemical properties and solubilities with the similar barium salts, it was thought that strong nitric acid would dissolve the small amount of barium the ore contained and also the radium with it.

After the hydrochloric acid treatment the insoluble residue was treated with concentrated nitric; these two acid solutions were concentrated to small volume. Upon testing them for barium it was found that the precipitate would be small, so it was thought advisable to add a small amount of barium chloride, which would act as a carrier and help in the separation of the small amount of radium present; sulphuric acid was then added; the solutions diluted and allowed to stand several days to settle; the clear solutions siphoned off. The resulting sulphates after washing were fused with alkali carbonates. The melt dissolved in water, the insoluble carbonates after washing free of sulphuric acid were dissolved in hydrochloric acid. Hydrogen sulphide was then passed through the solution to free it of lead. From this solution free of lead the barium was precipitated as a carbonate, and dissolved in the least possible quantity of hydrochloric acid, when the barium and radium will be in the form of chlorides and are in a condition to concentrate the radium by fractional crystallization. This solution of chlorides was allowed to evaporate slowly until about one-half of the contained salts had separated as crystals, when the crystals were removed, redissolved, the solution again allowed to evaporate slowly until one-half had separated, and so on for a third time, when there was obtained as a final product a little less than one-half gramme of chlorides, the activity of which compared to uranyl nitrate was about 1500.



The residual chlorides amounting to two grammes were recovered, and proved to be quite active also; their activity as compared to uranium was measured by Pegram as 365.

The radio-activity of the final product could be increased by several fractional crystallizations, when a specimen much less in weight, but more active, would be obtained.

The radio-activity of the specimen as obtained was deemed sufficiently high to indicate that radium could be produced in quantity from carnotite, at least from this locality, as twenty-five pounds of rather a lean ore had been used. Had a ton been worked over in the same way it would yield a gramme of chlorides of 60,000 radio-activity as compared to uranium. This specimen was separated in November, 1902, and is as active now as then.

This establishes without doubt the fact that radium salts are dissolved in the acid with which the uranium minerals are treated in the commercial preparation of uranium salts. In the crystallization of these salts the radium would be carried in connection with the uranium, as it is in the natural formation of the uranium minerals. This would explain to a certain extent the variable activity of uranium salts, as their activity is not proportional generally to the uranium which they contain.

Since the separation of this first sample of radium from carnotite, I have received specimens of the mineral from other localities, all of which are active, their activity depending upon the amount of carnotite in the ore. One specimen of quite pure mineral gave an activity of 4, the highest observed in the crude ore.

A short time ago 3.5 kilos (about eight pounds) were obtained from Montrose County, Colo., selected specimens of which were exposed, in the ordinary way, in making X-ray negatives, with very satisfactory results.

These photographs show very clearly the bands of active carnotite separated by the inactive matrix.

The plates used were Carbutt's B, and exposed to the action of the mineral for sixty hours. With more sensitive plates the same effect could be obtained in much shorter time.

I am at present at work upon the separation of the uranium, vanadium, and radium salts from these eight pounds of ore as an exhibit at the St. Louis Fair. This work is as yet not completed.

After pulverizing and thoroughly mixing, its radio-activity was measured as 1.71, compared to uranyl nitrate. It was then treated

with dilute acids, as it was intended in this case to boil the insoluble residue in a concentrated solution of sodium carbonate, to extract the last of the radium. After the acid treatment the residue from the 3500 gms. originally taken weighed 2200 gms. and gave an activity of 1.40. The solution contained 1300 gms. of the amount taken.

If the activity is calculated to gramme units compared to uranyl nitrate the 3500 gms., activity  $1.71 = 5985$  units.

Residue insoluble in dilute acids, 2200 gms., activity  $1.40 = 3080$  units. The solution contained, therefore, 2905 units, considerable of which would be due to the uranium dissolved and emanation from the radium. The dilute acid extracted nearly all of the uranium, but there was still some found in the residue. This ore contained considerable barium and a large amount of calcium. No barium was therefore added to the solutions, as before. After precipitation of the sulphates, and the separation of barium from other bases, 3.8 gms. of barium carbonate were obtained, which gave an activity of 35.8, or 135 units compared to uranium nitrate. This activity was measured upon the same day (*i.e.*, yesterday) that the barium salt was separated from the other bases; it may be expected that its activity will increase, from the accumulation of the emanation; this increase may in some cases amount to several times the original activity of the compound when first prepared.

This demonstrates that dilute acids, while they dissolve considerable of the barium salts present, the greater proportion of the radium is still left in the residue; but even this amount, which is small compared to that left in the residue, as indicated by the radio-activity of the residue, if calculated upon the basis of a ton, would yield a gramme of chlorides of 11,300 activity as compared to uranium.

These facts prove beyond question that carnotite will become a commercial source of radium.

*Princeton University, March 7, 1904.*

ON THE OCCURRENCE OF ARTIFACTS BENEATH A  
DEPOSIT OF CLAY.

BY DR. CHARLES CONRAD ABBOTT.

*(Read April 8, 1904.)*

A recent examination of the surface soils of a shallow valley-like depression in upland fields, elevated 50-70 feet above the Delaware River and its flood-plain, made evident that the present little brook was not the original and only watershed of this tract of land, but the remnant of a stream of greater volume which had at one time practically filled the valley. To reach the flood-plain of the present river, the brook of to-day passes through a deep valley that has been worn into the face of the bluff that extends for a long distance parallel to the river's course. A bird's-eye view of the region shows at a glance that when the present flood-plain was permanently under water, the gully did not exist in its present width and depth and the greater volume of the present brook emptied directly into the river. As the river's volume decreased and the stream confined itself to the channel now existing, the brook wore away the face of the bluff until it reached the abandoned river bed or what is now a wide meadow, ordinarily dry and cultivable, but occasionally overflowed to a considerable depth.

In a cross-section of the upland valley, extending over two hundred feet in width, it was found that immediately below the present soil and deeper sand as yet unaffected by decomposition of vegetable matter, there was a well-defined deposit of clean, sharp river sand, a few pebbles and a trace of clay that resulted in a slight cementation of the mass. Besides this condition, there was at one part of the section, some forty feet in extent, a deposit of clay, comparatively free from grit and so compact that no object could have intruded. It was nine inches in thickness and twenty-four inches from the surface of the ground to its base, which was compact coarse sand, pebbles and a little clay. Resting on this base, an unquestionable bed of a water-course, were artifacts, consisting of flakes of argillite, artificially produced and the hammer-stones, or oval pebbles, with the ends battered by continued violent contact with other minerals.

A closer examination of the spot indicated clearly that the clay

was derived from beds of Raritan clay, near the head of the valley. For some reason, not now definable, this clay, taken up from the bed of original deposition, was redeposited in a circumscribed area and, as it proved, at a point where previously traces of man had been lost in the waters of a prehistoric stream. Later, this upland stream had decreased in volume, shrinking to the present trifling brook. The bed of the greater stream had become choked with vegetation and eolian sands had drifted in until the valley was no longer well defined; its one-time features finally disappearing when forest trees for centuries thickly dotted the ground. For how long this condition continued it is impossible to determine. When the valley was a forested tract the Indian was in possession. For somewhat more than two centuries the forest has been gone and the ground under more or less constant cultivation, but the valley is still to be traced.

In the mid-autumn of 1903 there was a phenomenal flood in the Delaware River. The water rose to a height unrecorded by man, and the river reasserted its right to the flood-plain and beyond, for its waters flowed up the ravine and the hillside brook became for the time a navigable stream for a considerable distance. It was clearly a return for a time to those ancient days when the entire condition of the country was essentially different from what now obtains—when little brooks were considerable creeks, when creeks were rivers, and the river itself a stream that approached the present Mississippi in magnitude; and when this was true of the tamer conditions of to-day, not only man but an arctic fauna lived here. We can only refer such conditions to the closing days of the Glacial Epoch. The question of Glacial Man in North America, so long a vexing problem, has been found easier of solution than was to be hoped for. The evidence above given is not a single instance of deeply inhumed artifacts in undisturbed stratified deposits; but is submitted as a typical example of many such that have been brought to light by the author and other workers in the same field.

*Trenton, N. J., April 7, 1904.*

ONE EXPLANATION OF REPORTED SHOWERS OF  
TOADS.

BY DR. CHARLES CONRAD ABBOTT.

*(Read April 8, 1904.)*

The frequent references in newspapers to occurrences of "showers of toads" have suggested to the author that a condition in the life-history of the spade-foot toad, a little-known and strictly nocturnal species, living in the ground, might explain them more rationally than that the little batrachians are picked up by the wind in one place and dropped in another, perhaps miles away, or that other still more strange view quite common among the ignorant that toad-spawn is sucked up by the sun and hatched in clouds, where the tadpoles remain until they have advanced to the dignity of hoppers, when they fall to the earth. Unlike the common toad and the frogs, the spade-foot toad (*Scaphiopus solitarius*) does not have a regular season for deposition of ova, but the eggs may be laid at any time from April 1 to August 31. Furthermore, this batrachian does not resort to permanent watercourses or ponds on such errand, but takes advantage of temporary pools formed by showers of longer duration than is usual. It is remarkable how admirably this strange irregularity of an important event should be adapted to transitory conditions. Pools of rainwater seldom remain long on the ground's surface. Soakage and evaporation soon obliterate them; but that this may not prove a fatal objection, the eggs of the spade-foot toad hatch in about ninety-six hours, and in less than two weeks, or fourteen days at most, the tadpole has become a terrestrial animal or a "hopper" and leaves its nursery. The development is even more rapid occasionally, I am led to believe, being accelerated by excessive warmth or retarded if the days are cool and cloudy.

It will be readily seen that young spade-foot toads, congregated in or immediately about a temporary pool, will not wander far from it when their subterranean life begins, but will bury themselves in the comparatively moist ground where they happen to be. Should, at this time of their limited wandering, there occur one or more violent showers, the ground being wetted and little pools formed, the young spade-foot toads would necessarily, we might say, wander over a much wider extent of territory, and, escaping notice when

confined to one fast disappearing pool, would be observed when dotting the ground over an extent perhaps of an acre or more. Seen thus, immediately after rain, and not previously noticed, the inference is not so strange that they came to the earth with the rain, or that there had been a shower of toads as well as of water.

*Trenton, N. J., April 7, 1904.*

## EXPANSIONS OF ALGEBRAIC FUNCTIONS AT SINGULAR POINTS.

BY PRESTON A. LAMBERT.

(*Read April 7, 1904.*)

### I. INTRODUCTION.

An algebraic equation  $F(x, y) = 0$  of degree  $n$  in  $y$  defines  $y$  as an  $n$ -valued algebraic function of  $x$ . When these  $n$  values of  $y$  are all distinct for a given value of  $x$ , that value of  $x$  is called a regular point of the algebraic function, and the  $n$  branches of the function are extended by applying the law of the continuity of each branch.

In curve tracing  $x$  and  $y$  are real variables and only the real branches of the function are used. Real values of  $x$  and  $y$  which satisfy the equations  $F(x, y) = 0$ ,  $\frac{\delta F}{\delta x} = 0$ ,  $\frac{\delta F}{\delta y} = 0$  determine multiple points of the curve which represents the equation  $F(x, y) = 0$ . If  $x = a$ ,  $y = b$  is a multiple point of this curve, the behavior of the curve at the multiple point is determined from the expansions of  $y - b$  in terms of  $x - a$ . Inasmuch as the transformations

$$x = x_1 + a, y = y_1 + b$$

transfer the origin to the multiple point, the multiple point will always be taken at the origin.

An algebraic equation between complex variables  $F(w, z) = 0$  of degree  $n$  in  $w$  defines  $w$  as an  $n$ -valued algebraic function of  $z$ . Values of  $w$  and  $z$  which satisfy the equations  $F(w, z) = 0$  and  $\frac{\delta F}{\delta w} = 0$ , determine branch points of the algebraic function, that is points where several branches of the function meet. The behavior of the function at a branch point is determined from the expansions of the function at the branch point.

The multiple points in curve tracing and the branch points in algebraic equations between complex variables are grouped as the singular points of algebraic functions.

## II. HISTORICAL.

The problem of the expansion of algebraic functions at singular points dates back to Newton. Newton's "parallelogram method" determines the first term of the expansions as follows. The equation transformed to the singular point as origin becomes

$$\sum a_{mn} x^m y^n = 0.$$

Locate on squared paper to rectangular axes the points  $(m, n)$  whose coördinates are the exponents of  $x$  and  $y$  in the various terms of the transformed equation. Connect by successive straight lines, forming a broken line convex toward the origin, the points nearest the origin. The sums of the terms of  $\sum a_{mn} x^m y^n = 0$ , for which the points  $(m, n)$  are located on the same straight line, when equated to zero form equations which determine the first terms of the expansions at the singular point.

Puiseux in his classical "Memoir on Algebraic Functions," Liouville's *Journal*, t. XV, 1850, used Newton's parallelogram method and studied in detail the nature of the expansions of algebraic functions. Puiseux's Memoir is made the basis of Briot and Bouquet's "Elliptic Functions," and indeed is almost universally used in the study of algebraic functions.

Nöther's method in *Annalen*, IX, 1876, is representative of the more recent methods of expansion of algebraic functions. By successive quadratic transformations the singular point becomes a regular point, and from the expansions at this regular point the expansions at the original singular point are obtained by reversing the quadratic transformations and the reversion of series.

In the present paper an analytic method is presented which determines not only the first terms of the expansions but also the successive approximations of the several expansions. The method of expansion used is that application of Maclaurin's series which the author employed to compute all the roots of numerical equations and which is published in Vol. XLII of the *Proceedings of the American Philosophical Society*.

## III. A NEW METHOD OF EXPANSION.

For convenience of description the exponents in the equation to which the method is applied are assumed numerical.

Suppose the algebraic equation when the singular point is taken as origin to have the form

$$(1) \quad \underline{Gx^6y^{14}} + \underline{Fx^3y^{13}} + \underline{Hx^{10}y^{12}} + \underline{Jx^3y^{11}} + \underline{Kx^8y^{10}} + \underline{Ey^{10}} \\ + \underline{Ix^4y^7} + \underline{Dx^3y^5} + \underline{Lx^9y^4} + \underline{Cx^7y^2} + \underline{Bx^{10}y} + \underline{Ax^{18}} = 0,$$

where the terms are arranged according to the descending powers of  $y$ . In this equation  $y$  has fourteen branches, which are to be separated at the singular point by expanding  $y$  as a function of  $x$ .

The terms of equation (1) to be underscored are determined by the method used for this purpose in the paper on the "Solution of Equations," and which is adapted to the present case as follows. If  $Lx^{m_1}y^{n_1}$ ,  $Mx^{m_2}y^{n_2}$ ,  $Nx^{m_3}y^{n_3}$  are any three terms of equation (1), the value of

$$(2) \quad \lim_{x=0} \frac{M^{n_1-n_3} \Lambda^{n_1-n_2}}{L^{n_2-n_3} \Lambda^{n_1-n_2}} \frac{x^{m_2(n_1-n_3)}}{x^{m_1(n_2-n_3)} x^{m_3(n_1-n_2)}}$$

is zero, finite, or infinite. It is at once seen that this limit is zero, finite, or infinite, according as  $m_2(n_1 - n_3)$  is greater than, equal to, or less than  $m_1(n_2 - n_3) + m_3(n_1 - n_2)$ .

The underscored terms of equation (1) are all the terms which satisfy the following condition. The limit (2) for any three consecutive underscored single terms is infinite. If a group of terms is underscored as a single term, the limit (2) is finite for all the terms of this group, and the limit is infinite for the first term of the group and the next preceding underscored term, the limit is also infinite for the last term of the group and the next succeeding underscored term.

We now proceed to underscore the terms of equation (1) to satisfy this condition.

Underscore the first term of (1), and determine the limit (2) for the first three terms of (1). Since the limit is infinite, underscore the second term of (1) temporarily.

Determine the limit (2) for the terms 2, 3, 4. The limit is zero and term 3 is not underscored. Next determine the limit (2) for the terms 2, 4, 5. The limit is infinite and term 4 is temporarily, term 2 permanently underscored.

The limit for terms 4, 5, 6 is zero, the limit for terms 1, 2, 6 is infinite. Hence term 4 does not remain underscored, and term 6 is temporarily underscored.



The limit for the terms 2, 6, 7 is infinite, the limit for terms 6, 7, 8 is zero, the limit for the terms 2, 7, 8 is infinite. Hence term 6 permanently underscored, term 7 is not underscored, and term 8 is temporarily underscored.

The limit for terms 6, 8, 9 is infinite, for terms 8, 9, 10 zero, for terms 6, 8, 10 infinite. Hence term 8 is permanently underscored, term 9 is not underscored, and term 10 is temporarily underscored.

The limit for terms 8, 10, 11 is infinite, hence term 10 is permanently underscored.

The limit for terms 10, 11, 12 is finite, and these three terms are underscored as one term.

The several equations formed by retaining in equation (1) in succession only consecutive underscored terms, if these terms are single, and if a group of terms is underscored by retaining only the group of terms, the first term of the group and the next preceding underscored term, and the last term of the group and the next succeeding underscored term, will determine the first approximations of the fourteen branches of the function.

These equations are

$$a) Gx^3y + F = 0, \quad b) Fx^3y^3 + E = 0, \quad c) Ey^5 + Dx^2 = 0, \\ d) Dy^3 + Cx^4 = 0, \quad e) Cy^2 + Bx^2y + Ax^6 = 0,$$

and the fourteen first approximations are

$$a) y = -\frac{F}{G} \frac{1}{x^3}, \quad b) y = \left(-\frac{E}{F}\right)^{\frac{1}{3}} \frac{1}{x}, \quad c) y = \left(-\frac{D}{E}\right)^{\frac{1}{5}} x^{\frac{2}{5}}, \\ d) y = \left(-\frac{C}{D}\right)^{\frac{1}{3}} x^{\frac{4}{3}}, \quad e) y = \frac{-B \pm \sqrt{B^2 - 4AC}}{2C} x^3.$$

Of these fourteen branches the separate branch *a*) and the three separate branches *b*) go through infinity when  $x = 0$ . The cycle of five branches *c*), the cycle of three branches *d*), and the two separate branches *e*) constitute the ten branches which meet at the singular point.

If a factor  $t$  is introduced in succession into all the terms of equation (1) except the terms used to determine the first approximation of a branch of the function, the successive approximations of this branch are determined by developing  $y$  in ascending powers of  $t$ ,  $x$  considered constant, by Maclaurin's Series and making  $t$  unity in the result.

## IV. BEHAVIOR OF BRANCHES OF ALGEBRAIC FUNCTIONS.

If the algebraic equation takes the form  $\Sigma a_{mn}x^m y^n = 0$  when a regular point is taken as origin the method of expansion determines  $n$  separate branches of the function.

If the origin is a singular point of  $\Sigma a_{mn}x^m y^n = 0$  the behavior of the several branches is determined as follows.

*a)* If the first approximation is independent of  $x$  or contains a negative power of  $x$ , the corresponding branches are either finite or infinite and consequently these branches do not go through the singular point.

*b)* To each pair of consecutive underscored terms in which the exponents of  $y$  differ by unity there corresponds a separate branch of the function through the singular point.

*c)* To each pair of consecutive underscored terms in which the exponents of  $y$  differ by more than unity there corresponds a separate cycle of branches hanging together at the singular point, provided the exponents of  $x$  and  $y$  in the equation determining the first approximation are prime to each other, and the number of branches in the cycle equals the exponent of  $y$ . If, however, the exponents of  $x$  and  $y$  in this equation have a common divisor greater than unity, the corresponding branches break up into cycles equal in number to the common divisor and the number of branches in each cycle is the exponent of  $y$  divided by the common divisor.

*d)* If a group of terms is underscored and the equation formed by equating this group to zero has equal roots, these equal roots must be removed before the branches corresponding to the group can be separated. If this equation is now solved the branches will be separated into single branches and cycles of branches, provided the exponents of  $y$  in this equation have no common divisor greater than unity. If, however, there is a common divisor greater than unity the branches corresponding to this group break up into sub-cycles.

## V. APPLICATIONS IN CURVE TRACING.

*Example 1.*—Let it be required to trace the curve represented by the equation

$$(1) \ y^3 - 3x^4y - x^6y + 9x^3y + 2x^6 - 2x^8 = 0$$

in the neighborhood of the singular point  $(0, 0)$ .

Collecting terms in like powers of  $y$

$$(2) y^3 + (-3x^4 - x^6 + 9x^7)y + (2x^6 - 2x^8) = 0.$$

Since in a first approximation the lowest powers of  $x$  in the several coefficients alone count, this equation may be written

$$(3) y^3 - 3x^4y + 2x^6 = 0.$$

The application of the method of underscored terms shows that in equation (3) the three terms must be underscored as one term, hence

$$(4) \underline{y^3 - 3x^4y + 2x^6} = 0.$$

The equation  $y^3 - 3x^4y + 2x^6 = 0$  has two roots each equal to  $x^2$ .

Diminishing each root of equation (1) by  $x^2$ , if we write  $y = y_1 + x^2$ , we obtain the equation,

$$(5) y_1^3 + 3x^2y_1^2 + (-x^6 + 9x^7)y_1 + (-3x^8 + 9x^9) = 0.$$

Retaining for a first approximation only the lowest powers of  $x$

$$(6) y_1^3 + 3x^2y_1^2 - x^6y_1 - 3x^8 = 0.$$

In equation (6) the terms 1, 2, 4 must be underscored, that is

$$(7) \underline{y_1^3} + \underline{3x^2y_1^2} - x^6y_1 - \underline{3x^8} = 0.$$

From equation (7) the first approximations of  $y_1$  are

$$(8) y_1 = -3x^2, y_1 = x^2, y_1 = -x^2.$$

Consequently the first approximations of  $y$  are

$$(9) y = -2x^2, y = x^2 + x^2, y = x^2 - x^2.$$

The three branches of  $y$  are separated by these approximations and the behavior of the curve at the multiple point is found by tracing the three equations (9) in the neighborhood of the origin.

*Example II.*—Let it be required to trace the curve represented by the equation

$$(1) y^3 - 3x^4y + 9x^7y + 2x^6 = 0$$

in the neighborhood of the singular point  $(0, 0)$ .

To obtain a first approximation this equation may be written

$$(2) \ y^3 - 3x^4y + 2x = 0.$$

The three terms of this equation must be underscored as a single term, when it is found that the equation from which the first approximations are to be found has two roots each equal to  $x^2$ .

Transforming equation (2) by writing  $y = y_1 + x^2$ , there results

$$(3) \ y_1^3 + 3x^2y_1^2 + 9x^7y_1 + 9x^9 = 0.$$

In equation (3) terms 1, 2, 4 must be underscored, which gives

$$(4) \ \underline{y_1^3} + \underline{3x^2y_1^2} + 9x^7y_1 + \underline{9x^9} = 0.$$

The first approximations of  $y_1$  are

$$(5) \ y_1 = -3x^2, \ y_1 = 3ix^{\frac{5}{2}}, \ y_1 = -3ix^{\frac{5}{2}},$$

and consequently the first approximations of  $y$

$$(6) \ y = -2x^2, \ y = x^2 + 3ix^{\frac{5}{2}}, \ y = x^2 - 3ix^{\frac{5}{2}}.$$

The approximations (6) separate the three branches of the curve at the multiple point.

## VI. APPLICATIONS IN FUNCTIONS OF THE COMPLEX VARIABLE.

*Example I.*—Let it be required to determine the behavior of the five-valued algebraic function defined by the equation

$$(1) \ w^5 - (1 - z^2) w^4 - \frac{4^4}{5^4} z^2 (1 - z^2)^4 = 0$$

at the branch-points of the function.

The branch-points, the common solutions of (1) and the partial derivative of (1) with respect to  $w$ ,

$$(2) \ 5w^4 - 4(1 - z^2) w^3 = 0$$

are located at  $z = 0$ ,  $z = \pm 1$ .

At  $z = 0$  the first approximations of  $w$  are determined by the equation

$$(3) \ \underline{w^5} - \underline{w^4} - \frac{4^4}{5^4} \underline{z^2} = 0.$$

These first approximations are

$1, az^{\frac{1}{2}}, -az^{\frac{1}{2}}, aiz^{\frac{1}{2}}, -aiz^{\frac{1}{2}}$ , where  $a$  satisfies the equation

$$a^4 = -\frac{4^4}{5^5}.$$

This shows that at the origin there is one separate branch, and two separate cycles of two branches each.

To determine the behavior of the function at  $z = \pm 1$ , place  $z = z' \pm 1$  in equation (1). There results

$$(4) \ w^5 - (\mp 2z' - z'^2) w^4 - \frac{4^4}{5^5} (z' \mp 1)^2 (\mp 2z' - z'^2)^4 = 0,$$

which for a first approximation may be written

$$(5) \ \underline{w^5} \pm 2z' \underline{w^4} - \frac{4^6}{5^5} \underline{z'^4} = 0.$$

The first approximations are

$$w = \frac{4}{5} (4)^{\frac{1}{5}} z'^{\frac{1}{5}}$$

from which it is seen that at the branch-points  $z = \pm 1$  five branches of the function hang together in a cycle.

To determine the behavior of the function at the point  $z = \infty$ ,  $w = \infty$ , substitute in (1)  $z = \frac{1}{z'}$ ,  $w = \frac{1}{w'}$ , whence

$$(6) \ \frac{4^4}{5^5} (1 - z'^2)^4 w'^5 - z'^3 (1 - z'^2) w' - z'^{10} = 0.$$

Equation (6) for a first approximation at ( $u^1 = 0$ ,  $z' = 0$ ) may be written

$$(7) \ \frac{4^4}{5^5} \underline{w'^5} - z'^3 \underline{w'} - z'^{10} = 0.$$

Equation (7) has two roots each equal to  $-\frac{5}{4} z'^2$ . Increasing each of the five roots of (6) by  $+\frac{5}{4} z'^2$  and retaining for a first approximation only the lowest powers of  $z'$  in the several coefficients,

$$(8) \ \frac{4^4}{5^4} \underline{w'^5} - \frac{4^3}{5^3} z' \underline{w'^4} + \frac{4^2}{5^2} z'^4 \underline{w'^3} - \frac{4}{5} z'^6 \underline{w'^2} - z'^{10} \underline{w'} - z'^{10} = 0.$$

Equation (8) shows that at the point ( $w = \infty$ ,  $z = \infty$ ) the function has five separate branches, that is the point at infinity is not a branch-point of the algebraic function.

*Example II.*—To illustrate the method of finding the successive approximations let it be required to determine to three terms the expansion of the branches of the cycle corresponding to the under-scored terms of the equation

$$(1) \quad \underline{w^5} - \underline{z^4 w^2} - z^7 w - z^{10} = 0.$$

Introducing a factor  $t$  into the terms of (1) which are not under-scored, then differentiating twice with respect to  $t$  considering  $z$  constant,

$$(2) \quad w^5 - z^4 w^2 - z^7 w t - z^{10} t = 0.$$

$$(3) \quad 5w^4 \frac{dw}{dt} - 2z^4 w \frac{dw}{dt} - z^7 t \frac{dw}{dt} - z^7 w - z^{10} = 0.$$

$$(4) \quad (5w^4 - 2z^4 w - z^7 t) \frac{d^2 w}{dt^2} + (20w^3 - 2z^4) \frac{dw^2}{dt^2} - 2z^7 \frac{dw}{dt} = 0.$$

Making  $t = 0$  in (2), (3), (4)

$$(w)_0 = z^{\frac{5}{3}}, \left(\frac{dw}{dt}\right)_0 = \frac{1}{3}z^{\frac{2}{3}} + \frac{1}{3}z^{\frac{4}{3}}, \left(\frac{d^2 w}{dt^2}\right)_0 = -\frac{2}{9}z^{\frac{1}{3}}.$$

Substituting in Maclaurin's series

$$w = (w)_0 + \left(\frac{dw}{dt}\right)_0 t + \left(\frac{d^2 w}{dt^2}\right)_0 \frac{t^2}{2} + \dots$$

and making  $t = 1$  in the result we find

$$(5) \quad w = z^{\frac{5}{3}} + \frac{1}{3}z^{\frac{2}{3}} + \frac{1}{3}z^{\frac{4}{3}}$$

which is correct to three terms. Equation (5) has the form of a power series in  $z^{\frac{1}{3}}$  beginning with the fourth power and represents a cycle of three branches of the algebraic function  $w$  hanging together at the singular point.

*Lehigh University, South Bethlehem, Pa., April 7, 1904.*

## THE HAMITES AND SEMITES IN THE TENTH CHAPTER OF GENESIS.

BY MORRIS JASTROW, JR.

(Read April 4, 1903.)

## I.

The 10th chapter of Genesis is generally admitted to be one of the most remarkable but also one of the most puzzling documents of antiquity. Scholars have been engaged ever since the days of the Talmud<sup>1</sup> and of Eusebius in attempts to identify the nations named in the chapter and in endeavors to determine the point of view from which the division of nations has been made and to ascertain the character of the underlying ethnological and ethnographical scheme, if there be one in the chapter. Modern research, aided to a certain extent by ancient tradition, has succeeded in identifying a large number of the nations enumerated,<sup>2</sup> but the attempts to discover any system in the grouping of the nations have failed chiefly because of the erroneous assumption that an ancient document could give evidence either of scientific accuracy or of ethnological *finesse*. An adequate conception of what really constituted a nation lay beyond the mental horizon of the ancient

For a partial bibliography see Dillmann's *Genesis* (Engl. transl. of sixth ed., Edinburgh, 1897), p. 325. For the Talmudical views and identifications see Neubauer, *La Géographie du Talmud* (Paris, 1868), pp. 421-429.

<sup>2</sup> See for recent expositions the commentaries of Gunkel (1901), Holzinger (1899), Strack (1894), and Driver (1903) to the chapter in question; also Schrader, *Cuneiform Inscriptions and the Old Testament* (London, 1885), Vol. i, pp. 61-103; and Glaser, *Skizze der Geographie und Geschichte Arabiens*, ii (Berlin, 1890), chaps. 26 to 28. The chapter in Alfred Jeremias' *Das Alte Testament im Lichte des Alten Orients* (Leipzig, 1904), pp. 145-170, is to be especially recommended as the latest summary of accepted identifications and because of its valuable supplementary statements, and suggestions toward the solution of the many problems in the 10th chapter of Genesis. A serious defect, however, of Jeremias' treatment of the chapter is his failure to take sufficiently into account its composite character, consisting, as it does, of two distinct documents together with many glosses and insertions. Thus, what he says about the supposed "Arabian" origin of Nimrod (p. 158) falls to the ground if verses 8-12 are recognized as an addition that stands in no connection with verse 7; nor does Jeremias' general view of the *Völkertafel* as a *unit* (p. 145) commend itself in the light of the critical analysis of the chapter.

world, certainly of the ancient Orient. Apart from a certain instinct—to speak indefinitely—which correctly led a people to predicate its own closer or remoter relationship to others, reliance was placed on more or less uncertain traditions, and the value of such tradition was still further diminished by the subjective factors—a people's likes and dislikes, its experiences and ambitions—that entered as elements into its formation; and when we pass beyond the immediate political environment of an ancient people, we must be prepared for a nebulosity of views that is almost inconceivable to a modern mind and for inconsistencies that are as bewildering as they are numerous. In view of this, it is evident that the critical analysis of the chapter to which modern scholarship has devoted itself with marked success is insufficient for a solution of the problems involved unless it also takes into account the uncritical attitude of the ancient world toward ethnological and geographical data.

The critical analysis of the 10th chapter of Genesis has reached a stage that may, with reasonable certainty, be regarded as definite and as having attained its utmost limits.<sup>1</sup> Of the two documents combined to form the present *Völkertafel*—to use the convenient German term—the one that forms part of the Priestly Code, distinguished by critics as P, forms the chief element, as is the case throughout the first eleven chapters of Genesis,<sup>2</sup> while the other, designated as J, has only been drawn upon to the extent of furnishing supplementary data, though at times those supplementary data exceed in length the account in P, and, occasionally, J furnishes material, like the story of Cain and Abel, not found in P at all. In the case of the 10th chapter, while J is actually longer than P, yet the latter document represents a far closer approach to a systematic arrangement, whereas J, marked by many glosses, is extracted in so arbitrary a fashion in order to supplement P that it is difficult to obtain an accurate view of the system followed by the "J" document in its original form.

When the two documents are placed side by side, the differences between them will become clear.

<sup>1</sup> Wellhausen, *Composition des Hexateuchs* (3d ed., 1899, pp. 4-7).

<sup>2</sup> Budde's *Urgeschichte*, pp. 499 *sq.*, pp. 464-465, and also pp. 521-531, where the Jahwistic source in the first eleven chapters of Genesis is put together.



## P.

10, (1a) These are the generations of the sons of Noah; Shem, Ham and Japheth. (2) The sons of Japheth were Gomer, Gog,<sup>1</sup> Madai, Javan, Tubal, Meshech and Tiras. (3) The sons of Gomer were Ashkenaz, Riphath and Togarmah. (4) The sons of Javan were Elishah, Tarshish, Kittim and Rodanim.<sup>2</sup> (5) Of these the islands of the nations branched off. [These are the sons of Japheth] according to their lands, each according to his language, according to their clans among their nations. (6) The sons of Ham were Cush, Mizraim, Put and Canaan. (7) The sons of Cush were Seba, Havilah, Sabtah, Raamah and Sabtechah. The sons of Raamah were Sheba and Dedan. (20) These are the sons of Ham according to their clans, their language, according to their lands among their nations. (22) The sons of Shem were Elam, Asshur, Arpachshad, Lud and Aram. (23) The sons of Aram were Uz, Hul, Gether and Mash. (31) These are the sons of Shem according to their clans, their language, according to their lands, according to their nations. (32) These are the clans of the sons of Noah according to their generations, among their nations and from them the nations were divided in the earth after the flood.

<sup>1</sup> Hebrew text has *magog*, which, however, appears to be an error for *gog*.

<sup>2</sup> So read according to I Chr. i, 6 instead of *Dodanim*.

## J.

9, (18) The sons of Noah that went forth of the ark were Shem, Ham and Japheth (gloss: *ana Ham is the father of Canaan*). (19) These three were the sons of Noah; and of them was the whole earth overspread. . . . (10, 1b) to them sons were born after the flood. (8) Cush begat Nimrod. [He was the first mighty one in the earth. (9) He was a mighty hunter before Yahweh: wherefore the saying: A mighty hunter like Nimrod before Jahweh. (10) The beginning of his kingdom was Babel, Erech, Accad and Calneh in the land of Shinar. (11) Out of that land he went forth to Assyria and founded Nineveh, Rehoboth-Ir, Calah and (12) Resen (between Nineveh and Calah) (gloss: *that is the great city*)]. . . . (13) Mizraim begat Ludim, Anamim, Lehabim, Naphtuhim, (14) Pathrusim, Casluhim and Capthorim (gloss: *whence went forth the Philistines*<sup>1</sup>). [(15) Canaan begat Sidon his first born and Heth (16) (gloss: *the Jebusite, Amorite, Girgasite, (17) Hivite, Arkite, Sinite, (18) Arvadite, Zemarite and Hamathite*)]. Afterwards the clans of the Canaanite spread, (19) so that the boundary of the Canaanite extended from Sidon to Gerar [gloss: to Gaza] to Sodom and Gomorrah [gloss: to Admah and Zebaim] to Lasha. . . . (21) And to Shem also (sons) were born, the father of all the sons of Eber, the elder brother of Japheth. . . . (24) Arpachshad begat Shelah and Shelah begat Eber. (25) To Eber two sons were born, the name of the one was Peleg (gloss: *for in his days the earth was divided*<sup>2</sup>) and the name of his brother was Joktan. (26) Joktan begat Almodad, Sheleph, Hazarmaveth, Jerah, (27) Hadoram, Uzal, Diklah, (28) Obal, Abimael, Sheba, (29) Ophir, Havilah and Jobab. All these were the sons of Joktan. (30) Their settlement was from Mesha to Sephar, the mountain of the east.

<sup>1</sup> Cf. Amos 9, 7; Jer. 47, 4; Deut. 2, 23.

<sup>2</sup> *niphlegû*.

## II.

Beginning with 10, 1<sup>a</sup>, as a heading,

“These are the generations of the sons of  
Noah; Shem, Ham and Japheth,”

P furnishes (verses 2-5) the list of nations sprung from Japheth and then takes up (vv. 6-7) the second son Ham, the close of which enumeration is to be sought in v. 20. Thirdly, Shem, the oldest son, is taken up (vv. 22-23), the continuation appearing in v. 31, while v. 32 represents the conclusion of the version as follows:

“These are the clans of the sons of Noah, according to their generations, according to their tribes and from them the nations were divided in the earth after the flood.”

It will be observed that in this compact survey, resting on the theory of the descent of all the nations of the earth from a single ancestor, Noah, through three groups represented by Noah's three sons, there are decided inequalities in treatment. Of the sons of Japheth, only two, Gomer and Javan, are carried down into further subdivisions. In the genealogy of Ham, only one, Cush, is singled out for further subdivision, but this one is carried down through its branch, Raamah, into a further subdivision, while of the sons of Shem, again, only one, Aram, is further subdivided. Now it is noticeable that none of these nations particularly singled out are such as have had any close or direct contact with the Hebrews. The identification of Gomer with the Gimirraï who appear in the inscriptions of Assyrian kings being quite certain,<sup>1</sup> the subdivisions of Gomer, viz., Ashkenaz,<sup>2</sup> Riphath and Togarmah, must likewise represent peoples whose settlements are to be sought in the north-eastern or eastern section of Asia Minor. They belong to the “extreme north,”<sup>3</sup> have nothing to do with Hebrew history and could only have been of interest to Hebrews because of the general terror inspired throughout the ancient Orient by the threatening

<sup>1</sup> Cf. Schrader, *Cuneiform Inscriptions and the Old Testament*, i, p. 62, and Meyer, *Geschichte des Alterthums*, i, pp. 516 and 543-548.

<sup>2</sup> Distorted from Ashkuza, according to Winckler (*Keilinschriften und das Alte Testament*, i, p. 101), who regards them as the Scythians.

<sup>3</sup> Cf. Ezekiel 38, 6. Ashkunaz is only referred to once again in the Old Testament, viz., Jer. 51, 27; Riphath not at all and Togarmah twice in Ezekiel 27, 14; 38, 6. The parallel *Völkertafel* (I chr. i, 5-25) dependent on Genesis 10 is, of course, excluded from consideration.

advance movement of northern hordes during the seventh century B.C. The case is somewhat different with Javan, which is to be identified with Ionia.<sup>1</sup> While none of the subdivisions of Javan enter into direct relations with the Hebrews, with the possible exception of Tarshish,<sup>2</sup> until the time of the inpouring of the Greeks into Semitic settlements after the conquest of the Greeks, Cyprus, represented by Kittim, as well as Rhodes, represented by Rodanim,<sup>3</sup> must have been at all events familiar names to the Hebrews in pre-exilic days. A certain amount of interest due to commercial relations may also have been attached to the settlements of the Greek archipelago, comprised under the designation, "Islands of the Nations." For all that, the sons of Javan have little to do with Hebrew history proper until a comparatively late period. Among the sons of Ham—Cush, Put, Mizraim and Canaan—we might have expected the two last-named to have been taken up in detail and carried down into further subdivisions. If instead of this, it is Cush that is carried down into two subdivisions, the conclusion appears justified that in this case, likewise, the point of view is not that of one primarily interested in Hebrew history; and it is equally remarkable that of the sons of Aram, viz., Uz, Hul, Gether and Mash, the last three are never mentioned again in the Old Testament, while Uz appears only as the home of Job and in a passage in Lamentations (4, 21) where it is used in parallelism with Edom.<sup>3</sup> To be sure, we have the genealogy of Shem in the line Peleg-Eber once more introduced in P, namely, Genesis 11, 10-26, and this time carried down to the immediate ancestor of the Hebrews, Abram. But the very fact that this is not done in the 10th chapter is a further proof for the proposition that

<sup>1</sup>The term is, however, extended to include Greeks in general (see Meyer, *Geschichte des Alterthums*, i, p. 492). In a paper read before the American Oriental Society at Washington, April 8, 1904 (to be published in Vol. 25 of the *Journal of the Amer. Or. Soc.*), Prof. C. C. Torrey showed that in the book of Daniel (8, 21; 10, 20; 11, 2) and in the first book of Maccabees, as well as in the Talmudic notices, Javan is even used to designate the Greek kingdom of Syria, replacing the earlier usage as, e.g., in the 10th chapter of Genesis, for which we would thus have as a *terminus ad quem* the fourth century B.C.

<sup>2</sup>See Haupt's discussion of the historical and archæological problems connected with Tarshish in his paper published in abstract in the *Proceedings of the Thirteenth International Congress of Orientalists* (1902), Section v.

<sup>3</sup>Jer. 25, 20, is to be excluded, because of the doubtful state of the text.

the enumeration of the thirty-four nations or groups included in P's *Völkertafel* is not done from the point of view of one interested in Hebrew history. The situation is just reversed when we come to the other source, known as J, which has been combined by later compilers with P. Though, unfortunately, only a fragment of the original *Völkertafel* of the Jahwist has been preserved, yet what data there are, including a number of later glosses and other additions, are all of a kind that betray a manifest interest in Hebrew history and not in general ethnology.

### III.

For the introduction to the second version, we must go back to the close of the 9th chapter where we read (verses 18-19):

“The sons of Noah that went forth of the ark were Shem, Ham and Japheth.<sup>1</sup> These three were the sons of Noah and of them was the whole earth overspread.”

The continuation of the genealogical tradition appears chap. 10, 1<sup>b</sup>:

. . . . “to them sons were born after the flood.”

After which a break occurs and when we again encounter this Jahwistic version (10, 8) we are in the midst of the genealogy of the Hamites, which extends from verses 8 to 19. First Cush, who begets Nimrod, is taken up, then Egypt and finally Canaan with its offshoots. A second break follows and when the Jahwistic source is again resumed, verses 21 and 24-30, the genealogy of Eber the son of Shem is set forth. Fragmentary as the version thus is—the genealogy of Japheth, *e.g.*, being entirely wanting—a further analysis points to at least two strata of tradition which, apparently distinct from the Jahwistic *Völkertafel*, have been combined with it, together with a number of supplementary or explanatory glosses. The little section 8<sup>b 2</sup> to 12, enlarging upon Nimrod and the origin and extension of Babylonia and Assyria, is couched in an entirely different style from 9, 18-19 and from 10, 13-14, and even in this section verse 9<sup>a</sup>, which aims to furnish an explanation for a

<sup>1</sup> There is added here a gloss, “and Ham is the father of Canaan,” to prepare us for the tale of Ham's disgrace and for the confusion between Ham and Canaan in the curse pronounced by Noah upon his youngest son (vv. 25-27).

<sup>2</sup> The words “and Cush begat Nimrod (8<sup>a</sup>) may belong to the original Jahwistic *Völkertafel*.

popular proverb, is a gloss added to the section itself, and interrupts the context. Again 16-18<sup>a</sup> represent either a series of glosses or belong to a different source, while the style of verses 21 and 25-30 is so different again from chap. 9, 18-19, etc., that we are forced to assume here likewise a different stratum. Gunkel<sup>1</sup> distinguishes these two strata as Jj and Je, on the supposition that the Jahwistic documents in the book of Genesis represent the combination of the original Jahwist with additions from the Elohist. Whether we accept this or not, there can be no doubt that within the Jahwistic version several distinct and originally independent sections are to be distinguished. In accordance with this view, we would have of the original Jahwistic *Völkertafel* only a brief notice about Cush, a fuller one of Mizraim, while in the case of Canaan there is left only the indications of the geographical boundaries of Canaanitish settlements. Still all these three groups are of profound interest to a Hebrew historian, Cush because of Nimrod the representative of the Babylonians and Assyrians, while Egyptians and Canaanites enter of course into Hebrew history at frequent points and at important crises.

Taking up the additions to the remains of the original Jahwistic list of nations, it will be found that they fall in the same category of data that have a special interest for the Hebrew historian. The notice about Nimrod specifies the important centres of the Euphrates Valley, Babylon, Erech, Accad (= Agade) and Calneh.<sup>2</sup> In agreement with the testimony of modern research, the foundation of Assyria is traced back to Babylonia and the extent of Nineveh, "the great city," with its suburbs is set forth.

The introduction of Heth as a son of Canaan (15*b*) may represent already a supplement to the original Jahwistic document, added because of the interest that the Hittites have for Hebrew history,<sup>3</sup> and to this notice a complete list has been added of the groups of the Canaanitish nations which the Hebrews found upon entering the country and with whom they are thus brought into direct contact.<sup>4</sup> Leaving aside variants or further specifications

<sup>1</sup> *Genesis*, p. 77.

<sup>2</sup> According to the Babylonian Talmud (Yoma 10<sup>a</sup>), Nippur.

<sup>3</sup> For a summary of the relations between Hebrew and Hittites, see the writer's article "Hittites" in the *Encyclopædia Biblica*, Vol. II.

<sup>4</sup> It is to be noted, however, that verses 17-18 furnish names of groups outside of the Hebrew settlements proper in Canaan.

of the geographical boundaries of Canaanitish settlements, we have lastly the genealogy of Shem, introduced, however, as the opening words show (v. 21),

"To Shem also (sons) were born, the  
father of all the sons of Eber,"

for the sake of Eber to whom, through the Eber-Peleg line, the Hebrews are directly traced back. Since, however, this genealogical chain is furnished by P in the following chapter (11, 16-26) the final redactor contented himself in the 10th chapter with supplying from the J source the genealogical line of the other son of Eber, namely, Joktan. This list of Joktanides (verses 26-30) is most valuable for several reasons. In the first place it furnishes the proof for the thesis that the redactor who combined J and P uses the former source as a supplement to P and secondly it shows conclusively that J<sup>1</sup> contained much fuller indications than the other extracts from it used by P might lead us to believe. Indeed the thirteen subdivisions of Joktan represent a much fuller genealogical chain than any to be found in P which records only seven subdivisions for Japheth and five for Cush.<sup>2</sup> The special reason why the redactor introduces this long line of Joktanites appears to be because it embodies a varying addition from P which places Havilah among the sons of Cush and Sheba under Raamah the son of Cush (verse 7), whereas the other source includes Havilah and Sheba among the Joktanites (verses 28-29) and thus makes them descendants of Shem. It is hardly reasonable to suppose that so palpable an inconsistency should have escaped the notice of the redactor and it is certainly more plausible to assume that just *because* of this contradiction between the two sources, both were introduced side by side, in accordance with the general character of historical composition in the ancient Orient which is so largely compilation. The Arabic historians of later days who are the

<sup>1</sup> Or *J<sup>h</sup>* (*i.e.*, Jahwist and Elohist) if we follow Gunkel's view as set forth above (p. 179).

<sup>2</sup> If it be assumed that the enumeration of the Eber-Peleg line in the 11th chapter has been transferred from its proper place in P's *Völkertafel*, it would follow that P's list may also have originally been somewhat fuller than at present appears, but this would not alter the main proposition that P represents the *basis* in the 10th chapter of Genesis, supplemented by J and possibly other sources.

natural successors of the Hebrew compilers and redactors would have proceeded in the same way, only they would probably have introduced the second source by the word *kila*, "others say," and would have summed up the situation by the usual exclamation, "Allah knows best"—which source is correct.

How complete the Jahwistic *Völkertafel* originally was is, of course, a question to which no definite answer can be given. If the reference to Nimrod as the son of Cush (8\*) belonged to the oldest source in J, it would suffice as evidence that at least two branches—Semites and Hamites—were included and this conclusion is confirmed by the inclusion of Canaan and Mizraim (13-15) but there is no reference in any of the remaining parts of J to Japheth. This may of course have been due to the omission of the Japheth genealogy by the redactor who combined J with P, and if this be the case the further conclusion would be justified that J contained nothing of moment with regard to Japheth that was not already mentioned in P. But besides the possibility that J did not contain any genealogy of the descendants of Japheth—though in view of the heading Gen. 9, 18 this is unlikely—there remains as an alternative that Japheth may have been included by J under Shem. There are some strong reasons for concluding that such was the case in at least one of the sources worked up by the "J" school of narrators. Attention has long since been directed<sup>1</sup> to the circumstance that in the story of Noah's curse pronounced on his youngest son (9, 25-27) which is attributed by Gunkel<sup>2</sup> to J°, the name of the son who is disgraced is Canaan, doomed to be "a servant of servants unto his brethren," and this is emphasized by a triple repetition of the curse (verses 25, 26, 27), each time with the name of Canaan. It follows accordingly that the three sons according to what is evidently an earlier tradition are Shem,<sup>3</sup> Japheth and Canaan. In the poetical fragment of the curse, Shem and Japheth are represented to be in close contact with each other. Accepting with Gunkel,<sup>4</sup> Grätz's simple and striking emendation of verse 26<sup>b</sup>,

<sup>1</sup> See, e.g., Budde, *Urgeschichte*, p. 300 sq., and the discussion of Gunkel (*Com. to Genesis*, pp. 71-76) and Holzinger (*Genesis*, pp. 91-93).

<sup>2</sup> *Genesis*, p. 71.

<sup>3</sup> Or perhaps Eber. See below, pp. 201 and 204.

<sup>4</sup> *L. c.*, p. 78. The change proposed by Grätz merely involves an alteration in the vowels of one word *barâk* ("blessed") for which Grätz suggests *barêk*

“Bless, O Jahweh, the tents of Shem,”

we find in the next verse the hope expressed that Japheth “may dwell in the tents of Shem.” Whatever else may be meant by this phrase, it certainly points to a close association of Japheth with Shem. The phrase is intelligible only on the supposition that Shem and Japheth represent two subdivisions of some larger unit in alliance against a common enemy, Canaan; the three—Shem, Japheth and Canaan—so far from representing the nations of the known world, would thus turn out to be originally designations for tribes or clans dividing between them a comparatively restricted strip of territory. Canaan is of course a perfectly definite geographical and ethnic term, and if he is to be the servant of Shem and Japheth, it can only be because he has been or is to be reduced to servitude and subjection in his own land, and if Shem and Japheth are the subjectors they too must belong to the district in which Canaan lies. Shem in the combination stands for the Hebrews as conquerors of Canaan and whatever may have been meant by Japheth—presumably some allies of the Hebrews—the Japheth introduced into the poetical fragment of Noah’s curse is totally different from the Japheth who appears in the 10th chapter in P as the ancestor of the “distant” nations or groups.

The later stratum of J no longer knows the subdivisions Shem, Japheth and Canaan. Ham has taken the place of the latter and in order to reconcile the contradiction between the older poem and the later story of Ham’s conduct towards his father, the gloss is added in verse 18 “and Ham is the father of Canaan” and again in verse 22 the words “father of Canaan” after Ham’s name.<sup>1</sup> The story and the poem do not appear to have originally stood in any connection with each other, the latter being here introduced merely as an appropriate climax, just as elsewhere in the Old Testament we find snatches of old poems attached to later narratives

“bless” (imperative) and the change of *elôhê Shem* “God of Shem” to *’Oholê Shem* “tents of Shem.” Budde (*Urgeschichte*, p. 73) proposes to read *berûkê* and to omit *elôhê* so that the section would read

“Blessed of Jahweh is Shem.”

The objection to this view (though preferred by Holzinger, *l. c.*, p. 90) is the omission of a word whose presence must be accounted for.

<sup>1</sup> This view seems to me more satisfactory than to regard “Ham the father” as the gloss which, to be sure, would make Canaan the chief actor as in the original form of the story was the case.



having no connection originally with the tale itself.<sup>1</sup> Whether the introduction of Ham led to the implied change and to the enlargement of the conceptions connected with Japheth is, again, a question on which it is useless to speculate, and we must content ourselves with the recognition of the wide gulf existing between Shem, Japheth and Canaan on the one hand as they appear in the old poem and Shem, Ham and Japheth as found in the later strata of J and in P. The poem is a fragment of an old composition reflecting tribal dissensions—probably in Palestine—whereas the later figures of Shem, Ham and Japheth belong to the period of an enlarged historical perspective and of more advanced political organization, when, through contact with the nations around, interest was aroused in the larger aspects of humanity as a motley group of peoples and when speculation arose as to the origin of the great variety of nations into which mankind appeared to be divided. This speculation woven in with more or less uncertain traditions and legendary lore finds its first definite expression in a survey of the nations of special interest to the Hebrews and its final outcome in such an elaborately constructed list as is furnished by the present *Völkertafel*.

#### IV.

Coming back, now, to this contrast presented by the remains of an older *Völkertafel* as embodied in J and the later one in P, we are permitted to conclude from the fact that the final redactor of J and P supplemented P's list by data which bear primarily on those nations with whom the Hebrews came into more or less close contact in the course of their history, and since J (with later editions) constituted the source of the compiler for such data, J's *Völkertafel* would thus represent the natural intermediate stage between an indifference on the one hand to the determination of the relationships existing between the nations of the known world—the feature of the period in which Shem, Japheth and Canaan living in close proximity to one another marked the extent of ethnological interest—and the endeavor, on the other hand, to view this relationship

<sup>1</sup> *E.g.*, the so-called "Song of the Well" (Numbers 21, 18) which certainly does not fit in with the narrative in which it has been inserted, and the "Song of Heshbon" (*ib.* vv. 28–30) which is a song celebrating the triumph of some people—hardly the Hebrews—over Moab and which is introduced in connection with a tale of Israel's victory over Sidon. See Gray's *Commentary to Numbers*, pp. 301, 302.

from the broadest standpoint possible to an ancient writer or to a school of ancient writers with imperfect ethnological conceptions and still swayed to a certain extent by various subjective factors.

If, therefore, Japheth formed part of J's *Völkertafel*, we may feel reasonably certain that it did not concern itself with such nations as Gomer, Gog, Ashkenaz, Riphath and Togarmah, to mention only some groups with whom Hebrew history has nothing to do, but at the most with such groups as Tarshish, Cyprus and Tubal and Meshech, with whom at a certain period the Hebrews had at least commercial relations. Leaving this question aside as impossible of more definite determination, the remarkably inclusive though compact character of P's list, drawn up from a point of view which betrays no special interest in Hebrew history, suggests a foreign source for the list itself, or at all events points to foreign influences at work in its composition.

The Priestly Code, being an exilic production, of which at least the substantial elements were drawn up in Babylonia, it would be natural to seek in it influences due to the Babylonian environment. The earlier political relations of their own people with Egypt and Assyria would be sufficient, with the rise of the historical sense, to arouse in the minds of Hebrew writers an interest in nations lying outside of their own immediate circle, but this interest would be materially strengthened under such conditions as confronted the Hebrew exiles settled in the Euphrates Valley. With the national catastrophe putting an end for the time being to their own political history, the Hebrews were in a peculiarly favorable position for realizing what the world meant to a world-power such as Babylonia, which had undertaken to still further develop the legacy of conquest and subjugation bequeathed to her by her rival Assyria, had become in the sixth century. They found themselves in a country which stood for the ideal of world conquest, and which had taken decisive steps for many centuries toward the realization of this ideal. The Assyrians and the Babylonians had come into direct contact with distant nations to the north, south, east and west, and, although their relationship to those nations had generally been hostile, they had, yet, by the encouragement of international commerce brought about a closer affiliation between the peoples of the ancient world, than is ordinarily recognized. It would have been strange indeed if, under such surroundings, the Hebrews had not been led to modify and enlarge their views of the complicated

constitution of mankind. The inscriptions of the Assyrian kings abound in geographical details,<sup>1</sup> and the interest of both Babylonians and Assyrians is still further attested by the numerous geographical lists<sup>2</sup> that have been found in Ashurbanapal's Library and elsewhere. While it is true that these lists, as a rule, were prepared for practical purposes, in connection with the campaigns or as tribute lists or as exercises to serve in the training of scribes, yet a theoretical interest must also in the course of time have been awakened and some of the lists clearly betray such interest. What applies to Assyria is true also of Babylonia, with perhaps this difference: that in a land like the latter in which culture had reached a higher level than in the north, the theoretical or, as we might also put it, the scientific interest must, if anything, have been much stronger. That the intellectual class among the Hebrew writers was acquainted with Babylonian literature admits scarcely of doubt,<sup>3</sup> and whether the compilers of the Priestly Code actually had some cuneiform models before them to serve as the bases for such a list as is found in P, it is certainly permissible and indeed a most reasonable supposition to attribute to Babylonian-Assyrian influence the striking feature of P's list that it deals so largely with groups of peoples that are of interest to Babylonian-Assyrian history and of scarcely any at all to Hebrew history. So of the sons of Japheth, Gomer, Madai, Tubal and Meshech occur more or less frequently in Assyrian inscriptions,<sup>4</sup> and to these we may add Ashkenaz,<sup>5</sup> and perhaps Togarmah.<sup>6</sup> Nor can it be entirely accidental that so many of the groups included under Japheth should be encountered again in the exilic prophet Ezekiel living in Babylonia. He refers to Gomer, Gog, Javan, Tubal,

<sup>1</sup> A glance at the Indices to such works as Schrader's *Keilinschriften und Geschichtsforschung*, Delitzsch's *Wo Lag das Paradies*, and Winckler-Zimmer's *Keilinschriften und das Alte Testament* will suffice to show how large the geographical horizon represented by the cuneiform annals is.

<sup>2</sup> E.g., Rawlinson, ii, 50-53.

<sup>3</sup> See, e.g., D. H. Müller's *Ezechiel Studien*, pp. 56-62, who gives some interesting illustrations that seem to point conclusively to Ezekiel's acquaintance with Babylonian literature. See also Winckler's paper, "Der Gebrauch der Keilschrift bei den Juden" (*Altorientalische Forschungen*, iii, 1, pp. 165-174).

<sup>4</sup> See the Indexes in the works above referred to.

<sup>5</sup> See above, p. 176, note 2, and also Baer's *Libri Danielis, Ezrae et Nehemiae* (Leipzig, 1882), p. ix.

<sup>6</sup> See Delitzsch's *Wo Lag das Paradies*, p. 246, and Jeremias' *A. T. im Lichte des Alten Orients*, p. 152.

Meshech and Togarmah,<sup>1</sup> and in general this prophet is distinguished by the very wide range of his geographical knowledge. We are, therefore, justified in concluding that Babylonian influence and contact with the intellectual atmosphere of Babylonia are responsible for the display of geographical interest and learning in P's *Völkertafel* and in Ezekiel. On the other hand, for the knowledge of Ionia (Javan) it was not necessary to turn to Babylonia or Assyria, for as already suggested,<sup>2</sup> commercial relations between Palestine and the islands and districts lying to the west up to distant Tarshish would account for the knowledge of the chief settlements in the Greek archipelago and regions beyond. This knowledge may well have existed among the Hebrews in pre-exilic days, and the view here maintained by no means implies that all the geographical learning displayed in P comes from contact with Babylonia, but merely that, apart from certain direct influences, the enlargement of the ethnological horizon of Hebrew writers and the impulse to draw up such a *Völkertafel* as is found in P can best be accounted for by the new factor that entered into the intellectual life of the Hebrews through their settling in the Euphrates Valley. Be this as it may, the political contact of the Hebrews with those groups enumerated as sons of Javan did not begin until the period of Greek conquests in the Orient, and, unless we choose to bring the compilation of P's *Völkertafel* down beyond the age of Alexander the Great, which on other grounds is improbable, we are forced to conclude that all the nations enumerated under Japheth are to be placed in the category of peoples with whom the Hebrews up to the time of the composition of the Priestly Code had practically nothing to do. The division of Japheth into two branches, (a) Gomer and offshoots and (b) Javan and offshoots, merely represent from the point of view here maintained the distant nations dwelling to the northeast and north on the one hand, and the groups to the west and northwest on the other, more particularly the inhabitants of the Grecian islands, and those settled along the coast of Asia Minor.

## V.

Coming to the Hamitic genealogy, the wavering of traditions

<sup>1</sup> See, e.g., chapter 38 of Ezekiel.

<sup>2</sup> See above, p. 177.

in the case of the sons of Cush makes it difficult to reach any definite conclusion as to the point of view which guided the compiler of P's *Völkertafel*. Besides the contradictions already pointed out in the case of Havilah and Sheba,<sup>1</sup> it is to be noted that Dedan, who in P appears in the genealogy of Cush, is, according to Genesis 25, 3, included with Sheba in the genealogy of Abraham. That in the mind of P, the sons of Cush represent certain nations of southern and central Arabia, with perhaps an inclusion of some groups lying along the eastern coast, is about all that can be said with any degree of definiteness.<sup>2</sup> That Put in P's list represents primarily the western coast of Africa, from upper Egypt and southwards to Somali (though also applied to the corresponding Arabian coast land), has now been definitely shown.<sup>3</sup> We would thus obtain a point of union for Cush and Put in the circumstance that they represent remote people in the mind of P, lying to the extreme south. This might be extended to Mizraim, but certainly Canaan, which has always been the stumbling block in attempts at recognizing any system in the grouping of Hamites, cannot be placed among the nations of the south without our having recourse to the most

<sup>1</sup> See above, p. 180.

<sup>2</sup> See Jeremias, *A. T. im Lichte d. Alten Orients*, p. 155, and Glaser, *Skizze der Geschichte und Geographie Arabiens*, ii, pp. 387-404. It is unnecessary to pass over to the African coast for the identification of any of the seven groups, though it is certain that P as well as J, in accord with the general usage of the Old Testament, regards Cush also as a designation of Nubia. The term seems to be somewhat indefinitely used for the extreme south (or what appeared to be such to Hebrew writers) without a sharp differentiation between southern Arabia and the corresponding district on the African coast. On Cush as a designation of a part of Arabia in the Old Testament, and in the Cuneiform Inscriptions, see Winckler, *Keilschriften und das alte Testament*, p. 144-145, summarizing views expressed in his essay, "Musri-Meluhha-Ma'in," i and ii (*Mittheilungen d. Vorderasiatischen Gesellschaft*, Berlin, 1898, pp. 47 sq.), and the same author's *Alttestamentliche Untersuchungen*, p. 165. This double nomenclature of Cush may well be supposed to rest on traditions of an ultimate close relationship between the settlements in Africa and those of southern (and extending into central) Arabia; and if there is any value to be attached to the precise form given to the tradition in the Old Testament, the conclusion might be drawn that the "Arabic" settlements represent the offshoot, *i.e.*, "sons" of the African Cush—a view that on the whole seems more plausible than the contrary hypothesis.

<sup>3</sup> See W. M. Müller's *Asien und Europa*, chap. vii. That it designated primarily Arabia is the view of Meyer, *Geschichte des Altertums*, i, p. 86, while Glaser, *Skizze*, etc., ii, pp. 405, 406, proposes southern Arabia and the east coast of Africa.

risky and hazardous conjectures.<sup>1</sup> It is to be noted that Canaan occupies the fourth and last place among the sons of Ham, which of itself raises the suspicion that its addition is due to an after thought, and that, moreover, P does not follow up the genealogy of either Mizraim or Canaan, so that the later redactor was obliged to supply the omission from J. I venture to suggest, therefore, that we have in the addition of Canaan the first betrayal of the compiler's subjective point of view. Under the influence of the same hostile spirit toward the Canaanites which manifests itself in the old poem embodied in J, but with the extension of this hostility to a larger group—to Ham, which was substituted for Canaan—the compiler of P's list places Canaan in the group now associated with the accursed nations, but which was originally intended merely to represent the remote nations of the south, as Japheth represented remote nations of the west, north and northeast. That even a learned compiler living in Babylonia, and actuated primarily by a scholastic aim to draw up an elaborate scheme of a series of nations and peoples in illustration of his theory that all mankind can be traced back to a single ancestor, should be subject to the deeply imbedded hostility existing from the days of the Hebrew invasion of Palestine between Hebrews and Canaanites is surely not surprising. Such a limitation of the mental horizon is precisely of the kind that we would have a right to expect. Removing Canaan from the group, we would have the Hamites consistently representing the remote nations of the south, as the Japhethites represent the remote nations of the west, north and northeast.

## VI.

Leaving aside for the moment the problem involved in the change of sentiment which converted the Hamites into a group synonymous with the "accursed" nations and turning to the genealogy of Shem, it is noticeable that the beginning is made with Elam, lying immediately to the east of Babylonia, and that the group is closed with Aram, which appears to be a general designation for the district lying to the west and northwest of Babylonia and Assyria. We now know that the political relations between Elam

<sup>1</sup>As, *e. g.*, the view maintained by Dillmann (*Genesis*, p. 179) that the inclusion of Canaan among the sons of Ham rests upon the knowledge that the Canaanites came from a southern district.

and Babylonia date back to a very early period,<sup>1</sup> and that in fact the history of the one district is so closely entwined with the fortunes of the other that it would be quite as natural to group Elam and Babylonia together as to place Babylonia and Assyria side by side. Linguistic and ethnic differences between Elamites and Babylonians would not obtrude themselves to the mind of an ancient writer in the face of such close political associations as bound Elam and Babylonia together.

Again, a grouping which begins with Elam as the eastern outlying province of Babylonia and ending with Aram as the western limit would be intelligible from the standpoint of one living within the district of Babylonia, and this view is confirmed by the introduction of Asshur immediately after Elam. Moreover under Aram, subdivisions are recorded—Uz, Hul, Gether, Mash<sup>2</sup>—that play no part whatsoever in Hebrew history, and could have been of interest only to Babylonians and Assyrians as representing districts lying beyond the Euphrates, and with which their armies would come into contact in the course of expeditions to the west or by which they might at one time or the other have been menaced. At all events, Aram designates a miscellaneous group of peoples whose settlements form the western boundary of Babylonia and Assyria proper, and so far we would have as the point of union in the enumeration of the sons of Shem, the settlements in the immediate environment of Babylonia and Assyria—to the east and west respectively. This view is not contradicted by the mention of Arpachshad immediately after Asshur, for however we wish to account for this name, the last element *k-sh-d* is certainly in some way connected with *Kashdim*—the designation of the Chaldeans. Of the various explanations offered,<sup>3</sup> the most plausible is to divide the word into two elements, *a-r-p* which may be identified with Arrapachitis (= *Arbakra*) and *k-sh-d* which is Chaldæa, so that we would have two distinct districts that have by an error been

<sup>1</sup> See De Morgan, "L'Histoire de l'Elam" (*Revue Archeol.*, 3em. Serie, Vol. 40, pp. 149-171).

<sup>2</sup> For proposed identifications of Uz, Hul and Mash see Gunkel (*Genesis*, p. 142), Holzinger (*Genesis*, p. 105) and Glaser (*Skizze, etc.*, pp. 411-422). The situation of Gether is entirely unknown.

<sup>3</sup> See Holzinger, *Genesis*, p. 105, and Gunkel, *l.c.*, p. 143, who accept Cheyne's view of the division of the word (*Zeits. f. Alttest. Wiss.*, 1897, p. 190), into Arpach and Keshed.

merged into one. However this may be, so much is certain that Arpachshad is still to be sought within or near the district represented by Babylonia and Assyria. More puzzling than Arpachshad is the fourth subdivision Lud, and no entirely satisfactory explanation of its occurrence here has as yet been offered. Certainly Lud in P's list can have nothing but the name in common with the Lud that occurs in Isaiah 66, 19, and in Ezekiel 27, 10 and 30, 5—which is clearly Lydia in Asia Minor—and unless we assume (as I am inclined to do) that the introduction of Lud in Genesis 10, 22 is due to an error—

Arpachshad w\*-Lud

being here (verse 22) superinduced by

Arpachshad ya-lad

in verse 24<sup>1</sup>— we must provisionally accept the possibility of there having been a district Lud between the Babylonian-Assyrian district and what P understood by Aram. For the present, there are no substantial reasons for questioning on this account the thesis here maintained that in P the Shemites represent Babylonia and Assyria and the groups adjacent, in contrast to the Japhethites and Hamites who represent the remote nations in the various directions of the compass. We may, therefore, conclude that P's list, taken as a whole and leaving aside more or less obscure details which do not, however, upset the general conclusion, betrays the learned compiler whose geographical horizon has been enlarged by becoming subject to his Babylonian environment. In addition to gathering some of his geographical knowledge from Babylonian documents or through intercourse with the learned scribes of Babylonia, his general point of view in his grouping of nations has regard for interests affecting Babylonia and Assyria, as in the case of the northern and northeastern branches of the Japhethites, or is determined, as in his grouping of Shemites, by his residence in Babylonia.

The purely scholastic character of the list is interfered with only by the addition of Canaan to the Hamitic group, the introduction

<sup>1</sup> Wiedemann supposes (*Geschichte Aegyptens*, p. 24), that Lud is the original form of Rut which with a "denominative" ending—*i.e.*, Ruten—occurs in Egyptian inscriptions as the designation of Syria and Palestine. See however the objections to this conjecture in Schrader's *Cuneiform Inscriptions and the Old Testament*, i, p. 99. Nor is Jensen's proposition to read Lubdi (adopted by Jeremias, *A. T. im Lichte des alten Orients*, p. 170), at all satisfactory.



of which is due to the hostility existing between Hebrews and Canaanites.<sup>1</sup> Taking up now this departure on the part of the compiler of P from the scholastic principles that guided him in drawing up the list, it is clear that he could only have been led to destroy the harmony of his scheme by placing Canaan under Ham instead of, according to their proper position, next to Aram, if the view had become general that the Hamites represent the "accursed" nations.

## VII.

To justify this assumption, which involves a radical change from the original conception of the Hamites as the nations of the remote south, it is necessary to find other evidence for it. Such evidence is forthcoming not merely in the narrative which substitutes Ham for Canaan, but also in J's grouping so far as his *Völkertafel* has been preserved.

We have seen that J enlarges the curse originally pronounced upon Canaan into a general denunciation of a larger group whom he calls Hamites. At the same time, he does not venture to alter the ancient tradition entirely but makes a compromise by including Canaan under Ham. Whatever the source may have been whence J derived the name of Ham, for him this youngest son of Noah has clearly come to be synonymous with those nations which are particularly obnoxious to him. Let us see whom J places in this group. We have in the first place Nimrod whom he connects with Cush as against P who does not mention Nimrod, but who places seven other nations, representing groups settled in Arabia, among the sons of Cush.<sup>2</sup> Nimrod, however, as verses 10 and 11 clearly show, is in J's list the representative of Babylonia and Assyria—nay the founder of these empires, in marked contradistinction therefore to P who, as

<sup>1</sup> It is only proper to note that the view which assumes Canaan's place among the Hamites to be due to feelings of natural hostility was maintained by older writers as, e.g., Sprenger (*Geographie Arabiens*, p. 294 seq.) who lays strong emphasis on the point, but since the days of Dillmann has been generally abandoned. The attempts, however, that have been made to account for the place assigned to Canaan are singularly inadequate. Recent writers either ignore the point entirely or content themselves, like Holzinger (*Genesis*, p. 96), with the suggestion that the inclusion of Canaan among Hamites is merely characteristic of the prevailing ignorance among the Hebrews in matters pertaining to ethnology.

<sup>2</sup> See above, p. 187.

we have seen, places these nations among the sons of Shem. If Nimrod is a Hamite, it follows that Babylonians and Assyrians are Hamites and the attitude towards Nimrod implied in thus placing him among the Hamites is clearly indicated by the gloss (verse 9)

*“ he was a mighty hunter before Jahweh ”*

where the words “before Jahweh” indicate as is now generally recognized by commentators<sup>1</sup> “in defiance of Jahweh,” implying an opposition of some kind to Jahweh or if that is going too far, as, at all events, carrying on a pursuit which was not pleasing in the eyes of Jahweh. Whatever the original force of the phrase “mighty hunter”—concealing perhaps some reference to an ancient myth—may have been, to the one who introduced the gloss in J’s list of nations Nimrod was a conqueror, a “hunter” of spoil, as it were, fired by the ambition to extend his dominion. As a conqueror he, therefore, appears in the following verses where the enlargement of his kingdom is referred to and the extent of Babylonia and Assyria is indicated by the mention of the chief cities of both districts. To J, therefore, the chief if not the only interest attaching to Cush lies in his being the ancestor through Nimrod of Babylonia and Assyria and whatever other nations—if any—were included by him under Cush. His motive for making Babylonia and Assyria descendants of Cush was not geographical position, nor is it at all likely that he had in mind a district by the name of Cush to the east of Babylonia whence in his opinion Babylonians and Assyrians came<sup>2</sup>—though it may be admitted that the notice rests ultimately on a confusion between two Cushes<sup>3</sup>—but he was actuated solely by the desire to place Babylonians and Assyrians among the Hamites

<sup>1</sup> See, e.g., Budde, *Urgeschichte*, p. 393; Holzinger, *Genesis*, p. 99. Renan, too, explained the phrase as indicating opposition to Jahweh. Compare also the phrase “a great city to God” (Jonah, 3 3), equivalent to a “godless city.”

<sup>2</sup> So e.g., Winckler, *Alttestamentliche Untersuchungen*, p. 149. Cf. Gunkel, *Genesis*, pp. 81–82.

<sup>3</sup> For our purposes it is immaterial whether Cush in the mind of the writer who added the section about Nimrod meant the African or the Arabic Cush; and even though some faint tradition of a third “Babylonian” Cush (*i.e.*, the Cassites) underlies the tale, it is certain that the writer has the same Cush in mind as in P (verse 7). Delitzsch’s view (*Wo Lag das Paradies*, p. 52 *seq.*, and pp. 127–129) of a close historical connection between the “Babylonian” and “African” Cush is untenable, though he correctly places the seven subdivisions of Cush in Arabia and not in Africa. See above, p. 187.

under his general view that the latter represent the accursed nations. If we turn to Hebrew history, we will find in the relations existing between the Hebrews and the Babylonians and Assyrians the all-sufficient motive for this hostility. Babylonia which exercised a control over Syria and Palestine at a very early date as the Tel El Amarna tablets show,<sup>1</sup> until she was obliged to yield to Egypt and to concentrate her efforts on the endeavor to check the growing power of Assyria, must have been regarded as a natural menace to the Canaanitish settlers in Palestine even before the Hebrews entered the land. The latter therefore inherited from their predecessors a feeling of hostility towards Babylonia and not differentiating Babylonia sharply from Assyria, the bitter feeling towards both would be accentuated by the subsequent course of events.<sup>2</sup> From the ninth century on, the two Hebrew kingdoms were exposed to frequent attacks from the military expeditions undertaken by the Assyrian conquerors. The fall of the northern kingdom in 722 B.C. and the practical subjection of the southern by Sennacherib and his successors further strengthened this hostility, which found a forcible expression in the utterances of the pre-exilic prophets and is reflected in the grouping of Babylonia and Assyria with the "accursed" nations in J. It is not necessary for our purposes to assume that the form given to the feelings of resentment against Babylonia and Assyria actually presupposes the destruction of the southern kingdom, for long before this catastrophe the feelings must have been sufficiently strong to prompt a writer to regard Babylonians and Assyrians as "accursed" in the eyes of Jahweh, so that the little section inserted in J verses 8-12 may be, like J's list, of pre-exilic date; but we may well suppose the post-exilic redactor who combined J with P to have been still further incensed at the recollection of the havoc wrought by Assyria and Babylonia, the one in bringing about the downfall of the northern kingdom and the other the extinction of political life in the south, to prompt him to preserve from J—in its final form—the notice which groups

<sup>1</sup> See Winckler, *Keilinschriften und das alte Testament*, pp. 23-25 and 192 seq.

<sup>2</sup> See for the general relationship between Babylonia and Assyria, and the two Hebrew kingdoms, Winckler, *Keilinschriften und das alte Testament*, pp. 258-280; also for the cuneiform texts bearing on the subject Schrader's *Cuneiform Inscriptions and the O. T.*, i, 176-ii, 59, and Winckler, *Keilinschriftliches Textbuch zum alten Testament* (2d ed., Leipzig, 1903), pp. 14-55.

these two peoples among those whom Jahweh himself has cursed—much in the same spirit that leads to the retention (Genesis 19, 30–38) of the scandalous story of the origin of Moab and Ammon—two other bitter enemies of Israel—from an incestuous union of Lot with his daughters, as a bit of tribal satire, calculated to expose these peoples to the humiliation and contempt of their rivals.<sup>1</sup>

After Nimrod, we find Egypt introduced in J. Among the Hamites we have seen that the grouping of Egypt with Cush and Put in P fits in with the latter's general view that the Hamites represent the nations of the remote south, but J for whom Cush is neither southern Arabia nor Nubia does not appear to have had such a scheme in mind, and it is in keeping with the spirit of the narrative at the close of the 9th chapter that J's motive in adding Egypt to Babylonia and Assyria among the Hamites was again the desire to illustrate the truth and the justification of the view that the sons of Ham are the "accursed" nations. It is only necessary to mention the name of Egypt in order to conjure up the picture of the hostility towards it that crops out in every section of the Old Testament. The recollection of Egyptian oppression is so strong in the Old Testament as to become almost a part of the Hebrew religion. An old nomadic sheep-offering festival combined with an agricultural spring festival, the latter adopted by the Hebrews from the Canaanites, becomes associated in the Pentateuchal codes<sup>2</sup> with the deliverance from the hated yoke of Egypt. The Decalogue begins in both versions that we possess with the description of Jahweh as the god who brought his people out of Egypt (Ex. 20, 2; Deut. 5, 6), and according to the Deuteronomistic version or recension of the Decalogue, the most characteristic institution of Judaism—the Sabbath as a day of rest

<sup>1</sup> So according to the best of the modern commentators (see Holzinger, *Genesis*, p. 158). Somewhat different is Gunkel's view (*Genesis*, pp. 197–198), who believes that the story was originally told as an illustration of the favor and grace of the Deity in saving Lot as the ancestor of Moab and Ammon from the general destruction and in providing for this unusual method of securing offspring. Granting this, it is still evident that in the mind of the Hebrew writers, the story assumes a lowering and contemptuous aspect—to be compared with the bitter taunts and satires to be found in ancient Arabic poems when they deal with tribal hostilities. See e.g., Goldziher, *Muhammedanische Studien* (Halle, 1888), I, pp. 43–50.

<sup>2</sup> See Baentsch, *Com. to Exodus*, pp. 88–91; Robertson Smith, *Religion of the Semites*, pp. 445 seq.

from all labor—is instituted to serve as a reminder to the people of the conditions under which they lived in Egypt (Deut. 5, 15). If we turn to the Prophets, we find Egypt invariably associated with cruelty, deceit and oppression.<sup>1</sup> Pharaoh becomes a type of the persecutor and of the oppressor. Egypt is therefore placed like Babylonia and Assyria in the same category as Canaan—with the “accursed” races. It so happens, as already pointed out, that the position of Egypt accords with the geographical scheme that P adopts for the Hamitic nations; and while, in view of this, we are not justified in attributing to this compiler a motive of national hatred in placing Egypt with Cush, J, who does not appear to have had such a geographical *system* and for whom Ham is merely the larger term for Canaan which permits him to place under one category a whole series of nations who were hostile to his people, and who in his opinion are responsible for the dark pages in pre-exilic Hebrew history, is evidently actuated by such motives of national hatred in associating Egypt with Canaan; and as already intimated, the compiler who combined J with P, likewise, no longer occupies the objective and more purely scholastic standpoint of P, and takes over therefore from J the extended notices about Egypt and Canaan in order to point out in detail all those who belong to the “accursed” sons of Ham.

### VIII.

This spirit of hostility crops out again in the inclusion of the Capthorites (verse 14) where the addition of the gloss “whence came the Philistines” reveals the animus of the compiler. Capthor, as Prof. W. Max Müller<sup>2</sup> has shown, is a term of indefinite character but which certainly included Cilicia and adjacent parts of the Asia Minor coast, and even a writer of so limited a range of ethnological and geographical knowledge as J, granting that he no longer knew the exact distinction of Capthor,<sup>3</sup> could hardly have supposed the Capthorites to belong in the same category with the

<sup>1</sup> It is sufficient to refer to such passages as Isaiah 11, 15, and chap. 19; Ezekiel, chap. 30; Jeremiah, chap. 46; Amos 8, 9.

<sup>2</sup> *Asien und Europa*, p. 347, supplemented by the same writer's *Studien zur vorderasiatischen Geschichte*, ii (*Mitteilungen der vorderasiatischen Gesellschaft*, 1900), pp. 6–11.

<sup>3</sup> That in accord with prevailing views or traditions he identified Capthor with Crete is, on the whole, more than likely.

subdivisions of Egypt, whose mention precedes that of Caphor.<sup>1</sup> Moreover, the position of the Caphorites at the close of verse 14 suggests (as we have seen to be the case in other instances of nations placed at the end of a series of groups), a later addition to what precedes, and the gloss indicating the origin of the Philistines in accord with the tradition recorded in Amos<sup>2</sup> and Jeremiah,<sup>3</sup> and which is also found in Deuteronomy,<sup>4</sup> unmistakably reveals the purpose of the addition. Next to the Canaanites, whom the Hebrews had to drive out before they could acquire a foothold in Palestine, the Philistines constituted the most serious obstacle to the growth of an independent Hebrew state. Prior to the days of Saul, we have three distinct periods of Philistine aggressiveness with disastrous results to the Hebrews (Judges chapter 10; Judges chapter 13; 1 Samuel chap. 4). Hostilities continued with changing fortunes through the days of Saul and David. Solomon appears to have held them in check, but after his death they regained their independence and continued to be a source of annoyance to Israel if no longer a serious menace. The Caphorites, accordingly, as identical in the mind of the one who added the gloss with the Philistines are ranked like Canaan, Babylonia, Assyria and Egypt with the "accursed" nations, who were assigned this character because of the bitter feelings of hostility of the Hebrews towards them. The "accursed" nations thus turn out to be the enemies of the people of Jahweh, whose opposition is looked upon as a defiance of Jahweh himself.

Outside of the addition of Caphorim in verse 14, the subdivisions of Egypt, enumerated in the verse in question, obscure as some of the names are, are introduced as an exhibition of learning from purely scholastic motives, which J is also willing to display where they do not interfere with his nationalistic likes and dislikes. On the other hand, it is in all probabilities a personal interest that is displayed in the enumeration of the clans constituting the subdivisions of the Canaanites. This enumeration is not set forth in the form of a genealogical chain and the proof that the list itself

<sup>1</sup> Verses 13-14. Of the six subdivisions of Egypt, only two, Lechabim = Lybians, and Pathrusim = Upper Egypt, are certain, but that the other four, all probably more or less corrupt forms, represent sections or nomes of Egypt is generally admitted. For further attempts at identifications see Holzinger, *Genesis*, pp. 101-102.

<sup>2</sup> Amos 9, 7.

<sup>3</sup> Jeremiah 47, 4.

<sup>4</sup> Deut. 2, 23.

represents a later gloss, incorporated however with J and not belonging to P, is furnished by the gentilic form (Jebusite, Amorite, etc.) given to the nine Canaanish subdivisions.<sup>1</sup> The subdivisions themselves further emphasize and illustrate the point of view from which the Canaanites are regarded in J. Of the nine subdivisions, four (Jebusite, Amorite, Girgasite, Hivite) belong to the seven nations of Palestine, with whom marriage is forbidden in the Pentateuchal codes,<sup>2</sup> and with whom no alliance of any kind is to be made; and since it is likely that the Hamathites, referred to in Gen. 10, 18, stand for the Hittites of Deuteronomy 7, 2, we would have five of the ordinary seven subdivisions of Canaanites enumerated in this addition to J. The author of this addition, well acquainted with the various Canaanitish settlements in Palestine, introduces these five because of his special interest in that part of Palestine with which Hebrew history is especially concerned, and which was promised to them by Jahweh as their future possession (cf. Gen. 15, 18-20). In adding the Arkites, Sinites, Arvadites and Zemarites, which play a less conspicuous part in Hebrew history, he reveals his learning and scholastic interest, whereas on the other hand verse 15, which reads

“And Canaan begat Sidon his first born and Heth,”

reveals the original force attached to Canaan as embracing the Phœnicians as well as those settled in the interior. The style of this verse shows that it belongs to the original J document, though there are reasons for believing that the verse has not been preserved in its original form. If Sidon is mentioned as “the first born” we would expect other sons to have been included in the genealogy; and, again, the words “and Heth” impress one as a later addition of the same nature as the additions at the end of verse 14<sup>3</sup> and elsewhere. The suspicion is, therefore, raised that “Heth” has been attached to Canaan from the same motive of nationalistic senti-

<sup>1</sup> Jebusite, Amorite, Girgasite, Hivite, Arkite, Sinite, Arvadite, Zemarite, Hamathite. The traditions in regard to the forms of these names seem to be pretty definitely established, except in the case of Sinite, for which the Greek version has *Hasennite* and the Aramaic (*Targum Onkelos*, ed. Berliner, Berlin, 1884) *Antusite*.

<sup>2</sup> See e.g., Ex. 34, 11-16; Deut. 7, 1-3. Cf. also Gen. 28, 1-8—a narrative that well reflects the bitterness of the feeling toward the Canaanites.

<sup>3</sup> See above, pp. 179, 188, 196.

ment which relegates all enemies of Israel who hindered the advance of the latter among the "accursed" nations. It is needless for our purposes to enter upon the vexed question whether the B<sup>ne</sup> Heth, settled in southern Palestine, are to be identified with the Hittites in the northeast, where Hamath formed one of the centres of their settlements.<sup>1</sup> The Hebrew writers, as is quite evident; considered them identical, and although those in the south enter into friendly relations with the early Hebrew invaders, as illustrated by the traditions regarding Abraham's dealings with the B<sup>ne</sup> Heth,<sup>2</sup> those in the north are included among the enemies with whom no alliances of any kind are to be made. The term "Heth" may indeed have been introduced by the one who added it to Sidon to include the entire interior of Palestine, which a later glossator not satisfied with so vague an expression amplified by the specification of the nine subdivisions in verse 16-18.<sup>3</sup> However this may be, the addition of Heth and the further specification of nine subdivisions, whether originally intended as specifications of Hittites or of Canaanites, are prompted and retained by the desire to make it perfectly clear that the groups with which the Hebrews were to make no entangling alliances of any kind, whether social or political, belong to the "accursed" Hamites.

This same motive is further illustrated in the indication of the boundaries of the Canaanish settlements. Taking in the Phœnician coast to Gerar, or according to the variant to Gaza,<sup>4</sup> he carries the eastern boundary to Sodom and Gomorrah. I venture to suggest that this specification is not prompted by purely scholastic interests, but from a desire to leave no doubt, on the one hand, as to the inclusion of the hated Philistines, represented by Gerar and Gaza, among the Hamites, and, on the other, to point out by the

<sup>1</sup> That the term "Hittites" was used to embrace large groups of peoples that entered Syria and Palestine from the mountain districts of the north and northwest is now generally recognized. The vagueness of the nomenclature complicates the historical and ethnological problems, but it may be said that what evidence is available does not militate against regarding the northern and southern Hittites of Palestine and Syria as belonging to the same general group.

<sup>2</sup> Genesis, chap. 23.

<sup>3</sup> See above, p. 197.

<sup>4</sup> Verse 19. It matters little whether we take Gerar or Gaza as the gloss, though the former, about six miles farther south of Gaza, being less well known, probably represents the original reading, to which a glossator added as a memorandum "Gaza," as a better known boundary of Philistine settlements.



introduction of Sodom and Gomorrah that the inhabitants of this district as well as two other peoples particularly obnoxious to the Hebrews, namely, Moab and Ammon, whose origin, according to the libellous tradition recorded in Genesis 19, 30-38, is distinctly connected with Sodom and Gomorrah, also belong to the "accursed" nations. This tale follows immediately upon the story of the destruction of Sodom and Gomorrah, evidently with the intention of associating Moabites and Ammonites,—whose hostile relations to the Hebrews are illustrated in many a page of the Old Testament,—with wickedness and shameful immorality. However this may be, Sodom and Gomorrah are for J, as for the Hebrew prophets, the type of all that is "accursed,"<sup>1</sup> and for this reason those who dwelt in this region are singled out as belonging with peculiar appropriateness to the sons of Ham.

Naturally, there are innumerable details in the early history of the Hebrews, as also in the later periods, which escape us so that it is no longer possible to determine the full extent to which this motive of national dislike influenced the school of writers, the result of whose work is to be seen in J's list as modified by later additions, insertions and glosses, but enough has been shown to justify the proposition that in contradistinction to P, who betrays not only a much broader geographical and ethnographic knowledge but also greater objectivity, J and the school that he represents are largely, if not completely, under the spell of the character given to Ham at the close of the 9th chapter of Genesis. For J, Ham is not an ethnic unit nor a designation for a group of peoples settled in a certain section of the known world, but a kind of ethnological purgatory to which all those nations are assigned,—Babylonians, Assyrians, Egyptians, Canaanites, Philistines, Sodomites, Gomorrites,—who have merited this fate in the mind of the writer by their hostility to Jahweh's people, and as the cause of the misfortunes, hardships, struggles and catastrophes in the career of the Hebrews. On a supposition of this kind we can account for the jumble of such heterogeneous groups as Canaanites in Palestine, Egyptians in the South, Babylonians and Assyrians in the East, and Philistines in the West into one category, unless, indeed, we are prepared to commit exegetical suicide by assuming that no principle whatso-

<sup>1</sup> Cf., *e.g.*, Isaiah 1, 10; 3, 9; 13, 19. Jer. 23, 14. Amos, 4, 11, and Zeph. 2, 9, where Moab and Ammon are compared to Sodom and Gomorrah.

ever presided over the grouping. The view here advanced of the different conceptions regarding Ham by the J-group of writers from that which is found in P also accounts in a rational and, I believe, in a satisfactory way for the manifest contradictions between J and P as, *e.g.*, the grouping of Asshur with Cush by the former and with Shem by the latter.

### IX.

In conclusion, a few words about the genealogy of Shem in J and P, which will further illustrate the thesis here maintained. If Ham in the mind of the nationalistic J is the type of the "accursed" son, Shem appears with equal distinctness as the favored one. This view is clearly brought out in the blessing over Shem (Gen. 9, 25-27). The double mention of Shem already shows this, and whether we read with Grätz and Gunkel,<sup>1</sup>

"Bless, O Jahweh, the tents of Shem,"

or with Budde and Holzinger,

"Blessed of Jahweh is Shem,"

there can be no doubt of the preference shown for Shem by the J group of writers to whom this blessing belongs. The source and original force associated with Shem<sup>2</sup> is as obscure as that of Ham. Back of both names no doubt lies a mass of traditions and possibly also myths which have been lost, but when once in some way the favorable conception in regard to Shem had become current it would be natural for J to make the endeavor to trace the origin of his own people to this favorite son. Such is the purpose of the rather

<sup>1</sup> See above, p. 181 *seq.*

<sup>2</sup> Shem signifying "fame," "distinction," has been compared with Aryan "ruler," "noble," as a designation of the favorite group (see Holzinger, *Genesis*, p. 92), but all such explanations are open to the objection that they assume the introduction of the name to be due to the Hebrew writers, whereas it is evident that both Shem and Ham (which on the same supposition has been explained as "hot," *i.e.*, 'the southerners' of Holzinger, *l. c.*) are terms adopted by Hebrew writers and belong presumably to a much earlier age than their use in the *Völkertafel*. There is much to be said in favor of the view which regards both names as designations of old deities, though this view, likewise, is open to objections which cannot easily be set aside. See Hommel, *Allisraelitische Ueberlieferung*, pp. 47 and 115.

awkwardly constructed 21st verse of the 10th chapter.<sup>1</sup> The curious phrase defining Shem as "the father of all the sons of Eber" reveals the existence of an earlier tradition, which traced the Hebrews back to Eber. In view of this, one is tempted to conjecture that in an older form of the blessing at the end of the 9th chapter, Eber took the place now occupied by Shem, so that the original personages concerned in the blessing and curse were Eber, Canaan and Japheth, subsequently enlarged to Shem, Ham and Japheth. However this may be, it is interesting and of some importance to observe that when Eber was first associated with Shem, the former was made the son of the latter, whereas in the more scholastic ethnological scheme devised by P, the relationship of Eber to Shem was altered into that of greatgrandfather and greatgrandson.<sup>2</sup> How far this view already prevailed in pre-exilic days among some groups of writers it is, of course, impossible to say. Of the four<sup>3</sup> sons of Shem in P, Elam, Asshur, Arpachshad and Aram, it would appear that Elam is used as an inclusive term to embrace Babylonia. If this be correct we might have in this use of Elam an indication of the date of P's *Völkertafel*, inasmuch as such a usage would point to the absorption of Babylonia by a power advancing from Elam. This power would, of course, be none other than Persia, and the use of Elam here as including Babylonia would thus force us to the conclusion that P's list belongs to the close of the exilic period, subsequent to Cyrus' conquest of Babylonia in 539 B.C. The theory, it must be admitted, encounters an obstacle in Arpachshad, if, as seems plausible, the latter embodies a reference to Chaldæa, since it would involve the further supposition of a differentiation on the part of Hebrew writers between Chaldæa and Babylonia. One can understand and indeed recognize the necessity of such a differentiation from the standpoint of one who, while placing Baby-

<sup>1</sup> It reads literally "and to Shem, there was born even he the father of all the sons of Eber, the brother of Japheth the elder." Then follows "the sons of Shem are Elam, Asshur, etc." Comparing the beginning of verse 21 with the beginning of verse 25, "and to Eber were born two sons, etc.," we should expect the enumeration of the sons of Shem immediately after the words "and to Shem there was born."

<sup>2</sup> Shem, Arpachshad, Shelah, Eber (verse 24).

<sup>3</sup> Omitting Lud, which is a hopeless stumbling block (cf. Holzinger, *Genesis*, p. 105), and which as has above been suggested (p. 190) may have slipped in here through confusion with *yalad* in verse 24.

lonia and Assyria with the genealogy of Ham through Nimrod, the grandson of Ham, yet shares the common tradition which traces Eber the ancestor of the Hebrews (or Terah the descendant of Eber) to Ur-Kasdim, *i. e.*, to Chaldæa. Hence J, despite his hostility to Assyria and Babylonia, admits Arpachshad, which certainly stands in some relationship to Ur-Kasdim, among the Shemites. Since P, however, places Asshur or Assyria with the sons of Shem, he does not share J's view of Assyria or Babylonia, and there would be no reason why he should either omit Babylonia or specifically differentiate Chaldæa from Babylonia, unless it be, indeed, that he includes Arpachshad in obedience to the tradition which associated the latter with the home of his people. On the whole, this appears to be the more plausible view, for while P, as we have seen, manifests his purely scholastic interests to an astonishing degree, he yet is not entirely free from the natural spirit of national likes and dislikes, and at all events would be inclined to embody in his list current traditions regarding the origin of his people, even where such an embodiment might be superfluous or render his scheme somewhat ambiguous. Assuming then that Elam includes Babylonia, and that Arpachshad is Chaldæa, the Shemites, according to P, would represent the groups living in the district to which the Hebrews traced their origin, Elam, Babylonia, Assyria and Chaldæa, and the groups immediately to the west and northwest, classed by P under the general designation of Aram. We have no means of determining whether J's list also included Aram among the sons of Shem, but there is also no positive evidence against it. If it did, the genealogy of Aram was probably identical with the one preserved in P, or at all events did not contain sufficiently important derivations to warrant the compiler who combined J with P in extracting anything from J's list. So much seems certain, that J's chief interest lay in Arpachshad, because of the supposed connection between this district and Ur-Kasdim or Chaldæa as the home of the Hebrews, and J's interest here was sufficiently pronounced to induce him to carry down the line of Arpachshad in its two branches, Eber-Peleg and Eber-Joktan, the former representing a northern group, the latter a southern, much as the Arabs carry the genealogies of their clans to a northern and southern ancestor.<sup>1</sup>

<sup>1</sup> See Wüstenfeld's *Genealogische Tabellen der Arabischen Stämme und Familien* (Göttingen, 1852).

Of J's double list, only the Eber-Joktan, the southern branch, has been preserved in the 10th chapter,<sup>1</sup> the northern branch being omitted by the compiler of J and P, because of its preservation in the P document in the 11th chapter, verses 16-26. The groups thus included in J's genealogy of Shemites would be limited to those descended from Arpachshad and Aram, or since Arpachshad represents on the one hand the Hebrews as the descendants of the northern branch of Eber-Peleg, and the Arabs on the other hand as the descendants of the southern branch of Eber-Joktan, the Shemites would be limited to groups in the immediate environment of the Hebrews. The point of view is apparently that of the Hebrew settlements to the east of the Jordan, Eber-Joktan representing the southern groups and Aram the northern and northwestern, with Eber-Peleg occupying the central position. Here too, therefore, we find J presenting a contrast to P, who, standing for an enlarged geographical and ethnological view, begins his enumeration with Elam to the East and passes on in a westerly and then northwesterly direction, which leads him to include Chaldæa, Babylonia and Assyria and to end with Aram. The point of view here suggests Babylonia or Chaldæa as the home of P, or at all events as the central seat of the Shemites, with Elam constituting the eastern and Aram the western limit and environment. Consistent, moreover, with his view of the Hamites as the designation of groups settled in the remote south, he excludes those peoples included by J in the Eber-Joktan branch of Arpachshad from the Shemites, and as the Eber-Peleg list of P in the 11th chapter shows, P limits the Shemite branch of Arpachshad to the Eber-Peleg or northern division.

The general scheme in P's *Völkertafel* is thus quite clearly based on a geographical distribution into three zones, Japheth representing the remote groups to the west, north and northeast, the Hamites representing the remote nations in the south, while the Shemites represent those in the immediate environment of the Hebrews from the point of view of a writer who, living in Babylonia, is influenced both by conditions prevailing in his days, by the tradition which traced the Hebrews to Chaldæa, as well as by the fact of the later settlements of the Hebrews to the east of the Jordan and in Palestine proper. Taking all these factors together, to which we ought perhaps to add the inclusion of Babylonia under Elam as due to

<sup>1</sup> Verses 26-29.

special circumstances, the Shemites are for P the groups that live in districts in which, at one time or the other, the Hebrews had settled, or which represent districts adjacent to those settlements. The Shemites are, therefore, the groups that are "near" to the Hebrews as against the Japhethites and Hamites who are "remote." Again, while as we have seen P is actuated by large geographical views and displays considerable ethnological knowledge set forth in a scholastic spirit, it is natural that when he comes to the group to which his own people belongs he should show some traces also of a nationalistic spirit. His general point of view in regard to the Shemites as representing those nations which are adjacent to the Hebrews, or "near" them, may be put down to the credit of his nationalistic spirit, while the departure from his scheme in including Canaan among the Hamites instead of placing them with the "near" nations or Shemites may represent a trace of the influence of the spirit of hostility towards Canaanites which controls J, though it is also possible that the addition of Canaan in verse 6 is due to the compiler who combined J with P, and who is actuated by the same spirit as is J.

## X.

In sharp contrast, both as to geographical views and ethnographical knowledge and general spirit, stands J and the group of writers to which he belongs or who follow in his path. Showing distinct traces of the older view which limits the geographical horizon to three groups, Shem (or perhaps Eber<sup>1</sup>), Canaan and Japheth, all dwelling within the confines of Hebrew settlements in Palestine, J, though representing an enlarged view in substituting Ham for Canaan (and Shem for Eber), and in extending Japheth to include remote nations with which Hebrew history has nothing to do, arranges his *Völkertafel* entirely from the Hebrew point of view. Though apparently agreeing with P in his definition of Japhethites it is doubtful whether J's list of sons and descendants of Japheth was as extensive as P's, and at all events the Japhethites did not represent the geographically remote nations but rather those that were historically remote, toward which a writer interested primarily

<sup>1</sup> In view of the importance which Eber plays as the ancestor of the two groups, Eber-Peleg and Eber-Joktan, it would indeed appear as already suggested (p. 201) that a tradition was current which made him rather than Shem the ancestor of the groups allied with the Hebrews.

and, indeed, exclusively in Hebrew history would be wholly indifferent. The Japhethites are, accordingly, no longer "a group dwelling in the tents of Shem," but quite outside of these tents. More marked is the contrast between J and P in regard to the Hamites. While here, too, it happens that from P's point of view Egypt falls into the category of the Hamites, still the whole character of Ham's genealogy in P shows that this is done because of the agreement with P's definition of Hamites as embracing the "remote" nations of the south. In the mind of J, however, the Hamites take the place of Canaan, the "accursed" son of Noah, and the enlargement of Canaan to Ham furnishes him with the opportunity of adding to Canaan a whole series of nations who, because of the mischief they wrought at one time or the other in Hebrew history, merit the fate of being cast into the purgatory of the "accursed" nations. From this point of view, J includes Egypt among the Hamites and adds to Canaan and Egypt, the Babylonians and Assyrians, as well as the Philistines, while subsequent writers, actuated by the same spirit as J, are at pains to specify the subdivisions of the Canaanites, and with a view of leaving no possible loophole for such types of "wickedness" as Sodom and Gomorrah, even indicate the exact boundaries of the Canaanitish settlements. The mention of Sodom and Gomorrah, even if the view above set forth that the names are intended to include Moab and Ammon be not accepted, shows too clearly to admit of any doubt the picture in J's mind of the character and nature of the Hamites.

Coming to Shem, there is a closer approach to be observed between the views of J and P and yet even here there are some striking contrasts. Not only is P's list of Shemites on the whole more inclusive, since he makes them extend from Elam in the East to Aram and Palestine in the West, though on the other hand he excludes the southern Arabs who in J represent the southern branch of Eber-Joktan, but his historical standpoint is also larger than that of J, since he embodies in his list not only the tradition of the original home of the Hebrews but draws the proper conclusion from this tradition that the inclusion of Arpachshad or Chaldæa among the sons of Shem carries with it Babylonia (including Elam) and Assyria. J in all probabilities included Aram by the side of Arpachshad among the sons of Shem, but his point of view is that of one who is exclusively interested in Hebrew history. The im-

portance of Shem lies for him in the fact that Shem is "the father of all the children of Eber." For him the "remote" nations of the south, with whom Hebrew history is as little concerned—barring the relationship between Judæa and southern Arabia reflected in the legends of King Solomon's dealings with the Queen of Sheba<sup>1</sup>—as the "remote" nations of the north and east represented by the Japhethites, are not as in P the Hamites, but the groups which represent the subdivisions of southern Arabia. J, therefore, like P has two "remote" groups, but the entire character of the former's *Völkertafel* is changed by his definition of the Hamites as those representing the enemies of Israel.

To sum up, therefore, J's list includes three general groups: (*a*) peoples towards whom J was indifferent because of little or of no moment to Hebrew history, (*b*) peoples towards whom he harbored bitter feelings of hostility, and (*c*) his own people towards whom he was partial and whose descent he traced from the favorite son of Noah. The first group includes again (1) the Japhethites in the west, north and northeast and (2) the Eber-Joktan branch or southern Arabs. His nationalistic spirit manifests itself in those whom he places in the second group, while on the other hand the limits to this spirit are represented by his willingness to place the southern Arabs among the favored Shemites, being prompted to this display of generosity by the absence of any motive for excluding them and the self-evident consideration that the Shemites must include other subdivisions besides his favorites—the Hebrews. The scholastic spirit which J also possesses when it does not interfere with his natural dislikes, though not to the same degree as P, leads him likewise to recognize the close relationship between Hebrews and Aramæans, so that his Shemites as seems likely also included Aram.

P, on the other hand, free from the nationalistic spirit, except possibly when the Canaanites are involved, sets up two very well-defined groups: (*a*) the remote nations of the west, north and northeast—the Japhethites, and (*b*) the remote nations of the south—Nubia, Egypt and southern Arabia—the Hamites, to which he adds (*c*) as a third group the Hebrews and those adjacent or "near" to them, though his definition of "near" again displays a larger historical

<sup>1</sup> I Kings, chap. x—amplified by further details in the "Midrashic" literature. See e. g. Weil's *Biblische Legenden der Muselmänner*, pp. 247–271.



and geographical view than does J and the school of writers that follow him. Lastly, it is to be noted that the writers responsible for the numerous additions and glosses to J as well as the compiler who combined J with P stand under the influence of the narrower view manifested by J, so that in its present form the *Völkertafel* in the tenth chapter of Genesis regarded as a "combined" document impresses one as bearing out J's conception of Hamites and Shemites, the former as the "accursed," the latter as those "blessed" by Jahweh, rather than P's definition. Nor is it surprising, in view of political events and religious developments in the post-exilic period, that the more rigidly "scholastic" division of nations should have been eclipsed by one that appealed more to the national interests and that must have been a source of hope and consolation in trying days—encouraging the Hebrews to look forward to a time when the "curse" and "blessing" pronounced on Ham and Shem, or Canaan and Eber, respectively, would be fulfilled.

*University of Pennsylvania, June, 1904.*

---

## REGULATION OF COLOR-SIGNALS IN MARINE AND NAVAL SERVICE.

BY CHARLES A. OLIVER.

*(Read April 9, 1904.)*

When it is considered that the most dangerous periods of time for the safety of lives and preservation of property at sea are those during which the proper recognition of color-signals constitutes the main and, at times, the only guide for immediate action, the importance of the regulation of the choice of the colors used, the character of the materials employed, the size of the objects submitted for inspection, and the degree and the character of the visual acuity necessary for the determination of such colors, become evident.

So long as the high seas are necessarily free, and harbors constantly changing in topography and oftentimes difficulty of access; rivers and streams occupied in similar places by crafts of varied size and differing speeds; permanently fixed objects, such as buoys and direction and danger indicators, must have color differentiation employed as their main expressive feature; and color-signs must be used to signify the position of large floating masses, such as ships at

anchor,—just so long will it remain necessary continually to improve the color material employed during actual service, and to render the apparatus which is to be used the most simple in construction that can be employed.

The well-filled harbor, with its changeable and constantly crossing paths containing traffic of every conceivable kind, the instability of the water mass itself, and the uncertain factors, such as fogs, mists and snow, all show to what great degree of danger every moving object placed within such a situation is exposed. These conditions are far different in degree of uncertainty from those that are seen in railway travel, in which the directions of movement are comparatively fixed, every change of direction well protected, and all of the trains carefully guarded by block systems.

The first question which arises is, Can the system of signalling now in vogue in marine and naval service be so changed as to give better results with less liability to error?<sup>1</sup>

Experiment and trial have shown that the visual apparatus which projects man's ordinary sensory powers possibly to the greatest distance into space must be the sensory organ which is preferably to be employed during the common routine of duty. Fixed or intentionally changed color differentiations being less unstable, and hence more certain for visual perception than mere recognition of form and objective motion, must be that which should be practically employed. As the result of experience, the coarse colors, red, green, yellow, white and blue, are the ones which have been found to be the best for use during maritime signalling. These colors which are either placed in related situations upon movable bodies (both while in motion and while at rest upon bodies of water), or which are situated in fixed positions, are made interchangeable and time-regulated. These colors, possessing definite color-arrangement and color-sequence, are intended either to express direction, signify protection or designate code-signalling; varieties of work—the correct and, at times, vital answers to which are dependent solely upon color recognition at distances which are

<sup>1</sup> Better, less complicated, and hence cheaper and more easily applied adaptations of the Hertzian Ray apparatus might accomplish the purpose in one way; but unfortunately, unless such instrumentation is automatic in action, and unless its management and use can be kept constantly correct, this method must be considered in the light of the future.

comparable with safety to large moving masses that often can be alone stopped slowly and gradually—colors and relative positions which must be carefully chosen in regard to distances, situations, etc.

In the following paragraphs it has been endeavored to express clearly and briefly the specific reasons for the improvements and changes suggested.

I. All of the color tints to be used both by reflected light-stimuli and transmitted light-stimuli (day and night) during actual duty, should be officially proven copies of standards which have been carefully chosen in such a way that the signals may be uniform in tint in spite of variations in the character of the illuminants themselves. These selections should be made by an international commission of normal-eyed color experts. The color-signals will then be universally alike, thus minimizing danger from confusion due to false color exposure.

These results can probably best be obtained by mathematically and analytically obtaining sample pigment hues, both for diffuse reflected solar light and diffuse refracted artificial light, of specified kinds, character, degrees and tints, which are equivalent to the midway bands for the colors used in the corresponding portions of the color spectra obtained during exposure to the illuminant to be employed during actual service.

II. Each vessel of any importance should be provided with proportionately-sized miniature samples of color-boxes, color-lamps, signal-colors, etc.,—or better, fitted with full-sized examples of the same,—all carefully protected and boxed. These should be used as guides for the tinting of all material which employs color as its basis for signalling of any kind. These materials should be certified by proper authority, and should be obtainable at cost at licensed shops in every port of any consequence.

III. It should be a part of the official duty of every national, state and municipal government to see that the materials which are used for color-signalling in any form, as well as the samples, are periodically examined as to cleanliness and stability of tint. Dated certificates, brief and to the point, with plain instructions for the easiest manufacture and the best plans for the preservation of the color materials, together with clearly expressed rules for distances used, situations employed, and notes on any color peculiarity

of certain places, should be given; these to be submitted for inspection on demand.

IV. Every series of related colors used should be regulated, both as to their comparative sizes of exposure and the relative degrees of color saturation; these should be duly proportionate in reference to equalities, distinctness, relationships and association of safe distances, and with regard to differences in degrees of penetrability. This can be accomplished either by having the color values graded proportionately (a bad plan, since it tends to weaken the value of the stronger colors), or by making the color areas relative in size: for example, to give a green signal light a similar degree of brightness, and hence the same relative distinctness (which governs all apparent distances, and in consequence the relationships of the two colors), as red, it must either be five times more powerfully illuminated than the red or given five times more exposed superficial area: so too with all other color changes; there is an idiocratic relationship. Clinical experiment has shown this, and laboratory research has confirmed the practical findings. The importance of this factor can hardly be overestimated when the series of individual signal colors are numerous in well-filled and busy harbors.

These plans once agreed upon by such an international commission, all necessary data will soon become common property, and in consequence the system will be universally understood.

*Philadelphia, April 7, 1904.*

THE ARRANGEMENT OF COLLECTIONS OF  
METEORITES.

BY DR. ARISTIDES BREZINA, VIENNA.

*Late Director of the Mineralogical Department of the Natural History Museum at  
Vienna.**(Read April 8, 1904.)*

In making a collection of any kind of matter two ends must be kept in view; firstly, to secure in due time and to preserve as great and complete a variety of the material as possible, and secondly, to illustrate as fully as possible all ways in which the matter may be considered.

According as a collection provides for the first or the second purpose it is called a *systematic* or a *synoptical collection*.

Until 1889 there existed meteorite collections of the first kind only; in this year the new Natural History Museum of the Court at Vienna was to be opened; and as for a hundred years this collection had been worked upon by *Chladni*, *Schreibers*, *Widmanstätten*, *Partsch*, *Haidinger*, *Hörnes*, *Wöhler*, *Tschermak* and myself, most of its specimens from different localities had been investigated structurally and chemically so thoroughly, that I could for the first time divide the material into ten great series.

They were disposed as follows:

I. Ancient coins on which sacred meteorites were represented.

II. Historical meteorites which were worshiped by primitive nations or which formed standards in the development of meteoric science; related bodies, as fallen dust, bloody rain, meteor-paper, nuclei of hail and pseudo-meteorites.

III. Specimens of meteorites which show processes of melting, incrustation, cleaving and faulting, black and metallic veins, etc., (celestial alterations); and the results of experiments on meteorites for producing similar alterations.

IV. Specimens showing terrestrial alterations, viz., deformation by falling on the earth, erosion of the surface by terrestrial agents, chemical alteration after the fall, formation of new constituents by humidity, etc.

V. The constituents of the meteorites, from simple minerals

to complex bodies, free and in combination; artificial products, meteorites and their minerals formed synthetically.

VI. Slices through whole meteorites from all petrographic groups, showing the general structure on large surfaces.

VII. A series of specimens of equal size and normal constitution of all groups of meteorites, free from extraordinary inclusions, but showing the differences between pieces of the same fall; this series was intended to allow of a quick determination of the group to which a new meteorite belongs.

VIII. A collection of microscopic slides of all meteorites fit for microscopic study.

IX. The systematic collection, containing the main mass of the collection, arranged from the petrographical and mineralogical points of view.

X. Casts of all meteorites of characteristic outer form.

A collector who has considerable means at his disposal should begin by forming a systematic collection. An excellent example of such a collection built up within a moderate number of years is the Ward-Coonley collection, whose catalogue has lately been published. It represents a greater number of localities than any other public or private collection in the world, nearly 90 per cent. of all meteorites known; and it averages so high in weights, that later it may from its surplus furnish the material for all kinds of researches and for exchanges on the largest scale, so that it will be independent from acquisitions by purchases for a long time and will permit of the formation by and by of a synoptical collection.

In the following pages I give the description of a collection of this second kind, which I have formed since 1896, derived from a small number of monopolized falls by numerous exchanges. This description may serve as a guide for collectors who intend to develop a synoptical collection out of the material of a systematic one.

### I. BETYL COINS.

The ancients supposed the stars to be the domiciles of the gods; falling stars and falling meteorites signified the descending of a god or the sending of its image to earth.

These envoys were received with divine honors, embalmed and draped and worshiped in temples built for them.

From about 400 (or 500) B.C. to 300 A.D. coins were struck in honor of these divinities by emperors and autonomous cities.

In general the images were rather naturalistic in older times and became human-like (iconic) afterward.

Many of these beryl coins represent stones reported expressly to have fallen from heaven; some of them present as a common feature the likeness to conic stones, or obelisks or to archaic, half-iconic simulacra; so it comes that similar representations of unknown origin were likewise supposed to represent sacred meteorites.

#### *A. Betyls Reported to Have Fallen from Heaven.*

1. *The Omphalos of Delphi.*—A black stone which was given by Rhea to Uranos instead of the new-born Zeus, and rendered to Zeus after his victory over Kronos; Zeus or Saturn threw it on the Earth, on the point which was considered as the centre of the Earth.

Eleuthernai, Kreta; Autonomus 2 AE.<sup>1</sup>

Makedonia; Philippus II AR. Pl. I, Fig. 1.

Myrina, Aiolis; Auton. AR. Fig. 2.

Nakrasa, Lydia; Auton. AE. Fig. 3.

Neapolis, Campania; Auton. 3 AE. Fig. 4.

Parthia; Tiridates 3 AR, Fig. 5, Arsaces II AR, Phriapatius AR, Phraates I 4 AR, Mithradates I 5 AR. Fig. 6.

Roma, Italia; Sabina AE.

Syria; Antiochus I Soter 10 AR, Fig. 7, Antiochus II Theos AR, Antiochus Hierax 2 AR, Seleucus III Ceraunus 3 AR, Antiochus filius AR, Antiochus III Magnus 17 AR, Seleucus IV Philopator 2 AR, Antiochus IV Epiphanes AR, Demetrius I Soter 3 AR, Fig. 8, Alexander I Bala 4 AR.

2. *The Stone of Emisa, El Gabal.*—A black, conical stone, which Herodian reports to have fallen from heaven; Elagabal transferred it to Rome, where it remained until 222 A.D.

<sup>1</sup> AE bronzes, AR argent, AV aurum (gold); the number before gives the number of different kinds represented: 2 AE, two bronzes.

Emisa, Seleukis and Pieria; Antoninus Pius 2 AE. Fig. 9.  
Roma, Italia; Elagabalus 3 AR. Fig. 10.

3. *Zeus Kataibates*.—The descended god, who was represented sitting on a throne.

Kyrrhos, Kyrrhestika; Trajan AE, Fig. 11, Antoninus Pius 2 AE, Marcus Aurelius 2 AE, Lucius Verus AE, Commodus AE, Elagabal AE, Philippus pater AE, Fig. 12, Philippus filius 2 AE.

4. *Aphrodite Paphia*.—A stone said to have fallen from heaven as an image of the Paphian Aphrodite; an elongated cone in a temple of two columns.

Kypros; Galba AE, Vespasian 4 AR, Fig. 13, AE, Trajan AE, Septimius Severus AE, Julia Domna AE, Caracalla AE. Fig. 14.

5. *Artemis Ephesia*.—Image of Artemis reported to have fallen from heaven and been preserved in the temple of Ephesos. Form half-ionic.

Aizanis, Phrygia; Auton. AE, Commodus AE. Pl. II, Fig. 15.

Ankyra, Phrygia; Sabina AE, Faustina jun. 2 AE, Julia Domna AE.

Ephesos, Ionia; Antoninus Pius AE.

Ephesos and Pergamon; Commodus AE, Gallienus 2 AE. Figs. 16, 17.

Eumeneia, Phrygia; Auton. AE.

Nakrasa, Lydia; Auton. 2 AE.

Philadelphia, Lydia; Auton. AE.

Provincia Asia; Claudius AR, Fig. 18, Hadrian 2 AR.

Roma, Italia; Hostilia AR. Fig. 19.

Tabai, Karia; Auton. AR.

Tiberiopolis, Phrygia; Trajan AE.

6. *Stone of Astarte*, which fell as a star from heaven and was raised by Astarte, who consecrated it to the town of Tyros; a second stone of Astarte was worshiped at Sidon (represented laying on a car), and some coins of Tyros exhibit both stones (the Ambrosian petræ).

Sidon, Phoinikia; Auton. 3 AE, Hadrian AE, Caracalla AE, Elagabal 9 AE, Fig. 20, Julia Soæmias AE, Julia Mæsa AE, Annia Faustina AE, Alexander Sever AE.



Tyros, Phoinikia; Elagabal AE, Fig. 21, Valerianus pater AE, Salonina AE.

*B. Betyls Accepted by Analogy to Represent Meteorites.*

7. *The Pyramids or Obelisks of Apollon.*—

Ambrakia, Epeiros; Auton. 3 AE.

Apollonia, Illyria; Auton. 3 AE. Fig. 22.

Megara, Megaris; Auton. AE.

Myrina, Aiolis; Auton. AE.

8. *The Herms of Hermes, Ithyphallos and Priapos.*—

Makedonia; Alexander III Magnus AR. Fig. 23.

9. *Telesphoros.*—

Akrasa, Lydia; Auton. AE.

Eukarpeia, Phrygia; Auton. AE. Fig. 24.

Hadrianeia, Mysia; Antoninus Pius AE.

Roma, Italia; Caracalla AE.

10. *The Two Stones of Zeus Dolichenos or Herakles Sandan.*—

Syria (Tarsos); Antiochus VIII Grypus 3 AR, Fig. 25, Antiochus IX Cyzicenus AR.

Tarsos, Kilikia; Auton. 6 AE.

11. *Zeus Kasios*, represented as a conical stone suspended by a chain in a strap.

Seleukeia, Seleukis and Pieria; Trajan 8 AE, Fig. 26, Antoninus Pius 2 AE, Marcus Aurelius AE, Commodus AE, Septimius Severus AE, Caracalla AE, Alexander Severus AE.

12. *Conical or Quadratic Stones* without determination.—

Mallös, Kilikia or Rhosos, Seleukis and Pieria; Auton. 2 AR. Fig. 27.

Perga, Pamphylia; Gallienus AE.

Synnada, Phrygia; Gallienus AE. Fig. 28.

13. *The Conical Stone of Aphrodite Urania.*—

Makedonia (Uranopolis); Alexander III Magnus 12 AR. Pl. III, Fig. 29.

Uranopolis, Chalkidike; Auton. AE.

14. *The Simulacrum of Artemis Anaïtis*, half-iconic.—

Apameia, Phrygia; Auton. AE.

Hypaipa, Lydia; Trajan AE. Fig. 30.

15. *The Simulacrum of Artemis Leukophrys*, half-iconic.—

Magnesia ad Mäandrum, Ionia; Auton. AE. Fig. 31.

16. *The Simulacrum of Artemis Pergaia*; a cone with human head.—

Kaisareia, Kappadokia (Provincia Asia); Trajan AR. Fig. 32.

Perga, Pamphylia; Auton. 2 AE, Trajan AE, Caracalla AE, Diadumenian AE, Tranquillina 2 AE, Fig. 33, Philippus pater 3 AE, Valerianus pater AE, Gallienus 3 AE, Aurelian AE.

Pogla, Pisidia; Antoninus Pius AE.

Provincia Asia; Nerva 2 AR, Trajan 3 AR. Fig. 34.

17. *The Simulacrum of Astarte*, half-ionic.—

Gabala, Seleukis and Pieria; Macrinus AE.

18. *The Conical Stone of Hera*.—

Chalkis, Euboia; Auton. AE. Fig. 35.

19. *The Simulacrum of the Samian Hera*, half-ionic.—

Panionion, Ionia; Marcus Aurelius AE. Fig. 36.

Samos, Ionia; Caracalla AE, Fig. 37, Alexander Severus 3 AE, Philippus pater 2 AE, Trajanus Decius 2 AE, Etruscilla 2 AE, Gallienus AE, Fig. 38.

20. *The Simulacrum of Persephone*, half-ionic.—

Julia Gordos, Lydia; Marcus Aurelius AE.

Sardes, Lydia; Auton. AE, Fig. 39, Salonina 2 AE.

Sardes and Hierapolis; Philippus pater AE.

21. *Archaic Simulacrum of Double Goddess*.—

Capua, Campania; Auton. AE.

### C. Related Celestial Bodies.

22. *Comets*.—

Roma, Italia; Sanguinia (Julius Cæsar) AR, Augustus 5 AR. Fig. 40.

Silesia, Germany (modern); Auton. AV, Fig. 41, 2 AR, AE.

## II. HISTORICAL METEORITES.

Mordvinovka, Ekaterinoslav, Russia. Prehistoric. Cw.<sup>1</sup> 1 gram, 2 cm.

Casas Grandes, Mexico. Prehistoric. Om. 102 gr. 26 cm.

These two meteorites were found in prehistoric tumuli.

<sup>1</sup>The symbols following the date of fall designate the petrographic group as defined later on (VII, System of Meteorites). Weight and profitable surface are added in grams and square centimeters.

Wichita county, Brazos, Texas. Found 1836. Og. 168 gr. 44 cm. Worshiped by Indians as coming from "the Great Spirit."

Kesen, Iwate, Japan. Fell June 13, 1850. Ccb. 8 gr. 5 cm. Worshiped in a temple of Iwate as a betyl.

Ensisheim, Alsace, Germany. Fell November 16, 1492. Ckb. 10 gr. 5 cm. Oldest meteorite of known fall.

Elbogen, Bohemia. Known since about 1400. Om. 12 gr. 4 cm. The so-called "verwunschene Burggraf." Said to have occided in 1410 the burggrave Botho von Eulenburg, defamed for his cruelty, the ancestor of the principles of Eulenburg.

Krasnojarsk, Siberia. Found 1749. Pk. 25 gr. 8 cm. The meteorite on which Chladni demonstrated the cosmic nature of these bodies.

Albareto, Modena, Italy. Fell July, 1766. Cc. 3 gr. 2 cm. The fall was described carefully by the Jesuit Troili in the paper "Della caduta di un sasso dell' aria." Modena, 1766, 128 pages.

Barbotan, France. Fell July 24, 1790. Cga. 9 gr. 4 cm. These stones were thrown away by the Paris Academicians, who feared the ridiculousness, if believing in the reality of the fact of falling stars.

Laigle, France. Fell April 26, 1804. Cib. 115 gr. 18 cm. The fall was examined carefully by the celebrated Biot and dissipated the doubts in France.

Borodino, Russia. Fell September 5-6, 1812, during the battle of Borodino, in the chief-quarter of the Russians. Cgb. 5 gr. 2 cm.

Mazapil, Mexico. Fell November 27, 1885, with the Bielid star-shower which replaced the disappeared Biela comet. Om. 11 gr. 15 cm.

Bjurböle, Finland. Fell March 12, 1899, in the bottom of Stensböle Fjärde, and was raised by divers; shows adhering sea-ooze. Cca. 61 gr. 12 cm.

Breslau, Silesia. Fell January 31, 1848. 4 gr.—Rescht, Persia. Fell September 10, 1864. 3 gr.—Nacimiento del Rio Colorado, Argentina. Fell 1883. 1 gr.—Meteoric dust containing nickel.

Neusohl, Hungary. Fell January, 1848. 0.3 gr.—Niedertenzel, Bohemia. Fell February 18, 1899. 11 gr.—Terrestrial dust containing no nickel.

Ivan, Oedenburg. Hungary. Limonite pebbles which fell August 10, 1841, in accumulations of hundreds of tons, being raised by a cyclone from the exsiccated grounds of Lake Neusiedel.

### III. SCATTERING OF METEORITES.

Brenham, Kansas. Found 1885. Pk. Free of olivine. 250 gr. 38 cm.—Brenham, Kansas. Found 1885. Pk. Rich in olivine. 109 gr. 45 cm.—Glorietta, New Mexico. Found 1884. Pk. Free of olivine. 119 gr. 36 cm.—Members of the chain-fall Brenham ( $37^{\circ} 38' N.$ ,  $99^{\circ} 13' W.$ ), Glorietta ( $35^{\circ} 52' N.$ ,  $105^{\circ} 30' W.$ ), Port Orford ( $42^{\circ} 46' N.$ ,  $123^{\circ} 10' W.$ ).

Lerici, Italy. Fell January 30, 1868, 7 p.m. Cga. 6 gr. 3 cm.—Pultusk, Russia. Fell January 30, 1868, 7 p.m. Cgb. 57 gr.—Alike in structure, fell at the same time on a line coinciding with the flying-line of Pultusk; Lerici  $44^{\circ} 4' N.$ ,  $9^{\circ} 55' O.$ , Pultusk  $52^{\circ} 42' N.$ ,  $21^{\circ} 23' O.$

Vaca Muerta, Chile. Known 1861. Mg. 30 gr. 11 cm.—Cerro la Bomba, Taltal, Chile. Found 1888. Mg. 151 gr. 18 cm.—Quebrada Huanilla, Cachinal, Chile. Found 1887. Mg. 2 gr. 2 cm.—Mejillones, Chile. Found 1867. Mg. 1 gr. 1 cm.—Pieces misplaced by rancheros.

Lion River, Great Namaland. Found before 1853. Of. 27 gr. 7 cm.—Bethany-Berseba, Namaland. Known in 1874. Of. 4 gr. 3 cm. Mukerop, Gibeon, first block. Found in 1899. Of. 500 gr. 42 cm.—Mukerop, Gibeon, second block. Known in 1902. Of. 673 gr. 36 cm.

Lion River circa  $23^{\circ} 40' S.$ ,  $17^{\circ} 40' W.$ ; Bethany  $26^{\circ} 30' S.$ ,  $16^{\circ} 49' W.$ ; Berseba  $26^{\circ} 0' S.$ ,  $17^{\circ} 42' W.$ ; Gibeon  $25^{\circ} 6' N.$ ,  $17^{\circ} 48' W.$

### IV. MELTING AND FUSION, SCORIFICATION, FAULTING, SEPARATING.

Stannern, Moravia. Fell May 22, 1808. Eu. 162 gr. 28 cm. Crust melted easily; fritted earth on front side.

Juvinas, France. Fell June 15, 1821. Eu. 21 gr. 9 cm. Crust melted easily, with small rolls.

Mócs, Hungary. Fell February 3, 1882. Cwa. 135 gr. Five individuals; crust thick, scorified.

Orvinio, Italy. Fell August 31, 1872. Co. 30 gr. Whole individual orientated, scorified crust, interrupted.

Kernouvé, France. Fell May 22, 1869. Cka. 173 gr. 42 cm. Crust loose, scabby, partly fallen off.

Antifona, Italy. Fell February 3, 1890. Cc. 241 gr. 42 cm. Apex of the stone with radial drift.

Aleppo, Turkey. Found 1873. Cwb. 67 gr. 15 cm. Crust of back, scoriated and bubbly.

Pultusk, Russia. Fell January 30, 1868. Cgb. 233 gr. 30 cm. Whole individual, highly orientated; front crust primary, back crust secondary, thin.

Knyahinya, Hungary. Fell June 9, 1866. Cg. 292 gr. 50 cm. Highly orientated whole individual, front drift, roll border; back crust thin, brown, crust-sprinkled.

Knyahinya. 127 gr. 18 cm. Individual of loaf form with uncovered striking spots.

Estherville, Iowa. Fell May 10, 1879. M. 40 gr. 6 and 3 cm. Two whole individuals, the one with metallic, the other with stony crust.

Marjalathi, Finland. Fell June 1, 1902. Pi. 147 gr. 22 cm. Black crust, fine-drusy and even over the iron, even and bright over the olivine.

Glorietta, New Mexico. Found 1884. Pk. 492 gr. 40 cm. Highly orientated individual, free of olivine; front drift, roll border, back crust loose, partly fallen off.

Pultusk, Russia. Fell January 30, 1868. Cgb. 252 gr. 30 cm. Whole individual, polyhedral flake with primary crust.

Pultusk, 154 gr. Thirty-eight whole individuals of equal weight (4 grams each) with primary and secondary crust.

Hessle, Sweden. Fell January 1, 1869. Cc. 10 gr. 4 cm. Whole individual with four primary faces; apex-concavity after chondrule has fallen out.

Hessle. 13 gr. 5 cm. Individual of flake form.

Kansada, Kansas. Found 1897. Cib. 135 gr. 22 cm.

Whole individual, primary faces, partly even, partly piezoglyptic.

Forest, Iowa. Fell May 2, 1890. Ccb. 83 gr. Five individuals with faces partly polyhedral, partly rounded.

Cañon Diablo, New Mexico. Found 1891. Og. 122 gr. 28 cm. Individual in form of acute-angular, piezoglyptic flake.

Cañon Diablo. 51 gr. Twelve individuals of similar sharp angular flake form.

Aumières, France. Fell June 3, 1842. Cwa. 18 gr. 5 cm. Flawy crust (craquelé) on concave face.

Dhurmsala, India. Fell July 14, 1860. Ci. 257 gr. 40 cm. Stone which was extremely cold when it reached the earth.

Ochansk, Russia. Fell August 30, 1887. Ccb. 12 gr. 5 cm. Infiltration of crust and crust-drops on uncovered fissure, issuing from bubbly scoriaceous crust.

Girgenti, Italy. Fell February 10, 1853. Cwa. 132 gr. 22 cm. Parallel infiltration-veins with lateral apophyses. Plate IV, Fig. 42.

Fisher, Minnesota. Fell April 9, 1894. Cia. 208 gr. 27 cm. Ramified crust-infiltration.

Maëmê, Japan. Fell November 10, 1886. Cia. 97 gr. 24 cm. Chondrule transpierced by infiltration-vein.

Aumières, France. Fell June 3, 1842. Cwa. 18 gr. 5 cm. Chondrule faulted by a black vein.

Baratta, New South Wales. Fell May, 1845. Cgb. 45 gr. 18 cm. Broken chondrule, the parts dislocated.

Château-Renard, France. Fell June 12, 1841. Cia. 80 gr. 12 cm. Thick harness uncovered.

Ställdalen, Sweden. Fell June 28, 1870. Cgb. 34 gr. 9 cm. Harnesses in different directions, partly uncovered.

Alessandria, Italy. Fell February 2, 1860. Cga. 15 gr. 5 cm. Harnesses and black crust-veins.

Zavid, Bosnia. Fell August 1, 1897. Cia. 310 gr. 31 cm. Thin harness on even rupture-face.

Lasdany, Russia. Fell June 12, 1820. Cga. 77 gr. 12 cm. Harnesses on uneven rupture-faces.

Badger, New Mexico. Known 1897. Om. 427 gr. 45 cm.

Empty octahedral fissures, crust in an excavation, stowing of lamellæ.

Badger. 461 gr. 30 cm. Octahedral fissures filled with magnetite; faulting and bending of lamellæ.

Chantonay, France. Fell August 5, 1812. Cgb. 89 gr. 25 cm. Fluidal structure of black parts.

Mócs, Hungary. Fell February 3, 1882. Cwa. 6 gr. Unchanged original mass and pieces heated in copper enclosure (blackened)

Knyahinya, Hungary. Fell June 9, 1866. Cg. 4 gr. Heated in copper enclosure and blackened.

Albareto, Italy. Fell July, 1766. Cc. Ignition preparation (from old Italian experiments).

Arlington, Minnesota. Found 1894. Om. 28 gr. 6 cm. Iron-enamel, alteration-zone along natural surface.

Ngoureyrna, Algiers. Fell June 15, 1900. Obzg. 29 gr. 7 cm. Iron-slag in fissure; molten and tracted mass.

Carlton, Texas. Found 1887. Off. 147 gr. 30 cm. Iron-slag in concavity; bending and faulting of lamellæ.

Jamestown, Dakota. Found 1885. Of. 69 gr. 20 cm. Melting-slag and alteration-zone.

Mukerop (Bethany), Namaland. Found 1899 (1853). Of. 350 gr. 30 cm. Melting-slag and alteration-zone.

Reed City, Michigan. Found 1897. Oge. 122 gr. 23 cm. Mollified; alteration-zone.

Hammersley, Australia. Found 1894. Om. 119 gr. 22 cm. Alteration-zone of 60 mm. thickness.

Silver Crown, Wyoming. Found 1887. Og. 134 gr. 35 cm. Alteration-zone of 3-4 mm. thickness. Plate IV, Fig. 43.

Sarepta, Russia. Found 1854. Og. 19 gr. 9 cm. Alteration-zone, inner curve equalized, 1-3 mm. thickness.

Barranca Blanca, Chile. Found 1885. Obz. 17 gr. 4 cm. Alteration-zone of 1-3 mm. thickness.

Oscuro Mountain, New Mexico. Known 1898. Og. 67 gr. 17 cm. Alteration-zone of 0.4-2 mm. thickness.

Ballinoo, Australia. Found 1893. Off. 395 gr. 40 cm. Double alteration-zone, outer zone sparkling, inner dull. Plate V, Fig. 44.

Azucar, Chile. Found 1887. Og. 160 gr. 35 cm. Alter-

ation-zone of 1-8 mm. thickness, terminating at a concavity produced by molten and removed Troilite.

Puquios, Chile. Found 1894. 70 gr. 12 cm. Faulting of octahedral lamellæ.

Bridgewater, North Carolina. Described 1890. Om. 128 gr. 30 cm. Faulting of octahedral lamellæ.

Mukerop (Bethany), Namaland. Found 1899 (1853). 386 gr. 35 cm. Faulting of lamellæ on border-fissures.

Mukerop. 64 gr. 9 cm. Wall-border bent on two sides.

Mukerop. 400 gr. 42 cm. Wall-border bent on one side.

Bella Roca, Mexico. Described 1888. Of. 104 gr. 15 cm. Wall-border bent on one side.

Mukerop. 727 gr. 38 cm. Hexahedral chamfers.

Lime Creek, Alabama. Found 1834. H. 8 gr. 2 cm. Neumann-lines bent.

DeSotoville, Alabama. Found 1878. H. 158 gr. 25 cm. Canted Giant-Rhabdites on curvated faulting vein.

Badger, New Mexico. Known 1897. Om. 162 gr. 52 cm. Strong bending of inner octahedral lamellæ.

Smith Mountain, North Carolina. Known 1863. Of. 14 gr. 14 cm. Damascened, violet and blue (Kamacite), pink (Taenite).

Homestead, Iowa. Fell February 12, 1875. Cgb. 62 gr. 11 cm. Gray unchanged mass (48 gr.), green (serpentinized) mass (14 gr.).

Ophir, Montana. Found 1897. Dn. 30 gr. Chips 5-7 cm. long, 0.5-1 mm. thick.

#### V. WEATHERING, FORMATION OF NEW CONSTITUENTS.

Saline, Kansas. Fell November 15, 1898. Cck. 67 gr. 22 cm. Spots of rust piercing through the crust.

Stalldalen, Sweden. Fell June 28, 1870. Cgb. 37 gr. 9 cm. Limonite formed on a harness-face.

Long Island, Kansas. Found 1892. Cia. 160 gr. 30 cm. Rusted through the whole mass by resting in moist earth.

Amana, Somaliland. Fell July 4, 1889. Ckb. 93 gr. 30 cm. Stratified Limonite crust on the surface.

Amana. 8 gr. 3 cm. Loose stratified Limonite crust.



Mackinney, Kansas. Fell 1870. Cs. 91 gr. 40 cm. Limonite crust on the surface.

Mackinney. 50 gr. Loose Limonite crust.

Orgueil, France. Fell May 14, 1864. K. 33 gr. Weathering grains.

Brenham, Kansas. Found 1885. Pk. 98 gr. 29 cm. Olivines partly fresh, partly limonitized.

Brenham. 187 gr. 36 cm. Olivines browned.

Brenham. 75 gr. Loose limonitized grains as products of weathering.

Mount Dyrning, New South Wales. Known 1902. Pk. 26 gr. 9 cm. Olivines browned, Nickel-iron limonitized, Schreibersite fresh.

Mount Dyrning. 149 gr. 35 cm. Nearly entirely limonitized; weathering in layers; olivines mostly changed into reddish-white substances.

Admire, Kansas. Found 1892. Pr. 244 gr. 20 cm. Weathering-crust 5-10 mm. thick; beginning of falling to pieces by formation of fissures.

Imilac, Chile. Found 1800. Pi. 100 gr. Twenty-three weathering individuals.

Wichita, Texas. Found 1836. Og. 44 gr. 14 cm. Worm-like limonitic rust-figures, free of Bacteria.

Joe Wright, Arkansas. Found 1884. Om. 15 gr. 4 cm. Dividing along the octahedron-faces.

Lipan Flats, Texas. Found 1897. Om. 184 gr. 27 cm. Dividing partly along octahedron-faces, partly curvilinearly.

Tarapaca, Chile. Known 1894. Om. 264 gr. 22 cm. Uncovered (disintegrated) octahedron-faces of 3-4 cm. by weathering on fresh mass.

Ranchito, Mexico. Found 1871. Off. 65 gr. 12 cm. Uncovered octahedron-faces of 2 cm. by weathering on fresh mass.

Cosby's Creek, Tennessee. Found 1837. Og. 37 gr. 6 cm. Uncovered (disintegrated) octahedron with superposed Taenite lamellæ.

Welland, Canada. Found 1888. Om. 11 gr. Uncovered octahedron lamellæ.

Nelson County, Kentucky. Found 1860. Ogg. 261 gr. 40 cm. Octahedral weathering on fresh mass.

Sao Juliao, Portugal. Found 1883. Ogg. 14 gr. Nail formed by weathering.

Mount Joy, Pennsylvania. Found 1887. Ogg. 29 gr. Fallen down in grains of 2-3 cm.

Badger, New Mexico. Known 1897. Om. 5 gr. Grains of Limonite as products of weathering.

Apolonia, Mexico. Found 1897. 40 gr. 12 cm. Changed into Limonite.

Sao Francisco, Brazil. Found 1874. Tell. 343 gr. 28 cm. Penetrating of limonitic alteration in layers.

Sao Francisco. 47 gr. 8 cm. Altered to Hematite.

Sao Francisco. 89 gr. 19 cm. Cellular alteration to Hematite and Limonite.

Augustinowka, Russia. Found 1890. Of. 130 gr. 22 cm. Stratified Limonite-crust of 2-3 cm. thickness.

San Cristobal, Chile. Found 1882. Dl. 5 gr. Whitish limonitic products of alteration.

Vaca Muerta, Chile. Known 1861. Mg. 63 gr. 12 cm. Forming of Nickel sulphates.

Doña Inez, Chile. Found 1888. M. 15 gr. 6 cm. Forming of Nickel sulphates.

## VI. CONSTITUENTS OF METEORITES.

Saline, Kansas. Fell November 15, 1898. Cck. 146 gr. 36 cm. Free Phosphorus by opening the interior.

Nowo Urej, Russia. Fell September 22, 1886. U. 14 gr. 6 cm. Diamond as microscopic component, one per cent. of mass.

Carcote, Chile. Known 1888. Ck. Splinters. Diamond as microscopic component.

Badger, New Mexico. Known 1897. Om. 537 gr. 42 cm. Graphite with attached Troilite in form of a **T**, 3 to 4 cm. Plate V, Fig. 45.

Toluca, Mexico. Described 1784. Om. 177 gr. 22 cm. Graphite as layer between nuggets of Troilite and their mantle of Schreibersite.

Senhadja, Algiers. Fell August 25, 1865. Cwa. 145 gr. 20 cm. Crystals of Nickel-iron, partly with cleavage faces, in Troilite; chondrule of 11 mm. diameter with bar.

Vaca Muerta, Chile. Known 1861. Mg. 1 gr. Grain of Nickel-iron with Widmanstätten-figures.

Crab Orchard, Tennessee. Found 1887. Mg. 35 gr. 12 cm. Chondrule of Nickel-iron with Widmanstätten-figures.

Mincy, Missouri. Found 1856. M. 140 gr. 30 cm. Chondrule of Nickel-iron, 2 cm. diameter, with worm-like residues of Silicates.

Morristown, Tennessee. Found 1887. Mg. 101 gr. 35 cm. Chondrules of Nickel-iron, 1-3 cm. diameter, with Silicate grains.

Hainholz, Germany. Found 1856. M. 77 gr. 19 cm. Chondrules of Nickel-iron, 5-10 mm. diameter.

Baratta, New South Wales. Fell May, 1845. Cgb. 58 gr. 18 cm. Chondrules partly with Iron cover, partly with Troilite cover.

Mackinney, Texas. Fell 1870. Cs. 300 gr. 40 cm. Black chondrules with Iron cover.

Marjalathi, Finland. Fell June 1, 1902. Pi. 61 gr. 17 cm. Crystals of Nickel-iron up to 6 mm. diameter, with rounded edges; crystals of Chromite; cylinder of Troilite.

Sao Francisco, Brazil. Found 1874. Tell. 24 gr. 6 cm. Crystals of Nickel-iron with folded faces.

Ovifac, Greenland. Found 1808. Tell. 242 gr. 50 cm. Nickel-iron grains in Basalt.

Ovifac. 225 gr. 42 cm. Chondrules of Nickel-iron in Basalt. Plate VI, Fig. 46.

Ovifac. 176 gr. 40 cm. Veins of Nickel-iron in Basalt.

Coahuila, Mexico. Known 1837. H. 293 gr. 30 cm. Kamacite with hexahedral cleavage.

Cañon Diablo, New Mexico. Found 1891. Og. 118 gr. 20 cm. Consisting of Kamacite.

Toluca, Mexico. Described 1784. Om. 347 gr. 30 cm. Kamacite with hatchings.

Merceditas, Chile. Known 1884. Om. 177 gr. 38 cm. Kamacite with hatchings.

Seeläsgen, Germany. Found 1847. Ogg. 52 gr. 10 cm.  
Kamacite with strong orientated glitter.

Pila, Mexico. Known 1804. Om. 240 gr. 30 cm. Kama-  
cite sparkling.

Fort Pierre, Missouri. Found 1856. Om. 330 gr. 43 cm.  
Iron dull.

Plymouth, Indiana. Found 1893. Om. 45 gr. 28 cm.  
Iron dull.

Nelson County, Kentucky. Found 1860. Ogg. 103 gr.  
38 cm. Iron with silky luster.

Walker Township, Michigan. Found 1886. Of. 333 gr.  
45 cm. Kamacite banded.

Burlington, New York. Known 1819. Om. 10 gr. 3 cm.  
Kamacite puffy.

Brenham, Kansas. Found 1885. Pk. 267 gr. 28 cm.  
Wrapping-Kamacite.

Welland, Canada. Found 1888. Om. 9 gr. Taenites iso-  
lated by weathering.

Bella Roca, Mexico. Described 1888. Of. 85 gr. 28 cm.  
Taenite prevailing.

LaCaille, France. Found 1600. Om. 25 gr. 14 cm. Tae-  
nite prevailing beneath sparkling Kamacite and Plessite.

Misteca, Mexico. Described 1804. Om. 128 gr. 42 cm.  
Taenite with fernlike skeletons.

Thunda, Australia. Described 1886. Om. 49 gr. 9 cm.  
Taenite strongly developed.

Coopertown, Tennessee. Known 1860. Om. 49 gr. 11 cm.  
Skeletons of Taenite.

Carlton, Texas. Found 1887. Off. 131 gr. 33 cm. Ples-  
site prevailing.

Mungindi, Australia. Known 1897. Off. 47 gr. 17 cm.  
Plessite prevailing, with central skeletons.

Thurlow, Canada. Found 1888. Of. 22 gr. 6 cm. Ples-  
site with central skeletons.

Toluca (doubtful). 27 gr. 6 cm. Bridges (bars) through  
fields and between puffy beams.

Tazewell, Tennessee. Found 1853. Off. 100 gr. 20 cm.  
Dodecahedral lamellæ beneath octahedral ones.

Bella Roca, Mexico. Known 1888. Of. 37 gr. 12 cm.  
Iron-tongue in Troilite.

San Cristobal, Chile. Found 1882. Db. 301 gr. 35 cm  
Shagreen Iron in meandering latticed Iron.

San Cristobal. 29 gr. 2 cm. Gold-yellow crystal in Troilite.

Beaconsfield, Australia. Found 1897. Og. 1 gr. Isolated crystals of Cohenite.

Niakornak, Greenland. Found 1819. Tell. 1 gr. Isolated Cohenite crystals.

Glowed steel with 1.3 per cent. C. Artificial. 1 gr. Isolated Cohenite crystals.

Ruffs Mountain, South Carolina. Known 1850. Om. 47 gr. 12 cm. Ribs of gray Cohenite in Kamacite.

Bendego, Brazil. Found 1784. Og. 148 gr. 25 cm. Cohenite-ribs in Kamacite, porous.

Wichita, Texas. Found 1836. Og. 428 gr. 40 cm. Cohenite ribs with high lustre in Kamacite.

Magura, Hungary. Found 1840. Og. 174 gr. 36 cm. Cohenite ribs in Kamacite, united to skeletons.

Penkarring Rock, Australia. Found 1864. Og. 73 gr. 11 cm. Cohenite ribs and Schreibersite in Kamacite.

Cañon Diablo, New Mexico. Found 1891. Og. 159 gr. 23 cm. Cohenite ribs in Kamacite porous and compact.

Rosario, Honduras. Known 1897. Og. 18 gr. 7 cm. Cohenite lamellæ and skeletons in Kamacite.

Deep Springs Farm, North Carolina. Found 1846. Db. 30 gr. 5 cm. Orientated plates of crystals of Cohenite in dull Iron.

Ovifac, Greenland. Found 1808. Tell. 152 gr. 42 cm. Cohenite forming with Nickel-iron grains in Basalt.

Sao Juliao, Portugal. Found 1883. Ogg. 2 gr. Isolated crystals of Schreibersite, iridescent.

Sao Juliao. 100 gr. Isolated crystals of Schreibersite.

Sao Juliao. 60 gr. 12 cm. Uncovered skeleton of Schreibersite.

Carlton, Texas. Found 1887. Off. 5 gr. Isolated Schreibersite crystals.

Carlton. 277 gr. 31 cm. Crystals of Schreibersite in Wrapping Kamacite in the Trias.

Primitiva, Chile. Found 1888. Dp. 4 gr. Isolated fragments of Schreibersite crystals.

Toluca, Mexico. Described 1784. Om. 119 gr. 13 cm. Crystals of Schreibersite with smooth faces and rounded edges; Graphite.

Saint François, Missouri. Known 1863. Og. 47 gr. 30 cm. Schreibersite ribs in Kamacite.

Bischtübe, Russia. Found 1888. Og. 263 gr. 40 cm. Skeleton-like crystals of porous Schreibersite in parallel layers of compact Schreibersite in wrapping-Kamacite in the Trias.

Tennant's Iron. Found 1784. Og. 9 gr. 4 cm. Crystals of Schreibersite in parallel layers of Cohenite beneath free Cohenite crystals.

Dacotah, Indian Territory. Found 1863. Ogg. 90 gr. 35 cm. Hieroglyphic Schreibersite, partly faulted by a fissure.

DeSotoville, Alabama. Found 1878. H. 298 gr. 45 cm. Schreibersite crystals partly turning into Schreibersite hieroglyphs.

DeSotoville. 287 gr. 40 cm. Crystal of Schreibersite in Limonite-Magnetite beneath Schreibersite hieroglyphs and Rhabdite ranges.

San Cristobal, Chile. Found 1882. Dl. 14 gr. 7 cm. Two layers of Schreibersite (compact inward, grainy outward) on Troilite.

San Cristobal. 67 gr. 12 cm. Schreibersite with hatchings in a Troilite crystal.

Ballinoo, Australia. Found 1893. Off. 99 gr. 28 cm. Schreibersite points in Troilite nuggets.

Ballinoo. 8 gr. 8 cm. Three loose Troilite nuggets, partly with crystalline surface, with points of Schreibersite.

Sao Juliao, Portugal. Found 1883. Ogg. 280 gr. 40 cm. Plates of Giant-Rhabdites, 2 cm. long, terminating hieroglyphs of Schreibersite.

Locust Grove, North Carolina. Found 1857. Ds. 206 gr. 38 cm. Rhabdite plates of 5-12 mm., apparently orientated.

Seelagen, Germany. Found 1847. Ogg. 20 gr. 5 cm.

Rhabdites abundant in Kamacite; etching zones round Taenites.

Hex River Mounts, Capeland. Found 1882. H. 216 gr. 45 cm. Parallel ranges of diagonal Rhabdites.

DeSotoville, Alabama. Found 1878. H. 266 gr. 43 cm. Parallel ranges of diagonal Rhabdites beneath skeletons of Schreibersite. Plate VI, Fig. 47.

Scottsville, Kentucky. Found 1867. H. 57 gr. 14 cm. Wreath of Rhabdites around Troilite-grain.

Fort Duncan, Texas. Found 1882. H. 99 gr. 24 cm. Inversion of orientated glitter inward and outward of etching zone of Troilites; Neumann-lines traversing; rust figures worm-like.

Floyd Mountain, Virginia. Found 1887. Ha. 400 gr. 40 cm. Spot-ranges and Rhabdite-ranges in parallel planes; Troilite with Cohenite or Schreibersite points.

Butler, Missouri. Found 1874. Off. 5 gr. Isolated Troilites limonitized.

Sao Francisco, Brazil. Found 1874. Tell. 2 gr. 1 cm. Troilite crystals on folded Troilite plates.

Kansada, Kansas. Found 1894. Cib. 194 gr. 25 cm. Troilite nuggets of various forms beneath Nickel-iron grains in Chondrite.

Zavid, Bosnia. Fell August 1, 1897. Cia. 67 gr. 14 cm. Nest of 3 cm. diameter of Troilite grains in Chondrite.

MacKinney, Texas. Fell 1870. Cs. 250 gr. 40 cm. Troilite vein 3-10 mm. thick.

MacKinney. 351 gr. 48 cm. Troilite grains of 3-7 mm. in Chondrite.

Baratta, New South Wales. Fell May, 1845. Cgb. 138 gr. 38 cm. Chondrules with Troilite mantle beneath grains of Troilite and Nickel-iron.

Bella Roca, Mexico. Known 1888. Of. 94 gr. 30 cm. Nuggets of Troilite with wrapping-Kamacite in the Trias.

Mukerop (Bethany), Namaland. Found 1899. (1853.) Of. 363 gr. 41 cm. Nuggets of two kinds of Troilite; the soluble, with fluidal structure interlocking as tongues in the insoluble one.

Mukerop. 489 gr. 45 cm. Nuggets of soluble and insolu-

ble Troilite; Reichenbach lamellæ consisting of bulbous Troilite. Plate VII, Fig. 48.

Lagrange, Kentucky. Found 1860. Of. 29 gr. 18 cm. Reichenbach lamellæ with bent borders, trailed.

Merceditas, Chile. Known 1884. Om. 115 gr. 41 cm. Reichenbach lamellæ originating in Troilite nuggets.

Joe Wright, Arkansas. Found 1884. Om. 135 gr. 40 cm. Reichenbach and Schreibersite lamellæ 2-3 cm. long.

Trenton, Wisconsin. Found 1858. Om. 57 gr. 30 cm. Reichenbach lamellæ 2-3 cm. long.

Primitiva, Chile. Found 1888. Dp. 25 gr. 14 cm. Troilite nuggets with Iron tongues in Nickel-iron, small Troilite globes swarming around, beneath hieroglyphs of Schreibersite.

Sao Julia, Portugal. Found 1883. Ogg. 157 gr. 20 cm. Troilite points in parallel ranges beneath crystals and hieroglyphs of Schreibersite.

Bendego, Brazil. Found 1784. Og. 54 gr. 13 cm. Crystal of Daubrélite with adhering Troilite, 1 cm. diameter.

Santo Domingo Yanhuitlan, Mexico. Known 1804. Of. 42 gr. 36 cm. Oval Troilite nuggets transversed by bands of Daubrélite; Reichenbach lamellæ.

Badger, New Mexico. Known 1897. Om. 434 gr. 33 cm. Daubrélite crystal in Troilite nugget, the whole in wrapping Kamacite, on which stowed the octahedral lamellæ; half detached octahedron.

Shalka, India. Fell November 30, 1850. Chl. 10 gr. 4 cm. Chromite individuals up to 5 mm. diameter, strongly deformed.

Marjalathi, Finland. Fell June 1, 1902. Pi. 192 gr. 30 cm. Crystals of Chromite, uncovered and in section.

Mount Dyrning, New South Wales. Known 1902. Pk. 52 gr. 20 cm. Crystals of Chromite, octahedron, dodecahedron, trapezohedron and two hexakisoctahedra.

Krasnojarsk, Siberia. Found 1749. Pk. 4 gr. Isolated crystals of olivine, olive-green and brown.

Jamyschewa, Siberia. Found 1885. Pk. 2 gr. Isolated olivine crystals.



Brenham, Kansas. Found 1885. Pk. 50 gr. Isolated olivine crystals.

Brenham. 64 gr. 33 cm. Parallel laces of olivine crystals in Nickel-iron.

Estherville, Iowa. Fell May 10, 1879. M. 20 gr. Isolated individual of olivine.

Mincy, Missouri. Found 1856. M. 154 gr. 42 cm. Olivine crystal 5 cm. diameter, in Mesosiderite.

Eagle Station, Kentucky. Found 1880. Pr. 86 gr. 25 cm. Olivine crystals up to 2 cm. diameter, broken, with inserted Nickel-iron between the fragments.

Vaca Muerta, Chile. Found 1861. Mg. Three thin sections of an olivine crystal.

Stannern, Moravia. Fell May 22, 1808. Eu. 130 gr. 25 cm. Vein of Anorthite in normal Eukrite.

New Concord, Ohio. Fell March 1, 1860, Cia. 74 gr. 15 cm. Grains of Anorthite in Chondrite.

Toluca, Mexico. Found 1784. Om. Microscopic preparation of crystals of Kosmochlore.

Saint Caprais, France. Fell January 28, 1883. Ci. 1 gr. 1 cm. Greenish-yellow crystals of Enstatite.

Fisher, Minnesota. Fell April 9, 1894. Cia. 10 gr. 6 cm. Foliated chondrule of Enstatite, 1 cm. diameter.

Hvittis, Finland. Fell October 21, 1901. Cek. 11 gr. 3 cm. Enstatite chondrule, 1 cm. diameter.

Alfanello, Italy. Fell February 16, 1883. Ci. 36 gr. 12 cm. Chondrules black, gray and striated (black and white).

Zavid, Bosnia. Fell August 1, 1897. Cia. 24 gr. 7 cm. Greenish-gray, fragmentary chondrule of 1 cm. diameter in Chondrite.

Zavid. 71 gr. 12 cm. Dark gray chondrule with white, cruciform skeleton.

Antifona, Italy. Fell February 3, 1890, Cc. 2 gr. 3 cm. White chondrule with blue nucleus.

Kaande, Russia. Fell May 11, 1855. Cw. 12 gr. 4 cm. White chondrule of 5 mm. diameter.

Bath, Dakota. Fell August 29, 1892. Ccb. 18 gr. 5 cm. Radiated chondrule of white and dark gray sectors with black mantle.

Chantonay, France. Fell August 5, 1812. Cgb. 176 gr. 35 cm. Chondrule of 1 cm. diameter, reticulated hexagonally.

Bjurböle, Finland. Fell March 12, 1899. Cca. 128 gr. 20 cm. Gray, oval chondrule of 1 to 1.3 cm. diameter; iridescent Troilite.

Bjurböle. 5 gr. Isolated chondrules.

Allegan, Michigan. Fell July 10, 1899. Cco. 7 gr. Isolated chondrules with drusy surface.

MacKinney, Texas. Fell 1870. Cs. 301 gr. 38 cm. Olive-green, black and Troilite-bearing chondrules up to 1 cm. diameter.

MacKinney. 280 gr. 40 cm. Leek-green cross-chondrules, 1 cm. diameter.

MacKinney. 260 gr. 38 cm. Dull black, rectangular crystalline inclusion.

MacKinney. 300 gr. 42 cm. Yellow and glassy chondrules.

Baratta, New South Wales. Fell May, 1845. Cgb. 214 gr. 40 cm. Chondrule with black and white faulted halves; black glassy chondrules partly with Nickel-iron, partly with Troilite mantle.

Baratta. 196 gr. 42 cm. White, gray, yellow chondrules and black glassy chondrules.

Baratta. 159 gr. 39 cm. Radiated Troilite-bearing chondrule with Iron mantle; fragmentary chondrules.

Manbhoom, India. Fell December 22, 1863. Am. 3 gr. 2 cm. Nugget of crystalline Chondrite Ck, isolated from Amphoterite.

Netschajevo, Russia. Found 1846. Obn. 20 gr. 5 cm. Nugget of veined crystalline Chondrite Cka, isolated from Octahedrite.

Devitrified molten pitchstone in the form of a radiated globe with adhering fragments of glass; 6 cm. diameter.

## VII. SYSTEM OF METEORITES.<sup>1</sup>

### STONES—SILICATES PREVAILING.

A. ACHONDRITES.—Stones poor in Nickel-iron, essentially without round chondrules.

<sup>1</sup> All groups are defined, whether represented in the collection or not. The weights and Roman numbers in parentheses, e. g., Shalka (10 gr. VI), refer to specimens listed in foregoing sections (VI constituents, etc.).

1. *Chladnite*, Chl. Chiefly Bronzite.  
Shalka, India. Fell November 30, 1850. (10 gr., VI.)  
Ibbenbüren, Germany. Fell June 17, 1870. 4 gr. 3 cm.
  2. *Veined Chladnite*, Chla. Bronzite with black or metallic veins.
  3. *Angrite*, A. Chiefly Augite.
  4. *Chassignite*, Cha. Chiefly Olivine.  
Chassigny, France. Fell October 3, 1815. Spl. 1 cm.
  5. *Bustite*, Bu. Bronzite with Augite.
  6. *Amphoterite*, Am. Bronzite with Olivine.  
Manbhoom, India. Fell December 22, 1863. 219 gr. 30 cm. Three sections. (3 gr., VI.)  
Jelica, Servia. Fell December 1, 1889. 126 gr. 25 cm. Seven sections.
  7. *Rodite*, Ro. Bronzite with Olivine, breccia-like.  
Bandong, Java. Fell December 10, 1871. 46 gr. 9 cm.
  8. *Eukrite*, Eu. Augite with Anorthite.  
Constantinople, Turkey. Fell June, 1805. Spl.  
Stannern, Moravia. Fell June 22, 1808. Two sections. (162 gr., IV; 130 gr., VI.)  
Juvinas, France. Fell June 15, 1821. (21 gr., IV.)
  9. *Shergottite*, She. Augite with Maskelynite.
  10. *Howardite*, Ho. Bronzite, Olivine, Augite and Anorthite.  
La Vivionnière, France. Fell July 14, 1845. Spl.  
Zmen, Russia. Fell August, 1858. Spl.
  11. *Breccia-like Howardite*, Hob. Bronzite, Olivine, Augite and Anorthite, breccia-like.
  12. *Leucituranolite*, L. Leucite, Anorthite, Augite and glass.
- B.—CHONDRITES.—Bronzite, Olivine and Nickel-iron, with round or round and polyhedric chondrules.
13. *Howarditic Chondrite*, Cho. Polyhedric secretions prevailing, round chondrules scarce. Crust partly bright.  
Borgo San Donino, Italy. Fell April 19, 1808. Two thin sections.  
Krähenberg, Germany. Fell April 5, 1869. 2 gr. 1 cm.  
Ottawa, Kansas. Fell April 9, 1876. 65 gr. 12 cm. One section.

14. *Veined Howarditic Chondrite*, Choa. Polyhedral secretions prevailing, round chondrules scarce. Black or metallic veins.

15. *White Chondrite*, Cw. White, rather friable mass with scarce, mostly white chondrules.

Mordvinovka, Russia. Prehistoric. (1 gr., II.)

Mauerkirchen, Upper Austria. Fell November 20, 1768.

3 gr. 2 cm.

Linum, Germany. Fell September 5, 1854. Spl. 1 cm.

Kaande, Livland. Fell May 11, 1855. 7 gr. 4 cm. (12 gr., VI.)

Tourinnes, Belgium. Fell December 7, 1863. 16 gr. 5 cm.

San Pedro Springs, Texas. Found 1887. 4 gr. 2 cm.

Pricetown, Ohio. Fell February 13, 1893. 2 gr. 1 cm.

16. *Veined White Chondrite*, Cwa. White, rather friable mass with scarce, mostly white chondrules; black or metallic veins.

Lucé, France. Fell September 13, 1768. Two thin sections.

Wold Cottage, England. Fell December 13, 1795. Spl.

Kuleschowka, Russia. Fell March 12, 1811. 1 gr. 1 cm.

Honolulu, Hawaii. Fell November 27, 1825. 6 gr. 3 cm.

Drake Creek, Tennessee. Fell May 9, 1827. 2 gr. 1 cm.

Aumières, France. Fell June 3, 1842. (36 gr., IV.)

Schönenberg, Bavaria. Fell December 25, 1896. 7 gr. 2 cm.

Marion, Iowa. Fell February 25, 1847. 40 gr. 9 cm.

Girgenti, Italy. Fell February 10, 1853. (132 gr., IV.)

Scheikahr, Curland. Fell June 2, 1863. 66 gr. 30 cm.

Senhadja, Algiers. Fell August 25, 1865. (145 gr., VI.)

Grossliebenthal, Russia. Fell November 19, 1881. 79 gr. 16 cm.

Möcs, Hungary. Fell February 3, 1882. Thirty thin sections. (141 gr., IV.)

17. *Breccia-like White Chondrite*, Cwb. White, rather friable mass with scarce, mostly white chondrules; breccia-like.

Lissa, Bohemia. Fell September 3, 1808. 3 gr. 3 cm.

Aleppo, Turkey. Found 1873. (67 gr., IV.)

Pacula, Mexico. Fell June 18, 1881. 2 gr. 3 cm.

18. *Intermediate Chondrite*, Ci. Firm, polishable mass with white and gray chondrules breaking with matrix

Dhurmsala, India. Fell July 14, 1860. (257 gr., IV.)

Rakowka, Russia. Fell November 20, 1878. 130 gr. 30 cm.

Saint Caprais, France. Fell January 28, 1883. (1 gr., VI.)

Alfianello, Italy. Fell February 16, 1883. 286 gr. 38 cm. (36 gr., VI.)

19. *Veined Intermediate Chondrite*, Cia, Firm, polishable mass with white and gray chondrules breaking with the matrix; black or metallic veins.

Berlanguillas, Spain. Fell July 8, 1811. 1 gr. 1 cm.

Durala, India. Fell February 18, 1815. 37 gr. 8 cm.

Vouillé, France. Fell May 13, 1831. 31 gr. 7 cm.

Maçao, Brazil. Fell November 11, 1836. 3 gr. 2 cm.

Château-Renard, France. Fell June 12, 1841. 307 gr. 33 cm. (80 gr., IV.)

Mainz, Germany. Found 1852. 26 gr. 6 cm.

New Concord, Ohio. Fell May 1, 1860. (74 gr., VI.)

Nerft, Curland. Fell April 12, 1864. 98 gr. 20 cm.

Maêmê, Japan. Fell November 10, 1886. (97 gr., IV.)

Long Island, Kansas. Found 1892. 173 gr. 35 cm. (160 gr., V.)

Zabrodje, Russia. Fell September 22, 1893. 4 gr. 3 cm.

Fisher, Minnesota. Fell April 9, 1894. (208 gr., IV; 10 gr., VI.)

Bori, India. Fell May 9, 1894. 12 gr. 5 cm.

Lançon, France. Fell June 20, 1897. 1 gr. 1 cm.

Zavid, Bosnia. Fell August 1, 1897. 147 gr. 36 cm. Four sections. (310 gr., IV; 162 gr., VI.)

Gambat, India. Fell September 15, 1897. 1 gr. 1 cm.

Bath Furnace, Kentucky. Fell November 15, 1902. 5 gr. 3 cm.

20. *Breccialike Intermediate Chondrite*, Cib. Firm, polishable mass, white and gray chondrules breaking with matrix; breccialike.

Laigle, France. Fell April 26, 1803. 47 gr. 12 cm. Four sections. (115 gr., II.)

Saint Mesmin, France. Fell May 30, 1866. 8 gr. 4 cm.

- Laborel, France. Fell June 14, 1871. 3 gr. 2 cm.  
Bjelokrynitschie, Russia. Fell January 1, 1887. 7 gr. 5 cm.  
Kansada, Kansas. Found 1894. 25 gr. 9 cm. (135 gr., IV; 194 gr., VI.)
21. *Gray Chondrite*, Cg. Firm, gray mass, chondrules of various kinds breaking with matrix.  
Knyahinya, Hungary. Fell June 9, 1866. Eight thin sections. (423 gr., IV.)
22. *Veined Gray Chondrite*, Cga. Firm, gray mass, chondrules of various kinds breaking with matrix; black or metallic veins.  
Barbotan, France. Fell July 24, 1890. (9 gr., II.)  
Charsonville, France. Fell November 23, 1810. 153 gr. 22 cm.  
Lasdany, Russia. Fell July 12, 1820. (77 gr., IV.)  
Parnallee, India. Fell February 28, 1857. 40 gr. 11 cm.  
Alessandria, Italy. Fell February 2, 1860. 137 gr. 20 cm. (15 gr., IV.)  
Lerici, Italy. Fell January 30, 1868. (6 gr., III.)  
Kerilis, France. Fell November 26, 1874. 39 gr., 14 cm.  
Cronstadt, Orange River Free State. Fell November 19, 1877. Spl. 1 cm.
23. *Breccialike Gray Chondrite*, Cgb. Firm, gray mass, chondrules of various kinds breaking with matrix; breccia-like.  
Chantonay, France. Fell August 5, 1812. One thin section. (89 gr., IV; 176 gr., VI.)  
Borodino, Russia. Fell September 5-6, 1812. (5 gr., II.)  
Baratta, New South Wales. Fell May, 1845. (45 gr., IV; 765 gr., VI.)  
Mezo-Madarasz, Hungary. Fell September 4, 1852. 67 gr. 14 cm.  
Elgueras, Spain. Fell December 6, 1866. 16 gr. 6 cm.  
Pultusk, Russia. Fell January 30, 1868. Four sections. (57 gr., III; 639 gr., IV.)  
Homestead, Iowa. Fell February 12, 1875. (62 gr., IV.)  
Stalldalen, Sweden. Fell June 28, 1876. (34 gr., IV; 37 gr., V.)  
Midt Vaage, Norway. Fell May 20, 1884. 1 gr., 1 cm.

24. *Orvinite*, Co. Black infiltrated mass, fluidal texture; surface uneven, crust interrupted.

Orvinio, Italy. Fell August 31, 1872. 1 gr. 1 cm. One section. (30 gr., IV.)

25. *Tadgerite*, Ct. Black, half-glassy, crust-like mass without crust on surface.

26. *Black Chondrite*, Cs. Dark or black mass, chondrules of various kinds breaking with matrix.

Mikenskoï, Russia. Fell June 28, 1861. 2 gr. 2 cm. Two sections.

MacKinney, Kansas. Fell 1870. 243 gr. 45 cm. Five sections. (141 gr., V; 2002 gr., VI.)

Sevrufkof, Russia. Fell May 11, 1874. 19 gr. 8 cm.

Tschuwaschskaja, Russia. Found 1898. 15 gr. 7 cm.

27. *Veined Black Chondrite*, Csa. Dark or black mass, chondrules of various kinds, breaking with matrix; black or metallic veins.

Farmington, Texas. Fell June 25, 1890. 68 gr. 14 cm. Two sections.

28. *Ureilite*, U. Black mass, chondritic or granular; Iron in veins or incoherent.

Nowo Urej, Russia. Fell September 22, 1886. (14 gr., VI.)

29. *Coaly Chondrite*, K. Dull black, friable chondrite with free carbon, low specific gravity, metallic Iron nearly or wholly wanting.

Cold Bokkeveld, Cape Colony. Fell October 13, 1838. 2 gr. 1 cm. One section.

Orgueil, France. Fell May 14, 1864. 6 gr. 5 cm. (33 gr., V.)

Nogoya, Argentina. Fell July 1, 1879. 1 gr., 1 cm.

Mighei, Russia. Fell June 18, 1889. 12 gr. 4 cm.

30. *Globular Coaly Chondrite*, Kc. Dull gray or black, friable mass with free carbon; chondrules not breaking with matrix; metallic Nickel-iron.

31. *Veined Globular Coaly Chondrite*, Kca. Dull black firm mass with free carbon; chondrules not breaking with matrix; metallic veins.

Indarch, Russia. Fell April 7, 1891. 136 gr. 16 cm.

32. *Globular Chondrite*, Cc. Friable mass with hard (radiated) chondrules not breaking with matrix.

Albareto, Italy. Fell July 1766. (3 gr., II; Spl. IV.)

La Baffe, France. Fell September 13, 1822. 2 gr. 1 cm.

Praskoles, Bohemia. Fell October 14, 1824. 11 gr. 5 cm.

Le Pressoir, France. Fell January 25, 1845. 10 gr. 4 cm.

Yatoor, India. Fell January 23, 1852. 77 gr. 16 cm.

Avilez, Mexico. Fell June, 1856. 5 gr. 2 cm.

Quenggouk, India. Fell December 27, 1857. 65 gr. 12 cm.

Aussun, France. Fell December 9, 1858. 110 gr. 17 cm.

Motta di Conti, Italy. Fell February 29, 1868. 33 gr. 10 cm.

Hessle, Sweden. Fell January 1, 1869. 132 gr. 24 cm. (23 gr., IV.)

Sarbanovac, Servia. Fell October 13, 1877. 1 gr. Two sections.

Tieschitz, Bohemia. Fell July 15, 1878. 3 gr. 1 cm. Three sections.

Gnadenfrei, Germany. Fell May 17, 1879. 1 gr. 1 cm.

Torre, Italy. Fell May 24, 1886. 3 gr. 2 cm.

Antifona, Italy. Fell February 3, 1890. 232 gr. 33 cm. (241 gr., IV; 2 gr., VI.)

Misshof, Curland. Fell April 10, 1890. 69 gr. 11 cm.

Mount Browne, New South Wales. Fell July 17, 1902. 81 gr. 25 cm.

33. *Veined Globular Chondrite*, Cca. Friable mass with hard (radiated) chondrules not breaking with matrix; black or metallic veins.

Trenzano, Italy. Fell November 12, 1856. 171 gr. 22 cm.

Bjurböle, Finland. Fell March 12, 1899. 199 gr. 32 cm. (61 gr., II; 133 gr., VI.)

34. *Breccia-like Globular Chondrite*, Ccb. Friable, breccia-like mass with hard (radiated) chondrules not breaking with matrix.

Krawin, Bohemia. Fell July 3, 1753. 6 gr. 3 cm.

Weston, Connecticut. Fell December 14, 1807. 23 gr. 4 cm.

Mooresfort, Ireland. Fell August, 1810. 14 gr. 6 cm.

Cereseto, Italy. Fell July 17, 1840. 1 gr. 1 cm.



- Kesen, Japan. Fell May 13, 1850. (8 gr., II.)  
Gnarrenburg, Germany. Fell May 13, 1855. Spl.  
Waconda, Kansas. Found 1874. 35 gr. 11 cm.  
Ochansk, Russia. Fell August 30, 1887. 95 gr. 16 cm.,  
16 gr. 5 cm. (12 gr., IV.)  
Forest, Iowa. Fell May 2, 1890. Nine sections (83 gr.,  
IV.)  
Bath, Dakota. Fell August 29, 1892. 300 gr. 40 cm.  
(18 gr., VI.)  
35. *Ornansite*, Cco. Friable mass of chondrules.  
Ornans, France. Fell July 11, 1868. 1 gr. 1 cm.  
Warrenton, Missouri. Fell January 3, 1877. 15 gr. 7 cm  
Allegan, Michigan. Fell July 10, 1899. 232 gr. 35 cm.  
(7 gr., VI.)  
36. *Ngawite*, Ccn. Friable breccialike mass of chondrules.  
37. *Crystalline Globular Chondrite*, Cck. Hardly friable,  
crystalline mass with hard (radiated) chondrules, partly break-  
ing with matrix, partly not.  
Menow, Germany. Fell October 7, 1862. 7 gr. 4 cm.  
Prairie Dog, Kansas. Found 1893. 96 gr. 16 cm.  
Beaver Creek, British Columbia. Fell May 26, 1893. 36  
gr. 8 cm.  
Sawtschenskoje, Russia. Fell July 27, 1894. 22 gr. 9 cm.  
Ambapur, India. Fell May 27, 1895. 22 gr. 9 cm. Two  
sections.  
Saline, Kansas. Fell September 15, 1898. Four sections.  
(67 gr., V; 146 gr., VI.)  
Chervettaz, Switzerland. Fell November 30, 1901. 32 gr.  
8 cm.  
38. *Veined Crystalline Globular Chondrite*, Ccka. Hardly  
friable, crystalline, veined mass with hard (radiated) chon-  
drules partly breaking with matrix, partly not.  
39. *Breccia-like Crystalline Globular Chondrite*, Cckb. Hardly  
friable, crystalline, breccia-like mass with hard (radiated)  
chondrules partly breaking with matrix, partly not.  
40. *Crystalline Chondrite*, Ck. Hard crystalline mass with  
hard (radiated) chondrules breaking with matrix.  
Pillistfer, Livland. Fell August 8, 1863. 187 gr. 33 cm.  
Two sections.

Tjabé, Java. Fell September 19, 1869. Two sections.

Alastoewa, Java. Fell March 19, 1884. 1 gr. 2 cm.

Carcote, Chile. Found 1888. (Spl. VI.)

Gilgoi, New South Wales. Described 1889. 7 gr. 3 cm.

Guareña, Spain. Fell July 20, 1892. 5 gr. 3 cm.

Oakley, Kansas. Found 1895. 195 gr. 38 cm.

41. *Veined Crystalline Chondrite*, Cka. Hard crystalline veined mass with hard (radiated) chondrules breaking with matrix.

Kernouvé, France. Fell May 22, 1869. 122 gr. 28 cm. (173 gr., IV.)

Pipe Creek, Texas. Found 1887. 87 gr. 31 cm.

42. *Breccialike Crystalline Chondrite*, Ckb. Hard, crystalline breccialike mass with hard (radiated) chondrules breaking with matrix.

Ensisheim, Germany. Fell November 16, 1492. (10 gr., II.)

Bluff, Texas. Found 1878. 258 gr. 42 cm. Four sections.

Amana, Somaliland. Fell July 4, 1889. 174 gr. 36 cm. (101 gr., V.)

C. ENSTATITE-ANORTHITE-CHONDRITE. Enstatite, Anorthite and Nickel-iron with round chondrules.

43. *Crystalline Enstatite-anorthite Chondrite*, Cek. Hard crystalline mass with hard (radiated) chondrules.

Hvittis, Finland. Fell October 21, 1901. 87 gr. 32 cm. (11 gr., VI.)

D. SIDEROLITE.—Transitions of stones to irons. Nickel-iron in the mass cohering, on sections separated.

44. *Mesosiderite*, M. Crystalline Olivine and Bronzite.

Hainholz, Germany. Found 1856. (77 gr., VI.)

Mincy, Missouri. Found 1856. 100 gr. 23 cm. (294 gr. VI.)

Estherville, Iowa. Fell May 10, 1879. 121 gr. 15 cm. (40 gr., IV; 20 gr., VI.)

Karand, Persia. Fell May, 1880. 26 gr. 10 cm.

Inca, Chile. Known 1888. 41 gr. 8 cm.

Doña Inez, Chile. Known 1888. 54 gr. 12 cm. Four sections. (15 gr., V.)

45. *Grahamite*, Mg. Crystalline Olivine, Bronzite and Plagioclase.

Vaca Muerta, Chile. Known 1861. 46 gr. 14 cm. 12 sections. (184 gr., III; 63 gr., V; 4 gr., VI.)

Crab Orchard, Tennessee. Found 1887. 88 gr. 28 cm. (35 gr., VI.)

Morristown, Tennessee. Found 1887. (101 gr., VI.)

46. *Lodranite*, Lo. Granular-crystalline Olivine and Bronzite.

IRON-METEORITES. METALLIC CONSTITUENTS PREVAILING OR ALONE.

E. LITHOSIDERITE.—Transition from stones to irons; Nickel-iron cohering in mass and on sections.

47. *Siderophyre*, Si. Grains of Bronzite with accessory Asmanite in the Trias.

Rittersgrün (Steinbach), Saxony. Found 1843 (1724). 30 gr. 12 cm.

48. *Pallasite-Krasnojarskgroup*, Pk. Rounded crystals of Olivine in the Trias.

Krasnojarsk, Siberia. Found 1749. (25 gr., II; 4 gr., VI.)

Mount Vernon, Kentucky. Found 1868. 300 gr., 42 cm.

Glorietta, New Mexico. Found 1884. (119 gr., III; 492 gr., IV.)

Brenham, Kansas. Found 1885. (359 gr., III; 360 gr., V; 350 gr., VI.)

Jamyschewa, Siberia. Found 1885. 10 gr. 4 cm. (2 gr., VI.)

Finmarken, Norway. Found 1902. 250 gr., 40 cm.

Mount Dyrning, New South Wales. Known 1902. (175 gr., V; 52 gr., VI.)

49. *Pallasite-Rokičky group*, Pr. Polyhedral crystals of Olivine partly broken, and fragments separated by Nickel-iron.

Eagle, Kentucky. Found 1880. (86 gr., VI.)

Admire, Kansas. Found 1892. 74 gr. 22 cm. (244 gr., V.)

50. *Pallasite-Imilac group*, Pi. Olivine crystals cracked and squeezed.

Imilac, Chile. Found 1800. 89 gr., 12 cm. (100 gr. V.)

Marjalathi, Finland. Fell June 1, 1902. 259 gr. 33 cm. (147 gr., IV; 253 gr., VI.)

51. *Pallasite-Albach group*, Pa. Olivine crystals in fine brecciated Trias.

F. OCTAHEDRITE.—Kamacite, Taenite and Plessite (Trias), in lamellæ and concamerations of the four octahedron faces.

52. *Finest Octahedrite*, Off. Lamellæ up to 0.2 mm. thickness. Fields prevailing on lamellæ.

Tazewell, Tennessee. Found 1853. (100 gr., VI.)

Ranchito, Mexico. Found 1871. (65 gr., V.)

Butler, Missouri. Found 1874. (5 gr., VI.)

Carlton, Texas. Found 1887. (147 gr., IV; 413 gr., VI.)

Ballinoo, Australia. Found 1893. (395 gr., IV; 107 gr., VI.)

Mungindi, New South Wales. Known 1897. (47 gr., VI.)

53. *Fine Octahedrite Victoria group*, Ofv. Lamellæ of Troilite and Schreibersite in fine Trias.

54. *Fine Octahedrite*, Of. Thickness of lamellæ 0.2–0.4 mm.

Santo Domingo Yanhuitlan (Teposcolula), Mexico. Known 1804. (42 gr., VI.)

Putnam, Georgia. Found 1839. 22 gr., 5 cm.

Bethany (Mukerop, Lion River), Namaland. Found 1853. (1204 gr., III; 1927 gr., IV; 872 gr., VI.)

Jewell Hill, North Carolina. Known 1854. 14 gr. 4 cm.

Lagrange, Kentucky. Found 1860. (29 gr., VI.)

Smith Mountain, North Carolina. Known 1863. (14 gr., IV.)

Bückeberg, Germany. Found 1863. 12 gr. 3 cm.

Walker Township, Michigan. Found 1883. (333 gr., VI.)

Jamestown, Dacotah. Found 1885. (69 gr., IV.)

Bella Roca, Mexico. Known 1888. 82 gr. 28 cm. (104 gr., IV; 216 gr., VI.)

Saint Genevieve, Missouri. Found 1888. 313 gr. 45 cm.

Thurlow, Canada. Found 1888. (22 gr., VI.)

Cuernavaca, Mexico. Described 1889. 5 gr. 4 cm.

Apoala, Mexico. Found 1890. 5 gr. 1 cm.

Augustinowka, Russia. Found 1890. 39 gr. 9 cm. (130 gr., V.)

55. *Mollified Fine Octahedrite*, Ofe. Figures fallen in disorder by mollifying; points instead of Troilite lamellæ.

56. *Medium Octahedrite*, Om. Thickness of lamellæ 0.5-1 mm.

Casas Grandes, Mexico. Prehistoric. (102 gr., II.)

Elbogen, Bohemia. Known 1400. (12 gr., II.)

LaCaille, France. Known 1600. (25 gr., VI.)

Adargas, Mexico. Known 1780. 135 gr. 24 cm.

Descubridora, Mexico. Known 1783. 88 gr. 20 cm.

Toluca, Mexico. Described 1784. (660 gr., VI.)

Misteca, Mexico. Described 1784. (128 gr., VI.)

Pila, Mexico. Known 1784. (240 gr., VI.)

Burlington, New York. Known 1819. (10 gr., VI.)

Carthage, Tennessee. Found 1840. 12 gr. 3 cm.

Ruffs Mountain, South Carolina. Described 1850. (47 gr.,

VI.)

Fort Pierre, Nebraska. Found 1856. (330 gr., VI.)

Staunton IV, Virginia. Found 1858. 51 gr. 18 cm.

Trenton, Wisconsin. Found 1858. (57 gr., VI.)

Coopertown, Tennessee. Known 1860. (49 gr., VI.)

Nejed, Arabia. Found 1864. 25 gr. 11 cm.

Caperr, Patagonia. Known 1869. 6 gr. 2 cm.

Merceditas, Chile. Known 1884. (292 gr., VI.)

Joe Wright, Arkansas. Found 1884. (15 gr., V; 135 gr.,

VI.)

Puquios, Chile. Found 1885. (70 gr., IV.)

Mazapil, Mexico. Fell November 27, 1885. (11 gr., II.)

Thunda, Queensland. Described 1886. (49 gr., VI.)

Tonganoxie, Kansas. Found 1886. 40 gr. 25 cm.

Algoma, Wisconsin. Found 1887. 13 gr., 8 cm.

Welland, Canada. Found 1888. 85 gr. 25 cm. (11 gr.,

V; 9 gr., VI.)

Independence, Kentucky. Found 1889. 305 gr. 42 cm.

Bridgewater, North Carolina. Described 1890. (128 gr.,

IV.)

Hammersley, Australia. Found 1892. (119 gr., IV.)

Oroville, California. Known 1893. 18 gr. 3 cm.

Plymouth, Indiana. Found 1893. (45 gr., VI.)

El Capitan, New Mexico. Found 1893. 60 gr. 13 cm.

- Tarapaca, Chile. Known 1894. (264 gr., V.)  
 Arlington, Minnesota. Found 1894. (28 gr., IV.)  
 Nocolche, New South Wales. Found 1895. 84 gr. 20 cm.  
 Luis Lopez, New Mexico. Found 1896. 34 gr. 6 cm.  
 Badger, New Mexico. Known 1897. 17 gr. 5 cm. (1050 gr., IV; 5 gr., V; 971 gr., VI.)  
 Lipan Flats, Texas. Found 1897. (184 gr., V.)  
 57. *Mollified Medium Octahedrite*, Ome. Figures fallen in disorder by mollifying; points instead of Taenite lamellæ.  
 58. *Coarse Octahedrites*, Og. Thickness of lamellæ 1.5–2.0 mm.  
 Tennant's Iron. Found 1784. (7 gr., VI.)  
 Bendego, Brazil. Found 1784. (202 gr., VI.)  
 Bohumilitz, Bohemia. Found 1829. 54 gr. 6 cm.  
 Wichita, Texas. Found 1836. (168 gr., II; 44 gr., V; 428 gr., VI.)  
 Cosby's Creek, Tennessee. Found 1837. 22 gr. 5 cm. (37 gr., V.)  
 Smithville, Tennessee. Found 1840. 39 gr. 7 cm.  
 Magura, Hungary. Found 1840. (174 gr., VI.)  
 Cranbourne, Victoria. Found 1854. (1 gr., VI.)  
 Sarepta, Russia. Found 1854. (19 gr., IV.)  
 Saint François, Missouri. Known 1863. (47 gr., VI.)  
 Canyon City, California. Found 1872. 100 gr., 12 cm.  
 Nochtuisk, Siberia. Found 1876. 1 gr. 1 cm.  
 Penkarring Rock, Australia. Found 1884. (2 gr., IV; 73 gr., VI.)  
 Silver Crown, Wyoming. Found 1887. (133 gr., IV.)  
 Azucar, Chile. Found 1887. (160 gr., IV.)  
 Bischtube, Russia. Found 1888. (263 gr., VI.)  
 Cañon Diablo, New Mexico. Found 1891. (173 gr., IV; 272 gr., VI.)  
 Oscuro Mountain, New Mexico. Found 1895. (67 gr., IV.)  
 Rosario, Honduras. Known 1897. (18 gr., VI.)  
 59. *Mollified Coarse Octahedrite*, Oge. Figures fallen in disorder by mollifying; points instead of Taenite lamellæ.  
 Reed City, Michigan. Found 1895. (122 gr., IV.)  
 60. *Coarsest Octahedrite*, Ogg. Thickness of lamellæ 2.5 mm. and more.

- Seeläsgen, Germany. Found 1847. (72 gr., VI.)  
 Union County, Georgia. Described 1853. 11 gr. 3 cm.  
 Nelson County, Kentucky. Found 1860. (261 gr., V; 103 gr., VI.)  
 Dacotah, Indian Territory. Found 1863. (90 gr., VI.)  
 Sao Juliao, Portugal. Found 1883. 275 gr. 48 cm. (493 gr., V; 599 gr., VI.)  
 Mount Joy, Pennsylvania. Found 1887. 57 gr. 7 cm. (29 gr., V.)  
 Mooranoppin, Australia. Known 1893. 26 gr. 14 cm.  
 Arispe, Mexico. Found 1898. 19 gr. 3 cm.  
 61. *Breccia-like Octahedrite, Netschajev group*, Obn. Medium Octahedrite with nuggets of Silicate.  
 Netschajev, Russia. Found 1846. 38 gr. 10 cm. (20 gr., VI.)  
 62. *Breccia-like Octahedrite Kodaikanal group*, Obk. Fine Octahedrite brecciated with nuggets of Silicate.  
 63. *Breccia-like Octahedrite Copiapo group*, Obc. Coarsest Octahedrite brecciated with Silicate-nuggets.  
 Copiapo, Chile. Found 1863. 4 gr. 2 cm.  
 64. *Breccia-like Octahedrite Zacatecas group*, Obz. Octahedral nuggets breccialike with globes of Troilite.  
 Zacatecas, Mexico. Known 1520. 30 gr. 10 cm.  
 Barranca Blanca, Chile. Found 1855. (17 gr., IV.)  
 65. *Breccia-like Octahedrite Ngoureyima group*, Obzg. Molten and tracted Iron of the Zacatecas group.  
 Ngoureyima, Algiers. Fell June 15, 1900. 173 gr. 40 cm. (29 gr., IV.)

G. HEXAHEDRITE.—Structure and cleavage hexahedral.

66. *Normal Hexahedrite*. Neumann-lines ungrained.  
 Lime Creek, Alabama. Found 1834. (8 gr., IV.)  
 Coahuila, Mexico. Known 1837. (293 gr., VI.)  
 Fort Duncan, Texas. Known 1852. 183 gr. 45 cm. (99 gr., VI.)  
 Scottsville, Kentucky. Found 1867. (57 gr., VI.)  
 DeSotoville, Alabama. Found 1878. (158 gr., IV; 851 gr., VI.)  
 Hex River, Cape Colony. Found 1882 (216 gr., VI.)

Iredell, Texas. Found 1898. 6 gr. 4 cm.

Murphy, North Carolina. Found 1899. 43 gr., 13 cm.

67. *Grained Hexahedrite*, Ha. Structure and cleavage running through the whole mass consisting of grains with differently orientated sparkling.

Floyd Mountain, Virginia. Found 1887. (400 gr., VI.)

68. *Brecciated Hexahedrite*, Hb. Mass consisting of differently orientated hexahedral grains.

Kendall County, Texas. Known 1887. 299 gr. 41 cm.

H. ATAXITE.—Structure interrupted.

69. *Capegroup*, Dc. Rich in Nickel; sharp (hexahedral?) etching bands in dull mass.

70. *Shingle Springs group*, Dsh. Rich in Nickel; not sharp parallel spots.

71. *Babbsmill group*, Db. Rich in Nickel; lusterless, homogeneous mass.

Deep Springs, North Carolina. Found 1846. (30 gr., VI.)

72. *Linnville group*, Dl. Rich in Nickel; meandering-veined or latticed.

San Cristobal, Chile. Found 1882. (5 gr., V; 411 gr., VI.)

Tenera, Chile. Described 1891. 1 gr. 1 cm.

73. *Nedagolla group*, Dn. Poor in Nickel, grained, no ridges.

Rafrüti, Switzerland. Fell October, 1856. 1 gr. 1 cm.

Forsyth County, Georgia. Found 1891. 221 gr. 37 cm.

Ophir, Montana. Found 1897. 55 gr. 30 cm. (30 gr., IV.)

74. *Siratic group*, Ds. Poor in Nickel; ridges, incisions or enveloped Rhabdites.

Campo del Cielo, Argentina. Found 1873. 8 gr. 2 cm.

Chesterville, South Carolina. Found 1847. 12 gr. 6 cm.

Locust Grove, Georgia. Found 1857. (206 gr., VI.)

75. *Primitiva group*, Dp. Poor in Nickel; silky streaks and luster.

Primitiva, Chile. Found 1888. 306 gr. 44 cm. (29 gr., VI.) Plate VII, Fig. 49.

76. *Muchachos group*, Dm. Poor in Nickel, grained, porphyritic with Forsterite.

*Telluric Iron*, Tell.

Ovifac, Disco, Greenland. Found 1808. (795 gr., VI.)













BREZINA-METEORITES.



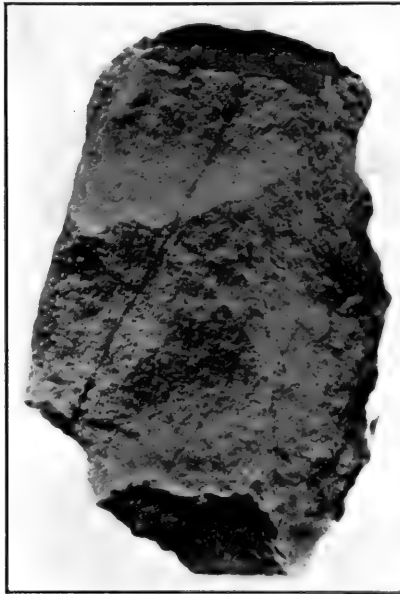

FIG. 42.

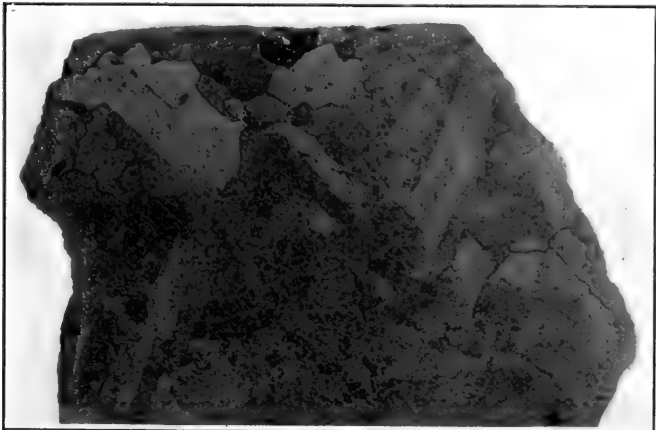

FIG. 43.





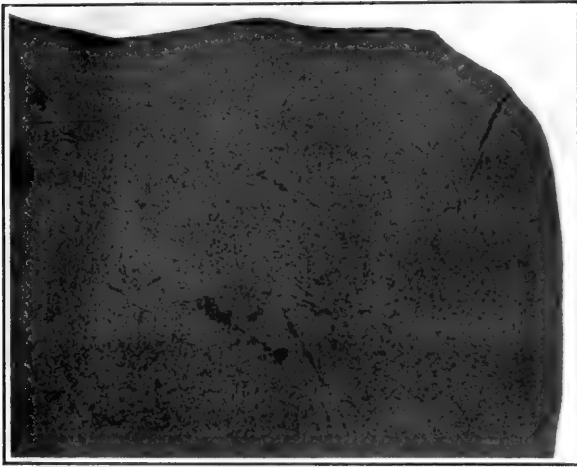

FIG. 44.

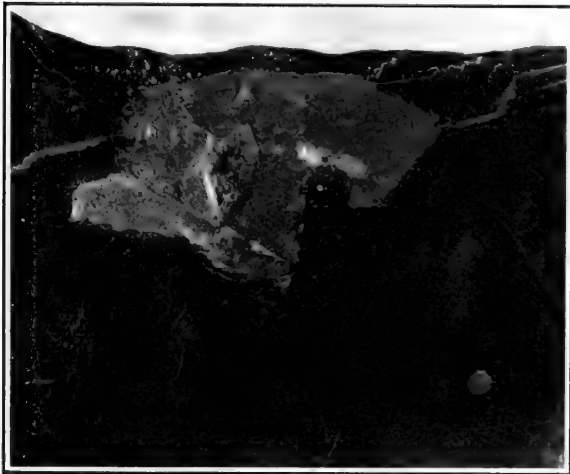

FIG. 45.



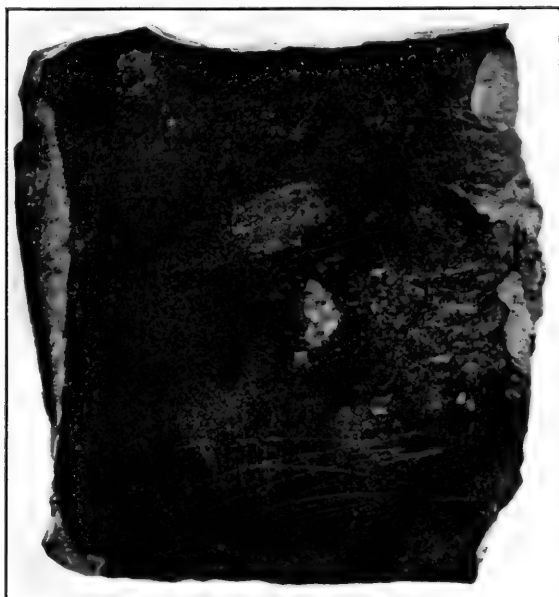

FIG. 46.

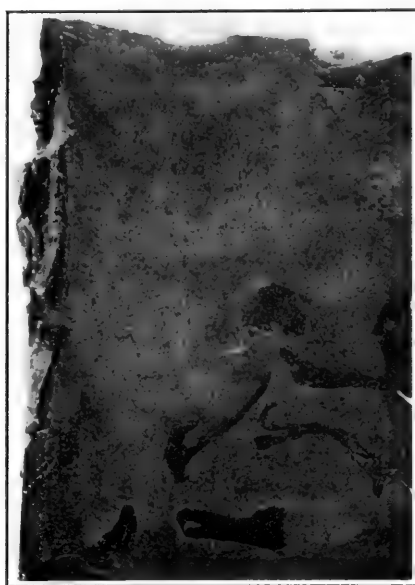

FIG. 47.

BREZINA—METEORITES.





FIG. 48.

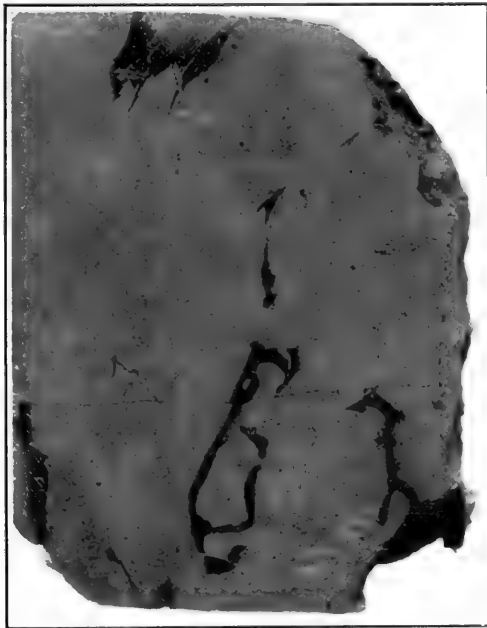

FIG. 49.

BREZINA—METEORITES.



Niakornak, Greenland. Found 1819. (1 gr., VI.)

Sao Francisco, Brazil. Found 1874. (479 gr., V; 26 gr., VI.)

Nikolajewskaja Wosimskaja, Russia. Found 1883. 87 gr. 8 cm.

*Artificial Products.*

Glowed Steel. (1 gr., VI.)

Devitrified molten Pitchstone. (VI.)

IX. DUPLICATES FOR EXCHANGES.

In a synoptical collection the duplicates destined for exchanges should be registered separated from the pieces of the main collection by three reasons: to avoid the constant moving of weights in the catalogue, to avoid parting with specimens, which show important peculiarities and to enable directors or owners of other collections to arrange propositions for exchange.

As the present article has a more theoretical scope, duplicates were not registered at all; they form a series of 90 localities in the weight of together 85 kilograms.

---

A SYSTEM OF PASSENGER CAR VENTILATION.

BY CHAS. B. DUDLEY, PH.D.,  
CHEMIST, PENNSYLVANIA RAILROAD COMPANY.

(Read April 8, 1904.)

The ventilation of passenger cars is no small problem. The ordinary passenger coach includes about 4,000 cubic feet of space, and the difficulties of the problem will be apparent when it is stated that it is proposed to take into this limited space sixty people, to keep them in that space for from four to six hours at a time, to keep them warm enough for their comfort in winter, to supply them with the necessary amount of fresh air, and at the same time to, as far as possible, exclude objectionable material from without, such as smoke and cinders. It is perhaps not strange, in view of the small space and large number of people and the inclemency of the weather, that progress in the solution of the problem has been slow. It is believed that the system which will be described is a decided step forward in this matter, and while it may not be the

final solution, it certainly can be justly claimed that it is a marked amelioration of the conditions which have prevailed heretofore.

Before proceeding to describe the system, it may perhaps be wise to consider briefly a few preliminary questions as follows:

First, is it possible to properly ventilate a car without having the heating system a part of the ventilating system? It will be quite obvious on a moment's reflection, we think, that in the climate in which we live unwarmed air, especially in view of the large amount of it required, as will appear later, cannot be successfully taken through so small a space as a passenger coach in sufficient quantity to properly ventilate it. Little argument is needed on this point, and in the system to be described the heating system has been regarded as an essential feature. A few proposed systems have ignored the heating system, but none of them, so far as known, can be regarded as efficient in cold weather.

A second point that deserves a moment's attention is, "When can a space be said to be well ventilated, or what is the standard of good ventilation?" It is well known that three things are continually given off from the bodies of human beings which tend to make any space in which they are situated for any length of time have the characteristic which is called "ill ventilated." These three things are carbonic acid, water vapor, and a certain substance which for want of a better name is commonly called "organic matter," and which is believed to be the source of the odor. Of these three, carbonic acid is easily determined. Those who are familiar with the studies that have been devoted to ventilation, and which are described in standard works on Hygiene, are aware that formerly an arbitrary amount of carbonic acid in the air was taken as the measure of good ventilation. It is well known that the ordinary outside air contains about four cubic feet of carbonic acid in 10,000 of air, and formerly it was customary to say that if the carbonic acid in any closed space occupied by human beings did not exceed ten cubic feet per 10,000, the space might be regarded as well ventilated. Later studies seemed to have changed this view, and the test that is now given in the standard works on ventilation is that a space can be said to be well ventilated when a person coming into that space from the outside air does not detect any of the odor which is characteristic of badly ventilated spaces. Quite a large number of analyses have been made to determine how much carbonic acid is characteristic of air of this kind. The best and most careful studies on this subject are probably those given



in Parke's *Practical Hygiene*, and it is found that when the carbonic acid naturally in the air, is increased by two cubic feet per 10,000 from human beings, it is possible to begin to detect the odor mentioned. So that when an analysis of the air in any closed space, which is occupied by human beings, shows not more than six cubic feet of carbonic acid per 10,000, it is claimed that the space may be regarded as well ventilated.

The third point to be discussed is, since carbonic acid is given off from human beings, and since the amount of it in the air from this source is an essential element in ventilation, it is necessary to know how much carbonic acid per person per hour goes into the air. The same authority already quoted, namely, Parke's *Practical Hygiene*, gives the results of a very large number of experiments on this subject. Men usually give off more than women, and children less than either. A man in vigorous work gives off more than in idleness. The mean of a mixed community, such as may be assumed to ride on cars, is 0.60 cubic foot per person per hour. It will be seen in a moment where these figures apply.

Fourth, one of the most important questions in car ventilation is, "How much air per car per hour is it necessary to take through a car in order to have it well ventilated?" If the data above given are to be trusted, it will be evident that when a car contains sixty people, each one giving off on the average 0.60 cubic foot of carbonic acid per hour, there will be per hour thirty-six cubic feet of carbonic acid to deal with, and the problem becomes how much fresh air is it essential to mix with these thirty-six cubic feet of carbonic acid, in order that it may be diluted to such an extent that it will not add to the carbonic acid already in the air, more than two cubic feet per 10,000. The problem may be stated in the form of proportion. If 10,000 cubic feet of air are to contain two cubic feet of carbonic acid in addition to its normal amount how many cubic feet are essential to contain thirty-six? Reducing the proportion and the astounding figure is reached that, in order to have a passenger car well ventilated according to the data already given, it is essential to take through the car 180,000 cubic feet of fresh air per hour. This figure may be stated in another way, and this is the form in which it is usually given in treatises on ventilation, namely, it requires 3,000 cubic feet of fresh air per person per hour to maintain the air in any closed space in the conditions required for good ventilation, according to the standards already mentioned. This is hardly the place to discuss the validity of this

figure. There is some difference of opinion as to whether the amount is not excessive, and it is perhaps fair to say that the point cannot be regarded as satisfactorily settled. It may not be amiss to mention that in conversation with Professor Atwater, of the Wesleyan University, Middletown, Conn., who has made a large number of experiments in the human calorimeter, he stated that the inmates of the calorimeter do not complain of drowsiness or of any unpleasant feeling even though the carbonic acid reaches a very much higher figure than anything that has been mentioned, but do complain of drowsiness and languor with occasional headache if the amount of moisture in the air gets much above the normal. It may not be amiss to mention at this point that, in the system of car ventilation to be described, no attempt has been made to get the large amount of air mentioned, namely, 180,000 cubic feet per car per hour. The experimental work has been limited to an attempt to get 60,000 cubic feet of air per car per hour, or about 1,000 cubic feet of fresh air per person per hour.

Fifth. One more question must be discussed a little in order that what follows may be completely understood, namely, how is it possible to measure the amount of air that goes into and out of a car per hour? It may be said that attempts to do this by means of sizes of apertures and velocity of currents have not succeeded very well, and it will be obvious why this should be so, since there are a very large number of small apertures in a car, both inlets and outlets, all of which are elements in the problem. No window or door is tight, and even though the velocity of the air going out of the ventilators is measured, the friction against the sides of the ventilators is such that it is very difficult to get an average figure for velocity. Accordingly another method has been employed, as follows:

A car is loaded with a definite number of inmates, and after a run under ordinary conditions a sample of the air from the car is secured and analyzed for carbonic acid. It may be supposed that the analysis shows twelve cubic feet of carbonic acid per 10,000 cubic feet of air. But four cubic feet are a normal constituent of the air, leaving eight cubic feet coming from the inmates of the car. If there were sixty of these and each one gives off carbonic acid at the rate of 0.60 of a cubic foot per hour, it is obvious thirty-six cubic feet per hour are to be dealt with and the problem becomes, "How much fresh air must be mixed with thirty-six cubic feet of carbonic acid from the car inmates, so that the resulting mixture would show on analysis eight cubic feet of carbonic acid from the same source

per 10,000 of the mixture?" or in other words, if 10,000 cubic feet of air contains eight cubic feet of carbonic acid, how many cubic feet of air will be required to contain thirty-six cubic feet of carbonic acid on the same ratio? Reducing the proportion and it appears that under the conditions assumed, 45,000 cubic feet of fresh air per hour would pass through the car. In this illustration the amount of air in the car to start with is ignored, since it is not

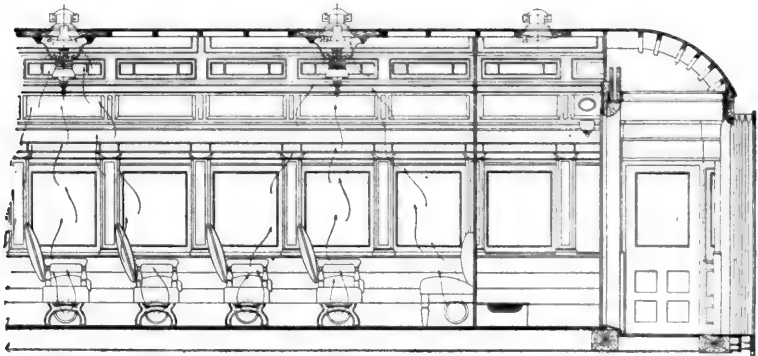
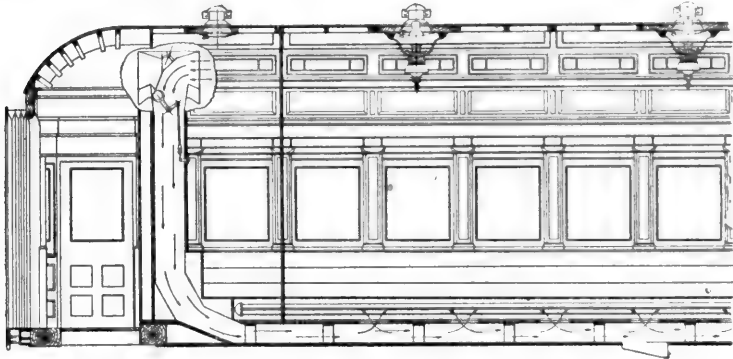

an important element, and since results accurate to a few hundred cubic feet are not essential.

This brings us to the consideration of the ventilating system which has been adopted as standard by the Pennsylvania Railroad Company, and which is now in daily use on some 800 passenger coaches on the lines east of Pittsburg and Erie, and on nearly 200 coaches on the lines west of Pittsburg and Erie. It may not be amiss to say that the development of the system has taken several years of study. A very large number of experiments have been

made. Each experiment led to modifications and changes, which were followed often by runs on the road, with analyses of air from the cars, the information obtained from each trial being used to lead to further modification, until a satisfactory result was obtained. Of course, the system as described is the one finally decided on. It will be noted by an examination of the plate that, taken as a whole, the system is extremely simple. It consists in taking air from the outside in through hoods located on what is known as the lower deck near the top of the car, and at diagonally opposite corners of the car. The opening of the hoods is toward the direction in which the car is moving, and, as will be noted a little later, the movement of the car is an element in the problem of getting the air into the car. The opening is covered with a gauze to exclude large cinders. The hood is fitted with a valve operated from the inside of the car in such a way that as the car changes direction the proper passageway is provided. From the hood the air passes through what is technically called a "down-take," about 100 square inches in area, which conducts the air down underneath the floor of the car to a passageway which occupies the space between the outside sill, the floor, the first intermediate sill and the false bottom. This space has an area of a little over 100 square inches, and extends the whole length of the car. From this space the air passes up through apertures in the floor into the heater boxes, where it is warmed. From the heater boxes the air passes out into tubes situated under each seat, and is delivered into the aisle of the car from the tubes. From these points it disseminates through the car, and finally passes out of the car through ventilators situated along the center line of the upper deck. These ventilators may be of any approved form. The kind most used thus far has been what is known as the "Globe Ventilator," which ventilator has the characteristic that when the car is moving through the air, or when the wind is blowing across the ventilator, a suction is produced on the air in the car. It will be observed from what has already been stated, that there are two things that cause the ventilating air to move through the car. First, the heating system. The ventilators in the upper deck are situated some two feet higher than the top of the hood, and accordingly, when there is heat in the car, or when the lamps are lighted, there is the proper ventilating movement of air through the car, due to this force. Also it will be noted that the movement of the car is an element in the problem likewise. The car movement produces pressure in the hood and down-take and the

ventilators produce suction as has already been described, and these two acting together lead to change of air in the car. The control of the system, that is the means by which the amount of air passing through the car is diminished, is in the ventilators. Each ventilator is provided with a register, and when these registers are closed the total amount of air passing through the car is diminished a little over one-half. It will be observed that by partly closing all the ventilators, or closing a part of them, any intermediate figure between these two can be obtained. It is found essential to have a portion of the passageway in the ventilators over the lamps continuously open, in order to carry off the products of combustion. The register at no time closes this portion of the ventilators over the lamps.

The experimental work having led up to the construction finally decided on, it remained to actually put the system to test and see exactly what was being obtained. The first experiment was to see whether when the car was standing still, and heat was in the car, the movement of the air would be in the desired direction, namely, into the car through the hood, and out through the ventilators on the upper deck. With some systems of car ventilation where the movement of the air is almost wholly a function of the movement of the train, when the train stops the air movement is in the opposite direction, owing to the relation between the heating system and the ventilating system. In the system which we are dealing with this does not take place, for obvious reasons, namely, as has already been stated, the exits are higher than the in-takes.

The second test concerned the air from the closet. Some anxiety was felt as to whether the ventilating system would take air from the closet into the car. As a precautionary measure a small "Globe" ventilator was put in the roof of the closet, and also the proportions of parts of the system were designed in such a way that when the car was in service, there would be a plenum in the car produced by the hood rather than a vacuum produced by the suction of the "Globe" ventilators. As a matter of fact, the construction finally adopted gave very close to a balance between these two features. However, many experiments show without question that when the car is in motion, and the ventilating system in full operation, the air movement is toward the closet, instead of from it.

A third test of the system was to determine the actual amount of air passing through the car. In order to decide this question, a car

fitted as above described was filled with men from the shops, who were paid for their time, under the charge of a foreman, so that they could be controlled in the matter of opening doors and windows, and a trip was made early in December from Altoona to Johnstown and return. Rubber bags and hand bellows were taken along with which to secure samples of the air in the car. Steam heat was necessary since the temperature outside was from 23 to 30 degrees Fahrenheit, and neither door nor window was opened during the trip, except that after the proper samples of air had been taken at Johnstown the men were allowed some freedom, since a wait of a couple of hours must ensue before the return trip could be made. The air samples for analysis were taken by pumping air into the rubber bags by means of the hand bellows, moving from one end of the car and back again in the aisle during the operation, and taking the air from about the level of the heads of the passengers. The analyses were made immediately after the return. In making the air analyses the carbonic acid only was determined, and from this was calculated the amount of fresh air taken through the car per hour by the ventilating system, the method used being the one described earlier in this article. As a matter of fact, there were fifty-two men in the car, and being workmen it was assumed that they gave off 0.72 of a cubic foot of carbonic acid each per hour. The figures obtained on the trip mentioned are as follows:

## WESTBOUND.

	<i>Per cent. of carbonic acid</i>	<i>Cubic feet of air per car per hour</i>
All Globe ventilators closed—Bennington . . . . .	0.18	26,700
All Globe ventilators open—Buttermilk Falls . .	0.10	62,400
All Globe ventilators open—standing twenty minutes at Johnstown . . . . .	0.21	22,000

## EASTBOUND.

All Globe ventilators closed—Cresson . . . . .	0.14	37,400
All Globe ventilators open—McGarvey . . . . .	0.10	62,400
All Globe ventilators open—standing twenty minutes at Altoona . . . . .	0.20	23,400

In explanation of the figures it may be stated that the stations mentioned denote locations at which air samples were taken. Bennington, on the schedule used, is about twenty-three minutes from Altoona; Buttermilk Falls is about fifty-seven minutes from Bennington, and Johnstown is about ten minutes from Buttermilk Falls. Returning, Cresson is about forty-two minutes from Johnstown; McGarvey about twenty minutes from Cresson, and Altoona about five minutes from McGarvey. These figures will give some idea of the interval between samples.

As has already been stated, the system was designed to give 60,000 cubic feet of air per car per hour, and it was felt that the figures given above show that the system fairly well fulfills the purpose for which it was designed. Not more than 60,000 cubic feet were planned for, for the reason that it was found impossible, as the result of experiments made early in the studies on this subject, to warm the large amount of air required by theory. While it would perhaps be possible to warm more than 60,000 cubic feet of air, yet it is always desirable to have some little factor of safety in the appliances used, and accordingly, after very careful consultation over the matter, it was decided not to attempt to get more than 60,000 cubic feet per car per hour.

Two points further were made the subject of test: First, the ability to keep the cars warm, even in the severest weather. This with the heating system, for which the ventilating system was designed, was found to be extremely satisfactory. Careful observations were made both on long runs and during severe cold blizzards on this point by competent persons, and at no time has there been any difficulty in keeping the car comfortable. Furthermore, the distribution of the heat in the car seems to be entirely satisfactory. Even under the influence of severe winds, not more than two or three degrees difference in different parts of the car are observable. It may be worth while to mention that, as will be noted from the description, the ventilating system consists of two halves, which are entirely independent of each other, except that the heating system on the two sides takes steam from the same point. Careful experiments with cars on the road indicate that when the wind is directly ahead, the two sides of the car take in approximately equal amounts of fresh air. When the wind, however, is to the right of the line of motion of the car, that side of the car seems to do most of the ventilating, and when it is to the

left, that side does the most of the ventilating. This will be readily understood from the construction. The curvature of railroads, however, is so great that this fluctuation in the amount of fresh air taken in on the two sides does not, as already stated, seriously affect the temperature in different parts of the car.

The final test made has been as to the ability of the ventilating system to exclude objectionable matter, such as smoke, cinders and dust. A good deal of interest was felt over this matter at the start, and it is to be confessed that anything which is fine enough to be carried in the air will ultimately find its way into the car. As a matter of fact, it is found that small cinders which pass the gauze on the hood of the in-take are distributed more or less along the bottom of the space underneath the floor, and it occasionally becomes essential to clean these cinders out. Also in going through tunnels, sometimes smoke and gases are taken into the car in small amount. To meet this difficulty a butterfly valve was put in the down-take, and the instructions provide that this shall be closed when going through tunnels. Furthermore, the air being taken from near the top of the car, dust rarely gets high enough to cause any trouble. Smoke from the locomotive usually is either diverted by the wind, or is high enough not to reach the in-takes, so that, as a matter of fact, less difficulty has been experienced from objectionable material going in along with the fresh air than was feared. Finally, the air in the car being completely changed once in four minutes, it is evident that the inconvenience from temporary foul air going into the in-takes is reduced to a minimum.

The system as described has been in daily use on more or less cars, for now some five years, and the criticisms leading to modifications have been less than might have been expected. The system is being applied to all new cars as fast as they are built, and to other cars in the equipment as fast as circumstances will admit. It is unfortunate to be compelled to say that the system has not yet been applied to a sleeping car.

*Altoona, Penna., April 7, 1904.*



PROCEEDINGS  
OF THE  
AMERICAN PHILOSOPHICAL SOCIETY  
HELD AT PHILADELPHIA  
FOR PROMOTING USEFUL KNOWLEDGE

---

VOL. XLIII.

APRIL-SEPTEMBER, 1904.

No. 177.

---

THE ORIGIN AND NATURE OF COLOR IN PLANTS.

BY HENRY KRAEMER.

(Read April 8, 1904.)

A list of the more important papers published, up until within the past ten years, on the subject of plant colors is given in Dippel's *Das Mikroskop*.<sup>1</sup> Of these the papers by Pringsheim<sup>2</sup> on the examination of chlorophyl and related substances, and by Müller<sup>3</sup> on the spectrum-analysis of the color substances of flowers, are probably the most important.

Pringsheim confined his attention mainly to a spectroscopic study of chlorophyl and the yellow substances in germinating plants, yellow flowers and yellow autumn leaves. He concluded that the yellow substances from these several sources were but modifications of chlorophyl. The yellow principle found in germinating plants he regarded as closely related to chlorophyl, and the yellow substance in autumn leaves as a more remote modification of it. He did not consider, however, as subsequent writers have claimed, that these substances were identical.

Two years before the appearance of Pringsheim's paper, Kraus<sup>4</sup> stated that he had separated from an alcoholic solution of chlorophyl by means of benzol two distinct substances, one yellow and the other blue, the latter being taken up by the benzol. Pringsheim, however, showed that the blue substance was in reality chlorophyl, and that the alcoholic solution, which showed faint chlorophyl-like bands in the spectroscope, still contained some chlorophyl.

While Pringsheim believed that there were two modifications of chlorophyl, one yellow and the other green, the former predominating in germinating plants grown in the dark, and the latter or green substance in leaves exposed to the light, still he did not believe that they could be separated from each other by the method proposed by Kraus.

Yet notwithstanding Pringsheim's well-founded criticisms of the method employed by Kraus, and taking for granted that there were two principles composing chlorophyl, nearly all investigators since Kraus's work was published have practically employed his method as modified by Hansen<sup>5</sup> for the separation of the so-called yellow and green chlorophyl. According to this method of Hansen, fresh material is extracted with 95 per cent. alcohol, the liquid filtered, and to the filtrate 30 to 50 per cent. of water is added; the solution is shaken with petroleum ether and the liquids separated, the ether taking up the green substance, or chlorophyl proper, and the hydro-alcoholic solution holding the yellow principle.

If autumn leaves are treated in the same way, the ether solution will contain very little chlorophyl, while the hydro-alcoholic solution will contain a yellowish or reddish substance, depending upon the kind of material examined. It has usually been considered that this yellow substance in autumn leaves is associated in summer with the active plastids, and on account of its having little food value remains behind. It has furthermore been considered by many that the yellow principle in young leaves is identical with that in autumn leaves and the yellow substance found in yellow flowers, fruits and roots.

#### KINDS OF COLORS IN PLANTS.

Colors in plants may be considered to be due to definite constituents which either themselves are colored or produce colors when acted upon by other substances. These substances are found in all parts of the plant, and apparently in all of the cells excepting certain meristematic or dividing cells. They may be divided into two well-differentiated classes, namely, (1) those which are associated with the plastids, or organized bodies in the cell, and (2) those which occur in the cell-sap, or liquid of the cell.

## SO-CALLED WHITE COLORS.

The so-called white colors in plants do not properly belong to either class, but may be said to be appearances rather, due to the absence of color, and depending upon the reflection of light from transparent cells separated by relatively large intercellular spaces containing air. In other words the effect produced by these cells may be likened to that produced by the globules in an emulsion. The white appearance is most pronounced in the pith cells of roots and stems, where on the death of the cells the size of the intercellular spaces is increased and the colorless bodies in the cells as well as the walls reflect the light like snow crystals.

## METHODS OF EXTRACTION.

During this investigation I have examined by means of the Leitz micro-spectroscope the various kinds of coloring substances to which I shall refer but, except in the case of chlorophyll, did not obtain results which were entirely satisfactory, and will endeavor to give special attention to this phase of the subject in another paper. It is frequently difficult to extract and isolate these substances in a sufficiently pure condition for spectroscopic work, particularly as many of them change rapidly.

In this paper, therefore, I shall confine myself to the consideration of the behavior of the extracted coloring substances toward chemical reagents.

The material containing the coloring matter was in all cases separated as nearly as possible from that which was free from color or contained it in less amount. Various solvents were used in the extraction of the coloring substances, depending upon the solubility or nature of the substance. The solvent mostly employed was alcohol (95 per cent.), in some cases dilute alcohol (50 per cent.) or water (hot or cold) was employed.

The plastid colors were extracted by placing the fresh material in 95 per cent. alcohol and allowing it to macerate in the dark for a day or two. I usually took the precaution to tear the material with the fingers rather than to cut it. The solution so obtained contains other than the plastid coloring substances, which latter may be isolated in a more or less pure condition by either of the following methods: (1) The alcohol is distilled off and the solution evaporated on a water bath to near dryness, boiling water is then added and

the solution filtered, the extract washed with hot water until the filtrate is colorless; the extract is then taken up with cold alcohol. (2) In the other method the alcoholic solution is diluted with water; and ether, benzin, benzol, xylol, or other similar solvent is added, and the mixture shaken in a separatory funnel. The ethereal layer containing the plastid color may be further purified by shaking it in a separatory funnel with alcohol, adding sufficient water to cause separation of the two layers. The ethereal solution is then distilled and evaporated on a water bath to near dryness, and the pigment taken up with cold alcohol. In either case the alcoholic solution may be boiled for an hour or two with zinc in a reflux condenser, whereby the more or less oxidized plastid pigments are restored. This is a particularly important procedure in the micro-spectroscopic examination of chlorophyll, and may be used as a means of detecting chlorophyll in other substances.

In order to obtain the coloring principles in early leaves, as the red coloring principle in the leaves of oak, rose, etc., it was found most satisfactory to extract the material with alcohol, add xylol or similar solvent, and then sufficient water to effect separation of the solutions, using a separatory funnel. The cell-sap color remains in the hydro-alcoholic solution, and the traces of xylol should be removed by heating the solution on a water-bath, as the presence of xylol causes a cloudiness in the solution on the addition of the reagents to be subsequently employed.

The cell-sap colors of flowers, as of pansy, tulip, etc., are separated from the plastid pigments in the same way as just mentioned in connection with early leaves.

The cell-sap colors in fall leaves are easily removed by treating the more or less comminuted material with hot or cold water.

In some cases there are several associated colors, and these may be extracted separately by taking advantage of their varying solubility, as in the case of carthamus, where the red principle is extracted with water and the yellow principle with alcohol.

In still other cases special methods are employed, as in the extraction of carotin from carrot according to the method proposed by Husemann.<sup>6</sup> The grated carrot is mixed with water, squeezed through cheese-cloth, and a small quantity of dilute sulphuric acid and tannin added to the mixture, forming a coagulum which settles to the bottom of the precipitating jar. The supernatant liquid is removed by means of a syphon and the coagulum treated six or

seven times with 80 per cent. alcohol, which removes mannit and hydro-carotin; the coagulum is then extracted with hot carbon disulphide, which removes the carotin. This solution is evaporated to about half the original volume, an equal amount of absolute alcohol added, and set aside to crystallize, the carotin separating.

One of the striking observations made during this investigation was that in the case of the cell-sap colors the solution was different in color, as compared to the natural color, or sometimes almost colorless, reagents, however, striking colors as intense or even more intense than the original colors.

For the convenience of those who may wish to follow similar studies, the plants which I examined may be grouped according to the solvents which I found best adapted for the extraction of the coloring substances. There is also given the part of the plant employed and the color of the solutions I obtained.

#### COLOR PRINCIPLES EXTRACTED WITH ALCOHOL.

Name of Plant.	Part Used.	Color of Solution.
1. Apple (Baldwin) ( <i>Pyrus Malus</i> ) . . . . .	Epicarp	Light yellowish-red
2. Apple (Bellefleur) ( <i>Pyrus Malus</i> ) . . . . .	Epicarp	Pale straw
3. Arbutus ( <i>Epigæa repens</i> ) . . . . .	Petals	Pale straw
4. Azalea ( <i>Azalea nudiflora</i> ) . . . . .	Petals	Deep green
5. Beet ( <i>Beta vulgaris</i> ) . . . . .	Leaves	Reddish-brown
6. Blackberry ( <i>Rubus Canadensis</i> ) . . . . .	Stems	Deep yellow
7. Buttercup ( <i>Ranunculus acris</i> ) . . . . .	Petals	Purplish-red
8. Cabbage, red ( <i>Brassica oleracea</i> ) . . . . .	Leaves	Yellowish-red
9. Capsicum ( <i>Capsicum fastigiatum</i> ) . . . . .	Dried fruit	Deep red
10. Carnation, red ( <i>Dianthus Caryophyllus</i> ) . . . . .	Petals	Deep reddish-yellow
11. Carrot ( <i>Daucus Carota</i> ) . . . . .	Root	Bright greenish-yellow
12. Celery ( <i>Apium graveolens</i> ) . . . . .	Etiolated leaves	low
13. Chondrus ( <i>Chondrus crispus</i> ) . . . . .	Fronds	Light yellowish-green
14. Cinquefoil ( <i>Potentilla Canadensis</i> ) . . . . .	Petals	Greenish-yellow
15. Cranberry ( <i>Oxycoccus macrocarpus</i> ) . . . . .	Fruit	Deep red
16. Daffodil ( <i>Narcissus Pseudo-Narcissus</i> ) . . . . .	Petals	Deep yellow
17. Dandelion ( <i>Taraxacum officinale</i> ) . . . . .	Petals	Lemon-yellow
18. Dock ( <i>Rumex crispus</i> ) . . . . .	Spring leaves	Reddish-brown
19. Dogwood ( <i>Cornus Florida</i> ) . . . . .	Fruit	Brownish-yellow
20. Dulce ( <i>Rhodymenia palmata</i> ) . . . . .	Fronds	Light yellowish-green
21. Elder ( <i>Sambucus Canadensis</i> ) . . . . .	Spring leaves	Reddish-brown
22. Fucus ( <i>Fucus vesiculosus</i> ) . . . . .	Fronds	Greenish-brown
23. Hepatica ( <i>Hepatica triloba</i> ) . . . . .	Petals	Lemon-yellow or greenish-yellow
23a. Hepatica ( <i>Hepatica triloba</i> ) . . . . .	Involucre	Purplish-red
24. Iris ( <i>Iris versicolor</i> ) . . . . .	Petals	Violet
25. Jack-in-the-pulpit ( <i>Arisæma triphyllum</i> ) . . . . .	Spathe	Purplish-red
26. Japanese quince ( <i>Cydonia Japonica</i> ) . . . . .	Petals	Bright purplish-red
26a. Lemon peel . . . . .	Epicarp	Yellow
27. Mallow ( <i>Malva sylvestris</i> ) . . . . .	Petals	Violet
28. Maple ( <i>Acer rubrum</i> ) . . . . .	Flowers	Yellowish or brownish-red
29. Marigold ( <i>Calendula officinalis</i> ) . . . . .	Petals	Deep yellow
30. Oak, red ( <i>Quercus coccinea?</i> ) . . . . .	Spring leaves	Reddish-brown
30a. Orange peel . . . . .	Epicarp	Orange-yellow
31. Pansy, blue ( <i>Viola tricolor</i> ) . . . . .	Petals	Purplish-red

COLOR PRINCIPLES EXTRACTED WITH ALCOHOL—*Continued.*

Name of Plant.	Part Used.	Color of Solution.
32. Pansy, yellow ( <i>Viola tricolor</i> ), . . . . .	Petals	Deep yellow
33. Pineapple ( <i>Ananas sativa</i> ) . . . . .	Outer portion	Brown
34. Radish ( <i>Raphanus Raphanistrum</i> ) . . . . .	Purplish layer of root	Light red
35. Rose ( <i>Rosa gallica</i> ) . . . . .	Dried petals	Light brown
35a. Rose ( <i>Rosa</i> —) . . . . .	Early leaves	Reddish-brown
36. Safflower ( <i>Carthamus tinctorius</i> ) . . . . .	Petals	Deep yellow
37. Saffron ( <i>Crocus sativus</i> ) . . . . .	Dried stigmas	Yellowish-red
38. Skunk cabbage ( <i>Spathyema fatida</i> ) . . . . .	Green leaves	Deep green
39. Skunk cabbage ( <i>Spathyema fatida</i> ) . . . . .	Inner portion of leaf	Deep yellow
40. Skunk cabbage ( <i>Spathyema fatida</i> ) . . . . .	Spathes [buds]	Deep yellowish-red
41. Skunk cabbage ( <i>Spathyema fatida</i> ) . . . . .	Scales	Purplish-red
42. Skunk cabbage ( <i>Spathyema fatida</i> ) . . . . .	Tips of leaf buds	Yellowish-red
43. Spinach ( <i>Spinacea oleracea</i> ) . . . . .	Leaves	Deep green
44. Sweet Cicely ( <i>Washingtonia Claytoni</i> ) . . . . .	Spring leaves	Reddish-brown
45. Tomato ( <i>Lycopersicon esculentum</i> ) . . . . .	Fruit	Pale yellow
46. Tulip ( <i>Tulipa Gesneriana</i> ) . . . . .	Petals	Light reddish-brown
47. Turnip ( <i>Brassica napus</i> ) . . . . .	Purplish layer of root	Pale yellow
48. Violet, blue ( <i>Viola cuculata</i> ) . . . . .	Petals	Pale purplish-red
49. Violet, yellow ( <i>Viola scabriuscula</i> ) . . . . .	Petals	Yellow
50. Wahoo ( <i>Euonymus Americanus</i> ) . . . . .	Winter leaves	Reddish-brown

## COLOR PRINCIPLES EXTRACTED WITH DILUTE ALCOHOL.

51. Black Mexican corn ( <i>Zea Mays</i> ) . . . . .	Grains	Light purplish-red
52. Geranium, house ( <i>Pelargonium</i> —) . . . . .	Petals	Light purplish-red
53. Geranium, wild ( <i>Geranium maculatum</i> ) . . . . .	Petals	Pale straw
54. Houstonia ( <i>Houstonia cœrulea</i> ) . . . . .	Petals	Pale straw
55. Hyacinth, dark red ( <i>Muscari botryoides</i> ) . . . . .	Petals	Light yellowish-red
56. Hyacinth, blue ( <i>Muscari botryoides</i> ) . . . . .	Petals	Purplish-red
57. Lilac ( <i>Syringa vulgaris</i> ) . . . . .	Petals	Brownish-yellow
58. Rhubarb ( <i>Rheum</i> —) . . . . .	Outer portion of petioles	Pale red
59. Strawberry ( <i>Fragaria</i> —) . . . . .	Fruit	Yellowish-red
60. Violet, blue ( <i>Viola cuculata</i> ) . . . . .	Petals	Greenish-yellow
61. Wistaria ( <i>Kraunhia frutescens</i> ) . . . . .	Petals	Pale brown

## COLOR PRINCIPLES EXTRACTED WITH WATER.

62. Beech ( <i>Fagus Americana</i> ) . . . . .	Autumn leaves	Reddish-yellow
63. Beet ( <i>Beta vulgaris</i> ) . . . . .	Root	Deep red
64. Blackberry ( <i>Rubus Canadensis</i> ) . . . . .	Outer portion of stems	Brownish-red
65. Blackberry ( <i>Rubus Canadensis</i> ) . . . . .	Fruit	Purplish-red
66. Cranberry ( <i>Oxycoccus macrocarpus</i> ) . . . . .	Fruit	Deep red
67. Dogwood ( <i>Cornus Florida</i> ) . . . . .	Autumn leaves	Reddish-brown
67a. Dulce ( <i>Rhodymenia palmata</i> ) . . . . .	Fronds	Purplish
69. Elder ( <i>Sambucus Canadensis</i> ) . . . . .	Dried fruit	Purplish-red
69. Grape ( <i>Vitis vinifera</i> ) . . . . .	Fruit	Purplish-red
70. Holly ( <i>Ilex Aquifolium</i> ) . . . . .	Fruit	Deep brownish-red
71. Hydrangea ( <i>Hydrangea Hortensis</i> ) . . . . .	Neutral flowers	Brownish-red
72. Indian cucumber ( <i>Medeola Virginiana</i> ) . . . . .	Autumn leaves	Deep brownish-red
73. Mallow ( <i>Malva sylvestris</i> ) . . . . .	Petals	Dark purplish-red
74. Maple ( <i>Acer saccharum</i> ) . . . . .	Autumn leaves	Brownish-red
75. Marigold ( <i>Calendula officinalis</i> ) . . . . .	Dried petals	Deep brownish-red
76. Oak, white ( <i>Quercus alba</i> ) . . . . .	Autumn leaves	Brownish-red
77. Rhubarb ( <i>Rheum</i> —) . . . . .	Outer portion of petioles	Pale red
78. Rose, wild ( <i>Rosa</i> —) . . . . .	Pericarp	Deep brownish-red
79. Safflower ( <i>Carthamus tinctorius</i> ) . . . . .	Dried petals	Deep brownish-red
80. Saffron ( <i>Crocus sativus</i> ) . . . . .	Dried stigmas	Deep yellowish-red
81. Solomon's seal ( <i>Vagnera racemosa</i> ) . . . . .	Fruit	Deep red

## PLASTID COLOR SUBSTANCES.

The green color in plants is due, as is well known by botanists, to a green pigment known as chlorophyl which is associated with a plastid or organized protoplasmic body, forming a so-called chloroplast. Chlorophyl is distinguished from all other plant substances by possessing a dark broad band between the Fraunhofer lines A and C at the red end of the spectrum, which is apparent even in very dilute solutions. It also shows in more concentrated solutions a broad band extending from F to the violet end of the spectrum, a narrow band between C and D, or the orange portion of the spectrum, and two narrow bands between D and E, or the yellow portion of the spectrum.

Pringsheim examined spectroscopically solutions of the yellow substances found in etiolated germinating leaves, and also the yellow substances of yellow flowers and autumn leaves, and observed the characteristic chlorophyl bands only by using tubes more than three hundred millimeters thick. Inasmuch as small tubes holding five or ten cubic centimeters are sufficient for the examination of chlorophyl, by means of the Zeiss or Leitz microspectroscope, and also because a dilute solution is necessary, one is surprised that Pringsheim and others have used tubes of such enormous thickness, and that they concluded from the more or less indistinct bands which they observed that these substances were modifications of chlorophyl. It is not at all unlikely that what he actually had were concentrated solutions of as many different principles, each of which contained traces of chlorophyl, notwithstanding the care he exercised in separating the green and yellow portions in the material which he used.

In my own studies on the yellow principle of developing leaves I used the buds of skunk cabbage, which develop under ground and under leaves and are of considerable size before exposed to light. The outer light greenish-yellow portions were removed, and only the intense yellow central portion used. This material was extracted in the dark with alcohol. The solution thus obtained is of a pure lemon-yellow color, and may be freed from cell-sap substances either by evaporation to an extract, washing with water, dissolving in cold alcohol, and then boiling with zinc; or by treating the original alcoholic solution with petroleum benzin, whereby the pure yellow leaf substance is separated from the cell-sap substance.

This yellow principle is combined with plastids, which are about one micron in diameter, being spherical or polygonal in shape, and lying closely packed in the palisade cells of both the upper and lower surfaces of the leaf. The yellow plastids are distinguished from the leucoplastids, which occur in the epidermal and mesophyll cells, as well as the chloroplastids, which are found later in the green leaves, by being smaller, relatively more numerous and by not manufacturing either reserve or assimilation starch. The associated pigment is further distinguished from chlorophyll by not being fluorescent; in having a broad band extending from 65 to the red end of the spectrum, and another extending from 50-52 to the violet end of the spectrum, when examined by means of the Leitz micro-spectroscope; and in being less soluble in alcohol and more so in benzol than chlorophyll. This latter characteristic affords a means of partially separating it from chlorophyll, and for this principle I propose the name *etiophyll*, and for the associated plastid, which seems to be a distinct body, I propose a corresponding name, *etioplast*, these terms being used expressly for the purpose of avoiding confusion. The etioplasts completely pack the cells in which they are found, and may be regarded as meristematic plastids, which later give rise to the chloroplastids.

The yellow color in certain roots, flowers and fruits is apparently in all cases due to a yellow pigment associated with a plastid known as a chromoplast. These plastids are distinguished from the other plastids by being of variable shape and in usually containing protein grains. The associated pigment resembles in some respects etiophyll and chlorophyll, in that it is more or less soluble in ether, benzol, xylol, carbon disulphide, etc. These pigments, for the most part, appear to be unaffected by either mineral or organic acids, but usually give some shade of green with alkalies, potassium cyanide, sodium phosphate or iron salts. In some cases they are affected by alum, iodine, sodium nitrite, or sodium nitrite and sulphuric acid, as given in Table I.<sup>1</sup>

<sup>1</sup> In the examination of plant colors the following reagents were found useful: Sulphuric acid, 10 per cent.; hydrochloric acid, 10 per cent.; nitric acid, 10 per cent.; citric acid, 5 per cent.; oxalic acid, 5 per cent.; sodium hydrate, 10 per cent.; ammonium hydrate, 10 per cent.; potassium cyanide, 1 per cent.; sodium phosphate, 5 per cent.; ferric chloride, 3 per cent.; ferrous sulphate, 2.5 per cent.; hydrogen peroxide, 3 per cent.; salicylic acid, saturated solution, gallic acid, 1 per cent.; sodium nitrite, 1 per cent.; sodium nitrite followed by sulphuric



Inasmuch as there seems to be a class of these principles which are distinguished by their solubility, as well as reactions with various chemicals, I venture to propose the name *chromophyl* for these yellowish or orange-colored pigments.

All of the coloring substances given in Table I are soluble in xylol, ether and similar solvents, as well as alcohol, but are sparingly soluble in water.

There are several substances which behave much like the plastid substances, but which are insoluble in xylol, ether, etc., and appear to occupy an intermediate position between the true plastid color substances and the cell-sap colors. I have therefore placed them in class by themselves in Table II.

#### CELL-SAP COLOR SUBSTANCES.

During the course of metabolism the plant cell manufactures other color substances which are not combined with the protoplasm, but which are contained in the cell-sap, or liquid of the cell. These substances, unlike the plastid colors, are insoluble in xylol, ether and similar solvents, but are soluble in water and alcohol, which affords a means of separating them from the plastid colors. These cell-sap pigments may occur in cells free from plastids or in the vacuoles of cells containing plastids, but not associated with them as a part of the organized body or plastid. They are usually extracted along with the chlorophyl and remain in the hydro-alcoholic solution after separation of the plastid pigment by means of xylol or other solvent. These pigments have one property in common with the chromophyl substances, namely, with alkalis, potassium cyanide and sodium phosphate, they assume some shade of green. They are distinguished, however, by the fact that the colors are markedly affected by acids and alkalis and by iron salts. They are in most cases also affected by other reagents, as shown in the accompanying tables. These substances being so sensitive to reagents, probably accounts for the various shades and tints characteristic not only of flowers but of leaves as well. My observations on the germinating kernels of black Mexican corn show that even in contiguous cells the constituents associated with the dye

---

acid; potash alum, 10 per cent.; ammonio-ferric alum, 5 per cent.; iodine solution containing .1 per cent. iodine and 0.5 per cent. potassium iodide; tannin, 3 per cent.

vary to such an extent that the pigment in one cell is colored reddish, in another bluish-green, and in another purplish.

The results of the examination of the cell-sap colors are given in Tables III, IV and V, and while it might seem a very easy matter to divide plant colors into reds, blues and purples, it will be seen that this is almost impracticable, and that the colors given in these tables merge into one another.

An examination of the color substances found in early spring leaves and in autumn leaves showed that these substances are in the nature of cell-sap colors, behaving toward reagents much like the cell-sap colors of flowers, and indeed in some instances they are apparently identical, as will be seen by comparing the results given in Table VI with those given in Tables III, IV and V.

#### CONCLUSIONS.

1. The white appearance in flowers and other parts of plants is due to the reflection and refraction of light in more or less colorless cells separated usually by large intercellular spaces containing air.

2. The green color of plants is due to a distinct pigment, chlorophyl, contained in a chloroplastid, and appears to be more or less constant in composition in all plants. The chloroplastid is furthermore characterized by usually containing starch.

3. The yellow color substance in roots, flowers and fruits is due to a pigment, to which I have given the name chromophyl. This substance is contained in a chromoplastid which varies considerably in shape, and usually contains proteid substances in addition.

4. In the inner protected leaf-buds there is a yellow principle which I have termed etiophyl, and which is contained in an organized body which I have termed an etioplast. The etioplast does not appear to contain either starch or proteid substances.

5. The blue, purple and red color substances in flowers are dissolved in the cell-sap, and are distinguished for the most part from the plastid colors by being insoluble in ether, xylol, benzol, chloroform, carbon disulphide and similar solvents, but soluble in water or alcohol. While quite sensitive to reagents yet none of these colors behave precisely alike.

6. Cell-sap color substances corresponding to the cell-sap colors of flowers are also found in early or spring leaves and in autumn leaves.

In addition I desire to say that I am inclined to look upon the chromoplastids of both flowers and fruits as having the special function of manufacturing or storing nitrogenous food materials, for the use of the developing embryo or developing seed, particularly as protein grains are usually contained in them. The same may be said of the chromoplasts in roots, as in carrot, where the proteids of the chromoplasts are utilized by the plant of the second year.

I am further inclined to consider the cell-sap colors, like other unorganized cell-contents, as alkaloids, volatile oils, etc., to be incident to physiological activity, and of secondary importance in the attraction of insects for the fertilization of the flower and dispersal of the seed.

Finally, I acknowledge my indebtedness to Miss Florence Yaple, Philadelphia, for valuable assistance in the preparation of this paper.

#### BIBLIOGRAPHY.

1. DIPPPEL: *Das Mikroskop*, 2te Auflage, zweiter Theil, erste Abtheilung, pages 65 and 66.
2. PRINGSHEIM: "Untersuchungen über das Chlorophyll," *Monatsberichte der Königlich Preussischen Akademie der Wissenschaften zu Berlin*, 1874, p. 628.
3. MUELLER: "Spectralanalyse der Blütenfarben," *Pringsheim's Jahrbuch*, Bd. XX (1889).
4. KRAUS: "Ueber die Bestandtheile der Chlorophyllfarbstoffe und ihrer Verwandten," *Sitzungsber. d. med. phys. Gesellsch. in Halle* (1871).
5. HANSEN: "*Farbstoffe des Chlorophylls*," 1888, quoted by Dippel.
6. HUSEMANN, A.: *Die Pflanzenstoffe*, 2te Auflage, p. 959.

## I. EXAMINATION OF PLASTID COLOR SUBSTANCES.

	Etiophryl			Chlorophryl			Chromophryl				
	39. <i>Skunk cabbage</i>	12. <i>Celery</i>	43. <i>Spinach</i>	38. <i>Skunk cabbage</i>	16. <i>Daffodil</i>	7. <i>Buttercup</i>	14. <i>Cinquefoil</i>	32. <i>Yellow pansy</i>	49. <i>Yellow violet</i>	29. <i>Marigold violet</i>	
Mineral acids.	Cloudy •	Cloudy	Cloudy	Pale brown, cloudy	Cloudy, color less intense	Cloudy	Paler and slightly cloudy	Decolorized, cloudy	Slightly cloudy	No effect	
Organic acids.	(Cloudy)	No effect	Cloudy	Light brownish-green	Cloudy, color less intense	Slightly cloudy	Paler and slightly cloudy	Decolorized, cloudy	Slightly cloudy	No effect	
Alkalies . . . . .	O. c. intn. acidified	Yellowish-green	No effect	No effect	Slightly green	No effect	Yellowish-green	Yellowish-green	Yellowish-green, becoming colorless	Light yellowish-green	
Potassium cyanide . . . . .	O. c. intn. acidified	Yellowish-green	No effect	No effect	Slightly green	No effect	Yellowish-green	Yellowish-green	Yellowish-green	Light yellowish-green	
Sodium phosphate . . . . .	O. c. intn. acidified	Yellowish-green	No effect	No effect	Slightly green	No effect	Yellowish-green	Yellowish-green	Yellowish-green	Light yellowish-green	
Ferric chloride.	Light olive-green	Brown	No effect	Brownish-green	Light olive-green, slightly cloudy	Yellowish-brown, cloudy	Brownish-green	Olive-green	Yellowish-green	Light yellowish-green	
Ferrous sulphate . . . . .	Light olive-green, cloudy	Pale brown	Light brown	Brownish-green	Light olive-green, slightly cloudy	Yellowish-green, cloudy	Pale green	Green, becoming olive-green	Yellowish-green, cloudy	Pale greenish-brown	
Salicylic acid. . . . .	Remains clear	No effect	No effect	No effect	No effect	No effect	Slightly decolorized	Decolorized	Partly decolorized	No effect	
Galic acid . . . . .	Remains clear	No effect	No effect	No effect	No effect	No effect	Slightly decolorized	Decolorized	Partly decolorized	No effect	
Hydrogen peroxide . . . . .	No effect	No effect	No effect	No effect	No effect	No effect	Slightly decolorized	Decolorized	Partly decolorized	No effect	
Sodium nitrite . . . . .	No effect	No effect	No effect	No effect	No effect	No effect	No effect	No effect	Faint brown	No effect	
Sodium nitrite and sulphuric acid . . . . .	Cloudy	Cloudy	Light bluish-green	Pale brown, cloudy	Decolorized	Decolorized	Decolorized	Faint brown	Decolorized	No effect	
Alum . . . . .	Cloudy	Slightly cloudy	Cloudy	Pale brownish-green, cloudy	Cloudy	Cloudy	No effect	Pale green, cloudy	Pale green, cloudy	No effect	
Ammonio-ferric alum . . . . .	Olive-green	Brown	Greenish-brown	Brownish-green, cloudy	Olive-green	Yellowish-brown	Gr'n-brown, changing to brown	Brownish-green	Pale yellowish-brown	Greenish-brown	
Iodine solution.	No effect	No effect	No effect	Greenish-brown	Slightly cloudy	Pure green, distinct	No effect	Brownish	No effect	No effect	
Tannin . . . . .	No effect	No effect	No effect	No effect	Slightly cloudy	No effect	No effect	Slightly decolorized	No effect	No effect	

\*The cloudy appearance of solutions recorded in this table is probably due to an oily or resinous substance associated with the coloring principle, or to the fact that the coloring principle is insoluble in much diluted alcohol.

†O. c., original color of solution.



## II. EXAMINATION OF INTERMEDIATE COLOR SUBSTANCES.

	37. 80. <i>Saffron</i>	36. <i>Safflower</i>	79. <i>Safflower</i>	2. <i>Apple (Bellefleur)*</i>	70. <i>Holly</i>
Mineral acids . . . . .	No effect	Cloudy	No effect	No effect	Light yellow
Organic acids . . . . .	No effect	Cloudy	No effect	No effect	Slightly decolorized
Alkalies . . . . .	No effect	Greenish-yellow	Darkened slightly	Greenish-yellow	Brown
Potassium cyanide . . . . .	No effect	Greenish-yellow	Darkened slightly	Greenish-yellow	No effect
Sodium phosphate . . . . .	No effect	Greenish-yellow	Darkened slightly	Pale yellow	No effect
Ferric chloride . . . . .	Darkened or greenish-brown	Light olive-green to light brown	Dark greenish-brown	Green, changing to olive-green	Light greenish-brown
Ferrous sulphate . . . . .	No effect	Light olive-green to light brown	Light greenish-brown	Pale green	Light greenish-brown
Salicylic acid . . . . .	No effect	No effect	No effect	No effect	No effect
Galic acid . . . . .	No effect	No effect	No effect	No effect	No effect
Hydrogen peroxide . . . . .	No effect	No effect	No effect	No effect	No effect
Sodium nitrite . . . . .	No effect	No effect	No effect	Pale brown	No effect
Sodium nitrate followed by sulphuric acid . . . . .	Pale yellow	Cloudy	No effect	Light brown	No effect
Alum . . . . .	No effect	No effect	No effect	No effect	No effect
Ammonio ferric alum . . . . .	Darkened or yellowish-brown	Light yellowish-brown	Deep olive-brown	Greenish to greenish-brown	Greenish-brown
Iodine solution . . . . .	No effect	No effect	No effect	No effect	No effect
Tannin . . . . .	No effect	No effect	No effect	No effect	No effect

\* Cloudy on addition of water to alcoholic solution.

## III. EXAMINATION OF BLUE CELL-SAP COLOR SUBSTANCES.

	23. <i>Hepatica</i>	48. <i>Violet, blue</i>	31. <i>Pansy, blue</i>	56. <i>Hyacinth, blue</i>	61. <i>Wistaria</i>	54. <i>Houstonia</i>	27. <i>Mallow flowers</i>	<i>Litmus solution</i>	24. <i>Iris</i>
Natural color . . .	Blue	Violet-blue	Purple	Purplish-blue	Light blue	Light blue	Dark blue	Deep purple	Purple to violet
Mineral acids . . .	Pale yellowish-red	Pure deep red	Intense rich red	Intense rich red	Purplish	Light yellowish-red	Deep purplish-red	Yellowish-red	Pure deep red
Organic acids . . .	Pale yellowish-red	Pure red	Purplish-red	Violet-red	Pale purplish-red	Light yellowish-red	Deep purplish-red	Yellowish-red	Pure deep red
Alkalies . . . . .	Green	Green	Greentobrownish-green	Light brownish-green	Yellowish-green	Yellowish-green	Brownish-green	Pure blue	Green, changing to yellowish-green
Potassium cyanide	Green	Green	Green	Green	Yellowish-green	Yellowish-green	Brownish-green	Pure blue	Green
Sodium phosphate	Pale green	Green	Green	Green	Yellowish-green	Yellowish-green	Brownish-green	Pure blue	Green
Ferric chloride . .	Olive-green	Olive-green	Intense blue	Purplish-brown to blue	Olive-green	Deep olive-green	Brownish-green	Purplish-red	Purplish-blue, changing to brown
Ferrous sulphate .	Light olive-green	Bluish-green	Deep blue	Blue	Brownish-purple	Olive-green	Reddish-brown	Purplish-red	Pure blue
Salicylic acid . . .	Faint yellowish-red	Faint red	O. c. intensified	No effect	Pale reddish	Slightly reddened	No change	Yellowish-red	Faint red
Galic acid . . . . .	Faint yellowish-red	Slight red	O. c. intensified	O. c. intensified	No effect	No effect	No effect	Yellowish-red	Faint red
Hydrogen peroxide	No effect	Slight red	O. c. intensified	No effect	No effect	No effect	No effect	Yellowish-red	No effect
Sodium nitrite . . .	No effect	Green	Pure green	No effect	Slightly greenish	Light green	Pale purplish	No effect	Decolorized
Sodium nitrate, followed with sulphuric acid	Pale yellowish-brown	Red, becoming decolorized	Red, then colorless	Yellowish-red	Pale reddish	Light yellowish-red	Golden yellow	Yellowish-red	Faint red, almost decolorized
Alum . . . . .	Slightly yellowish-green	Gobelin-blue	Sky-blue, blue	Decolorized	No effect	No effect	No effect	Yellowish-red	Pure blue, distinct
Ammonio-ferric alum . . . . .	Olive-green	Greenish-brown	Deep blue, rapidly changing to bluish-green	Reddish-brown	Olive-green	Olive-green	Greenish-brown	Yellowish-red	Purplish, changing to brown
Iodine and potassium iodide . . . . .	No effect	No effect	Pale yellowish-red	No effect	No effect	No effect	No effect	Blue	Decolorized
Tannin . . . . .	No effect	No effect	Reddened	No effect	No effect	No effect	No effect	Purplish-red	No effect

## IV. EXAMINATION OF PURPLE CELL-SAP COLOR SUBSTANCES.

	33. <i>Jack-in-the-pulpit</i>	40. <i>Skunk cabbage</i>	41. <i>Skunk cabbage</i>	23a. <i>Hepatica involucres</i>	57. <i>Lilac</i>	51. <i>Black Mexican corn</i>	68. <i>Elderberries</i>
Natural color . . . . .	Violet-red	Purplish-red	Purplish-red	Purplish	Purple	Purplish	Purplish
Mineral acids . . . . .	Pure deep red	Deep red	Red	Faint salmon	Somewhat cloudy	Pure red	Purplish-red
Organic acids . . . . .	Pure deep red	Light purplish-red	Light red	Faint salmon	Somewhat cloudy	Pure red	Purplish-red
Alkalies . . . . .	Green	Intense green	Green	Yellowish-green	Greenish, changing to yellowish-brown	Bluish-green	Pure green
Potassium cyanide . . . . .	Green	Intense green	Green	Yellowish-green	Greenish, changing to yellowish-green	Bluish-green	Pure green
Sodium phosphate . . . . .	Green	Green	Green	Pale yellowish-green	Greenish, changing to yellowish-green	Light bluish-green	Light green
Ferric chloride . . . . .	Purplish-red, changing to brown	Dark purple	Purplish-red	Pale greenish-brown	Deep brownish-green	Greenish-brown	Pale greenish-brown
Ferrous sulphate . . . . .	Violet	Dark purple	Purplish-red	Very pale greenish-brown	Faint olive-green	Purple	Pale purplish
Sulphuric acid . . . . .	Pure red	No effect	No effect	No effect	No effect	Pinkish	O. c. slightly intensified
Gallic acid . . . . .	Pure red	No effect	No effect	No effect	No effect	Slightly pink	O. c. slightly intensified
Hydrogen peroxide . . . . .	Pure red	No effect	No effect	No effect	No effect	Red	No effect
Sodium nitrite . . . . .	No effect	No effect	Becoming cloudy	No effect	No effect	No effect	Pale brown
Sodium nitrite, followed by sulphuric acid . . . . .	Pure deep red	Yellowish-red	Yellowish-red or orange	Pale yellowish-brown	Pale yellow	Yellowish-red	Purplish-red
Alum . . . . .	Violet	Purplish-red, fluorescent	Faint purplish-red	No effect	No effect	Red, changing to violet	No effect
Ammonio-ferric alum . . . . .	Purplish-brown	Greenish-brown	Purplish-green	Greenish-brown	Deep brownish-green	Yellowish-brown	Olive-green
Iodine solution . . . . .	No effect	No effect	No effect	No effect	No effect	No effect	No effect
Tannin . . . . .	Slightly red	No effect	No effect	No effect	No effect	Faint pink	No effect



## IV. EXAMINATION OF PURPLE CELL-SAP COLOR SUBSTANCES—Continued.

	64. <i>Blackberry</i>	69. <i>Concord grapes</i>	8. <i>Red cabbage</i>	47. <i>Turnip</i>	71. <i>Hydrangea</i>	67a. <i>Dulce</i>	53. <i>Wild geranium</i>
Natural color . . . . .	Reddish-purple	Bluish-purple	Purplish-red	Purplish-red	Reddish-purple	Purplish-red	Light purplish-red
Mineral acids . . . . .	Purplish-red	O. c. intensified	Rose-red	Purplish-red	Yellowish-red	Purple, losing fluorescence	Deep red
Organic acids . . . . .	Purplish-red	O. c. intensified	Light rose-red	Light purplish-red	Yellowish-red	Purple, losing fluorescence	Faint red
Alkalies . . . . .	Brownish-purple	Pure green, changing to olive-green	Intense green	Light green	Yellowish-green	Pale yellowish-brown	Yellowish-green, changing to yellowish-brown
Potassium cyanide.	Brownish-purple	Pale bluish-green	Intense green	Light green	Yellowish-green	Yellowish-brown	Greenish-yellow
Sodium phosphate.	Slightly changed	Violet	Bluish-green	Light green	Yellowish-green	No effect	Greenish-yellow
Ferric chloride . . . . .	Purplish-brown, changing to brown	Greenish-brown	Rose-purple	Light greenish-brown	Olive-green	Purplish-brown	Deep olive-green
Ferrous sulphate . . . . .	Purple	Purplish-brown	Purple	Light blue	Olive-green	No effect	Blue
Salicylic acid . . . . .	No effect	No effect	O. c. intensified	No effect	Slightly reddened	No effect	Red
Galic acid . . . . .	No effect	No effect	O. c. intensified	Slightly pink	Slightly reddened	Slightly purple	No effect
Hydrogen peroxide . . . . .	No effect	No effect	No effect	No effect	No effect	No effect	No effect
Sodium nitrate . . . . .	Purple color intensified	Purplish-brown	No effect	No effect	Light greenish	No effect	No effect
Sodium nitrite, followed by sulphuric acid . . . . .	Brownish-red	Brown	Yellowish-red	Pale yellowish brownish-red	Brownish-yellow	Faint purple, losing fluorescence	Deep red
Alum . . . . .	No effect	No effect	Violet, purplish-red	Faint violet	No effect	No effect	No effect
Ammonio-ferric alum . . . . .	Deep purple	Olive-green	Purplish-brown	Pale brown	Olive-green	Purplish-brownish red	Bluish-brown green
Iodine solution . . . . .	No effect	No effect	No effect	No effect	No effect	No effect	Red, becoming colorless
Tannin . . . . .	No effect	No effect	No effect	No effect	No effect	O. c. rendered bluish	No effect

## V. EXAMINATION OF RED CELL-SAP COLOR SUBSTANCES.

	3. <i>House geranium</i>	46. <i>Tulip</i>	10. <i>Carnation</i>	58. <i>Hyacinth</i>	35. <i>Rose</i>	4. <i>Azalea</i>	28. <i>Maple flowers</i>	15. <i>Cranberry</i>
Natural color . . . . .	Very deep red	Reddish	Deep red	Red	Red	Pink	Red	Deep red
Mineral acids . . . . .	Deep orange-red	Purplish-red	Yellowish-red	Deep orange-red	Rose red	Pale red	Yellowish-red, cloudy	No change
Organic acids . . . . .	Pale orange-red	Purplish-red	O. c. intensified	O. c. intensified	Light purplish-red	Pale red	Yellowish-red, clear	No change
Alkalies . . . . .	Yellowish-green, changing to brown	Green	Olive-green, changing to redish-brown	Green, changing to brown	Green, changing to brown	Light greenish-yellow	Dark green	Brownish - purple
Potassium cyanide.	Yellowish-green	Green	Olive green	Green	Green	Light greenish-yellow	Green, changing to brown	Brownish - purple
Sodium phosphate.	Yellowish-green	Green	Light green	Green	Green	Pale greenish-yellow	Green, changing to brown	Brownish - purple
Ferric chloride . . . . .	No effect	Light green	Light green	Green	Greenish-black	Greenish - yellow	Olive-green	Brownish-red
Ferrous sulphate . . . . .	Purplish, changing to greenish brown	Purplish-brown	Brownish-red	Deep red	Bluish-black	Pale purplish-brown	Deep blue	Reddish-brown
Salicylic acid . . . . .	Deep violet	Deep brownish-red	Brownish-red	Pinkish changing to wine-red	O. c. intensified	Faint pink	Yellowish-red	No effect
Gallie acid . . . . .	Yellowish-red	Purplish-red	O. c. intensified	O. c. intensified	O. c. intensified	Faint pink	Yellowish-red	No effect
Hydrogen peroxide . . . . .	Yellowish-red	Purplish-red	O. c. intensified	O. c. intensified	O. c. intensified	Faint pink	Yellowish-red	No effect
Sodium nitrite . . . . .	No effect	Light purplish-red	O. c. intensified	O. c. intensified	O. c. intensified	No effect	Faint yellowish-red	No effect
Sodium nitrate, followed with sulphuric acid . . . . .	Deep orange-red	Light brownish-red	Slightly decolorized	No effect	Slightly decolorized	No effect	Light greenish-yellow	Yellowish-brown
Alum . . . . .	Pale red	Light brown	O. c. restored and intensified	Deep orange-red	Yellowish-red	Pale red	Yellowish-red, cloudy	Yellowish-brown
Ammonio-ferric alum . . . . .	Deep violet, changing to purplish-brown	Purplish-red	Yellowish-red	Yellowish-red	Pale yellow, changing to reddish-brown with a greenish fluorescence	Faint pink	Purplish - red, cloudy	No effect
Iodine solution . . . . .	Red, becoming decolorized	No effect	Brownish-red	Deep red	Dark olive-green	Pale greenish-brown	Deep blue	Brown
Tannin . . . . .	Faint red	Purplish-red	No effect	No effect	Yellowish-red	No effect	No effect	No effect





## VI. EXAMINATION OF LEAF COLORING PRINCIPLES—Continued.

	44. <i>Sweet cicely</i>	74. <i>Maple</i>	76. <i>Oak</i>	67. <i>Dogwood</i>	72. <i>Indian cucumber</i>	62. <i>Beech</i>
Natural color . . . . .	Greenish-red	Dark red	Dark red	Dark red	Reddish	Greenish to brownish-yellow
Mineral acids . . . . .	Faint yellowish-red	Yellowish-red	Yellowish-red	Yellowish-red	Deep purplish-red	Partly decolorized
Organic acids . . . . .	Faint yellowish-red	Slightly yellowish-red	Slightly yellowish-red	Yellowish-red	Deep purplish-red	Partly decolorized
Alkalies . . . . .	Yellowish	Yellowish	Reddish-brown	Brown	Green	Brown
Potassium cyanide . . . . .	Yellowish	Olive-green, with ammonia, reddish brown	Reddish-brown	Brown	Green	Very light brown
Sodium phosphate . . . . .	Yellowish	Deep brownish-red	Purplish-red	Light brown	Light green	Faint brown
Ferric chloride . . . . .	Olive-green	Light olive-green	Greenish-brown	Deep blue	Reddish-brown	Greenish-brown
Ferrous sulphate . . . . .	Olive-green	Deep blue precipitate	Blue, changing rapidly to olive-green	Deep blue	Reddish-brown	Pale greenish-brown
Salicylic acid . . . . .	No effect	Deep blue solution	Blue	Deep blue	Reddish-brown	Partly decolorized
Galic acid . . . . .	No effect	Slightly yellowish-red	No effect	Yellowish-red	Purplish-red	Partly decolorized
Hydrogen peroxide . . . . .	No effect	Slight effect	No effect	Yellowish-red	Purplish-red	Partly decolorized
Sodium nitrite . . . . .	No effect	No effect	No effect	No effect	Purplish-red	Partly decolorized
Sodium nitrate, followed with sulphuric acid . . . . .	Brownish	No effect	No effect	Brownish-yellow	Faint brown	No effect
Alum . . . . .	Yellowish-brown	Yellowish-red	Yellowish-red	Yellowish-red, changing to yellowish-brown	Yellowish-brown	Light brown
Ammonio-ferric alum . . . . .	Light greenish-yellow	No effect	No effect	Purplish-red	Purplish-red	Partly decolorized
Iodine solution . . . . .	Olive-green	Deep blue	Blue, changing to olive-green	Deep blue, changing to olive-green	Purplish-brown	Greenish-brown
Tannin . . . . .	No effect	No effect	No effect	No effect	No effect	No effect
	No effect	No effect	No effect	No effect	Purplish-red	No effect

THE HISTORICAL USE OF THE RELATIVE PRONOUNS  
IN ENGLISH LITERATURE.

BY PROFESSOR WATERMAN T. HEWETT, PH.D.

(Read April 9, 1904.)

In examining the manuscript of a new volume submitted for publication, I was struck with the fact that the relative pronoun *which* was not used by the author. The question arose, whether there was a portion of our country in which, through historical or possibly educational influence, the use of *that* prevailed in place of *which*. In my subsequent reading, I marked the use of these pronouns in order to determine their literary use. Many of the characteristics of literary form depend upon the choice of the pronoun adopted. The use of one or the other pronoun is a characteristic of the style of representative English writers and lends a special quality to their form and expression.

The Germanic languages did not possess a distinctive relative pronoun. The place of such pronoun in Old English was supplied by *sē*, *séo* and *paet*, also by the indeclinable demonstrative form *pē* (the), which was frequently added to the article, and, though less frequently, by the interrogatives *which* and *who*. *What* (*hwaet*) as a relative occurs first at the beginning of the thirteenth century. Following the Conquest, the use of *pē* (the) as a relative declined, due, possibly, to the increasing tendency to use this particle in place of all the forms of the definite article. About 1200, the neuter *paet* was, in general, used as a relative in both numbers and in all persons and genders in the nominative and accusative cases. This use may have been promoted by the influence of the French conjunction *que*.

The interrogatives *who* and *which* were used, but only in isolated cases, as relatives, *who* referring mainly to persons and *which* to things. By the time of the translation of the King James version of the Bible, in 1611, the development in the use of the relative pronouns had attained certain distinct features. The most striking differentiation in use consisted in the fact that *that* was made to refer to pronouns and *which* to nouns. The use of *which* had constantly increased and had gradually displaced *that*, and *who* and *what* had gained in frequency of use. The

present tendency in literature is to employ *who* and *which* at the expense of the earlier *that*.

Every scholar will judge from his own use, or from the environment in which his speech has been formed, in respect to the frequency and naturalness of the use of *which* and *that* in his own case. That which we do instinctively is the test of familiar expression. Writers upon the use of language in rhetorics and popular grammars exhibit great diversity of judgment respecting the use of these pronouns. Dean Alford, in his book upon the Queen's English, fourth edition, 1874, in speaking of the use of *who* and *which*, remarks: "Now we do not commonly use either one or the other of these pronouns, but make the more convenient one *that* make duty for both. We do not say 'The man *who* met me, nor the cattle *which* I saw grazing,' but 'The man *that* met me, the cattle *that* I saw grazing.'"

Bain, in his *Higher English Grammar*, says that *who* and *which* are most commonly preferred for co-ordination, but that they may also be used as restrictives. "However, *that* is the proper restrictive, explicative or defining relative. It would be a clear gain to confine *who* and *which* to co-ordination and to reserve *that* for the restrictive use alone. In the sentence 'His conduct surprised his English friends *who* had not known him long,' we mean either that his English friends generally were surprised (the relative being in this case co-ordinating), or that only a portion of them—namely, the particular portion that had not known him long—were surprised. The doubt would be removed by writing thus, 'His English friends *that* had not known him long.' So, also, in the sentence 'The next winter *which* you will spend in town will give you opportunity to make a more prudent choice;' this may either mean you will spend next winter in town or the next of the winters when you are to live in town, let that come when it may. In the former case *which* is the proper relative, and in the latter case *that*." According to my own impression, the ambiguity in the sentence "His English friends *that* had not known him long" would not be removed, as the author thinks, by the substitution of *that* for *which* in this case.

Genung, in *The Working Principles of Rhetoric*, 1902, says: "Typically, the relatives *who* and *which* assume that the antecedent is fully defined in sense, their office being to introduce additional information about it. They may accordingly be called

the additive relative, and are equivalent to a demonstrative with a conjunction, 'and he,' 'and this,' 'and these.' The relative *that* assumes that its antecedent is not yet fully defined, its office being to complete or restrict its meaning. It may accordingly be called the restrictive relative, and may generally be represented, by way of equivalent, by an adjectival or participial phrase."

Professor Hill, of Harvard, says: "Few good authors observe the rule that *who* or *which* should be confined to cases in which the relative clause explains the meaning of the antecedent or adds something to it, and *that* to cases in which the relative clause restricts the meaning of the antecedent. This rule, however helpful to clearness it may be in theory, few good authors observe; considerations of euphony prevent adoption of the rule" (*Principles of Rhetoric*, revised and enlarged, page 136).

Meiklejohn, in his *English Language*, says: "*That* is generally employed to limit, distinguish and define. Thus we say 'The house *that* I built is for sale.' Here, the word *that* is an adjective limiting or defining the noun house. Hence, it may be called the defining relative. *Who* or *which* introduces a new fact about the antecedent; *that* only marks it off from the other nouns."

We thus have here representative opinions from English, Scotch and American scholars, who base their judgment mainly upon their practical experience of language and not upon an examination of the literary monuments in different periods. It is our purpose, therefore, to ascertain the historical use of these pronouns and to determine the frequency with which they occur in representative works in literature, since the period of Wiclif's translation of the Bible.

An examination of the two texts of Layamon's *Brut*, issued about seventy years apart, show how complete the distinction between these pronouns had become in that period. In the older text (of about 1205) the earlier relatives of different genders as well as *pe* are used, while the later manuscript B. (of about 1275) represents these pronouns by a uniform *paet* (that).

## A.

(Line 13,827) An alle mine liue, pe ich, iluued habbe.

## B.

In al mine liue, pat ich ileued habbe.

In the century which follows, *who* and *which* occur, but less frequently. In the language of Chaucer (1340-1400), *that* is the



prevailing relative; *who*, *whose* and *whom* occur but in few instances, and may then relate either to persons or things, as in Shakespeare. Chaucer stood more under French influence as regards language than his great contemporary, Wiclif (1324-1384), who in his translation of the Bible was influenced more by Latin constructions. If we examine the *Morte d'Arthur* of Sir Thomas Malory (1400-1470), which lies intermediate in time between Wiclif and Tyndale, we find in 555 lines 30 cases of the use of *that* as a relative, 6 cases of the use of *who* or *whom* in indirect questions, or as an indefinite relative equal to *whoever*, while *which* (*the whiche*) occurs but once in the nominative and once, "*for the which,*" governed by a preposition. This shows that *that* retained its supremacy in the fifteenth century.

If we now compare the use of the relative pronouns in Wiclif's (1384) and in Tyndale's (1526) translations of the Gospels, which are separated by about a century and a half, we find the following results.

The approximate number of times that the relative pronouns *which*, *that* and *who* occur in the four Gospels in the Wiclif and Tyndale versions is as follows:

#### In Wiclif's version of the Gospels

<i>which</i> occurs	29	times in	Matthew
	18	" "	Mark
	97	" "	Luke
	27	" "	John
	<hr/>		
	171	" "	the four Gospels

#### In Tyndale's version

<i>which</i> occurs	135	times in	Matthew
	61	" "	Mark
	241	" "	Luke
	125	" "	John
	<hr/>		
	562	" "	the four Gospels

#### In Wiclif's version

<i>that</i> occurs	205	times in	Matthew
	84	" "	Mark
	284	" "	Luke
	228	" "	John
	<hr/>		
	801	" "	the four Gospels

## In Tyndale's version

<i>that</i> occurs	120	times in	Matthew
	78	" "	Mark
	161	" "	Luke
	144	" "	John
	—		
	503	" "	the four Gospels

## In Wiclif's version

<i>who</i> occurs	8	times in	Matthew
	8	" "	Mark
	21	" "	Luke
	25	" "	John
	—		
	62	" "	the four Gospels

## In Tyndale's version

<i>who</i> occurs	13	times in	Matthew
	10	" "	Mark
	21	" "	Luke
	30	" "	John
	—		
	74	" "	the four Gospels

## In Wiclif's version

<i>whose</i> occurs	1	in	Matthew
	0	" "	Mark
	3	times	" Luke
	5	" "	John
	—		
	9	" "	the four Gospels

## In Tyndale's version

<i>whose</i> occurs	0	in	Matthew
	1	" "	Mark
	5	times	" Luke
	5	" "	John
	—		
	11	" "	the four Gospels

The relatives *that*, *which* and *who* occur in Wiclif 1043 times, *that* 801 times or in about 76 per cent. of the cases, *which* 171 times or in 16.4 per cent., *who* or *whose* 71 times or in 6.8 per

cent. of all cases. In Tyndale's version we find a change, the same pronouns occur 1150 times; *which* has gained in frequency of use, occurring 562 times or in about 50 per cent. of all cases, *that* 503 times or in 44 per cent., *who* in 85 cases or in about 7.4 per cent.

To summarize: *that* occurs in Wiclif's version in 76 per cent. of all cases, but in the Tyndale version in only 44 per cent. of such cases, while *which*, appearing in but 16.4 per cent. of such cases in Wiclif, has risen to 50 per cent. in Tyndale, and soon becomes the leading relative.

In Tyndale's translation of 1526, a usage was established which was preserved with only limited exceptions in the King James version of 1611. As religion appeals to the strongest convictions of our nature, and is associated with glowing feeling, the fixed forms in which truth is conveyed in the Bible have stamped themselves upon human thought and expression. From the restricted use of *which* in 1200 it had in the fourteenth century, the period of Wiclif and Chaucer, attained a recognized currency, while 150 years later (1526) it divided almost equally the sovereignty with *that*.

The dominant use of *which* with nouns is a fact which we might have anticipated from the primitive meaning of *which*, hwi-lic or hwa-lic, *of what kind, how constituted*, like the Latin *qualis*. Substantives naturally possess character or quality, and the relative in referring to them means *of which kind*. *That* merely identifies and does not describe; similarly, *who* indicates usually an individual. Thus in Shakespeare, "I have known those *which* (*qualis*) walked in their sleep, *who* (equal to *and yet they*) died holily in their beds" (*Macbeth*, V, 1, 66). Quoted by Abbott, *Shakespearean Grammar*, page 182.

*Which* is uniformly employed with proper names: "And thou, Capernaum, *which* art exalted unto heaven" (Matthew 11 : 23); "Then cometh he to a city of Samaria, *which* is called Sychar" (John 4 : 5); "For he was father-in-law to Caiaphas, *which* was the high priest that same year" (John 18 : 13); "The same day came to him the Sadducees, *which* say that there is no such resurrection" (Matthew 22 : 23); occurring in such use 151 times, while *that* is similarly used but 5 times.

In Tyndale's version of 1526, *which* refers in the Gospels to a noun about 418 times, *that* to a noun 119 times, a total of 537 times, or in the proportion of 78 per cent. to 22 per cent. *Which*

refers to a noun denoting a place or thing 153 times, to a personal noun 265 times. *Which* refers to a personal, indefinite or demonstrative pronoun 144 times. *That* refers to a non-personal noun 77 times, to a noun denoting a person 42 times, or a total of 119. *That* refers to a pronoun 384 times. Out of 602 cases of the use of a simple relative referring to a pronoun, *that* is used in 64 per cent. of all cases, *which* in 23.5 per cent. of all cases.

The limited use of *who* in the Gospels in Tyndale's version is shown by the fact that out of about 1165 cases of the use of the simple relative, *who* is used only 55 times or a little more than in 5 per cent. of the cases.

The two translations of the Bible by Tyndale, 1526, and the King James version of 1611 present often kindred features in the use of words. The translators of the King James version adopted substantially the usage of the version of Tyndale. Nothing shows the dependence of the translators of the King James version upon Tyndale more than a comparison of the use and relative frequency of certain forms. We note a striking change which the language had undergone since the period of Wiclif. The relative pronoun *which* refers in the greatest number of cases to nouns, the relative pronoun *that*, in addition to its use with nouns, is used almost universally with personal and indefinite pronouns. The form of two petitions in the Lord's Prayer illustrate this usage, and have remained fixed in liturgical service to the present time: "Our Father *which* art in Heaven," "forgive us our sins, for we also forgive everyone *that* is indebted to us." The relative pronouns *which* and *that* occur in the four Gospels in the Tyndale version 1065 times. Of these, *that* is used 503 times, and *which* 562 times.

The use of the relatives *which* and *that* in the King James version does not differ greatly from the use of these pronouns in the version of Tyndale. In Tyndale, the relative pronoun *that* is used 32 times, where *which* is substituted in the King James version; *which* takes the place of *that* 4 times, and *which* is used 6 times instead of *who*, of the King James version, while in 60 cases an equivalent expression is used instead of a relative pronoun.

In Shakespeare, if we take the *Merchant of Venice* as representing fairly the plays, *that* is used 75 times, or in 83 per cent. of the restrictive clauses, while *which* is used in the same class of clauses 20 times, or in about 17 per cent.; *that* is used in co-ordinate clauses 11 times, or in 32 per cent., and *which* is used 23 times,

or in 68 per cent. of such cases. The usage which we have found in the King James version, and earlier in the Tyndale version, occurs also in Shakespeare. In the above play, *that* refers to personal nouns 15 times, or in about 88 per cent. of the cases, while *which* refers to personal pronouns but twice, or 12 per cent. *Who* refers to personal pronouns 26 times, to nouns 8 times, to animals personified once. In the entire play, *that* occurs 122 times, equal to 62.5 per cent., *which* 73 times, or 37.5 per cent. *Which* is used in restrictive clauses 20 times, in co-ordinate clauses 23 times.

The usage of Shakespeare is thus very flexible, showing greater variety and greater freedom, as we should expect, than occurs in the version of the Scriptures.

The relative pronoun was omitted in restrictive, but not in subordinate clauses. *Who* originally referred to things as well as to pronouns, and such use is familiar in Shakespeare. Thus, in the *Merchant of Venice*, the Prince of Morocco, in describing the three caskets, says: "The first of gold *who* (which) this inscription bears, *who* chooseth me shall gain what many men desire." "The second silver, *which* this promise carries, *who* chooses me shall get as much as he deserves."

A little later, *that* occurs, often with great uniformity, apparently to lend smoothness to the verse. "In the prologue of Fletcher's *Faithful Shepherdess* (1610), which was probably not written by Fletcher, *which* occurs, but *that* appears uniformly in the remaining acts of the play" (Morris).

A century later (1726), we find Swift using the relative *that* when the antecedent is a pronoun, thus following the usage in Tyndale and in the King James version of the Bible.

In the eighteenth century, there was a manifest effort on the part of certain writers to promote the use of *who* and *which* at the expense of *that*. We have in No. 78 of the *Spectator*, Steele's humorous plea in behalf of the restoration of *who* and *which* to their ancient rights: "We are descended of ancient families, and kept up our dignity and honor many years, till the jack-sprat *that* supplanted us. How often have we found ourselves slighted by the clergy in their pulpits and the lawyers at the bar. Nay, how often have we heard in one of the most polite and august assemblies in the universe, to our great mortification, these words, 'That that that noble lord urged'; which, if one of us had had justice done,

would have sounded nobler thus, 'That which that noble lord urged.' Senates themselves, the guardians of British liberty, have degraded us and preferred *that* to us; and yet no decree was ever given against us. In the very acts of Parliament, in which the utmost right should be done to everybody, word and thing, we find ourselves often either not used, or used one instead of another. In the first and best prayer children are taught they learn to misuse us. 'Our Father *which* art in Heaven' should be 'Our Father *who* art in Heaven'; and even a convocation, after long debates, refused to consent to an alteration of it. In our general confession we say, 'Spare thou them, O God, *which* confess their faults,' which ought to be '*who* confess their faults.' What hopes then have we of having justice done us, when the makers of our very prayers and laws, and the most learned in all faculties, seem to be in a confederacy against us, and our enemies themselves must be our Judges?"

Steele's view is specious, and is not based upon an accurate knowledge of the historical use of the relatives, or he may have had in mind a contemporary fashion in literature which he sought to counteract. If so, it is not clear against whom his shafts were directed.

In the Sir Roger de Coverley papers in the *Spectator*, written by Addison and Steele, the relatives *which* and *that* occur 531 times; of these, *which* is used 353 times, *that* 178 times. *Which* is used in restrictive clauses 179 times, or in 53 per cent. of all cases, *that* 161 times, or in 47 per cent. of all cases. *Which* refers to nouns 255 times, *that* to nouns 129 times. The influence of an antecedent modified by demonstrative or an indefinite pronoun, to which in certain instances the choice of the relative may be due, is shown by the fact that *which* refers to a noun so modified 83 times, equal to 76 per cent. of such cases; *that* refers similarly to a noun so modified in 26 cases, equal to 24 per cent. of such cases. *That* refers to a demonstrative or an indefinite pronoun 39 times, equal to 76½ per cent. of such cases, *which*, 12 times, equal to 23½ per cent. We see here a revival or perpetuation of the usage of the earlier centuries. In spite of the great influence ascribed, apparently erroneously, to Addison in re-establishing the use of *that*, he uses this relative only one-third as often as *which*.

In Macaulay's essay on Milton, the relative *which* occurs 191 times, *that* 7 times, total 198 times. *Which* refers to noun ante-

cedents 174 times, or in 99 per cent. of all cases; *that* refers to a noun antecedent but once. There is a striking use of *who* as a relative. This pronoun occurs in all 101 times; referring in 58 instances to a noun, and in 43 to a pronoun; to a personal pronoun 6 times, to a demonstrative or indefinite pronoun 37 times. This is the highest proportion obtained in the examination of any author. It shows a distinct mannerism, affecting noticeably the style of the historian. *That* as a relative occurs only 7 times. *Which* is used in restrictive clauses 198 times, or in 97 per cent. of all cases; *that* occurs in the same class of clauses 6 times, or in 3 per cent. of all cases. *Which* refers to an indefinite or demonstrative pronoun 10 times, or 71 per cent.; *that* 4 times, or 29 per cent. *What* is used 17 times. *Which* is used to introduce co-ordinate clauses 6 times, *that* in no instance. *Which* refers to an indefinite or demonstrative pronoun 13 times, or 81 per cent., *that* 3 times.

In the *Sartor Resartus* (1831) of Thomas Carlyle, the relatives *which* and *that* occur in all 393 times. *Which* is used in restrictive clauses 259 times, or in 66 per cent. of all cases, *that* 134 times, or in 34 per cent. of all cases. The relative in co-ordinate sentences is *which*, occurring 34 times, and is universally employed. *Which* is the relative employed with nouns, as in the King James version of the Bible, in about 243 instances, or in 90 per cent. of all cases. *What* is used as a relative 93 times, *that which* 4 times.

In Emerson's *Essays*, second series (1844), the relatives *which* and *that* occur 402 times; of these, *which* is used in restrictive clauses 344 times, or in about 86 per cent.; *that* is used in restrictive clauses 58 times, or in 14 per cent. of all cases. *Which* is used in co-ordinate sentences 27 times, or in all cases, *that* not at all. *What* is used 55 times, *that which* 21 times. *Which* nearly always relates to nouns, namely, in 330 out of 344 instances of its use.

Matthew Arnold, in his *Essays on Criticism* (1865), shows a uniform preference for *which* in both restrictive and co-ordinate clauses, greater variety and a more flexible adoption of one or the other relative. In four essays, namely, those on "Heinrich Heine," "A Guide to English Literature," "A French Critic on Goethe" and "George Sand," in 201 cases of the uses of the relatives *which* and *that*, these pronouns are used in restrictive clauses 188 times. *Which* is used in 186 instances, or in about

99 per cent. of all cases, *that* 2, or in 1 per cent.; *which* is used in co-ordinate clauses 12 times, *that* once. *What* is used as a relative 68 times in the same essays, *that which* 4 times. The use of *what* as a relative shows a steady and remarkable growth in frequency in later writers. Its use by Matthew Arnold in the above selections occurs 68 times, or in 25 per cent. of all cases of the use of a relative pronoun. *Which* is the common relative in co-ordinate clauses, being used in about 92 per cent. of all the cases.

The striking frequency of *which* in modern literature is shown in the writings of Mrs. Humphry Ward. The conclusions reached in our examination of the works of Macaulay and De Quincy are maintained, though not in as extreme a degree. Thus in *Robert Elsmere* (1888), Book 1, in about one-fourth of the volume, the relatives *that* and *which* occur 400 times; of these, *which* occurs 350 times, or about 87½ per cent., *that* 50 times, or 12½ per cent. Of relatives referring to noun antecedents *which* is used 341 times, to pronoun antecedents 9 times; *that* is used referring to a noun antecedent 41 times or 82 per cent., to a pronoun antecedent 9 times or 18 per cent. Mrs. Ward's use of these relatives is apparently confined to restrictive clauses.

Proverbs which have existed in the popular language for many centuries have preserved an archaic type of expression and are permanent representatives of primitive usage. Similarly children's rhymes, such as "The house *that* Jack built," which goes back to a mediæval Hebrew version in a hymn. In "This is the house that Jack built," "This is the malt *that* lay in the house *that* Jack built," we have the early use of the relative *that* in restrictive clauses; so also, in such proverbs as "Handsome is *that* handsome does," quoted from Goldsmith in the *Vicar of Wakefield*, chapter first; "He *that* will not when he may, when he will he shall have nay"; "There is none so blind as they *that* won't see"; "'Tis an ill dog *that* is not worth whistling for."

We thus see that the dominant relative *þe* of early English times was displaced by *that* in the thirteenth century, that *what* also appeared at that time in isolated cases in its relative use, while *who* and *whose* occur but seldom and then usually in direct and indirect questions. At the close of the fourteenth century, *that* was used in Wiclif's translations of the Gospels in 76 per cent. of all cases of the use of the relative, *which* in 16 per cent. of such cases.

One hundred and fifty years later, in 1526, *that* occurs as a rela-



tive in the Tyndale version in only 44 per cent. of all cases, while *which* has risen from 16 per cent. in Wiclif to 50 per cent. in Tyndale. *Which* was confined largely to nouns and *that* to pronouns. In the eighteenth century, *which* declines in use in the classical English of Addison and Steele, while *that* gains slightly in frequency. A more marked change is manifest in the nineteenth century in the English of Macaulay, where *which* refers to a noun in 99 per cent. of all cases of its use as a relative, constituting a marked feature of his style. In Matthew Arnold, this proportion is preserved; also, though in a less degree, in the writings of Mrs. Humphry Ward. The present tendency is to subordinate the use of *that*, perhaps in part due to its use as a declarative conjunction, while *who* has gained in frequency of use and refers mainly to personal nouns.

*Cornell University, Ithaca, April 9, 1904.*

---

## OPISTHENOGENESIS, OR THE DEVELOPMENT OF SEGMENTS, MEDIAN TUBERCLES AND MARKINGS *A TERGO*.

BY ALPHEUS S. PACKARD, LL.D.

(Received June 15, 1904.)

Weismann, in his suggestive *Studies in the Theory of Descent* (1876), was the first to discuss the origin of the markings of caterpillars, and to show that in *Deilephila hippophaës* the ring-like spots of the larva "first originated on the segment bearing the caudal horn, and were then gradually transferred as secondary spots to the preceding segments" (Vol. 1, p. 277).

Afterwards (1881-1890), Eimer<sup>1</sup> showed that in the European wall-lizard "a series of markings pass in succession over the body from behind forwards, just as one wave follows another, and the anterior ones vanish while new ones appear behind." He speaks

<sup>1</sup> "Untersuchungen ueber das Variiren der Mauereidechse," *Archiv f. Naturg.*, 1881; "Ueber die Zeichnung der Thiere," *Zool. Anzeiger*, 1882, 1883, 1884; *Organic Evolution*, London, 1890.

of this mode of origin of the markings as the "law of wave-like evolution, or law of undulation." In confirmation of this process or law he cites the conclusions of Württenberger,<sup>1</sup> who had long before (1873) observed that in ammonites all structural changes show themselves first on the last (the outer) whorl of the shell, such a change in the following generations being pushed farther and farther towards the beginning of the spiral, until it prevails in the greater number of the whorls."

Cope, in his *Primary Factors of Organic Evolution* (1896), also shows that in the lizards *Cnemidophorus tessellatus* and *gularis* the breaking up of the striped coloration into transverse spots begins first at the sacral and lumbar regions: "The confluence of the spots appears there first."

We may cite some examples of this law of growth *a tergo*, or opisthenogenesis, as it might be called, which have fallen under our own observation.<sup>2</sup>

In *Dasylophia anguina*, as shown by the figures in Plate XXI of my monograph of the bombycine Moths, Pt. 1, it will be observed that in stages III, IV and the last stage the dark longitudinal lines become on the eighth to tenth abdominal segments broken up into separate isolated dark spots. In the larva, before the second molt, there are no spots on the ninth and tenth segments. In stage III, however, *i. e.*, after the second change of skin, as stated in my monograph (p. 175), four black spots now appear on the front part of the suranal plate. In the last stage, the reddish spots on the eighth abdominal segment which are detached from the lateral lines of stages I and II, now become specialized into the two black comma-like spots, with a linear spot above and beneath; the two, sometimes divided into four, black spots arise on the suranal plate.

It thus appears that in the ontogeny of this species the process of breaking up or origin of the spots from the longitudinal lines takes place on the last three segments of the body.

In *Symmerista albifrons* the same phenomenon occurs. In stage I, as stated in my monograph (p. 180), on each side of the ninth segment is a large black comma-shaped spot, the point directed forward and downward, while behind there is a median black dot.

<sup>1</sup> *A New Contribution to the Zoological Proof of the Darwinian Theory*, Ausland, 1873, Nos. 1, 2, and *Studies on the History of the Descent of the Ammonites*, Leipzig, 1880 (in German).

<sup>2</sup> *Proc. Amer. Asso. Advancement Science*, Boston Meeting, 1898, pp. 368-9.

After the first molt there arises behind the dorsal hump two, instead of one, median black spots, and two black spots are added on the side of the body near the base of the anal legs, *i. e.*, two each on the ninth and last segments.

After the second casting of the skin, the marking of the three last abdominal segments becomes specialized; what on the body in front are parallel black and red lines being in this region now represented by separate spots. Thus as regards the marking, the anterior part of the body remains ornamented with the primitive parallel lines; while the process becomes on the three hinder segments accelerated or specialized. It thus appears that the more advanced or ontogenetically later style of ornamentation originates at the end of the body.

A parallel process takes place with the formation of the caudal horn or hump. Thus in *Symmerista*, *Dasylophia* and other horned *Notodontidæ* and members of other groups, the eighth abdominal segment is the theatre of the process of fusion of the two dorsal tubercles of the first larval stage into a single tubercle or horn; so that this segment appears to be the theatre of a process of specialization which does not take place on any other segments of the body.

When in other genera it does take place and there is a specialized single tubercle on the first abdominal segment, as in *Notodonta*, *Nerice* and more especially in *Hyparpax* and *Schizura*, the process of fusion of two tubercles into a single specialized one, as on abdominal segments 1, proceeds from behind forward, as it were in waves of translation of the specialized growth-force from behind forwards.

This may clearly be seen in the figures on Plate XXIV, showing the development of the single hump in *Hyparpax aurora*. In Fig. 1, the dorsal tubercles *i* in stage I are all separated; in Fig. 2, those on the eighth abdominal segment have all begun to unite at their bases before they have on the first abdominal segment; they seem to be a little behind at first, though later on the hump on the first segment becomes higher and larger than the caudal horn.

If there were any doubt as to the relative period when the tubercles become fused in *Hyparpax*, in *Schizura leptinoides* (Pl. XXXVI) it is very clearly shown by Fig. 1 that the fusion of the two tubercles forming the caudal hump as we will call it, *i. e.*, that on the eighth abdominal segment, has taken place before any signs

of such fusion have appeared in the pair on any of the segments in front.

When the ontogeny of *Nerice bidentata* is worked out, it will be a matter of much interest to observe whether the dorsal humps are formed from behind forward, or whether they appear simultaneously, and thus form an apparent exception to the law of transfer of growth-force from behind forwards.

In this connection it might be observed that in the larva of *Schizura unicornis*, in which there is the very unusual occurrence of a pair of short thick spines on the vertex of the head (Pl. XXVIII, Fig. 2, 2a, 2b), these spines do not appear in stage I and not until after the first molt. These spines persist through stages II and III, but after this disappear, not being present in the two last stages. Thus the growth-force resulting in the development of the armature of stage I does not reach the head until after the first molt, and then does not persist throughout larval life.

In the ontogeny of the Notodontian family, as well as that of Ceratocampidæ and Saturniidæ, the process of fusion of the two dorsal tubercles always first begins on the eighth abdominal segment.

Opisthenogenesis, as regards the markings, appears to be of a piece, or somehow connected, with the opisthenogenetic origin in post embryonic development of new segments. In the cestodes and in annelid worms, multiplication of segments occurs between the head-region and the extreme end of the body. Thus in *Polygordius*, as stated by Balfour (*A Treatise on Comparative Embryology*, 1880, I, pp. 271, 272), the conversion of the larva into the adult takes place "by the intercalation of a segmented region between a large mouth-bearing portion of the primitive body and a small anus-bearing portion."

This region in the larval or early stages of worms and more primitive arthropods is the "budding zone" of embryologists. While at the outset, in the beginning of embryonic life, the head-region is the first to be formed and the trunk-segments arise later, as in the trochosphere of worms and the protaspis of trilobites and of merostomes, a third portion, arising from the budding zone or seat of rapid cell-formation, appears to be a secondary or inherited region, due to the post-embryonic acquisition of new characters (certain trunk-segments and their appendages) in many segmented or polymerous animals, *i.e.*, those which have passed beyond the trochozoön stage or type.

Prof. E. B. Wilson<sup>1</sup> has clearly stated the nature, now so well known, of the growth-processes involved in the interpolation at the growing point or budding-zone of new segments. In *Polygordius*, after the trochosphere has been formed and when it is about to enter on the adult stages, the segments are formed successively, those in front being the oldest, "while new segments are continually in process of formation, one after another, at the growing point." This, he says, is "a typical case of apical or unipolar growth." It is what we would call opisthenogenetic growth.

Professor Whitman<sup>2</sup> has shown that in the leech the internal tissues (mesoblast) of the budding zone are arranged in two widely separated lateral bands which, to quote Wilson's exposition, "as the trunk grows older, widen out and grow together along the median line, ultimately giving rise to muscles, blood-vessels, excretory organs, reproductive organs, etc." Now if this is the case with the more important tissues, why in caterpillars as well as in lizards may not this opisthenogenetic mode of growth also involve the arrangement and distribution of the pigment-masses of the integument?

Without entering into the mode of development of the germ-bands, which are behind completely separated, gradually becoming united in front, resulting in their union or condescence, we would make the suggestion that this phenomenon may be the initial cause or at least in some way connected with the breaking up of the longitudinal stripes of the body, and their transformation into spots at or near the budding zone of their polymerous or polypodous (*Peripatus*-like) ancestors.

In the trilobites, *Limulus* and Diplopods, the new segments after embryonic life are interpolated between the penultimate and anal or last segment of the body, and it is from this region in certain Lepidopterous larvæ that the transformation of longitudinal stripes into spots takes place. The question next arises whether there is any connection between the opisthenogenetic origin of the markings of lizards and that of caterpillars. The fact, now well established by embryologists, that the phenomena of condescence occurs not only

<sup>1</sup> *Some Problems of Annelid Morphology*. Biological lectures delivered at the Marine Biological Laboratory at Woods Holl, 1891, p. 61. See also A. D. Mead, "The Early Development of Marine Annelids," *Journal of Morphology*, XIII, May, 1897, pp. 227-326.

<sup>2</sup> "The Embryology of Clepsine," *Journ. Micr. Sc.*, XVIII, 1878; *Journal of Morphology*, Boston, 1887. I am indebted to Prof. A. D. Mead for calling my attention to the condescence process in this connection.

in fishes but in Amphibia and reptiles, would suggest that the cause of the transformation of longitudinal stripes into spots on the lumbar and sacral regions of lizards is the result of the same specializing growth-force. It may perhaps be regarded as a surviving remnant of the segment-forming force, which has affected the pigment bands in a manner identical in the vertebrates and insects. This transformation of stripes into spots, and the fusion of two dorsal tubercles into a median one, may be, then, the sign of some latent or surviving amount of force concerned in the origin and formation of segments, which crops out in the larval stages of insects and in young lizards, resulting in this opisthenogenetic mode of origin of spots from bands.

---

## ORTHIC CURVES; OR, ALGEBRAIC CURVES WHICH SATISFY LAPLACE'S EQUATION IN TWO DIMENSIONS.

BY CHARLES EDWARD BROOKS, A.B.

(Read May 20, 1904.)

I propose a study of the metrical properties of algebraic plane curves which are apolar, or, as it is sometimes called, harmonic, with the absolute conic at infinity. If we disregard the right line, the simplest orthic curve is the equilateral (conic) hyperbola, and the name equilateral hyperbola is sometimes extended to orthic curves of higher order. Doctor Holzmüller,<sup>1</sup> who devotes a section to curves of this kind, calls them hyperbolas; and M. Lucas<sup>2</sup> calls them "stelloides." M. Paul Serret, in a series of three papers in *Comptes Rendus*,<sup>3</sup> uses the word "équilatère" for a curve with

<sup>1</sup> *Einführung in die Theorie der Isogonalen Verwandtschaften und der Conformen Abbildungen*, Gustav Holzmüller, Leipzig, 1882, p. 202. . . .

<sup>2</sup> "Géométrie des Polynomes," Felix Lucas, *Journal de l'École Polytechnique*, 1879, t. XXVIII.

<sup>3</sup> *Comptes Rendus*, 1895, t. 121. Sur les hyperboles équilatères d'ordre quelconque, p. 340.

Sur les faisceaux régulières et les équilatères d'ordre n. p. 372.

Sur les équilatères comprises dans les équations

$$0 = \Sigma_1^{2n} l, \gamma_1^n = H_n,$$

$$0 = \Sigma_1^{2n-1} l, \gamma_1^n = H_n + \lambda H'.$$

asymptotes concurrent and parallel to the sides of a regular polygon. It seems advisable to follow M. Serret's usage, and to denote such a curve by the name equilateral, using another term to express apolarity with the absolute. For this purpose I have adopted the word orthic.

If we use Cartesian coördinates, a curve

$$U(XY) = 0,$$

is apolar with the absolute conic,

$$\xi^2 + \eta^2 = 0,$$

if

$$\frac{\partial^2 U}{\partial X^2} + \frac{\partial^2 U}{\partial Y^2} = 0.$$

In other words, an orthic curve is one which satisfies Laplace's equation in two dimensions.

#### PART ONE—THE ORTHIC CUBIC CURVE.

##### I. *The Condition that a Curve be Orthic.*

In the analysis which may be required, I shall employ conjugate coördinates,  $x, \bar{x}$ , which may be defined as follows: If  $X$  and  $Y$  are rectangular Cartesian coördinates of any point, the conjugate coördinates of that point are

$$x = X + iY, \quad \bar{x} = X - iY,$$

when the origin is retained, and the axis of  $X$  is chosen as the axis of reals, or base line. It is sometimes convenient to think of  $x$  as the vector from the origin to the point, and of  $\bar{x}$  as the reflection of this vector in the base line. If  $x, \bar{x}$  is a real point of the plane, not on the base line,  $x - \bar{x} = 0$ ,  $x$  and  $\bar{x}$  are conjugate complex numbers. Since if one of its coördinates is known the other is immediately obtainable, we shall, as a rule, name a point by giving only one of its coördinates. It is convenient to reserve the letters  $\iota$  and  $\tau$  for points on the unit circle,

$$x\bar{x} = 1.$$

Now, Laplace's equation,

$$\frac{\partial^2 U}{\partial X^2} + \frac{\partial^2 U}{\partial Y^2} = 0,$$

when applied to a function of  $x$  and  $\bar{x}$ , becomes

$$\frac{\partial^2 \mathcal{L}(x\bar{x})}{\partial x \partial \bar{x}} = 0.$$

It follows that :

*The necessary and sufficient condition that a curve be orthic is that its equation in conjugate coordinates contain no product-term.*

## II. Kinematical Definition of the Orthic Curve.

Let us now proceed to the study of the orthic curve of the third order. I shall obtain the equation of an orthic cubic in a way which will suggest immediately a method for the construction of points on the curve.

*The path of a point which moves in such a way that it preserves a constant orientation from three fixed points is an orthic cubic curve.*

If  $x$  is the moving point, and the three fixed points are  $a, \beta, \gamma$ , then the sum of the amplitudes of the strokes which connect  $x$  with  $a, \beta, \gamma$ , must remain constant. That is, we must have

$$(x - a)(x - \beta)(x - \gamma) = \rho\tau_1.$$

If the curve is to be real, the conjugate relation,

$$(\bar{x} - \bar{a})(\bar{x} - \bar{\beta})(\bar{x} - \bar{\gamma}) = \rho\tau_1^{-1},$$

must hold simultaneously.

The equation of the curve is obtained by eliminating the parameter  $\rho$  between these. It is

$$\begin{aligned} x^3 - (a + \beta + \gamma)x^2 + (a\beta + \beta\gamma + \gamma a)x - a\beta\gamma \\ = \tau_1^2 \{ \bar{x}^3 - (\bar{a} + \bar{\beta} + \bar{\gamma})\bar{x}^2 + (\bar{a}\bar{\beta} + \bar{\beta}\bar{\gamma} + \bar{\gamma}\bar{a})\bar{x} - a\beta\gamma \}. \end{aligned}$$

This is the most general equation of the third degree which we can have without introducing the product. As a consequence it represents a perfectly general orthic cubic.

If we transform to

$$x = \frac{1}{3}(a + \beta + \gamma),$$

the centroid of  $a\beta\gamma$ , as a new origin, and so choose the base line that  $\tau_1^3$  is real, the equation takes the form



$$x^3 + a_0x + a_1 + \bar{a}_0\bar{x} + \bar{x}^3 = 0.$$

The equation of any orthic cubic can be brought to this form. The three points,  $a$ ,  $\beta$  and  $\gamma$ , are on the curve, and form what it is convenient to call a triad of the curve.

### III. *The Orthic Curve is an Equilateral Curve.*

Consider the orthic cubic,

$$x^3 - s_1x^2 + s_2x - s_3 = \tau_1^2 (\bar{x}^3 - \bar{s}_1\bar{x}^2 + \bar{s}_2\bar{x} - \bar{s}_3),$$

where the  $s$ 's are the elementary symmetrical functions of  $a$ ,  $\beta$   
The approximation at infinity,

$$(x - \frac{1}{3}s_1)^3 - \tau_1^2 (\bar{x} - \frac{1}{3}\bar{s}_1)^3 = 0,$$

makes both the square and the cube terms vanish, and therefore represents the asymptotes. The factors of this are :

$$x - \frac{1}{3}s_1 - \sqrt[3]{\tau_1^2} (\bar{x} - \frac{1}{3}\bar{s}_1) = 0,$$

$$x - \frac{1}{3}s_1 - \omega \sqrt[3]{\tau_1^2} (\bar{x} - \frac{1}{3}\bar{s}_1) = 0,$$

$$x - \frac{1}{3}s_1 - \omega^2 \sqrt[3]{\tau_1^2} (\bar{x} - \frac{1}{3}\bar{s}_1) = 0.$$

where  $\omega^3 = 1$ .

These three lines meet at the point

$$x = \frac{1}{3}(a + \beta + \gamma)$$

which we may call the centre of the curve. We notice that :

*The centre of the orthic cubic is the centroid of the triad.*

The clinants of the asymptotes are  $\tau_1^{\frac{2}{3}}$ ,  $\omega\tau_1^{\frac{2}{3}}$ ,  $\omega^2\tau_1^{\frac{2}{3}}$ . They differ only by the constant factor  $\omega$ . Now we know that multiplying the clinant of a line by  $\omega$  is equivalent to turning the line through an angle  $\frac{2\pi}{3}$ . A rotation  $\frac{2\pi}{3}$  about the centre sends each asymptote into another. It follows that the asymptotes of an orthic cubic are concurrent and parallel to the sides of a regular triangle. M. Serret<sup>1</sup> calls such a figure of equally inclined lines which meet in a point a regular pencil, and a curve with asymptotes forming a regular pencil he calls an "équilatère."

<sup>1</sup> *Comptes Rendus*, Sur les hyperboles équilatères d'ordre quelconque. 1895, t. 121, p. 340.

Now any cubic curve, the asymptotes of which form a regular pencil, can be brought to the form :

$$x^3 + a_0x + a_1 + \overline{a_0x} + \overline{x^3} = 0,$$

in which we recognize it as orthic. It follows that :

*The orthic cubic and the equilateral of order three are identical.*

The relation

$$(x - a)(x - \beta)(x - \gamma) = \rho\tau_1 = z$$

may be regarded as mapping a line through the origin in the  $z$  plane,

$$z - \tau_1^2 \overline{z} = 0$$

into the orthic cubic. We are thus able to identify the latter with the curves discussed by Holzmüller<sup>1</sup> and by Lucas.<sup>2</sup>

#### IV. Construction of Points of an Orthic Cubic.

A figure of the orthic cubic may be obtained without great difficulty by constructing points of the curve. In order to show how this may be done, it is necessary to prove the following lemma :

*Elements of the pencil of equilateral (orthic) hyperbolas, of which the stroke  $\beta\gamma$  is a diameter, intersect corresponding elements of the pencil of lines through  $a$  on an orthic cubic of which  $a\beta\gamma$  is a triad.*

For the line through  $a$ ,

$$(x - a) = \rho\tau',$$

and the equilateral hyperbola on  $\beta\gamma$  as a diameter,

$$(x - \beta)(x - \gamma) = \rho\tau'',$$

intersect on the orthic cubic

$$(x - a)(x - \beta)(x - \gamma) = \rho\tau_1$$

<sup>1</sup> Holzmüller, *Conformen Abbildungen*, p. 205.

<sup>2</sup> Lucas, *Géométrie des Polynomes*, *Journal de l'École Polytechnique*, t. XXVIII, p. 23.

if

$$\tau' \tau'' = \tau_1.$$

If the two pencils are given, it is only necessary to pair off lines and curves according to the relation

$$\tau' \tau'' = \tau_1,$$

and to mark intersections. These will be points of the curve.

A very simple instrument for drawing the equilateral hyperbolas required in the construction is made in the following way: Two toothed wheels of equal diameters are attached beneath the drawing

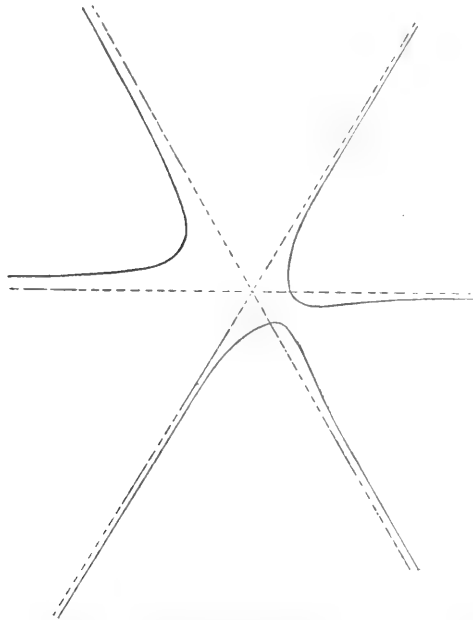

Figure 1. A unipartite orthic cubic which has three real inflections, one of which is at infinity.

board in such a way that their teeth engage. The axles are perpendicular to the board and come through it at  $\beta$  and  $\gamma$ . The axles, which turn with the wheels, carry long hands or pointers which sweep over the board. On account of the cogs, the wheels can turn only through equal and opposite angles. As a consequence,  $x$ , the

intersection of the hands, has a constant orientation from  $\beta$  and  $\gamma$ , and in fact generates the orthic curve of the second order given by

$$(x - \beta)(x - \gamma) = \rho\tau',$$

which is the hyperbola required.

#### V. *Mechanical Generation of an Orthic Cubic.*

A mechanism which will actually draw an orthic cubic is very much to be desired. One might be made in some such way as the following: Suppose three hands like those described above (IV) to be pivoted at  $\alpha$ ,  $\beta$  and  $\gamma$ . Let them be held together in such a way that, while each is free to move along the others, they must always meet in a point, which is to be the tracing point. Each hand is to receive its motion from a cord wound about a bobbin on its axle. The bobbins are to be equal in diameter. The cords pass through conveniently placed pulleys, and are kept tight and vertical by small equal weights at their ends. Consider, to fix ideas, those three weights which by their descent give the hands positive rotation. If, now, the tracing point be moved along an orthic cubic which has  $\alpha$ ,  $\beta$ ,  $\gamma$  for a triad, the total turning of the bobbins will be zero, and as a consequence the total descent of the weights will be zero. Conversely, if we can move these vertically and in such a way that the total descent will be zero, the tracing point can move only along an orthic cubic. This result will be obtained if the centre of gravity of the three weights can be kept fixed. It will not do, however, to connect the three weights by a rigid triangle pivoted at its centre of gravity, for then they will not move vertically. But since a parallel projection does not alter the centroid of a set of points, the desired result will be attained if the weights are constrained to vertical motion by guides of some kind, and are kept in a plane which always passes through the centre of gravity of one position of the weights.

#### VI. *The Orthic Cubic through Six Points of a Circle.*

Consider the general orthic cubic given by

$$x^3 - a_0x^2 + a_1x - a_2 + a_3\bar{x} - a_4\bar{x}^2 + a_5\bar{x}^3 = 0.$$

It cuts the unit circle,

$$x\bar{x} = 1,$$

in six points, the roots of

$$x^6 - a_0x^5 + a_1x^4 - a_2x^3 + a_3x^2 - a_4x + a_5 = 0.$$

If we want the cubic to meet the circle in six given points, say  $\tau_1, \tau_2, \dots, \tau_6$ , then this equation must be identical with

$$x^6 - s_1x^5 + s_2x^4 - s_3x^3 + s_4x^2 - s_5x + s_6 = 0,$$

in which the  $s$ 's stand for the elementary symmetrical combinations of the six  $\tau$ 's. This requires

$$a_0 = s_1, a_1 = s_2, a_2 = s_3,$$

$$a_3 = s_4, a_4 = s_5, a_5 = s_6$$

The coefficients of the cubic equation are then precisely determined, with the result that :

*But one orthic cubic can be constructed through any six points of a circle.*

It remains for us to show that one such curve can always be drawn : that is, that the equation

$$x^3 - s_1x^2 + s_2x - s_3 + s_4\bar{x} - s_5\bar{x}^2 + s_6\bar{x}^3 = 0$$

always represents a real curve. If we so choose the base line that  $s_6 = 1$  then we have

$$\bar{s}_1 = s_{6-1} s_6^{-1} = s_{6-1},$$

and the equation takes the form

$$x^3 - s_1x^2 + s_2x - s_3 + \bar{s}_2\bar{x} - \bar{s}_1\bar{x}^2 + \bar{x}^3 = 0,$$

which is, obviously, self-conjugate, and is therefore satisfied by the coördinates of real points. As a result :

*An orthic cubic can always be drawn through six points of a circle. It is then determined uniquely.*

## VII. The Intersections of an Orthic Cubic with a Circle.

When the orthic cubic is referred to the six points in which it cuts the unit circle, the equations of the asymptotes take the form

$$x - \frac{1}{3} s_1 = (-s_6)^{\frac{1}{2}} \omega^i (x - \frac{1}{3} s_3 s_6^{-1}).$$

$$i = 0, 1, 2.$$

These three lines meet at

$$x = \frac{1}{3} s_1,$$

the centre. This point, the origin, and the point which is the centroid of the six points on the circle lie on a line; and the latter point is midway between the other two. This leads to the interesting fact that:

*The centroid of the six points in which any circle meets an orthic cubic bisects the stroke from the centre of the curve to the centre of that circle.*

### VIII. *Triads of the Curve.*

We spoke of the three points  $a, \beta, \gamma$ , which have the same orientation from every point of the curve, as a triad of the curve. Let us see how many such triads there are, and how they are arranged. The relation

$$(x - a)(x - \beta)(x - \gamma) = z$$

may be regarded as establishing a correspondence between points  $x$  in one plane and points  $z$  in another plane, in such a way that if  $z$  describe a line  $\xi$  through the origin, the point  $x$  generates an orthic cubic on  $a\beta\gamma$  as a triad. To every position of  $z$  on the director line  $\xi$  there correspond three points in the  $x$ -plane. I shall show that each such set of three points is a triad. Write

$$F(x) = (x - a)(x - \beta)(x - \gamma).$$

Then, if  $x_1, x_2, x_3$ , are the three points which correspond to  $z$ ,

$$F(x) - z = (x - x_1)(x - x_2)(x - x_3).$$

And also

$$F(x) - z' = (x - x_1')(x - x_2')(x - x_3').$$

Now this relation is satisfied by  $x_1$ , or  $x_2$ , or  $x_3$ .

$$F(x_1) - z' = (x_1 - x_1')(x_1 - x_2')(x_1 - x_3') = z - z'.$$

Since  $z - z'$  is a point of the director line, it follows that the three points  $x_1', x_2', x_3'$ , which correspond to any point  $z'$  of the director line, have the same orientation from every point of the curve. We conclude that:

*To every point of the director line corresponds a triad; all the*

points of the curve have the same orientation from any triad, and all the triads of the curve have the same orientation from any point of the curve.

IX. *The System of Confocal Ellipses Connected with the Triads.*

We seek the points of a triad which correspond to a given point  $z$ .<sup>1</sup> The map equation can be brought to the form

$$x^3 - 3x = 2z$$

by choosing the centre of the curve as a new origin and making a suitable choice of the unit stroke. We see at once that the sum of the  $x$ 's for a given  $z$  is zero. In other words: *The centroid of any triad is the centre of the cubic.*

Making use of the method known as Cardan's solution, put

$$x = \mu t + v,$$

where  $\mu$  is real. Then

$$x^3 - 3x = 2z$$

becomes

$$\mu^3 t^3 + v^3 + 3\mu^2 t^2 v + 3\mu t v^2 - 3(\mu t + v) = 2z$$

And we have as two relations between  $v$  and  $\mu t$ ,

$$2z = \mu^3 t^3 + v^3,$$

and

$$(\mu t + v)(\mu t v - 1) = 0.$$

When  $z$  is zero, the values of  $x$  are  $\pm \sqrt[3]{3}$  and 0; and when  $z$  is not zero, we must have

$$v = \frac{1}{\mu t}.$$

This leads to the expression of  $x$  and  $z$  in terms of  $\mu t$  as follows:

$$x = \mu t + \frac{1}{\mu t},$$

$$2z = \mu^3 t^3 + \frac{1}{\mu^3 t^3}.$$

Now if we assign any value to  $\mu$ , and let  $t$  run around the unit circle,  $x$  describes an ellipse with foci at  $x = +2$  and  $x = -2$ .

<sup>1</sup> Harkness and Morley, *A Treatise on the Theory of Functions*, p. 39.

But at the same time,  $z$  also describes an ellipse with its foci at  $z = +1$  and  $z = -1$ . These two ellipses are related in such a way that a point  $z$  on one of them is correlated by the equation

$$x^3 - 3x = 2z$$

with three points on the other. Now the foci of both these ellipses are independent of the particular value of  $\mu$  selected; it follows that if we assign successive values to  $\mu$ , we shall obtain in each plane a system of confocal ellipses of such a sort that the equation

$$x^3 - 3x = 2z$$

establishes a one to one correspondence between them. In each plane the origin is the centre of all the ellipses. Applying this scheme to the case in hand, we see that a triad must be inscribed in one of the ellipses in the  $x$ -plane. But the centroid of the triad is the centre of the ellipse; so the ellipse must be the circumscribed ellipse of least area of that triad. We may say, then, that:

*The triads of the orthic cubic are cut out on the curve by a particular system of confocal ellipses, and each ellipse is the circumscribed ellipse of least area of the triad on it.*

#### X. *The Riemann Surface for an Orthic Cubic.*

If we examine the equation

$$x^3 - 3x = 2z$$

for equal roots, we find that the double points of the  $x$ -plane are at  $x = +1$  and at  $x = -1$ . These values of  $x$  correspond to the branch points in the  $z$ -plane,  $z = +1$  and  $z = -1$ .

Let us for a moment replace the  $z$ -plane by a three-sheeted Riemann surface. All three sheets must hang together at infinity, and two sheets at each of the branch points. Let the first and second sheets be connected by a bridge along the base line from  $+1$  to infinity, and the second and third sheets be similarly connected by a bridge along the real axis from  $-1$  to infinity.

Select on this surface any large ellipse with foci at the branch points, and any line as a director line. Now consider the contour obtained by starting from a point of this inside the ellipse, going thence along the line to meet the ellipse, along an arc of the ellipse to meet the line, and then along the line to the point of departure.



We can choose this path in such a way that one of the following three cases must arise :

- (1) *The contour passes through a branch point.*
- (2) *The contour surrounds two branch points.*
- (3) *The contour surrounds no branch point.*

In case (1) we know that the cubic must have a node. In the second case, by going three times around we can pass continuously through every sheet of the Riemann surface and therefore through every value of  $x$ . Or, thinking again of the  $x$ -plane, we have a unicursal boundary. Now it happens that the ellipse we choose maps into one and not three ellipses on the  $x$ -plane. If we imagine this to expand indefinitely we shall have to consider the boundary as our orthic cubic. It follows at once that :

*The orthic cubic which corresponds to a line which does not pass between the branch points is unipartite.*

If the contour includes one branch point, and therefore crosses one bridge of the Riemann surface, we must go along two unconnected curves to reach all the values of  $x$ . When these two curves are spread on the  $x$ -plane they lead at once to the conclusion that :

*The orthic cubic which corresponds to a line which passes between the branch points is a bipartite curve.*

### XI. *Triads in Special Cases.*

Let us turn our attention again to the two planes connected by the relation

$$x^2 - 3x = 2z$$

We notice that while the ellipses in the  $z$ -plane have their foci at the branch points, the foci of the corresponding system of ellipses are not the double points of the  $x$ -plane, but are the points  $x = +2$  and  $x = -2$ , each of which, with one of the double points counted twice, forms a triad.

As a rule there are two triads of the curve on each ellipse, corresponding to the two points in which the director line cuts an ellipse of the system in the  $z$ -plane. But unless the line go between the branch points it will be tangent to one ellipse, consequently two triads will coincide, and the cubic will be tangent at three places to one of the ellipses of the system. No part of the cubic can be inside of that ellipse. ●

When  $\mu$  is 1, the two ellipses degenerate into two segments,

$$x = t + t^{-1} \text{ or } 2, -2,$$

$$2z = t^3 + t^{-3} \text{ or } 1, -1.$$

If the line pass between the branch points, and so cut the segment  $1, -1$ , two triads again coincide, but in this case the three points lie on a line, and we do not have the triply tangent ellipse.

When the line  $\xi$  cuts the axis of imaginaries,

$$z + \bar{z} = 0,$$

we have

$$z = \rho \varepsilon^{\frac{\pi i}{2}},$$

and

$$t^3 = \rho' \varepsilon^{\frac{\pi i}{2}}.$$

It follows that  $\arg t = \frac{\pi}{6}$ , and so  $\omega t$  is the reflection of  $t$  in the axis of imaginaries and  $\omega^2 t$  is a pure imaginary. Then, since we know that

$$x_1 = \omega^i \mu t + \frac{1}{\omega^i \mu t},$$

$$i = 1, 2, 3,$$

we see that  $x_1$  is the reflection of  $x_2$  in the line  $x + \bar{x} = 0$ , and that  $x_2$  is on that line. It follows that the triangle  $x_1 x_2 x_3$  is isosceles and that its base  $x_1 x_2$  is parallel to the real axis. There is again an isosceles triangle when  $t^3$  is real. This triangle has its vertex on the axis of reals and its base perpendicular to that axis. From the discriminant of the quadratic in  $\mu^3 t^3$ ,

$$z^2 - 4,$$

we see that  $t^3$  is real when  $z > \pm 1$ . In other words, if the director line  $\xi$  cut the axis of reals, but not between the branch points, we have such an isosceles triangle.

From the above considerations, we see that if the director line is either of the axes

$$x + \bar{x} = 0, \quad x - \bar{x} = 0,$$

then one branch of the orthic cubic must be a right line; the re-

maining portion of the curve must then be an ordinary hyperbola, and the inclination of its asymptotes must be either  $\frac{\pi}{3}$  or  $\frac{2}{3}\pi$ . The first value refers to the case when the director line is the axis of imaginaries; and the last, to the case when it is the axis of reals.

### XII. *The Intersections of the Circumscribed Circle of a Triad with the Cubic.*

Suppose we put a circle through the points of a triad, and ask, Where are the remaining three points in which it cuts the cubic? For convenience, let three points of the unit circle be taken as a triad. The cubic is then

$$(x - t_1)(x - t_2)(x - t_3) = \tau_1^2 (\bar{x} - t_1^1)(\bar{x} - t_2^1)(\bar{x} - t_3^1).$$

On eliminating  $\bar{x}$  from this and the equation of the circle we obtain

$$(x - t_1)(x - t_2)(x - t_3) = \frac{\tau_1^2 (t_1 - x)(t_2 - x)(t_3 - x)}{t_1^1 t_2^1 t_3^1 x^3},$$

or

$$x^3 = \frac{-\tau_1^2}{t_1^1 t_2^1 t_3^1},$$

as the equation of the three points sought. The roots of this,

$$x_1 = x, \quad x_2 = \omega x, \quad x_3 = \omega^2 x,$$

are the coördinates of the vertices of an equilateral triangle. As there is no restriction in taking the triad on the unit circle, we have the following theorem:

*If a circle cut an orthic cubic in a triad, then the two curves have three other intersections, which form an equilateral triangle.*

### XIII. *The Pencil of Orthic Cubics Which Have a Triad in Common.*

We have seen that the relation

$$(x - a)(x - \beta)(x - \gamma) = z$$

maps a line through the origin into an orthic cubic of which  $a\beta\gamma$  is a triad. It must then map all the lines through the origin into a single infinity of orthic curves<sup>1</sup> which have the common triad  $a\beta\gamma$ .

<sup>1</sup> Felix Lucas, *Journal de l'Ecole Polytechnique*, t. XVIII, p. 21.

If we regard  $\tau$  as a parameter, we may say that

$$(x - a)(x - \beta)(x - \gamma) = \tau(\bar{x} - \bar{a})(\bar{x} - \bar{\beta})(\bar{x} - \bar{\gamma})$$

is the equation of the pencil of orthic cubics which have the triad  $a\beta\gamma$ . It will be convenient to give a pencil of this sort some name; let us refer to it as a *central pencil*, noting for our justification that the centroid of the triad is the centre of every curve of the pencil.

If there were any real point other than  $a, \beta, \text{ or } \gamma$ , on two curves of this pencil, it would map into a real point of the  $z$ -plane, not the origin, which would be on two of the lines through the origin. As this is manifestly impossible, it follows that:

*Two orthic cubics which have a triad in common have no other real intersection.*

Now we know that two cubic curves intersect in nine points, and that if the curves given by the equation

$$(x - a)(x - \beta)(x - \gamma) = \tau(\bar{x} - \bar{a})(\bar{x} - \bar{\beta})(\bar{x} - \bar{\gamma})$$

really constitute a pencil, there must be six imaginary points whose coördinates satisfy this equation whatever the value of  $\tau$ . Let us form the following table of coördinates. The real intersections are

$$x_1 = a, \bar{x}_1 = \bar{a},$$

$$x_2 = \beta, \bar{x}_2 = \bar{\beta},$$

$$x_3 = \gamma, \bar{x}_3 = \bar{\gamma}.$$

It is evident that each of the following points:

$$x_4 = a, \bar{x}_4 = \bar{\beta},$$

$$x_5 = a, \bar{x}_5 = \bar{\gamma},$$

$$x_6 = \beta, \bar{x}_6 = \bar{a},$$

$$x_7 = \beta, \bar{x}_7 = \bar{\gamma},$$

$$x_8 = \gamma, \bar{x}_8 = \bar{a},$$

$$x_9 = \gamma, \bar{x}_9 = \bar{\beta},$$

satisfies the equation, independently of  $\tau$ . These points, the six imaginary intersections of the pencil, are the antipoints<sup>1</sup> obtained

<sup>1</sup>Cayley, *Collected Mathematical Papers*, Volume VI, p. 499.

by selecting pairs in all possible ways from  $a, \beta, \gamma$ .

The figure of nine points in which two orthic cubics intersect may be regarded as an extension of the orthocentric four-point determined by two equilateral hyperbolas. It is convenient to extend the term *orthocentric* to such a figure. Resuming the results obtained above, we have:

*When three of the points of an orthocentric nine-point are a triad of the orthic curves through the nine points, the remaining six points are imaginary, and are the antipoints of the three real points. The centroid of the nine points is the centre of every orthic cubic through them.*

It is convenient to speak of a set of orthocentric points determined by a central pencil as a *central set*. Since any three points determine a pencil of orthic cubics of which they are a triad, any three points, with all their antipoints, form a central orthocentric nine-point.

#### XIV. *The Foci.*

We shall now attack the problem of finding the foci of the orthic cubic. Let us begin with a few words as to the way in which the foci of a curve appear in analysis with conjugate coördinates. The focus of a curve is the intersection of a tangent from one circular point with a tangent from the other circular point. In other words, if the circular rays from a point are tangent to a curve, that point is a focus of the curve. Now the equation of the circular rays from a point  $a, \bar{a}$ , is

$$(x - a)(\bar{x} - \bar{a}) = 0.$$

Therefore, one of the lines is

$$x - a = 0,$$

and the other is

$$\bar{x} - \bar{a} = 0.$$

Suppose the equation of the curve is

$$F(x\bar{x}) = 0.$$

Now if the circular ray

$$x - a = 0$$

is tangent to the curve, then

$$F(a\bar{x}) = 0,$$

the eliminant of  $x$  between these two, will have equal roots. But since the equation of a real curve must be self-conjugate, if this has two coincident roots, then

$$F(ax) = 0$$

must also have, and the point  $a, \bar{a}$ , is a focus. It follows that to find the foci of a curve, we have merely to find those values of  $x$  which make two values of  $\bar{x}$  coincide. They are the vectors of the foci. Let us apply this method to the orthic cubic. The equation may be taken in the form

$$x^3 - 3x = 2z = a_0 + \lambda a_1$$

where  $\lambda$  is a real parameter and the director line is

$$a_0 + \lambda a_1 = 2z, \bar{a}_0 + \lambda \bar{a}_1 = 2\bar{z}.$$

These relations imply the conjugate expression

$$\bar{x}^3 - 3\bar{x} = 2\bar{z} = \bar{a}_0 + \lambda \bar{a}_1.$$

Two values of  $\bar{x}$  become equal when  $D_{\bar{x}}\bar{z} = 0$ , *i.e.*, when

$$\bar{x}^2 - 1 = 0,$$

or

$$\bar{x} = \pm 1.$$

These values of  $\bar{x}$  occur when

$$\bar{a}_0 + \lambda \bar{a}_1 = \pm 2,$$

or

$$\lambda = \frac{-\bar{a}_0 \pm 2}{\bar{a}_1}.$$

Either of these values of  $\lambda$  when substituted in

$$x^3 - 3x = a_0 + \lambda a_1$$

gives three points which are foci of the cubic.

There are, in general, six real foci, which fall into two sets of three. Each set of three corresponds to a single point of the  $z$ -plane, and is, therefore, a maximum inscribed triangle of one of the ellipses described above.

### XV. The Foci and the Branch Points.

If we eliminate the parameter between

$$2z = a_0 + \lambda a_1$$

and

$$2\bar{z} = \bar{a}_0 + \lambda \bar{a}_1,$$

we get the equation of the line  $\xi$ ,

$$\bar{a}_1 z - a_1 \bar{z} = a_0 \bar{a}_1 - a_1 \bar{a}_0.$$

Now suppose, for a moment, that this line does not contain either of the branch points  $z = \pm 1$ . Then, if we put  $\bar{z} = \pm 1$  in the equation of the line and solve for  $z$ , we get a value which is not the conjugate of  $\bar{z}$ , but is the vector of the reflection of the point  $z = \pm 1$  in the line considered. The three points in the  $x$ -plane got by putting

$$\lambda = \frac{-\bar{a}_0 \pm 2}{a_1}$$

in the equation

$$x^3 - 3x = 2z$$

are the points mapped in the  $z$ -plane by the reflection of  $z = \pm 1$  in the line  $\xi$ . It follows that:

*The real foci of the orthic cubic which corresponds to a given line are the six points which correspond to the reflections in that line of the branch points.*

If the director line pass through one of the branch points (*i.e.*, if  $\frac{-\bar{a}_0 \pm 2}{a_1}$  is real), two foci coincide to form the node, and the remaining one of the set is on the curve. One who looks at the matter from the point of view of the Riemann surface might be surprised that a branch point is to be reflected in the line in each sheet of the surface and not in the two sheets alone which it connects. A moment's consideration will show that whether or not

two  $\bar{x}$ 's coincide depends on  $\lambda$  alone, and that either of three values of  $x$  give  $\lambda$  a particular value. It is clear that the reflection must be in every sheet of the surface.

In general, the orthic cubic is of class six. Since it cuts the line at infinity in three points apolar with the circular points, it cannot contain one of the circular points unless it is as a point of inflection. There should, therefore, be six tangents from each of the circular points and, consequently, thirty-six foci. The thirty foci still to be accounted for are the antipoints<sup>1</sup> of the six real foci, paired in all possible ways. When the cubic has a node it is of class four, and has but four real foci. The node takes the place of the two foci which coincide there.

The circular rays

$$x - a_1 = 0$$

and

$$\bar{x} - \bar{a}_2 = 0$$

meet at  $a_1, \bar{a}_2$ . So the thirty-six foci of an orthic cubic may be represented by the scheme of coördinates:

$$a_i, \bar{a}_j,$$

where  $i$  and  $j$  run from one to six. It follows that the centroid of the whole thirty-six is the centroid of the six real points; that is, the centre of the cubic.

Consider any selection of three foci. All their antipoints are foci, and the nine points together make up a central orthocentric set.

#### XVI. *The Foci of the Orthic Cubics which Have a Triad in Common Lie on Two Cassinoids.*

*The foci of all the orthic cubics which have a common triad  $\alpha\beta\gamma$  lie on two cassinoids which have their foci at  $\alpha, \beta$ , and  $\gamma$ , and are orthogonal to the orthic curves.*

We know that these cubics correspond to all the lines through a point, and that their foci correspond to the reflections of the branch points in those lines. Now the reflections of a fixed point in all the lines through a second point lie on a circle which goes through the first point, and which has its centre at the second point. Accord-

<sup>1</sup> Salmon, *Higher Plane Curves*, third edition, p. 122.



ingly, the foci of the cubics will lie on the curves which are the maps in the  $x$ -plane of two concentric circles in the  $z$ -plane. The centre of these circles maps into the triad common to all the cubics, and the circles themselves map into two cassinoids of the sixth order, about the triad, as M. Lucas<sup>1</sup> has shown. Each of the circles goes through one of the branch points, and, therefore, each of the cassinoids must have a node. If the point which corresponds to the triad  $a\beta\gamma$  is equidistant from the branch points, the two circles and also the two cassinoids coincide. In this case the cassinoid has two double points.

The lines which correspond to the cubics are all perpendicular to the circles which correspond to the cassinoids, and so, by the principle of orthogonality, the ovals are orthogonal trajectories of the cubics of the pencil.

#### XVII. *The Position of the Orthic Cubic in Projective Geometry.*

I shall close this study of the metrical properties of the orthic curve of the third order by showing that from the point of view of projective geometry the orthic cubic is really a general cubic. Any proper plane curve of the third order can be projected into an orthic curve.

We know that the points of contact of three of the six tangents to a cubic curve from any point of its Hessian lie in a line. Now these three points, considered as a binary cubic, have a Hessian pair. If this pair of points be projected to the circular points at infinity, the three tangents become equally inclined asymptotes, and continue to meet in a point. The cubic curve is then orthic and the transformation is accomplished. This projection requires two points to go into given points, and can, therefore, always be made. *In projective geometry the orthic cubic is any proper plane cubic.*

As an illustration of the way in which information about the orthic cubic applies to cubic curves in general, let us see what the characteristic property that the asymptotes are concurrent and equally inclined means. The circular points  $I$  and  $J$  are a pair of points apolar with the curve. Their join, the line at infinity, meets the curve in three points such that the tangents at these points meet

<sup>1</sup>Felix Lucas, Géométrie des Polynomes, *Journal de l'Ecole Polytechnique*, XXVIII, p. 5.

in a point,  $C$ , of the Hessian. Now we know<sup>1</sup> that such a line meets the Hessian in the point which corresponds to  $C$ . This leads to the theorems that :

*The line joining two points apolar with a cubic curve meets the cubic in three points, the tangents at which meet in a point of the Hessian, and are apolar with the two points apolar with the curve.*<sup>2</sup>

*The line joining two points apolar with a cubic curve, and a tangent to the cubic at a point of this line, meet the Hessian of the given cubic in corresponding points.*

A more novel result is the following. We have seen (XIV, p. 28) that the foci of an orthic cubic fall into two sets of three, in such a way that the two sets are triangles of maximum area inscribed in two confocal ellipses. Now if we consider tangents from  $I$  and  $J$  instead of foci, we have the following theorem :

*If  $a$  and  $b$  are a pair of points apolar with a cubic curve, then the tangents from either of these points, say  $a$ , fall into two sets of three in such a way that the line  $ab$  has the same polar pair of lines as to each set of three.*

## PART TWO—ORTHIC CURVES OF ANY ORDER.

### I. *Introduction.*

In the preceding pages we have studied the metrical properties of the orthic cubic in some detail. In the following portion of the work I shall indicate an extension of the more important results obtained in the study of the cubic to orthic curves of any order.

The general equation of the  $n^{\text{th}}$  degree between  $x$  and  $\bar{x}$  contains  $\frac{1}{2}n(n-1)$  product terms. If it is to represent an orthic curve the coefficients of these terms must be made zero. In other words, to make a curve of the  $n^{\text{th}}$  order orthic is equivalent to making it satisfy  $\frac{1}{2}n(n-1)$  linear conditions. After this has been done there remain  $2n$  degrees of freedom.

### II. *The Orthic Curve is Equilateral.*

The kinematical definition which we obtained for the orthic cubic may be extended to curves of any order, that is :

<sup>1</sup> Salmon, *Higher Plane Curves*, third edition, articles 70 and 175.

<sup>2</sup> "On the Algebraic Potential Curves," Dr. Edward Kasner, *Bulletins of the American Mathematical Society*, June, 1901, p. 393.

*The path of a point which moves so that its orientation from  $n$  fixed points is constant is an orthic curve of order  $n$ .*

If  $a_1, a_2, \dots, a_n$  are the fixed points, the condition on  $x$  is expressed by the relations

$$(x - a_1)(x - a_2) \dots (x - a_n) = \rho\tau_1$$

and

$$(\bar{x} - \bar{a}_1)(\bar{x} - \bar{a}_2) \dots (\bar{x} - \bar{a}_n) = \rho\tau_1^{-1}.$$

These lead to the equation of the curve,

$$x^n - s_1x^{n-1} + s_2x^{n-2} \dots + \tau_1^2(\bar{s}_n \dots + \bar{s}_1x^{n-1} - \bar{x}^n) = 0,$$

where the  $s$ 's are the elementary symmetric combinations of the  $a$ 's. This is the general equation of an orthic curve. If we take  $x = \frac{1}{n}s_1$  for a new origin, and make  $\tau_1^2$  real, the equation becomes

$$x^n + a_1x^{n-2} - a_2x^{n-3} \dots - \bar{a}_2x^{n-3} + \bar{a}_1x^{n-2} + \bar{x}^n = 0.$$

The asymptotes are the  $n$  equally inclined lines given by the factors of the highest terms,

$$x^n + \bar{x}^n = 0.$$

These lines all pass through the origin; it follows that the centroid of the  $n$  points  $a_1, \dots, a_n$ , is the centre of the curve. Since every orthic curve can be brought to the above form, we see that every orthic curve is equilateral. The converse proposition, every equilateral is orthic, is not true. The general equation of an equilateral may be put in the form

$$x^n + a\bar{x}^n + \Phi(x\bar{x}) = 0,$$

where  $\Phi(x\bar{x})$  is a perfectly general function of degree  $n-2$ .  $\Phi$  contains  $\frac{1}{2}(n-2)(n-3)$  product terms, which must vanish for the curve to be orthic. To make an equilateral curve orthic is, therefore, equivalent to making it satisfy  $\frac{1}{2}(n-2)(n-3)$  linear conditions. For  $n=2$  and  $n=3$  this number is zero, so the equilateral conic and cubic are orthic. For the quartic, this says that to be orthic is one condition.

### III. *N*-ads, Foci, Intersections with a Circle.

The relation

$$(x - a_1)(x - a_2) \dots (x - a_n) = \rho\tau_1 = z$$

may be regarded as mapping a line through the origin in the  $z$ -plane into the orthic curve in the  $x$ -plane. The methods of analysis which were used, in the paragraphs referred to, in the study of the orthic cubic may be extended to any  $n$ , and lead to the following general theorems:

*On an orthic curve of order  $n$  there is a single infinity of sets of  $n$  points,  $n$ -ads of the curve, from which all points of the curve have the same orientation. All the  $n$ -ads have the same orientation from any point of the curve (Part One, VIII).*

Any  $n$  points may be taken as an  $n$ -ad of an orthic curve. If we take  $n$  points of the unit circle as an  $n$ -ad, and find the remaining intersections of the circle and the curve, we see that they are the vertices of a regular polygon (Part One, XII).

*Every circle through an  $n$ -ad of an orthic curve of order  $n$  meets the curve again in the  $n$  vertices of a regular polygon.*

*The centre of an orthic curve is the centroid of every  $n$ -ad of the curve.*

For when the equation is taken in the form

$$x^n + nx^{n-2} + \dots + a_{n-2}x = z$$

the origin is the centre of the curve, and is also the centroid of the  $n$  points which correspond to a point  $z$ . This equation will have two coincident roots whenever

$$D_x z \equiv nx^{n-1} + n(n-2)a_1x^{n-3} \dots = 0.$$

In general, this will give  $n-1$  branch points in the  $z$ -plane. Each branch point, when reflected in the director line, gives rise to  $n$  real foci. If the line  $\xi$  revolve about a point, each reflection generates a circle (Part One, XIV). All  $n-1$  of these circles are concentric; and they map into  $n-1$  cassinoids, on which lie the foci of the curves which have the  $n$ -ad which corresponds to the centre of the system of circles. These cassinoids are orthogonal trajectories of the central pencil of orthic curves. Since each of the circles must contain a branch point, each cassinoid must have at least one node.

#### IV. *The Orthic Curve Referred to its Intersections with a Circle.*

We know that we may put  $2n$  linear conditions on an orthic curve. If we make it go through  $2n$  points on the unit circle, its

equation, expressed in terms of the elementary symmetrical functions of the points where it meets the circle, becomes

$$x^n - s_1 x^{n-1} + s_2 x^{n-2} - \dots + (-s_{2n-1}) \bar{x}^{n-1} + s_{2n} \bar{x}^n = 0.$$

The centre, found by equating to zero the  $n - 1^{\text{st}}$  derivative as to  $x$ , is

$$x = \frac{1}{n} s_1.$$

This is the midpoint of the stroke from the centre of the circle to the centroid of the  $2n$  points. The equation of an asymptote now takes the form

$$x - \frac{1}{n} s_1 = \sqrt[n]{-s_{2n}} (\bar{x} - s_{2n-1} s_{2n}^{-1}).$$

#### V. Construction of an Orthic Curve.

The method which I have proposed (Part One, V) for the construction of an orthic cubic might be extended to the construction of any orthic curve. For this purpose the instrument must have  $n$  hands, moved by  $n$  weights. The centre of gravity of any number of weights could be held by joining them together in sets of three or less, and then joining again the centres of gravity of these sets. This operation could be repeated until the required number of weights is reached.

#### VI. Geometrical Characteristics.

*The geometrical characteristics of an orthic curve of order  $n$  are that it is equilateral, and that it intersects its asymptotes in points of a second orthic curve of order  $n - 2$ .*

For consider the orthic curve referred to its centre,

$$x^n + a_1 x^{n-2} - a_2 x^{n-3} \dots - \bar{a}_2 \bar{x}^{n-3} + \bar{a}_1 \bar{x}^{n-2} + \bar{x}^n = 0.$$

The asymptotes, which are given by

$$x^n + \bar{x}^n = 0,$$

are concurrent and equally inclined, so the curve is equilateral. The points common to the curve and its asymptotes lie on the curve

$$a_1 x^{n-2} - a_2 x^{n-3} + \dots - \bar{a}_2 \bar{x}^{n-3} + \bar{a}_1 \bar{x}^{n-2} = 0.$$

But this curve is of order  $n - 2$ , and is orthic.

To require a curve to be equilateral is to impose  $2n - 3$  conditions, and to require the curve of order  $n - 2$ , along which it cuts its asymptotes, to be orthic is to impose  $\frac{1}{2}(n - 2)(n - 3)$  further conditions, in all  $\frac{1}{2}n(n - 1)$ . But  $\frac{1}{2}n(n - 1)$  is the number of conditions required to make a curve of order  $n$  orthic.

PART THREE—PENCILS DETERMINED BY TWO ORTHIC CURVES AND ORTHOCENTRIC SETS OF POINTS.

I. *Introduction.*

We shall now take up the study of the pencils of curves determined by two orthic curves. The main purpose of this investigation shall be to learn what we can about the figure of  $n^2$  points in

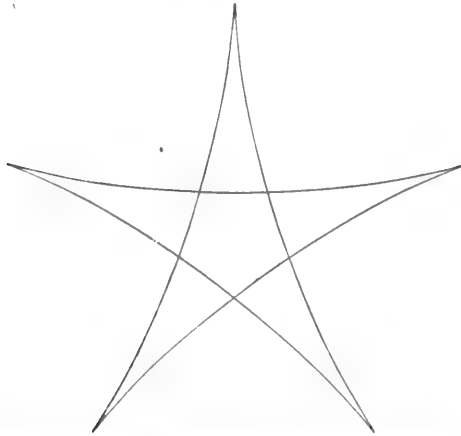

Figure 2. The hypocycloid of class five and order six, which is enveloped by the asymptotes of curves in a pencil of orthic cubics.

which two orthic curves intersect. Such a figure of  $n^2$  points we shall call an *Orthocentric Set*, or an *Orthocentric  $n^2$ -point*.

There is a well-known proposition that all the equilateral hyperbolas (orthic conics) which can be circumscribed to a given triangle pass through the orthocentre of the triangle. The four points, the vertices and the orthocentre of a triangle, or, what is the same thing, the intersections of two orthic curves of the second order, have the property that the line joining any two of them is perpendicular to the line joining the other two. The term orthocentric is applied

to a set of four points related in this way. We wish to find out what metrical property distinguishes the  $n^2$ -point, in which two orthic curves of order  $n$  intersect.

## II. *The Central Pencil and Its Orthocentric Set.*

The first generalization which we shall make is to show that any pair of points,  $a, \beta$ , together with their antipoints,  $\bar{a}, \bar{\beta}$  and  $\beta, \bar{a}$ , form an orthocentric four-point.  $a$  and  $\beta$  determine a central pencil of orthic conics,

$$(x - a)(x - \beta) = \tau(\bar{x} - \bar{a})(\bar{x} - \bar{\beta}),$$

and the antipoints are evidently on all the curves of the pencil.

If we consider  $\tau$  as a parameter in the general equation of an orthic curve,

$$(x - a_1)(x - a_2) \dots (x - a_n) = \tau(\bar{x} - \bar{a}_1)(\bar{x} - \bar{a}_2) \dots (\bar{x} - \bar{a}_n),$$

we obtain the equation of all the curves of which  $a_1 \dots a_n$  is an  $n$ -ad. The points of the orthocentric  $n^2$ -point determined by this are the  $n$  real points  $a$ , and all their antipoints. But as the pencil is determined by the  $n$  real points it follows that:

*Any  $n$  points, with all their antipoints, form a central orthocentric  $n^2$ -point.*

The centroid of the  $n^2$ -point determined in this way is the centroid of the  $n$  real points. The real and imaginary foci of any curve are such a set of orthocentric points.

## III. *The Pencil of Orthic Cubics through Five Points of a Circle. The Locus of Centres.*

We have seen that six points of a circle determine an orthic cubic curve. If the six points are  $t_1, t_2, t_3, t_4, t_5, t_6$ , then, as we have seen, the equation of the orthic cubic through them is

$$x^3 - s_1x^2 + s_2x - s_3 + s_4\bar{x} - s_5\bar{x}^2 + s_6\bar{x}^3 = 0.$$

If we replace  $t_6$  by a variable parameter  $t$ , and put  $\sigma$ 's for the elementary symmetrical combinations of  $t_1 \dots t_5$ , we have

$$\begin{aligned} s_1 &= \sigma_1 + t, & s_4 &= \sigma_4 + t\sigma_3, \\ s_2 &= \sigma_2 + t\sigma_1, & s_5 &= \sigma_5 + t\sigma_4, \\ s_3 &= \sigma_3 + t\sigma_2, & s_6 &= \sigma_6 t. \end{aligned}$$

If we make this substitution we get

$$\begin{aligned} x^3 - (\sigma_1 + t)x^2 + (\sigma_2 + t\sigma_1)x - (\sigma_3 + t\sigma_2) \\ + (\sigma_4 + t\sigma_3)\bar{x} - (\sigma_5 + t\sigma_4)\bar{x}^2 + \sigma_6\bar{x}^3 = 0. \end{aligned}$$

This is the equation of a pencil of orthic cubics through five points of a circle.

The centre of the curve through the six points is  $x = \frac{1}{3}\sigma_1$ . If the sixth point move around the unit circle, this becomes

$$x = \frac{1}{3}(\sigma_1 + t).$$

This is the map equation of a circle. We have thus the theorem:

*The locus of centres of the orthic cubics through five points of a circle is a circle. Its radius is one-third that of the given circle, and its centre is the point  $\frac{1}{3}\sigma_1$ .*

M. Serret<sup>1</sup> gives an elegant synthetic proof of the theorem that the locus of centres of the curves of a pencil of equilaterals is a circle. I obtained the same result for orthic curves independently, and, as the analysis is so direct, it seems advisable to let it stand.

#### IV. *The Hypocycloid Enveloped by the Asymptotes.*

I shall now prove, for the pencil of orthic cubics through five points of a circle, a theorem which M. Serret<sup>1</sup> states without proof. The theorem referred to, when stated for orthic cubics of the pencil under discussion, becomes:

*The curve enveloped by the asymptotes of all the orthic cubics through five points of a circle is an hypocycloid of order six and class five.*

It is circumscribed to the centre-circle of the pencil, and its cusps lie on a concentric circle five times as large.

We found that the equation of an asymptote, in terms of the six points where the curve cuts the unit circle, is

$$(x - \frac{1}{3}\sigma_1) + \sqrt[3]{\sigma_6}(\bar{x} - \frac{1}{3}\sigma_6\sigma_6^{-1}) = 0.$$

If we replace  $t_6$  by the parameter  $t$ , this becomes

$$x - \frac{1}{3}(\sigma_1 + t) + \sqrt[3]{\sigma_6 t}(\bar{x} - \frac{1}{3}\{\sigma_6\sigma_6^{-1} + t^3\}) = 0.$$

<sup>1</sup> Sur les faisceaux réguliers et les équilatères d'ordre  $n$ . Paul Serret, *Comptes Rendus*, 1895, t. 121, pp. 373-5.



we seek the curve enveloped by this line, as  $t$  runs around the unit circle.

For the sake of simplicity, let us refer this equation to a new system of coördinates, so chosen that the centre circle of the pencil becomes the new unit circle. The equation becomes

$$x - t + \sqrt[5]{\sigma_5 t} (\bar{x} - t^{-1}) = 0.$$

If now we take an axis of reals which makes  $\sigma_5 = 1$ , and also put  $\tau^3$  for  $t$ , we have

$$x\tau^{-1} - \tau^3 + \bar{x} - \tau^{-3} = 0.$$

The map equation of the curve enveloped by this line is obtained by equating to zero the result of differentiating with respect to  $\tau$ . It is

$$x = 3\tau^{-3} - 2\tau^3.$$

This is a curve of double circular motion. The curve is of order six, for it meets any line,

$$x = \frac{a}{1 - \tau},$$

where

$$\frac{a}{1 - \tau} = \frac{3}{\tau^2} - 2\tau^3,$$

or

$$2\tau^6 - 2\tau^5 - a\tau^3 + 3\tau - 3 = 0.$$

This gives six  $\tau$ 's, and, therefore, the curve is of the sixth order. In order to determine the class of the curve, we must examine the equation of a tangent,

$$x\tau^{-1} - \tau^2 + \bar{x} - \tau^{-3} = 0.$$

This is of the fifth degree in the parameter, and there are, therefore, five tangents from any point  $x$ .

The stationary points, or cusps, are the points where the velocity of  $x$  is zero. For such a point we must have  $D_\tau x = 0$ , and at the same time  $|\tau| = 1$ . Both these conditions are satisfied by

$$\tau = \sqrt[5]{-1}.$$

The curve has, therefore, five real cusps; one when  $\tau$  is each of the fifth roots of minus one.

If we put  $\kappa^2 = -1$  we get a cusp.

$$\begin{aligned}x &= 3\kappa^2 - 2\kappa^3, \\ \kappa^2 x &= 5.\end{aligned}$$

Since multiplication by  $\kappa^2$  is equivalent to a rotation  $\frac{4}{5}\pi$ , we see that the locus of cusps is a circle, about the centre of the pencil, and five times as large as the centre circle. A rotation  $\frac{2}{5}\pi$  sends each cusp into another, and so the cusps are equally spaced along the cusp circle. The intersections of the hypocycloid with the centre circle,

$$x\bar{x} = 1,$$

are obtained by solving  $\bar{x} = x^{-1}$  for  $\tau$ .

We have

$$x = 3\tau^{-3} - 2\tau^3,$$

and

$$\bar{x} = 3\tau^3 - 2\tau^{-3}.$$

The parameters of the points sought are the roots of

$$12\tau^6 - 6\tau^{10} - 6 = 0,$$

or of

$$(\tau^5 - 1)^2 = 0.$$

There are five pairs of coincident intersections. But since  $x$  cannot be less than 1, it follows that the curve is tangent to the circle in five places.

We have obtained this hypocycloid as the locus of one asymptote. But all three asymptotes envelop the same curve, for if we put  $\omega$  for  $\sqrt[5]{\bar{\sigma}_5}$  we get

$$x = 3\omega\tau^{-3} - 2\tau^3.$$

This has a cusp at  $\kappa^2 x = 5$ ; it is, obviously, the same curve.

#### V. *Perpendicular Tangents of the Hypocycloid.*

The equation of a tangent to the curve is

$$x\tau^{-1} - \tau^2 + \bar{x} - \tau^3 = 0.$$

That of a perpendicular tangent,

$$-x\tau^{-1} - \tau^2 + \bar{x} + \tau^3 = 0.$$

These two lines meet at

$$x = \tau^{-2}.$$

In other words, *Perpendicular tangents to the envelope of the asymptotes meet on the centre circle.*

We have here a verification of the known property of the hypocycloid of this class, that the tangents from a point of the vertex circle are all real and form two regular pencils.<sup>1</sup>

VI. *The Orthocentric Nine-point of the Pencil through Five Points of a Circle, and the Extension to  $2n-1$  Points.*

Let us now consider the figure of nine orthocentric points, five of which are on a circle. The equation of the pencil of orthic cubics through five points of a circle is

$$\begin{aligned} x^3 - (\sigma_1 + t)x^2 + (\sigma_2 + t\sigma_1)x - (\sigma_3 + t\sigma_2) \\ + (\sigma_4 + t\sigma_3)\bar{x} - (\sigma_5 + t\sigma_4)\bar{x}^2 + \sigma_5 t \bar{x}^3 = 0. \end{aligned}$$

We know five of the points of the orthocentric nine-point determined by this pencil, and we seek the remaining four. Rewrite the above equation as

$$\begin{aligned} (x - t)(x^2 - \sigma_1 x + \sigma_2) \\ + (t\bar{x} - 1)(\sigma_3 - \sigma_4 \bar{x} + \sigma_5 \bar{x}^2) = 0. \end{aligned}$$

Now if both

$$x^2 - \sigma_1 x + \sigma_2$$

and

$$\bar{x}^2 \sigma_5 - \sigma_4 \bar{x} + \sigma_3$$

can become zero for conjugate values of  $x$  and  $\bar{x}$ , then those values are the coördinates of a real point which is on every curve of the pencil, and is one of the nine points. If we put  $\sigma_5 = 1$ , as we may, these two relations become

$$x^2 - \sigma_1 x + \sigma_2 = 0,$$

<sup>1</sup>F. Morley, "On the Epicycloid," *American Journal of Mathematics*, Vol. XIII, No. 2.

and

$$\bar{x}^2 - \bar{\sigma}_1 \bar{x}_1 + \bar{\sigma}_2 = 0.$$

These are conjugate equations and so can be satisfied by the coordinates of real points. Solving them, we get a pair of real points

$$x_1 = \frac{\sigma_1 + \sqrt{\sigma_1^2 - 4\sigma_2}}{2}, \quad \bar{x}_1 = \frac{\bar{\sigma}_1 + \sqrt{\bar{\sigma}_1^2 - 4\bar{\sigma}_2}}{2};$$

and

$$\frac{\sigma_1 - \sqrt{\sigma_1^2 - 4\sigma_2}}{2}, \quad \bar{x}_2 = \frac{\bar{\sigma}_1 - \sqrt{\bar{\sigma}_1^2 - 4\bar{\sigma}_2}}{2}.$$

But further, we notice that the antipoints,  $x_1, \bar{x}_2$ , and  $x_2, \bar{x}_1$ , of these make the equation of the pencil vanish for all values of the parameter. They are the remaining points of the orthocentric nine. This leads to the theorem that:

*If five points of an orthocentric nine-point are on a circle, of the remaining four points two are real, two are imaginary; and these four form an orthocentric four-point.*

The centroid of the nine points is

$$x = \frac{1}{9} (t_1 + \dots + t_5 + 2\sigma_1) = \frac{1}{3}\sigma_1.$$

This is the centre of the centre circle of the pencil.

We can extend these results to the case of  $n^2$ -points,  $2n - 1$  of which lie on a circle.

The pencil of orthic curves of order  $n$  which go through  $2n - 1$  points of the unit circle is given by

$$x^n - (\sigma_1 + t) x^{n-1} + (\sigma_2 + t\sigma_1) x^{n-2} - \dots + (\sigma_{2n-1} + t\sigma_{2n-2}) \bar{x}^{n-1} - (\sigma_{2n-1} + t\sigma_{2n-2}) \bar{x}^{n-1} + \sigma_{2n} t \bar{x}^n = 0.$$

If we let  $\sigma_{2n-1} = 1$ , this becomes

$$(x - t) (x^{n-1} - \sigma_1 x^{n-2} + \sigma_2 x^{n-3} - \dots + \sigma_{n-1}) + (\bar{x}t - 1) (\bar{x}^{n-1} - \bar{\sigma}_1 \bar{x}^{n-2} + \dots + \bar{\sigma}_{n-1}) = 0.$$

Now since the coefficients of  $(x - t)$  and  $(\bar{x}t - 1)$  are conjugate forms, there are  $n - 1$  real points, in addition to the points  $t_1, t_2, \dots, t_{2n-1}$ , which are on all the curves of the pencil. Further,

all the antipoints obtained by pairing these in all possible ways satisfy the equation for all values of  $t$ . Now we know that the  $(n - 1)^2$  points thus found form an orthocentric set. We are now in a position to state the following general theorem :

*If  $2n - 1$  points of an orthocentric set of  $n^2$ -points lie on a circle, then the remaining  $(n - 1)^2$  points of the figure form a central orthocentric set of which  $n - 1$  points are real.*

The vectors of the  $n - 1$  real points are the roots of

$$x^{n-1} - \sigma_1 x^{n-2} + \sigma_2 x^{n-3} - + \dots - \sigma_{n-1} = 0.$$

VII. *The Pencil Determined by Any Two Orthic Curves.*

We are now ready to consider the most general pencil of orthic curves. Form the equation

$$x^n - (a_1 + ta'_1) x^{n-1} + (a_2 + ta'_2) x^{n-2} - + \dots - (a_{2n-1} + ta'_{2n-1}) \bar{x}^{n-1} + t\bar{x}^n = 0,$$

where  $t$  is a parameter which has the absolute value unity. Now for every value of  $t$  this represents a real orthic curve of the  $n^{\text{th}}$  order, provided

$$\overline{a_v + ta'_v} = (a_{2n-v} + ta'_{2n-v})t^{-1},$$

or

$$| \bar{a}_v - a'_{2n-v} | = | \bar{a}'_v - a_{2n-v} |.$$

For if this holds, the equation can be put in the known form

$$(x - a_1) (x - a_2) \dots = \tau_1 (\bar{x} - \bar{a}_1) (\bar{x} - \bar{a}_2) \dots (\bar{x} - \bar{a}_n).$$

Now let

$$x^n - a_1 x^{n-1} + a_2 x^{n-2} - + \dots - a_{2n-1} \bar{x}^{n-1} + a_{2n} \bar{x}^n = 0,$$

and

$$x^n - a'_1 x^{n-1} + a'_2 x^{n-2} - + \dots - a'_{2n-1} \bar{x}^{n-1} + a'_{2n} \bar{x}^n = 0,$$

be the equations of any two real orthic curves. Then

$$a_{2n} = t_1, a'_{2n} = t_2,$$

and

$$\bar{a}_v = a_{2n-v} t_1^{-1}, \bar{a}'_v = a'_{2n-v} t_2^{-1}.$$

We can choose the  $a$ 's in such a way that the pencil will include the given curves, (1) and (2), for the  $4n - 2$  equations

$$\begin{aligned} a_v &= a_v + t_1 a'_v, \\ a'_v &= a_v + t_2 a'_v, \quad v = 1 \dots 2n-1 \end{aligned}$$

just suffice. We must show now that when the coefficients are determined as above, all the curves of the pencil are real.

Now we have

$$a_v = a_v + t_1 a'_v,$$

and

$$a_{2n-v} = a_{2n-v} + t_1 a'_{2n-v}.$$

From these, we get

$$\overline{a_v + t_1 a'_v} = \overline{a_v} = a_{2n-v} t_1^{-1} = a_{2n-v} t_1^{-1} + a'_{2n-v},$$

and therefore

$$\overline{a_v} - a'_{2n-v} = (a_{2n-v} - \overline{a'_v}) t_1^{-1}.$$

But this is the condition that every curve of the pencil be real. It is clear that no curve not orthic can be included in the pencil. So we see that:

*Any two real orthic curves of order  $n$  determine a pencil of real curves of the same order, all of which are orthic.*

### VIII. *The Serret Circle, or Locus of Centres.*

M. Serret's theorem (Part Three, IV) on the locus of centres is easily verified. The centre of any curve of the pencil is

$$x = \frac{1}{n}(a_1 + t a'_1).$$

Now if  $t$  is regarded as a parameter, this is the map equation of a circle with its centre at

$$x = \frac{1}{n} a_1.$$

*The locus of centres of the most general pencil of orthic curves is a circle.*

In the special case where  $n$  of the intersections of the pencil are at infinity, the locus of centres degenerates into a right line. A pencil of this type may be written

$$x^n - \frac{a_1 - \lambda a'_1}{1 - \lambda} x^{n-1} + \dots + \frac{a_{2n-1} - \lambda a'_{2n-1}}{1 - \lambda} x^{n-1} + x^n = 0,$$

where  $\lambda$  is a real parameter. The locus of centres is

$$x = \frac{1}{n} \left( \frac{a_1 - \lambda a'_1}{1 - \lambda} \right).$$

The elimination of  $\lambda$  from this and its conjugate gives

$$x (a_{2n-1} - a'_{2n-1}) - \bar{x} (a_1 - a'_1) + \frac{1}{n} (a_1 a'_{2n-1} - a'_1 a_{2n-1}) = 0,$$

the equation of a right line.

### IX. *The Hypocycloid Enveloped by the Asymptotes.*

Let us now seek the curve enveloped by the asymptotes of the curves of a general pencil. The equation of an asymptote of the curve given by  $t_1$  is

$$x - \frac{1}{n} (a_1 + t_1 a'_1) + \sqrt[n]{t_1} \{ \bar{x} - \frac{1}{n} (a_{2n-1} t_1^{-1} + a'_{2n-1}) \} = 0,$$

or

$$x - \frac{1}{n} (a_1 + t_1 a'_1) + \sqrt[n]{t_1} \{ \bar{x} - \overline{(a_1 + t_1 a'_1)} \} = 0.$$

For convenience, transform to the centre of the pencil,  $\frac{1}{n}a$ , as a new origin. The equation becomes

$$x - \frac{1}{n} a'_1 t_1 + \sqrt[n]{t_1} (x - \frac{1}{n} \overline{a'_1 t_1}) = 0.$$

Putting  $\tau^n = t$ , we get

$$x - \frac{1}{n} a'_1 \tau^n + \tau \bar{x} - \frac{1}{n} \overline{a'_1 \tau^{1-n}} = 0,$$

and finally,

$$x \tau^{-1} - \frac{1}{n} a'_1 \tau^{n-1} + \bar{x} - \frac{1}{n} \overline{a'_1 \tau^{-n}} = 0.$$

Now the map equation of the curve enveloped by this line as  $\tau$  varies is

$$nx = n \overline{a'_1 \tau^{1-n}} + (1 - n) a'_1 \tau^n.$$

Now this equation represents a curve of double circular motion.

We know that

$$\overline{a'_1} = a'_1 t_2^{-1},$$

and using it we get

$$nx = n a'_1 t_2^{-1} \tau^{1-n} + (1 - n) a'_1 \tau^n.$$

Now if we make  $t_2$  real, and then regard the centre circle as the unit

circle, *i.e.*, adopt  $|\frac{a'}{n}|$  as the unit length, the equation takes the form

$$x = n\tau^{1-n} + (1-n)\tau^n.$$

This is the equation of an hypocycloid of the kind found as the locus of asymptotes of a special pencil of orthic cubics. Its vertex circle is the centre circle of the pencil. It has cusps when

$$D_\tau x = 0,$$

and

$$|\tau| = 1,$$

simultaneously, or when

$$\tau^{2n-1} + 1 = 0.$$

The parameters of the cusps are the  $2n - 1^{\text{st}}$  roots of  $-1$ . If we let  $\kappa^{2n-1} = -1$ , a cusp is

$$x = n\kappa^{1-n} + (1-n)\kappa^n$$

or

$$x\kappa^{n-1} = n - (1-n)$$

The absolute value of a cusp is, therefore,  $2n - 1$ .

Since the equation of a tangent,

$$x - \frac{1}{n}a'_1\tau^n + \tau\bar{x} - \frac{1}{n}\tau^{1-n}\bar{a}'_1 = 0$$

is of the  $2n - 1^{\text{st}}$  degree in the parameter  $\tau$ , the hypocycloid is of class  $2n - 1$ . If we eliminate  $x$  between the equation of the curve and the equation of any line,

$$x = \frac{a}{1-\tau}$$

we get an equation of the  $2n^{\text{th}}$  degree to determine the parameters of the points of intersection. The curve meets any line in  $2n$  points, and is therefore of order  $2n$ . We have now established analytically the theorem stated by M. Serret, as far as orthic curves are concerned. It is:

*The curve enveloped by the asymptotes of a pencil of orthic curves of order  $n$  is an hypocycloid of order  $2n$ , and of class  $2n - 1$ . Its vertex circle is the centre circle of the pencil, and its cusp circle is concentric with that circle, and  $2n - 1$  times as large.*

If we bear in mind that any difference between an orthic curve



and any equilateral does not affect the terms of the  $n^{\text{th}}$  and  $n - 1^{\text{st}}$  degrees of the equation, we see that the method of proof used above is applicable to equilaterals in general.

### X. *A Circle Determined by Any Odd Number of Points.*

It is a well-known proposition that the centres of the equilateral hyperbolas circumscribed to a triangle lie on the circle through the mid-points of the sides of the triangle. This circle is usually called the Feuerbach, or nine-point circle of the triangle. Now we have seen that an orthic curve of order  $n$  may be made to satisfy  $2n$  linear conditions; it follows that any odd number,  $2n - 1$ , of points determine a pencil of orthic curves of the  $n^{\text{th}}$  order. Connected with this pencil is the centre circle, or, as I propose to call it, the Serret circle, which is, in a sense, the generalized nine-point circle.

*Every figure of an odd number of points has connected with it a unique circle, the Serret circle, which in the case of three points is identical with the nine-point circle of Feuerbach.*

Further, every odd number of points,  $2n - 1$ , determine the pencil of orthic curves through them, and therefore the remaining  $(n - 1)^2$  points of the orthocentric  $n^2$ -point. In the case of three given points, this set of  $(n - 1)^2$  points is a single point, the orthocentre of the given points. So we are led to the theorem:

*To every figure of  $2n - 1$  points belongs a figure of  $(n - 1)^2$  points.*

In one sense the Serret circle belongs to  $n^2$  points, but of these only  $2n - 1$  may be taken at random.

### XI. *A Point Determined by An Even Number of Points.*

Now consider an even number,  $2n$ , of points which do not belong to an orthocentric  $n^2$ -point. There is a pencil of orthic curves through every  $2n - 1$  points which can be selected from them, or  $2n$  pencils in all. Now these pencils give rise to  $2n - 1$  Serret circles, but there is one orthic curve through all  $2n$  points and its centre is on each of the circles. We have, therefore, the result:

*The  $2n$  Serret circles, given by all the sets of  $2n - 1$  among  $2n$  points, meet in a point.*

### XII. *The Relation of the Orthocentric $n^2$ -point to the Circle of Centres.*

In section VIII we obtained the pencil of orthic curves determined by the two given curves,

$$(1) \quad x^n - a_1x^{n-1} + a_2x^{n-2} - + \dots - a_{2n-1}\bar{x}^{n-1} + a_{2n}\bar{x}^n = 0,$$

and

$$(2) \quad x^n - a'_1x^{n-1} + a'_2x^{n-2} - + \dots - a'_{2n-1}\bar{x}^{n-1} + a'_{2n}\bar{x}^n = 0.$$

We now wish to show that the centroid of the orthocentric  $n^2$ -point in which these two curves intersect is the centre of the centre circle of the pencil. If we rewrite (1) and (2) in terms of  $\bar{x}$  we get

$$(1) \quad (\bar{x} - \bar{x}_1) (\bar{x} - \bar{x}_2) \dots (\bar{x} - \bar{x}_n) = 0,$$

and

$$(2) \quad (\bar{x} - \bar{x}'_1) (\bar{x} - \bar{x}'_2) \dots (\bar{x} - \bar{x}'_n) = 0.$$

If the  $s$ 's refer to the elementary symmetrical functions of the roots, we have

$$\begin{aligned} s_1 &= a_{2n-1}, \quad s'_1 = a'_{2n-1}, \quad i = 1, 2, \dots, n-1. \\ s_n &= -(x^n - a_1x^{n-1} + a_2x^{n-2} \dots a_n) a_{2n}^{-1}, \\ s'_n &= -(x^n - a'_1x^{n-1} + a'_2x^{n-2} \dots a'_n) a'_{2n}^{-1}. \end{aligned}$$

Now the eliminant of  $x$  between these two equations is

$$\begin{aligned} &(\bar{x}_1 - \bar{x}'_1) (\bar{x}_1 - \bar{x}'_2) \dots (\bar{x}_1 - \bar{x}'_n). \\ &(\bar{x}_2 - \bar{x}'_1) (\bar{x}_2 - \bar{x}'_2) \dots (\bar{x}_2 - \bar{x}'_n). \\ &\vdots \quad \vdots \quad \vdots \quad \vdots \quad \vdots \quad \vdots \quad \vdots \\ &(\bar{x}_n - \bar{x}'_1) (\bar{x}_n - \bar{x}'_2) \dots (\bar{x}_n - \bar{x}'_n) = 0. \end{aligned}$$

This is a function of degree  $n^2$  in  $x$ , and as  $x$  occurs in  $s_n$  and  $s'_n$  alone, we need consider those terms alone in which the products  $s_n$  and  $s'_n$  appear. These are:

$$s_n^n - ns_n^{n-1}s'_n + \frac{n \cdot n - 1}{2} s_n^{n-2}s_n'^2 \dots s_n'^n,$$

or

$$(s_n - s'_n)^n;$$

or, in terms of  $x$ ,

$$\left\{ x^n \begin{pmatrix} a_{2n} & -a'_{2n} \\ a_{2n} & a'_{2n} \end{pmatrix} - x^{n-1} \begin{pmatrix} a_{2n}a'_1 & -a'_{2n}a_1 \\ a_{2n} & a'_{2n} \end{pmatrix} + \dots + \begin{pmatrix} a_{2n}a'_n & -a'_{2n}a_n \\ a_{2n} & a'_{2n} \end{pmatrix} \right\}^n.$$

When this is expanded and arranged in powers of  $x$  the first and second terms are

$$x^n \left( \frac{a_{2n} - a'_{2n}}{a_{2n} a'_{2n}} \right)^n - n \left( \frac{a_{2n} - a'_{2n}}{a_{2n} a'_{2n}} \right)^{n-1} \left( \frac{a_{2n} a'_{2n} - a'_{2n} a_{2n}}{a_{2n} a'_{2n}} \right) x^{n^2-1}.$$

Now the sum of the roots is

$$\sigma_1 = n \frac{a_{2n} a'_{2n} - a'_{2n} a_{2n}}{a_{2n} a'_{2n}},$$

and their centroid is

$$\frac{1}{n^2} \sigma_1 = \frac{1}{n} \frac{a_{2n} a'_{2n} - a'_{2n} a_{2n}}{a_{2n} a'_{2n}} = x'.$$

Now  $a_{2n} = t_1$ , and  $a'_{2n} = t_2$ , and we have also the relations

$$a_v = a_v + t_1 a'_v,$$

and

$$a'_v = a_v + t_2 a'_v,$$

from which we obtain

$$\begin{aligned} x' &= \frac{1}{n} \frac{t_1 a_1 + t_1 t_2 a'_1 - t_2 a_1 - t_1 t_2 a'_1}{t_1 - t_2} \\ &= \frac{1}{n} a_1. \end{aligned}$$

But this is precisely the centre of the centre circle

$$x = \frac{1}{n} (a_1 + t a'_1).$$

We are thus enabled to conclude with the general theorem:

*The centroid of an orthocentric set of points is the centre of the centre circle of the pencil of orthic curves through those points.*

*Johns Hopkins University, May 20, 1904.*

## PALLADIUM (Pd).

BY JOSEPH WHARTON, S<sub>C.</sub>D., LL.D.*(Read April 7, 1904.)*

Although palladium belongs to the platinum group of metals, it is in some respects nearly related also to silver, its atomic weight and specific gravity being respectively about 107 and 11.4, while the corresponding figures for silver are 108 and 10.5. In its high melting point, however, of 1500° C., it approaches more nearly to platinum which melts at 1750° C., and in color its grayish-white resembles the color of platinum more nearly than that of silver.

Palladium has long been known to occur native in company with platinum, and also alloyed with gold in the Brazilian mineral porpezite which contains about 5 to 10 per cent. of it. That it occurs in notable quantity in the nickeliferous pyrrhotite of Canada is an important recent observation.

Both platinum and palladium probably exist to a greater or less extent in all the many deposits of nickeliferous pyrrhotite throughout the world; certainly in those of Norway and Sweden, and particularly in every one of the numerous deposits of that mineral which are found in the Laurentian and Huronian rocks surrounding the little town Sudbury, in the province of Ontario, Canada. The quantity, however, is extremely small, varying from a mere trace to one or more ounces per ton; the average for each metal being about one-hundredth of an ounce per ton of ore, platinum and palladium usually being present in approximately equal parts.

Yet, though known to exist in many parts of the world, palladium has not been diligently sought for, because there was until recently no considerable demand for it; the reworking of platiniferous residues from the mints of several countries having supplied most of that which appeared in commerce. The prevailing scarcity of platinum is now directing attention to palladium as a practicable substitute for some purposes.

The nickeliferous pyrrhotite deposits of the Sudbury region have recently become the most important source of nickel in the world and appear certain to continue so for many years, having quite surpassed in yield the great nickel-silicate ores of New Caledonia which come next in rank. In these Canadian ores, silver, gold, platinum, iridium and rhodium occur as well as palladium; all in very minute quantities—palladium as above mentioned to the extent of about .01 oz. per ton.

The form in which palladium there occurs has not been detected, for owing to its minute quantity and the consequent difficulty of isolating it, none has yet been directly observed in any ore of that region; since, however, platinum occurs there as arsenide in the interesting mineral sperrylite ( $\text{Pt,As}_2$ ), palladium may exist in similar combination, though none has been observed in any specimen of sperrylite that has been examined. Prof. Horace L. Wells indeed notes a trace of palladium in sperrylite, but this has not I think been confirmed in any of the careful analyses of other good chemists.

In the one mine where platinum-arsenide has been found, Prof. Wells says it occurs in small pockets of decomposed rock at the contact of ore and rock, these pockets being filled with loose gravelly material. It was in the metallic sparkles of that sandy stuff where the sun's rays struck it that Mr. Sperry first noticed what proved to be platinum-arsenide—a substance till then unknown.

Ten years ago, when I visited the mine in question, the Vermillion Mine, I observed, upon the surface of the ground where the ore had been dumped, a moderate quantity of sand which appeared to have resulted from the disintegration and metasomatism of ore by atmospheric penetration, and this seems to afford a plausible explanation how palladium-arsenide might have been present in the ore with platinum-arsenide and yet no palladium be now detectible in the Sperrylite; for the greater oxidability of palladium may have led to the conversion of its arsenide into arseniate, afterward leached away by the percolating water.

Though the Vermillion Mine is not at present in operation, it affords, as above stated, the only indication we have as to the probable condition of both platinum and palladium in the ores of other mines in that region from which those metals are extracted, though neither metal has been directly observed in any of those other mines.

The ore from those other mines is not simply nickeliferous pyrrhotite, but is also to a considerable extent chalcopyrite, yielding therefore much copper, as well as nickel and minute proportions of the above-named precious metals. The ores of the various mines in the Sudbury region may be reckoned as containing  $1\frac{1}{2}$  to 8 per cent. of nickel (some small quantities even 30 to 40 per cent.) and 1 to 4 per cent. of copper.

Those ores are roasted in open heaps and then smelted into matte containing by average about 30 per cent. of nickel and copper,

and containing also practically all of the precious metals which the ores carried.

After further roasting and smelting, the concentrated matte is treated for separation of copper from nickel, which is effected by repeated melting with nitre cake and coke in cupola furnaces. The coke converts the nitre cake into sodium sulphide; when the charge is run out of the furnace and cooled it separates easily into two parts, the bottoms containing practically all the nickel, the tops consisting of sodium sulphide and copper sulphide; the gold and silver going with the tops, the platinum-group metals going with the bottoms.

In the refining processes that follow, palladium is obtained as a slime, carrying about a thousand times as much palladium proportionally as did the original ore, carrying also the other platinum-group metals, and the gold and silver.

This palladium-bearing slime is melted and refined in a small reverberatory furnace, from which it is ladled out into cold water, forming shot which are charged into small leaden towers, into the top of which hot dilute sulphuric acid is run. Palladium and the other precious metals being electro-negative to the base metals, a galvanic action now takes place in which nickel, copper and iron dissolve rapidly, leaving palladium in a black mud containing two per cent. or more of that metal. If this residue still contains much copper, that is mostly eliminated by further treatment with hot sulphuric acid until the stuff contains about 25 per cent. of palladium, when it is treated with aqua-regia, thus dissolving all the platinum, palladium and gold.

From this solution platinum is precipitated by ammonium chloride, the palladium in the filtrate is electrolytically precipitated with a platinum anode, appearing as a dull gray metal which is hard and brittle, peeling off easily from the cathode. It is then dried and ignited in a reducing atmosphere, when it takes great brilliancy and becomes very soft and pliable, capable of being worked into any ordinary form. I have, for instance, a remarkably nice teaspoon made of it.

If air is not completely excluded during ignition the palladium will oxidize on the surface taking most beautiful colorations of pink and green. When prepared as above stated palladium is almost absolutely pure, but for occasional traces of copper and iron.

I purposely refrain from giving all details of the various stages of

the processes by which pure palladium is finally attained, but enough is stated to show that a complete working system is established, requiring, of course, delicacy of perception and dexterous manipulation, yet yielding at last a beautiful substance capable of sundry uses, which are undeveloped only because no regular supply could hitherto be counted on. The steady production of palladium by the Orford Copper Co. is now more than 3000 ounces annually, from approximately 300,000 tons of Canadian ores treated. It is obvious that only as a by-product in the working of very great quantities of ore can palladium be produced as here stated.

Besides having so very high a melting point, and being at the same time both hard, ductile and malleable, palladium is so absolutely non-corrodible that a sheet of it may hang for a long time in a laboratory exposed to chlorine and hydrogen-sulphide gases without losing its polish or tarnishing.

The wonderful occlusion or absorption of hydrogen by palladium deserves special attention and invites further study.

The volume of hydrogen thus absorbed varies greatly under different circumstances, and has been variously stated by different observers. According to Graham (*Phil. Mag.*, [4] 32, 401, 503):

Fused palladium at 200°	absorbs	68 volumes.
Finely divided palladium at 200°	“	686 “
Sheet palladium at ordinary temperatures (after ignition)	“	376 “
“ “ “ 90° to 97°	“	643 “
“ “ “ 245°	“	526 “

In Poggenдорff's *Annalen* for 1869, Graham describes experiments in which 900 volumes were absorbed.

The greatest absorption observed before the experiments of McElfresh (mentioned below) was shown by electrolytically precipitated palladium; the maximum being 982.14 volumes of hydrogen.

Schmidt (*Ann. Physik.*, iv, 13,747), *J. Chem. Soc.*, 85, 86, 312 (1904), finds that the volume of hydrogen absorbed by palladium increases with the fall of temperature to about 140°; below this he finds concordant results. From 140° to 300° the absorption curve approaches a straight line. Absorption, and also diffusion, increases with pressure as well as with temperature.

Hoitsema (*Zeit. physikal. Chemie.*, 1895, 17, 1), *J. L. C. S.*, 78, 11,388 (1895) examines the hypothesis of Troost and Hauteville, that in the absorption of H by Pd a compound is formed repre-

sented by  $\text{Pd}_2\text{H}$ , but he does not agree with those authors. Debray thought the compound  $\text{Pd}_4\text{H}_2$  was formed. Why should a chemical formula be sought for the compound of palladium and hydrogen since they combine together in practically all proportions, thus indicating it to be a simple alloy?

McElfresh (*Proc. Am. Acad. Arts and Sciences*, vol. xxxix, No. 14, Jan., 1904), examining critically the influence of occluded hydrogen upon the electrical resistance of palladium, finds that resistance upon to increase constantly, but not at a uniform rate, as the occluded hydrogen increases; the maximum increase of the resistance being 68 per cent. when 1030 volumes were occluded. This absorption, reached by continuous exposure for 30 hours, is the highest yet observed and probably indicates complete saturation.

McElfresh considered Knott's method (*Proc. Roy. Soc. Edin.*, vol. xii, 1882, 1883) of determining the amount of occlusion, by measuring the increase in weight of the palladium treated, to be incapable of accuracy; he was also dissatisfied with the results obtained with imperfect apparatus by supplying to palladium a measured quantity of electrolytically produced hydrogen and deducting therefrom the quantity remaining after various periods of absorption. He therefore avoided the error inherent in such apparatus by using in this latter method ingenious apparatus of his own devising, thus reaching conclusions which appear quite reliable.

It is remarkable that Richter's *Chemistry*, as translated by Edgar F. Smith, states (p. 46) that the conductivity of palladium for both heat and electricity is little affected by its occlusion of hydrogen.

As for the discharge of occluded hydrogen from palladium, Graham states that "the gas exhibits no disposition to leave the metal and escape into a vacuum at the temperature of its absorption." Edgar F. Smith informs me that he finds charged palladium immersed in water at  $160^\circ$  to give off hydrogen with freedom comparable to the escape of carbonic acid from soda water.

Baskerville informs me that, in examining palladium for radio-activity, he found none in either of the two forms I sent him at his request for that purpose—namely, electrolytically deposited scale such as mentioned above in this paper, and similar scale which had been fused into a large button. But when he examined the same specimens after charging them in a finely divided state with hydrogen, he found slight indications of radio-activity in the first, but none in the second. He therefore asks whether, during the electro-deposition, a tension might have accumulated which



appeared afterward as beta-rays. Query: If so, why should the electro-scale require charging with hydrogen to enable it to indicate radio-activity?

Sir William Ramsay, to whom I mentioned this experiment and surmise, suggested the possibility that the original ore might have contained a trace of radium, which persisted with the palladium until the final fusion vaporized it or passed it to the slag.

Among the chemical characteristics of palladium may be mentioned these, not of course as novelties but as practically useful:

1. It is completely precipitated from an acid solution as sulphide by hydrogen-sulphide.

2. It is thrown down as a black precipitate from even a dilute solution by potassium-iodide. This very sensitive reaction is important in practical treatment of material containing palladium.

3. It is precipitated by mercury-cyanide as white slimy palladium-cyanide: a property useful for quantitative determination in laboratory.

Among the uses hitherto of palladium are:

1. For the mechanism of delicate instruments such as chronometers, and for verniers, etc., of astronomical instruments.

2. For surgical instruments.

3. For plating searchlight mirrors. Why not for the mirrors of reflecting telescopes?

4. For alloying with silver to make dental plates, etc., instead of the  $\frac{2}{3}$  silver,  $\frac{1}{3}$  platinum hitherto used in Europe. Also as palladium amalgam for fillings in cavities of teeth.<sup>1</sup>

Other uses will naturally arise as men's minds are turned toward this metal, which, while in many respects equal to platinum, sells for no more than the price by weight of that metal, and of course

<sup>1</sup> Palladium amalgam has been used to but very small extent for tooth fillings, though well adapted for that use except for its dark color, arising apparently from palladium black being used to form the amalgam, which is made by the dentist at the moment he wishes to use it, by triturating palladium black with mercury. That darkness of color might probably be obviated by using fine palladium filings instead of palladium black.

Dr. Joseph Pettit, a careful observer, told me that he had found this amalgam so made to become too hot to be comfortably held in the hand. Dr. W. Storer How, of the S. S. White Dental Co, informed me that he had noticed some warmth evolved in the making of the amalgam. I observed very little heat, no more in fact than I thought referable to the friction of trituration.

therefore for much less than that by bulk; the specific gravity of platinum being variously stated as 17 to 19, and that of palladium as 11.4 to 11.8.

It would seem that palladium might be useful under some circumstances for resistance wire.

I conclude by remarking that, in the several reports by the Canadian Government upon the metallic and mineral resources of "The Dominion," palladium is never mentioned; not even in the report for 1904.

---

*Stated Meeting, April 15, 1904.*

President SMITH in the Chair.

Prof. Edward Potts Cheyney and Dr. Harvey W. Wiley, newly elected members, were presented to the Chair, and took their seats in the Society.

Letters accepting membership were read from:

President Roosevelt, Washington, D. C.

Prof. Maurice Bloomfield, Baltimore.

Prof. Henry Pickering Bowditch, Jamaica Plain, Mass.

Prof. Edward Potts Cheyney, Philadelphia.

Prof. Russell H. Chittenden, New Haven.

Prof. Frank Wigglesworth Clarke, Washington.

Prof. Kuno Francke, Cambridge, Mass.

Prof. Edward Leamington Nichols, Ithaca.

Prof. Samuel W. Stratton, Washington.

Dr. Harvey W. Wiley, Washington.

Prof. C. L. Doolittle discussed a letter from Mr. Germers on the Aurora Borealis, and explained the phenomena referred to therein.

The following papers were read:

"The Trail of the Golden Dragon," by Dr. George B. Gordon.

"Views of Old Philadelphia," by Mr. Julius F. Sachse.

*Stated Meeting, May 6, 1904.*

President SMITH in the Chair.

Letters accepting membership were read from:

Gen. A. W. Greely, Washington.

Prof. P. A. Lambert, Bethlehem.

Prof. Edgar Odell Lovett, Princeton.

Prof. Friedrich Delitzsch, Berlin.

Sir Richard C. Jebb, Cambridge.

Prof. Ernest Rutherford, Montreal.

Prof. J. H. Van't Hoff, Berlin.

Prof. Wilhelm Waldeyer, Berlin.

The decease was announced of Sir Henry Thompson, Bart., at London, on April 18, 1904, æt. 84.

The following papers were read:

"The Vegetation of the Island of Dominica," by Prof. Francis E. Lloyd, who was introduced by the President.

"Orthic Curves; or Algebraic Curves which Satisfy Laplace's Equation in Two Dimensions," by Mr. Charles Edward Brooks, presented by Prof. George F. Barker (see page 294).

*Stated Meeting, May 20, 1904.*

President SMITH in the Chair.

A letter accepting membership was read from Dr. J. Chalmers DaCosta, Philadelphia.

The decease was announced of:

M. Otto von Böhtlingk, at Leipzig, on April 1, 1904, æt. 89.

Dr. Roberts Bartholow, at Philadelphia, on May 10, 1904, æt. 72.

The following papers were read:

"Recent Researches on Inscriptions from Nippur," by Dr. Albert T. Clay, presented by the President.

"Observations on the New Metallic Salts," by Dr. Edgar F. Smith (by title).

*Stated Meeting, October 7, 1904.*

President SMITH in the Chair.

Dr. J. Chalmers DaCosta, a newly-elected member, was presented to the Chair, and took his seat in the Society.

The decease of the following members was announced:

Prof. William Henry Pettee, at Ann Arbor, Mich., on May 26, 1904, æt. 66.

Dr. Hermann Rollett, at Baden bei Wien, on May 30, 1904, æt. 85.

Prof. John B. Hatcher, at Pittsburgh, on July 4, 1904, æt. 45.

Alfred H. Allen, F.C.S., at Sheffield, Eng., on July 14, 1904, æt. 60.

Dr. Isaac Roberts, at Crowborough, Sussex, Eng., on July 17, 1904, æt. 75.

Hon. Robert E. Pattison, at Philadelphia, on August 1, 1904, æt. 54.

Matthew Huizinga Messchert, at Douglassville, Pa., on August 23, 1904, æt. 75.

Rev. Dr. Charles W. Shields, at Newport, R. I., on August 26, 1904, æt. 80.

The following papers were read:

"Is Abraham Historical?" by Dr. Albert T. Clay, presented by the President.

"The Morphological Superiority of the Female Sex," by Thomas H. Montgomery, Jr.

"The Morphology of the Skull of the Pelycosaurian Genus, *Dimetrodon*," by Prof. E. C. Case, presented by the Secretaries.

PROCEEDINGS  
OF THE  
AMERICAN PHILOSOPHICAL SOCIETY  
HELD AT PHILADELPHIA  
FOR PROMOTING USEFUL KNOWLEDGE

---

VOL. XLIII.

OCTOBER-DECEMBER, 1904.

No. 178

---

AN ATTEMPT TO CORRELATE THE MARINE WITH  
THE NON-MARINE FORMATIONS OF  
THE MIDDLE WEST.

BY J. B. HATCHER.

*Read April 7, 1904.*

It is the purpose of this paper to call attention to and to direct investigation along certain lines by which, as it appears to the present writer, we may be able eventually to reach a better understanding regarding the relative age of the various Jurassic and Cretaceous horizons of the Middle West.

It has doubtless frequently occurred to every geologist and paleontologist who has conducted investigations relating to the formations referred to in the title of this paper that marine, terrestrial, fresh and brackish water conditions must have prevailed simultaneously and continuously over extensive areas in our Middle West throughout that long period in middle and late Mesozoic times during which sea and land alternately held dominion over considerable portions of that region. Nevertheless, no serious attempt has been made to correlate the various marine and non-marine deposits with one another. In our geological text-books and in numerous monographs, memoirs and less pretentious papers relating to the geology and paleontology of this region these various formations are described in the text and represented in the accompanying geological columns as occurring in regular sequence one above the other, and the impression is given that where a marine formation is superimposed by a non-marine or *vice versa* the over-

lying bed belongs to a separate and distinctly more recent age than the underlying deposit. To the present writer this assumption appears in not a few instances to be quite unwarranted, the burden of evidence when carefully considered being in favor rather of considering the two formations, largely at least, as contemporaneous in origin, marine and non-marine conditions having existed simultaneously not over the same but over adjacent regions, each giving origin to its characteristic deposit and the marine beds appearing above or below the non-marine according to whether the sea was encroaching upon or receding from the land-mass during the period of their deposition.

The physical conditions that prevailed during the deposition of any geological formation or series of formations and the manner in which a marine deposit is replaced by a non-marine or *vice versa*, are best understood by a study of those regions where, under existing conditions, similar deposits are in process of formation. As an illustration let us consider the conditions that at present prevail almost continuously along our Atlantic coast from Florida to Long Island. Throughout this entire coast line a broad and little elevated coastal plain extends inland from the sea to the eastern foothills of the Appalachian Mountains, while to the eastward of this coast line there lies an equally broad and gently inclined continental plateau at present but little submerged beneath the sea. The eastern limit of this submerged portion of the continental plateau may be regarded as having formed the coast line of the continent at some former period in our earth's history, when the eastern portion of this continent stood at a greater elevation than at present. It was during this earlier period of increased elevation that the Appalachians suffered most from denudation and that the coastal plain, together with the submerged continental plateau, were formed, not as at present differentiated, but as a continuous coastal plain reduced by erosion to a more or less uniform base level extending westward from the eastern limits of the present continental plateau to the foothills of the mountains. A glance at any good map of this region will reveal the fact that the entire coast line, more especially to the northward of Charleston, is deeply indented by numerous shallow sounds and bays, like Delaware and Chesapeake Bays in the north and Albemarle and Pamlico Sounds farther south, while the country for many miles inland from the coast frequently consists largely of more or less impenetrable

marshes, such as the Dismal Swamp in Virginia and North Carolina and others bordering the lower courses of the James, Roanoke, Cape Fear, Pedee, Neuse and Savannah rivers, and to a less extent the Potomac, Susquehanna and Delaware rivers farther north.

If we trace the courses of the larger rivers of this region, those rising in the Appalachians, from their sources to their mouths, the course of each will be found to be divisible into three sections, when considered according to the eroding and transporting power of the stream. The first of these three sections, commencing above, extends from the source of the stream to the point where it leaves the foothills of the mountains and emerges upon the coastal plain. Throughout this portion of its course the stream is both an eroding and a transporting agent, displaying about equal efficiency in either capacity. Below this point, which has been called the "Piedmont escarpment," the stream ceases to be to any great extent an eroding agent, and between the foothills and the swampy region bordering the coast it is chiefly a transporting agent, the current being too sluggish to accomplish any appreciable amount of erosion, and at times becoming so slow as to permit of considerable deposition. Between that point where it enters the marsh lands and its mouth the stream drops all that remains of its load of sediment, save that which is carried seaward by the action of the tides, aided to some slight extent perhaps by the feeble current of the stream, which has now become almost entirely an agent of deposition.

Now if we turn our attention to the changes that are taking place in the region traversed by these rivers, it will be seen that the first section, or that between their sources and the Piedmont escarpment, is one almost exclusively of degradation, there being little or no deposition going on in this region, while throughout the second section, that lying between the escarpment and the swamps along the coast, the eroding and depositing agencies are unimportant, though about equally effective, resulting on the whole in comparatively little change in the topography, while in the third region, or that lying between the swamps and the coast, deposition is taking place with considerable rapidity. The inland swamps are being filled in, while along the coast of Virginia and North Carolina the estuaries and sounds located at the mouths of the various rivers or enclosed between the mainland and the low sand spits, thrown up by the waves and extending almost continuously along the coast,

are receiving vast quantities of material from the numerous streams emptying into them and are destined at some future time to be converted into fresh-water swamps like those now found inland, while the coast will be pushed farther eastward, repeating the same or very similar conditions.

If now we examine the material that is being deposited at various localities, commencing with that point on the coastal plain where deposition is more rapid than erosion, and extending eastward not only to the coast line but beyond to the eastern border of the continental plateau, we shall find that deposits of every character, from fresh water to estuary or brackish, littoral and purely marine, are being formed simultaneously, in each of which are preserved remains of the life characteristic of the conditions attending its deposition. In the swamps will be found peat bogs and beds of sand, clay and marl, with remains of terrestrial and fresh water vertebrates and invertebrates. Over the river bottoms will be found fluvial deposits. In the estuaries, bays and sounds beds with the remains of a brackish water fauna are forming. Outside the sand spits that enclose Albemarle and Pamlico Sounds will be found other beds of sand with a littoral fauna. Still farther seaward and continuing to the limits of the submerged continental plateau a typically marine deposit is being laid down with remains of its characteristic fauna. Beyond this we reach the abysmal depths of the ocean with a fauna and deposit distinct from any of the others mentioned. Assuming that the average depth of the ocean just west of the eastern border of the continental plateau is 3000 feet, and that the western limit of true marine conditions extends to within fifty miles of the eastern limit of true fresh water or terrestrial conditions, we have then within a distance of fifty miles from east to west every character of deposit from terrestrial and fresh water to true marine forming at the same time; and if we continue our section to the eastern limit of the continental plateau, at altitudes differing more than 3000 feet from one another, as indicated by the curved line *a. a'*, which in the accompanying diagram, seen in figure 1, represents an imaginary line drawn along the surface of the ground and bottom of the sea from the western border of the swamps lying west of Pamlico Sound in North Carolina, across this sound and eastward to the eastern border of the continental plateau. Along this line *a. to b.* is the swamp region with fresh water deposits, *b. to c.* Pamlico Sound with its estuary depos-



its, *c.* to *d.* the shallow water and littoral deposits extending eastward from the coast, *d.* to *a.'* true marine conditions.

Let us suppose present conditions to continue without any elevation or depression of the earth's surface in this region, until by the process of erosion and deposition the present coast line is advanced to a position approximating that of the eastern limits of the continental plateau, as shown in the curved line *a.'-a."* We would then have deposited between the lines *a.-a.'* and *a.'-a."* sediments aggregating in vertical thickness something more than 3000 feet, and comprising four formations more or less distinct when considered from their faunal and lithological characters but of the same age, all four having been laid down in the same time interval and all conformable with one another save for an unconformity by

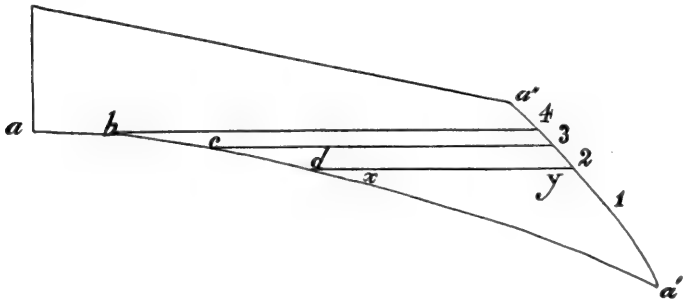

Fig. 1.

overlap along their western borders necessitated by the topography existing at the time when present conditions were inaugurated. Commencing below, No 1. of these four formations would be the thickest of the series and would form a wedge of purely marine and deep water deposits at the base with the blade directed westward. Above these deep water deposits would come No. 2 of the series, a marine shallow water and littoral deposit of nearly uniform thickness, which would be determined by the depth of water at which such deposits may take place. This would contain a littoral fauna and would overlap the western border of No. 1. Above this and overlapping it on the west would come No. 3, an estuary formation with its beds of oysters and other brackish water mollusca, now occurring in such abundance in the sounds and bays of this coast. The vertical range of these brackish water deposits, like that of No.

2, would, of course, be limited if, as we assumed above, perfectly stable conditions of the earth's surface were maintained in this region during the entire period required for the eastward extension of the coast line from its present position to that of the eastern border of the submerged continental plateau. Above No. 3 would come No. 4, the uppermost of the series, a fresh water and to some extent aeolian deposit, with its beds of peat transformed perhaps into lignite and remains of a terrestrial and fresh water vertebrate and invertebrate fauna. The thickness of these fresh water deposits would not be limited as would that of Nos. 2 and 3 of the series, since as the coast line advanced eastward it would leave behind a low and flat region growing continually wider from east to west and increasing very slowly in elevation by the accumulation over its surface of fluvial, lacustrine and aeolian deposits. As the width of the coastal plain increased the inclination of its surface toward the sea would become less and less and the drainage or runoff would be reduced to a minimum, transforming the region into one of lakes and marshes connected by sluggish streams and increasing its capacity for the accumulation of fresh water and aeolian deposits. By the uninterrupted continuance of such conditions these deposits would go on accumulating over this entire region long after the shore line had advanced far to the eastward of its present limits, resulting in a greater thickness of fresh water and aeolian deposits along the western than along the eastern border. These deposits would therefore form an overlying wedge with the blade directed eastward, or in a direction opposite to that of the wedge of marine deposits constituting No. 1 at the base of the series, and tending to produce a somewhat uniform thickness of the combined series of beds, with the fresh water deposits predominating in the western region and the true marine deposits in the eastern, while the interstratified brackish water and littoral deposits would continue practically of the same uniform thickness from the eastern to the western border of the region.

Thus far we have only considered what would take place here under perfectly stable conditions in the earth's crust. Let us next consider what would result from certain oscillations in the earth's surface along this coast.

If a period of elevation should set in affecting the coastal plain and submerged continental plateau the effect would be to hasten the recovery of the continental plateau from the sea and to decrease

the thickness of the various deposits forming in this region. Moreover, if the elevation to the westward should become appreciably more rapid than to the east the run-off would be increased by the greater inclination of the surface toward the sea, and a period of erosion would be inaugurated over a considerable portion of that area where formerly fresh water deposits were being formed.

If on the other hand the region should undergo a general but gradual subsidence, so gradual that the rate of upbuilding by deposition would be more than sufficient to keep pace with the subsidence, the result would be a lengthening of the time necessary for the coast line to advance eastward from its present position to that of the eastern border of the continental plateau and a corresponding increase in the thickness of the various deposits. Under such conditions the thickness of the littoral and estuarine or brackish water deposits would not be so restricted as under those conditions previously considered, but these might attain to almost any depth, varying in thickness at any given point according to whether the rate of subsidence during the deposition of these deposits at such point approximated or fell far below the rate of sedimentation taking place there. The more nearly the rate of subsidence approximated that of sedimentation at any point where littoral and brackish water conditions prevailed, the greater would be the length of time necessary to recover the area from the sea and the greater the thickness of the littoral and brackish water deposits.

If at any time the rate of subsidence exceeded that of sedimentation, conditions would immediately be reversed, the sea would encroach upon the land, the coast line would recede to the westward, and the fresh water beds seen at No. 4 in the diagram would be overlaid first by a brackish water deposit, over which would be laid down a littoral deposit, followed later by beds of deep water origin as the subsidence increased and the sea advanced upon the land. If this period of more rapid subsidence were only temporary it would result merely in a local interstratification of fresh water, brackish and marine deposits. If on the other hand it became permanent it would result in the entire resubmergence of the region already recovered from the sea, and there would be a repetition in reversed order of the fresh water, brackish, littoral and true marine deposits already described as having been formed during that period when the land was advancing upon the sea. At the close of this period of subsidence, when the sea had regained its original

shore line, a section through the deposits formed before and during this period would exhibit a structure similar to that shown in the second diagram, where *A.* represents a wedge of fresh water deposits immediately overlaid and underlaid by the brackish water beds *B. B.*, followed above and below by the littoral deposits *C. C.*, which are in turn underlaid and overlaid by the true deep water marine beds *D. D.*, and the time interval during which the single fresh water formation represented by *A.* was deposited will have equaled that employed in the deposition of the underlying and

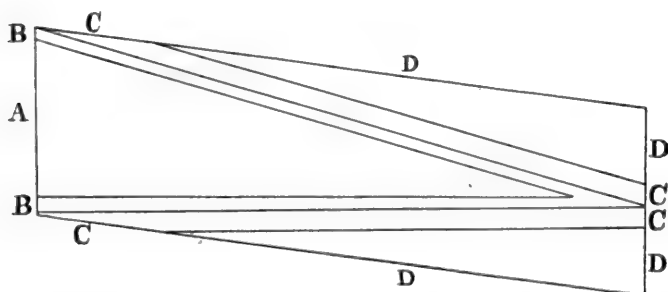

Fig. 2.

overlying marine and brackish water beds combined. The fresh water beds should, therefore, be correlated with both the underlying and overlying marine beds.

The actual conditions at present existing along our Atlantic coast, together with the possible results following a long continuance of these conditions, with variations similar to those outlined above, have evidently been repeated at certain intervals in Mesozoic times throughout our Middle West.

The Judith river beds at about the middle of the Upper Cretaceous, together with the overlying and underlying marine formations, known respectively as the Pierre or Bearpaw shales and the Claggett formation, form a splendid example of the conditions illustrated in the second diagram. They are composed of a series of deposits for the most part of fresh water origin, but overlaid and underlaid by brackish water beds. They attain to a known thickness of something over 500 feet and extend continuously from the Saskatchewan river region in Canada to southern Montana. They are well developed along about the 110th meridian of west longitude, where they may perhaps be regarded as attaining their maxi-

imum thickness. Some distance to the eastward of this meridian, however, they decrease in thickness and finally disappear, passing into the overlying and underlying marine beds mentioned above. In the second diagram *A.* would represent the fresh water and middle portion of the Judith river beds, *B. B.* the underlying and overlying brackish water beds usually referred also to the Judith river formation, while *C. C.* and *D. D.* inclusive would represent the Bearpaw shales at the top and the Claggett formation at the bottom, *C. C.* representing littoral deposits or passage beds from brackish water to true marine deposits and occurring everywhere throughout this region both at the top and bottom of the Judith river beds.

Having now seen how two or more formations occurring in regular sequence one above the other may originate simultaneously instead of pertaining to different and distinct ages, let us next consider what bearing this will have on the relative age of different horizons in any one of these formations. To the paleontologist this is an important point, since in working out the phylogeny and relations of fossil forms within the same formation it is often of the greatest importance to know whether a given genus or species preceded or succeeded another, or if the two were contemporaneous. Heretofore we have been inclined to consider any given stratum within a formation as having been deposited near the beginning, at about the middle or near the close of that time interval during which the formation was laid down, according to whether it occurs near the top, in the middle or near the bottom of the formation and regardless of the geographical position of that point at which the stratigraphical determination was made. To say that two fossils were found fifty feet beneath the top of a given formation which had not been subjected to erosion, but at a distance from each other of several, perhaps many miles, has usually been regarded as establishing for them an identical or very similar age. Every consideration has been given to the stratigraphic position, none to the geographic. Yet in not a few instances the latter is of equal or even far greater importance than the former, and must be considered in determining at just what period in the time interval necessary for the deposition of a certain formation any given stratum was laid down. Furthermore, we have been accustomed to estimate the time employed in the deposition of any given formation solely by its vertical thickness, and regardless of its geographical

extent assuming that conditions were more or less uniform over the entire region occupied by the formation from the beginning to the close of its deposition—an assumption wholly unwarranted, as we have seen in formations deposited under conditions similar to those represented in the first diagram and more especially in the littoral and brackish water beds, represented respectively by 2 and 3. In beds such as these the actual area over which deposition takes place at any given time is limited to a narrow strip along the coast, and materials are there being added simultaneously and continuously throughout the entire vertical extent of both these beds. It is thus evident that in deposits such as these geographical distribution rather than vertical thickness is the basis upon which to estimate the length of time employed in their deposition. The age of any fossil found in these beds will be greater or less than that of another found at a different locality, not according as to whether it occurred at a higher or lower level in the series, but according to the difference in the geographical position of each relative to the original coast line, and the actual difference in age will, of course, depend upon the difference in the geographical positions at which the two occurred and the rate of advance or recession of the coast. The difference in age would be expressed in years by dividing the distance between the two localities, measured along a line at right angles to the original coast line, by the annual rate of advance or recession of the coast.

Let us consider again the conditions at present existing along our Atlantic coast and represented in the first diagram. It will be readily apparent that as the coast line is advanced eastward by the deposition of the material brought down by the streams, the western limits of true marine, littoral and brackish water conditions will be more and more restricted and that marine conditions with a depth of sea of more than 2000 feet will prevail over the region near the eastern border of the submerged continental plateau long after the present coast line has advanced to the position shown at *X*. on the diagram, while to the westward of this position the region has all been brought above sea level and only fresh water and aeolian deposits are being formed. It is evident then that when the coast line has been advanced to *a*," the uppermost stratum of the marine formation, No. 1, will not be of uniform age from *X*. to *Y*., but that this stratum at *X*. will exceed in age the same stratum at *Y*. by the length of the time required for the

coast to advance from *X.* to *Y.*, represented at *Y.* by a vertical thickness of deposits of about 2000 feet.

With the overlying brackish water and littoral formations represented by Nos. 2 and 3, the stratigraphic position of any horizon at any locality within either would be of minor importance in determining its age relative to the formation as a whole. Since the deposition of these beds would not take place simultaneously over the entire area of their distribution, but would be restricted to a narrow belt along the coast which would move eastward as the coast advanced, it is evident that these deposits would be oldest to the west and newest toward the east. This is an instance where geographical position is of far more importance than stratigraphical in determining the relative age of a given stratum within a formation.

From the above observations it appears to the present writer that other elements than their present stratigraphic position relative to one another must be considered in determining the age and in correlating any series of formations deposited along a receding or advancing coast. There is evidence that several of the Mesozoic formations of our Middle West were deposited under such conditions. It should first be determined whether the sea was advancing or receding during the deposition of any given series. Next the direction taken by such advance or recession of the sea should be ascertained, in order to determine in what geographical position the older beds of the series are to be found. Then the rate of deposition as compared with the rate of advance or recession of the sea should be determined, so as to be able to correlate with one another, approximately at least, strata within the same formation but occupying different geographic and stratigraphic positions. In the following attempt to correlate various formations in the region referred to the methods and principles outlined above have been applied only in a very general way, and the results can only be considered as suggestive of what might be accomplished by more extended observations and careful determinations in the same region.

*The Atlantosaurus Beds and Dakota Sandstones considered as the possible equivalents of the Upper Jurassic and Lower Cretaceous.*

There is a considerable thickness of non-marine sandstones and shales with a wide geographical distribution in the region under question, concerning the age of certain members of which there has been much difference of opinion. The lower member of these was

first differentiated by Marsh who named them the *Atlantosaurus beds*.<sup>1</sup> They have since received various other names by other authors, such as the Como beds, the Morrison beds, the Beulah shales, etc. Since these later names are no more appropriate than the one first given there is no good reason for accepting any of them and rejecting the name first bestowed on these beds by their discoverer. Moreover, if stability in geological nomenclature be desirable there would seem to be no better way of securing it than by recognizing priority. It may be well to adopt certain rules governing the formation of new names for new formations, but these rules should not be made retroactive in their application, since such application will not only fail to do full justice to many earlier geologists but, what is of far more importance, will result in increasing still further that synonymy already existing in our geological nomenclature.

In their typical exposures the *Atlantosaurus* beds consist of rather fine shales. At certain localities there are in them occasional small lenses of limestone with fresh water invertebrates and more important lenses of sandstones frequently appearing as distinct and quite continuous strata. Toward the top the sandstones become more frequent and the whole is everywhere overlaid by a heavy bed of sandstone known as the Dakota sandstones, save where these have been removed by erosion. In some places the passage from the sandstones and shales of the *Atlantosaurus* beds to the Dakota is quite abrupt, but as a rule it is very gradual, the two grading into one another in such manner that it is difficult to say where the one ends and the other begins. Both these formations are of fresh water and aeolian origin, though there is evidence of brackish water or littoral deposits in a few places near the top of the Dakota.

The Dakota sandstones have usually by general consent been considered as representing the base of the Upper Cretaceous, both from their stratigraphic position beneath the Benton and from their fossil flora. The latter, however, can scarcely be considered as being at present at least of any special value in determining the exact age of these sandstones, which in many places in the western portion of the region under consideration pass insensibly below into the sandstones and shales of the *Atlantosaurus* beds. In the region near Buffalo Gap, S. D., Darton has distinguished these transitional

<sup>1</sup>The *Hallopus beds* of the same author are disregarded here as of minor importance and being usually not distinguishable.



beds as the Lakota formation and has discovered in them dinosaurian remains representing types differing from and distinctly more recent than those commonly met with in the typical *Atlantosaurus* beds. Moreover at several localities these transitional beds have yielded cycads and other plant remains which, according to Prof. L. F. Ward who has studied this flora, are of Lower Cretaceous types. At present the dinosaurian fauna is too meagre to determine certainly whether its affinities are with the Jurassic or Lower Cretaceous. Its aspect is however, in so far as we know it, more modern than that of the typical Jurassic. The *Predentata* appear to be assuming the predominant position held throughout the Jurassic by the *Sauropoda*, and I am inclined to consider the dinosaurian fauna as indicative also of a Lower Cretaceous age for these beds.

The *Atlantosaurus* beds, consisting of dark shales with intercalated sandstones, have a wide distribution throughout the western portion of the region under consideration, where they appear at the proper position in the geological section encircling every mountain upthrust and occupying many of the intermediate valleys. These beds contain the remains of an exceedingly rich and varied dinosaurian fauna, concerning the age of which there has been some difference of opinion. At present, however, this fauna together with the beds containing it is very generally regarded as of Jurassic age. There are, however, certain geologists and paleontologists who still regard these deposits as of Lower Cretaceous age. The dinosaurs, which probably offer the most reliable evidences as to the age of these beds, are unmistakably Jurassic in type, whether the comparison be made between the individual species or the faunas as a whole. Marsh was wont to correlate the *Atlantosaurus* beds with the Wealden which he regarded as of Upper Jurassic age, but which is now usually placed at the base of the Lower Cretaceous. It is not quite clear upon what evidence Marsh relied when making this correlation. The dinosaurian fauna of the Wealden is certainly quite different and more modern than that of the *Atlantosaurus* beds. In the Wealden the *Sauropod* dinosaurs, which form such a conspicuous feature in the faunas of the Middle and Upper Jura, are on the wane and that group of *Predentate* dinosaurs known as the *Iguanodontia* has attained unusual importance, assuming to a certain extent at least the position formerly held by the *Sauropoda*. In the *Atlantosaurus* beds, however, the *Sauropoda* predominate and

the Iguanodont group of the Predentata are represented by smaller and less specialized forms. The dinosaurian fauna of the Atlantosaurus beds as we now know it is certainly more nearly allied to that of the Kimmeridge and the underlying Oxfordian than to the Wealden or the Purbeck, and there is little doubt that the true Atlantosaurus beds, those lying below the Lakota of Darton, are of Upper Jurassic age.

Throughout the northern area of their distribution the Atlantosaurus beds are conformably underlaid by a series of marine deposits variously known as the Baptonodon beds, the Shirley beds, the Sundance formation, etc., and universally referred to the Upper Jurassic. That these beds are of Upper Jurassic age has not been questioned and is abundantly confirmed by both their invertebrate and vertebrate faunas. About the Black Hills in South Dakota, the Big Horn Mountains in northern Wyoming, and at other places these marine beds attain a considerable thickness, 400 to 500 feet, while the overlying Atlantosaurus beds of fresh water origin show a more restricted development in these regions than they attain farther to the southward. As we proceed southward, however, the marine deposits diminish in thickness and disappear altogether near the boundary line between the States of Colorado and Wyoming. Farther south the Atlantosaurus beds attain to a maximum thickness of perhaps 500 feet and rest directly but unconformably upon the "Red Beds," now usually considered in their upper members at least as of Triassic age, but formerly referred to as the Jura-Trias. Still farther south in New Mexico, Lee has found conditions which lead him to believe that these fresh water beds are continuous with marine beds of Lower Cretaceous age pertaining to the Comanche series. Though the evidence is at present not at all conclusive and nothing is known concerning the character of the vertebrate fauna of the fresh water beds at this locality beyond the fact that they contain dinosaurian remains, yet it is quite possible that the upper members of this series, the Lakota of Darton, may pass eastward into true marine deposits of Lower Cretaceous age.

To the eastward the Dakota sandstones, at the summit of the series of fresh water and aeolian deposits under discussion, overlap the underlying Lakota sandstones and Atlantosaurus beds, and in eastern South Dakota, Nebraska and Kansas they rest unconformably upon strata pertaining to the Carboniferous or Permo-Carboniferous.

From the foregoing remarks it will appear that in the region referred to in the title of this paper there is a conformable series of marine and fresh water or in part aeolian deposits, commencing below in the north with marine beds unquestionably of Jurassic age and passing upward and toward the south and east into a series of fresh water and aeolian deposits containing a dinosaurian fauna, with affinities clearly allying it also with the Upper Jurassic and another still later horizon, the Lakota of Darton, with a Lower Cretaceous flora and a dinosaurian fauna of the character of which as yet little is known, but which is certainly more recent than that of the true *Atlantosaurus* beds, the entire series terminating above in the Dakota sandstones generally referred to the base of the Upper Cretaceous. This entire series rests unconformably upon the "Red Beds" in such manner as to show conclusively that prior to the beginning of its deposition there was in this region a long and continued period of erosion, embracing perhaps the close of the Triassic and a considerable portion of the Jurassic. At the top the Dakota sandstones are overlaid with apparent conformity by the Benton, the lowermost marine member of the Upper Cretaceous. As yet no evidence has been advanced to show that sedimentation was not continuous in this region from that period which marked the beginning of the deposition of the marine *Baptanodon* beds at the base of the series to the close of that much later period which witnessed the deposition of the Dakota sandstones, and I see no reason why this series of deposits may not represent in this region the entire Lower Cretaceous and Upper Jurassic, as their floras and faunas and the stratigraphy and conditions of sedimentation would seem to indicate. I am well aware of the enormous time interval which a correlation such as that just suggested presupposes for the deposition of this comparatively meagre series of deposits, aggregating a thickness nowhere of perhaps as much as 1000 feet and in no way comparable with the thousands of feet of beds which in other regions are known to be included in the Lower Cretaceous alone, to say nothing of the Upper Jurassic. Nevertheless this objection does not seem an especially important one when we consider the wide geographical distribution of those non-marine deposits which constitute by far the greater bulk of this series, and the time interval necessary for the deposition of which, as we have seen at the beginning of this paper, should be estimated not so much by their vertical thickness as by the extent of their geographical distribution.

## NON-MARINE EQUIVALENTS OF THE MARINE BEDS OF THE COLORADO AND MONTANA FORMATIONS.

Between the Dakota sandstones and the base of the Tertiary there is in this region a number of formations the characters of which are indicative of littoral, brackish, fresh water and terrestrial conditions.

The lowermost of these is the Eagle formation, consisting for the most part of massive sandstones with intercalated beds of lignite and shales. This formation is known to have a considerable distribution in Montana and it doubtless extends northward into Canada. In general it is not very fossiliferous, but in places, usually of very limited extent, it has been found to contain considerable abundance marine invertebrates, indicative of littoral conditions. Although as yet no fresh water vertebrate or invertebrate remains have been found in these beds, yet the nature of the materials composing them and the manner in which the sandstones, shales and lignites replace one another are indicative of an adjacent land mass, and it is quite probable that they are to some extent at least of fresh or brackish water origin. A few remains of terrestrial vertebrates have been found in them. They afforded the type of *Ornithomimus grandis* Marsh and other fragments of terrestrial dinosaurs. The presence of these remains may be considered as additional evidence of an adjacent land-mass.

The Eagle formation is conformably underlaid and overlaid respectively by the Benton and the Claggett formations. Its stratigraphical position is nearly, perhaps identically, the same as that occupied by the Niobrara farther to the southeast, and it was I think quite properly correlated with that horizon by Mr. Earl Douglass, though I should not be in favor of applying the same name, as was done by Mr. Douglass, to formations so different in lithological and faunal characters. From the nature of these deposits it is evident that toward the close of the Benton there was in this region a decided change of conditions which materially altered the character of the sedimentation, and that the true marine conditions which had prevailed continuously throughout the Benton gave place to at least shallow waters and in part perhaps to brackish and terrestrial conditions, though it is evident from the character of the beds composing the Eagle formation that the transformation was by no means so complete at this interval as during the preceding one which witnessed the deposition of the *Atlantosaurus* beds and

Dakota sandstones, or the two succeeding intervals marked by the deposition of the Judith river beds and the Laramie.

After the deposition of some 300 to 400 feet of the sandstones, shales and lignites of the Eagle formation true marine conditions were again restored in this region. That this return to marine conditions was gradual and due to a slow advance of the sea over the region in question is evidenced in certain places by the manner in which the uppermost Eagle sandstones pass by a series of shales and lignites into the overlying true marine beds of the Claggett formation, and is well shown on Eagle Creek a short distance above where it empties into the Missouri river, some twenty miles above Judith, Mont., at a place which may be regarded as the type locality for the Eagle formation.

Although we have not been able to trace this formation continuously to the east and south and to observe its actual passage in those directions into the overlying and underlying marine formations, yet we do know that it disappears in these directions and is entirely replaced by marine deposits resembling those of the Niobrara and the base of the Montana. From all the evidence at hand it seems probable that over the region now occupied by the Eagle formation shallow water and in part terrestrial conditions prevailed for a considerable period, commencing toward the close of the Colorado and continuing uninterruptedly well up into the Montana, and that this formation should be correlated with the upper portion of the Colorado and the lower portion of the Montana.

After the deposition of the Eagle formation marine conditions again prevailed over this region, as is evidenced by the 300 to 400 feet of characteristically marine deposits known as the Claggett formation intercalated between the Eagle sandstones and the Judith river beds. From the nature of the deposits constituting the Claggett formation it is evident that this return to marine conditions was not so complete as it had been in the Benton, for at intervals in the Claggett there are beds of sandstones with marine invertebrates, indicative of shallow water or littoral conditions. These are especially prevalent toward the top, where they may be regarded as prophetic of that return to terrestrial conditions which was soon to follow and which witnessed the deposition of the overlying 500 to 600 feet of non-marine deposits known as the Judith river beds. As remarked earlier in this paper the passage from the Claggett formation to the Judith river beds is in most places extremely

gradual, as is also that from the latter to the overlying marine deposits known as the Pierre or Bearpaw shales. In the first instance there is abundant evidence of the gradual replacement of marine conditions by non-marine, commencing below with littoral and brackish water deposits and terminating above with beds indicative of typical fresh water and terrestrial conditions, while in the second instance the evidence is equally conclusive of a gradual replacement of terrestrial by true marine conditions. As with the Eagle formation the Judith river beds continue for some distance to the south and east, but decrease in importance and are finally entirely replaced by marine deposits now universally referred to the Pierre or Montana group of the Upper Cretaceous. It is evident therefore that the Judith river beds in their typical development represent deposits that were contemporaneous in origin with these marine beds farther to the southeast and that they should be correlated with them.

Overlying the Judith river beds but partly contemporaneous with them in origin is the series of shales already mentioned as the Pierre or Bearpaw shales. These are true marine deposits and pass upward through the Fox Hills sandstones into that great series of brackish, fresh water and aeolian deposits aggregating from 2,000 to 3,000 feet in thickness and known as the Laramie formation. The passage from the Pierre to the Laramie is everywhere very gradual, and the evidence is so strong as to be almost conclusive that there was in this region a gradual advance of the land upon the sea resulting finally in the recovery of the entire area from the latter. Considering the enormous extent of the area which marks the present distribution of the Laramie, a very great length of time must have elapsed between that period when the first portion of this region began to appear above the level of the sea and that later period which marked the final recovery of the entire region. The length of this period is also indicated to some extent at least by the difference in the character of the brackish water faunas that in various and widely separated localities are found in beds immediately overlying the Pierre-Fox Hills<sup>1</sup> and which would have been contemporaneous had brackish water conditions been

<sup>1</sup> This sentence was written with the idea that the Bear River fauna of Western Wyoming really belongs to the Laramie, as was once generally believed. It is now known to belong to an entirely different horizon, and this statement was agreed to by Mr. Hatcher at the time of our discussion.—T. W. S.

brought about simultaneously over this entire region, conditions however which are absolutely prohibited by any even fairly reasonable hypothesis. It seems quite reasonable therefore to suppose that the early Laramie was largely contemporaneous in origin with the later Pierre; and were the geological records complete it is not impossible, and I may say improbable, that somewhere to the westward of the 110th meridian the wedge of Pierre shales interposed between the Judith river beds below and the Laramie above would thin out and become entirely replaced by these two formations, just as the Judith river beds below pass into the overlying and underlying marine deposits to the eastward of that meridian.

From the nature of the terrestrial and fresh water vertebrate and invertebrate faunas of the various deposits represented in this region, from the base of the *Atlantosaurus* beds below to the summit of the Laramie above, it is evident that somewhere in this region or adjacent to it terrestrial and fresh water conditions prevailed continuously throughout this entire period though perhaps not in any one locality. Although we have at present only a partial record of such terrestrial conditions it is probable that the record may be still further perfected by the discovery of remnants at least of other non-marine formations.

From the above remarks it will, I think, have been made clear that the various non-marine Jurassic and Cretaceous deposits of our Middle West do not necessarily represent time intervals distinct from those which witnessed the deposition of the marine beds of the same region, but that marine and terrestrial conditions existed simultaneously and more or less continuously, each giving origin to its peculiar deposit. It thus happens in this region that every non-marine deposit, save the uppermost Laramie, has its marine equivalent with which by careful study it may be correlated, and the following diagram<sup>1</sup> is submitted as representing the author's present views as to the proper correlation of these deposits.

<sup>1</sup> The diagram as originally prepared has been altered slightly, as follows: The Laramie is made to extend over the Montana group; the Claggett formation is made to blend with the Pierre-Fox Hills beyond the limits of the Judith River beds; and the Niobrara is interpolated between the Benton shales and the Montana group. These changes make the diagram agree with the text.—T. W. S.

<p>Laramie. Non-marine.</p>	<p>UPPER CRETACEOUS.</p>
<p>Pierre-Fox Hills. Marine.</p> <p>Judith River Beds. Non-marine.</p> <p>Claggett Formation. Marine.</p> <p>Eagle Formation.</p> <p>Marine and Non-marine?</p> <p>Benton Shales. Marine.</p> <p>Dakota Sandstones. Non-marine.</p> <p>Lakota Formation. Non-marine.</p> <p>Atlantosaurus Beds. Non-marine.</p> <p>Baptanodon Beds. Marine.</p>	
<p>MONTANA GROUP</p> <p>Niobrara.</p>	<p>LOWER CRETACEOUS.</p>
	<p>JURASSIC.</p>



The points which it is especially desired to emphasize in the preceding pages are the following:

1. *That stratigraphic position is not the only factor to be considered in determining the relative age of geologic formations.*
2. *That an overlying deposit may have been contemporaneous in origin with that immediately underlying it instead of more recent.*
3. *That in determining the relative age and working out the phylogeny of fossil forms the geographical position at which they occur in a given formation is frequently of greater importance than the stratigraphic.*
4. *That the determination of the approximate time within a given period at which any stratum was deposited is often a more complicated problem than has been generally supposed and cannot always be estimated by its position relative to the base or summit of the series.*
5. *That every correlation should be based when possible on stratigraphy, aided by the contained fossils and an interpretation of those physical conditions attending the deposition of the beds in question.*
6. *That further studies are necessary relating to the physical conditions that prevailed and the changes that were taking place over the region occupied by the formations discussed above during the period of their deposition before we may hope to attain even a fairly satisfactory correlation.*

#### NOTE.

Justice to the memory of my much lamented friend, J. B. Hatcher, impels me to state my belief that had he lived he would not have published the above paper without considerable revision and alteration. The ideas that he has here attempted to express were largely suggested or confirmed by the field study of the Judith River beds in coöperation with the present writer during the summer of 1903. A preliminary statement of our results has already been published<sup>1</sup> and a fuller account, which will shortly appear as a bulletin of the U. S. Geological Survey under the title "Geology and Paleontology of the Judith River Beds," was written by Mr. Hatcher and myself last spring. On account of this association and of my familiarity with the region and formations under discussion, Hatcher came to me with his manuscript immediately after reading it in Philadelphia and invited criticism. At least one other friend

<sup>1</sup> *Science*, n. s., Vol. XVIII, pp. 211-212, Aug. 14, 1903.

in Washington also read it. Hatcher and I spent an evening in earnest, friendly discussion, at the close of which he stated that on some points he had evidently not expressed his ideas clearly, while on others his views had been modified, and that he would seek further criticism from some good stratigrapher and would revise his manuscript thoroughly before publishing it. Evidently he never found time for the revision as he did not change the manuscript in any particular.

There is certainly a lack of clearness of expression, which seems to me due to confusion of ideas, in the repeated statements that imply that stratigraphic sequence in undisturbed deposits does not necessarily mean chronologic sequence. As an example the second of Hatcher's emphasized conclusions may be quoted: "That an overlying deposit may have been contemporaneous in origin with that immediately underlying it instead of more recent." Obviously he did not mean to assert that in any actual exposure one stratum is contemporaneous with another on which it rests, or with still another above it. That would be contrary to the fundamental principle of stratigraphic and historical geology, and Hatcher repeatedly denied that he intended to express any such ideas. He meant rather that distant exposures holding the same apparent position in a formation laid down along a changing coast may not be strictly contemporaneous, and that a formation may be overlain or underlain by deposits similar to those formed simultaneously with it in another area. Thus when he says that the Pierre shales overlie the Judith River beds but are partly contemporaneous with them in origin, he refers to the fact that the Pierre shales in one area form an undivided marine formation which includes the equivalents both of the Judith River beds and of the overlying marine beds which we have designated as the Bearpaw shales. The confusion is caused by calling a part of a formation by the same name as the whole.

Mr. R. T. Hill has long ago suggested that the Dakota sandstone was a littoral formation laid down while the sea was transgressing the land from Texas, Kansas and Nebraska to the Rocky Mountain region, and that it may represent in different parts of the area a much longer time interval than its thickness would indicate. The same author gives a still better example in his discussion of the "Basement Sands" of the Lower Cretaceous, which, he says,<sup>1</sup>

<sup>1</sup> *Twenty-first Ann. Rep. U. S. Geol. Survey*, Pt. VII, pp. 132, 133.

“are undoubtedly of shallow-water or near-shore origin and represent the ancient marginal deposits of the sea as it encroached upon the land. Everywhere, next to the Paleozoic floor and conformable to its slope, this bed of sand, which seldom reaches 200 feet in thickness, persists as an apparent formation, blanketed between the underlying Paleozoic floor and overlying calcareous beds, and inclines toward the sea at a slightly greater angle than the latter.

“While these Basement sands of the Cretaceous, both in the area of outcrop and in that of the embed penetrated by the deepest wells, have the aspects of a continuous formation, they are in fact the interior margin of many formations, and were in process of deposition during a long period of time, and their successive layers are of later and later age as one descends the slope of the old Paleozoic floor.”

The whole discussion from which these sentences are quoted is a clear description of an apparently continuous deposit which is not of the same age in different parts of its area, and which is thus an illustration of the principle that Hatcher especially emphasized. Such conditions are exceptional, however, and it by no means follows, as Hatcher seems to have supposed, that all, or even most, littoral and non-marine formations were extended only by accretions along their borders, and consequently that if they cover any considerable area the time required for their deposition is proportionally long, or, to quote Hatcher's words, that the time interval “should be estimated not so much by their vertical thickness as by the extent of their geographical distribution.” In cases like those above cited it is usually possible to determine the true character of the deposits and to form some idea of the time interval represented by them by studying the associated formations. If a conformably overlying formation is the same throughout the area occupied and shows no change in paleontologic contents, we must conclude that the interval represented by the upper layers of the deposit in question is brief in a geological sense, although we may be convinced that the deposits at different localities were not strictly contemporaneous when measured by the smaller time units of human history. The fact that in certain cases a formation may not be strictly contemporaneous throughout its geographic extent is not denied, but the relative importance of this fact in its bearing on paleontologic and stratigraphic work is questioned. In my opinion it is greatly exaggerated in the third of Hatcher's conclusions.

Concerning two important assumptions in Hatcher's argument we could not reach an agreement: (1) That the continuance of present conditions along the Atlantic coast would result in such a succession of formations as is represented by Fig. 1; and (2) that the conditions now obtaining along this coast are comparable to any considerable extent with those of the Middle West in Mesozoic time.

The diagram (Fig. 1) was of course intended only as a crude illustration of the author's ideas. Granting that the littoral deposits might extend progressively seaward over the true marine beds, it is scarcely conceivable that the sediments laid down in brackish and fresh waters could constitute continuous formations across the entire area, nor that any great thickness of fresh water deposits could be built up above sea level on a coastal plain. Nor does it seem to me probable that even the littoral deposits laid down under such conditions would be treated as a single formation.

It is difficult to reconstruct the physiographic conditions that prevailed in the middle West during later Mesozoic time, but it should be remembered that there was then a great shallow continental or mediterranean sea, and that there were large areas so near sea level that very slight movements would bring them beneath the sea or partly or wholly drain them, so that it is probable that shallow water and non-marine conditions were often extended over large areas very rapidly. It should be remembered also that in speaking of the great geographic distribution of the resulting formations we are often dealing with their extension along a shore, or with contemporaneous deposits on opposite shores of the same sea. With such conditions it is easy to understand the many alternations of marine with non-marine formations, and it is recognized that both classes of deposits were formed contemporaneously in adjacent areas. This has made the geologic record of that region very complex, if not obscure, and it is still far from being completely interpreted.

The correlations indicated by the diagram have mostly been worked out by stratigraphic methods aided by paleontology, and agree with the present state of knowledge so far as the Upper Cretaceous is concerned. The treatment of the lower horizons is more tentative and represents Hatcher's opinions as stated in the text.

More detailed criticism and comment are unnecessary, although many minor points are subject to discussion. The whole paper is

full of suggestive ideas and again calls to mind the loss that geology has sustained in the untimely death of J. B. Hatcher. Had he lived he would have continued to make important contributions to the geologic history of the West, especially in connection with the problems concerning the non-marine formations whose importance he fully recognized and in which he was so deeply interested.

T. W. STANTON.

*Washington, D. C., November 17, 1904.*

## THE MORPHOLOGICAL SUPERIORITY OF THE FEMALE SEX.

BY THOMAS H. MONTGOMERY, JR., PH.D.<sup>1</sup>

*Read October 7, 1904.*

It is remarkable the view should still generally obtain that the male sex is superior structurally to the female. This has resulted mainly from the fact that most writers upon sexual dimorphism have been males and, on the principle that charity begins at home, wished to give their sex all credit. Social economists in their ill-considered gleanings from Biology hold for the most part that the male is the superior, structurally and psychically, speaking of man as the "progressive" and woman as the "conservative" element of human society. But even if these terms are correctly applied, which is assuredly open to question, it does not follow that conservatism denotes inferiority and progressiveness superiority, at least from the morphological standpoint. Some naturalists share this opinion, though the facts are in patent contradiction to it; others grant the female is the superior in the lower animals, but not in the higher; most express themselves very decidedly that in the human species at least the male is the morphologically more perfect. It is a question of fundamental importance in any consideration of sexual dimorphism, especially in the valuation of the so-called secondary sexual characters. And should the common view be disproved, the relations of the sexes would show in a very different light; the male must be regarded as the inferior organism.

<sup>1</sup> Contributions from the Zoological Laboratory of the University of Texas, No. 62.

The object of the present contribution is to deal with the subject briefly from the anatomical and embryological standpoint; considering first the Invertebrates, and lastly the Vertebrates.

### I. THE INVERTEBRATE ANIMALS.

Lamarck's collective group of the "*Invertebrata*" is of course retained to-day only for convenience; the numerous phyla which compose it differ far more greatly from each other than do any of the extremes of the *Vertebrata*.

In the *Invertebrata*, whenever there are marked structural differences between the sexes, it will be found to be a rule almost without exceptions that the male is morphologically inferior.

There are, in the first place, those numerous cases where the sexes are markedly different, in that one is much less developed than the other, *i. e.*, is the resultant of much shorter embryonic growth. Thus all the families of the *Rotatoria* so far as known, with the exception of the *Asplanchnidae* and *Seisonidae*, possess males inferior to the females in much smaller size and complete absence of the digestive system. As I expressed myself in a study of the *Flosculariidae*, these males are arrested individuals. A more marked example is found in the Echiurid *Bonellia*, where the male is only one one-hundred-and-fiftieth the length of the female, and lacks an anal aperture; he is a degenerate, living as a parasite within the female. Similar examples occur in the *Cirripedia*. On the other hand it is seldom found that the female is embryologically more arrested than the male; such a case is that of the glowworm, however, where the male is winged but the female apterous, and in certain *Hemiptera heteroptera*. But these are arrests in external organs of locomotion, implicating less profound changes than those shown in the preceding cases.

Our case holds even for most hermaphrodites, paradoxical though it may at first appear to speak of males and females among hermaphrodites. In almost all examples of hermaphroditism it is the rule that the male and female organs of generation and reproductive cells do not mature simultaneously, but successively, as I have shown elsewhere.<sup>1</sup> In the greater number of these cases the male germ cells mature and are discharged first, then the female, a condition known as protandry. Here the individual is functionally

<sup>1</sup> "On Successive, Protandric and Proterogynic Hermaphroditism," *Amer. Nat.*, 1895.

first male, then (for a limited period) hermaphrodite (functionally male and female), lastly female; but since there is the same cycle of reproductive conditions in each individual of the species, the individual as a whole is ranked as hermaphrodite. This holds for some *Nemertini*, *Pelecypoda*, *Spongiaria*, most *Turbellaria*, *Myzostomida*, and for numerous other cases. These show the male condition to be established at the earlier ontogenetic period, before the individual has attained its complete growth; consequently the male condition is morphologically inferior to the female. There is, however, another state of hermaphroditism known as proterogyny (protogyny), with the female condition preceding the male. This is of course the reverse of protandry; it is very restricted in its occurrence, and is described only for certain pulmonate *Gastropoda* and for the tunicate *Salpa*, cases that need reëxamination.

Hermaphroditism in the strict sense implies a condition of union of sexes in one individual, not an indifferent, non-sexual state. With this definition it is probable that hermaphroditism is a secondary condition wherever it is found, and not a primitive one. The earliest phyletic state is non-sexual, as in certain generations of some *Protozoa*. These are of anatomically distinct sexual individuals, as shown in the sporulation generations of some *Protozoa* (with micro-gametes and macro-gametes), and in most of the *Metazoa*. While hermaphroditism has appeared independently in different groups, such as the *Platodes*, the *Mollusca*, *Tunicata*, etc., where it occurs it is frequently the case that the more primitive members of the group are dicecious (with separate sexes). No Protozoan can be correctly termed hermaphrodite, but sexual or non-sexual. *Volvox* cannot be considered either Protophyte or Protozoan, but Metaphyte or Metazoan, since it contains distinct germ cells and tissue cells; it accordingly is no exception.<sup>1</sup> But however the hermaphroditic state may be interpreted, it stands as an indubitable fact that in most hermaphrodites the male condition occurs during the less perfect stage of the individual.

In speaking of the male as being so frequently the more arrested, more embryonic individual, corroborative examples are found in

<sup>1</sup> It is indeed strange that *Volvox*, at this late date of our knowledge, should still be grouped with the *Protista*. The fundamental criterion of the *Metaphyta* and *Metazoa* is not number of cells, nor their specialization, but the possession of cells which are reproductive and other cells which are not. This is the only truly important physiological distinction.

the condition known as Neotenia. This term is applied when the germ cells mature before the tissue cells have attained their final specialization; the individual is mature sexually before it is corporeally. Neotenia is found mostly (whether always, I cannot say) in males. It is not infrequent, particularly among parasites; thus in the male Gordiacean the spermatozoa may be fully mature before the animal's external enticula is completely developed. This is but another case of the male condition, *i.e.*, the essentially masculine characteristic, appearing earlier, at a more embryonic stage, than the female state appears. An increasing acceleration (in the sense of Cope) of neotenia would throw the male condition further back into the ontogeny, and could lead to the formation of embryonic males, such as in the *Rotatoria*, etc.

There next comes up for consideration an array of forms where there are no well-marked secondary sexual differences, *i.e.*, differences apart from those furnished by the reproductive systems, and where the sexes are separate. These are found mostly in the lower *Invertebrata*; most *Nemertini* (but *Carinella* with distinct coloration of the sexes), most *Hydrozoa*, *Scyphomedusæ*, *Echinodermata*, *Enteropneusta*, most dioecious *Mollusca* and *Annelida*. Absence of secondary sexual differences is here correlated with aquatic life, fertilization of the germ cells without copulation, and relative simplicity of the genitalia. The latter in each sex consists of gonads, regions of localization of the germ cells known as testes and ovaries, and comparatively simple efferent ducts (or no preformed ducts). Accordingly, the testes and ovaries may be essentially alike, as simple sacs in the *Hydrozoa* and *Nemertini*, or surfaces in the *Polychata*. When this is the case, and in the absence of secondary sexual differences, we cannot say which sex is morphologically the more advanced; but there is no evidence that the male is the superior. In the dioecious *Mollusca* the reproductive organs of the female are the more complex, in the presence of various glands concerned with the formation of egg envelopes, so that in these forms the female is the more perfect.

In the large groups of *Nematoda*, *Gordiaceae*, *Crustacea*, *Arachnida*, *Insecta*, progoniate and opisthogoniate *Myriapoda*, there are generally present secondary sexual differences as well as differences in the genitalia. In the *Gordiaceae* the male is smaller than the female, and sometimes with greater specialization of the cuticular protuberances; but the female has more complex reproductive



organs—glandular organs not present in the male, ovaries with lateral diverticula, while the testes are simple tubes. Among the dioecious *Nematoda* the male is always the smaller, with copulatory spicules and a bursa not represented in the female; also the testes are usually impaired, a higher condition, *i. e.*, one involving more modification, than the condition in the female where there are paired ovaries. On the other hand the female is larger, with the genital ducts more complicated and with a receptaculum seminis; and unlike the simpler male condition where the genital ducts open into a cloaca, the female shows the higher morphological state of a separate aperture for the reproductive ducts (with the single exception of *Cloacina*). In both these groups, then, the female appears structurally more advanced. In the group of *Insecta*, *Arachnida*, *Crustacea*, *Opisthogoneata* and *Progoneata* we find forms that in many respects appear the most specialized of all the Invertebrates (not excluding the *Tunicata*). They are all essentially terrestrial forms, for there is good reason to conclude with Simroth<sup>1</sup> that even the *Crustacea* arose from ancestors that lived upon the land, or at least in very shallow water, though most of the modern representatives are aquatic. In these annulate groups, contrary to the groups considered in the preceding paragraph, we find the association of terrestrial life necessitated thereby an intimate copulation process and notable differences in the reproductive organs, also secondary sexual differences. In these forms the male is almost always smaller than the female, notably so in many *Araneæ* (particularly of the family *Argiopidæ*). The only exceptions to this rule that occur to me are a few beetles and certain *Hymenoptera*. The male may be more complex than the female in the possession of clasping organs, and sometimes in the more complete development of sensory organs. So in the ants and flies particularly the compound eyes are frequently larger in the males, and sometimes differ from those of the female in being confluent (a secondary condition). The most important olfactory and tactile organs of Insects, the antennæ, are frequently larger and more complex in the males, as shown especially in the case of the Moths; and in the Spiders the special tactile organs, long hairs, are in some cases relatively and even absolutely larger in the males. Then it is well known that in these forms the male differs frequently in external form, and often is more brightly colored than the

<sup>1</sup> *Die Entstehung der Landtiere*. Leipzig, 1889.

female—frequently a morphological character, as in the case of all metallic, non-pigmental colors. In these groups then the male may be the morphological superior in the possession of clasping organs or greater development of sensory organs, or of external modifications of form and structural coloration.

But we must recollect that special clasping organs are not general; they are found mainly among the *Crustacea*, by no means in all of them, and usually in correlation with the lack of an intromittent organ. With the development of an intromittent organ, which attains the greatest complexity among all animals in the Insects and Spiders, special clasping organs are rarely found. When they exist they are for the most part comparatively simple modifications of already existing structures, usually limbs. Accordingly the possession of clasping organs is a character of little morphological import.

In regard to the point that the males of these groups are sometimes superior in sensory equipment, every comparative anatomist realizes that sense organs are of little morphological value, because they are not conservative and are readily changed or lost. The *Medusæ* have more complex sensory organs than, *e.g.*, the *Turbellaria*, but no one would rank the former higher on this account. Any change of life leading toward loss of locomotion, as in sedentary and parasitic animals, is followed by degeneration of the sense organs as one of the first modifications; and in the case of subterranean and cavernicolous species, such a comparatively slight change as that from light to darkness, induces the replacement of visual organs by tactile and olfactory. Notice the loss of the lateral line system of sense organs in the case of the emergence of aquatic Vertebrates from the water to the land; or at least, according to a recent theory, their change into non-sensory hairs. That greater size of sense organs by no means induces greater complexity of the nervous system is shown by the comparison made by Forel:<sup>1</sup> in the male ant (*Lasius*) the compound eyes are largest but the cerebrum (supra-oesophageal ganglion) most rudimentary, while in the female (particularly the worker) the eyes are smallest but the cerebrum with the greatest number of ganglion cells. In fact we may say, in the light of phylogeny, that greater size and complexity of peripheral sense organs is a more primitive condition than that of small and less complex sense organs but more concentrated

<sup>1</sup> *Ants and Some Other Insects*. Translated by Wheeler, Chicago, 1904.

nervous system. Phylogenetically the peripheral nervous system, composed essentially of sensory nervous units, is the earlier, more primitive condition; while the centralized reflex-mechanism is later and morphologically higher. First the simple surface sensory apparatus, later the internal coördinating centre. As the central nervous system becomes more complex, a process denoting morphological advance, the more complex sense organs are apt to disappear or to be replaced by more numerous ones of less complexity.

It follows from these considerations for the arthropodous groups, that though in a few cases the males may be equipped with sense organs of larger size, this character by no means implies structural superiority, and especially not when it can be shown that with it is associated a less complex central nervous system. Indeed in the ant the male is decidedly inferior, with regard to the nervous system as a whole.

The other secondary differences, as those of external form and coloration, are generally to the credit of the male. But it is obvious that such characters, from their very lack of conservatism, imply little structural value.

Now let us examine in these groups of *Nematoda*, *Gordiacea*, *Crustacea*, *Insecta*, *Arachnida* and *Myriapoda*, to which might be added a number of smaller groups such as the *Acanthocephala*, the points in which the female is the superior of the male. One has been mentioned, the presence in some Insects of a better developed cerebrum. The other point is the greater complexity of the reproductive organs. As homologous in the sexes we consider ovary with testis, oviduct with vas deferens, certain mucous glands, and in some cases vagina with intromittent organ. The male usually possesses as dilations of the vasa efferentia seminal vesicles; except for these and the intromittent organ he has no structures not represented also in the female. The intromittent organ may be very complex as in most Insects and in Spiders (terminal joint of the maxillary palpus), or it may be very rudimentary and simple. Where it is complex the vagina of the female is frequently as correspondingly complex (*Diptera*, *Coleoptera*). On this account the intromittent organ cannot be regarded in all cases as evidencing greater complexity in the male; and probably when systematic entomologists employ characters of the external female apparatus as extensively as they have done the male for purposes of diagnosis, they will find the receptive apparatus of the female to be quite as

complex in many cases. Whenever there is intra-parental development the oviducts become specialized in a portion of their extent as uteri; such structures are not represented in the male. Very frequently also there are special glands for the elaboration of egg envelopes. Very generally there is in the female a more or less complex receptaculum seminis, usually with its peculiar musculature and duct, which is not found in the male. The ovaries may have the same structure as the testes. But not infrequently the ovaries are more complex than the testes, and this is shown particularly in the arthropodous forms. This follows from the necessity of the production of yolk substance for the egg cells, substance to be stored up in the egg for the nourishment of the embryo, whereas such substance is used by the sperm cells only in limited amount. The first formation of the yolk substance is an elaboration by the vitellocytes (nurse or follicle cells), which are germ cells that have lost their reproductive ability and become nutritive. These have their representatives in the testes in the cells of Sertoli, also nutritive. But the ovarian vitellocytes play a greater part in the growth of the embryo, and accordingly they are larger or more numerous. Further they are segregated to form particular chambers of the ovary, so that the nutritive and reproductive cells occupy different places within the ovary. This is the case in the *Rotatoria* and some *Crustacea* (*Branchiopoda*), and in the Insects, where the egg-tubes that compose each ovary have each a terminal chamber of vitellocytes (*Hemiptera*), or vitellocyte chambers alternating with egg-cell chambers (*Coleoptera*). These are all specializations in the arrangement of the nurse cells which mark the ovary as being a more complex structure than the testis. Then there is found in the female of many Insects an apparatus for oviposition, known as the sting or ovipositor, often of high degree of complication, involving parts of two (or more?) segments; this is entirely absent in the male. The female usually guards and protects the young, sometimes with the development of a brood chamber (some *Crustacea*); that is only exceptionally the case with the male, and sometimes, as in the hemipteron *Zaitia*, he is forced by the female to carry the eggs against his will. But the males of the *Pycnogonida* carry the young.

From this rapid survey of some of the facts of sexual dimorphism, we find the supposed excellence of the male to consist in what are mainly unimportant morphological characters, of which the (not

universal) possession of an intromittent organ is perhaps of the most weight. Beyond this the male may possess clasping organs, in a few cases have larger sense organs, and show brighter or more contrasted coloration, and sometimes be more varied in external form. This is all he has to show in the claim of superiority. While the female possesses an internal reproductive apparatus which is generally of much greater complexity than that of the male, and sometimes a central nervous system of higher specialization, a condition which probably will be found to be general in all those numerous cases where the female carries out the chief cares of maternal solicitude for the young. And almost without exception the female is larger than the male, a character of some structural value, because it implies, *ceteris paribus*, a longer or intenser process of embryonic development. When either of the sexes is rudimentary in comparison with the other, it is in almost all cases the male. All the facts point to the male being the more embryonic and less developed, and none to his being the morphologically more progressive.

Physiologically, also, the female appears the superior in most of the Invertebrates. The male Rotatorian, as I have watched him, emerges from an egg much smaller than that which produces a female, lives a day or two without feeding for the good reason that he has no digestive organs, then dies; while the much larger and more complicated female lives for months. In Insects and Spiders the male seems to be always shorter-lived than his mate, generally takes no part in the care of the young and dies immediately after impregnating the female. But the female lives on after impregnation, sometimes for months before depositing the eggs; then oviposits, often after great care for the protection of the young; not until all this is accomplished does she die. We may say that the female develops more slowly, reaches a larger size and lives longer, and this, together with her care for the progeny, classes her as the distinctly important individual in the economy of Nature.

## 2. THE VERTEBRATE ANIMALS.

When we turn to the Vertebrates the comparison of the sexes becomes more difficult, especially in the higher forms. The primary sexual characters may be considered first, then the secondary.

In the matter of the reproductive organs there is a complicated series of facts of structure, which have not yet received adequate

consideration with regard to the relative morphological status of the sexes, nor yet with reference to their bearing upon the questions of phyletic relationship. Relative simplicity and similarity of the genital organs, as in the Invertebrates, is found only in aquatic forms, and in those where there is neither intimate union of the sexes nor intra-uterine development. This condition is realized in most Fishes, *Dipnoi* and *Batrachia*.

Among the Fishes, more especially the *Teleostomi* (*Ganoidei* and *Teleostei*), the testes and ovaries are much alike in structure, usually sacs with more or less folded walls; this is also the condition in the *Acrania* (*Amphioxus*). In the *Batrachia*, particularly the *Urodelia*, the testes are more complicated than the ovaries since they are divided into lobes. In the *Sanropsida* and *Mammalia* the ovaries are no longer sacs, but solid cellular masses with follicle cells and germ cells intermingled; there is always, however, more or less of a radiate lobulation of the organ. The testes of the same forms are composed each of masses of tubules, of which the walls are made of cells of Sertoli and early generations of spermatogonia, while their lumen becomes filled with more mature germ cells. There can be no question that in the higher Vertebrates the testes are more complicated than the ovaries, the reverse of the case in the Invertebrates. But while the testis is morphologically more complex, it nevertheless retains primitive embryonic structures more than does the ovary. For the vasa afferentia, namely, of the testis, as at least the proximal portions of the vasa efferentia (these together constituting the tubules of the testis), represent persistent mesonephric tubules, the second kidney system of the embryo; these persist in only very rudimentary form in the ovary. From this standpoint the testis, while more complex, is concurrently less progressive; the ovary, though structurally simpler, has changed more in the course of the ontogeny.<sup>1</sup>

The gonads are primarily paired in the Vertebrates, except in the *Cyclostomata*. When in higher forms there is degeneration of one of the pair it is always an ovary, as in Birds, and never a

<sup>1</sup> In regard to the comparison of the testis and ovary, it becomes obvious that greater complexity of structure, or specialization, does not imply greater morphological advancement of its possessor, unless it is associated with correspondingly greater change in the ontogeny. So an extreme parasite, as *Tenia*, is structurally simpler than its free-living ancestor, though in point of phyletic change it is far more advanced. Regressive development is still development. This is an important consideration which anatomists do not always appreciate.

testis. Reduction of one member of a structural pair is always a departure from the primitive condition, hence a more advanced morphological state than retention of both members. But with the case in point this morphological difference cannot be justly thought of much value, for with the right ovary of Birds, as with one of the lungs of Snakes, the reduction is due simply to mechanical pressure inducing stoppage of the nutritive blood fluid, and not to any profound change in the growth processes.

Turning to the comparison of the genital ducts, we find the most primitive condition in the *Cyclostomata*, certain *Teleostei*, and, according to Gegenbaur, in the Selachian *Læmargus*: there are no genital ducts, but the germ cells fall directly into the body cavity (coelom), and are discharged to the exterior through abdominal pores. In the *Acrania* there are also no ducts, but the relations are less simple in that the genital products fall into the atrium (an ectodermic cavity) and from there are passed to the exterior through the atriopore. In these forms the sexes are alike in the mode of discharge of the genital products.

In all other Vertebrates there are special genital ducts, which may be considered separately for each sex.

Four kinds of genital ducts may be distinguished in the male, according to their mode of embryonic formation. (1) The segmental duct (pronephric duct, duct of the earliest kidney system, the pronephros) persists as the urogenital duct, as the common duct of testes and kidneys. This is the most usual condition, and is found in all the *Amniota* (Reptiles, Birds, Mammals) and *Batrachia*, all the *Selachii* except *Læmargus*, in *Lepidosteus* and *Acipenser*. In all these cases a Müllerian duct is laid down, but either remains embryonic or disappears more or less completely. (2) A direct backward growth of the testis itself is the genital duct: most *Teleostei*. (3) An open groove of the peritoneum serves as a genital duct: *Polypterus* and *Amia*, according to the description by Jungersen.<sup>1</sup> (4) In *Protopterus* a tube formed within the testis is the sperm-duct, and this unites with the persisting posterior end of what is considered a Müllerian duct.<sup>2</sup> Of these kind of ducts the last three are much more alike among themselves than is any of them to the first kind. It follows that for all gnathostomatous Vertebrates, except some *Teleostomi Læmargus* and *Protopterus*,

<sup>1</sup> *Zoolog. Anzeiger*, 1900.

<sup>2</sup> According to the account by W. N. Parker.

there is in the male a common urogenital duct, the segmental duct, which is a duct persisting from a very early stage of the embryo.

In the female of gnathostomatous Vertebrates but two kinds of genital ducts are found. (1) The oviduct is a direct backward growth of the ovary: *Lepidosteus* and most *Teleostei*. (2) The oviduct is a Müllerian duct, separate from the ovary and from the segmental duct. This may arise as an off-splitting from the ventral side of the segmental duct (most *Selachii*), but it more usually develops independently of the latter as a fold or ingrowth of the peritoneal epithelium (*Batrachia*, *Amniota* and possibly *Dipnoi*). In the female there is accordingly never a urogenital duct, but the oviducts are separate from the ureters. Further than this, while the vas deferens of the male usually possesses dilations in the form of seminal vesicles, also a prostrate gland, the oviducts are much more specialized whenever there is intra-parental development of the young. For the oviducts, besides the possession of special glands, have very complicated dilations, the uteri, much more specialized than the seminal vesicles; and in most of the Mammals the oviducts are fused for a great portion of their extent, so that in the place of paired uteri there is but a single one—a further advance beyond the male condition. The uterus is not only a receptacle for the young, but a complicated nourishing apparatus, with recurring profound morphological changes. Even in some *Teleostei* (e.g., *Zoarces*) uteri may be present, though most species of this group are oviparous. The complications of the female reproductive ducts are induced by viviparity.

From this comparison of the ducts of the reproductive organs, it follows that in respect to these structures the female is morphologically the more advanced. The most important fact is the embryological one that in the male there is generally a persisting urogenital duct, in the female never a urogenital duct but oviducts separate from the ureters.

With regard to other differences in the sexual organs, the most important is the relative position in the body of ovaries and testes. Both arise in gnathostomatous Vertebrates as parallel longitudinal ridges of the peritoneum, close to the dorsal mesentery. Of these ridges only a portion fully develops, the remainder becomes arrested. An ovary is a growth at about the middle of such a ridge, a testis at a point of the ridge somewhat further back. Both ovaries and testes retain their abdominal position in most Verte-



brates. But in the higher Mammals the testes move from this position (*descensus testicularum*), at least periodically (*Rodentia*), into an external sac, the scrotum; morphologically speaking they are still, however, intra-peritoneal. This is of course a change without parallel in the female. But in those forms where this condition obtains the female shows a structural advance which quite balances the *descensus testicularum*, namely, complex mammary glands. These are groups of enlarged cutaneous glands, usually with complicated ducts of discharge; in the male they do not advance beyond the embryonic condition and are rarely functional. The intromittent organ of the male attains its greatest complexity in certain *Teleostei*, *Reptilia* and the higher *Mammalia*, and then is always more complex than its female homologue, the clitoris. But in the Vertebrates it is never as complex a structure as in Insects and some Mollusks, and is hardly to be considered more specialized than the clitoris and vulva considered together. Special clasping organs of the male are infrequent (*Selachii*, *Anura*). The female, on the other hand, has in some cases brood chambers for the carriage of the young, as the pouch in the Marsupial Mammals and the skin of the back in the toad *Pipa*; the mouth cavity is of use in the Viper for protection of the young. It is more rare for the male to care for the young, and to have special structures for this purpose, but such cases are found in the abdominal pouch of the teleostean *Sygnathidæ* and the oral cavity of certain *Anura*.

The foregoing facts show that the genitalia of the male and female are essentially alike in the *Acrania* and *Cyclostomata*. In most *Teleostei* they are also alike, except that the male sometimes possesses an intromittent organ. But in most higher forms they are markedly dissimilar, and we can conclude that as a rule the female is morphologically more advanced in the point of gonads, genital ducts, and apparatus for the protection or nursing of the young. From the standpoint of the reproductive organs the female is clearly the superior.

Most investigators of mammalian embryology explicitly hold that the male represents an individual advanced beyond the condition of the female. They adduce the facts that the external genitalia are at first alike in the sexes, then while the clitoris remains small the intromittent organ continues to grow, and while the ovaries retain their original position the testes descend into the scrotum. But these are relatively small differences in comparison with the others we have reviewed.

The other characters in which the males of Vertebrates differ from the females are secondary sexual. Sometimes such external differences are very slight or not perceptible, as in many of the Fishes, Birds and urodelous *Batrachia*. In most of the group, as we found for the Invertebrates also, the male is smaller; this is the case in the *Acrania*, *Cyclostomata*, *Selachii*, most *Teleostomi*, *Dipnoi*, most *Batrachia*, even in most *Reptilia*. In most Birds where there are sexual differences in size the male is the larger (but the female is in certain species of *Falconidæ* and *Scolopacidæ*), and in Mammals too the male is generally larger. This is an important difference, particularly when it implies a longer growth period and slower attainment of maturity, as in the Primates; we shall recur to this point. When there occurs dichromatism, it is the male that has the brighter or the more contrasted colors, as it is the male that possesses more marked integumentary structures, such as odoriferous glands, combs, plumes, greater development of feathers and hair, spurs, etc. But the greater intensity of coloration does not always denote morphological advance, for frequently the colors are not structural (diffractive) ones. And the greater complexity or size of integumentary structures is well known to be a character of little morphological importance, because of the lack of conservatism of such parts, their ready susceptibility to change. Among closely related forms, as in some families of Birds, we may find a species in which the sexes are externally alike in color and plumage, and another species in which they are quite dissimilar in these respects. In the Reindeer the cow has antlers as well as the bull, contrary to the condition in other deer. It is only rarely that the differences of the male are of greater morphological import, as in the different form of skull in the male salmon. We may decide from another point of view that secondary sexual characters must be estimated as of little value, because they have not even the worth of a species diagnostic, being not representative of all the individuals of a species. Accordingly, such secondary sexual differences are of too small worth to occupy much attention in the matter of comparing the sexes.

We have now briefly compared the sexes by the standards of the structure of the reproductive organs and of the secondary sexual differences. We have found that while the female usually shows more advancement in the reproductive organs, the male evinces more in secondary sexual characters. Obviously it becomes a question of which of these characters is the more important.

The only secondary sexual character of morphological importance is that of bodily size, as we found in discussing the Invertebrates; it is the only one at all commensurate with anatomical differences in the genitalia. Its importance lies in the fact that greater size of one sex means a longer or more intense growth, greater continuation of development. This is the more evident where greater size is associated with longer time before the attainment of reproductive maturity. To be sure this must not be interpreted to mean that longer embryonic growth period is always to be construed as implying higher morphological rank, for the Elephant takes longer to mature than does Man, yet the Elephant is decidedly lower in the phyletic scale; so, also, some Reptiles take a longer time than many Mammals. But within the same species, where one sex grows larger than the other it is, *ceteris paribus*, a sign of distinct morphological advance beyond the other.

Now in most of the lower Vertebrates (most Anniotes and Reptilia) the female is the larger, and at the same time usually the more advanced with regard to the reproductive organs; the male shows his superiority only in unimportant integumentary characters. For such Vertebrates it is very plain that the female is structurally superior. But in most Birds and Mammals (much more rarely in lower forms), while the female is still more advanced in the structure of the genital organs, the male is usually the larger—a condition rare among animal groups treated as a whole. Is then the female still morphologically superior in these forms, or are we to consider that the relation has reversed itself so that in the highest forms the male has become the morphological superior? It is the question of the relative worth of the two characters: greater complication or embryological advancement of the reproductive organs or greater bodily size implying a longer period of development. Or we may state it: the female is embryologically the superior in respect to the reproductive organs, the male in regard to the other organs of the body—which of course is directly correlated with the greater part that the female takes in the process of procreation. While different morphologists might estimate the value of these characters differently, I am inclined to judge the greater embryological advancement of the reproductive organs to be a condition of more morphological importance than greater bodily size.

So we reach the conclusion, that the female is clearly the super-

ior, from the standpoint of morphological advancement, in the Invertebrates and the Lower Vertebrates; and still superior, but in less degree, in the higher Vertebrates. This is certainly the opposite of the view of most naturalists, but to my mind there can be no other inference from the facts.

*University of Texas, September 22, 1904.*

---

*Stated Meeting, October 21, 1904.*

President SMITH in the Chair.

The death was announced, at Philadelphia, of Rev. Jesse Y. Burk, on October 18, aet. 64.

Dr. George T. Moore, of the Department of Agriculture, Washington, read a paper on "A New Method for the Purification of Water Supplies."

---

*Stated Meeting, November 4, 1904.*

President SMITH in the Chair.

The death was announced of the Marquis de Nadaillac, at Château de Rougemont, St. Jean Froidmentel (Loir-et-Cher), on October 1, 1904, aet. 87.

The following papers were read:

"The Behavior of the Lowest Organisms," by Dr. Herbert S. Jennings.

"Electrolytic Calcium," by Joseph H. Goodwin.

---

*Stated Meeting, November 18, 1904.*

President SMITH in the Chair.

The death was announced, at Bethlehem, Pa., on November 16, of Dr. Thomas M. Drown, aet. 62.

Prof. Bailey Willis, of the Carnegie Institution, read a paper entitled "By Courtesy through China."

## ELECTROLYTIC CALCIUM.

[*Contribution from the John Harrison Laboratory of Chemistry.*]

BY JOSEPH H. GOODWIN.

(*Read November 4, 1904.*)

Metallic calcium can be easily made in large quantities as shown by the following experiments which required only a short time and simple and easily constructed apparatus. The method used was the electrolysis of fused calcium chloride with a hollow cylindrical anode vessel of Acheson graphite (Fig. 1). At first the bottom was

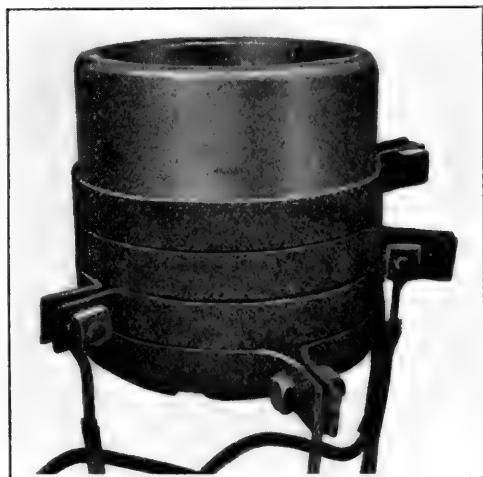

Figure 1.



Figure 2.

closed by a smaller iron cylinder insulated from the graphite by asbestos, cooled by circulating water in it and having an iron rod projecting upward through its centre to form the cathode (Fig. 2). This was discarded because the calcium (1) often short-circuited the furnace by the formation of spongy metal, (2) was obtained in small pieces, (3) was difficult to remove, and (4) was surrounded

by molten calcium chloride with which it combined, greatly lowering the current efficiency. In connection with this form of cathode an attempt was made to use a cylinder of fine iron gauze to collect

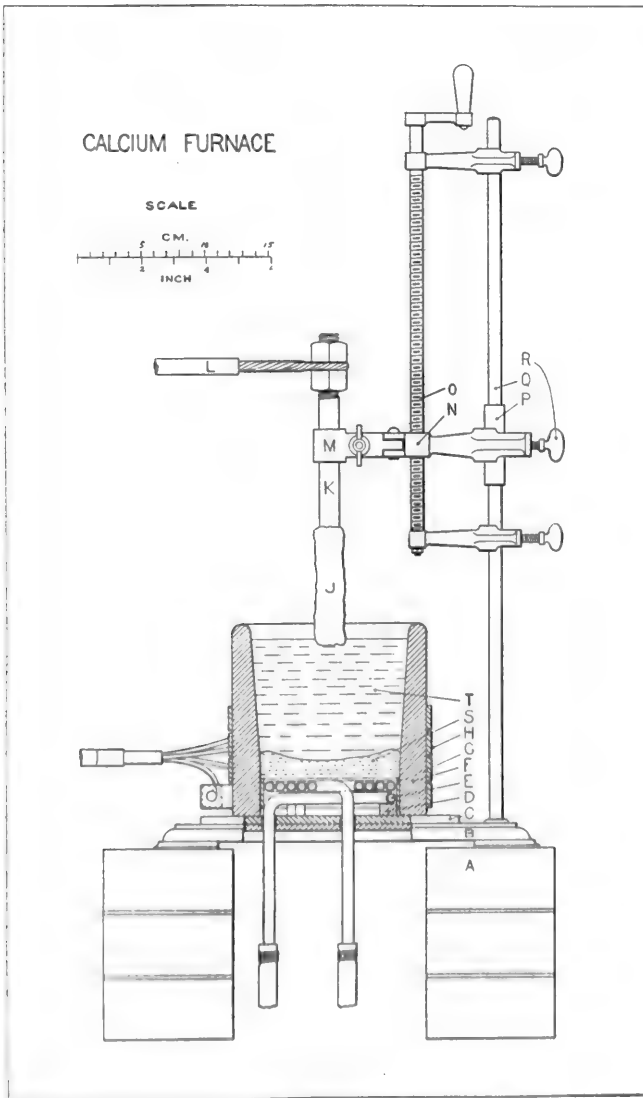

Figure 3.

and retain the molten calcium, like the nickel gauze in the Castner sodium furnace, but the long continued action of 225 amp. would not fill this gauze with calcium because it presented a large surface for the rapid recombination of the calcium:  $\text{Ca} + \text{CaCl}_2 = 2 \text{CaCl}$ .<sup>1</sup> The formation of calcium and chlorine almost ceases and active reaction and circulation are seen to take place in the molten electrolyte.

In the satisfactory furnace (Fig. 3) the bottom of solid calcium chloride was maintained by the cooling effect of a copper coil (E, Fig. 3 and Fig. 4) through which water was circulated. This coil was insulated from the graphite by asbestos, but a Weston milliammeter indicated that it was carrying .17 amp. of the anode current (190 amp.); therefore, to prevent contamination of the bath by copper, a gravity cell (B, Fig. 5) was connected between the copper and the graphite and the milliammeter indicated .04 amp. flowing the other way. This very simple and efficient cooling coil was made by annealing four feet of  $\frac{5}{16}$ -inch seamless copper tube in a Bunsen flame, filling it with sand, plugging the ends and bending it easily into shape by hand.



Figure 4.

The new form of cathode was a  $\frac{5}{8}$ -inch iron rod (K, Fig. 3), dipping into the bath from above and capable of being raised or lowered by the screw mechanism O. As the calcium was deposited on the end of this iron rod it solidified, due to the cooling effect of the cold upper part, the whole was gradually raised, the calcium itself conducted the current away and formed the cathode, continuing to grow in the shape of an irregular cylinder J. This is simplicity itself because it accomplishes at once—

1. A method of making cylinders of calcium up to 4 cm. diameter and of any length desired with this small furnace. (When the limit of the screw is reached the clamp M can be loosened, lowered and a new hold taken.)
2. Quick removal of the calcium from the molten calcium chloride, which is essential to maintain a fair current efficiency.

<sup>1</sup> Borchers, *Elektro-Metallurgie*, 1896, p. 78.

3. Oxidation prevented by a covering of calcium chloride, fine particles being deposited by the bursting of bubbles of chlorine rapidly evolved at the anode.

The furnace is shown in detail in Fig. 3, and all dimensions can be found by reference to the scale. The bricks A support the retort stand B, on which is a thick piece of asbestos C, holding by the blocks D the copper coil E well up in the Acheson graphite anode F and insulated from it by the asbestos G. The iron bands H conduct the current from the positive cable I to the graphite vessel F. The calcium grows and forms the stick J, which is started by the iron cathode K connected with the negative cable L and supported by the clamp M, which is drilled and tapped at N to receive the screw O by which it can be raised or lowered. P is a tube sliding freely on the rod Q of the retort stand, and against which R is firmly screwed to make the clamp M fairly rigid without interfering with its vertical motion. Fluor-spar covers the copper coil and fills the space about it, while the furnace is filled with calcium chloride which becomes solid at S and is kept molten at T solely by the current passing through the furnace. The whole apparatus was set up inside an empty wind furnace from which the grate bars had been removed. In this way the escaping chlorine was drawn from the room. Pure anhydrous calcium chloride was used, melted in a Dixon graphite crucible and added from time to time, but this was found to introduce much iron, aluminium and silicon from the clay binding used in the crucible, so that finally the chloride was added cold and melted by drawing an arc from the iron rod K. Thus the furnace was filled sufficiently for a run.

Fig. 5 is a diagram of the circuits. A direct current dynamo

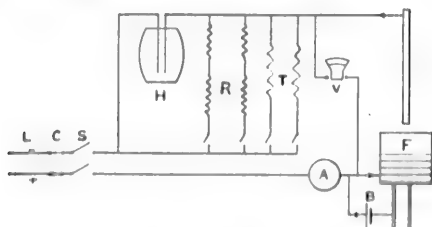

Figure 5.

supplied the current to the furnace line L at about 95 volts, having 250 amp. fuses at C and a double pole switch at S. Regulating



resistance was supplied by a barrel of soda solution H, having two ten-inch square cast iron furnace doors for electrodes and capable of carrying 75 amp., two pairs of two wire resistance frames R of 75 amp. capacity and 1 ohm resistance per pair in series, two wire resistance frames T of 10 amp. capacity and 8 ohm resistance each. A Siemens 320 amp. ammeter is indicated at A and a 150 volt Weston voltmeter at V. F is the calcium furnace and B the gravity battery to keep the copper coil from carrying any of the anode current. The anode was turned in a lathe from a six-inch length of Acheson graphite electrode six inches in diameter. Being pure and able to withstand the high temperature and chlorine without disintegration made this material by far the most suitable for constructing the furnace.

In operation the volts and amperes vary when the cathode is raised, but the following rough furnace record will give a pretty close average of the working conditions :

<i>Run.</i>	<i>Date</i> <i>1904.</i>	<i>Volts.</i>	<i>Amp.</i>	<i>Hours.</i>	<i>Grams</i> <i>Calcium.</i>	<i>Current</i> <i>Efficiency.</i>
1.....	July 12	20	105		40	
2.....	" 14	15	160	4	200	41.9
3.....	" 15	14	175	8	225	21.5
4.....	" 16	22	125	6	150	26.8
5.....	" 18	19	160	6	295	41.2
6.....	" 21	18	180	5	150	22.3
7.....	" 22	19	185	4	125	22.6
Total.....					1185	

Taking account of the different length of runs and averaging we get for runs 2 to 7—

$$\begin{aligned} \text{Average volts } \dots &= 17.7 \\ \text{" amp. } \dots &= 163. \\ \text{" efficiency } &= 29.1\% \end{aligned}$$

On finally weighing the total yield of clean calcium there remained 1050 grams. Adding 35 grams for loss by oxidation, analysis and samples (= 1085 grams), the efficiency becomes

$$29.1 \times \frac{1085}{1185} = 26.6\%$$

If covered by an inverted graphite crucible the furnace can be left cold for more than forty-two hours, and then started again in a

couple of minutes without the least trouble by drawing an arc between the iron cathode and graphite anode at the surface of the solid calcium chloride which immediately melts, allowing the iron end to be immersed and moved slowly to the centre of the furnace as the zone of fusion widens until it soon extends to the graphite on all sides. The sticks of calcium obtained were of irregular shape and covered with chloride. The bright metal showed the following composition, found by an analysis of the piece used in the tension and conductivity tests:

Si.....	0.03%
Fe.....	0.02 "
Al.....	0.03 "
Ca.....	98.00 "
Mg.....	0.11 "
Cl.....	0.90 "
O (by difference).....	0.91 "
	100.00 "

The product of run No. 5 is shown in Fig. 6. This piece was 56 cm. (22") long, .8 cm. ( $\frac{5}{16}$ ") least and 3.2 cm. ( $1\frac{1}{4}$ ") greatest diameter, weighed 295 grams and represented a current efficiency of over 40%. Some of the other pieces were of larger diameter. The difficulty experienced until recently in making metallic calcium was probably due to the small scale on which the operation was tried. The simple and satisfactory operation of this furnace would lead one to believe that, technically, the process would be still more efficient and easily controlled. A furnace five times as large, using about 1200 amperes, would require about 8 volts, and the screw mechanism could be electrically controlled, keeping the current constant and the product perfectly uniform, as the rotary furnaces of the Union Carbide Co. are controlled. A water-cooled shield might be necessary to cool the large calcium cathode as it was drawn from the bath. The two essential conditions of operation are—

1. Rapid withdrawal of the metal formed to increase the yield and minimize recombination.

2. Narrow temperature limits. The bath must be hot enough to deposit the metal molten, not spongy, and cool enough to let it congeal upon the cathode and be raised without breaking off.

To clean the metal most of the chloride was broken off with a

hammer and the rest dissolved off by leaving the pieces in 95 per cent. alcohol over night. Some hydrogen was evolved but the loss due to this cause was not very great. To keep the metal for a long time it was put under oil, dipped in melted paraffin or simply put in a dry stoppered bottle.

An attempt was made to fuse several pieces into one big stick. A two-foot length of one-inch iron pipe was threaded at both ends



Figure 6.

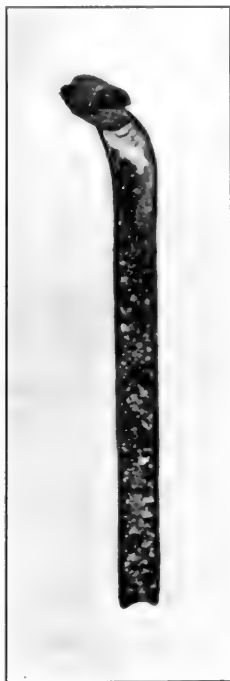

Figure 7.

and a cap screwed firmly on one end. The inside was cleaned with dilute sulphuric acid and washed with water, alcohol and ether, and in it were placed about 300 grams of clean pieces of calcium. The whole was heated in a wind furnace to a bright red heat, and on looking down into the tube one could see the red-hot molten metal which was quite fluid as shown by a thick iron wire used as a poker. The upper cap was then screwed on, the tube drawn from the fire,

its lower end hit smartly on the cement floor several times, after which the tube was quickly cooled in water. The lower cap was broken off and the walls of the tube cut lengthwise in the milling machine. When torn apart the two halves, split down the centre, displayed a most beautiful mass of large, reddish violet, cubical crystals (Fig. 7). There was much speculation as to the composition of this peculiar "compound" until the following analysis showed it to be over 90 per cent. calcium:

Gangue.....	0.03%
SiO <sub>2</sub> .....	0.77 "
Fe <sub>2</sub> O <sub>3</sub> .....	0.46 "
Al <sub>2</sub> O <sub>3</sub> .....	0.77 "
Ca.....	91.28 "
Mg.....	0.11 "
Cl.....	1.28 "
C.....	trace
N.....	trace
O (by difference).....	5.30 "
	<hr/>
	100.00 "

The crystals showed a specific gravity of 1.5425 at 28.1° C. In water they evolved hydrogen with an odor of acetylene. Carbon was probably extracted from the iron melting tube, which reaction may be of technical importance for converting pig iron into steel, and the power of calcium to combine with and remove sulphur and phosphorus are very important as is also its strong reducing action on organic compounds, the reaction being more easily controlled and less dangerous than with metallic sodium. These crystals were quite soft and were hammered as thin as paper, often exploding with a slight flame under the impact of the hammer. When filed or cut they showed a brilliant metallic lustre, being not as pure a white as silver but slightly yellow. The solid metal at times has this same slight yellow tint. The crystals near the top of the tube evolved ammonia with water, showing that they had combined with the nitrogen in the melting tube.

The solid metal can be worked like other metals and is much more stable than imagined. It can be heated red hot continuously in a triple Bunsen flame without igniting, but at this temperature its texture is like clay and it can be easily squeezed apart with the tongs, sometimes igniting at the edges and burning feebly till the

lime formed smothers the flame. When sent whizzing through the air against asbestos, bricks or cement it burns violently with a brilliant white light like magnesium and leaves a streak like antimony. It is not hardened by heating red hot and plunging into water. At  $300^{\circ}$ – $400^{\circ}$  C. it is as soft as lead and the irregular sticks can be easily hammered on an anvil, rolled, swaged or worked into any shape whatever by simply heating from time to time. When cold a bright calcium surface becomes dull rapidly in ordinary air, but if hot the metal can be brightened with a file or polished in the lathe with emery cloth and will remain bright as long as it is hot. About 300 grams of fine bright specimens were prepared as follows: A glass cylinder and its stopper were put in an air bath, gradually

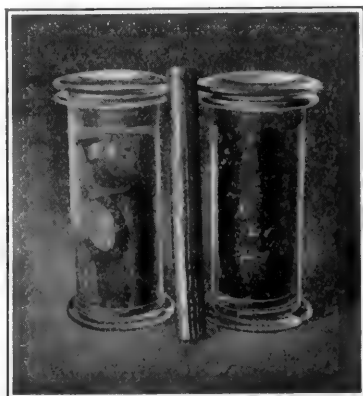

Figure 8.

heated and kept at  $150^{\circ}$  C. The calcium was kept hot on a stove plate and the pieces polished one at a time and put in the cylinder in the air bath where they kept bright till all were polished. A little paraffin was rubbed around the stopper and the cylinder closed. In this dry air they have lost none of their lustre and their bright surfaces are as distinctly metallic as any other metal. Fig. 8 shows the cylinders of crystals and solid metal and a six-inch stick of polished calcium.

#### SPECIFIC GRAVITY.

The density of oil was determined by the density bottle and from weighings of a bright piece of calcium in air, and in this oil its

specific gravity was found to be 1.5446 at 29.2° C., which is compared with some other metals in the following table:

Li .....	.59	Sb.....	6.76	Ag .....	10.505
K.....	.87	Zn.....	7.00	Pb.....	11.38
Na.....	.97	Sn.....	7.35	Hg .....	13.58
Rb.....	1.52	Fe.....	7.93	Au .....	19.258
<b>Ca.....</b>	<b>1.54</b>	Co.....	8.55	Pt .....	21.5
Mg.....	1.74	Cu .....	8.89	Ir .....	22.4
Al .....	2.68	Bi.....	9.82	Os.....	22.5

#### CONDUCTIVITY.

On the milling machine a piece of calcium about 10 cm. long was accurately finished on the sides and measured  $1.43 \times 1.02$  cm. It was imbedded in a block of wood with a mercury cup at each end and connected through a 15-ampere Weston ammeter, variable resistance and switch with storage batteries. Sharp brass potential points near the ends led to a large, very sensitive, horizontal D'Arsonval galvanometer whose deflections were read by a telescope and scale. The value of the galvanometer deflections in volts was obtained by using a standard low resistance in place of the unknown piece of calcium. The average of several readings gave the resistance between points 7.2 cm. apart 19.4 microhms at 30° C., and 26.7 microhms at 123° C. in a bath of hot paraffin.

Solving the equations

$$R_{30} = R_0 (1 + 30a) = 19.4$$

$$R_{123} = R_0 (1 + 123a)$$

we get the resistance at 0° C.

$$R_0 = 16.94 \text{ microhms}$$

and the temperature coefficient

$$a = .00457.$$

Hence the specific resistance at 0° C.

$$= \frac{16.94 \times 1.02 \times 1.43}{7.2} = 3.43 \text{ microhms per cm. cube.}$$

At the mercury cups calcium slowly formed a voluminous amalgam.

In the table below these values for calcium are placed in Sir Roberts-Austen's relative electrical conductivity table and show

that calcium is the fifth best conductor, being surpassed by silver, copper, gold and aluminium, if wires of equal diameter and length are compared, but for wires of equal weight and length the order is entirely different, calcium being second and exceeding silver by 67 per cent., copper by 62 per cent., gold by 86 per cent., and aluminium by almost 20 per cent. This method takes into account the specific gravity of the metals and gives the following order of conductivity: sodium, calcium, potassium, aluminium, magnesium, copper, silver, gold, etc. With purer metal still better results are to be expected.

<i>Metal.</i>	<i>Spec. Res.</i> <i>°C. Mic-</i> <i>rohms per cm.</i> <i>Cube.</i>	<i>Temp. Coef.</i>	<i>Relative Conductivity.</i>	
			<i>Similar Area</i> <i>and Length.</i>	<i>Similar</i> <i>Weight and</i> <i>Length.</i>
Ag .....	1.55	.00377	100.	32.5
Cu .....	1.59	388	97.6	37.5
Au .....	2.02	365	76.6	13.6
Al .....	2.45	390	63.	80.4
<b>Ca</b> .....	<b>3.43</b>	<b>457</b>	<b>45.1</b>	<b>100.0</b>
Mg .....	3.92	.....	39.4	75.5
Na .....	5.04 <sup>1</sup>	438 <sup>1</sup>	31.4	115.
Zn .....	5.22	365	29.6	14.5
Cd .....	6.34	.....	24.4	9.7
K .....	7.01 <sup>1</sup>	581 <sup>1</sup>	22.1	86.8
Co .....	9.15	.....	16.9	6.8
Fe .....	10.6	117	14.6	6.3
Pt .....	10.7	247	14.4	2.3
Sn .....	10.7	365	14.4	6.7
Ni .....	12.0	.....	12.9	5.0
Pd .....	12.8	.....	12.1	3.6
Th .....	16.9	.....	9.1	2.6
Pb .....	18.4	387	8.4	2.5
As .....	33.1	.....	4.7	2.8
Sb .....	43.1	389	3.6	1.8
Hg .....	94.0	93	1.6	.4
Bi .....	110.	.....	1.4	.5

An attempt was made to find the specific heat of calcium, but the results are too poor for publication.

#### TENSILE STRENGTH.

From the piece of calcium used in the conductivity test a specimen was cut with a hack-saw, finished to .458 x .135 cm. and marked off into half centimeters. The upper end was gripped in a

<sup>1</sup>A. Bernini, *N. Cimento*, 6, pp. 27 and 294, 1903.

vise, and to a hand-vise clamped on the lower end a 50-lb. weight and empty bucket were freely hung. Sand was poured into the bucket and the specimen broke with a total load of 83.5 lbs., showing a tensile strength of 8,710 lbs. per sq. in. or 612 kg. per sq. cm. The elongations in the middle

1 cm.	=	23. %
2 "	=	15.
3 "	=	11.
5 "	=	6.6

The following table shows the comparative strength of some metals :

<i>Metal.</i>	<i>Ultimate Tensile Strength.</i>	
	<i>Lbs. per sq. in.</i>	<i>Kg. per sq. cm.</i>
Ag .....	41,000	2,880
Pt .....	32,000	2,250
Mg .....	30,000	2,110
Cu .....	24,000	1,690
Au .....	20,000	1,410
Al (cast) .....	15,000	1,050
<b>Ca</b> .....	<b>8,710</b>	<b>612</b>
Zn .....	7,500	527
Sn .....	4,600	323
Pb (sheet) .....	3,300	232
Bi. ....	3,200	225
Sb .....	1,000	70.3

Calcium is harder than sodium, lead or tin, almost as hard as aluminium, but softer than zinc, cadmium or magnesium.

The activity with which strontium and barium recombine with their chlorides makes them more difficult to produce. Their production was not tried in the furnace just described. There are many interesting things to be learned about the alkaline earth metals—their isolation, purification and action on gases, solutions, organic compounds, salts, oxides and metals. The question of alloys is a broad one; some might be found of special value because of their electrical conductivity, strength or extreme lightness, calcium being only  $\frac{1}{4}$  as heavy as the light metal aluminium. The manufacture of cyanide and peroxide were uses found for metallic sodium, and in like manner uses will be found for calcium. It should be of use in the steel industry and for reduction purposes.

*University of Pennsylvania.*



*Stated Meeting, December 2, 1904.*

President SMITH in the Chair.

The list of donations to the Library was laid on the table, and thanks were ordered for them.

The death was announced of Dr. Helen Abbott Michael, at Boston, on November 29, 1904.

The following papers were read:

“Mineral Symmetry,” by Prof. Amos P. Brown.

“The Origin of the Markings of Organisms due to the Physical rather than to the Biological Environment,” by Prof. Alpheus S. Packard.

---

THE ORIGIN OF THE MARKINGS OF ORGANISMS (PŒCIOGENESIS) DUE TO THE PHYSICAL RATHER THAN TO THE BIOLOGICAL ENVIRONMENT; WITH CRITICISMS OF THE BATES-MÜLLER HYPOTHESES.

BY ALPHEUS S. PACKARD, LL.D.

*Read December 2, 1904.*

CONTENTS.

1. Introduction.
2. Facts against the Bates-Müller hypotheses, from observations made in North America.
3. The case of the milkweed butterfly (*Anosia plexippus*).
4. Facts in favor of the Bates-Müller hypotheses, observed in India.
5. Adverse evidence, from observations made in Europe and Asia.
6. Cases observed in Natal, South Africa.
7. The Batesian and the Müllerian hypotheses.
8. Criticisms of the Bates-Müller hypotheses.
9. Protective mimicry not necessarily applied to snakes.
10. Müllerian mimicry not applicable in certain cases even in butterflies.
11. Indifference shown to butterflies by birds.

12. Sokolowsky's views on the origin of the markings of mammals, and the formation of spots from longitudinal stripes.
13. Pœcilogeny in zebras and African antelopes shown by Pocock to be due to the action of light and shade.
14. Blending of the stripes of the chipmunk.
15. Protective coloration and blending of the markings in the sandpeep.
16. Blending of white and black bars in moths, butterflies, etc.
17. The abundance of variously marked animals of coral reefs due to the nature of their environment.
18. The lack of markings or color-patterns in deep-sea fishes and Crustacea as contrasted with their prevalence and variety in those of shoal and sun-lit waters.
19. Thayer's law and his experimental proofs.
20. Experiments on the obliteration of bars and spots with Bradley's color-wheel.
21. Pœcilogeny in paleozoic times.
22. Keeble and Gamble's studies on the origin of markings in shrimps.
23. Conclusions.

#### I. INTRODUCTION.

In this essay I have first attempted to bring together the more important published facts or results concerning the supposed destruction of butterflies by birds, together with others gathered from correspondents, with a few observations of my own. At the outset it should be observed that protective coloration, a generally accepted fact, is quite a different matter from protective or Müllerian mimicry. Soon after the subject of protective mimicry was broached I found myself unable to accept the views of Bates, Müller, Wallace and others, and offered<sup>1</sup> the suggestion that the mimickers have survived simply by reason of their resemblance to the more abundant forms which appeared as the old-fashioned or primitive types were on the wane or dying out. In my little books I expressed the belief that the resemblance in pattern and color between insects belonging to different groups is probably due to causes more fundamental than natural and sexual selection, and possibly reaching farther back in geological time than the present period.

<sup>1</sup> *Half Hours with Insects*, 1876, pp. 281, 286; also *Zoology for High Schools and Colleges*, 1879.

Thus a day-flying brightly-colored broad-winged moth such as the East Indian *Callamesia midama* "mimics" the blue *Euplœa* butterfly, and the species of *Chalcosia* mimic, in the shape and markings of their wings, certain butterflies of the family *Heliconidæ*. It occurred to me that the brilliantly colored day moths, which are evidently of earlier origin than butterflies, may have been preserved from their resemblance to butterflies. But this is supposing that butterflies serve as a staple food of insectivorous birds, which now seems to be by no means the case, butterflies in reality appearing to enjoy a peculiar immunity from the attacks of birds.

Since looking more carefully into the subject and realizing the slight basis of fact which underlies the original hypotheses of their propounders, and that the importance of Bates-Müllerian mimicry in species-making has been unduly magnified by more recent writers, I have felt more strongly inclined than ever to discard these hypotheses and to look for a broader and better founded theory or explanation of the fact of the recurrence of similar colors, designs or patterns in butterflies and in animals of other groups.

It is now evident that protective mimicry in the case of butterflies, supposed to result from the attacks of birds, is not an isolated series of facts, to be explained by the struggle for existence of butterflies resulting from the attacks of birds, but that the same phenomena occur in a number of other classes of animals. Thus antelopes may be said to mimic zebras; the spotted leopard of the Old World is marked like the jaguar and ocelot of the New World, their habits and environment being the same; shallow water fishes, both those abounding in the shoal waters of coral reefs, as well as the fresh water minnows, perch, darters, Lycodes, cottoids, etc., and the poisonous Elaps, as well as the harmless species marked like them—this similarity of markings and patterns in animals exposed to direct sunlight, or living under the same conditions of life, is due not so much to Bates-Müller mimicry as to what we call convergence, or the result of adaptation to similar physical environments or backgrounds and to similar modes of life.

It may be questioned whether the same physical agencies which have painted sun-loving animals have not also ornamented the petals or corollas of flowers with bars, stripes, lines and spots, the patterns being subject to almost infinite variation.

Thus the subject has entered on a new phase, and what has been understood as protective mimicry, in the sense of Bates and of

Müller and their followers, has a precarious basis. There are, to be sure, interesting coincidences, but a coincidence is not a *vera causa*. Natural selection as such is inadequate as an originating cause, though it operates as a preservative agent. The markings apparently did not originate in single variations, liable to be swamped by crossing, but whole masses of individuals, all those inhabiting a given area with its peculiar features, have been affected alike. The causes were not primarily biological and limited, dependent on sporadic and individual variations, but physical and widespread, occurring in different regions.

It will also be seen that the Bates-Müller hypotheses are seriously undermined by the fact that the wings of insects were, as early as the Carboniferous period, striped or barred and spotted, long before birds ever appeared.

Mr. Abbott H. Thayer, with the keen powers of observation of the artist as regards the effects of light and shade, hits upon the right explanation when he claims that protective coloration makes the animal "cease to appear to exist at all," and that "animals are painted by nature darkest on those parts which tend to be most lighted by the sky's light," and *vice versa*. He likewise points out that what naturalists call conspicuous colors, *i. e.*, strong arbitrary patterns of color, "tend to conceal the wearer by destroying its apparent continuity of surface. Thus the mallard's dark green head tends to detach itself from its body and to join the dark green of the shady sedge, or the ruby of the humming bird to desert it and to appear to belong to the flower it searches." His experiments capitally illustrate and confirm his views.

Steinach's earlier experiments seem to conclusively prove that light and shade acting on the integument of the living frog, or its dead and dry skin, cause light and dark markings.

Pocock has clearly shown that zebras and antelopes are banded, or not, in accordance with the nature of their habitat or environment, *i. e.*, whether they are confined in their range to forest regions or to the bush or to open plains.

It thus appears to be fairly well established that the markings of the skin and scales or feathers and hair of animals are due to the effect of the sun's light, or its absence, on the pigment in the integument, or its covering.

The biological cause suggested by Bates and by Müller, and so strongly advocated and extended by their followers, now appears to

be quite inadequate and misleading. On the other hand the physical causes we here advocate must be our main reliance in a thoroughgoing and satisfactory explanation of the phenomena of protective coloration. There is nevertheless need of much additional observation and experimentation.

## 2. FACTS AGAINST THE BATES-MÜLLER HYPOTHESES, FROM OBSERVATIONS MADE IN NORTH AMERICA.

For the first time in my life, having for over forty years observed and collected insects, though by no means constantly in the field, I actually saw a bird chase a butterfly. It was with great interest that I watched the procedure both of the bird and butterfly from the piazza of my summer cottage on the shores of Casco Bay, Me., at noon of a bright sunny day early in July, 1901. The aggressor was a black-throated green wood-warbler, the quarry a *Pieris*, apparently *Pieris rapæ*, then not uncommon about the house. The warbler was seen to dart swiftly after the butterfly, whose flight is very erratic and unsteady. It disappeared after flying a few yards, and as the bird kept on alone in its course, I had good reason to believe that it had caught and swallowed the butterfly. Prof. H. H. Wilder, then living in the next house, at about the same date actually observed one of these warblers eating a *Catocala* in a path. It ate the body of the moth and left the wings lying on the ground. I also saw one of these warblers chase a *Catocala* around an elder bush on the edge of my piazza, but did not see that the bird was successful in his pursuit.

Kingbirds were common about the house and shore, but I did not see any chase the cabbage butterflies, but was interested in witnessing one pursue a red-under-wing moth (*Catocala*). The moth flew in its usual very rapid and zigzag fashion, darting in this and that direction, as usual with species of this genus. The bird in vain tried to seize the saucy moth so secure in its rapid, zigzag, tumbling, headlong flight. The race was maintained for about five hundred feet; but so far as I could see, for the racecourse led directly from me, the moth escaped scot-free, the kingbird being baffled and outflown. I then realized, as must every one who watches the swift, zigzag, apparently aimless flight of any butterfly, how admirably adapted such a mode of progression is for the preservation of the species.

I might add a case which a few years ago fell under my observation when I observed in a street in Providence a small bird about the size of the English sparrow—perhaps it was one—pecking away at a large dragon fly (*Aeschna grandis*). The dragon fly was disabled, could not fly. I picked it up, but the bird flew off, and was not with certainty identified.

These occurrences have led me to review the subject of the Batesian and Müllerian hypotheses and to come to the conclusion that the theories of these and of later advocates have in reality but a slight basis of fact. The two points of interest are, first, do birds to any appreciable extent, even the few species, like swallows, the European bee-eater, and our kingbird, shrike and fly-catcher, occasionally pursue and devour butterflies, *i.e.*, depend much on these lepidoptera as an article of diet? It is of course admitted that moths, as other insects, are often caught and eaten by insectivorous birds. Secondly, is the protective or adaptive coloration of butterflies and other insects due to the action of natural selection, or are the similarities of colors and of patterns of colors, so frequently observed in all parts of the world, but especially in the tropics, primarily due to simple physical causes, such as the physiological deposition of colored pigments, and the action of light and moisture?

To this end I have with some care reviewed the original papers by Bates, Müller, Wallace, Poulton and others, but to my surprise find that neither of these framers and advocates of the hypotheses in question have themselves ever actually witnessed a bird catch and devour a butterfly.

*Evidence from cases observed in the United States.*—We will first review the evidence from cases observed in the United States of America. The insect-eating habits of sparrows have recently been described in a very interesting and satisfactory way by Mr. Sylvester D. Judd in a recent bulletin issued by the Biological Survey of the U. S. Department of Agriculture, entitled "The Relation of Sparrows to Agriculture." Mr. Judd has made this a specialty for several years, spending a great deal of time in field work, both in the Northern and Middle States, observing the habits of sparrows. And yet he writes me, "Personally, I have never even seen a bird in the field give chase to a butterfly. The following birds, either in captivity or in the wild state, have been known to eat butterflies: the catbird, kingbird, wood pewee, purple martin, scarlet tanager,

crown blackbird, cuckoo, English sparrow, song sparrow and the migrant shrike. I do not know of a kind that feeds upon butterflies during any month of the year to the extent of one-tenth of one per cent. of its food." This is certainly a strong statement, and is based on prolonged and very thorough investigations.

Mr. L. H. Joutel informs me that he has seen the English sparrow chase, seize and devour one *Pieris rapæ* and an *Orgyia*. He also observed these birds running after and catching little moths and flies, and also saw a sparrow pull off the abdomen of a large moth and devour it. These birds will, in the side streets of New York, dart out into the open and apparently catch some insects, and then perch on a neighboring tree or telephone pole. The sparrow, which on the whole eats few destructive insects, is occasionally in the city very voracious. Mr. Joutel had 150 caterpillars of *Callosamia promethea* in the last stage on the shrubs in his back yard on East 117th street. In the course of a couple of hours in the forenoon the sparrows ate them all. And some Japanese *A. pernyi* worms living on his oak trees were similarly massacred.

Mr. Joutel corroborates the statement made that *Lycænæ* when at rest on a leaf hold the wings closed upright over the back, but the hind wings with ocellus and tail are continually moved up and down, so that the two little tails look like its antennæ and the ocelli like the eyes of the same butterfly.

In a captured *Thecla* he observed where pieces had been bitten out of the hind wings, as if attacked by some birds which had mistaken the hind wings for the head.

Prof. J. B. Smith writes me: "I have never observed birds chasing butterflies except once. That was some years ago and the bird was a sparrow: the victim *Pieris rapæ*."

Miss Caroline G. Soule writes: "I have seen chipping sparrows, Savannah and song sparrows catch and eat a few *V. milberti*, *P. rapæ* and *myrina* butterflies. I have seen thistle-finches attack *turnus* and *cybele*, but not eat them. I have seen dogs eat *philodice* more than birds. When it comes to moths the tale is quite different. *Clisiocampa disstria* and *americana* (imago) are eaten by four kinds of vireos, three kinds of fly-catchers, both cuckoos, robins, rose grosbeaks, scarlet tanagers, cedar wax-wings, catbirds, orioles, red-winged blackbirds, martins, song, chipping, and even English sparrows. I noticed this fact for three successive seasons in

Brandon, Vt., where the pests covered everything. Nuthatches and downy woodpeckers eat them when they find them at rest.

“Chipping sparrows—in my experience—will chase almost any butterfly and often kill kinds they do not seem to eat. I have watched the chase and seen the dead butterflies which fell to the ground. These sparrows seem to enjoy the chase, turning, twisting, tumbling in the air, and I have seen them chase a blowing dead leaf in the same way, following it until it touched the ground.

“I have seen English sparrows catch *P. pandorus* and *achemon* moths, having first hunted them out of a woodbine, bite off the wings and carry the bodies to trees or roofs, presumably for food, though I have not seen the act of eating them. I have not seen this many times.”

“Nuthatches, black and white creepers, brown creepers, eat the noctuid moths which hide in crevices of the bark and under the eaves of houses or piazzas, in the blinds or folds of awnings. I have often watched nuthatches go thoroughly over the cornice of our house, dropping one pair of moth wings after another, then go the length of the gutter-pipe on the piazza roof. They are the most methodical and thorough hunters I know among birds except the little summer warbler, which will clear a pea vine of aphids so that not one could I find in a careful search. It cleans one vine before going to another unless startled away. Of course these are only my personal experiences, and I learned years ago that experiences vary much, even with the same species, under different conditions.

“Your paper seems to show a lack of belief in the value of ‘imitation’ as a protection to butterflies, and rejoices me, for observation compels me to believe that too much value has been placed on this as on the theory that flower colors please insects.”

The ornithologists appear to have had the same experience as the entomologists.

Dr. J. A. Allen writes me under date of January 31, 1902: “In regard to birds catching butterflies, I have consulted with Mr. Chapman about the matter, and neither of us recall having seen birds capture butterflies except in rare sporadic instances. It is certainly not a habit of birds to prey upon butterflies.”

Dr. S. H. Scudder,<sup>1</sup> in 1870, writes: “Although I have hunted butterflies for fifteen years, I confess I have never seen one in a

<sup>1</sup> *Nature*, lii, 1870, p. 147.



bird's bill, and my faith in that method of lessening their numbers is very slight."

Afterward, in a letter dated October 9, 1901, he says: "I believe that in temperate countries butterflies at least are rarely attacked by birds. I have myself seen proof only once in New England."

Mr. F. P. Drowne informs me that he once saw a phœbe bird catch *Pieris rapæ*, or a similar species, in Virginia.

Mr. William Dearden tells me that he saw a pewee catch a small butterfly, and a kingbird catch *Pieris rapæ*.

In Florida, as we have been informed by Mrs. Annie T. Slosson, the mocking bird frequently chases butterflies, but she has not observed any other bird thus occupied.

In his "Notes on the Food of Birds," 1901, Prof. Cockerell gives no cases of butterflies being pursued and eaten by birds.

Prof. W. M. Wheeler, of Austin, Tex., under date of February 6, 1902, informs me that he has never seen birds pursuing butterflies.

My friend and pupil, Mr. T. E. B. Pope, tells me he once saw an English sparrow pecking away at a *Macrosila 5-maculata*; he does not know whether it caught it or found it crippled. Another member of my class distinctly remembers seeing a kingbird catch a butterfly; Mr. H. H. Hill, another pupil, saw a kingbird chase and catch "a small white butterfly," and another member of my class, Miss Geraldine E. Street, has seen "a sparrow chase a little white butterfly."

Prof. C. V. Weed, of Durham, N. H., writes that he saw an *Antiopa* butterfly in the mouth of a Maryland yellow throat.<sup>1</sup>

Prof. E. A. Popenoe, of Manhattan, Kan., under date of February 3, 1902, writes: "I have occasionally seen butterflies chased by birds. So far as I can recall *Pieris rapæ* is the species."

Mr. Wm. T. Davis writes November 4, 1901, that he "observed several English sparrows endeavoring to capture a *Deilephila lineata*; the moth flew in circles, while the sparrows made vain efforts to head it off." It is quite a common thing to see them catch such moths as *Spilosoma virginica*, and also *Datana*. "My wife saw a bird (species not recognized) catch a little white butterfly, she thinks a cabbage butterfly, in the garden. I have not seen birds catch butterflies, though I have seen great crested fly-catchers and kingbirds catch small moths, etc. I once observed a chipmunk capture a noctuid."

<sup>1</sup> See "Nature Biographies," 1903.

“In July, 1897, at Newfoundland, N. J., I saw two specimens of the large dragon fly, *Hagenius brevistylus*, chasing species of *Papilio* and *Limenitis ursula*. They would station themselves on dead limbs, and when a butterfly came by they would sally forth after the pilgrim like robbers of old from their wayside castle. I did not see them catch any butterflies, though they came pretty near to doing so. Mr. Calvert writes me that Dr. Hagen has a note in *Ent. Monthly Mag.* (1884?) on *Anax longipes* catching *Papilio* at Wood’s Hole.

Among those whose attention I have called to the matter, Prof. James G. Needham, of Lake Forest, Ill., writes that “neither I myself nor any of my students have seen a bird chase and eat a butterfly.”

Miss Annie H. Pritchett, of Austin, Tex., and Mr. Ernest Ingersoll write to the same effect.

The late Mr. C. V. Riley states<sup>1</sup>: “Individually I have on several occasions seen butterflies captured by birds, and have seen dragon flies dart after them.” He adds that “any amount of evidence might be collected on this head,” but we are convinced that this is an over-statement.

### 3. THE CASE OF THE MILKWEED BUTTERFLY (*ANOSIA FLEXIPPUS*).

It is a generally accepted belief, first expressed by Walsh and Riley in June, 1869,<sup>2</sup> that this butterfly enjoys an immunity from the attacks of birds by reason of its nauseous taste or odor, and that *Basilarchia archippus (disippus)*, which is edible and inodorous, is protected by its resemblance to its model. This hypothesis has been generally accepted, and yet it needs far more facts of observation to support it than have yet been brought forward. Just how nauseous or malodorous *Anosia* is needs further investigation.

We have been able to find in the literature but two cases of the *Anosia* being caught by birds, while there is no record, says Riley, “of any person having actually seen a bird or other animal attack the species of *Limenitis* in this country,” *Limenitis* being a synonym of *Basilarchia*, the mimic.

The first case is recorded by Riley,<sup>3</sup> who relates an occurrence noticed by the late Mr. Otto Lugger, then of Chicago. “While

<sup>1</sup> *Third Ann. Rep. Insects Missouri*, 1871, p. 167.

<sup>2</sup> *American Entomologist*, I, June, 1869, p. 189.

<sup>3</sup> *Third Annual Report Insects Missouri* 1871, p. 169. Footnote 1.

employed on the U. S. Lake Survey he once saw a bird dart after an Archippus butterfly, seize it and immediately drop it without devouring the body. The butterfly dropped close by his side and he picked it up and examined it, and had no means of accounting for the singular action of the bird."

The second case is thus mentioned by Mrs. Mary Treat:

"The beautiful Archippus butterfly, *Danais archippus*, is a common species and enjoys a wide range. It occurs in Upper Canada and extends into South America, where, according to Prof. Agassiz, it is common throughout the region of the Lower Amazon, and in the Mississippi Valley it is one of the most frequent species. This Archippus butterfly enjoys almost perfect immunity from enemies. Neither birds nor any of the hymenopterous parasites will interfere with it. It probably has a nauseous, disagreeable taste that birds do not relish. Last summer a pair of kingbirds built their nest on a low limb of a tree close to our door. They consumed and fed to their young a great many butterflies, especially the Rape butterfly. Toward evening they were very active, taking indiscriminately all insects that ventured on the wing—great grasshoppers and cicadas, as well as butterflies. One evening several Archippus butterflies came to their tree as they were fluttering about fixing themselves on the branches for the night; the kingbird very comically turned his head from side to side, eyeing them closely; becoming satisfied with his observations he gave his head a sudden jerk and vigorously wiped his bill on the limb, as if the remembrance of the disagreeable morsel was enough to nauseate him."<sup>1</sup>

The Heliconidæ are said by Bates to have a peculiar smell. According to Wallace (*Contributions*, etc., p. 78), when an entomologist "squeezes the breast of one of them between his fingers to kill it, a yellow liquid exudes which stains the skin, and the smell of which can only be got rid of by time and repeated washings." Messrs. Walsh and Riley in their joint article on Anosia state: "We ourselves have never noticed any particular smell about it, but we can add our testimony to the negative fact of its never being attacked by any carnivorous animal, so far as our experience has gone" (*Amer. Ent.*, I, p. 187). The nauseous secretion probably emanates from the scales, as Burgess in his anatomy of the milk-

<sup>1</sup> From "Butterflies and Moths," by Mary Treat, in *Hearth and Home*, Vol. 4, Jan. 13, 1872, p. 25.

weed butterfly does not mention the occurrence of any anal or other foetid glands.

The only case mentioned by Belt in *The Naturalist in Nicaragua* is the following: "Thus I had an opportunity of proving in Brazil that some birds, if not all, reject the *Heliconii* butterflies, which are closely resembled by butterflies of other families and by moths. I observed a pair of birds that were bringing butterflies and dragon flies to their young, and although the *Heliconii* swarmed in the neighborhood and are of weak flight so as to be easily caught, the birds never brought one to their nest." He mentions no case of birds eating butterflies in Nicaragua, though a tame white-faced monkey would greedily eat butterflies.

Scudder<sup>1</sup> says that Riley in a letter remarks that the butterfly "has a rank but not strong smell," and Scudder adds: "Experiment shows that all the scales have a carroty odor, and that those in the pouch of the hind wings differ from them only in being stronger scented with a slightly honeyed character."

According to an early statement by Scudder,<sup>2</sup> the eggs and larva of *Anosia* enjoy a greater immunity from the attacks of parasites than those of other butterflies. From this Mr. Wallace<sup>3</sup> infers that the peculiar secretions of the butterfly "extend to their larva and egg state"; but this statement concerning parasites, repeated in his later work, entitled *Darwinism*, appears to be an assumption not based on rigid investigation, for Dr. Scudder in 1889<sup>4</sup> corrects his earlier statement and says that *Anosia* has its fair share of parasites, *i.e.*, not only an egg-parasite but an ichneumon and *Tachina* parasite of the larva, while from a single pupa issued over fifty *Pteromalus* flies.

Here it might be added that Seitz<sup>5</sup> questions whether the *Heliconidæ* are themselves invariably malodorous, denying that this is invariably the case. He tested as many as fifty species of *Danaids*, both African and American, but could not recognize the least odor, disagreeable or otherwise; and a number of these species were models for mimicry. In some but not in all *Heliconids*, Dr. Seitz

<sup>1</sup> *Butterflies of New England*, I, p. 745.

<sup>2</sup> *Nature*, III, 1870, p. 147.

<sup>3</sup> *Nature*, III, Dec. 29, 1870, p. 165. Also see *Darwinism*, 1889, p. 238.

<sup>4</sup> *Butterflies of New England*, I, p. 745.

<sup>5</sup> *Zool. Jahrbücher Spengel*, III, p. 888. See also Beddard's *Animal Coloration*, p. 197.

detected an odor like that of naphthaline. "In *Heliconius beskii*, a species with a particularly evil odor, it was found that only a few individuals were odoriferous . . . the odor is not persistent, but depends upon some variable circumstance, as food."<sup>1</sup>

I may add my own slight experience with *Anosia plexippus*, taken from my notes. September 4 I caught one, and pinching it between my fingers I could not detect any odor, nor could three other members of my family, but Prof. H. H. Wilder detected a slight odor which he compared to that of the larva of *Samia ceceopia*, only the odor of the latter "is ten times as strong." On cutting out a bit of the under side of the middle of the abdomen I tasted it and perceived a very slight taste not like any substance known to me, and certainly not resembling that of laudanum. On removing a larger piece and pressing the abdomen the odor became more distinct, and one of my family at once detected it, although at first before it was wounded she could perceive no odor. I tasted two pieces cut from the middle of the abdomen, but the taste was hardly perceptible and not unpleasant, neither bitter, acid, or in any way pungent.

To sum up, the following birds in the United States of North America have been seen to pursue butterflies, viz.: the black-throated green wood warbler, English sparrow, chipping sparrow, Savannah and song sparrow, thistle finch, kingbird, phœbe bird, pewee, mocking bird, purple martin, scarlet tanager, crow blackbird, cuckoo and shrike.

Butterflies of the following species have been actually seen to have been eaten: *Pieris rapæ* (many more than any other kinds), *Vanessa milberti*, *Brenthis myrina*, while *Papilio turnus* and *P. cybele* were not eaten. It is evident that for temperate North America and for Europe the evidence is entirely too slight to even suggest the theory.

#### 4. FACTS IN FAVOR OF THE BATES-MÜLLER HYPOTHESES.

The strongest body of facts in favor of the view that birds in confinement have an appetite for butterflies is afforded by Mr. F. Finn in his "Contributions to the Theory of Warning Colors and Mimicry,"<sup>2</sup> his observations having been made in India. He concludes that there is a general appetite for butterflies among insectivorous birds, "even though they are rarely seen when wild to

<sup>1</sup> Quoted by Beddard, *l. c.*, p. 197.

<sup>2</sup> *Journal of the Asiatic Society of Bengal*, LXVII, 1897, pp. 613-668.

attack them." His experiments were made with caged passerine birds of the babbler and bulbul groups. He fed the birds with a number of non-warningly-colored butterflies, together with four *Danais chrysippus* and a *Delias*. On five occasions the supposed inedible *Danais* was eaten by the bird, and at other times the *Danais* were eaten, though on the whole the edible species were preferred by the *Liothrix*, while Mr. Finn was not so sure about the bulbuls. In other series of experiments the "protected" butterflies were eaten by the bulbuls, even when offered as a choice a non-protected *Catopsilia*.

It is to be observed that the birds would peck at *Euploea* and other protected butterflies, and afterward wipe their beaks, but subsequently would return to the attack, beat off the *Euploea*'s wings and swallow it. It thus seems that even if a bird wipes its beak as if in disgust after attacking an inedible butterfly, it may eventually devour it.

Experimenting with a single bird in a cage, the racket-tailed drongo shrike, it eat "without persuasion" several *Danais chrysippus* and three *D. genutia*, and "with persuasion" two *Papilio aristolochia* and a *P. polites*, though maggots had been fed to them or were available. The foregoing experiments give us the impression that these birds in nature would not eat butterflies, when seed, fruit or maggots, etc., were to be had.

Experimenting with birds at liberty, on giving a *Papilio demoleus* to a wild mynah (*Acridotheres tristis*) which he had seen trying to get at some butterflies in an insect cage, the bird knocked off most part of the butterfly's wings and flew off with the body. Another mynah seized a disabled *Danais genutia*, and after battering it ate most of it. Another mynah seized a disabled *Catopsilia* and *Danais limniace*, knocked off a fore wing of each and flew with them to a high building. On another occasion birds of the same species pecked at *Papilios*, then leaving them.

Of two hornbills (*Anthracoceros*) one did not care about insects at all, while the other readily ate several unprotected butterflies, but "took, rubbed and refused *Danais chrysippus* and *D. genutia* and *Euploea*," yet it also refused a *Junonia* and a *Papilio*.

It seems, then, in the words of Mr. Finn, that the common babblers (*Crateropus canorus*) ate the Danaid butterflies readily enough in the absence of others, but when offered a choice showed their dislike of these "protected" forms by avoiding them. "This

avoidance was much more marked when the birds were at liberty, though even so a few of the objectionable butterflies were eaten." He saw a wild red-vented bulbul eat a white butterfly.

"Although I did not experiment on any of these at liberty, my experience with the *Liothrix* (*Liothrix luteus*), mesia (*Mesia argenteauris*), bhimraj (*Dissemurus paradiseus*), king crow (*Dicrurus ater*), starling (*Sturnus menzbieri*), and shama (*Kittacincla macrura*) was similar in that all of these birds objected to the Danainæ, *Delias eucharis* and *Papilio aristolochiæ*, especially, as a rule, to the last, in comparison with other butterflies, or absolutely."

"I never saw the *Chloropsis* (*Chloropsis aurifrons* or *malabarica*) or the *Sibia* (*Malacias capistrata*) eat any 'nauseous' butterfly, except that in the case of the former one Euploea body and a few bits of wing were eaten."

"The latter bird refused with apparent dislike the male of *Elymnias undularis*, which should be palatable, and was as a matter of fact usually liked by the birds to which I offered it. Another mimetic species, *Papilio polites*, was not very generally popular with birds, but much preferred to its model, *P. aristolochiæ*."

"In several cases I saw the birds apparently deceived by mimicking butterflies. The common babbler was deceived by *Nephronia hippia*, and *Liothrix* by *Hypolimnas misippus*. The latter bird saw through the disguise of the mimetic *Papilio polites*, which however was sufficient to deceive the bhimraj and king crow."

"Young hand-reared birds, like the shama and bhimraj, had no instinctive knowledge of the 'nauseous' forms, and ate them quite readily at first, but soon gained experience. Birds caught when old, when watched from the first, like the *Sibia*, first *Mesia* and starling, appeared to know and avoid unpalatable species."

He finally concludes: "That many, probably most species dislike, if not intensely, at any rate in comparison with other butterflies, the 'warningly-colored' Danainæ, *Acraea viola*, *Delias eucharis*, and *Papilio aristolochiæ*; of these the last being the most distasteful, and the Danainæ the least so."

##### 5. ADVERSE EVIDENCE, FROM OBSERVATIONS MADE IN EUROPE AND ASIA.

Prof. Theo. D. A. Cockerell writes: "When I was a boy in Sussex, England, there was a wooden summer house roofed, but

open at the sides, in which we used to find great quantities of moth's wings. The wings were scattered over the floor, and were mostly of noctuids; the only species I now recall definitely is *Scoliopteryx libatrix*. We always supposed that this destruction was the work of bats, but now I think of it, we had no real proof of that."

R. Newstead, in the *Gardener's Chronicle*, 1901, pp. 197, 217, states that a fly-catcher (*Muscicapa grisola* L.) was seen flying after butterflies, but each time when it could seize it stopped and let the butterfly escape.

Mr. A. G. Butler<sup>1</sup> states: "I have collected in Kent for at least thirty years, and it must be quite twenty-five years since I last saw *Aporia crataegi* flying in that county, but during the whole of the thirty years I have never seen any bird but a sparrow attempt to catch a butterfly."

Previously,<sup>2</sup> however, he says: "I have frequently seen birds catch and devour the unprotected species upon the wing."

Prof. L. Katharina<sup>3</sup> had an opportunity to observe a striking case of the chase and capture of butterflies by a bird. "I was with Dr. Escherich in Central Asia, May 6, 1895, where I was busy in a fallow field in the neighborhood of Angora catching *Thais cerysii*, which at this time flew in such numbers that I could catch six at a time in my net, when a flock of bee-eaters (*Merops apiastor*) began to attack them. I heard the snapping of their bills and in a very short time there was no trace of the slowly flying butterflies left, and the birds disappeared." He had at home seen the redstart (*Ruticilla*), which has a special predilection for butterflies, seize flying *Pieris* and carry them to their nests. "An ornithological friend tells me that he has often raised caterpillars so as to feed the butterflies to his birds, and that the chaffinch (*Fringilla caelebs*) are great lovers of them."

"I am convinced that the very beautiful protective coloring of butterflies is of no use, the bee-eater being attracted by their fluttering motion. I also think that the mimicry of protected species by those not protected (*Danaidæ*, *Papilionidæ*, etc.) has as regards color and markings no great value.

<sup>1</sup> *Entomologist's Monthly Magazine*, London, XXIV, p. 40, July, 1887.

<sup>2</sup> *Nature*, III, p. 165.

<sup>3</sup> "Werden die fliegenden Schmetterlinge von Vögeln verfolgt?" *Biol. Centralblatt*, 1898, p. 680.



“When a deception of its enemy by a flying butterfly occurs this happens mostly through the mimicry of the mode of flight of the protected butterfly.”

“The experienced collector to some extent recognizes a species by its flight, and is unable to recognize it by its color and marking on account of the distance and rapidity of its flight, or for some other reason. I say intentionally the species, since the species of one and the same genus is distinguished from one another by certain peculiarities of flight, or by its appearance when at rest, etc.

“But what attracts the eye of the collector may certainly more readily attract the notice of animals engaged in the pursuit of butterflies. I should only consider such cases of mimicry as protective mimicry in which the model, besides form and size, also mimics it *in the peculiarities of its movements*. Isolated statements thereupon are scattered through the literature, but so sparsely that most of the cases regarded as those of mimicry should most of them be considered as cases of similarity of development resulting from similar external conditions, above all climatic; certainly not to selection.”

Dr. Carl Russ expressly recommends seeking for butterflies as a special dainty for singing birds.

In an article on the pursuit of butterflies by birds, called out by that of Prof. Katharina, Prof. J. Kennel,<sup>1</sup> of Dorpat, states that a pair of warblers (*Sylvia*) fed their five young all day long with *Vanessa urticae*, some *Parnassius amemosyne* and *apollo*, which last species was very rare in that region (the Estland coast), also *Pieris rapae*, and on many days *Libellulidæ*. The butterflies were carried to the nest with their wings “cut in pieces.” Also among the woods were scattered the wings of different species of *Catocala*, *Arctia*, *Euprepia*, whose bodies may have been eaten by bats and the goat-sucker (*Caprimulge*), or perhaps by small owls.

“Near Kreman, Liveland, I found one day among the bushes a freshly emerged *Pleuretes matronula* and nearby the wings of two other specimens. Here was proof that these Lepidoptera were caught by birds (or bats) and eaten, all except the wings.” He also had seen swallows catch small moths (*Tortrix viridana*) and small *Noctuina*.

He concludes that (1) such butterflies as are caught by birds are edible, and (2) that their colors are neither protective or warning to the pursuer.

<sup>1</sup> *Biol. Centralblatt*, 1898, pp. 810-812.

“Notwithstanding that insect-eating birds are relatively rare, and perhaps only exceptionally capture butterflies, the latter are with their small bodies and large wings difficult to seize. As a rule only such birds as swallows with their long bills can catch them. And because of this difficulty in butterflies their colors and markings are not of very much importance. They are all rejected or captured exceptionally, but at the same time almost without choice.

“It is not to be denied that many species are perhaps truly inedible, but this must be carefully confirmed by painstaking observation. It seems inadvisable to draw conclusions as to inedibility and protection only from coloring, markings, shape of wing, or special odors, which are not essentially perceptible to us.”

Weismann, in his *Vorträge*, etc. (1902), claims that many butterflies are sacrificed by birds, though he records no instance of his own observations, but quotes Pöppig as saying that in the primitive forest of South America it is not difficult to recognize where one of the Galbulidæ has chosen its favorite perch, since the wings of the largest and most splendid butterflies, whose bodies are alone eaten, cover the ground for some steps in circumference.

Direct observations on the pursuit of butterflies by birds are due especially to Dr. Hahnel, who while collecting in Central and South America found many opportunities of observing it. He writes: “No other kind of butterflies are so much hunted as the Pieridæ, and these robbers often snapped up the most beautiful and fresh specimens close to me. The unfailing certainty of their flight made me wonder, and I willingly paid for the spectacle with the loss of a specimen.” As to the chase of that large species of Caligo, on whose leaf-like under side is an ocellus, he says: With incredible adroitness did the great creature escape the strokes of the beak of the bird following hard after it and escape from one bush to another, until finally the hunted game was driven into the thickest of the mass of tangled branches and the tired bird flew off to a distance on another chase. Hahnel adds that the wonderfully beautiful *Morpho cissus* was seized by dragon flies, while quantities of lizards pursue and eat butterflies (Weismann). Caspari observes that swallows catch butterflies. He once let about a hundred *Vanessa antiopa* fly out of his window, “but scarcely ten reached the woods nearby, the rest were eaten by the swallows,” which collected expressly for the purpose before his window.

Slevogt has brought forward many proofs that our native butter-

flies suffer much harm from birds, though Weismann does not quote his instances.

But another German naturalist, Eimer, had previously arrived at a different conclusion. In his *Ontogenesis der Schmetterlinge* he remarks: "But who has ever seen a bird flying after butterflies to such an extent that by this means a protective transformation through selection could be attained?" From his own experience Eimer only remembered one case, *i.e.*, where a redstart (*Ruticillus phœnicurva*) seemed to carry a *Pieris* (?) in its beak. From lepidopterists and his students he could only get information regarding scattered cases where butterflies were pursued by birds.

*Cases observed in India and Ceylon.*—About the year 1884 a discussion arose in the Bombay papers as to whether birds preyed on butterflies, and the general opinion expressed was that it was comparatively rare for them to do so. This led Col. Yerbury to notice such occurrences, with the following results. He saw a young king crow (*Dicrurus ater*) stoop at a big blue *Papilio* and miss it. The bird did not repeat the attempt. He afterward saw a young king crow stoop at a *Vanessa kaschmirensis*, and after missing it once take it at the second attempt. He did not notice whether the insect was eaten. He saw a bee-eater (*Merops philippinus*) keep flying in front of his carriage and taking *Pierinæ* as they rose in clouds. The bird seemed to select the yellow females, which are rare, the white females being to them probably in the proportion of 100 to 1. "An ashy swallow shrike (*Artamus fuscus*) caught six *Euplœa* (*Crastia cove*)." (Marshall and Poulton.)

*Cases observed in Burmah.*—Col. Bingham saw a bee-eater (*Merops swinhoi*) catch a butterfly (*Cyrestis*); more than once it missed a butterfly, but eventually caught it; of the butterflies hawked and eaten by the bee-eaters there were five species. "I also particularly noticed that the birds never went for a *Danais* or *Euplœa* or for *Papilio macareus* and *P. xenocles*, which are mimics of *Danais*, though two or three species of *Danais*, four or five of *Euplœa*, and the two above mentioned mimicking *Papilios* simply swarmed along the whole road." The large *Merops philippinus* with some king crows were seen hawking *Catopsilia*, flying in clouds. The pigmy hawk or falconet (*Microhierax cœrulescens*) was seen seizing a *Papilio sarpedon* in his claws. This bird also uses butterflies' wings to form a pad for the bottom of its nest made in a hole of a dry tree.

Mr. A. G. Butler<sup>1</sup> states that an entomologist in Bombay had informed him "that the *Charaxes psaphon* of Westwood was continually persecuted by the bulbul, so that he rarely captured a specimen of this species which had not a piece snipped out of the hind wing; he offered one to a bulbul in a cage, and it was greedily devoured, whilst it was only by repeated persecution that he succeeded in inducing the bird to touch a Danais, which he offered to it."

In his article "Mimetisme," Piepers refers to his experience during twenty-nine years spent in Java.

"One day when a *Euplœa rafflesii* Moore, *i. e.*, a Danaid reputed to be inedible, was disclosed in my garden where several of the caterpillars of this species had lived, I saw a bird (*Edoljüs?*) seize and eat it; the next day another shared the same fate. Twice also have I seen a sparrow attack an *Amathusia phidippus* L." These large butterflies, though *Rhopalocera*, only fly at twilight, and the one attacked had taken refuge on a whitewashed wall. "These four cases are the only ones during the twenty-eight years of my sojourn in the Indies where I have seen birds attack any butterflies. And even to justify the fact in question it is not enough that here and there a butterfly is eaten by birds, but there should be a chase of this kind so general and common that the existence of unprotected species should be endangered, and that an evolution like their assumed mimicry should become of great utility. Moreover the same thing occurs in other regions. Pryer has never seen an instance during twenty years entomologizing in Borneo, nor Skertchley during thirty years of observation in Europe, in Asia, in Africa and in America. According to this last the celebrated entomologist Scudder would not credit this fact. In the session of the London Society named below, held May 3, 1869, Home enumerated a number of insects which he had seen in India devoured by several kinds of animals; among these insects he mentioned moths but no butterflies. Here in Holland it is also the same thing. According to observations published in 1890 by Butler, a small English bird, also found with us in captivity, devoured with apparent relish hundreds of *Pieris brassicæ* and *P. napi*, but it is not observed here that the birds chase these butterflies, although they are very common. Moreover as to England, Jordan has at times seen a certain small insectivorous bird seize a butterfly, but Butler states that

<sup>1</sup> *Nature*, III, p. 165.

during thirty years' residence in Kent he has not observed a single fact of this kind.

Mr. Skertchly's statement is as follows :

"Mr. W. B. Pryer, in his notes on the Rhopalocera of British North Borneo, casts a doubt on certain points connected with the theory of mimicry, stating that during twenty years' collecting in the Far East he never saw a butterfly taken by a bird.<sup>1</sup> Discussing this question with him in England and Borneo I was led to study the matter more particularly, and as my work takes me for months at a time into the virgin forest, my opportunities have been unusually great. . . . That mimicry does exist probably no one has ever doubted since Bates first called attention to the phenomena. The explanation, too, proffered at the time, that edible species copied nauseous morsels, was so simple, so full, so entirely explanatory that, like Darwin's theory of coral reefs, it seemed unassailable. Indeed so strong was this feeling, that few naturalists ever seem to have looked for facts to support it.

"Yet how meagre the evidence is! Surely if birds are in the habit of eating butterflies as a staple article of food, the fact would be patent to every ornithologist and entomologist, to every one who delights in the beauties of nature. Such is not the case, and even Distant, in his 'Rhopalocera malayana,' can only cite a few isolated cases. That some birds frequently, and others occasionally, devour butterflies is certain. But these are rare exceptions.

"Mr. Pryer's remark has been paralleled by Mr. Scudder, and after thirty years' observation of insects and birds in Europe, Asia, Africa and America, I can confidently assert that I have never yet seen a bird take a butterfly."<sup>2</sup>

Prof. E. A. Minchin, while in Madras, saw a bird swoop down and carry off a butterfly (*Elymnias undularis*).<sup>3</sup>

#### 6. CASES OBSERVED IN NATAL, SOUTH AFRICA.

In his "Five years of observations and experiments on the biometrics of South African insects," G. A. K. Marshall gives records

<sup>1</sup> *Annals and Mag. Nat. Hist.*, Jan., 1887, p. 44. Mr. Pryer's statement is as follows: "Moths are ruthlessly eaten by birds by day and by bats at night; but I have never once in a twenty years' experience seen a butterfly taken by a bird." (A. S. P.)

<sup>2</sup> *Annals and Mag. Nat. Hist.*, 6th Ser., III, 1889, p. 477.

<sup>3</sup> *Trans. Ent. Society, London*, 1904, p. xxxvii.

of attacks on butterflies by wild South African birds. He remarks: "Personally I do not suppose I have seen such an occurrence more than perhaps half a dozen times, the birds being the paradise fly-catcher (*Terpsiphone perspicillata*), the bee-eater (*Merops apiaster*), and two rollers (*Coracias spatulata* and *Eurystomus afer*); but then I admit that I have paid little or no attention to the matter until quite recently." This was in a letter written in Natal, October 7, 1897. After this, as Prof. Poulton states, Mr. Marshall kept a careful record of his observations. At Durban he saw a paradise fly-catcher catch a specimen of *Eronia cleodora*, seizing it *with its feet*, and carry it off. In 1898 he saw a Marico wood shrike (*Bradyornis mariquensis*) dart down from a tree and catch a *Sarangesa eliminata* (Holl.) which was sitting with outspread wings on a small plant. He saw a bush kingfisher (*Halcyon chelicutensis*) catch and eat two butterflies (*Junonia cebrene* and *Catopsilia florella*), both of which were captured when feeding. He also saw a fly-catcher (*Pachyprora molitor*) make several futile attempts to catch a *Tarucus plinius*. A drongo (*Buchanga assimilis*) was seen flying past with a white butterfly (probably *C. florella*) in its beak. Remains of a *Papilio demodocus* were found in the stomach of a cuckoo (*Coccyser caffer*).

In 1899 a paradise fly-catcher passed by and with a loud snap of its beak tried to catch a butterfly (*Atella phalantha*), which escaped, though the bird had cut off the tip of one wing. A hobby (*Falco subbuteo*) had in its stomach an almost entire *Terias*. He saw a drongo catch a white moth, and almost at once drop another white moth of the distasteful genus *Diacrisia* (*D. maculosa*). An observer at Gazaland saw a South African stonechat (*Pratincola torquata*) in chase of a *Tarucus plinius*, and he saw the wings of a lot of butterflies (chiefly *P. corinneus*) below the branch of a tree on which some swallows were constantly settling. Marshall saw a drongo hawking insects from the top of a dead tree. "There were many *Pierina* about, chiefly *Teracolus* and *Belenois*, but the bird paid not the least attention to them." At last one with broken wings went by so that its flight was weak and erratic; the drongo swooped down on it, but the butterfly dropped into the long grass. "This episode would point to the conclusion that the fact that birds refrain from pursuing butterflies may be due rather to the difficulty in catching them, than to any widespread distastefulness on the part of these insects."

The beautiful plates illustrating the injuries to the wings of various butterflies attributed to the bites of birds, lizards, etc., are of much interest, though even if it were proved that the mutilations were actually due to the attempts of such vertebrates to seize the insects, rather than to their being battered and torn by wind or rain, they scarcely form a body of evidence proving that butterflies constitute an important article of food for birds, but rather that they are only stray tid-bits; much less does the evidence seem to us sufficient to afford a foundation for a theory of the origination of species.

Thus of the twenty-five figures on Pl. IX, it is stated that ten of the figures represent mutilations attributed to the bites of lizards, and one to the attacks of a mantis. Of the thirty-three figures on Pl. X eleven are referred to the attacks of birds, six to those of lizards, while the others are not explained. Of the twenty-four figures on Pl. XI thirteen are referred to the bites of birds, one to the attempt on the part of a lizard and two to injury by a possible mantis.

Mr. Mansel Weale<sup>1</sup> mentions seeing in Brooklyn, Kaffraria, *Tchitrea cristata* darting at *P. agathina*; "*Cypselus caffer* I have seen take small moths from the grass, and dart at *Terias rahel* on our open flats; *Motacilla capensis* I have seen take moths and *P. hellica*; *Dururus musicus* is a voracious bird amongst insects, and takes moths, though I cannot state I have seen it capture Rhopalocera, yet I think it also attacks Pieridæ."

## 7. THE BATES-MÜLLER THEORIES.

The theory of protective coloration, *i.e.*, that animals of many groups are protected from observation by their color, is generally accepted, though there is a difference of opinion as to the active cause of the adaptation, or harmony, *i.e.*, whether it is the result of the physical agency of light and shade, with or without moisture, or is due to natural selection.

*The Batesian theory.*—Mr. Bates<sup>2</sup> first states that the majority of the species of Heliconidæ have very limited ranges. "I was surprised," he says, "when traveling on the upper Amazons from east to west, to find the greater part of the species of Ithomiæ changed

<sup>1</sup> *Nature*, III, p. 508.

<sup>2</sup> *Trans. Linn. Soc. London*, xxiii, 1862, pp. 495-566.

from one locality to another, not further removed than 100 to 200 miles. . . . This is remarkable when we consider that the whole of the country of the upper Amazons is a nearly level plain, uniformly covered with forest, and offering no perceptible difference in soil or other physical conditions." Many of these local species have the appearance of being geographical varieties, but they are "good and true species"; where a number of very closely allied species fly together they keep themselves perfectly distinct, not hybridizing. These species led Bates to believe that "many of the now distinct species of Heliconidæ have arisen from local varieties, segregated from the variations of preëxisting widely disseminated species." Corresponding races of counterfeiting butterflies of other families and moths accompany these local forms. "In some places I found proof that such species are modified from place to place to suit the peculiar forms of Heliconidæ there stationed." He then mentions the well-known case of the mimicry of *Ithomia* by *Leptalis*. The *Ithomiæ* are all excessively numerous in individuals, while the *Leptalides* are exceedingly rare, and "cannot be more than as 1 to 1000 with regard to the *Ithomiæ*." In a polymorphic form like the *Leptalis lysinæ*, the variations he thinks "have not arisen by simple variation or *sports* in one generation, but, as we shall presently see, by an external agency accumulating the modifications of many generations, in two diverging directions." On p. 508 he states that it is "clear that the mutual resemblance in this and other cases cannot be entirely due to similarity of habits or the coincident adaptation of the two analogues to similar physical conditions," yet in the next sentence he remarks: "I think the facts of similar variation in two already nearly allied forms do sometimes show that they have been affected in a similar way by physical conditions," adding that a "great number of insects are modified in one direction by a seaside habitat." "I found also the general colors of many widely different species affected in a uniform way in the interior of the South American continent. But this does not produce the specific imitation of one species by another; *it only prepares the way for it.*" The italics are ours, and in this pregnant sentence we have the whole matter of mimicry in a nutshell. The physical agents, variations of light and heat, are what prepare the way; they are the initial causes.

Bates then asks what advantage the Heliconidæ possess to make so flourishing a group, adding: "It is probable they are unpalatable



to insect enemies." And then after stating that they all have a peculiar smell, he mentions almost incidentally: "I never saw the flocks of slowly-flying *Heliconidæ* in the woods persecuted by birds or dragon flies, to which they would have been an easy prey; nor, when at rest on leaves, did they appear to be molested by lizards or the predaceous flies of the family *Asilidæ*, which were very often seen pouncing on butterflies of other families." Here it may be added that Bates nowhere states that he ever saw a bird pursuing or devouring a butterfly, and does not dwell on this subject, beyond remarking (on p. 499) that the *Heliconidæ* "show every sign of flourishing existence, although of slow flight, feeble structure, unfurnished with apparent means of defense, and living in places which are incessantly haunted by swarms of insectivorous birds."

Bates' explanation of the origin of mimetic species is by natural selection, although he says: "In what way our *Leptalis* originally acquired the general form and colors of *Ithomiæ* I must leave undiscussed." He suggests, however (p. 512), that the selecting agents are insectivorous animals, which gradually destroy those sports or varieties that are not sufficiently like *Ithomiæ* to deceive them." He also says: "The conditions of life of these creatures are different in each locality where one or more separate local forms prevail, and those conditions are the selecting agents."

Bates' discussion of this subject is broad and sound, due to his observations over wide regions of country, and to careful studies on his return to England. He was evidently impressed with the fact that local varieties arise from local conditions of the environment, and does not entirely rely on the attacks of insectivorous birds; in this respect he is less narrow than later writers on mimicry, allowing as he does, and even seeming to waver between, the modifications due to changes in the physical conditions and the action of insectivorous birds alone.

How Mr. Bates regarded the subject seventeen years later may be seen by his comments on Müller's theory, made at a meeting of the Entomological Society of London in June, 1879 (*Trans.*, p. xxviii), which we quote on p. 419.

Here might be cited the statement of another naturalist, Dr. Seitz,<sup>1</sup> who found in a forest of southern Brazil a perfectly circumscribed region in which the insects were almost entirely blue; a few

<sup>1</sup> *Zoolog. Jahrbücher*, V, p. 317, 1890. Quoted by Beddard, "Animal Coloration," p. 46.

miles away from this locality the insects were red, yellow—any color but blue; but in this particular locality blue was so characteristic a tint, that out of twenty butterflies ten were entirely blue and the remaining ten partially blue. Nor was blue found to be confined to the Lepidoptera, the flies and Hemiptera were also largely blue. Dr. Seitz adds that we must not put down every color to mimicry, need for protective resemblance, warning coloration and so forth; for there are plenty of phenomena which do not seem capable of explanation on any of these theories.

*Müller's theory.*—In his paper published in *Kosmos*, May, 1879, and translated with notes by Mr. Meldola in the *Transactions of the Entomological Society of London*, for the same year, Müller stated his theory.

After discussing the resemblances in shape and color between *Ituna ilione* and *Thyridia megisto*, and the structural differences which prove that they must have had separate ancestors, he inquires which is the original form and which the mimic. "Does not," he says, "a species which serves as a model occur always in countless swarms, while the mimic is a hundred times more rare? Does not the model bear the hereditary coloring of its genus and family, while the mimic appears in borrowed plumes? And finally, is not the model unpalatable on account of its repulsive taste and odor, being for these reasons safe from foes, while the mimic finds protection in its disguise, without which it would be devoured as a tasty model?"

Müller then states that the imitating species may, at least in some districts, be more common than its model; "it is also conceivable," he says, "that the model species may become extinct while the mimicking species remains unaffected." He then says that in the case of the *Ituna* and *Thyridia* under consideration, both species are rare, at least in Santa Catharina, "and their relative numbers give no clue, therefore, as to which is the model." Both also are equally well protected by distastefulness. He also adds: "Now what does the mimicry of protected species signify? What advantage can it be to the rare *Eueides parana* to be so wonderfully like the common *Acraea thalia*, and what benefit can one species derive from resembling another, if each is protected by distastefulness? Obviously none at all if insectivorous birds, lizards, etc., have acquired by inheritance a knowledge of the species which are tasteful or distasteful to them—if an unconscious intelligence tells them

what they can safely devour and what they must avoid. But if each single bird has to learn this distinction by experience, a certain number of distasteful butterflies must also fall victims to the inexperience of the young enemies. Now if two distasteful species are sufficiently alike to be mistaken for one another, the experience acquired at the expense of one of them will likewise benefit the other; both species together will only have to contribute the same number of victims which each of them would have to furnish if they were different. If both species are equally common, then both will derive the same benefit from their resemblance—each will save half the number of victims which it has to furnish to the inexperience of its foes. But if one species is commoner than the other, then the benefit is unequally divided, and the proportional advantage for each of the two species which arises from their resemblance is *as the square* of their relative numbers.

“If two species are concerned, of which the one is very common and the other very rare, then the advantage falls almost entirely on the rarer species. If, for example, *Acræa thalia* were a thousand times commoner than *Eueides parana*, the latter would derive a million times greater benefit from the resemblance of the two species, whilst for the *Acræa* the benefit is practically *nil*. Thus *Eueides parana* might by natural selection be converted into one of the most exact mimics of *Acræa thalia*, although it is just as distasteful as the species imitated.

“On the other hand, if two or even several distasteful species are about equally common, resemblance brings them a nearly equal advantage, and each step which the other takes in this direction is preserved by natural selection—they would always meet each other numerically—so that finally one would not be able to say which of them has served as the model for the others. In this manner are explained those cases where several allied distasteful species (*e.g.*, *Colænis julia*, *Eueides aliphera*, and *Dione juno*) resemble one another—cases where such resemblance cannot be regarded as inherited, and yet where neither of the species appear to claim to have served as a model for the others.

“To this category *Ituna* and *Thyridia* may belong, although the first has probably made the greater step in passing from the former dissimilarity to the present resemblance of the two species.”

It will be interesting to read the comments on this paper made by Mr. Bates at the same meeting. He remarked that “he could

not see that Dr. Müller's explanations and calculations cleared up all the difficulties. The numerous cases where species which are themselves apparently protected by their offensive secretions evidently mimic other species similarly protected still form a great stumbling block. The excessive complexity of the question must be evident to all who read Dr. Fritz Müller's writings on this subject. The phenomena with regard to the Heliconidæ, stated broadly, were these: In tropical South America a numerous series of gayly-colored butterflies and moths, of very different families, which occur in abundance in almost every locality a naturalist may visit, are found all to change their hues and markings together, as if by the touch of an enchanter's wand, at every few hundred miles, the distances being shorter near the eastern slopes of the Andes than nearer the Atlantic. So close is the accord of some half a dozen species (of widely different genera) in each change that he (Mr. Bates) had seen them in large collections classed and named respectively as one species. Such a phenomenon was calculated to excite the interest of the traveling naturalist in the highest degree. Although the accordant changes were generally complete, cases occurred in which intermediate varieties were still extant, and the study of these had given him, when he was in South America, the clue to an explanation which, however, does not embrace the whole of the problem" (p. xxix).

From the facts regarding these local varieties thus stated by Bates, we seem warranted in ascribing the mimetic resemblances to convergence, or exposure to the same conditions of light, heat, moisture, etc., affecting all the individuals of a variety simultaneously, rather than to what is vaguely called "natural selection." A geographical series of each locality arranged in order from east to west would graphically elucidate the problem.

#### 8. CRITICISMS OF THE BATES-MÜLLER HYPOTHESES.

The color and markings of animals in general are primarily due to the action of light and the color of the environment or background. To suppose that in the case of butterflies alone the colors of the mimics are due to the attacks of birds, whereas remarkably few butterflies, as we have seen, are ever eaten by them, is a cause so inadequate, so limited in its scope and so one-sided, that it is no wonder the hypotheses has many opponents.

*Mimicry not primarily due to natural selection.*—As has been often stated by Semper and others, natural selection is not a transforming agent, but rather results in the preservation of species. With little doubt models and mimics resemble each other because the light and background or environment are the same, and act on great numbers of individuals in a given area.

While Bates, and apparently Fritz Müller, put forward their views in a tentative way, later writers of the extreme Darwinian school, notably Wallace, Poulton, Weismann, and a few others, strongly insist on the entire sufficiency of the selection hypothesis, claiming that it is the sole, primitive cause of the mimicry. Thus Prof. Poulton<sup>1</sup> goes so far as to claim that "birds are among the chief enemies of butterflies," adding: "That they have been the chief, if not the only, agents in the production of mimicry, whether Batesian or Müllerian, "I have little doubt." Again he says: "The intensely procryptic habits and colors of many nymphaline genera have certainly been brought about by selection, due to the great keenness and success of insect-eating animals in their pursuit."

This conclusion does not harmonize with what appears to be the fact that only a very limited number of birds in any country, temperate or tropical, is as yet known to pursue butterflies, or that they, with the exception of the bee-eater, use these insects as a staple article of food.

*Bright colors not invariably associated with a nauseous taste or odor.*—While certain showy, brilliantly painted butterflies and other less conspicuously marked species are known to have a disagreeable taste or odor, there are multitudes of black or obscurely marked beetles, bugs, etc., which are still more malodorous and provided with "stink-glands." Many more detailed observations and anatomical investigations need to be made on the subject of inedible Lepidoptera. The unpalatable nymphalid butterflies (Ithomiinæ, Danainæ, Heliconinæ and Acraeinæ) apparently vary in the nature and extent of the secretions. For nearly all that we know of the occurrence of repugnatorial glands in Heliconid butterflies we are indebted to Fritz Müller, who detected in Colænis, Heliconius, Eueides and Dione a pair of anal eversible glands which give out a disagreeable odor, and which appear to be the homologue of the odoriferous glands of butterflies of other groups.

<sup>1</sup> *Transactions Ent. Soc. London*, 1902, p. 356.

Such glands have not yet been detected in our *Anosia plexippus*. In this as in other butterflies the slightly disagreeable taste or smell is probably due to the pigment in the scales of the wings. The lepidotic acid of *Gonopteryx rhamni* is thought by Hopkins to be repellant to birds.<sup>1</sup>

It is well known that *Arctia virgo*, *Leucarctia acraea*, *Spilosoma virginica*, *Pyrrharctia isabella*, etc., secrete in eversible abdominal glands a rank, bad smelling odor which, as we have observed, is like that of laudanum. Yet these moths have no mimics, and only one of them, the *Arctia*, has warning colors. A few of the *Syntomidæ* and *Zygænidæ* are known to emit a disagreeable odor, as the species of *Zygæna*, but on tasting bits of the abdomen of a female *Ctenucha virginica* I was unable to detect any unpleasant taste; on offering one to a parrot it seized it, but let it drop and did not eat it. I do not, however, regard this experiment as a satisfactory one, as the bird may have been frightened by my attempts to hand the moth to it.

*Mimicry due to convergence.*—It is plainly evident that the Batesian, and more especially the Müllerian, hypotheses rests on an insecure basis and will have to be abandoned, and that the phenomena of mimicry should be attributed to convergence; certainly not primarily to the biological environment, *i. e.*, to the fancied struggle for life with insectivorous birds.

That protective mimicry is due to convergence is denied by Mr. Marshall.<sup>2</sup> In stating the case of *Papilio leonidas* of Mashonaland and Delagoa Bay, with its "strong and rapid flight," in contrast with the "slow sailing movements" of its southern parallel variety *brassides*, "to show off its coloration which is so characteristic of the protected *Danainæ* and *Acraeinæ*," he does not attribute the difference in these two varieties to simple climatic or local causes, but to adaptation by mimicry owing to the abundance of its model *Amauris echeria*, adding: "It does not seem to me that convergence would explain the facts, for if *leonidas* is itself protected it

<sup>1</sup> *Phil. Trans. Roy. Soc. London*, 1895, pp. 661-682. See also Packard's *Text-book of Entomology*, p. 206.

<sup>2</sup> Five years' observations and experiments (1896-1901) on the bionomics of South African insects, chiefly directed to the investigation of mimicry and warning colors, by Guy A. K. Marshall. With a discussion of the results and other subjects suggested by them, by E. B. Poulton, etc., *Trans. Ent. London*, 1902, p. 507.

should exhibit throughout its range that slow flight which is the 'hall-mark' of protection, which it certainly does not in Mashonaland." We venture, however, to inquire whether climatic or local causes are not sufficient to account for the "reduction in size and number of the spots in the fore wing, and the toning down of the color from glaucous green to greenish-white, accompanied by the marked change in its mode of flight."

The changes in shape of wings and in color are probably due to the action of light and temperature, and also to the difference in amount and nature of the pigment. The cases of mimicry in butterflies of different groups, as well as in beetles, Hemiptera and other orders, seem also due to the fact that there is in day-flying insects, after all the variety of hues, a somewhat limited range of colors, and also of patterns. I am inclined to believe that these factors have so operated as to bring about the wonderful cases of convergence exemplified by the instances of Batesian and Müllerian mimicry.

In a discussion on mimicry Mr. Elwes<sup>1</sup> affirmed "that there was too much assumption about both the Batesian and Müllerian theories. In many supposed cases he doubted whether the so-called models were protected by taste or smell. He referred to the extraordinary superficial resemblance between two Pieridæ found in the high Andes of Bolivia and two others found at similar elevations in Ladak, Asia, and was inclined to think that similar conditions of environment produced similar effects."

Referring to Meldola's opinion that *Euplæa distanti* is the mimic of the somewhat abundant *E. breweri*, Mr. Distant<sup>2</sup> states that the former is found both in the Malay Peninsula, Java and Sumatra, whilst the latter is unknown to inhabit either Java or Sumatra, though plentiful in the Malay Peninsula. "Consequently in Java and Sumatra it mimics a species which does not exist nearer than in the Malay Peninsula (that is, accepting this 'mimicry hypothesis')."

Eisig has suggested, and Beddard and others have enlarged the view, that those bright colors of animals which have hitherto been regarded as of warning significance, are merely the substance or secretions which confer the unpleasant taste, and that therefore Wallace's older interpretation is unnecessary and in fact erroneous.

<sup>1</sup> *Trans. Ent. Soc. London.*

<sup>2</sup> *Annals and Mag. Nat. Hist.*, 5th ser., xi, 1883, p. 46.

We fall back on the experiments of Steinach, which demonstrate that light often acts as a direct stimulus. He glued strips of black paper to the skin of frogs which were kept in the dark; when they were exposed to the light only the uncovered parts of their skin returned to a lighter color, while the covered parts remained dark. To avoid all doubts the experiments were repeated on skin separated from the body, and photograms of letters and flowers, cut out of black paper and glued to the skin, were reproduced upon it. These experiments prove the truth of Biederman's claim that the color-cells of the frog change their shape owing to the direct action of light and temperature.<sup>1</sup>

The researches of Krukenberg and others show that light has a marked influence on the colors of insects; and the criticisms of Hagen, with the later researches of Hopkins, Urech, Mayer and others on pigments, all tend to show that the colors and markings of insects and other animals which by some theorists are attributed to natural selection, are really the result of the action of the primary factors of evolution, such as changes of light, heat and cold, moisture and dryness, etc., color and pattern being at the outset produced by metabolic and physiological processes.<sup>2</sup>

*So-called warning colors in Coleoptera, etc.*—Some of the so-called "warning patterns" of ground and tiger beetles, especially the former (*Anthia*), are claimed by Marshall and Poulton to be "very remarkable and effective." They are ornamented with large spot and stripes. When alarmed they are said to adopt a very characteristic warning attitude, and like *Brachinus* they eject to the distance of from four to five feet a strong acid secretion which produces a strong stinging sensation when it touches the skin of the face or back of the hands.

Here it should be observed that these spotted *Carabidæ*, unlike the majority of the family, are diurnal in their habits, preferring open, treeless places exposed to the direct heat and sunlight.

They are purely terrestrial in their habits, very conspicuous, and prefer an open, treeless country; they can project an acid, caustic secretion to a distance of four or five feet.

Upon looking over the beautiful plates illustrating Marshall and Poulton's interesting memoir, it strikes one that in accumulating so many examples of warning colors, they attempt to prove too much.

<sup>1</sup> Pfliüger's *Archiv Phys.*, p. 51, 1892.

<sup>2</sup> See our *Text-book of Entomology*, pp. 201-210, for abstracts.



In other words, the repetition in so many insects of such different orders, often in different parts of the world, of certain colors in certain designs or patterns can scarcely be explained by attributing their appearance to the action of natural selection. Upon looking at the colored plates of Hymenoptera, Coleoptera, Hemiptera, Diptera, etc., in Marshall and Poulton's memoir, or examining similar series in a collection, where the colors are chiefly black or brown and yellow or yellow-brown, one is struck by what after all is the slight range of colors, and by the repetition of the same style of markings and of similar patterns or designs. These, being especially frequent and characteristic of day-flying, light-seeking Lepidoptera, Hymenoptera and Diptera, as well as Hemiptera, dragon flies, etc., appear to be due to the stimulus of light and shade, to high temperature, combined as a rule with moisture. These modifications and adaptations also have evidently affected multitudes of individuals in a given area; *i.e.*, all those exposed to a similar physical environment.

The claim that the markings of the Coleoptera represented on Pl. XVII, entitled "Warning patterns and mimicry of Mutillidæ in Carabidæ and Cicindelidæ, etc.," are the result of natural selection, seems rather far-fetched. The Cicindelæ in northern countries, however it may be in South Africa, are much more abundant than the species of *Mutilla*, and therefore less liable to be exterminated or eliminated than these rather scarce Hymenoptera; moreover, nearly all tiger beetles are day-flyers and are more or less bright colored, spotted, or adorned with metallic tints. The spotted Carabidæ are exceptional; we have spotted species in North America, and their supposed models, *Mutilla*, are as infrequent. We should prefer to look upon the species of *Anthia* figured (*A. 6-guttata* from India, *A. nimrod* and *A. omoplata* from West Africa) as simply due to convergence; the spots in the beetles and in the Mutillæ arising from the same exposure to the sun's rays in a warm country. in this case we should waive any further causal connection.

That the coloration of the Mutillæ and of the carabids cited is protective is quite evident, but we would doubt whether Müllertian mimicry is suggested or proved by the similarity of the markings of these insects. Mr. Marshall states: "The Mutillidæ of course are armed with a powerful sting, which however they are slow to use, and besides they are very hard; the red prothorax is by no means conspicuous when they are running on the ground, the abdomen being the part that catches the eye, and when hard pressed this is

elevated in the air evidently as a warning. I have noticed that it is very difficult to distinguish the pattern while the insect is running, the general impression being merely that of a black body with white spots. The same applies to the Cicindelidæ and Carabidæ, which are all fast runners and most of them very difficult to distinguish *inter se* in the field at first sight." Now we would inquire whether we need to invoke so speculative a hypothesis as the Müllerian one for these cases. Are they not almost exactly paralleled by the spots and bands of animals of numerous other orders which live exposed to the direct sunlight or to light and shade, such as the day-flying insects of different orders, spiders, the exceptionally marked rodents, myrmecophaga, chipmunk, zebra, African kudu, the tiger, leopard and other cats; in all these animals when running, leaping or flying the outlines of the body are rendered more or less indistinct by the blending of the markings. The Müllerian theory should either be extended to include all banded and spotted animals or discarded.

On Pl. XVIII, entitled "Mashonaland insects of many orders with Lycoid pattern and coloring, etc.," are sixty-two figures of as many species—"which live on flowers, are most conspicuous"—all claimed to imitate *Lycus*, the species of which are distasteful, and which presumably owe, according to the advocates of the Müllerian theory, their origination and preservation to this cause. All the insects on this plate have the same general yellowish-ochre hue, the end of the body or of the wings tipped or colored dark brown; a selection is made of Coleoptera of different families, of various heteropterous Hemiptera, of various Hymenoptera, such as species of *Cerceris*, *Pompilus*, and slow-flying, strong-smelling ichneumons (*Bracon*, etc.). How *Pompilus*, so amply equipped with its sting for protection against birds and lizards, should enjoy immunity from attack by its resemblance to a harmless beetle protected by its bitter flavor is not clear. The great group of *Pompilidæ* and allies taken the world over vastly outnumber the few scattered species of *Lycus*, so that in this case, as well as the carnivorous Coleoptera mentioned, to assume, as the Müllerian theory does, that such great groups, or certain of them, have come into being and maintain themselves by natural selection seems an unnecessary hypothesis. Are not the resemblances to a *Lycus* of the two *Zygænidæ*, which are paralleled by the American *Lycomorpha*, simply cases of convergence due to similar heat, dryness and other

conditions on the elevated plateau of Mashonaland? As to the supposed resemblance of the Pimplæ with dark barred wings, do they not bear quite as close a resemblance to Panorpa?

"Müllerian mimicry in South African beetles, etc.," is further illustrated by Pl. XIX, with fifty-nine excellent colored figures. The first sixteen figures represent "a powerful group of Cantharidæ and the insects convergent toward them, and having conspicuous cream, orange or red bands on a black ground." In reflecting on the causes of this similarity in coloring of Ethiopian Cantharidæ, Mylabris, etc., it occurs to one that in the humid and cool climate of the northern United States the species of Cantharis are black or gray, in the southwestern States and Territories that they become gray and spotted, in southern Europe the typical species is of a brilliant rich green, but not banded or spotted, while in Africa, with its torrid heats, these beetles though of differing genera are banded, or run into secondary forms in which the bands are broken into spots. Is there not here a direct and controlling relation to the climatic conditions, *i.e.*, heat and heat-loving habits, elevation, moisture or dryness? Whatever the style of coloration, they all secrete from the waste products of the blood a bitter vesicant pigment, by which the individuals are protected, whatever be their color, by their more than disagreeable taste and after effects.

In this plate a number of Hemiptera, yellowish or reddish banded with black, somewhat resembling the beetles, are introduced, but they are themselves distasteful and sufficiently protected unless very unlike their congeners known to be such.

The markings of beetles of various other families, Coccinellidæ, Chrysomelidæ and Cerambycidæ, some distasteful, others innocuous or neutral, are evidently the result of convergence, and the more such examples are multiplied the stronger is the case for convergence.

In the last figures (53-59) are blackish ants, with shades of reddish, *Megapetus atratus*, a hemipter, and a *Myrmecophana? fallax*, a cricket-like form. Now there is at first sight a general resemblance to the ants on the part of these hemipterous and orthopterous mimickers, but this is due to the loss of wings by disuse, the result of lack of exercise in flight, a cause vastly more thoroughgoing and transforming than the good or bad taste of the pigment.

Again, take the case of Belt's Nicaragua frog. All the frogs observed by Belt, with this one exception, are like those in all other

parts of the world, green or brown, imitating green or dead leaves and living among foliage, while others hide in holes and under logs. "All these come out only at night to feed, and they are all preyed upon by snakes and birds." But the single inedible species is conspicuously marked with red and blue, and it is a significant fact that it hops about in the daytime. It is apparently to this habit of living in the hot sunlight that the color markings of this frog owe their origin, driven perhaps by competition to the necessity of seeking insects in broad daylight. The sunlight and moisture of the Nicaraguan climate is perhaps with little doubt the cause of the deposition of a larger amount of pigment than in the other species; it is consequently more concentrated and acrid or nauseous, and thus repugnant to birds. We know that toads are not eaten so readily as frogs, owing to the acrid secretion from their skin. The Nicaraguan frog then, as a result of an original change in habit, became permanently diurnal, consequently the more abundant pigment, varying in thickness and density on different parts of its body, made it gayly banded and spotted, so that birds learned to avoid it. The result is that by selection, if one pleases, the species becomes established and preserved, so long as the natural conditions of existence remain unaltered. But we submit that the primary or initial causes or factors in the evolution of the so-called warning colors and taste are the result of exposure to the direct sunlight, and consequent excessive pigmentation; the food also being more abundant, as the other species are hidden away; finally we will allow that the species are preserved by what is called natural selection, though we grant this with the proviso that natural selection is powerless to act and entirely wanting and insufficient should a change of conditions, physical, climatic and biological, supervene to change the creature's habits. And so it is with the bitter-tasting butterflies and their conspicuous colors and markings; their light-loving habits and a hot, moist climate are the causes of modification—causes which cannot be overlooked or ignored.

#### 9. PROTECTIVE MIMICRY NOT NECESSARILY APPLICABLE TO SNAKES.

O. Boettger,<sup>1</sup> as the result of the examination of a collection from Brazil, finds that the prevailing colors are red, black and white or

<sup>1</sup> *Bericht d. Senckenberg. Naturforsch. Ges.*, 1899, pp. 75-88. Also *Journ. Roy. Micr. Soc.*, 1900, p. 311.

yellow, arranged in certain definite patterns. Of eight species of Elaps and the same number of species of harmless snakes, the latter "mimic" the Elaps.

But in India where three poisonous genera are mimicked by three harmless genera, the poisonous, however, prey on the mimics; they are not protected except from birds.

#### 10. MÜLLERIAN MIMICRY NOT APPLICABLE IN CERTAIN CASES EVEN IN BUTTERFLIES.

Mr. G. F. Matthews, visiting the Solomon Islands, writes: "A very interesting case of mimicry occurred here. A dark brown *Euplœa* with broad white outer margins, and *Danaïs insolata* with markings almost identical, were fairly plentiful; but, to add to the confusion of things, a *Hypolimnas*, which on the wing might have been mistaken for either, was flying with them. Which mimicked which it was difficult to say, or the reason of the mimicry, as all three genera are avoided by birds both in the larva and perfect stages. The theories of Müller and of Bates have been strongly maintained by ultra-Darwinians; but there is on the part of some who have seen how seldom birds seem to care to chase butterflies of any kind a feeling that the theories in question have but a limited basis of fact."

Sir George F. Hampson discusses in *Nature* what he aptly calls "museum mimicry." "It was," he says, "recently stated by Colonel Swinhoe that Danaid butterflies are mimicked, as a means of protection, by three genera of the *Chalcosia* group of moths." But it appears that the latter secrete strong acrid juices, as does the whole family to which they belong, while they are so distasteful that hardly any other animals will touch them; their habits too are very different from those of butterflies, and no one, he says, who knows them could possibly believe in protective mimicry between the two groups.

#### 11. INDIFFERENCE SHOWN TO BUTTERFLIES BY BIRDS.

It appears to be the case in Europe that birds actually reject or at least are indifferent to butterflies, and this seems to be the case in the United States and Canada, judging from the facts now known, and my own slight observations. Birds will as if in play dart after butterflies, as they will after a flying leaf, but will not devour them, while they will catch and eat moths.

Thus Irmscher<sup>1</sup> states that on setting free a large number of common Noctuids (species of *Agrotis* and *Leucania*) most of them were eaten by the redstart resting near by. But it was remarkable that of the numerous *Vanessa io* which he set free, not a single one was caught by the redstarts.

Dr. A. Seitz<sup>2</sup> records having seen *Pieris* make a rush after the feathers of birds and bits of paper which had fluttered down in the air. He saw a young wagtail pursue a *Colias hyale*; it rushed after the butterfly, which fell to the ground, but the bird then flew at least four or five times over the prostrate butterfly without taking any further notice of it whatever. From this observation he infers that the insectivorous birds in Europe are indifferent to or disdain butterflies, and he goes on to theoretically prove that butterflies are not molested by birds. Undoubtedly the irregular wavering flight of butterflies enables them to escape the occasional onset of birds. Thus Seitz states from his observations that the kind of flight of Lepidoptera has a good deal to do with the matter. The males of several species of moths (e.g., *Gastropacha quercus*) whose flight is irregular, restless and fluttering, are not followed by birds, which will devour the females whose flight is more steady.

## 12. SOKOLOWSKY'S VIEWS ON THE ORIGIN OF THE MARKINGS OF MAMMALS AND THE FORMATION OF SPOTS FROM LONGITUDINAL STRIPES.

In his interesting paper Sokolowsky<sup>3</sup> has been the first to thoroughly discuss the markings of mammals. He contends that the most primitive style of markings are longitudinal stripes developed in small ground mammals, and caused by the long, slender shadows of the fern vegetations of the ground-zone of the primitive forests. In the larger animals of the bush-zone there appeared a change of markings, due to the play of light and shadow in the plants of this zone. Such are *Centetes*, *Geomys*, *Tamias* or the chipmunk. In *Calogenys paca* the five rows of round white spots on each side are due to the breaking up of the originally five stripes into spots. The greater variety of plants in the bush-zone formed a chaos of contrasting light and shade, so that the markings of these or similar mammals

<sup>1</sup> *Illust. Zeit. Ent. Neudamm.*, V, p. 75, März, 1900.

<sup>2</sup> Spengel's *Zool. Jahrbücher*, lii.

<sup>3</sup> *Über die Beziehungen zwischen Lebensweise und Zeichnung bei Säugetieren* Zürich, 1895.

became adapted to it. "Nature," he says, "has settled this question with masterly skill. She dissolved the longitudinal stripes into spotted markings by interrupting the separate longitudinal lines. . . . The advantage of this kind of marking is this, that the whole impression of the animal's form is broken up by the many interruptions of the ground coloring by means of the spots, and therefore the particular animal is lost to sight in the confusion of light and shade in the forest."

This process of development of spots is especially seen in the Carnivora and more particularly in the Viverridæ, which date back to the Miocene Tertiary. These forms still possess the traces of the more primitive longitudinal striping, as seen in *Viverra schlegeli*, in which there are plain longitudinal dorsal stripes. In *Viverra indica* the spots are arranged in longitudinal rows, which are still partly connected on the back, and form short longitudinal lines. In *V. genetta* are traces of the primitive longitudinal lines. All these animals prefer bushy regions. The larger Carnivora, *i.e.*, the Felidæ, inhabit not the deep, dark forest, but the edge of the woods near the banks of the rivers, where they have become adapted in coloration to the "luxuriant chaos" of lights and shadows. "As eye-witnesses report, the form of the leopard, for example, is so dissolved by means of the variegated parti-colored ring-like markings that it becomes difficult even for the accustomed eye of a native of these regions to perceive the animal in the leafy confusion." The evolution of the ringed marking has perhaps originated from both forms of marking, the longitudinal stripes and the spots, and is discussed at some length by the author. He supposes that the rings are caused by a subdivision of the single spots. Thus in the ocelot the longitudinal stripes may have split lengthwise and formed rings by their falling apart into sections which again divide into dots. Whether the markings of the tiger arose from the dissolving of the horizontal cross partitions (seen in *F. nebulosa*) or were formed by the blending of spots lying on top of each other is, he thinks, an open question, yet it is a fact that the markings of the tiger show rings which are arranged both vertically and lengthwise. Eimer regards the transverse stripes as due to a blending of the spots in a vertical direction. The origin of transverse series of spots from longitudinal stripes is clearly seen in the ontogeny of *Datana major*. (See my monograph of bombycine moths, Pt. I, Pl. XII, and Pt. II, p. 8, 1905.)

On the other hand arboreal mammals, as the squirrels, tree monkeys, etc., have lost their primitive markings, so that we have in them an entire group of unmarked species, or what markings are left are confined to a ring on the tail, and to shorter or longer stripes on the forehead and back; such are *Nasua*, *Procyon*, *Ailurus*, *Bassaris*, *Lemur calla*, several species of *Hapale*, as also *Cebus leucogenys*.

Leaving the tropical forests, Sokolowsky then considers the style of marking of those mammals inhabiting steppes, prairies surrounding the edge of woods, savannas, pampas, and finally deserts. He confines himself to the steppes of middle and southern Africa, with their often rich vegetation and great seasonal changes, so that the mammalian life has become adapted to the most varying and strict privations and necessities.

In the mammals of the grassy steppes or plains, while originally migrating from forest and bush regions, the markings have undergone a process of reduction, and there are two styles of markings, *i.e.*, the dots and the diagonal stripes. Martin alleges that the form of leopard frequenting the extensive grassy plains of the flat Nile lands has a dotted coat suggestive of the markings of the geparde. The sleek spotted mammals of the steppes also show similar modifications in markings. *Felis serval*, although it conforms most closely to the forest forms, still shows even on the back of the head and on the shoulders four longitudinal black stripes which are certainly mingled with spots, whereas on the cheeks occur small spots recalling the dots of the geparde, those on the side of the body being larger. The spotted hyena (*Hyæna acuta*) lurks on the edges of the deserts, and it presents many climatic variations differing in color and markings, while the sojourn in the steppes has produced an irregular arrangement of spots. The uniformly dusky-toned ground-color of its coat so blends at nightfall with the irregularly placed spots that it may be justly regarded as a twilight clothing.

Sokolowsky here refers to the fact that each style of marking, however varied in color in the daytime, yet at the appearance of darkness is so combined with the ground-tone of the coat and with the surroundings that a protective clothing is provided at night also.

Mammals which are notoriously nocturnal in their habits are generally destitute of markings, as are the burrowing mice and rats which live on the ground in Northern Africa.

The giraffe has a special kind of spotted marking. The large



irregularly situated spots lie so close together that the ground-tone of the coat looks like network. Stanley discovered in Central Africa a variety with large round black spots. The giraffe has been observed to strikingly resemble the dead lichen-covered trunks of last year's mimosa trees, so as to be mistaken for them. (Also see Wallace's *Darwinism*, p. 212.) This spotted style of marking merely results, adds Sokolowsky, from a splitting of the original longitudinal stripes due to the great size of the animal. The variety with dark markings is indisputably nearer to the earlier forest form than to the lighter colored form.

He considers that the lion has descended from ancestors with a ringed kind of marking, as in quite young stuffed examples there are ring-like spots on the body. Here we might add that we have observed in the young panther (*F. concolor*) when three months old that the coat is distinctly spotted, showing that it originally was a forest cat, becoming afterward adapted to a life on treeless plains.

The markings of the zebras, asses and wild horses, as well as antelopes, are discussed at length, the effacement of the primitive stripes being attributed to a life on grassy plains. The Canidæ are supposed by our author to have originally been more or less transversely striped, cases of partial dorsal striping in *Canis mesomelas*, *C. azaræ*, *C. lupus*, and others being attributed to reversion.

In foxes this is seen, especially the cross fox, which bears a dark dorsal stripe with darker transverse bands on the shoulders.

### 13. PÆCIOGENY IN ZEBRAS AND AFRICAN ANTELOPES DUE TO THE ACTION OF LIGHT AND SHADE.

As has been observed by several hunters and naturalists, the zebra is rendered nearly indistinguishable, when swiftly running, by the blending of the bars and stripes. Prof. Ewart states that the lion is the most inveterate enemy of the zebra, which is protected by its style of coloration as well as the rapidity of its movements. There is no animal, he says, which could turn about and break into a trot so quickly as the zebra. He points out that the stripes of the zebra are undoubtedly protective, causing the animal to become indistinguishable at a comparatively short distance. This he has experimentally proved by tying ribbons upon a dun-colored pony so as to break up the uniform coloration, the result being that the pony thus rendered zebra-like in its stripes was similarly indistinguishable.

Mr. Pocock has clearly shown that the stripes and bars of zebras and antelopes are in close relation to the environment of these animals, and that the stripes and spots are the result of light and shade. In *Nature* for August 13, 1903, p. 356, he states that Grant's quagga, which inhabits northeastern Africa, is one of the most completely striped of existing horses. It is, he says, a mass of stripes from head to tail, from hoof to spine. Intermediate forms connect it with Gray's quagga of Cape Colony, which has pale stripeless limbs, under sides and hind quarters. Now a series of three local races lead from Grant's to Gray's quagga. The tendency of these modifications is to convert a striped and conspicuously parti-colored animal into one which, even at a short distance, must have appeared to be an almost uniform brown, paling into cream on the under side, limbs and back of the haunches.

A zebra, he says, has such a coloration as to render it invisible under three conditions, *i.e.*, at a distance in the open plain in mid-day, at close quarters in the dusk and on moonlit nights, and in the cover afforded by thickets. The white stripes blend with the shafts of light sifted through the foliage and branches and reflected by the leaves of the trees, and in an uncertain light or at long range they mutually counteract each other and fuse to a uniform gray. Also the alternate arrangement of the black and white bars contributes something to the effect produced, by imparting a blurred appearance to the body.

The asses of northeastern Africa are perfectly adapted to their surroundings in color, and so with the kiang and with Prjevalsky's horse of Central Asia. Their coloration and the resulting protection is explained by Thayer's theory or law of the counteraction of light and shade. Pocock gives a good example. When the Asiatic kiang or the quagga of Cape Colony lies on the ground in the attitude characteristic of ungulates, the white on the back of the thighs is brought into line with that of the belly, and a continuous expanse of white, obliterating the shadow, extends all along the under side from the knee to the root of the tail. "In correlation with the adoption of a life in the open, a new method of concealment by means of shadow counteraction was required, and was gradually perfected by the toning down of the stripes on the upper side and the suppression of those on the hind quarters, belly and legs." The same style of markings occurs in many antelopes, gazelles and in the bonte-bok. They need to be thus concealed when lying

down and chewing the cud. When they are in motion the white rump may act as "follow-the-leader" or as danger signals, and Pocock thinks they are not necessarily recognition marks.

In his interesting article entitled "Antelopes and their recognition marks,"<sup>1</sup> Mr. Pocock regards the face and foot markings as, like the stripes, "representing spots or streaks of sunlight passing through foliage or reflected from leaves." Accepting Thayer's hypothesis of concealment by the counteraction of light and shade and applying it to the lesser kudu, "it will be seen," he says, "that the white is laid on where shadows are thrown; that the white rim on the upper lip and the white chin must counteract the shadows caused by the fold of the mouth and by the muzzle; the two white blotches on the neck must counteract the shadows thrown by the head and by the curvature of the throat, and the shadows cast by the breast and groin must be similarly obliterated by the white patches on the inner side of the base of the limbs."

That the markings or their absence are the result of adaptation to the environment is clearly established by the examples given by Pocock. The markings of the African elands are correlated with their habits, there being "a complete gradation from the strongly marked forest species through the weakly marked species frequenting the open bush to the unmarked desert species." The kudus illustrate the same principle. "Both the species of kudu are well marked with white stripes on body and head, but the smaller (*S. imberbis*) is much more strikingly marked than the larger (*S. strepsiceros*), having more stripes on the body and two patches on the throat. In Somaliland, where both species occur, the larger lives, according to Swayne, in the mountains, on very broken ground where there is plenty of bush; and sometimes indeed ventures into the open plain (Inverarity). The lesser kudu, on the contrary, is 'found in thick jungles . . . especially where there is an undergrowth of the slender pointed aloe which grows from four to six feet high' (Swayne). Evidence of a like kind is furnished by other species of Tragelaphines. . . . The beautifully marked nyala (*T. angasi*) and bongo (*T. euryceros*) live in dense thickets; and the lovely little bush-bucks (*T. sylvatica*, *scriptus*, etc.) seldom venture out of cover except at night time to feed. On the other hand the nylghaie, an aberrant member of the same tribe, is without body-stripes, and lives for the most part in more or

<sup>1</sup> *Nature*, Oct. 11, 1900, p. 584.

less open country in India, and is not a typical denizen of the jungle at all."

Pocock supplies another set of facts, showing the coexistence of white marks with long ears of zebras and antelopes and a bush life, bearing out the supposition that the marks, like the ears, are primarily for protection.

"The markings take the form of strongly contrasted bands of white and black or brown. Objects banded in this way are as a rule more, and not less, difficult to see in their natural surroundings than those that are uniformly colored. There is little of the gloss on the coat of a gray or white horse that is seen on a bay or black, because white hair reflects the light less vividly than dark. Hence alternating bands of these hues impart a blurred irregular aspect to a body, destroy the apparent evenness of its surface and break up the continuity of its outline. In an uncertain light a zebra's stripes merge 'into a gray tint,' and naturally counteract each other, so that the animal is nearly invisible."

Pocock also, as Thayer, insists that for concealment perfect stillness is of all things most important. "Movement means detection, and detection may mean death." Hence protective markings on the face are important, and he presumes that the pair of sunlight patches on the tiger's face increases its chances of concealment when watching for prey or creeping toward it.

This is confirmed by hunters. Mr. M. E. Robertson, of Chocorua, N. H., in shooting a deer on the edge of Chocorua Lake, entirely overlooked another one still nearer, within fifteen feet of the road, which stood perfectly still, being only partly concealed among the trees and bushes until it moved and was seen. The white markings on the face, around the eyes and on throat, as also on the inside of the large ears of our deer, serve, as in the cases of the deer and antelopes of other continents, to make the head blend with the lights and shades of the foliage in which it stands.

#### 14. BLENDING OF THE STRIPES OF THE CHIPMUNK.

In this conspicuously striped squirrel there appears to be a blending of the stripes when the animal is swiftly running. Although I have frequently seen this species running, I confess I have not clearly seen a partial obliteration or blending of the stripes; in the most favorable instance the animal ran from me so swiftly that it was not possible to tell whether or not the stripes blended.

Several of my students whom I asked about the matter, after showing them a stuffed specimen and explaining the theory of blending, have related their experience. Mr. C. A. Weeks tells me that he noticed a blending of the stripes while seeing a chipmunk running. Mr. T. McA. Webb reported that the chipmunk when running "appears all one color." Mr. J. H. Breslin writes, "I have often gone shooting for chipmunks, and found it very difficult to shoot one because it is so difficult to see it. I have often seen them on the rails of fences, and when you look right down upon one, it looks like part of the rail."

Mr. T. E. B. Pope tells me that "when the chipmunk runs slowly the black stripes are very distinct, but when running rapidly the dark stripes along the back appear to blend, so that the back appears dark as compared with the reddish or chestnut color of the under side; there is a black mass above and a chestnut mass beneath."

Mr. Glover M. Allen writes: "I have never looked particularly for the blending of stripes in the chipmunk as it runs, but my recollection would be that the stripes are not distinctly seen in rapid movement, and the general effect is of a brownish animal." He tells me that he has since observed that when it runs slowly the white stripes are distinct, but the dark ones less so.

Mr. W. J. Long writes me: The effect of the stripes is when it is running to make a *blur* of the animal, making it a difficult object for hawk or owl to hit. I used to try sighting a gun or rifle at chipmunks (not to shoot, for I am especially fond of the little creatures) and was surprised to find how hard it was to catch him with the head, much harder than a running red squirrel for instance. The stripes also help it when it is sitting still, for it gives at times the curious effect of sunlight streaming down between the leaves or twigs making bars of light and shade. The same results of the stripes may be noticed in young woodcock, as mentioned, but not carried out, in my "Little Brother to the Bear."

I also inquired of Mr. Abbott H. Thayer whether he had observed the blending of the stripes, and he kindly wrote me as follows:

"Chipmunks, like the vast majority of mammals and the whole animal kingdom, with exceptions almost wholly confined to male birds, are graded from dark above to white beneath in exactly the degree to efface their appearance of normal rotundity, and hence

like all objects so graded inevitably lack appearance of solidity, so that their resultant color passes for a part of their background. Stripes, dots, and all other patterns which are found participating in this graduation in most animals that live where their background is diversified with corresponding *degrees* of pattern (as it is in the forest by twigs, dead leaves and little dark holes and the shadows along the under side of light colored twigs) are simply a sort of resultant picture of the average background, just as high-swimming fishes like herring, pompano, bluefish, etc., having no patterns in their background have none on their coats. Chipmunk's stripes are very good rendering of horizontal twigs lighted from above and seen against a more distinct ground." (Also see p. 445).

#### 15. PROTECTIVE COLORATION AND BLENDING OF THE MARKINGS IN THE SANDPEEP.

After writing this paper I had the opportunity of observing on the Maine coast, September 3, a flock of sandpeeps which were very tame and allowed me to approach in my skiff within a few feet of them. At the distance of from about seventy-five to one hundred feet I could scarcely detect them as they were slowly walking over a little beach of coarse dark gneiss pebbles, the upper part of the oval body being of the same hue as the pebbles; it was only when within from forty to thirty feet that they could be clearly distinguished; it was a clear case of obliteration. On the other hand when standing at the level of my eyes on a dyke of feldspar, their whitish under side blended with the rock when resting, but on the dark gneiss rock enclosing the dike they stood out distinctly.

The flock was made up of old birds and young ones, the latter so tame that I could approach them in my skiff within about four feet.

When flying away they reminded me of the hawk-moth, *Deilephila lineata*, the bars on the wings and neck blending in the same manner, yet the dark and white bands on the body of the young birds remained distinct in slow flight.

*The stripes and bars of no value as recognition marks.*—Without entering at length into a discussion of Wallace's theory of recognition marks, which it seems to me has been effectually disposed of by Pocock, it at once struck me in watching these birds on the wing that the light and dark bars and rings so far from being distinct, and thus serving as recognition marks, actually so blended as to make the bird's shape less distinct, and thus the markings were

of no avail, producing the contrary effect of rendering these birds unrecognizable by their own species. And this it is obvious will apply to any birds and beasts similarly marked. Yet it may be that the white rump of deer, etc., may when the creatures are walking or slowly running serve as a guide to those following, as allowed by Pocock.

#### 16. BLENDING OF BLACK AND WHITE BARS IN MOTHS, BUTTERFLIES, ETC.

*Blending of the bars in moths.*—The flight of certain species of geometrid and pyralid moths, which are black marked with broad white bands, many years ago attracted my attention. When any of these smaller moths, such as the geometrids mentioned below and *Desmia funeralis* and other black and white Pyralids, are rather rapidly flying away from one the singular effect is that of whirling incomplete black and white broken circles, making the outlines of the body and wings confused, which, added to their irregular flight, renders them difficult to catch.

I well remember when on the Labrador coast in 1864, where the geometrid moth, *Rheumaptera hastata*, was abundant, flying in considerable numbers, the peculiar effect on my mind of its flight. This moth has broad black wings, marked with conspicuous white bands or bars. It ranges from the Arctic regions to Maine. In its uncertain devious flight the effect of the moth in its not particularly rapid flight was that of black and white incomplete and confused rings circling through the air. This partial blending of the white and black bands, added to the zigzag, uncertain flight, would make it very difficult for a bird to follow and seize such insects, which when disturbed fly by day and are thus protected. There are several other boreal or Arctic geometrids similarly marked, and also the species of *Helioimmata* and *Euchæca* (*Baptia*).

*Blending of the black and yellow stripes of Papilio turnus.*—On June 22, 1902, at Brunswick, Me., I for some time watched this butterfly leisurely flying from flower to flower. It seemed to me that during its flight there was a slight blending of the pale yellow orange of the wings with the black ground color, so that the general effect was that of pale yellow. A member of my family independently noticed the same blending and corroborated my own observations. She noticed that the black borders of the wings were rendered less distinct by the blending of the series of round yellowish

spots. The above was written out at the time, but my later experiment with the rotating wheel (p. 445) quite satisfactorily corroborates my observations.

*Blending of the bars and lines in Deilephila lineata.*—Early in September I observed at Sugar Hill, N. H., one of these hawk moths flying over and probing the flowers of the sweet william, of which it seemed especially fond, and paying little attention to the candytufts, petunias and marigolds in flower in the same beds.

During its rapid flight the bars or stripes and lines on its wings certainly blended, rendering the outlines and markings of the wings in their swift motion blurred and very indistinct, with no definite outline. The bars on the outstretched wings are parallel with the transverse bars or rings on the abdomen, the latter being more distinct, as also the longitudinal ones on the back of the thorax. The circumstances then reminded me of the statements regarding the blending of the stripes of the zebra, and the effect was such as to plainly make the moth invisible, or at least much less easily seen and caught by birds.

I also on the same day observed another of the same species on the other side of the road visiting red clover, etc., and my observations (written as here the same day) were corroborated by a member of my family.

*Blending of the bars in a dragon fly.*—On June 27th of the present year I watched a *Libellula trimaculata* flying in my yard. The wings are whitish, with a broad dark brown middle patch, the abdomen being a hoary whitish gray, and very conspicuous.

During its flight it seemed to me that the colors blended so as to make it more indistinct when more swiftly flying. The observation needs however to be completed, yet this dragon fly is a capital case for further examination.

#### 17. ABUNDANCE OF MARKINGS IN THE LIFE OF CORAL REEFS.

In a lecture delivered at the London Institute on the animal life on a coral reef, Dr. S. J. Hickson said that the richest fauna in the tropics is the region which extends from the growing edge of the reef to a depth of some ten or fifteen fathoms beyond it. And here it is that the struggle for existence is most severe, where the animals are protected and concealed by the most pronounced marks and colors, and provided with stings and spines to defend them in the battles with their enemies. The crowded life appears to be



primarily due to the *abundance of light and heat*, there being no great or sudden changes of temperature or of the chemical composition of the water; while there is an abundant food supply brought by the tidal currents from the surface of the ocean. Prof. Hickson thinks that the brilliant tints, spots and stripes seen on polyps, prawns, octopods and fishes are due to the fact that they live among the brilliant surroundings of the coral reef: "or, to put it in another way, animals similarly organized and of similar habits would be at a disadvantage on the coral reefs if they were not so marked and colored." The other fishes of the tropics, he observes, do not possess these curious and beautiful characters; the sharks, bonitos, flying fishes, herrings and others that do not live habitually on the coral reefs are not unlike in general color and ornamentation the fish of temperate seas. Hence, these characters of coral-reef animals are *not directly due to the high temperature and bright light of the tropics, but are due to the character of the surroundings*. He adds that most of the tints are concealment colors. The only example of what appears to be a warning color that he noticed occurs in connection with the spines on the tails of certain surgeons and trigger fish. *Acanthurus achilles*, for example, has a uniform purple color, but there is a bright red patch surrounding the formidable tail spines that give these fish the name of surgeons. Similar warning colors are very pronounced also in *Naseus unicornis* and *N. lituratus*, and in some of the Balistidæ.

#### 18. THE LACK OF COLOR-PATTERNS IN DEEP-SEA FISHES AND CRUSTACEA AS CONTRASTED WITH THOSE OF SHOAL SUNLIT WATERS.

Alcock, in his *Naturalist in Indian Seas*, states that the majority of deep-sea fishes are of uniform usually sombre color, only a minority in that ocean being banded, striped, or otherwise marked in definite patterns. To enter into details: of 168 species dredged below the 100-fathom line, fifty-two were black or some shade of blue or purple-black; fifty-six were dull brown; ten were silvered over a blackish or brownish ground color; ten were bright silver; four gray—thus 78 per cent. were simply-colored species. Fourteen species living between 100 and 250 fathoms were nearly uniform red or of a rosy hue. Only eighteen species, and those dredged near the 100-fathom line, were striped or marked with patterns, and only four were brilliantly variegated with many colors.

*Colors of Deep-Sea Crustacea.*—Alcock also remarks that while in the decapods dredged in abyssal waters the colors were red, pink, orange, yellow, a few brown, purple and white, none were spotted, striped or with variegated patterns. Thus they entirely differ from shallow-water forms with their freaks of color or labyrinthine mottlings and dapplings.

#### 19. THAYER'S LAW AND HIS EXPERIMENTAL PROOF.

In a suggestive article on protective coloration Mr. Abbott H. Thayer<sup>1</sup> considers the subject from an artist's point of view. "Animals," he says, "are painted by Nature darkest on those parts which tend to be most lighted by the sky's light, and *vice versa*." The prevalent idea of protective mimicry, he says, makes an animal appear to be some other thing, whereas it makes it cease to appear to exist at all.

The colors of the ruffed grouse are a complete gradation from brown above to silvery-white beneath. It grows light under the shelving eyebrows and darker again on the projecting cheek. When it stands alive on the ground its obliteration by the effect of the top light is obvious. By extending its protective color all over it, treating the under side with brown to match its back, the bird was made distinctly visible.

Thayer proved this by the following experiment. He had about a dozen egg-shaped pieces of wood made of the size of a woodcock's body. They were mounted on wire legs to poise six inches above the ground. Most of them he painted in imitation of the color gradation of a grouse or hare—earth color above to pure white beneath—while to two others he gave a coat of earth color above and below. He then set the whole lot like a flock of shore birds on the bare ground in a city lot, and invited a well-known ornithologist to look for them at a distance of from forty to fifty yards, who at once saw the two monochrome ones, but, although told exactly where to look, he failed to detect any of the others until within six or seven yards of them, and then only by knowing exactly where to look. He also painted bright blue and red spots on the brown back of one of them, which spots only passed for details of the ground beyond the egg.

<sup>1</sup> "The law which underlies protective coloration," *The Auk*, xiii, April and Oct., 1896. Also *Smithsonian Report* for 1897, p. 477.

In his second paper<sup>1</sup> Mr. Thayer points out that the coloration of every individual of the "mimicking groups" of butterflies seems to be the best conceivable for effacing the aspect of its wearer. "Most animals," he well says, "wear on their coats pictures of their habitat." "As I before pointed out, even the under side of the wings and tails of hawks bear the general twig patterns so common on forest birds, as if Nature found it worth while to efface the white silhouette their wings' under sides would make when they extended them while perching. We see how completely such patterns (when couched, of course, as they always are, in the effacive gradation) *do* help to obliterate a partridge, grouse, woodcock, hare, or any other of almost all the species in every order; since they prove to be actual *animated pictures* of their environment. As I said before, in my paper on so-called 'Banner-marks,'<sup>2</sup> these forest-like patterns are found on forest creatures, and not on desert creatures or ocean creatures. Sand birds are usually marked in longitudinal, delicate patterns, very like those the sand assumes when seen at the same angle at which one observes the birds themselves. Tigers and zebras are resolved into pictures of tall, strong flags, grasses and bamboos, while the lion is a picture of the desert. (It will some day be plainly understood that the effacive gradation is the essence of the success of these patterns. Were they not arranged to compose one perfect counter gradation, from top-dark to under-white, they would appear merely as what artists call 'lines of quantity,' like the hoops of a barrel, *emphasizing* the rotundity, not effacing it.)"

Butterflies, he claims, are "mainly either flying pictures of various combinations of flowers and their backgrounds, pictures of the *shadow under foliage*, with delicate patterns of vegetation or flowers drawn across it, as, for instance, in the North American *Papilio polydamas* and the dark *Satyrinæ*, or that they are wonderful representations of flowers themselves, as in the *Pierinæ*." He also claims that "any pattern is less conspicuous than bright, unshiny monochrome."

He likewise briefly recognizes the effect of rapid movement in

<sup>1</sup> "Protective coloration in its relation to mimicry, common warning colors and sexual selection," *Trans. Ent. Soc.*, London, Dec., 1903, pp. 553-569. The copy kindly sent me by Mr. Thayer has some valuable emendations and additions.

<sup>2</sup> *The Auk*, xvii, 1900, p. 108.

obliterating patterns. "The act of flight tends to obliterate patterns, by the too quick substitution of one color for another before the eye. A black and white butterfly, therefore, tends to look simply *gray* in swift flight."

#### 20. EXPERIMENTS ON THE OBLITERATION OF BARS AND SPOTS WITH BRADLEY'S COLOR WHEEL.

The following experiments on the artificial blending and obliteration of stripes and spots, by means of a revolving disk covered with parti-colored stripes or spots, throw, it seems to me, much light on this subject and satisfactorily proves that the stripes, bars and spots, contrasting with the ground colors of moths, butterflies, fishes, reptiles, birds and mammals thus marked, must necessarily blend so as to render the outline of the animal indistinct when it is in rapid motion.

I covered a six-inch black disk with squares of white paper about a quarter of an inch wide, in imitation of the squarish white spots on a loon's back. Moving the disk slowly there resulted three quite distinct black rings about a quarter of an inch wide, separated by white rings. When the wheel was revolved at full speed the black ground color and white spots all blended into whitish pearl-gray, of the general color of the under side of the loon's body. The white spots certainly all produced a decidedly blurred, indistinct whitish pearl-gray tone. It is thus probable that the loon's back during rapid flight harmonizes with the neutral gray of the sky, especially in cloudy weather, and tends to either obscure it or render it more or less invisible.

On a white disk was then pasted a series of wide dark brown stripes, in imitation of the stripes on a zebra. On rapidly revolving the wheel the stripes and ground color blended into a grayish-white or neutral tint. On a six-inch black disk were pasted three sinuous white bands from a quarter to half an inch in width, one white band on one side one inch long and that on the opposite side five inches long. When the disk was slowly revolved the black and white stripes blended, but there were visible two darker rings; but when the wheel was revolved more rapidly all perfectly blended into a whitish-gray hue like the color of the sky. This shows that the stripes of a zebra when in rapid motion would be blended, and its outlines rendered more or less indistinct, in accordance with the statements of different hunters and naturalists.

It will be remembered that on the outer margin of the wings of *Papilio asterias* there is a row of rather large round yellow spots on a black-brown ground. I pasted near the edge of a six-inch black disk several roundish dark buff spots nearly an inch in diameter. On revolving the disk, the spots formed a wide dark yellowish-gray band. The result was that the edge of the disk was made indistinct; the same effect is apparently produced by the yellowish spots on the butterfly's wing. A member of my family noticed that in a *Papilio* thus ornamented the outline of the wings was during flight blurred and made indistinct. Also the ground beetles *Anthia* and others, the *Cicindelidæ* and *Mutillidæ* are ornamented with large conspicuous yellow dots or spots which probably more or less blend.

I stuck on the same black disk five one-half-inch buff bands. On slowly turning the wheel two black rings were formed, the ground color of the disk being dark buff; on more rapidly turning the wheel a general dusky buff hue pervaded the disk.

In revolving a half or a three-quarters black disk over a white one the colors blended into gray. A disk half green and half black formed a darker green, and a disk three-quarters green and one-quarter black blended into a slightly darker green. A disk one-half or two-thirds yellow, the rest Venetian red, upon revolving produced a deep orange hue. A disk three-quarters yellow and one-quarter Venetian red produced an ochre-yellow, less deep than the orange effect. On revolving a disk one-half blue and one-half yellow a royal purple hue resulted.

From these experiments it appears to result that in any striped or spotted animal, when rapidly running or flying, the stripes or spots must inevitably tend to be confused or blended; and when the ground color and stripes or spots are of opposite hues, as black and white, the result will be a pearl-gray or cloud-like neutral tint, thus obliterating or at least obscuring the outlines of the body. Thus birds like the loon, pigeons with their barred wings, moths and butterflies with striking bands of very different hues, the tiger or zebra with its stripes, and the ocelot with its spots, tend when rapidly moving to become obscured to the vision, and to harmonize with the earth or sky.

The following experiment was less satisfactory than the foregoing. I fastened a stuffed chipmunk with its back upward on the outer edge of a large disk of white pasteboard. On revolving it slowly on

a color wheel the stripes remained distinct, not blending. When the speed was increased to a degree evidently exceeding that of the animal in its swiftest movements, it formed a dark grayish-brown, almost black ring, and the stripes were nearly if not wholly blended, certainly enough so to render the animal inconspicuous. One would expect that as the ground color of the chipmunk is a russet or reddish-brown the ring would be russet or reddish-brown, but this was not the case.

The animal was then placed on its side and so attached to the white disk that the subdorsal whitish stripe was visible, and also the upper portion of the light under side of the body. On rapidly revolving the disk the lighter and darker portions of the chipmunk still remained somewhat distinct, not perfectly blending. The result was a blurred, confused mass lighter on the under side and darker along the back.

The experiment was not so satisfactory as those with the zebra markings, and it is hoped that some one will make further experiments. The direction of rotation was parallel with that of the striped body of the chipmunk. There are in this animal no transverse bars, hence the stripes do not so readily blend. Moreover the body of the animal in running is more or less unsteady, undulating or arched. Until further observations are made we would provisionally conclude that the stripes of the chipmunk remain distinct when the animal is slowly running, but that they become blurred or confused when the creature is darting off at its greatest speed.

#### 21. PŒCIOGENY IN PALEOZOIC TIMES.

In claiming that all Müllerian mimicry is due to the attacks of birds, one would do well to bear in mind that a number of paleozoic net-veined insects had wings which were banded or spotted, and that these insects lived at a period when modern lizards, much less birds, did not exist. It may therefore be inferred that these markings originated from the simple action of physical and physiological causes, irrespective of the biological environment, such as the attacks of insectivorous animals, unless they suffered from the desultory warfare waged by the small active terrestrial labyrinthodents, such as the *Hyalonema*, etc., of the Upper Carboniferous period of Nova Scotia.

If we examine the works of Brongniart and of Scudder on fossil insects it becomes apparent that pœciogeny was an active process as

early as the Carboniferous period. The wings of many net-veined insects were then not only barred but spotted and ocellated as completely and beautifully as those of insects at the present time.

*Wings banded.*—Among those with banded wings were *Protophasma dumasi*, whose wings of both pairs were marked with six large parallel dusky bands. The wings of *Brodia priscocincta* were ornamented with three broad transverse bands or series of spots of a dull umber brown color. On the wings of *Lithomantis goldenbergi* were broad shades, the outer half of the wings being shaded.

*Wings with solid spots.*—Of the known species the great number of those ornamented at all already had the wings well spotted, showing that the process of specialization or division of stripes into spots had already been active, perhaps during the Devonian period.

On the wings of *Becquerelia superba* and of other species there are traces of at least seven rows of large spots. The wings of *Spilaptera packardii* were much spotted, the spots being large and oval, situated in the cells, with ten costal spots on the inner half of the wing; all the spots being arranged in about twenty-two series very oblique and parallel with the veins.

Nearly all the Carboniferous primitive Ephemeridæ had wings as well spotted as those now existing. In some kinds the wings were actually more numerous banded and beautifully spotted than any now existing. In *Sphecoptera gracilis* the wing is crossed by nine rows of large spots. In *Fouquea lacroixi* there are eight sets of large pale blotches, two or three in a row. *Palæoptilus brullei* has wings crossed by six rows of very large blotches, two in a row.

*Ocellated wings.*—In *Lamproptilia grand'euryi* the wings bear large somewhat eyed spots irregularly arranged. *Psilothorax longicauda*, an Ephemerid, is ornamented on the fore wings with at least twelve rows of ocellated spots.

In insects of the Oligocene tertiary age the wings were banded much as in existing insects. Thus in *Phryganea antiqua* the fore wings were crossed with eleven broad parallel bars; and *P. fossilis* had nine bars.

## 22. KEEBLE AND GAMBLE'S STUDIES ON THE ORIGIN OF MARKINGS OF THE SHRIMP.

That stripes and bars are due to the lights and shadows of a forest or grass land is the opinion of the authors we have quoted in these pages.

Much light, it seems to us, has been thrown on the actual mode of origin of stripes and bars in general by Keeble and Gamble<sup>1</sup> in their valuable essay on the color physiology of the higher Crustacea. They hold that the adult color pattern of *Hippolyte varians* "is determined by the environment and not inheritance." "The adult pattern arises in spite of difficulties which are thrown in its way. Gaps are bridged over, stripes are evolved, stripes are made to bars, and bars blend to a monochrome." How a bar is formed by a bar of shadow is thus stated :

"We know (see Section IX) that the pigments of the chromatophores expand into the branches under certain conditions of illumination (*e g.*, on dark background) and contract into the centres in diffuse light. Imagine a practically transparent Hippolyte (such, for example, as the earliest adolescent faint brown-lined forms) resting persistently, as it does rest, in such a situation that a bar of shadow falls across it, whilst over all the rest of its body light falls. In the region of the bar of shadow the chromatophores will expand. In the rest of the body they will be contracted to mere dots. Grant that where the conditions are favorable to the activity of the chromatophores growth will be greater than where its contents are aggregated in the manufacturing centre—a supposition which is no more unreasonable than that which supposes that functional activity favors growth—then in the region of shadow new chromatophores are formed, either by budding from or in relation to an existing centre. These in turn give rise to new centres in a like manner. The bar of shadow is now reflected on the surface of the animal by a bar formed of chromatophore branches. Hippolyte has grown into its surroundings."

"Further, if we accept a recent explanation of absorption color photography, we can see how the color of this bar of shadow comes to resemble that of the object that casts it. For Wiener has shown (1895) that a combination of substances may exist so sensitive to light as to be decomposed thereby, and give rise to a pigment of the same color as that of the incident light. If we postulate such a substance or combination in the chromatophores of Hippolyte, then the bar which we have just seen produced will be of the same color as that of the object which throws the shadow. We may then picture the mode whereby *Hippolyte varians* becomes infinite in variety."

<sup>1</sup> *Phil. Trans. Roy. Soc., London, Vol. 196, 1904, pp. 327-8.*



We may suppose that by somewhat the same process the shadows cast on the bodies of primitive tigers, antelopes, reptiles, birds, fishes, caterpillars, etc., produced stripes, bars and spots. I think that these observations, coupled with the experiments of Steinach and those of Poulton on the formation of pigment in the pupæ of butterflies, will enable us to understand how the markings of animals arose. Keeble and Gamble add that the results obtained with respect to background as the chief factor in inducing pigment movement in Crustacea offer a curious and interesting parallel to the results of Prof. Poulton, though for his word "formation" they would substitute that of "movement." With this change the outcome of Poulton's experiments "summarizes the state of affairs in Crustacea."

### 23. CONCLUSIONS.

1. The alleged cases of Müllerian mimicry can be explained by convergence due to the action of similar physical and climatic causes. The attacks of birds are a negligible factor.

2. The oftentimes striking and wonderful resemblances in coloration and markings are the result of pigmentation caused by exposure to the combined effects of sunlight and shade, and due—

*a.* To the repetition of the fundamental colors, brown, black, red, yellow, in insects of different orders, as well as animals of different classes, living exposed to direct sunlight, and often having exceptional diurnal or light-loving habits in contrast with the lucifugous habits of the other species of the genus, family or order.

*b.* The similarity of design appears in many, if not most, cases to be due to the repetition of markings with identical shapes or patterns, *i.e.*, lines, bars, which are eventually broken up into spots and repeated *ad infinitum*, owing to the economy everywhere seen in Nature of material and design, differing in details in different groups, owing to their different origin and hereditary constitution.

It is no wonder therefore that there should be apparent cases of mimicry in regions like the hot and humid forest-covered plains of Brazil and the East Indies, or the upland hot plains of southern Africa, or in Australia where there are yellow flies, beetles and Hymenoptera with a broad black band around the abdomen, hence curiously mimicking each other.

3. Extreme advocates of Batesian and Müllerian mimicry appear to entirely overlook the operation of the physical agents of sunlight

or excessive contrasts of light and shade combined, moisture and dryness, differences in environment or other climatic causes as affecting the amount and distribution of pigment. These markings probably gradually arose simultaneously in a given region in all the individuals, and not as a variation in a single individual, which is supposed to have become favored in the struggle for existence.

4. While the initial causes therefore are Lamarckian, natural selection as a preservative process may form a subordinate factor.

5. To claim that Müllerian mimicry is due to the attacks of birds, is to overlook the fact of the existence of stripes, bars and spots on the wings of paleozoic insects which flourished before the appearance of birds, and even of modern types of lizards.

6. As observers and collectors differ so greatly in their interpretation of the facts, the subject of protective mimicry, even if the data and arguments here presented do not to some seem conclusive, should at least be considered as an open one, the importance of Bates and of Müller's hypotheses as factors in evolution having been in some quarters unduly magnified.

We hope that no one will suppose that there is any disposition on our part to underestimate the value of the labors of either Bates or Fritz Müller. On the contrary, no one has a higher appreciation of their work than myself. Mr. Bates' essay shows that he should rank with Darwin and Wallace; while Fritz Müller's brief article were in the nature of suggestions confined to a few pages. As a zoologist he ranks with Darwin in fertility of suggestion and as an original co-founder of evolution. Darwin's own estimate of Müller's little paper is given in *More Letters of Charles Darwin*, wherein he says that Müller's views on mimicry are "too speculative to be introduced into my book" (p. 91).

---

*Stated Meeting, December 16, 1904.*

President SMITH in the Chair.

Mr. Alden Sampson read a paper entitled "A Deer's Bill of Fare."

Dr. M. J. Greenman, on behalf of Henry W. Fowler, presented a paper entitled "Description and Figure of *Coregonus nelsonii* Bean."

The President delivered his Annual Address which included "A Chapter in Electro-Analysis."

DESCRIPTION AND FIGURE OF COREGONUS NELSONII  
BEAN.

(Plates VIII and IX.)

BY HENRY W. FOWLER.

*(Read December 16, 1904.)*

Through the courtesy of Drs. Horace Jayne and M. J. Greenman I have recently had the opportunity of examining several large examples of the above White Fish received at the Wistar Institute of Anatomy in Philadelphia. As this species is only known from Dr. Bean's description and several references, it is of value to have more detailed information for the comparison of the species.

## COREGONUS NELSONII Bean.

*Proc. U. S. Nat. Mus.*, VII, 1884 (1885), p. 48. Nulato, Alaska.  
(E. W. Nelson.)

Head 5; depth 4; D. III, 11; A. III, 9; P. II, 16; V. I, 10; scales 81 in lateral line to base of caudal; 11 scales between origin of dorsal and lateral line, and 9 between latter and origin of ventral; about 33 scales before dorsal; width of head  $1\frac{7}{8}$  in its length; depth of head  $1\frac{1}{8}$ ; snout 4; eye  $7\frac{1}{2}$ ; maxillary  $4\frac{1}{8}$ ; interorbital space  $3\frac{1}{10}$ ; mandible  $3\frac{1}{4}$ ; second dorsal ray  $1\frac{1}{4}$ ; first anal ray  $1\frac{3}{8}$ ; length of pectoral  $1\frac{1}{8}$ ; ventral  $1\frac{1}{3}$ ; least depth of caudal peduncle  $2\frac{1}{4}$ .

Body elongate, oblong, robust, compressed, sides flattened, back hardly elevated, and profiles similar though upper is a little more convex or gibbous anteriorly than lower. Greatest depth about origin of ventral. Caudal peduncle stout, compressed, and its least depth about equal to its length.

Head small, compressed, sides flattened, and upper profile a little concave. Snout convex, a little produced and broad. Eye small, circular, and placed near first third in length of head. Mouth inferior, small, gape a little curved in profile, and its width much greater than gape. Lips rather thick or fleshy. No teeth either in jaws, on roof of mouth or on tongue. Tongue not free. Nostrils adjoining, a little nearer front of eye than tip of snout, and anterior with a fleshy or cutaneous rim, posterior margin enlarged a little and more or less conceals posterior nostril. Interorbital space convex, elevated more medianly. Opercles with striæ. Opercular flaps rather broad.

Gill-opening large, extending forward a little over half way in length of head but not to posterior margin of eye. Rakers 6 + 14, short, pointed, about  $3\frac{1}{2}$  in longest filaments. Filaments long, longest 5 in head. No pseudobranchiæ. Branchiostegals 8, rather large and conspicuous, and graduated to uppermost which is largest. Isthmus rather long, triangular and with convex surface.

Scales small, cycloid, well exposed and more or less of equal size except on base of caudal and on breast. None on chest. Distributed in longitudinal even series. A pointed scaly flap in axil of ventral. Head and fins naked, except base of caudal. Lateral line continuous, more or less parallel with lower profile most of its course and extending posteriorly along middle of side of caudal peduncle to base of caudal. Tubes simple.

Origin of dorsal nearer that of adipose fin than tip of snout or a little behind tip of pectoral, high, and second branched ray longest. Adipose fin well developed, beginning a little behind that of anal, and length of fin a trifle less than half length of head. Height of adipose fin nearly half of its base. Anal originating much nearer base of caudal than origin of ventral, lower than dorsal, and first branched ray highest. Caudal robust, deeply emarginate, and lobes pointed. Pectoral rather long, about equal to height of dorsal, and reaching a little over half way to ventral. Ventral inserted behind origin of dorsal, a little longer than first branched anal ray, and reaching half way to origin of anal. Vent close in front of anal.

Color in alcohol more or less faded uniform brown, lower side and under surface paler. Fins brownish and immaculate. Each longitudinal series of scales on trunk with median portion paler so that body has appearance of many alternate dark and light longitudinal bands, most distinct or pronounced above. Iris slaty.

Length about 24 inches.

No. 7258, Wistar Inst. Anat. Phila. Meade River, Alaska. Nov. 1897. E. L. MacIlhenny. This is an adult female. Also three others which show the following: Head 5 to  $5\frac{1}{4}$ ; depth  $3\frac{2}{3}$  to  $4\frac{1}{3}$ ; D. III, 10 or III, 11; A. III, 9 or III, 11; scales 80 or 81 in lateral line to base of caudal and 4 to 6 more continued out on latter; gill-rakers about 12 on lower half of first arch and 7 to 9 on upper half; total length 21 to 24 inches. The smallest was obtained at Point Barrow, Alaska.

The following notes relative to the alimentary canal are expli-

cable by means of Plate IX, and were made from a rough dissection of the example described above.

Pharynx rather capacious.

Stomach large, elongate, sack-like and somewhat muscular anteriorly.

Pyloric appendages very numerous, rather short and more or less subequal.

Spleen large.

Intestine straight from pylorus, without sigmoid curve.

*Philadelphia, Academy of Natural Sciences, December 15, 1904.*

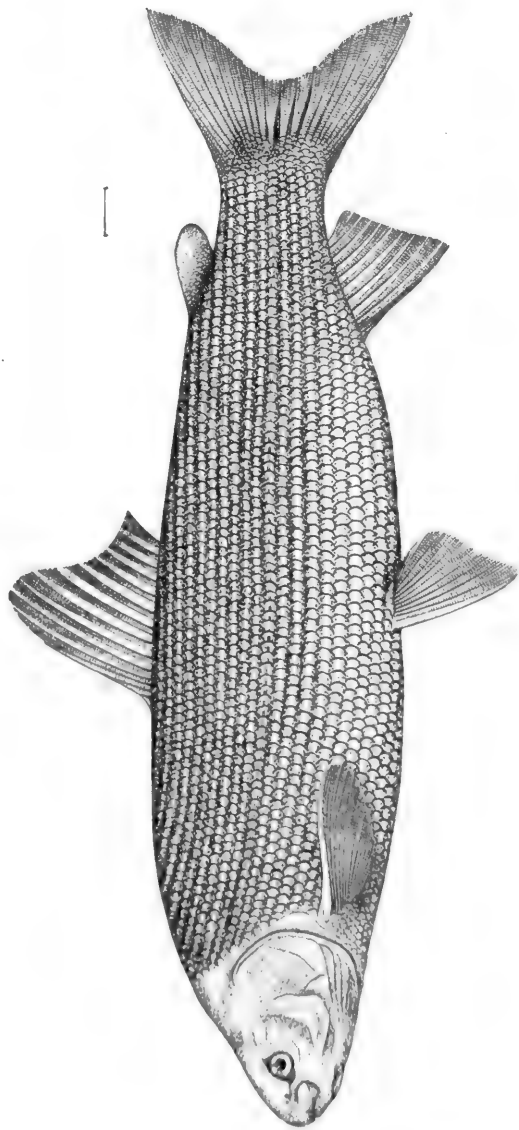

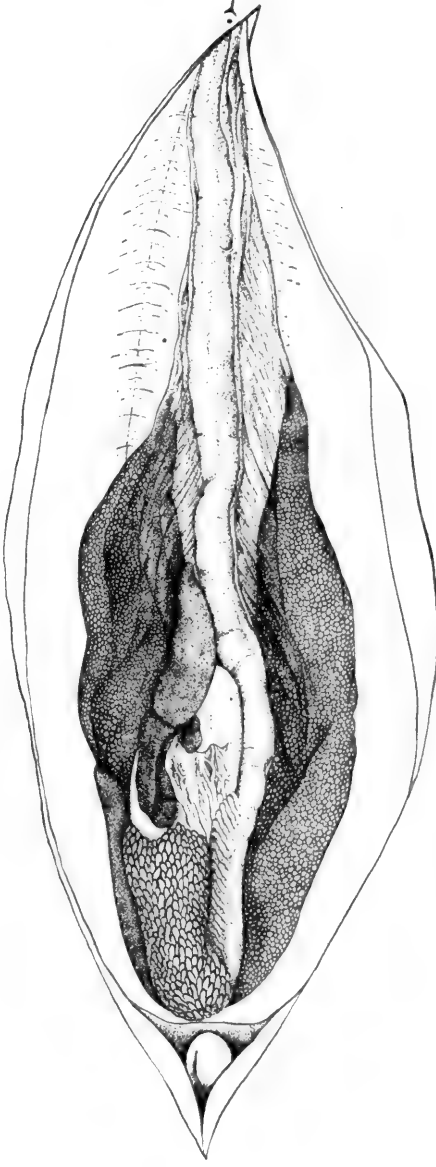

FOWLER—COREGONUS NELSONII BEAN.





## INDEX TO VOLUME XLIII.

	<i>Page</i>
Abbott, Breeding Habits of the Spade-Foot Toad . . . . .	101
Explanation of Reported Showers of Toads . . . . .	163
Occurrence of Artifacts Beneath a Deposit of Clay . . . . .	101, 161
Abraham, "Is Abraham Historical?" . . . . .	340
Acid, Dimethyl Racemic: Its Synthesis and Derivatives . . . . .	97, 105
Trisulphoxyarsenic . . . . .	98, 112
Algebraic Functions, Expansions of, at Singular Points . . . . .	98, 164
American Academy of Political and Social Science, Invitation to its Sessions . . . . .	97
American Ethnographical Survey, Results of . . . . .	102
American Revolution, Effect of the, upon the English Colonial System . . . . .	102
Arnold, Miocene Diabase of the Santa Cruz Mountains . . . . .	14
Artifacts Beneath a Deposit of Clay . . . . .	101, 161
Atmospheric Nucleation . . . . .	101
Barker, Uranium Minerals and their Photographic Action . . . . .	54
Barus, Atmospheric Nucleation . . . . .	101
Boas, Horizontal Plane of the Skull . . . . .	98
Brezina, Classification of Meteorites . . . . .	101, 211
Brooks, Orthic Curves; or, Algebraic Curves which satisfy Laplace's Equation in Two Dimensions . . . . .	294, 339
Brooks, W. K., Doliolum and Salpa . . . . .	101
Calcium, Electrolytic . . . . .	380, 381
Campbell, Spectra and General Nature of Temporary Stars . . . . .	99
Carbon, The Rôle of . . . . .	97, 102
Case, Morphology of the Skull of the Pelycosaurian Genus Dimetrodon . . . . .	340
China, By Courtesy Through . . . . .	380
Clay, "Is Abraham Historical?" . . . . .	340
Recent Researches on Inscriptions from Nippur . . . . .	339
Color in Plants, Origin and Nature of . . . . .	101, 257
Color-signals in Marine and Naval Service, Regulation of . . . . .	102, 207
Congrès Internationale des Orientalistes, XIVth, at Stuttgart, Inviting Delegates, 54, 97	
Conklin, Organization of the Germ Cells and Its Bearings on Evolution . . . . .	101
Coregonus nelsonii Bean . . . . .	450, 451
Creation, Babylonian and Hebrew Accounts of, in the Light of Recent Criticism . . . . .	14
Deer's Bill of Fare . . . . .	450
Diabase, Miocene, of the Santa Cruz Mountains, in San Mateo County, Cal . . . . .	14
Doliolum and Salpa . . . . .	101
Doolittle, Reflex Zenith Tube . . . . .	99
Doolittle, Eric, Faint Double Stars . . . . .	99
Dragon, The Trail of the Golden . . . . .	338
Drama, Academic, in the Age of Elizabeth and James . . . . .	96
Dudley, A System of Passenger Car Ventilation . . . . .	101, 247
Edentata, Phylogeny of the . . . . .	4
Election of Officers, Annual . . . . .	3
Electro-analysis, A Chapter in . . . . .	450
Exner, Smith and, The Atomic Weight of Tungsten . . . . .	98, 123
Fauna, Silurian, of Arkansas . . . . .	99
Female Sex, Morphological Superiority of the . . . . .	340, 365
Fisher, Effect of the American Revolution upon the English Colonial System . . . . .	102

	<i>Page</i>
Floods of the Mississippi River, A Method of Controlling the.....	53, 71
Forestry in Pennsylvania, Present Aspects and Future Prospects of.....	53
Fowler, Description and Figure of <i>Coregonus nelsonii</i> Bean.....	450, 451
Franklin Bi-centennial.....	100
Franklin, Herder and.....	4
Game Refuges in the United States Forest Reserves.....	101
Germ Cells, Organization of, and Its Bearings on Evolution.....	101
Goodwin, Electrolytic Calcium.....	380, 381
Gordon, The Trail of the Golden Dragon.....	338
Haehl and Arnold, Miocene Diabase of the Santa Cruz Mountains, in San Mateo County, Cal.....	14
Hamites and Semites.....	173
Hatcher, Attempt to Correlate the Marine with the Fresh and Brackish Water Mesozoic Formations of the Middle West.....	98, 341
Haupt, A Method of Controlling the Floods of the Mississippi River.....	53, 71
Heilprin, Pompeii and Saint Pierre.....	99
Herder and Franklin.....	4
Heredity, Main Facts in Regard to the Cellular Basis of.....	4, 5
Hewett, Use of the Relative Pronouns in Standard English Writers.....	101, 278
Horse, Evolution of the.....	98, 156
van Ingen, Silurian Fauna of Arkansas.....	99
International Zoological Congress at Berne, Inviting Delegates.....	97
Jastrow, Babylonian and Hebrew Accounts of the Creation, in the Light of Recent Criticism.....	14
Hamites and Semites in the Tenth Chapter of Genesis.....	173
Jennings, The Behavior of the Lowest Organisms.....	380
Jochelson, Yukaghir Language.....	98
Keasbey, The Hedonic Postulate.....	102
Keller and Maas, Dimethyl Racemic Acid: Its Synthesis and Derivatives.....	97, 105
Kraemer, Origin and Nature of Color in Plants.....	101, 257
Lambert, Expansions of Algebraic Functions at Singular Points.....	98, 164
Learned, Herder and Franklin.....	4
Results of the American Ethnographical Survey.....	102
Literary Remuneration in the Eighteenth and Nineteenth Centuries.....	54
Lloyd, Vegetation of the Island of Dominica.....	339
Lovett, Systems of $n$ Periplegmatic Orbits.....	99
Maas and Keller, Dimethyl Racemic Acid: Its Synthesis and Derivatives.....	97, 105
McCay, Trisulphoxyarsenic Acid.....	98, 112
Marshall, The Constituents of the Venom of the Rattlesnake.....	98
Mason, Ripening of Thoughts in Common.....	102, 148
Masses, Continuum and the Theory of.....	98
Mathews, Native Tribes of Victoria, Their Languages and Customs.....	54
Meetings, General.....	97-101
Meetings, Stated.....	3, 4, 14, 53, 54, 96, 338, 339, 340, 380, 450
<b>Members Deceased:</b>	
Allen, Alfred H.....	340
Bartholow, Roberts.....	339
von Böhtlingk, Otto.....	339
Burk, Jesse Y.....	380
Canby, William Marriott.....	96
Drown, Thomas M.....	380
Hatcher, John B.....	340
Menschert, Matthew Huizinga.....	340
de Nadaillac, Marquis.....	380
Pattison, Robert E.....	340
Pettee, William Henry.....	340
Roberts, Isaac.....	340

	<i>Page</i>
<b>Members Deceased:</b>	
Rollett, Herman.....	340
Selwyn, Alfred R. C.....	4
Shields, Charles W.....	340
Thompson, Sir Henry, Bart.....	339
<b>Members Elected:</b>	
Bloomfield, Maurice.....	100
Bowditch, Henry Pickering.....	100
Cheyney, Edward Potts.....	100
Chittenden, Russell H.....	100
Clarke, Frank Wigglesworth.....	100
Da Costa, John Chalmers.....	100
Delitzsch, Friedrich.....	100
Francke, Kuno.....	100
Greely, Adolphus W.....	100
Jebb, Sir Richard C.....	100
Lambert, Preston Albert.....	100
Lovett, Edgar Odell.....	100
Nichols, Edward Leamington.....	100
Roosevelt, Hon. Theodore.....	100
Rutherford, Ernest.....	101
Stratton, Samuel W.....	100
Van't Hoff, Jakob Heinrich.....	101
Waldeyer, Wilhelm.....	101
Wiley, Harvey W.....	100
Members Presented.....	338, 340
Membership Accepted.....	338, 339
Mesozoic Formations of the Middle West.....	98, 341
Meteorites, Classification of.....	101, 211
Minerals, Uranium, and their Photographic Action.....	54
Miocene Rodentia of Patagonia.....	98
Montgomery, Main Facts in Regard to the Cellular Basis of Heredity.....	4
Morphological Superiority of the Female Sex.....	340, 365
Moore, A New Method for the Purification of Water Supplies.....	380
Nadaillac, Marquis de, Delegate to Soc. Nationale des Antiquaires de France.....	3, 96
Nippur, Recent Researches on Inscriptions from.....	339
Nitrogen, Sources of Error in the Determination of the Atomic Weight of.....	98, 116
Nucleation, Atmospheric.....	101
Oliver, Regulation of Color-signals in Marine and Naval Service.....	102, 207
Opisthenogenesis.....	289
Orbits, Systems of <i>n</i> Periplegrmatic.....	99
Organisms, The Behavior of the Lowest.....	380
Origin of Markings of.....	393
Orthic Curves.....	294, 339
Osborn, Recent Advances in Our Knowledge of the Evolution of the Horse.....	98, 156
Packard, Opisthenogenesis, or the Development of Segments, Median Tubercles and Markings <i>a Tergo</i> .....	289
Origin of Markings of Organisms.....	393
Palladium (Pd.).....	99, 332
Passenger Car Ventilation, A System of.....	101, 247
Pelycosaurian Genus.....	340
Philadelphia, Views of Old.....	53, 338
Phillips, Radium from American Ores.....	99, 157
Plants, Origin and Nature of Color in.....	101, 257
Pompeii and Saint Pierre.....	99
Postulates, The Hedonic.....	102
Prescott, The Rôle of Carbon.....	97, 102
President's Annual Address.....	450

	<i>Page</i>
Pronouns, Use of Relative, in Standard English Writers.....	101, 278
Radium from American Ores.....	99, 157
Rattlesnake, Venom of the.....	98
Richards, Sources of Error in the Determination of the Atomic Weight of Nitrogen.....	98, 116
Rothrock, Present Aspects and Future Prospects of Forestry in Pennsylvania.....	53
Sachse, Views of Old Philadelphia.....	53, 338
Salts, Observations on the New Metallic.....	339
Sampson, A Deer's Bill of Fare.....	450
Establishment of Game Refuges in the United States Forest Reserves.....	101
Schelling, Academic Drama in the Age of Elizabeth and James.....	96
Schwatt, The Continuum and the Theory of Masses.....	98
Scott, Miocene Rodentia of Patagonia.....	98
Phylogeny of the Edentata.....	4
Skull, Horizontal Plane of the.....	98
Smith, A Chapter in Electro-analysis.....	450
Observations on the New Metallic Salts.....	339
Smith and Exner, The Atomic Weight of Tungsten.....	98, 123
Smyth, Literary Remuneration in the Eighteenth and Nineteenth Centuries.....	54
Société Nationale des Antiquaires de France, Centenary of.....	3
Delegate Appointed to.....	3
Stars, Faint Double.....	99
Spectra and General Nature of Temporary.....	99
Thoughts, Ripening of, in Common.....	102, 148
Toad, Spade-Foot, Breeding Habits of.....	101
Toads, Showers of.....	163
Tribes, Native, of Victoria: Their Languages and Customs.....	54
Tungsten, Atomic Weight of.....	98, 123
University of Wisconsin, Jubilee.....	53
Vegetation of the Island of Dominica.....	339
Ventilation, Passenger Car.....	101, 247
Water Supplies, Method for the Purification of.....	380
Wharton, Palladium (Pd.).....	99, 332
Willis, By Courtesy Through China.....	380
Yukaghir Language.....	98
Zenith Tube, Reflex.....	99











Q  
11  
P5  
v.43

American Philosophical  
Society, Philadelphia  
Proceedings

Physical &  
Applied Sci.  
Serials

PLEASE DO NOT REMOVE  
CARDS OR SLIPS FROM THIS POCKET

---

UNIVERSITY OF TORONTO LIBRARY

---

**STORAGE**

