



LIBRARY OF  
THE NEW YORK BOTANICAL GARDEN

*By exchange*  
1908-10

Septemb 1897 R. W. Gibson. Inv.

2770-502  
S-1







# PROCEEDINGS

OF THE

# Indiana Academy of Science

1908

---

LIBRARY  
NEW YORK  
BOTANICAL  
GARDEN.

EDITOR . . . . . H. L. BRUNER

---

INDIANAPOLIS, IND.

1909

XP  
.R684/

INDIANAPOLIS  
WM. B. BURFORD, PRINTER  
1909



THE STATE OF INDIANA,  
EXECUTIVE DEPARTMENT,  
April 19, 1909. }

Received by the Governor, examined and referred to the Auditor of State for verification of the financial statement.

---

OFFICE OF AUDITOR OF STATE,  
INDIANAPOLIS, April 28, 1909. }

The within report (no financial statement) has been examined and found correct.

JOHN C. BILLHEIMER,  
*Auditor of State.*

---

APRIL 28, 1909.

Returned by the Auditor of State, with above certificate, and transmitted to Secretary of State for publication, upon the order of the Board of Commissioners of Public Printing and Binding.

MARK THISTLETHWAITE,  
*Secretary to the Governor.*

---

Filed in the office of the Secretary of State of the State of Indiana,  
April 29, 1909.

FRED A. SIMS,  
*Secretary of State.*

---

Received the within report and delivered to the printer April 29, 1909.

A. E. BUTLER,  
*Clerk Printing Board.*

## TABLE OF CONTENTS.

	PAGE.
An act to provide for the publication of the reports and papers of the Indiana Academy of Science.....	6
An act for the protection of birds, their nests and eggs.....	8
Officers, 1908-1909.....	9
Committees, 1908-1909.....	10
Principal officers since organization.....	11
Constitution.....	12
By-Laws.....	14
Members and Fellows.....	15
Members, non-resident.....	16
Members, active.....	17
Program of the Twenty-fourth Annual Meeting.....	22
Report of the Twenty-fourth Annual Meeting.....	26
Papers presented at the Twenty-fourth Annual Meeting:	
President's Address: Deforestation and Its Effects Among the Hills of Southern Indiana, by Glen Culbertson.....	27
Work of the Pathological Laboratory of the Central Indiana Hospital for Insane, Indianapolis, by George F. Edenharter.....	39
An Addition to the Birds of Indiana, by Amos Butler.....	49
Biography and the Influence of Environment, by Robert Hessler....	51
Felkner Island, Wabec Lake, Kosciusko County, Indiana, by J. P. Dolan.....	67
A Strange Nurse, by A. J. Bigney.....	69
The Shake Dance of the Quilente Indians, with Drawing by an Indian Pupil in the Indian School, by Albert B. Reagan.....	71
Photographic Observations of Morehouse's Comet, by W. A. Cogshall.	75
Field Observations on Rusts for the General Botanist, by J. C. Arthur.	83
The Rust of Timothy, by F. D. Kern.....	85
Notes on the Heteroecious Plant Rusts of Indiana, by Aaron G. Johnson.....	87
Some Anomalies in the Female Gametophyte of Pinus, by D. M. Mottier.....	95

	PAGE.
Notes on the Seedless Persimmon, by Wm. L. Woodburn . . . . .	99
Testing Seed Corn by Specific Gravity, by Herbert A. Dunn . . . . .	103
Notes on the Flora of Cass County, Indiana, by Robert Hessler . . . . .	107
A New Anthracnose Attacking Certain Cereals and Grasses, by A. D. Selby and Thomas F. Manns . . . . .	111
Dissemination of Disease by Means of the Seed of the Host Plant, by M. F. Barrus . . . . .	113
The Histological Difference between <i>Pinus taeda</i> and <i>P. palustris</i> , by Katherine Golden Bitting . . . . .	127
Report of Work in Corn Pollination, by M. L. Fisher . . . . .	133
The Killing of Mustard and Other Noxious Weeds in the Grain Fields of Dakota, by E. W. Olive . . . . .	135
The Meyer Molecular Weight Calculation, by Percy N. Evans . . . . .	139
The Relation of Fats to Moisture Content of Butter, by O. F. Hunziker . . . . .	141
The Use of the Polariscope in Testing High Tension Insulators, by C. Francis Harding . . . . .	147
Some Contributions to the Chemistry of Mucoïd, by C. E. May . . . . .	151
The Estimation of Lead by Titration of Lead Chromate, by W. C. Brooks . . . . .	157
An Evolution Method for the Determination of Sulfur in Sulfides and Sulfates, by F. C. Mathers . . . . .	159
The Destruction of Platinum Crucibles through Ignition of Magnesium Ammonium Phosphate, by R. E. Lyons . . . . .	161
Probable Origin of the Depressions in the Mesa South of the Tijeras Canyon, New Mexico, by Albert B. Reagan . . . . .	165
Headwaters of the Tippecanoe River, by J. T. Scovell . . . . .	167
Caves and Cave Formations of the Mitchell Limestone, by F. C. Greene . . . . .	175
Life Zones of Indiana as Illustrated by the Distribution of Orthoptera and Coleoptera Within the State, by W. S. Blatchley . . . . .	185
Animals of the Olympic Peninsula, Washington, by Albert B. Reagan . . . . .	193
The Circulation of Mixed Blood in the Embryo Mammal and Bird and in the Adult Reptile, Amphibian and Fish, by A. G. Pohlman . . . . .	201
The Indiana Academy of Science, by J. T. Scovell . . . . .	209
Index . . . . .	211

**AN ACT TO PROVIDE FOR THE PUBLICATION OF THE REPORTS  
AND PAPERS OF THE INDIANA ACADEMY OF SCIENCE.**

[Approved March 11, 1895.]

WHEREAS, The Indiana Academy of Science, a chartered scientific association, has embodied in its constitution a provision that it will, upon the request of the Governor, or of the several departments of the State government, through the Governor, and through its council as an advisory body, assist in the direction and execution of any investigation within its province, without pecuniary gain to the Academy, provided only that the necessary expenses of such investigation are borne by the State; and,

**Preamble.**

WHEREAS, The reports of the meetings of said Academy, with the several papers read before it, have very great educational, industrial and economic value, and should be preserved in permanent form; and

WHEREAS, The Constitution of the State makes it the duty of the General Assembly to encourage by all suitable means intellectual, scientific and agricultural improvement; therefore,

SECTION 1. *Be it enacted by the General Assembly of the State of Indiana,* That hereafter the annual reports of the meetings of the Indiana Academy of Science, beginning with the report for the year 1894, including all papers of scientific or economic value, presented at such meetings, after they shall have been edited and prepared for publication as hereinafter provided, shall be published by and under the direction of the Commissioners of Public Printing and Binding.

**Publication of  
the Reports of  
the Indiana  
Academy of  
Science.**

SEC. 2. Said reports shall be edited and prepared for publication without expense to the State, by a corps of editors to be selected and appointed by the Indiana Academy of Science, who shall not, by reason of such services, have any claim against the State for compensation. The form, style of binding, paper, typography and manner and extent of illustration of such reports shall be determined by the editors, subject to the approval of the Commissioners of Public Printing and Stationery. Not less than 1,500 nor more than 3,000 copies of each of said

**Editing  
Reports.**

**Number of  
printed  
Reports.**

reports shall be published, the size of the edition within said limits to be determined by the concurrent action of the editors and the Commissioners of Public Printing and Stationery: *Provided*, That not to exceed six

**Proviso.** hundred dollars (\$600) shall be expended for such publication in any one year, and not to extend beyond 1896: *Provided*, That no sums shall be deemed to be appropriated for the year 1894.

**Disposition of Reports.** SEC. 3. All except three hundred copies of each volume of said reports shall be placed in the custody of the State Librarian, who shall furnish one copy thereof to each public library in the State, one copy to each university, college or normal school in the State, one copy to each high school in the State having a library, which shall make application therefor, and one copy to such other institutions, societies or persons as may be designated by the Academy through its editors or its council. The remaining three hundred copies shall be turned over to the Academy to be disposed of as it may determine. In order to provide for the preservation of the same it shall be the duty of the Custodian of the State House to provide and place at the disposal of the Academy one of the unoccupied rooms of the State House, to be designated as the office of the Indiana Academy of Science, wherein said copies of said reports belonging to the Academy, together with the original manuscripts, drawings, etc., thereof can be safely kept, and he shall also equip the same with the necessary shelving and furniture.

**Emergency.** SEC. 4. An emergency is hereby declared to exist for the immediate taking effect of this act, and it shall therefore take effect and be in force from and after its passage.

AN ACT FOR THE PROTECTION OF BIRDS, THEIR NESTS AND EGGS.

**SECTION 602.** It shall be unlawful for any person to kill, trap or possess any wild bird, or to purchase or offer Birds. the same for sale, or to destroy the nests or the eggs of any wild bird except as otherwise provided in this section. But this section shall not apply to the following named game birds: The Anatidæ, commonly called swans, geese, brant, river and sea duck; the Rallidæ, commonly known as rails, coots, mudhens, and gallinules; the Limicolæ, commonly known as shore birds, plovers, surf birds, snipe, woodcock, sandpipers, tatlors and curlews; nor to English or European house sparrows, crows, hawks, or other birds of prey. Nor shall this section apply to any person taking birds or their nests or eggs for scientific purposes under permit, as provided in the next section. Any person violating the provisions of this section shall, upon conviction, be fined not less than ten dollars nor more than fifty dollars.

**SEC. 603.** Permits may be granted by the Commissioner of Fisheries and Game to any properly accredited person, permitting the holder thereof to collect birds, their nests or eggs for strictly scientific purposes. In order to obtain such permit the applicant for the same must present to said Commissioner written testimonials from two well-known scientific men certifying to the good character and fitness of said applicant to be entrusted with such privilege, and pay to said Board one dollar therefor, and file with him a properly executed bond in the sum of two hundred dollars, payable to the State of Indiana, conditioned that he will obey the terms of such permit, and signed by at least two responsible citizens of the State as sureties. The bond may be forfeited and the permit revoked upon proof to the satisfaction of such Commissioner that the holder of such permit has killed any bird or taken the nests or eggs of any bird for any other purpose than that named in this section.

# Indiana Academy of Science.

## OFFICERS, 1908-1909.

PRESIDENT

A. L. FOLEY.

VICE-PRESIDENT

P. N. EVANS.

SECRETARY

JAMES H. RANSOM.

ASSISTANT SECRETARY

A. J. BIGNEY.

PRESS SECRETARY

GEORGE A. ABBOTT.

TREASURER

WILLIAM A. MCBETH.

### EXECUTIVE COMMITTEE

A. L. FOLEY,

P. N. EVANS,

J. H. RANSOM,

A. J. BIGNEY,

G. A. ABBOTT,

W. A. MCBETH,

GLENN CULBERTSON,

D. M. MOTTIER,

ROBERT HESSLER,

JOHN S. WRIGHT,

CARL L. MEES,

W. S. BLATCHLEY,

H. W. WILEY,

M. B. THOMAS,

D. W. DENNIS,

C. H. EIGENMANN,

C. A. WALDO,

THOMAS GRAY,

STANLEY COULTER,

A. W. BUTLER,

W. A. NOYES,

J. C. ARTHUR,

O. P. HAY,

T. C. MENDENHALL,

J. C. BRANNER,

J. P. D. JOHN,

J. M. COULTER.

D. S. JORDAN,

### CURATORS

BOTANY..... J. C. ARTHUR.

ICHTHYOLOGY..... C. H. EIGENMANN.

HERPETOLOGY }  
MAMMOLOGY }..... A. W. BUTLER.

ORNITHOLOGY }  
ENTOMOLOGY..... W. S. BLATCHLEY

## COMMITTEES, 1908-1909.

---

## PROGRAM,

W. J. MOENKHAUS,                      H. L. BRUNER,                      J. P. NAYLOR.

## MEMBERSHIP,

R. HESSLER,                      D. ROTHROCK,                      P. N. EVANS.

## NOMINATIONS,

J. S. WRIGHT,                      S. BURRAGE,                      D. M. MOTTIER.

## AUDITING,

W. J. MOENKHAUS,                      W. A. COGSHALL,                      E. G. MAHIN.

## STATE LIBRARY,

J. S. WRIGHT,                      W. S. BLATCHLEY,                      A. W. BUTLER,  
G. W. BENTON.

## RESTRICTION OF WEEDS AND DISEASES,

R. HESSLER,                      J. N. HURTY,                      A. W. BUTLER  
S. COULTER,                      D. M. MOTTIER.

## DIRECTORS OF BIOLOGICAL SURVEY,

STANLEY COULTER,                      C. R. DRYER,                      M. B. THOMAS,  
C. H. EIGENMANN,                      J. C. ARTHUR.

## RELATIONS OF THE ACADEMY TO THE STATE,

R. W. MCBRIDE,                      M. B. THOMAS,                      G. CULBERTSON,  
W. S. BLATCHLEY.

## DISTRIBUTION OF THE PROCEEDINGS,

J. S. WRIGHT,                      H. L. BRUNER,                      G. W. BENTON,  
R. E. LYONS,                      J. H. RANSOM.

## PUBLICATION OF PROCEEDINGS,

H. L. BRUNER, Editor.                      D. BODINE.                      D. M. MOTTIER.



OFFICERS OF THE INDIANA ACADEMY OF SCIENCE.

YEARS.	PRESIDENT.	SECRETARY.	ASST. SECRETARY.	PRESS SECRETARY.	TREASURER.
1885-1886	David S. Jordan.....	Amos W. Butler.....			O. P. Jenkins.
1886-1887	John M. Coulter.....	Amos W. Butler.....			O. P. Jenkins.
1887-1888	J. P. D. John.....	Amos W. Butler.....			O. P. Jenkins.
1888-1889	John C. Branner.....	Amos W. Butler.....			O. P. Jenkins.
1889-1890	T. C. Mendenhall.....	Amos W. Butler.....			O. P. Jenkins.
1890-1891	O. P. Hay.....	Amos W. Butler.....			O. P. Jenkins.
1891-1892	J. L. Campbell.....	Amos W. Butler.....			C. A. Waldo.
1892-1893	J. C. Arthur.....	Amos W. Butler.....	{ Stanley Coulter..... }		C. A. Waldo.
			{ W. W. Norman..... }		
1893-1894	W. A. Noyes.....	C. A. Waldo.....	W. W. Norman.....		W. P. Shannon.
1894-1895	A. W. Butler.....	John S. Wright.....	A. J. Bigney.....		W. P. Shannon.
1895-1896	Stanley Coulter.....	John S. Wright.....	A. J. Bigney.....		W. P. Shannon.
1896-1897	Thomas Gray.....	John S. Wright.....	A. J. Bigney.....		W. P. Shannon.
1897-1898	C. A. Waldo.....	John S. Wright.....	A. J. Bigney.....	Geo. W. Benton.....	J. T. Scovell.
1898-1899	C. H. Eigenmann.....	John S. Wright.....	E. A. Schultze.....	Geo. W. Benton.....	J. T. Scovell.
1899-1900	D. W. Dennis.....	John S. Wright.....	E. A. Schultze.....	Geo. W. Benton.....	J. T. Scovell.
1900-1901	M. B. Thomas.....	John S. Wright.....	E. A. Schultze.....	Geo. W. Benton.....	J. T. Scovell.
1901-1902	Harvey W. Wiley.....	John S. Wright.....	Donaldson Bodine.....	Geo. W. Benton.....	J. T. Scovell.
1902-1903	W. S. Blatchley.....	John S. Wright.....	Donaldson Bodine.....	G. A. Abbott.....	W. A. McBeth.
1903-1904	C. L. Mees.....	John S. Wright.....	J. H. Ransom.....	G. A. Abbott.....	W. A. McBeth.
1904-1905	John S. Wright.....	Lynn B. McMullen.....	J. H. Ransom.....	G. A. Abbott.....	W. A. McBeth.
1905-1906	Robert Hessler.....	Lynn B. McMullen.....	J. H. Ransom.....	Charles R. Clark.....	W. A. McBeth.
1906-1907	D. M. Mottier.....	Lynn B. McMullen.....	J. H. Ransom.....	G. A. Abbott.....	W. A. McBeth.
1907-1908	Glenn Culbertson.....	J. H. Ransom.....	A. J. Bigney.....	G. A. Abbott.....	W. A. McBeth.
1908-1909	A. L. Foley.....	J. H. Ransom.....	A. J. Bigney.....	G. A. Abbott.....	W. A. McBeth.

## CONSTITUTION.

---

### ARTICLE I.

SECTION 1. This association shall be called the Indiana Academy of Science.

SEC. 2. The objects of this Academy shall be scientific research and the diffusion of knowledge concerning the various departments of science, to promote intercourse between men engaged in scientific work, especially in Indiana; to assist by investigation and discussion in developing and making known the material, educational and other resources and riches of the State; to arrange and prepare for publication such reports of investigation and discussions as may further the aims and objects of the Academy as set forth in these articles.

Whereas, The State has undertaken the publication of such proceedings, the Academy will, upon request of the Governor, or of one of the several departments of the State, through the Governor, act through its council as an advisory body in the direction and execution of any investigation within its province as stated. The necessary expenses incurred in the prosecution of such investigation are to be borne by the State; no pecuniary gain is to come to the Academy for its advice or direction of such investigation.

The regular proceedings of the Academy as published by the State shall become a public document.

### ARTICLE II.

SECTION 1. Members of this Academy shall be honorary fellows, fellows, non-resident members or active members.

SEC 2. Any person engaged in any department of scientific work, or in original research in any department of science, shall be eligible to active membership. Active members may be annual or life members. Annual members may be elected at any meeting of the Academy; they shall sign the constitution, pay an admission fee of two dollars, and thereafter an annual fee of one dollar. Any person who shall at one time contribute

fifty dollars to the funds of this Academy may be elected a life member of the Academy, free of assessment. Non-resident members may be elected from those who have been active members but who have removed from the State. In any case, a three-fourths vote of the members present shall elect to membership. Applications for membership in any of the foregoing classes shall be referred to a committee on application for membership, who shall consider such application and report to the Academy before the election.

SEC. 3. The members who are actively engaged in scientific work, who have recognized standing as scientific men, and who have been members of the Academy at least one year, may be recommended for nomination for election as fellows by three fellows or members personally acquainted with their work and character. Of members so nominated a number not exceeding five in one year may, on recommendation of the Executive Committee, be elected as fellows. At the meeting at which this is adopted, the members of the Executive Committee for 1894 and fifteen others shall be elected fellows, and those now honorary members shall become honorary fellows. Honorary fellows may be elected on account of special prominence in science, on the written recommendation of two members of the Academy. In any case a three-fourths vote of the members present shall elect.

### ARTICLE III.

SECTION 1. The officers of this Academy shall be chosen by ballot at the annual meeting, and shall hold office one year. They shall consist of a President, Vice-President, Secretary, Assistant Secretary, Press Secretary and Treasurer, who shall perform the duties usually pertaining to their respective offices, and in addition, with the ex-Presidents of the Academy, shall constitute an Executive Committee. The President shall, at each annual meeting, appoint two members to be a committee, which shall prepare the programs and have charge of the arrangements for all meetings for one year.

SEC. 2. The annual meeting of this Academy shall be held in the city of Indianapolis within the week following Christmas of each year, unless otherwise ordered by the Executive Committee. There shall also be a summer meeting at such time and place as may be decided upon by the Executive Committee. Other meetings may be called at the discretion of the Executive Committee. The past Presidents, together with the officers and Executive Committee, shall constitute the council of the Academy, and

represent it in the transaction of any necessary business not especially provided for in this constitution, in the interim between general meetings.

SEC. 3. This constitution may be altered or amended at any annual meeting by a three-fourths majority of the attending members of at least one year's standing. No question of amendment shall be decided on the day of its presentation.

---

## BY-LAWS.

---

1. On motion, any special department of science shall be assigned to a curator, whose duty it shall be, with the assistance of the other members interested in the same department, to endeavor to advance knowledge in that particular department. Each curator shall report at such time and place as the Academy shall direct. These reports shall include a brief summary of the progress of the department during the year preceding the presentation of the report.

2. The President shall deliver a public address on the morning of one of the days of the meeting at the expiration of his term of office.

3. The Press Secretary shall attend to the securing of proper newspaper reports of the meetings and assist the Secretary.

4. No special meeting of the Academy shall be held without a notice of the same having been sent to the address of each member at least fifteen days before such meeting.

5. No bill against the Academy shall be paid without an order signed by the President and countersigned by the Secretary.

6. Members who shall allow their dues to remain unpaid for two years, having been annually notified of their arrearage by the Treasurer, shall have their names stricken from the roll.

7. Ten members shall constitute a quorum for the transaction of business.

## MEMBERS.

*FELLOWS.*

G. A. Abbott.....	*1908.....	Indianapolis.
R. J. Aley.....	1898.....	Bloomington.
J. C. Arthur.....	1894.....	Lafayette.
J. W. Beede.....	1906.....	Bloomington.
George W. Benton.....	1896.....	Indianapolis.
A. J. Bigney.....	1897.....	Moore's Hill.
Katherine Golden Bitting.....	1895.....	Lafayette.
W. S. Blatchley.....	1893.....	Indianapolis.
Donaldson Bodine.....	1899.....	Crawfordsville.
H. L. Bruner.....	1899.....	Indianapolis.
Severance Burrage.....	1898.....	Lafayette.
A. W. Butler.....	1893.....	Indianapolis.
W. A. Cogshall.....	1906.....	Bloomington.
†Mel. T. Cook.....	1902.....	Newark, Del.
†John M. Coulter.....	1893.....	Chicago, Ill.
Stanley Coulter.....	1893.....	Lafayette.
U. O. Cox.....	1908.....	Terre Haute.
Glenn Culbertson.....	1899.....	Hanover.
E. R. Cumings.....	1906.....	Bloomington.
S. C. Davisson.....	1908.....	Bloomington.
D. W. Dennis.....	1895.....	Richmond.
C. R. Dryer.....	1897.....	Terre Haute.
C. H. Eigenmann.....	1893.....	Bloomington.
Percy Norton Evans.....	1901.....	West Lafayette.
A. L. Foley.....	1897.....	Bloomington.
M. J. Golden.....	1899.....	Lafayette.
†W. F. M. Goss.....	1893.....	Urbana, Ill.
Thomas Gray.....	1893.....	Terre Haute.
A. S. Hathaway.....	1895.....	Terre Haute.
W. K. Hatt.....	1902.....	Lafayette.
Robert Hessler.....	1899.....	Logansport.

\*Date of election.

†Non-resident.

†H. A. Huston.....	*1893.....	Chicago, Ill.
Edwin S. Johannatt.....	1904.....	Terre Haute.
Robert E. Lyons.....	1896.....	Bloomington.
W. A. McBeth.....	1904.....	Terre Haute.
V. F. Marsters.....	1893.....	Bloomington.
C. L. Mees.....	1894.....	Terre Haute.
†J. A. Miller.....	1904.....	Swarthmore, Pa.
W. J. Moenkhaus.....	1901.....	Bloomington.
D. M. Mottier.....	1893.....	Bloomington.
J. P. Naylor.....	1903.....	Greencastle.
†W. A. Noyes.....	1893.....	Champaign, Ill.
Rolla R. Ramsey.....	1906.....	Bloomington.
J. H. Ransom.....	1902.....	Lafayette.
L. J. Rettger.....	1896.....	Terre Haute.
David Rothrock.....	1906.....	Bloomington.
J. T. Scovell.....	1894.....	Terre Haute.
Albert Smith.....	1908.....	Lafayette.
†Alex Smith.....	1893.....	Chicago, Ill.
W. E. Stone.....	1893.....	Lafayette.
†Joseph Swain.....	1898.....	Swarthmore, Pa.
M. B. Thomas.....	1893.....	Crawfordsville.
†C. A. Waldo.....	1893.....	St. Louis, Mo.
†F. M. Webster.....	1894.....	Washington, D. C.
Jacob Westlund.....	1904.....	Lafayette.
†H. W. Wiley.....	1895.....	Washington, D. C.
W. W. Woollen.....	1908.....	Indianapolis.
John S. Wright.....	1894.....	Indianapolis.

\*Date of election.

†Non-resident.

### NON-RESIDENT MEMBERS.

George H. Ashley.....	Charleston, S. C.
J. C. Branner.....	Stanford University, Cal.
M. A. Brannon.....	Grand Forks, N. D.
D. H. Campbell.....	Stanford University, Cal.
A. Wilmer Duff.....	Worcester, Mass.
B. W. Everman.....	Washington, D. C.
W. A. Fiske.....	Los Angeles, Cal.

C. W. Garrett	Pittsburg, Pa.
Charles H. Gilbert	Stanford University, Cal.
C. W. Green	Columbia, Mo.
C. W. Hargitt	Syracuse, N. Y.
O. P. Hay	New York City.
Edward Hughes	Stockton, Cal.
O. P. Jenkins	Stanford University, Cal.
D. S. Jordan	Stanford University, Cal.
J. S. Kingsley	Tufts College, Mass.
D. T. MacDougal	Tucson, Arizona.
L. B. McMullen	Valley City, N. D.
T. C. Mendenhall	Worcester, Mass.
A. H. Purdue	Fayetteville, Ark.
A. B. Reagan	Mora, Wash.
Alfred Springer	Cincinnati, Ohio.
Robert B. Warder	Washington, D. C.
Ernest Walker	Clemson College, S. C.
G. W. Wilson	Fayette, Ia.

---

### *ACTIVE MEMBERS.*

C. E. Agnew	Delphi.
L. E. Allison	West Lafayette.
H. W. Anderson	Ladoga.
H. F. Bain	San Francisco, Cal.
Walter D. Baker	Indianapolis.
Edward Hugh Bangs	Indianapolis.
W. H. Bates	West Lafayette.
Lee. F. Bennett	Valparaiso.
Harry Eldridge Bishop	Indianapolis.
Lester Black	
William N. Blanchard	Greencastle.
Charles S. Bond	Richmond.
H. C. Brandon	Bloomington.
Fred J. Breeze	Remington.
E. M. Bruce	Terre Haute.
Lewis Clinton Carson	Detroit, Mich.

Herman S. Chamberlain . . . . .	Indianapolis.
E. J. Chansler . . . . .	Bicknell.
A. G. W. Childs . . . . .	Kokomo.
C. D. Christie . . . . .	West Lafayette.
Howard W. Clark . . . . .	Chicago, Ill.
Otto O. Clayton . . . . .	Geneva.
H. M. Clem . . . . .	Monroeville.
Charles Clickener . . . . .	Silverwood, R. D. No. 1.
Charles A. Coffey . . . . .	Petersburg.
William Clifford Cox . . . . .	Columbas.
J. A. Cragwall . . . . .	Crawfordsville.
M. E. Crowell . . . . .	Franklin.
Lorenzo E. Daniels . . . . .	Laporte.
E. H. Davis . . . . .	West Lafayette.
Charles C. Deam . . . . .	Bluffton.
Martha Doan . . . . .	Westfield.
J. P. Dolan . . . . .	Syracuse.
Herman B. Dorner . . . . .	Urbana, Ill.
Hans Duden . . . . .	Indianapolis.
Arthur E. Dunn . . . . .	Logansport.
Herbert A. Dunn . . . . .	Logansport.
M. L. Durbin . . . . .	Anderson.
J. B. Dutcher . . . . .	Bloomington.
A. A. Eberly . . . . .	West Lafayette.
C. R. Eckler . . . . .	Indianapolis.
Max Mapes Ellis . . . . .	Vincennes.
H. E. Enders . . . . .	West Lafayette.
Samuel G. Evans . . . . .	Evansville.
William P. Felver . . . . .	Logansport.
C. J. Fink . . . . .	Crawfordsville.
M. L. Fisher . . . . .	West Lafayette.
A. S. Fraley . . . . .	Linden.
Austin Funk . . . . .	Jeffersonville.
John D. Gabel . . . . .	Madison.
Andrew W. Gamble . . . . .	Logansport.
H. O. Garman . . . . .	Lafayette.
J. B. Garner . . . . .	Crawfordsville.
Robert G. Gillum . . . . .	Terre Haute.



Vernon Gould	Rochester.
Frank Cook Greene	New Albany.
Walter L. Hahn	Springfield, S. D.
C. F. Harding	West Lafayette.
Mary T. Harman	State College, Pa.
Victor Hendricks	St. Louis, Mo.
John P. Hetherington	Logansport.
C. E. Hiatt	Bloomington.
John E. Higdon	Indianapolis.
Frank R. Higgins	Terre Haute.
S. Bella Hilands	Madison.
John J. Hildebrandt	Logansport.
G. E. Hoffman	Logansport.
Allen D. Hole	Richmond.
Lucius M. Hubbard	South Bend.
O. F. Hunzicker	West Lafayette.
John N. Hurty	Indianapolis.
J. Isenberger	Lebanon.
C. F. Jackson	Durham, N. H.
A. G. Johnson	Lafayette.
H. E. Johnson	Greenfield.
A. T. Jones	West Lafayette.
W. J. Jones, Jr.	West Lafayette.
O. L. Kelso	Terre Haute.
A. M. Kenyon	West Lafayette.
Frank D. Kern	Lafayette.
Charles T. Knipp	Urbana, Ill.
L. V. Ludy	West Lafayette.
R. W. McBride	Indianapolis.
Richard C. McClaskey	Terre Haute.
N. E. McIndoo	Lyons.
Edward G. Mabin	West Lafayette.
James E. Manchester	Vincennes.
Wilfred H. Manwaring	Bloomington.
William Edgar Mason	Borden.
Clark Mick	Berkley, Cal.
A. R. Middleton	West Lafayette.
G. Rudolph Miller	Indianapolis.

F. A. Miller	Indianapolis.
Richard Bishop Moore	Indianapolis.
F. W. Muncie	Crawfordsville.
Fred Mutchler	Terre Haute.
Charles E. Newlin	Indianapolis.
John F. Newsom	Stanford University, Cal
J. A. Nieuwland	Notre Dame.
D. A. Owen	Franklin.
Rollo J. Pierce	Indianapolis.
Ralph B. Polk	Greenwood.
James A. Price	Ft. Wayne.
C. A. Reddick	Crawfordsville.
C. J. Reilly	Syracuse.
Allen J. Reynolds	Emporia, Kansas.
Giles E. Ripley	Decorah, Iowa.
George L. Roberts	Lafayette.
J. Schramm	Crawfordsville.
E. A. Schultze	Chicago, Ill.
Will Scott	Bloomington.
Charles Wm. Shannon	Bloomington.
Fred Sillery	Indianapolis.
J. R. Slonaker	Madison, Wis.
C. Piper Smith	Pacific Grove, Cal
Essie Alma Smith	Bloomington.
E. R. Smith	Indianapolis.
J. M. Stoddard	Indianapolis.
J. C. Taylor	Logansport.
Albert W. Thompson	Owensville.
W. P. Turner	West Lafayette.
W. B. Van Gorder	Worthington.
H. S. Voorhees	Ft. Wayne.
Frank B. Wade	Indianapolis.
Daniel T. Weir	Indianapolis.
A. E. White	Connersville.
Herbert Milton Woollen	Indianapolis.
J. F. Woolsey	Indianapolis.
G. A. Young	West Lafayette.
L. E. Young	West Lafayette.

W. J. Young . . . . .	Hyattsville.	
Lucy Youse . . . . .	Palo Alto, Cal.	
W. A. Zehring . . . . .	West Lafayette.	
Charles Zeleny . . . . .	Bloomington.	
Fellows, resident . . . . .		48
Fellows, non-resident . . . . .		10
Members, active . . . . .		131
Members, non-resident . . . . .		25
		<hr/>
Total . . . . .		214

NOTE.—For list of Foreign Correspondents, see Proceedings of 1904.

PROGRAM  
OF THE  
TWENTY-FOURTH ANNUAL MEETING  
INDIANA ACADEMY OF SCIENCE,  
PURDUE UNIVERSITY, LAFAYETTE, INDIANA,  
NOVEMBER 26, 27 AND 28, 1908.

OFFICERS AND EX-OFFICIO EXECUTIVE COMMITTEE.

GLENN CULBERTSON, President	A. J. BIGNEY, Assistant Secretary	
A. L. FOLEY, Vice-President	G. A. ABBOTT, Press Secretary	
J. H. RANSOM, Secretary	W. A. McBETH, Treasurer	
DAVID M. MOTTIER	D. W. DENNIS	J. C. ARTHUR
ROBERT HESSLER	C. H. EIGENMANN	O. P. HAY
JOHN S. WRIGHT	C. A. WALDO	T. C. MENDENHALL
C. L. MEFS	THOMAS GRAY	JOHN C. BRANNER
W. S. BLATCHLEY	STANLEY COULTER	J. P. D. JOHN
H. W. WILEY	AMOS W. BUTLER	JOHN M. COULTER
M. B. THOMAS	W. A. NOYES	DAVID S. JORDAN

All sessions of the Academy will be held in the Chemical Building on the campus of Purdue University. Rooms will be provided in this building for the Secretary and other officers, and for committees. A general lounging room will also be furnished.

ENTERTAINMENT.

Arrangements have been made to care for those attending the Academy in fraternity houses within two blocks of the University grounds. A very low rate of \$1.50 has been secured for supper on Friday night, night's lodging and breakfast on Saturday morning.

On Friday noon a lunch will be served at the University for 50 cents.

Those desiring to have accommodations reserved for them should notify Dean Stanley Coulter at once.

All attending the Academy should report at once at the Chemical building, where their reservation will be given them and they will then be shown to their lodging places.

PROGRAM COMMITTEE.

M. B. Thomas, Crawfordsville	C. H. Eigenmann, Bloomington
Glenn Culbertson, Hanover	

LOCAL COMMITTEE.

Stanley Coulter	Percy N. Evans
C. H. Benjamin	

## GENERAL PROGRAM.

THURSDAY, NOVEMBER 26.

Meeting of the Executive Committee at the Lahr House..... 8:30 p. m.

FRIDAY, NOVEMBER 27.

CHEMICAL BUILDING.

General Session ..... 9:00 a. m.  
 President's Address ..... 11:00 a. m.  
 Lunch at the University ..... 12:00 m.  
 Inspection of University and Exhibits ..... 1:00 p. m.  
 Section Meetings ..... 2:30 p. m.  
 Lecture and Demonstration--High Frequency Currents. By Professor H. T. Plumb, Associate Professor of Electrical Engineering, Purdue University. Lecture Room, Electrical Building ..... 8:00 p. m.

SATURDAY, NOVEMBER 28.

CHEMICAL BUILDING.

General Session followed by Section Meetings ..... 9:00 a. m.,  
 Round Table.

## PAPERS TO BE READ.

At eleven o'clock November 27 the Academy will hear the address of the retiring president, Professor Glenn Culbertson, on "Deforestation and Its Effects Among the Hills of Southern Indiana."

## GENERAL.

1. Work of the Pathological Laboratory of the Central Indiana Hospital for the Insane, 15m..... Dr. Geo. F. Edenharter
- \* 2. New Species of Birds in Indiana, 10m..... Amos Butler
- \* 3. The Recent International Congress on Tuberculosis, 10m..... Severance Burrage
- \* 4. Biography and the Influence of Environment, 15m..... Robert Hessler
- \* 5. Felkner Island, Wabec Lake, Kosciusko County, Indiana, 10m..... J. P. Dolan
6. A Strange Nurse, 5m..... A. J. Bigney
- \* 7. The Shake Dance of the Quilente Indians, with drawing, by an Indian in the Indian School. Presented by..... Albert B. Reagan
- \* 8. Invasion of School Building by Bed Bugs, *Acanthia Hirundinis*, Parasites on Chimney Swifts H. E. Enders
- \* 9. Photographs of Morehouse's Comet, 1908 (lantern)..... W. A. Cogshall
- \* 10. Selective Fertilization Among Fishes..... W. J. Moenkhaus
- \* 11. Nature Study..... J. G. Coulter

## BOTANY.

- \* 1. Field Observations on Rusts for the General Botanist, 5m..... J. C. Arthu
- \* 2. The Rust of Timothy, 10m..... F. D. Kern
- \* 3. Notes on the Heteroecious Rusts of Indiana, 10m..... Aaron G. Johnson
- \* 4. Some Anomalies in the Endosperm of *Pinus*, 5m..... D. M. Mottier
- \* 5. Notes on the Seedless Persimmon, 5m..... Wm. L. Woodburn
- \* 6. A Preliminary List of the Fungi of Indiana, 5m..... J. M. VanHook

\*Papers read.

- \* 7. Testing Seed Corn by Specific Gravity, 5m..... H. A. Dunn
- \* 8. Notes on the Flora of Cass County, Indiana, 10m..... Robert Hessler
- \* 9. Bean Anthracnose, 10m..... M. F. Barrus
- \*10. Endophytic Algae, 10m..... Jacob Schramm
- \*11. Report of Work in Corn Pollination, 5m..... M. L. Fisher
- \*12. Effect of the Recent Drought Upon Forest Trees, 10m..... Stanley Coulter
- \*13. Difference Between *Pinus taeda* and *Pinus palustris*, 10m..... Katherine G. Bitting
- 14. A Forest Problem, 10m..... W. H. Freeman
- \*15. Botany in the High School, 10m..... E. C. Snarr
- \*16. The Killing of Mustard and Other Noxious Weeds in the Grain Fields of South Dakota, 10m..... E. W. Olive
- \*17. The Plankton of an Underground Stream..... Will Scott
- 18. Anthracnose on Cereals and Grasses..... A. D. Selby and T. F. Manns

## CHEMISTRY AND MATHEMATICS.

- \* 1. The Meyer Molecular Weight Calculation, 10m..... Percy N. Evans
- \* 2. The Vapor Pressure Method of Determining Molecular Weights, 15m..... J. B. Garner
- 3. Reaction of Sulphuric Acid Interpreted Upon the Basis of the Electrolytic Dissociation Theory, 10m..... W. A. Ruth
- \* 4. Action of Alpha Bromoacetyl esters on Sodium Acetylacetonate, 10m..... G. A. Reddick
- \* 5. Action of Alpha Bromoacetyl esters on Sodium Benzoylacetonate, 10m..... J. B. Garner and G. J. Fink
- \* 6. Relation of Fats to Moisture Content of Butter, 10m..... O. F. Hunziker
- 7. Note on a Class of Definitions, 5m..... F. R. Higgins
- 8. A Graphical Representation of the Epsilon-Delta Definition of the Limit of a Function and Continuity, 5m..... F. R. Higgins
- \* 9. The Beckmann Rearrangement..... J. B. Garner
- \*10. The Use of the Polariscopes in Testing High Tension Insulators..... C. F. Harding
- \*11. A Contribution to the Chemistry of Mucoid..... C. E. May
- \*12. The Determination of Lead by Titration of Lead Chromate..... C. E. Brooks
- \*13. An Evolution Method for the Determination of Sulfur in Sulfates and Sulfides..... F. C. Mathers
- \*14. The Deterioration of Platinum through Ignition of Phosphates..... R. E. Lyons

## GEOLOGY.

- \* 1. Probable Origin of Depressions in the Mesa South of the Tijeras Canyon, New Mexico, 10m. Albert B. Reagan
- \* 2. Headwaters of the Tippecanoe River, 10m..... J. T. Seovell
- \* 3. Origin of Cyclones and Anticyclones of Temperate Latitudes, 10m..... W. A. McBeth
- 4. Some Drainage Modifications in Southeastern Indiana..... W. M. Tucker
- 5. Soil Survey of Daviess County..... L. C. Snyder
- 6. Caves and Cave Formations of the Mitchell Limestone of Indiana..... F. C. Greene

## ZOOLOGY.

- 1. The Nasal Muscles of the Reptiles, 10m..... H. L. Bruner
- 2. Swell Mechanisms of Vertebrates, 10m..... H. L. Bruner
- \* 3. Life Zones of Indiana as Illustrated by the Distribution of Orthoptera and Coleoptera Within the State, 15m..... W. S. Blatchley
- \* 4. Animals of the Olympic Peninsula, Washington, 10m..... Albert B. Reagan
- 5. The Effect of Successive Removal on the Rate of Regeneration..... Charles Zeleny
- 6. Proportional Regeneration..... M. M. Ellis
- 7. Curves Representing the Rate of Regeneration..... M. L. Durbin
- 8. Circulation of Mixed Blood in the Adult Reptile and Amphibian as well as in the Fetal Mammal and Bird..... A. G. Pohlman

## EXHIBITS AND DEMONSTRATIONS.

All of the laboratories of the University will be open for inspection during the session of the Academy and from 1:00-2:30 on Friday members of the Instruction Staff will be present to explain apparatus and methods of work.

Some special exhibits will be made as follows:

## TESTING LABORATORY OF THE MECHANICAL BUILDING.

In the Timber Testing Laboratory will be demonstrated the methods used in the Forest Service for testing wood.

## CHEMICAL BUILDING.

Exhibit of Literature and Apparatus used in the fight against Tuberculosis.

## AGRICULTURAL BUILDING.

The Departments of Agronomy and Extension Work and the State Chemist will make exhibits in the Soil Physics Laboratory and the Agronomy Class Room.

The Department of Agricultural Engineering will exhibit in Room 201.

The Department of Animal Husbandry will exhibit micro-photographic work, hog cholera vaccine and other research work in the Veterinary Science Laboratory and Museum.

## HORTICULTURAL LABORATORY.

Exhibit of appliances used in spraying infected plants.

## DAIRY LABORATORY.

Exhibit of appliances used in the care of dairy products.

## UNIVERSITY FARM.

Exhibit of experimental feeding work, the dairy herd and various breeds of sheep and hogs.

## THE TWENTY-FOURTH ANNUAL MEETING OF THE INDIANA ACADEMY OF SCIENCE.

---

The twenty-fourth annual meeting of the Indiana Academy of Science was held at Purdue University, Lafayette, Indiana, Thursday, Friday and Saturday, November 26, 27 and 28, 1908.

Thursday evening the Executive Committee met at the Lincoln Club and transacted the business coming before them. They directed the Secretary to request of the Legislative Committee, having the matter in charge, the doubling of the appropriation for the Academy. It was voted that the next meeting be a celebration of the twenty-fifth anniversary of the founding of the Academy and that an attempt be made to bring together all the educational interests of the State, as well as to have present all the living ex-Presidents of the Academy.

At nine o'clock Friday morning the Academy met in the chemistry building at Purdue. President Culbertson presided. The transaction of business and the reading of papers occupied the attention of the meeting until eleven o'clock, when the President delivered his address on "Deforestation and Its Effects Among the Hills of Indiana."

At noon a luncheon was served on the top floor of the chemistry building, followed by an inspection tour of the buildings of the University.

On reconvening at two o'clock a short business meeting was held, after which papers were read in sectional meetings. In the evening Professor H. T. Plumb, of the University, delivered an interesting lecture on the subject of "High Frequency Electric Currents."

Saturday morning at nine o'clock the Academy reconvened and completed the reading of papers and the transaction of business, adjourning at eleven o'clock to meet in next annual session at time and place selected by the program committee.



## PRESIDENT'S ADDRESS:

DEFORESTATION AND ITS EFFECTS AMONG THE HILLS OF  
SOUTHERN INDIANA.

---

BY GLENN CULBERTSON.

---

No region of America, east of the Rocky Mountains, was in the past more densely wooded than were the hills and valleys of southern Indiana. Some of the most magnificent specimens of the temperate latitude forest trees found a suitable habitat along the crests of the divides, and upon the valley slopes of the Ohio River and its tributaries. Very few unwooded areas were found among the hills of southern Indiana, and such as were present were not large.

The "flats" or "slash" lands, forming the watersheds between the Ohio and the Wabash and their tributaries in many parts of southeastern Indiana, were occupied largely by the sweet gum, or liquidamber, the black gum, beech, shell-bark hickory, black-jack and red oaks, red maple and hackberry.

On the gently-rolling land and among the hills the yellow poplar, white and chinquapin oaks, the black walnut, sugar maple, beech, hickory, buck-eye, black locust, linn or basswood, the white and blue ash, and on the still more precipitous and rocky ridges the chestnut oak and cedar, were found.

In the rich alluvial bottoms, and along the streams, in addition to many of the rolling land trees, were present in their greatest luxuriance the elm, the cottonwood and the sycamore. Many of these trees were among the giants in dimensions. There were yellow poplars from one hundred to one hundred and twenty-five feet in height, and from twenty to twenty-five or more feet in circumference. Sycamores grew along the larger streams and in the river bottoms, of such dimensions that their hollow trunks were sometimes used as rude dwellings and as stables.

White oaks and black walnuts grew to such size and in such profusion that were they to be had now, in their original numbers, their value would be twenty-fold greater than the present value of the land from which they were cut.

To clear the ground of such a forest growth, the pioneers had indeed a difficult task. After a generation of fierce fighting on the part of our fathers that they might overcome their then common enemy, the forest, it is not at all surprising that it is even yet difficult to bring the present generation to a proper realization of the benefits of the living forest. All appreciate the value of the timber, but very few of the people realize the benefits of the forest to the country at large; nor do they yet understand the methods by which forest lands may be made as profitable as cultivated areas. To cut away the trees, and to bring the land under cultivation, appears to be the great purpose of the majority of those still possessing a few acres of woodland. To such an extent has the work of deforestation been carried on, even among the hills of southern and southeastern Indiana, that less than ten per cent of the original forest areas are still left intact. Those portions of the original forests yet standing have in the greater number of instances not more than 30 per cent of their former number of trees.

Contrary to what might have been supposed, a larger per cent of the steep hill slopes has been cleared than the land of the more level regions. The slopes of the higher hill lands, such as are found in portions of Clark, Jefferson, Switzerland, Ohio, and Dearborn counties, and to an equal extent in the river counties to the southwest and in the adjoining State of Kentucky, have been almost entirely denuded of their forest growth. Here and there, however, on land that has become valueless for agricultural purposes, nature has begun to repair the general destruction, and a scattering growth of bushes and young trees has sprung up.

It is the purpose of this paper to treat of some of the questions, geological and meteorological, as well as economic, arising from the deforested conditions found in the hills of southern Indiana. Special study, however, has been made of the regions comprised in the basins of Fourteen Mile, Indian Kentucky, Indian and Laughery creeks and the smaller streams emptying into the Ohio River in Clark, Jefferson, Switzerland, Ohio, Dearborn and Ripley counties. What may be said of this general region is largely applicable likewise to other localities with approximately similar conditions.

One of the most striking effects of the deforestation of this region has been upon the "immediate run off" of the streams. As could have been predicted, the amount of this "immediate run off," for any given precipitation, has rapidly increased as the forests have disappeared. The volume

of the flood waters of the streams has year by year kept pace with the destruction of the wooded areas. This has been notably true of the volume of the different tributaries of Indian Kentucky Creek, which has come more immediately under my observation. Within the last ten years these streams have repeatedly had record-making floods.

It has been estimated that, upon all the lands of the earth, some 36,000 cubic miles of water fall per year, and that of this amount some 6,000 cubic miles finds its way into the sea by way of the rivers and streams. Thus the annual average run off from the lands is approximately 16 per cent. The average "immediate run off" of such streams as obtain their water supply from the hills referred to in this paper must have varied enormously with the change from the completely forested condition of the past to that of the present. Then, there was a universal leaf mulch, and a deep, porous soil, filled with roots and decaying vegetation. As compared to that, there is now a compact sod, a shallow and very compact clay or a rock surface. The average annual "immediate run off" from these streams today is at least 50 per cent greater than that from the same regions under the forested conditions of the past.

One of the most apparent consequences of the greatly increased "immediate run off" is the gradual lowering of the ground water level in all portions of the State and especially among the hills. As the ground water level is lowered the flow of springs and of wells is stopped, or very much reduced, in time of drouth. At no time in the history of southern Indiana and northern Kentucky have springs and wells so completely failed as has occurred during the season just past. Water for family use and for stock has in hundreds of instances, and during many weeks, been obtained from distances of one or two miles. The water supply in villages and small towns became very limited or gave out entirely. In many parts of the State, even at a distance from those portions having a rough topography, wells are being driven to greater and greater depths in the endeavor to obtain a permanent water supply for mills and factories, as well as for farm animals. These unfortunate conditions may properly be attributed in large part to the greater immediate run off of the rainfall resulting from deforested conditions.

That deforestation in general, and in the regions referred to in this paper in particular, causes a decrease in the total precipitation can hardly be doubted. The problem of the influence of forests on precipitation is one not easily solved, and is one which has long troubled investigators.

It appears to the writer that both theory, and the observation of the phenomena, substantiates the statement that deforestation greatly influences the rainfall.

It is not probable that the ordinary winter and spring precipitation is to any extent affected by the presence or absence of forest growth. That the summer and autumn rains are often greatly modified, on the other hand, can hardly be questioned.

In the first place, the presence of a heavy leaf mulch, and of the very porous and highly-absorbent soil of a forested area, is a sufficient guarantee that at the beginning of the hot season the soil shall be filled with moisture from the winter and spring rains. Under the present deforested conditions of the hill lands the immediate run off is so great, because of their compact and rocky surfaces, that it is at least questionable whether the ground is ever fully saturated, even at the beginning of the summer season. Moreover, if such a compact soil were saturated, capillary action would cause a very rapid evaporation during the first few weeks of warm weather, and hence greatly diminish the supply of ground water before midsummer.

Given, however, the soil and subsoil of a forested region thoroughly saturated with water at the opening of the hot season, the leaf and loose soil mulch effectively stops evaporation resulting from capillary action. The ground water then is largely conserved until drawn from the soil by means of the roots of the forest trees, and evaporated from the leaf surfaces later in the season, when the trees need the moisture for growth. It is a well-known fact that the evaporation from the leaf surfaces of the greater number of trees in a moist climate is very important. Carefully conducted experiments have shown that from the leaves of a birch tree of moderate size, from 600 to 900 pounds of moisture is evaporated in twenty-four hours, and that from a large elm there may be given to the atmosphere as much as several tons in the same period. The amount, however, varies very considerably with the atmospheric conditions. It is a fact of common observation that large trees, such as the oak, growing in cultivated fields, so completely take up the moisture from the earth that the corn or other crop fails to mature for a distance of many yards from them.

In a forested region the approach of a low barometric area, with its accompanying high temperature conditions, in accordance with the laws of vaporization, causes a corresponding increase of evaporation from the

foliage. Moreover, as the evaporation increases, in the same degree the temperature is modified, since the greater the amount of water changed into vapor the greater the quantity of heat absorbed in the process. Reducing the temperature increases the relative humidity of the atmosphere. Hence, in two ways the atmospheric conditions are made more favorable for a copious and general rainfall at the approach of low barometric areas during the hot season.

It has always been true, perhaps, that many thunder-storms and showers during the summer months, and particularly in July and August, give moisture to very limited areas. Careful observation during a number of years has convinced the writer that as the forests have disappeared the average territory covered by our summer thunder-storms has been gradually and greatly decreasing. Repeatedly during the last few hot seasons, and especially during the one just past, the arrival of a low barometric area caused the formation of a few thunder-clouds, but these, instead of increasing in volume and advancing so as to cover a larger and larger region, soon dwindled and disappeared. The failure of the present deforested areas to add to the sum total of the general atmospheric moisture, as the heated conditions of the low barometric area approached, and also the failure in the formation of vapor in the given locality, both served to decrease the rainfall of the thunder-storm. This was due, first, to the lack of a local vapor supply to add to that brought in by the winds from a distance, and which is very necessary for the formation of clouds in the hot season. Again, when the supply of moisture may have been sufficient to form a thunder-cloud, its advance was into a highly heated dry region with its low relative humidity. The absence of any considerable local evaporation, and the resulting high temperature caused the re-evaporation of the condensed moisture of the clouds and no precipitation followed.

The weather conditions of the deforested areas during the hot months are more and more nearly approaching those of the hot arid regions of the west, where a thunder-cloud formed under favorable conditions very frequently disappears because of re-evaporation as it advances into a territory more highly heated, and of a lower relative humidity.

In another way also the presence of forests tends to add to, and their absence to diminish, the precipitation of the summer months, and that is in causing secondary showers after the main storm is over. The enormous leaf surface, covered with moisture by the rain just passed,

causes a very rapid evaporation to take place almost immediately. Hence, during the hot months, a number of secondary showers quite often followed a thunder-storm under forested conditions. The old weather adage that "Fog rising from the hills will soon give water to the mills," seldom failed of fulfillment. The benefits derived from the more gently falling showers following the hard downpour of the thunder-storm in filling the soil of the cultivated fields and pasture lands can hardly be estimated. It is the moisture from these rains that adds very greatly to the ground water, especially on the firmer earth surfaces.

Again, if it be true, as now appears from records kept during the last ten years, that the summer rainfall of the trans-Mississippi states, particularly Oklahoma, Kansas and Nebraska, be increasing, it would uphold the theory just advanced. In contrast with the naked prairie of the past, which had a large immediate run off, the plowed lands of today are a much better absorber of moisture, and would increase very much the ground water supply. The early summer cultivation of extensive cornfields would tend to conserve this moisture, until the rank growth of corn or other cultivated vegetation, with its extensive leaf surface, would add greatly to the evaporating surface. This would increase the local atmospheric moisture, especially during July and August. Hence, if the above theory be true, there should be ordinarily an ever-increasing rainfall during those months year by year, just in proportion to the area of original prairie land put under cultivation. If trees were more extensively planted, the results in increased rainfall should be marked to the same degree.

In résumé, we may say that theory upholds, and observation substantiates the statement, that deforestation greatly increases the immediate run off, and as greatly decreases the ground-water supply of a given region. It is equally true that the absence of forests seriously decreases the evaporation, and the amount of vapor in the atmosphere, during the hot months. Again, the absence of evaporation permits of higher local temperatures on the approach of low barometric areas and hence the relative humidity of the atmosphere must be lower. All tend toward the reduction of the rainfall during the late summer months, when of all times it is most needed for the growth and maturing of vegetation.

Furthermore, we believe that it can be shown that deforestation has a tendency in a region of rough topography, such as is found among the hills of southern Indiana, to localize the hot season rainfall, and to produce conditions approximating those of the so-called "cloudbursts" of the

Rocky Mountain regions of the West. A case in point occurred during the past summer in the latter part of July over an area of some six or eight square miles along the divide between the basins of Indian Kentucky and Indian creeks and their tributaries, in eastern Jefferson and western Switzerland counties of this State. The rainfall in this case was unprecedented for the region. On one border of the given area a government rain gauge, kept by J. R. Shaw, Jr., was filled to the brim, the measurement amounting to three and one-half inches, and then ran over for an unknown period. Afterward the gauge was emptied and received one and one-half inches more, making at the least five inches, and probably much more, in the period of two hours during which the rain fell. Other and more reliable measurements in locations more nearly the center of the storm area were made and a precipitation of at least ten inches in the two-hour period were recorded.

The conditions producing this exceptional and very destructive rain-storm were as follows: The region to the west and southwest of the storm-swept region is one of the roughest topographically in southern Indiana. The whole area for ten or twelve miles in this direction forms the basin of Indian Kentucky Creek and tributaries, and the hills rise in many instances 400 to 450 feet above the valleys, and the slopes are very steep. From the whole basin the forests have been almost entirely removed. On the day referred to the temperature was unusually high, some thermometers within the area registering 102 degrees in the shade. There was no movement of the air until early in the afternoon, when a gentle southwest wind arose, and this caused the highly-heated air of the whole region to move northeastward. The valley of Brushy-fork Creek, one of the principal tributaries of Indian Kentucky Creek, became the center of the air movement. About three in the afternoon a cloud began to form above the divide and around the head of the valley of Brushy-fork Creek. The highly-heated air ascended very rapidly on reaching the divide, and the consequent rapid cooling of the air by expansion caused an equally rapid condensation of the moisture of the air. The cloud increased in volume with very great swiftness, and the rain fell in torrents, first over a very limited area and then over a wider region. The center of the storm, however, instead of moving, as is usually the case, remained almost stationary for a period of two hours. During this time the winds from almost the entire surrounding region moved slowly towards the now enlarged area of precipitation. There were few if any clouds outside of

the six or eight square miles covered by the storm, but the hot air from the proximity, on reaching this area of rapidly rising atmosphere, constantly added its moisture to that being condensed, with the result that for two hours the downpour continued. This very unusual precipitation proved exceedingly disastrous to the soil of the cultivated fields, and to the roads and bridges as well as to property of all kinds along Brushyfork Creek and the larger tributaries of Indian Creek. Both of these streams were several feet above any previous record. Where a few moments before there were dry, rocky creek beds, now became a wild flood from six to ten feet in depth and from 300 to 500 feet wide. Buildings were carried away that had seldom or never been touched by previous floods.

In the opinion of the writer this cloudburst, which in truth it was, was caused by the intense heating of the deforested region of very rough topography to the southwest, followed by the gentle movement of great volumes of heated air in a northeasterly direction, until in its passage over the divide it rapidly ascended. Becoming cooled in its ascent, the enormous quantity of moisture held in the highly-heated atmosphere rapidly condensed, and the unprecedented rainfall for that region followed. It may be years before conditions of temperature, moisture and winds would unite to produce another such storm in the same locality, yet the probabilities are that in the future such rainfalls will become increasingly frequent somewhere in such deforested areas of rough topography.

From observations in the Rocky Mountains of Colorado and Wyoming, the cloudbursts of those regions are formed under essentially similar conditions, so far as the absence of forests and areas of highly-heated air are concerned. In the mountains, however, these storms may be more intense, and more frequent, because of the greater height of the divides and the almost entire absence of vegetation or even of any considerable mantle of soil.

Observation of the hill region of southern Indiana compels one to believe that as the forest growth has disappeared such storms have become more prevalent. Excessive rainfall occurs over limited areas, while drouth conditions prevail over the surrounding country. In the one place of rainfall the destruction caused by the flood may be even more disastrous than the continued drouth over the nearby territory.

The effect of forest destruction upon streams has often been described and need not be dwelt upon in this paper at any length. In the area



of hill lands of southern Indiana there can be no reasonable doubt that as the trees have been removed there have been greater and greater floods; and now as the forests have almost entirely disappeared the floods have become exceedingly destructive. Dwelling houses that had stood above the highest waters of the streams for half a century have, within the last decade, since the higher prices for timber have caused the more rapid disappearance of the trees, been inundated repeatedly and many of them carried away. Bottom lands that twenty years ago had a deep and fertile soil are now almost worthless. The flood waters have carried away the greater part of the tillable earth and left in its place stones and gravel. In other places the alluvium of the bottoms has been covered by material from the hills. Thousands of acres of such land, which a few years ago was the most fertile and valuable in the State, are now undesirable.

Hand in hand with the flooded conditions and consequent destruction caused by the larger streams has gone the loss of soil by erosion from the deforested hill lands. It is no exaggeration to say that, from the greater number of hill farms placed under cultivation a quarter of a century ago, there has been removed on the average a foot of soil, and from many slopes there has been taken three or four times as much. Tens of thousands of acres of the steeper hillsides have been denuded of their soil covering and are at present valueless for ordinary agricultural purposes. How to prevent this denudation is the most serious problem that the hill farmer has to solve. In many cases a single heavy rain in February or March, when the departing frost has left the ground in its least compact condition, has been known to remove from a whole slope an average of four or five inches of the soil. Fields that before the rain were considered good farming land were left so covered with rocks, and with so little soil, that they were practically abandoned. Farmers among the hill lands are realizing more and more that a loss of soil is the most serious of property losses, since a damage of this character cannot be repaired except by the ordinary processes of nature, which require scores and even hundreds of years. Farm after farm in southern Indiana, considered very valuable thirty years ago, is practically deserted today. The population of this region first occupied the hills, and considered the soils of the flats and divides very undesirable. For many years now, however, the tide of movement of the people has been from the hills to the flat or gently rolling

lands. As a result the population and wealth of many of the hill counties have been gradually and greatly diminishing.

Many of the streams, flowing down steep beds in their short courses from the divides to the Ohio, at one time furnished valuable water power. They are now useless. Were it possible to control such streams as Fourteen Mile, Indian Kentucky, Indian and Laughery creeks and many others in Clark, Jefferson, Switzerland, Ohio, Dearborn, Ripley and other counties in southern Indiana, very valuable water power could be obtained. Under the present condition of floods and drouths, however, they are valueless as a source of power. Streams that thirty years ago furnished abundant power for mills during ten months of the twelve now are even without flowing water for almost half the time.

The alternate floods and drouths have had a serious effect also upon the animal life of these streams. The great volume of muddy and rapidly-flowing water sweeps thousands of the smaller fish from their proper habitats into larger pools, where they become a prey to their own kind. On the other hand, drying up of the pools of almost every small and of very many of the larger streams causes the destruction of the young of our most valuable game and food fishes as well as of minnows and of crayfish upon which the more highly-prized fishes feed. In the flooded streams following the unusual freshets of March and April of the present year bass and other species of fish ascended the smaller streams almost to their very sources for the purpose of spawning. The severe drouth of the late summer and autumn months dried up the pools and caused the death of such quantities of the young fish and other animal life that the odor of their decaying bodies was very offensive to persons dwelling along the streams near the pools. It would be quite within the truth to say that several wagon loads of minnows and the young of our food fishes thus perished this season in the tributaries of Big and Indian Kentucky creeks in Jefferson County alone. Some of the young bass were removed to larger pools, but thousands upon thousands were destroyed. It would seem almost useless to restock our streams with bass and other valuable food and game fishes if the periodic floods and drouths are to continue and to grow in magnitude and severity.

The points already discussed represent but a part of the evils resulting from deforestation among the hills and valleys of our southern counties. We need not speak of the more manifest economic phases of the subject, such as the failure of the timber and the fuel supply, and the

higher prices resulting. Enough has been said to convince all that the only hope for the future prosperity of great areas of our State lies in reforestation. In the first place, reforestation should be urged upon the present land owners. Many an acre of untillable soil could be planted in black locust, catalpa, black walnut or shell-bark hickory with good prospect of speedy returns upon the investment. Wealthy men, interested in the preservation of game or fish, should be encouraged by favorable laws, or otherwise, to purchase large tracts of the hill lands of the State, and to plant them in timber.

Our State has already made a good, although very small, beginning in forestry. In the writer's opinion it would be the highest economy for the commonwealth to purchase and reforest tens of thousands of acres of her rougher hill lands along the Ohio and other streams. These lands are almost valueless for agricultural purposes. Covered with a growth of our most useful trees, they would in time return a rich revenue to the State; they would again become covered with soil; the present unsightly and unprofitable gullied fields and yellow clay points would disappear; the loose soil and leaf mulch resulting would again absorb great quantities of moisture, reduce the immediate run off, and hence diminish the volume of the flooded streams. At the same time the ground water supply would be greatly augmented; our late summer rains would be more numerous and more copious; wells and springs would be more permanent and give larger volumes, and our most severe drouths, destructive to all life, prevented.

The probabilities are, however, that private enterprise alone will never restore the forests to our hills as fully as the best interests of the people demand, hence the State and Nation must be called upon to take a leading part in reforestation.



## WORK OF THE PATHOLOGICAL LABORATORY OF THE CENTRAL INDIANA HOSPITAL FOR INSANE, INDIANAPOLIS.

BY DR. GEO. F. EDENHARTER, SUPERINTENDENT.

The time allotted to review the work of our Pathological Department barely permits even a brief presentation of its policies, methods and results.

It should not be inferred from the name that the work therein is purely of a pathological character, because in addition thereto all methods of clinical investigation—psychical, physiological, chemical, bacteriological, etc.—are employed.

This department had its inception in a desire to establish the work of this hospital upon a scientific basis—to provide our medical staff with facilities for the accurate determination of the character of the diseases met with in institutional life.

It was also our ambition to create a scientific department—a medical center—for the use of the physicians and medical students of the State, wherein the diseases of the mind and nervous system could be clinically studied and, if possible, to determine their cause and formulate methods for their prevention and cure.

We recognized that ultimate success in preventing and controlling these diseases could only be achieved by providing every community with practitioners who had been thoroughly taught the most approved methods of care and treatment of the incipient stages in these cases, and this in connection with a close clinical study of the various forms of insanity.

We knew that the greatest opportunity for successful results presented itself in the early stages of these maladies and therefore determined to exert our energies in an endeavor to provide facilities for the education of the individual who expected at some future time to assume the role of a family physician.

Students who interest themselves in this specialty are urged to visit this department, where every effort will be made to assist them in obtaining a knowledge of the laboratory and clinical methods in vogue.

When requested, our pathologist properly directs their efforts in research in any desired direction.

Our expectations for this department are gradually being realized, and it is with a feeling of personal pride that I am able to make the statement that this hospital is today presenting to the students of the medical colleges of Indiana a course of lectures—didactic and clinical—concerning the diseases of the mind and nervous system, their cause, pathology and treatment, unsurpassed by any educational institution in this country.

We believe that you who are at all conversant with the facts, recognize the many serious obstacles to be overcome in inaugurating and prosecuting work of a scientific character in public institutions.

In the very nature of things there must be many plans, and many defeats, and in the end, when the decisive battle is waged, you may achieve one victory.

It is the hope that this may be the final outcome of our effort wherein we find the sustaining strength to carry the burden.

It is fortunate indeed that we cannot peer into the future and expose to view all the keen anxieties and bitter disappointments which are to be our portion in connection with prospective work.

The building was erected in 1895, and the equipment was installed in 1896.

The dedicatory exercises were held under the auspices of the Marion County Medical Society on December 18, 1896. At this meeting a paper on "The Evolution of the Physiology and Pathology of the Brain and Spinal Cord" was read by Prof. Ludwig Hektoen, M. D., of the Rush Medical College.

Prior to the appointment of a resident pathologist the hospital staff utilized the facilities of this department in making such examinations as occasions demanded. They also performed autopsies.

The first attempt to systematize and direct the work was outlined in the following notice:

"The laboratory work for the staff of the hospital will begin April 1, 1898.

"The department is now ready for making examinations of material for diagnostic purposes.

"Each member of the staff should possess a copy of Stirling's Histology, several dozen glass slides and covers.

"The study will be from ten to twelve in the forenoon, each member to be in the laboratory every other day.

"Attendance upon this course is obligatory.

"When autopsies are made, the assistant physician who had charge of the patient shall assist the pathologist in making it."

Under the above arrangement the hospital staff was given a thorough review of histology, bacteriology, microscopy, chemistry and pathology.

The sphere of work was gradually broadened.

I quote from the report of 1900-1901:

"Two objects have been constantly in mind in developing the work of the laboratory during the past year:

"First. That of enabling the members of the resident medical staff to conduct their study and treatment of the cases committed to the care of the hospital with a knowledge of the pathological basis of disease and a more intimate knowledge of the structure and functions of the nervous system as revealed by recent scientific researches in this field.

"Second. That of placing upon a thorough systematic and working basis the study of the nervous system and organs of those cases upon which an autopsy is allowed.

"In carrying out the former the following methods have been adopted:

"Each morning for two hours, from ten to twelve, three members of the medical staff are engaged in the study of the normal and diseased organs. In these morning classes the work is individual and inductive. In studying an organ, stained, injected and digested sections are first drawn with different magnifications and then descriptions of the same written without the aid of books or teaching. The gross anatomy and anatomical relations of the organs are then reviewed. When this has been accomplished, a pathological section of the same organ is given without the student knowing its designation. From this drawings and written descriptions are made of those parts differing from the normal sections before studied. This having been done, the pathologist goes over the section with him, correcting the work where necessary and pointing out those parts of more importance, and together they arrive at a diagnosis of the diseased condition. From the changes found, the student then constructs the gross appearance of the organ thus diseased and describes the clinical symptoms which would be most likely present during life in a patient so afflicted. The process of reasoning in this work, it will be seen, is practically the same as that which the physician pursues in diagnosing his case upon the wards; here, however, he starts with the diseased organ and builds up his clinical symptoms; there he arrives at the changes in his organ from the clinical evidence. Incorporated with this

work there is constantly a review of the anatomical and physiological relations of the organ studied.

"Besides these morning classes, two evening courses of lectures have been given, the first on 'Clinical Anatomy,' the second on 'The Finer Anatomy of the Nervous System.' In the former, which extended over a period of two months, the time was spent in the study of the normal relations and position of the abdominal and thoracic organs, the staff outlining these by clinical methods on living subjects after the position of each had been indicated by drawings and upon a skeleton.

"To the second series of lectures the physicians of the city were also invited. This course extended over a period of three months.

"The excellent library of the laboratory has been rearranged and two different catalogues made, to enable the staff to carry on their studies with more freedom and to open for them every opportunity to do original work. The medical journals have also been rearranged in regular series, with the same object in view.

"To aid in teaching and study, the gross specimens in the museum have been carefully mounted and arranged in groups. As this is added to from time to time it will form a very important feature in the advantages which the laboratory offers for study.

"Enlarged drawings have been made of Miss Florence Sabin's excellent model of the medulla, pons and mid-brain, to aid in the teaching of this important and very intricate portion of the central nervous system. Nothing could be of more service in enabling the student to grasp the structure of this region than the model which Miss Sabin has constructed."

In 1900 the medical colleges commenced their didactic and clinical lectures to their students. This course, with a variation of the program, has been continued each year. Indiana University also presents an annual course in psychology. The pathologist each lecture-day presents some pathological demonstration, the program for each session being:

Didactic lecture, one hour.

Clinical lecture, one hour.

Pathological lecture, one hour.

Members of the hospital staff alternate in arranging cases for the clinical lectures. This course is free to practitioners and students of medicine; others are admitted upon special permission of the superintendent or lecturer.



From the report of 1905 we take the following :

“Beginning October 1, 1903, and continuing until the last of December of the same year a series of lectures and demonstrations was given to the assistant physicians on the anatomical relations and the physiological functions of the various parts of the nervous system, on the different changes produced by the different pathological conditions that were liable to involve them, and upon the clinical symptoms manifested by such involvement.

“After the 1st of January, 1904, regular staff meetings were instituted and held three times weekly, namely, Monday, Wednesday and Friday mornings from 10:30 to 12. At these meetings the assistant physicians alternated in presenting one or more cases. A systematic examination was made of the mental condition and also of the physical condition, where this had not been done beforehand, by the physician in charge, followed by a discussion of the case by those in attendance. A synopsis of the more important clinical features of each case, together with a summary of the clinical manifestations, was recorded.

“The object of these meetings was to create a nucleus upon which more complete clinical records could be built, and for this purpose a short report was made and filed away of each case, pointing out the prominent and characteristic feature of the individual cases presented. An endeavor was also made to determine the underlying conditions that were the probable factors in bringing about the mental disturbance. This problem was found to be an extremely difficult one. Many important factors came into consideration when an attempt was made to bring about a solution of this problem which were most difficult to regulate and control, in many cases wholly impossible, and tended to make this part of the work a source of discouragement and in many respects very unsatisfactory. One of the first essentials in the study of all pathological conditions, whether mental or physical, is, of course, to have a correct conception of the normal, or what is regarded as normal, in the individual case. Without this one cannot arrive at a definite conclusion as regards the degree and extent of the abnormal conditions that developed or that may do so. In the majority of cases presented very little information was obtainable, apart from that of the commitment record, or from the patients themselves. The former reports, unfortunately, were very incomplete, and the latter almost invariably were more or less distorted or modified by the trend and coloring of the mental disturbance existing. Consequently, any conclusions arrived at

can only be of corresponding value. In addition to this, it is of the greatest importance to have a full report of the heredity, early education, training and environment of each case in order to understand and appreciate the character and nature of the disturbances that may be manifested. And, finally, there is requisite a full report of the results of a complete examination of the patient's condition at the time of admission, or as soon thereafter as possible, both mental and physical, together with a record of the case while in the institution. Without these data it is impossible to place the pathological work in its proper relationship to the clinical aspect, or to place the latter upon a definite pathological basis."

Since the above was written the work has been carried on practically along the same lines, with a constant endeavor to improve the methods and perfect the details.

This year we have undertaken the re-examination of every patient in the hospital in accordance with an approved schedule with regard to the mental and physical condition.

This procedure will be followed in all new cases admitted.

When this work is completed we will have a systematized record of each patient that will be of the greatest practical value.

The Marion County Medical Society has held a number of meetings in this department. These occasions were largely attended and marked by an awakening of professional spirit that was extremely gratifying. It has been the policy of the hospital to have each of these meetings addressed by an eminent medical man.

The first was addressed by Prof. L. Hektoen, of Chicago, upon "The Contributions of Anatomy and Pathology to the Nervous System."

The second by Jos. G. Rogers, M. D., of Logansport, upon "The First Aid to the Insane."

The third by C. B. Burr, M. D., of Flint, Mich., upon "The Care of the Recent Case."

The fourth by Lewellyn F. Barker, M. D., of Chicago, on "The Importance of Pathological and Bacteriological Laboratories in Connection with Hospitals for the Insane."

The fifth by Stewart Paton, M. D., of Baltimore, upon "The Recent Advances in Psychiatry and Their Relation to Internal Medicine."

The sixth was for the purpose of dedicating the new hospital. The attendance at this meeting was the largest of any, there being present upward of three hundred prominent persons.

The seventh, by F. W. Langdon, M. D., of Cincinnati, upon the "Cardio-Vascular and Blood States as Factors in Nervous and Mental Diseases."

A summary of the work done in this department shows:

1. That the laboratory facilities were in daily use for the examination of various tissues, specimens of blood, urine, sputum, etc.
2. That two-hundred and seventy-four autopsies were held and the findings demonstrated and recorded.

(Under the hospital rule no autopsies are held, except in coroner's cases, without the permission of the relatives.)

3. That many sections of tissues and organs were preserved for chemical, bacteriological and microscopical examination.
4. That one hundred and thirty-six gross specimens were placed in the museum.
5. That twenty papers covering important cases were written.
6. That over four hundred staff meetings were held, at which over five hundred cases were presented for clinical examination.
7. That two hundred and four lectures were given by the colleges to their classes.
8. That one hundred lectures upon neuropathology were delivered to these classes by the pathologist.
9. That thirteen hundred and forty-one cases were taken before the college classes for clinical demonstration.

This record alone, if there were no other advantages to be derived, would fully justify the maintenance of this department.

But there are other reasons for its continuance:

First. Because it stimulates the individual members of the staff to greater professional effort.

Second. It creates a demand for accurate case and clinical histories. This requires more attention to the individual patient.

Third. It incites to study and systematic investigation by having at hand the requisite appliances, books, models, charts, etc.

Fourth. It enables the institution to offer something to the ambitious student seeking an opportunity for medical advancement.

Fifth. It provides instruction to the physicians and the students in the State; prepares them to render early skilled attention to the mentally afflicted in their community. This directly benefits the citizen.

Sixth. It increases the ability of the outside physician to deliver an

intelligent judgment in insanity inquests and dictate a description of the case of value to the hospital.

Seventh. It economizes for the counties and State ultimately by decreasing the number of persons annually committed to this or institutions of like character.

Eighth. It actuates some students to undertake a special study of mental and nervous diseases. With additional opportunities given these, for clinical observation and for practical work in the laboratory, will eventually develop material from which to select physicians for positions in the hospital.

Ninth. It establishes a valuable medium to create harmonious relations between the outside members of the profession and the institution.

Tenth. It affords the hospital staff the benefits of consultations with specialists in all lines of practice.

Eleventh. It collects pathological data for the records and specimens for the museum which will be of incalculable value for future reference and study.

Twelfth. It assists in educating the public to the needs of the hospital and arouses an interest in its behalf.

Thirteenth. It furnishes the medical colleges with clinical advantages unobtainable without the aid of an institution of this character.

Fourteenth. It extends its influence in time to the individual of every community: it teaches that "prevention is better than cure," and that, if the people really desire to impede the "onward march to the hospitals for the insane" in future generations, they must begin at once to heed the advice given, assist in locating and studying the causes, and by precept and example lend every influence toward their removal.

From the foregoing it is apparent that the main object of our work in this direction is to provide the best medical service possible for the mentally afflicted individual, within or without the hospital.

The State should establish at every institution a department fully equipped for scientific work. I say at every institution, because with me the basic principle of this movement is the creation of centers around which the members of the local profession may gather and study mental and nervous diseases, their causes and treatment.

Again, I believe in encouraging individuality, and know that a State can well afford, in view of the great benefits derived, to have a number of investigators pursuing original and independent work in this cause:

and last, but not least, I contend that each and every institution, with its medical staff, is entitled to equal advantages and equal opportunities.

In conclusion I extend to each and every member of the Academy a cordial invitation to visit this department and inspect the equipment and the methods pursued.



## AN ADDITION TO THE BIRDS OF INDIANA.

---

BY AMOS W. BUTLER.

---

Harris Sparrow.

*Zonotrichia querula* (Nutt).

A specimen of this western species was taken May 4, 1907, near Sheridan, Hamilton County, Indiana, by Ernest P. Walker. It is an adult male in good plumage and was found along a hedgerow in company with White-crowned Sparrows. The time of capture was about noon. The day was rather cool and the birds were hopping about near the ground. It was not at all wary and was shot at close range. No others of this species were observed.

Mr. Walker has kindly presented the specimen to the Academy and it has been deposited in my collection as a verification of this record.

Harris Sparrow is a bird of the middle United States. It ranges from Illinois over the central plains and casually to Oregon. It is reported as a rare winter visitor in Illinois and Wisconsin. (Ridgway, Ill., Orn., I, pp. 266-7). One was taken near Riverdale, Ill., October 6, 1894, by J. O. Dunn (Butler, Birds of Indiana, 1897, p. 1178).





## BIOGRAPHY AND THE INFLUENCE OF ENVIRONMENT.

---

BY ROBERT HESSLER.

---

Biography concerns itself with 'the history of the life of a particular person.' This is the primary definition given in the Century Dictionary, a second being 'biographical writing in general, or as a department of literature.' Again as a third definition, 'In natural history, the life-history of an animal or a plant.'

Biology, on the other hand, concerns itself with the science of life and living things; with a knowledge of vital phenomena; in a technical sense, the life-history of an animal.

Environment is another name for surroundings, and environmental influences may be regarded as the influence of surroundings.

In speaking of the evils entailed by the lack of knowledge of surroundings, Ward in his *Dynamic Sociology* says: "Indeed, the greater part of all suffering is the result, direct or remote, of such ignorance. Obviously, therefore, the first great duty of man is to acquaint himself with his environment. This can only be done by study. The phenomena that lie on the surface are of little value. They mislead at every turn. Not only must the deep-lying facts, difficult of access, be sought out with great labor and perseverance, but they must be co-ordinated into laws capable of affording safe and reliable guides to human operations. To do this requires a vast amount of patient study. Only a little has yet been revealed of the more important truths of nature, yet consider the amount of research which it has required! Nevertheless, only a few individuals have contributed any thing at all to the result. It is as yet only the simpler and more obvious relations between man and nature that have been determined. In the domain of physical forces and chemical substances he is able to exercise prevision in many ways to secure advantages and avert evils, but in most of the higher fields of vital, mental, moral, and social phenomena, these relations are either utterly ignored or but dimly suspected, so that his knowledge of them avails him nothing. The great work before him, therefore, still is study." (Ward, *Dynamic Sociology*, Vol. II, p. 11.)

Ward further says: "But what constitutes the environment of the civilized man? The character of the environment of animals and of savage man is easy to perceive. It is the earth, the air, the rocks and waters, the trees, grass, birds and animals, the last to include, in the case of the savage, the men of his own tribe and of other tribes, and also civilized races, in case any such ever come in contact with him. It is by learning to know these things that he is enabled to protect and defend himself.

"But, looking to races somewhat more advanced than the crude savage, we find, as frequently shown before, that their advancement has been due to action on their part in taking advantage of certain deeper laws of nature, in making use of materials that savages fail to make use of, in interpreting phenomena that savages do not correctly interpret, and, through these means, in devising plans and inventing appliances for multiplying the products of nature and increasing the supply of physical, social, and intellectual wants. And, when we have reached the highest forms of social existence, we find that the only effective means by which desire is gratified, progress achieved, and happiness attained, consist in still deeper knowledge of the natural surroundings, in a still wider grasp of laws and principles, in the correct interpretation of still more obscure phenomena, and in the discovery and invention of still better means and methods of securing remote ends. To know one's environment is to possess the most real, the most practical, the most useful of all kinds of knowledge, and, properly viewed, this class of information constitutes the only true knowledge." (Ward, *Dynamic Sociology*, Vol. II, p. 495.)

In discussing the expression 'knowledge of the environment,' Ward comes to the conclusion that it is co-extensive and synonymous with the word science. He says: "Knowledge of man's environment is nothing more nor less than scientific knowledge; and, conversely, all scientific knowledge consists in knowledge of the environment \* \* \*" (Vol. II, p. 497). Farther on he says: "The only useful knowledge is that which furnishes relations. Isolated facts, until employed for this purpose, are not really employed at all. An object known only in itself can scarcely be said to be known. \* \* \* Science is dynamic. Whatever it touches is transformed. The only object in knowing is by means of it to do something \* \* \*." (Vol. II, p. 497).

He refers to the attenuation of knowledge and of getting away from things, and how especially in the Middle Ages men were inclined to neglect facts, and how science brings us back to facts and to nature. We can

readily see how students of environment and environmental influences are not likely to be misled by the present fad of psychotherapy. Ward also refers to much of our literature as being simply a jugglery of words, pleasing to the ears, but of little value in keeping man acquainted with his environment.

Perhaps few of us realize fully the importance of environmental influences, of how our life and our very thoughts and actions are dependent thereon. No doubt many of us have at times wondered what our own life and the life of others would be under different surroundings.

The field is a large one, and by way of delimitation I may say that my original observations and studies are confined largely to one phase of the subject, that of air conditions. The problem is this: To what extent do the effects of air conditions crop out in biography? To answer this requires, first a study of men who are today living under good and bad air conditions; it means to contrast lives of men, those who live under good air conditions with those living under bad air conditions; it requires, moreover, observation of individuals who alternately live under good and bad air conditions. Secondly, it requires the 'fossil remains,' so to speak, which can be studied, just as the paleontologist studies fossil remains which enable him to reconstruct and explain past animal life—the material in the present instance being biographical remains, books that are often known under the name of Life and Letters, as those of Huxley and of Darwin.

We all like to read about great men and emulate them; their lives are held up as examples to follow, yet the number of great men living at any one time is small, and where one becomes great, there will be thousands and thousands who are mediocre. A biographer scarcely deems it worth while to pick out the life of one of this latter class.

It may be entertaining to the average man to read the biography of a literary man, of a poet, or of a musician, but he may get comparatively little instruction from it. On the other hand, he may read the life of a common fellow citizen and get many ideas that will be of value to him in the conduct of his own life. This is a fact that seems to be little realized by biographers, but it has been appreciated by certain novelists who write about the common people, and such books are therefore very popular. Formerly novelists were concerned chiefly with the life of the 'upper classes,' but since they have begun to write of the 'common man,' to depict his life, we now know that such 'lives' can be made of general interest.

Likewise, in former days, the physician was concerned chiefly with the well-to-do; the diseases and affections of slaves and agricultural laborers and artisans were given little attention. Today distinctions are of course still made between the literate and the illiterate, but there is a very large class between these extremes—the common people, and writers have this class of readers in mind rather than the small cultured class.

Some one has said that under each grave lies a world's history, and in this light the life of the most common-place man would likely reveal many incidents that are worth recording, both on account of their general interest and the lesson they may teach.

---

In the course of years I have accumulated many notes and 'case reports,' that is, histories of individuals in chronic illhealth. Some of these histories cover the individual's whole life, from beginning to end, and if published would be biography, but since they relate to illhealth and give a minimum of facts in regard to other affairs of life, such a biography would be of interest primarily to physicians, to biologists, and individuals in chronic illhealth who might profit by the experiences of others. A wise man has been defined as one who profits by the experiences of others; a fool as one who scarcely learns from his own.

My paper is to be considered as a continuation of papers given in former years before this Academy, but to fully understand the subject, this series of papers should be considered in connection with another series given before the State Medical Society.

I have prepared a number of case histories, more or less briefly, in the form of long charts which I shall show with a few remarks on each. (Charts on rolls and diagrams were shown, the following notes being abstracts.)

---

**BIOGRAPHY A.** The environmental influences crop out very strongly in the family history, as shown in the genealogical table. The ancestry goes back into early colonial days, and until now the members have always lived under rural conditions. The great-grandfather's generation was a long-lived one, likewise the grandfather's and the father's and his own also, that is, his brothers and sisters; ten to twelve usually constituted a family. The individual himself until recently had always lived on a farm and led an active life. He had good health, but when he

came to the city his health began to fail, ascribable to 'change of air.' To stand on a street corner in a 'spitter's town,' with clouds of dust blowing about, is a rather risky occupation. His children show an entirely different history from that of the ancestry, a long life history being displaced by a short one. The children die of the 'diseases of civilization,' and that means chiefly a bad sanitary environment. The offspring, instead of living to the age of sixty, seventy, or eighty years, die prematurely, eight out of twelve dying in childhood.

Judging by or from the ancestral history, one can predict what the final termination in this case will be. One can predict—as well as that can be done in complex biological predictions. Recently the man had a cerebral apoplexy which disabled him for a time, but he gradually recovered; a continued high blood pressure means that before long there will be another apoplexy, in fact there may be several, until one is sufficiently severe to carry him off.

Some of my case histories cover a period of only a few years, but where much attention has been given, the thoroughness of study may offset the length of time. One can readily see that if an observer were to devote his attention, say for only a year, to the study of the life of an individual in chronic illhealth, much might be learned, more than where one attempts to cover an individual's whole life in a superficial manner, and we can readily understand how a physician with many patients to look after can so scatter his attention with so little time for each that he simply cannot do his patients, or the subject, justice.

People in health scarcely know what illhealth means to one who has 'chronic illhealth,' where the subject necessarily is more or less constantly in mind, and that certain symptoms—symptoms of illhealth, indicative of a reaction to a certain cause or to an abnormal environment—are present all the time, every hour of the day, and from one day to another.

The individual in chronic illhealth naturally seeks relief; he applies to the physicians, and if the physicians do not understand the case and if no good results follow their treatment, the individual naturally applies elsewhere. Some chronics are constantly drifting from one physician to another and from one form of treatment to another, even the most outlandish. In the last month one of these 'chronics' came to me. On critically studying the case, I found that she reacted to her environment, that is, in this case, to dust influences. The patient was intelligent; she promptly acted on my suggestions and many symptoms gradually vanished;

others were greatly modified, both in severity and number. One day, after the patient had been with me for some time, she told me that I was the eighteenth physician she had consulted. This individual could write a book on her experiences among doctors, and it might make painful yet beneficial reading to many who prescribe purely on a statement of symptoms.

BIOGRAPHY B. Next in order would come a history, a biography, in the making, of a bright boy of fourteen years, but for certain reasons it was thought best not to put this case in the form of a chart. This boy reacts to his environment, but the chronic illhealth under certain conditions promptly subsides under other conditions. At the International Congress on Tuberculosis, at Washington, two months ago, Dr. Koch made a statement which I have repeatedly verified. He said it was very important to teach school children the important facts connected with tuberculosis, that they will learn readily and remember, whereas the old learn with difficulty and forget readily. I have frequently met elderly people whom I attempted to instruct, but after a time I would ask myself, What is the use? One is apt, on the other hand, to take unusual pains in instructing the young and intelligent, who are both willing and capable, and it will be interesting to read the biography of an individual who keeps a daily record of what he does and where he is, and of the conditions relating to health and illhealth.

The question at times arises: Should an individual in chronic illhealth be asked to keep a daily record of events and of symptoms? I have had persons tell me they had so many symptoms that it would be impossible to keep track of them—yet in a short time there would be only a few to record, if they heeded rational advice. When the sick begin to realize that there is a relationship between symptom and cause, they no longer lie awake at night ‘wondering what it all means.’

One can readily understand why the individual brought up in the country under good air conditions should suffer on removing to the crowded city, and why the individual who is chronically ill in the crowded city may quickly regain health on going to the country, or by merely exchanging a dirty city for a clean one. We can also see how a study of biography in the light of air influences, of coniotics, so to speak, may be both interesting and profitable.

BIOGRAPHY C. The influence of environment crops out in several ways in this case, a man of 57. His father and mother were Irish; he was picked up as a waif in New York City when a small child, and, with

a number of others, was sent West; he reached Indianapolis and was adopted by a German Protestant. To see the man now and to speak with him, one would never suspect that he is Irish, for he seems to be a thorough-going German, with all the German characteristics. As one might expect, he adopted the religion of his foster parents. Some one has said that our very thoughts and actions are determined by our environment, and this man is an exemplification of it. In a general way, it may be said that the Irish in their own country live mainly under a rural environment; when they come to our crowded cities many fail. This man seems to have gotten along fairly well in his earlier days, but there has gradually developed a greater and greater susceptibility to city environmental influences.

When this man first came to me five years ago, he thought his sand of life had run down, and on superficial examination I was inclined to agree with him, but when I studied his environment and past history, I came to a different conclusion. I saw no reason why he should not continue to live for a number of years. In explaining the condition to him, I referred to Huxley and how he reacted to his environment and yet lived to the age of 75, and might perhaps have lived still longer had he known more about the influence of environment. I mentioned the English saying, that in order to live long one should acquire an incurable disease, explaining what is meant by 'disease'—that it is really no disease at all, simply a reaction to environmental influences: that the pains and aches, the warnings of nature, could be prevented by avoiding the cause, and that means to observe and to seek to avoid them. In proportion as causes are avoided, one may live on and on. It took some time to fully explain matters to him and to induce him to give up his occupation, an indoor one with dusty air. There was a constant tendency to high blood pressure, and I explained the danger of 'bursting the boiler,' but he continued until he 'burst a pipe,' that is, there was a break of a small blood-vessel in the brain, resulting in slight apoplexy. The break occurred in the speech center and temporarily rendered him speechless; fortunately the effects passed off in a day or two. This was a warning which he heeded; shortly after he abandoned his occupation and lived out of doors. But he could not live indefinitely without work, and in a 'spitter's town' the number of occupations attended by good air conditions are limited. He finally obtained employment in a hospital, as attendant. Here the air conditions are good and now he is getting along very well—as I had predicted.

One can of course see that when an individual has spent years and

years under an unfavorable environment, structural changes may have been produced—we need only think of inflammatory processes followed by the formation of scar tissue—and that the outlook for a long life is not as favorable as in the case of a young person who gets out in time and before many organic changes have occurred or much scar tissue formed. In this case, it is not so much a matter of living a long life as it is of the subsidence of chronic illhealth and the ability to do a 'fair day's work,' to make a living instead of being dependent on charity.

It will be noticed that this biography is in several sections:

1. An outline of his life, by years, in the form of a chart.
2. A detailed statement up to the time he came to me, in loose sheets.
3. A statement of his observations since he has been with me. It

will be observed that all are autobiographic—that is, written by the individual; they were given me in the belief that his experience might be of benefit to others.<sup>1</sup>

4. My own observations briefly summarized and charted, with sphygmograms here and there showing circulatory conditions. In the light of other cases, one can predict that this individual will, in all probability, ultimately die from heart and renal trouble. In a general way, one can divide men into two groups, high pressure and low pressure; each group has certain symptoms.

BIOGRAPHY D. It is only occasionally that one is able to get a complete life-history, that is, from beginning to end. I shall show one of this kind. The long sheet gives an outline of incidents, arranged by years (of factors which the individual, more or less conversant with the subject of dust infection, considered of sufficient importance to be noted). The details that I asked for concerning certain factors, incidences and occurrences, are given in these notes (shown). This individual was with me for only a short time, barely long enough to study her history and condition. She died some time later after having been under observation of two non-resident physicians. The influence of environment crops out all through this history, or strictly speaking, biography. The influence of life in the large city or in the country can be clearly traced. One environmental influence may be especially mentioned: This individual went to Korea as a medical missionary and there contracted a tropical disease from which she ultimately perished. One can readily see that had

---

<sup>1</sup>The number of individuals who will allow the history of their lives to be used, as here presented, is rather limited—it takes the "missionary spirit" to do that.



she not gone into the environment under which foreign diseases flourish, she would not have contracted such a disease. Missionaries are a self-sacrificing class of individuals; popularly it is often believed that they break down on account of overwork, but one can look at it from the standpoint of a change of environment—and this may lead us to critically study a case of overwork in our midst; perhaps after all it is simply the influence of environment. It may not be so much a question of the amount of work done as where the work is done. One may seriously question whether our school children break down from 'overwork'—perhaps the defenses of the body in fighting off infection, bad air, are overworked.

To study the life-history of any one case is a task of magnitude. There are many details, and the more factors one considers, the greater the number of details that have to be studied. An individual in chronic ill-health may complain constantly; all his symptoms and all his complaints have a cause; they must have a cause. To what extent can or does the student physician take up such details?

There are few physicians who have many patients whose lives they can study from beginning to end—and to study a long life is wholly beyond a single man's opportunity, because the physician, the student, is already well advanced in years before he has the requisite knowledge to make such a study. He must begin with the individual at birth, and if the latter has a long span of life, the physician will be dead long before his patient. To properly study the subject requires co-operation of many men.

Biography is valuable chiefly in that it teaches us how to conduct our own life, that is, we can profit by the experience of others. Moralists like Samuel Smiles will take a biography and from it teach certain lessons (Prudence; Self-help; Industry; Forethought; Self-reliance; etc.), but the idea that the illhealth or sickness of a man may teach us how to avoid similar experiences has scarcely been considered and to the best of my knowledge not at all in the light of good and bad air conditions.

Many biographies contain so few references to health and illhealth and disease that one might come to the conclusion that these were things not worth mentioning; very few are satisfactory to the student. Personally I have never met one that gave all the details I wanted.

The individual who is influenced by his environment manifests certain symptoms. Some of these symptoms can be grouped, and one can speak of types. Some part of the body or some organ may show the reaction in

a marked manner, and in this way determine the type. Thus, one can speak of a respiratory type of dust infection, of a gastric type, of a nervous type, etc. In some there is no localization; the body as a whole reacts. There may be a large number of symptoms and yet there is nothing definite that would enable one to speak of disease. It would appear that the body is really 'healthy' but is simply reacting to the abnormal environment, and the moment the environment is changed, the symptoms disappear.

---

I have made a search through biographies relating to Indiana people for a good example of the influences of environment. I found only one biography that is sufficiently full to enable one to trace such influences, but as I am in search of further data, I shall not take this up at present. Instead I will take up the Life and Letters of Huxley.

Thomas H. Huxley. The life of a man like Huxley or Darwin can be written from many different standpoints. If the biographer is a naturalist, he can bring in the development of Natural History that has taken place throughout the long life of such a man and the prominent part he took in it. If an evolutionist were to write the life, he would likely treat it from the standpoint of the development of the theory of evolution in which Huxley took such an aggressive part. The geologist, the paleontologist, the ichthyologist, etc., each would find material enough to write a work that would be of interest to the specialist. The physician likewise finds material enough to write what may be called a medical biography, of special interest to physicians, and more especially because Huxley began life as a physician and throughout his long life was associated with medical schools and with the best medical men of England. An individual in chronic illhealth can learn much by carefully studying Huxley's Life and Letters, on account of the many references to chronic illhealth. Such a study may enable him to avoid many of the common symptoms of illhealth, or at least to reduce them to a minimum.

Huxley reacted strongly to his environment, and to understand this one must study the lives of people living today who react in a similar manner. Analogy enables us to bring together cases of the same type. In studying the life of a man no longer living, one is in the position of the paleontologist who studies the fossil remains and thereby is enabled to more or less accurately reconstruct for us a picture of the thing that once was living, as already mentioned. According as a biography contains many references to illhealth conditions, one is enabled to more or less fully

understand the nature of the illhealth—which may not have been thoroughly understood during the life of the individual.

Huxley was a voluminous writer along many lines, chiefly, as most of you know, on biological subjects. Beginning with papers on certain groups of animals, he gradually branched out to include man, not only from a biological and anthropological standpoint, but also from that of biography; to understand his many-sided mind, one has to read his various volumes.

To the student of dust influences there is likewise much of interest, not so much in his technical writings as in his biography. Although Huxley realized the general influence of environment, he seemed not to have realized the influence of dust conditions, of coniotics. One can readily see how such a gifted man might have avoided much illhealth, and perhaps have lived many years longer, by having such a knowledge.

Huxley was eminently sane in his views regarding man's position in the universe; unfortunately for medical science, he did not follow medicine closely. He distributed his mind among many fields of inquiry, some of which have only remote relationship to medicine.

At the time when he was actively engaged in the practice of medicine, there was little science compared to what is found today; it was before the days of cellular pathology and bacteriology. Conditions were such as to create disgust in a scientific mind like that of Huxley, and so it is very natural that he should have drifted away from the practice of medicine and become a teacher of some of the sciences on which medicine rests, notably anatomy and physiology.

Although cellular pathology arose during Huxley's lifetime, yet he never took it up. It is an exemplification of the saying, "You can't teach an old dog new tricks," and when a man's eyesight begins to fail on account of age, the days for close microscopic study are past. Unless one studies pathology and bacteriology in the laboratory, makes his own cultures and examines them, one's knowledge is not apt to be thorough and the difficulties of working out certain problems are not realized, and, on the other hand, the brilliant results obtained by some men cannot be fully appreciated. It is only the student who works 'in a practical manner' who gets the best insight, assuming of course that he has the mental capacity also to reason on the 'imaginary or theoretical side,' to form theories and then attempt to verify them.

Huxley did not understand the influence of air conditions. At one

time we hear him exclaim, "I do wish I could sometimes ascertain the exact *juste milieu* of work which will suit, not my head or will, *these* can't have too much; but my absurd stomach." (Life and Letters, Vol. I, p. 131). Herbert Spencer voices the same sentiment when he says, "I want a keeper to be always taking care that I do not overstep the limits on one side or the other \* \* \*."

We need not be surprised that Huxley and men of his type did not understand the influence of air conditions, when we consider that the best medical men, active practitioners of medicine, did not understand it. The two most eminent physicians contemporary with Huxley were undoubtedly Dr. Andrew Clark and Dr. Henry Thompson. These men were constantly sending their patients away from London. Dr. Clark used to say, "What you need is rest, pure air, cheerful companions, simple diet, and no end of out-doors." They got results, patients improved, but they did not press their inquiry and seek the reason why. One can of course readily excuse them for the same reason upon which Huxley must be excused—They began work before the days of cellular pathology and bacteriology and did not take it up in their old days. Perhaps needless to say a knowledge of pathology and etiology is one of the absolute essentials in studying dust infection.

Huxley had a rural ancestry and that means that there had not been an active weeding out through urban influences. When he first came to London as a young man he seems to have gotten along fairly well, but in time there was a greater and greater susceptibility to unsanitary urban conditions and he reacted to his environment. He lived in the West End where air conditions are good, and lectured at Kensington, which, as some of you know, is situated half way into the heart of the city. At first he could lecture several hours a day without difficulty, but after a time he complained that he could only bear one hour and that two hours 'does him up.' Still later he was not able to do even an hour's work under bad air conditions, but when he removed from the city and went to the South Shore, he was again able to do an almost unlimited amount of work.

SYMPTOM NAMES. (Chart with all symptom names grouped was shown.) In looking over this formidable list of names, a few facts stand out.

1. There is only one name that refers to a definite disease, that is, a disease with a specific cause: Influenza.

2. Many of the names are very indefinite, or, one might say, they are just as definite as the conditions to which they refer, and where a thing is indefinite, one naturally cannot expect a definite name.

3. There was no 'organic disease' (until the very end), and some of the names and expressions used were later on found to be erroneous. Take, for instance, the terms relating to the heart, 'dilatation,' and 'enlargement.' The diagnosis was made at a time when Huxley was feeling bad and he was therefore sent to Switzerland. But he began to feel better almost as soon as he got into the good mountain air—and then he began to climb the mountains. Offhand, one would be inclined to say that that was a very foolhardy act, because he might have fallen off the mountain, or dropped into a crevice, and no one would have known what had become of him; but he felt he could climb, and he did climb higher and higher day after day. Then one of the English physicians made him a visit and naturally examined him. Huxley says, "H. Thompson treats the notion that I ever had a dilated heart with scorn!" and then adds, "Oh these doctors; they are worse than theologians." But when he returned to England his old complaint came back. Evidently, however, he had the satisfaction of knowing that he did not have organic heart disease.

With increasing years there was an increasing reaction to an unsanitary environment, he could spend less and less time in the crowded city, finally he had to leave altogether. One wonders why Huxley did not leave the enervating city life and retire to the good air of the country, as did Darwin.<sup>1</sup>

What do we mean by health and illhealth and disease? A man may complain of illhealth and yet not be diseased. As a matter of fact, we constantly meet people who look the picture of health, but on studying them we find that they are always suffering, yet on account of their 'healthy' appearance, they get no sympathy when they do complain, and so many do not complain—only to the physician who critically studies conditions.

Many of these individuals are simply out of harmony with their environment. If we take a native of the torrid zone and put him in the frigid zone, we would likely find him complaining constantly of the in-

---

<sup>1</sup>Charles Darwin reacted to his environment, after the manner of Huxley. Some of you may recall my paper before this Academy several years ago in which I aimed to bring out this point. But Darwin lived in isolation and came little in contact with sick people, and his symptoms are even less well defined, although he complains almost constantly and loses much time. Getting a lot of old books from the city and reading them while reclining on a couch are among the important factors in Darwin's ill health.

fluence of cold, of a condition to which he was not accustomed and perhaps wholly unadapted. If, on the other hand, we take an inhabitant of the frigid zone and put him in a warm country, we would in all probability find another series of complaints. In the temperate zone where there is an alteration of heat and cold, one might say six months of tropical life and six months of arctic life, many individuals cannot adapt themselves to this semi-annual change, and as a consequence they suffer.

Again, the individual who has been brought up on plain, substantial food in the country, free from all infectious matter, may complain greatly if confined to the food obtained in the city, which has passed through many hands. The milk which so well agreed with him in the country may be a veritable poison to him in the city; even the drinking-water may disagree.

We see this again illustrated in the matter of air conditions. The man who has always lived under good air conditions, and whose ancestors have lived under such conditions, may complain greatly on removal to a dirty city where the air is loaded with dust derived from different sources, partly from the bodies of those who are diseased. Such an individual may have a sound body and may have sound health under his proper environment, but he may complain in the city simply because his body reacts to the abnormal environment. Thus, if he inhales much dust, there may be cough—nature's way of getting rid of offending material. The dust may set up a profuse flow of mucus, resulting in so-called catarrh—and yet this may be simply a natural reaction of the body in protecting the respiratory organs and in getting rid of the inhaled dust particles, which are brought up with the mucus in the process of coughing and hawking. Various pains may come on, yet they are to be looked upon as warnings from nature—to change the environment. When an individual does change and finds all these symptoms of illhealth (not of real disease) disappear, that ought to clearly indicate to him the conditions under which he should live. If he persists in living under the abnormal environment, we know what will happen: nature is constantly weeding out the unadapted—a process that has been going on for countless ages, and still continues. The doctrine of the Survival of the Fittest is a terrible reality from the standpoint of the biologist and physician.

One may come into a new environment and discover that there is a non-adaptation. The thoughtful man will see two courses open; first,

to modify his environment and make it fit to live in; second, to abandon the environment and go into a better one.

To what extent shall one make efforts to modify his environment, to improve it? How early or how late shall one abandon efforts? These are questions of varying importance in the life of all. There are many factors to be considered. With some it is an easy matter to 'pull up stakes,' as the race did in its pastoral stage. The very evolution of the race, from a wandering life to one anchored, so to speak, to a city environment makes it difficult for the average individual to leave the crowded city and go back to the more primitive country life. We need only read the pathetic letters of Mrs. Carlyle with her chronic illhealth in smoky London, but with good health in her old country home in Scotland. She evidently realized relationships and made many trips to and fro, but after being accustomed to London life and meeting congenial people, it was next to impossible to go back to the monotonous life in the country. We thus see that physically she needed one sort of environment, that of the pure air of the country; mentally she required the contact of kindred minds, to be found in the large city.

---

What we get out of a book depends largely on the interest with which we take it up and on our previous knowledge. We get out of it what we put in. A book in Greek or in Science will be understood by comparatively few, in contrast to the many who read and understand a popular novel; even 'problem novels' are not always understood. By observing a man turned loose in a large library one can arrive at certain conclusions.

A biography may be so simple that most any reader can understand it. The biography or life of a military man is full of descriptions of battles, best understood by old soldiers; the life of the musician is apt to be full of technical musical matters and best understood by musicians; the scientist best understands the biographies of men of science. The individual in chronic illhealth will likely be the most appreciative reader of the biography of a man who had chronic illhealth—and the physician who studies the subject from a biological standpoint will likely be the one who not only appreciates, but understands such a life and the influence of environment.

If I can induce some of you to read biography in the light of environmental influences, especially of such a man as Huxley, then I shall have accomplished all I had in mind in beginning this paper.





## FELKNER ISLAND, WABEE LAKE, KOSCIUSKO COUNTY, IND.

---

BY J. P. DOLAN.

Wabee Lake is in Kosciusko County, Ind., about one mile southeast of the town of Milford. A good description of its physical features is given by Prof. Blatchley (State Geological Report for 1900, pages 186-7). Quoting therefrom—"A small and very pretty island occurs in the southeast of the lake." When Profs. Ashley and Blatchley visited the lake, there was so little of the island above the water line that a title was deemed needless. However, the protracted drought of the past season has shrunk the lake away from the island, showing it to be of sufficient dignity to bear a title, temporarily at least.

"Felkner" is the name of its former owner and is associated with the best history and development of Milford and its environment.

The island at the highest point is six feet above the lake level and has a dry area of about one acre. It is destitute of vegetation save for a few tufts of stunted willows, a scraggy sycamore about five feet high, a small patch of Canada thistle numbering about twenty individuals, and five or six strong stalks of evening primrose besides a few species of grasses.

Its general appearance is that of a coarse, undisturbed gravel bed. There is no field of shallow water upon it. Its sides slope abruptly into water twenty-five to forty-five feet deep. One can stand at the water's edge and with an ordinary cane pole fish in deep water. This body of deep water extends almost to the shore on the north and west, while on the south and east it is found to be a few feet shallower. Taking a radius of five hundred feet and the island is surrounded by water forty feet deep. Thus Felkner Island is removed from shore influences.

In 1906 the Sandusky Portland Cement Company which is operating a cement mill at Syracuse, a town six and a half miles east, became the owners of the island. To satisfy themselves of the extent, character, and distribution of the marl and clay said to be found there, a careful survey was made of the lake, the island, and the adjoining marshes. The lake was cross-sectioned at intervals of 100 feet. At these several points

thorough tests were made measuring the depth of water, marl, muck, clay or other minerals that might appear. In making these tests a drill capable of being extended to forty feet was employed.

The general distribution of the marl and other minerals around the *shore of the lake and the territory adjoining* is reported in the Volume of Geol. Reports for 1900, fully and accurately.

The island, as far as could be determined, is a unit of granular marl. The 40-ft. drill failed to reach the bottom of the deposit at several places. The marl is accounted for by the presence of several strong springs at the west end of the island. One of them, about four inches in diameter, issuing at a point where the water was six inches deep, would push its way up intermittently so that one could see the disturbance at the surface standing a hundred feet away. These springs, doubtless have their origin in the clay and gravel hills near Dewart Lake three miles to the east and bring their burden of calcium carbonate from that rich field. This theory is borne out by the presence of a flowing well at the east end of the lake at an elevation thirty feet above the level of Wabee. It flows strongly through a two-inch pipe and reliable men of the town who tested its force say that it rose twelve feet above the present point of escape through a pipe of smaller diameter. It is known that Dewart Lake has an elevation of fifty-two feet above that of Wabee Lake.

The Mollusca found in the island deposit, below the upper portion thereof, are only a small fraction of the whole. This is all that distinguishes this island from the many other "beautiful" spots dotting the lakes of Northern Indiana, but it is a fine type of the island formed by springs. The Syracuse & Milford Railway transports the marl to the factory, delivering daily from four hundred to five hundred cubic yards. The small steel cars are loaded on the track by the dredging apparatus, an improved clam shell excavator having a 75-foot boom. Felkner Island will be loaded on the cars with the present dredging machine, pontoons being employed to carry up the train from the island to the shore.

Involved in this matter of removing the marl from the lake is the question of its effect upon the flora and fauna of the lake. This is a question which comes within the province of this association. If an answer is desired a biological survey of the lake should be made at an early date.

## A STRANGE NURSE.

---

BY A. J. BIGNEY.

---

On June 1, 1908, there was born on the farm of Will H. Sedam, near Moores Hill, Indiana, a litter of kittens, only one of which lived. The mother of these kittens died August 1. The surviving kitten began to try to nurse the sire. Soon milk began to flow a little and as the nursing continued the milk increased in its flow. The sire soon had two well developed nipples doing service. The kitten lagged a little in its growth for a while, but soon was in good condition and continued to do well. This is the first instance of the kind that has come under my observation.



THE SHAKE DANCE OF THE QUILENTE INDIANS, WITH DRAW-  
ING BY AN INDIAN PUPIL OF THE QUILENTE DAY SCHOOL.

---

BY ALBERT B. REAGAN.

---

In this dance the Indians worship Jesus, calling Him Jesus-Man, confounding him with Kwatte, their god. This religious movement began in the early eighties. It is a compromise between the old Indian worship and Christianity. The former having been forbidden by the government, the Shaker "church" was organized so that the Indians could still have their performances under the constitutional rights granted to all religious denominations. And in this they have entirely won, for Judge James Wickersham, of Tacoma, Wash., fought the Shaker Church case through the courts and obtained for the aborigines the right to worship God according to the dictates of their own conscience.

The movement began on the Big Skookum River, near Shelton, Wash., in 1882. An Indian, John Slocum, was very sick and was unconscious for several days. Regaining consciousness, coming back to "life" again as the Indians say, he said he had been dead and in heaven, but that the keeper of that blissful place had told him that he was a bad Indian and that he would have to go to hell. But one more chance would be given him. If he would go back to earth, lead a good life and teach other Indians to do the same, he would in time be admitted into the happy hunting ground. He at once began to preach the Shaker doctrine, exhibiting the power conferred upon him by those above in a vigorous shaking and quivering of all the muscles of his whole body. And all his followers exhibit their power the same way to this day.

They have candles and usually a cross. They begin their services with a prayer and close them with a "doxology." The Shaker dancing ceremony which usually lasts for hours is a hypnotic performance.

The watchword of the organization is: "Do good to those who do good to you and get 'even' with those who mistreat you." And the guiding prayer "Our God is in heaven. If we die He will take our life to heaven. Help us so that we shall not die. Wherever we are, help us not to die. Our Father who is there, always have a good mind to us."



In the performance continuous hand bells are rung to the tune of the chant "Hi, hi, hi," etc. The dancers jump up and down to the time of the "music." The faces of all the actors become hideously distorted. The quivering, trembling, twisting, writhing hands, wave, whirl, gyrate in all directions till the scene reminds one much of the demons in the "inferno" dancing over a lost soul. And the simple-hearted Indians believe that in this performance they are worshipping the most high God.

Below is a copy of the Quilente Shaker organization, creed, etc., taken from the "Quilente Independent," the only paper in Washington published by an Indian (W. H. Hudson) :

#### PREAMBLE.

In order to form a more perfect union and to secure recognition of our rights under the Constitution of the United States, to worship God according to our conscience, We, the delegates, from the Shaker Sects of LaPush, in conference assembled, do hereby organize, ordain and establish the Shaker Church.

#### OBJECT.

Our object is to teach the Gospel of Jesus Christ, and to forward His Kingdom among the Indian race; to fight against the evils of intemperance, which we believe to be a detriment to the advancement of our race; to the pursuits of civilization and Christian living.

#### ARTICLES OF FAITH.

1. We believe in God the Father, Jesus Christ the Son, and the Holy Spirit, the Three in One.
2. We believe that the Shaker movement was a dispensation of Almighty God to His Indian Children, to the end that they may see with spiritual eyes, their evil ways, and to point our way to salvation through Jesus Christ the Son.
3. We believe that Jesus Christ has the power to forgive sins on earth.
4. We believe that God hears our prayers for the sick, and that if we pray and believe, He will heal us of our physical ailments.

#### COVENANT.

1. We promise to support the Church in all the ways that we can, spiritually and temporily.

2. We promise to accept the Shaker Religion, and hereby consecrate our time, our talents, our all to its maintenance.

3. We promise to abstain from use of all intoxicating liquors.

We, the members of this church, in view of the solemn promises you have made, do promise to help and sustain you in your efforts to live a better life.

4. We promise to pray for you, that God in His Infinite Goodness, may make you and us, worthy to walk in His footsteps, looking forward unto the day when we all stand before His Judgment Seat, equals with all men, and hear the words, "Come ye blessed of my Father, inherit the Kingdom prepared for you from the foundation of the world." Amen.



## PHOTOGRAPHIC OBSERVATIONS OF MOREHOUSE'S COMET.

---

BY W. A. COGSHALL.

---

Comet c 1908 was found on a plate taken at the Yerkes Observatory on September 1st and has been so situated as to allow observation from any point in the northern hemisphere for several hours each night.

Most of the comets, during the time they are visible to us, are in nearly the same direction from us as the sun, and so are seen only for a short time before sunset in the evening, or before sunrise in the early morning.

Comet c had a high northern declination when found, and afterward passed within about 16 degrees of the north pole of the sky, so that during this time it was visible all night. As a result continuous records were secured through several hours, from the time it became dark in Europe till daylight in California.

These records show beyond doubt what has been indicated by several other comets—that the tail is composed of matter driven off by the action of the sun from the head of the comet, and that the velocity of motion of these particles in the tail is such that practically a new tail is formed each day.

While this comet was not very bright visually, it photographed very quickly, exposures of an hour with a short focus lens showing from 6 degrees to 10 degrees extension of tail, and it also showed unusual and sudden changes in the details of its tail.

The most prominent of these are shown in the accompanying photographs.

The first of these happened on September 30th. The photograph of September 29th shows nothing unusual in the appearance of the comet, but the next plate whose mid-exposure time was September 30th, 11 hours, shows a great change in the size, direction, and general character of the tail. This change began during the afternoon of September 30th, and by early morning following had produced the appearance shown in the plate of September 30th, 14 hours, 45 minutes.

The great cloud-like mass of tail moved away from the head of the comet at a rate of about 20 miles per second, and on the next evening

(See plate October 1st, 11 hours, 00 minutes) was at a considerable distance from the head, and connected with it by very faint and straight streamers.

On plate October 2d, 10 hours, 30 minutes, it is visible still farther away, and much fainter, and the new tail near the head of the comet, is beginning to assume its usual form.

The next great disturbance took place on October 15th. The night before, the comet was quite normal in appearance, as shown in plate October 14th, 10 hours, but on October 15th, 8 hours, a great puff or explosive action is shown.

On the next plate of the same night this is shown at a greater distance from the head, and of a little different form, measurement of the plates giving velocities as high as 70 miles per second.

The plate of November 15th, 6 hours, 15 minutes, shows the comet during the latter part of its time of visibility, and when it could be seen for only an hour or two before setting, and shows a great variety of detail in the streamers and condensation in the tail, all of which were invisible in any telescope, and were known only through photography.

About seventy-five plates of the comet were secured in all, and gave a fairly complete history of it from September 21st to December 1st.

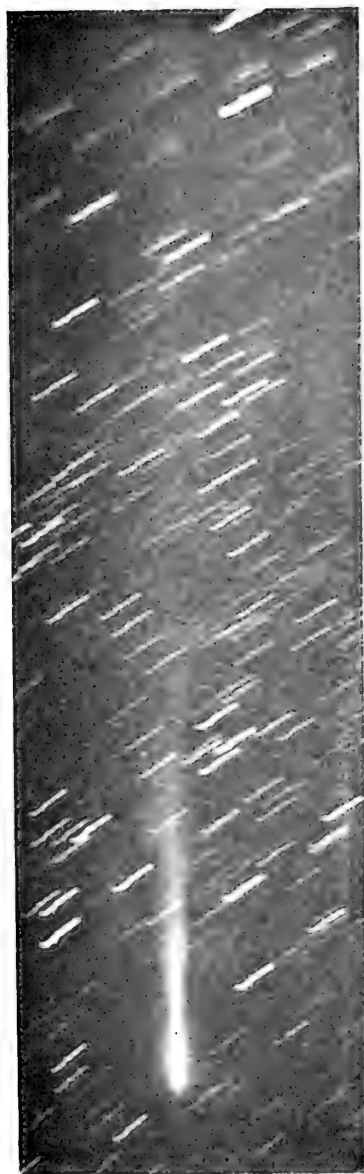

'08, Sept. 29, 9h 50m.



'08, Sept. 30, 11h 00m.



'08, Sept. 30, 11h. 5m.

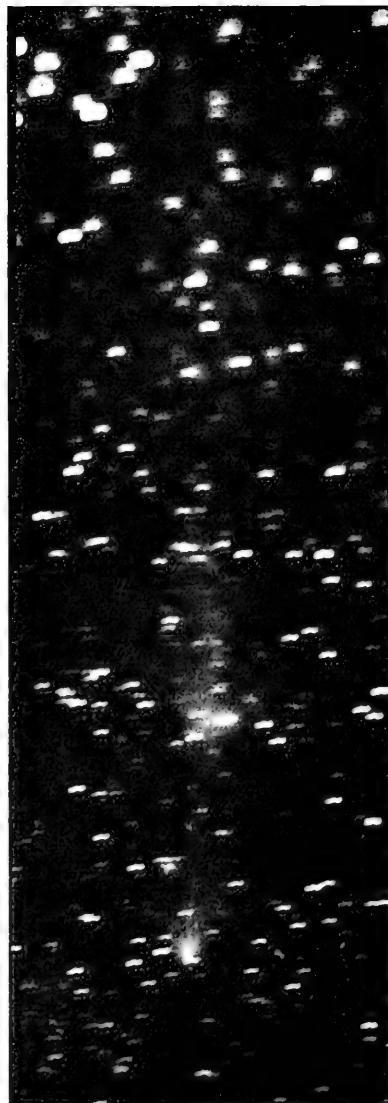

'08, Oct. 1, 11h. 00m.

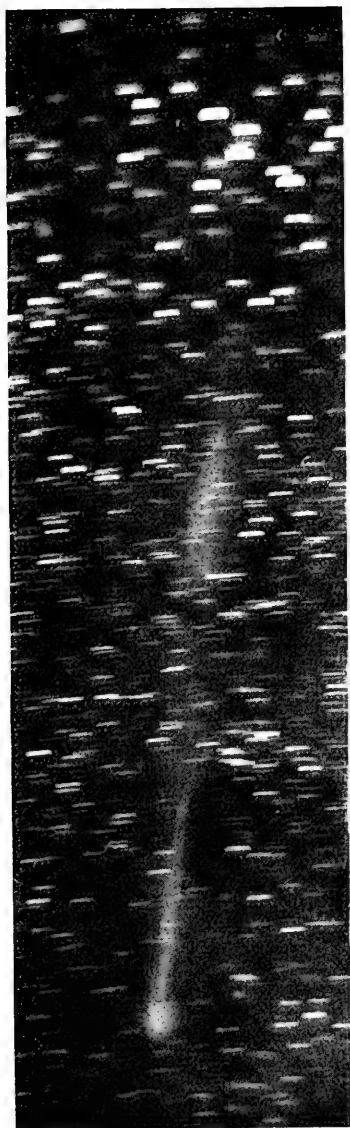

'08, Oct. 2, 10h 30m.



'08, Oct. 14, 10h 00m.

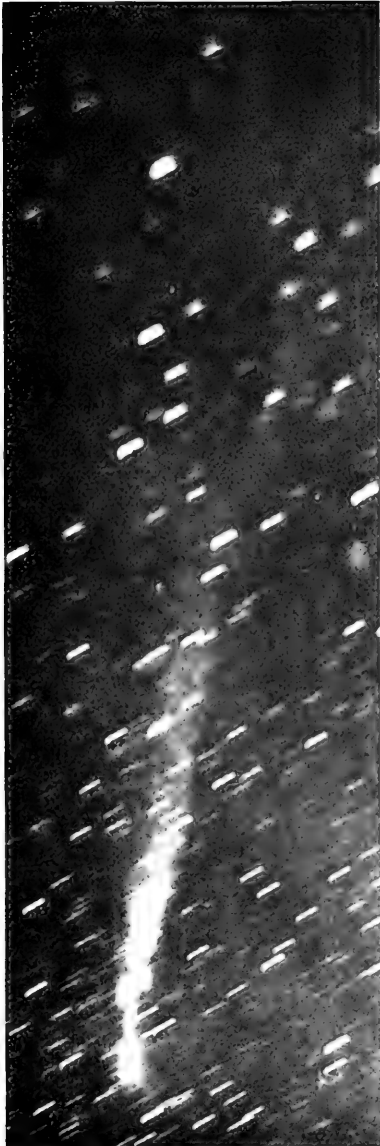

708, Oct. 15, 8h 00m.

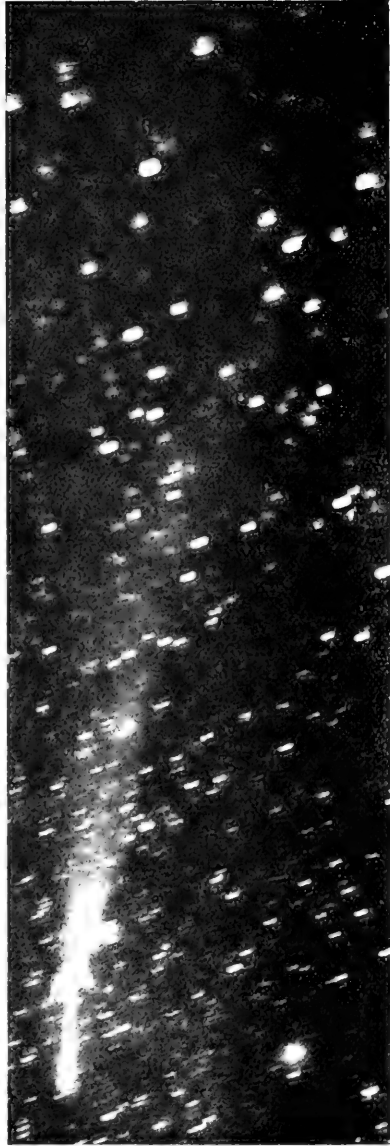

708, Oct. 15, 9h 35m.

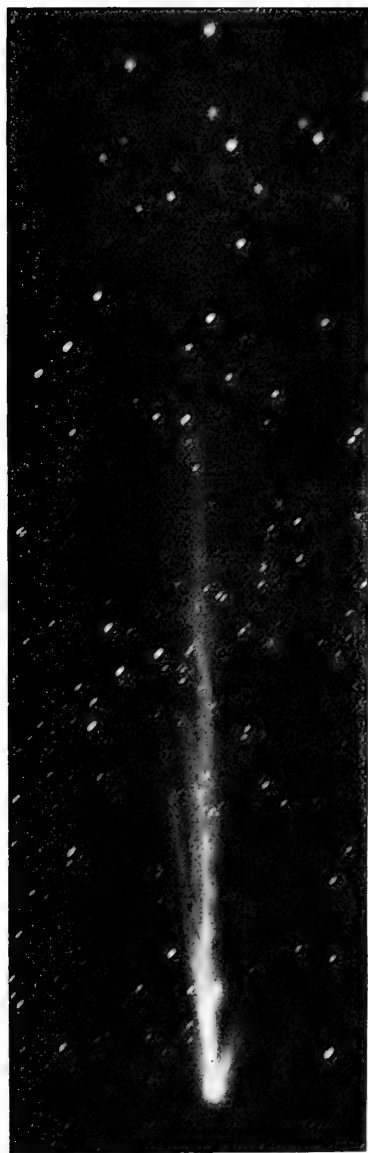

'08, Nov. 15, 6h 15m.





## FIELD OBSERVATIONS ON RUSTS FOR THE GENERAL BOTANIST.

---

BY J. C. ARTHUR.

(Abstract).

The polymorphic character of many species of rusts, together with the discontinuous growth between the forms of most of such species, and the further fact that some species live upon unlike hosts at different stages of their life cycle, make the study of the rusts unusually attractive for those who enjoy a varied problem. A very important part of the field observation consists in later visits to the spot where a rust has been found in order to ascertain if it is followed by another form of the same species either on the same host or on a host of some other kind. In either case, but especially the latter, a suitable specimen of the rust may be taken to a locality where it does not occur and placed beside a healthy plant of the kind observed. It is then watched to see if the rust infects the healthy plant. If it does, the correctness of the inference from the first observation, that the two forms of rust found to succeed each other in the same locality belonged to the same species, is established. But if the healthy plant does not become infected, either the two forms found in the original locality belong to distinct species and only incidentally happen to follow one another, or else the sowing of the rust in the new locality was not well done. In either case further trials and observations are required. There are many variations to the inferential and deductive reasoning required to solve these problems, and to come to a conclusion repeated observations may be required extending over many months or even years.



## THE RUST OF TIMOTHY.

---

BY FRANK D. KERN.

---

(Abstract).

This paper discusses the importance of timothy rust, showing that it is seemingly increasing in distribution. The results of an investigation concerning its identity and nature are given, followed by a brief statement of what may be expected from it in the future.



## ON THE HETEROECIOUS PLANT RUSTS OF INDIANA.

BY AARON G. JOHNSON.

In the study of any organism, a knowledge of its life history is one of the things of first interest. Particularly is this true in the study of the heteroecious plant rusts, exhibiting, as they do, alternating phases on entirely different host plants. The complexity, which these plant parasites present, adds varied interest to their study, although the same complexity offers abundant obstacles in determining the connection of the various forms.

It is the purpose of this paper briefly to show what has been done in the way of connecting forms represented in the State, and what remains to be done in this particular line. In presenting the unattached forms, particularly the unattached aecia, it is hoped to help engage the interest of others in assisting in any way possible in properly connecting up these forms. The three lists given below show respectively the connected forms, with the authorities and dates of connection for each species, the unattached telial forms, and lastly the unattached aecial forms. The first two tables are based on Dr. Arthur's Revised List of Indiana Plant Rusts (Proc. Ind. Acad. Sci. for 1903.) For convenience, the familiar genus names *Uromyces* and *Puccinia* are used, the species names, as far as possible, being revised to date. The third table is based on specimens in Dr. Arthur's herbarium, as are also the aecial forms appearing in the first table which have been connected up since the presentation of Dr. Arthur's list. For host names Britton's Manual (2nd. Ed.) is followed. The sincere gratitude of the writer is here expressed to Prof. J. C. Arthur for access to his very valuable herbarium as well as to his extensive library. Most able assistance was also given throughout by both Dr. Arthur and Mr. F. D. Kern, for which the writer is very greatly obliged.

The life histories of thirty-four species of heteroecious rusts represented in Indiana are now known. The aecial stage, however, of nine of this number is not known to occur within the State. In some cases

it may have been missed by collectors, as on *Larix*, for example, and may subsequently be found; in others, however, it is doubtful if the aecial stage occurs here. In this case the species doubtless depends entirely upon its urediniospores for reinfection of its host from year to year. Such, for instance, is no doubt the case with the *Poa* rust (*P. epiphylla*) and the leaf rust of cereals and certain grasses (*P. Rubigo-vera*).

In view of these facts it seems very doubtful that all of the sixteen still unattached telial forms in the State have their respective aecia here. In the first place, only nine unattached aecia are reported for the State, though others may occur. In the second place, and apparently much the better reason for the inference, of the thirty-four connected-up species previously mentioned, only twenty-five have their aecial forms reported for the State, while all of the connected-up aecial forms reported for the State have their telial forms here also. This latter being very natural to suppose for the teliospores are not readily transported by the wind or otherwise, and the sporidia, which give the aecial infection, are very perishable and entirely incapable of being blown very great distances and still remain viable. Hence there seems little if any question but that some unattached telial forms come into the State by uredinial infections, and are thus kept up through the season and possibly even from season to season in some cases. The aecia belonging to such forms may, therefore, be far distant.

This condition, then, centers our interest in connecting unattached forms, largely on the unattached aecia. For of necessity, their respective alternate forms must be somewhere in the immediate vicinity of their occurrence, except in the few cases where the aecial mycelium is perennial, in which cases the forms may become somewhat separated. By carefully searching for and finding unattached telial forms, especially near where the unattached aecia occur in abundance, clues may often be obtained that may ultimately lead to proof of the genetic relationship of such forms.

The tables are as follows:

## CONNECTED TELIAL AND AECIAL FORMS.

### EXPLANATION OF SYMBOLS USED.

\* Cultured in Europe.

\*\* Cultured in Europe, verified in America.

† Form not yet reported for Indiana.

†† Form not yet reported for America.

<p><i>Coleosporium Solidaginis</i> (Schw.) Thuem. (<i>Solidago</i> spp. &amp; <i>Aster</i> spp.)</p>	<p>†<i>Peridermium acicolum</i> Und. &amp; Earle (<i>Pinus rigida</i>)</p>	<p>Clinton 1906</p>
<p><i>Melampsora Medusae</i> Thuem. (<i>Populus</i> spp.)</p>	<p>††<i>Cacoma</i> sp. (1) (<i>Larix</i> sp.)</p>	<p>Arthur 1903</p>
<p><i>Melampsora Bigelovii</i> Thuem. (<i>Salix</i> spp.)</p>	<p>†<i>Caeoma</i> sp. (<i>Larix</i> spp.)</p>	<p>Arthur 1904</p>
<p><i>Melampsorium Betulae</i> (Schum.) Arth. (<i>Betula lutea</i>)</p>	<p>††<i>Peridermium Laricis</i> Arth. &amp; Kern (<i>Larix</i> sp.)</p>	<p>*Plowright 1890</p>
<p><i>Gymnosporangium Juniperi-virginianae</i> Schw. (<i>Juniperus Virginiana</i>)</p>	<p><i>Roestelia pyrata</i> Thaxt. (<i>Malus</i> spp. &amp; <i>Pyrus communis</i>)</p>	<p>Thaxter 1886</p>
<p><i>Gymnosporangium globosum</i> Farl. (<i>Juniperus Virginiana</i>)</p>	<p><i>Roestelia globosa</i> Farl. (<i>Crataegus</i> spp.)</p>	<p>Thaxter 1887</p>
<p><i>Uromyces acuminatus</i> Arth. (<i>Spartina cynosuroides</i>)</p>	<p>†<i>Accidium</i> sp. (2) (<i>Stictonema ciliatum</i>)</p>	<p>Arthur 1905</p>

1. Proven by cultures, not yet collected.

2. Connection not yet verified with Indiana material.

- Uromyces Solidagini-Caricis Arth.  
(Carex spp.)
- Uromyces Silphii (Syd.) Arth.  
(Juncus tenuis)
- Puccinia Sorghii Schw.  
(Zea Mays)
- Puccinia pustulata (Curt.) Arth.  
(Andropogon spp.)
- Puccinia Andropogi Schw.  
(Andropogon spp.)
- Puccinia Pammelii (Trel.) Arth.  
(Panicum virgatum)
- Puccinia Majanthae (Schum.) A. & H.  
(Phalaris arundinacea)
- Puccinia verbenicola (K. & S.) Arth.  
(Sporobolus longifolius)
- Puccinia Rhamni (Pers.) Wettst.  
(Avena sp. & Colamogrostis sp.)
- Puccinia Windsoriae Schw.  
(Triticopsis sesterioides)
- Aecidium sp.  
(Solidago spp.)
- Aecidium Silphii (Bur.) Syd.  
(Silphium perfoliatum)
- Aecidium oxalidis Thuem.  
(Oxalis cymosa)
- Aecidium pustulatum Curt.  
(Comandra umbellata)
- Aecidium Pentstemonis Schw.  
(Pentstemon hirsutus)
- Aecidium Pammelii Trel.  
(Euphorbia corollata)
- †Aecidium Majanthae Schum.  
(Salomonina & Vagnera)
- Aecidium verbenicola K. & S.  
(Verbena stricta)
- Aecidium Rhamni Pers.  
(Rhamnus lanceolata)
- Aecidium Pteleae B. & C.  
(Ptelea trifoliata)
- Arthur 1903
- Arthur 1906
- Arthur 1904
- Arthur 1903
- Arthur 1899
- Stuart 1901
- \*Sopitt 1889
- Arthur 1899
- \*\*DeBary 1865
- Arthur 1899



- Puccinia Eatoniae* Arth.  
(*Eatonia Pennsylvania*) Arthur 1903
- Puccinia epiphylla* (L.) Wettst.  
(*Poa pratensis*) \*Nielson 1876
- Puccinia Impatiensis* Arth.  
(*Elymus Virginicus*) Arthur 1902
- Puccinia poculiformis* (Jacq) Wettst.  
(Various grasses and grains) \*\*DeBary 1864
- Puccinia Rubigo-vera* (DC.) Wint.  
(Various grains) \*DeBary 1865
- Puccinia canaliculata* (Schw.) Lagerh.  
(*Cyperus strigosus*) Arthur 1905
- Puccinia Eleocharidis* Arth.  
(*Eleocharis palustris*) Arthur 1905
- Puccinia obtecta* Pk.  
(*Scirpus* sp.) Arthur 1907
- Puccinia angustata* Pk.  
(*Eriophorum* spp. & *Scirpus* spp.) Arthur 1899
- Aecidium Rannuculi* Schw.  
(*Rannuculus abortivus*)
- Aecidium Tussilaginis* Pers. (3)  
(*Petasites frigida*)
- Aecidium Impatiensis* Schw.  
(*Impatiens* spp.)
- Aecidium Berberidis* Pers.  
(*Berberis vulgaris*)
- ††*Aecidium asperifolii* Pers.  
(*Anchusa arvensis*)
- Aecidium Compositarum Xanthii* Burr.  
(*Xanthium Canadense*)
- Aecidium Compositarum Eupatorii* DeT.  
(*Eupatorium perfoliatum*)
- †*Aecidium Compositarum Bidentis* Burr.  
(*Bidens frondosa*)
- Aecidium Lycopi* Ger.  
(*Lycopus Americanus*)

3. Nielson, in his cultures, employed *Tussilago Farfara* L. which is the host of this not uncommon aecium in Europe. So far as is known to the writer, this aecium has not been collected on this host in North America, but the one on *Petasites frigida*, which seemingly is morphologically identical, has been collected by Piper in Alaska, and by Macoun on St. George's I., Behring Sea.

Puccinia albiperidica Arth. (Carex spp.)	Accidium albiperidum Arth. (Ribes spp.)	Arthur 1901
Puccinia Caricis-asteris Arth. (Carex spp.)	Accidium asterum Schw. (Aster spp.)	Arthur 1901
Puccinia Caricis-Erigonitis Arth. (Carex spp.)	Accidium erigeronatum Schw. (Erigeron spp.)	Arthur 1901
Puccinia Caricis-Solidaginis Arth. (Carex spp.)	Accidium Solidaginis Schw. (Solidago spp.)	Arthur 1902
Puccinia Sambucis (Schw.) Arth. (Carex spp.)	Accidium Sambuci Schw. (Sambucus canadensis)	Arthur 1901
Puccinia Peckii (DeT.) Kellerm. (Carex spp.)	Accidium Peckii DeToni (Onagra biennis)	Kellerman 1902
Puccinia Urticae (Schum.) Lagh. (Carex spp.)	Accidium Urticae Schum. (Urtica gracilis)	**Magnus 1872
Puccinia Polygoni-amphibii Pers. (Polygonum spp.)	Accidium sanguinolentum Lindr. (Geranium maculatum)	**Franzschel 1903

## SUMMARY.

	1864	1865	1872	1876	1886	1887	1889	1890	1899	1901	1902	1903	1904	1905	1906	1907	Total for Each Worker.
DeBary.....	1	2															3
Magnus.....		1															1
Nielson.....				1													1
Thaxter.....					1	1											2
Plowright.....								1									1
Sopitt.....							1										1
Arthur.....								4	4	2	4	2	3	1	1	1	21
Stuart.....									1								1
Kellerman.....										1							1
Tranzschel.....											1						1
Clinton.....															1		1
Total for each year	1	2	1	1	1	1	1	1	4	5	3	5	2	3	2	1	

## TELIAL FORMS WHOSE AECIAL CONNECTIONS ARE UNKNOWN.

<i>Coleosporium Ipomoeae</i> (Schw.) Burr.	on <i>Ipomoea pandurata</i> .
<i>Coleosporium Vernoniae</i> B. & C.	on <i>Vernonia</i> spp.
<i>Pucciniastrum Agrimoniae</i> (DC.) Diet.	on <i>Agrimonia</i> spp.
<i>Pucciniastrum Hydrangeae</i> (B. & C.) Arth.	on <i>Hydrangea arborescens</i> .
<i>Uromyces graminicola</i> Burr.	on <i>Panicum virgatum</i> .
<i>Uromyces Rynchosporae</i> Ellis	on <i>Rynchospora alba</i> .
<i>Uromyces perigynius</i> Halst.	on <i>Carex virescens</i> .
<i>Puccinia Ellisiana</i> Thuem.	on <i>Andropogon scoparius</i> .
<i>Puccinia emaculata</i> Schw.	on <i>Panicum capillare</i> .
<i>Puccinia Muhlenbergiae</i> A. & H.	on <i>Muhlenbergia</i> spp.
<i>Puccinia vexans</i> Farl.	on <i>Atheropogon curtispendus</i> .
<i>Puccinia Melicae</i> Syd.	on <i>Melica diffusa</i> .
<i>Puccinia apoerypta</i> E. & T.	on <i>Hystrix Hystrix</i> .
<i>Puccinia Dulichii</i> Syd.	on <i>Dulichium arundinaceum</i> .
<i>Puccinia vulpinoideis</i> D. & H.	on <i>Carex vulpinoidea</i> .
<i>Puccinia ludibunda</i> E. & E.	on <i>Carex sparganioides</i> .

## AECIAL FORMS WHOSE TELIAL CONNECTIONS ARE UNKNOWN.

<i>Accidium</i> sp.	on <i>Syn-desmon thalictroides</i> (Rue Anemone).
<i>Accidium</i> sp.	on <i>Anemone Virginiana</i> (Tall Anemone).
<i>Accidium Dicentrae</i> Trel.	on <i>Bicuculla cucullaria</i> (Dutchman's Breeches).
<i>Accidium</i> sp.	on <i>Euphorbia commutata</i> (Tinted Spurge).
<i>Accidium Napaeae</i> Arth.	on <i>Napaea dioica</i> (Glade Mallow).
<i>Accidium hydroideum</i> B. & C.	on <i>Dirca palustris</i> (Leather-wood).
<i>Accidium Polemonii</i> Pk.	on <i>Polemonium reptans</i> (Greek Valerian).
<i>Accidium Physalidis</i> Pk.	on <i>Physalis heterophylla</i> (Ground-cherry).
<i>Accidium Compositarum Ambrosiae</i> Burr.	on <i>Ambrosia trifida</i> (Great Ragweed).

## SOME ANOMALIES IN THE FEMALE GAMETOPHYTE OF PINUS.

---

BY D. M. MOTTIER.

---

The object of this note is to call attention to some peculiarities in the number and arrangement of archegonia and to certain other anomalies similar in character to those reported for the same and other species of *Pinus*. In her excellent and elaborate paper on the life history, etc., of *Pinus*, Miss Ferguson has directed attention to a number (9) of archegonia arranged along the top and sides of the endosperm of *Pinus montana uncinata*, together with other peculiarities regarding the number, origin and position in other species (Proc. Washington Acad. Sci., 6: 1-202, 1904).

In the work of a class of advanced students studying the gametophyte and embryogeny of *Pinus*, a number of peculiarities mentioned in the following have been found to be of rather frequent occurrence. In *Pinus austriaca* (a form of *P. laricio* frequently cultivated), several instances were observed in which a group of archegonia occurred at the chalazal end of the endosperm in addition to the group normally at the top or micropylar end. In addition to this a few cases were found in which a third group of archegonia was present at one side. Among those ovules in which a group of archegonia was present at either end, one case is especially of note in which a total of eleven archegonia was present, two near the micropylar and nine at the chalazal end of the gametophyte. The two near the micropylar end were not directly at the top but at opposite sides of that end. The nine at the chalazal end were arranged in groups of three each. One group of three was at the end, the others being more deeply seated. The second three were just beyond the first and a little to the right, while the third group was beyond the second, though somewhat to the left. In the majority of cases here under consideration the collections were made before the archegonia were mature, the ventral canal cells not having been formed. Four of the archegonia near the chalazal end had fused in pairs, a cytoplasmic union having taken place at the contiguous sides. This was made possible by the absorption of several sheath, or jacket, cells separating the archegonia. The three

groups were separated from each other by a layer of tissue from one to three cells in thickness. The central cells of two of the archegonia of the end group had fused at the outer ends only, although the sheath cells had entirely disappeared along the contiguous sides, leaving only a delicate line between the plasma membranes of the slightly shrunken cells. No nuclear fusions had taken place. Near each of these several archegonia one or more sheath cells had begun to bud out apparently to form archegonia as figured by Miss Ferguson (i.e., Fig. 265). In several preparations showing one or more of the anomalies herein mentioned, the enlargement of one or more of the sheath cells was of frequent occurrence. These enlarging cells possessed each a large nucleus and a dense cytoplasm, showing that they were being well nourished. In one ovule presenting a group of archegonia at each end of the endosperm, two large cells very poor in cytoplasm and about one-third the size of the normal archegonia lay between a normal archegonium and the end of the gametophyte at the chalazal extremity. From all appearances they had developed from sheath cells. They were not surrounded by jacket cells, hence their sparse cytoplasm.

Of this class of anomaly, namely, the presence of archegonia at opposite ends of the gametophyte, a few cases were observed in which there were *three* separate groups, one at each end and one at one side nearly midway between the extremities. In another instance the nucleus of the central cells had divided, the two daughter nuclei, which were well formed, lying in contact side by side. In this ovule all archegonia were immature; the ventral canal cells were not formed, and there was no fusion of the central cells. The two nuclei must, therefore, have been formed by the division of the nucleus of the central cell.

A second class of anomaly was observed in a single instance. It was the presence of a pollen tube containing supernumerary nuclei. This tube had grown down prematurely along one side of the endosperm and had just begun to indent the latter. The tube contained the two male nuclei surrounded by the cytoplasm of the body cell, together with about twelve other nuclei varying greatly in size. The largest of these nuclei were about the size of the male nuclei or larger. Their structural details were sharp and distinct; each contained a very distinct, but delicate, nuclear net with two or more relatively small nucleoli. In the same ovule another pollen tube had traversed about two-fifths of its way down through the nucellar tissue. In this ovule archegonia were present at each end

of the gametophyte. These organs were not mature; the adult size had not been attained nor were the ventral canal cells cut off.

A third kind of peculiarity was observed in two instances in which three archegonia formed a group at the geometrical center of the endosperm. There was no sheath layer between adjacent sides of their central cells, but on all other sides they were surrounded by the typical jacket layer. In one archegonium of this group a ventral canal cell was in process of formation; the other two were younger. No canal or opening leading to the surface of the gametophyte could be made out, neither were any necks distinguishable in connection with these nor with many other cases mentioned in preceding paragraphs.

A fourth peculiarity to be recorded is the premature arrival of the end of the pollen tube at the archegonium. In two different cases out of the material used the pollen tube had reached an archegonium in which the ventral canal cell had not been formed, nor had these organs attained their adult size. In one of these instances the tube had actually penetrated the archegonium, but had not discharged its contents.

Of the number of ovules of *Pinus austriaca* in the collection from which these anomalies were found, about one-tenth showed archegonia in either end of the endosperm. A few anomalies similar to those were observed in *Pinus virginiana*. In this paper the author has endeavored only to record the facts as observed, reserving a discussion of their probable significance until more data will have been collected.





NOTES ON THE NATIVE SEEDLESS PERSIMMON.  
(Preliminary Report.)

---

BY WILLIAM L. WOODBURN.

---

In the vicinity of Indiana University there are a number of persimmon trees (*Diospyros Virginiana L.*) which during the year 1908 bore large numbers of seedless fruits. No single tree, however, was found which bore only seedless berries, while four or five bore fruits nearly all of which contained seeds. The size of the seedless berries, their distribution on the tree, the time of ripening and their flavor as compared with those containing seeds was noted. A preliminary study of the embryology of the persimmon was also made. Entire ovaries were fixed in chromic-acetic acid and embedded in paraffin for sectioning, and later as the ovaries hardened ovules were similarly prepared. As later developments showed, the material was taken from a part of the tree which bore for the most part seedless berries, so that the development of the embryo was not observed. This led to a careful observation of the distribution of the seedless persimmons on the tree.

As the persimmons matured it was noted that the lowest branches of the tree from which the material was collected bore mostly seedless fruits, while somewhat higher were a few with seeds, and in the top of the tree the majority contained seeds. The seedless fruits on this tree were somewhat smaller than those containing seeds. Another tree younger than the one just mentioned bore throughout the branches berries with and without seeds, although more seedless below than above. On this latter tree there were many seedless fruits quite as large as the others.

The following questions naturally arise: Why did one tree produce persimmons on the lowest branches which were practically all seedless, while the majority on the upper part produced seeds? Did fertilization depend on the transfer of pollen from some other tree bearing only staminate flowers, since all the flowers examined contained sterile stamens, but these were from a part of the tree which bore only seedless berries? Or were there perfect flowers present which produced all the fruits containing

seeds? Is pollination necessary for the production of a well-flavored and good-sized fruit? Is the absence of mature seeds due only to the lack of fertilization?

In regard to the first question observations have been made which answer it only in part. At the time of flowering, which occurs about the last of May and the first of June, ovules were prepared for sectioning from the lower part of the first tree already referred to. No difference was noted among the flowers, although those in the upper part of the tree were not examined. The flowers from the lower part so far as noted bore a well-developed pistil but sterile stamens. Sections through the ovaries of these flowers showed occasionally a well developed embryo sac, but in some instances complete embryo sacs were not observed. Quite often the antipodal cells, part of the egg apparatus or the polar nuclei seemed to be lacking. Difficulties in staining due to the presence of tannin in certain parts of the ovary may have been responsible for this apparent condition. The polar nuclei were found several times in an early state of fusion, but further than this there were no evidences of endosperm or embryonal development in any part of the embryo sac. The contents disorganize and small aborted seeds which often occur seemed to be due merely to a slight growth of the integuments. There were no evidences noted of either fertilization or pollination having taken place.

As regards the transfer of pollen from staminate trees, the latter are not known to exist within three or four miles of the tree in question. Whether bees carry pollen to this tree from a distance has not been observed. If the tree bears in part perfect flowers, which has not yet been determined, this may account for the production of seeds in some fruits and not in others. The flowers so far as examined contained only sterile stamens. If no perfect flowers are present the question as to the absence of seeds being due to the lack of fertilization becomes of some import.

While the seedless berries on this tree were nearly all small, on a second tree seedless fruits were found quite as large as the others, the flavor in each case being quite as good if not better, since the seedless fruits as a rule have less of the astringent quality so characteristic of most persimmons until thoroughly ripe and which often persists even then. Whether the large size of the persimmon with seeds is due to the influence of fertilization or to some native quality of the pistillate flower has not been discovered.

The Industrialist (No. 20, March, 1904, Kansas State Agricultural

College) figures and describes imperfect staminate flowers as borne on separate trees from those bearing perfect flowers. Among the perfect flowers on the same tree are sometimes borne imperfect pistillate flowers. From the perfect flowers and the imperfect pistillate flowers similar fruits ripened, but no occurrence of seedless fruits was noted. Purdue University Agricultural Experiment Station Bulletin No. 60 reports two or three varieties of seedless persimmons which had been sent into the station.

A second tree already referred to bore mainly seedless fruits. In the upper part of the tree about 75% of the persimmons and in the lower part probably about 80% were seedless. Sometimes an entire picking (the fruits do not all ripen at the same time) would be seedless. These persimmons were excellently flavored, of a good size, and usually ripened earlier than those with seeds. The seedless, however, do not always ripen earlier, for some of the greenest on the tree, after ripening had begun, were found to be seedless. On the other hand, the earliest ripe were always seedless, one having been found on August 20th ripe and well flavored but rather small.



## TESTING SEED CORN BY SPECIFIC GRAVITY.

---

BY HERBERT A. DUNN.

---

The corn of our native Indians as found by the first settlers in this country was small in size and of an inferior quality. The white man realized the possibilities of this new corn and at once began to select and improve it. This has been a slow process, and more improvement has probably been made in the last generation than in all the years preceding. The average yield in the United States for the decade ending in 1875, according to J. W. T. Duvel, assistant in the seed laboratory, Bureau of Plant Industry, Washington, was 26.07 bushels per acre, and the yield for the decade ending in 1905 was 25.2 bushels; the largest yield in any one year was in 1906, 30.3 bushels per acre.

During the year 1907 practically one hundred million acres were planted in the United States, requiring sixteen and a half million bushels of seed. Observation has shown that 20% of this seed does not germinate, the chief reason for this being carelessness in selecting and caring for the seed corn.

The yield will depend on the vitality of the seed and on contingency of the weather and soil and cultivation. In years past corn has been planted with little thought of the type of grain and germinating power; often only a random test was made by the aid of a pocket knife. Experienced farmers say that this is a fairly good test but experiment stations rely on and advocate the germinating test. Both of these tests require much time.

Since the yield is largely dependent on the quality of the seed corn, a comparatively simple and efficient seed test is very desirable.

One day I accidentally dropped some kernels in a basin of water. I noticed that the majority of the kernels lay flat on the bottom, while some stood on end, and on examining the latter they were found to be shriveled on the germ end, or had blisters. This gave me an idea of using a specific gravity test, for it must be evident that by increasing the density of the solution the light kernels would rise to the top. The question arose: What should be added to the water that is both harmless and cheap? I

decided on glucose, one part of glucose to three of water, Sp. Gr. 1.21. In this mixture the light kernels came to the top. I thus had light and heavy kernels, and with these I experimented as follows:

*First Test.*—300 kernels were taken from every other row of an ear that tested “good” in the usual “seed box” germinating test: Lot 1, 300 kernels from the alternating rows were divided into two lots by the specific gravity test; lot 2 showed 258 heavy grains; lot 3, 42 light grains. (Lot 1 was not put in solution.) The vitality of these three lots was determined by testing in a box, under identical conditions.

GERMINATING RESULTS.

Lot 1 (300 grains).....	86% germinated
Lot 2 (heavy kernels).....	89% germinated
Lot 3 (light kernels).....	69% germinated

*Second Test.*—100 kernels were taken from an ear which showed a germinating test of 4 dead kernels and 1 weak out of 5 (the usual test number being 5). These kernels were separated by the specific gravity test and tested as before.

GERMINATING RESULTS.

Of the 68 heavy kernels.....	47% germinated
Of the 32 light kernels .....	15½% germinated

*Third Test.*—100 kernels were taken from two ears which showed “extra strong” in the germinating test. They were separated by the specific gravity test, which gave a high percentage of heavy kernels, and were tested under conditions similar to the above. (It will be noticed that the per cent of light kernels is quite small and that all germinated.)

GERMINATING RESULTS.

Heavy kernels (91).....	100% germinated
Light kernels (9).....	100% germinated

*Fourth Test.*—Two full rows were taken from 25 ears, in which all of the five test kernels had failed to germinate in the “box test.” This gave a total of 2,116 kernels. The specific gravity test showed 592 heavy and 1,524 light; these were tested as mentioned above.

GERMINATING RESULTS.

Of the 592 heavy kernels.....	54% germinated
Of the 1,524 light kernels.....	22% germinated

*Field Test.*—Out of 125 bushels of selected seed corn, I reselected enough to plant a thirty-acre field—from which in turn seed for the following year was to be selected, and the germinating test for each ear had to be high. Out of this reselected seed a sufficient amount was put through the specific gravity test until there were enough light kernels to plant a row of 80 rods. The test corresponded with test No. 3, that is, 90 per cent. of the kernels were heavy; all germinated. These light seed were planted in a row alongside of one of heavy; the rows were “checked” and ran east and west, the light row being on the south. Now as our prevailing winds are from the southwest, one can readily see how there might thus be a slight difference: the row of heavy kernels might be fertilized by pollen from the light kernels rather than the reverse.

There was no perceptible difference in the appearance of these two rows, but when a count of stalks was made in August, the heavy row showed an excess of 129. When ripe, the ears from each row were husked and weighed, and there was found to be a difference of 20 pounds in favor of the heavy row—equivalent to nearly three bushels to the acre.

My conclusions from these experiments are as follows:

1. To test seed corn by the germinating test is time-consuming and expensive, and requires great care.
2. Choosing five kernels to represent 600 to 1,000 others from an ear does not prove to be an infallible method. (Test 4.)
3. To test by specific gravity is simple, rapid, and inexpensive.
4. The specific gravity test enables one to eliminate the weak kernels in a simple and practical manner.
5. The crucial test, the field experiment, shows that the light grains should be discarded.





## NOTES ON THE FLORA OF CASS COUNTY.

BY ROBERT HESSLER.

(Abstract.)

This paper embraces a large collection of notes on the flora of Cass County, covering the years from 1894 to 1908, excepting the years 1898 and 1899, when the writer was away. The paper relates more particularly to plants which are not of general distribution in the State. The notes given under the different species of plants may be grouped as follows:

(a) Relating to plants, especially weeds, that have recently wandered in, particularly along the railways, either to maintain themselves and perhaps overrun the country, or, on the other hand, to lead a precarious existence for a year or two and then again disappear.

(b) Relating to plants that are apparently extinct or on the verge of extinction on account of the destruction of their natural habitats, as the cutting down of forests and bringing the ground into cultivation, or by simply thinning the trees to such an extent that shade-loving plants can no longer thrive. Moreover, with the thinning of the trees many weeds come in, also grasses, and they tend to crowd out the native plants. The draining of wet places, of swamps and bogs, has been going on actively in recent years and few such now remain in Cass County. There are fewer and fewer places where plants that were once common are now to be found, and it is only a matter of time until these, too, will lose their native flora. The old-time rail fence has furnished a home for many species, to which the wire fence gives no protection.

(c) Relating to plants that are undoubtedly native but which seem to come and go, being found in one locality for a year or a few years, and then disappear, to reappear in a distant locality and where they had not been seen before; that is, like people, they seem to be moving about—especially plants that are fond of moist soils; perhaps birds carry the seed.

(d) A lot of notes not fully worked up (for lack of time) relating to plants of interest on account of their medicinal or supposed medicinal value—either as “simples” or as real remedies used by the educated phy-

sician (a number are used by the patent and proprietary medicine men, with extravagant statements as to their value).

One can distinguish between: (1) Plants that have been brought in purposely, or which have come in accidentally, the ancient medical lore connected with them being continued; (2) Native plants to which old European lore has been transferred, often along with the old European names; (3) Native plants about which independent knowledge has been obtained (whether real or supposed is at times difficult to determine), that is, not based on old statements in European literature.

The writer wishes these notes to be considered as a contribution to the knowledge of the flora of Indiana, and as showing more particularly how old plants are disappearing and new ones coming in. The writer says:

"This is a subject that should be of interest to botanists everywhere, and especially to the amateur. To me it is certainly a great pleasure to get out occasionally and note the changes that are constantly going on—changes so gradual that few are aware of them at all. I have repeatedly seen a new plant, generally a weed, come in and within a few years become a feature of the landscape. We need only think of the White Sweet Clover, a rank plant, that in places, especially along country roadsides, has crowded out all other plants.

"In this connection I might refer to my paper on the Adventitious Plants of Fayette County, presented before this Academy in 1893, and on the Flora of Lakes Cicott and Maxinkuckee, in 1896; also to the many papers given before the Academy by men from all over the State. Such lists are useful for the purpose of making comparative studies.

"I hope some one will gather up all the available data and publish them for the benefit especially of high school students, many of whom can be led to interest themselves in this subject. It is not a difficult matter to become acquainted with one's local flora, and to detect new arrivals. Such information may also be of value to the farmer.

"In going over my notes, I realize the importance of making memoranda of observations at the time. There are some facts about the flora of Cass County that I thought I would always remember, but I now find that I am not sure about the presence or absence of certain plants, say twelve years ago, and in my list I have several times been compelled to refer to this. One may be reasonably sure about a fact, but unless one has notes, made at the time, there may always be some doubt.

"I would like to add another word, and that is, the value of the training derived in studying botany, in identifying plants, and in noting the changes going on. This training is of great value to the man who desires to become a physician. To differentiate many species (and we need only think of the Asters and Golden-rods) requires patience and close study—and the experience is of value to the physician, by helping him to make distinctions between diseases and states of ill health that appear as one to the careless observer.

"I may add that a number of photographs have been taken of native plants in localities or habitats that are now undergoing destruction, especially of swamps and bogs and wet woods. A few years more and the localities will be wholly altered, and with this alteration the flora will have disappeared; it will exist only in herbaria, in photographs, and in memory."



A NEW ANTHRACNOSE ATTACKING CERTAIN CEREALS AND  
GRASSES.

---

BY A. D. SELBY AND THOS. F. MANNS.

---

(Abstract.)

This paper states briefly the results of culture investigations of a fungus described as *Colletotrichum cereale*, n. sp. This has been found to be present over the State of Ohio, attacking the spikes, culms and sheaths of rye, the culms and sheaths of wheat, oats, chess, orchard-grass, timothy, red-top and blue-grass. Upon the cereals the attack is timed to the approaching maturity of the plant and produces marked shriveling of the grain. The behavior of the fungus on different media is stated, and different illustrations are included. It will be published in bulletin No. 203 of the Ohio Agricultural Experiment Station.



## THE DISSEMINATION OF DISEASE BY MEANS OF THE SEED OF THE HOST PLANT.

BY M. F. BARRUS.

(Abstract from thesis presented in June, 1908, at Wabash College, Crawfordsville, Indiana, for Eastman Biological Prize.)

It has been known for a long time that diseases can be spread by means of the seed of the host plant. As early as 1730 Jethro Tull recommended a change of seed to avoid smut. Since then the list of such diseases has steadily increased until now there is a large number of them.

A knowledge of the method by which infection of the seed takes place and of the subsequent growth of the parasite is of value, since it will reveal a vulnerable point of attack, if there be any, in seeking means of controlling the disease. It is the purpose of this paper to indicate briefly those diseases of cultivated plants which are disseminated by means of the seed of the host plant and to point out the method by which the seed becomes infected.

These diseases can be divided into two classes, those which infest the seed internally, i. e., the organism entering the maturing seed and existing within in a dormant condition until the germination of the seed; and those which infest the seed externally, i. e. the organism or its spores becoming attached to the surface of the seed and entering the host plant at the time it germinates. The diseases belonging to the former class are the Anthracnose of Beans, the Blight of Peas, the Loose Smut of Wheat and Barley, and possibly a few of the Rusts. Under the latter class may be included most of the Smuts, the Wilt of Flax, and probably some of the Rusts and a few Bacterial diseases.

### BEAN ANTHRACNOSE.

*Colletotrichum lindemuthianum* (Br. & Cav.) on *Phaseolus vulgaris*.

The fungus causing this disease survives the winter in the seed of the host plant. If the affected pods are allowed to ripen on the vines, the mycelium of the fungus penetrates further and further, eventually entering the seeds, usually causing them to become spotted (Figs. 1 and 2). Here

the mycelium remains in a more or less dormant state until conditions are favorable for the germination of the bean seed, when it renews its activity.

An examination of a diseased seed will reveal an abundance of mycelium in the infected portions. By carefully treating the seed with hot water or formalin to rid them of surface fungi and placing them in a sterile moist chamber, one is able to obtain spores in great profusion on the seed before it has germinated and later on the cotyledons, stems and leaves of the seedling in the sunken and discolored cankers caused by the fungus. Dr. Halstead reports that he has found spores of the Anthracnose on the dry beans, especially in the cavity between the cotyledons.<sup>1</sup>

In the germinating plant, no doubt the plumule is often infected by contact with the diseased portions of the cotyledons. (Fig. 3.) Spores, however, are produced upon the cotyledons after the bean has expanded its true leaves and when released by the dissolution of the mucilaginous matrix they are washed to the ground or on the stems below. The stems become infected from these spores and cankers are formed at the infected places. Often these cankers encircle the stem and thus cut off the supply for the leaves above. Sixty-one German Wax Beans apparently healthy were planted in the greenhouse. When well up five were observed which had infected cotyledons, the others appearing healthy. Seventeen days after planting thirty-one of the plants were affected by the disease at the base of their stems, showing, doubtless, that spores from the cotyledons of the five plants had infected the stems of the others. (Fig. 4.)

When the plants are moist the spores of the fungus are in a condition to be easily disseminated, so that working among the plants at this time or otherwise disturbing them aids in the dissemination of the fungus if any diseased plants are present. Even the wind aids dissemination by scattering contaminated drops of water to healthy plants, or by blowing the plants against each other. In this way the disease spreads to the leaves, stems and pods of the plant during the growing season.

The selection of seed from unaffected pods seems at present to be the most satisfactory method to pursue in controlling the disease. The pods should be selected in the field and only such as are perfectly free from all evidence of disease should be selected. Apparently healthy beans within an infected pod may harbor the mycelium of the fungus without showing any evidence of it. Enough seed can be selected in this way to plant small patches. Those who grow large areas should select enough beans to plant

---

1. Halstead, B. D., The Anthracnose of the Bean. A Remedy Suggested. Ann. Rept. N. J. Agr. Exp. Sta. 1891, p. 284.



half an acre and use the beans from this seed-patch for subsequent plantings. By careful selection after this manner each year the disease can be controlled to a profitable extent.

#### SUNSCALD OF PEA.

*Ascochyta pisi* Libert. on *Pisum sativum*.

During the summer of 1907, my attention was called to this disease affecting the garden pea. As observed at this time, the leaves, stems and pods were badly spotted. (Fig. 5.) The spots on the pods were not confined to the surface alone, but in many cases extended entirely through the pod, as was evident from the fact that spots were found exactly opposite those on the other side and the seed between the affected portions was discolored or distinctly spotted by the disease. I gathered a number of the diseased pods of both early and late varieties and planted twenty-three seeds of each variety in the greenhouse during the winter following. Several seeds of the late variety were distinctly spotted. All of the early variety germinated and thirteen of the late variety. Those that did not germinate were found to be decayed. Soon after they came up, nearly all of the plants died. Usually the stem near the base withered and turned brown, resulting in the death of the young plant.

Five of the forty-six planted lived and produced pods. Even the lower leaves of these withered and dropped off, giving the plant a very straggling appearance. No spots such as were observed on the plants grown in the garden were to be seen, contrary to my expectation, but from the description of the disease given by others,<sup>1</sup> the trouble was undoubtedly due to *Ascochyta*.

Kruger, a German mycologist, found that if diseased seed was soaked in water from forty-eight to seventy-two hours, the mycelium of the fungus would completely encircle it, and grow out into the water, forming a white mass of radiating threads. Van Hook verified this statement and also found that if the diseased pea seed were placed in a germinator for a few days a heavy coat of white mold would be formed about them in which, if seed were removed to a covered dish with less moisture, numerous reddish-brown pycnidia would be formed.<sup>2</sup> These pycnidia were produced by the mycelium of the fungus which had lain dormant in the seed since its maturity. When the conditions were right for the germination of the seed the fungus renewed its growth. The mycelium grows within the stem con-

1. H. G. Howell, J. M. Van Hook.

2. Van Hook, J. M., Blighting of Field and Garden Peas. Ohio Bul. 173, 1906.

currently with the growth of the plant, causing lesions at its base and a withering of its lower leaves, and often its death before or soon after its appearance. Probably the embryo is affected by the fungus in most cases where the seeds do not germinate. The spores exuded from the lesions on the stems, leaves and pods are scattered by the wind and other agents, and infect healthy plants. If the spotted pods are left upon the vines until the seeds are mature the mycelium penetrates some of these seeds, which thus carry the fungus over the winter, making this an important means for the dissemination of the parasite.

Seed treatment has not been very effective in controlling this disease which, fortunately, with the exception of an occasional epidemic, is not very destructive. Rotation of crops is one method usually recommended.

#### LOOSE SMUT OF WHEAT.

*Ustilago tritici* (Per.) Jens. on *Triticum vulgare*.

It was formerly thought that the spores of this fungus became attached to the coat of the healthy seed and germinated at the time of the germination of the seed, infection threads from the promycelium penetrating the first leaf-sheath, as is the case with stinking smut. But later investigations have made quite certain that the germinating spore infects the pistil of the healthy wheat at flowering time, the mycelium establishing itself within the ovary during its development and remaining dormant in the ripened seed until it had germinated, the mycelium then continuing its own development.<sup>1</sup> This fact explains why the results of seed treatment for this species have been negative to so large a degree.

During the latter part of June, 1907, I inoculated many wheat plants with the spores of *U. tritici* by dusting the young stigma with the spores. The stigma seemed to be most receptive when quite young. Records of inoculations were kept and heads gathered at varying intervals of time from date of inoculation. A pistil examined one day after inoculation showed that a number of spores adhered to the stigmas and that several had germinated. It was hoped that the point of infection would be observed and although the germ tubes of spores were seen directed toward the interior of the stigma, none were seen entering or within. Spores were also germinating on the surface of the ovary and it may be that the point of entrance is through the ovary coat. Of those seeds which were

1. Bredfeld and Falek, K., Flower Infection by Smuts. Untersuch. ges. Gebiet Mykol. 1905, No. 13. Abs. in Bot. Centbl. 101 (1906) No. 8: 212-213.

allowed to mature after being inoculated, thirty were planted in a box in the greenhouse on October 10th, 1907. On the 15th of May, 1908, the resulting wheat-plants had begun to head out. All the heads were more or less smutty. The majority of them were reduced to a mass of spores as is commonly observed in the field. In a few cases the ovary was the only part entirely destroyed, the outer portion being unaffected or only streaked with sori containing the spores. As the wheat plant develops the mycelium of the fungus grows upward probably much after the manner of the mycelium of the stinking smut. It enters the young head early in its formation and branches into numerous sporogenous hyphae, which completely destroy the pistil and other parts of the flower. These hyphae divide into a number of cells within each of which a chlamydospore is formed as in Oat Smut. The walls of the hyphae become gelatinous and later disappear, leaving the spores free. These dry on exposure to the air, forming a dusty mass so commonly observed at the flowering time of wheat. These spores are blown about by the wind and infect the ovaries of healthy heads, thus establishing the fungus for another year. (Fig. 6.)

#### NAKED SMUT OF BARLEY.

*Ustilago nuda* (Jens.) Kell. and Sw. on *Hordeum vulgare*.

This Smut is similar in methods of attack and in field characteristics to the Loose Smut of wheat. The head is reduced to a mass of spores which are scattered at the flowering time of barley. These spores infect the ovaries of the healthy plants in which the mycelium of the fungus develops until the seed is ripe, remaining throughout the winter in a dormant condition and continuing its growth concurrently with the growth of wheat after seed is planted.

#### THE STINKING SMUT OF WHEAT.

*Tilletia foetens* (B., & C.) Trelease and *T. Tritici* (Bjerk.) Wint. on *Triticum vulgare*.

*Tilletia foetens* has a spore with a perfectly smooth coat, while the epispore of *T. tritici* is much reticulated. Their method of infection and growth are similar.

The spores of these two smuts are scattered about at harvesting time or in some other way become attached to the healthy seed. When placed in a situation favorable for their germination they send out a short, thick promycelium and at its tip is borne a cluster of slender tapering sporidia

which conjugate in pairs. Infection threads are either produced by these sporidia capable of penetrating the host plant or, as is usually the case, secondary sickle-shaped sporidia are borne on short filaments and these sporidia produce infection threads. The formation of sporidia greatly increases the chances of the fungus to infect the host.

The infection of the wheat plant takes place soon after the germination of the grain and even before the first leaves are put forth. Hoffman believed that the infection threads can enter only the sheathing primary leaf or the collar between the root and stem while they are yet very young and delicate and concludes that anything which would hasten the growth of the young plant would tend to lessen the chances of infection.<sup>1</sup> Bolley believes that infection does not take place unless there is a large number of sporidia in close contact with the seedling during the infection period.<sup>2</sup> The mycelium after gaining entrance to the young plant pushes its way upward with the growth of the host, the older mycelium dying and its contents passing upward into the young advancing ends, and finally fruits in the ovaries by the production of chlamydo-spores from sporogenous hyphae that have developed abundantly in them. The Stinking Smut differs from the Loose Smut of Wheat in that the destruction is entirely confined to the ovary contents. The ovary coat is left intact, so that one would easily fail to recognize any infection unless he made particular observation or noticed the disagreeable odor characteristic of the fungus. The affected kernels are somewhat larger than healthy ones and this increase in size causes the florets to spread, making the head more open than a healthy one. When the kernels are cut open they are found to be filled with a mass of olive-brown spores of a greasy character.

#### THE LOOSE SMUT OF OATS.

*Ustilago avenae* (Pers.) Jens. and

#### THE HIDDEN SMUT OF OATS

*Ustilago levis* (Kell. & Sw.) Magnus on *Avena sativa*.

There are two distinctive species of oat smut called respectively the Loose and the Hidden Smut of Oats. Both are much alike in their methods of development and both succumb to the same method of treatment. *Ustilago avenae* is by far the commoner and is the one which causes the

1. Note from Kellerman and Swingle, Report on the Loose Smut of Cereals. 2d Ann. Rept. Kan. Exp. Sta. 1889, pp. 213-238.

2. Bolley, H. L., New Studies upon the Smuts of Wheat, Oats and Barley N. Dak. Bul. 27, 1897.

greatest damage of all grain smuts in the United States. The disease makes its appearance at the time of blossoming of the oat-plant, the whole head becoming a dusty olive-brown mass. The infected flowers are entirely destroyed by the disease and even the awns are affected. In the Hidden Smut the spore mass is more or less concealed by an outer membrane of the floral parts that remain intact from the disease. The dusty mass is made up of great numbers of spores which are blown about by the wind, some being caught in the open glumes of flowering oat-plants. Since after blossoming the glumes close tightly about the ovary, such spores are held imprisoned and remain so until the seed is in a condition to germinate. Then the imprisoned spores germinate after the manner of several smuts, producing a three or four-septate promycelium, which usually bears oval or elliptical sporidia at the apex or laterally at the septa. Infection threads are usually produced by these sporidia, but the promycelial threads may also produce them. These infection threads gain entrance to the host by piercing the delicate young cells of the first leaf-sheath before the leaf has appeared. Plants are free from infection after the growing leaves have pushed themselves as much as one c. m. through the leaf-sheath. Brefield found by experimentation that oats germinated up to 15° C. gave 3 per cent. smutted heads, but when grown at a higher temperature give 1 to 2 per cent. smutted heads or more.<sup>1</sup> This bears out ordinary experience that late sown oats while more liable to rust are freer from smut. This immunity is probably due to the short period when the plant is open to infection as a result of the rapid germination and growth of the seed in the more favorable condition of temperature.

In from thirty-six to forty-eight hours after infection considerable mycelium will be developed which penetrates the first and second leaves and gains entrance to the stalk or culm. It grows upward and invades the young head in quite the same manner as in case of other smuts. In place of a healthy head, a dusty mass of spores appears, which are scattered to healthy heads by the wind.

---

1. Brefield, O., Recent Investigations of Smut Fungi and Smut Diseases. Trans by Erwin F. Smith, *Jour. Mycol.* VI, pp. 1-8; 59-71; 153-164. 1890-91.

## COVERED SMUT OF BARLEY.

On *Hordeum vulgare*.*Ustilago hordei* (Pers.) Kell. & Sw.

This smut differs from *Ustilago nuda* in its method of infection and in its appearance in the field. The floral parts are not as completely destroyed and these serve to confine the spore mass and thus keep the spores from escaping until threshing time. Although they have a smooth epispore they cling to the seed and germinate with it, producing sporidia in abundance, laterally and terminally, upon a two to three-septate and elongated promycelium. These sporidia send out infection threads which penetrate the host in its early stage of growth. The swollen segments of isolated promycelium may also produce infection threads. The manner of growth in the host and the production of chlamydospores is similar to that of other loose smut.<sup>1, 2</sup>

## OTHER SMUTS CARRIED OVER BY THE SEED OF THEIR HOST PLANTS.

Grain Smut of Rice.

*Tilletia horrida* Tak. on *Oryza sativa*.

Head Smut of Sorghum.

*Spacelotheca Reitziana* (Kuhn) Clint. on *Sorghum vulgare*.

Grain Smut of Sorghum.

*Spacelotheca sorghi* (Lk.) Clint. on *Sorghum vulgare*.

Grain Smut of Hungarian Grass.

*Ustilago crameri* Kom. on *Setaria italica*.

Leaf Smut of Timothy, Red-top, Blue-grass, and other Grasses.

*Ustilago striaciformis* (West.) Miessl.

Smut of Tall Oat Grass.

*Ustilago perennans* Rostr. on *Arrhenatherum avenaceum*.

And smuts of many wild grasses.

## FLAX WILT.

*Fusarium lini* Bol. on *Linum usitatissimum* and *L. humile*.

The spores of this fungus become attached to the seed and germinate with it in the soil. These infect the roots of the young plant, often killing the seedling before it appears above ground. In case when plants live and

1. Clinton, G. P., Smuts of Illinois Agricultural Plants. Ill. Bul. 57, 1900.

2. Kellerman & Swingle, Reports on the Loose Smut of Cereals. 2d Ann. Rept. Kan. Exp. Sta., pp. 313-288: 1889.

are able to mature their seeds, they are frequently internally infected by the mycelium of the fungus and thus serve to carry the disease from season to season.<sup>1, 2, 3</sup>

#### RUSTS.

It is now believed by some pathologists that certain species of *Puccinia* are perpetuated by means of the seed of the host plant. Eriksson, after long investigation, came to believe that the fungus exists in the seed in a mycoplasmic form which can only with difficulty be detected from the protoplasm of the cells in the seed. As the plant grows, the mycoplasma spreads from cell to cell, finally appearing as mycelium in the intercellular spaces. He believes that the rust may be inherited from preceding crops by means of this mycoplasma.<sup>4</sup> It is generally believed that the facts do not warrant the acceptance of this theory. Bolley thinks that infection may take place from spores inside the seed itself. He found both uredo and teleutospores of *Puccinia graminis* borne in spore beds just below the bran layer of wheat and also found plenty of rust-mycelium within the seed.<sup>5</sup> Eriksson reports seed infection with *Puccinia graminis* and *P. glumarum* in wheat, oats, and barley, and *P. dispersa* on rye. Noack reports a case from Cooke of carnations being affected by rust which must have been caused by seed infection and he himself observed an incident of celery-rust that was likewise caused by infection from the seed.<sup>6</sup>

#### ANTHRACNOSE OF TOMATO.

*Colletotrichum lycopersici* Ches. on *Lycopersicon esculentum*.<sup>7</sup>

#### BACTERIOSIS, OR BACTERIAL BLIGHT OF BEANS.

*Bacterium phascoli* Sm. on *Phascolus vulgare*.<sup>8</sup>

This disease affects the stems, leaves, and pods (Fig. 7) of various field and garden beans, including limas. It spreads through the pods into the seeds, where the bacteria live through the winter, thus carrying the disease from season to season.

1. Bolley, H. L., Flax Wilt and Flax Sick Soils. N. D. Bul. 50, 1901.
2. Bolley, H. L., Flax and Flax Seed Selection. N. D. Bul. 55, 1903.
3. Bolley, H. L., Flax Culture. N. D. Bul. 71, 1906.
4. Eriksson, J., A General Review of the Principal Results of Swedish Research on Grain Rusts. Bot. Gaz. XXV; 26; 1898.
5. Bolley & Pritchard, Rust Problems, etc. N. D. Bul. 68; 1906.
6. Noack, Fritz, Die Verschleppung von Pflanzenkrankheiten durch Sämereien. Zeitsch. land. u. ver. Hersen, 1893, No. 20, pp. 161-2. Trans. by Prof. H. H. Whetzel.
7. Harvey, F. L., Tomato Anthracnose. Me. State Coll., Ann. Rept. 1893. Part II, p. 152.
8. Whetzel, H. H., Some Diseases of Beans. Cor. Exp. Sta. Bul. 239, 1906.

## BLACK ROT OF CABBAGE.

*Bacillus campestris* (Pam.) Sm. on *Brassica oleracea* and *B. campestris*.

Infection takes place through the water pores of the leaves. The margins become affected and later the whole leaf withers and dies from thrombosis, i. e. by the plugging up of the xylem vessels by the bacilli. It has been shown while the bacilli will die when exposed from 8-10 days on a dry cover glass, they are able to live ten to thirteen months on the smooth surface of a cabbage seed, and that they often pass the winter in such a position.<sup>1</sup>

## STEWART'S SWEET CORN DISEASE.

*Bacterium stewartii*. Sm. on *Zea Mais*.

This is a thrombotic disease of sweet corn that is believed to be disseminated from year to year chiefly by means of bacteria clinging to the seed.<sup>2</sup>

- 
1. { Harding, H. A. } Vitality of the Cabbage Black Rot Germ on Cabbage Seed. N. Y.  
    { Stewart, F. C. } Exp. Sta. Bul. 251, 1904.  
    { Prucha, M. J. }
  2. Stewart, F. C., A Bacterial Disease of Sweet Corn. N. Y. Exp. Sta. Bul. 139, 1897.



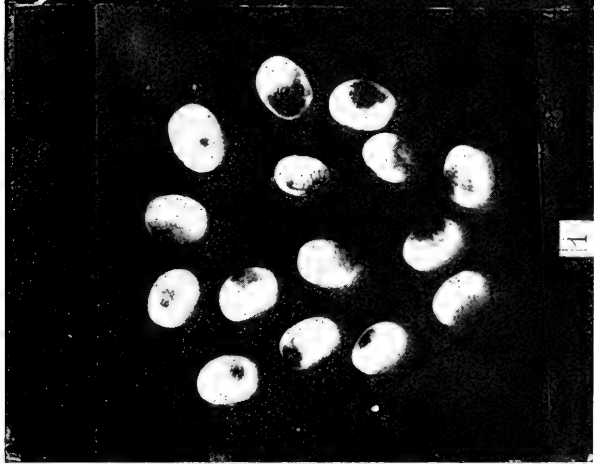

Fig. 1. Bean seed spotted with Anthracnose.

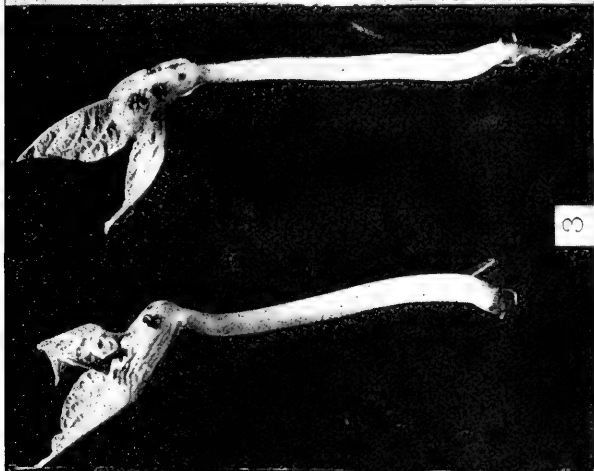

Fig. 3. Seedling bean plants showing Anthracnose spots on the cotyledons.

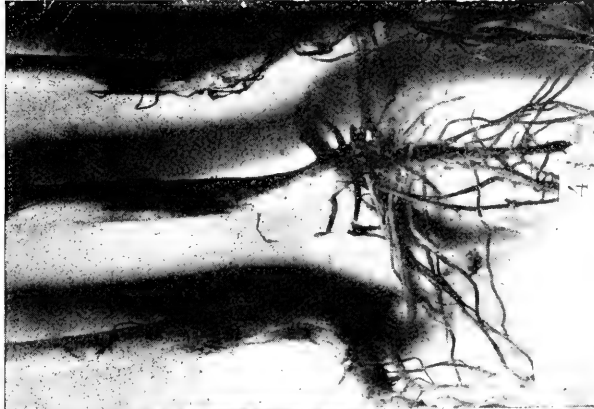

Fig. 4. The lower portion of bean plants affected with Anthracnose, showing lesions near the base.

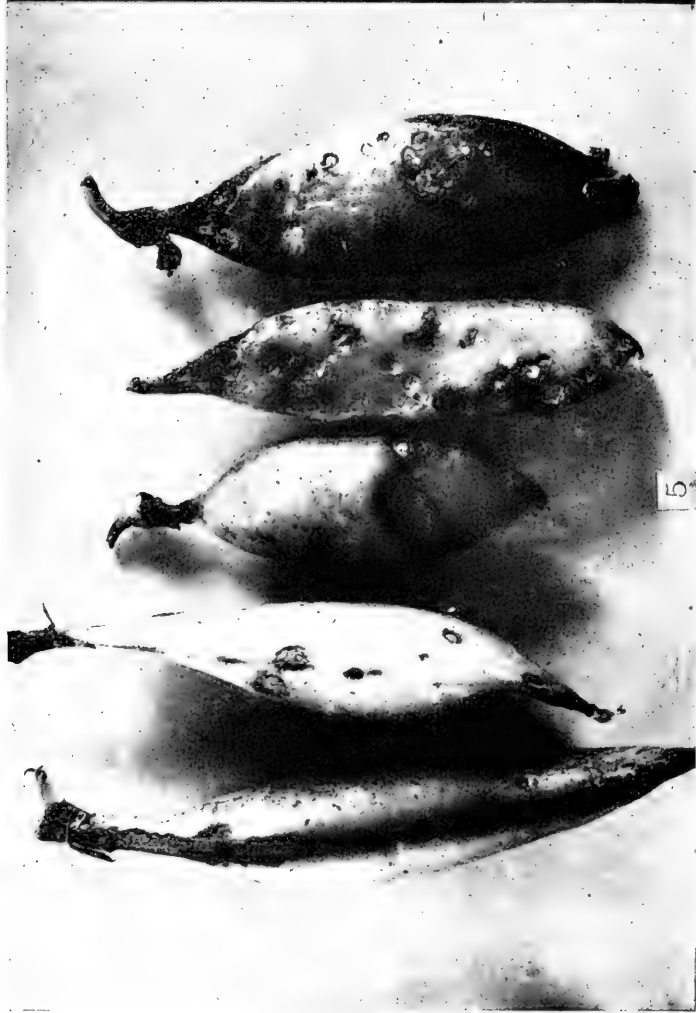

Fig. 5. Pea pods affected with *Ascochyta pisi*.



Fig. 2. Bean pod with canker cut away so as to show that the fungus had penetrated the seed.

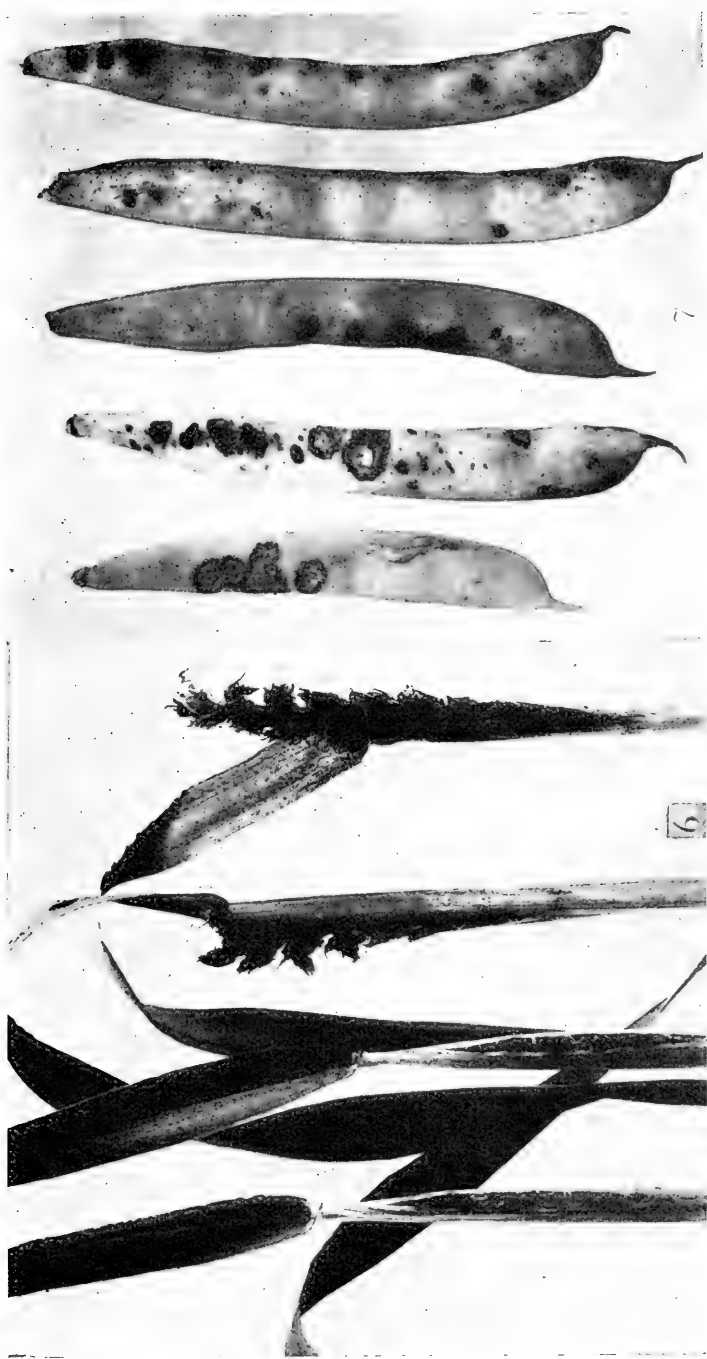

Fig. 6. Heads of wheat affected with the Loose Smut.

Fig. 7. Bean pods spotted with Bacterial Blight.



## THE HISTOLOGICAL DIFFERENCE BETWEEN *PINUS TAEDA* AND *PINUS PALUSTRIS*.

BY KATHERINE GOLDEN BITTING.

Though the structure of the wood of a tree will show considerable variation due to environment and conditions of growth, the variation will be manifest in the amount of wood formed, and the size of the cells. The characteristics which distinguish the particular wood remain constant, no matter what the external conditions may be, so that it is always possible to distinguish the wood of any species by the use of the microscope. It is not always possible to distinguish woods macroscopically, even by expert lumber men. This is particularly true of Coniferous woods, which are composed of only one form of element, the tracheides.

The close macroscopical resemblance of many Conifers, coupled with the variety of local names possessed by nearly every species, has caused much confusion in the lumber business. At present when a certain lumber is specified in a contract, many times the only guarantee that the contract will be properly filled will be the resemblance to the lumber named, along with information as to the locality from which it was shipped, the latter being the more reliable, if it be known to furnish pure groups.

Two of the hardwood Conifers which are confounded are *Pinus taeda* and *Pinus palustris*, or as they are more commonly known, Loblolly and Longleaf pine. In addition to these Loblolly has twenty-two other common names, and Longleaf twenty-seven, three of which are common to both.

*Pinus taeda* is of wide distribution, due to its adaptability to grow in different soils, consequently it shows considerable variation in its annual growth in both height and diameter. The best lumber is obtained from trees grown in mixed forests on well drained and fertile soil. These trees give the greatest growth in height, and a slower growth in diameter, both varying with the age of the tree. The zones of the spring and summer wood in the annual ring are nearly equal in extent, the spring wood shading gradually into the summer wood. In the gross, the zones are fairly distinct, but under the microscope it is difficult to define their proximate limit, as seen in the transverse and radial sections. The tracheides in

cross-section are approximately square or oblong, those in the summer wood being much thickened, leaving an irregular-shaped opening. The thickness varies from .00454 mm. in the spring wood to .0106 mm. in the summer wood. The length and width of the tracheides also vary, those in the spring wood being 6.444 mm. in length by .05606 mm. in diameter, those in the summer wood being 6.735 mm. by .03333 mm., being very slightly longer but decreased considerably in diameter, the decrease in width being accompanied by a greatly increased thickness. These figures are taken from the early spring and the late summer tracheides.

The resin ducts occur singly in both the spring and summer zones.

The medullary rays are somewhat obscure, one row of cells in width and 2 to 17 cells in height, except those which contain resin ducts, which widen and have a greater height.

In the longitudinal sections, the walls show striations which are fairly prominent, but have very little bowing apart of the walls.

*Pinus palustris* requires a drained soil in which to grow, its seed years occur at longer intervals, and thus it has a more limited distribution than *P. taeda*. It also has a lesser height and diameter, but has a finer grain, and greater weight. The zones of the spring and summer wood are distinct from each other, showing in well-marked lines, the summer wood appearing oily and compact as against the lighter line of the spring wood. The summer zone varies from about one-third to one-half of the annual ring. The two zones are so distinct that unless the thickness of the walls be noted carefully, the only difference between the limits of the summer wood is that the first growth shows an irregular line, whereas, the end of the zone for the year's growth forms a clean-cut ring.

The tracheides in transverse section are approximately square or oblong, with approximately round or elliptic openings left in the summer wood. Those in the spring wood average 4.4555 mm. in length by .04356 mm. in diameter, and the walls .00643 mm. in thickness. The summer tracheides average 4.8533 mm. in length by .0409 mm. in diameter, and the walls .01363 mm. in thickness. There is only a slight difference between the tracheides of the spring and summer zones in length and diameter, but the thickness of the walls is more than doubled.

The resin ducts occur singly, near to, and in, the summer wood.

The medullary rays are conspicuous, being one row of cells, rarely more, in width. They vary from 2 to 28 cells in height, except those containing resin ducts, which are much larger.

The walls of the tracheides bow apart to such an extent as to appear like a string of beads in the longitudinal sections.

In distinguishing the woods of the two trees the factors which are most prominent and also most readily obtained are in *Pinus taeda*, the junction of the spring and summer wood, in the year's zone, not distinct, the medullary rays somewhat obscure, and close together; in *Pinus palustris* spring and summer wood distinct from each other, the medullary rays conspicuous and farther apart, having a ratio of 4 to 11 to those in *Pinus taeda*. The other differences noted might be used in verification, but are not essential in the differentiation of the two woods.

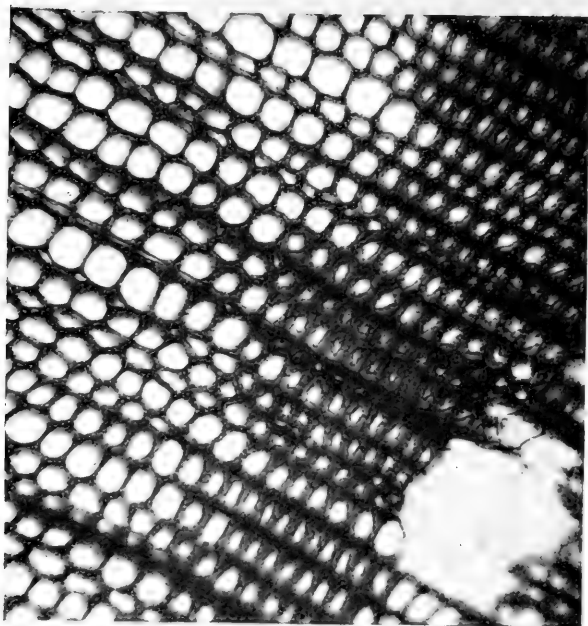

Fig. 1. *Pinus taeda*, Trans. sec. x 110.



Fig. 4. *Pinus palustris*, Trans. sec. x 110.



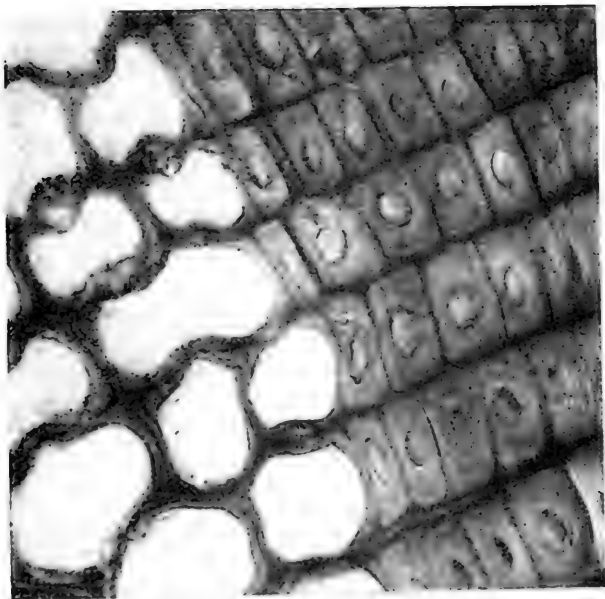

Fig. 5. *Pinus palustris*. Trans. sec. x 385.

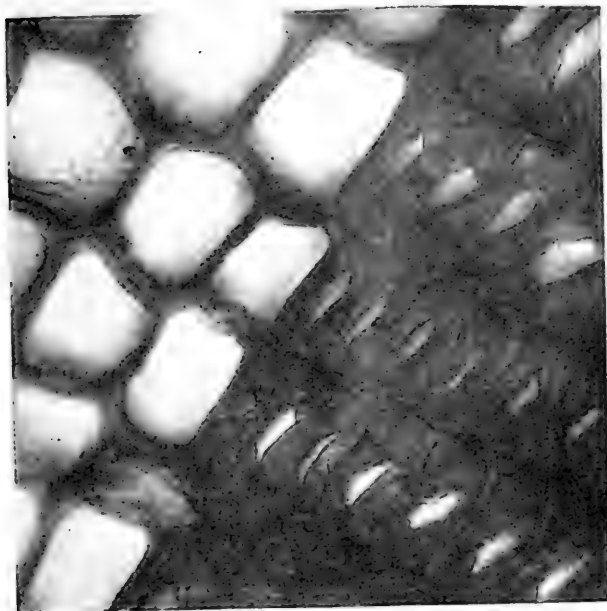

Fig. 2. *Pinus taeda*. Trans. sec. x 395.

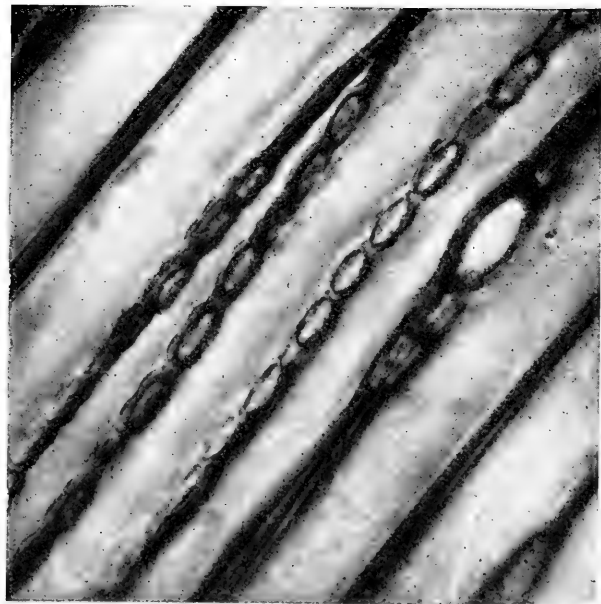

Fig. 6. *Pinus palustris*. Tang. sec. x 395.

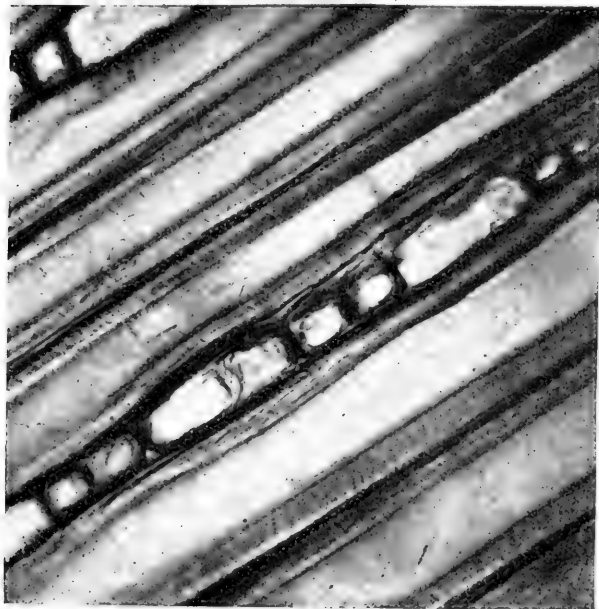

Fig. 3. *Pinus taeda*. Tang. sec. x 395.

## REPORT OF WORK IN CORN POLLINATION.

BY M. L. FISHER.

The work here reported was done during the season of 1908. A series of six studies was carried out in duplicate, as follows:

- a. To determine period necessary for pollination in the field.
- b. To determine the best condition of silks for pollination.
- c. To determine time of day when pollination takes place most actively.
- d. To determine the result of crossing with pollen from a variety of a different color or race.
- e. To determine the vitality of pollen grains.
- f. To determine the effectiveness of hand pollination.

All prospective ears were covered with paper bags before the silks appeared. Where hand pollination was performed, an umbrella was held over the shoot and to the windward while it was uncovered. Only the results obtained from "d" and "e" will be reported upon at this time. In all but "b," the silks used were three inches or more in length and in fresh condition.

The work under "d" was divided into four parts: d<sup>1</sup>. The silks of Reid's Yellow Dent, a yellow variety, were pollenized with pollen from Boone County White, a white variety. Fairly well filled ears were obtained. The kernels had yellow bodies and almost uniformly whitish crowns. A few kernels were yellow throughout. The character of the kernel and ear, other than color, was uninfluenced.

d<sup>2</sup>. The silks of Reid's Yellow Dent were pollenized with pollen from Stowell's Evergreen, a sweet corn, whitish in color and having wrinkled kernels when mature. Fairly well filled ears were obtained, but the character of the ear and kernel was unchanged. The only variation noticeable was a somewhat broader kernel, but such variation might occur without the effect of crossing.

d<sup>3</sup>. Reid's Yellow Dent was pollenized with pollen from a speckled variety. None of the kernels was speckled. A few had whitish crowns. Otherwise no change.

It should be said in this connection that the tassels from which the pollen was obtained were plucked in the afternoon and mailed in an envelope from Galveston, Ind., in the evening and used the next morning at Lafayette, Ind. The fertilization was not so complete as in other cases of hand pollination.

d<sup>1</sup>. The silks of Boone County White were pollenized with pollen from Reid's Yellow Dent. Well filled ears were obtained. The kernels had uniformly yellowish bodies and white crowns. The kernels were shorter than the usual Boone County White kernel, but this may have been due to the extreme dry weather of the season. In all other ways the character of the ear was unchanged.

The work under "e" was divided into three parts.

e<sup>1</sup>. Two five ear lots were pollenized with pollen 24 hours old. To obtain this pollen tassels were plucked in the afternoon and laid on paper in a room. The next morning the pollen was jarred out of the ripe anthers. The following morning this pollen was used to pollenize the selected ears. With pollen 24 hours old very well filled ears were obtained.

e<sup>2</sup>. Two five ear lots were pollenized with pollen 48 hours old, obtained as in "e<sup>1</sup>." The ears obtained from this pollination were not so well filled, there being many vacant places, showing a failure to fertilize.

e<sup>3</sup>. Two five ear lots were pollenized with pollen 72 hours old, obtained as in "e<sup>1</sup>." In this case practically no fertilization took place. The best ears had not more than 8 or 10 kernels on the cob, and the others only 3 or 4 kernels.

No conclusions are offered concerning these experiments. It is proposed to repeat the experiments in 1909, also to plant the corn obtained in d<sup>1</sup>, d<sup>2</sup>, d<sup>3</sup>, and d<sup>4</sup>, and note results.

## THE KILLING OF MUSTARD AND OTHER NOXIOUS WEEDS IN THE GRAIN FIELDS OF SOUTH DAKOTA.

BY E. W. OLIVE.

To the best of the writer's remembrance, mustard, though abundant enough, was not considered some years back as a serious pest in Indiana grain fields. But throughout the great grain fields of the Northwest the situation is different. The traveler sees on every hand, during the month of June, field after field of grain absolutely yellow with the blossoms of the common wild mustard. The fields sown to cereals are often enormous in extent; it is not an uncommon sight to see a quarter-section or even a section sown to one crop of wheat, barley, oats or flax. Only small areas here and there bear what we call "cultivated crops." Cultivation cannot therefore hold in check troublesome weeds as is done in the smaller farms of the older States. Hence the great abundance of the yellow pest through the older parts of the Dakotas is actually startling to a stranger from Indiana or Illinois.

One large land-owner in an effort to rid his ranch of mustard, two years ago spent a hundred dollars in pulling the weed. A year ago he doubled his expenditures in this work; but had to acknowledge finally that it seemed as though no matter how careful and clean his methods of farming, for years to come he might have to continually increase his appropriation in geometrical ratio before he could ultimately hope to conquer the pest.

It may be of some interest to the members of the Academy to hear a brief account of some of the experiments conducted by the writer during the past summer in trying to eradicate mustard and other weeds in grain fields. Similar experiments had already been performed in North Dakota, Canada, Minnesota, Wisconsin, and other western States, so that the results obtained in South Dakota are in the main corroboratory.

The method, in brief, is this: The grain field is carefully gone over with a traction spraying machine, and sprayed thoroughly with a strong solution (about 20 per cent.) of iron sulphate (or copperas). The machine used in our experiments covered a swath about twenty-five feet wide and threw a very fine and powerful spray, under a pressure of from 80

to 100 pounds, directly down on to the young mustard and grain. Twenty-five acres were easily covered in five hours, so that under favorable conditions, 40 to 50 acres could be readily sprayed in one day. The spraying is best done when the grain and weeds are from 6 to 10 inches high, or just before the mustard plants begin to bloom.

Further, it is highly important that the spraying be done during favorable weather. The great importance of this will be seen when we come to consider the physiological side of the problem. The best time for the most successful work is just after the dew is off, on a bright, sunshiny day. A little Dakota wind also helps the process; but if a rain soon follows, the iron salt is washed off and the work comes to naught.

Now if we keep close watch of the plants sprayed we can readily follow the various steps of the destructive action of the salt. First, the sulphate dries on the leaves, leaving minute, whitish flakes on the surface. Next, we note after two or three hours, particularly in the case of such succulent plants as mustard, the appearance of many scattered, more or less translucent, *sunken* areas on the leaves. The leaves by this time appear to be somewhat wilted and the whole plant looks somewhat sick. Two or three hours later, close examination reveals the next step of the process, in the gradual blackening of the sunken areas. The microscope shows this to be due to the blackening of the cell contents of the shrunken cells. Further wilting and drying up of the leaves is soon followed, in 24 hours or so, by their complete death. In a few days to a week, most of the mustard leaves have fallen off, or remain as dry, withered remnants on the dead stems. Occasionally a leaf may make a weak revival; or a plant here and there may make a futile effort at flowering and seed production. But if the work is thoroughly done, but few weeds survive. I have seen mustard so thick as to approximate 100 plants to the square foot, all totally destroyed by effective spraying.

After following the above description of the various steps in the appearance of a sprayed leaf the interpretation of the physiological action of the sulphate seems clear. First, the salt drying in minute flakes on the surface of the leaf, undoubtedly acts as a strong plasmolyzing agent to draw the water out of the cells with which it is in immediate contact. Thus results the scattered, translucent, sunken areas, merely from plasmolysis of those regions by the overlying salt. This plasmolysis is particularly striking in the case of the ragweed, which responds to the action of the sulphate even more quickly than does mustard or other weeds in-

vestigated. A sprayed solution of common salt apparently acts likewise, first as a strongly plasmolyzing agent, but its action is even quicker than that of the sulphate, plasmolysis resulting even in from 10 to 15 minutes after the application of the spray. Wilting of the entire leaf soon follows, due to general withdrawal of water, to be succeeded in a few hours by the blackening of the protoplasm of the plasmolyzed cells. This blackening is quite probably due to the formation of sulphides by the union of the absorbed iron sulphate with the protoplasm. After the use of common salt, on the other hand, the plasmolyzed spots turn reddish brown; possibly chlorides of some sort, formed in the killed protoplasm, may be responsible for the color in this instance.

It seems clear, then, that the action of the salts in killing the weeds in these experiments is due primarily to their osmotic properties rather than to their toxic properties; although it may well be that chemical action also may enter in after the first steps in the process and may contribute toward the death of the plants.

One of the most interesting sides of the whole problem of spraying for weed destruction is the fact that while mustard, ragweed and most other common weeds are for the most part totally destroyed, the wheat, oats, flax, etc., are themselves but little injured. This sounds almost unbelievable—much like a patent medicine advertisement, in fact. But it is nevertheless true that the grain soon recovers from the effects of the treatment; and further, Prof. Bolley's statement seems true, that the sprayed field often yields as much as one-third more grain than the unsprayed.

A little examination of the sprayed field soon shows to what the grasses and grains owe their peculiar protection from serious injury. It is true that the tips of the young wheat leaves are blackened and killed; but it will be remembered that, when the plants are only six inches to a foot in height, the bases of most of the leaves are amply protected, enwrapped within the sheaths and lower leaves. Their freedom from injury arises, therefore, in the main from the method of indeterminate growth of grains and grasses. The waxy bloom which covers flax and many of the grains must also contribute considerable protection against injury, since the minute droplets of salt solution do not adhere readily to such a surface.





## THE MEYER MOLECULAR WEIGHT CALCULATION.

---

BY PERCY N. EVANS.

---

In the Victor Meyer method of determining molecular weights of vaporizable substances, as usually carried out, the material is converted into vapor at the bottom of the inner tube, the latter being kept at a constant temperature at least twenty degrees above the boiling point of the substance by keeping a suitable liquid in the outer jacket steadily boiling. When the vaporizing occurs, a quantity of air equal to the increase in volume is forced out from the upper part of the inner tube, through the lateral capillary, and collected over water in a eudiometer. It is assumed that this increase in total volume is the volume of the vapor; it would be more correct to deduct from this volume that of the original liquid, but failure to do so introduces an error of usually only one part in two hundred or more, and this may be considered negligible in view of unavoidable experimental inaccuracies.

In passing from the heated tube to the eudiometer the temperature of the air changes to that of the room, with a corresponding volume change; it is assumed that the vapor would undergo the same change in volume if reduced to the same temperature without condensation, since all gases and vapors show a nearly identical behavior with changes in temperature.

After passing into the eudiometer the air is saturated with water vapor. If the air in the inner tube at the beginning of the experiment is already saturated with moisture at room temperature no change in the degree of moistness results, and hence no change in volume due to this cause. It would therefore be incorrect in calculating the volume of air under standard conditions to deduct from the observed barometer reading the tension of aqueous vapor.

If, on the other hand, the air in the apparatus had been perfectly dry its volume is increased by its becoming saturated with moisture, and this should be allowed for by deducting the tension of aqueous vapor from the barometer reading.

If, lastly, the air in the apparatus at the beginning of the experiment

is neither saturated at room temperature nor perfectly dry, the change in the degree of moistness of the air on becoming saturated is what the air originally lacked of being saturated. The appropriate correction to introduce is that fraction of the tension of aqueous vapor for the room temperature which it lacked of saturation. Suppose the apparatus was originally filled with the air of the room, and that it was forty per cent. saturated at room temperature, sixty one-hundredths of the tension of aqueous vapor is the number to be subtracted from the observed barometer reading; the corrected reading is  $B - \frac{100 - H}{100} w$ , in which B is the barometer reading, H is the hygrometer reading in per cent., and w is the tension of aqueous vapor for the room temperature.

Nearly all works accessible to the author give such directions for the manipulation as involve the use of the air of the room in the inner tube, yet give for the calculation the correction B-w. The error introduced in this way would be greatest if the air were saturated with moisture, and would then amount at a room temperature of 20 deg. C. to 17 in approximately 760, or 1 in about 45, and this condition is closely approached in damp, warm weather. Omitting the correction altogether when the air used is nearly dry gives an equal error in the opposite direction, approximated in very cold weather.

A quite appreciable error, then, may be avoided and the calculation made more nearly correct theoretically by using the correction given above.

Of the works accessible to the author only H. Erdmann's *Anorganische Chemie* discusses the correction, directing that if the apparatus is filled with a dried gas the tension of aqueous vapor should be deducted; if with ordinary air, no correction should be made. All other works fail to consider the point, some deducting the tension, others not, without specifying the conditions.

## RELATION OF FATS TO MOISTURE CONTENT OF BUTTER.

---

BY O. F. HUNZIKER.

---

### IMPORTANCE OF MOISTURE CONTENT OF BUTTER.

The two principal constituents of butter are the fats and the water. The average sample of butter contains about 83.5 per cent fats and 13.5 per cent water; the remainder being made up of salt, curd, ash, sugar and acid.

The more water butter contains the lower is its per cent of fats, and the more butter can, therefore, be made from a given amount of fats. It did not take the alert butter maker, the creamery operator, the commercial man very long to appreciate the financial significance of this fact. In many instances the process of butter making was so modified as to increase the per cent of moisture to the extent where as high as 130 to 150 pounds of butter were made from 100 pounds of fats, while under normal conditions 100 pounds of fats yield between 116 to 122 pounds of butter. The result was that, up to a few years ago, the American markets were flooded with water-soaked butter.

Butter containing an excess of moisture is inferior in quality; its keeping quality is poor and its food value is low. So, in order to save the butter industry of the country from certain ruin and to protect the consumer from buying his drinking water in the form of water-soaked butter, a law was passed by act of Congress in 1902 and revised in 1904, classifying as adulterated butter all butter containing 16 per cent or more of water and placing a fine of 10 cents per pound of butter and a special tax of \$50 per month on the manufacturer of adulterated butter.

When this law was put in force by the Internal Revenue Department it was found that, in certain localities and at certain seasons of the year butter makers experienced difficulties in keeping the moisture content below the legal maximum of 16 per cent, and the question naturally arose as to the practicability and justice of this standard and as to the advisability of modifying it.

## EXPERIMENTS CONCERNING THE FACTORS INFLUENCING THE MOISTURE CONTENT OF BUTTER.

Accurate data concerning the moisture content of butter were meager, and it seemed obvious that this question could be satisfactorily settled only by means of careful experiments. So, about two years ago, the Dairy Department at Purdue University started investigations concerning the variations of the moisture content of butter and the causes of these variations.

Analyses of butter of the Purdue Creamery and of about 30 creameries in the State showed that in spring and early summer there was a rapid and decided increase in the per cent of water in butter. Analyses of the composition of the butter fats in the same butter showed a decided increase in the per cent of volatile and soft fats (fats of a low melting point) and a corresponding decrease in the per cent of hard fats in spring and early summer.

These results suggested the possibility that the composition of the fats may, in a measure, control the per cent of moisture incorporated in butter. On the strength of this assumption the pure butter fat was extracted from various lots of butter, and by means of fractional crystallization at different temperatures the soft and the hard fats were separated from one another as completely as was possible with this method. The two classes of fats were then churned separately and under identical conditions as to the moisture present and temperature. The analyses of these churnings showed that the butter made from the soft fats contained about 50 per cent more water than the butter made from the hard fats.

The uniformity of the results of repeated experiments justified the conclusion that, other conditions being equal, the relation of soft to hard fats controlled the moisture content of butter.

## EXPERIMENTS CONCERNING THE CAUSES OF VARIATIONS IN THE PER CENT OF VOLATILE, SOFT AND HARD FATS.

The results just described naturally lead to the question, What are the causes underlying the variation in the proportion of soft and hard fats?

It is an established fact that certain feeds, when fed in excess, have a tendency to produce an excess of soft or hard fats in butter. Thus, for instance, cotton-seed meal, bran, corn, overripe fodders, etc., tend to

increase the per cent of hard fats, while linseed meal, gluten feeds, succulent pasture grasses, etc., are conducive to raising the per cent of soft fats. It is by no means established, however, that the feed is the only nor even the chief factor controlling the proportion of fats in milk. Thus at the time when the soft fats increase in milk and butter produced in this section of the country most of the cows are fresh, and it is quite possible that the period of lactation exerts an important influence on the fats. It was, therefore, deemed expedient to investigate in how far the period of lactation does affect the fats in milk.

Three cows of the university herd were selected and fed during their respective periods of lactation on an uniform ration, evading such feeds as would tend to materially influence the hard or soft fats. The milk from each cow was separated, the cream ripened and churned separately, and the butter analyzed for volatile, soft and hard fats.

The generally accepted classification of milk fats is as follows:

Glycerides of  $\left\{ \begin{array}{l} \text{a. volatile or soluble fatty acids.} \\ \text{b. insoluble fatty acids.} \end{array} \right.$

The glycerides of the insoluble fatty acids are subdivided into hard and soft fats. The dairy literature, in dealing with the soft fats and their relation to the melting point of butter, gives consideration to the glycerides of the insoluble fatty acids alone. Inasmuch as the glycerides of the volatile or soluble fatty acids have a very low melting point as compared with that of insoluble fats, a comparatively slight change in the per cent of the volatile fatty acids must greatly influence the hardness or softness, as well as the melting point of butter. In determining the variations of the soft fats in butter it is necessary, therefore, to take into consideration the soluble as well as the insoluble fats.

The following charts show the results of analyses of butter made from the milk of the three cows under experiment:

TABLE I.—COWS 1 AND 2.

SHOWING THE EFFECT OF THE PERIOD OF LACTATION ON THE MILK FATS.

TIME.	Reichert-Meissl Number.	Soluble Acids.	Insoluble Acids.	Iodine Number.	Melting Point.
1st month.....	32.41	7.39	87.26	29.96	36.2
2d month.....	29.48	7.07	87.99	30.05	36.1
3d month.....	29.95	7.08	87.90	29.98	36.4
4th month.....	29.97	7.11	87.72	30.16	36.3
5th month.....	29.56	7.00	87.72	31.88	35.9
6th month.....	29.21	6.82	88.19	34.64	34.4
7th month.....	28.06	6.45	88.4	36.15	35.0
8th month.....	25.32	5.84	88.6	38.20	25.4
9th month.....	25.45	6.01	88.5	36.4	35.5
10th month.....	27.45	6.26	88.1	34.21	34.2

TABLE II.—COW 3.

SHOWING EFFECT OF THE PERIOD OF LACTATION ON THE MILK FATS.

TIME.	Reichert-Meissl Number.	Soluble Acids.	Insoluble Acids.	Iodine Number.	Melting Point.
1st month.....	36.68	8.20	86.76	34.20	34.1
2d month.....	35.75	8.09	86.74	34.25	34.2
3d month.....	33.19	7.59	86.99	33.36	34.3
4th month.....	33.80	7.56	86.95	33.83	34.0
5th month.....	33.63	7.47	87.10	32.73	33.5
6th month.....	33.57	7.55	86.94	31.02	33.7
7th month.....	32.72	7.49	86.99	33.32	34.0
8th month.....	31.63	7.25	87.41	33.59	33.92
9th month.....	31.98	7.10	87.50	34.05	33.9
10th month.....	32.03	7.12	87.46	33.22	33.8
11th month.....	26.64	6.50	88.20	35.8	34.5
12th month.....	30.48	6.86	87.69	32.05	34.3

These charts bring out the following facts:

1. The Reichert-Meissl number and the per cent of soluble fatty acids were highest at the beginning of the period of lactation; slight irregularities excepted, they decreased as the period of lactation advanced and were lowest towards the close of the period of lactation.

2. The insoluble fatty acids were lowest at the beginning, gradually increasing during and were highest at the end of the period of lactation.

3. The fact that the Reichert-Meissl Number, the soluble and the insoluble fatty acids bear a definite relation to one another shows clearly that the per cent of soluble and insoluble acids is affected by the period of lactation, and that the soluble acids decrease while the insoluble acids increase as the period of lactation advances.

4. The results concerning the iodine number are irregular, and, considering the relatively small number of data, do not warrant the drawing of definite conclusions as to the effect of the period of lactation on the per cent of olein in butter.

5. The relation of the per cent of soluble fats and olein to the melting point emphasizes that the olein is not the only factor controlling the melting point or softness of butter, but that the volatile or soluble fats play a part in the determination of the softness of butter.





## THE USE OF THE POLARISCOPE IN TESTING HIGH TENSION INSULATORS.

BY C. FRANCIS HARDING.

It has long been known that glass internally strained, when placed in a polariscope in the path of polarized light produces upon the screen a chromatic effect, and that the colors thus produced rotate across the field as the analyzer of the polariscope is rotated. If, however, this peculiarity of glass has ever been put to practical use along engineering lines, such usage has not been common and its results have not been made accessible.

Without going deeply into the theory of the action of polarized light upon crystalline bodies or the similar phenomenon produced by the action of polarized light upon the imaginary planes into which the molecules are forced to arrange themselves within glass subjected to internal stresses, the writer has found the above mentioned color rotation in glass which is internally strained of the utmost value in testing glass insulators. Any ordinary piece of glass which shows no color rotation in the polariscope, when compressed in a vise or clamp and subjected again to the polarized light test exhibits streaks of purple and brown radiating from the points where the pressure is applied. The greater the pressure the brighter and more far-reaching the color effects seem to be, and when the analyzer is turned each color field seems to rotate about the point of application of the compressing force as a center. Similarly if a piece of ordinary glass showing no such effect be heated to a molten state and allowed to cool suddenly, the internal stresses due to irregular and unequal cooling will produce similar color rotation upon the screen.

With these facts at hand, several high tension glass insulators of different makes designed for a 33,000 volt transmission line were subjected to the polarized light test. Those of the No. 1 type, manufactured by one company, showed no color rotation in any portion, while those of type No. 2, designed and manufactured by another company for the same service, showed very marked effects. Some of the latter showed results more marked than others. In some the principal peculiarity noticeable

was the lack of uniform darkening and lighting of the entire field projected upon the screen as the analyzer was turned; while in others, especially in those that were whole, bright streaks of violet, purple and brown were seen, and found to rotate as the analyzer was rotated. In some cases these colored streaks were radial, and in still others they formed concentric rings about the knob of the insulator as a center. In order to prove more conclusively that these phenomena were caused by internal stresses, which were in turn produced by poor annealing, a portion of insulator No. 1, which showed no initial color rotation, was poorly annealed, and when tested again in the polariscope the color rotation effect was found to have been introduced. Conversely when a portion of insulator No. 2 was properly annealed the color rotation initially present was found to have disappeared.

The insulators which were first tested were those which had actually broken while in service upon the line, the parts of which were found on the ground near the poles where they were formerly installed. When later whole insulators of the same lot were tested it was found that in the latter the stresses were much more marked than in the broken parts. This fact caused the writer to suspect that some of the internal stresses produced by poor annealing were relieved by the breaking of the insulator, and to test this belief a whole insulator showing very marked color rotation was broken and the various parts placed in the polariscope for inspection. It was found that in spite of the fact that the same portion of the insulator which showed the most marked stresses was used when broken out, practically all the color rotation had been eliminated, although the stresses were still present to a less degree in the remainder of the insulator. In turn each quadrant of the umbrella of the insulator was broken out, and in each case the stresses were found to have been either reduced to a minimum or entirely eliminated. A further proof of the poor annealing was found in the fact that in insulators where the greatest stresses were present the umbrella shivered to bits when broken; while from insulators showing lesser stresses a whole quadrant could be broken out in a single piece.

Although it is very probable that insulators which are improperly annealed fail in service because of sudden temperature changes due to the weather and leakage of current over their surface, it seemed advisable to show, if possible, what effect, if any, the internal stresses had upon the mechanical strength of the insulator in order to determine whether the

possible unequal strain from the line wire could be considered a cause for breakage. Only four whole insulators were available for this test, two of which had marked internal stresses, while in the other two the stresses were almost negligible. The insulators were broken by placing them upon an iron pin as in service and by exerting a strain upon them in the direction of the line wire. One insulator which was poorly annealed broke at 960 pounds, while the others failed at 1,890, 1,675 and 2,220 pounds respectively, the latter being one which was also poorly annealed. While this test did not show very conclusively that the poorly annealed insulators were weak mechanically, it is believed that if the pull in the latter case, could have been in such a direction as to cause the insulator to break along strained internal planes as was probably the case in the first test, the latter insulator as well would have been found to have been weak mechanically. For conclusive evidence of this fact, however, a much larger number of tests should be available.

It will be seen from the foregoing, therefore, that a very practical use has been made of the phenomenon which has so long been only an interesting physical experiment. With the aid of the polariscope it is not only possible to determine some of the causes for the unsatisfactory service given by certain glass insulators, but it is also possible to make preliminary acceptance tests upon new insulators and to eliminate all of those which show signs of improper annealing and which for this reason would be undesirable for installation where they must be subjected, not only to severe electrical and mechanical strains, but also to vibration and sudden temperature changes. Although porcelain is rapidly supplanting glass for high tension insulators, it is expected that this method of test will be used in the future to advantage and that it will prove of equal, if not greater value, than it has in this particular instance.



## SOME CONTRIBUTIONS TO THE CHEMISTRY OF MUCOID.

---

BY CLARENCE E. MAY.

---

In Physiological Chemistry, one meets with a proteid that has been receiving more or less attention for several years past. This proteid is classed among the glyco-albumins and occurs especially in ligaments and tendons. Heretofore, the main problem connected with the chemistry of this substance or group of very closely related substances, as the case may be, has been the quantitative separation of the mucoid from mixtures of albumin such as blood and egg albumin, and mucoid. The usual method of separation has been to boil the neutral solution of true albumin and mucoid, thereby coagulating the blood or egg albumin and leaving the mucoid in the filtrate. By acidifying the filtrate, it yielded the mucoid as a flocculent precipitate which could be filtered and then weighed.

The purpose of this work was to ascertain first, whether mucoid was completely precipitated by the addition of a slight excess of dilute acid to the mucoid solution (the solvent being half-saturated lime water). Secondly, we wished to find out whether albumins were precipitated from a mixture of albumin and mucoid, by acidifying the mixture in the cold. Thirdly, we wished to ascertain whether mucoid coagulated by being boiled in a neutral solution in the presence of neutral salts. And lastly, we wished to see whether the various precipitations of the mucoid sample showed any differences in nitrogen content; in other words we desired to examine the homogeneity of the various acid precipitates.

The mucoid used was from several beef tendons (Achilles), and was prepared by removing all water-soluble proteids by careful washing of the tendons in tap water. The tendons were then cut into thin slices transversely and again thoroughly washed with cold water. The next treatment was to allow the slices of tendon to extract with half-saturated lime water for a day. This extract was filtered and made slightly acid with .2 per cent. hydrochloric acid, using litmus paper as indicator. The solution, with a casein-like precipitate was allowed to stand a short time when the precipitate flocked together and settled to the bottom of the container, leaving a perfectly clear supernatant liquid.

The filtered residue was dissolved in half-saturated lime water, filtered through silk and again precipitated with an excess of .2 per cent. HCl. This precipitation and solution alternation was continued until the eighth precipitation, when this precipitate was filtered by decantation and the residue was thoroughly dried by standing with absolute alcohol. The powdery white precipitate was carefully filtered and pulverized, then further dried at 100-105° C. for several hours. The bottled sample so obtained was used in this set of experiments.

In the study of the complete precipitability of tendon-mucoid by means of dilute HCl, a definite amount (2 grams) of the dried sample was weighed and dissolved in a mortar with the least quantity of half-saturated lime water necessary, about 300cc. The solution was then filtered through silk and by means of a pipette, equal portions of the filtrate were removed to respective beakers and were precipitated by varying amounts of acid. This phase of the acid precipitation was subdivided into a study of the effect of dilution of the mucoid and the effect of the use of varying amounts of acid. In each case duplicate checks were carried along on the amount of actual mucoid present and precipitable under the most favorable conditions. In every instance the mucoid precipitated by the acid was filtered on weighed papers, dried at 105° C. for several hours and weighed on the paper. The paper and mucoid were then ashed and the ash deducted from the original weight on the paper. The acid filtrates, usually about 250cc. in volume, were poured into about five liters of strong alcohol, allowed to stand 24-36 hours and filtered on weighed papers. The precipitates were washed with strong alcohol, dried and weighed; the precipitates and papers were burned respectively, and the ash, ranging from a few tenths of a milligram to a hundred milligrams, was deducted in order to get a value for ash-free mucoid material.

As results of an extended investigation of the deportment of mucoid in a half-saturated lime water solution, with .2 per cent. HCl, it was found that not all the mucoid was precipitated under the best conditions. There was always 10 to 20 per cent. of the mucoid precipitated by the strong alcohol treatment and part, perhaps 8 to 10 per cent. of the original mucoid, was not precipitated by the acid nor alcohol treatment. It was found that the more concentrated the solution of mucoid, the more complete was the precipitation. The weaker the final acidity of the solution was with .2 per cent. HCl, the less complete the precipitation. The best results were obtained with a half-saturated lime water solution saturated with the

mucoid sample (about a 2 per cent. solution), the mixture diluted slightly and made acid enough to turn fresh litmus paper red immediately. This treatment yielded a solution that filtered readily (an item of vast importance with mucoid and other gelatinous solutions), that washed rapidly and gave a filtrate yielding the minimum quantity of mucoid with strong alcohol treatment. With the use of acetic acid instead of HCl, much more acid was required to precipitate any mucoid at all, and with an excess of acetic acid the results were very unsatisfactory, much more than with even a little dilute HCl.

In testing the action of dilute acid on a mixture of albumin and mucoid, the details were as follows: A standard solution of mucoid was made and equal amounts of the alkaline solution were placed in each of several beakers. The actual amount of mucoid added to each beaker was determined by duplicate checks. To the various beakers containing equal amounts of mucoid diluted to the same volume, varying amounts of meat extract were added. The meat extract was made in the laboratory by extracting fresh meat with cold water and filtering the proteid-bearing solution through silk. Duplicates were run on the meat extract and also on each of the mixtures of meat extract and mucoid. For precipitation, the same acidity was maintained in each beaker using .2 per cent. HCl as the reagent.

By way of results, although the meat extract alone yielded no precipitate in the cold, it was found that when mixed with mucoid, practically all the mucoid and some of the albumin separated. With increased non-mucoid proteid content, the weight of material precipitated by .2 per cent. HCl likewise increased. In fact, all the precipitates from the meat extract-mucoid mixture weighed more than the amount of mucoid which the solution was known to contain. All the precipitations were made in duplicate and found to check closely with each other, and each set of duplicates in the series varied approximately the same. By knowing the position of the set of duplicates in the series, one could closely approximate the actual weight before weighing. The experiments showed that the precipitation of mucoid in the presence of albumins was inaccurate for the determination of mucoid.

With the coagulation test for mucoid, the general opinion is that mucoid does not coagulate on boiling a neutral solution in the presence of salts. To test this, a solution of mucoid was prepared by rubbing up about 10 grams mucoid in a mortar with about a liter of half-saturated

lime water. When complete solution was attained, the alkaline solution was carefully neutralized with .2 per cent. HCl. The neutral point was determined by litmus paper that was fresh and quite sensitive. No mucoid precipitated in the neutral solution, but it was strained through silk for the sake of uniformity of conditions. Duplicate samples were taken to determine the mucoid content before heating. The major portion of the solution was gently boiled under a water condenser. Every half hour, about 100 cc. of the solution was removed, allowed to cool rapidly without any loss of water vapor, filtered and duplicate aliquot portions of the filtrate were used for acid precipitation of the mucoid content.

By way of results, it was noticed that continued boiling had a fatal effect on the mucoid. At first the solution became turbid. At the end of the first half hour's heating, there was a nice coagulum in the solution. This increased gradually until about the fourth hour, when there was a heavy coagulum throughout the solution. During the process of continued heating, the solution remained neutral without the addition of any alkali or acid. The longer the heating continued, the more rapidly the solution filtered. The first few filtrates were very slightly turbid, but the turbidity gradually decreased to water-clearness in the last few filtrates.

With regard to the filtrates, on treatment with dilute acid it was found that with the initial precipitations, less mucoid was recoverable than was obtained from the unboiled mucoid solution. The amount of mucoid precipitated gradually decreased as the experiment advanced and finally filtrates were obtained from which no mucoid could be precipitated with an excess of dilute acid. This was coincident with the heavy coagulum in the major portion of the solution. This experiment seemed to show conclusively that mucoid did coagulate on heating in the presence of neutral salts. It was deemed useless to try to separate a coagulable albumin from mucoid by this method.

The work done in this research was carried out, using a mucoid sample that had been purified by solution in alkali and precipitation by acid, this alternation for eight times. To test whether the eighth precipitate might be different from the sixth or tenth precipitate, or any other precipitate in the series, about 20 grams dry mucoid that had been precipitated probably twice, were dissolved in several liters of half-saturated lime water, strained through silk and precipitated with a slight excess of .2 per cent. HCl. This was filtered, dissolved and precipitated, the whole process being repeated fifteen times. Samples of the fifth, tenth and fifteenth precipitate were re-



moved, partly dried by standing in absolute alcohol, filtered and dried in an oven at 105° C. Duplicate Kjeldahl nitrogen determinations were made on each of the respective precipitates. Each of the six duplicates were found to check quite closely, thus indicating that there was nothing gained by the continued solution and precipitation of the mucoid. Incidentally it might be mentioned that there was mucoid lost at each precipitation by incomplete precipitation. This was evident from the fact that by most careful work, starting with 20 grams mucoid, it was only possible to wind up with about 13 grams actual dry mucoid.

In conclusion, it may be stated that tendon mucoid coagulates, the amount increasing with the duration of boiling, in the presence of neutral salts; that mucoid is not completely precipitated by an excess of dilute acid; that in a mixture of albumin and mucoid, most of the mucoid and part of the albumin are precipitated by dilute hydrochloric acid in excess.

As for a remedy, nothing is offered as yet, but this work seems to show that the older methods are inaccurate.

This work was carried on largely during the last year in the laboratories of the College of Physicians and Surgeons, Columbia University, New York, where the author was associated with Dr. William J. Gies, and under whose supervision the details were worked out. Owing to the non-possession of the actual notes at present, many valuable data must be left out of this paper, but every statement made can be further demonstrated by experimental data.



## THE ESTIMATION OF LEAD BY THE TITRATION OF LEAD CHROMATE.

BY W. C. BROOKS.

The first experiments were made to test the accuracy of the method. Weighed amounts of pure lead nitrate were dissolved in water and the lead was precipitated by potassium dichromate in slight excess. The lead chromate was filtered, was washed and was dissolved in hydrochloric acid. The resulting chromic acid was determined by adding potassium iodide and then by titrating the free iodine with sodium thiosulphate. The results of several titrations are given below :

$\text{Pb}(\text{NO}_3)_2$ Used. Grams.	$0.2 \text{ Na}_2\text{S}_2\text{O}_3$ Used. cc.	Lead Found. Per cent.	Error.
0.1	18.15	62.56	+0.05
0.1	18.15	62.56	+0.05
0.2	36.35	62.60	+0.09
0.2	36.3	62.55	+0.04

A method for the estimation of lead in ores was worked out from these results. Weigh out 0.2 gms. of the ore, dissolve in 10 to 15 cc. of nitric acid and evaporate almost to dryness. Add 50 cc. of water and 5 gms. of ammonium acetate and heat to boiling. Precipitate the lead from the boiling solution with a slight excess of potassium dichromate. Filter, wash and dissolve the precipitate with 20 cc. of 1:1 hydrochloric acid, the solution being received into the original beaker. Dilute the solution and washings to 150 cc., add 0.3 to 0.5 gms. of potassium iodide and titrate the iodine that is liberated with sodium thiosulphate.

The only element that has been found to interfere with this method is barium, which gives high results. Experiments are being carried on to obtain a simple means of removing this metal. Although the work upon this method is not complete, it promises to become an accurate and a rapid means for the estimation of lead in the presence of all of the common elements.



## AN EVOLUTION METHOD FOR THE DETERMINATION OF SULFUR IN SULFIDES AND SULFATES.

BY FRANK C. MATHERS.

The object of this research was to devise a rapid method for the estimation of sulfur in sulfates and sulfides, especially in the presence of such elements as molybdenum, which interfere with the precipitation of barium sulfate. The idea was to heat the material with some metal which would reduce all of the oxidized sulfur and then combine with it to form a sulfide. The rest of the method would coincide with the ordinary volumetric evolution method for sulfur in iron and steel.

Powdered potassium sulfate, containing 18.39 per cent. of sulfur, was used in these experiments. In each experiment, 0.2 gm. of the potassium sulfate was thoroughly mixed with the reducing metal and was placed in a crucible which was heated. Experiments with zinc dust as a reducing agent showed that it was impossible to reduce all of the sulfate at low temperatures and that at higher temperatures some sulfur was lost by volatilization along with the zinc.

Gms. of Zn Used.	Temperature.	Per cent. of S Evolved.	Per cent. of S in the Residue.
3.0	<b>Bunsen burner, 5 minutes.</b>	17.05	0.64
3.0	<b>Blast, 5 minutes.</b>	17.20	0.11

The use of a mixture of zinc and aluminum gave still poorer results. The addition of bases such as calcium oxide, calcium carbonate, sodium carbonate, or magnesium oxide were without beneficial effects. The use of some charcoal did not help.

Magnesium turnings gave the best results. To protect the porcelain crucibles, they were partly filled with 1.5 gms. of magnesium oxide and a cavity was made in this with the end of a test tube. The charge was placed in this cavity and was covered with 0.5 gm. of magnesium oxide. The porcelain crucibles, with well fitting lids, were heated for 5 minutes with a

Bunsen flame. A number of good results were obtained. Small amounts of sulfur remain in the residue in the evolution flask. The amount is apparently not constant and varies from 0.3 to 0.5 per cent.

These preliminary experiments have so far been just successful enough to encourage hope and call forth more work.

## THE DESTRUCTION OF PLATINUM CRUCIBLES THROUGH THE IGNITION OF MAGNESIUM AMMONIUM PHOSPHATE.

BY ROBERT E. LYONS.

Platinum is not oxidized in the air at any temperature, nor attacked by any single acid, yet there are many substances that attack and combine with it at comparatively low temperatures.

It sometimes happens that a platinum crucible is cracked or is fused through during the burning of the filter paper containing magnesium ammonium phosphate, or during the final ignition required to convert magnesium ammonium phosphate into magnesium pyrophosphate. This has again and again been a source of annoyance and expense to the phosphate analyst. The break down of the crucible is not due to invisible mechanical defects in the crucible, nor to the quality of the platinum or platinum alloy used in its construction. The cause of these occasional accidents is to be found in the reduction of the phosphate through incorrect procedure in burning or igniting the paper in connection with the precipitate, or, indirectly and less frequently, by failure to observe the well-established conditions for properly precipitating and washing magnesium ammonium phosphate.

The direction for the treatment of the magnesium ammonium phosphate residue given in the texts and handbooks, at the disposal of the writer, is by no means sufficient to enable the inexperienced operator to safely use a platinum vessel in this operation. The notes on the use and care of platinum ware, published by Baker & Co., Heraeus and other platinum smiths, do not suggest the possibility of a mishap from the ignition of magnesium ammonium phosphate in a platinum crucible. The notes furnished by the Baker Co. have long contained the statement: "Organic matter containing phosphorous should not be ignited in platinum dishes, as it affects the platinum seriously." This "serious affect" is the same as that noticed occasionally in connection with the ignition of magnesium ammonium phosphate in platinum crucibles, and is caused by the combination of reduced phosphorous with the platinum, forming platinum phosphide.

The reduced phosphorous unites with platinum even at a dull red heat (600° C.).

The external appearances of a crucible which has suffered such an attack are characteristic. Cracks of varying length appear, usually in the bottom, but sometimes in the sides; the fractured surfaces are distinctly crystalline; the edges of the fractures are usually raised and puffed and at times present unmistakable signs of fusion.

Reduced phosphorous, the immediate cause of the destruction of the crucible, may be accounted for by inquiry into the nature, the origin and the conditions governing the deportment of reducing agents which could act upon magnesium ammonium phosphate during the processes of incineration and ignition.

The reduction of the phosphate may be due to any or all of the following:

1. Carbon from the imperfectly ashed filter paper.
2. Ammonia liberated by heat from magnesium ammonium phosphate, or from sodium ammonium phosphate, or ammonium phosphate, which may be present in abnormal amount in the magnesium precipitate.
3. Hydrogen from the dissociation of ammonia at the high temperature, and also from the incomplete combustion zone of the gas flame by diffusion through the platinum crucible.‡

The reduction of magnesium pyrophosphate by carbon begins at 950° Cent. and becomes violent at 1,100 to 1,200° Cent.‡ The reduction by hydrogen begins somewhat below 900° Cent.‡ Dry ammonia gas passed over magnesium pyrophosphate heated to 950° Cent. yields phosphine and red phosphorous.‡ The destruction of the platinum vessel is most rapid when the residue contains free ammonium phosphate, which upon fusion yields most of its ammonia and meta-phosphoric acid. Ammonium phosphate heated in a covered platinum crucible to 700-800° Cent. causes complete destruction of the vessel. Holes appear in the bottom and sides, and the lid may fuse. The quantity of ammonia from the magnesium ammonium phosphate, which has been properly prepared, will prove destructive only under especially unfavorable conditions, e. g. very rapid heating of the phosphate to a high temperature.

Strict observance of the following summarized suggestions will insure the safety of the platinum crucible in the ignition of magnesium ammonium phosphate:



1. Precipitate the magnesium with sodium hydrogen phosphate, or with ammonium sodium hydrogen phosphate, rather than with ammonium phosphate.

2. Do not neglect to wash the precipitate with water containing one-fourth its volume of conc. ammonium hydroxide until the washings show but a faint turbidity with silver nitrate acidified with nitric acid. If ammonium phosphate is present thorough washing is particularly important.

3. Remove the main portion of the residue from the paper before incinerating, or burn the paper with a small residue, in the crucible, over a very small Bunsen flame. This may be quickly accomplished in a draught produced by tilting the lid of the crucible. *Do not ignite strongly nor heat to the fusing point of the phosphate until the material in the crucible is white (carbon free).* If the ashing of the paper has been imperfect, allow the crucible to cool, moisten the residue with a few drops of conc. nitric acid, cover the crucible with the lid, carefully evaporate the acid and heat again in the Bunsen flame. The process must be repeated until the residue becomes white.

4. To the residue in the crucible add the main portion of the precipitate and heat in the Bunsen flame gently at first, or until the greater part of the ammonia has been expelled, then heat strongly in the blast flame until the material ceases to decrease in weight.



A PROBABLE ORIGIN OF THE NUMEROUS DEPRESSIONS IN THE  
MESA SOUTH OF THE ARROYO FORMED BY THE OUTLET  
OF TIJERAS CANYON IN THE SANDIAS NEAR  
ALBUQUERQUE, NEW MEXICO.

---

BY ALBERT B. REAGAN.

---

The occurrence of numerous slight depressions, thickly distributed over the mesa south of Tijeras arroyo on the east side of the Rio Grande, south of Albuquerque, New Mexico, is very noticeable. These were observed to be rarely more than five yards across and commonly from eighteen inches to two feet in depth and are provided with a raised border. They resemble buffalo wallows very much; but are too abundant and their distribution is too general. The stratum in which they are indented is a very loose, unlithified formation, superimposed upon the Albuquerque Marl,\* a calcareous deposit some six feet in thickness.

The depressions extend in depth to this marl stratum and seem to hold water.

These depressions seem to be the "blowouts" of mud upheavels. They seem to have been formed at the time the Albuquerque marl was in a semi-fluid state. The loose unlithified stratum that is superimposed upon the marl was washed down from the Sandias onto the area faster than the marl could harden or "ereep" from its advance over the bottom of the then Albuquerque lake which occupied the Rio Grande embayment at that point. As a result of the pressure caused by the superincumbent weight, mud lumps formed in size proportionate to the pressure, like those now forming in the Mississippi Delta.\*\* And like those of the Southeast Pass of that delta, they collapsed on reaching the mature stage, leaving a small pit surrounded by a raised ring. Thus the mud lump, "blowout" theory seems to explain the origin of the depressions.

---

\*C. L. Herrick. *The Geology of the Environs of Albuquerque, New Mexico.* American Geologist, Vol. XXII, pp. 29-33.

\*\*E. W. Hilgard. *The Exceptional Nature and Genesis of the Mississippi Delta.* Science, Vol. xxiv, pp. 861-866.



## THE HEADWATERS OF THE TIPPECANOE RIVER.

BY J. T. SCOVELL.

---

The Wabash is the great river of Indiana. It rises in Ohio, flows westerly across Indiana, then southerly along the western boundary of the State into the Ohio River. The Tippecanoe River is the chief tributary of the Wabash from the north.

The Tippecanoe has its sources in two groups of lakes situated in the southwestern part of Noble County and in the northern part of Whitley County, Indiana.

Crane Lake and Crooked Lake, through short outlets, flow into Big or Tippecanoe Lake. Goose Lake, New Lake and Old Lake flow into Loon Lake. The outlet of Tippecanoe Lake flows westerly and northerly about two miles, where it joins the outlet of Loon Lake, forming Tippecanoe River. This stream flows northwesterly about five miles into Smalley Lake, and thence westerly  $1\frac{1}{2}$  miles into Baughner Lake, thence south of west through marshes and ponds  $1\frac{1}{2}$  miles into a mill-pond, called "the Dam;" thence northwesterly through Kaiser Lake, the Backwater and the Channel about  $3\frac{1}{2}$  miles into Boydstone Lake, in the eastern part of Kosciusko County; thence westerly about two miles into Tippecanoe Lake, of Kosciusko County.

Through the greater part of this distance there is quite a distinct valley. It varies greatly in width and in the height and steepness of its bluffs. This valley, these lakes and ponds, the marshes and connecting streams are in or on a mass of glacial materials that was probably deposited from the Erie Lobe of the continental ice sheet. These materials help to form what Frank Leverett calls the Mississinewa Moraine. This moraine extends from White County northwesterly to Steuben County. It covers Noble County and large parts of Steuben, Lagrange, Dekalb, Whitley, Kosciusko, Fulton, Wabash, Miami, Cass and White counties. It includes the northern portion of Dr. C. R. Dryer's Mississinewa—Eel Moraine.

Dr. Dryer says "it is an irregular, variously undulating pile of clay, sand, gravel, and boulders, with a total thickness of from 200 to 485 feet.

Its topography defies verbal description, but may be included under a few general types. The greater part of the area may be designated as *crumpled*. The ridges have no particular direction, their tops are broad and slopes gentle, yet there is very little level ground. This type passes by insensible gradations into the *corrugated*, in which the ridges are steeper, sharper and arranged in somewhat parallel lines. Similar features much exaggerated produce what may be called *gouged* or chasmed regions. The surface is entirely occupied by deep, irregular, elongated valleys with narrow, sharp, winding ridges between, all in indescribable confusion, and everywhere ponds and swamps, marshes and lakes." The greater part of the lakes of Indiana are in this moraine. The Pigeon, Fawn, and Elkhart rivers drain a large section of this moraine into the St. Joseph of Lake Michigan. Cedar Creek drains a small portion into the St. Joseph of Lake Erie; while the Eel and Tippecanoe rivers drain the balance into the Wabash.

#### CRANE LAKE.

Crane Lake, 30 to 35 acres in extent, lies mainly in the N. E.  $\frac{1}{4}$  of Section 33, Town 33 north, Range 9 east, Noble County, Ind. It is nearly a half mile long from N. E. to S. W. and about 40 rods wide. It is surrounded by marsh and swamp on all sides. Its chief tributary is a little stream about a mile long from the northeast, which drains the W.  $\frac{1}{2}$  of Section 27. Its outlet is by a ditch across a swamp westerly about  $\frac{1}{4}$  of a mile into Big Lake. The banks and surrounding regions are not more than ten feet above the water of the lake and before ditching they were probably not more than four feet above the water. The bottom is of soft mud and the slopes of the bed are rather abrupt, except in the southwest. Soundings at intervals of about 100 feet, commencing on the northeast, were as follows: 50 feet out, 15 feet deep; 150 feet out, 19 feet; then 15, 20, 24, 26, 32, 32, 30, 23, 26, 20, 19, 19, 19, 18, 17, 15, 10, 10, 10, 10, 10 feet, and 1 foot in the outlet ditch.

#### CROOKED LAKE.

The eastern extremity of Crooked Lake is in the southeast corner of the N. E.  $\frac{1}{4}$  Section 3, T. 32 N., Whitley County, Ind. It extends northwesterly about  $1\frac{1}{2}$  miles into the S. E.  $\frac{1}{4}$  Section 33, Noble County, and has an area of about 300 acres. A ridge about  $\frac{1}{4}$  mile wide and 18 feet high divides the east end of Crooked Lake from Cedar Lake which drains into Eel River. About the northern part of the lake there is considerable

low, swampy land, and the country back of the swamp rises scarcely ten feet above the lake. Farther south clay hills rise abruptly to an elevation of 25 or 30 feet on both sides of the lake. The road running N. and S. east of the lake crosses five massive clay ridges trending east and west within a mile, each rising 30 feet or more above the lakes. There are three small islands and considerable shallow water in the southwestern part of the lake and the northern

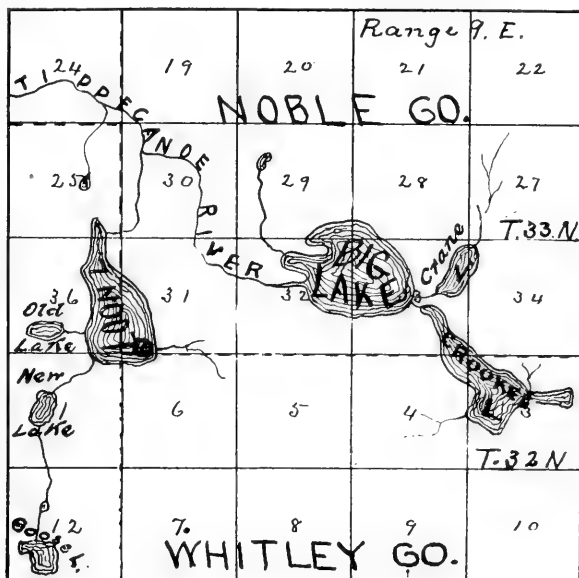

part is rather shallow, but fully one-half the area is covered with deep water. The area drained into the lake is very narrow. I saw only one inlet and that was short and small. Soundings, at intervals of about 80 feet, commencing on the east and following the axis of the lake, were as follows: 24, 30, 30, 30, 30, 36, 42, 36, 36, 30, 24, 21, 18, 9, 6, 4, 4, 6, 6, 18, 21, 27, 33, 39, 45, 45, 45, 45, 39, 42, 60, 75, 81, 81, 84, 87, 90, 95, 96, 102, 102, 102, 105, 106, 106, 105, 105, 106, 105, 105, 105, 105, 96, 93, 93, 96, 99, 93, 81, 81, 81, 96, 99, 100, 99, 96, 99, 84, 75, 54, 42, 21, 27, 30, 42, 45, 45, 48, 45, 42, 36, 30, 27, 27, 27, 30, 30, 27, 27, 21, 15, 12, 12, 12, and 4 feet among the lily pads near shore.

Going east on the county line, at intervals of 160 feet, I found water 66, 96, 96, and 66 feet deep.

The lake is well stocked with fish—bass, bluegills, perch, grass-pike, and others. Under much of the shallow water there is an abundance of workable marl.

#### TIPPECANOE LAKE, OR BIG LAKE, NOBLE COUNTY.

This lake occupies parts of sections 28, 29, 32 and 33, Town. 33 N., Range 9 east. It formerly had an area of about 400 acres, but a ditch has lowered the water about 7 feet and reduced the area to about 300 acres.

Before ditching, fully one-half the area was less than 10 feet deep. There is still considerable shallow water in the southeast and southwest portions of the lake, but much the greater part of the area is deep water. The bluffs are low, not more than 10 to 15 feet above the water. The ditching caused the destruction of a great mass of vegetation, and so changed the environment of another great body of plant life that it will be many years before the vegetation can adjust itself to the changed conditions and reach a stable equilibrium. At its present level the lake cannot support as much vegetation as formerly. The lake is famous for the quantities of fish found in its waters, but they are not as plentiful as formerly. On the southwest we found water 30, 35, 46, 47, and 36 feet deep, and going northwesterly along the axis of the lake at intervals of about 200 feet we found water 50, 65, 72, 65, 50 and 38 feet deep. Deeper water was claimed, but we could not find it. There is considerable marl in the lake bed, but it is not a workable deposit.

#### GOOSE LAKE.

This lake is in the southwest  $\frac{1}{4}$ , section 12, Town 32 N., Range 8 E., Troy Township, Whitley County. It has an area of about 150 acres. It is surrounded by considerable swamp and low land, in which are several small ponds. Back of these are several morainic hills rising from 30 to 50 feet above the surface of the lake. The slopes of the lake bed are rather steep and the water is in general quite deep. The lake has been lowered about 6 feet by a ditch. This drained adjacent swamps but lessened the area of the lake by only a few acres. Fishing is said to be fairly good. Commencing on the south and going northerly and westerly at intervals of about 100 feet we found the depth as follows: 100 feet out, 17, 20, 29, 30, 34, 34, 34, 37, 37, 41, 50, 54, 57, 62, 63, 62, and 61 feet; westerly,



53, 37, 37, 30, 31, 35, 38, 37, 36, 42, 50, 45, 37, 28 and 14 feet about 75 feet to shore. In the western part of the lake south of the line of soundings just given we found water 45, 57, 62, 54, 35, and 25 feet to south shore. The outlet ditch runs northerly from the northwest part of the lake, into Dollar Lake, thence into New Lake.

#### NEW LAKE.

New Lake, having an area of about 60 acres, is situated near the center section 1, Troy Township, about  $1\frac{1}{2}$  miles north of Goose Lake. It is surrounded by low, gently sloping hills, and is bordered on the east by broad areas of *Scirpus americana* and *Scirpus lacustris*. Commencing at the southeast and going northerly at intervals of about 100 feet, we found soundings as follows: 15, 12, 20, 39, 30, 29, 30, 31, 38, 43, 38, 34, 26, 23, 21, 22, 23, 26, 36, 37, 34, 31, 21, and 6 feet among the lily pads near shore. The outlet is by a ditch northeasterly about half a mile into Loon Lake.

#### OLD LAKE.

Old Lake, about the same size as New Lake, is situated about a half mile north of New Lake in the S. W.  $\frac{1}{4}$ , Sec. 36, Town. 33 north, Range 8 east, Etna Township, Whitley County. The shores are low and swampy or marshy. Considerable areas of swamp land to the west drain into Old Lake. The outlet is easterly a half mile or so into Loon Lake. Soundings at intervals of about 100 feet, going easterly, as follows: 25 feet out, 12, 30, 31, 31, 31, 27, 27, 32, 40, 42, 45, 45, 45, 43, 37, 34, 30, 28, 25, 21, and 15 feet 100 feet to shore.

#### LOON LAKE.

Loon Lake lies mainly in the east half of Sec. 36, Etna Township, Whitley County, and in the west half of Sec. 31, Noble Township, Noble County. It has an area of about 240 acres. A drainage ditch lowered the level of the lake about 7 feet, greatly lessening the area, and reducing the proportion of shallow water. Lowering the lake uncovered large areas of muck, marl and sand. Some of the muck is well covered with vegetation, but the sand and marl are still quite barren after six years of exposure. There is considerable marsh land and swamp in the west, but on the south, east and north there are low bluffs rising 10 to 15 feet above the lake. To the northwest of the lake there are some hills that rise fifty feet above the lake. Commencing at the south and working northerly along the axis of the lake at intervals of about 136 feet we found depths as follows:

136 feet out, 18, 42, 39, 24, 39, 48, 57, 66, 66, 81, 75, 63, 51, 36, 33, 54, 36, 30, 21, 18, 21, 33, 36, 39, 36, 36, 33, 24, 27, 39, 42, 48, 48, 36, 27, 27, 33, 33, 18, and 2 feet among the lily pads. Going north from island about 40 rods east of the above line we found, 150 feet out, 15 feet, and at intervals of 136 feet, 36, 48, 54, 54, 33, 57, 63, 60, 60, 57, 39, 27, 24, 27, 33, 36, 51, 54, 45, 33, 33, and 18 feet 136 feet to shore. Going westerly from the island, at intervals of about 136 feet, as follows: 21, 24, 27, 39, and 57 feet, near station 7 on first line, 60, 93, 93, 93, 93, 81, and 48 feet, the water shoaling rapidly to the west.

The soundings show a large area of deep water and a very uneven bed. Fishing is fairly good but not as good as before the lake was drained.

The outlet flows from near the north end of the lake easterly a few rods, then north a half mile or so, where it joins the outlet of Tippecanoe Lake, forming Tippecanoe River, which flows westerly into Smalley Lake, draining on the way considerable areas of marsh and swamp.

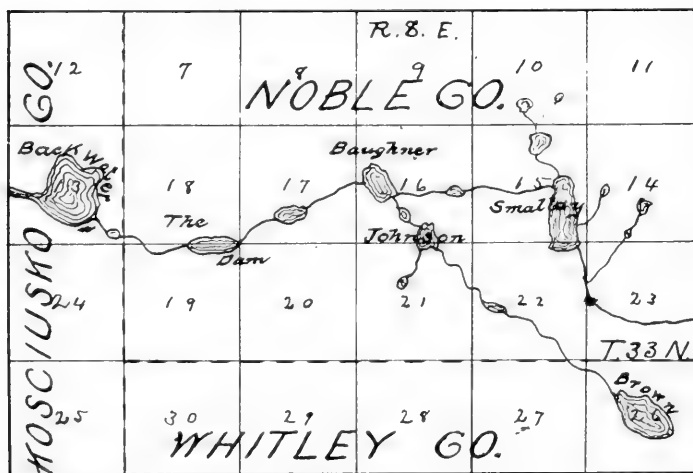

#### DOLLAR LAKE.

This lake, having an area of 12 to 15 acres, is situated near the center of Sec. 25, a little northwest of Loon Lake. Hills rise abruptly from the shore of this lake to an elevation of about 50 feet. A narrow zone of marsh surrounds the lake. The slopes of the lake bed are steep. The

soundings were 26, 30, 37, 44, and 51 feet. The water was reported much deeper, but we found only 51 feet. The outlet is northerly into the river in the S. E  $\frac{1}{4}$  Sec. 24.

#### SMALLEY LAKE.

Smalley Lake, having an area of about 80 acres, lies mainly in the S. E.  $\frac{1}{4}$  Sec. 15, extending a little way into the N. E.  $\frac{1}{4}$  Sec. 22, Washington Township, Noble County. There is considerable low land on the south and east, with low bluffs 12 to 20 feet on the west and northwest. A little stream drains three small ponds and some marsh land into the northern part of the lake and two ponds with some low land on the east are drained into the lake or the river just south of the lake. Commencing at the inlet and going northwesterly we found at intervals of about 100 feet water as follows: In mouth of inlet, 1 foot; 100 feet out, 8, 16, 28, 35, 37, 37, 38, 38, 39, 39, 39, 40, 40, 39, 39, 38, 38, 38, 39, 40, 42, 38, 32, 21, 25, 25, 20, and 12 feet; 3 feet near the head of the outlet, water in the outlet about 8 inches deep and 10 feet wide. From Smalley Lake near the center of Sec. 15 the river flows westerly about  $1\frac{1}{2}$  miles into Baughner Lake, draining on the way a wide tract of low swamp land and Gallup's pond or lake, having an area of about three acres, near the center of Sec. 16. It is reported to be shallow.

#### BAUGHNER LAKE.

This lake is located just west of the center of Sec. 16 and has an area of about 30 acres. We did not make any soundings in this lake. It is reported as rather shallow, not more than 20 to 25 feet. Baughner Lake receives considerable water from the southeast through Johnson Lake and its tributaries.

#### BROWN LAKE.

Brown Lake is in the center of section 26, Town. 33 N., Range 8 E. It has an area of about 30 acres. It is somewhat elliptical in form, being longer from southeast to northwest. Commencing on the southeast, at intervals of about 100 feet, we found water as follows: 100 feet out, 21, 29, 39, 47, 48, 44, 46, 46, 46, 42, 37, 31, 29, 26, and 21 feet, and 6 feet in the lily pads about 20 feet from shore. There is some swamp land to the southeast and considerable marsh land on the north, but the zone of wet land is narrow on the south. The slopes are gentle on all sides, the highlands rising to 20 to 30 feet above the lake. The slopes of the lake bed seemed to be abrupt on all sides. The lake is drained northwesterly by

a ditch into McDonald Lake or pond, in the western central part of Sec. 22, thence northwesterly into Johnson Lake, on the north line of Sec. 21, which has an area of about 10 acres. Water is reported deep, 30 to 35 feet. Baker Lake or pond, a little northwest of the center of Sec. 21, drains into Johnson Lake. The outlet of this lake flows northwesterly through a pond and surrounding marsh into Baughner Lake. The outlet of Brown Lake drains a wide area of land, but there is considerable wet land along this valley that the present ditch does not drain. Two other ponds in Sec. 16 are drained into Baughner Lake. From this lake the river runs a little south of west about  $1\frac{1}{2}$  miles into "the Dam," a pond on the line between sections 18 and 19, so that it is in the S. E.  $\frac{1}{4}$  Sec. 18 and N. E.  $\frac{1}{4}$  Sec. 19. It has an area of about 15 acres and was formed by a dam about 10 feet high. It is shallow and abounds with vegetation. From "the Dam" the river flows westerly and northwesterly through Keiser Lake, small and shallow, into the Backwater, a shallow body of water occupying a large part of the south half of Sec. 13, Town. 33 N., Range 7 W., Kosciusko County; thence northwesterly through "the channel" into Boydstone or Webster Lake, in sections 10, 11, 12, 14 and 15, Tippecanoe Township, Kosciusko County, Ind.

## CAVES AND CAVE FORMATIONS OF THE MITCHELL LIMESTONE.

BY F. C. GREENE.

## THE MITCHELL LIMESTONE.

The Mitchell limestone, otherwise known as the St. Louis, barren, or cavernous limestone, is a bluish or grayish, hard, compact, even-grained stone, generally having a conchoidal fracture. It is so compact as to make it rather impervious. Intercalated layers of blue-gray shale are frequent. Large concretions or chert are characteristic of certain horizons. When the stone weathers, these masses of chert do not dissolve, but break into more or less angular fragments which strew the ground over the Mitchell area. In Indiana the formation is also characterized by the common presence of a genus of corals known as *Lithostrotion* or *Lonsdaleia*. In some places, such as western Monroe or southern Crawford County, there is a typical white oölite found near the top of the formation.

Analysis shows the Mitchell to be a very pure calcium carbonate, and at Mitchell, Lawrence County, from which place the formation received its name, it is extensively quarried for making lime and cement.

It is found in Harrison, Floyd, Crawford, Washington, Orange, Martin, Lawrence, Monroe, Greene, Owen, Morgan, Putnam, Parke, and Montgomery counties.\* It extends south into Kentucky and west into Illinois, where it exhibits similar characteristics.

In the southern part of the State it reaches a thickness of 350 to 400 feet; in the central part of its area, that is, in Lawrence and Monroe counties, the thickness is from 150 to 250 feet, and from here gradually thins toward the north.\*\*

The greater part of the Mitchell lies in the non-glaclated portion of the State, thus exposing an erosion topography unaffected by other agencies. Several factors enter into the cause of its present topographic aspect. During Cretaceous time the area in which the Mitchell is located was eroded to base level, forming part of the great Cretaceous peneplain. After this event had occurred, a period of elevation began so that erosion

---

\*Hopkins, T. C., 28th An. Rept. Ind. Dept. Geol., p. 57.

\*\*Op. cit., p. 58.

again commenced to cut down the surface, and probably during the Tertiary period, it again reached partial peneplanation with a few monadnocks here and there standing above the general surface. It is this Tertiary peneplain which gives the country its level appearance when viewed from a distance. Since this second peneplanation, the country has probably been relatively elevated to the present time. The western edge of the Mitchell area is overlain by the Huron formation, which, by reason of its hard and soft strata, has taken on a very rugged aspect. To the east of this belt level lies the central or slightly rolling area of the Tertiary peneplain, while to the east of this, the eastern edge again becomes rolling, owing to the underlying Salem and Harrodsburg limestones.

The Mitchell has a dip to the southwest which probably averages 20 to 30 feet to the mile. This affects surface streams, though these are very few, owing to the extensive underground drainage.

The general relief of the surface of the Mitchell area becomes greater toward the Ohio River. This is probably due to at least three causes, namely, the dip to the southwest, the increasing thickness of the formation, and the fact that the Ohio River is the largest stream draining the area and has cut down to the lowest level of any stream in the area under consideration. In the vicinity of Wyandotte Cave the general level of the upland is about 300 feet above the level of Blue River.

The Mitchell limestone has long been known as the "Cavernous limestone." Both the Wyandotte Cave of Indiana and the Mammoth Cave of Kentucky occur in its strata. In three counties in the vicinity of Mammoth Cave, over five hundred caves are known to exist. These facts lead us to investigate the general adaptability of this limestone to cave formation.

The reasons of this adaptability are numerous. Besides the bedding planes, two sets of vertical joint-planes exist, one set having a general east and west direction and the other a north and south direction. Vertical joint-planes are probably more numerous in this, than any other of the Mississippian limestones. Owing to the fact that the Mitchell is rather impervious and often of a lithographic nature, the down flowing water is forced to follow the joint and bedding planes. The underlying Salem limestone contains joint-planes but is porous enough to become thoroughly saturated instead of confining the water to joint-planes.

The Mitchell limestone has a great thickness of rocks of nearly uniform texture. It is composed of nearly pure calcium carbonate, which renders

it soluble to meteoric water. Many of these facts are brought out by Cumings in his paper, "On the Weathering of the Subcarboniferous Limestones of Southern Indiana," in the Proceedings of this society for 1905, pages 85-100. The great central area is practically level, owing to Tertiary peneplanation, thus lessening the amount of run-off. The western part of the area is overlain by the Huron formation, composed largely of porous sandstone which absorbs precipitation and passes, a part of it, at least, downward into the underlying Mitchell. The area as a whole is wooded, which also tends to hold meteoric water rather than to give it up to such surface drainage as exists. The area in Indiana lies in a section of country which is one of relatively great humidity.

The individual layers of the formation are comparatively thin and are generally separated by thin layers of impervious shale. This factor tends to weaken the layers when a cave is formed beneath them and allows them to collapse, thus giving the stream the opportunity of enlarging the cave in a mechanical way by removing the debris.

#### FORMATION OF CAVES.

Limestone ( $\text{CaCO}_3$ ) is only slowly and difficultly soluble in pure water, but when water descends through the atmosphere as in rain and snow, a certain per cent. of  $\text{CO}_2$  is dissolved, forming  $\text{H}_2\text{CO}_3$ . This is enabled to dissolve calcium carbonate, forming calcium bicarbonate thus:  $\text{H}_2\text{CO}_3 + \text{CaCO}_3 = \text{CaH}_2(\text{CO}_3)_2$ . The latter product remains in solution until evaporation takes place. It is owing to this fact that stalactites and stalagmites are formed in caves.

Now when rain-water falls on an area such as that underlain by the Mitchell limestone where the conditions favor a minimum amount of run-off and evaporation, and where the greater amount of precipitation soaks into the soil, it will tend to collect and flow downward through the most available passages. Such passages are furnished by the above-mentioned joint-planes. Where two of these joint-planes cross at right angles, the passage will be freest and it is probably at such points that most of the ground-water passes downward. This downward flow of water may be arrested by several causes, four of which are most important. The joints become tighter as they descend into the earth; the level of ground-water, where the flow in the joints is retarded, may be reached; an unusually impervious layer of limestone or shale may be present; or what is probably most important, a level corresponding to that of the local base level

of erosion may be reached and divert the downward moving water. Any or all of these causes may change the downward flow of water into lateral flow, although in time they may cease to have this function, owing to chemical or mechanical erosion.

Locally other factors may enter into the stoppage of the downward flow. These may be greater hardness or impurities of the limestone, etc.

The horizontal flow will naturally follow the line of least resistance, which will be along the line of one of the joint-planes. Thus young caves and many which are older, follow approximately straight north and south, and east and west lines and have right-angled turns. The direction of the cave stream will be determined by local conditions, such as hardness, dip, solubility and nearness to surface streams.

At first the erosion will be by solution, but in time the cave stream will come to be governed by much the same laws as surface streams and corrosion will do its share in enlarging the cave. The original downward opening will become larger and surface material with its hard, angular pieces of chert, and soil will be washed into the opening, and sinkholes such as are characteristic of the Mitchell area, will be formed. In time these become very large, occasionally containing many acres; however, it may be said that the very large sinkholes (and these only) are formed by collapse of caves.

In the young cave there will be no evidence of any erosion except that by solution. The water is very clear and contains a minimum amount of solid matter; the cave will be bounded on all sides by solid rock walls and angular protuberances will be everywhere conspicuous.

So much for the common type of a very young cave. A multitude of factors determine the size and shape of a cave as it grows older. Much depends on the level of the surface stream into which the cave stream flows. If the surface stream is much lower than the level on which the cave stream flows, the latter will cut down rapidly, other things being equal, thus forming a narrow and deep cave such as is seen at the entrance of Shawnee Cave in Lawrence County, or in Wyandotte Cave. If the level of the surface stream is near that on which the cave stream flows, the tendency will be toward lateral erosion, and the cave will cut downward only as rapidly as does the surface stream of which it is a tributary.

Most of the surface streams and probably all of the cave streams of the area had their origin since the Tertiary peneplanation. The Mitchell area has been elevated since then, as was mentioned above, but owing to



the fact that this elevation has been more or less interrupted, the surface streams have developed terraces and the caves near the Ohio and its older tributaries have in some cases four or five levels, probably due to the same cause. Only the lowest of these levels will contain water at the present time. The four or five levels of passages in caves in the region under discussion may have had other local causes, such as differences in hardness or solubility, etc. It is not meant that all caves in this region have several levels, for new caves are continually being formed.

The bedding planes being planes of weakness, the cave will be broader at the bedding planes than between them. (Fig. 1.) Softness or unusual solubility of a particular layer will cause a broadening of the cave, while hardness or insolubility will result in a narrowing. If a cave is following some particular joint-plane, a cross joint (which perhaps carries a larger or smaller stream) will cause a decided broadening, due to the weak spot caused by the cross-joint.

When a particular cave stream reaches temporary base level it will cease downward cutting and begin eroding laterally. In this case the stream is generally supplied with abundant abrasive material. In time this will produce a cave with a sort of an inverted T-shape. (Fig. 2.) Owing to the thinness of the layers, in time this will cause a collapse of the sides and roof, such as has taken place in many parts of Wyandotte Cave. (Fig. 3.)

If such action takes place where two joints cross, the amount of rock precipitated from the roof and walls will be enormous, producing such a mound as Monument Mountain in Wyandotte, where a mound over one hundred feet high has been formed. In the upper part of Shawnee Cave, Lawrence County, the lateral erosion has been very great and in some places in this and also in Wyandotte Cave, this tendency has resulted in the collapse of the floor of an older passage above. Thus it will be seen that the floor of an old cave will be apt to be rough and rocky instead of level, although there are cases where the stream has suddenly found another outlet, leaving an old cave with a smooth and firm floor.

Most of the old caves and some of the younger do not follow straight cardinal lines or have right-angled bends. In young caves this is due to a tendency of the stream to straighten its course just as a surface stream does, although hardness and solubility of the rock play a large part. (Fig. 4.) For example, if on one side of a joint-plane which a cave stream is following, there is a particularly soluble spot, there will probably be a

bend or curve developed at the soluble place. (Fig. 5.) In old caves these factors, together with that of collapse from lateral erosion after base level has been reached, change the shape so that a straight line or right-angled bend is seldom seen.

#### SPECIAL PHASES—PITS AND DOMES.

Many caves are characterized by pits and domes. The former may be formed in two ways. Where there is a particularly soft or soluble place in the floor of a cave, the hard, angular fragments of chert will congregate, and by a whirlpool-like abrasion and solution, a pot-hole will be produced. These sometimes reach large dimensions, as in Wyandotte, where pits twenty or thirty feet deep have been formed. In one particular passage of Wyandotte, the downward erosion has been very rapid, so that the stream has cut down to a lower level, leaving several natural bridges of solid rock.

The second type of pit and the domes are related. Often where two sets of vertical joint-planes cross, the water trickling down will dissolve out an erosion dome. In Mammoth Cave of Kentucky, these domes often reach a height of one hundred feet or more. They may be formed down to the level of the passage along one of the joints, in which case they are simply domes, or they may continue eroding after one passage has been deserted by the stream and continue to erode to a lower level occupied by another stream, thus forming a pit or dome according to the level from which they are viewed. (Figs. 6 and 7.)

#### CAVE ENTRANCES.

Cave entrances may be formed in four principal ways. A sink-hole may become large enough to serve as an entrance, either by corrosion and solution, or by subterranean solution of the dome-forming type. Ropes, ladders, or steps are generally needed in this type of an entrance. The entrances to Little Wyandotte and Marengo caves of Crawford County are of this type.

Another and common type of entrance is that by way of the mouth of the out-flowing cave stream. In a young cave this is apt to be on the horizontal; but when one mouth is abandoned for another at a lower level, weathering produces a curious change. The rocks above the cave mouth will weather and fall to the floor, thus causing the entrance to progress up the slope and a great pile of debris to collect on the original floor of the cave. (Fig. 8.) The entrances to Wyandotte and Saltpeter caves

of Crawford County, and Mammoth Cave of Kentucky are of this type. A shaft was sunk to the depth of sixty feet at the mouth of Wyandotte before the solid rock floor was reached.

A cave stream may undermine the rock beneath a low place such as a sink-hole, causing the overlying strata to collapse. In this case there will be two entrances at the place where the cave-in occurred. Should atmospheric agencies weather back the two entrances the cave stream will flow above ground for a greater or less distance. This action has occurred twice in Shawnee Cave, Lawrence County, and the surface portions of Lost River, Orange County, have probably come about in an analogous manner.

A fourth type of cave entrance is that produced by a surface stream eroding its way into a cave; but this type is probably common only in regions of great relief, such as those bordering the Ohio, since surface streams of sufficient size to accomplish this are rather rare in the Mitchell belt.

#### MATERIALS DEPOSITED IN CAVES AFTER FORMATION.

It was stated in the second portion of this paper that calcium bicarbonate ( $\text{CaH}_2(\text{CO}_3)_2$ ) was formed by the action of atmospheric water on limestone. This substance will remain in solution until evaporation takes place, when it will split up as follows:  $\text{CaH}_2(\text{CO}_3)_2 = \text{CO}_2 + \text{H}_2\text{O} + \text{CaCO}_3$ . The carbon dioxide being 1.5 times as heavy as air sometimes settles in the lower portions of caves, rendering them dangerous, but this is not often the case in the caves of the Mitchell area owing to the presence of air currents which remove the gas. The  $\text{CaCO}_3$  will remain as stalactitic and stalagmitic deposits. Owing to the fact that in the lower and younger parts of the cave, which contain water, the air is generally saturated so that evaporation is at least not rapid, the calcareous deposits are found in greatest abundance in the higher and drier passages.

In the deposition of calcareous material the joint-planes again play a prominent part, due to the fact that water is able to find its way down through them. Very often the vertical joint along which a cave was formed will be marked overhead by a row of stalactites and sometimes by a row of stalagmites on the floor beneath. Where two joints cross each other the deposition is apt to be greatest. In Wyandotte cave in two places where large piles of rock have fallen (Senate Chamber and Monument Hill) owing to cross joints, the piles of rock are crowned with large stalagmites directly beneath the crossing of the vertical joints.

Often the water does not evaporate right at the base of the joint but trickles down the side walls, depositing a coating of calcareous material there.

In Milroy's Temple, Wyandotte cave, and in Shawnee cave, Lawrence County, the evaporation has not always taken place at the lower end of the stalactite, but they are curved outward and upward. This is possibly due to the twining tendency in the crystallization of the calcite. Local conditions may give rise to an almost endless variety of these calcareous deposits.

Under certain conditions gypsum and epsomite are deposited in caves, the former as a coating of the walls and as curved crystals or "Oulopholites," and the latter as delicate needle-shaped crystals in the earth of the cave floor. H. C. Hovey in the "Manual of the Mammoth Cave of Kentucky" states that the black deposit on the ceiling of the Star Chamber of this cave is the oxide of manganese. All of these materials are derived from the Mitchell limestone, but owing to its purity are not nearly in such great abundance as the calcite deposits.

The materials deposited on the floors of caves are generally of three classes: fallen rock, chert gravel and nitrous earth. Of the first class there is little to be said, as it has already been mentioned. The chert is derived from the concretions of chert in the limestone. Owing to its insolubility, it remains after all other materials have been dissolved. In Shawnee cave, Lawrence County, it has in places been cemented together by calcite and some oxide of iron to form a hard, firm conglomerate.

The nitrous earth or "saltpeter dirt" is practically always found in passages now abandoned by the streams which formed them. It seems to have been originally the finer portion of the solid matter carried by the cave stream. Some slackening of the current, probably due in most cases to fallen rock, caused this material to be deposited. The deposition then continued until the stream found another outlet. Another source of this fine earth, and probably equally as important, is that of material washed in through crevices and small sink-holes to the passages directly beneath them, which, of course, would be the higher passages of the cave. Now these high and dry passages are the ones most liable to be frequented by bats, and it is probably from the dung of these animals, which, according to Hahn,\* spend about five-sixths of their existence in a dormant state, that the potassium nitrate is derived. Inspection of the earth in a

---

\*Hahn, W. L., Some Habits and Sensory Adaptations of Cave-inhabiting Bats. Biol. Bul., Vol. XV, No. 3. Aug. 1908, p. 190.

dry passage of Shawnee cave, Lawrence County, revealed a multitude of bat bones scattered through this earth, a fact that seems to confirm this theory.

In conclusion it may be stated that local causes may and often do exist that affect the formation of a particular cave and that are diametrically opposed to the factors enumerated above, so that no set of rules or conditions can be formulated for determining the formation of a cave or explaining its formation.

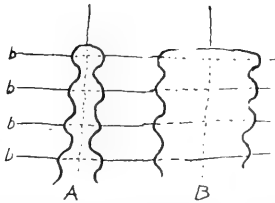

Fig. 1. Showing the effects of bedding planes where the stream has cut down rapidly (A) and slowly (B).

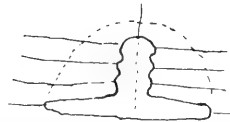

Fig. 2. Showing the effect of long continued lateral erosion. The dotted line shows the curve of greatest strength.

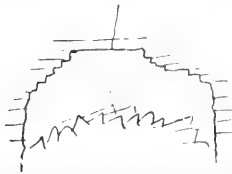

Fig. 3. Showing collapse due to weakness from lateral erosion. The cave has assumed the curve of greatest strength.



Fig. 4. The solid lines show the original cave and the dotted lines the course the stream will seek to pursue.



Fig. 5. Effect of unusually soft or soluble rock.

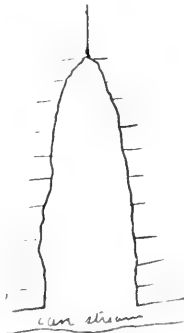

Fig. 6. Dome.

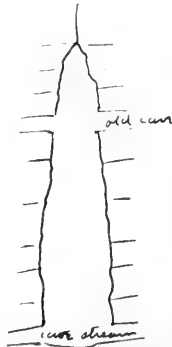

Fig. 7. Pit and dome.

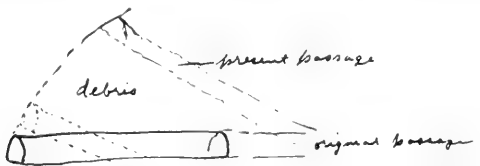

Fig. 8. Progression of a cave entrance up a slope.

THE LIFE ZONES OF INDIANA AS ILLUSTRATED BY THE DISTRIBUTION OF ORTHOPTERA AND COLEOPTERA  
WITHIN THE STATE.

---

BY W. S. BLATCHLEY.

---

During the past twenty years much of my spare time has been devoted to the collecting and classification of the insects of Indiana, especially Orthoptera, or katydids and grasshoppers, and Coleoptera, or beetles. In the report of the Department of Geology for 1902 the results of the work on Orthoptera were published, about 150 species being therein classified and described. The Coleoptera are at present being worked up, and I hope to be able to publish a descriptive catalogue of them within the next two years. Up to the present about 2,700 species have been collected in the State.

The collecting and detailed study of the distribution of the above mentioned insects in Indiana has developed certain facts regarding the life zones of the State which I thought might be of interest. In a map accompanying his paper entitled "Life Zones and Crop Zones of the United States," published in 1898, Dr. C. H. Merriam, chief of the Biological Survey of the U. S. Department of Agriculture, showed the "Upper Austral Zone" as covering the entire State with the exception of a very small area of the Lower Austral in the extreme southwestern corner. The facts brought out regarding the distribution of Orthoptera and Coleoptera in Indiana, which are supplemented by numerous field notes on other groups of insect and animal life, and on the flowering plants, prove conclusively that the "Transition Zone," represented by the Alleghanian fauna and flora, overlaps the northern fourth of the State, while the "Lower Austral Zone," represented by the Austroriparian fauna and flora, overlaps the greater part of the southern third. The Carolinian fauna and flora of the Upper Austral embraces, of course, the prevailing forms of life in the State, 93 of the 148 species of Orthoptera belonging to it. The majority of these range over the entire State, mingling with the representatives of the Alleghanian fauna in the north and with those of the Austroriparian fauna in the southern third. The proportion of Coleoptera belonging to

the Carolinian fauna will be about the same, but the exact figures cannot as yet be given. To the Carolinian fauna belong also the great majority of the other forms of animal life in the State.

As some members of the Academy may not be acquainted with Dr. Merriam's paper I would state that he divides the continent of America, according to the distribution of its animals and plants, into three primary transcontinental regions, viz., Boreal, Austral and Tropical. The Boreal region covers the whole of the northern part of the continent from the Polar sea southward to near the northern boundary of the United States, and occupies also the higher parts of the three great mountain systems, viz., the Sierra-Cascade range, the Rocky and the Alleghany mountains.

The Tropical region is represented in the southern part of the peninsula of Florida only. The Austral occupies the intervening territory, covering the whole of the United States and Mexico except the Boreal mountains and Tropical lowlands.

Each of these three great regions is again subdivided into a number of minor belts or areas, known as zones, and characterized by particular associations of animals and plants, the Austral region, which alone is represented in Indiana, being subdivided into the three transcontinental belts mentioned above, namely, the "Transition," "Upper Austral" and "Lower Austral" zones.

#### THE TRANSITION ZONE.

The uppermost of the three Austral divisions is the transcontinental belt in which the Boreal and Austral elements overlap. In Indiana it is represented in the two northern tiers of counties, which counties embrace several hundred fresh water lakes within their bounds. These lakes range in size from an area of half an acre up to five and a half square miles. About their margins are often extensive areas of low boggy land covered with numerous forms of plant life whose main distribution is far to the north and which have here their southern limit. Among the more characteristic plants of the Alleghanian flora, which are found only in the northern fourth of Indiana, are the following: Larch or tamarack, *Larix laricina* (Du Roi); arbor vitae or white cedar, *Thuja occidentalis* L.; false lily of the valley, *Unifolium canadense* (Desf.); moccasin flower, *Cypripedium acaule* Ait.; showy lady's slipper, *Cypripedium reginae* Walt.; bog orchis, *Archusa bulbosa* L.; fen orchis, *Leptorchis loeselii* (L.); sweet fern, *Comptonia peregrina* (L.); paper or canoe birch, *Betula papyrifera* Marsh; speckled or hoary alder, *Alnus incana* (L.); gold-thread, *Coptis tri-*



*folia* (L.); round-leaved sundew, *Drosera rotundifolia* L.; black chokeberry, *Aronia nigra* (Willd.); round-leaved wintergreen, *Pyrola rotundifolia* L.; shinleaf, *Pyrola elliptica* Nutt.; creeping wintergreen, *Gaultheria procumbens* L.; large cranberry, *Oxycoccus macrocarpus* (Ait.); chickweed wintergreen, *Tricentalis americana* Pursh., purple bladderwort, *Utricularia purpurea* Walt., and the twin-flower, *Linnaea borealis* L.

Among the mammals and reptiles the following representatives of the Alleghanian fauna occur in the northern fourth of the State: Canada porcupine, *Ercthonion dorsatus* (L.); red squirrel or chickaree, *Sciurus hudsonicus* Erxleben; star-nosed mole, *Condylura cristata* (L.); hoary bat, *Atalapha cinerea* (Beauv.); American badger, *Taxidea americana* (Boddaert); speckled tortoise, *Clemmys guttata* (Schneider); and Blanding's tortoise, *Emys melegris* Shaw.

Of the Orthoptera from the State, 23 species, or 15.5 per cent of the total, may be classed as belonging to the Alleghanian fauna and as occupying the southern limits of the Transition Zone, which lies between the Boreal and Upper Austral zones. These truly northern members of our Orthopteran fauna are as follows:

#### INDIANA ORTHOPTERA BELONGING TO THE ALLEGHANIAN FAUNA.

- |                                               |                                             |
|-----------------------------------------------|---------------------------------------------|
| 1. <i>Orphulella pelidna</i> (Burm.)          | 12. <i>Melanoplus extremus</i> (Walker)     |
| 2. <i>Orphulella speciosa</i> (Scudd.)        | 13. <i>Melanoplus angustipennis</i> (Dodge) |
| 3. <i>Stenobothrus curtipennis</i> Harr.      | 14. <i>Phætalioles nebrascensis</i> (Thom.) |
| 4. <i>Mecostethus lineatus</i> Scudd.         | 15. <i>Paroxya scudderi</i> Bl.             |
| 5. <i>Cannula pellucida</i> (Scudd.)          | 16. <i>Scudderia pistillata</i> Brun.       |
| 6. <i>Hippiscus haldemanni</i> (Scudd.)       | 17. <i>Conocephalus robustus</i> Scudd.     |
| 7. <i>Spharagemon wyomingianum</i><br>(Thom.) | 18. <i>Orchelimum indianense</i> Bl.        |
| 8. <i>Trimerotropis maritima</i> (Harr.)      | 19. <i>Orchelimum delicatum</i> Brun.       |
| 9. <i>Schistocerca rubiginosus</i> (Harr.)    | 20. <i>Orchelimum gladiator</i> Brun.       |
| 10. <i>Hesperotettix pratensis</i> Scudd.     | 21. <i>Nemobius paustris</i> Bl.            |
| 11. <i>Melanoplus fasciatus</i> (Walker)      | 22. <i>Nemobius confusus</i> Bl.            |
|                                               | 23. <i>Gryllus arenaceus</i> Bl.            |

No list of the Coleoptera of the Transition Zone has ever been published, but about 1848 Louis Agassiz and other parties made a trip to the northern shore of Lake Superior, and in a volume published in 1850, treating of the natural history and other features of that region, Dr. J. L. Le Conte listed the beetles taken and described many new species. Of these more than forty have been taken in the northern fourth of Indiana

and nowhere else in the State. They occur for the most part in and around the borders of the Tamarack marshes, which are familiar features in many of the counties in this area of Indiana. Numerous other species whose range is given by Le Conte and Horn as "southern border of British America and northern United States" occur in this Transition Zone of the State, and a complete list of them will be given in the paper on Coleoptera when published.

#### THE LOWER AUSTRAL ZONE.

The extreme northern boundary of the Lower Austral life zone passes in a northwest-southeast direction through the following counties in Indiana: Vigo, Clay, Owen, Monroe, Jackson, Jennings, Jefferson and Switzerland. In the territory south of this line the Austroriparian fauna of that zone overlaps and merges with the Carolinian fauna of the Upper Austral zone. The extension northward on the western line of the State is, without doubt, due to the presence of the broad and sheltering valley of the Wabash River, within the confines of which certain southern forms have found a climate mild and suitable to their habits. Within this valley the following members of the Austroriparian flora grow indigenously, a number of them as far north as Terre Haute: Bald cypress, *Taxodium distichum* (L.); upright burhead, *Echinodorus cordifolius* (L.); showy amaryllis, *Hymenocallis occidentalis* (LeC.); pecan, *Hicoria pecan* (Marsh); swamp or downy poplar, *Populus heterophylla* L.; chinquapin, *Castanea pumila* (L.); Texan red oak, *Quercus texana* Buckley; pipe vine, *Aristolochia tomentosa* Sims; American lotus, *Nelumbo lutea* (Willd.); Carolina moonseed, *Ocubatha carolina* (L.); great burnet, *Sanguisorba canadensis* L.; water or swamp locust, *Gleditsia aquatica* Marsh; water ash, *Frazinus caroliniana* Mill, and crossvine, *Bignonia crucigera* L.

Among other characteristic southern plant forms occurring in Indiana south of the northern boundary of the Lower Austral zone are: The yellow pine, *Pinus echinata* Mill.; mud plantain, *Heteranthera reniformis* R. & P.; false aloe, *Agave virginica* L.; Spanish oak, *Quercus digitata* (Marsh); southern hackberry, *Celtis mississippiensis* Bosc.; American mistletoe, *Phoradendron flavescens* (Pursh.); cucumber tree, *Magnolia acuminata* L.; pencil flower, *Stylosanthes biflora* (L.); Carolina buckthorn, *Rhamnus caroliniana* Walt.; yellow passion flower, *Passiflora lutea* L.; Hercules club, *Aralia spinosa* L.; persimmon, *Diospyros virginiana* L.; unicorn plant, *Martynia louisiana* Mill.; catalpa, *Catalpa catalpa* (L.), and the rough button-weed, *Diodia teres* Walt.

The southern mocking bird, *Mimus polyglottos* (L.), nests in numbers as far north as Terre Haute, and the "chuckwills widow," a southern ally of the whip-poor-will, occurs in Knox and Gibson counties; while among the batrachians and reptiles the hellbender, *Cryptobranchus alleghaniensis* (Daud.); the southern cricket frog, *Aeris gryllus* Le Conte; the corn snake, *Ophibolus doliatius* (L.); Say's chain snake, *Ophibolus calligaster* (Say); the bead snake, *Elaps fulvius* (L.); the ground lizard, *Oligosoma laterale* (Say); the alligator snapping turtle, *Macrochelys lacertina* (Schweigger), and the yellow-bellied terrapin, *Pseudemys troosti* (Holbrook), all forms whose main distribution is far to the south, find in southern Indiana a congenial abiding place.

It is not strange, therefore, that we find living with these plants and animals a number of Orthoptera and Coleoptera whose range has heretofore been thought to be confined to the region mapped by Merriam as the "Lower Austral." Thirty-two of the 148 species of Orthoptera, or 21.6 per cent of the total, may be classed as southern forms. They are as follows:

#### INDIANA ORTHOPTERA BELONGING TO THE AUSTRORIPARIAN FAUNA.

- |                                                      |                                             |
|------------------------------------------------------|---------------------------------------------|
| 1. <i>Temnopteryx deropeltiformis</i><br>Brunn.      | 16. <i>Schistocerca damnifica</i> (Sauss.)  |
| 2. <i>Ischnoptera inaequalis</i> Sauss-<br>Zehnt.    | 17. <i>Melanoplus morsei</i> Bl.            |
| 3. <i>Ischnoptera major</i> (Sauss.-Zehnt.)          | 18. <i>Melanoplus impudicus</i> Scudd.      |
| 4. <i>Stagmomantis carolina</i> (L.)                 | 19. <i>Amblycorypha uhleri</i> (Brunn.)     |
| 5. <i>Gonalista grisea</i> (Fab.)                    | 20. <i>Conocephalus bruneri</i> Bl.         |
| 6. <i>Anisomorpha ferruginea</i> (Pal. de<br>Beauv.) | 21. <i>Atlanticus dorsalis</i> (Burm.)      |
| 7. <i>Tettix arenosus</i> Burm.                      | 22. <i>Camptonotus carolinensis</i> (Gers.) |
| 8. <i>Neotettix hancocki</i> Bl.                     | 23. <i>Ceuthophilus stygius</i> (Scudd.)    |
| 9. <i>Tettigidea spicata</i> Morse.                  | 24. <i>Ceuthophilus uhleri</i> Scudd.       |
| 10. <i>Tettigidea lateralis</i> (Say).               | 25. <i>Myrmecophila pergandei</i> Brun.     |
| 11. <i>Syrbula admirabilis</i> (Uhl.)                | 26. <i>Nemobius canus</i> Scudd.            |
| 12. <i>Hippiscus phænicopterus</i> (Germ.)           | 27. <i>Nemobius cubensis</i> Sauss.         |
| 13. <i>Mestobregma cinctum</i> (Thom.)               | 28. <i>Gryllus firmus</i> Scudd.            |
| 14. <i>Trimerotropis citrina</i> Scudd.              | 29. <i>Miogryllus saussurei</i> (Scudd.)    |
| 15. <i>Leptygma marginicollis</i> (Serv.)            | 30. <i>Phylloscirtus pulehellus</i> (Uhl.)  |
|                                                      | 31. <i>Apithes agitator</i> Uhl.            |
|                                                      | 32. <i>Orocharis saltator</i> Uhl.          |

Of the species listed but four, one of them being the Carolina mantis or rear-horse, *Stagmomantis carolina* (L.), and the others *Camptonotus carolinensis* (Gers.), *Syrbula admirabilis* (Uhl.) and *Orocharis saltator* Uhl., have been taken in small numbers as far north as Marion County; all of the others only south of the line mentioned as forming the northern border of the Lower Austral.

In this Lower Austral zone I have also taken more than one hundred species of beetles whose range heretofore has been given as the Gulf or Southern States. Among them are some of the largest and most striking members of Coleoptera taken within the State, regular "Oh, my! beetles;" that is, those which beget the ejaculation "Oh, my!" when they are noted by persons not especially interested in the order. Among these two of our largest tiger beetles of the genus *Tetracha*; the stag beetle, *Lucanus claphus* Fab.; the rhinoceros beetle, *Dynastes tityrus* Linn.; the unicorn beetle, *Xyloryctes satyrus* Fab., and the fig-eating beetle, *Allorhina nitida* L., are examples most worthy of note.

It will be noted that the line which separates the Lower Austral from the Upper Austral zones in the State corresponds somewhat approximately with the southern border of the glacial invasion of Indiana, and it is more than probable that the ancestors of many of these southern forms existed in southern Indiana in preglacial times, when the climate was much warmer than now. It is also probable that many of these Orthoptera and Coleoptera, as well as a number of those species inhabiting the entire State, advanced into the State from the south as fast as it was uncovered by the receding ice.

#### UPPER AUSTRAL ZONE.

Of the Upper Austral Zone, which covers the greater portion of the State and whose fauna and flora overlap and merge with those of the Transition Zone in the north and the Lower Austral Zone in the south, I have but little to say, as this fauna and flora are the ones whose members are most familiar to all present. Merriam, in his paper above cited, states that counting from the north, the Upper Austral area, represented by the Carolinian fauna and flora, is that in which the sassafras, tulip tree, hackberry, sycamore, sweet gum, redbud and short leafed pine first make their appearance. Along with these trees and shrubs are found the opossum, gray fox, fox squirrel, cardinal, Carolina wren, tufted titmouse, blue-gray gnatcatcher, summer tanager and yellow-breasted chat.

As already mentioned, the great proportion of the Orthoptera and Coleoptera of the State belong to this Carolinian fauna, and a great majority of the same species are found in Ohio, the eastern two-thirds of Kentucky, nearly all of Illinois, Iowa and Missouri and the eastern halves of Nebraska and Kansas.

To the facts above given many others could doubtless be added by those members of the Academy from the extreme northern or southern portions of the State who have studied rather closely the fauna and flora of their respective areas.



ANIMALS OF THE OLYMPIC PENINSULA, WASHINGTON.<sup>1</sup>

BY ALBERT B. REAGAN.

For the past three years I have been making observations on the animals of the Olympic Peninsula as time would permit. These I give below: *Sciurus douglasi* Bach.

This is a very common squirrel. It is colored grizzly rufus to rusty; but in color its tail is very variable. It lives in the coniferous forest and feeds upon the cones.

*Tamias townsendi* Bach. Washington Chipmunk.

A very pretty chipmunk found everywhere to an elevation of 2,000 to 4,000 feet. I saw one specimen at snow line at the head of the Soleduck River.

From the shore line to the snow-capped mountains these squirrels were observed to bark when suddenly disturbed; but when calling each other they uttered a querulous chirp. This squirrel is very shy till it gets "acquainted." Then it becomes quite a pest and a little thief. At the Soleduck springs I have seen them crawl over a person while lying still, and have known them to steal bread off of a table in the same tent where cooking was going on.

*Tamias caurinus* Merr.

Only one individual of this species was seen at timber line in the Happy Lake country.

*Arctomys olympicus* Merr. Olympic Marmot.

I saw only one pair of these animals on a ridge between the Soleduck River and East Fork. Their color was ochraceous yellow. In actions they imitate a prairie dog very much; but in size they are considerably larger. Some are said to weigh as much as twenty-five pounds.

---

1. In identifying the species here given I have used the "Catalogue of Mammals from the Olympic Mountains, Washington," by D. G. Elliot ("Field Columbian Museum Publication 32"), and Jordan's "Manual of Vertebrates," as reference books.

# RAILROADS OF THE OLYMPICS

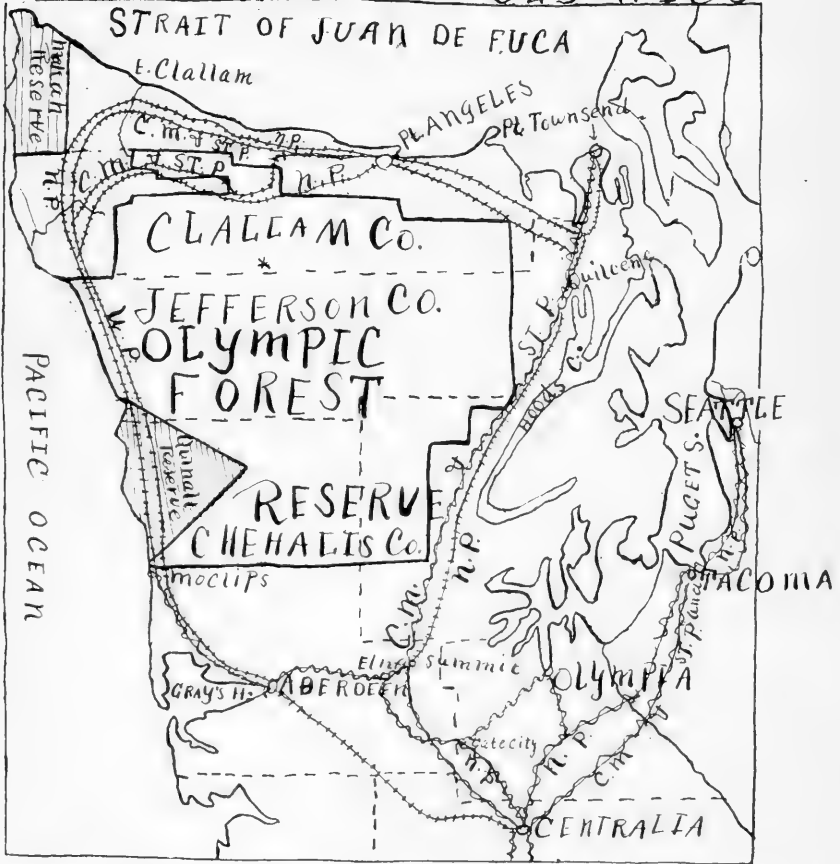

— LINES IN OPERATION. - - - RAILROAD EXTENSIONS TO BE MADE IN THE NEAR FUTURE.



*Sciuropterus alpinus olympicus* Elliot. Olympic Flying Squirrel.

One individual of this species was caught in a trap at La Push by one John Sailto last winter while trapping for mink. This is the only one seen in the region so far as the writer knows. The animal is supposed to be nocturnal in its habits.

*Hoplodontia olympica* Merr. Olympic Mountain Beaver or "Gehalis Farmer."

I have seen several hides of these animals which the Indians had procured to sell to the fur companies; also some captured young. But I have never visited their farms. The natives tell me that these little animals cut down a grass or low lily near where they make their burrows, spread out the hay and dry it in the sun and then take it into their holes to serve as food or bed. These beavers are much smaller than the beavers of the Mogollon Mountains, the only other beavers I have seen.

*Peromyscus akeleyi* Elliot.

This long-tailed, large-eared mouse is a common pest and is to be found everywhere. It rivals the domestic mouse of the Eastern States in its efforts to live in the same house with the master of creation when a cabin is pitched in the forest. But it is more easily caught than its brother mouse; 54 were drowned in a waterpail in a house on the edge of a new clearing near here in one night. In color it is rather dark with an almost black dorsal area. And in size it is a little under that of the domestic mouse. Its tail is as long or longer than the head and body.

*Neotoma occidentalis* Baird. Wood Rat.

A colony of these rats was found at the mouth of the Hoh River. I went to stay all night in a house where a bachelor was staying. The owner said the house was haunted, that the former owner was a sea captain, and that, wrecking his ship on the reefs at the mouth of the river adjacent, his troubled spirit came back at night and thumped and knocked about the floors and house walls. I said nothing but set a "figure four" trap; and the next morning it was not the sailor's spirit that was in it, but instead there was a huge wood rat.

In color this rat resembles *Neotoma cinerea columbiana* very much but is darker, especially along the dorsal area. It has a conspicuous bushy tail. The animal has some very peculiar habits. It carries large sticks of wood around, and when on a floor or anything which will produce a sound it thumps the wood up and down on the sounder for no other purpose, it seems, than that of hearing the noise. It makes its nest of

sticks. Another peculiar characteristic it has is that of "trading;" it never takes anything without leaving something in its place. For this reason it is called the "trade rat" by the settlers. In size it is about as large as a common gray squirrel.

*Erotomys nivarius* Bailey.

This alpine species of mouse was seen only near the Happy Lake country. It lives in colonies. In color its dorsal surface is strongly marked with chestnut, sides of body gray and buff, under parts white, tail bi-color. The tail is half as long as the body.

*Microtus macrurus* Merr.

I found a dead specimen on the trail from Crescent Lake to the Sole-duck Hot Springs. It seems to be rare.

*Microtus morosus* Elliot.

A common species.

*Microtus gregoni* Bach. Meadow Vole.

Not many individuals of this species were seen by the writer.

*Thomomys melanops* Merr. Gopher.

This animal is a common pest in hay fields. In color it is pale brown to reddish, with considerable black about the head and face.

*Zapus imperator* Elliot. Kangaroo Mouse.

This is an abundant species, but hard to catch. In color its sides are buff, back dark, under parts white.

*Sorex vagrans* Baird. Shrew.

Only three individuals of this species were seen.

*Lepus washingtoni* Baird. Washington Rabbit.

Description: Male—Brown from head to tail on back and sides. Chin and lower jaw white to light brown, neck brown beneath, rest of under parts white, legs brown without, front legs white on outside, front of hind legs white, hair reddish brown on flanks just in front of each hind leg, tip of toes of each foot white. Tail short, ending in a tuft of dark hair, color of hair above dark brown, light brown beneath. Anal tuft nearly white. Hind legs from knee to foot on back dark to dark brown. Each front leg has a small linear white spot on front of knee.

Length of head 3.125 in., thickness of head at base of skull 2.625 in., width of base of lower jaw 1.875 in., width of ear at widest part 1.375 in., length of middle front toe 1 in., length of hind leg 11.125 in., length of hind foot and leg beneath the knee 4.875 in., length of hind foot 1.875 in., length

of middle toe of hind foot 1.375 in., length of claw of middle toe of hind foot .5 in., length of neck 2 in., length of body 11 in., length of tail 1.125 in.

Female—The sides of the female are a lighter brown than those of the male and the white of the lower parts have longer hairs of brown scattered through them in numbers enough to make those parts appear light brown. The female is considerably larger than the male.

Both the male and female rabbits walk more on the hind leg from the knee down to the foot than the "cotton tail" does. These rabbits are quite numerous.

*Cervus canadensis occidentalis* H. Smith (*C. roosevelti* Merr.) Roosevelt Elk.

Description: Head, neck, legs, rump black to brown.

This animal is now found principally above three thousand feet elevation. They are not plentiful. I saw seventeen near the Soleduck Hot Springs in August, 1906.

*Odocoileus (Cervus) herminous* Rafin. Black-tailed Deer.

This deer is found principally in the "Frozen Lake" country up near the Olympics proper. It is not plentiful.

*Felis rufa fasciata* Elliot (Raf.).

This animal is large and savage. It is due to the ravages of this animal that the deer and elk have been so reduced in numbers. In color it is a rich chestnut to a mahogany red.

*Canis latrans* Say. Coyote.

Two of these animals were killed by one of the forest rangers last year. They evidently were strays.

*Canis nubilus* Say. Gray Wolf.

These animals are now practically extinct; the settlers killed them by wholesale with poison to keep them from making raids on their sheep ranches.

*Ursus americanus* Pall. Black Bear.

This is a very common animal. It lives principally on berries in the fall of the year. The principal berries it eats are salal, salmon, red elder, thimble, huckleberries and blueberries. It gets fat on berries and is then good eating. In the spring it lives principally on skunk cabbage. It digs it up and eats it root and all. But when the salmon begin to "run" the bear leaves his cabbage garden and his berry patch and turns fisher-

man. And he catches the fish, too. He goes to a ripple and wades out into the water and waits for a fifty pounder to come along, and then he seizes it with his front paws and teeth and drags it ashore. At other times he gets on a log over the stream or on the bank and when the vanguard of the salmon army comes along on its march to the upper tributaries he springs into the water and seizes one of their number; and he seldom misses his aim.

*Mustela pennanti pacifica* Rhoads. The Fisher.

This animal is about the same size as the eastern fisher. Its fur is long, thick and glossy, varying from a jet black to a grizzly gray, especially on the head and neck. The tail is long and bushy. This animal is rare.

*Mustela americana* Kerr. Pine Marten.

In color this animal is brown and not darker below than above, with tawny throat patch. The ears are high and sub-triangular. I have seen but a few of these animals. They seem to be rare.

*Putorius vison encygaminus* Bangs. Mink.

This animal is large and the usual mink color. Some specimens, however, have chin, center of throat and anal regions white, with a few scattering white hairs upon the breast.

*Putorius washingtoni* Merr.

Only two individuals of this species were seen at the head of the Soleduck River.

*Putorius stricatori* Merr.

This is a very common weasel. It has a somewhat variable color, with a black spot thrown in now and then.

*Lutra canadensis* Schreber. American Otter.

These animals are frequently trapped by the Indians. Their skins sell for \$25 or more each.

*Mephitis foetulenta* Elliot.

This is a very common skunk. It is met with principally along the beach, where it feeds on seaweed and shellfish. A dozen of them have been seen on the beach in an hour's walk. They come out usually just before dusk, though an occasional one may be seen at any hour of the day. They are not the least bit shy, as a rule, and are not troublesome unless attacked.

*Spilogale olympica* Elliot.

This is a very common striped skunk. The Indians catch them for their skins; also for the skunk oil, which they use as medicine.

*Scapanus townsendi* Bach. Mole.

In color this animal is black with a silvery gloss; its feet are human skin color.

A stuffed specimen is now in the museum of the Kansas Academy of Science.

*Myotis yumanensis saturatus* Miller. Yellowish-Brown Bat.

This species is quite numerous.

*Procyon lotor* L. Raccoon.

This animal is very common.

*Enhydra (lutris?) marina*. Sea Otter.<sup>1</sup>

This animal is not common; but it is occasionally captured or found dead on the beach.

A starving aged squaw found one on the beach near here some four years ago while looking for barnacles to eat. She put it in her basket and brought it home, skinned it and sold the pelt for more than \$200; then gave a "potlatch" with the money and starved to death herself the next summer.

*Eumetopias atleri*. Sea Lion.<sup>1</sup>

These animals inhabit the jagged island group between Ozette and La Push. I have visited the islands twice, and each time have had the luck to see hundreds of these animals basking in the sun on the rocks, hear their bellowing and see their playing. It is quite amusing to see a sea lion "scratch" himself with his flippers. The Indians kill the sea lion for its flesh, which they relish very much.

*Phoca vitulina*. Hair Seal.<sup>1</sup>

These seals inhabit the rocky islands of the whole coast. The Indians kill them for their flesh and also for their hides. The skins are removed as near whole as possible, turned hair side in, tied up so as to be airtight, then inflated. They are then used as buoys in catching whale. No other wild animal is so useful to the Quillentes.

---

The last three species are sea animals and are classed here only for convenience



THE CIRCULATION OF MIXED BLOOD IN THE EMBRYO MAMMAL AND BIRD, AND IN THE ADULT REPTILE, AMPHIBIAN AND FISH.

---

BY A. G. POHLMAN.

---

Our conception of the course of the blood through the heart of the lower vertebrates appears to be based almost entirely on the conditions found in the adult of the warm-blooded forms (birds and mammals). It is well known that the adult bird and mammal possess a double circulation, i. e., a cycle in which venous blood is propelled from the heart to be returned oxygenated (pulmonary circulation), and one in which arterial blood is expelled to be returned venous (systemic circulation). The afferent and efferent vessels are in no way connected save through a capillary system, and for this reason the heart may be divided into a right or venous and a left or arterial heart. While the greater part of the seventeenth century was occupied with the Harvey doctrine, the eighteenth century found men equally engaged with the course of the blood through the fetal heart. Three distinct theories were suggested before the beginning of the nineteenth century—one based on alleged physiological necessity, a second on the anatomical relations found in the fetal mammalian heart, and a third on the logical deductions from the differences between the fetal and adult circulatory conditions. The differences between the fetal and adult heart in mammals are, briefly, the right auricle receives the precavals (venous) and the post-caval vein (*V. cava inf.*), which is arterial; a communication between the right and left auricle is present (foramen ovale), and a connection is found between the heart efferents (pulmonary artery and aorta) in the ductus arteriosus.

The theory based on physiological necessity (von Haller-Sabatier) was this: if the left heart in the adult is arterial, then the chances are it must also be arterial in the fetus; hence the oxygenated blood in the post-caval vein must pass through the foramen ovale into the left heart. It was further inferred that because the ductus arteriosus short-cut the venous blood from the pulmonary artery into the descending aorta, the vessels arising from the aortic arch would convey a better quality of blood.

The net result of this scheme was that not only did the head and upper extremities receive a better quality of blood, but a right venous and a left arterial heart was maintained and a function was suggested for the Eustachian valve in the right auricle. Unfortunately this doctrine has been antagonized since 1835 with little effect on the described circulation in the mammalian fetus, and with no consideration of its evident defects in the latest text-book (3) on chick embryology. At the last meeting of the Academy I labeled the scheme "morphologically inaccurate, developmentally unnecessary and physically impossible." The second theory (Wolff) was based on excellent anatomical observation but does not fulfil the physical requirements of the proposition. The third theory (Harvey), a mixing of the blood in the right auricle, was quite definitely demonstrated to occur in the living fetal pig. I found by injection experiments that the blood passing into the heart from the right precaval and the postcaval veins found its way into both ventricles. Interpreted in a physiological manner, the result is that all the arteries in the mammalian embryo contain a mixed blood. The point raised, while of no practical importance in itself, is interesting because it was first suggested by Harvey in 1628; because it may lead to a more perfect understanding of the anatomical changes from the fetal to the adult circulation; and lastly because of its morphological significance. It is the latter point that I would bring out in greater detail.

It is well known that the double circulation is found only in the warm-blooded adult vertebrates (bird and mammal); animals in other words, where the body temperature demands a greater degree of oxygenation and in which the oxygenation is entirely confined to the lungs. In the lower vertebrates this condition does not obtain, reptiles excepted. The amphibian has other means of obtaining oxygen than through the lungs, and the fish, other paths than through the gills. The relatively low body temperature does not necessitate so rich a content of oxygen in the blood. If we examine this statement closely we see that the embryos of mammal and bird resemble the reptile and amphibian; they do not possess a distinct four-chambered heart, and while in the latter the element of warmth does not enter, in the former all of the warmth, practically speaking, is supplied by the maternal body through internal or external incubation. The metabolic processes of the mammal and bird are therefore insufficient to maintain the essential body temperature.

If we examine the phylogenetic relation of the mammal and bird we



note that the higher mammals carry the offspring to term; the marsupials have a short period of gestation, and while the young are born in a very immature condition, they are brooded in a sac (marsupium); the monotreme's method does not differ essentially from that of the bird save perhaps in the mode of the incubation of the egg and the postembryonal care of the offspring. It would therefore be a logical inference to grant that the circulatory conditions in the fetal mammal and bird were about the same. Indeed the von Haller-Sabatier theory has been carried over directly to the bird, i. e., the right heart of the fetal bird is described as venous, the left as arterial.

I have stated that the latest text-book on chick embryology translates this blood segregation theory from mammal to bird with no comment on its defects. If the postcaval vein in the chick does carry the arterial blood richly laden with nourishment from the yolk to the left auricle through the foramen ovale, then the relations of the precaval to the postcaval openings must be vastly different from what they are in the mammal—but they are not. Further, if this is a developmental necessity, what is the character of the circulation in the anomalies where the right precaval opens with or into the postcaval? Is it possible for the described conditions to obtain in these cases or in *Rhea americana*, where, according to Gasch (2), the common opening of the right precaval and the postcaval is the normal. I have no experimental evidence to bring up as yet for the mixing of the blood in the right auricle of the bird, but I believe there is sufficient ground for the claim that it occurs from the similarity to the mammal in heart structure, developmental requirements, and from the aberrant types such as I have mentioned.

Phylogenetically the connecting link between bird and reptile is particularly strong; ontogenetically the requirements for development differ only in body temperature (viviparous forms excluded), and we would therefore expect little difference in the character of blood circulation, although the heart structure is quite different. Taking the turtle as the type, the described circulation is about as follows: the right auricle is venous, the left auricle arterial—both open into the incompletely divided ventricle by separate openings. The blood from these two sources is segregated in corresponding parts of the ventricle, and when the ventricle contracts, the incomplete septum touches the ventricular wall, isolating a part of the venous blood in a sort of right chamber of the ventricle. The venous blood is expelled through the pulmonary artery, mixed blood is

sent out through the right aorta, while the left aorta is purely arterial. This is again the same scheme as we found in the mammal and results in the head receiving a better quality of blood.

Experiments were performed on three species of turtles to ascertain if this condition prevailed. The plastron removed and the heart laid bare, a double ligature was passed through the transverse pericardial sinus and arranged to tie one at the distal, the other at the proximal edge of the sinus. Next cornstarch granules suspended in normal salt solution were introduced into the auricles during diastole; the auricle allowed to contract, giving time to have the distal ligature ready to tie off; the distal ligature was tightened during ventricular systole and immediately the proximal one—isolating three columns of blood in the three vessels. These were bled separately into watch glasses containing dilute acetic acid and examined for the granules. It was found that granules injected into the right and left, and in both auricles simultaneously, were always recovered from all three efferent vessels. It must also be remembered that in the turtle the fetal circulation is not unlike that found in the fetal bird—the postcaval vein conveys the oxygenated blood, and if this segregation of blood occurred as described in the adult, the head would receive only venous blood. This objection also holds good in the Crocodilia, where, according to Wiedersheim (6), the condition is as follows: “The blood from the right ventricle passes into the pulmonary artery as well as into the left aortic arch and, according as the septum ventriculorum is complete or incomplete, is either entirely venous (Crocodilia) or mixed (other reptiles). A complete septum ventriculorum thus appears for the first time in crocodiles, in which, consequently, the right ventricle contains unmixed venous blood and the left ventricle unmixed oxygenated blood, although, as will be seen presently, an admixture takes place in the systemic arteries.” Again, according to this scheme, the head will receive a better quality of blood because the carotids arise from the left aortic arch, but again the objection as to the manner of transformation from the fetal crocodile to the adult crocodile heart would arise. This form certainly needs careful investigation. The purely venous blood would far exceed the purely arterial, and the mixture at the foramen of Panizza might be very complete.

The amphibian circulation is naturally described on the basis of the segregation of blood and must therefore fall into two classes, the anural and the urodele. The description of the anural circulation is delightfully

exact and comprehensive and is as follows: "It will be perceived that the blood poured into the right auricle is mostly impure or venous, that poured into the left fully aerated or arterial. When the auricles contract, which they do simultaneously, each passes its blood into the corresponding part of the ventricle, which then *instantly* contracts before the venous and arterial bloods *have time to mix*. Since the conus arteriosus springs from the right side of the ventricle, it will at first receive only venous blood, which, on contraction of the conus, might pass either into the bulbus aortae or into the aperture of the pulmo-cutaneous trunks. But the carotid and systemic trunks are connected with a much more extensive capillary system than the pulmo-cutaneous, and the pressure in them is proportionately great, so that it is easier for the blood to enter the pulmo-cutaneous trunks than to force aside the valves between the conus and bulbus. A fraction of a second is, however, enough to get up the pressure in the pulmonary and cutaneous arteries, and in the meantime the pressure in the arteries of the head, trunk, etc., is constantly diminishing owing to the continual flow of the blood toward the capillaries (*sic*). *Very soon*, therefore, the blood forces the valves aside and makes its way into the bulbus aortae. Here again the course taken is that of least resistance; owing to the presence of the carotid gland the passage of blood into the carotid trunks is less free than into the wide elastic systemic trunks. These will therefore receive the next portion of blood, which, the venous blood having mostly been driven to the lungs, will be a mixture of venous and arterial. Finally, as the pressure rises in the systemic trunks, the last portion of blood from the ventricle, which, coming from the left side, is arterial, will pass into the carotids and so supply the head."

It will be seen on critical examination of this scheme that several points are open to argument even if we grant the segregation of bloods in the spongy ventricle: 1, the element of time; 2, the mechanics; 3, the comparative anatomy; and 4th, the experimental evidence. 1. The frog's heart under normal conditions beats about 60 to the minute with a ventricular systolic phase of about 0.2 sec. Now if one reads the description, bearing in mind that the whole process is completed in one-fifth of a second, and that all this is inferred in order that the head shall receive a better blood supply, one is tempted to hold one's breath. The time is short and much must be accomplished. If the blood in the systemic arteries is being forced toward the capillaries, what is holding it back in the pulmo-cutaneous and carotid trunks? Again the regulation of the valves and re-

sistance to the flow of blood must indeed be very minutely adjusted to separate the venous from a mixed and a mixed from an arterial blood issuing from the same opening with say, one-fifteenth of a second to accomplish each phase. 2. Further the tracings made by Gompertz show that the blood reaches the pulmo-cutaneous and aortic trunks at the same time and under the same pressure. Still further the inspiration in the frog increases, not decreases, the intrathoracic pressure and would retard the pulmo-cutaneous system, and it has not been demonstrated satisfactorily to my knowledge that the capillary system of the pulmo-cutaneous vessels is actually less developed than in the systemic area. 3. The comparison of the various types of amphibian circulation is of interest. Bruner (1), for example, makes the following statement: "The fact that the septum atriorum disappears with the lungs indicates clearly that in the salamanders with lungs the septum performs a certain function which becomes superfluous or impossible after the loss of these organs. This function is the separation of the venous blood of the right auricle from the aerated blood of the left auricle. But what is the significance of this separation if the two sorts of blood are afterward mixed during the passage through the ventricle and conus? Or is there, after all, in salamanders with lungs a partial separation of the aerated and the venous blood in its entire course through the heart? Such a separation occurs, as is well known, in the heart of *Rana*. Now as regards the atrium and ventricle, we find essentially the same structure in *Salamandra* as in *Rana*. It is true that the septum atriorum in the salamander is perforated, while in the frog it is not. But during the brief stay of the blood in the auricles the small perforations which have been described would permit little mixing of the blood. There would be much better opportunity for this to occur in the ventricle, but here we have the same spongy condition in *Salamandra* and *Rana*. So far then, *Rana* does not seem to have a decided advantage over the salamander in respect to the separation of venous and arterial blood in the heart. We may therefore conclude that in the salamander, as in *Rana*, the first blood passing from the ventricle into the conus during the ventricular systole is chiefly venous. In *Rana* this is directed into the pulmonary artery. In the salamander, however, the structure of the conus does not indicate that it could influence the direction of the blood current. We must turn, then, to the bulbus arteriosus and the great arterial vessels for further light on our problem." "The spiral valve of the salamanders can have no control over the direction of blood which passes

through the conus." Preceding this Bruner states: "The conus of the Salamandrina shows the same general structure as that we found in the conus of the Salamandra. A spiral valve is distinctly recognizable in the lungless form." (Salamandra has lungs; Salamandrina has none.)

This point in the comparative anatomy of the amphibian circulation I hold to be an excellent objection to the described course of the blood through the frog heart.

4. Experimental evidence on the amphibian circulation leaves much still to be done. Mayer found that if the tip of the ventricle was cut off the blood issued in two distinct streams. This, in addition to the coloration in the beating frog heart, seems to hold for a segregation of the venous and arterial blood in the spongy ventricle. But Gompertz's experiments also seem to indicate that even if this be true a mixing must occur in the vessels.

The step from the amphibian to the class of Dipnoi is not a very great one, and still we find something which may throw light on the character of blood circulating in the fish. According to Wiedersheim "in *Ceratodus* the conus arteriosus is provided with eight rows of valves and begins to be divided into two chambers. In *Protopterus* this division is complete, so that two currents of blood, mainly arterial and mainly venous respectively, pass out from the heart side by side. The former comes from the pulmonary vein, from which it passes into the left atrium, thence into the left portion of the ventricle, and thence to the two anterior branchial arteries. The venous current, on the other hand, passes from the right portion of the ventricle into the third and fourth afferent branchial arteries and thence to the corresponding gills, where it becomes purified; it reaches the aortic roots by means of the efferent branchial arteries. The paired pulmonary artery, like the corresponding vessel in the crossopterygians, arises from the fourth efferent branchial in *Ceratodus*, and from the aortic root in *Protopterus* and *Lepidosiren*."

There appears to be a physiological flaw in this description unless the fish blood behaves quite differently from that in other animals. Under the assumption that the blood in the fish becomes fully oxygenated in its passage through the gills, the blood carried to the lungs from the efferent branchial artery would already be charged with oxygen, and in this case the lungs would only be functional when the fish is hibernating in the dried mud. Under the assumption that the fish blood is not fully oxygenated in its passage through the gills, the lungs would be accessory to

the gill function. In neither case would there be any physiological reason for the separation of the blood issuing from the conus. If the gills in the fish do not entirely oxygenate the blood, and in some fish the fins apparently assist in oxygenation, then the fish blood really corresponds to our notion of "the mixed blood" (not fully oxygenated) in the higher forms. Here again is a problem upon which no definite information may be given.

In conclusion, my position on the quality of blood circulating in the arteries of the vertebrates is that it is what may be termed "mixed" in all forms from the embryonic mammal and bird to the fish, and if there have been advanced various theories on the mechanics of the passage of the blood through the heart of a given form they have been based on the alleged physiological necessity for a better quality of blood circulation in the head. In other words the systemic arteries convey arterial blood only in the mammal and bird after birth. I believe if one eliminates the idea that the head must receive a better quality of blood (Sabatier scheme) the whole doctrine of the character of the circulation in all forms of vertebrates is not only simplified but placed upon a sound physiological and developmental basis.

#### LITERATURE.

1. Bruner, H. L.  
On the heart of lungless Salamanders, Jr. of Morph., Vol. XVI, No. 2, 1900.
2. Gasch, F. R., Klassen und Ordnungen des Thierreichs, Vol. 6, Sect. 4, p. 763.
3. Lillie, F. R., Development of the Chick. Henry Holt, 1908.
4. Parker and Haswell. Manual of Zoology, 1900, p. 422.
5. Pohlman, A. G.  
The course of the Blood through the Heart of the Fetal Mammal. Anat. Rec., Vol. III, No. 2, 1909.
6. Wiedersheim, R.  
Comparative Anatomy of Vertebrates. Macmillan, 1907.
7. Ziegenspeck, R.  
Die Lehre von der doppelten Einmündung der unteren Hohlvene in die Vorhöfe des Herzens. Samml. Klin. Vorträge, Ser. XIV, Heft II, No. 401.

## THE INDIANA ACADEMY OF SCIENCE.

---

BY J. T. SCOVELL.

---

Professional men engaged in almost every kind of scientific work united to form the Indiana Academy of Science.

These people hoped to be benefited by the Association; they believed that it would promote scientific research and aid in the diffusion of knowledge concerning scientific affairs. The people who formed the Academy and aided in its development hoped that as the years rolled by it would so stimulate and encourage scientific work as to make it an important adjunct to the educational system of the State.

From the first, in addition to professional work, it has been the policy to encourage students and amateurs to prepare papers which in effect are reports of work done along some line of scientific investigation. The work may be new to science or it may not, but is new to the writer. The student gets the benefit of the work done and of the friendly criticism of the Academy.

Many valuable papers have been prepared on many different phases of scientific work. Considerable work has been done by the Academy on the flora of the State. Some of the best work that has been done on the botany of the State has been done by members of the Academy. The conservation of forests the study of streams and of climate and all sorts of geological questions have been discussed in the Academy. There have been reports on the reptiles of the State and on the fish that abound in the streams. And several papers have been presented on the insects of the State. One could not discuss any of these subjects fully without consulting the reports of the Academy. Several papers that were presented to the Academy appear in a Geographical Study of Indiana, and several Academy papers appear in the geological reports of Indiana.

Similar work has been done in Chemistry, Physics, Mechanics, Mathematics and in other subjects.

The Academy affords an opportunity for social converse among scientific men, for exchange of ideas and the stimulus of association.

It is in some sense a laboratory where students are stimulated to work, the work in many cases counting as credits on university work. Again these reports are printed, and so this work becomes accessible to many outside the members of the Academy. Again, the Academy has established an extensive system of exchanges of publications with other societies, so that a large number of valuable publications are accumulated in the State Library to the credit of the Academy.

Various sanitary problems have been discussed and some phases of bacteriology and some economic questions have been considered: as to the supply of coal, of building stones and of materials for all kinds of articles made of clay or shale.

The list of presidents contains the names of many noted men who have done good work in the Academy. And the list of members is large, showing that hundreds of people have been inspired and stimulated by association with these prominent educators. A large proportion of the members of the Academy are teachers, and through them thousands of young people in Indiana have been benefited and encouraged by the work of the Academy.

The Indiana Academy of Science has been a success. It has accomplished in a large way all that its founders hoped for. May it continue to prosper.



# INDEX.

	PAGE.
Act for the protection of birds.....	8
Act providing for the publication of the Proceedings.....	6
Animals of the Olympic Peninsula, Washington.....	193
Annual meeting of the Academy, Report of the Twenty-fourth.....	26
Anthraenose, A new, attacking certain cereals and grasses.....	111
Arthur, J. C., Paper by.....	83
Barrus, M. F., Paper by.....	113
Bigney, A. J., Paper by.....	69
Biography and the influence of environment.....	51
Birds of Indiana, An Addition to.....	49
Bitting, Katherine Golden, Paper by.....	127
Blatchley, W. S., Paper by.....	185
Brooks, W. C., Paper by.....	157
Butler, Amos, Paper by.....	49
Butter, Relation of fats to moisture content of.....	141
By-laws.....	14
Caves and cave formations of the Mitchell limestone.....	175
Circulation of mixed blood in the embryo mammal and bird and in the adult reptile, amphibian and fish.....	201
Cogshall, W. A., Paper by.....	75
Committees, 1908-1909.....	10
Constitution.....	12
Corn pollination, Report of work in.....	133
Culbertson, Glenn, Paper by.....	27
Deforestation and its effects among the hills of Southern Indiana.....	27
Disease, Dissemination of, by means of the seed of the host plant.....	113
Dolan, J. P., Paper by.....	67
Dunn, H. A., Paper by.....	103
Edenharter, Dr. G. F., Paper by.....	39
Evans, Percy N., Paper by.....	139
Felkner Island, Wabee Lake, Kosciusko County, Indiana.....	67
Female gametophyte of Pinus, Anomalies of.....	95
Fisher, M. L., Paper by.....	133
Flora of Cass County, Indiana, Notes on the.....	107
Greene, F. C., Paper by.....	175
Harding, C. Francis, Paper by.....	147
Hessler, Robert, Papers by.....	51, 107
Heteroecious plant rusts of Indiana, Notes on.....	87
High tension insulators, Use of the polariscope in testing.....	147
Histological difference between Pinus taeda and P. palustris.....	127

	PAGE.
Hunziker, O. F., Paper by.....	141
Indiana Academy of Science.....	209
Johnson, Aaron G., Paper by.....	87
Kern, F. D., Paper by.....	85
Killing of mustard and other noxious weeds in the grain fields of Dakota..	135
Lead, Estimation of, by titration of lead chromate.....	157
Life zones of Indiana as illustrated by the distribution of Orthoptera and Coleoptera within the State.....	185
Lyons, R. E., Paper by.....	161
Mathers, F. C., Paper by.....	159
May, C. E., Paper by.....	151
Members, active.....	17
fellows.....	15
non-resident.....	16
Molecular weight calculation, The Meyer.....	139
Morehouse's comet, Photographic observations of.....	75
Mottier, D. M., Paper by.....	95
Mucoid, Some contributions to the chemistry of.....	151
Officers, 1908-1909.....	9
past.....	11
Olive, E. W., Paper by.....	135
Origin of depressions in the mesa south of Tijeras canyon, New Mexico...	165
Pathological laboratory of the Central Indiana Hospital for Insane.....	39
Platinum crucibles, Destruction of, through ignition of magnesium am- monium phosphate.....	161
Pohlman, A. G., Paper by.....	201
Program of the Twenty-fourth Annual Meeting.....	22
Reagan, Albert B., Papers by.....	71, 165, 193
Report of work in corn pollination.....	133
Rust of timothy.....	85
Rusts, Field observations on, for the general botanist.....	83
Heteroecious, of Indiana.....	87
Scovell, J. T., Papers by.....	167, 209
Seed corn, Testing by specific gravity.....	103
Seedless persimmon, Notes on the.....	99
Selby, A. D., and Thos. F. Manns, Paper by.....	111
Shake dance of the Quilente Indians.....	71
Strange nurse. A.....	69
Sulfur in sulfides and sulfates, An evolution method for the determina- tion of.....	159
Table of contents.....	4
Tippecanoe River, Indiana, Headwaters of.....	167
Woodburn, Wm. L., Paper by.....	99

PROCEEDINGS

OF THE

*Indiana Academy*  
*of Science*

TWENTY-FIFTH ANNIVERSARY

1909

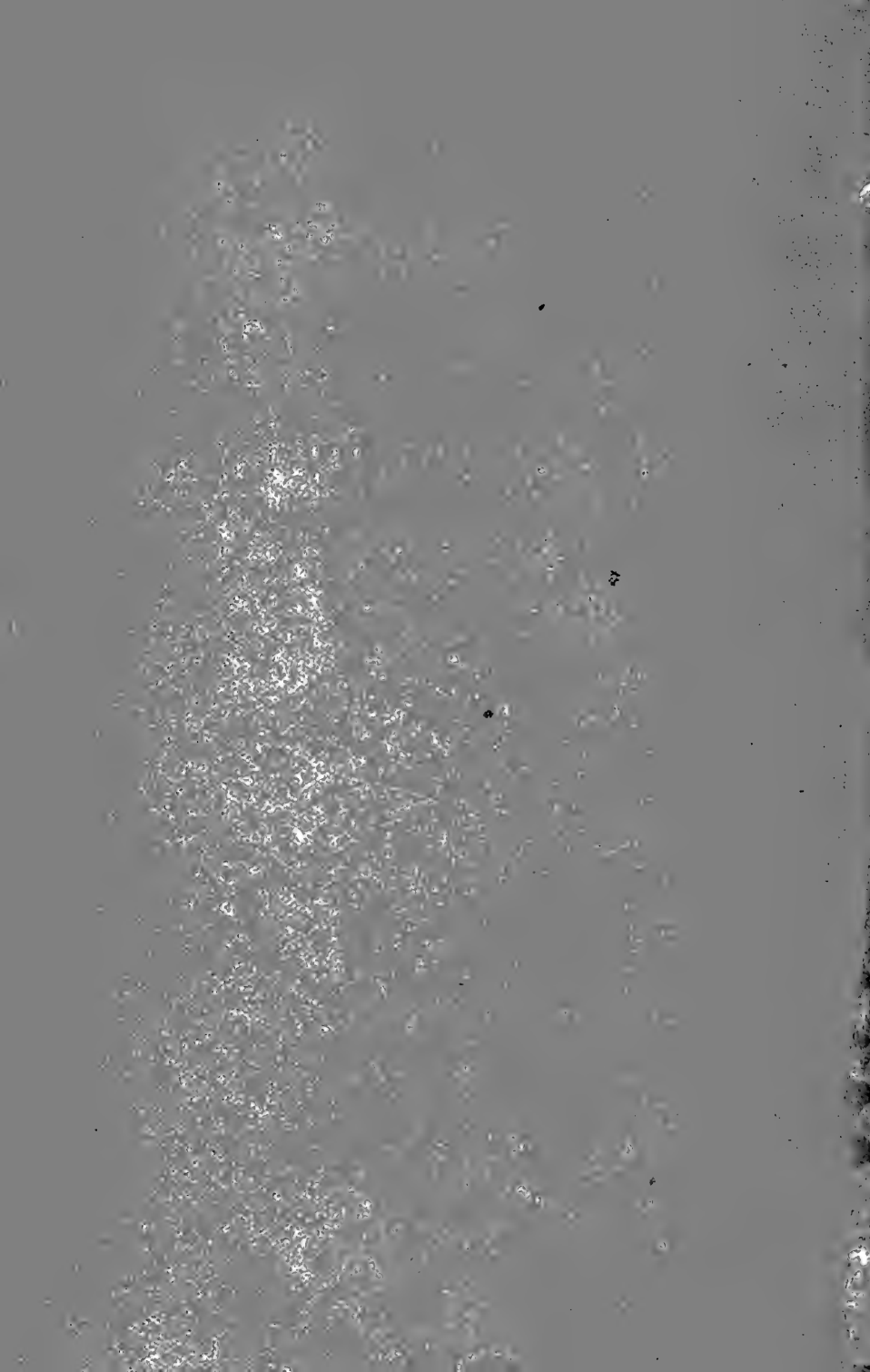

# PROCEEDINGS

OF THE

# Indiana Academy of Science

TWENTY-FIFTH ANNIVERSARY

1909

LIBRARY  
NEW YORK  
BOTANIC  
GARDEN.

---

EDITOR . . . . . H. L. BRUNER

---

INDIANAPOLIS, IND.  
1910

**INDIANAPOLIS :**  
**WM. E. BURFORD, PRINTER**  
**1910**

THE STATE OF INDIANA,  
EXECUTIVE DEPARTMENT,  
January 17, 1910.

Received by the Governor, examined and referred to the Auditor of State for verification of the financial statement.

---

OFFICE OF AUDITOR OF STATE,  
INDIANAPOLIS, Feb. 7, 1910.

The within report, so far as the same relates to moneys drawn from the State Treasury, has been examined and found correct.

J. C. BILLHEIMER,  
*Auditor of State.*

---

February 8, 1910.

Returned by the Auditor of State, with above certificate, and transmitted to Secretary of State for publication, upon the order of the Board of Commissioners of Public Printing and Binding.

MARK THISTLETHWAITE,  
*Secretary to the Governor.*

---

Filed in the office of the Secretary of State of the State of Indiana, February 8, 1910.

FRED A. SIMS,  
*Secretary of State.*

---

Received the within report and delivered to the printer February 9, 1910.

A. E. BUTLER,  
*Clerk Printing Board.*

## TABLE OF CONTENTS.

	PAGE
An Act to provide for the publication of the reports and papers of the Indiana Academy of Science .....	7
Appropriation for 1910 and 1911.....	8
An act for the protection of birds, their nests and eggs.....	9
Officers, 1909-1910.....	10
Committees, 1909-1910.....	11
Principal officers since organization.....	12
Constitution.....	13
By-Laws.....	15
Members, Fellows.....	16
Members, non-resident.....	17
Members, active.....	18
Necrology.....	24
Program of the Twenty-fifth Annual Meeting.....	27
Resolution providing for the celebration of the Twenty-fifth Anniversary of the Indiana Academy of Science.....	33
The beginning of the Indiana Academy of Science, by Amos W. Butler....	35
Greetings from Indiana Associations.....	39
Plans for the future of the Indiana Academy of Science.....	48
Banquet Addresses .....	54
Minutes of Twenty-fifth Annual Meeting.....	73
President's Address: "Recent Progress in Physics," by A. L. Foley.....	89
Address: "Recent Progress in Botany," by John M. Coulter.....	101
Address: "Darwin Fifty Years After," by D. S. Jordan.....	107
Address: "Methods and Materials Used in Soil Testing," by H. A. Huston..	111
Address: "Federal Control of International and Interstate Waters," by B. W. Evermann .....	119
Address: "The Speed of Migration of Salmon in the Columbia River," by Chas. W. Greene (Abstract).....	125
Papers presented at the Twenty-fifth Annual Meeting:	
Thought stimulation, under What Conditions Does it Occur? by Rob- ert Hessler.....	127
Hygiene of Indoor Swimming Pools, by Severance Burrage.....	145
The Problem of Sewage Purification in Indiana, by R. L. Sackett ....	157



	PAGE
That Erroneous Hiawatha, by Albert B. Reagan.....	161
The Medicinal Value of <i>Eupatorium perfoliatum</i> , by A. J. Bigney....	163
Refractive Index as a Measure of Dry Substance in Saccharine Products, by A. Hugh Bryan.....	165
Conductivity of Certain Salts in Ethyl Amine, by E. G. Mahin.....	175
A Study of the Chemical Composition of Butter Fat, by O. F. Hun- ziker and George Spitzer.....	181
On a New Complex Cyanogen Compound, by A. R. Middleton.....	197
The Determination of Endothermic Gases by Combustion, by A. R. Middleton.....	199
Methods in Solid Analytics, by Arthur S. Hathaway.....	201
Motion of n Bodies, by Arthur S. Hathaway.....	203
Direct Reading Accelerometers, by C. R. Moore.....	205
Notes on the Strength of Concrete Building Blocks, by H. H. Scofield..	225
Polarization of Cadmium Cells, by Rolla R. Ramsay.....	229
An Investigation of a Point Discharge in a Magnetic Field, by Oscar W. Silvey.....	233
The Tenacity of Gelatine, by A. L. Foley.....	243
Cohesion of Water as Modified by Certain Dissolved Salts, by Edwin Morrison.....	249
Some Features of Delta Formation, by Charles R. Dryer.....	255
A Physiographic Survey of an Area near Terre Haute, Ind. by Charles R. Dryer and Melvin K. Davis.....	263
The Collecting Area of the Waters of the Hot Springs of Hot Springs, Ark., by A. H. Purdue.....	269
Where Do the Lance Creek ("Ceratops") Beds Belong, in the Creta- ceous or Tertiary? by Oliver P. Hay.....	277
Paleonto'ogy and the Recapitulation Theory, by E. R. Cumings.....	305
The Tippecanoe, an Infantile Drainage System, by W. A. McBeth....	341
A Paired Entoplastron in <i>Tryonix</i> and Its Significance, by H. H. Lane..	345
Some Notes on Parasites Found in Frogs in the Vic'n ty of St. Paul, Minn., by H. L. Osborn.....	351
The Mocking Bird about Moores Hill, Ind., by A. J. Bigney.....	353
Observations on Woodpeckers, by John T. Campbell.....	354
Observations on Cerebral Localization, by J. Rollin Slonaker.....	355
The Evolution of Insect Galls as Illustrated by the Genus <i>Amphibolips</i> , by Mel. T. Cook.....	363

	PAGE
Apparatus to Illustrate Boyle's Law, by F. M. Andrews.....	369
Some Monstrosities in Plants, by F. M. Andrews.....	373
A List of Algae (Chiefly from Monroe Co., Ind.) by F. M. Andrews....	375
Additions to Indiana Flora, Number 4, by Charles C. Deam.....	381
Right and Wrong Conceptions of Plant Rusts, by J. C. Arthur.....	383
The Effect of Preservatives on the Development of <i>Penicillium</i> , by Katherine Golden Bitting.....	391
Further Notes on Timothy Rust, by Frank D. Kern.....	417
The Woodlot for Central Indiana, by E. C. Pegg and M. B. Thomas...	419
Recent Work in Wood Physics, by W. K. Hatt.....	441
Forest Conditions in Indiana, by Stanley Coulter.....	447
Index.....	463

AN ACT TO PROVIDE FOR THE PUBLICATION OF THE REPORTS  
AND PAPERS OF THE INDIANA ACADEMY OF SCIENCE.

[Approved March 11, 1895.]

WHEREAS, The Indiana Academy of Science, a chartered scientific association, has embodied in its constitution a provision that it will, upon the request of the Governor, or of the several departments of the State government, through the Governor, and through its council as an advisory body, assist in the direction and execution of any investigation within its province, without pecuniary gain to the Academy, provided only that the necessary expenses of such investigation are borne by the State; and,

**Preamble.**

WHEREAS, The reports of the meetings of said Academy, with the several papers read before it, have very great educational, industrial and economic value, and should be preserved in permanent form; and

WHEREAS, The Constitution of the State makes it the duty of the General Assembly to encourage by all suitable means intellectual, scientific and agricultural improvement; therefore,

SECTION 1. *Be it enacted by the General Assembly of the State of Indiana,* That hereafter the annual reports of the meetings of the Indiana Academy of Science, beginning with the report for the year 1894, including all papers of scientific or economic value, presented at such meetings, after they shall have been edited and prepared for publication as hereinafter provided shall be published by and under the direction of the Commissioners of Public Printing and Binding.

**Publication of  
the Reports of  
the Indiana  
Academy of  
Science.**

SEC. 2. Said reports shall be edited and prepared for publication without expense to the State, by a corps of editors to be selected and appointed by the Indiana Academy of Science, who shall not, by reason of such service, have any claim against the State for compensation. The form, style of binding, paper, typography and manner and extent of illustration of such reports shall be determined by the editors, subject to the approval of the Commissioners of Public Printing and Stationery, Not less than 1,500 nor more than 3,000 copies of each of said reports shall be published, the size of the edition within said limits to be determined by

**Editing  
Reports.**

**Number of  
Printed  
Reports.**

the concurrent action of the editors and the Commissioners of Public Printing and Stationery: *Provided*, That not to exceed six hundred dollars (\$600) shall be expended for such publication in any one year, and not to extend beyond 1896: *Provided*, That no sums shall be deemed to be appropriated for the year 1894.

**Proviso.**

SEC. 3. All except three hundred copies of each volume of said reports shall be placed in the custody of the State Librarian, who shall furnish one copy thereof to each public library in the State,

one copy to each university, college or normal school in the State, one copy to each high school in the State having a library, which shall make application therefor, and one copy to such other institutions, societies or persons as may be designated by the Academy through its editors or its council. The remaining three hundred copies shall be turned over to the Academy to be disposed of as it may determine. In order to provide for the preservation of the same it shall be the duty of the Custodian of the State House to provide and place at the disposal of the Academy one of the unoccupied rooms of the State House, to be designated as the office of the Indiana Academy of Science, wherein said copies of said reports belonging to the Academy, together with the original manuscripts, drawings, etc., thereof can be safely kept, and he shall also equip the same with the necessary shelving and furniture.

**Disposition of Reports.**

SEC. 4. An emergency is hereby declared to exist for the immediate taking effect of this act, and it shall therefore take effect and be in force from and after its passage.

**Emergency.**

#### APPROPRIATION FOR 1910-1911.

The appropriation for the publication of the proceedings of the Academy during the years 1910 and 1911 was increased by the legislature in the General Appropriation bill, approved March 9, 1909. That portion of the law fixing the amount of the appropriation for the Academy is herewith given in full:

For the Academy of Science: For the printing of the proceedings of the Indiana Academy of Science, twelve hundred dollars: *Provided*, That any unexpended balance in 1909 shall be available in 1910, and that any unexpended balance in 1910 shall be available in 1911.

**Academy of Science—Regular.**

AN ACT FOR THE PROTECTION OF BIRDS, THEIR NESTS AND EGGS.

SEC. 602. Whoever kills, traps or has in his possession any wild bird, or whoever sells or offers the same for sale, or whoever destroys the nest or eggs of any wild bird, shall be deemed guilty of a misdemeanor and upon conviction thereof shall be fined not less than ten dollars nor more than twenty-five dollars: *Provided*, That the provisions of this section shall not apply to the following named game birds: The Anatidae, commonly called swans, geese, brant, river and sea duck; the Rallidae, commonly called rails, coots, mud-hens, gallinules; the Limicolae, commonly called shore birds, surf birds, plover, snipe, woodcock, sandpipers, tattlers and curlew; the Gallinae, commonly called wild turkeys, grouse, prairie chickens, quails and pheasants; nor to English or European house sparrows, crows, hawks or other birds of prey. Nor shall this section apply to persons taking birds, their nests or eggs, for scientific purposes, under permit, as provided in the next section.

SEC. 603. Permits may be granted by the Commissioner of Fisheries and Game to any properly accredited person, permitting the holder thereof to collect birds, their nests or eggs for strictly scientific purposes. In order to obtain such permit the applicant for the same must present to such Commissioner written testimonials from two well-known scientific men certifying to the good character and fitness of such applicant to be entrusted with such privilege, and pay to such Commissioner one dollar therefor and file with him a properly executed bond in the sum of two hundred dollars, payable to the State of Indiana, conditioned that he will obey the terms of such permit, and signed by at least two responsible citizens of the state as sureties. The bond may be forfeited, and the permit revoked upon proof to the satisfaction of such Commissioner that the holder of such permit has killed any bird or taken the nest or eggs of any bird for any other purpose than that named in this section.

# Indiana Academy of Science.

## OFFICERS, 1909-1910.

PRESIDENT

P. N. EVANS.

VICE-PRESIDENT

C. R. DRYER.

SECRETARY

GEO. W. BENTON.

ASSISTANT SECRETARY

A. J. BIGNEY.

PRESS SECRETARY

JOHN W. WOODHAMS.

TREASURER

W. J. MOENKHAUS.

### EXECUTIVE COMMITTEE

P. N. EVANS,  
C. R. DRYER,  
G. W. BENTON,  
A. J. BIGNEY,  
J. W. WOODHAMS,  
W. J. MOENKHAUS,  
A. L. FOLEY,  
GLENN CULBERTSON,  
D. M. MOTTIER,  
ROBERT HESSLER,

JOHN S. WRIGHT,  
CARL L. MEES,  
W. S. BLATCHLEY,  
H. W. WILEY,  
M. B. THOMAS,  
D. W. DENNIS,  
C. H. EIGENMANN,  
C. A. WALDO,  
THOMAS GRAY,  
STANLEY COULTER,

A. W. BUTLER,  
W. A. NOYES,  
J. C. ARTHUR,  
O. P. HAY,  
T. C. MENDENHALL,  
J. C. BRANNER,  
J. P. D. JOHN,  
J. M. COULTER,  
D. S. JORDAN,

### CURATORS

BOTANY.....	J. C. ARTHUR.
ICHTHYOLOGY.....	C. H. EIGENMANN.
HERPETOLOGY } .....	A. W. BUTLER.
MAMMALOLOGY } .....	
ORNITHOLOGY } .....	W. S. BLATCHLEY.
ENTOMOLOGY.....	

## COMMITTEES, 1909-1910.

### PROGRAM.

J. P. NAYLOR,	E. S. JOHONNATT,	J. S. WRIGHT
---------------	------------------	--------------

### MEMBERSHIP.

S. COULTER,	A. W. BUTLER,	M. B. THOMAS
-------------	---------------	--------------

### NOMINATIONS.

A. J. BIGNEY,	L. J. RETTGER,	W. A. COGSHALL
---------------	----------------	----------------

### AUDITING.

W. J. MOENKHAUS,	G. W. BENTON,	W. S. BLATCHLEY
------------------	---------------	-----------------

### STATE LIBRARY.

J. S. WRIGHT,	W. S. BLATCHLEY,	A. W. BUTLER
	G. W. BENTON.	

### RESTRICTION OF WEEDS AND DISEASES.

R. HESSLER,	J. N. HURTY,	A. W. BUTLER
S. COULTER,		D. M. MOTTIER.

### DIRECTORS OF BIOLOGICAL SURVEY.

STANLEY COULTER,	C. R. DRYER,	M. B. THOMAS
C. H. EIGENMANN,		J. C. ARTHUR.

### RELATIONS OF THE ACADEMY TO THE STATE.

R. W. MCBRIDE,	M. B. THOMAS,	G. CULBERTSON
	W. S. BLATCHLEY.	

### DISTRIBUTION OF THE PROCEEDINGS.

J. S. WRIGHT,	H. L. BRUNER,	G. W. BENTON
R. E. LYONS,		J. H. RANSOM.

### PUBLICATION OF PROCEEDINGS.

H. L. BRUNER, Editor,	D. BODINE,	D. M. MOTTIER.
-----------------------	------------	----------------

## OFFICERS OF THE INDIANA ACADEMY OF SCIENCE.

YEARS.	PRESIDENT.	SECRETARY.	ASST. SECRETARY.	PRESS SECRETARY.	TREASURER.
1885-1886	David S. Jordan.	Amos W. Butler.	(Stanley Coulter.		O. P. Jenkins.
1886-1887	John M. Coulter.	Amos W. Butler.	W. W. Norman.		O. P. Jenkins.
1887-1888	J. P. D. John	Amos W. Butler.	A. J. Bigney.		O. P. Jenkins.
1888-1889	John C. Branner	Amos W. Butler.	A. J. Bigney.		O. P. Jenkins.
1889-1890	T. C. Mendenhall	Amos W. Butler.	A. J. Bigney.		O. P. Jenkins.
1890-1891	O. P. Hay.	Amos W. Butler.	A. J. Bigney.		O. P. Jenkins.
1891-1892	J. L. Campbell.	Amos W. Butler.	(Stanley Coulter.		C. A. Waldo.
1892-1893	J. C. Arthur.	Amos W. Butler.	W. W. Norman.		C. A. Waldo.
1893-1894	W. A. Noyes.	C. A. Waldo.	W. W. Norman.		W. P. Shannon.
1894-1895	A. W. Butler.	John S. Wright.	A. J. Bigney.		W. P. Shannon.
1895-1896	Stanley Coulter.	John S. Wright.	A. J. Bigney.		W. P. Shannon.
1896-1897	Thomas Gray.	John S. Wright.	A. J. Bigney.		W. P. Shannon.
1897-1898	C. A. Waldo.	John S. Wright.	A. J. Bigney.	Geo. W. Benton.	J. T. Scovell.
1898-1899	C. H. Eigenmann.	John S. Wright.	E. A. Schultze.	Geo. W. Benton.	J. T. Scovell.
1899-1900	D. W. Dennis.	John S. Wright.	E. A. Schultze.	Geo. W. Benton.	J. T. Scovell.
1900-1901	M. B. Thomas.	John S. Wright.	E. A. Schultze.	Geo. W. Benton.	J. T. Scovell.
1901-1902	Harvey W. Wiley.	John S. Wright.	Donaldson Bodine.	Geo. W. Benton.	J. T. Scovell.
1902-1903	W. S. Blatchley.	John S. Wright.	Donaldson Bodine.	G. A. Abbott.	W. A. McBeth.
1903-1904	C. L. Mees.	John S. Wright.	J. H. Ransom.	G. A. Abbott.	W. A. McBeth.
1904-1905	John S. Wright.	Lynn B. McMullen.	J. H. Ransom.	G. A. Abbott.	W. A. McBeth.
1905-1906	Robert Hessler.	Lynn B. McMullen.	J. H. Ransom.	Charles R. Clark.	W. A. McBeth.
1906-1907	D. M. Mottier.	Lynn B. McMullen.	J. H. Ransom.	G. A. Abbott.	W. A. McBeth.
1907-1908	Glenn Culbertson.	J. H. Ransom.	A. J. Bigney.	G. A. Abbott.	W. A. McBeth.
1908-1909	A. L. Foley.	J. H. Ransom.	A. J. Bigney.	G. A. Abbott.	W. A. McBeth.
1909-1910	P. N. Evans.	Geo. W. Benton.	A. J. Bigney.	John W. Woodhams.	W. J. Moenkhaus.



## CONSTITUTION.

---

### ARTICLE I.

SECTION 1. This association shall be called the Indiana Academy of Science.

SEC. 2. The objects of this Academy shall be scientific research and the diffusion of knowledge concerning the various departments of science, to promote intercourse between men engaged in scientific work, especially in Indiana; to assist by investigation and discussion in developing and making known the material, educational and other resources and riches of the State; to arrange and prepare for publication such reports of investigation and discussions as may further the aims and objects of the Academy as set forth in these articles.

Whereas, The State has undertaken the publication of such proceedings, the Academy will, upon request of the Governor, or of one of the several departments of the State, through the Governor, act through its council as an advisory body in the direction and execution of any investigation within its province as stated. The necessary expenses incurred in the prosecution of such investigation are to be borne by the State; no pecuniary gain is to come to the Academy for its advice or direction of such investigation.

The regular proceedings of the Academy as published by the State shall become a public document.

### ARTICLE II.

SECTION 1. Members of this Academy shall be honorary fellows, fellows, non-resident members or active members.

SEC. 2. Any person engaged in any department of scientific work, or in original research in any department of science, shall be eligible to active membership. Active members may be annual or life members. Annual members may be elected at any meeting of the Academy; they shall sign the constitution, pay an admission fee of two dollars and thereafter an annual fee of one dollar. Any person who shall at one time contribute fifty dollars to the funds of this Academy may be elected a life member of

the Academy, free of assessment. Non-resident members may be elected from those who have been active members but who have removed from the State. In any case, a three-fourths vote of the members present shall elect to membership. Applications for membership in any of the foregoing classes shall be referred to a committee on application for membership, who shall consider such application and report to the Academy before the election.

SEC. 3. The members who are actively engaged in scientific work, who have recognized standing as scientific men, and who have been members of the Academy at least one year, may be recommended for nomination for election as fellows by three fellows or members personally acquainted with their work and character. Of members so nominated a number not exceeding five in one year may, on recommendation of the Executive Committee, be elected as fellows. At the meeting at which this is adopted, the members of the Executive Committee for 1894 and fifteen others shall be elected fellows, and those now honorary members shall become honorary fellows. Honorary fellows may be elected on account of special prominence in science, on the written recommendation of two members of the Academy. In any case a three-fourths vote of the members present shall elect.

### ARTICLE III.

SECTION 1. The officers of this Academy shall be chosen by ballot at the annual meeting, and shall hold office one year. They shall consist of a President, Vice-President, Secretary, Assistant Secretary, Press Secretary and Treasurer, who shall perform the duties usually pertaining to their respective offices and in addition, with the ex-Presidents of the Academy, shall constitute an Executive Committee. The President shall, at each annual meeting, appoint two members to be a committee, which shall prepare the programs and have charge of the arrangements for all meetings for one year.

SEC. 2. The annual meeting of this Academy shall be held in the city of Indianapolis within the week following Christmas of each year, unless otherwise ordered by the Executive Committee. There shall also be a summer meeting at such time and place as may be decided upon by the Executive Committee. Other meetings may be called at the discretion of the Executive Committee. The past Presidents, together with the officers and Executive Committee, shall constitute the council of the academy, and

represent it in the transaction of any necessary business not especially provided for in this constitution, in the interim between general meetings.

SEC. 3. This constitution may be altered or amended at any annual meeting by a three-fourths majority of the attending members of at least one year's standing. No question of amendment shall be decided on the day of its presentation.

---

## BY-LAWS.

---

1. On motion, any special department of science shall be assigned to a curator, whose duty it shall be, with the assistance of the other members interested in the same department, to endeavor to advance knowledge in that particular department. Each curator shall report at such time and place as the Academy shall direct. These reports shall include a brief summary of the progress of the department during the year preceding the presentation of the report.

2. The President shall deliver a public address on the morning of one of the days of the meeting at the expiration of his term of office.

3. The Press Secretary shall attend to the securing of proper newspaper reports of the meetings and assist the Secretary.

4. No special meeting of the Academy shall be held without a notice of the same having been sent to the address of each member at least fifteen days before such meeting.

5. No bill against the Academy shall be paid without an order signed by the President and countersigned by the Secretary.

6. Members who shall allow their dues to remain unpaid for two years, having been annually notified of their arrearage by the Treasurer, shall have their names stricken from the roll.

7. Ten members shall constitute a quorum for the transaction of business.

## MEMBERS.

## FELLOWS.

†G. A. Abbott.....	*1908.....	Fargo, N. D.
R. J. Aley.....	1898.....	Indianapolis.
J. C. Arthur.....	1894.....	Lafayette.
J. W. Beede.....	1906.....	Bloomington.
George W. Benton.....	1896.....	Indianapolis.
A. J. Bigney.....	1897.....	Moores Hill.
Katherine Golden Bitting.....	1895.....	Lafayette.
W. S. Blatchley.....	1893.....	Indianapolis.
Donaldson Bodine.....	1899.....	Crawfordsville.
H. L. Bruner.....	1899.....	Indianapolis.
Severance Burrage.....	1898.....	Lafayette.
A. W. Butler.....	1893.....	Indianapolis.
W. A. Cogshall.....	1906.....	Bloomington.
†Mel. T. Cook.....	1902.....	Newark, Del.
†John M. Coulter.....	1893.....	Chicago, Ill.
Stanley Coulter.....	1893.....	Lafayette.
U. O. Cox.....	1908.....	Terre Haute.
Glenn Culbertson.....	1899.....	Hanover.
E. R. Cumings.....	1906.....	Bloomington.
S. C. Davisson.....	1908.....	Bloomington.
D. W. Dennis.....	1895.....	Richmond.
C. R. Dryer.....	1897.....	Terre Haute.
C. H. Eigenmann.....	1893.....	Bloomington.
Percy Norton Evans.....	1901.....	West Lafayette.
A. L. Foley.....	1897.....	Bloomington.
M. J. Golden.....	1899.....	Lafayette.
†W. F. M. Goss.....	1893.....	Urbana, Ill.
Thomas Gray (Died Dec. 19, 1908).....	1893.....	Terre Haute.
A. S. Hathaway.....	1895.....	Terre Haute.
W. K. Hatt.....	1902.....	Lafayette.
Robert Hessler.....	1899.....	Logansport.

\*Date of election.

†Non-resident.

†H. A. Huston.....	*1893.....	Baltimore, Md.
Edwin S. Johannatt .....	1904.....	Terre Haute.
Robert E. Lyons.....	1896.....	Bloomington.
W. A. McBeth.....	1904.....	Terre Haute.
V. F. Marsters.....	1893.....	Santiago, Chili.
C. L. Mees.....	1894.....	Terre Haute.
†J. A. Miller.....	1904.....	Swarthmore, Pa.
W. J. Moenkhaus.....	1901.....	Bloomington.
D. M. Mottier.....	1893.....	Bloomington.
J. P. Naylor.....	1903.....	Greencastle.
†W. A. Noyes.....	1893.....	Urbana, Ill.
Rolla R. Ramsey.....	1906.....	Bloomington.
J. H. Ransom.....	1902.....	Lafayette.
L. J. Rettger.....	1896.....	Terre Haute.
David Rothrock.....	1906.....	Bloomington.
J. T. Scovell.....	1894.....	Terre Haute.
Albert Smith.....	1908.....	Lafayette.
†Alex Sm'th.....	1893.....	Chicago, Ill.
W. E. Stone.....	1893.....	Lafayette.
†Joseph Swain.....	1898.....	Swarthmore, Pa.
M. B. Thomas.....	1893.....	Crawfordsville.
†C. A. Waldo.....	1893.....	St. Louis, Mo.
†F. M. Webster.....	1894.....	Washington, D.C.
Jacob Westlund.....	1904.....	Lafayette.
†H. W. Wiley.....	1895.....	Washington, D.C.
W. W. Woollen.....	1908.....	Indianapolis.
John S. Wright.....	1894.....	Indianapolis.

\*Date of election.

†Non-resident.

---

#### NON-RESIDENT MEMBERS.

George H. Ashley.....	Washington, D. C.
J. C. Branner.....	Stanford University, Cal.
M. A. Brannon.....	Grand Forks, N. D.
D. H. Campbell.....	Stanford University, Cal.
H. W. Clark.....	Washington, D. C.
H. B. Dorner.....	Urbana, Ill.
A. Wilmer Duff.....	Worcester, Mass.

B. W. Everman.....	Washington, D. C.
W. A. Fiske.....	Los Angeles, Cal.
C. W. Garrett.....	Pi tsburg, Pa.
Charle H. Gilbert.....	Stanford University, Cal.
C. W. Greene.....	Columbia, Mo.
C. W. Hargitt.....	Syracuse, N. Y.
O. P. Hay.....	Washington, D. C.
Edward Hughes.....	Stockton, Cal.
O. P. Jenkins.....	Stanford University, Cal.
C. T. Knipp.....	Urbana, Ill.
D. S. Jordan.....	Stanford University, Cal.
J. S. Kingsley.....	Tufts College, Mass.
D. T. MacDougal.....	Tucson, Arizona.
L. B. McMullen.....	Valley City, N. D.
T. C. Mendenhall.....	Worcester, Mass.
J. F. Newsom.....	Stanford University, Cal.
A. H. Purdue.....	Fayetteville, Ark.
A. B. Reagan.....	Orr, Minn.
J. R. Slonaker.....	Stanford University, Cal.
Alfred Springer.....	Cincinnati, Ohio.
Robert B. Warder (Deceased).....	Washington, D. C.
Ernest Walker.....	Fayetteville, Ark.
G. W. Wilson.....	Fayette, Ia.

---

*ACTIVE MEMBERS.*

C. E. Agnew.....	Delphi.
L. E. Allison.....	West Lafayette.
H. W. Anderson.....	Ladoga.
Paul Anderson.....	Crawfordsville.
H. F. Bain.....	San Francisco, Cal.
Walter D. Baker.....	Indianapolis.
Walter M. Baker.....	Red Key.
Edward Hugh Bangs.....	Indianapolis.
Howard J. Banker.....	Greencastle.
H. E. Barnard.....	Indianapolis.
W. H. Bates.....	West Lafayette.
Guido Bell.....	Indianapolis.

Lee F. Bennett	Valparaiso.
Thomas Billings	West Lafayette.
Harry Eldridge Bishop	Indianapolis.
Lester Black	Bloomington.
William N. Blanchard	Greencast'e.
Charles S. Bond	Richmond.
A. A. Bourke	Edinburg.
Omer C. Boyer	Lebanon.
H. C. Brandon	Bloomington.
Fred J. Breeze	Lafayette.
Chas. Brossmann	Indianapo'is.
E. M. Br ce	Terre Haute.
Wm. R. Butler	Indianapolis.
Edward N. Canis	Indianapolis.
E. Kate Carman	Indianapolis.
Lewis Clinton Carson	Detroit, Mich.
Herman S. Chamberlain (Deceased)	Indianapolis.
E. J. Chansler	Bicknell.
A. G. W. Childs	Kokomo.
C. D. Christie	Cincinnati, O.
J. H. Clark	Connerville.
Otto O. Clayton	Portland.
H. M. Clem	Monroeville.
Charles Clickner	Silverwood, R. D. No. 1.
Charles A. Coffey	Petersburg.
William Clifford Cox	Columbus.
J. A. Cragwall	Crawfordsville.
M. E. Crowell	Franklin.
Chas. M. Cunningham	Indianapolis.
Lorenzo E. Daniels	Laporte.
E. H. Davis	West Lafayette.
Melvin K. Davis	Terre Haute.
Charles C. Deam	Indianapolis.
E. M. Deem	Frankfort.
Harry F. Dietz	Indianapolis.
James P. Dimonds	Indianapolis.
Martha Doan	Westfield.
J. P. Dolan	Syracu e.

Hans Duden.....	Indianapolis.
Arthur E. Dunn.....	Logansport.
Herbert A. Dunn.....	Logansport.
M. L. Durbin.....	Anderson.
J. B. Dutcher.....	Philadelphia, Penn.
Samuel E. Earp.....	Indianapolis.
A. A. Eberly.....	Nowata, Okla.
C. R. Eckler.....	Indianapolis.
Max Mapes Ellis.....	Vincennes.
H. E. Enders.....	West Lafayette.
Samuel G. Evans.....	Evansville.
William P. Felver.....	Logansport.
C. J. Fink.....	Crawfordsville.
M. L. Fisher.....	West Lafayette.
A. S. Fraley.....	Linden.
Austin Funk.....	Jeffersonville.
John D. Gabel.....	North Madison.
Andrew W. Gamble.....	Logansport.
H. O. Garman.....	Indianapolis.
J. B. Garner.....	Crawfordsville.
Florence A. Gates.....	Wabash.
Robert G. Gillum.....	Terre Haute.
E. R. Glenn.....	Brookville.
Frederic W. Gottlieb.....	Morristown.
Vernon Gould.....	Rochester.
Frank Cook Greene.....	New Albany.
Earl Grimes.....	Russelly Ile.
Walter L. Hahn.....	Springfield, S. D.
C. F. Harding.....	West Lafayette.
Mary T. Harman.....	State College, Pa.
Walter W. Hart.....	Indianapolis.
Victor Hendricks.....	St. Louis, Mo.
L. R. Hessler.....	Crawfordsville.
John P. Hetherington.....	Logansport.
C. E. Hiatt.....	Philadelphia, Pa.
John E. Higdon.....	Indianapolis.
Frank R. Higgins.....	Terre Haute.
S. Bella Hilands.....	Madison.



John J. Hildebrandt.....	Logansport.
Geo. N. Hoffer.....	Lafayette.
G. E. Hoffman.....	Logansport.
Allen D. Hole.....	Richmond.
Lucius M. Hubbard.....	South Bend.
Martha Hunt.....	Indianapolis.
O. F. Hunziker.....	West Lafayette.
John N. Hurty.....	Indianapolis.
Roscoe R. Hyde.....	Terre Haute.
J. Isenberger.....	Lebanon.
C. F. Jackson.....	Durham, N. H.
A. G. Johnson.....	Lafayette.
H. E. Johnson.....	Greenfield.
A. T. Jones.....	West Lafayette.
W. J. Jones, Jr.....	West Lafayette.
O. L. Kelso.....	Terre Haute.
A. M. Kenyon.....	West Lafayette.
Frank D. Kern.....	Lafayette.
L. V. Ludy.....	West Lafayette.
R. W. McBride.....	Indianapolis.
Richard C. McClaskey.....	
T. S. McCulloch.....	Crawfordsville.
N. E. McIndoo.....	
Edward G. Mahin.....	West Lafayette.
James E. Manchester.....	Minneapolis, Minn.
Wilfred H. Manwaring.....	Bloomington.
William Edgar Mason.....	Borden.
Clark Mick.....	Indianapolis.
A. R. Middleton.....	West Lafayette.
G. Rudolph Miller.....	Indianapolis.
F. A. Miller.....	Indianapolis.
Chas. R. Moore.....	West Lafayette.
Geo. T. Moore.....	St. Louis, Mo.
Richard Bishop Moore.....	Indianapolis.
Frank K. Mowrer.....	Marion.
F. W. Muncie.....	Crawfordsville.
Fred Mutchler.....	Terre Haute.
Leslie C. Nanney.....	Bedford.

Charles E. Newlin.....	Indianapolis.
J. A. Nieuwland.....	Notre Dame.
G. A. Osner.....	Crawfordsville.
D. A. Owen.....	Franklin.
Everett W. Owen.....	Indianapolis.
Ferman L. Pickett.....	Bloomington.
Rollo J. Pierce.....	Richmond.
Ralph B. Polk.....	Greenwood.
James A. Price.....	Ft. Wayne.
W. H. Rankin.....	Ithaca, N. Y.
C. A. Reddick.....	Crawfordsville.
C. J. Reilly.....	Syracuse.
Allen J. Reynolds.....	
George L. Roberts.....	Lafayette.
J. Schramm.....	Crawfordsville.
E. A. Schultze.....	Laurel.
Will Scott.....	Bloomington.
Charles Wm. Shannon.....	Brazil.
Fred Sillery.....	Indianapolis.
Oscar W. Silvey.....	W. Lafayette.
C. Piper Smith.....	Logan, Utah.
Essie Alma Smith Shannon.....	Bloomington.
E. R. Smith.....	Indianapolis.
Geo. Spitzer.....	Lafayette.
Brenton L. Steele.....	Pullman, Wash.
Chas. Stoltz.....	South Bend.
J. M. Stoddard.....	
Milo H. Stuart.....	Indianapolis.
Julius W. Stürmer.....	Lafayette.
J. C. Taylor.....	Logansport.
Albert W. Thompson.....	Owensville.
A. D. Thorburn.....	Indianapolis.
Iro C. Trueblood (Miss).....	Greencastle.
W. P. Turner.....	West Lafayette.
Chas. A. Vallance.....	Indianapolis.
J. M. Van Hook.....	Bloomington.
W. B. Van Gorder.....	Lyons.
H. S. Voorhees.....	Ft. Wayne.

Frank B. Wade . . . . .	Indianapolis.	
Luther C. Weeks . . . . .	West Lafayette.	
Mason L. Weems . . . . .	Valparaiso.	
Daniel T. Weir . . . . .	Indianapolis.	
James E. Weyant . . . . .	Indianapolis.	
Virges Wheeler . . . . .	Montmorenci.	
A. E. White . . . . .	Connerville.	
Alfred T. Wiancko . . . . .	Lafayette.	
William L. Woodburn . . . . .	Bloomington.	
John W. Woodhams . . . . .	Indianapolis.	
Herbert Milton Woollen . . . . .	Indianapolis.	
J. F. Woolsey . . . . .	Cleveland, O.	
G. A. Young . . . . .	West Lafayette.	
Jacob P. Young . . . . .	Huntington.	
L. E. Young . . . . .	West Lafayette.	
W. J. Young . . . . .	Washington, D. C.	
Lucy Youse . . . . .	Terre Haute.	
W. A. Zehring . . . . .	West Lafayette.	
Charles Zeleny . . . . .	Urbana, Ill.	
Fellows, resident . . . . .		46
Non-resident . . . . .		12
Members, active . . . . .		183
Members, non-resident . . . . .		30
<hr/>		
Total . . . . .		271

---

## THOMAS GRAY.

---

Dr. Thomas Gray, a member of the Indiana Academy of Science since 1888, was President in 1897-8, died in Terre Haute, Ind., December 19, 1908.

He was born in Lochgelly, Scotland, February 4, 1850, received his early education in the schools of the district and, after serving an apprenticeship in handicraft, entered the University of Glasgow, graduating from the Mechanical Engineering course, with high honors, in 1874. After graduation he became Research Assistant to Lord Kelvin (Sir William Thompson). His work lay especially in the direction of absolute measurements in electricity and magnetism, electrical and heat conductivity of glasses of various compositions and the variation in conductivity of metals under stress. In 1878 he became Professor of Telegraph Engineering in the University of Tokio, Japan. While there he became interested in earthquake phenomena and invented several seismographs and investigated the elastic constants of many rocks. In 1881 he returned to Scotland, becoming Lord Kelvin's personal assistant, undertaking investigations in connection with practical problems in electricity then coming to the front. He developed and investigated methods for electrolytic measurements of electric currents and largely designed the well known Kelvin balances. He was Lord Kelvin's and Flemming Jenkins' representative as engineer for the Commercial Cable Companies and supervised the laying of the Bennett-Mackay transatlantic cables. In 1888 he came to Terre Haute, Ind., as professor of dynamic engineering in the Rose Polytechnic Institute, which position he held until his death. His investigational work was now mainly of an engineering character, too well known to recount. He was the author of several important works, the best known perhaps being the Smithsonian Physical Tables. The articles in the Encyclopedia Britannica on telegraphs and telephones were from his pen. He also edited the definitions in electricity and magnetism for the Century Dictionary. He was the author of about sixty papers on scientific subjects, communicated to engineering societies and scientific journals. He was a member of most of the American scientific and engi-

neering societies and held high offices in a number of them. His interest in the work of the Indiana Academy of Science made him a faithful and regular attendant at most of its meetings. On the roll of American and European scientists, his name stands high, and his contribution to science, as well as his work in the educational field while in this country, has been of the highest order.

*Be it Resolved*, That the Indiana Academy of Science recognize the services of Dr. Thomas Gray as investigator, experimentalist, teacher, and loyal supporter of the Academy by placing these resolutions and a sketch of his life upon the minutes of this meeting and print them in the volume of Proceedings.

The Committee: C. L. MEES.  
A. W. BUTLER.  
G. W. BENTON.

Adopted by the Indiana Academy of Science, in session in Indianapolis,  
Nov. 27, 1909.



---

## W. H. RAGAN.

W. H. Ragan, for many years connected with the United States Department of Agriculture, and who recently died, was one of the charter members of the Indiana Academy of Science. He was one of that company, of which a number of members are here today, who were present at the first meeting. At that time he was a member of the faculty of DePauw University. He has had a deep interest in the progress of science, and especially in its application to horticulture, to which line of usefulness his life was devoted.

We make a tribute herewith to his memory.

The Committee: C. L. MEES.  
A. W. BUTLER.  
G. W. BENTON.

Adopted by the Indiana Academy of Science, in session in Indianapolis,  
Nov. 27, 1909.

---

TWENTY-FIFTH ANNUAL MEETING  
INDIANA ACADEMY OF SCIENCE

CLAYPOOL HOTEL, INDIANAPOLIS, IND.

NOVEMBER 25, 26 AND 27, 1909

*Officers and Ex-Officio Executive Committee*

A. L. FOLEY, President	A. J. BIGNEY, Assistant Secretary
P. N. EVANS, Vice-President	G. A. ABBOTT, Press Secretary
J. H. RANSOM, Secretary	W. A. MCBETH, Treasurer

GLENN CULBERTSON

DAVID MOTTIER

ROBERT HESSLER

JOHN S. WRIGHT

C. L. MEES

W. S. BLATCHLEY

H. W. WILEY

D. W. DENNIS

C. H. EIGENMANN

C. A. WALDO

THOMAS GRAY

STANLEY COULTER

AMOS W. BUTLER

W. A. NOYES

M. B. THOMAS

J. C. ARTHUR

O. P. HAY

T. C. MENDENHALL

JOHN C. BRANNER

J. P. D. JOHN

JOHN M. COULTER

DAVID STARR JORDAN

The meetings of the Indiana Academy of Science Thursday evening, November 25th; Friday, November 26th, morning and afternoon; Saturday, November 27th, morning; and the informal dinner Thursday night, the luncheon Friday noon and the banquet Friday night, will be at the Claypool Hotel.

The rates quoted by the management are \$2.00 per day and upward on the European plan and \$1.00 per day and upward on the American plan. Where two or more persons occupy a room, the rates are \$1.50 and upward per day, European plan, and \$3.50 and upward per day, American plan. Hotel reservation and reservations for the banquet should be made at once.

A stereopticon will be provided.

*Committee on 25th Meeting*

AMOS W. BUTLER, Chairman

M. B. THOMAS

C. L. MEES

H. L. BRUNER

W. E. STONE

W. J. MOENKHAUS

J. P. NAYLOR

*Local Committee*

GEORGE W. BENTON

JOHN S. WRIGHT

JOHN W. WOODHAMS

## OUTLINE OF GENERAL PROGRAM

*Thursday, November 25*

- 4:00 p. m. Meeting of the Executive Committee  
 6:30 p. m. Informal dinner  
 8:00 p. m. Opening session  
 Business  
 Address—"By Packtrain to the Tiptop of the United States  
 in Quest of the Golden Trout," B. W. Evermann, U. S.  
 Bureau of Fisheries, Washington D. C.

*Friday November 26*

- 9:00 a. m. Business  
 President's Address—"Recent Progress in Physics," Dr. A. L.  
 Foley, Bloomington  
 Address—"Recent Progress in Chemistry," Dr. H. W. Wiley,  
 Chief of the Bureau of Chemistry, U. S. Department of  
 Agriculture, Washington, D. C.  
 Address—"Recent Progress in Botany," Dr. John M. Coulter,  
 Department of Botany, Chicago University  
 Greetings from other societies  
 12:00 noon Informal luncheon  
 2:00 p. m. Address—"Darwin Fifty Years After," Dr. David Starr Jordan,  
 President Leland Stanford Jr. University, President  
 American Association for the Advancement of  
 Science  
 3:00 p. m. Section meetings  
 The Academy will meet in sections. A few papers, preferably  
 those of historical character, will be read  
 8:00 p. m. Banquet—D. W. Dennis, Toastmaster

*Saturday, November 27*

- 9:00 a. m. Business  
 Address—"Methods and Materials Used in Soil Testing," H. A.  
 Huston, Chicago  
 Address—"Federal Control of International and Interstate  
 Waters," B. W. Evermann, U. S. Bureau of Fisheries  
 Address—"The Speed of Migration of Salmon in the Columbia  
 River," Charles W. Greene, University of Missouri  
 Address—"Some Hoosier and Academy Experiences," C. A.  
 Waldo, Washington University, St. Louis, Mo.



## Suggestions: Plans for the Academy—

John S. Wright	W. E. Stone
Stanley Coulter	C. Leo Mees
H. E. Barnard	W. A. Cogshall

## PAPERS TO BE READ

Unless otherwise stated, papers will be understood to be limited to fifteen minutes. The first circular of the Committee stated: "These papers will be presented, and while probably few of them will be read at the meeting, they will be printed in the Proceedings."

*General*

Thought Stimulation, Under What Conditions Does It Occur? 10 minutes .....	Robert Hessler
Does Blood Tell? .....	William B. Streeter Greensboro, N. C.
Hygiene of Indoor Swimming Pools, with Suggestions for Practical Disinfection. 25 minutes .....	Severance Burrage
Indiana Problems in Sewage Disposal. 10 minutes.....	R. L. Sackett
Defective Elementary Science .....	William N. Heiney
Some Hoosier and Academy Experiences	C. A. Waldo, Washington University
Darwin Fifty Years After	David Starr Jordan, President Leland Stanford Jr. University
The Zia Mesa and Ruins .....	Albert B. Reagan
That Erroneous Hiawatha .....	Albert B. Reagan
The Medicinal Value of Eupatorium Perfoliatum .....	A. J. Bigney

*Chemistry*

Methods and Materials Used in Soil Testing. 25 minutes	H. A. Huston, Chicago, Ill.
The Discovery of the Composition of Water (illustrated)	W. A. Noyes, University of Illinois
Molecular Rearrangements of Derivatives of Camphor.....	W. A. Noyes
Use of Refractometer in Dry Substance Estimation	A. Hugh Bryan, U. S. Bureau of Chemistry
Conductivity and Ionization of Solutions of Certain Salts in Ethyl Amine. 10 minutes .....	E. G. Mahin
Recent Progress in Chemistry.	H. W. Wiley, Chief of the Bureau of Chemistry, U. S. Department of Agriculture
Electric Osmose. 15 minutes .....	Harry N. Holmes
A Study of the Chemical Composition of Butter Fat	O. F. Hunziker and George Spitzer

- On a New Complex Cyanogen Compound.....A. R. Middleton  
 The Determination of Endothermic Gases by Combustion...A. R. Middleton

*Mathematics*

- Methods in Solid Analytics. 15 minutes.....Arthur S. Hathaway  
 Motion of  $n$  Bodies. 20 minutes.....Arthur S. Hathaway  
 Discussion of the Regular Inscribed Pentagon. 5 minutes...John C. Gregg  
 If the Bisectors of Two Angles of a Triangle are Equal, Those Angles  
 are Equal. 5 minutes .....John C. Gregg

*Physics*

- Direct Reading Accelerometers. 20 minutes .....C. R. Moore  
 Recent Work in Wood Physics. 10 minutes .....W. K. Hatt  
 Expansion of Paving Blocks. 10 minutes .....W. K. Hatt  
 Notes on the Strength of Concrete Building Blocks. 10 minutes  
 H. H. Schofield  
 Slip of Riveted Joints. 10 minutes .....Albert Smith  
 Polarization of Cadmium Cells .....Rolla R. Ramsey  
 Investigation of a Point Discharge in a Magnetic Field...Oscar W. Silvey  
 The Tenacity of Gelatine .....Arthur L. Foley  
 Objections to LaPlace's Theory of Capillarity.....Arthur L. Foley  
 Cohesion of Water as Modified by Certain Dissolved Salts. 10  
 minutes .....Edwin Morrison

*Geology and Geography.*

- Some Features of Delta Formation. 15 minutes.....Charles R. Dyer  
 A Physiographic Survey of an Area Near Terre Haute, Ind. 25 min-  
 utes .....Charles R. Dyer, Melvin K. Davis  
 The Collecting Area of the Waters of the Hot Springs of Hot Springs,  
 Ark. 15 minutes .....A. H. Purdue, University of Arkansas  
 The Geographical and Geological Distribution of Some Pleistocene  
 Mammals .....O. P. Hay, U. S. National Museum  
 On the Restoration of Skeletous of Fossil Vertebrates.....O. P. Hay  
 Where Do the Lance Creek ("Ceratops") Beds Belong, in the Cretace-  
 ous or Tertiary?.....Oliver P. Hay  
 Paleontology and the Recapitulation Theory. 50 minutes...E. R. Cumings  
 The Tippecanoe, an Infantile Drainage System. 10 minutes..W. A. McBeth  
 Observations on Cyclones and Anti-Cyclones of North Temperate Lati-  
 tudes. 10 minutes .....W. A. McBeth

*Zoology.*

- A Paired Entoplastron in *Trionyx* and Its Significance. 15 min-  
 utes .....Henry H. Lane, Oklahoma State University

- Physiological Explanation of the Psycho-Physical Law of Weber. 15  
minutes .....Guido Bell
- On the Nature and Source of Thrombin. 12 minutes.....L. J. Rettger
- Federal Control of International and Interstate Waters  
B. W. Evermann, U. S. Bureau of Fisheries
- By Packtrain to the Tiptop of the United States in Quest of the Golden  
Trout (illustrated) .....B. W. Evermann
- The History of Zoology in Indiana. 15 minutes.....C. H. Eigenmann
- An Analytic Study of the Faunal Changes in Indiana. 25 minutes  
Walter L. Hahn, South Dakota State Normal School
- Some Notes on Parasites Found in Frogs in the Vicinity of St. Paul,  
Minn. 20 minutes.....H. L. Osborn, Hamlin University
- The Mocking Bird About Moores Hill, Indiana.....A. J. Bigney
- Cross-Fertilization Among Fishes.....W. J. Moenkhaus
- Observations on Woodpeckers. 5 minutes.....John T. Campbell
- Paroxysmal Hemoglobinuria. 10 minutes.....Oliver P. Terry
- The Evolution of Insect Galls as Illustrated by the Genus *Amphibolips* .....Mel T. Cook, Delaware College
- The Speed of Migration of Salmon in the Columbia River  
Charles W. Greene, University of Missouri
- Observations on Cerebral Localization  
J. Rollin Slonaker, Leland Stanford Jr. University
- The Nasal Muscles of Vertebrates.....H. L. Bruner

### *Botany.*

- Physiological Apparatus .....Frank M. Andrews
- Some Monstrosities in Plants.....Frank M. Andrews
- A List of Algæ .....Frank M. Andrews
- Re-Vegetation of the Salton Basin (illustrated)  
D. T. MacDougal, Director Desert Laboratory, Tucson, Ariz.
- Forest Conditions in Indiana. 15 minutes.....Stanley Coulter
- Additions to Indiana Flora, Number 4. 3 minutes.....Charles C. Deam
- The Development of the Reproductive Organs of *Chara fragilis*. 20  
minutes .....George N. Hoffer
- Right and Wrong Conceptions of Plant Rusts.....J. C. Arthur
- The Effect of Preservatives on the Development of *Penicillium*. 10  
minutes .....Katherine Golden Bitting
- Recent Progress in Botany.....John M. Coulter, Chicago University
- Further Notes on Timothy Rust.....Frank D. Kern

### *Editorial Notice.*

All members of the Academy will doubtless be ready to assist in any efforts put forth having in view correct and early publication of the Pro-

ceedings. To this end the following conditions of publication are announced by the editor:

1. All papers to be included in the report of 1909 must be in the hands of the editor not later than December 15, 1909.

2. All papers should be typewritten as far as the nature of the subject will allow.

3. All tracings and maps should be drawn to correspond with the size of the page of the Proceedings, and must come within the following limits:  $4\frac{1}{2} \times 7$ . If necessary, it may be made to cover two pages, or measure  $8\frac{1}{2} \times 11$ .

4. Authors are especially requested to carefully mark and number all illustrations and to carefully indicate in the MSS. the exact location of such illustrations.

5. To secure proper representation of mathematical work, authors are particularly cautioned to send in carefully traced figures on separate paper.

6. The limits of the appropriation require that all illustrations shall be in one color, and either photographs or etchings. As a consequence, all illustrations must be in black and white.

RESOLUTION PROVIDING FOR THE CELEBRATION OF THE  
TWENTY-FIFTH ANNIVERSARY OF THE INDIANA  
ACADEMY OF SCIENCE.

*Resolved*, That in view of the fact that the next meeting will be the Twenty-fifth Annual Meeting of this Academy, a special effort be made at that time to celebrate the quarter centennial of its organization.

That a committee of seven be appointed to have charge of the program and all necessary arrangements for such meeting.

That the time and place of the next meeting be left to said committee.

That an effort be made to have present all the living ex-presidents and all of the living charter members of the Academy. Also that all the universities, colleges and other educational institutions of the State, all scientific organizations, including the State Medical Society, Indiana Engineering Society, Indiana Section of the American Chemical Society, State Science Teachers' Association, and all individuals interested in scientific work and the press of the State be cordially invited to co-operate to make this a successful meeting and memorable occasion.

Adopted November 28, 1908.



## THE BEGINNING OF THE INDIANA ACADEMY OF SCIENCE.

BY AMOS W. BUTLER.

In my early years the lack of association with persons who were interested in scientific pursuits and of opportunity to refer to books on scientific subjects was greatly felt. I planned to interest several persons in establishing a local society which would bring kindred spirits together. This resulted in the organization of the Brookville Society of Natural History in 1881. That year, for the first time, I attended the meeting of the American Association for the Advancement of Science at Cincinnati. There I had the pleasure of meeting many persons of whom I had only known by reading. This was the beginning of many acquaintances that have been permanent, helpful and inspiring. In my efforts to study local natural history I found it difficult to obtain information from students in other parts of the State. In talking with others I found they had had the same difficulty. In the winter of 1883-1884, the need of a State organization was strongly impressed upon me. Correspondence was begun with a number of persons whose names were prominent in scientific work of the State, and the majority of them favored such an organization. Among these were Dr. David Starr Jordan, Dr. J. P. D. John, Professors John M. Coulter, Stanley Coulter, Philip S. Baker, Daniel Kirkwood, Richard Owen and Oliver P. Jenkins. There were others who discouraged it. The subject was fresh in mind at the time of the meeting of the American Association for the Advancement of Science at Ann Arbor in 1884. There opportunity was given to talk the subject over, and for the first time I met Dr. John C. Branner, who had just been appointed professor of geology at Indiana University, and he strongly urged the formation of such a society. Finally it was decided to call a meeting to organize an Indiana Society. The Brookville Society of Natural History, as the most active organization of its kind in the State, was asked to take the initiative and call the first meeting. Accordingly that society appointed a committee for that purpose, consisting of Rev. David R. Moore, its president, Dr. S. P. Stoddard and Amos W. Butler. The meeting was called for Indianapolis on December 29, 1885. The plan was to have a series of papers on the status of different branches of science in Indiana. The meeting was held in the Marion County court house. The program included the following papers:

"Meteorology" .....	Wm. H. Ragan
"Progress in the Study of Mammalogy in Indiana".....	Edgar R. Quick
"Sketch of the Work Accomplished for Natural and Physical Science in Indiana".....	Richard Owen
"Sketch of C. S. Rafinesque".....	D. S. Jordan
"Work Done in Ichthyology in Indiana".....	D. S. Jordan
"Work Done in Botany in Indiana".....	John M. Coulter
"Work Done in Physics in Indiana".....	J. P. Naylor
"Work Done in Study of the Lower Invertebrates".....	O. P. Jenkins
"Present Condition of the Study of Indiana Herpetology".....	O. P. Hay
"The Study of Entomology in Indiana".....	P. S. Baker
"The Present Knowledge of Indiana Mineralogy".....	Maurice Thompson
"Work Done for Geology in Indiana".....	Ryland T. Brown
"Chemistry" .....	R. B. Warder
"The Present Condition of Indiana Conchology".....	David R. Moore
"Indiana Statistics" .....	J. B. Conner
"The Past and Present of Indiana Ornithology".....	Amos W. Butler
"Geography" .....	J. T. Scovell
"Astronomy" .....	David Kirkwood

(Of these only Richard Owen and David Kirkwood were absent, and their papers were read by others.)

Dr. J. P. D. John was chosen president pro tem. There were about forty persons present, representing most of the educational institutions of the State, and including most of the scientific workers. Dr. David Starr Jordan was chosen first president and Amos W. Butler the first secretary. A constitution and by-laws were adopted. Since that time regular annual meetings have been held. All but one, which was held at Lafayette, have been held in Indianapolis, and until recently spring meetings at different points in the State. The first one of these was appropriately held at Brookville May 20-22, 1886.

The following persons are mentioned in minutes of December 29, 1885, as being present and taking part in the meeting:

J. P. D. John, Greencastle.	J. P. Naylor, Bloomington.
A. W. Butler, Brookville.	O. P. Hay, Irvington.
O. P. Jenkins, Greencastle.	*P. S. Baker, Greencastle.
J. C. Branmer, Bloomington.	*Maurice Thompson, Crawfordsville.
S. P. Stoddard, M.D., Brookville.	J. B. Conner, Indianapolis.
*W. H. Ragan, Greencastle.	*T. B. Redding, New Castle.
E. R. Quick, Brookville.	*Ryland T. Brown, Indianapolis.
D. R. Moore, Brookville.	*R. B. Warder, Lafayette.
D. S. Jordan, Bloomington.	J. T. Scovell, Terre Haute.
J. M. Coulter, Crawfordsville.	

\*Deceased.



The following persons' names appear on the treasurer's book for that meeting, and they were probably present:

D. W. Dennis, Richmond.	C. A. Waldo, Terre Haute.
*Joseph Moore, Richmond.	C. W. Hargitt, Moores Hill.
Stanley Coulter, Terre Haute.	*W. P. Shannon, Greensburg.
B. W. Evermann, Bloomington.	*T. J. McAvoy, Indianapolis.
S. E. Meek, Bloomington.	L. D. Waterman, M. D., Indianapolis.
C. H. Eigenmann, Bloomington.	John Hurty, M. D., Indianapolis.
*J. L. Campbell, Crawfordsville.	F. M. Webster, Lafayette.
D. A. Owen, Franklin.	*F. Stein, Indianapolis.
C. R. Dryer, Fort Wayne.	
A. J. Phinney, M. D., Muncie.	

---

\*Deceased.

Of about forty persons in attendance upon the first meeting, twelve are present at this meeting.



## GREETINGS FROM INDIANA ASSOCIATIONS.

---

FROM THE INDIANA STATE TEACHERS' ASSOCIATION.

---

BY GEO. W. BENTON.

---

Mr. President and Members of the Academy: In the absence of Dr. Robert J. Aley, State Superintendent, and president-elect of the Indiana State Teachers' Association, it has devolved upon me and is my great privilege as retiring president to extend to you the greetings of the teachers of the State, and to congratulate you upon the completion of the series of notable meetings culminating in this anniversary.

It is peculiarly fitting that we do this in view of the importance of each of these societies, and of the part which each has had, and is destined to continue to perform in the life history of the State of Indiana.

The State Teachers' Association last December passed its fifty-fifth milestone, and in its uninterrupted history of fifty-four years has marked the successive stages of educational progress in the State, and has had an increasing influence in establishing standards and in directing the current of educational thought. Many of its officers and members have become prominent in the educational work of the State and nation, and many of them have enjoyed the privilege and honor of membership and active participation in the affairs of the Academy.

No less prominent in its own sphere, through the years of its activity, we recognize the importance of the great work which the Academy has done for the State and for the nation, in the spreading of scientific knowledge, in the encouragement of research, and in the inspiration of the younger generation of science teachers to greater effort and increased efficiency. We see in the Academy the most powerful agency in the solution of the great problem of fitting the highest development of scientific thought into the general scheme of education for all the people; and we confidently look forward to the achievements of the coming years of the Academy, believing that its services to the State and to education will con-

time to receive that recognition which it has so richly deserved in the past, and which we now so inadequately express.

The teachers of Indiana would consider me lacking in truth and courtesy, I am sure, should I fail to give expression to the deep pleasure and pride which we feel in the great history of the Academy, and in the exceptional capacity for usefulness with which it is so richly and generously endowed.

We greet you, and we bid you Godspeed!

---

FROM THE INDIANA MEDICAL ASSOCIATION.

---

By DR. S. E. EARP.

---

Mr. Chairman: It surely is a pleasure as well as an honor to be chosen to appear before you for the Indiana Medical Association. I am the custodian of the good-will and hearty congratulations of the Indiana State Medical Association, but it is not the casket that assumes any importance; it is the jewel I bring you. Now, when we extend our greetings we desire that they shall have a cultured application and not a provincial one. Perhaps an explanation is in order.

One of your splendid members, Prof. Stanley Coulter, recently delivered an address before The Young Physicians' Club, of which I am a member—and I am a member by virtue of the fact that all physicians are young, but some are younger than others—and Prof. Coulter in his address said that culture is an instinctive appreciation of the very best, and that provincialism is *narrowness*, the antithesis of culture. And that whenever he had come in contact with a provincialist he had two impulses, first to laugh at him, and second to kill him. He had done the first, but so far he had been able to control himself and not do the second.

So we appreciate that everything concerning you is the very best, and that it is the very best who can appreciate the best in you.

The Indiana State Medical Association has passed its golden anniversary by ten years. It has 2,690 members in good standing, and yet there are not more than twenty-five who are members of this splendid body of yours. There ought to be more. There are men who are authorities in

their line who should through this channel help themselves, help the association, help you and help the public by contributing what they possess. We must learn that, taking all the departments of science, "in union there is strength."

Another important factor is this: For a time in scientific medicine, on account of the number of medical institutions in this State, the interests were varied; but during the past year, for the first time in forty years, there has not only been an amalgamation of scientific medical interests, but there is complete unity. And now with the medical college we have here that is under the control of one of your best Universities, Indiana University, with its opportunities and facilities, we take it you will soon hear us rapping at your door, and we trust that the latch-string will be out.

We fully appreciate, as we congratulate you and bring our greetings, all that you have done and are doing for scientific medicine, and that it is valuable beyond price. Again I say, as I bring you our greetings, that we congratulate you most heartily.

---

FROM THE INDIANA HISTORICAL SOCIETY.

---

BY J. P. DUNN.

---

I have been delegated by the Indiana Historical Society to extend its greetings to the Academy of Science. This is therefore an historic greeting; just what a scientific greeting should be, I am not quite certain. In the good old days that Dr. Coulter told about, I should think the proper thing was, "Have something with me," but in the course of the great progress that has been made in the last twenty years in the Pure Food Department, I do not know whether that would be safe. I judge that scientific people believe all the awful revelations that have been made, and that they are all on the water-wagon now.

There is one thing in which I think this society and the other learned societies of the State should be at a unit. We have a centennial in 1916. There has been some talk of having an exposition, but everybody knows that the recent expositions have been failures, and it would be a failure

in Indiana. But it has been suggested that instead of this we erect a permanent memorial building devoted primarily to the preservation of the history of Indiana. This is being done now through the State librarian and the State museum, but we have not room enough. Mr. Blatchley has not room enough to do his work, and I understand valuable gifts have had to be refused on account of lack of room in that museum. There is also scientific work being handled in the State House by Dr. Hurty and Dr. Barnard, and we really need a building of this sort. These things ought to have ample quarters. I would like to see that centennial of 1916 celebrated by an ample building in which a museum and library could be housed, in which there would be room for laboratories and other work of the State, room for the Academy of Science, room for the Historical Society and all these other bodies.

I trust you will take that matter into consideration as you go out from here. Keep it in mind, and when you talk to your Representatives and Senators and people who have influence in the Legislature, lay it before them, and thus help in a work which I believe is of very great importance to the State of Indiana, both scientifically and historically. (Applause.)

FROM THE INDIANA BRANCH OF THE AMERICAN CHEMICAL  
SOCIETY.

BY PROF. R. B. MOORE.

Mr. President: As representative of the Indiana branch of the American Chemical Society I extend congratulations to the Academy upon its twenty-fifth anniversary. It is needless to argue the use of such a society in the State. It does a work which none of the national societies can do, and it is needless also to state that this work has been done well. Congratulations are especially in order, to those men who founded the Academy and have borne the burden of the work since that time.

I am also glad to see that the social life of the society is receiving sufficient attention at this meeting. We have little opportunity to get together during the year; it is all the more important therefore that the social side of our meeting should be emphasized.

The Indiana branch of the American Chemical Society extends to you congratulations and greetings. (Applause.)

## FROM THE STATE PHYSICS TEACHERS' ASSOCIATION.

BY PROF. J. P. NAYLOR.

---

Mr. President and Members of the Academy: I stand in the rather unfortunate position of belonging to the Committee of Arrangements for this meeting, and also representing one of the other societies. But I assure you that I did not make the assignment. The fact is I was simply held responsible for the presentation of the greetings of the State Physics Teachers' Association and tried to get a good man who could present the greeting in better words than I, although not in better spirit, I am sure.

As I look around over the faces of those present I see many members of the Physics Teachers' Association who are also members of the Academy, and it may occur to someone to ask why the Physics Teachers' Association should exist at all. The work in any science is many sided, and there are some things that can be done in the Indiana Academy and some things that can not be done. We, the physics teachers of the State, need to get together and compare notes. We want to know what the other man is doing and how he does it. This sort of work can not well be done by the Academy, for its province is rather along the line of investigation, and besides its program is always crowded; therefore the State Physics Teachers' Association.

Our association is, however, a sort of offspring of the Academy, and we look to it as the mother society. And as good children we come back at this time with our congratulations and hearty greetings, and hope for the Academy that the next two and a half decades may be even better than the past has been. We do not come like the Orientals, wishing that her shadow may never grow less but that her bright light may be ever enlarged, and that she may go on to larger accomplishments in the future. I bring you greetings. (Applause.)

## FROM INDIANA SOCIETY OF ENGINEERS.

---

BY CHAS. BROSSMANN.

---

Mr. President and Gentlemen: I feel that it is an honor to address your meeting, and am glad to speak a few words of greeting on behalf of the Indiana Engineering Society.

On your program I notice the names of more than one engineer and subjects relating to engineering work. I feel that the scientist and engineer need no introduction, for they have ever worked either together or in sequence for the betterment of man and civilization.

On the vital questions relating to the physical development of our vast industrial system the scientist has made the work of the engineer possible.

The first step belongs to your work. You took the initiative and advanced radical though perhaps unappreciated theories, labored for years to prove them, and had to work and keep the courage of your convictions to establish your point beyond question.

Your reward has not usually come from a grateful public, but you have the reward of a greater knowledge.

I wish to mention one or two papers on your program, one "A List of Algae." A list of algae means nothing to a community, but when an entire water system becomes clogged with *Crenothrix*, they cry for the scientist to find the remedy.

The subject, "The Problem of Sewage Disposal," does not appeal to a city until the stench is apparent, then succor from scientist and engineer is needed.

Most of the papers to be read, touch upon the betterment of the human race, the conservation of its health, and the country's resources.

Today Dr. Von Lendenfeld investigates the organs of flight of the best flyers of the insect orders, Lepidoptera, Hymenoptera and Diptera. The public hears and smiles.

Tomorrow the Wrights fly for hours in the upper air. The public sees and gasps in wonder and amazement.

And so the scientist needs be the silent man. Carlyle says: "The noble silent men—scattered here and there—each in his department—



silently thinking—silently working, whom no morning newspaper makes mention of—they are the salt of the earth. A country that has none, or few of them, is in a bad way.”

I am glad we have many in this country, and that this State is so well represented in the “silent men”—although perhaps they will not be so silent in the ensuing two days.

Gentlemen, I am pleased and honored in extending to you the greeting and good wishes of a brother society which appreciates its debt to science. The Indiana Society of Engineers greets you and wishes you a successful meeting.

---

FROM THE INDIANA ASSOCIATION OF SCIENCE AND MATHEMATICS TEACHERS.

---

By W. W. HART.

---

Mr. Chairman: As I have sat here listening to the expressions of greeting on this occasion, I had the great pleasure of hearing the other gentlemen say the things I expected to say.

I feel that it is especially proper that our society should join with the other organizations today in expressing their interest in your Academy. In some respects, while not a child of the Academy, as is the Physics Teachers' Association, yet we might call ourselves a younger brother. Our interests are somewhat similar. We are interested in the sciences and mathematics, and I think that on that account we can appreciate better than others, possibly, the feeling of need which led to the organization of the Indiana Academy of Science twenty-five years ago. We are all of us working in a field in which we must look for sympathy, for encouragement, for inspiration, not to the public at large, because they frequently misunderstand us, but to our colleagues and fellow-workers. That, as I understand it, was one of the reasons for the organization of this society.

Also many of our number are directly indebted to some of you for the instruction and inspiration that led them to take up their life work. And we are all indebted to you for the standing you have given to scientific pursuits in the country at large.

So I bring to you today the most hearty congratulations upon your past history, and upon the glorious achievements of some of your number, and say that we wish you abundant success for the future. (Applause.)

---

FROM THE INDIANA AUDUBON SOCIETY.

---

BY WILLIAM WATSON WOOLLEN.

---

Mr. President, Ladies and Gentlemen: The first Audubon Society was organized in New York in 1886. Its purpose was "the protection of American birds, not used for food, from destruction for mercantile purposes." In 1889 it seemed to have accomplished the purpose for which it was organized and the movement died out.

A subsequent revival of the demand for birds for millinery purposes led to a re-awakening of sentiment on the subject, and in January, 1896, a State Audubon Society was organized in Massachusetts and in October of the same year one was organized in Pennsylvania. Such societies now exist in all of the states, except perhaps a half dozen, the object of their organization being the preservation of our birds which were fast being exterminated. It was thought that the people must be educated as to the worth of our birds, and these societies entered upon that work.

In April, 1898, principally through the instrumentality of the Indiana Academy of Science, the Indiana Audubon Society was organized. I have in my office the minutes of that meeting, at which I was present. In looking over the minutes of that meeting I find the society was mainly constituted of members of this Association.

The work which has been accomplished by the Audubon Societies of the country has been immense. I am not sure that I know of any other organization which, with as little money, has accomplished so much good. Its work for good has been of such a character as to attract the attention of the people of the country and especially the Department of Agriculture at Washington. The annual reports of that department have taken account of these societies and commended them for the work which they have accomplished. You all must be aware of the legislation that

has been brought about through the influence of these societies, and especially the Lacey act passed by Congress for the protection and preservation of our birds.

I am glad to say that there is not a State in the Union which does not have its laws for the protection of our birds. In this State we have not lagged. We have placed upon our statute books the ideal law for that purpose, originally suggested by the American Ornithological Association.

Now, ladies and gentlemen, allow me to suggest in conclusion, that the membership roll of our Audubon Society contains but few names of the members of this association. We have a membership of about one hundred and fifty. Our first annual meetings under the provision of the constitution were held at Indianapolis. We learned, to our regret, however, that in this great and beautiful city there were very few people who were interested in this work. We changed our constitution. Since then we have gone to Franklin, Richmond, Shelbyville, Fort Wayne, and New Castle, where we have been received most cordially, and we hope we have done good.

Now, we bring our greetings to you, with the hope for future success, and that you will renew your love for this, one of your offspring. I have looked over the program arranged for this the twenty-fifth annual meeting of the Academy with its sixty-nine numbers and the additional numbers which Mr. Butler has read, and I find there are but two numbers which have any reference to our birds. These are No. 45, "The Mocking Bird in Indiana," and No. 47, "Observations in Woodpeckers." Now, ladies and gentlemen, to my way of thinking, this is not as it should be. I believe these other things which you have been writing and talking about are important, but of all of them the one particular thing which is of the greatest interest and value is the preservation of our birds. Without them you will have no occasion to talk about botany or any of the other things about which you have been writing and talking. It is the birds of our country to which we must look for its salvation. I thank you for the opportunity to say a word for them.

PLANS FOR THE INDIANA ACADEMY OF SCIENCE.

---

JOHN S. WRIGHT: Mr. Chairman, the committee made arrangements for several persons to speak of the plans for the Academy, with reference to future expansion and development. Now, most of the points that I had in mind have been covered very adequately by the speeches which have been made at different times during the meetings, particularly last night by Dr. John M. Coulter with reference to the social side of the Academy, making the members better acquainted with each other. I feel sure that the program committee will endeavor in planning the next meeting to emphasize the social aspect more and more. Possibly a smoker will serve very well to this end. I do not suppose we would attempt a banquet of as large proportions as the one we had last night, as that would entail too much effort.

I believe the Academy will do well to enlist the interest of men who are in industrial lines. There are within this State at the present time a great many men who are in industrial lines. Mr. Brossmann, who represents the Engineering Society, referred particularly yesterday morning to the interest that engineers and chemists have in scientific work, and that their work rests upon developments along the lines of science. These men in industrial lines may properly be enlisted in the Academy interests, and I am certain we can thus enlarge the number of those engaging in the work of the Academy.

I believe that is all I care to say, because other features of the Academy work will be mentioned by those who follow.

---

DR. STANLEY COULTER: Mr. Chairman, I think we are a unit upon the matter of the development of the social side of the Academy. It has occurred to me that one way in which that might be brought about would be to have the Executive Committee constitute itself a committee of introduction at each session, and make it a regular part of the program to introduce the new members to the older ones. I have frequently told young men that the only way for them to broaden out was by coming in contact with these older members, and they have come to the Academy meetings, stayed a day or two and have gone home without meeting a

single one of them. We should certainly have some committee that would see that the young members are properly introduced to those with longer years of service in the State.

Another matter which should be taken up by the Academy and the Executive Committee is the length of time taken to print our reports. A man who is doing a bit of scientific work which is worth publishing, the preparation of which involves much time and labor, must wait eleven months for its appearance if he presents it to the Academy. A paper that may be of value at the time of its presentation, may not be worth nearly so much after a year has elapsed. You can not be sure that the thing you say today is the thing you would say in the same form a year from now. I think the Executive Committee should take this matter up in some definite way, and see that the proceedings are ready for distribution in less than a year from the date of meeting.

Another thing, it seems to me, that we need is that our programs should not be made up as they are now, in a comparatively haphazard fashion. In the past we had some programs that were really capital, and those who had these programs in charge would begin, say, in March or April to send the various members letters, suggesting that it would be a good time to arrange in their minds the subject they would present to the Academy, and thus, long before the Academy meeting the Executive Committee had in hand a well organized program.

In conclusion, I suggest: a recognition of the social side, an improvement in the methods of getting out our reports, so that they may be received very much more promptly than heretofore, and a return to the old method of having the Executive Committee, made up of the President, Secretary and Program Committee, feel that a large part of their work must be done before summer vacation if the meeting is to be a success. The request for my subject, under the present practice, always comes at a time when I am busier than at any other time of the year. As a consequence I send in some title that sounds well, and does not take much preparation, and trust in the main to the inspiration of the moment.

I am thoroughly in accord with Mr. Wright's suggestion that this organization is losing a very great element of strength in not having associated with it more closely the industrial scientists of the State. (Applausè.)

DR. H. E. BARNARD (Indianapolis): Mr. President and Members, I cannot but feel that it is presumption for me, whose name was enrolled in the Academy but yesterday, to attempt to give advice to you who were at Brookville, and who have guided the Academy from its infancy through youth to manhood. But if there is a word I can say this morning it is to the older members, whom I would urge to give of their wisdom and advice to these young men, not only in lectures, but in heart-to-heart talks and fraternity with them. I wish to express my thanks to Dr. Coulter for his admirable toast last evening. More fraternity and fewer scientific papers I believe will be the key-note of the future of the society. Some of the papers stand a poor chance of being appreciated, because they are not understood; but we all want to know the men who write the papers, not for the papers, but for themselves. One may gain quite as much inspiration in the company of the worker in other fields as in association with his fellows, not in their papers, but in the social hour.

So I would urge more and more this fraternity among the members, especially at the spring meetings. That first gathering at the swimming pool has taken hold of me; it gives us a glimpse of an esprit de corps that will carry the Academy far, and make an Academy that we will be as proud of twenty-five years hence as we are today. (Applause.)

---

PRESIDENT W. E. STONE: Mr. Chairman and Members of the Academy, perhaps what I have to suggest will not permit of practical application, and yet as I have been in attendance upon this meeting I am impressed with this thought about the Academy. It has become in a sense a child of the State; it owes something to the State as an organization. It represents a body of men who certainly have a great deal of influence in shaping the future of the State. Now, it occurs to me that the particular thing which this Academy can do is in the direction of shaping public appreciation of scientific methods and scientific spirit. You can not formulate that policy for immediate action, but I submit to you if it would not be a very valuable thing if the public at large, the press, business men and public officials, had a better conception of what scientific methods and the scientific spirit stand for. How much we should be spared in the press of the sensational talk of scientific attainment; how much we should economize in the administration of the affairs of city and state; how much more it would mean to the private affairs of our citizens if there

was a conception of the idea that knowledge is to be gained on all of the common affairs of life which put into practice would result in efficiency and in economy.

Now, that is a matter of slow growth—public education. We are striving to bring people to a conception of that idea in all of our schools and colleges, and here is a public body which should be recognized as having influence and standing and weight in this State. What better service could it render in the course of a quarter century than to have promulgated steadily that notion of appreciation of scientific methods and scientific spirit? It is worth more than papers. It is the ultimate object of this Academy. It is the highest service it can render the State as a matter of public welfare and public education.

Now, that is very intangible, I realize, but I think it is an end worth thinking about. (Applause.)

---

DR. C. L. MEES: It appears to me that the remarks I had prepared upon being notified to speak have been stolen by those who have preceded me. It is an old Chinese saying that it is dangerous to stoop down even to fasten your shoe strings in your neighbor's melon patch. So there is very little left for me to say.

I certainly am thoroughly in accord with all that has been said this morning, and by Dr. Coulter last evening, but there are one or two practical things which come to my mind now. Dr. Coulter referred to the fact that we are in danger of dissipation. Owing to the fact that the number of scientific workers in special lines in Indiana has increased very greatly in the last two years, papers presented to the Academy have become more and more technical in narrow specialties and the number capable of discussing them or even following them as presented was necessarily small and interest correspondingly flagged. This condition led to the formation of half a dozen or more of scientific societies made up of men especially interested along narrow lines of scientific research, commanding the interest and attendance of those having common interest and drawing their attention and membership from the Academy. Now the question is whether the Academy cannot devise some plan by which the work of these various societies could be co-ordinated and perhaps their meetings be arranged to occur about the same time as the Academy meeting. If the program of the Academy meeting could be somewhat shortened and the papers be

made of more general interest, they would serve the purpose, as Dr. Stone has just intimated, of developing the scientific spirit, and then let the different societies meet and discuss the technical papers they may have to offer. I merely offer this as a suggestion, and do not know whether it would be practical.

There is another suggestion which possibly might be worked out. The American Institute of Electrical Engineers has tried a somewhat similar plan, that is, to have scholars from the various colleges where more or less graduate work is being done, attend meetings, and thus give them an enthusiasm which contact alone will bring, and publish their papers, if worthy, and interest them in the work of the Academy later on.

These are some of the practical points that come to my mind in connection with the future plans of this Academy. I believe the danger is now that, unless the character of the activity of the society is somewhat changed, we will become a sort of body which exists upon paper and in lists of membership, rather than in active work.

---

Mr. W. A. COGSHALL (Bloomington): I have been very much interested in the statements during the last two days of the early work of the Academy—its early organization and membership, and in the large number of suggestions that have been made for the future of the Academy. I think most of these are good. It only remains to adopt some definite plans by which these suggestions can be put into something tangible. I do not know whether such plans can be worked out in the immediate future or not.

It seems to me the aim of this Academy is first to encourage scientific work among a good many who without the Academy would not do any such work. It does that to a certain extent. We have every year a long list of papers from men who do not belong to other scientific societies, and it is a good thing for them and a good thing for the State at large that these papers should be prepared and printed.

The other aim of the Academy, and which I believe to be the main one, is the bringing together of the scientific men of the State—not necessarily to hear the papers, as was very well said last night. I do not know that I should put the papers in quite so insignificant a place as was indicated, but we could well have the program the real excuse for meeting, and make that the frame-work of the whole thing. But I think a good



deal of the scientific benefit is lost or perhaps not realized, by having such a large number of papers of such short duration. To my mind it takes a man who is a good deal better than the average to prepare a paper of five or ten minutes in length, that has anything in it, and if that is all there is to the paper, I do not know that it is really worth while to read it. I believe the whole work of the Academy could be much better carried on if we did not try to crowd sixty or seventy papers into one short meeting.

With the great number of things that have come into life since this Academy was organized, it is not possible for us to give two or three days continuously to a meeting of this kind very often, and so we could not have sixty or seventy papers. But if we could have papers that are long enough to be beneficial, and put them into a shorter space of time, we could then devote more time to the social element of the meeting. I do not believe we get much social benefit from the meeting, as it only happens once a year. We come up here and meet a few men and go back home, and in the course of a few months we have forgotten who these men were and where they came from and what sort of work they are particularly interested in. I believe we should have meetings which would not be too scientific very much oftener than once a year, which would serve to bring the members of this Academy into closer touch with each other.

I would suggest that we have, if possible, some sort of Academy headquarters here in Indianapolis, and that once a month or once in two months, or once a quarter, as may seem advisable, notices be sent out to the members that there will be a meeting. Have not over one or two papers, that could be presented after a little dinner or lunch. I think this would be well worth while.

I was very much interested yesterday in the statements of the Librarian of the State, in regard to the new building that is proposed. If by any possibility that building could be obtained through appropriation from the Legislature, a permanent headquarters for the Indiana Academy could be secured, a most excellent place for carrying out some such idea. It would give us a place for our library, and it seems to me it would be a benefit to the Academy on every side. It would bring the whole scientific body of the State of Indiana together often enough to get acquainted and keep acquainted.

I believe that some sort of permanent headquarters, more frequent meetings and shorter meetings, would give us the best results in this State.

## BANQUET.

FRIDAY EVENING, NOVEMBER 29, 1909.

---

DAVID W. DENNIS, Toastmaster.

### SPEAKERS.

DAVID STARR JORDAN.  
ALFRED SPRINGER.  
GLENN CULBERTSON.  
M. H. STUART.  
JOHN M. COULTER.

GEORGE T. MOORE.  
W. A. NOYES.  
CHAS. W. GREENE.  
B. W. EVERMANN.

### MEMBERS AND THEIR FRIENDS PRESENT.

Andrews, F. M.  
Bangs, E. H.  
Barnard, H. E., and wife.  
Barnhill, Dr. J. F., and wife.  
Bennett, L. F.  
Benton, G. W.  
Bigney, A. J.  
Bitting, Dr. A. W.  
Bitting, Mrs. Katherine Golden.  
Blanchard, W. M.  
Blatchley, W. S.  
Bodine, D.  
Brayton, Dr. A. W.  
Breeze, F. J.  
Bross, Ernest.  
Brossman, C.  
Brown, D. C.  
Brown, Hilton U.  
Bruner, H. L.  
Burrage, S.  
Butler, A. W., and wife.  
Bruce, E. M.  
Carmen, E. K., Miss.  
Cogshall, W. A.  
Coulter, J. M.  
Coulter, Stanley.  
Cox, W. C.  
Cox, U. O.

Culbertson, Glenn.  
Daniels, L. E.  
Deam, C. C.  
Dennis, D. W.  
Dillan, Miss F. E.  
Dryer, C. R.  
Dunn, J. P.  
Earp, Dr. S. E.  
Eigenmann, C. H.  
Enders, H. E.  
Evans, P. N.  
Evermann, B. W.  
Felver, W. P.  
Foley, A. L.  
Francis, J. R.  
Gabel, J. D.  
Golden, M. J.  
Gottlieb, F. W.  
Greene, C. W.  
Greene, F. C.  
Hadley, A. N.  
Hankinson, T. L.  
Hart, W. W.  
Hathaway, A. S.  
Hofer, G. N.  
Hole, A. D.  
Hyde, Roscoe.  
Johnson, A. G.

Johnson, S.	Springer, Dr. A.
Jordan, D. S.	Stoddard, Dr. S. P.
Kenyon, A. M.	Stoltz, Charles.
Kern, F. D.	Stoltz, Charles, Jr.
King, R. M.	Stone, W. E.
McBeth, W. A.	Stuart, M. H.
McBride, R. W.	Swift, L. B.
Mees, C. L.	Taylor, F. B.
Millis, W. A.	Thomas, M. B.
Moenkhaus, W. J.	Thompson, Willis S.
Montgomery, H. T.	Transeau, E. N.
Moore, G. T.	Turner, W. P.
Moore, R. B.	Van Gorder, W. B.
Morrison, E.	Waterman, Dr. L. D.
Mowrer, F. K.	Weems, M. L.
Noe, Fletcher M.	Williamson, E. B.
Noyes, W. A.	Woodhams, John W.
Pohlman, A. G.	Woollen, W. W.
Potter, Dr. Theodore.	Wright, John S., and wife.
Ransom, J. H.	Young, J. P.
Rettger, L. J.	Zimmer, H. E.
Smith, E. R.	

DR. A. L. FOLEY: It seems to me the Program Committee has shown particularly good judgment in the program it has provided, and in no way has that good judgment been better shown than in the selection of the Toastmaster for this evening.

There is no man in Indiana who has had more influence upon the teachers of the State, upon the schools of the State; there is no man who has been closer to the hearts of his pupils. There is no man who has had more to do with the development of science in Indiana than has Professor David W. Dennis, of Earlham College, who will preside. (Applause.)

PROF. DAVID W. DENNIS: I am sure, ladies and gentlemen, that I wish more than any of you possibly can that all of that was true.

In science we have many of us been very lately instructed by an eminent Hoosier that nothing at all is settled, and I came to the conclusion this morning when recapitulation went overboard that perhaps it is so. But the records of the Indiana Academy of Science would furnish many exceptions to this rule. During these twenty-five years we have been settling a considerable number of questions; some of these have been settled so effectually that they have never come up again. For instance,

many years ago—so many that I have forgotten the exact date—Dr. Jordan presented a discussion on “Fishing all the way from the Amazon to Greenland,” and he said that the number of vertebrae in the fishes of the same species always increases with the latitude in which the fish is caught. He suggested that he knew no reason for it unless perhaps it is that life expresses itself in more vigorous terms at the pole than at the equator. But Prof. T. C. Mendenhall offered a theory that was received with much applause, and that everyone thought was right. He said the North always had more backbone than the South, anyway. (Laughter). So that is one question we have settled.

I remember also that twenty-four years ago our botanist presented to us what he was pleased to call a very important question. Several others have been presented that were more or less important, but this was really important, and it was, in general terms, the development of life from the plasmodium to the oak. He referred to the fact that mushrooms—I tried to get his exact words, but we did not publish in those days, so this is as I remember it—that mushrooms “are degenerates, mere driftwood cast up by the waves of life’s ocean.” Incidentally this idea was illustrated by another journey parallel to it, from the Amœba by way of the ascidian to man. In the discussion which followed, our zoölogist arose and said the ascidians “are degenerates, mere driftwood cast up by the waves of life’s ocean;” so the status of the mushroom and the ascidian was settled.

We really took up some serious questions. I remember that Professor Waldo in a wide discussion of mathematical questions, had a good deal to say about parabolas, hyperbolas, asymptotes and other similar things; Professor Neff then followed with a paper dealing with the refinements of organic chemistry, which he illustrated with what appeared to be colored chalk; all of us were lost some of the time and some of us were lost all the time for some hours. This was followed by a glowing vision of creation from a Darwinian standpoint. It was an interesting occasion; we all understood and took on a benevolent expression. But the many things we used to teach that are discarded now were useful in their day. Carlyle says somewhere that the present time is “child and heir of all the past and parent of all the future,” and I could not help thinking this morning when Prof. Coulter was talking, that as one after another these theories have been set aside, there has been a reason for the existence of

each one, and it has called into existence something that is better than it was itself. Our criticism is constructive.

I believe scientific men—or at least if you will make it a little broader than that, the school-master today is the priest of today; and he is going to be the priest of the future. There were some questions submitted to the children of the schools in one of our cities; one of them was, "Where is Heaven?" In the answers one of the pupils (it was a girl, so there could not have been any malice in it) said that Heaven was said to be above the clouds, but she added that physical geography teaches that the atmosphere is only about forty-five miles high, and that even a very few miles up it is probably not possible for anybody to live, so Heaven could not be there at all. Whatever that child may have thought that was wrong or inadequate about Heaven, it is clear that she believed the things her teacher had taught her about the air. He, instead of her minister—if she had one—was her priest.

I happened to be present at the inception of this Society after Amos Butler brought it to us, and of course it would be very easy to continue these reminiscences; but that is not what the committee asked me to do, and I do not intend to do it. But this Society has been a great help to me and to all of us, not only in its meetings, but in the rambles we have had over all parts of Indiana in our Spring meetings. We went out to Fort Quiatanon and hunted beads the Indians had lost at the old trading post and were as happy when we found one as the Indians were sorry when they lost it; we have gone over the whole State getting acquainted with whatever of interest it had to offer. Even at the very first meeting down at Brookville, the home of the Academy, we went swimming, and naturally got acquainted with ourselves; saw ourselves in a sense in which others did not very often see us. (Laughter). These social occasions have been the best part to me, after all is said, of the meetings of the Academy from the beginning until now.

I have the pleasant and easy task of introducing first a man who needs no presentation to scientific men anywhere; a man who needs no title, but whose titles are so numerous that there would not be time to read them. He is an investigator and a teacher, was for a time the premier of Indiana teachers. He is an author to whom science owes much and man owes more; the man for whom the river Jordan was named. (Laughter). Dr. David Starr Jordan, President of Leland Stanford University. (Applause.)

DR. DAVID STARR JORDAN: Mr. Toastmaster and President, Members of the Academy, Ladies and Gentlemen: It is a pretty hard thing to respond, impromptu, to all that. I only hope there is some of it that is not true. It is a very great pleasure to me to get back here, and yet that pleasure is not unmixed with a certain kind of pain. I was just remarking to Dr. Coulter that in the "fierce democracy" of this Indiana Academy "there was a Brutus once who would have brooked the eternal devil to take his seat in Rome" as easily as he would have sat for dinner in a dress-suit. But to see this "fierce democracy" in the brook at Brookville—it gives me a certain sense of pain. (Laughter.) And speaking of Brutus calls to my mind Marc Anthony, and I remember an occasion when a gentleman was called upon to speak, and he had only one speech which he said over and over, and just before going in he asked if anyone could give him the address of Marc Anthony. A friend said, "You know Anthony's style of life and the people he associated with; I should think his address would be at the same old place." (Laughter.)

I saw a statement not long ago by Henry Fairfield Osborn, that he did not think it possible for an American University to produce a Darwin, and the reasons he gave were that first, he—that is, the student nowadays—did not have to contend in his early life with something that was distasteful to him, as Darwin did; second, scientific men do not have the appreciation here that scientific men do in England; and third, that the scientific men of this country do not have the leisure to become such as Darwin was. It does not seem to me that these reasons are very good. I do not think, perhaps Darwin did not think, that any appreciable part of his greatness was due to the work in the University which he said was incredibly dull, and which led him to feel that he would never read a book on a certain subject afterwards. And as for appreciation in this country, you have just heard how scientific men are appreciated in Indiana, and it is even so everywhere we go. And so we have this kind of treatment, in America, whereas Darwin was named "gas" by his fellow-students, because he confined himself more or less to chemical experiments. And as for leisure, I know a great many scientific men of leisure who have never made any pretense to being Darwins on that account. It seems to me that Darwin was first made by heredity. There will never be another; you cannot get a man of high scientific rank and quality unless heredity starts the thing. You have to get the right kind of stock. There is no reason why the right kind of stock should not be found in Indiana,

for there is such an amount of genius in this State that it spills over into all the other States. California is full of it that has been borrowed from Indiana, and so with the other States. The first thing, then, is heredity. The second thing is to be "up against it." We read in history that Darwin went to see horse races and watched them very closely; that he was interested in the beetles of England and gathered beetles in season and out of season. In other words, with all the scientific training a student gets he should be brought right up against nature; against the things that do not lie if you listen to what they have to say. Then the third thing. We read in the various historical sketches of Darwin that he "walked with Henslow," a man with enthusiasm, and this enthusiasm was passed from the teacher to him. I take it, then, that the making of a great man of science rests on these three things, and I do not think the other things have anything to do with it. I notice a man will do just as much when he has not any time, as he will when he has all the time there is.

Now, I think we have these elements to a greater or less extent in our modern Universities. Of course, heredity is not included, but the second element, that of coming up against it, is more or less within the power of every institution now. There was a time when institutions prided themselves that they did not let the students come up against any scientific knowledge. There was a time when the University teacher—an A. B.—was more interested in the song of the oriole than the students in his classes. But the Universities have recognized that defect. Now, the third element, "walking with Henslow." Jacques Loeb, of the University of Chicago, told me awhile ago that he received a very enthusiastic letter from a young man who said he wanted above all things to study the origin of life, and that he wanted above all things to study under Loeb and enjoy his fellowship. Then Loeb wrote back that, unfortunately, he had decided to go to California, and the young man wrote back: "Will you kindly turn my letter over to your successor?"

Now, to a large degree, young men are training themselves wrong. Instead of "walking with Henslow," they are going where they are hired for \$200 to \$500 a year. They are a bar to scientific research, for what professor can teach his students to do a thing which he cannot do himself? You may remember in the last number of the *Atlantic Monthly*, an article by Professor Showerman of the University of Wisconsin. The professor had worked for some time on the prefixes in P, of Plautus, he was then working on the suffixes in S, of Seneca, to be followed by the termi-

nations in T of Terence. The point I want to get at is that this is not advanced work, and the student will not gain enthusiasm. I do not think we ought to mistake for advanced study this very elemental work, the things that are of no consequence, and just so far as we allow our young men to do this elementary work, so far will we find them going out as teachers without enthusiasm, and saying that it is impossible in this country ever to see another Darwin. (Applause.)

MR. DENNIS: The next speaker is a member of the Academy, and has been for eighteen years. He came to us from the neighboring State of Ohio, and we expect him this evening to bring the greetings of his native State to the Academy. He is the gentleman who in his earlier scientific career invented the torsion balance. At the present time his specialty is fermentation.

Dr. Alfred Springer, of Cincinnati.

DR. ALFRED SPRINGER: Mr. Toastmaster, Ladies and Gentlemen: It certainly affords me great pleasure to be here with you this evening, and no little gratification to be permitted to address a body of men, many of whom have carved their names deeply in the records of scientific achievement. The achievements of those of you who have remained at home have become household words, and the fame of those who have left the State to spread such brightness as only science can convey, has loomed up conspicuously among many brilliant lights. Twenty years ago the American Association for the Advancement of Science, in looking over its list of eligible candidates, selected from your members T. C. Mendenhall as the man worthy to represent it as President. Chairmen for the various sections of the American Association have frequently been selected from the Indiana Academy on account of the good work they have done. As for the General Secretary of the American Association, where could a better and more popular one be found than in our own Amos W. Butler? He graced that position in 1892, and ornithologically speaking, he was a "bird." (Laughter.) This year the American Association for the Advancement of Science has honored itself in selecting one of your past presidents for its President. No one who knows Dr. David Starr Jordan doubts but that he will add additional lustre to its already bright pages.

Permit me, as a delegate from the Cincinnati Section of the American Chemical Society, to congratulate you on the twenty-five years of your existence, and to bespeak for the future, if such a thing be possible, greater success than in the past. (Applause.)



PROFESSOR DENNIS: The program committee wished a man to speak for the small college, and it has asked Professor Culbertson to do this. He was President of this Academy last year, and it is a fact that he has been a member of the Indiana State Legislature. I cannot understand how it came to pass, but will leave that for him to explain—it is true. If he occupies six minutes' time, he has obtained for us through the Legislature \$100 a minute every year for all of that time, and I think he will be entitled to at least that much. Prof. Glenn Culbertson, of Hanover College.

PROFESSOR GLENN CULBERTSON: Mr. Toastmaster, Ladies and Gentlemen: I shall not attempt to explain how I came to the Legislature. I enjoyed the experience very much, but I do not know that I shall care to go through it again, so you had better be looking up another candidate if you want the appropriation continued two years longer. I was very much pleased to hear the expression this morning, but there really was not very much difficulty in getting the appropriation. And I want to say this in regard to that appropriation, that I did not do anything that was against my conscience in attempting to get it. If I had not felt that there were good papers presented to this Academy every year that ought to be published in its report, I should not have worked for this \$600 additional appropriation.

My subject is "The small college in its relation to the Academy of Science." I think by going back twenty-five years in the history of the Indiana Academy of Science, every college in the State would come in that class. Since then, of course, some of them have moved forward into a higher class. I have been a member of the Academy for some fifteen or sixteen years, and it has been a great pleasure to come up here year after year to hear the papers read and the discussions entered into. They certainly have been an inspiration to me, and I take it they have to every man in a small institution in Indiana. We are spread out over a considerable territory, and we have a great deal of work to do. Dr. Jordan says that the more work a man has to do the more he will do, but it is true that if we have a great deal of work along different lines we do not have time to put in special work in preparing such papers as we have heard here year after year; nevertheless we have all done our part. Of course, we of the smaller colleges rather envy a good many of the teachers in larger institutions because of their ability and opportunity to pursue their work along certain lines, but there are compensations. We get a broader grasp

of things in a certain way, and we have certain relationships that are very pleasant to us. I will admit that with some of the papers, all I can do is to look wise, but I have received a great benefit from a good many of them, and have gone back home resolved to understand more fully these things that are brought to our notice.

So far as the work of the small institutions of the State is concerned, you have only to look at the program to see that the small institutions have done their share in producing the scientific men that have been an honor to Indiana. We are very proud of them today.

I want to thank you for listening to the words I have spoken, but I think you can listen to better advantage to those who are to follow me.

PROFESSOR DENNIS: Mr. Milo H. Stuart, of the Manual Training High School, has been requested by the committee to speak on the subject of High Schools. He was principal of the High School at St. Paul before coming here, and is certainly as well qualified to speak from that standpoint as any member of the Academy.

PROFESSOR MILO H. STUART: Mr. Toastmaster, Ladies and Gentlemen: It is easy to see, in the splendid addresses to which we have been listening, why the Academy has endeared itself to the people of Indiana. I would be pleased to add other reminiscences if I could do so, but I am too late a recruit to make any contribution along that line.

Coming from the High School field, I naturally think of the work of the Academy from that standpoint. As we have heard these inspiring addresses today I have been thinking how fine it would be if every science teacher of the State of Indiana could have been induced to come to this fount of inspiration. I believe he would have gone back to his classes with fresh ardor.

We all remember when we left our Universities and got into original work, how great a pleasure it was to feel that we had contributed just a little to the volume of knowledge. The compensation that comes from that kind of labor is certainly very great, and it seems to me if the teachers of the State could come into touch with the people who are doing it, they would feel their load a great deal lighter. I know they would take back to their boys and girls inspiration that would fast make scientists out of them.

This Academy of Science marks its twenty-fifth milestone today, and its face is set toward the golden anniversary. I am reminded of the story

of the Irishman who said he wished he knew just the spot where he would die. His brother asked him what he wanted to know that for, and he said if he knew the exact spot, he would spend the rest of his life keeping away from it. So I think the Indiana Academy of Science, through some of its officials, must have discovered the spot where it might die, and started in the opposite direction, and we are twenty-five years removed from that place tonight.

That leads me (with apologies to Tennyson) to conclude by saying, that

Scientists may come and scientists may go,  
But the Academy goes on forever.

(Applause.)

PROFESSOR DENNIS: Every word I said in introducing Dr. Jordan is true of the next speaker; every teacher in the state would forgive me for saying that after Dr. Jordan left us he became our premier. There was, however, one difference. Dr. Jordan, as President of the State University, had for his rule a motto "Die Luft der Freiheit weht."

The students hardly knew what this meant but finally concluded it was "No smoking in the buildings." Prof. Coulter succeeded Jordan and the first day he smoked in the office. (He sometimes smoked in those days.) The students made a bonfire of their best hats:—they had had but one rule and now they had none. Prof. John M. Coulter, of the University of Chicago.

DR. JOHN M. COULTER: Mr. Toastmaster and Friends: All these ancient and new members of the Academy, who have spoken, have about exhausted the subjects, and I hardly know where to find myself. One thing I had in mind when Dr. Jordan was suggesting that heredity perhaps determined in the first place whether a man was going to do anything or not, and that things that followed were more or less auxiliary. I remember to have heard Dr. Wiley some years ago raise the question why there were so many scientific men in this State as well as men who had achieved more or less distinction in other callings. He answered it then to his own satisfaction. I have never seen it tested, but he concluded that the men in Indiana who had made their mark in science or in any of the other professions were the men whose early life had been spent in the most forbidding parts of the State from an agricultural point of view, and that there was nothing to become interested in except education. Just how many scientific men were lined up in this roll-call, I do not know, but

when this State is unable to produce anything else, it can produce distinguished men.

I suppose a charter member is expected to be more or less reminiscent, and there are two or three things that the other speakers have left unmentioned.

In its early days, twenty-five years ago, this Academy meant a great deal to those who were members, and for two or three reasons. I think Dr. Jordan and Amos Butler, for example, will bear me out in this. In the first place this State science was comparatively new; it was new to us, new to the State, and new to the country. We came together as a set of young men who were interested in a new thing with a sort of fine enthusiasm with respect to the unknown that is found everywhere. In the next place, the instruction in science, with which all of us were more or less concerned, was just as new. It was even newer, because in those days the position of science in the colleges we represented was more or less doubtful and some of the things we taught were often looked at askance. The whole situation in the matter of scientific instruction was in its very beginnings. This also gave us a fine enthusiasm, a sort of feeling of comradeship in a campaign. We felt the need of companionship, and we found it in the Academy. We would come here from our various colleges, full of enthusiasm, and talk over the problems, and this formed a nucleus of sentiment, an esprit du corps that first developed among us, and which has since developed and given to the Academy the place it now occupies in the State. I think perhaps a feature that sustained us, and that made as much for the solidarity of this Academy as any other, was that one of our first campaigns in the State was educational. Science was fighting for its life, for a place in the colleges. There was another association that met at the same time in Indianapolis, known as the "College Association," and one of the functions of the Academy was to lay plans to assault that "College Association." I remember distinctly one of the things we had to combat. There was a tendency to antagonize the intellectual tastes of the students in those days, and one of the old professors said he thought that the very thing a student needed was the thing he disliked the most. If he disliked mathematics, *make* him take it; if he disliked Greek, *make* him take it. That was one of the educational slogans at that day,—every student needs what he dislikes. I have an idea that no one thing could have brought us closer together in our community of interest than the discussion of these educational questions.

But today you are threatened by a danger that we did not encounter. Every interest brought us together; every impulse was to come here to meet friends and associates. Now the tendency is rather the other way. We are becoming more and more independent; we are becoming more and more narrow; and we are in greater danger of working apart than ever before in our history. Many fine men are growing up who have the very smallest amount of interest in anything that is going on outside of their own field, and as a consequence there is a tendency to segregation which I feel to be a thing that must be combated.

There are two dangers I wish to call to your attention, two dangers that reunions of this kind will help to correct. One of these is the matter of personality, the kind of personality that can only be developed in contact with men, that cannot be developed in connection with one's own theories and one's own way of looking at things. It is the kind of personality that influences men and is sympathetic with them, and can only be obtained by knowing men, thus gaining a very much wider range than is possible within the limits of one's own field. It seems to me that is one of the striking features that ought to be thought of in connection with this Academy. Frankly, I think that papers are relatively very unimportant things. I never saw very much inspiration in papers. The inspiration comes from association with men, and that is the thing to cultivate—this opportunity to associate one with another.

The other thing we are in danger of losing sight of, and which this Academy can correct, is the tendency to become narrow in our vision and lose our perspective of the whole general field, not only of science but also of education. You will find that as scientific men become less and less interested in other fields of work, as they grind their own grooves deeper and deeper, they become less and less effective as teachers and less and less influential with their students. You will find men with broad outlook, clear and wide vision, men with sympathy—and men can only get these things by coming in contact with larger fields than their own—are the men who win with students.

These two things we want in these days, men with sympathetic personality, with a broad view over science in general, with an appreciation of the work of others, and with larger view of education as well. I hear that the art of teaching is disappearing. It seems to me that the fine enthusiasm which a teacher must impart to his student, is in danger of dis-

appearing from our scientific laboratories, which are too much in danger of becoming mere factories.

Your number is so small that you can really know one another and can know the work that is being done by one another, and that is just the sort of thing you need. You do not need to come here for training in science; the Academy is no place for training, it is for association and personal inspiration. (Applause.)

PROFESSOR DENNIS: Ladies and Gentlemen: Some years ago "plankton" got into the reservoir of our waterworks at Richmond, and we were a unit that we could not get along with it there any longer, and when we set out to procure a remedy we found that such a remedy had been worked out by a member of this Academy, and this man is the one I will now call on to speak. He is a graduate of Wabash College. He is the inventor of a means of culture for the nitrifying bacteria of the soil, which invention he did not patent, but gave to the American people. This puts us all under obligations to him.

Mr. George T. Moore, of the Botanical Gardens of St. Louis. (Applause.)

In his response Mr. Moore called attention in a humorous way, to some of the advantages of scientific knowledge, and in conclusion presented the greetings and best wishes of the St. Louis Academy of Science and the Missouri Botanical Garden.

PROFESSOR DENNIS: A number of telegrams and letters have been received since the adjournment, and I will ask Prof. Butler to read them now.

(The letter of Dr. Wiley is appended as it was the basis for action in the closing session on Saturday morning).

WASHINGTON, D. C., Nov. 22, 1909.

Mr. A. W. Butler, Indianapolis, Indiana.

Dear Mr. Butler—I have received from you and other members of the Academy of Science, cordial invitations to be present at the 25th anniversary meeting, November 25th-27th, 1909. Should I consult my personal desires I would surely accept the invitation. Just at this time, however, two extremely important cases are in preparation for trial before the United States courts, (1) the use of borax in foods, and (2) the use of peroxides of nitrogen in bleached flour. I am compelled to give every moment of my time to the preparation for these cases, the first one of which will be called in the federal court in Peoria on the 8th of December. I

therefore am constrained by reason of these public duties to decline the invitation to be present at the meeting of the Academy of Science. I want to say, however, just one word to the members of the Academy, and that is a word of congratulation on the work which has been accomplished by the Indiana Academy of Science in the quarter of a century which has passed.

I do not believe that any state association in the country of a similar character has accomplished so much, nor has brought together a band of men more devoted to research, more single in purpose and more enthusiastic in the pursuit of scientific truth. Many of the members of the Association have from time to time gone out into other parts of the country to pursue their work in other States. Not one of them, I believe, has lost his love for the Academy nor parted with his devotion to its cause and welfare.

I have been reading lately some of the early history of Indiana in its political and literary development. I should like to suggest that some member of the Society, before the data are scattered and while it is still possible to derive from the mouths of living witnesses important facts, should write the history of early scientific education in Indiana, beginning with the work of the Owens at New Harmony, almost a hundred years ago, and bringing it up to the era of the establishment of the new science, say about to 1875, or 1880. To write the work of scientific research of Indiana in the last twenty-five years would be too much of an undertaking for any one man, but the greatest interest would attach to a history of the scientific development of Indiana from the time of its beginning, or a little after, up to the date which I have mentioned above. I feel sure that there are enthusiastic and industrious members of the Society who would undertake to do this, either by collaboration or by helping some one who would voluntarily assume the burden of the work. Scientific men of Indiana whose experience goes back of 1875 might contribute personal recollections of scientific development which would prove of intense interest. The scientific work of the early colleges of Indiana is worth the most careful study and would make interesting chapters in the history of those days when the study of science was not considered to be a requisite for a liberal education as it is at the present time. The story of the work of such men as R. T. Brown, E. T. Cox, Dr. Levette, John Coburn, and others of that class would make most interesting contributions to a work of this description. At the present time when there is so much interest in the early political and literary history of the State it seems to me the scientific history should not be neglected.

I had hoped to present and read some paper of a scientific character at the meeting, but as this is not to be, I should like to present in lieu thereof this suggestion, which I hope will be given due consideration, because if it can be carried out it will be historical as well as a scientific

work which will prove of immeasurable interest in the near future, if not at the present time.

Let me close with the hope that this meeting may be all its promoters have intended it should be—a feast not only of science but of friendship—that it may result in the stronger cementation of the bonds which hold the love of the loyal Hoosiers firmly to the State, and excite a pride in the scientific work of Indiana which may rival that which so justly exists respecting its literary accomplishments.

Sincerely,

H. W. WILEY.

PROFESSOR DENNIS: The Committee wishes to honor many more members of the Academy by asking them to speak to you this evening, but on account of the lateness of the hour we will have to restrict the number. I will now call on our old comrade, Prof. W. A. Noyes, of the University of Illinois.

PROFESSOR W. A. NOYES: Mr. Toastmaster, Ladies and Gentlemen: I have been resting very quietly and easily all the evening, not seeing my name on the program, and not having the slightest hint that I would be called upon. It is surely a very great pleasure to be here, and I would like to say just a word about the old times when the Academy started. I believe I was one of the charter members, and one of the things I remember of that time was the discussion in regard to the name that we should adopt. It was finally agreed, if I remember correctly on the recommendation of Dr. Jordan, that we should call it the Indiana Academy of Science, not the Indiana Academy of Sciences. I think that in his mind and in ours, as we selected that name, was the thought that after all there should be but one science, which is all-embracing, and I feel that as one of the ideals of the Academy it has been of the greatest value to us. As we come together in these meetings of the Indiana Academy, we feel that no matter how separated our lines of work may be, how different—so different sometimes that we can understand but little of each other's language—yet after all we are simply working in different parts of one great whole of scientific knowledge, and that it is our place to look at our part, our field, as merely one part of the whole, all parts of which may in some way or other touch our own. And this opportunity of seeing, of catching even a little glimpse of this work that is so far removed, perhaps, from our own, and the acquaintance of these men who are working in the different fields, is, it seems to me, one of the features of greatest value in these friendships and associations which we have made here in this Academy.



PROFESSOR DENNIS: We shall now hear from Professor Charles W. Greene, of the University of Missouri.

PROF. CHARLES W. GREENE: Mr. Toastmaster: It seems rather unfortunate that a man such as I, of no ability as a speaker, should be called upon, but I will do the best I can to express the feeling of enthusiasm and encouragement this meeting has given me. It has been a great pleasure to meet so many friends and to recall old times when the Academy first began, the time when at DePauw, through the genial personality of Professor Jenkins, we began to catch the scientific spirit. I remember my first meeting with the Academy was at Greencastle. We went out on a field excursion and we younger men were brought into intimate contact with the stimulating personal enthusiasm which always characterizes Indiana scientists.

I think one of the features of this meeting has been the showing of the great tolerance that has been developed in our scientific lines of thought. Dr. Coulter showed us that this morning. It is certainly very encouraging to the physiologist to learn that in the life of the plant, in its growth from the plasmodium, it is not predestined to go through any fixed and inflexible schedule of development. I felt at the time that probably the calm cold conservatism of morphology was yielding to the seductive charms of physiology as expressed in environment, that a new era in botany was still possible to us. That was not the old botany but a glimpse of the new.

PROFESSOR DENNIS: Dr. Evermann for a long time a member of the Academy is with us and will tell us what members of the Academy are doing in Washington. He represents the Atlantic here as Dr. Jordan the Pacific. He gave us last night an account of a fishing trip to the "Tiptop of the United States" but he did not produce his "records or his instruments" or even his fishes; he gave us only fish stories. Perhaps he has the real article with him this evening. Dr. Barton Warren Evermann of the U. S. Fish Commission.

DR. BARTON W. EVERMANN: Mr. Toastmaster and Amos Butler—or the Indiana Academy—they mean the same thing. I have been looking at this program ever since I came into the room, and I notice what my friend, Dr. Coulter, also noticed, and mentioned in his remarks—the toast immediately following my name, which I fear bears some relation to what I have already said or what I may say in this meeting. "Lord, Lord, how

this world is given to lying!" But I am glad Dr. Coulter noticed this and put in a disclaimer, thus relieving me to some extent of the suspicion that my fish stories were the only ones in mind.

I would like to say a word regarding those of the Indiana Academy who are now in Washington, and to tell you something of what they are doing. I noticed, perhaps you noticed, in a recent magazine, a long article on "The Plunderers of Washington." There were a dozen or more of them, and I am glad to say to you that there was not among these plunderers who were pictured in this article, any Washington member of the Indiana Academy. We all escaped that distinction at least! I think I can also say that no member of the Indiana Academy in Washington has been seriously involved in the Cook-Pearry controversy. We have kept clear of that, also. If there is anything the Indianian learned long ago, it is to take care of himself and not to get into embarrassing situations needlessly. So in this case the members of the Indiana Academy have read the very interesting article by George Kenman in the Outlook which proved very conclusively that Dr. Cook did not have more than one-tenth of the pemmican necessary to enable him and his dogs to reach the North Pole. They took that for what it was worth, and waited for something further. Then in another magazine some man from the West had the whole thing figured out, showing that Kenman had Cook's dogs continuing to eat pemmican at the rate of a pound a day even after they were dead and the Indiana Academy people in Washington hope Kenman may be able to explain why and how they did such an unusual thing.

Several of your friends in Washington are engaged in very interesting work which has an important bearing upon matters in this State. Our good friend, Dr. Wiley, the most distinguished Washington member from this State, is still continuing his pure food work and trying to answer the question "What is whisky?" Dr. Hay, a former President of the Academy, and now in Washington, is trying to determine, no doubt for the benefit of the Academy, the age of the Ceratops beds in Wyoming, Idaho and Montana.

One matter that I think will be of some interest to you here in the Mississippi Valley, is that the Bureau of Fisheries is establishing a biological station at Fairport, Iowa, in the interest of pearls and the pearl button industry, a matter which will appeal to the ladies. There was established some few years ago a small button factory at Davenport. A

German came over and saw the great numbers of mussels in the Mississippi River, and thought they might make good buttons. He began experimenting and soon demonstrated that they were well adapted to this purpose, and now more than fifty thousand tons of these fresh-water mussels are used annually. This is a greater quantity than natural production can supply. The supply, of course, cannot keep up. Fifty thousand tons a year will soon use up the supply. The Bureau of Fisheries realized the possibility of an early depletion of the supply of shells and arranged with Professors Lefevre and Curtis of the University of Missouri to experiment and see if they could not develop a method for the artificial propagation of fresh-water mussels; and they have succeeded, so that the propagation of fresh-water mussels will soon be an easy proposition. Congress made an appropriation for a biological station in which these experiments may be carried forward. We have acquired sixty-five acres of land at Fairport, and the construction work is now going on at that place. It is the ambition of those who are particularly interested in that station to see there a station which will appeal to every biologist in the Mississippi basin. We want to make it a fresh-water biological station where any biologist of the Mississippi Valley or elsewhere may go and find the facilities and material for the study of any fresh-water biological problem in which he is interested; and the Bureau of Fisheries not only hopes you may avail yourselves of the advantage of the station when completed but most cordially invites you to do so.

Again on behalf of the Washington contingent I extend greetings to the Indiana Academy of Science. I thank you.

PROFESSOR DENNIS: I hope you will permit me to take another minute. Reference has been made again and again to the large number of splendid men who have gone out from this Academy. It would be equally proper to refer to the large number of valuable men who have come into the Academy. Reference was made this morning by Mr. William Watson Woollen to the fact that the Audubon Society was an offspring of this Academy. I am sure the mother of that Society was necessity, and the father of that Society as well as of this was Amos Butler. I ask now that the Academy stand, and drink the health, in cold water, of Amos Butler, the father of the Indiana Academy of Science. (Applause.)



MINUTES OF THE TWENTY-FIFTH  
ANNUAL MEETING

# Indiana Academy of Science

CLAYPOOL HOTEL, INDIANAPOLIS, INDIANA,  
Nov. 25, 26, 27, 1909.

---

*Friday Morning, November 26, 1909.*

Meeting called to order by the President, Dr. A. L. Foley.

Reading of the minutes dispensed with.

DR. FOLEY: We will now have the minutes of the Executive session of last evening.

ASSISTANT SECRETARY BIGNEY: The Indiana Academy of Science met in the Claypool Hotel at four p. m., November 25th. Eleven members were present and several visiting members of the Academy.

Members present were: A. L. Foley, President; J. H. Ransom, Secretary; A. J. Bigney, Assistant Secretary; Robert Hassler; John S. Wright; Carl L. Mees; W. S. Blatchley; M. B. Thomas; C. H. Eigenmann; A. W. Butler; D. S. Jordan.

A. L. Foley, President of the Academy, in the chair.

The report of the Committee on the 25th meeting, by A. W. Butler, as printed on program, with several additional papers, was read.

G. W. Benton, J. S. Wright and J. W. Woodhams reported that all plans for the banquet had been made.

Membership Committee made no report. Report of State Library Committee was made by J. S. Wright. He stated that the Proceedings of the Academy were being cared for in good order and that many volumes had been bound.

No report from Committee on Weeds and Diseases.

No report from Directors of Biological Survey.

No report from Committee on Relations to the State.

Committee on Distribution of Proceedings reported through J. S. Wright. All work had been performed.

Editorial Committee, by H. L. Bruner, reported work done as ordered.

Report of Secretary on non-resident list was taken up. On motion it was decided to place only those members on the non-resident list who had done work of marked credit to the Academy. The list was passed on by the Executive Committee.

Deaths of Dr. Gray and W. H. Ragan reported. Committee on Resolutions appointed, consisting of C. L. Mees, A. W. Butler and G. W. Benton.

Bills of expense were reported by A. W. Butler. They were referred to Auditing Committee.

Foreign Exchange list ordered to be revised and printed in next report.

Summer meeting to be passed on tomorrow.

Committee on Fellows also to consider a list of Honorary Fellows.

It was voted to place \$25.00 at the disposal of the Secretary for his official duties.

Resolution from California Academy of Science read.

Dr. Jordan extended greeting from the California Academy of Science, and thanks for books.

Committee of two on Fellows was ordered to be appointed by Academy.

Motion that the chairmen of Committees be retained, committees to be filled by chairmen.

Auditing, Membership, Program and Nominating Committees not to be covered by previous motion.

On motion G. W. Benton was chosen as another Assistant Secretary.

Adjourned.

J. H. RANSOM, Secretary.

A. J. BIGNEY, Assistant Secretary.

(Report adopted as read.)

DR. FOLEY: I will now call on Mr. A. W. Butler to make a statement in regard to this meeting of the Academy.

MR. A. W. BUTLER: Mr. Chairman, and Members of the Academy: The program as printed, and which I suppose the most of you have in

your hands, has on it a list of sixty-three papers. There are six additional papers which have been added. One of these, a paper by Prof. M. B. Thomas, was omitted from the original list. The additions are as follows:

"The Wood Lot," M. B. Thomas.

"The Nasal Muscles of Vertebrates," H. L. Brumer.

"Streamers that Show Reversal of Curvature in the Corona of 1893," J. A. Miller.

"On a New Complex Copper Cyanogen Compound," A. R. Middleton.

"Determination of Endothermic Gases by Combustion," A. R. Middleton.

"That Erroneous Hiawatha," A. B. Reagan.

This brings the number of papers up to sixty-nine.

At the conclusion of the business of the meeting there will be responses from other State societies, some six or eight in number.

The program as printed indicates a banquet this evening, to which attention has been called, and the program for which will be announced later.

The program for tomorrow morning is also printed here, including four principal addresses, and suggestions as to plans for the Academy.

I want to say in behalf of the Committee on the Twenty-fifth Anniversary that we have been very much gratified by the interest that has been taken by the educational and scientific societies throughout the State. The Indiana Medical Association, the Historical Society, the Teachers' Association, and a number of other associations have by formal resolution recognized this twenty-fifth meeting, and several of them have appointed delegates to attend the meeting.

I would also like to call attention to the fact that we have had a very large number of congratulatory letters on the period we have arrived at in the history of this Society, and there are three I would like to call attention to. One is from one of the ex-Presidents whom we always delighted to honor, Mr. T. C. Mendenhall. He is at present in Europe in search of health, and as he cannot be present, sends his congratulations. Also a letter from Professor Goss, of the University of Illinois, who had expected to be present until he found that this date is the same as that of the dedication of their new Physics building, so he could not come. Also one from Prof. Kingsley, of Tufts College, Mass. These three letters are particularly earnest and cordial in their words of greeting.

We hope you will find everything arranged for your comfort and convenience, and beg to assure you that if anything has been overlooked or if there is anything you do not like in connection with the arrangements, we are sorry that such is the case. The Committee tried to do its best. (Applause.)

DR. FOLEY: I will now call for reports from the different standing committees.

Program Committee, Mr. W. J. Moenkhaus, chairman: (This report included in the statement of Mr. Butler.)

Membership Committee:

(Moved and seconded that the Secretary cast the ballot of the Academy for the names read. Carried, and persons declared members upon signing of the Constitution and payment of dues.)

Treasurer's report, Mr. W. A. McBeth, Treasurer:

To the Indiana Academy of Science:

On hands, last report.....	\$424 39	
Received dues and fees for 1909.....	95 50	
		\$519 89
Expended as per receipts and vouchers.....		118 67
		\$401 22

The papers and vouchers are ready for the Auditing Committee.

W. A. McBETH, Treasurer.

State Library Committee, J. S. Wright, chairman: (Postponed until later, when State Librarian Brown will make the report.)

Committee on Restriction of Weeds and Diseases: No report.

Directors of Biological Survey: No report.

Relations of Academy to the State: No report.

Distributions of Proceedings, J. S. Wright, chairman:

MR. WRIGHT: There is no special report to make. The Committee has the work in hand. We are now engaged in compiling a domestic exchange list.

Committee on Election of Fellows: Passed.

Report of Advertising Committee: (Included in statement of Mr. Butler.)



## Report of Editor:

MR. H. L. BRUNER: The Proceedings for 1908 were published in the usual form. Each contributing author also received one hundred free reprints of his own article. (No reprints of abstracts were furnished.) The financial part of my report is as follows:

Balance in State Treasury from 1908.....	\$244 98
Appropriation for fiscal year 1909*.....	600 00
	<hr/>
Total .....	\$844 98
Cost of Proceedings for 1908 .....	\$438 74
Cost of reprints for 1908 .....	85 68
	<hr/>
Total .....	524 42
	<hr/>
Balance available for fiscal year 1910.....	\$320 56
Appropriation for fiscal year 1910.....	1,200 00
	<hr/>
Total available for printing the Proceedings of 1909 .....	\$1,520 56

I wish to call the attention of the members of the Academy to one or two matters. First in regard to the editorial statement on the program. We desire that papers be in the hands of the editor or secretary as early as possible, in order that the Proceedings may be gotten out more promptly than last year. Reprints will be furnished of all papers printed, excepting abstracts, and these may be furnished, if request is made. These reprints are paid for by the State Printing Board.

I desire to ask for suggestions as to changing the style of binding and improving the quality of the paper for the coming year.

I would also ask that each one sending a paper for publication should give his address on the paper, so proof can be sent and the reprints mailed. This is a very important thing and I hope it will not be overlooked.

DR. FOLEY: Does anyone have any suggestions to make?

MR. J. S. WRIGHT: I am sorry to occupy so much time on the floor this morning, but I feel there is one thing that should be recognized, and that is the fact of the service rendered the Indiana Academy of Science by the past President, Mr. Glenn Culbertson, who succeeded in doubling the amount of money available for publishing. We now have \$1,200 per

\*The fiscal year 1909 began Oct. 1, 1908, and closed Sept. 30, 1909.

year, as against \$600 before Mr. Culbertson took this in hand. I think this Academy owes him a debt of gratitude. (Applause.)

DR. FOLEY: I wish to second what Mr. Wright has said. I also wish to point out another fact, that formerly any money left reverted to the State, while now it can be carried over until the next year.

Are there any other suggestions?

MR. M. B. THOMAS: It seems to me it would be best to improve the quality of the paper and printing, and possibly of the illustrations, but that this matter should be left to the Committee on Printing, of which Prof. Bruner is the chairman.

(Taken by consent.)

MR. WRIGHT: I move that the Academy extend a vote of thanks to Mr. Culbertson for his unusual service.

(Seconded and carried.)

Report of Resolutions Committee: No report at this time.

MR. G. W. BENTON: I would like to suggest that the Academy is under obligations to the press of the city for courtesies extended, in giving us column after column of space for advertising this meeting. We have been unusually privileged in this regard, and I think it is proper and courteous that we should recognize it in some definite way. Therefore I move that we extend a vote of thanks to the press of the city for courtesies extended to the Academy in announcing this Anniversary meeting.

(Seconded and carried.)

DR. STANLEY COULTER, (for the Membership Committee): It seems to me it would be remarkably pleasant if we could mark this twenty-fifth anniversary by a large increase in membership, and if you will see that applications are in the hands of the committee some time during the forenoon, we will report on them at the afternoon session, so the neophytes will have the feeling that they are full-fledged members.

After an announcement by the Treasurer in regard to payment of dues; and another by Mr. Benton regarding the banquet tickets, etc., Dr. Foley called on Mr. D. C. Brown, the State Librarian, to report in regard to the Academy and its relation to the State Library.

PROF. D. C. BROWN: I am not a member of the Academy of Science, but as State Librarian I made an agreement with the Academy of Science by which the State Librarian is to classify, catalog and shelve the docu-

ments and reports belonging to the Academy, making them subject to removal by any members of the Academy, and subject to reference by the public. I am very greatly interested in having the State Library the center for reference of the entire State on every subject, and by the agreement made with the committee of your Academy two years ago this work has been begun and is progressing fairly well.

The agreement was that the catalog department of the State Library should, as fast as possible and as fast as funds would allow, proceed with this work. Up to the present time we have classified, cataloged, and made analytical catalogs of 143 volumes of domestic reports and 96 foreign reports, making a total of 239 volumes. These have all been bound, and there are about one hundred volumes at present ready to go to the bindery, some foreign and some domestic. These volumes are systematically cataloged and at the present time I have had them all bound alike in good buckram, with a certain kind of label on the back, with "Academy of Science" at the top and the library call number at the bottom. Inside, a label showing to whom the book belongs, and that it can be borrowed only by the members, but used for reference by the general public. I am not quite sure that it is advisable to bind all these books in exactly the same way, but it makes them easily understood when on the shelves. Members can tell instantly that that book belongs to the Academy of Science. A separate card list is also made in pencil and ink, and easily accessible at any moment.

I fancy you all understand that the binding is paid for by the library, with the understanding that if the Academy ever withdraws the books it must pay that amount, so the bills for binding are kept separate, and the public has the use of the books. The Academy would also have the right to have the cards that are made showing the books properly cataloged. Whether that will ever come, I do not know.

I am struggling as best I can for a State Library and Historical Museum, in which all the valuable records and scientific reports of the State can be kept, and in making the argument for that I have said that the Academy of Science would help.

I do not know that I can make any further statement about it, only to have it known to you that the reports are cataloged now about as fast as they come in. I have one request to make—that we may have a definite and correct list of your foreign exchanges, your domestic exchanges, and

your membership. I have had considerable trouble about that, but have worked it out fairly well so far. The foreign exchanges are made through the Smithsonian Institute at Washington. The files of the reports sent to members are paid for by the Academy. The library pays for the others, and through the library they are distributed.

I am very anxious that the members come to the library, as their coming there to use these reports will make it known to the public that the reports are there and can be used.

I believe I have nothing further of interest, but I am very anxious to see you in the library. (Applause.)

DR. FOLEY: I am sure I voice the sentiments of the Academy when I thank our Librarian for the efforts he has put forth in getting the Academy library in good shape, available for use.

The program calls for greetings from the various other scientific societies after the addresses of the morning. I am informed, however, that Mr. Brossmann, representing the Indiana Engineering Society, is here and cannot remain, therefore I will call upon Mr. Brossmann at the present time.

Mr. Brossmann's address will be found in full on page 44.

DR. FOLEY: I might ask if there are any other representatives of societies here that cannot remain during the period. If so, we will have the greeting at this time.

There is just one other point that might be taken up at this time, and that is the question of a summer meeting. The question was mentioned at the Executive Committee meeting last evening, but was not settled. Are there any suggestions as to whether we shall or shall not have a summer meeting? I think the Program Committee would like to have an expression from the Academy. It does not wish to announce a meeting unless somebody meets. On the other hand, it does not wish to discontinue this meeting if it is the desire of any considerable number of members to continue them. What is the wish of the Academy?

If no one has any suggestions, I will call on Dr. S. E. Earp, who fears he may not be able to remain during the entire morning, to respond for the Indiana Medical Society.

Dr. Earp's remarks will be found in full on page 40.

(Mr. P. N. Evans, Vice-President, in the chair.)

MR. EVANS: We will now proceed with the regular order of business, and will hear the President's Address by Dr. A. L. Foley, of Bloomington.

Dr. Foley's address will be found on page 89.

Following the President's address:

MR. EVANS: Evidently this chair should be occupied by a physicist instead of a chemist, so I will vacate in favor of Dr. Foley. (Applause.)

DR. FOLEY: It now gives me great pleasure to introduce one who needs no introduction, Dr. John M. Coulter, of Chicago University, who will speak to us on "Recent Progress in Botany." (Applause.)

Dr. Coulter's address will be found on page 101.

Following Dr. Coulter's address:

DR. FOLEY: You will note from the program that Dr. Harvey Wiley was to have been here this morning to address us. I understand Dr. Barnard has a letter from Dr. Wiley. We would be glad to hear from Dr. Barnard.

DR. H. E. BARNARD: Mr. President, I just this morning received a communication from Dr. Wiley, in which he said he was engaged in the preparation of a very important case involving one of the basic principles of the Pure Food Law. He said if he came on here for four days, he did not know what would happen to the case, and that while he would be with us in spirit and thought, it would be impossible for him to leave his work in Washington to attend this convention. He sends to you his best wishes and hopes for a successful meeting.

DR. FOLEY: You will note from the program that we now have greetings from several associations, scientific and otherwise, who have sent delegates to this association at this time. I will call first for the Indiana Teachers' Association, through its President, Mr. Geo. W. Benton.

(See page 39.)

DR. FOLEY: We will now hear from the Indiana Branch of the American Chemical Society, through Mr. R. B. Moore.

(See page 42.)

Following the various society greetings the Academy adjourned until 2:00 p. m.

*Saturday Morning, November 27, 1909.*

Meeting called to order by President Foley.

(After asking the members who had not already done so to leave their names at the desk, so that a complete list of those in attendance at this meeting might be obtained, Dr. Foley called for the report of the Committee on Resolutions, Mr. C. L. Mees, chairman.)

For this report see page 24.

(Moved and carried that the report be adopted.)

DR. FOLEY: It seems to me that the Academy is under great obligations to the Program Committee, especially to Mr. Butler, and I think a vote of thanks to this committee would be in order.

(Moved and carried that a vote of thanks be extended to the Program Committee, especially Mr. Butler, for the great amount of work that has been put on the program.)

REPORT OF NOMINATING COMMITTEE.

President, P. N. Evans, Lafayette.  
 Vice-President, Chas. R. Dryer, Terre Haute.  
 Secretary, George W. Benton, Indianapolis.  
 Assistant Secretary, A. J. Bigney, Moores Hill.  
 Treasurer, W. J. Moenkhaus, Bloomington.  
 Editor, H. L. Bruner, Indianapolis.

(Moved and carried that the report be accepted and that the Secretary cast the ballot of the Academy for these officers.)

REPORT OF AUDITING COMMITTEE.

We have gone over the vouchers of the Treasurer, the Program Committee, and the Editor's Report, and find the sums have been done correctly.

W. J. MOENKHAUS, Chairman.

(Moved and carried that the report be adopted.)

REPORT OF COMMITTEE ON MEMBERSHIP.

Thirty-five additional names reported.

Applicants for Membership elected by vote of Academy, 1909.

Thomas Billings . . . . . West Lafayette.  
 Earl Grimes . . . . . Russellville.

Earl Rouse Glenn .....	Brookville.
A. A. Bourke .....	Edinburg.
Geo. Hall Ashley .....	Indianapolis.
James Persons Dimonds.....	Washington, D. C.
Guido Bell .....	Indianapolis.
Florence Anna Gates .....	Wabash.
Oscar William Silvey .....	Bloomington.
James E. Weyant .....	Indianapolis.
John W. Woodhams .....	Indianapolis.
Melvin Knolen Davis .....	Terre Haute.
E. Kate Carman .....	Indianapolis.
Paul Anderson .....	Crawfordsville.
Howard J. Banker .....	Greencastle.
Charles Alexander Vallum .....	Indianapolis.
Thad. S. McCulloch .....	Crawfordsville.
Frank Karlston Mowrer .....	Marion.
E. M. Deem .....	Frankfort.
Milo H. Stuart .....	Indianapolis.
Charles Ruby Moore .....	West Lafayette.
L. R. Hesler .....	Crawfordsville.
Martha Hunt .....	Indianapolis.
Brenton L. Steele .....	Bloomington.
Alfred Theodore Wianco .....	Lafayette.
Walter W. Hart .....	Indianapolis.
Ira C. Trueblood, Miss.....	Greencastle.
Luther Cornelius Weeks .....	West Lafayette.
Fermen L. Pickett .....	Bloomington.
William Logan Woodburn .....	Bloomington.
Roscoe Raymond Hyde .....	Terre Haute.
Chas. M. Cunningham, Dr.....	Indianapolis.
Mason L. Weems .....	Valparaiso.
Edward N. Canis .....	Indianapolis.
G. A. Osner, .....	Crawfordsville.
Frederick W. Gottlieb .....	Morristown.
Geo. T. Moore .....	St. Louis.
Samuel E. Earp .....	Indianapolis.
J. H. Clark .....	
Leslie C. Nanney .....	Bedford.
Everett W. Owen .....	Indianapolis.
Geo. Spitzer .....	West Lafayette.
Geo. N. Hoffer .....	West Lafayette.
Julius Wm. Sturmer .....	West Lafayette.
Virges Wheeler .....	Montmorenci.
Harry F. Dietz .....	Indianapolis.
Chas. Brossman .....	Indianapolis.

A. D. Thornburn .....	Indianapolis.
Chas. Stiltz, M. D. ....	South Bend.
Jacob P. Young .....	Huntington.
J. M. Van Hook .....	Bloomington.
Walter M. Baker .....	Red Key.
Wm. Reynolds Butler .....	Indianapolis.
W. H. Rankin .....	Ithaca, New York.
Omer C. Boyer .....	Lebanon.
W. M. Blanchard .....	Greencastle.

(Moved and carried that the Secretary cast the ballot of the Academy for these names, and that the persons be considered members after paying fees and signing the Constitution.)

DR. FOLEY: I should like to bring up a matter at this time which was brought up yesterday, but we could not get an expression from the Academy. That is, in regard to the Summer meetings. Does this Academy want a Summer meeting? I think the Program Committee would like to have an expression from the members.

DR. STANLEY COULTER: I want to say that in twenty-five years' membership I have found that the Summer meeting is equivalent to about three Winter meetings in the way of uplift and encouragement. Of course, one of the objections is that a good many members—mathematicians, chemists and physicists—would not be specially interested in these Summer meetings. I would very much regret to see the Summer meeting abolished. If, however, it does not seem feasible, I presume it might be dropped. I move that the Program Committee be instructed to proceed with plans for the Summer meeting, and if in their judgment the signs are not favorable for a session, they be authorized to drop it.

W. A. MCBETH: I want to second that motion. I remember with great pleasure the Spring meetings. I made it a point to attend them regularly, and through the fact that we had Spring meetings I have visited some very interesting points in Indiana which are hard to get to unless you particularly go there. The town of New Harmony was one of these places; it is full of historical associations. We went to Madison, to Bloomington, to many of the caves, and to various other points throughout the State where we would probably not have gone if it had not been for this particular attraction. Now, my own way of thinking is that if we would resolve to go to these Spring meetings they would be worth two of the Winter meetings to those who go. I am heartily in favor of resuming the Spring meetings.



(At the suggestion of Mr. Butler a standing vote was taken, which resulted unanimously in favor of resuming the Spring meetings.)

MR. BUTLER: Mr. Chairman. We have a telegram of greeting from the Ohio Academy of Science, and I move that the Secretary be instructed to telegraph the greetings of the Indiana Academy in return.

(Taken by consent.)

MR. BUTLER: In reference to the letter from Dr. Harvey Wiley read at the banquet last night, I move that a committee, consisting of Stanley Coulter, Harvey W. Wiley and C. H. Eigenmann be appointed to see that the suggestions in Dr. Wiley's letter in regard to obtaining some one to prepare a history of early science in Indiana, are carried out.

(Seconded.)

J. H. RANSOM: I would like to amend that by adding Mr. A. W. Butler's name to that committee as a fourth member.

(Seconded.)

STANLEY COULTER: I suggest that Mr. Butler be the first member instead of the fourth.

MR. BUTLER: I think the purpose of the committee is simply to study the situation, and a smaller committee is better than a large one. The three first chosen are the proper members and would be able to do the work better than a larger committee.

(Amendment put and carried; motion as amended carried.)

MR. BUTLER: I move that the Treasurer and Secretary be directed to notify all delinquent members that the constitutional rules against such will be enforced, by order of the Academy.

(Seconded and carried.)

MR. BUTLER: Another matter I think should be acted upon by the Academy. The Editor this year has not put in any bill for expenses, and the expense of editing the Proceedings will probably be larger next year. I move that an appropriation of \$25 be allowed the Editor for the expenses of this year and the year coming.

(Seconded and carried.)

MR. J. S. WRIGHT: In view of the fact that the Academy has received many favors from the Claypool Hotel in giving us this room without charge, and a room for the section meetings, and other courtesies, I move

that we extend a vote of thanks to the management of the Claypool Hotel for courtesies shown the Academy.

(Seconded and carried.)

DR. FOLEY: We will now take up the program of the morning. The first number is an address by Dr. B. W. Evermann, of the U. S. Bureau of Fisheries, on "Federal Control of International and Interstate Waters."

For Dr. Evermann's address see page 119.

DR. FOLEY: The next paper is by Prof. Charles W. Greene, of the University of Missouri, on "The Speed of Migration of Salmon in the Columbia River."

An abstract of Professor Greene's address is given on page 125.

DR. FOLEY: The last paper on the program, "Some Hoosier and Academy Experiences," is by C. A. Waldo, of the Washington University, St. Louis, but Mr. Waldo is not here. The first paper, "Methods and Materials Used in Soil Testing," is by H. A. Huston, of Chicago. Mr. Huston is not here, but his paper is, and it will take about fifteen minutes to read it. It is contrary to precedent that a paper should be read by anyone but the author. However, the Academy can change that, of course, at will. What shall we do with this paper?

(Moved and carried that the paper be read.)

For Professor Huston's address see page 111.

DR. FOLEY: I am sure the members of the Academy would like to hear from anyone who has any suggestions to offer. This completes the list on the program, but we will be glad to hear from anyone else.

If you will pardon me, I would like to make a suggestion or two, one of which was made to me last evening.

Those of us who are members of the American Association know that when we register there, a number is given us corresponding to the name, address and business of the member. So all we need to do to find any man's pedigree is to refer to the number in the list, which is the registration list. Now, it seems to me that some scheme like that might be an advantage in connection with this Academy, so that any member can find out who the other man is. I know I am introduced to people a half-dozen at a time, whom I cannot place and name a few minutes afterwards. A great many people I find are like to me in that respect. We cannot associate names and faces after having been introduced to three or four persons at once. Perhaps some sort of a scheme might be adopted to advantage.

Another thing is that this meeting is the largest that we have ever had during my connection with the Academy, and the reason is evident. We have had men of national reputation to address us. I do not think this large attendance comes from the fact that this is an anniversary meeting, but from the fact that the program has been made worth while by having men who will draw people to the meeting.

You will note that the State is now doing our printing; we do not have to pay that ourselves, and you will note from the Treasurer's report that we have some money and that we are going to get more money, and we have nothing particular to do with this. Now, it seems to me that the Program Committee might arrange to bring one or two speakers here each year, speakers of national reputation, and spend some of this money for their expenses. If we could have some such program as we have had this year every year, with men like Dr. Jordan, and Dr. Coulter and Dr. Wiley, there is no question but what we would have a large attendance, and I think our funds will justify that. I merely offer these as suggestions.

H. L. BRUNER: AS editor of the Proceedings I would urge the importance of getting the manuscripts in as soon as possible. The fact that the Proceedings were late this year is due largely to the tardy reception of the papers by the editor. If the members, will turn over their papers promptly, I will see that they get into the hands of the printer as early as possible.

DR. FOLEY: I want to second what Mr. Bruner has said. I was Editor one year.

This completes the program, unless the Academy wishes to take up some of the papers which are departmental. What is your will?

(Motion to adjourn.)



[PRESIDENT'S ADDRESS.]

## RECENT DEVELOPMENTS IN PHYSICAL SCIENCE.

[Publication No. 34.]

BY ARTHUR L. FOLEY.

On this—the twenty-fifth—birthday of the Indiana Academy of Science, it is meet that we survey the progress made and take an inventory of stock on hand. Where were we? Where are we?

Comparing physical science of today with physical science of twenty-five years ago, I am forced to the conclusion that there has been a revolution.

In the first place there has been a revolution in the methods of teaching science. I would remind you that the physics laboratory of the University of Berlin was founded in 1863, the Cavendish laboratory of Cambridge in 1874. In 1871 Professor Trowbridge, of Harvard, was obliged to borrow some electrical measuring instruments, as the university had none of its own. It is not surprising, then, that a few years later—at the time the Indiana Academy of Science was founded—there were in the United States very few physics laboratories worthy of the name. Physics teaching in college and high school was chiefly from the text-book. Today a college which would offer work in physics without a laboratory would be considered a joke; and in order to be commissioned, a high school must have a certain minimum of laboratory equipment and the physics teacher must devote a part of his time to laboratory instruction.

In the second place there has been a complete change in the attitude of men of affairs toward the physics professor and his students. No longer do they consider us theoretical, and therefore impractical. No longer do they look with distrust or contempt on laboratory methods and data. No longer do they hold that apprenticeship and experience are sufficient for their needs. Today the large industrial concerns are establishing laboratories of their own and employing in them the best trained men they can command.

In the third place, there has been a revolution in some of our physical theories. By the term revolution I do not mean a destructive upheaval

in which the work of the past has been repudiated and destroyed and a new order of things established. I mean that some of our ideas have undergone such a complete and rapid change that what some might term an evolution is really a revolution. Indeed, we have had two revolutionary periods within the life of this Academy.

The first came in 1887 with the epoch-making researches of Heinrich Hertz. Faraday had given us his theory of lines of force and the mathematicians had attacked it. Young and Fresnel had given us the undulatory theory of light and Laplace and Poisson had "befuddled us with their objections." Ampere had given a theory of magnetism, but Poisson and Weber had given two others. To explain an electric charge we could resort to the one-fluid theory, the two-fluid theory, the potential theory, the energy theory, the ether-strain theory. Maxwell had written a treatise on electricity which few could read and no one could fully understand. A distinguished French physicist said he understood everything in Maxwell's book except what was meant by a body charged with electricity. Maxwell had given us but a vague idea of electric displacements and displacement currents, because his ideas were bound up in equations without experimental verification, or even illustration.

Then came Hertz's researches, which confirmed the fundamental hypotheses of the Faraday-Maxwell theory and "annexed to the domain of electricity the territory of light and radiant heat." "Many thinkers," said Lord Kelvin, "have helped to build up the nineteenth century school of *plenum*, one ether for light, heat, electricity and magnetism; and Hertz's electrical papers, given to the world in the last decade of the century, will be a permanent monument of the splendid consummation now realized." Some one has said that Hertz enthroned Maxwell in every chair of physics in Europe and America.

It appears that many of the ancient philosophers had a shadowy idea of a medium in space which they personified and called "Aether." According to Heriod, Aether was the son of Erebus and Night and the brother of Day. The Orphic hymns speak of Aether as the soul of the world, the animator of all things, the principle of life. The children of Aether and Day were the objects about us, the heavens with all their stars, the land, the sea. Aether was the lightest and most active form of matter and Day had the power of converting it into heavier matter. Plato speaks of the

<sup>1</sup>Kelvin. Introduction to Jones' translation of Hertz's "Electric Waves." Macmillan, 1893.

Aether as being a form of matter far purer and lighter than air, so light that its weight cannot be ascertained because distributed through infinite space.

During the fifteen years following the publication of Hertz's researches it is probable that greater homage was paid to Ether by modern physicists than was ever given it by the ancients. The ether was appealed to from every quarter. Light, radiant heat and electric waves were ether waves. An electric charge was an ether strain. An electric current was a phenomenon in the ether and not in the wire in which it appeared to flow. Magnetism and gravitation were phenomena of the ether. Matter itself became an aggregation of ether vortices. Ether and motion were expected to explain everything. Such terms as natural philosophy and physics were discarded by some of our text-book writers who adopted such titles as "Matter, Ether and Motion"; "Ether Physics"; "Ether Dynamics"; "The Mechanics of the Ether." Physics was defined as the science of motion.

The classical mechanics of LaGrange was built on what were considered fundamental concepts—mass, force, space and time. Hertz, in his treatise on mechanics published in 1894, endeavored to eliminate force and potential energy and reduce a universe to ether movement. Space and time were not fundamental ideas, but as Kant had said, were subjective notions. We measure time by a change of space relation; that is, a movement of a star, of the earth, of a clock hand. "In a world void of all kind of movement there would not be seen the slightest sequence in the internal state of substances. Hence the abolition of the relation of substances to one another carries with it the annihilation of sequence and of time." Thus everything was made to depend upon movement. The equations of motion became the chief instruments of physical research, and the criterion by which the results of experiments were interpreted. Galileo lost his professorship because he dared to dispute the authority of Aristotle. Daguerre was for a time placed in an asylum because he said he could take a picture on a tin plate. Galvani was ridiculed by his friends and dubbed "the frog's dancing master." Franklin's paper on lightning conductors was considered foolish, and refused publication by the Royal Society. Fifteen years ago it would have been almost as disastrous for a physicist to question the authority of LaGrange or Maxwell. Not only were the *results* of experiments subjected to mathematical analysis, the *direction* of scientific investigation was largely so determined. The

question was first put to mechanics. If a positive answer was indicated the question was put to nature and the research went on. If the equations indicated a negative result the question was dropped and the research abandoned.

Physics was an *exact* science. Other sciences were not exact sciences because their theories and hypotheses could not be mathematically expressed—the relation between cause and effect was not expressible in algebraical symbols. Physics was an exact science whose fundamental principles had been discovered and its laws expressed by equations. All that remained to be done was to make more accurate measurements of physical quantities for use as coefficients and exponents.

Let me quote from the 1894 catalogue and later catalogues of one of the largest universities in the United States.

"While it is never safe to affirm that the future of physical science has no marvels in store. \* \* \* it seems probable that most of the grand underlying principles have been firmly established and that further advances are to be sought chiefly in the rigorous application of these principles to all the phenomena which come under our notice. \* \* \* An eminent scientist has remarked that the future truths of physical science are to be looked for in the sixth place of decimals." The foregoing is a verbatim quotation from the introductory statement preceding the list of courses in physics offered at one of our great universities, written, I think, in 1894. "Underlying principles firmly established," "Future truths in sixth decimal place," 1894. Then came the discovery of Roentgen rays, 1895; Becquerel rays, 1896; Zeeman effect, 1896; radium, 1898; atomic disintegration, the transformation of matter, the thermal effect of radioactivity, and intra atomic energy, 1903. I am unable to locate the sixth decimal idea in recent catalogues.

J. J. Thomson likens the discovery of Roentgen rays to the discovery of gold in a sparsely populated country. Workers come in large numbers to seek the gold, many of them finding that "the country has other products, other charms, perhaps even more valuable than the gold itself."

The chief value of Roentgen's discovery was not that it furnished us a new kind of light for the investigation of dark places, but in the fact that it led a host of workers to study vacuum tube discharges—the discharge of electricity in gases and the effects of such discharges on matter itself. The old dusty Crookes' tube was taken down from the far corner



of the upper shelf and regarded with new interest. In a day it had ceased to be a forgotten, though curious, plaything, and had become a powerful instrument of research. It was before Roentgen's discovery that a well-known professor said to me that he considered it foolish for one to spend any part of his departmental appropriation for a vacuum; that when he paid out money he wanted something in return—not an empty space. And yet this man was familiar with the work of Faraday and of Crookes, both of whom with prophetic mind had foreseen and foretold. Let me quote from a lecture by Faraday on the significant subject "Radiant Matter."

<sup>1</sup>"I may now notice a peculiar progression in physical properties (of matter) accompanying changes of form, and which is perhaps sufficient to induce, in the inventive and sanguine philosopher, a considerable degree of belief in the association of the radiant form with the others in the set of changes I have mentioned.

"As we ascend from the solid to the fluid and gaseous states, physical properties diminish in number and variety, each state losing some of those which belong to the preceding state. \* \* \* The varieties of density, hardness, opacity, color, elasticity and form, which render the number of solids and fluids almost infinite, are now supplied by a few slight variations in weight and some unimportant shades of color.

"To those, therefore, who admit the radiant form of matter, no difficulty exists in the simplicity of the properties it possesses \* \* \* . They point out the greater exertions which nature makes at each step of the change and think that, consistently, it ought to be greatest in the passage from the gaseous to the radiant form." The lecture from which the foregoing is a quotation was delivered in 1816, when Faraday was but twenty-four years old.

Let me quote again, this time from a lecture by Sir William Crookes delivered sixty years later, more than thirty years ago, on the same subject—"Radiant Matter."

"In studying this fourth state of matter we seem at length to have within our grasp and obedient to our control the little indivisible particles which with good warrant are supposed to constitute the physical basis of the universe. We have seen that in some of its properties radiant matter is as material as this table, whilst in other properties it almost assumes the character of radiant energy. We have actually touched the borderland where matter and force seem to merge into one another, the shadowy realm

---

<sup>1</sup>Life and Letters of Faraday, Vol. 1, p. 308.

between known and unknown, which for me has always had peculiar temptations. I venture to think that the greatest scientific problems of the future will find their solution in this borderland, and even beyond; here, it seems to me, lie ultimate realities, subtle, far-reaching, wonderful."

The developments of the last few years have demonstrated that no truer prophecy was ever uttered, and the prophet Crookes has lived to witness and to take a part in its fulfillment.

The importance of the present rejuvenation of physical science does not consist alone in the abundance of the harvest. There have been abundant harvests in the past. Consider the decade which closed one hundred years ago. In 1798 Rumford boiled water by friction. In 1799 Davy melted ice by friction in a vacuum and Laplace published his work on mechanics. In 1800 Volta constructed the Voltaic pile, Nicholson and Carlisle decomposed water, Davy discovered the properties of laughing gas, and Herschel discovered dark heat rays. In 1801 Piazzi discovered the first asteroid, Ritter the chemical rays, and Young the interference of light. In 1802 Wedgwood and Davy made sun pictures by the action of light on silver chloride, and Wollaston discovered dark lines in the sun's spectrum. In 1808 Malus discovered polarization by reflection, Gay Lussac the combination of gases by multiple volumes, and Dalton the law of multiple proportions.

So great was the exhilaration and satisfaction produced by these discoveries that many scientists of that period appear to have become infected with something akin to the "sixth decimal" delusion. "Electricity," wrote the French scientist Haüy, "enriched by the labor of so many distinguished physicists, seems to have reached the term when a science has no more important steps before it, and only leaves to those who cultivate it the hope of confirming the discoveries of their predecessors and of casting a brighter light on the truths revealed." A statement which was almost immediately followed by the discoveries of Oersted, Ampere, Seebeck and Faraday. A statement which has been followed by the telegraph, the telephone, the dynamo, the motor, the electric light, the electric railway, the Roentgen rays, and the wireless telegraph and telephone.

If anyone today is disposed to criticise the men of science of other times because of their limited view, their complacent opinions and their intolerance of all that did not agree with theories they considered established, let him first read and ponder over what One spake about notes and beams.

The real significance of recent developments is in the fact that they change—in a way revolutionize—some of our ideas of things. And here let me say that proven facts and proposed theories should not be confused. A theory is simply a working hypothesis, invented for the purpose of explaining facts, to be discarded when facts are discovered with which the theory is not in harmony. A theory may explain many facts, it may be generally accepted, it may have survived for generations and be false. The phlogiston theory, the corpuscular theory are two examples. Shall we say that the theory of the indestructibility of matter and of the conservation of energy are two others?

The usual chemistry text-book would have us believe in the indestructibility of matter because the chemist can change the form of matter almost at will, and in all the chemical reactions there is no loss of weight. In replying to this argument I wish to make three points.

First. The balance, notwithstanding the statement of text-books, compares weights and not masses, and it is only because weight is assumed to be proportional to mass that we say we determine mass by the balance. What we really compare is the gravitational force which the earth exerts on two masses, and we have no a priori right to assume that this gravitational force is absolutely independent of the state or molecular arrangement of the attracted body. Why, for instance should we expect an absolutely uniform field of force about a crystal when that same crystal will, if placed in a proper solution, continue to grow symmetrically, and perhaps replace a broken-off corner before beginning its growth?

It is conceivable that there should be a loss of weight in chemical reactions and yet no destruction of matter. It is possible that mass and weight are not strictly proportional. If J. J. Thomson were not disposed to question the equation  $w = m \cdot g$  he would not have experimented with a pendulum of radium, and he would not now be experimenting with a pendulum of uranium oxide.

In the second place there *is* an apparent change of weight in chemical reactions as has been shown by several experimenters, notably by Landolt,<sup>1</sup> who found a loss in forty-two out of fifty-four cases. The chemical reactions were brought about in sealed glass tubes which generally weighed less after the reactions than they weighed before. Later<sup>2</sup> it was found that some of these losses might be attributed to temperature and volume

<sup>1</sup> H. Landolt. Preuss. Akad. Wiss. Berlin, Sitz. Ber. 8, pp. 266-298, 1906.

<sup>2</sup> Landolt. Preuss. Akad. Wiss. Berlin, Sitz. Ber. 96, pp. 354-387, 1908.

changes. Whatever the testimony of the balance may have been, some of the reactions must have been accompanied by a loss of weight, for it has been proven by chemical means that such reactions are frequently attended by the escape of something through the walls of the glass tubes.<sup>1</sup> This loss is readily explained by the disintegration theory. If one wishes to explain it by assuming the diffusion of ordinary gases through the glass walls of the tube he must explain the fact that, in many cases, it was the heavy and least volatile substances that escaped fastest.

In the third place the element of time has been overlooked. Matter may be disintegrating, but at such a slow rate that in the limited time over which experiments have been extended the balance has failed to detect the change. As far as our experience goes the time of rotation of the earth is constant; but we know that it cannot be absolutely constant. The moon has slowed down until it takes a month to make one turn. To an ephemeral insect almost everything would appear to be eternal. With due respect for the balance and the wonderful work it has enabled chemists to do, it must be admitted that it is, comparatively, a very crude instrument. Let me prove it.

Suppose we fix the limit of sensibility of the balance at one one-thousandth of a milligram. Our books on chemistry tell us that 1 c.c. of gas, say hydrogen, at ordinary pressure contains  $4 \times 10^{19}$  molecules. The density of H being  $896 \times 10^{-7}$ , then 1 gm. of H would consist of  $(4 \times 10^{19}) \div (896 \times 10^{-7})$  molecules. Taking 112 as the ratio of the molecular weights of radium and H, then 1 gm. of radium would consist of  $[(4 \times 10^{19}) \div (896 \times 10^{-7})] \div 112 = 4 \times 10^{22}$  molecules. Therefore .001 mgm. of radium would consist of  $4 \times 10^{16}$  molecules, and this would be the smallest possible number that our most sensitive balance could detect. If the gram of radium were disintegrating and its molecules escaping at the rate of a million per second it would require  $4 \times 10^{10}$  seconds = 463,000 days = 1270 years for that gram of radium to lose in weight only the one-thousandth part of one milligram, all the while its molecules trooping away at the rate of a million per second.

The population of the earth is about 1,500 millions. The smallest number of molecules a balance will detect is  $4 \times 10^{16}$ , or about 26,600,000 times the population of the earth. We wonder if Mars is inhabited. If a Martian were to come to the earth to make an experiment to determine whether or not the earth is populated and he had no better instrument

<sup>1</sup>C. Zenghelis. *Zeitschr. Phys. Chem.* 65, 3, pp. 341-358, Jan. 5, 1909.

“for the detection of the existence of a man” than is the balance for a molecule, he would be obliged to go back and report the earth uninhabited. In fact his instrument for the man test would need to be 26,600,000 times as sensitive as the balance to give him even a hint of the probability of an earth population.

Thomson says that the smallest quantity of unelectrified matter ever detected is probably neon, and this was discovered by the spectroscope—not the balance. But the number of molecules of neon required to give a spectroscopic effect is about ten million million, or about 7,000 times the population of the earth. It has been shown that the presence of a single charged atom can be detected by electrical means. Thus the electroscope is millions of millions of times as sensitive as the spectroscope, which is itself in many cases far more sensitive than the balance. This explains, in part, why radium was discovered by physicists, and why physicists have been most active in all the work which has had to do with the theories of electricity and matter. If chemists wish to compete with physicists in this field of investigation they must adopt physical methods and apparatus or devise some of their own which shall be far more sensitive than the balance or spectroscope. Further, many of the great chemists of the world need to awake to the fact that there is something doing and that they are not doing it. Their indifference is surprising. Only three months ago one of them expressed the following sentiments in a paper read before the chemical section of the British Association. \* \* \* “Those who feel that the electron is possibly” (note the possibly) “but a figment of the imagination will remain satisfied with a symbolic system which has served us so long and so well as a means of giving expression to facts which we do not pretend to explain. \* \* \* Until the credentials of the electron are placed on a higher plane of practical politics, until they are placed on a practical plane, we may well rest content with our present condition and admit frankly that our knowledge is insufficient to enable us even to venture on an explanation of valency.” Think of it! We, the chemists, “remain content” in this day when, as the Hon. A. J. Balfour has said, the attempt to unify physical science and nature “excites feelings of the most acute intellectual gratification. The satisfaction it gives is almost

<sup>1</sup>Scientific American Supplement. 63, No. 1761. P. 21<sup>o</sup>, Oct. 2, 1909.

<sup>2</sup>“Reflections Suggested by the New Theory of Matter.” Presidential Address, British Association for the advancement of Science, 1904. Science. 20 No. 504, pp. 257-266, Aug. 26, 1904.

aesthetic in its intensity and quality. We feel the same sort of pleasurable shock as when from the crest of some melancholy pass we first see far below the sudden glory of plain, river and mountain." "Rest content!" No wonder the Noebel prize in chemistry was awarded to Rutherford, a physicist.

As to the second principle, the conservation of energy, some have had misgivings. It was Kelvin, I believe, who said that radium placed the first question mark after this great principle. Many have refused to believe in the electron and disintegration theories because they saw, or thought they saw, in these theories a contradiction of the principle of energy conservation. Personally I do not see that there are necessarily any contradictions. But even if there were and we were therefore justified in rejecting the theories proposed to explain the facts, we certainly should not be justified in rejecting the facts themselves.

In this connection I am reminded of the story of a lawyer whose client was placed in jail for some very trivial offense. When the lawyer learned the nature of the charge he said to his client: "My friend, they cannot put you in jail on such a charge as that." "Yes, but they have," replied the prisoner. When our physicist says that radium cannot remain at a higher temperature than its surroundings and continue to radiate heat, as that would be contrary to the second law of thermodynamics, the answer is, Yes, but it does. When he says that it cannot continue to radiate energy without receiving energy from some other body, as that would be contrary to the principle of the conservation of energy, the answer is, Yes, but it does it.

When some one says that helium or carbon dioxide cannot appear in sealed tubes which contained no trace of these substances to begin with, the answer is, Yes, but they do.

Let us suppose that we have a mass of gunpowder and that it is possible to, and we do, cause it to explode, one grain at a time, each grain firing its neighbor as in the fuse of a firecracker. The temperature of the mass of gunpowder will be higher than its surroundings, and it will give off heat and other forms of energy and continue to do so as long as the powder lasts. No one would think of calling this an exception to the law of the conservation of energy or the second law of thermodynamics. The source of the energy is the atomic potential energy of the powder itself.

Let us suppose that we have a sphere with frictionless surface rotating at an enormous speed. Suppose that particles of matter are thrown

off at frequent intervals. These particles, on account of their high speed, have considerable potential energy. Thus the sphere continues to give off energy without receiving any as long as any mass remains. The source of the energy is the kinetic energy stored in the sphere at the outset, of which energy we are conscious only when we have some method of detecting and slowing down the projected particles.

Thus the energy radiated by radium might be stored within the radium atom as potential energy and liberated by a sort of atomic—or sub-atomic—explosion. Or it might be stored as kinetic energy—of revolving electrons—and liberated gradually as these electrons escape from their orbits. It might be stored in both forms. In any case it is intra-atomic energy because stored *within* the atom itself and liberated only by atomic change—disintegration. In neither case would there be a violation of the principle of the conservation of energy or of the second law of thermodynamics. Sooner or later all the energy will have been radiated. The fact that the supply is destined to last so long is what appeals to us as wonderful. And so it is. The world is full of wonderful things to anyone who pauses long enough to think.

In this paper I have endeavored to give a general notion of the trend of thought and investigation in physical science rather than an enumeration and discussion of discoveries and theories. I might say, however, that there are strong reasons for believing in the molecular structure of electricity the electrical nature of matter, and the dependence of mass upon velocity. The theories of radioactivity and disintegration of matter are fairly well established. According to Ramsay, one of the most eminent chemists in the world, “we are on the brink of discovering the synthesis of atoms, which may lead to the discovery of the ordinary elements.” Perhaps the dream of the alchemist is about to be realized. Certain it is that we are face to face with energies of which no one even dreamed a few years ago. Whether we call this energy intra-atomic, sub-atomic, interelemental or some other name, we know certainly that it exists, and that it exists in quantities far beyond the power of man’s mind to comprehend. Man hopes some day, somewhere, somehow, to discover the means of unlocking this infinite storehouse. If this discovery is ever made, all the others which man has ever made will pale into insignificance beside it.

Lodge says of the one-pound shot and the one-hundred-pound shot which Galileo dropped from the top of the Leaning Tower, that “their

simultaneous clang as they struck the ground together sounded the death knell of the old system of philosophy and heralded the birth of the new." The age of reverence for authority had passed away and the day of experimental investigation had dawned.

In a sense the discoveries of the past few years have resulted in a similar revolution. The revival of the experimental method has been complete. Accepted theories are being put to the test. What we have long regarded as proven facts are being questioned and, in many cases, challenged. There is no field of investigation which has not been cultivated anew.

In closing I wish to quote from the presidential address of J. J. Thomson<sup>1</sup> before the British Association at its last meeting. "The new discoveries made in physics the last few years, and the ideas and potentialities suggested by them, have had an effect upon the workers in that subject akin to that produced in literature by the Renaissance. Enthusiasm has been quickened and there is a hopeful, youthful, perhaps exuberant, spirit abroad which leads men to make with confidence experiments which would have been thought fantastic twenty years ago. It has quite dispelled the pessimistic feeling, not uncommon at that time, that all the interesting things had been discovered, and all that was left was to alter a decimal or two in some physical constant. There never was any justification for this feeling, there never were any signs of an approach to finality in science. The sum of knowledge is, at present at any rate, a diverging, not a converging series. As we conquer peak after peak we see regions in front of us full of interest and beauty, but we do not see our goal, we do not see the horizon: in the distance tower still higher peaks, which will yield to those who ascend them still wider prospects, and deepen the feeling, whose truth is emphasized by every advance in science, that 'Great are the works of the Lord.'"

<sup>1</sup>Scientific Am. Sup. 63, Nos. 1757 and 1758, pp. 154, 155 and 174-176. Sept. 4 and Sept. 11, 1909.



## RECENT PROGRESS IN BOTANY.

---

By JOHN M. COULTER.

Mr. Chairman and Members of the Academy: When I face the Indiana Academy of Science at its twenty-fifth anniversary, I feel more like speaking of old times than upon any technical subject. However, perhaps some of these reminiscences may appear at the banquet tonight, and I will restrict myself just now to the program.

It is very hard for one who has not lived and worked through the period covered by the history of this Academy to appreciate the changes that have taken place in the science of botany. Those of you who have come into the subject during the last decade can hardly have a full appreciation of what you have missed and of what rapid development has taken place. At the time this Academy was being founded, almost all the instruction and investigation in botany was in taxonomy or classification, and that was chiefly restricted to the classification of flowering plants. I shall not weary you by recounting all of the important changes that have taken place since that time, but I wish to point out a few things that have impressed me.

The first impressive change is the tremendous development and differentiation of the subject during the period covered by the history of this Academy. In the background we have still the old historic field of taxonomy, which is being cultivated with greater zeal than ever. But the first change to note is the great development of the comparatively new science of morphology. In these days morphology has come to mean the structure and evolution of the plant kingdom as a whole, and its development has been little short of marvelous. Perhaps the first change from the old régime was brought about in this country by the appearance of Bessey's Botany in 1880, and from that date began the development of modern morphology in the United States.

In connection with the development of morphology there have grown up various expressions of it that have demanded special technique. The first of these to appear was that which is known as cytology. In collecting the facts in reference to the cell as a unit of structure, morphologists soon discovered that something must be known about cell structure, and

thus a very special technique has been developed and is still developing. Cytology might be defined, therefore, as morphology at the limit of technique.

In more recent years there has been another outgrowth from morphology and still a part of it. For many years there had been what was recognized to be a great rubbish heap of facts called anatomy. For example, the classic "Comparative Anatomy of Phanerogams and Ferns," by De Bary, contains a mass of facts, but they are inchoate. Many of them were used in instruction, for in the early days of morphological instruction facts were simply collected without reference to their relationships. Presently, as morphology began to develop ideas, it was felt that these anatomical facts might mean something when organized; but in the absence of such organization they were largely abandoned in instruction. Recently, however, there has been rescued from this rubbish heap the new subject of vascular anatomy, which has become a tremendous instrument in the development of our knowledge of plant groups and of the evolution of vascular plants in particular. Thus vascular anatomy has greatly extended morphology, which at first chiefly concerned itself with the reproductive structures. It still remains for some one to organize in a similar way the vegetative structures outside of the vascular system, and then morphology for the first time will have its facts fairly in hand.

Under the shadow of this morphological development there appeared another growth known as pathology. The progress made in plant pathology during the period covered by the life of this Academy is familiar to many of its members. It began as morphology, but as it progressed it became more and more clear that it would have to join itself to physiology, and so pathology may be called a cross between morphology and physiology in its recent development.

Another great field that came in connection with this development of morphology, even more recently, is paleobotany. There has been such a subject ever since people have uncovered plant remains and their impressions in the rocks; but its method was to match fossil fragments with living plants, so that identification was always uncertain. The technique of today, however, has enabled us to secure knowledge of structures, and since vascular anatomy has been put upon a phylogenetic basis we have a key by which the relationships of these ancestral plants may be unlocked.

I can only mention the remarkable advance that has taken place in plant physiology, and also in the new subject of plant ecology. There should be added plant breeding, which has not only its important scientific aspects in connection with theories of heredity and the origin of species, but has also such enormous practical applications that it is reaching out into the needs of men.

This gives merely a glimpse of how the old science of botany, as it really was when this Academy was founded, has branched out into its present field of achievement. The student of twenty-five years ago who had studied botany in our colleges and learned just enough about gross morphology to be able to use Gray's "Manual" intelligently, and who regarded that to represent all there was in botany, would be astonished to see the development of today.

Following this outline of the expansion of botany in general, I wish to speak of three or four of the most notable advances made in my own special region of morphology, and that is the morphology of vascular plants. To me the most striking feature of morphological progress during the last twenty-five years has been the breaking down of the old barrier set up between what were called cryptogams and phanerogams, the barrier that separated fern plants from seed plants. Not only was this felt to be a solid barrier, but even in universities chairs of botany have been distinguished on the basis of this division of plants. If there is any place in the whole series of plants where there is no gap between great groups it is this very place. I can call attention only to two conspicuous facts that stand out in this connection. One is the discovery a few years ago that certain gymnosperms (cycads) possess fern-like swimming sperms, a feature that associates these seed plants very closely with ferns. The second is the discovery during the present decade of the great paleozoic group of fern-like seed plants. All are familiar with the fact that the coal vegetation was thought to be largely a fern vegetation because the preserved leaves looked like fern leaves; but it is now recognized that all of these great frond groups of the coal vegetation were seed-bearing plants. In fact, paleobotanists are sure now of only one family of paleozoic ferns.

Another fact of equal interest is the uncovering of the so-called mesozoic cycads. These have proved to be far removed from the other gymnosperms in their essential characters. We have a sort of national pride in

the uncovering of this singular group, because the greatest deposits are in this country. The work of Wieland in revealing the rich deposits of these plants in the Black Hills region and in sectioning the cones with admirable skill and patience is well known. For the last five months Wieland has been exploring southern Mexico, and has discovered a section 2,600 feet in thickness that is packed with the remains of this peculiar group, making it undoubtedly the greatest deposit of these plants in the world. They are regarded now as of great interest because the peculiar structure of their cones has suggested the possibility that they may be a group of gymnosperms that has given rise to angiosperms.

Perhaps another notable change that deserves mention is the practical demonstration of the relationship between the two groups of angiosperms. It was thought once that the monocotyledons were the more primitive angiosperms, and that the dicotyledons were the more recent. We feel assured now that the monocotyledons have been derived from dicotyledons, for every monocotyledon starts with the vascular system of a dicotyledon; and if there is anything true in the old theory of recapitulation, the relationship of these two groups is evident.

Perhaps the most notable change in morphology is the change in mental attitude, and particularly in reference to the construction of phylogenies. I remember that at the early meetings of this Academy we were in the habit of constructing very complete and satisfactory phylogenies. We were sure just how one plant group descended from another. That is always easy when the facts are few; but now that facts are numerous, no one is able to construct a satisfactory phylogeny. No one imagines now that any living group has descended from any other living group.

Another marked advance is the change of mental attitude in connection with morphological work, in which morphology has clasped hands with physiology. I can only indicate some of its results. It has destroyed the old rigid categories. Botany was once largely an extensive system of terminology. Now we have passed from the days of terminology to the days of knowledge, and terminology no longer masquerades as knowledge. Not one of the old definitions has stood the test of experimental morphology. Experimental morphology has also helped to rid us of that old, Calvinistic notion of predestination in plant organs. Once it was thought that every primordium was destined to be one particular structure and nothing else. Now we know that a primordium may become almost

anything under appropriate conditions, and is not destined to be some particular structure.

One of the most interesting recent results of experimental morphology has been that obtained in experimental work on heterospory. It has been shown that it is possible to develop megaspores from cells that ordinarily develop microspores. It is such results that are playing fast and loose with our old conceptions of rigidity of structure and function.

I can merely mention the field of plant physiology. If I speak of the changes that have taken place within the last twenty-five years, I must show the atmosphere in which we are living by assuring you that I am not the one to make such a presentation. In the old days one man taught all there was of botany, and probably he taught all there was of science. Today I have been compelled to ask a competent plant physiologist concerning the notable changes. He tells me that there are two conspicuous changes in the point of view. One is the gradual passing of the old vitalistic idea, which implied that there was some such thing as vital force that explained most things. Now the facts are explained, not in terms of vital force, but in terms of chemistry and physics. Another shifting point of view is a change from the old idea that form and structure are the result of some mysterious law of development, to the idea that form and structure are entirely expressions of the conditions under which growth has been conducted.

The very new field of ecology at present is in the condition of these other fields more than a decade ago. Young fields are largely jokes to the older ones; but there has been a change in ecology during the last few years. It has passed from the stage of inchoate observation, in which instruction in ecology could not be differentiated with distinctness from a holiday excursion, to methods of precision.

In conclusion, as one looks out over this great progress, he finds that it is all really an inevitable evolution from the stimulus that was given first by Hofmeister in 1898 to morphology, and ten years later by Charles Darwin to biology in general.

University of Chicago,  
Chicago, Ill.



## DARWIN FIFTY YEARS AFTER.

BY DR. DAVID STARR JORDAN.

Scientific men, as a rule, do not pay much attention to birthdays; but certain anniversaries have been impressed upon our minds of late, and in the last two years there have been many celebrations: The two hundredth anniversary of Linnaeus, and the one hundred and fiftieth of his great work, "Systema Naturæ"; the one hundredth anniversary of the birth of Agassiz, the greatest teacher of science; the one hundredth anniversary of the birthday of Charles Darwin, and the fifth anniversary of the publication of "The Origin of Species," the greatest landmark of the history of the nineteenth century. Twenty-five years ago we note another landmark of import to us. It was then that Amos Butler brought his Brookville academy to Indianapolis, where its first meeting was held on December 29, 1885. As I was just then elected president of Indiana University, the youngest of all the college presidents—and the greenest—being, therefore, by some preferred to the drier article, I was made president. With this came the suggestion that two others who, like myself, had fought each year on the bloody sands of the educational arena of Indiana—John Coulter and Harvey Wiley—would be my successors.

At that time the idea of evolution was in the air, the theory of descent, that the forms now living were created, not by mysterious power, but by the operation of natural selection and the survival of the fittest. It was my fortune to have been brought up as a student of Agassiz, having heard all his lectures on this subject, and inherited his prepossessions. It was my own studies of animals which led me little by little to become an evolutionist, and I have said that I went over to that view of the case about as graciously and as willingly as a cat which a boy draws across the carpet by its tail.

I remember it was out at Broad Ripple, just north of this city, where Copeland and myself first definitely decided that we were converts to Darwinism. The little sand darter in the river is a sort of perch, but differs from any others in having very few scales, and these very thin ones. We testified to our faith by an article in which we said that these little animals are derived from the scaly perches; that we did not know whether it has

lost its scales because it buries itself in the sand and does not need them, or whether it buries itself in the sand because it has no scales and needs protection, or whether burying itself in the sand there has come to be a gradual selection of those whose scales are fewest and thinnest. Anyhow, we were sure of its origin, and that it was descended from some of the other forms of dwarf perch to that called the Johnny Darter.

Many men before Darwin had taught the theory of descent, but Darwin gave the first rational exposition of how it came about by natural processes. He showed that adaptation is the natural result of the survival of the adapted in the struggle for existence. Variation is everywhere among animals and plants. No two animals or plants are ever alike. There is everywhere a great wealth of life—more are born than can mature, and those survive and live who are able to fit themselves into the scheme of life. Darwin did not believe in evolution in vacuo, that is, evolution wholly independent of external circumstances and conditions, but this heresy that the laws of evolution, which are simply the way things come about, can produce evolution and divergence without any except metaphysical causes, still has a large body of followers. It is, in my judgment, one of the heresies of the present time.

In the evolution of any species in the rough-and-tumble of life, we have these four elements: Variation, heredity, selection and segregation. Variation is the starter. It is interwoven with the operation of heredity. The favorable variation survives, and the animal or plant possessing it gives rise to the next generation. This is selection.

The operation of isolation is this: A group becomes separated by some barrier which the individual can not cross. Little by little the species become separated into two or more species, one just as well adapted as the other. It is not often that differences between species are differences in adaptation. It is therefore not often that they are due to natural selection. The final difference, the final polishing or rounding off of the species giving it its distinctive minor character, is due to isolation. Variation and heredity are inside the individual. The incidents of selection and isolation are of the outside world. They are part of the modifying conditions of life. Without contact with the outside influences, in my belief, there is no evolution.

Darwin may be compared to an explorer in a new country. From some high point he makes a map of the country, locating its salient fea-



tures, its rivers, lakes, peaks and cliffs. The detail must be worked out by those who come after. In the case of Darwin the map remains substantially as it was, although many have worked at the various details with which the modern chart is filling up. The discovery of the microscope has enabled us to frame a rational theory of heredity and to understand with some degree of certainty the physical basis of the functions of inheritance. The morphology of animals has been very fruitfully studied by many men. Many others have developed the history of past life on the earth, and we would have to have a theory of evolution to account for this, if Darwin had not furnished one already.

The three men most famous since Darwin are these: Wagner, Weismann and Mendel. Mendel died before Darwin wrote and his work on the "Heredity of Peas" was forgotten until after Darwin's time, but has become a very important factor in our experimental studies of living forms in relation to inheritance. Wagner was the first one to lay adequate stress on the idea of isolation as a species-forming influence. His weakness was that he rejected selection as an element, assigning to isolation the impossible task of accounting for all the external phenomena in the origin of species. To Weismann we owe more than to any one else our present knowledge of heredity.

Theories of less importance are Eimer's orthogenesis, which has a good deal behind it, and which we shall probably accept if some genius will arise to tell us what it means. It rests on the fact that we have many long series of animals which seem to have progressively varied as time went on.

The study of the mutations of the evening primrose by De Vries has given many hints as to possibilities in plant breeding. I do not believe that the theory that species are mainly or largely formed by sudden mutations will survive the present generation of De Vries' followers, but the impulse given to experimental study of plants will long continue.

More than thirty years ago I used these words in Indianapolis:

"Darwin lies in Westminster Abbey, by the side of Isaac Newton, one of the noble men of the past whose life had made his own life possible. Of all who have written or spoken, by none has an unkind word been said. His was a gentle, patient and reverent spirit, and by his death has not only science, but our conception of Christ, been advanced and ennobled."



## METHODS AND MATERIALS USED IN SOIL TESTING.

BY H. A. HUSTON.

The consumption of commercial plant foods in the United States has reached approximately 5,000,000 tons and the cost to the consumer is nearly equal to the sum which we formerly paid for imported sugar, and which became the slogan in the campaign to establish the beet sugar industry in America—\$100,000,000.

The industry is established, but by no means stationary. It has increased at least 50 per cent. during the past five years, a very high rate considering the magnitude of the business.

In the manufacture and control of these products there is employed a large number of chemists, and the Association of Official Agricultural Chemists, now over a quarter of a century old, was originally formed for devising suitable methods of analysis for these products. Thirty-three States have special laws for fertilizer inspection. The American Chemical Society recently organized a Division of Fertilizer Chemists, and most of our agricultural colleges and experiment stations devote a considerable amount of attention to the subject.

The farmer wants to know the facts about commercial plant foods and all officialdom, from the bureau chiefs of the National Department of Agriculture to the local speaker at the township farmers' institute, undertakes to enlighten him.

In those sections of the country where fertilizers have been longest used—along the Atlantic, the eastern gulf coast and the upper Ohio Valley—the experiment stations and control officials appreciate the magnitude and importance of the industry and understand its vital relation to crop production. In marked contrast to this is the state of affairs in the greater part of the great area drained by the Mississippi, where the most of our maize, wheat and oats are produced. Here we find also the curious combination of land rapidly increasing in money value and at the same time declining in productiveness, while the cost of farm labor is increasing. These circumstances cause the farmer to inquire how his crops may be increased and whether commercial plant foods may be profitable in this connection.

Some thirty-five years ago the winter wheat growers of the Ohio Valley began to use fertilizers, most of the material being the side products of the packing houses, mainly bone meal. Very profitable results were secured and the trade rapidly increased. In time acidulated goods were introduced, often being mixtures of equal parts of acid phosphate and bone. Later came the "complete" fertilizer, being ammonia 2, available phosphoric acid 8, and potash 2 per cent. This is still the so-called basal formula, that is, the one used as a starting point in calculating the trade value of goods with different formulas. About two-thirds of the fertilizer used in that section consist of complete fertilizer; the use of bone and ammoniated phosphate is declining and the use of mixtures of acid phosphate and potash is rapidly increasing. Common applications for wheat are from one to two hundred pounds per acre, and it is almost invariably applied with a fertilizer attachment at the same time the seed is sown. The efficiency of the fertilizer in securing a stand of clover, the seed of which is sown before the wheat starts its spring growth, is a point to which the farmers attach considerable importance and the increase in clover production may in part account for the reduction in the amount of nitrogen in the fertilizers now used as compared with that used at an earlier period.

The use of fertilizers gradually extend to other crops, but fully two thirds of the fertilizer sold in the Ohio Valley are used on winter wheat. The general tendency in composition has been to reduce the nitrogen and increase the potash, while the phosphoric acid has remained practically unchanged. Ready mixed brands are the rule, home mixing the rare exception.

It is, however, unnecessary to state that much of this plant food has been used in a most haphazard way and that both buyer and local seller knew little about the composition of the goods sold or their fitness for the crop or soil on which they were to be used.

The one thing which stood out very clearly was that they paid; that by their use good crops of wheat could be secured where unprofitable crops grew before; and that a stand of clover or grass could be secured, a suitable rotation of crops established and maintained, and that the cost of the fertilizer was returned many fold in the increase of wheat grain alone. Ten pounds of fertilizer costing from ten to fifteen cents produced on the average an increase of a bushel of wheat. This condition exists over much of the winter wheat belt extending from Kansas east and com-

prising an area of probably 200,000 square miles. These facts have existed too long and cover too much territory to be ascribed to local peculiarities of soil or season. The wheat grower knows that fertilizers pay. But as brands multiplied the question arose which is the more profitable, and many made simple tests of different brands in which the popularity of the local agent received more consideration than the amount and kind of plant food in the goods: they obtained the confusing results that might have been expected under these conditions. Better informed farmers applied to their experiment stations and agricultural colleges for aid, and in most cases were surprised to be told either that commercial plant foods did not pay or that they were unnecessary.

An examination of the records of field tests conducted by experiment stations in the winter wheat section shows that many experiments have been made, especially on wheat, and that most of them have been reported unprofitable. This apparent conflict between the results of practical and scientific agriculture has to some extent prevented the extension of the sale of plant food to territory where it was very much needed. One may fairly inquire why the results of the experimental field tests differ so widely from the results obtained in ordinary farm practice in the same sections.

First, we may consider certain things that are general in their nature. Many experiments are reported where relatively heavy applications of farm yard manure have been compared with applications of various brands and quantities of fertilizers without any clear statement or apparent knowledge of the composition of the latter. Such experiments are almost invariably reported as showing that manure is more profitable than the fertilizer, which is not strange in view of the fact that in the valuations the full cost of the fertilizer is charged up, while to the manure is charged only the cost of hauling. In such reports there is often a very clear intimation that the result is quite in line with the preconceived notions of the experimenter and that in discouraging the use of "expensive fertilizers" he is at least telling farmers what they like to hear even though it conflicts with what they need to know.

The method of application of the plant food is in many cases responsible for a considerable part of the difference observed between field practice and plot experiments. Application with the drill at the time of sowing small grains, which is the common method, frequently gives profitable

results when the same amount and kind of fertilizer applied broadcast is unprofitable, and the same remark applies to light applications on maize.

One of the principal reasons for unprofitable results from plot tests is found in failure to make a distinction between the fertilization of crops producing high money values per acre, like truck and fruit, where the whole plant food supply may be profitably secured from chemical manures, and such crops as wheat, oats and maize, where the chemical fertilizers must be used to supplement and balance the supplies from the soil, farm yard and legume field. The cost of full rations of commercial nitrogen can only occasionally be recovered in the wheat crop and rarely if ever in the case of oats and maize. Double rations of phosphoric acid are often profitable and from one-half to full rations of potash. In most of the early plot experiments full rations were used, and sometimes the cost of the fertilizer for maize was greater than the total sum received for the crop even when the yields were good.

Perhaps the contrast between the plot tests and the farm practice can be shown better in the form of the amounts per acre and the formula. In some of the wheat plot tests extending over twenty years the fertilizer is the equivalent of 500 pounds per acre of goods having formula of nitrogen 10 per cent., phosphoric acid 5 per cent. and potash 6 per cent.; at the same time this series was started the common wheat fertilizer was 100 to 200 pounds per acre of 2-8-2, which has gradually changed to 2-8-6; nitrogen is sometimes increased to 3 per cent. The maize series of plots received the equivalent of 1,000 pounds per acre of a goods having a formula of nitrogen 12 per cent., phosphoric acid 4 per cent. and potash 6 per cent., while farm practice on maize uses 100 to 300 pounds per acre of goods having little or no nitrogen and containing from 5 to 10 per cent. phosphoric acid and 4 to 10 per cent. of potash. For clay soils a common maize fertilizer is 0-10-4, for loams 0-8-8 and for black sandy soils 0-6-10, while on the peat or muck soils 100 pounds per acre of muriate of potash or its equivalent in kainit are commonly used. A small amount of nitrogen is sometimes added, usually about 1 per cent.—rarely over 2.

The cost per acre of the maize fertilization would be about \$30 for the plot work and from \$1 to \$4 per acre for the fertilizers commonly used. The cost per acre of the wheat fertilization would be about \$15 for the plot work and from \$1 to \$3 per acre for the fertilizers commonly used.

In general it may be said that the fertilizers used on wheat and maize furnish about as much phosphoric acid as the crop removes, rarely as

much as one half ration of potash and never over one-fifth ration of nitrogen, while the plot experiments have undertaken to supply full rations for a full crop, which is fully double an average crop.

The quantities of fertilizer used in the plot tests mentioned above seem quite absurd to the American grain grower, yet they are very conservative compared with another set inaugurated at about the same time in which 2,000 pounds of acid phosphate, 600 pounds of sulphate of potash and 600 pounds of sulphate of ammonia per acre were used, or with an extensive set of orchard experiments in which the plans called for the application of 40 pounds of muriate of potash with corresponding amounts of nitrogen and phosphates to each two year old tree.

In the case of the plot experiments conducted for the purpose of determining the value of the different plant foods, the excessive quantities have often caused a profit to be shown for only the particular plant food which was most deficient, while if more reasonable quantities had been used each would have shown a profit. It is not unusual to find reports of these experiments that recommend the use of a single plant food as all that is necessary merely because it was the one that chanced to give the largest profit.

As compared with this line of plot experiments with full rations we may, perhaps, devote a moment to results of plot experiments where amounts and formulas generally used in farm practice were taken as a basis.

On a typical worn clay wheat land an experiment was undertaken on the basis of 300 pounds per acre of goods containing nitrogen 3 per cent, available phosphoric acid 10 per cent and potash 6 per cent, each element being omitted in turn in the usual way.

The following results were obtained:

Fertilizers applied per acre. Equal to—	Yield, bushels per acre.	Reduction from Omitting			
		Nitrogen.	Phos. Acid.	Potash.	All.
300 lbs. 3-10-6. ....	33.8	.....	.....	.....	.....
300 lbs. 0-10-6. ....	29.1	4.7	.....	.....	.....
300 lbs. 3- 0-6. ....	7.6	.....	26.2	.....	.....
300 lbs. 3-10-0. ....	25.0	.....	.....	8.8	.....
None .....	6.5	.....	.....	.....	27.3

The nitrogen in the fertilizer cost per acre.....	\$1 80
The phosphoric acid cost per acre .....	1 50
The potash cost per acre .....	1 10

---

The complete fertilizer cost per acre .....\$4 40

The nitrogen increased the crop 4.7 bushels at a cost of \$1.80, the phosphoric acid increased it 26.2 bushels at a cost of \$1.50, while the potash increased it 8.8 bushels at a cost of \$1.10. As wheat sold at 90 cents per bushel it will be seen at a glance that all the plant foods were used at a profit, although, of course, we are not in a position to show that the combination is the one most profitable. Nor do we know that this was the most profitable amount. We do know that it was very profitable even neglecting the value of the increase in the straw and the very striking effect on the clover which followed the wheat.

The experiment is a typical one for soils in the winter wheat belt, and numerous others could be given showing results of just the same character and even more striking in profits.

The figures show how the lack of phosphoric acid limited the crop, and they serve to explain why bone gave such increases on these soils that for nearly a generation it was considered the only profitable thing to use.

In another series at a different place the amounts of the plant foods were varied, but the season was so unfavorable that the crop was limited by other considerations than plant food, the maximum crop being only about 13 bushels per acre and that of the unfertilized plots being only 2 bushels.

In these experiments the nitrogen is supplied from blood, the phosphoric acid from precipitated calcium phosphate free from gypsum, and the potash from muriate of potash, the purpose being to use materials exerting as little indirect effect as possible.

This matter is too often overlooked in planning such experiments, and for a considerable time the indirect effects may be so great as to mislead one who does not take them into consideration. Thus the gypsum in ordinary acid phosphate, amounting to about one-third of its weight and the sodium in the nitrate, may each release so much potash from zeolites in the soil that the plot with nitrate acid phosphate and potash may show little if any increase over that with nitrate and acid phosphate. Comparatively few experiments exist which have been conducted long enough and in such a way as to shed much light on the extent to which the indirect effects mask the direct effects.



In such cases one always turns to the admirable work at Rothamsted for help and the constantly increasing difference between the yields of plots 11 and 13 Broadbalk Field seem to show that the indirect effects are decreasing. The gypsum alone on plot 11 would theoretically release 90 pounds per acre of potash annually while the total annual application of potash on plot 13 is 100 pounds. The theoretical amount of potash that could be released by the bases in the minerals used on the fully fertilized plots at Rothamsted amounts to about 400 pounds of potash per acre annually while the potash applied in sulphate amounts to 100 pounds. While Director Hall has clearly pointed out the difference between the early years and the later, too many who use Rothamsted results to fortify their arguments simply take the average for the whole period and neglect to consider the results by decades.

Especially when we wish to secure indication of soil needs as promptly as possible should we take pains to use materials that will exert as little indirect effect as possible. By using blood as a source of nitrogen and gypsum free precipitated phosphates as the source of phosphoric acid we can remove most of these indirect effects and at the same time use materials easily secured and of high availability.

Another point that is never considered in planning the plot tests in the section under consideration is the marked difference in the fixing power of soils for plant foods and the firmness with which they hold them. This is roughly recognized in providing for an excess of phosphoric acid in commercial formulas but is seldom considered in plot tests.

The plot tests in most cases have simply been copied from plans made before the nitrogen gathering power of bacteria associated with legumes was understood and sometimes altered because of the injurious effect of the excessive nitrogen applications or too often abandoned altogether because the growth of the institution demanded the land for other purposes. The frequent changes in the staff of workers has also interfered seriously with both the conduct of the work and the interpretation of the results.

The conditions in the winter wheat section of the United States are such that large crops must be produced in order to realize a suitable return on the selling value of the land and the money spent for farm labor. The small grain crops are so related culturally with the clover crop that they are almost necessary in a rotation if we expect to utilize our most widely distributed legume as a source of nitrogen.

The chemical industries supplying plant foods and the purchaser of these products would both be greatly benefited by the inauguration at our experiment stations in the grain growing section of experiments properly planned to solve the question of the most profitable method of supplementing the plant food resources of the farms.

Up to the present time it must be confessed that the purely empirical methods of the fertilizer manufacturers have produced results that yield the farmer better returns than anything derived from the experiments started under the old system by the educational institutions in the grain growing section, but these are far from being the best obtainable. Both farmer and fertilizer manufacturer need the help of the educational institutions in the direction of securing facts relative to the most profitable methods of utilizing plant foods in the production of our great cereal crops—facts that will help and not discourage.

But such experiments must take into consideration

The kind of materials to use,

The avoidance of indirect effects,

The right methods of application,

The question of the most profitable amount, and finally

The rational interpretation of the results obtained.

German Kali Works, Chicago, Ill.

## FEDERAL CONTROL OF INTERNATIONAL AND INTERSTATE WATERS.

By BARTON W. EVERMANN.

Mr. President, Members of the Academy—I shall talk a very few minutes on this subject. The idea of federal control in matters pertaining to fisheries and game is a recent one, and one of recent and gradual development. I think perhaps the idea was first advanced in connection with the control of migratory birds. Ornithologists and others interested in the preservation of birds realized a number of years ago that the state laws of the various states were inadequate for the control of migratory birds. A bird today is in Louisiana or Alabama, tomorrow in Tennessee, next week in Kentucky, then Indiana, then Michigan, and the game laws in the different states are different. In some of these states there would be a law adequate for the protection of migratory birds as they went north or south, but in the next state into which they went there would be no law, so that migratory birds received very inadequate protection or no protection at all.

The first bill that was introduced into Congress that had any bearing on this question was introduced by George Shiras III, of Pittsburg. In this bill he proposed that the Federal government should take over the control of the regulations for protecting migratory birds. A little later the idea expanded and Mr. Shiras introduced a bill in Congress providing for the protection of migratory fishes. His attention had been called to the fact that in the Atlantic coast States there is no law adequate to protect the shad and other migratory fishes. The difficulty existed in all of the streams where migratory fishes came, but particularly in those streams which lie between two States and which are controlled by two or more States. The Potomac River was taken as an illustration. The laws of Virginia on one side and Maryland on the other were never the same, and at the same time it was legal to fish in one State and illegal in the other. The inevitable result was a series of evasions of the law by the fishermen of these States.

The Columbia River is another illustration, perhaps the most serious of all. There you have Montana, Idaho, Washington and Oregon, all con-

cerned in the Columbia River. Idaho and Montana are not seriously interested in the salmon, but Washington and Oregon are both vitally interested in the salmon fisheries of that stream. But these two States have never been able to agree upon concurrent legislation which adequately protects the fisheries, and things have gone from bad to worse. Two years ago an effort was made by certain people interested to restrict the taking of salmon in the upper Columbia by cutting out the use of certain kinds of apparatus. This matter was referred to the people in Oregon, and at the same time those who were interested in the fisheries in the upper Columbia had a similar question submitted to the people stopping fishing in the lower river, and a very curious result followed. The people said it would be a good thing to restrict fishing in both parts of the river, so both amendments carried, and the inevitable result followed that neither is enforced, illustrating very clearly the impossibility of two or more States agreeing upon adequate measures in questions of that kind.

Then the question came up as to the control of the fisheries in international waters. The question there has for many years been a serious one, particularly on Lake Erie. That lake has abutting on it four States on this side of the line—Michigan, Ohio, Pennsylvania and New York—and the province of Ontario on the other—five political units that are all interested in the fisheries of Lake Erie, and no two having the same laws, so that at one time it would be legal to fish at a certain distance from the shore and with certain apparatus off that narrow portion of Pennsylvania which fronts on Lake Erie, and just beyond that narrow strip in Ohio or New York it would be illegal, and there was constant difficulty to keep the fishermen of one State within the strip in which they had a right to fish; and the regulations on our side were in every case entirely different from those on the Canadian side, so that friction followed there. It was impossible for the individual States to handle this question, and in that way the question of federal control came up.

In addition to these questions, and of more recent development perhaps, has come the question of the desirability of federal control of interstate waters and other waters in the matter of public health. We have a good illustration of the necessity for this in the Potomac River. Washington City has sometimes suffered from an epidemic of typhoid fever, and investigation has shown again and again that the source of infection was not in the District of Columbia, but was brought from some place

else; and carrying the investigation still further it has been proved on more than one occasion that Cumberland, Maryland, is responsible for at least some of the typhoid epidemics at Washington. The waters of the Potomac become infected at Cumberland, many miles above Washington, and the germs are carried from there and people infected. The District of Columbia, of course, is absolutely powerless in the premises; it can do nothing. The State of Maryland has done nothing, and the outlook is not encouraging. I do not believe Maryland will do anything to remedy the difficulty. It affects not only the District of Columbia, but every town between Cumberland and the District of Columbia, so that in that case the matter of public health is concerned in Maryland, the District of Columbia and Virginia.

A little more than a year ago the United States and Great Britain entered into a treaty providing for the appointment of an international Fisheries Commission, with power to draw up regulations governing the fisheries in international waters between the United States and Canada. That treaty specified the waters—from Passamaquoddy Bay on the east to Puget Sound on the west—taking in all of the Great Lakes except Michigan. As I see it, the principal point, the principal necessity for that treaty was to secure a set of uniform regulations for these waters. Under it, fishing on one side, in Canada, and in Ohio, Pennsylvania or New York, on the other, as far as Lake Erie is concerned would be the same. There would not be the conflicts which now exist. It does not seem to me that that treaty was necessary in order that the Federal government might take control of the fisheries in these waters, and for some reasons it would have been better if they could have brought about federal control of fisheries in these waters without entering into a treaty between the two countries. There may be some little risk in giving a foreign nation a hand in determining what shall be the regulations in the waters of Ohio, of Michigan, Pennsylvania or New York, and make it impossible for the United States to change the fisheries regulations on our side of the line without the consent of another country. But that may be laid aside as a matter of secondary importance.

One of the first men to become interested, to recognize the importance of the question of federal control in these matters was George Shiras III, a grandson of Chief Justice Shiras, an angler, sportsman and all-round naturalist, who is very much interested in the preservation of game

and migratory birds. He first became interested in the protection of migratory birds, then fishes, and then in the larger question of all animal life in the streams which cannot receive adequate protection from individual States, and from that he has taken up the question of pollution of streams, and it has been shown by him and by others that the Federal government always had power to control interstate and international waters in all matters of navigation and fisheries and public health, because these three questions are larger than the interests of individual political units. The Federal government has exercised that power in the matter of navigation, but it has never exercised it in matters of fisheries or public health—the pollution of streams. But that it has that power and can exercise it whenever it wishes to do so, and that it is perfectly constitutional, I have no doubt in my mind, and I think the time is coming soon when it will be done. In this day when the question of public health is being agitated and considered so seriously, and when we understand more fully than we ever did before the sources of disease epidemics, when we realize more and more that the question is broader than the boundaries of a single State, it is clear that this question is a question which must be handled by the Federal government and cannot be handled by the individual States.

In the treaty between the United States and Great Britain, as you doubtless know, President Jordan was appointed commissioner representing the United States, and Prof. Edward E. Prince to represent Canada, and these two commissioners have gone over the boundary line from St. Johns to Vancouver, and at the end of last May they submitted their report to the respective governments, a report embracing a set of recommendations—some sixty-six in number—which they hope will control in a satisfactory way the fishing in international waters. That report will be made public, doubtless, soon after Congress meets. It will go to Congress and to Parliament, where the necessary provisions for enforcing these regulations will be provided. As it now stands, Canada already has the machinery which is needed to enforce the regulations on her side of the line. She has a very efficient system of patrol, facilities and men and means to enforce her fisheries regulations far better than they are enforced on this side of the line, particularly in Puget Sound. There is no such machinery on this side of the line for enforcing any set of fisheries regulations, because the matter has been and is now in the hands

of the respective States. Each State has its own machinery; but under the terms of the treaty it would seem that the Federal government is morally bound to provide the necessary machinery for doing as well on this side of the line as Canada is doing on the other.

Now, if it turns out, as we believe it will, that this is the beginning of federal control in all of these large and important streams, then will come federal control not only of international waters, but interstate streams, and in all matters of pollution of any and all streams.

Mr. Shiras cites a number of cases: The State of Missouri vs. Chicago Drainage Canal, in which the decision of the court showed that the question is one larger than the State of Illinois and the State of Missouri, and that the Federal government must take it up. A similar case, Kansas City vs. The State of Colorado, the decision of the court pointed to the same view. And there is every reason to believe that the Supreme Court will uphold these decisions.

Bureau of Fisheries,  
Washington, D. C.





## THE SPEED OF MIGRATING SALMON IN THE COLUMBIA RIVER.

BY CHAS. W. GREENE.

(Abstract.)<sup>1</sup>

In the solution of this problem I devised a scheme whereby individual fishes could be given individual tags that would render identification absolutely certain if the fish should be recaptured. This plan was nothing more or less than the use of the conventional stock-marking aluminum buttons. These buttons are light and cannot be torn apart and they carry serial numbers on one face; on the other can be placed such special marks as one may select.

On August 14, 1908, I marked fifty-nine fish at Sand Island, just within the mouth of the Columbia River. These fish were liberated in the river in the hope that some would be retaken, and thus we might glean the story of their migration. The fish were marked by inserting numbered buttons through the caudal fin.

Seventeen of the fifty-nine fish liberated were retaken and reported to me; sixteen buttons were also returned to me. The fish were retaken along the river from a point four miles below where they were liberated up to the Dalles of the Columbia, just below Celilo Falls, a total distance of two hundred and fourteen miles. Near the upper limit quite a number of fish were taken and six of these had traveled a distance which, when rated, gives an average individual speed of from six and one-third to seven and one-half miles a day.

The following table is constructed to show the actual time from liberation to recapture, the distance covered, the probable time consumed in the straight-away run on a basis of the speed of number 76 (seven and one-half miles), and the days unaccounted for. My view is that these unaccounted days are chiefly spent in the lower estuary of the river in becoming acclimated to the fresh water.

---

<sup>1</sup>This investigation was undertaken in cooperation with the United States Bureau of Fisheries. This abstract is published by the consent of and with the approval of the U. S. Commissioner of Fish and Fisheries.

SPECIES AND NUMBER.	Distance Traveled in Miles.	Days Out.	Days Required to Cover the Distance at a Speed of $7\frac{1}{2}$ Miles a Day.	Days Unaccounted for, i. e., Available Acclimatization.
Silver..... 76	210	28	28	0
Silver..... 75	210	29	28	1
Silver..... 89	210	30	28	2
Silver..... 79	210	33	28	5
Silver..... 97	210	33	28	5
Steelhead..... 124	210	33	28	5
Chinook..... 80	15	11	2	9
Steelhead..... 98	210	52	28	24
Steelhead..... 125	70	35	9	26
Chinook..... 123	15	31	2	29
Silver..... 87	70	57	9	48
Chinook..... 113	4	6	0	6

University of Missouri,  
Columbia, Mo.

## THOUGHT STIMULATION: UNDER WHAT CONDITIONS DOES IT OCCUR?

BY ROBERT HESSLER.

This is a subject of interest to nearly every one, but more especially to educated persons, as I found in discussing it with several hundred individuals. In a general way one may divide human beings into two classes: the educated and the uneducated. The uneducated usually pay but little attention to what is going on in the mind, what sort of thoughts they have, while on the other hand those who write or otherwise utilize their thoughts may pay much attention to the subject. Indeed, the latter may at times be worried because they can not think and cannot write, or because they "run out of" thoughts and vainly "rack their brains" for new ones. In the very beginning we must distinguish clearly between getting new thoughts or new ideas and the ability to write them out. In other words, to get the germ or plot of a story and then to write out the story to best advantage are two widely different things.

The difference between these two classes of individuals is shown very strongly in the matter of dreams. The ignorant pay considerable attention to their dreams, but only from the standpoint of "What does it mean?" They look upon a dream as an omen, while a writer may utilize a dream as a plot for a story, the dream being of actual value to him. Poets constantly tell about their dreams and of having dreamed. Again, we see this difference in attitude in the matter of the subconscious or automatic action of the mind, especially at night. There may be a great rush of thoughts. Many worry simply because they are unable to sleep on account of the "curious thoughts," while a writer may jot down a number of them and utilize them in his work.

The subject of thought stimulation may be studied from different standpoints, depending on the individual's occupation and training and the object of his investigation. Thus, the psychologist may approach it from a standpoint entirely different from that of the neurologist or of the alienist, while the viewpoint of a story writer may differ from all others. My standpoint may quite naturally be said to be mainly that of a physician interested in a study of chronic ill health as distinguished from ac-

tual disease. Many of the symptoms occurring in chronic ill health relate to disturbances in mental functioning, and hence must be given considerable attention.

If a physician desires to study normal individuals, that is, those who are neither sick nor diseased, he must go after his material. And here I might say that some, knowing my profession, have accused me of "talking shop." It is of course only those in search of a physician's services who come to him—and this paper may therefore be regarded as that of a seeker after knowledge, that is, a plea for more data from these in health. I hope that when it appears in the published proceedings some at least will take sufficient interest in the matter to give me their experiences and observations.

In regard to what I say here, it should be understood that this is simply a short abstract of a longer abstract. If I were to bring together all my data, and especially my case reports, they would make a large volume.

CLASSIFICATION OF DATA. For the purpose of classification as well as for convenience of study, I have divided my notes under several general subheads, as follows:

1. Simple observations on thought or mental stimulation before my days of medical schooling, such as any one not paying special attention to the subject might make.

2. Early days of medical practice. These notes are also rather simple, for it should be understood that in times past a medical student's attention was not called to the subject of mental influences.

3. Notes gathered while working among the insane.

4. Travel notes while in Europe, among them many relating to the environment of noted men and women, particularly of writers.

5. Notes, covering the last ten years, based on a systematic study of people in ill health, as distinguished from those afflicted with well-defined diseases. The bulk of my notes relate to this class of individuals.

6. Notes obtained from individuals who may be regarded as healthy, that is, not complaining of symptoms of ill health.

7. References to the literature, a comparatively small amount of data, chiefly incidental references found in biographies. This phase of the subject has been neglected, as it requires access to extensive libraries.

References to childhood are here omitted; my work concerns adults only. But we need only think of nightmare to realize how profoundly the mind of the child is influenced at times. I shall go over these sub-heads ery briefly, following the above classification.

**PEOPLE.** Some people, or minds, with whom we come in contact stimulate us, just as there are those who depress us and many who do not affect us at all.

**BOOKS.** These may also be classified according as they do or do not set us to thinking; some books act as decided mental stimuli.

**DREAMS.** Dreams may be a source of mental stimulation to the intellectual, who may get some new ideas and utilize them. The ignorant dwell chiefly on the significance of dreams as good or bad omens. One can hardly realize what an important factor dreams are in the life of some people. This topic will be considered a little more fully later on.

**FOOD AND DRINK.** These have more or less influence on our well being and our thinking. One need only think of what often occurs after eating a late lobster salad or a welsh rarebit, when the thoughts are usually anything but agreeable. There is an old saying, "Who drinks beer, thinks beer"; and another, "One is what one eats."

**ALCOHOL.** Some know from personal experience whether alcohol excites or depresses the mind; certainly all have noticed the effects in others, how some individuals become greatly excited, with an active flow of words.

**TOBACCO** should also be mentioned. Just how much truth there is in the claim of some men that they can think best while smoking or chewing is a question.

**ANGER, JEALOUSY, RESENTMENT, OR GRIEF, etc.,** may act as powerful stimuli.

**FRIGHT and DANGER** should also be mentioned; there may be a great rush of thoughts at what seems to be a critical moment.

**FEVER FANTASY.** Those subject to colds and feverish conditions may have noticed in themselves the abnormal stimulation of thought at such times. The physician cannot avoid noticing it, especially in those delirious on account of fever.

**DRUG STIMULATION.** The most common is that of opium or its alkaloids, cocaine coming perhaps next. Hasheesh effects I have not observed. Not all persons are stimulated after the fashion of DeQuincey. Some brains are stimulated but little or not at all. The same is true of alcohol. The effect depends, moreover, largely on the dosage, varying from a more or less transient stimulation to complete stupor. It should be kept in mind that to a large extent anodynes that depress, such as acetanilid, are now used in place of opium.

**COFFEE.** This is an active stimulant to some; many know that it will keep them awake at night, as night nurses. Some persons say coffee makes them dream. Literary workers may be actively stimulated by it, their thoughts flowing freely after its use.

---

**MANIA.** An individual delirious in acute mania is a sight never to be forgotten. The delirium may continue for days, even for weeks, until the body is physically exhausted. Compared with this, the amount of mental work an ordinary brain worker does seems insignificant, and the idea of nervous prostration from mental overwork is made to appear ridiculous.

**RECURRENT MANIA.** This recurs at intervals, depending on the individual, after days, weeks, months, or even years.

**ALTERNATION OF MANIA AND MELANCHOLIA.** In this there are periods when the mind is very active, followed by periods of the opposite extreme. One of my insane patients during a period of exaltation had *Cacothes scribendi*, the mania to write, and wrote me his autobiography; it would form a fair-sized book if put into print. He wrote continuously, did not even want to take time for meals or to sleep at night.

**CHRONIC MANIA.** In this condition many individuals see visions and hold imaginary conversations; at times the brain is very active.

**DEMENTIA.** At times when there is some disease producing fever there may be a transient lighting up of the mental faculties in demented, subsiding again with the subsidence of the fever. A study of such cases often sheds light on the mental processes in the normal, or sane.

**EPILEPSY.** Epileptics about the time of an oncoming seizure may have active mental stimulation; the fact that some see visions is well known.

As a rule those confined in the hospitals for insane are quite demented, though there may be a transient mental improvement during or following some acute disease.

One of my unique experiences was the observation of the great mental improvement following the injection of erysipelas antitoxin<sup>1</sup> in an epileptic who was greatly demented; this mental stimulation, however, was only transient, subsiding on withholding the remedy, which proved too costly for continued use; in time there was a complete relapse.

**KATATONIA.** Under this head I could write some lengthy accounts relating to mental stimulation from the use of desiccated thyroids.<sup>2</sup> Individuals who had been practically dead, both physically and mentally, had a veritable return to life under the use of thyroids.

**THYROID MEDICATION OR STIMULATION.** The above experiments were continued with different classes of patients to find out the limitations or usefulness of the new drug. This was quickly found.<sup>3</sup> In a chronic maniac it brought on acute maniacal disturbance and had to be discontinued. On the other hand, in individuals who were very dull and stupid on account of myxedema<sup>4</sup> all that was required to restore normal activity was the use of this remedy.

**REDREAMING DREAMS.** A personal experience while still living among the insane first directed my attention to dreams and the part they play in daily life. My experience in dreaming a dream over and over again during an attack of sore throat seemed so odd to me that I looked up the subject in the literature, and since then have questioned hundreds. I found nothing in the literature, and until recently did not meet any individuals who had had a similar experience—for this reason I gave a brief account in the *Psychological Review* for November, 1901. It may be added that while I dream much, but few dreams, comparatively, stand out vividly and are remembered next morning. An interesting study would be to seek the causation of dreams, why at times one dreams much and then again very little; likewise why certain periods of one's life rather than others are picked out, so to speak, by dreams.

**DISEASE INFLUENCE ON MENTAL STIMULATION AND DREAMS.** Here belongs a number of notes on cases in which the stimulating influence was

<sup>1</sup> Epilepsy and Erysipelas. *Journal Amer. Med. Assn.*, May 14, 1898.

<sup>2</sup> Thyroid Medication. *Indiana Medical Journal*, June, 1896.

<sup>3</sup> Notes on Thyroid Medication. *Ind. Med. Journal*, Feb., 1898.

<sup>4</sup> Myxedema. *Indiana Medical Journal*, June, 1904.

noticed, as for instance in tonsillitis, when the mind becomes very active, with a great rush of thoughts, but without ability to hold them. After an attack of acute illness there may be a "clear brain" with active thinking. This can be explained by assuming that the brain was rested while the body was sick, or that it was stimulated by the disease or sickness, or by returning health, and now has a new set of thoughts.

Tuberculosis acts in many as a stimulant, producing especially cheerfulness and hopefulness, just the opposite from the next.

Acute Dyspeptic Attacks, as after the proverbial lobster salad. Here almost invariably the thoughts and the dreams are disagreeable, oppressive. Often it is less a question of the kind of food than of conditions under which the food is eaten. In the case of the lobster salad, the most favorable condition under which it is likely to produce disagreeable thoughts or dreaming is, in the opinion of some, a midnight lunch after attending a theater.

Chronic Dyspepsia. This to most of us brings up thoughts of pessimism, the effects thus standing opposite to those of tuberculosis. As a supposed classical example, Carlyle might be mentioned.

ATMOSPHERE, THE AIR OF PLACES. Literary people speak of the influence of atmosphere, but this may not at all refer to air conditions. On the other hand, physicians since the days of Hippocrates speak of the air of places. From a study of the subject one might almost come to the conclusion that the locality, the environment, has as much influence on thought stimulation as on the production of ill health and disease.

WAR TIMES. In my chronological account are some data relating to a friend whose regiment was called into camp on the breaking out of the Spanish-American War. The event was a great thought stimulant to him, especially when lying awake at night.

TRAVEL. Next in order comes a mass of data based on a year's travel in Europe. The value of travel as a stimulant to the mind is recognized by everybody. The following is taken from my notes relating to this period:

"One day, at Heidelberg, I dropped into an inn for a bite to eat. I was going to sit down before a long empty table, when I was informed that it was a *Stammtisch*; that meant I had to take a seat elsewhere. While eating my modest meal, there was a rush of thoughts concerning the influence of the *Stammtisch* on the life of German thinkers, especially



college professors, who frequently meet about such a table to exchange ideas, or get new ones, or both. Then my thoughts went to England, to its old coffee houses and the influence on the English writers who met there. That in turn brought to the mind the relative merits of beer and wine and coffee as aids to thought stimulation, and this again brought up the thought of the influence of tobacco smoke, whether this at bottom had anything to do with the matter, and that again brought me back to America, to our newspaper offices, where reporters often work in dingy offices densely filled with tobacco smoke and where many of the so-called 'pipe dreams' are concocted."

— — —

HEALTH, ILL HEALTH, CHRONIC ILL HEALTH, DISEASE. During the last ten years I have been occupied more especially with adults in chronic ill health, as distinguished from real disease, and very naturally I have followed the subject of thought stimulation among this class. There is one very practical aspect, one, however, that is largely neglected by the average practitioner of medicine; that is, long sleepless nights during which the mind of a patient may be thinking all sorts of thoughts, usually disagreeable; if there is sleep there may be much disagreeable dreaming. The physician who is able to give patients of this kind restful nights is usually accomplishing something that his predecessors failed to do.

Individuals in chronic ill health often have very active minds and react acutely to certain drugs, such as opium, alcohol, caffeine; similarly to the salicylates, which are largely used in counteracting infection and inflammation. Many react acutely to the influence of travel. Thus while travel at home may disagree, travel in a foreign country may be beneficial. One can, of course, readily understand how in the case of literary persons one country may be preferred to another. But even common people who do not lead much of a mental life may notice the influence of travel, as when a farmer living in isolation complains of active dreaming or of restlessness at night after a trip to town. Among my case reports are at least four in which there was active stimulation of the mind while traveling on railways—in one case the thoughts or ideas were used in literary work. It may also be said that individuals with lively minds, literary people generally, react acutely to their surroundings, or to influences that scarcely produce an effect on the average man.

During the past few years I have been trying in my practice to distinguish between individuals who lead an active "Seelenleben" and those

who do not. In a general way I can divide my cases (whether active minded or not) into four groups according to their ill health.

(a) Catarrh Victims, especially those subject to common colds and sore throat accompanied by disturbance in temperature, febrile condition, with more or less "fever fantasy," when all sorts of thoughts rush through the mind. If the individual is a writer and not too ill he may jot down some of these thoughts and utilize them. In some a recumbent position is an additional stimulating factor, and, indeed, people in health can often think best when reclining. One of my friends explained it by saying: "The pressure is equalized when lying down, there is less blood in the feet and more in the brain."

Catarrh victims may or may not be cheerfully excited—those infected with tuberculosis may be very cheerful and hopeful, the opposite of the next.

(b) Dyspeptics as we all know are usually pessimistic. One of my friends has said: "Beware of the literary critic who has dyspepsia or an acute dyspeptic attack, for he will see nothing to praise in your work or effort; all is gloom to him and mankind is going to the bow-wows." The depressed mental state may not last long in an acute attack, just as in the case of the boy who has colic from eating green apples, who thinks he is going to die, although he will be as well as usual the next day.

(c) So-called neurasthenics, known also as neurotics, and "the nervous." As a rule this class reacts acutely to environmental influences, and at night there may be insomnia with the mind actively at work. As to actual work, individuals vary greatly. Many have large thoughts but produce little; some are simply regarded as dreamers. What is commonly regarded as brain tire may really be motor tire; the brain is active enough, but there is no desire or little inclination for physical exertion necessary to write out the thoughts—a mental overstimulation with a motor paralysis, so to speak.

I have notes on one case, a man who would ordinarily be regarded as a neurasthenic, who dreams much and gets new ideas in his dreams, jotting them down in the dark at night, in bed. But frequently he finds in the morning that he has no notes, for, after a dream that he wants to record, he dreams further that he is recording it or has made an entry on his scratch tablet, and then sleeps on; all has been a dream. Sometimes on awakening he retains an indistinct idea of the dream which he wanted to record.

The influence of environment may be very marked in this group, as already mentioned. Some men can do their best work in the city, others in the country. I have a curious account of a writer who habitually ran out of ideas and then went to the nearby large city to spend a day, or rather night, for he would lie awake in the dark, in his room at some large hotel, filling scratch tablets with all sorts of thoughts or ideas that came to him. It would be interesting to know whether there was any marked change in blood pressure, whether he may not have belonged to the next group.

I shall refrain from citing more such cases, for to make reports valuable they should give a lot of details, or we may be wholly unable to draw conclusions regarding possible causes. In a general way it may be said that the more details in a case report the better.

(d) A group of cases that may be called cardio-vascular, in which there are disturbances in the blood pressure. At times of a high blood pressure there may be great mental activity. Brief mention may be made of a few cases.

Mrs. A. Middle-aged woman with a persistently high blood pressure, rarely under 200 mm, and often much above that, even to 250 mm. Complains of the mind being very active, all sorts of "komische Gedanken" passing through the brain; but at times of unusually high pressure the thoughts are anything but comical, the "Gedankenflucht" being the opposite; she at times fears enacting a tragedy. When I add that my own pressure runs from 100 to 110 mm, the significance of a pressure of 250 mm will be better understood.

Mrs. B. Elderly woman, gloomy and worrying thoughts both on account of ill health and possible financial difficulties. To distract her mind, to change the trend of her thoughts, her relatives nightly took her to a crowded revival meeting, but it was quickly found that conditions grew worse, and that the rush of thoughts seemed to prevent sleep altogether. She came to me and I found a high blood pressure. Simple medication and remaining away from the meetings caused the high pressure to disappear within a week, and the mental disturbance to subside, followed by a philosophical state of mind with cessation of worry.

Neither of these two individuals is intellectual; they do not utilize their thoughts.

Mrs. C. Middle-aged intellectual woman. Great rush of ideas at times of occasional high blood pressure, especially at night, often prac-

tically sleepless on this account. In the day time felt too fatigued, tired out, to be inclined to exert herself physically, but the mind would perhaps be very active. Often had "bright thoughts" at night and wanted to get up and jot them down, for she was unable to recall them the next morning, but her physician had told her not to do this, as it would aggravate her insomnia. When she came to me, I promptly advised her to jot down her thoughts, that with a little practice she could do this in the dark; at the same time I instituted measures to reduce the blood pressure—and when the pressure went down the automatic action of the brain ceased and sound sleep returned. How to bring down a high blood pressure is a medical question that need not be discussed here.

MR. D. Middle aged man in whom a tendency to increased blood pressure gradually developed, along with much dreaming at night and subconscious mental activity, the thoughts coming at such times being utilized in his work. Problems and matters awaiting solution would be taken up and worked out at such times. This subconscious activity was always orderly, entirely different from that of dreams, for in the latter there were all sorts of incongruities and anachronisms. A change in environment caused the high pressure to subside and with it the subconscious mental activity, but the dreaming continued as formerly. Now and then there is a period, or it may be but a single night, of automatic activity, and the question is to find out the why and the wherefore of this activity.

MR. E. The most literary man in a small community; past middle age; mind always at work. Came to me complaining of symptoms of ill health. I suspected cardio-vascular disturbance and on examination found a high blood pressure. I at once proposed a systematic examination, with health supervision. But to be literary does not necessarily imply the possession of good common sense, and instead of following my advice, given him at length, he adopted an easier and simpler course; he changed doctors. He went to a man who merely gave him a little medicine. A short time ago he died suddenly of cerebral hemorrhage.<sup>1</sup>

Ordinary people when they have a rush of thoughts at night may simply worry because they are not able to sleep, whereas the brain worker who utilizes his thoughts may welcome at least an occasional such rush

<sup>1</sup> There is a possibility that in this case arterio-sclerosis had set in, but I am inclined to believe there was none at the time he came to me. It should be kept in mind that in this paper I am excluding children and the aged, as well as those afflicted with well-defined diseases or pathologic processes.

of thoughts, because it may furnish him material, data, plots. He may even seek to bring about this condition, or what is commonly called "inspiration." In this connection I might mention one case which may shed some light. A middle-aged literary woman had been complaining of disturbed heart action, marked especially by arrhythmia. In order to correct the difficulty, her physician prescribed digitalis in larger doses than is usual. In a short time her mind became very active, with sleeplessness at night and with a great rush of thoughts. She then came to me and I promptly had her discontinue the digitalis, when the mental excitement subsided. The supposed heart disturbance itself was treated by methods other than drug treatment.

To what extent high blood pressure is a factor in thought stimulation in normal individuals I am unable to say. To study that will require "material." If, as earlier stated, the physician wants to study those in health he must go to them, and seek out those whom he thinks suitable for his work. Moreover, a physician never has that complete control over his "material" as the biologist. He can take up or leave off work at any moment; the physician must get the consent of his patients. Even the hospital physician has a great advantage in this respect.

It would seem a natural and simple inference that the increased circulation in the brain stimulates the cells, and thereby stimulates thought—and then at once the question arises, What brings on increased blood pressure?

**BORDERLAND CASES.** Just where the normal shades off into the abnormal or where "perfect health" changes into "ill health" is often difficult to determine. There is no norm, there are no standards; what agrees with one may disagree with another. I will mention a few more factors which in some individuals play a role in thought stimulation.

**MUSIC.** The mind or imagination of some people is strongly excited by music. When one critically studies cases he may be able to make distinctions between the influence of grand opera and rag time music, and whether the music is heard indoor or out of doors, as on a street corner or in a park.

**THEATER.** Attending a play may bring on a lively "play of the imagination."

**CHURCH.** A merchant once told me that he did his best business thinking or planning while apparently listening to a long sermon. And I

know of a college student whose thoughts were most active while "listening to a sermon." Such stimulation is known to but few, while the opposite, drowsiness, is known to nearly everybody. Perhaps the "constitution" has something to do with it. I have notes on a preacher who gets his ideas for his next sermon a week ahead. If he fails to get them on Sunday night, he probably gets them at the time of the midweek prayer meeting. Local option meetings also seem to excite some—is it the enthusiasm?

**STORMS.** Among my case reports are some of individuals whose minds were set agoing during the prevalence of a storm; if at night, there was much restlessness and sleeplessness with a rush of thoughts. An inquiry into details often leads to curious results.

**WEATHER CHANGES** should also be mentioned. The state of the weather is by many supposed to have an influence. I should especially like to hear from those who have made any observations along this line.

**BOOKS.** Books, as a source of thought stimulation or of inspiration, are generally classified as good or bad, ancient or modern, new or old. To the average reader a book is simply a book, but those who utilize their thoughts or bright ideas may be able to make distinctions. Reading between the lines, an individual with a vivid imagination may get all sorts of new ideas, he may get more out of them than the author put in.

**LECTURES** differ greatly in their stimulating influence. To some an occasional lecture may be helpful, while repeated lectures may fail to stimulate, or one may say there is overstimulation and the mind fails to retain the impressions. We all know how the lectures of instructors vary; some stimulate the students, others do not.

**BARBER-SHOP INFLUENCES.** One of my old patients, who lived at home all the time, went once a week to the barber shop, and then complained of insomnia with much dreaming at night. (But to make the story more complete it should be added that he was a chronic consumptive and that much coughing accompanied the insomnia and dreaming—some might regard this as a relationship of cause and effect.)

I recall a statement in a French reader, "Nothing refreshes the mind like having the hair dressed." A man is supposed to have made the remark—I mention this here as a possible factor in mental stimulation in

women, as they often spend much time in dressing the hair. Perhaps that statement is on a level with that of the poet who spoke about "scratching the head, thinking the thoughts would come," etc.

EXERCISE may be an essential to a writer or sedentary thinker, as for the man who writes all forenoon and puts in the afternoon walking, riding, rowing, gardening, etc. Here one would have to distinguish between properly working up ideas and getting new ones, between resting the brain by a different occupation and getting new thoughts while so occupied; the new thoughts may perhaps come involuntarily while physically employed.

BATHS of various kinds seem to be a stimulant to some persons.

"BEING IN HARNESS" is an important factor, as in the case of the business man who could not think, could not plan, while on a vacation, but the moment he returned to his dingy office his mind became very active. One man of affairs told me he would rather wear out than rust out, meaning that although he felt better physically while away from his old occupation his mind was dull; he would rather not feel so well bodily than to have ennui and boredom.

#### SUBCONSCIOUS MENTAL ACTIVITY.

Perhaps the most interesting phase of the whole subject is that of so-called subconscious cerebration, with its various synonyms, such as automatic cerebration, unconscious cerebration, etc. This form of mental activity is to be clearly distinguished from conscious activity on the one hand and from dreaming on the other; it is neither. Thus, while writing these notes, an old patient to whom the question was put gave me a good illustration.

This woman is a clerk in a county treasurer's office (I am not naming the county). Ordinarily she does not dream, or so lightly that few of the dreams are recalled the next morning. She has what may be considered good health, but at times does complain of some minor ills. Twice a year she works under great stress, at taxpaying time, when from early morning till late at night she is at the office, taking in money and receipting for it. After a day or two of this hard work she continues the work at night, "in her mind," to the exclusion of sound or refreshing sleep—the mind automatically and in spite of all her efforts to prevent going over and

over the work of the day. On account of the loss of sleep, etc., she begins to suffer in health, and feels sure that at times if there were a few more days of it she would break down. But she admits one advantage of this automatic action of the mind or brain: Errors are constantly occurring, and when the books are balanced at night no one can account for the various discrepancies, and, of course, there is worry. Now in her "night work," during this automatic cerebration, she generally "sees" just where the discrepancies are and the next morning is usually able to make the corrections promptly.

She has some well-defined ideas regarding causes, that is, of the conditions under which such activity comes on, and I shall consider her remarks later on in summing up "causes" and "supposed causes."

Asked about dreams, she said they occurred in the winter time, rarely in the summer—the exceptions usually being times of actual illness.

Another patient told me that as a boy in school he worked out his mathematical problems while in bed at night. After he left school this form of mental activity largely disappeared and now only occasionally returns; he utilizes it in planning his business affairs.

**INSOMNIA.** After a wakeful period at night, perhaps of an hour or two, there may gradually come repose, and then when one is about to fall asleep, subconscious mental activity may come on with a flow of thoughts, perhaps valuable in one's work. Then comes the conscious thought, "If I don't jot down these thoughts or ideas they will be lost; if I do write, then the composure to sleep will disappear and I will again be wakeful and sleepless. Shall I write or not? Shall I put the thoughts on paper or get the sleep?" While undecided, sleep may come on, there may even be a dreaming that the thoughts have been written; the mind is relieved and deep sleep follows. In the morning nothing is remembered of the train of thoughts. If, however, they were written out, then on awakening the whole occurrence likely comes vividly to mind, or at least there are notes more or less clearly decipherable. This may also occur in the morning when one is about to turn over for another nap, and then this mental activity is confused with dreaming, but the coherency of ideas enables us to distinguish.

Sleepless nights of active minded people who utilize their thoughts are often due to the fact that they do not want to let go of the thoughts that come. They lie awake, thinking about them, or they will be kept



awake by the very act of writing them down. When the mind is relieved and sleep is about to come, there may be another train of thought, and this too must be disposed of. This may recur over and over, and as a result there is a sleepless night. Insomnia is usually considered the bane of the brain worker, but perhaps after all it has its compensations.

Some individuals can distinguish very clearly between dreaming and subconscious mental activity. Some who utilize their thoughts refer to the latter as "inspiration," and in their attempts to bring on such a condition have tried all sorts of experiments. In reading biography one at times comes across statements that seem to refer to this condition of mind, as when Voltaire or Pope in the middle of the night called for his clerk or stenographer to take down a train of thought. This form of mental activity occurs in all kinds of persons, but as already mentioned is most marked in brain workers. The question naturally arises, What is back of it all? What produces this form of mental activity? By gathering a large mass of data one may be able to arrive at some conclusions. One can not solve the problem from a study of books, it must be studied in living persons whom one can question about details and antecedents.

Here again my own observations have been confined mainly to those in ill health. To what extent automatic mental activity is a question of medicine and to what extent a problem in psychology may largely depend on the individual studied, as well as on the student—on his knowledge and purpose. But we should not forget that the modern psychologist studies and investigates largely by the use of instruments, in his laboratory.

To study the influence of blood pressure requires the use of a sphygmograph, and that means that the study of thought stimulation due to the changes in blood pressure is beyond the man who makes but simple observations. The man not connected with a laboratory might, of course, seek out a physician who makes blood pressure tests and would interest himself in the subject.

On the other hand, auto-observations of what is going on in one's own mind are or can readily be made by any one who will take the trouble to observe, no apparatus being required, unless it be a watch or clock to note the time of day or night and a fever thermometer in the case of those who have "fever fantasy"—which may or may not be distinguishable from the mental activity unaccompanied by fever or dis-

turbance in the temperature of the body. At times the mental stimulation may be wholly out of proportion to the rise of temperature, and I have had cases where there seemed to be a high temperature, judging by the redness of the face and the complaints of the patient, and yet the thermometer failed to reveal any elevation of temperature. One has to distinguish between "feeling feverish" and having a real fever, that is, an actual elevation of temperature.

Just now a fad has spread over the country which gives undue importance to this form of mental activity in the treatment of ill health and the cure of diseases. It would seem that there are two kinds of psychotherapists, the real and the pseudo. The former limit themselves to so-called neuroses and functional disturbances, while the latter ascribe subconscious mental activity to practically everything—except perhaps to the healing of broken bones.

I have already referred to the fact that some individuals make sharp distinctions between dreaming and subconscious mental activity or subconscious cerebration. I myself believe these are two different processes, but one will have to give close attention to what is going on in the mind to enable him to discriminate. As to the possible existence of a "subconscious mind," as an entity, that is another question. Perhaps it is synonymous with the "soul" of the old philosophers.

QUESTIONING ABOUT DREAMS. In questioning people about dreams one quickly learns to divide dreamers into three classes.

There are those who "wonder what it means," who are constantly speculating on the significance of a dream. Some will tell of having heard some one telling of seeing a certain event in his dream and found that very thing to have actually occurred at the time and place indicated in the dream. They will tell of it in detail, if one listens, and then ask. Now how do you explain that? Personally, I have never had such a dream, one in which I "saw in my dream" events or incidents that actually happened, either at the instant the dream occurred or the next day or next week, or at any time. Neither have I met a single individual who had such a dream or "foresaw" an unusual event. When we consider that out of thousands and thousands of dreams some one may have noticed such an incident, we must conclude that it was simply a coincidence, as where during a thunderstorm at night a relative or a friend exposed to the storm "is seen," either struck by lightning or being near the place where it did strike.

Now it would seem quite natural for one when awakened by the peal of thunder to think of his relative, and the sudden thought may be mistaken for a dream. Even if it were a real dream and "came true" it must still be regarded as a coincidence, as one instance out of thousands of dreams the rest of which did not come true. We hear of the particular one, and as just remarked, at second hand, or even a number of removes from the original source, to the neglect of all dreams that did not come true. At times we see a mention in the newspapers of dreams that "came true."

A second class is composed of those who pay no attention whatever to dreams, and also those whom one can not interest in the subject at all, who may even express disgust at the very idea of giving a dream a second thought. This class is as unsatisfactory to the student as the other.

Those who do give some attention to dreams and may be made to take additional interest when their attention is called to the subject form a third class—the class I have in mind in this paper. They are comparatively few—but, as in other things, to the few we owe our increase in knowledge.

Out of the long list of factors and conditions enumerated in this paper only a few, perhaps only one or two, may play an important role in the life of any one person; to him, however, they may be essential. As an example, we have the man who requires the quiet of the country, or on the other hand, the man who requires the stimulation of city life.

In asking for data one can put the question in several ways: In the case of those who have occasional periods when the mind is very active, we can ask, "Under what conditions does this occur?" "What causes the mind to become thus active?" While in those whose minds are nearly always active, but where there are occasional intervals of inactivity, when a man says, "I can't think," we may ask, "Why not?"

---

As an addendum may be mentioned several other factors that stimulate the mind and bring on thoughts.

Trying It on the Audience—"for further inspiration." I recall how Dr. Jordan used to do this before his classes in Evolution, as he himself told us. I have often wondered how much inspiration he got from a dull class.

An Assigned Task, as a factor, as where a member of the Academy sends in his title, and as the time for the meeting approaches gradually

"gets busy," knowing that his paper must be ready at a certain time—for instance, myself during the last few days.

Finally may be mentioned the Annual Academy Meetings as a source of stimulation and of inspiration, especially to those of us who live in isolation. This is a factor in thought stimulation not to be undervalued.

## HYGIENE OF INDOOR SWIMMING POOLS, WITH SUGGESTIONS FOR PRACTICAL DISINFECTION.

By SEVERANCE BURRAGE.

The "Ole Swimmin' Hole" of our boyhood days is doomed. The favorite spot in pond or stream to which we used to go after school for a good swim and play, with no thought for the microbe in the water nor the bathing suit for our bodies, is, for the boy of today almost unknown, and for the boy of the future will be but an unrealizable dream. With the advance of civilization these swimming holes are being replaced by public bath-houses, and to these, or to gymnasiums that are provided with swimming tanks, the boys must go for their swim. The streams and ponds have become polluted to such an extent that it is dangerous for the boys to bathe therein. This is the result of the increase in population, coupled with the great carelessness of individuals and communities in the disposal of wastes. This replacement of the natural swimming pool by the indoor swimming pool may carry with it new unhygienic conditions, and it is a discussion of these conditions and their elimination that forms the purpose of this paper.

### CONSTRUCTION OF INDOOR SWIMMING POOLS.

One of the first requirements in the sanitary construction of the indoor swimming pool is that it must be so constructed that it may be easily cleaned. To this end the surface of the lining material of the pool should be very smooth, such a surface as is provided by glazed tiles so laid as to avoid all cracks and crevices. At the angles formed by the meeting of the sides and floor of the pool, curved tiling should be used, which would give the same result in the border of the pool flooring as is obtained in the angleless baseboard in up-to-date hospitals and operating rooms. The almost universal deposit of a slimy sediment in these pools, even when the water is comparatively clear, makes it necessary to provide for an easy and complete cleaning. A concrete or cement lining, made as smooth as it is possible to make it, furnishes a surface that is difficult to keep clean.

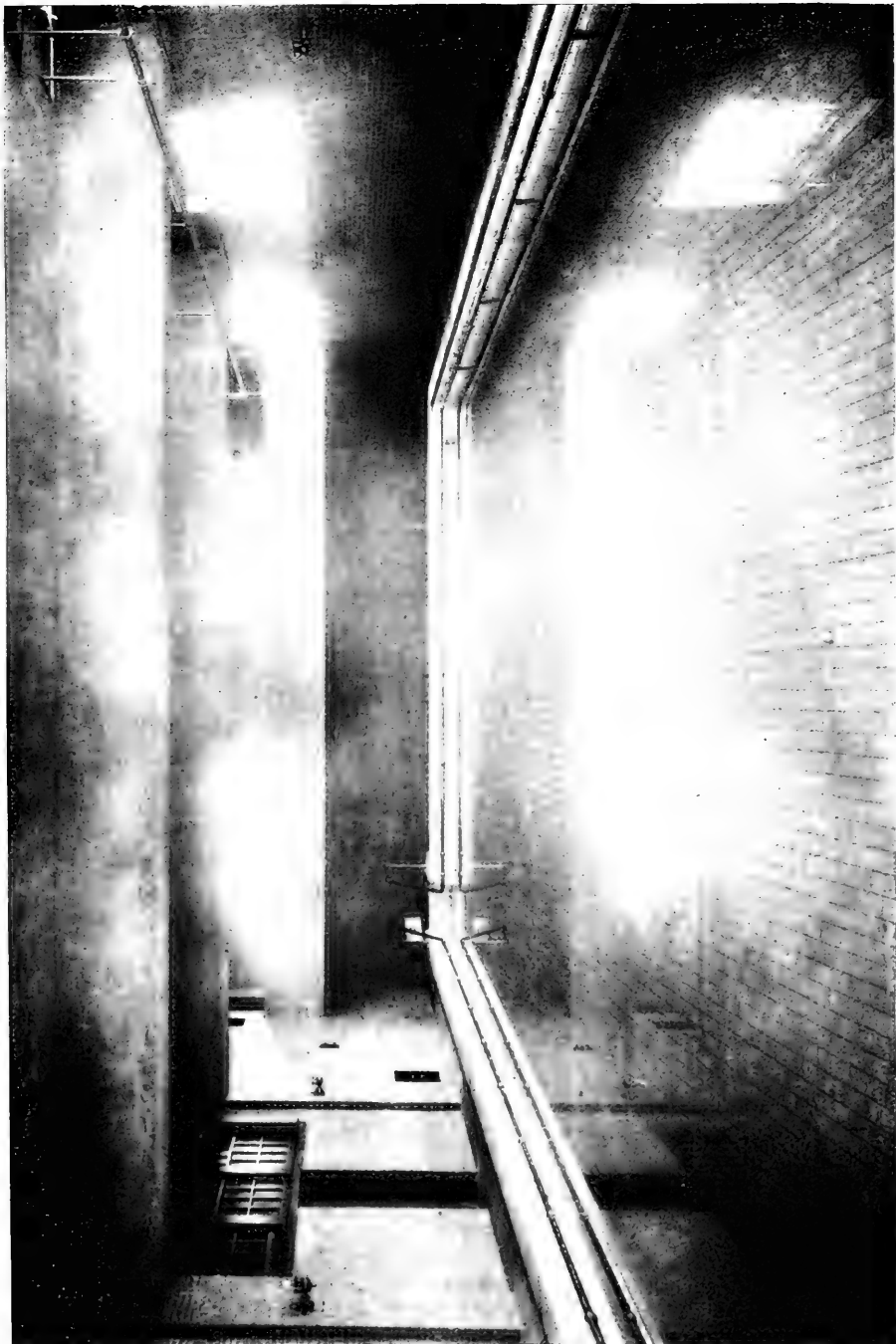

Fig. 1. Swimming Pool, Memorial Gymnasium, Purdue University.

A swimming pool lined with the glazed tile referred to above is shown in Fig. 1, Purdue University Memorial Gymnasium, 1909.

In addition to the outlets for the water in the bottom of the pool, it is advisable to have, at the overflow point, a sufficient number of outlets, or a trough extending all around the pool, so that when a scum or dirt collects on the surface of the water, the upper layers may be drawn off without necessarily emptying the whole pool.



Fig. 2. Men's Swimming Bath, Leeds, England. (Lighted by sky-light only.)  
By courtesy of "Modern Sanitation."

The floor of the pool room should be so drained that water dripping from bathers who have come out of the pool can not collect in puddles, and, furthermore, such water should drain, not back into the pool, but into the overflow waste pipes.

#### THE WATER SUPPLY.

The water supplied to the swimming pool must be pure, and every possible means used to keep it so during and after its use by the bathers. The nearest approach to an ideal water supply for an indoor swimming pool would be the provision for a pure water to start with, and a continuous change of water, during the use of the pool, the rate of this change being governed by the number of bathers in the pool. In most cases this is out of the question on account of the expense.

The water of these pools is not exposed to the many purifying factors that affect out-door waters. The pool is usually located in the basement or in buildings the interior of which the direct rays of the sun seldom reach. Thus one of the most important factors in the purification of natural waters is removed. It is true that the water does get some

eration while the bathers are stirring it up, but because of the constant contamination at such times, this aeration cannot be counted upon as very much of a purifying factor. During the times when the pool is not being used, when the water is stagnant, no purification is taking place. On the contrary, bacteriological tests have shown that there is an increase in the bacterial content, particularly if the water has been warmed up to a temperature of 75 degrees Fahr. or over. There is considerable sedimentation during such times, but if this sediment remains in the bottom of the pool to be stirred up when the bathers next use the water, this cannot be looked upon as purification.

The cold plunge at the Fleischmann baths, New York City<sup>1</sup> has "enormous windows of plate glass facing south and the medicine of the sun and the glory of the sky." (Fig. 6.) Comparing this elegant sunny pool room with the condition in our average basement swimming pools,



Fig. 3. Women's Swimming Baths, Leeds, England. (Direct sunlight rarely reaches water.) By courtesy of "Modern Sanitation."

it makes the latter look dark and gloomy. The pool room at the Purdue gymnasium is on the south side of the building, and the windows are large for a basement room, and yet even this does not get the necessary sunlight for purposes of purification of the water.

At the swimming baths at Leeds, England (Cookridge street), the skylight is used for lighting the rooms, but even here the effect is none too brilliant. (Figs. 3 and 4.)

<sup>1</sup> Lucy Cleveland, *Modern Sanitation*, Jan., 1908.

<sup>2</sup> Henry Gray, *Modern Sanitation*, Oct., 1909.



## POLLUTION OF WATER BY BATHERS.

A bacteriological study of the water used by a bather at the Victoria Baths at Bonn,<sup>1</sup> shows well the character and amount of pollution that may take place in public baths. The test was made on a stoker (Heizer), who was made to wash in a tub for three minutes, using no soap. Before the test, the bath water contained 24 bacteria in a cubic centimeter, and no *Bacillus coli*. After the three minute washing, the bath water contained 1,900 bacteria and 40 *Bacillus coli* in each cubic centimeter.

Bacteriological tests made by the writer on the water of the swimming pool in the new memorial gymnasium at Purdue University demonstrated the presence of 930 bacteria per cubic centimeter in the water of the pool before being used by the bathers. After use by about thirty bathers, all of whom were supposed to have taken a soap shower before entering the pool, the bacterial content was 100,200 per cubic centimeter. Tests were made for *Bacillus coli*, and the results were consistently positive after the pool had been used. The water immediately after cleaning the pool and refilling gave consistently negative results for *Bacillus coli*.

The available literature gave almost no data as to bacteriological analyses of swimming pool waters.<sup>2</sup>

## DISEASE DANGERS IN SWIMMING POOLS.

There are great chances for the dissemination of germ diseases through indoor swimming pools. The results of the bacteriological tests given in the preceding paragraphs, which showed the constant presence of the *Bacillus coli* in the water used by bathers, demonstrates the possibility of intestinal diseases, particularly typhoid fever. While bathers do not swallow the water intentionally, it is next to impossible to avoid getting some water into the nose and mouth, which would ultimately reach the intestinal tract. One does not have to be sick or to have any symptoms of typhoid fever to disseminate the germs of that disease. This is well shown in the notorious case of "Typhoid Mary" in New York.<sup>3</sup>

Diseases of the respiratory tract have an unusual chance to be spread in the swimming pool. The bather with incipient tuberculosis, pneumonia

<sup>1</sup> Zur Hygiene der Hallenschwimmbade. Dr. Selter. Aus dem Hygienischen Inst. der Univ. Bonn. Rundschau, Dec. 1, 1908.

<sup>2</sup> Hesse, Dresden. Zeitschrift f. Hyg. Bd. 25. Egen, Berlin. Arch. f. Hyg. Bd. 19. Koslik, Gratz. Diese Zeitschr. 1898, S. 361.

<sup>3</sup> Whipple. Typhoid Fever.

or tonsillitis, with his sputtering, coughing, snorting and spitting, would undoubtedly infect the water with the specific germs of those diseases. Ordinary colds and sore throats following the plunge bath are frequently laid to the effects of the bath, while in most cases such results are undoubtedly due to germ infection. One of the factors which lead the writer to take up this subject was an epidemic of colds among the users of the Purdue swimming pool this fall.

Venereal diseases could be transmitted through the agency of the swimming pool. One case of gonorrhoea could infect many eyes in a crowded swimming pool.

It is practically impossible to compel the bathers to submit to a complete medical inspection and physical examination before they are allowed to enter the pool, and yet from many points of view this would be a most desirable thing.

The least that can be done for the protection of the bathers is to insist that certain rules be strictly adhered to. For example, such rules as the following are posted prominently in the Purdue gymnasium:

#### TAKE A SOAP SHOWER BEFORE ENTERING POOL.

All gymnasium privileges will be denied persons affected by any contagious or communicable disease.

All persons MUST take a soap shower before entering the pool.

All persons using the pool MUST wear bathing suits or trunks.

Of course facilities must be provided for the required showers, and each person should provide his own towel and soap.

In the Central Baths, Bradford, England, special arrangements are provided for washing the feet,<sup>1</sup> a most desirable thing as a prerequisite to the use of the pool. (See Fig. 7.)

#### PRACTICAL PURIFICATION OF WATER IN SWIMMING POOLS.

The amount and character of the pollution in swimming pool waters point very clearly to the need of some practical process of purification. In most cases it is too expensive to have a continuous change of water, and

<sup>1</sup> Centralized Public Baths. Bertha H. Smith, *Modern Sanitation*. November, 1909.

in some too expensive to change the water once or twice a week. At the Central Baths, Bradford, England, the water is filtered. The expense of pumping the water and caring for the filter does not make the filtration process a particularly economical one.

It occurred to the writer that some chemical, as copper sulphate or chloride of lime, both of which are being used extensively in the purification of sewage and sewage polluted waters, might be used in the treatment of swimming pool waters with but small expense. Inquiries in many directions and a careful search in available literature resulted in but scant information. A single reference<sup>1</sup> reported the use of a chemical, an "electrolytic fluid," by the medical officer of health of the metropolitan borough



Fig. 5. Plunge, East 23d St. Public Bath, New York City. (A fairly well lighted indoor pool.) By courtesy of "Modern Sanitation."

of Poplar, Mr. F. W. Alexander. This fluid is obtained by the electrolysis of a solution containing magnesium chloride, the result being a solution of magnesium hypochlorite. Treatment of water in swimming baths by this fluid was thought to be simple, economical and efficient, bacteriological tests on water so treated giving sterile results.

Before finding this reference the writer had conducted a series of tests on the water of the swimming pool at the Purdue gymnasium, using chloride of lime.

Commercial chloride of lime (bleaching powder) is usually manufactured by passing dry chlorine gas over freshly slaked lime, the chlorine

<sup>1</sup> Scientific American Suppl. No. 1765, Oct. 30, 1909.

being obtained by the electrolysis of salt. This chloride of lime is composed largely of calcium hypochlorite. When added to water this hypochlorite dissolves, leaving a residue of calcium hydrate and calcium carbonate. Both of these substances are entirely harmless factors in a bath water. The oxidizing power of the commercial chloride of lime is represented by about 35 per cent of available chlorine. It is nascent oxygen that is the purifying factor, not the chlorine.

The capacity of the Purdue swimming pool is 85,000 gallons, and 680 grams of the chloride of lime were used at each dose. This would be about the equivalent of 20 pounds to the million gallons. Before starting the experiment with the chemical, bacteriological analyses were made of the water for a week, the pool being emptied twice. No attempt was made to keep track of the number of bathers in the pool.

The following table shows the results of the analyses for the week before using the chemical dosage, compared with the results of the analyses for the week while the dosage was going on. During the latter week, that is, while the tank was being dosed with the chemical, the water was not changed at all.

The method of applying the chemical was to sprinkle it on the surface of the water in the pool. This was easily done with one trip around the edge, throwing the powder as one walked. The time occupied in this process was less than two minutes.

<i>Date.</i>	<i>No. of Bacteria per c. c.</i>	<i>B. Coli.</i>
Monday, November 1, pool just filled.....	560	None
Evening, after use.....	6,160	Present
Tuesday a. m., November 2.....	20,650	Present
Evening, after use.....	37,600	Present
Wednesday a. m., November 3.....	27,800	Present
Evening, after use.....	60,500	Present
Tank emptied.		
Thursday a. m., just after filling.....	930	None
Evening, after use.....	8,500	Present
Friday a. m., temperature of water 85 Fahr.....	109,200	Present
Evening, after use.....	106,400	Present
Saturday a. m., November 6.....	118,000	Present
Evening, after use.....	140,000	Present

Monday, November 15, pool freshly filled.....	780	None
Evening, after use.....	23,100	Present
Pool dosed with 680 grams chloride lime.		
Tuesday, November 16, a. m.....	26	None
Evening, after use.....	12,000	Present
Pool dosed with chloride of lime.		
Wednesday a. m., November 17.....	14	None
Evening, after use (no sample).		
Pool dosed with chloride of lime.		
Thursday a. m., November 18, water had not been changed as was usually done.....	9	None
Evening, after use (no sample).		
Pool not dosed.		
Friday a. m., November 19.....	11,200	Present
Evening, after use.....	20,500	Present
Dosed with chloride of lime.		
Saturday, November 20.....	18	None
Evening (no sample).		

A study of the results shown on this table indicates that the effect of the chloride of lime treatment is almost complete sterilization. The samples of water taken the morning after the water had been dosed in no case showed more than 26 bacteria per cubic centimeter. And what I believe to be a very important factor is that the general average of the bacteria is lower, much lower, than during the week when the chemical was not used. The effect of stopping the dosage is prettily shown in the Friday morning sample, November 19. The pool is used by the "coeds" and faculty ladies on Thursday evenings, and it was inconvenient for the writer to arrange to have the sample collected. No arrangement was made to have the chemical applied.

#### SUMMARY AND CONCLUSIONS.

There are certain dangers to health in the indoor swimming pools. The construction of the pools, the enforcement or neglect of rules governing those who use the pools, the proper attention to the water supply, as to its purity before use by the bathers and after use, all have a direct bearing on the extent of these dangers;

On account of the expense it is practically impossible to provide for a continuous change of the water. The filtration of the pool water after use also involves some trouble and expense. The use of certain disin-

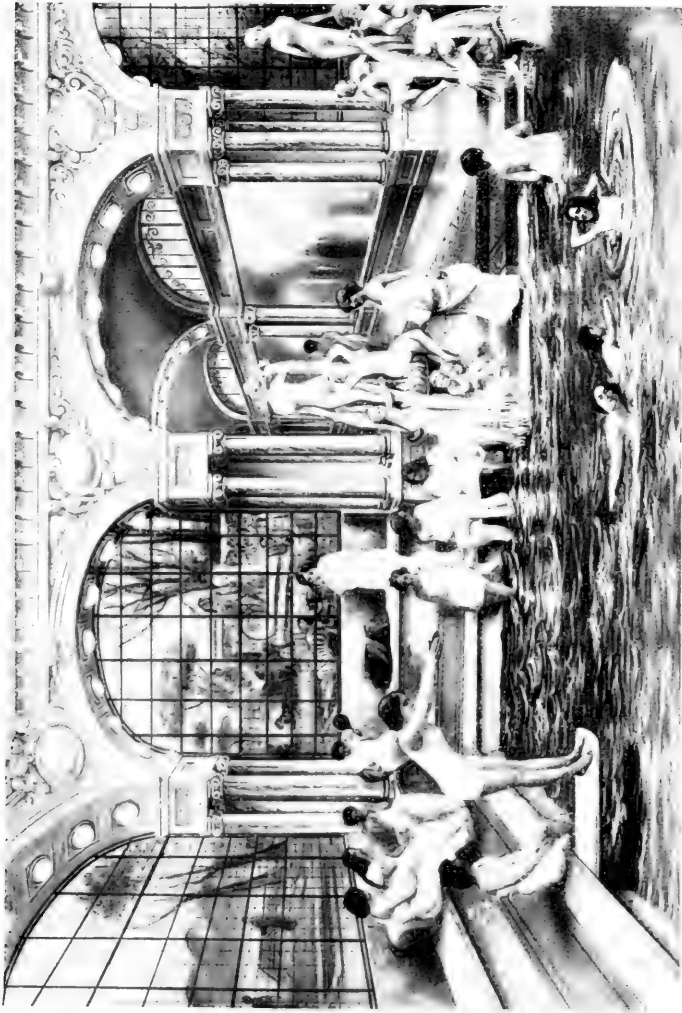

Fig. 6. Plunge, Fleischmann Baths, New York City, Women's Hour. (Showing unusual lighting for an indoor pool.) By courtesy of "Modern Sanitation."

fectants would seem to be more simple and economical. The writer would criticise the liquid or fluid chemicals as being harder to apply to the pool

water. They would have to be thoroughly stirred into the water. The substance used by the writer, chloride of lime, is sprinkled on the surface of the water, and it to a great extent distributes itself by sinking through the water. The results of the bacteriological tests certainly indicate that the substance has a very great purifying power.



Fig. 7. Facilities for foot-bath before entering plunge. Bradford, England.  
By courtesy of "Modern Sanitation."

The indoor swimming pool is a valuable hygienic factor in our public baths and gymnasiums. It makes the bath attractive to many who would otherwise look upon bathing as a bore. Anything which will tend to make the boys and girls, youths and maidens, men and women bathe more frequently is desirable. But the swimming pool has its dangers, and most of these depend not upon the users of the pools alone, but much more on the construction and management of them. Therefore we must look to the builders and directors of our baths and gymnasiums for the satisfactory hygiene and sanitation of indoor swimming pools.





## THE PROBLEM OF SEWAGE PURIFICATION IN INDIANA.

By R. L. SACKETT.

### CONDITIONS.

As the population of a city increases, the difficulties of obtaining a sufficient water supply which is free from contamination by sewage becomes more and more difficult. It is now a well established fact that sewage-contaminated waters are to a considerable extent the cause of summer complaint and other bowel troubles, besides the more dangerous disease, typhoid fever. The extensive death rate among children is in some measure chargeable to impure water.

There are very few large cities that are able to obtain a ground water of satisfactory quality and quantity. We are therefore driven to the use of surface water.

### OBJECT OF SEWAGE PURIFICATION.

Large volumes of sewage are discharged into the White, the Wabash and Ohio rivers and their branches, also into Lake Michigan, by the cities situated near them. In order to maintain a stream in a condition approaching normal purity, methods for the purification of sewage are applied, so that the resulting effluent discharged into a stream is purer. This purification is obtained by some method of oxidation which will remove the putrefactive material or highly organized food on which pathogenic bacteria live.

Sewage purification is a relative matter, and absolute purity of the effluent is practically impossible and generally is unnecessary. The problem, then, is to adapt available means to the conditions in order to economically defend the people against water-born diseases.

Dilution may be considered a process of purification, and therefore the larger the volume of pure water available in a stream the lower the percentage of purification required, for wherever there is running water not already contaminated, oxygen is present and some purification takes place; vegetation and sedimentation also assist.

The old theory that a stream would purify itself in a flow of ten miles was a dangerous one, because it depended distinctly on conditions.

In many instances no doubt typhoid has been carried thirty miles by a river, and then has caused a serious epidemic.

#### PROCESS OF PURIFICATION.

While a certain amount of purification takes place in a septic tank, its office is rather that of changing the organic matter from the condition of suspension to one of solution. Hence it is now more frequently called a hydrolytic tank. It is, however, important in that it makes the succeeding processes of nitrification easier and permits of much more rapid treatment than would otherwise be possible.

The second step is one of several types of filtration. First, we might place the slow sand filter, which was usually some 3 or 4 feet deep; over the surface sewage flowed either continuously or intermittently, the latter being the more efficient method.

A second form was the contact filter, which was a tight tank filled with broken stone, coal or hard clinker. This tank was filled with sewage from the bottom, and after a time was emptied automatically.

The third and most successful type of filter is formed of stone, about one-half inch in diameter. Over the surface sewage is sprayed or sprinkled periodically by automatic syphons.

After filtration there is still left some organic matter, but, if the process is successful, it does not cause putrefaction. It is quite probable that some bacteria pass through the filter and thus gain access to the stream. Hence it has been proposed that where a high degree of purification is necessary the effluent from the filters should be sterilized.

#### PURIFICATION PLANTS IN INDIANA.

Two or three tanks were installed in Indiana some ten years ago, and a set of four small sand filters was at one time (about 1900) in operation at Indiana Harbor, but has since been abandoned.

The oldest plant still in operation is at the Eastern Indiana Hospital for the Insane near Richmond. It consists of a concrete tank and intermittent sand filters. It treats the sewage of about 1,000 people and leaves the stream into which the effluent flows in a very satisfactory condition. It was built in 1901 at an expense of \$9,000. The cost of operation has been negligible.

The second plant of any size was built at the Southern Hospital near Evansville. It was a chemical precipitation plant using lime or soda ash. After precipitation in large concrete tanks the sludge was pumped to a press; the resulting cake of organic matter was dumped into a cistern made for the purpose. The cost of the plant was originally \$18,000, and the cost of operation about \$1,200 per year.

It was replaced in 1905 by a three-step process which included tanks, stone filters and finally intermittent sand filters.

The conditions here required a high degree of purification. The population is approximately 1,000, and the cost of operation is probably less than \$200 per year. The cost of reconstructing the plant was \$10,000.

In 1908 the city of Bloomington constructed a system of sanitary sewers and installed a purification plant consisting of a central concrete tank and two series of stone filters, the latter being sprinkling filters.

Angola, a city of about three thousand population, is now constructing a system of sewers and a sewage purification plant consisting of sedimentation tanks, stone filters for the first treatment and sand filters for the final. The city will build a second plant next year. The cost of the two plants will be about \$20,000. The cost of operation of these small municipal plants will be watched with interest, as it will determine in some measure the details of future designs.

The city of Laporte, with a population of 12,000 and rapidly growing, is completing plans for a system of sewers and is providing for sewage purification.

The city of Shelbyville is also constructing a system of sanitary sewers, and the entire town looks forward to sewage purification at some time.

There is no question but that the educational propoganda which the State Board of Health has been pursuing is bearing fruit. The state institutions themselves are with a few exceptions well provided with a good water supply and sewage purification plants where they would otherwise prove a danger to neighboring communities.

There can be no doubt but that this movement toward pure water will have a measurable effect upon the morbidity and mortality of the State.

Purdue University,  
Lafayette, Ind.



## THAT ERRONEOUS HIAWATHA.

By ALBERT B. REAGAN.

Hiawatha, hero of Longfellow's poem of the same name, is not recognized as a hero god by the Chippewa Indians. Neither the name nor the person designated occurs in the mythology of these people. Their god is Menibusha, and the only word approaching Hiawatha is Ket'-che-wah'-sah, which means "afar off." Through the kindness of the Indian missionary and court-agency interpreter here, Rev. Frank H. Pequette, who is himself a Chippewa and has lived and preached in various parts of the Chippewa country, I quote his own summing up of this subject:

"When a white man asks an American who is the greatest man of his country he answers, 'George Washington.' But I am here to declare that Hiawatha is not the hero of my race. This personage is unknown to the Chippewa Indian.

"The Indian lad sitting in the forest with his bow and arrow, observing the trees and the sky and the sand and the water of the Great Lakes and the animals and the fishes, asks himself, 'Who made these?' He cannot answer the question himself, so he asks the old medicine man of his tribe. 'Menibusha,' answers the sage. 'Menibusha made the earth, sky, the sun, moon and stars, and the wild things and the fishes, and he made you also, my son.' So says the medicine man of the tribe. Menibusha also made the land, the island-continental surface on which we now live. He is the first brother of all mankind and now lives in the East.

"All the Indians before they became Christians (that is, all Chippewas) supposed that Menibusha was the Supreme, the greatest man and god of his nation. And when the first white man asked the Indian the question who was their greatest personage the Indian replied, 'Menibusha.' 'Where does he live?' of course asked the white man. 'Ket'-che-wah'-sah,' replied the Indian—meaning (that he was) afar off. The white man's ears were not tuned to the Indian sounds used in pronunciation and he caught it Hiawatha, which did not mean god, but 'afar off'; and one great white fellow, Longfellow by name, wrote our legends with this unknown Hiawatha. But this Hiawatha is not known to us Indians."



## MEDICINAL VALUE OF EUPATORIUM PERFOLIATUM.

By A. J. BIGNEX.

---

*Eupatorium perfoliatum*, commonly known as thoroughwort, or boneset, is a well-known plant, yet its real medicinal value is not as well known as it should be. This plant varies from two to four feet in height, blossoming in August and September, and is abundant in flat and swampy lands. It seldom grows in hilly sections. Nature seems to have made provision for the curing of the diseases prevalent in certain regions. In swampy countries chills, malarial, intermittent, typhoid and other fevers are common. Since boneset occurs in these localities and is particularly valuable for curing such diseases it seems to substantiate the above statement.

The blossoms, small branches and leaves are the parts generally used. It has four medicinal properties—an emetic, a tonic, a light laxative and a diaphoretic. As a diaphoretic it should be taken hot just before retiring. This is specially helpful for colds and fevers. For restoring the powers of the stomach it is better to take boneset cold.

For the diseases already mentioned boneset has been known and used as a home remedy for a long time. In the so-called la grippe it has not been used very extensively so far as I can learn. Some prominent physicians say it is almost a specific for it.

My experience in its use dates from the first appearance of la grippe in this community, about 1889. As soon as the symptoms begin a teacupful of the infusion of the boneset is taken just before retiring. This produces some perspiration, strengthens the nerves, regulates the digestive organs, thus giving the body an opportunity to increase the building up of the system, and in this way the resisting power is sufficient to overcome the disease. Occasionally the next day some of the cold infusion may be taken, always before meals, for, after eating, the emetic power may predominate. The next night the hot solution should be taken. Usually this kind of treatment will cure the disease without going to bed at all. This treatment should be taken early in the development of the disease in order to get the best results.

The first time of taking it, it should not be very strong until a person finds out its action on his stomach, for the emetic influence is exerted much stronger in some persons than in others. If one can retain it, it matters but little about the strength of it. It is made as ordinary tea.

I have thoroughly tested it in my own case when la grippe has been making its invasion, and as a result I have never yet had a regular siege of the disease. My own family has tried it time and again with splendid results. Some people cannot take it at all because of its emetic effect. I have given my neighbors the benefit of my experience. While its results are always good, yet in some persons the results will not be as marked as in others.

The students of Moores Hill College have been very willing to respond to my desire to have them test it. Students have come into the classroom with the symptoms strongly developed, and on being advised to take this remedy have actually taken it that night. They would report that the results were even better than they could have expected in so short a time. They would not even have to stop work. Scores of reports could be given, but I do not think it necessary. The best way will be to test it for yourself. It can be secured from your druggist if it does not grow in your locality. An extract of boneset is made, but I have had no experience with it.

I am pretty thoroughly convinced that nearly every case of la grippe can be cured by this remedy if taken early in the development of the disease.

Moores Hill College,  
Moores Hill, Ind.



REFRACTIVE INDEX AS A MEASURE OF DRY SUBSTANCE IN  
SACCHARINE PRODUCTS.\*

By A. HUGH BRYAN.

Dry substance determinations are the most difficult determinations a chemist has to make, and again one of the most important. In sugar materials, containing many organic substances and also inorganic salts, various reactions and changes are going on when the sample is heated in the course of making a dry substance determination. Varying degrees of heat also tend to decompose these substances. Also, the length of time of heating is a very important factor. The accepted method for sugar compounds, where accurate results are desired, is the loss of weight at 70° C. when heated in vacuum. It has been found at that temperature that levulose shows little, if any, decomposition. Sugar chemists of Germany modify that procedure by drying at 65° to 70° C. in the air until all visible water is gone, and then heat for from 2 to 4 hours at 105° C. in vacuum, it being claimed that by first drying and then heating to 105° in vacuum, no sugar is decomposed. It is a fact, however, that if one makes two determinations of moisture on the same sample at different times, it is more than likely that the results will not check. Differences of as high as 0.5% have been noted, especially where the substance under examination is high in reducing sugars. It can hardly be expected to obtain a method for determining moisture accurately without a direct determination of this by drying. Such a procedure takes time, and at its best, so far, gives only approximate results.

The refractometer was first tried in sugar work by Strohmer (*Zeit Ruben Zuckerind.*, Vol. 21, p. 256) in 1884 and again in 1886 by Muller (*Ibid.* Vol. 37, p. 91). They showing that the index depended on the concentration of solution. The latter investigator gave a table for estimating the dry substance of beet juices from the refractive index. Again in 1901, Stolle published a table for the above. All of these used the old forms of instruments. Tolman and Smith,<sup>1</sup> using the heatable prism instrument, such as is used today, and pictured later in this paper, found

---

\*Published by permission of the Secretary of Agriculture.

<sup>1</sup>*Jour. Amer. Chem. Soc.* (1906), 28, 1476.

that for equal concentrations, all sugars have about the same index of refraction. Main<sup>1</sup> published tables of water content from refractive index in 1907, and called attention to the accuracy of this method, as compared with the true dry substance. Since that time the literature has been full of articles on this method of determining the dry substance.

All authors, with but few exceptions, claim much for this method as a quick one and yielding comparable results. They all agree that the results so obtained are nearer the true dry substance than by obtaining the dry substance from the specific gravity. The substances dissolved along with the sugar seemingly have a closer refractive index to sugar than specific gravity.

Working on syrups of various origins, I obtained the following average figures.<sup>2</sup> The method for true dry substance was loss of weight in vacuum at 70° C. The table of Prinsen Geerligs, and also his corrections for temperature were used. These are given later in this paper.

#### IN CASE OF MAPLE SYRUP.

Thirteen samples were examined. In only one case was the refractometer dry substance higher than the true, and in all others the true dry substance was higher. This difference ranged from 0.20% to 1.34% with an average of 0.50%.

#### WITH CANE SYRUP.

Ten samples were examined. In three cases the refractometer dry substance was higher than the true by 0.16%, 0.34%, 0.62%. The other cases range from 0.24% to 0.93%, or an average difference on the whole of 0.29%.

#### HONEYS.

Twenty-four samples were examined. In 2 cases the refractometer dry substance was higher than the true by 0.21% and 0.91%. In all the rest it was lower by from 1.15% to 2.52%, with an average of 1.45%. This is the greatest difference noted. One of three causes or all may account for this large difference. (1) The actual dry substance may not be right, viz., this product may not give up all of its water at 70° in vacuum, or, (2) the dextrin of the honey may change the refractive index of the

<sup>1</sup>Inter. Sugar J. (1907), 9, 481.

<sup>2</sup>NOTE. See Jour. Amer. Chem. Soc. (1908), 30, 1443, for a previous paper on this subject by the author.

whole, or, (3) the values given in the table for dry substance from refractive index may not be right.

#### COMMERCIAL GLUCOSE.

The two samples examined show the refractive index dry substance higher by 0.27% than the real dry substance. The closeness of these readings would tend to disprove the second cause for honey.

#### CANE MOLASSES.

Seventeen samples were examined. In 3 cases the refractometer dry substance was higher than the true by 0.16%, 0.39%, and 0.59%. In all the rest it was lower by from 0.38% to 1.53%. The average difference was 0.79%.

#### BET MOLASSES.

Fifteen samples were examined. In all cases the true dry substance was higher than the refractometer. The difference varied from 0.38% to 1.83%, with an average of 1.08%. When the original substance was diluted one-half with water, and a reading made on this, the dry substance obtained was doubled. The results showed 5 cases where the refractive index dry substance was higher than the true by from 0.25% to 0.53%. In all other cases, the true was the highest by from 0.39% to 1.62%, with an average of 0.36%. It is seen then by dilution, the average difference between the true dry substance and refractometer has dropped from 1.08% to 0.36%. The results then are nearer the true dry substance. This comes about by being able to get a clearer field and thereby a closer reading.

However, later work has shown that this dilution with water, even though it has brought the dry substance by refractometer nearer the true dry substance, introduces a serious error. When water is added to molasses there is a contraction in volume.

This contraction has been taken into account in the construction of specific gravity and refractometer table for pure sugars so that solutions of the latter, whether mixed with water or a sugar syrup, will give the correct percentage of solids either by specific gravity or refractive index.

The impurities, however, which accompany sugars in solution in molasses, have not only a different specific gravity than sugar, but also a

different contraction coefficient, so that the solution diluted with water shows a different specific gravity or refractive index than that calculated from tables for pure sugars.

To reduce these variations of contraction to the minimum, a concentrated pure sugar solution is used as a dilutant. Results obtained with some cane molasses samples show the error that is introduced by the water dilution and also the effect of the sugar dilution.

Sample No.	Undiluted Molasses.	DILUTED HALF WITH -	
		Water.	Sugar Sol.
1	80.57	83.24	80.91
2	72.32	72.94	72.21
3	77.92	78.44	77.91
4	73.92	75.34	73.81
5	82.05	84.44	82.41

In the undiluted form all of these can be easily read. The half dilution with water is anywhere from .62% to 2.7% higher than undiluted while the half dilution with sugar solution varies from 0.0 to 0.3%.

Tischtschenko (*Z. des Vereins Deut. Zuckerind.*, Feb. 1909, 103), calls attention to this possible error in the determination and recommends the use of a pure sugar solution. Von Lippman corroborates the results (*Deut. Zuckerind.*, 34, 1909, 401). It therefore behooves us to use sugar solution in diluting our dark colored solution in preference to water. The formula for calculating the dry substance when using a concentrated sugar solution as a dilutant is:

$$X = \frac{(A + B)C - BD}{A}$$

in which X=% dry substance of the original sample, (A) the grams of the original substance mixed with (B) the grams of concentrated pure sugar solution, (C) the % dry substance of the mixture obtained from its refractive index, and D= the % dry substance of the pure sugar solution obtained from its refractive index. The method of procedure is simply the preparation of a concentrated granulated sugar solution and mixing in a small beaker a weighed quantity of this with a weighed quantity of the original solution or sample, and taking refractive index of the mixture.

Summarizing the average results, we find that the refractometer dry substance is higher than the true.

	<i>Per Cent.</i>
The difference in case of maple syrup .....	0.50
The difference in case of cane syrup .....	0.29
The difference in case of honeys .....	1.45
The difference in case of glucose .....	0.27
The difference in case of cane molasses .....	0.79
The difference in case of beet molasses .....	1.08
The difference in case of beet molasses (half) .....	0.36

With the exception of the honeys and possibly cane molasses, also beet molasses undiluted, the differences are well within the error of determination of water by actual drying. By half dilution, the beet molasses is brought within the limits, and where dilution with sugar solution tried this difference would be cut down considerably. Cane molasses, showing 0.79%, might be considered within the limits, as a true moisture content on this material is a difficult task. Honeys are, then, the only ones whose difference is large, but it is hoped that with the work now being carried on, the reason for this difference will be obtained and a method for procedure be established for this grade of substance. However, there is one thing to be said in regard to the refractometer, that it is possible to obtain duplicate results that are identical, and different investigators should obtain identical results, which is a condition that does not exist with the other methods for dry substance determination in use now. The refractometer method has the advantage of being quick and not losing accuracy by speed, and then only small portions are necessary for a determination.

The method of making a dry substance determination is substantially this: The instrument (Fig. 1) is placed so that the light falls on the mirror (R) and this is turned on its axis to reflect the light up through the prism (B) and (A). The source of light can be daylight, but a better one is a 32 or higher candle power lamp. The tubular (D) is connected by rubber tubing to the source of water supply of constant temperature and the other tubular (E) has a rubber overflow connection. The thermometer is placed in its socket. The optical parts of the instrument are turned forward on the stand (a). By turning the catch (V) the prism B is swung open on (C) from prism (A) and a few drops of the solution to be examined is placed on the prism (A). Enough of the solution should be added so that on closing the prism (B) on (A) a part of the liquid is forced out. The optical parts are brought back into their original place.

The arm carrying the magnifying glass (L) should be down to the 1.3 end of the scale. Then by looking through the eyepiece (F), focusing the cross-hairs into plain view, the arm (L) is moved until a bright color appears in the lower half of the field. By turning the milled screw (M)

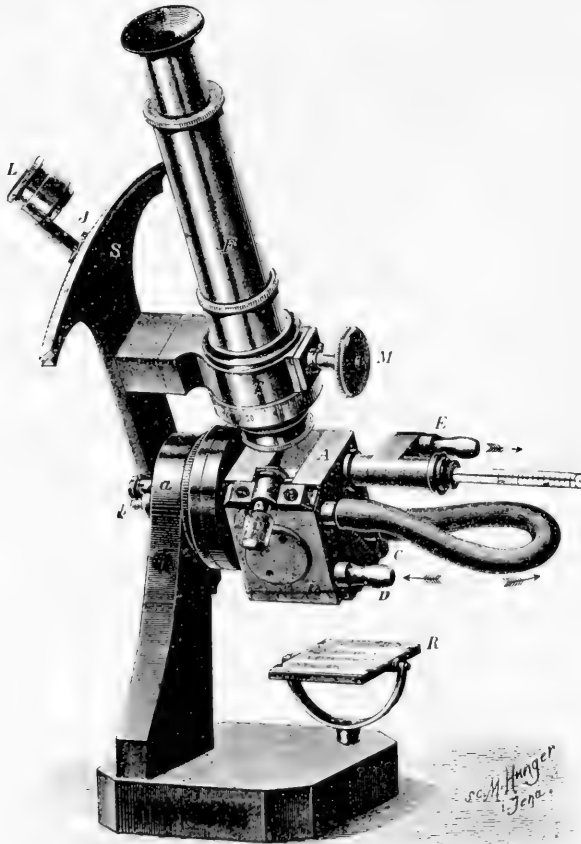

Fig. 1.

of the compensator the line of color is made more distinct; viz., there is sharpness of line dividing the light and the dark field. By moving the arm farther this line is brought up to a point where it coincides with the intersection of the cross-hairs. At this point, the index of refraction is

read on the scale (J). At the same time the temperature is read on the thermometer.

The instrument should be tested first with water and its accuracy established thereby: Ref. Ind. of water at  $20^{\circ}$  being 1.3330. The substance to be examined should be at about the same temperature at which the readings are to be made. Therefore waiting a few minutes after applying the liquid to the prism, it could be considered that this is at the same temperature.

Tables have been prepared for converting the refractometer readings to dry substance or per cent. of moisture. To some of these previous reference has been made. Hugh Main, in the *International Sugar Journal* of 1907, Vol. 9, page 481, gives a table covering this. The readings are to be made at  $20^{\circ}$  C. Geerligs has published a table also for dry substance from the refractive index. The temperature of the reading is  $28^{\circ}$  C. and he has also prepared a table for corrections for other temperatures than  $28^{\circ}$ . These are now given:

*Geertig's Table for Dry Substance in Sugar-House Products by Abbè  
Refractometer, at 28° C.*

(Intern. Sugar J., 10, 69-70.)

Index.	Per Cent. Dry Substance.	Decimals.		Index.	Per Cent. Dry Substance.	Decimals.	
1.3335	1	0.0001=0.05	0.0010=0.75	1.4104	46	0.0005=0.25	0.0016=0.8
1.3349	2	0.0002=0.1	0.0011=0.8	1.4124	47	0.0006=0.3	0.0017=0.85
1.3364	3	0.0003=0.2	0.0012=0.8	1.4145	48	0.0007=0.35	0.0018=0.9
1.3379	4	0.0004=0.25	0.0013=0.85	1.4166	49	0.0008=0.4	0.0019=0.95
1.3394	5	0.0005=0.3	0.0014=0.9	1.4186	50	0.0009=0.45	0.0020=1.0
1.3409	6	0.0006=0.4	0.0015=1.0	1.4207	51	0.0010=0.5	0.0021=1.0
1.3424	7	0.0007=0.5		1.4228	52	0.0011=0.55	
1.3439	8	0.0008=0.6		1.4249	53		
1.3454	9	0.0009=0.7		1.4270	54		
1.3469	10						
1.3484	11	0.0001=0.05		1.4292	55	0.0001=0.05	0.0013=0.55
1.3500	12	0.0002=0.1		1.4314	56	0.0002=0.1	0.0014=0.6
1.3516	13	0.0003=0.2		1.4337	57	0.0003=0.1	0.0015=0.65
1.3530	14	0.0004=0.25		1.4359	58	0.0004=0.15	0.0016=0.7
1.3546	15	0.0005=0.3		1.4382	59	0.0005=0.2	0.0017=0.75
1.3562	16	0.0006=0.4		1.4405	60	0.0006=0.25	0.0018=0.8
1.3578	17	0.0007=0.45		1.4428	61	0.0007=0.3	0.0019=0.85
1.3594	18	0.0008=0.5		1.4451	62	0.0008=0.35	0.0020=0.9
1.3611	19	0.0009=0.6		1.4474	63	0.0009=0.4	0.0021=0.9
1.3627	20	0.0010=0.65		1.4497	64	0.0010=0.45	0.0022=0.95
1.3644	21	0.0011=0.7		1.4520	65	0.0011=0.5	0.0023=1.0
1.3661	22	0.0012=0.75		1.4543	66	0.0012=0.5	0.0024=1.0
1.3678	23	0.0013=0.8		1.4567	67		
1.3695	24	0.0014=0.85		1.4591	68		
1.3712	25	0.0015=0.9		1.4615	69		
1.3729	26	0.0016=0.95		1.4639	70		
				1.4663	71		
				1.4687	72		
1.3746	27	0.0001=0.05	0.0012=0.6				
1.3764	28	0.0002=0.1	0.0013=0.65	1.4711	73	0.0001=0.0	0.0015=0.55
1.3782	29	0.0003=0.15	0.0014=0.7	1.4736	74	0.0002=0.05	0.0016=0.6
1.3800	30	0.0004=0.2	0.0015=0.75	1.4761	75	0.0003=0.1	0.0017=0.65
1.3818	31	0.0005=0.25	0.0016=0.8	1.4786	76	0.0004=0.15	0.0018=0.65
1.3836	32	0.0006=0.3	0.0017=0.85	1.4811	77	0.0005=0.2	0.0019=0.7
1.3854	33	0.0007=0.35	0.0018=0.9	1.4836	78	0.0006=0.2	0.0020=0.75
1.3872	34	0.0008=0.4	0.0019=0.95	1.4862	79	0.0007=0.25	0.0021=0.8
1.3890	35	0.0009=0.45	0.0020=1.0	1.4888	80	0.0008=0.3	0.0022=0.8
1.3909	36	0.0010=0.5	0.0021=1.0	1.4914	81	0.0009=0.35	0.0023=0.85
1.3928	37	0.0011=0.55		1.4940	82	0.0010=0.35	0.0024=0.9
1.3947	38			1.4966	83	0.0011=0.4	0.0025=0.9
1.3966	39			1.4992	84	0.0012=0.45	0.0026=0.95
1.3984	40			1.5019	85	0.0013=0.5	0.0027=1.0
1.4003	41			1.5046	86	0.0014=0.5	0.0028=1.0
1.4023	42	0.0001=0.05	0.0012=0.6	1.5073	87		
1.4043	43	0.0002=0.1	0.0013=0.65	1.5100	88		
1.4063	44	0.0003=0.15	0.0014=0.7	1.5127	89		
1.4083	45	0.0004=0.2	0.0015=0.75	1.5155	90		



Table of Corrections for the Temperature.

Temperature of the Prisms in ° C.	DRY SUBSTANCE.												
	0	5	10	15	20	25	30	40	50	60	70	80	90
	SUBTRACT.												
20	0.53	0.54	0.55	0.56	0.57	0.58	0.60	0.62	0.64	0.62	0.61	0.60	0.58
21	0.46	0.47	0.48	0.49	0.50	0.51	0.52	0.54	0.56	0.54	0.53	0.52	0.50
22	0.40	0.41	0.42	0.42	0.43	0.44	0.45	0.47	0.48	0.47	0.46	0.45	0.44
23	0.33	0.33	0.34	0.35	0.36	0.37	0.38	0.39	0.40	0.39	0.38	0.38	0.38
24	0.26	0.26	0.27	0.28	0.28	0.29	0.30	0.31	0.32	0.31	0.31	0.30	0.30
25	0.20	0.20	0.21	0.21	0.22	0.22	0.23	0.23	0.24	0.23	0.23	0.23	0.22
26	0.12	0.12	0.13	0.14	0.14	0.14	0.15	0.15	0.16	0.16	0.16	0.15	0.14
27	0.07	0.07	0.07	0.07	0.07	0.07	0.08	0.08	0.08	0.08	0.08	0.08	0.07
	ADD.												
29	0.07	0.07	0.07	0.07	0.07	0.07	0.08	0.08	0.08	0.08	0.08	0.08	0.07
30	0.12	0.12	0.13	0.14	0.14	0.14	0.15	0.15	0.16	0.16	0.16	0.15	0.14
31	0.20	0.20	0.21	0.21	0.22	0.22	0.23	0.23	0.24	0.23	0.23	0.23	0.22
32	0.26	0.26	0.27	0.28	0.28	0.29	0.30	0.31	0.32	0.31	0.31	0.30	0.30
33	0.33	0.33	0.34	0.35	0.36	0.37	0.38	0.39	0.40	0.39	0.38	0.38	0.38
34	0.40	0.41	0.42	0.42	0.43	0.44	0.45	0.47	0.48	0.47	0.46	0.45	0.44
35	0.46	0.47	0.48	0.49	0.50	0.51	0.52	0.51	0.56	0.54	0.53	0.52	0.50

*Example:* Desired, the dry substance of a sample whose refractive index is 1.4589 taken at 26° temperature. The nearest index is 1.4567, which equals 67% then 1.4589 minus 1.4567 (the nearest value in the table lower than it) = .0022. In the decimal column opposite look for .0022 and one finds a value of 0.95. So the reading is 67.95 but at a temperature of 26° (from the table of corrections) .16 must be subtracted or the correct dry substance would be 67.79. In like manner the dry substance of a sample with a refractive index of 1.5021 at 28° C. would be 85.05, and one of 1.3802 at 28° would be 30.1, and one of 1.3655 at 33° C. would be 22.06.

Bureau of Chemistry,  
Dept. of Agriculture.  
Washington, D. C.



## CONDUCTIVITY OF CERTAIN SALTS IN ETHYL AMINE.

BY EDWARD G. MAHIN.

The conductivities of silver nitrate, lithium chloride and ammonium chloride in ethyl amine were measured by Shinn,<sup>1</sup> who showed that the molecular conductivities change with dilution in an unexpected manner. In the case of silver nitrate the molecular conductivity decreases with dilution until  $V=75.15$ , this being the highest dilution used. The molecular conductivity of lithium chloride increases with dilution until  $V=0.867$ , then decreases until  $V=21.08$ , after which it apparently slightly increases. The molecular conductivity of ammonium chloride decreases with dilution until  $V=18.24$ , after which it increases. These facts would not seem remarkable were it not for the concluding words of the author's paper. After summarizing the results of his experimental work, he says:

"From the standpoint of the theory of electrolytic dissociation the electrical behavior of solutions in primary and secondary amines and in amides, so far as such solutions have been studied, is inexplicable. The facts that for one and the same solute the conductivities of solutions may not only be very large or very small, but may increase or decrease with dilution, or attain maximum or minimum values depending upon the specific nature of the solvent, suggest that the role of the solvent in the process of the transmission of an electric current through a solution is, in all probability, a very active rather than an indifferent one, and does not materially differ from that of the solute. In such event, the prevalent conception of 'molecular conductivity' becomes not only meaningless, but misleading."

In arriving at the conclusions here indicated it would seem that the author has overlooked certain facts which may not only serve to explain the apparent departure from the dilution laws, but which would make this departure seem inevitable. It has long been known that the aliphatic amines are strongly basic substances, forming simple salts analogous to the ammonium salts, as well as complex metallic salts which are analogous to those where hydrogen of the ammonium radicle is substituted by a metal. Indeed, this salt formation is to be expected since the ali-

---

<sup>1</sup>J. Phys. Ch., 11, 537.

phatic primary amines are members of a series of mono-substituted ammonias, of which the basicity is greater than that of the mother substance.

Köhler<sup>1</sup> isolated a salt having the composition represented by the formula  $C_2H_5NH_2.HgCl$ . Müller<sup>2</sup> investigated double salts of ethyl amine with palladium, Jorgensen<sup>3</sup> those with platinum, Carson and Norton<sup>4</sup> those with uranium, Bailey<sup>5</sup> with vanadium, Bonnefoi<sup>6</sup> with lithium chloride, and Hoffman and Marburg<sup>7</sup> with mercuric chloride. In most cases more than one salt was produced by varying the proportions of ethyl amine and the simple salt used. Hoffman and Marburg isolated and studied the compounds  $C_2H_5NH_2.HgCl_2$ ,  $(C_2H_5NH_2)_2.HgCl_2$  and  $C_2H_5NH.HgCl$ . Bonnefoi found that by leading the vapor of ethyl amine over dry lithium chloride various double salts were produced, the proportion of the constituents depending upon the temperature. The following compounds were formed under the conditions indicated:

<i>Temp.</i>	<i>Formula.</i>	<i>Heat of Formation, Calories.</i>
70°	$C_2H_5NH_2.LiCl$	+ 13834
58°-70°	$(C_2H_5NH_2)_2.LiCl$	+ 24817
Ord. to 58°	$(C_2H_5NH_2)_3.LiCl$	+ 35387

It seems probable, in the light of these facts, that at still lower temperatures other compounds will be present, having a still higher ratio of ethyl amine to the original salt; this should be particularly true with regard to solutions in liquid, anhydrous ethyl amine. In other words, we are here dealing with an application of the mass law, where the temperature and mass of the reacting substances are to be considered in the attempt to solve the problem regarding the composition of the resulting compound. We should expect that any solution would contain several compounds of the constituents, having a certain average composition which would depend upon the temperature and degree of dilution.

Shinn<sup>8</sup> tested, in an approximate but not quantitative manner, the action of ethyl amine upon 14 salts, concerning which the following résumé is here given:

<sup>1</sup> Ber., 12, 2323.

<sup>2</sup> Ann., 86, 366.

<sup>3</sup> J. pr. Ch., (2) 33, 517.

<sup>4</sup> Am. Ch. J., 10, 220.

<sup>5</sup> J. Ch. Soc., 45, 693.

<sup>6</sup> C. r., 129, 1257.

<sup>7</sup> Ann., 305, 191.

<sup>8</sup> Loc. cit.

- $\text{NH}_4\text{Cl}$  . . . Very soluble with evolution of ammonia.  
 $\text{LiCl}$  . . . . Soluble.  
 $\text{FeCl}_3$  . . . . Slightly soluble.  
 $\text{SnCl}_2$  . . . . Insoluble, unchanged.  
 $\text{CoCl}_2$  . . . . Reacts with evolution of heat, forming greenish yellow precipitate.  
 $\text{PbBr}_2$  . . . . Reacts, forming white precipitate which afterward redissolves.  
 $\text{KI}$  . . . . Insoluble, unchanged.  
 $\text{CdI}_2$  . . . . Reacts, forming white, insoluble precipitate.  
 $\text{AgCN}$  . . . . Slightly soluble.  
 $\text{Hg}(\text{CN})_2$  . . . Slightly soluble.  
 $\text{AgNO}_3$  . . . . Soluble with evolution of much heat.  
 $\text{NaNO}_3$  . . . . Insoluble, unchanged.  
 $\text{Pb}(\text{NO}_3)_2$  . . . Reacts, forming white, insoluble precipitate.

It is thus seen that, in all cases where the salt dissolves appreciably, there is evidence of chemical action, either through the evolution of heat or the formation of a precipitate, or both. In the case of ammonium chloride the well known action of evolution of ammonia was observed. There is, therefore, every reason for expecting that complex salts will be formed in every case excepting the last, where no doubt ethyl amine hydrochloride is produced, as Shinn has pointed out. If this be true, the question still remains as to whether the reaction is complete as soon as the salt is all in solution, so that henceforth all physical properties will be those of a solution in ethyl amine of a definite double or complex salt, changing with dilution only with respect to the degree of ionization. With the investigations of Hofmann and Marburg and of Bonnefoi in mind, the answer to this question would certainly be negative. We should expect that the ratio of ethyl amine to simple salt combined with it would not only change with lowering of temperature, but that it would increase with decreasing concentration, because as dilution progresses the ratio of amine to salt in solution increases. If the conductivity of the complex salt is much less than that of the simple salt the change in molecular conductivity with change in concentration would be the resultant of two influences, i. e., change in ionization and change in complexity of the ions. The migration velocity of a complex cation containing one or more molecules of ethyl amine could not be very high, and it is not likely that such a compound would possess a very high degree of ionization. This fact would then result in a more or less gradual tendency toward falling off in the molecular conductivity with increasing dilution, since we are actually dealing not only with more complex compounds, whose ioniza-

tion is probably less than that of the simpler ones, but also with more complex ions, whose velocity is probably less than that of the simpler ones. If, however, the ionization resulting from dilution proceeds at a greater rate than does the change in complexity, increase in molecular conductivity would then be the rule. This actually happens for a certain range in the case of lithium chloride, then later the increasing complexity of the ions perhaps gains the ascendancy and molecular conductivity decreases with further dilution. The effect of dilution upon molecular conductivity will necessarily be somewhat complicated, if the preceding reasoning is correct, involving at least the following changes: (a) Increase in molecular complexity, through increase in the active mass of ethyl amine, (b) change (probably decrease) in *ionization constant* because of increasing complexity, (c) increase in ionization of any one form, since at any dilution a considerable number of different complexes are probably present, and (d) probable decrease in migration velocity on account of increasing complexity of the ions.

This would seem to be merely another special case of the influence of solvate formation upon conductivity, and such influences have long been known. The formation of hydrates, for example, has a very marked effect upon the conductivity and upon the lowering of freezing point and vapor pressure of aqueous solutions.

In the case of solutions of ammonium chloride in ethyl amine it is by no means certain that the entire amount of salt is converted at once into ethyl amine hydrochloride when brought into a solution of any concentration. We should certainly expect that equilibrium will result when a certain amount of ammonium chloride remains as such in the solution, this amount becoming smaller as dilution proceeds. The molecular conductivity will then depend upon (a) the ratio of ethyl amine hydrochloride to ammonium chloride, (b) the relative ionization constants of the two compounds and (c) the relative migration velocities of the two (or more) cations involved.

The theory of electrolytic dissociation has proven of so great value to physical chemistry and has piloted the way to so many valuable investigations that one cannot fail to realize its importance. This does not mean that its imperfections should be ignored or that there should be any cessation in the search for facts which will test it to the extreme. But so many supposed objections have been urged against it that, on closer

investigation, have been found to entirely conform to the theory or to require only minor modifications, that we hesitate to accept such a sweeping statement as that contained in Shim's paper. The facts cited do not necessarily conflict with the theory—indeed, they would seem to point to the truth of the theory. What is needed is more experimental evidence covering these points.

Purdue University,  
Lafayette, Ind.





## A STUDY OF THE CHEMICAL COMPOSITION OF BUTTER FAT, AND ITS RELATION TO THE COMPOSITION OF BUTTER.

BY O. F. HUNZIKER AND GEORGE SPITZER.

### SUMMARY OF AUTHENTIC KNOWLEDGE OF THE COMPOSITION OF BUTTER FAT.

Milk fat or butter fat consists of triglycerides of fatty acids. The fatty acids of butter fat are monobasic and have the general formula  $C_nH_{2n+1}COOH$ , except oleic acid, which is a non-saturated acid belonging to the acrylic series with the general formula  $C_nH_{2n-1}COOH$ . The triglycerides of butter fat do not exist as glycerides of one fatty acid, but as a mixture of several acid radicals combined with glycerin. Glycerin is a triatomic alcohol,  $C_3H_5(OH)_3$ . Theoretically, therefore, the milk fat could contain triglycerides of the fatty acids present, that is, there could be tributyrin, triolein, tristearin, etc. In reality no such combination exists. Just in what order the triglycerides are present has not been definitely established. The acids present in butter fat are butyric, caproic, caprylic, capric, lauric, myristic, palmitic, oleic and stearic.

Bell<sup>1</sup> holds that butter fat consists of mixed glycerides, glycerides in the molecule of which the glycerol is combined with three different acid radicals forming a compound having the following composition:

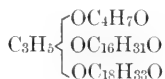

This theory is supported by the fact that the glycerol forms triacid compounds and not compounds of one acid, which theoretically could be possible. If the glycerol formed monoacid compounds, butter fat would contain glyceryl tributyrates, caproates, stearates, etc.

### SOLUBILITY OF BUTTER FATS IN ALCOHOL.

If butter fat is dissolved in alcohol, from 1.1 to 3.3 per cent of the fat goes into solution, the solubility depending on the temperature of the alcohol. If tributyrin existed in butter fat, all of the tributyrin would

<sup>1</sup> The Chemistry of Foods, Vol. II, page 44.

go into solution.<sup>1</sup> Analyses of the portion soluble in alcohol show that this is not the case. Tables I and II give the value of the constants as determined for the portion soluble in cold alcohol, the portion not soluble in cold alcohol, but soluble in hot alcohol, and the portion not soluble in either hot or cold alcohol.

TABLE I.

	Portion Soluble in Alcohol at 20 deg. C	Portion Not Soluble in Cold Alcohol, but Soluble in Alcohol at 75 deg. C.	Portion Not Soluble in Either Hot or Cold Alcohol.
Reichert-Meißl Number.....	48.1	29.6	20.7
Melting point.....	16.9°C.	31.5°C.	36.0°C.
Soluble acids (as Butyric).....	9.79%	6.60%	4.26%

TABLE II.

	At 20°C.	At 75°C.
Solubility of butter fat in 95 % alcohol.....	1.1%	3.3%

The melting point of the portion soluble in alcohol at 20° C. is 16.9° C., while that of the portion not soluble in either hot or cold alcohol is 36° C., showing a difference of 19.1° C. The Reichert-Meißl No. in the portion soluble in alcohol is 48.1, in the portion not soluble in alcohol it is 20.7, showing a difference of 27.3. Since only 1.1 per cent of the fat is soluble in cold alcohol, this would indicate that no tributyrin exists in butter fat. This fact becomes still more evident by an examination of the molecular weight of the glycerides soluble in alcohol and those not soluble in alcohol, as calculated from the figures in Table VII.

<sup>1</sup> Cochran, "Action of Alcohol on Butter Fats," Analyst, Vol. 13, page 55.  
Lewkowitzsch, "Oils, Fats and Waxes," Vol. II, page 675, 1909.

The saponification of a neutral fat yields a perfectly definite compound. This saponification takes place according to the following reaction for an ester with three molecules of acid combined with the radical of a trihydric alcohol:

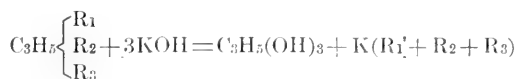

The molecular weight of the triglyceride is calculated as follows: Determine the per cent of KOH required to saponify the fat, and divide the molecular weight of 3(KOH) by the per cent thus obtained, or multiply the saponification equivalent by three.

Thus, from the figures in Table VII the saponification equivalent of the portion soluble in alcohol was found to be 216.5. This multiplied by 3 is 649.5. This equals the molecular weight of the triglyceride.

The saponification equivalent of the portion not soluble in alcohol was found to be 260.9; this multiplied by 3 equals the molecular weight, 782.7. The molecular weight of butyric  $C_3H_5(C_4H_7O)_3$  is 302, while the molecular weight of the triglycerides of the soft portion is 649.5.

The fact that only 1 per cent of the butter fat was dissolved in cold alcohol shows clearly the absence of tributyrin, otherwise the per cent of alcohol-soluble fat would be higher. The soft portion must, therefore, be made up of mixed glycerides of the acids found in butter fat, the acids having a low melting point and a low molecular weight predominating.

#### FRACTIONAL SEPARATION OR CRYSTALLIZATION OF BUTTER FATS.

The same condition presents itself if butter fat is subjected to fractional separation. When butter fat is exposed to a temperature below the melting point of the harder glycerides, the softer glycerides separate from the harder glycerides. When this process is repeated by lowering the temperature after each separation, a separation can be effected whereby the constants differ widely from the original mixed glycerides.<sup>1</sup> Table III shows the variation of the constants of the fats thus separated. The butter used in this experiment was made in March.

<sup>1</sup> Richmond Dairy Chemistry, page 37.

TABLE III.

*Composition of Portions of the Butter Fat Obtained by Fractional Separation.*

	Original Butter Fat.	Soft Portion.	Hard Portion.
Reichert-Meißl Number.....	29.06	32.65	26.74
Iodine number.....	34.97	42.10	30.11
Koetts. saponification number..	229.5	233.87	228.8
Refractive index at 40° C.....	{ Reading 44.1 1.4552	Reading 45.1 1.456	Reading 43.1 1.4546
Melting point.....	34° C.	14.5°C.	37.3C.
Per cent insoluble acids.....	88.76	87.89	89.47
Melting point of insoluble acids.....	40°C.	36.5°C.	42.5°C.
Per cent soluble acids (as butyric).....	5.89	6.67	5.46
Koetts. saponification number insoluble acids..	219.5	221.35	218.8
Iodine number insoluble acids.....	37.36	45.05	33.48

Later in the season (in May) another sample of butter was treated similarly, separating the liquid from the solid portions of the fat, and the constants were determined as shown in Table IV.

TABLE IV.

*Composition of Portions of the Butter Fat Obtained by Fractional Separation.*

	Original Butter Fat.	Soft Portion.	Hard Portion.
Reichert-Meißl number .....	30.00	33.85	24.66
Iodine number .....	39.82	43.55	33.08
Koetts. saponification number .....	230.1	232.78	226.4
Refractive index at 40° C. ....	{ Reading 44 1.4552	Reading 44.8 1.4558	Reading 43 1.4545
Melting point .....	32.5°C.	13.2°C.	38.1°C.
Per cent insoluble acids .....	87.54	86.67	88.64
Melting point insoluble acids .....	39.2°C.	35.3°C.	42.4°C.
Per cent soluble acids (as Butyric) .....	6.09	6.90	5.17
Koetts. saponification number insoluble acids .....	220.53	221.6	218.7
Iodine number insoluble acids .....	42.14	46.2	35.66
Per cent glycerin .....	12.58	12.89	12.33

Tables III and IV show that the soft portions contain more volatile or soluble acids, also a greater per cent of oleic acid in combination with the glycerol base than the hard portions. The melting point of the soft portions was 22.8° C. and 24.9° C., respectively, lower than the melting point of the hard portions.

The difference in the melting points between the soft and hard portions of the insoluble fatty acids was not as great as that of the soft and hard portion of the glycerides from which the insoluble acids were derived. The reason for this must lie in the fact that the soluble fatty acids have been removed and that, therefore, the melting points of the different portions of the insoluble fatty acids depend almost entirely on the per cent of oleic acid present.

The soft portion of the glycerides is made up of a higher per cent of acids with a lower melting point, i. e., oleic and soluble acids. The

soluble acids have a very low melting point. Therefore, even a slight increase in the per cent of soluble acids must cause a lowering of the melting point.

Tables V-A and V-B show a comparison of the iodine number of the soft and hard portions of the glycerides and of the insoluble acids derived from the glycerides. The iodine number of the soft and hard portions of the insoluble acids is higher than that of the corresponding portions of the glycerides of the butter fat. This is natural. The soluble acids and glycerin have been removed from the glycerides, raising the per cent. of the remaining constituents of the insoluble acids above that in the glycerides.

TABLE V-A.

*Iodine No. of Soft and Hard Portions of Butter Fat.*

	Soft Portion Iodine Number.	Hard Portion Iodine Number.	Soft Portion Per cent Olein.	Hard Portion Per cent Olein.	Gain Iodine Number.	Gain Per cent Olein.	Per cent Gain Olein of Soft Portion Over Hard Portion
From table III.....	42.10	30.11	48.83	34.92	11.99	13.72	39.31
From table IV.....	43.55	33.08	50.518	38.37	10.47	12.148	31.6

TABLE V-B.

*Iodine No. of Insoluble Acids of Soft and Hard Portions.*

	Soft Portion Iodine Number.	Hard Portion Iodine Number.	Soft Portion Per cent Olein.	Hard Portion Per cent Olein.	Gain Iodine Number.	Gain Per cent Olein.	Per cent Gain Olein of Soft Portion Over Hard Portion.
From table III.....	45.05	33.48	52.25	38.84	11.57	13.41	34.5
From table IV.....	46.2	35.66	53.59	41.36	10.54	12.23	29.5

## CONCERNING THE SOLUBLE FATTY ACIDS.

Table VI shows the per cent of soluble fatty acids and glycerin in the soft and hard portions of butter fat. The soft portion contained 2.06 per cent more soluble acids and .56 per cent more glycerin than the hard portion, as obtained from data in Table IV.

TABLE VI.

*Per Cent of Soluble Acids and Glycerin in Soft and Hard Portions.*

	Soft Portion.	Hard Portion.	Gain.
Per cent soluble acids.....	8.23	6.17	2.06
Per cent Glycerol.....	12.89	12.33	.56

The soluble acids were calculated on the basis of a mean molecular weight of 104.5. This molecular weight was calculated from the amount of glycerides of the soluble acids and other data taken from Table IV.

The glycerol ( $C_3H_5$ ) is calculated from the per cent of soluble acids, mean molecular weight 104.5. From this calculation the per cent of glycerin  $C_3H_5(OH)_3$  is readily determined.

The general formula for one molecule of a triglyceride is  $C_3H_5(R)_3$ , where R stands for mixed acid radicals  $R_3=104.5 \times 3=313.5$ ; allowing for the basic hydrogen  $C_3H_5=38$ , then the molecular weight of the triglyceride  $C_3H_5(R)_3$  is 351.5.

$$351.5 : 38 = 8.23 : X$$

$$X = .888\% C_3H_5$$

From these results the per cent of glycerin is calculated as follows, the molecular weight of glycerin being 92:

$$38 : 92 = .888 : X$$

$$X = 2.14$$

This is the per cent of glycerin combined with the soluble acids of the soft portion.

Likewise, the per cent of the glycerin combined with the soluble acids of the hard portion is calculated:

$$351.5 : 38 = 6.17 : X$$

$$X = .888\% C_3H_5$$

$$38 : 92 = .666 : X$$

$$X = 1.61$$

This is the per cent of glycerin combined with the soluble acids of the hard portion.

The difference between the per cent of glycerin combined with the per cent of soluble acids of the soft portion and the per cent of glycerin combined with the per cent soluble acids of the hard portion, then, is  $2.14 - 1.61 = .53\%$ . This agrees closely with the difference of the glycerin between hard and soft portions as shown by analyses. (See Table VI.)

The per cent of glycerin combined with the insoluble acids is nearly the same in both soft and hard portions, because the per cent of insoluble acids in the soft and hard portions differs very little. Also the variation in the composition of the insoluble acids would not materially affect the molecular weight. Therefore, it is reasonable to expect that nearly the same per cent of glycerin is combined with the insoluble acids of both the soft and the hard portions.



RELATION OF COMPOSITION OF BUTTER FAT SOLUBLE AND INSOLUBLE IN ALCOHOL TO COMPOSITION OF SOFT AND HARD PORTIONS OF FAT OBTAINED BY FRACTIONAL SEPARATION.

A comparison of the constants of the soft and hard portions with the constants of the fats soluble and insoluble in alcohol shows a close relation. The results are summarized in Table VII.

TABLE VII.

*Showing the Variation of the Constants of the Soluble and Insoluble Portions in Alcohol, Also of the Soft and Hard Portions of Butter Fat Taken for the Experiment.*

	A			B		
	Alcohol—Soluble Portion.	Alcohol—Insoluble Portion.	Original Butter Fat.	Soft Portion.	Hard Portion.	Original Butter Fat.
Reichert-Meissl number.....	48.1	20.7	27.70	33.85	24.66	30.00
Melting point.....	16.9°C.	36.°C.	33.5°C.	13.2°C.	38.1°C.	32.5°C.
Iodine number.....	34.07	39.75	37.63	43.55	33.08	39.82
Koetts. saponification number.....	259.14	215.06	227.4	232.78	226.4	230.1
Saponification equivalent.....	216.5	260.9	246.79	241.1	248.3	244.0
Refractive index at 40° C.....	Reading	Reading	Reading	Reading	Reading	Reading
	42.7 1.4543	45.6 1.4563	44.4 1.4555	44.8 1.4558	43 1.4545	44 1.4552
Per cent soluble acids (as Butyric).....	9.792	4.26	6.60	6.90	5.17	6.09

These data give the composition of the portions of fat soluble in alcohol and of the original butter fat; also the composition of the soft and hard portions of butter fat separated by fractional crystallization and of the original butter fat. The samples A and B of butter fat used for the two experiments were not taken from the same lot of butter.

The Reichert-Meissl No. is distinctly higher in the fat soluble in alcohol and in the fat of the soft portion, than it is in the fat insoluble in alcohol and in the fat of the hard portion, as well as in the original fat.

The melting point is lowest in both the fat soluble in alcohol and in the fat of the soft portion.

On the other hand, the iodine number is lowest in the fat soluble in alcohol and highest in the fat of the soft portion.

The figures in the above table show the influence of the constants on the melting point of butter fat. The portion of fat insoluble in alcohol and the original fat from which the above portion was taken show a decidedly higher iodine number than the portion soluble in alcohol. If the melting point depended solely on the iodine number, the melting point of the fat insoluble in alcohol and of the original butter fat would be distinctly lower than the melting point of the portion soluble in alcohol. Table VII shows that this is not the case. The melting point of the portion insoluble in alcohol and of the original butter fat is a great deal higher (19.1° C. and 16.6° C., respectively, higher) than the melting point of the fat soluble in alcohol. The only factor to which this fact can be attributed is the high Reichert-Meissl No. in the case of the fat soluble in alcohol, as compared with the low Reichert-Meissl No. of the fat insoluble in alcohol and of the original butter fat. These results make it perfectly clear that the softness or hardness (melting point) of butter fat is dependent to a great degree on the per cent of soluble fatty acids present.

This table further shows, as stated in the previous chapters, that butter fat is a mixture of triglycerides of different fatty acids. The soft portion is the result of mechanical separation at different temperatures. It, therefore, contains more glycerides combined with acids of low melting points including oleic and soluble acids. Furthermore, the fat soluble in alcohol represents glycerides of acids soluble in alcohol. Since it is known that some of the glycerides of the soluble acids are soluble in alcohol, we can assume that some of the molecules in butter fat are made up of the glycerides containing a larger proportion of the soluble acids than others.

#### CONDITIONS AFFECTING THE COMPOSITION OF BUTTER FAT.

The composition of butter fat varies with the season of the year. A series of analyses of butter fat of butter made during each of the twelve months of the year, yielded the results summarized in Table VIII.

The results in Table VIII show that the Reichert-Meissl number was lowest in October, increasing steadily until it reached its maximum in March. After March it dropped abruptly, holding about its own till July, then taking a second drop and declining slightly toward October.

TABLE VIII.

*Effect of the Season of Year on the Composition of Butter Fat.*

	Reichert Meissl Number.	Iodine Number.	Melting Point.
January.....	30.03	31.20	33.4° C.
February.....	30.58	31.97	33.5° C.
March.....	31.30	31.94	33.5° C.
April.....	29.35	35.83	33.3° C.
May.....	29.55	36.48	32.5° C.
June.....	29.56	38.23	32.45° C.
July.....	28.90	37.10	31.9° C.
August.....	27.13	38.99	32.1° C.
September.....	27.19	35.36	33.0° C.
October.....	26.54	34.27	33.2° C.
November.....	28.36	30.65	33.4° C.
December.....	29.62	30.30	33.6° C.

The Iodine number was lowest in December, increasing slightly toward and including March; rising abruptly in April and continuing to rise up to and including June, then gradually declining toward October and dropping suddenly in November, followed by a slight drop in December.

The melting point followed, in general, the Iodine number reversedly. It was lowest in mid-summer when the Iodine number was highest, and it reached its maximum in December, when the Iodine number was lowest. The variations of the melting point, however, were not so abrupt as those of the Iodine number. A careful study of Table VIII suggests that, at times, the variations in the melting point may have been influenced strongly by the Reichert-Meissl number.

Experimental data produced in this country and abroad show unmistakably that the feed which the cows receive influences the per cent of olein in butter. Such feeds as cottonseed meal, bran, corn, overripe dry

fodders, etc., when fed in excess, tend to decrease the per cent of olein, while linseed meal, gluten feeds, succulent pasture grasses, etc., are conducive of raising the per cent of olein.

The volatile fatty acids do not seem to be appreciably affected by the feed the cows receive. They are influenced, however, by the period of lactation as shown in Tables IX and X.<sup>1</sup>

TABLE IX.

*Showing the Effect of the Period of Lactation on the Milk Fats.*

TIME.	Reichert-Meissl Number.	Soluble Acids.	Insoluble Acids.
1st month.....	32.41	7.39	87.26
2d month.....	29.48	7.07	87.99
3d month.....	29.95	7.08	87.90
4th month.....	29.97	7.11	87.72
5th month.....	29.56	7.00	87.72
6th month.....	29.21	6.82	88.19
7th month.....	28.06	6.45	88.4
8th month.....	25.32	5.84	88.6
9th month.....	25.45	6.01	88.5
10th month.....	27.45	6.26	88.1

<sup>1</sup> Hunziker. Proceedings of the Indiana Academy of Science, 1908, page 144.

TABLE X.

*Showing Effect of the Period of Lactation on the Milk Fats.*

TIME.	Reichert- Meissl Number.	Soluble Acids Per Cent.	Insoluble Acids. Per Cent.
1st month.....	36.68	8.20	86.76
2d month.....	35.75	8.09	86.74
3d month.....	33.19	7.59	86.99
4th month.....	33.80	7.56	86.95
5th month.....	33.63	7.47	87.10
6th month.....	33.57	7.55	86.94
7th month.....	32.72	7.49	86.99
8th month.....	31.63	7.25	87.41
9th month.....	31.98	7.10	87.50
10th month.....	32.03	7.12	87.46
11th month.....	26.64	6.50	88.20
12th month.....	30.48	8.86	87.69

The data in Tables IX and X represent results of experiments with three cows whose period of lactation commenced in October and November respectively. They were fed on a uniform ration throughout the entire period of lactation with the exception that in July (the 9th month after calving) they were turned out on pasture.

The above tables clearly show that the soluble fatty acids are highest immediately after parturition, or at the beginning of the period of lactation. Slight irregularities excepted, they decreased as the period of lactation advanced and were lowest toward the close of the period of lactation.

It so happens that in most localities the majority of the cows drop their calves in late spring, at a time when they also change from dry feed to succulent pasture. This explains why in early summer both the per cent of volatile fatty acids and the per cent of oleic acids increase and the melting point decreases.

RELATION OF COMPOSITION OF BUTTER FAT TO COMPOSITION  
OF BUTTER.

During late spring and early summer, at a time when, as shown above, the Reichert-Meissl number and the Iodine number are high and the melting point is low, the butter-maker experiences usually considerable difficulty in manufacturing butter with a reasonably low moisture content. This coincidence has suggested to the writers that there may be a more or less intimate relation between the melting point of the butter fats and their power to absorb water during the process of butter-making. A series of experiments was, therefore, conducted bearing on this point. The results are shown in Table XI.

TABLE XI.

*Per Cent of Moisture Retained by Soft and Hard Fats Churned Separately.*

	Per Cent Water.		Per Cent Increase of Soft Over Hard
	Soft Fats.	Hard Fats	
March butter.....	43.84	24.76	77.02
May butter.....	50.62	24.78	104.28
Average.....	47.23	24.77	90.65

Table XI covers experiments in which soft and hard portions of butter fat (butter fat with a low and a high melting point) were separated from one another by fractional crystallization of the fats and by pressure. The soft and hard portions were churned separately under identical conditions, adding the same amount of water to each churning and churning at the same temperature.

Twelve separate churnings were made each, the March butter and the May butter. In the March butter the per cent increase of the moisture of the soft fats over that of the hard fats was 77.02. In the May butter the per cent increase of the moisture of the soft fats over that of the hard fats was 104.28. These figures unmistakably show that the soft fats are capable of taking up a great deal more moisture than the hard fats. They, therefore, can leave little doubt that the material increase in the

moisture content of butter made in early summer is due to the increase in the soft fats it contains.

The moisture-retaining property of the fats is largely dependent on their melting point. The lower the melting point, the greater is their power to mix with and retain water. Since the glycerides of the oleic and soluble fatty acids have a low melting point, it is reasonable that any increase in the per cent of these glycerides tends to increase the water-retaining properties of the butter.

Dairy Department,  
Purdue Experiment Station.





## ON A NEW COMPLEX COPPER CYANOGEN COMPOUND.

---

BY A. R. MIDDLETON.

---

(Preliminary Note.)

When a cold concentrated solution of KCN is added to a cold concentrated solution of cupric chloride or sulphate, but not nitrate, greenish brown cupric cyanide is precipitated; the precipitate dissolves on further addition of KCN with formation of a claret red to violet red compound, much resembling potassium permanganate solution. Further addition of KCN destroys the color, with precipitation of white cuprous cyanide (presumably), which then dissolves in excess of KCN. First addition of concentrated cupric salt solution, or the solid salt, to concentrated KCN solution produces a brilliant violet color, instantly destroyed by further addition and quickly disappearing on standing. Further additions of copper salt give the red compound, provided the solution is kept nearly at 0°; otherwise cyanogen is evolved and the red compound is not formed. If the solutions are too concentrated or too dilute, the red compound is not formed. Solutions about one-half saturated appear to give the compound most readily and in largest amount.

Search through the available literature has revealed no reference to such a compound. It is quite unstable, decomposing to a brown solution on standing in a warm room over night; is instantly decomposed by strong and weak acids and bases and by pyridine; soluble in alcohol, but insoluble in chloroform, ether, benzene, toluene and carbon tetrachloride. Attempts to crystallize out the compound are in progress, and at the time of writing appear promising. The method pursued is as follows: Solid  $\text{CuCl}_2 \cdot 2\text{H}_2\text{O}$  was added in small amounts to KCN solution about one-half saturated, with constant shaking in ice water. After the red color reached a maximum, the solution was filtered, three volumes of 95% alcohol added and placed in the icebox in an exhausted desiccator. After 24 hours white opalescent scales separated, which, after washing with alcohol and ether and drying, present a metallic appearance somewhat resembling tinfoil. These contain copper and may be cuprous cyanide. The solution retained its red color unchanged and it is hoped that the compound can be crystallized out in form suitable for analysis.

Purdue University,  
Lafayette, Ind.



## DETERMINATION OF ENDOTHERMIC GASES BY COMBUSTION.

BY A. R. MIDDLETON.

Endothermic gases such as ethylene and acetylene, even when mixed with sufficient air to form an explosive mixture, may be accurately and safely determined by combustion in a gas pipette provided the following conditions are observed: (1) Presence of a considerable excess of oxygen; (2) admixture with an exothermic gas; (3) slow admission of the combustible gases to the combustion pipette; (4) application of heat from below on the entering combustible gases; (5) reduced pressure. These conditions are secured by using a Winkler-Dennis gas combustion pipette, the platinum spiral being placed as near the juncture of the capillary with the pipette as possible without endangering the glass; mixing the endothermic gases with one to two volumes of pure hydrogen; and slowly leading this mixture into oxygen instead of the reverse as is usually done in combustion of the methane and hydrogen of illuminating gas.

The combustion is carried out as follows: The hydrogen used as a diluent is generated in a Hempel hydrogen pipette from zinc free from carbon; the requisite quantity is drawn into a burette, measured and transferred to a mercury pipette; a measured volume of acetylene or ethylene is then driven over into the hydrogen and the gases thus mixed drawn back into the burette. About 10 cc. more than the theoretical amount of oxygen required for the combustion is measured and transferred to the combustion pipette. The burette containing the mixed combustible gases over mercury is connected with the pipette and the level bulb of the latter so placed that the oxygen in the pipette is under a reduced pressure of one or two centimeters of mercury. The current is then turned on and the resistance so adjusted that the spiral is maintained at a bright red heat. The pinch-cock on the rubber connection of the burette with the capillary arm of the pipette is opened; the expansion of the oxygen by the heat from the spiral approximately balances the reduced pressure and little or no gas enters the pipette on opening the pinch-cock. The screw pinch-cock on the connecting tube of the burette and its leveling tube is then slightly opened and so adjusted that the flow of gas into the pipette is about 2 cc. per minute. After proper adjustment is effected

the apparatus requires no further attention until the combustion is ended.

If the inflow of combustible gases much exceeds the rate prescribed, a series of small explosions is likely to occur at the juncture of the capillary side-arm with the pipette, traces of carbon deposition are evident and the results are slightly low.

Some analyses of acetylene and explosive mixtures of acetylene with air are appended :

Exp. No.	C <sub>2</sub> H <sub>2</sub> , cc.	H <sub>2</sub> , cc.	O <sub>2</sub> , cc.	Res. cc.	After KOH cc.	CO <sub>2</sub> , cc.	O <sub>2</sub> Con- sumed, cc.	C <sub>2</sub> H <sub>2</sub> , %.
1	20.0	30.0	80.0	55.0	15.0	40.0	65.0	100.0
2	10.0	30.0	54.2	34.3	34.2	20.1	40.0	100.5
3	2.0	50.0	52.6	26.8	22.8	4.0	29.8	100.0
4	30.0	30.0	100.0	70.3	10.8	59.5	89.2	99.2
5	30.0	15.0	100.0	77.8	18.4	59.4	81.6	99.0
6	15.0	30.0	69.0	46.6	16.6	30.0	52.4	100.0
7	15.0	30.0	70.0	47.4	17.4	30.0	52.6	100.0
8	10.2	25.0	50.9	33.4	13.0	20.4	37.9	100.0

Explosive mixtures of air and acetylene :

1	15.0	30.0	50.6	35.2	13.4	21.8	.....	72.6
2	15.3	30.0	51.0	34.6	12.5	22.1	.....	72.2

Absorption by fuming sulphuric acid gave 72.0% and 72.3%.

Purdue University,  
Lafayette, Ind.

## METHODS IN SOLID ANALYTICS.

BY ARTHUR S. HATHAWAY.

Define the "vector"  $[h, k, m]$  as the carrier of the point  $(x, y, z) = P$ , to the point  $(x + h, y + k, z + m) = Q$ , and show that the distance and direction cosines of the displacement  $PQ$  are given by functions of the vector called its *tensor* and *unit*,  $T[h, k, m] = \sqrt{(h^2 + k^2 + m^2)} = n$ ,  $U[h, k, m] = [h/n, k/n, m/n]$ .

Interpret the sum  $[h, k, m] + [h', k', m'] = [h + h', k + k', m + m']$  as a resultant displacement,  $PQ + QR = PR$ , and the product  $n[h, k, m] = [nh, nk, nm]$ , as a repetition of the displacement.

Define the linear functions of  $q = [x, y, z]$  as the "scalars" or "vectors" whose values or components are linear homogeneous functions of the components of  $q$ , such as  $ax + by + cz$ , etc. Hence, for a linear function  $Fq$ ,  $F(q + r) = Fq + Fr$ ,  $nFq = F(nq)$ .

Hence, for a bi-linear function  $Fqr$ ,  $F(aq + a'q', br + b'r') = abFqr + ab'Fqr' + a'bFq'r + a'b'Fq'r'$ .

A special scalar and vector bilinear function of  $q = [x, y, z]$ ,  $q' = [x', y', z']$  are defined.

$$Sq'q' = xx' + yy' + zz' = Sq'q.$$

$$Vq'q' = [yz' - zy', zx' - xz', xy' - yx'] = -Vq'q.$$

If  $\theta$  be the angle between the displacements  $q, q'$ , these functions are interpreted as,

$Sq'q' = Tq \cdot Tq' \cdot \cos\theta$ .  $TVq'q' = Tq \cdot Tq' \cdot \sin\theta$ ; and  $Vq'q'$  is a displacement perpendicular to both  $q$  and  $q'$ , in the same sense as the axis  $OZ$  is perpendicular to  $OX$  and  $OY$ , i. e., on one side or the other of the plane  $XOY$ .

The use of this material is illustrated in the following examples:

$A = (2, 3, -1)$ ,  $B = (3, 5, 1)$ ,  $C = (8, 5, 2)$ ,  $D = (5, 7, 11)$ .

1. Find the lengths and direction cosines of  $AB, AC, AD$ .

Ans.  $TAB = 3$ ,  $UAB = [\frac{1}{3}, \frac{2}{3}, \frac{2}{3}]$ , etc.

2. Find  $\cos BAC$ . Ans.  $SUABUAC = \frac{1}{2} \frac{1}{2}$ .

3. Find area of  $ABC$  and volume of  $ABCD$ .

Ans.  $\frac{1}{2} TVABAC = \frac{1}{2} 185$ ,  $\frac{1}{6} SADVABAC = -13$ .

4. Find the cosine of the dihedral angle  $C-AB-D$ .

Ans.  $SUVABACUVABAD = \frac{-1}{37\sqrt{10}}$

5. Find the sine of the angle between  $AD$  and the plane  $ABC$ .

Ans.  $SUADVABAC = -\frac{6}{\sqrt{185}}$ .

6. Find the projection of  $AB$  on  $CD$  and the distance between them.

$$\text{Ans. } S_{ABUCD} = \frac{19}{\sqrt{94}}, S_{ADUV}ABCD = \frac{78}{\sqrt{485}}.$$

7. Find the equation of the line  $AB$ .

$$\text{Ans. } AP = tAB, \text{ or } \frac{x-2}{1} = \frac{y-3}{2} = \frac{z+1}{2} \quad (= t).$$

8. Find the equation of the plane  $ABC$ .

$$\text{Ans. } SAPVABAC = 2x + 9y - 10z - 41 = 0.$$

- (a) The distance from this plane to  $(x', y', z')$  is  $S_{AP'UV}ABAC$ , or

$$\frac{(2x' + 9y' - 10z' - 41)}{1185}.$$

9. The vector whose tensor and components are the moments of  $AB$  about  $C$  and about axes through  $C$  parallel to  $OX, OY, OZ$ , is  $VCLAB = [2, 9, -10]$ .

10. The work done by  $CD$  in making the displacement  $AB$  is  $S_{ABCD} = 19$ .

Rose Polytechnic Institute,  
Terre Haute, Ind.

MOTION OF  $N$  BODIES.

By ARTHUR S. HATHAWAY.

The relative motion of  $n$  bodies, in any order of space, and subject to any law of mutual action, is given by

$$(1) \quad \ddot{\phi} = \phi\pi$$

where  $\phi$  is a matrix which transforms  $n$  determining points of a reference space of order  $n - 1$  into the positions of the  $n$  bodies, and  $\pi$  is a self-conjugate matrix, depending solely upon the ratios of the mutual reactions to the corresponding mutual distances.

The matrix  $\phi$  is of order  $n - 1$ , if the motion of the bodies is within the reference space, and  $\phi'$ , the conjugate of  $\phi$ , annuls every direction of the reference space exterior to the space of the moving bodies. If the space which contains the moving bodies be greater than  $n - 1$ 'st order the matrix  $\phi$  must be of the same order, but must annul all directions outside of the reference space.

The reduced equations of motion are,

$$(2) \quad (\dot{\psi} + W) \psi^{-1} (\dot{\psi} - W) = 2 (\ddot{\psi} - \psi\pi - \pi\psi),$$

$$(3) \quad \dot{W} = \pi\psi - \psi\pi,$$

where  $\psi = \phi'\phi$ , a function of the mutual distances, and  $W$  is a skew conjugate matrix, whose elements are to be found from the quadratic equations between them in (2), and thence substituted in the remaining equations of (2) and in (3), giving a certain number of reduced equations of second and third order.

Another equation which is linear in the elements of  $W$  enables us to find the reduced equations in third and fourth orders,

$$(4) \quad D_t (\dot{\psi} - \psi\pi - \pi\psi) = \pi\dot{\psi} + \dot{\psi}\pi + W\pi - \pi W.$$

Rose Polytechnic Institute,  
Terre Haute, Ind.





## DIRECT READING ACCELEROMETERS.

---

By C. R. MOORE.

---

Every person is more or less familiar with the subject of acceleration or deceleration—changes of velocity—whether or not the laws governing the same or the mathematical expressions therefor are understood. Such everyday occurrences as passengers swaying to and fro partially suspended from street car straps, the hurry up that accompanies one's movements as he tries to reach the car door just as the motorman stops the car, are examples which prove this. Changes in the rates of motion are essential to all forms of transportation, and the more rapidly a car or train can be brought up to speed (or stopped) the shorter will be the time required between two points when a given number of stops must be made. Railway trains, street and interurban cars are therefore started and stopped as quickly as is consistent with reasonable comfort, in response to the demand of the traveling public for fast time.

It is the purpose of this paper to discuss briefly the laws of motion, and to describe a new device for measuring the rate of change of velocity, showing results of tests recently conducted in the Electrical Laboratories at Purdue University.

The author realizes at the outset that the subject of acceleration measurement is an old one and is rather reluctant to lay claim before this body of scientists that what is offered herein is new. However as far as his knowledge goes this device has not been used previous to this time. The scheme is brought to your attention for whatever consideration it may merit.

Before discussing accelerometers in detail, a brief study of just what is meant by acceleration and deceleration may be of value.

In Fig. 1 curve "D" shows distances plotted against time, the distances being taken as ordinates and the time as the abscissæ. The car is to be thought of as moving from a certain point "O," distances "d" being measured from that point at the end of the any time "td." It will be noted that during the first few time units after the car starts the distance passed through each successive unit is greater than that passed through during the preceding unit of time, i. e. the rate of motion is increasing. At the

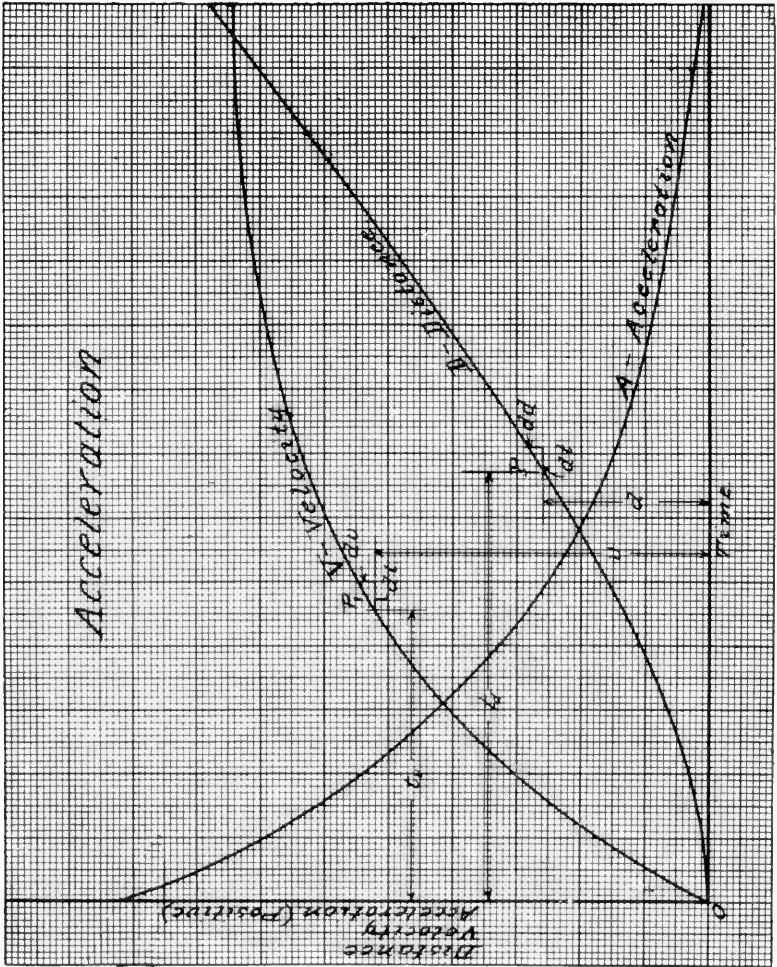

Fig. 1.

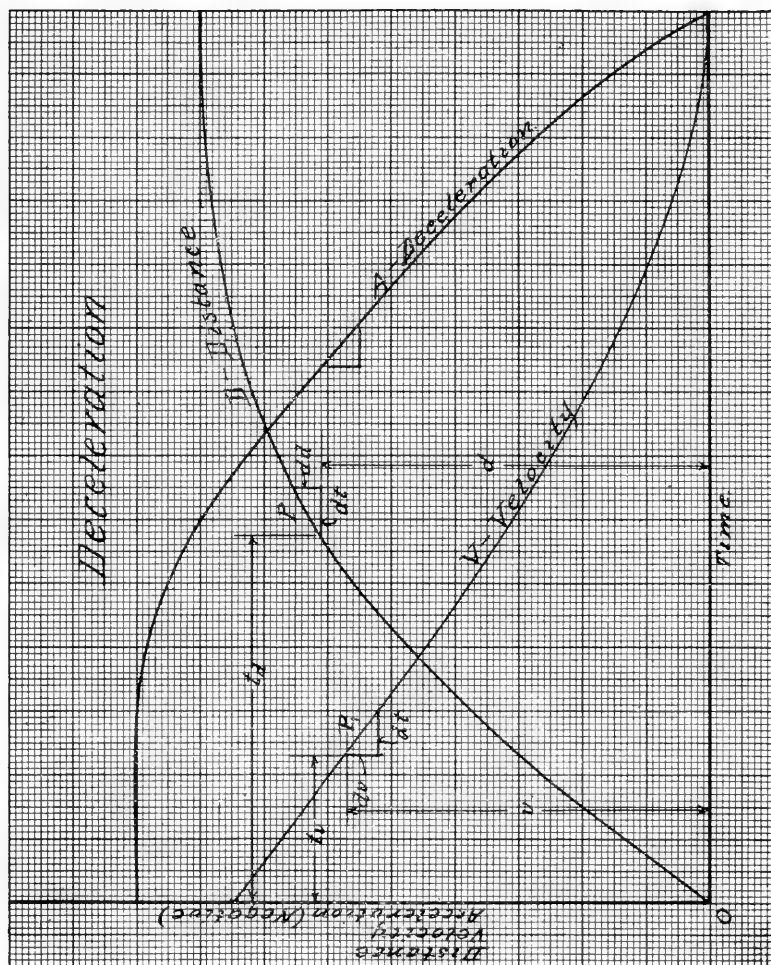

Fig. 2.

end of a certain time, however, equal increments of time show equal increments of distance. The curve then becomes straight because the rate of motion has become constant.

Velocity or the average rate of motion is defined as the space passed over divided by the time required for passage. The average velocity through any point then may be found by dividing small increments of distance by the corresponding increments of time. By taking these increments sufficiently small we may make the average velocity approach the true instantaneous velocity through any given point, as closely as we please. At the limit or when the increments become zero these velocities are equal.

Near the point "P" on the distance curves shown in Figs. 1 and 2 are drawn small triangles having for their vertical components small distances "dd" and for their horizontal components the corresponding increments of time "dt." From the above definition the average velocity for the space passed over designated by the small triangle will be  $v = \frac{dd}{dt}$ .

By taking this triangle very small the average velocity may be made to very closely approximate the instantaneous velocity at the point "P."

It is also to be noted that the ratio  $\frac{dd}{dt}$  is the expression for the tangent of the angle included between the line "dt" and that portion of the curve which completes the triangle. Values proportional to "v" may therefore be found at any point on the distance curve by drawing a tangent line at that point and finding the tangent of the angle between this line and the horizontal. Plotting these values multiplied by a constant gives the velocity curves "V" (See Figs. 1 and 2). From this curve we are able to determine the velocity of the car at any time "t."

By scanning curve "V" we note that the velocities for different time values until that time is reached where the distance curve became a straight line. At this point the tangent values become constant and the velocity curve becomes horizontal.

Just as velocity may be determined by dividing space passed over by the time required, so may the acceleration be determined by dividing the velocity change by the time required to make the change. The statements relative to average and instantaneous velocity also hold for average and instantaneous values of acceleration. We may therefore write  $a = \frac{dv}{dt}$

as the general expression for acceleration when derived from the velocity-time curve. As before, this expression denotes tangent values so that the acceleration curve may be obtained from the velocity curve in the same manner as the velocity curve was obtained from the distance curve. It is interesting to note that the acceleration curve reaches the X-axis at the same time the velocity curve becomes horizontal and at the same time the distance curve becomes straight. This is shown mathematically as follows:

$$v = \frac{dd}{dt} \quad a = \frac{dv}{dt} = \frac{d^2d}{dt^2} = 0 \text{ for } v = \text{a constant.}$$

or the value of "v" can be variable only so long as the distance time curve is not straight, and unless "v" is a variable the second derivative of the distance curve will be zero.

Physicists learned early that weight could not be taken as a standard of force on account of the variation of gravity with location on the earth's surface. Knowing however that force was required to change the velocity of a body it developed that when the amount of substance—mass—in a given body was known ( $m = \frac{w}{g}$ ) the force needed to give it a definite change in velocity in a given time was a definite function of these two quantities. The familiar expression for this is, Force = mass  $\times$  acceleration.

The equation is valuable to scientists and engineers alike. Using unit mass and unit acceleration, the scientist finds thereby a unit force which is constant. (The equation of the pendulum gives him the acceleration due to gravity at any point so that mass may be easily determined.) Knowing the masses involved in a given car or machine, the engineer is able to predetermine the torque necessary at the motor shaft to bring the same up to speed in a given time. This information is valuable for purposes of design.

After the apparatus has been assembled it is sometimes necessary to determine their performance. The mass being known it remains to measure the acceleration to see if the motors meet the requirements.

This measurement of acceleration has been attempted in many ways. A few of the more important schemes will now be considered. Accelerometers employing a freely moving mass of some sort have been most used. Dr. Sheldon's device is of this type, using a suspended weight carrying a pointer at the bottom (fastened thereto by rods) which plays over a scale.

The mass being free to move is sensitive to changes of velocity and the scale may be calibrated to read acceleration directly. The calibration is fairly simple and the device is not difficult to construct.

Another device working on the same principle consists of a "U" tube partially filled with mercury so placed that its plane is parallel to the motion of the car. It is obvious that changes of velocity will cause the mercury to rise in one side of the tube and to fall in the other. The more quickly these changes occur the greater will be the difference between the heights of the mercury in the two portions of the tube. The tube may therefore be calibrated to read acceleration directly.

Again the accelerometer takes the form of a slightly inclined track upon which rolls a ball. This track is made to extend in both directions and has a short level portion at the middle. Changes of velocity cause the ball to move one way or the other along the track. This device is difficult to read and is not very accurate.

All of these accelerometers are confined to horizontal motions and if the track be other than level corrections must be made therefor. This involves a great deal of labor and expense so that while the devices are simple in themselves their use is complicated. It is next to impossible to make them self-recording.

Another apparatus for reading acceleration consists of two magnetically actuated markers so arranged that dots may be made by each of them on a sheet of paper moved at a uniform rate of motion. The magnet of one of these pointers has its circuit closed through battery at regular time intervals by a clock. The other pointer has its magnet operated on a circuit which is closed through battery a definite number of times per revolution of the car wheel. From the record made by these pointers the acceleration at any time may be determined. This apparatus also involves a great deal of labor and expense and is seldom used.

The accelerometer which is the subject of this paper depends for its operation entirely upon electrical phenomena and is independent of its own location, motion or position. It will therefore read acceleration vertically or at any angle as well as in the horizontal direction. No corrections are necessary and it may easily be made self-recording. It is not difficult to calibrate and is permanent.

The circuit as originally conceived is shown in Fig. 3 in which "B" is an electric condenser, "C" an ordinary high grade direct current volt-

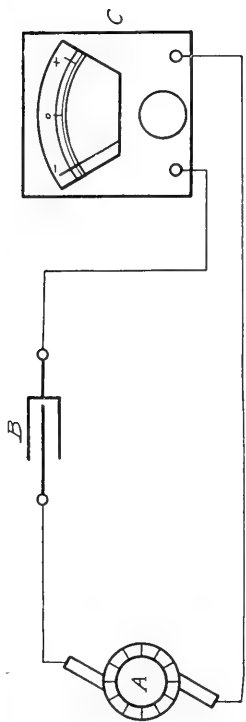

FIG. 3.

Fig. 3.

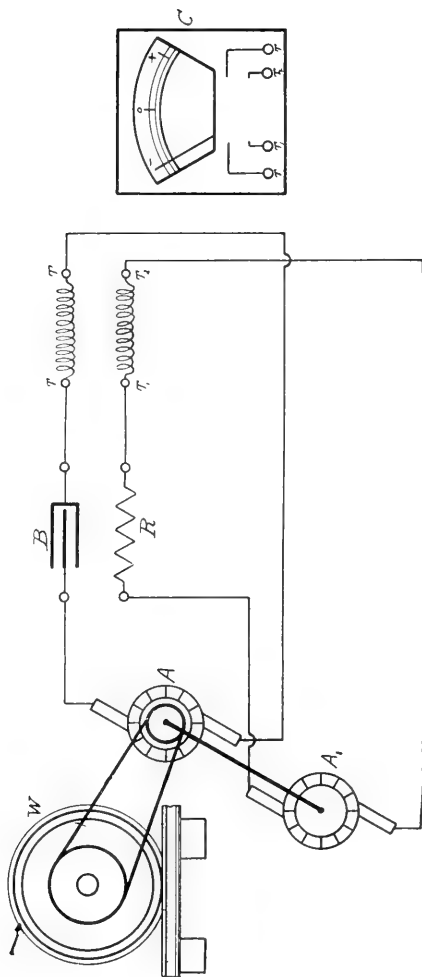

Fig. 4.

meter (with the extra resistance removed) and "A" is a direct current magneto generator having permanent magnet fields.

The equation of the condenser is  $Q=EC$ ; where  $Q$  is the quantity of electricity in Coulombs (ampere seconds),  $E$  is the voltage impressed, and  $C$  is the capacity in farads of the condenser. Studying this equation we find that if  $E$  is increased uniformly the quantity of charge  $Q$  on the condenser plates will also increase uniformly. Since  $Q$  is increasing uniformly with respect to time, the inflow of current is at a constant rate,

i. e.,  $i = \frac{dq}{dt}$ . Likewise a constantly decreasing  $E$  will give a constant outflow of current. However, as soon as  $E$  reaches a fixed value all current flow in the circuit ceases since it is one property of the electric condenser to arrest the flow of direct current. (The terms "inflow" and "outflow" refer to those condenser plates that are directly connected to the instrument terminal. Of course as much current flows on to one set of plates as flows off of the other plates, the current in the line having a definite direction during an increase of voltage and the opposite direction during a decrease of voltage.) The magnitude of these currents are shown by the direct current instrument which consists merely of a coil swinging in a uniform magnetic field. So long then as the voltage is changing uniformly the instrument will read a constant value returning to zero only when  $E$  ceases changing. It follows that if  $E$  does not change uniformly the instrument will not read a constant value but that its indications will be proportional to the instantaneous rate of change of the voltage. The direct current magneto is so designed that its voltage is directly proportional to its speed, so that changes of voltage at its terminals can only occur as a result of changes in speed. Therefore the instrument reads the rate of change of speed, i. e. acceleration whether positive or negative.

In a preceding paragraph it was implied that an electric condenser allows no current to pass when the voltage  $E$  has reached a fixed value. This would be a fact if an ideal condenser could be made, but it is a well known fact that there is always some leakage even in the best condensers. This means that the dielectric has a definite value of resistance which varies with different conditions and substances, and according to Ohm's law the leakage current will be  $i = \frac{E}{R}$ . This state of affairs renders our ideal circuit incorrect for any speed above zero because the instrument gets a small current in a definite direction that is practically proportional



to speed, and even if the voltages were constant—acceleration zero—the instrument could not return to its zero position.

The circuit must therefore be modified to compensate for this small leakage current, as is shown in Fig. 4. A second direct current magneto (or another commutator on the original machine) is arranged so that it can feed current through a high resistance to another coil on the moving element of the instrument. This second coil is wound over the first and works in the same magnetic field. The current is passed through it in such a direction that the torque produced thereby opposes the torque of the original coil. By adjusting the high resistance these torques may be made equal and the instrument will read zero for any constant value of voltage within reasonable limits. This allows the charging currents to actuate the instrument entirely independent of the leakage current and condensers of reasonable cost may be employed.

In Fig. 4 the second generator is shown at  $A_1$ , the high resistance at  $R$ , and the second coil on the moving element of the instrument has its terminals shown at  $T_1$  and  $T_2$ . These terminals are also shown in the separate sketch of the instrument C. It will be noted that the pair of magnetos are shown belted to a car axle. When this is done changes in the rate of motion of the car will produce changes in the voltages of the magnetos so that the instrument may be calibrated to read accelerations in terms of feet per second per second, as well as in terms of revolutions per second per second.

Figures 5 to 11 show the results obtained recently from tests on this type of accelerometer. Three curves (Figs. 5, 6 and 7) show positive acceleration, and three (Figs. 8, 9 and 10) show negative acceleration.

The experimental apparatus with which these results were obtained was made up as follows: the direct current machine in the condenser circuit was a separately excited generator of about 500 watts capacity having a normal speed of 1,800 R. P. M. The fields were excited from storage battery, about 140 milamperes being used. At 1,800 R. P. M. this excitation gave about 50 volts at the terminals. Since the field was constant and no appreciable current was taken from the armature the voltage remained directly proportional to the speed. The condensers had a combined capacity of about 65 micro-farads and were of the ordinary paper type. The instrument used was home made and very imperfect. Its moving element was very heavy, its frictional error large and the damping effect

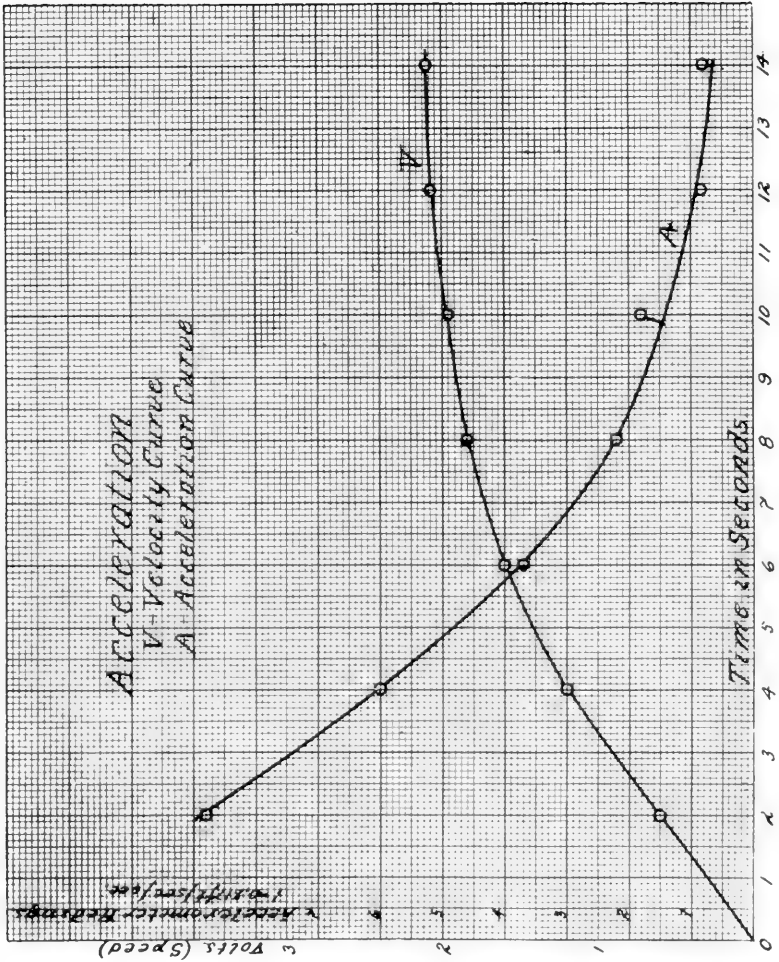

Fig. 5.

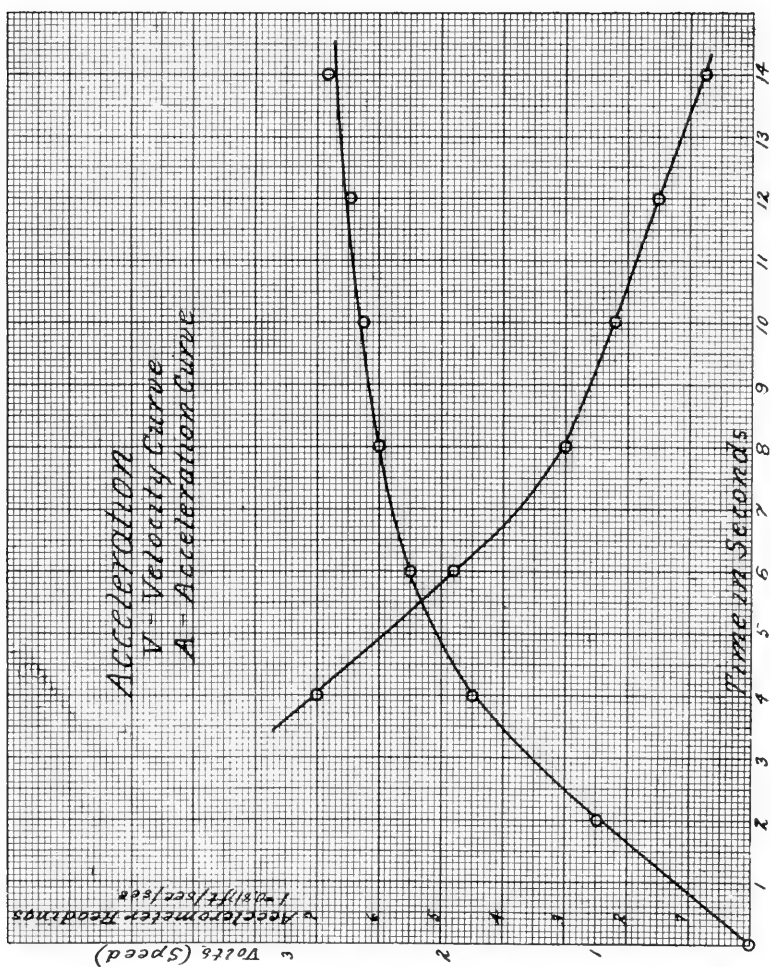

Fig. C.

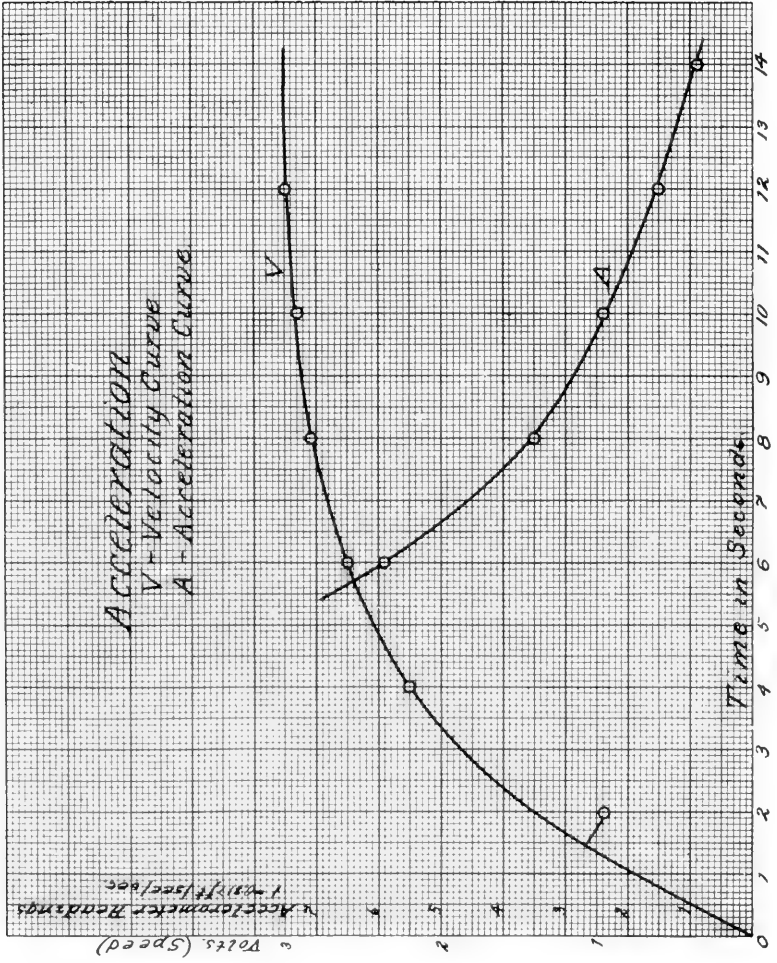

Fig. 7.

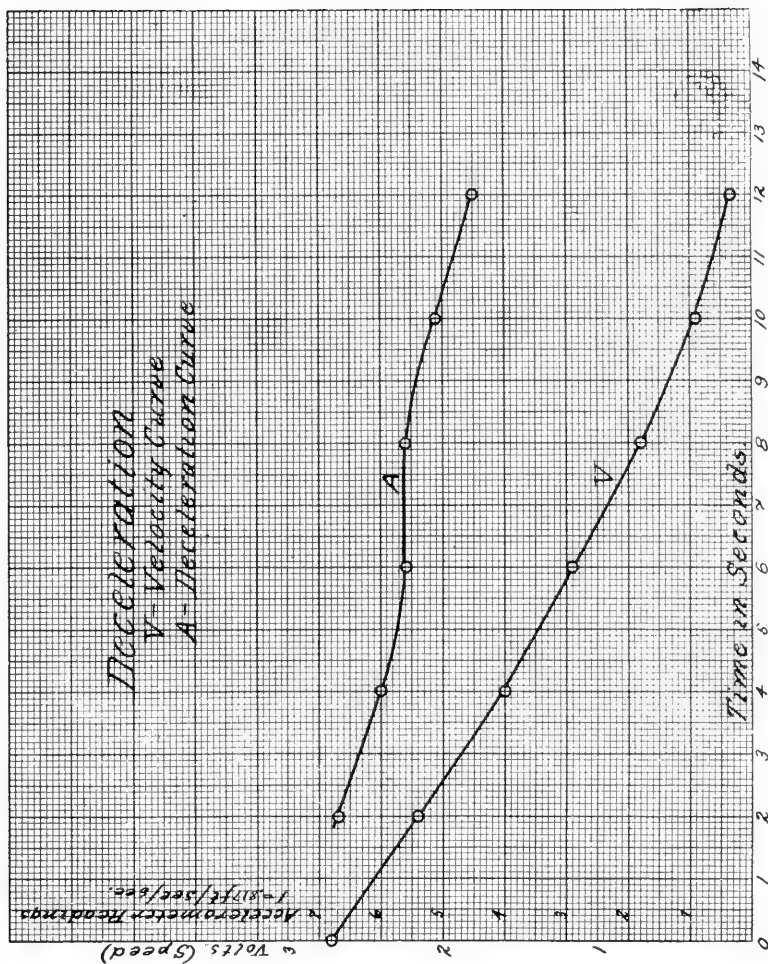

Fig. 8.

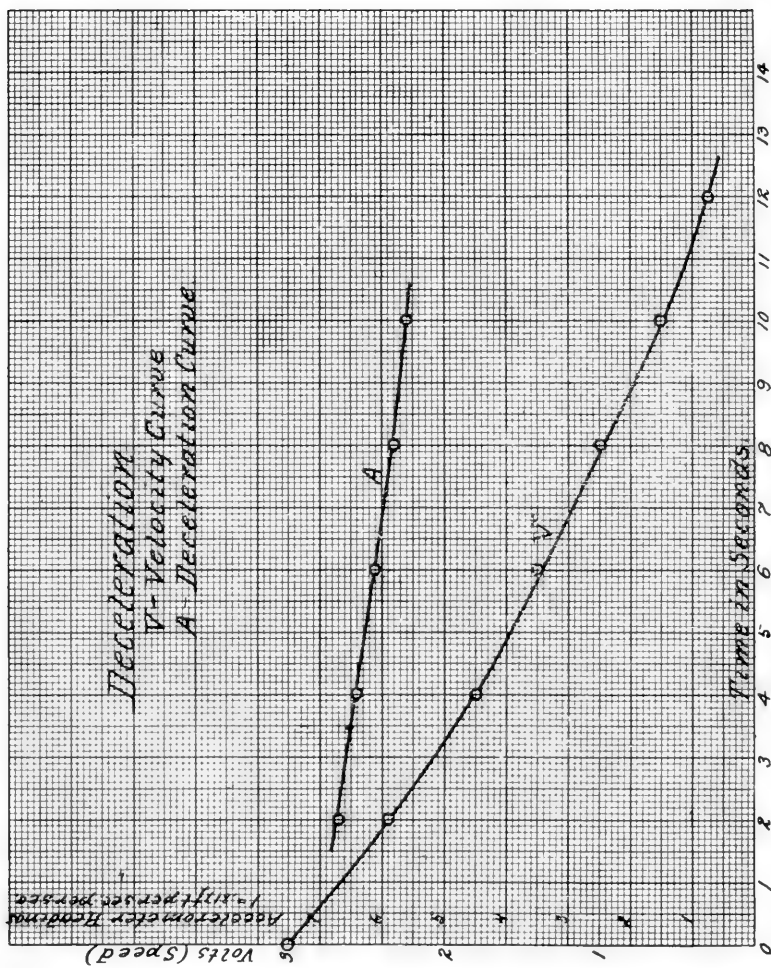

Fig. 9.

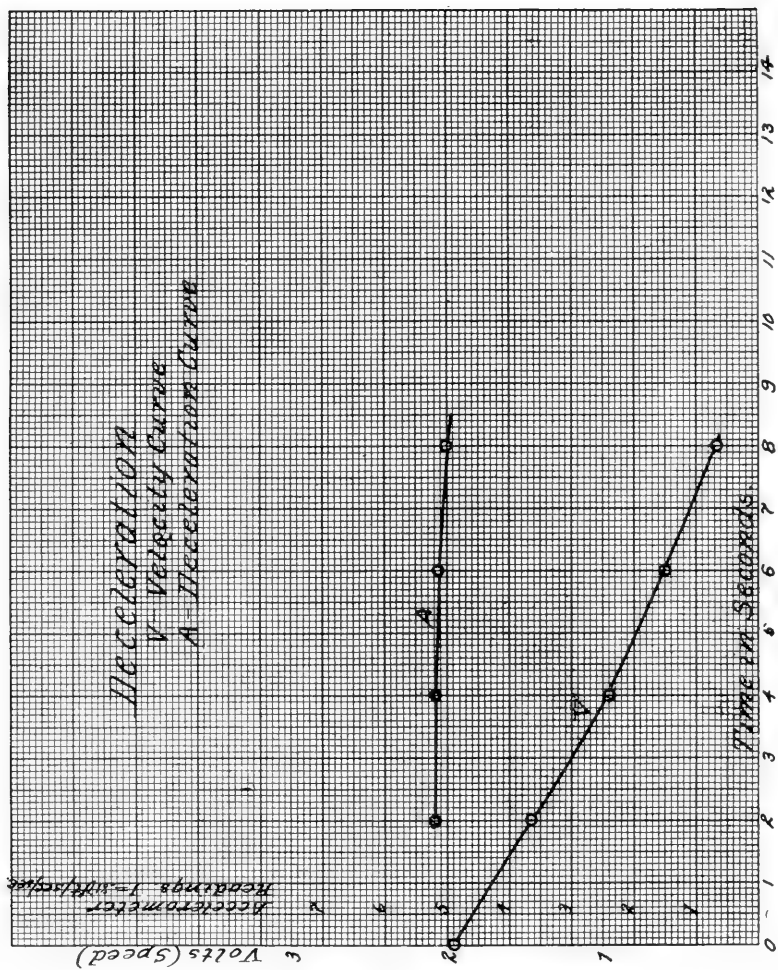

Fig. 10.

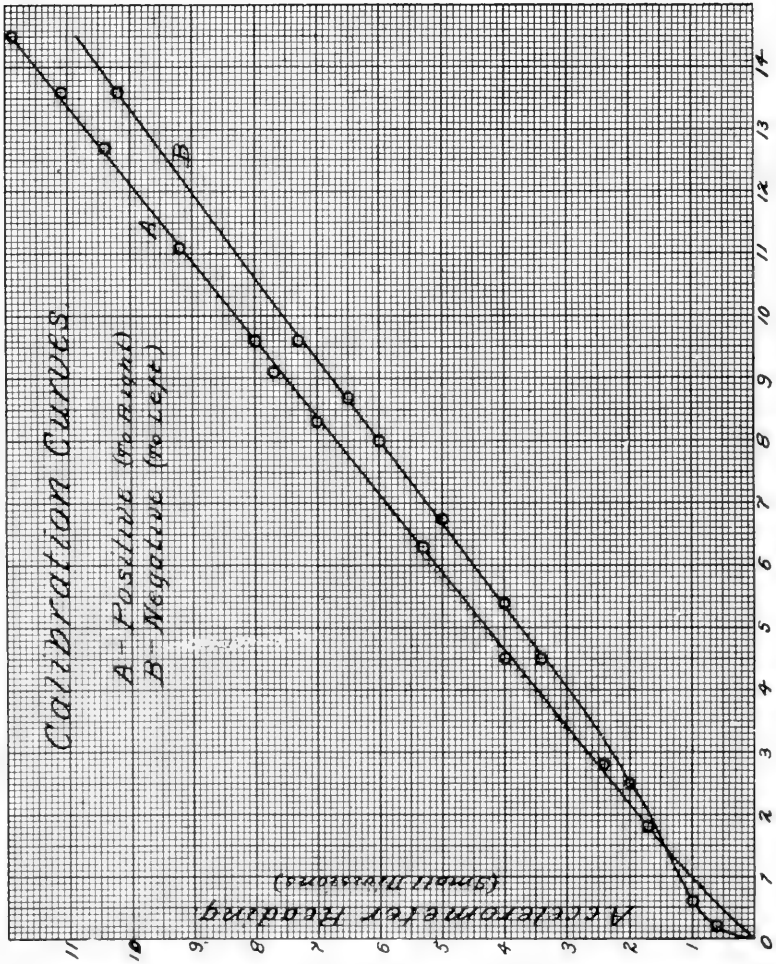

Fig. 11.



poor. Its calibration curves are shown in Fig. 11. These imperfections account for the variation in its calibration constant as will be stated later. The resistance circuit contained a three-volt, 1,800 R. P. M. magneto (permanent fields) directly connected to the motor shaft, as was the generator in the condenser circuit. The resistance employed was of the ordinary box type.

Acceleration was obtained by impressing suddenly a fixed voltage on the driving motor and reading values of speed and the accelerometer every two seconds. Deceleration was obtained by opening the motor switch and reading speed and the accelerometer every two seconds. The speed readings were secured by attaching a voltmeter to the three-volt magneto. Some of the readings thus taken are shown in Figs. 5 to 10 which are self-explanatory.

Scanning these curves brings out their similarity to the mathematical curves on Figs. 1 and 2.

Calibration is effected by drawing tangents at various points on the speed time curve and dividing the accelerometer reading at this point by the value of the tangent of the angle between this line and the horizontal. This quotient should be constant. Now by noting actual voltage and the corresponding speed the number of volts per revolution may be obtained. Our tangent value indicates volts change in a given time "t" which may now be reduced to revolutions change in the same time. If the generators be belted to a car axle the wheels of which have a known diameter this revolution change may be reduced to the corresponding change of linear velocity in the given time "t."

For the tests herein described, however, the instrument scale was arbitrarily drawn and, with the particular circuit set up, each small division corresponds to an acceleration of 0.33 revolutions per second per second. If it had been used on an interurban car having 24" wheels its scale would indicate 0.817 feet per second per second per small division. This value could be reduced to a workable figure by using a larger condenser, a higher voltage and a more sensitive voltmeter.

These calibration values varied from 15 to 25 revolutions per second per second per small scale division on account of imperfections in the instruments and the small readings made necessary by having insufficient capacity.

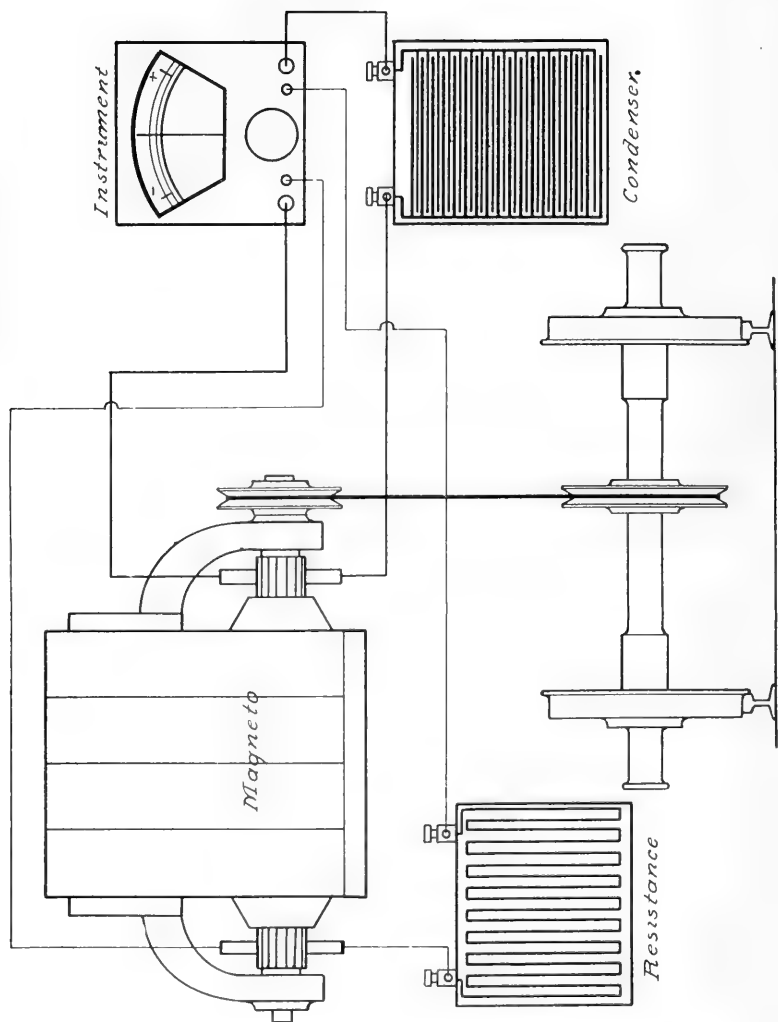

Fig. 12.

Almost any condenser when suddenly discharged if allowed to stand a few minutes will experience a rise in potential at its terminals. This rise is due to what is known as the residual charge. This phenomenon is explained as follows: When a condenser is charged its dielectric is strained and being non-homogeneous the strains are unequal. (By strain is meant the actual compression of the plates.) When discharged these strains are relieved but they do not decrease at the same rate, so that some parts of the dielectric become strained in the opposite sense and balance those parts which are slower in acting. The condenser is then apparently discharged, but after standing a while these strains tend to diminish and usually there is a resultant strain set up. This resultant strain is due to the fact that while the forces were originally balanced at the end of the first discharge, yet the distances are unequal and in nonhomogeneous materials stress is seldom proportional to strain.

The condenser may now be discharged again and after a time may show still another rise of potential. In the apparatus herein described this effect is entirely negligible, for the reason that the condenser is never charged or discharged suddenly, some few seconds being required to complete the action.

In all condensers there is also some absorption, but with good condensers used at the voltages proposed for this apparatus this effect is also quite negligible, and we may with certainty say that for a given voltage change at any part of the potential range equal quantities of electricity pass through the instrument.

With an instrument giving a uniform scale therefore we have an apparatus which will show equal increments of readings for equal rates of change of velocity, i. e. a direct reading accelerometer.

Fig. 12 shows the apparatus as assembled for use in railway work. The double commutator magneto is here shown belted directly to the car axle. It is obvious that the readings of the instrument are unaffected by grades or side tiltings of the car.

The apparatus may be made self-recording by employing a recording instrument instead of an indicating one, as shown in Fig. 13. These recorders may be obtained in the market and are very sensitive and reliable. The record is made by placing a pen on the end of the voltmeter pointer, the whole being pulled down upon a sheet of paper moving at a uniform rate of motion by means of a small magnet whose circuit is

closed through battery by a clock. The record is thus made automatically and needs no correction.

The accelerometer may be made self-contained and is easily transferred from one car to another.

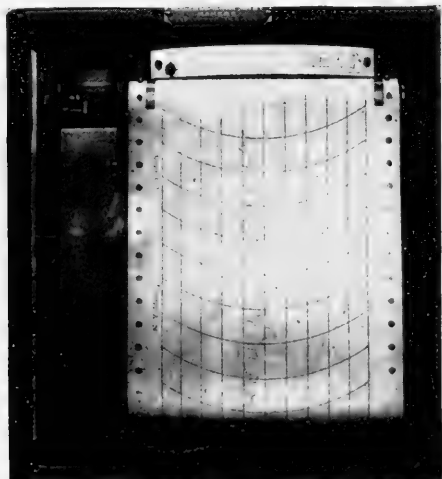

Fig. 13.

Before closing, the author wishes to express his appreciation of the efforts of Messrs. F. C. Weaver, G. T. Shoemaker and E. E. Thomas, members of the present Senior Electrical Class at Purdue University, whose kindly assistance made this paper possible.

Purdue University,  
Lafayette, Ind.

## SOME NOTES ON THE STRENGTH OF CONCRETE BUILDING BLOCKS.

BY H. H. SCOFIELD.

The concrete building block industry is rapidly assuming an important position and is now established on a firm basis among the other industries supplying building materials.

Reinforced concrete is now very largely used and seems to be the best form of concrete used for floors, beams and columns, but the concrete block seems to be the form of concrete most adaptable for use in the walls of residences and other buildings.

The industry has grown so rapidly in the past few years that standard specifications for their manufacture and use have been adopted by the National Association of Cement Users and by many cities of the United States. The need for proper specifications was brought about mainly on account of the large number of inferior blocks placed on the market by irresponsible manufacturers. The causes for this are various, such as: a desire for higher profits brought about by using inferior ingredients; ignorance as to the best methods of using the materials at hand, careless workmanship and improper treatment as to storage, etc.

The specification for crushing strength as called for by most specifications is so high that it can be filled only by the best methods and the best material, and although it is many times more than a block will ever be called upon to stand in actual use in a wall, yet it insures a block which is strong, dense and thereby water-proof, with clean-cut, smooth edges, and a block which will endure for ages.

The following are some items which enter into the making of good concrete blocks:

In the selection of a cement, a maker has two alternatives. He must either use a first-class, standard brand of known excellence, or he may use the competitive brands on the market, thereby getting lower prices. In the latter case, he should have each shipment sampled and tested by a reliable testing laboratory.

An unsound cement may not show up till the block is in the wall or for years after, but it is practically inevitable that the block will finally

crack and disintegrate. Some cement companies take proper precautions in the treatment of raw materials and storage of the finished product, such that very rarely does an unsound cement leave their mill. Other companies, in the rush of business, do not properly mix and grind their raw material and finished cement, and do not store the cement long enough for the hydration of the free lime present. These are conditions that tend to place more or less unsound cement on the market. The future of the concrete block manifestly depends to a great extent upon the use of a sound cement.

For maximum strength in concrete, the cement must be finely ground, but fine grinding is expensive and consequently this part of the manufacture is often slighted. The cement should also be slow setting, as a cement that reaches its initial set in two or three hours will be stronger at the end of seven days or a month than a quicker setting cement that reaches its initial set in forty or fifty minutes.

The cement to be used in concrete blocks should\* in all cases pass the specifications of the American Society for Testing Materials.

Too frequently the reason for poor concrete is ascribed to poor cement, and no thought is given the other materials entering in, namely; sand, gravel or broken stone. The selection and proportioning of the aggregate for the best concrete is very important in the building block industry. It is well known that the proportions of cement, sand and stone which will give the densest mixture of concrete will also give the highest strength. It is also recognized that a rich, dense mixture of concrete is the most nearly waterproof that concrete alone can be made. So that for a strong, water-proof block, it is important that the cement and aggregate be properly proportioned. This may be done by actual trial mixtures to determine the densest concrete. An aggregate containing coarse stones and sand has greater density than sand alone and consequently is better for use in concrete blocks.

According to Wm. B. Fuller, an eminent authority on concrete, the most nearly perfect gradation of sizes of particles in an aggregate may best be known by the process of mechanical analysis and subsequent re-proportioning. In case the business warrants it, samples of the gravel should be submitted to a reliable testing laboratory for mechanical analysis to determine the proper proportions,

A dirty gravel or one that contains impurities should be washed. This will not only improve the strength of the concrete, but will make a more uniform and desirable color for the finished block.

It is now agreed that cement hardens by a process of crystallization of the active elements. Water must be present for the crystallizing to go on. Therefore it is necessary that the proper amount of water be used in mixing the concrete. This, by some authorities, is from 8 to 18 per cent. Also it is necessary that after moulding, the block must not be allowed to dry out, as no subsequent addition of water will give perfect crystallization. Some makers cure their blocks in a steam bath, thereby insuring constant moisture. The economical value of steaming concrete blocks is a subject for experiment as yet. Most specifications limit the time after making at which blocks may be used in the wall, so that the increased speed of hardening by the steam process is not so important.

The specification for crushing strength of concrete blocks, in most cases, is 1,000 pounds per square inch of gross area, no allowance being made for the hollow spaces. The block must reach this strength in 28 or 30 days after making.

The city of Indianapolis has recently adopted specifications for concrete building blocks, and the results of the first series of tests for the block makers of that city by the Laboratory for Testing Materials of Purdue University, indicate a chance for improvement.

Of 75 tests of blocks, supposed to have been made under the specifications, only 28 per cent. passed the specification for crushing strength, and the average age of these was 41 days instead of 30. Similar results have no doubt been found in all cities which have adopted a building block ordinance. However, under the influence of these somewhat rigorous specifications, it is to be expected that the quality of the product on the market will greatly improve. This in itself will strengthen the industry for those makers who are content to manufacture good blocks at a reasonable profit.

Purdue University,  
Lafayette, Ind.





## POLARIZATION OF CADMIUM CELLS.

BY R. R. RAMSEY.

While working on another problem (Phys. Rev. Vol. 16, p. 105) it was noted that the E. M. F. of a cadmium cell was greatly decreased and at times apparently reversed after a considerable quantity of electricity had passed through it.

To investigate the cause of this phenomenon the experiments described below were undertaken. Work of a similar nature has been carried out by F. E. Smith (Phil. Trans. Roy. Soc. Lon., Series A, Vol. 207, p. 393); by S. J. Barnett (Phys. Rev. Vol. 18, p. 104, 1904), and by P. I. Wold (Phys. Rev., Vol. 27, p. 132, 1909). However, in their experiments the time of polarization was comparatively small, the attention of the investigators being directed to the initial polarization or to the rate of recovery. In my work I have attempted to find the cause of this polarization.

Cells were constructed of the H type and according to the accepted formula for cadmium cells. The chemicals used were C. P. chemicals of commerce. With ordinary care a cell could be obtained whose E. M. F. did not differ more than .001 volt from the standard value. Measurements of E. M. F. were made by means of a potentiometer. At times where rapid measurements were desirable and great accuracy was not necessary a voltmeter was used, the readings being corrected for the internal resistance of the cell. Current was measured with a milliammeter and time was measured with a watch. At first it was thought that the polarization was a surface effect, that a relation existed between the area of the surface of the electrode and the quantity of electricity required to polarize a cell to some standard amount. Cells were made with electrodes of various diameters. The current was noted at stated intervals, so that the total quantity could be calculated. This was found to differ in different cells, but it appeared to depend more upon the past history of the cell than upon the electrode surface exposed.

It was found that after a cell has been polarized once and has regained its normal E. M. F. again it required less quantity of electricity to polarize it than it did during the first run. A cell with three legs was

made. Two of the legs were filled with mercury and the third was filled with cadmium amalgam. Connection was made to the amalgam terminal and to one of the mercury terminals and current passed until the cells were polarized. Measurements were made by means of the potentiometer, and it was found that the E. M. F. between the unpolarized mercury terminal and the cadmium terminal was normal, while the polarized mercury terminal gave a very small value, showing the polarization to be at the mercury terminal. Measurements were made between polarized cells and unpolarized cells by connecting the two cells together by means of a siphon filled with cadmium sulphate solution. In every case it was found that the polarized mercury terminal gave low values, while the polarized cadmium terminal gave normal values when connected to unpolarized mercury terminals, never deviating more than could be explained by concentration and temperature effects.

A cell (5) was short circuited for some days and part of the mercury was removed with a pipette, washed and filtered through a pinhole and made the mercury terminal of a new cell (6) from which the mercurous sulphate was omitted. The E. M. F. was measured from time to time and the recovery noted. The following table gives the results.

		E. M. F.	
		(5)	(6)
March	9, 5:15 p. m.	0.1308	0.1290
March	10, 9:00 a. m.	.1320	.1307
March	10, 3:45 p. m.	.1363	.1310
March	12, 9:20 a. m.	.1488	.1339
March	13, 10:15 a. m.	.1675	.1322
March	14.	1.0222	.1317
March	15.	1.0242	.1335
May	14.	1.0146	.0691
June	8.	1.0177	.0533
August	26.	1.0189	.0637
September	24.	1.0150	.0462

The above table shows that cell (5), which contained mercurous sulphate, recovered its E. M. F. in a few days, while (6) remained polarized for six months. The results show the E. M. F. in March to be greater than the later values. This may be due to the cadmium sulphate solution not being concentrated in the early observations or to some constant error of the potentiometer. The table shows that the polarization is due to

something in the mercury which can not be washed or filtered out. But is removed by mercurous sulphate. The mercury from cell (6) was taken out and placed in a tube and sparked by a large electric machine. Cadmium lines were very distinct in the spectrum. Thus it would seem that polarization is caused by cadmium being deposited in the mercury and that the recovery is due to the removal of the cadmium by the mercurous sulphate.

Indiana University,  
Bloomington, Ind.



## AN INVESTIGATION OF A POINT DISCHARGE IN A MAGNETIC FIELD.

BY OSCAR WILLIAM SILVEY.

Since the announcement of the magnetic deflection of the electric arc and of the path of the particles of a vacuum tube discharge, there has been some investigation of the electric discharge in a magnetic field at atmospheric pressure.

Among the first of these investigations was that of Precht,<sup>1</sup> who found that when a spark passed transverse to the lines of force in a magnetic field, between a point anode and a blunt cathode, there was a deviation of the path of the spark, especially from the middle portion of the spark gap to the cathode, the spark increased in brightness, and there was a decrease in the fall of potential between the electrodes. Also, if the electrodes were separated farther until a brush discharge existed between them, the stream showed a deflection, the potential between the points decreased, and the brush often changed into a spark discharge, when the electro-magnets producing the field were excited. In case of the glow discharge, where there existed a small brush at the anode and a bright spot on the cathode, with the intervening space dark, the spot moved up or down according to the electrodynamic laws, when the field was magnetized first in one direction and then in the other.

In case a point cathode was used with a blunt anode, the spark was deflected and the potential raised, when the magnet was excited the spark discharge being often changed to a brush.

II. E. Schaeffer has recently studied the effect of the magnetic field on the spark discharge of an induction coil in each of the following types of spark:

"1. The spark obtained when neither capacity nor self-induction had been introduced into the secondary circuit of the induction coil.

"2. The spark obtained when a capacity of 0.005 to 0.012 microfarads had been introduced into the secondary circuit.

<sup>1</sup> J. Precht, *Wied. Annalen* (66-4, pp. 676, 697), 1898.

<sup>2</sup> H. E. Schaeffer, *Astro-Physical Journal* (28, pp. 121-149), Sept., 1908.

"3. The spark obtained when a capacity of .0005 to .012 M. F. and a self-induction of 0.003 henrys has been introduced into the secondary circuit."

In this study it was found that "when the magnetic field was parallel to the spark length, the first type of spark presented two sheets of vapor in the form of spirals. In a field at right angles to the spark length this vapor is in the form of two semicircular sheets, one being on each side of the spark gap in a plane perpendicular to the direction of the magnetic field.

"In the second type of spark (if the capacity did not exceed .002 M. F.) and in the third type brilliant spiral threads in a parallel field and brilliant circular threads in a transverse field took the place of the spiral and circular sheets respectively. In the first and second types of spark the bundle of threads across the gap could not be deflected by a magnetic field of 12,000 gausses. In the third type the metallic vapor and the threads across the gap were deflected in a very strong field and in a manner analogous to that of the circular and spiral threads. Reversing the direction of the magnetic field, or that of the current through the primary of the induction coil, changes the position of the sheets and of their ends. Decreasing the current through the primary or lengthening the spark gap sufficiently, causes one sheet or one set of threads to disappear."

The different parts of the deflected spark were analyzed by the spectroscope, and it was found that the "Circular sheet of the first type of spark gave a spectrum of nitrogen bands, while the central threads showed that of the metallic lines and the air lines. The second type gave the same spectrum of bright air lines, and fainter metallic lines, for both circular threads and central threads. The third type showed the same spectrum (air lines) for all metals used as electrodes. The spectrum of the circular threads showed the arc lines in addition to the air lines."

By means of a rotating mirror, the velocity of the circular threads of the spark was determined, and from this a value for  $\frac{E}{M}$  calculated.

Prof. A. L. Foley<sup>1</sup> passed transversely through a long tube which served as a pinhole camera an electric discharge and observed that when a photographic plate was placed at the opposite end of the tube from the pinhole, the plate after exposure showed a shadow picture of a stream

<sup>1</sup> Not yet published.







between the points which were used as electrodes. The picture of this stream was surrounded by interference or diffraction fringes, in some ways resembling the fringes about the solid points themselves.

The principal object of the present investigation was to study the effect of a magnetic field upon this stream and to study the character of the particles composing it.

The apparatus used was that constructed by Prof. Foley and Mr. Haseman for the investigation of interference fringes about a point discharge, air streams, and vapor streams. It consisted of a wooden tube 6.87 meters long (Fig. 1). One part 20.3x20.3x230 cm. was made to telescope over another part 15.2x15.2x457 cm. This provided a means of separating the two parts for adjusting the points and magnets. Another portion (E., Figs. 1 and 3) containing a plate holder (F) was made to fit over the end. The tube was painted a dead black inside, and at intervals screens (Fig. 9) were placed throughout the tube so that no light would be reflected from the sides. An opening was made in the lower side of the tube beneath the points and through this opening a magnet was introduced so that the lines of force were perpendicular to the direction of the line of discharge. During the latter part of the experiment a similar opening was cut in the top of the tube and a second magnet placed above the first one so that like poles faced each other. Figs. 4, 5, 6 and 8. show the successive attempts to increase the field strength. The end of the tube (C) was closed by a cap which shut out all light except from a pin hole, as shown by Fig. 2. A circular disc with holes of various sizes provided a means of regulating the amount of light. A is a 90° arc lamp, the crater of which is focussed on the pin hole by the lens B.

Light was shut out of the tube by placing a piece of black card board in front of the pin hole. When a photograph was to be taken, if the discharge was a silent or brush, the slide (S) was drawn from over the plate, and after the tube had come to rest, the card board was removed until the plate was sufficiently exposed. In case of the spark discharge which fogged the plate if exposed too long, the card board was first removed and the exposure made by withdrawing the slide.

The points first used were made of sharply pointed brass pins 0.61 mm. in diameter and 3 cm. long. In the latter part of the experiment the brass pins were replaced by steel millinery needles 0.70 mm. in

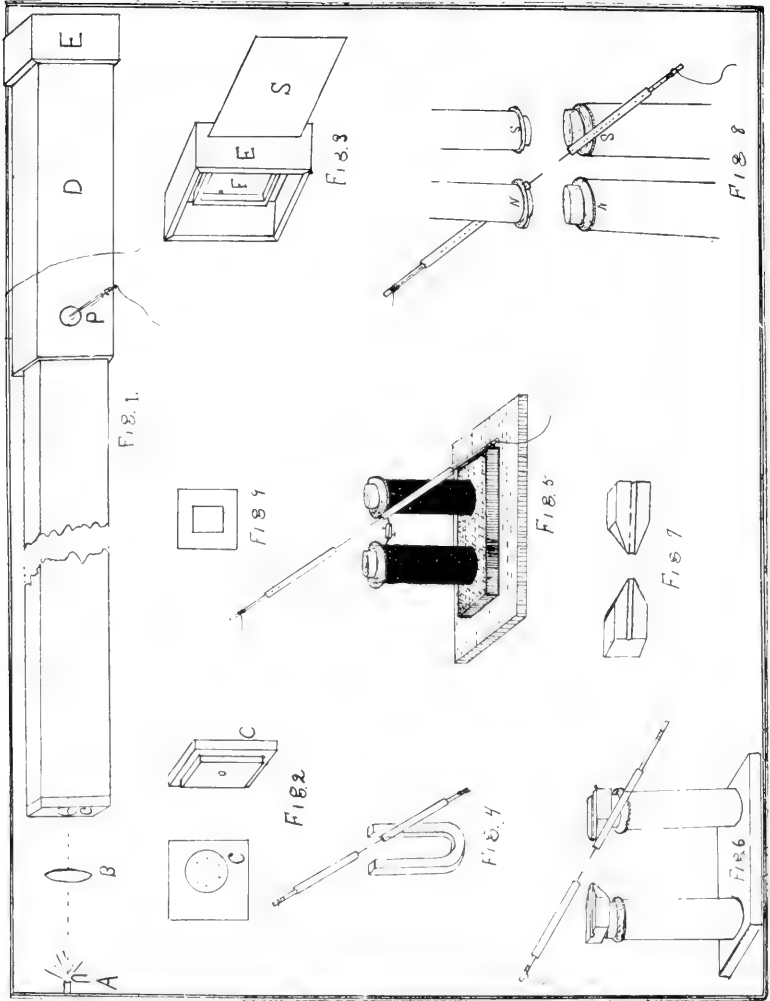

diameter and 5.2 cm. long. They were soldered into the ends of brass rods 0.5 cm. in diameter. The rods were placed in glass tubes and held firm by sealing wax at the two ends of the tubes. The points were charged by means of a four-mica-plate Wagner static machine (the Leyden jars had been removed), which was run by an electric motor with a rheostat in circuit for regulating the speed. The rods extended through the sides of the camera as shown by (P) Fig. 1, so that the points were near its axis. The points were about 15.5 mm. apart for the first three series of photographs and about 17 mm. apart for the last four series.

For the first series of photographs the magnet extended through the lower side of the tube directly below the points and was placed so that the tops of the pole pieces were about 0.5 cm. below the points. When the separable pole pieces, Fig. 7, were used they were covered with a layer of sealing wax about 3 mm. thick on all sides except the one facing the magnet cores, to prevent sparks passing to the magnet from the points.

As a preparation for the experiment the simpler part of Precht's work was repeated (i. e., apparatus was set up containing one point and one blunt electrode in the same position shown by the points in Fig. 6). The deflection of spark, brush and glow discharge were easily observed in a semi-darkened room when a transverse field was produced by exciting the magnets. Some cases were observed in which the discharge was transformed from one type into another, but no measurements were made of the potential, nor determination made of the signs of the charge on the points to see if they accorded with the results given by Precht.

The magnets and points were then placed in the tube as described and photographic records made of the discharge. The silent discharge was first studied. To produce the magnetic field a permanent horseshoe magnet was first used, and although it was strong enough to blow out the arc of an arc lamp, the photographs taken showed no deflection of the stream. It was then replaced by an electro-magnet, Fig. 5, later pole pieces, Fig. 7, were placed as shown in Fig. 6, and finally two electro-magnets placed in opposition, Fig. 8, in attempts to produce a field sufficiently strong to deflect the stream. The magnets were weak compared with those used by Precht and H. E. Schaeffer. The field measured only about 1,000 gauss as used in Figs. 5 and 6, and only about 1,500 gauss as used in Fig. 8. None of the photographs taken of the silent discharge showed any deflection when the magnets were excited.

Seven series of photographs were then taken.

A—Is a visible spark discharge.

B—Is a Brush discharge (a violent stream extended about 0.8 cm. from the positive point. The negative point showed only a bright speck).

C—The glow or silent discharge. (Nothing was visible between the points in the darkened tube. Each point showed a bright speck.)

D—Spark discharge representing the highest speed of the machine and highest potential between the points.

E—Spark discharge, representing the lowest speed of the machine at which a visible spark passed between the points. A lower speed would have caused the spark to change to brush.

F—Silent discharge, same as C.

G—Silent discharge, same as C. Deflected by a stream of air issuing from below the points.

The different series in decreasing order of their potential as represented by the relative speed of the machine are D, A, E, B (C, F or G). Series A, B and C were taken with magnet and pole pieces as represented in Fig. 6. The magnetic field strength was about 1,000 lines per sq. cm. in the region of the points. The points were 15.7 mm. apart. Series D, E and F were taken with the magnets as shown in Fig. 8. The magnetic field strength in the neighborhood of the points was about 1,500 lines per sq. cm.

The six numbers of each series, A, B, C, D, E and F, were taken in succession as rapidly as possible, it requiring 20 or 30 minutes to complete the series. In the photograph the longer stream is the one from the positive terminal and the shorter one the stream from the negative electrode. If the positive stream is from right to left it is designated as "first direction," if from left to right, as "second direction." Nos. 1, 2 and 3 then show current in the "first direction," while Nos. 4, 5 and 6 show current in the "second direction." If the magnets were excited so that the direction of the lines of force were from the front to the back of the photograph (i. e., after correcting for the reversal in direction caused by printing from the plate), the direction of magnetism is designated as "first direction," and those with the lines of force from back to front of the page are designated as magnetized in the "second direction."

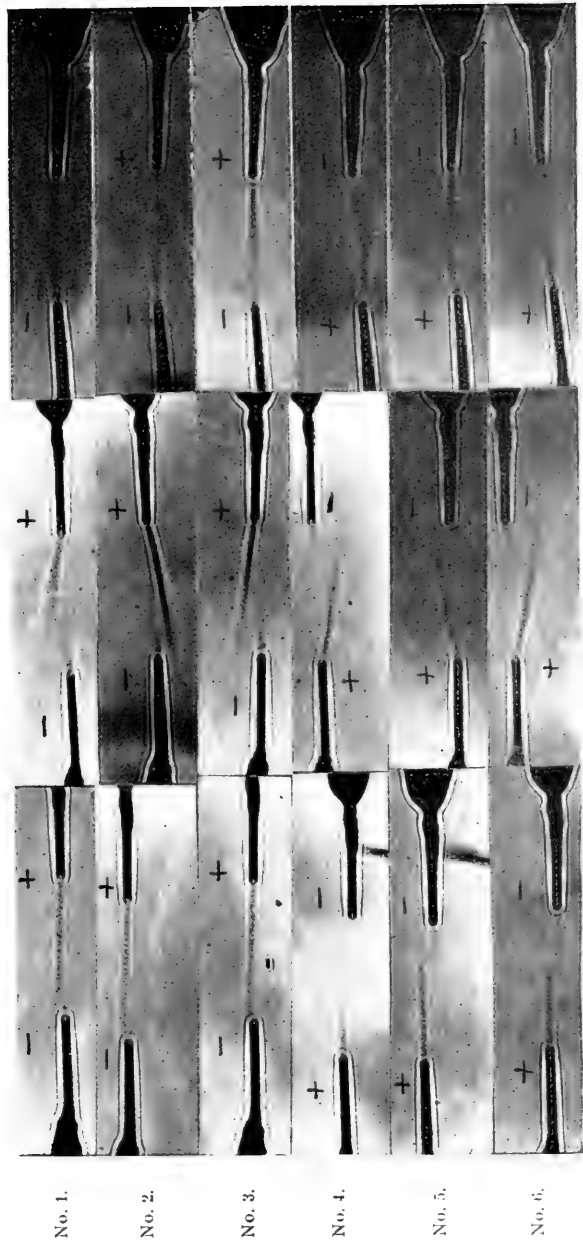

No. 1.

No. 2.

No. 3.

No. 4.

No. 5.

No. 6.

D

No. 1. Current first direction; magnetism (none).  
 No. 2. " " " " 1st direction.  
 No. 3. " " " " 2d

E

No. 4. Current second direction; magnetism (none).  
 No. 5. " " " " 1st direction.  
 No. 6. " " " " 2d

F



Following then this plan, Nos. 1 and 4 show the current when the magnets are not excited. Nos. 2 and 5 show the current in a field of the "first direction," and Nos. 3 and 6 show it in a field of the "second direction." It may be observed from the photographs that the streams in series A, B, D and E are deflected as if they were flexible conductors bearing a current, in so far as direction of deflection is concerned, thus indicating that the stream is one of charged particles.

But some characteristics of the photographed stream are hard to explain on the theory that the air is ionized and that the stream consists of charged particles. The glow discharge and the negative stream in all cases show no deflection in a field of 1,500 gauss. Also the stream goes in a straight line after leaving the point instead of following a curved path to the opposite electrode, and there seems to be no connection or joining of the negative and positive streams. In some ways it acts as the air and vapor streams investigated by Professor Foley and Mr. Haseman. In case of the silent discharge, where the machine was run at its lowest possible speed and the potential was the lowest, the stream retains the same size as far as it can be traced. In series B there is not much change in the width of the stream. Series E shows the stream growing broader as the distance increases from the electrode. Series A shows a still greater broadening and D an even greater dispersion. The greater pressure in the stream no doubt accompanies the greater potential difference, and therefore accompanies the greater dispersion of the stream, as was shown to be true in case of air and vapor streams by Professor Foley and Mr. Haseman. Series E and B show a greater deflection than any other series, and since B was the highest potential brush discharge and E the lowest potential spark discharge which could be obtained without a transformation of the type of discharge, these few photographs indicate that the greatest magnetic deflection is produced when the discharge is on the verge of changing from one type into the other. Enough photographs were not taken to verify this, however.

It will be observed in Nos. 1 and 4 of the series E that the stream does not always pass along a line directly between the points, even when the discharge takes place outside a magnetic field. In the observations made such cases were in a minority, the discharge as a rule passing directly between the points or nearly so. The cause of its deviation in these few cases was not learned.

Also, very often when adjusting the speed to obtain photographs for series B and E the discharge would change from one type to the other when the magnets were excited. Precht found that this was the case, but these observations can hardly be compared with his, since point electrodes were used in this case, while he used one point and one blunt electrode. In all cases observed where a change occurred, if a brush discharge in a nonmagnetic field passed above or below a line directly between the points as shown by the spark discharge E, 1 and 4, and the magnets were excited to deflect the stream in such a way as to make the path of discharge shorter, it changed to a spark discharge. Or if a spark discharge passed directly between the points and was deflected it changed to a brush. In all observed cases (possibly 25 or 30) the transformation could be explained by the change of distance.

The series G shows the effect of an air current on the path of discharge. The air current was led into the camera through the bottom side by means of a glass tube 2.25 cm. in diameter so that the mouth of the glass tube was 2.2 cm. below the points, and flowed at the rate of about 1,200 c. c. per second. Nos. 1 and 3 show the discharge without the air current, and Nos. 2 and 4 show deflection by the air current. It differs from the deflection produced by the magnetic field in that the greater deflection here is with the negative stream. This indicates that the pressure is not as great in the negative stream as in the positive, which agrees with the work of 'S. Arrhenius, who measured the torsion produced by a suspended wire cross with points bent at right angles to point in the same direction and found that the torsion produced by the negatively charged wire was less than the positively charged wire, which was more clearly shown the lower the potential. (Note—It was intended to show a photograph with current in second direction, deflected by an air current. G 4, which should have shown this, shows a current in the same direction as G 2, which was due to a reversal of polarity of the machine. The error was not observed until the apparatus was torn down.)

Series H shows photographs of the points when the poles of the machine were placed close enough for a spark to pass between them.<sup>1</sup> It was found that when a spark passed between the poles of the machine there was a violet stream (brush) between the points. This violet stream did not usually pass directly from one point to the other, but was curved with

<sup>1</sup> S. Arrhenius (Annal. Phys. Chem. 63, pp. 305-313), 1897.



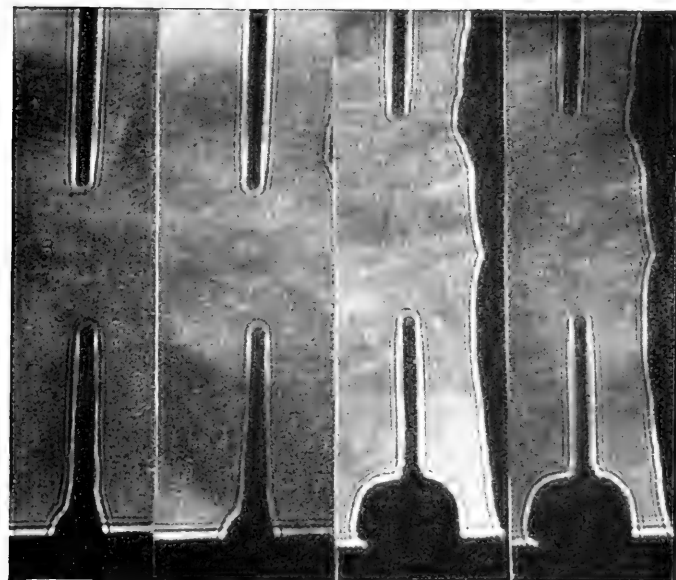

II. Spark between poles of the machine, violet brush  
between points.



Nos. (1 and 3) G. Without air-stream.  
Nos. (2 and 4) G. With

No. 1

No. 2

No. 3

No. 4



the two ends connected to the needles, not always at the points. When the magnets were excited there was no deflection observed in a field of 1,500 gausses. The photographs taken show nothing between the points.

Before putting on the cap containing the plate to take the photographs in series D a pencil drawing was made of the general form of each spark as seen from the end of the tube. Fig. 10 is a blue-print taken from these drawings, which shows that the direction of the spark as it leaves the electrode has the same direction as the photographed stream.

The width of the streams was measured in the proximity of the point with a micrometer microscope, and it was found that the width was independent of the potential between the points. The measurement was made between the outer edges of the central dark band. It will also be noticed in series D that the negative stream is almost as plain and almost as long as the positive stream.

The photographs of series E show plainly the interference fringes as described by Professor Foley. Although no special pains were taken to show these fringes in any of the work, one or two can be seen on each photograph.

#### SUMMARY OF RESULTS.

1. The positive stream between the points for a spark or brush discharge was deflected by a magnetic field as low as 1,000 gausses, the direction of deflection being in accordance with electro-dynamic laws.

2. The stream for glow discharge and the negative stream in any case were not deflected by a field of 1,500 gausses.

3. The direction of the photographed stream for a spark discharge as it leaves the point is the same as the visible direction of the spark.

4. The size of the stream at the points is independent of the potential between the points.

5. The stream was deflected by an air current, the negative being deflected more than the positive.

6. The stream for the high potential spark increased in width as the distance from the point increased, while the stream for the glow discharge retained its original size as far as it could be traced.

7. Some of the data indicate that the stream photographed is one of the ionized air particles, the stream as a whole having an index of refraction different from that of the surrounding air, due to its pressure.

If this is the case, however, the silent discharge stream and the negative stream should have been deflected also. This might possibly be done with a stronger field. Also, the stream, if it consists of charged particles, should terminate on the opposite electrode, which is very seldom the case.

---

The above investigation was suggested by Professor Arthur L. Foley of Indiana University. I wish to thank him and Professor R. R. Ramsey for their helpful suggestions during the course of the investigation.

Physics Laboratory of Indiana University,  
Bloomington, Ind.

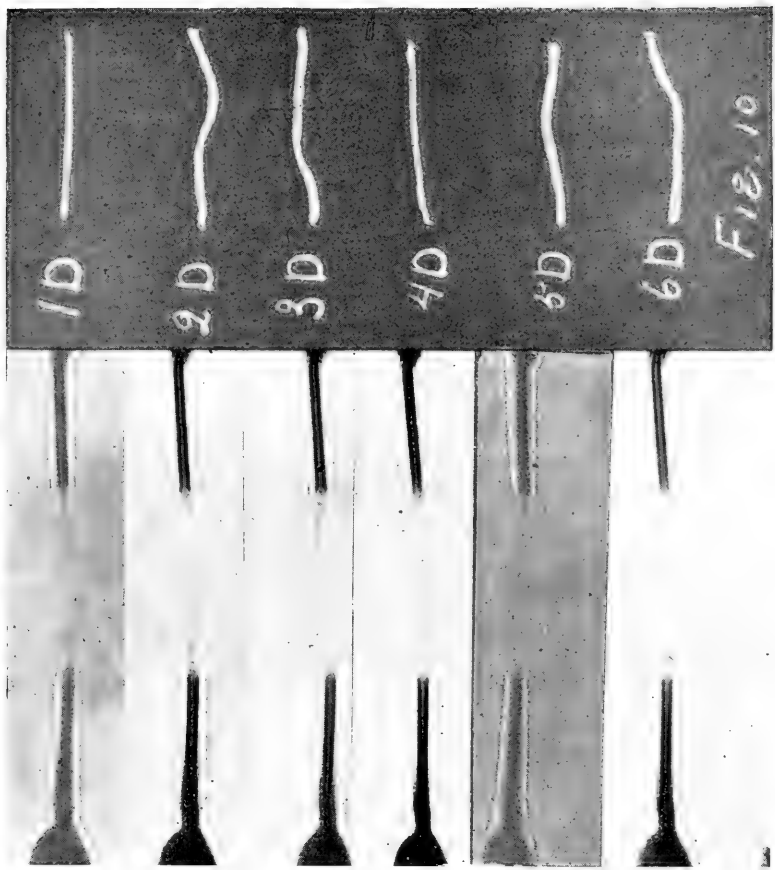

No. 1 D.

No. 2 D.

No. 3 D.

No. 4 D.

No. 5 D.

No. 6 D.



## THE TENACITY OF GELATINE.

[Publication No. 35.]

By ARTHUR L. FOLEY.

Some years ago the author called attention to the fact that the cohesive forces of gelatine must be considerably greater than those of glass in order that a single drop of gelatine in drying and contracting on a glass plate may pull a ring or disk of glass from the plate.<sup>1</sup> The forces here exhibited are apparently greater than shown in the common, though not well known, process of producing chipped glass by flowing a pane of glass with gelatine and allowing the gelatine to dry. Inasmuch as the author could not find in any of the literature at hand any recorded values of the tensile strength of gelatine, he requested one of his students to attempt to determine its value. Several plans were tried, the one giving the best results being as follows:

Gelatine threads were drawn out between the ends of small wooden sticks (about the size of a match) after dipping one end of each in melted gelatine. The diameter of a thread was varied by varying the size and temperature of the gelatine drop, the thickness of the fluid, the length of the thread and the time spent in drawing it. To the other end of the wooden sticks there had been attached previously small wire hooks for suspending the upper end of the threads and for attaching a small cloth sack to the lower end. Into this sack dust shot were slowly run until the thread broke. The cross-section of the thread was then measured at the point of break.

When the section of a thread was regular its cross-section was calculated from the diameters measured by a micrometer microscope. Threads of irregular cross-section were placed under a microscope with a camera lucida attachment and a tracing made of the perimeter. The area of the tracing was measured with a planimeter and the area of the section of the thread itself calculated from the known magnifying power of the microscope and attachment.

When glass threads are drawn they are usually almost cylindrical. Gelatine threads also are probably approximately cylindrical at the time

---

<sup>1</sup> Note on the Molecular Forces in Gelatine. *Science*, Vol. 23, p. 790, May 18, 1906.

of drawing, but they are not so after hardening and drying. The cross-section usually becomes quite irregular. This indicates a condition of internal strain which acts to lower the breaking strength of the thread. Coarse threads would be subject to greater strains than fine threads, and therefore we should expect them to show a smaller tensile strength than the fine threads. This is in accord with the results of experiment as shown by the data of Table I.

TABLE I.

Cross Section in sq. mm.	Breaking Strength in grams.	Tensile Strength in Kgm. per sq. cm.
.000835	27.6	3,305
.000919	21.5	2,340
.001002	21.1	2,106
.001334	37.2	2,778
.001670	35.0	2,096
.002610	58.2	2,230
.004524	96.5	2,133
.006729	138.1	2,052
.013920	211.4	1,519
.035900	400.1	1,114
.130300	800.0	614
.264900	2,850.0	1,076
.608900	5,600.0	919
1.709200	6,100.0	357

Inasmuch as the error in measuring the breaking strength of any particular thread was relatively small and all strains tended to decrease that strength as measured, I have included in Table I only maximum readings; that is, readings which gave the greatest values of the tensile strength for the several sizes of threads. Average readings gave results some twenty per cent lower.

Curve A of Fig. 1 is a plot of some of the individual maximum readings of Table I. It will be observed that the measured tensile strength increases very rapidly as the threads are made thinner. A similar increase takes place in wires and glass threads, and is attributed to a "skin effect." This increase is shown in Curve B, Fig. 1, which represents the results ob-



tained by drawing out glass threads and determining their tensile strength by the method already described. That the increase in the case of glass threads was due in part only to the "skin effect" was indicated by the fact that the tensile strength measurements for threads of different sizes were made more nearly uniform by carefully annealing the threads. This was done by hanging the threads in a vertical iron tube with a small weight attached to the lower end of each thread to keep it straight. The entire tube was then brought to a temperature slightly below the melting point of glass and maintained at that temperature for one hour, after which it was allowed to cool slowly in the asbestos jacket surrounding it.

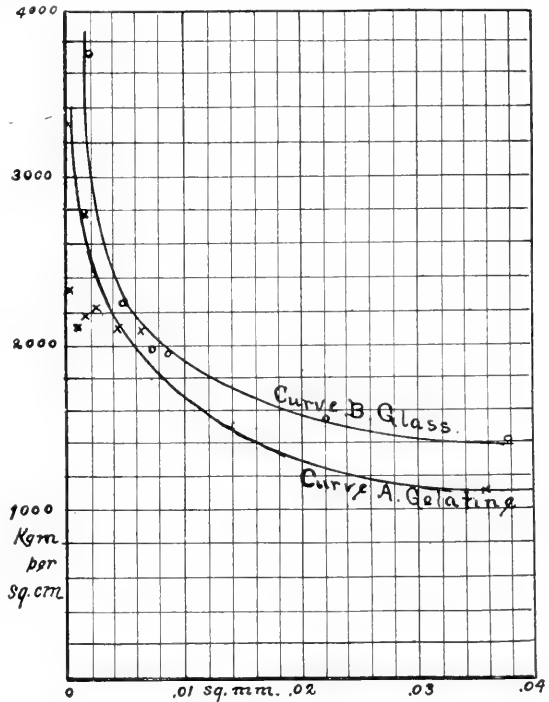

Fig. 1.

An attempt was made to anneal the gelatine threads by hanging them in a moist atmosphere in an enameling oven. Various oven temperatures were tried with little permanent effect on the threads. The author inclines to the view that the "skin effect" does not account for the larger values of the tensile strength shown by the finer gelatine threads, but that it is due chiefly to the cause already suggested—the greater uniformity in the finer threads.

The highest value of the tensile strength obtained for glass threads was 3,652 kilograms per square centimeter, while the maximum for gelatine threads was 3,305 kilograms per square centimeter. It is evident that these values cannot represent the true values or the relative values of the tenacity of glass and gelatine. It may be that the internal strains set up in the gelatine threads were such that the tensile strengths as determined in this experiment were always too low. Or it may be that the "skin effect" in glass threads gave values far beyond the tenacity of glass in a plate. Further experiments along this line are in progress.

The strength of the gelatine threads was found to increase for a few hours after drawing, and then to decrease—especially when the thread was exposed for a day or two to a dry atmosphere. Impurities tended to weaken the threads, Curve A of

Fig. 2 showing the tensile strength of threads of ordinary glue, Curve B those of gelatine containing six per cent of potassium chlorate, and Curve C those of supposedly pure gelatine. Gelatine containing six per cent of potassium alum gave a curve similar to Curve B; that is, the tensile strength of the gelatine was diminished by the salt. Still it must be greater than the tenacity of the glass, for in chipping glass about six per cent of some easily crystal-

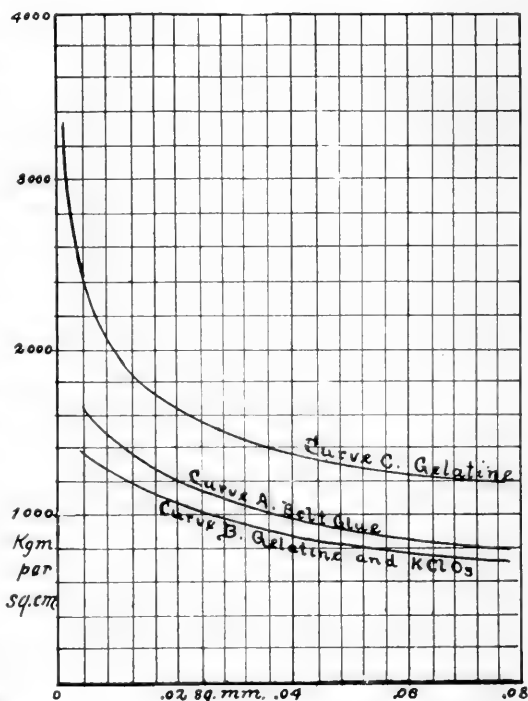

Fig. 2.

lizable salt is mixed with the glue in order to produce the peculiar fern-

like forms which give chipped glass its decorative effect. Evidently there are forces involved here other than cohesion and adhesion, as these terms are commonly used.

Most of the experimental work of this investigation was done by Mr. Elmer J. Harrel, now of the high school of St. Paul, ~~Minn.~~

Physics Laboratory of Indiana University.  
Bloomington, Ind



## EFFECT OF CERTAIN DISSOLVED SALTS UPON THE COHESION OF WATER.

By EDWIN MORRISON.

Cohesion is defined as "that force which holds molecules of the same kind together." This force is very manifest in all solids, giving rise to such properties as hardness, brittleness, malleability, ductility, tensile strength, etc. Although not so apparent, all liquids manifest the same kind of an attractive force between molecules. Surface tension and the phenomenon of capillarity are due in a measure to cohesion of the molecules. That molecules of water are held together by means of cohesion can be demonstrated by bringing a clean, horizontal disk of glass in contact with the surface of water and then adding sufficient force to pull the disk away from the water. In case the surface of the disk is wet when it comes away from the water we know that the force applied has separated two films of water, each equal in area to that of the disk.

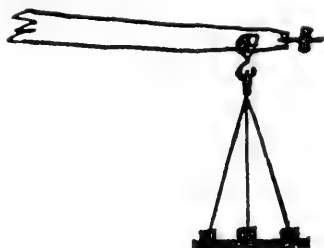

Fig. 1.

Probably Gay-Lussac first experimented upon this force and established the commonly accepted data of 526.875 dynes per square cm. Gay-Lussac used a glass disk supported by three guy cords as shown in Fig. 1.

The author designed and constructed a piece of apparatus for measuring cohesion of water and other liquids and reported the same to the Iowa Academy of Science in 1904. This apparatus consists of a round glass disk 10.6898 cm. in diameter mounted upon an accurately constructed cone 10.5 cm. high, with an eyelet in the apex for suspending the cone from the hook of a specific gravity balance. A cut of this apparatus is shown in Fig. 2.

In 1905 the author carefully worked out and reported to the Iowa Academy of Science the value of the cohesion of water as follows:

Data.—Diameter of the glass disk.

1 Measurement.....	10.662 cm.
2 Measurement.....	10.698 cm.
3 Measurement.....	10.727 cm.
4 Measurement.....	10.694 cm.
5 Measurement.....	10.645 cm.
6 Measurement.....	10.674 cm.
7 Measurement.....	10.702 cm.
<hr/>	
Average.....	10.6898 cm.

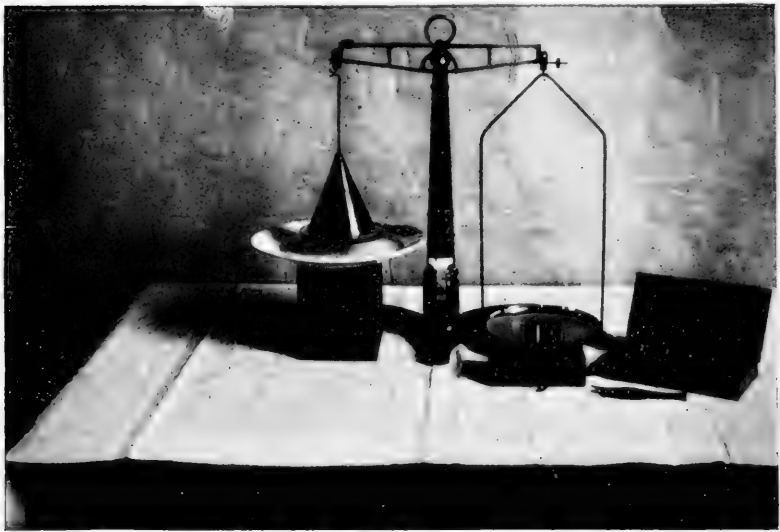

Fig. 2.

Test No. 1.—The number of grams to separate the disk from water at 4° C.

Trial 1.....	48.725
Trial 2.....	48.730
Trial 3.....	48.725
Trial 4.....	48.733
<hr/>	
Average.....	48.728

Test No. 2.—The number of grams to separate the disk from water at 7° C.

Trial 1.....	48.710
Trial 2.....	48.715
Trial 3.....	48.725
Trial 4.....	48.730
	48.720
Average.....	48.720

Test No. 3.—The number of grams to separate the disk from water at 7° C.

Trial 1.....	48.630
Trial 2.....	48.640
Trial 3.....	48.655
Trial 4.....	48.675
	48.650
Average.....	48.650

The diameter of the disk being 10.6898 cm., the radius being 5.3449 cm., the area is 89.7200 square cm. In the first test given above it required 0.5431 g. to separate one square cm. of water. In the second 0.5430 g. and in the third 0.5421 g. The average of the three tests is 0.5427 g. per square cm., which is equal to 531.846 dynes per square cm.

In comparing these results with those of Gay-Lussac we find that he used a disk which was 11.86 cm. in diameter, and that it required 49.40 g. to separate the disk from water, or 526.875 dynes per square cm.

At this point it may be well to state the precautions taken in the experiment. First, in order to insure that the water used was chemically pure, ordinary laboratory distilled water was redistilled in Jena glass vessels in the presence of sulphuric acid and potassium dichromate. Second, the disk was thoroughly cleansed by washing in a solution of potassium dichromate and sulphuric acid; then in alcohol; then the disk was dried in a current of air and washed again in redistilled water. Third, a delicate laboratory balance with a rider weight was used in the experiment.

At the time the above data on the cohesion of water was worked out it was suggested that certain dissolved salts have a marked effect upon the cohesion of water. It is the purpose now to note some of these effects.

A number of solutions of certain salts in distilled water have been tested by means of the same glass disk as used in the cohesion of water experiment. The first solution tested was that of sodium chloride. Six

solutions were prepared by dissolving each of the following number of grams of salt in 200 cc. of distilled water: 7.82 g., 15.64 g., 31.28 g., 46.92 g., 62.56 g., 72 g. (saturated solution).

Six solutions each of copper sulphate and sugar were prepared in the same way as in the case of sodium chloride, and each solution was tested for the number of grams to separate the liquid films.

The results for the eighteen different solutions are tabulated as follows:

First.—The number of grams to separate the disk from the solutions when 7.82 g. of each of the three materials were dissolved in 200 cc. of water.

Trial.	Sodium Chloride.	Copper Sulphate.	Sugar.
1	42.45	48.40	48.50
2	42.50	48.45	48.52
3	42.50	48.47	48.48
Mean.	42.48	48.44	48.50

Second.—The number of grams to separate the disk from the solution when 15.64 g. of each of the three materials were dissolved in 200 cc. of water.

Trial.	Sodium Chloride.	Copper Sulphate.	Sugar.
1	42.15	49.20	50.50
2	42.00	49.30	50.52
3	41.95	49.35	50.51
Mean.	42.03	49.28	50.51

Third.—The number of grams to separate the disk from the solutions when 31.28 g. of each of the three materials were dissolved in 200 cc. of water.

Trial.	Sodium Chloride.	Copper Sulphate.	Sugar.
1	46.39	50.35	51.50
2	46.30	50.37	51.49
3	.....	50.35	51.51
Mean.	46.345	50.356	51.50



Fourth.—The number of grams to separate the disk from the solutions when 46.92 g. of each of the three materials were dissolved in 200 cc. of water.

Trial.	Sodium Chloride.	Copper Sulphate.	Sugar.
1	50.00	51.00	53.10
2	50.02	51.05	53.10
3	50.01	51.07	53.50
Mean.	50.01	51.06	53.26

Fifth.—The number of grams to separate the disk from the solutions when 62.56 g. of each of the three materials were dissolved in 200 cc. of water.

Trial.	Sodium Chloride.	Copper Sulphate.	Sugar.
1	50.90	51.50	55.70
2	50.85	51.45	55.80
3	51.05	51.25	55.75
Mean.	50.90	51.46	55.75

NOTE. The copper sulphate solution was a saturated solution.

Sixth.—The number of grams to separate the disk from the solutions when each of the three materials were saturated solutions at the normal temperature.

Trial.	Sodium Chloride.	Copper Sulphate.	Sugar.
1	50.92	.....	57.00
2	51.05	.....	56.95
3	50.90	.....	57.10
Mean.	50.96	51.46	56.99

These results for each of the three dissolved salts may be plotted graphically by using the number of grams concentration as abscissas and grams to separate the disk as ordinates.

CONCLUSIONS.—First, the above data seem to indicate that within certain limits the cohesion of water with dissolved salts in it is a function of the concentration.

Second, as far as tested all dilute solutions of salts in water render the cohesion of the solution less than that of pure water.

Third, so far as tested the dilute strongly basic salts produce a greater decrease in the cohesion of

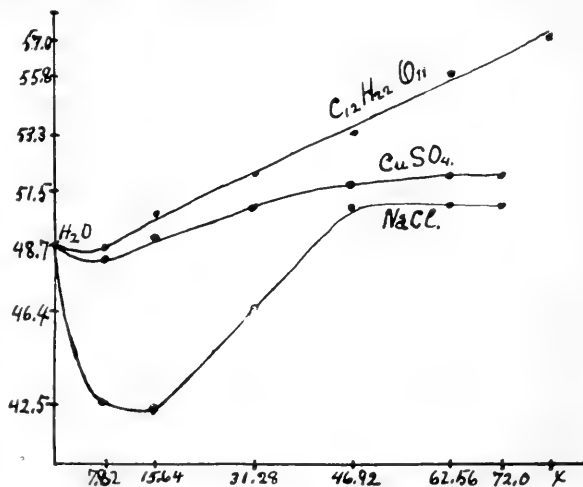

Fig. 3.

the solution from that of pure water than the nonbasic salts.

Fourth, it is also noted that before the point of saturation is reached in the strongly basic solutions, increased concentration does not produce increased cohesion.

Tests are in progress with various other salts than the ones referred to above. Also tests are in progress in which other solvents than water are being used.

Earlham College,  
Richmond, Ind.

## SOME FEATURES OF DELTA FORMATION.

By CHARLES R. DRYER.

In August and September, 1902, the writer spent some weeks among the western Finger lakes in Livingston and Ontario counties, New York. Along the shores of Hemlock Lake his attention was attracted by many recently formed deltas which seemed to present unusual features. Each delta was a semi-circular pile of fine shale shingle symmetrically arranged around the mouth of a little gully formed by a wet weather stream. The level top stood about two feet above the lake surface and was bounded by a bank of shale which sloped downward about three feet in six to a mud line under water. The wash of waves had cut at the top of the slope a vertical cliff six inches high. The land side was bounded by a very steep bank of stratified shale, a portion of the general lake shore, which is almost everywhere precipitous. From the mouth of the gully a groove a foot wide and six inches deep extended straight out half way or more across the top of the delta, but in no case reached the water's edge. Along the sides of the groove lay sticks of wood and fragments of shale of relatively large size. One medium sized delta measured thirty-one feet by twenty-six in diameter. No camera was at hand, but sketches were made from which a rough model was constructed and photographed. (Fig. 1.)

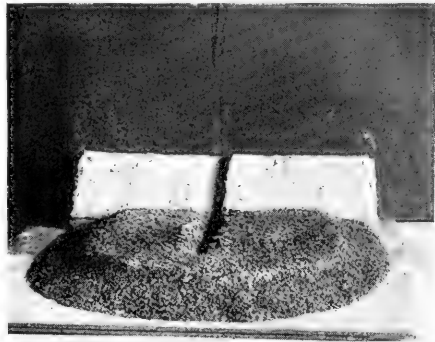

Fig. 1. Model of Torrential Delta in Shale Gravel.

The interpretation of the phenomena seemed plain. These deltas were built during an exceptionally violent storm which filled the gully with a rushing torrent and raised the level of the lake. The force of the stream was abruptly checked at lake level and its load was deposited in the form of a fan-like delta. Toward the last of the storm the stream striking the

flat top of the delta dug out the groove for a few feet, but was deflected upward and spread out into a thin sheet before reaching the edge. This interpretation was confirmed by the records of rainfall and lake level kept by the Rochester water works at the foot of the lake, which is the source of public supply for that city. These records are as follows:

<i>Date.</i>	<i>Hours.</i>	<i>Rainfall.</i>	<i>Lake Level Above Datum.</i>
July 5	12:30-7:00 p. m.	.921 in.	1.736 ft.
" 6	In the night.	2.349 "	2.926 "
" 7	10:00-11:00 p. m.	.546 "	3.106 "
" 8	.....	.....	3.126 "
" 18	8:00-11:00 a. m.	.101 "	2.176 "
" 19	In the night.	1.397 "	2.296 "
.....	2:00-6:00 p. m.	.607 "	.....
" 20	In the night.	.864 "	2.546 "
" 22	.....	.....	3.186 "

These deltas were begun during the heavy rains of July 5-7, when 3.816 inches of rain fell and the lake rose 1.39 feet, most of the work being done in the night of July 6, when 2.35 inches of rain fell. They were completed July 18-20, when 2.97 inches of rain fell and the lake rose 1.01 feet. These miniature torrential deltas furnish suggestions for the interpretation of similar but larger features which mark the shore lines of the temporary glacial lakes formerly occupying the Finger lake valleys.

A similar flat-topped, steep-sided feature caught the writer's eye on the east side of Honeoye Lake. Projecting from the steep hillside like a bracket it rose 200 feet above the lake, suggesting by its bold and symmetrical outlines an artificial origin similar to that of the dump pile of a mine (Fig. 2). It proved to be a torrential delta built at the mouth of Briggs gull. Its finely curved front slope, about 150 high, is as steep as the material will lie. Its flat top is traversed by a channel twenty feet wide and three feet deep which extends to the edge and is continued by a similar groove in the steep face. The southern side cut away by the main stream shows characteristic foreset beds of sand containing large fragments of shale near the top. Briggs gull now drains a basin of about six square miles. A heavy rain with rapid melting of ice or a sudden diversion of drainage by the breaking of an ice dam in glacial times may have enabled the stream to build this delta in a few days or weeks. Briggs delta helps to account for the anomalous distribution of glacial lake deltas. Similar features are numerous in the Finger lake valleys. Not their presence but their absence from the former mouths of many streams seems

the chief problem. Why do not deltas occur on all of the hundreds of streams that score the valley sides? Why did one stream a mile or two long build a delta a few rods in area while a much longer stream near by



A.



B.

Fig. 2. Briggs Delta. A. From below. B. From above.

built none? The answer seems to be that such features have no prolonged history, but owe their existence to a single local and brief accident of drainage which did not affect neighboring streams.

The largest delta of this class observed in the region, at Bristol Springs on the west side of the Canandaigua lake valley, was built in the Naples-Middlesex glacial lake at one nearly static or slowly subsiding level. The top, about one-half by one-quarter of a mile in area, is smooth and gently sloping forward from the 1,200 to the 1,100-foot level. The surface material is very coarse, containing rounded cobbles up to six inches in diameter, often with little admixture of finer sediment. This delta was built by a stream from the Bristol valley, which during the process must have drained a loaded ice lobe and not a lake.

Such simple, flat-topped, steep-sided deltas, resembling the bastion of a fort or an abutment prepared by a daring engineer from which to spring



Fig. 3. Naples Delta. Two Upper Levels. A kettlehole in the woods.

the arch of a bridge, are formed rapidly by strong or torrential streams and are composed of relatively coarse materials. From their striking and characteristic form and position they may be called *bracket deltas*.

Garlinghouse delta, a few miles south of Naples, does not project like a bastion from the face of the valley wall but fills a niche a mile deep and half a mile wide, the walls of which rise sharply 500 feet above its surface. The niche now receives two or three insignificant brooks, but one of them comes from a gap in the wall which opens northward to the upper Honeoye valley. This gap probably once transmitted a strong stream from the ice front but a few miles distant. This delta may be the only one of its kind, and if so, belongs in a class by itself—that of *niche deltas*.

Compound deltas built at several different levels are numerous in the Finger lake region. Coy Glen delta near Ithaca, a fine specimen of the type, rises from the Cayuga valley to a height of 700 feet like a giant staircase of seven steep, convex risers and as many flat treads, each of which has been evenly bisected by the stream. Such deltas are formed in waters the level of which is alternately standing and falling, the upper step being the oldest. They may be distinguished as *step deltas*.

The delta above Naples rises 400 feet and has a basal periphery of more than two miles. (Fig. 3). Seven levels are distinguishable, of which the upper three are the most conspicuous. The greater part of its mass



Fig. 4. Pitted Surface of Morainal Delta.

was brought by a stream which flowed out of the Honeoye valley from the west and was the outlet of the glacial Honeoye Lake. Streams which flow out of lakes cannot, as a rule, have sufficient load to build large deltas, and the question at once arises, how could the outlet of a lake build one in this case? Its construction was not a matter of a brief period but continued through the whole life history of the Naples-Middlesex glacial lake, into which the stream emptied. The presence of this delta is evidence, so far as it goes, that during that period no lake existed in the Honeoye valley. The area of the land which could have been drained to this delta is insignificant, and we are apparently forced to the conclusion that it was built by drainage from a drift-loaded ice mass. This inference is sustained

by the occurrence upon the highest level of a sharp kettle hole 300 feet in diameter and 25 feet deep, marking the place where a detached ice block stranded and melted.

The occurrence of kettle holes in deltas is not uncommon.<sup>1</sup> A remarkable case of this kind has been described by the writer where an area of ten acres of delta surface is thickly pitted with small kettles.<sup>2</sup> (Fig. 4.) This delta is the joint product of a land stream and a valley glacier which contributed ice blocks and an undetermined portion of the permanent material. There are probably many intermediate forms between such a *morainal delta* and one due wholly to stream work.



Fig. 5. Outer Face of Morainal Delta. Fan in front of notch.

When lake waters are withdrawn the bisection of a delta may result in the formation of an alluvial fan in front of it. This gives a characteristic combination of *notched delta and fan*. (Fig. 5). The fan of Mill Creek at the foot of Honeoye Lake is a mile in diameter, and is responsible for the existence of the lake, to which it acts as a dam. The fan of Canadice outlet bears a similar relation to Hemlock Lake, which, however, is too deep to owe its existence wholly to that cause.

Deltas occasionally take the form of long, narrow ridges upon one or both sides of a stream, resembling the natural levees in "the goosefoot"

<sup>1</sup> Fairchild, *Journal of Geology*, Vol. 6, p. 589.

<sup>2</sup> *Bulletin Geological Society of America*, Vol. 15, p. 457.



of the Mississippi. Normally the point where a tributary valley joins a larger one is marked by a notch in the wall of the latter, but in some cases a bisected spur appears instead. The delta of Canadice outlet, mentioned above, furnishes a good example. A delta at Lake Warren level, near East Bloomfield, what is left of it, has the form of a single narrow tongue more than a half mile long. Such lateral deposits of a stream may be called *levee deltas*.

Hanging deltas have been the chief guides to geologists in mapping the outline of temporary glacial lakes, but they are worthy of more careful study as simple and well displayed specimens of constructional shore forms.<sup>3</sup>

State Normal School,  
Terre Haute, Ind.

---

<sup>3</sup> Nearly all the features mentioned in this paper may be found upon the Wayland, Naples, Honeoye and Canandaigua sheets of the Topographic Map of United States.



## A PHYSIOGRAPHIC SURVEY OF AN AREA NEAR TERRE HAUTE, INDIANA.

By CHAS. R. DRYER and MELVIN K. DAVIS.

*The Survey.*—In the summer of 1909 the senior author of this paper, in despair of living long enough to receive any help from the U. S. Geological Survey or from the State of Indiana, resolved to try what might be done by his own students toward a serviceable topographic survey of the area around Terre Haute. Four young men and two young women were ambitious enough to undertake the work. For a base map the atlas of Vigo county was used and found to be very poor, in fact a disgrace to the surveyor, the draughtsman, the printer and the whole community concerned. We simply made the best of it. The profiles of three railroad lines traversing the region were obtained, and other base lines and points were determined with a surveyor's level. Most of the topographic work was done with the hand level and staff. It was found possible to require that no discrepancy between different lines of levels should exceed one foot. Highways and divides were followed and section and other cross-country lines were run wherever necessary. About two days a week for six weeks were spent in the field, and the result was found to be worth while. While surveying was being done the location of particular features was noted in order that no time would be lost when their special study should come. The map drawn by the junior author of this paper from the data thus secured has proved adequate for the purpose in view.

*General Description.*—The area surveyed is immediately west of Terre Haute and comprises about 25 square miles in Sugar Creek township, Vigo county, Indiana. It is bounded on the east by the Wabash river and includes a portion of its flood plain. West of the Wabash bluffs, here eighty to one hundred feet high, the area consists of an originally smooth upland of glacial drift 540 to 560 feet above sea level, which has been sub-maturely dissected by the branches of Sugar creek. The remnants of the original surface have been reduced to the scrap-tin outline characteristic of the leaves of the pin oak. The larger valleys are flat bottomed and contain alluvial filling to a depth of 40 or more feet. The drilling of a well at Vandalia mine No. 81, section 24, showed the deposit to be 40 feet

deep. The slopes of valley sides are generally steep and the ravines of the ultimate tributaries are exceedingly narrow and sharp. The depth of the glacial drift is generally from 40 to 60 feet, and the streams only here and there touch bed rock.

Many beds of recent conglomerate appear along west Little Sugar creek. The principal valleys are preglacial, with a base level determined by the level of the preglacial Wabash, which was 60 or 70 feet lower than the present river. These valleys were filled with drift which the post-glacial streams have scarcely half removed. The drainage has developed by headward erosion into an intricate, dendritic system of insequent branches which penetrate to nearly every acre of the area. Judging from the position of large trees there is reason to believe that the lines of drainage were well defined before vegetation sprang up.

*Stratigraphy.*—The underlying bed rocks of the area are the shales of the coal measures with several workable seams of coal, the uppermost of which outcrops along the foot of the Wabash bluffs. The shales above the coal form about one-half the height of the bluffs. The upper half consists of glacial drift. Intercalated with the shales are several thin strata of limestone, two of which exercise a notable influence upon the topography. Below the 500-foot level a tough, flinty limestone four or five feet thick has resisted river erosion to such an extent as to form a terrace between the Wabash flood plain and bluff, in some places 500 feet wide and 20 feet above the plain. We call it the flinty limestone. A similar but less silicious limestone lies about thirty feet higher. In section 31 the waters of the Sugar creek system have cut a gap in these strata and reach the Wabash at grade.

The glacial drift belongs to the Illinoian drift sheet of Leverett and lies just outside the border of the Shelbyville moraine. The mass of it consists of a tough boulder clay, weathering on exposed faces into roughly hexagonal columns and containing numerous striated and faceted boulders of moderate size. Large boulders are rare. In some places the till is one-half fine gravel. There are occasional thin partings of sand. In a railroad cut about one mile to the north of the area surveyed buried logs of wood up to nine inches in diameter are numerous along a level horizon, but no difference can be discovered between the overlying and the underlying till. In the south bluff of Sugar creek beds of laminated silt are intercalated in the till and point to the occurrence of an interglacial interval of notable extent. The upper four or five feet of drift often con-





TOPOGRAPHIC MAP  
 SUGAR CR. TP., WIS. CO., IND.  
 Drawn by M. E. Davis, 1909  
 Scale, One-Half Mile

sist of a deep red, pebbleless and structureless loam, the origin of which is an unsolved problem. The red loam, even upon moderate slopes, gullies rapidly and has greatly facilitated the dissection of the region.

*The Wabash Plain*, two miles in width, presents the usual flood plain features of levees and bayous. At one point, S. W.  $\frac{1}{4}$  of S. E.  $\frac{1}{4}$  of section 8, shale outcrops in the midst of the alluvium. Before the valley was filled this was an island in the river with deep water all around it. The valley filling in some places is 80 feet deep, and consists of sand and gravel carried into the valley by water and floating ice. At a railroad gravel pit in section 36 twenty-five feet of fine gravel is exposed, with an occasional stratum containing enough clay to resist rain wash and cause the formation of earth pillars two or three feet high. A terrace of coarse, roughly stratified gravel formerly occupied an area about one mile by one-half opposite the city of Terre Haute and was an island at high water. The town of West Terre Haute stands upon the southern half of it. The northern half has been entirely removed by the railroad companies and excavated to the level of low water in the river. The remaining surface is from 15 to 25 feet above the plain.

*The Sugar Creek Drainage System* presents several peculiar features and furnishes some of the most interesting problems of the area. The small tributaries of the Wabash are usually of the parallel type, not combining into systems, the main streams flowing nearly at right angles to the Wabash. The Sugar creek system is fan-shaped, consisting of four principal streams which converge southward and eastward to a junction and pass out through a single gap upon the Wabash plain. East Little Sugar creek flows southward seven miles parallel with the Wabash river and about one mile west of the bluff. In sections 25 and 26 a nameless stream flows about one mile eastward, turns northward one-half mile and again eastward, both bends being right angles. This seems to be due to harder material in the stream's course.

*Sugar Creek Lake*.—At the western border of the area surveyed the valley of Sugar creek widens abruptly from less than one-half mile to about a mile. Two miles below it narrows abruptly and flows for a mile through a gorge twenty to forty rods wide. The expansion and the narrows present each its own but related problem.

The expanded portion of the valley, about one mile by two, is bounded on the south by a boulder clay bluff sixty feet high; on the north by lower

and gentler slopes and is invaded near the east end by a flat spur projecting like a dam from the north side nearly to the bluff on the south. Near the south end of the dam the stream has cut a narrow gap thirty feet deep. The lower ten feet exposed in the gap is shale with a thin cap of flinty limestone. The upper twenty feet of the dam is glacial clay with the exception of a little poorly stratified gravel and sand at the south end of the dam near the creek. These features present on their face the characteristics of a drift-dammed lake drained by the down cutting of its outlet. The supposed lake bottom is underlaid, so far as discoverable, by six feet of alluvium on top of the flinty limestone. The flat-topped dam appears to be a terrace and is accordant in level with other terrace fragments in the valley of West Little Sugar creek above. In the south bluff the boulder clay is interrupted for a few rods by ten feet of finely laminated lacustrine silts, the bottom of which is at about the same level as the terrace tops.

Various hypotheses may be entertained; (1) The expansion of the valley is due to the lateral corrasion and shifting of the preglacial stream over the surface of the resistant flinty limestone. The whole valley was filled with glacial clay. The interglacial stream had a temporary base level fifty feet higher than at present and cleaned out the filling down to the terrace level (510 feet above the sea). During this process a tributary stream from the south cut a valley out of the boulder clay down to the terrace level, which was afterward filled with silt. By a lowering of the base level in the Wabash the stream was enabled to cut down the dam and to clear out the valley to the present level, draining the lake and leaving fragments of the valley filling as terraces.

(2) The preglacial and interglacial course of the stream was north-eastward into the valley of East Little Sugar Creek. A readvance of the ice left a till dam across the former course and the portion of the present valley through the narrows is entirely postglacial. The complete sequence of events is not so clear as could be wished.

(3) The resistance of the two limestone strata which outcrop along the Wabash bluff and over a belt about two miles wide, west of the bluff, may account for the southward course of East Little Sugar Creek, for the narrows of the lower end of the valley and for the single gap in the bluff through which the waters of the system escape to the Wabash plain.

*Period of Ravine Cutting.*—The valley slopes of the ultimate tribu-



taries are so steep and the ravines are so narrow and sharp as to prevent cultivation and they are in most places forested. The frequent occurrence of large trees, one hundred to two hundred years old, in the bottom of the ravines, indicates that the present rate of downward corrasion is very slow, and that possibly the dissection of the region in the drift area was mostly accomplished during the period of ice melting and the succeeding period of bare ground, before the surface was covered with vegetation.

*Culture.*—The alluvial lands in the valleys are chiefly occupied by corn fields. The broken upland areas between the ravines are inconvenient for farming but many of the small fields produce good corn, oats and hay, especially hay. The only way by which cuts, fills, and bridges can be avoided in road building is to run the roads on the narrow divides between the heads of ravines. Coal mines are numerous. Along the front of the Wabash bluffs shale and coal are accessible near the surface and four large brick and tile factories have been established. The new industries have multiplied the population of West Terre Haute by five in ten years, and have caused three considerable villages to spring up from nothing in the same time.

State Normal School,  
Terre Haute, Ind.



## COLLECTING AREA OF THE WATERS OF THE HOT SPRINGS, HOT SPRINGS, ARKANSAS.<sup>1</sup>

By A. H. PURDUE.

*Introduction.*—The conclusions in this paper were reached in the course of field work on the structure and stratigraphy of the area about Hot Springs during the summer of 1909. The paper is written with the assumption made partly because geologists in general have come to think of most of the ground water as having such origin, and partly because the assumption that the waters of the hot springs are meteoric. This assumption is supported by recent studies of Mr. Walter Harvey Weed upon the waters of these springs clearly indicate that they are meteoric.<sup>2</sup>

*Topography of the Highlands of Arkansas.*—The highlands of Arkansas and the eastern part of Oklahoma are divided into a northern and a southern part, separated by the valley of the Arkansas River. The northern division consists of the Boston Mountains, which are a dissected plateau, reaching the height of somewhat more than 2,200 feet above sea level, and a much lower area to the north of them. The southern division consists of the Ouachita Mountains, which cover an area about 60 miles in width. These mountains consist of ridges, the direction of which is in the main east and west and some of which surpass 2,000 feet in height.

*Topography of the Area About the Hot Springs.*—The topography in the vicinity of the hot springs is indicated by the accompanying relief map (Fig. 1). The springs (indicated by the cross) emerge from the western end of Hot Springs Mountain, which is known as Indian Mountain east of West Branch of Gulpha Creek. Immediately north of Hot Springs Mountain is North Mountain, which continues west of Hot Springs Creek as West Mountain. Three miles west of the springs West Mountain swings around in a horseshoe curve and extends northeastward, and is known as Sugarloaf Mountain. Hot Springs Creek, a considerable stream, flowing southward, carries off the overflow from the hot springs and the drainage of a portion of the valley just south of Sugarloaf Mountain.

<sup>1</sup> By permission of the Chief Geologist, U. S. Geol. Surv.

<sup>2</sup> The hot springs of Arkansas. Senate Document No. 282, p. 90, Washington, D. C., 1902. Prepared under the supervision of the Secretary of the Interior.

This valley is from a mile to a mile and a quarter in width. About two miles northeast of the hot springs, where West Branch of Gulpha Creek cuts through North Mountain, is a limited area with an elevation of about 620 feet. The greater part of the surface, however, stands above the 700-foot contour, and the highest hills exceed 800 feet. The highest elevation at which any of the springs emerge is about 640 feet.

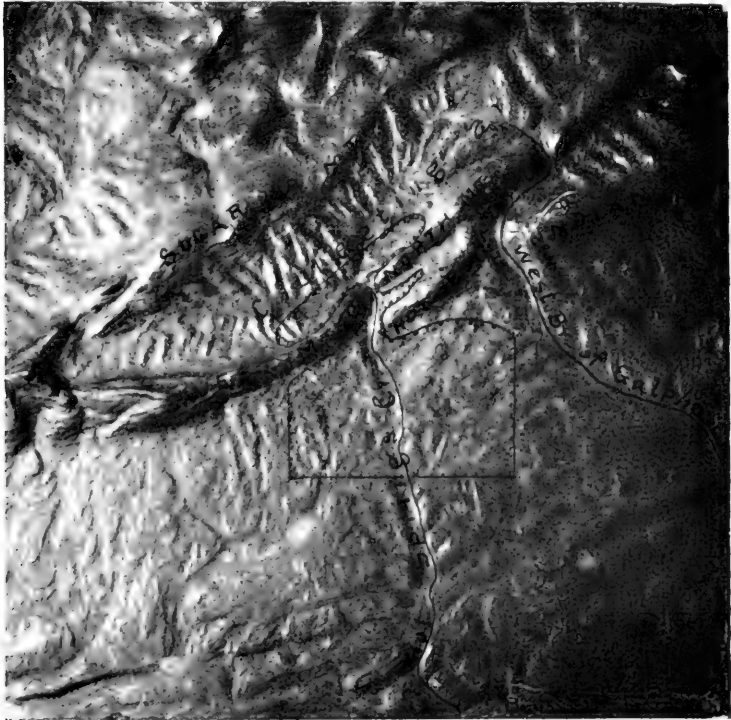

Fig. 1. Relief Map of the Hot Springs Area.

*Stratigraphy of the Area About the Hot Springs.*—The surface rocks about the hot springs are shown in the following section:<sup>3</sup>

<sup>3</sup> With the exception of the Stanley shale and the Hot Springs sandstone, these names were first applied to the formations as they appear in Montgomery County, Arkansas.

## Carboniferous—

Stanley shale .....	3,500 feet.
Hot Springs sandstone .....	100 “

## Age unknown—

Arkansas novaculite .....	380 “
Missouri Mountain slate .....	50 “

## Ordovician—

Polk Creek shale .....	210 “
Bigfork chert .....	570 “

The Bigfork chert is in layers from two to twelve inches thick. Throughout a good portion of the formation it consists almost entirely of chert, but in parts the layers are separated by thin beds of shale, and in other parts shale is the main constituent. The chert is very brittle and intensely fractured from the folding it has suffered.

The Polk Creek shale overlies the Bigfork chert, and is a very black, somewhat silicious shale, though soft enough from its graphitic nature to soil the fingers in handling. The upper part contains a few thin silicious beds, but the lower part is wholly shale.

The Missouri Mountain slate as it occurs in the vicinity of the hot springs is a red to brown or yellow shale, depending upon the stage of weathering. Further west in the Ouachita area it is a true slate.

The Arkansas novaculite as it is exposed in the city of the hot springs consists of three parts: A lower, massive one 275 feet thick, made up of heavy beds of much fractured novaculite. It is from this part of the formation that the Arkansas abrasives are secured. This is followed by fifty-five feet of very black clay shale, weathering in places to light gray; and this by fifty feet of what appears to be rotten, porous novaculite. The section of the novaculite formation over the Ouachita area varies greatly with the locality.

The Hot Springs sandstone<sup>4</sup> is a gray, quartzitic sandstone in beds from three to eight feet thick. The basal ten feet or more is conglomeratic. It is from this formation that most of the hot springs issue, which fact, however, is accidental and consequently not significant.

The Stanley shale is composed mainly of black to green clay shale, though a large per cent of it consists of rather soft, greenish sandstone. This shale skirts Hot Springs and West Mountains. While a large part

<sup>4</sup> This name has not been used before in Arkansas.

of the city of Hot Springs stands on this formation, only the waters of those springs that issue at the lowest levels move through it.

*Structure and Rocks of the Highland Area.*—The general structure of the highland area is that of a broad syncline with its trough in the Arkansas Valley. The rocks of the Boston Mountains and the area to their north lie for the most part horizontal, but in the south half of the Boston Mountains they dip perceptibly to the south, passing in the Arkansas Valley under several thousand feet of younger rocks.

The general structure of the Ouachita area is that of an anticlinorium dipping southward under the mesozoic and tertiary rocks, and northward beneath the Arkansas Valley. The rocks for the most part are intensely folded, to which, with erosion, is due the narrow valleys and parallel ridges of the area. The hot springs are located in the eastern part of this area.

The folds in the main have an east-west direction, but at Hot Springs and for some distance to the west their direction is northeast-southwest. The individual folds are as a rule not continuous for great distances, but are short and overlap each other laterally. Thrust faults, approximately parallel to the strike and of many hundred feet displacement, are common in the Ouachita Mountains and the Arkansas Valley.

*Structure of the Area About the Hot Springs.*—Like the remainder of the Ouachita region, the area about the hot springs is intensely folded. The folds are closely compressed and are all overturned to the south. As a result the dips are to the north. Some of these are as low as 15 degrees, and they seldom exceed 60 degrees. This means that at the points of greatest overturning the rock layers lie literally upside down, and in folding have described an arc of 165 degrees.

*Possibilities of Ground-Water Flowage.*—While the altitude of the Boston Mountains is sufficient to give the ground-water enough head for it to emerge at the height and distance of the hot springs, the intervening structure makes such impossible. The closely compressed folds, overlapping, and faulting of the Ouachita area are such as to prevent the uninterrupted movement of ground-water except for short distances. Likewise the stratigraphy, structure and topography to the south of the hot springs eliminate that area as a possible source of the water; and the same is true of the highlands of central and eastern Kentucky, Tennessee and Alabama and the intervening area.

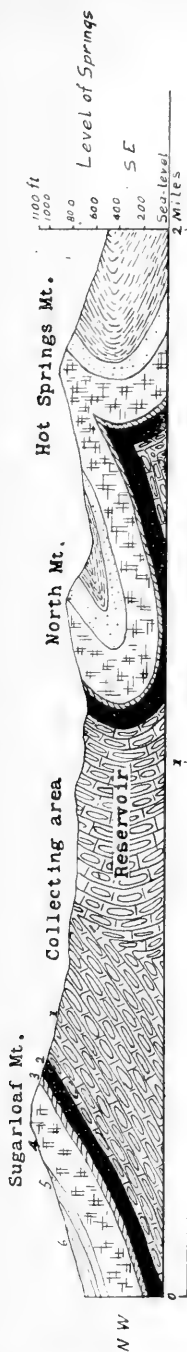

Fig. 2. Northwest-southeast section at Hot Springs.

1. Bigfork chert.
2. Polk Creek shale.
- .. Missouri Mountain slate.
4. Arkansas novaculite.
5. Hot Springs sandstone.
6. Stanley shale.

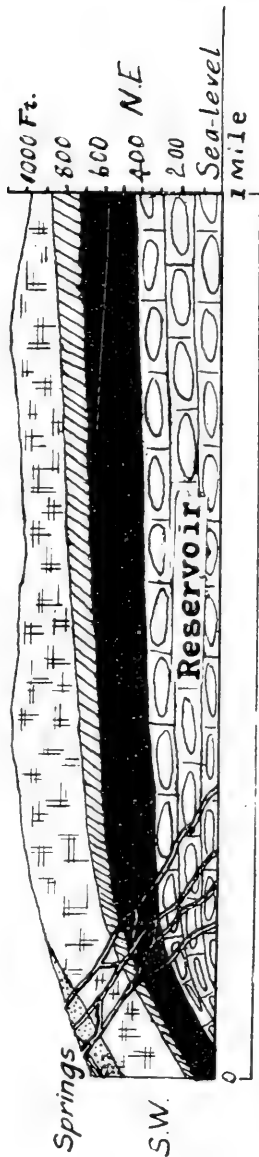

Fig. 3. Northeast-southwest (longitudinal) section of Hot Springs Mountain, showing the hypothetical water conduits at the plunging end of the anticline. Symbols same as in Fig. 2.

*The Collecting Area.*—It follows from the above that the collecting area must be in the near vicinity of the springs, and a study of the topography, stratigraphy and structure thereabout locates it with reasonable certainty. A glance at the section (Fig. 2) from Sugarloaf Mountain southeastward through Hot Springs Mountain will indicate the collecting area. The surface of the overturned, anticlinal valley between Sugarloaf and North Mountains is higher than the level of emergence of the springs. The rocks outcropping over the area are the Bigfork chert and the Polk Creek shale, the former occupying most of the area.

The considerable thickness of the Bigfork chert, its much fractured nature and the thin layers of which it is composed, all combine to make it a water-bearing formation of unusual importance. The greater number of the fine springs in the Ouachita area between Hot Springs and the western border of the state come from this horizon. In many places this formation occurs in anticlinal valleys with its highly inclinal beds truncated, affording the most favorable condition for the intake of water. A glance at figure 2 will show that these conditions obtain in the area between North Mountain and Sugarloaf Mountain. In addition to the favorable structure for the reception of water there is the stratigraphic condition for its retention brought about by the overlying Polk Creek shale. As a consequence of the topography, structure and stratigraphy the water is collected in the basin shown in the map (Fig. 1), conducted through the Bigfork chert beneath the North Mountain syncline, and rises in the Hot Springs anticline, at the western end of which it emerges in the hot springs. Including several of very weak flow, there are said to be seventy-two of these springs, and they are confined to a narrow strip about a quarter of a mile long.

The exact location of the springs is attributable to the southwestern plunge of the Hot Springs anticline, and as has been stated by Mr. Walter Harvey Weed<sup>5</sup> probably to fracturing and possible slight faulting in the process of folding, as shown in figure 3.

While not relevant to the title of the paper, it might be added that the considerable number of dikes in the immediate vicinity of the hot springs, the large number (eighty are known) only a few miles to the south on and near the Ouachita River, and the areas of igneous rock at Potash Sulphur Spring, Magnet Cove and other places, force the sugges-

<sup>5</sup> Loc. cit.



tion upon one that the waters of the springs owe their temperature to passing over hot rocks or the vapor from such in some part of their underground course.<sup>6</sup> The fact that these are practically<sup>7</sup> the only hot springs within the Ouachita area, though there are scores of cold springs issuing from the same formations and under practically the same geologic relations, gives this suggestion great weight; but inasmuch as some of the springs are said to be unusually radio-active, there is the alternative suggestion that atomic decomposition in igneous rocks (which may have lost their magmatic heat) is the source of the high temperature of the water.

Fayetteville, Ark.

---

<sup>6</sup> Dr. J. C. Branner has already called attention to this as the probable source of the heat. See Geol. Surv. of Ark., Report on Mineral Waters, pp. 9 and 10.

<sup>7</sup> Recently a spring, said to have a temperature of 98° to 100° F., has been discovered issuing from the Arkansas novaculite in the bed of the Caddo River, at Caddo Gap, Montgomery County.



# WHERE DO THE LANCE CREEK ("CERATOPS") BEDS BELONG, IN THE CRETACEOUS OR IN THE TERTIARY?

By OLIVER P. HAY.

## CONTENTS.

	PAGE
1. Historical Résumé .....	277
2. Necessity for accurate correlation of the primary divisions of the geological column in the different continents .....	279
3. The primary divisions are not usually indicated by great unconformities .....	280
4. The principal divisions of geological history are based on fossil organisms .....	283
5. The value of plants as indices of geological dates .....	286
6. Completeness of record of animal life as compared with that of plant life .....	288
7. The beginning of the Eocene in Europe and America .....	289
8. Relationships of fauna of Lance Creek epoch to those of Puerco and Torrejon .....	290
Fishes, tailed amphibians, <i>Champsosaurus</i> .....	296
Crocodiles, turtles .....	297
Dinosaurs .....	299
9. Relationships of Lance Creek fauna to that of the Judith River epoch .....	295
10. Conclusions .....	303

## HISTORICAL RÉSUMÉ.

Ever since the beginning of our knowledge of the geology of the Western plains and the Rocky Mountains there have existed contentions regarding the various deposits to which the names Laramie and Fort Union have been applied. These contentions have concerned the grouping of the various beds, the geological horizons to which the deposits of different basins and of different levels should be referred, and the members to which the names Laramie and Fort Union respectively should be restricted. Up to about the year 1896 certain deposits in the Judith River basin and others in Montana, Wyoming, Colorado and New Mexico were all regarded as the products of a single geological epoch and were all called Laramie. Although as early as 1860, or even earlier, some geologists, especially Dr. F. V. Hayden and Professor Leo Lesquereux, basing their opinion on the fossil plants, held that all or the greater part of the deposits in question belonged to the Tertiary, the prevailing opinion up to 1896 was that the Laramie, taking the term in its widest sense, was the uppermost portion of the Cretaceous. It may be said, however, that Professor Cope in his great work "The Vertebrata of the Tertiary Formations of the West" referred the Laramie, as well as the overlying Puerco

(including what is now known as the Torrejon), to the "Post-Cretaceous," a group holding a position between the Cretaceous and the Tertiary. He had previously assigned the Puerco to the Eocene. However, in 1887 (*Amer. Naturalist*, xxi, pp. 446, 450) he transferred this "Post-Cretacic System" to what he called the Mesozoic realm. In the year 1896 Messrs. S. F. Emmons, Whitman Cross and G. H. Eldridge published their "Geology of the Denver Basin," in which the previously so-called Laramie in the region of Denver, Colorado, was shown to consist of three distinct formations. The name Laramie was by them restricted to the lowest member of these, the succeeding formations being called respectively the Arapahoe and the Denver. The last two had, however, already been recognized, named and published by Eldridge and Cross as early as 1888.

Although the authors of the *Geology of the Denver Basin* referred to the Upper Cretaceous the three formations mentioned, Whitman Cross (*op. cit.*, p. 206, seq.) makes a strong argument in favor of including the Arapahoe and the Denver in the Tertiary. His plea was based especially on the existence of a great stratigraphical break between the lower and the middle of the three formations and on the evidence furnished by the fossil plants. Certain deposits in Middle Park, Colorado; others near Canyon, Colorado; others in the Huerfano basin; certain ones along the Animas River; still others in New Mexico, beneath the Puerco; and the so-called "Ceratops" beds of Wyoming were all provisionally correlated with one or other of the formations in the Denver basin.

It is interesting, therefore, to observe that about 1887 and 1888, while Cope was endeavoring to raise the boundary between the Mesozoic and the Cenozoic to a position above what is now known as the Torrejon, Cross was trying to depress it to the parting between the Arapahoe and the formation below it.

It was thought by Cross that the beds of the Judith River valley might be the equivalent of the Arapahoe beds; but it has since been conclusively shown by Stanton and Hatcher that, instead of being younger than the deposits called by Cross the Laramie, the Judith beds are older than the Fox Hills, older than the upper part of the Pierre.

Within the past two years the discussion of the subjects named above has again broken into flame and a number of papers have appeared, all presenting most instructive facts and suggestions, but very diverse con-

clusions.<sup>1</sup> Whether the name Laramie shall be restricted to the lower of the three divisions found in the Denver basin and its equivalents elsewhere, as proposed by Cross and Eldridge, Knowlton and Peale; or to one or both of the upper divisions, as advocated by Veatch; or retained to designate all the formations between the Fox Hills and the Fort Union; or wholly abandoned, is yet to be settled; and with this I have nothing to do. It is the purpose of the present paper to show that those deposits that lie above the Fox Hills and are known to contain remains of dinosaurs; more specifically the Laramie, as understood by Cross and Eldridge; the Arapahoe and the Denver of Colorado; the Lance Creek, or "Ceratops," beds of Converse County, Wyoming; the Hell Creek beds of Montana; and the beds underlying the Puerco in New Mexico, ought not to be referred to the Tertiary, but to be retained in the Upper Cretaceous.

## 2. NECESSITY FOR ACCURATE CORRELATION OF THE PRIMARY DIVISIONS OF THE GEOLOGICAL COLUMN IN THE DIFFERENT CONTINENTS.

It appears to the writer that it is a matter of great importance that the primary divisions of geological time, the ages and the periods, and the corresponding systems of rocks of all parts of the world should as far as possible coincide. By this is meant that geologists should not (to employ an illustration) include in the Lower Cretaceous any deposits of one continent that were being formed synchronously with Jurassic deposits of another continent. Nor ought they to include in the Tertiary of America any formations that are the time equivalents of European Cretaceous formations. It may be a matter of great difficulty to attain agreement in some cases, but it ought to be resolutely striven after. And in this connection the writer indorses fully the quotation made by Mr. Cross (*Proc. Wash. Acad. Sci.*, xi, p. 46) from Dr. C. A. White's address. It may be added that modification of the primary divisions ought to be made by international bodies of geologists and paleontologists.

The reasons why the primary divisions of geological history should be fixed as accurately as possible, even though arbitrarily, seem to be simple enough. Geology is the history of the development of the earth and its

<sup>1</sup> Veatch, A. C., *Amer. Jour. Sci.* (4), xxiv, 1907, pp. 18-22.

Cross, Whitman, *Proc. Washington Acad. Sci.*, xi, 1909, pp. 27-45.

Knowlton, F. H., *Washington Acad. Sci.*, xi, 1909, pp. 179-238

Stanton, T. W., *Washington Acad. Sci.*, xi, 1909, pp. 239-293.

Peale, A. C., *Amer. Jour. Sci.* (4), xxviii, pp. 45-58.

inhabitants. For sufficient reasons we divide this history into principal and subordinate portions, each having its own characteristics. Each continent has had its own course of development, physical and biological, this course sometimes agreeing only in a general way with that of other continents, being perhaps ahead of them or behind them, possibly sometimes only different. In order to compare and describe contemporary conditions in different lands there must be a few fixed dates from which to reckon the march of time and progress. These dates are found in the limits between the primary divisions, as that between the Silurian and the Devonian or that between the Cretaceous and the Tertiary. In a similar way we orient the history of even a savage people with reference to such dates as the founding of Rome and the birth of Christ.

### 3. THE PRIMARY DIVISIONS OF GEOLOGICAL TIME ARE NOT USUALLY INDICATED BY GREAT UNCONFORMITIES.

Inasmuch as those geologists and paleontologists who favor the reference of the Arapahoe and the Denver beds of Colorado, the Lance Creek beds of Wyoming and the Hell Creek beds of Montana to the Eocene, give as their principal reason therefor the existence of a great unconformity between the Arapahoe and the formation immediately below it, while there appears to be no similar unconformity below the Fort Union, it may be worth while to examine the adequacy of the reason. I believe that it is fallacious.

It is possible that, as Chamberlin and Salisbury suggest in their general work on geology (*Geology*, iii, p. 192), there is a natural basis for the larger divisions of geological history: that this basis is to be found in the profounder changes in the earth's crust; and that this basis is of world-wide application. This suggestion may be accepted as valuable without its arousing the expectation that a great stratigraphical break will be discovered everywhere between each great rock system and its predecessor and its successor. As a matter of fact, as geological history is now understood and now divided, such breaks are not commonly found. I will quote from Geikie's *Text-book of Geology*, ed. 4, 1903, p. 1081:

Though no geologist now admits the abrupt lines of division which were at one time believed to mark off the limits of geological systems and to bear witness to the great terrestrial revolutions by which these systems were supposed to have been terminated, nevertheless the influence of the ideas which gave life to these banished beliefs is by no means extinct.

On page 981 the author quoted, in speaking of the Old Red Sandstone, says :

\* \* \* in innumerable sections where the lowest strata of the system are found graduating downward into the top of the Ludlow group; and where its highest beds are seen to pass up into the base of the Carboniferous system.

On page 982 one reads as follows :

The rocks termed Lower Devonian may partly represent some of the later phases of Silurian life. On the other hand, the upper parts of the Devonian system might in several respects be claimed as fairly belonging to the Carboniferous system above.

As to the relation of the Lower Carboniferous to the Devonian, Geikie (Text-book, p. 1014) says :

Both in Europe and America it may be seen passing down conformably into the Devonian and the Old Red Sandstone. So insensible indeed is the gradation in many consecutive sections where the two systems join each other that no sharp line can be drawn between them. The stratigraphical passage is likewise frequently associated with a corresponding commingling of organic remains.

Chamberlin and Salisbury (Geology, ii, p. 499) tell us that the transition from the Devonian to the Mississippian seems to have been accomplished without notable deformative movement. Also (p. 518) it is stated that the Devonian fauna passed by graduation into the Mississippian.

There exists in many places the same doubt regarding the boundary line between the Carboniferous and the Permian. Geikie (Text-book, p. 1064) states that in the Midlands and the west of England no satisfactory line can be drawn between the two systems; (p. 1065) that the flora of the older Permian rocks presents many points of resemblance to that of the Carboniferous; (p. 1063) that in North America no good line of subdivision exists between Permian and Carboniferous; so certain deposits are called Permo-Carboniferous; (p. 1077) that in Russia the Permian attains an enormous development, the horizontal strata nearly lying conformably on the Carboniferous.

Of the Permian of North America Chamberlin and Salisbury write (Geology, ii, p. 620) :

The upper Barren Measures are commonly separated from the Pennsylvanian on the basis of the plant species rather than because of any stratigraphic break at their base.

The Artinskian of Russia is placed in the Permian by Lapparent and Geikie, but in the Carboniferous by Tschernyschew, a distinguished Russian geologist.

Similar difficulties are encountered in various parts of the world by geologists when they attempt to draw the line between the Paleozoic and the Mesozoic systems. Chamberlin and Salisbury (Geology, ii, p. 631) have this to say:

The Permian system of Europe seems to be more closely allied, stratigraphically, with the Trias than with the Carboniferous, and while the same is true of the western part of America, the opposite is true for the eastern part.

We have the statement of Geikie (Text-book, p. 1084) that in some regions, as in England, no very satisfactory line of demarcation can always be drawn between Permian and Triassic rocks.

Nor are geologists free from embarrassments when they endeavor to classify the Mesozoic and the Tertiary formations. The Rhætic is arranged by Geikie in the Triassic, by Lapparent in the Jurassic. Clark and Bibbins express doubt regarding the position of the two lower divisions of the Potomac formation of the eastern United States. They refer them provisionally to the Jurassic; the other two divisions are unhesitatingly placed in the Lower Cretaceous. According to Chamberlin and Salisbury, the fossils of the Trinity division of the Comanchean system have raised the question of its reference to the Jurassic. An indefinite number of similar cases could be cited.

The illustrations presented show that the great divisions of geological record are not even commonly separated by physical breaks, great or small. It would be quite as easy to show that important unconformities occur within the limits of systems of rocks. A few cases only need be cited. The following is quoted from Geikie (Text-book, p. 1007):

The Old Red Sandstone of Britain, according to the author's researches, consists of two subdivisions, the lower of which passes down conformably into the Upper Silurian deposits, the upper shading off in the same manner into the base of the Carboniferous system, while they are separated from each other by an unconformability. \* \* \* [In Scotland] it consists of two well-marked groups of strata, separated from each other by a strong unconformability and a complete break in the succession of organic remains.



Geikie states further (p. 1146) that a considerable stratigraphical and paleontological break is to be remarked at the line between the Portlandian and the Purbeckian. Chamberlin and Salisbury (*Geology*, ii, p. 639) tell us that the close of the Paleozoic was marked by much more considerable geographic changes than the close of any period since the Algonkian. The statement is qualified by the remark that these changes may be said to have been in progress during the Permian rather than to have occurred at its close.

#### 4. THE PRINCIPAL DIVISIONS OF GEOLOGICAL HISTORY ARE BASED ON FOSSIL ORGANISMS.

It may therefore be confidently affirmed that the primary divisions of geological history, as this history is now understood, are not based on unconformities and deformations, great or small, between the successive formations, but they are based on the history of the plants and animals whose remains have become entombed in the rocks. I will here quote from Lapparent (*Traité de Géologie*, ed. 5, p. 717) :

Il résulte de ces diverses considérations que les seules ressources de la stratigraphie, si précieuses et si indispensables qu'elles puissent être, sont insuffisantes pour l'établissement des grandes divisions de la géologie. Il faut donc recourir à quelque argument d'une portée plus générale. Cet argument, nous allons le trouver dans la considération des faunes et des flores fossiles.

It must not be supposed that the writer wishes to underestimate the value to the geologist of changes in the materials that constitute successive beds, of deformations of surfaces, or of unconformities, erosional and angular. All these indicate the physical changes that the earth was undergoing and mark the subordinate and more or less local divisions of geological history. Naturally the geologist in the field searches for such interruptions in the course of deposition and, following a bent very human, he may come to attach somewhat undue importance to them. In any case, however, final recourse must be had to the fossils enclosed in the rocks. Fossils are, to use a figure, the sands that, from the hour-glass of the universe, have in an uninterrupted stream dropped into the successive strata to mark the passage of time. Local interruptions of sedimentation enable us to note the changes undergone by the organisms that then existed; but whether there were breaks in deposition or not, the

evolution of the organisms went steadily on. The smaller divisions of time are marked by the less important changes that the animals and plants suffered; while the primary divisions are signalized by the profounder modifications of the living beings. These primary divisions are often indicated by such phrases as the age of mollusks, the age of fishes, and the age of mammals. As there were no universal cataclysms that characterized the terminations of the ages and the eras, so there were no sudden changes in the nature of the animals and the plants. The boundaries between the successive ages and the successive eras must therefore be more or less arbitrarily drawn. If one era is characterized by numerous powerful reptiles and a few inconspicuous mammals, while the next era presents mammals as the dominant animals, the reptiles as decadent, we must draw the line to suit our convenience and to express best the facts; but in the end it will be drawn more or less arbitrarily.

To appreciate the futility of seeking for great unconformities between the rock systems one has only to consider the relations of the Upper Cretaceous to the Tertiary in Europe. Lyell regarded the Thanet sands and certain equivalents in France and Belgium as the base of the Eocene. Between this and the Upper Cretaceous there appeared to be one of the profoundest breaks in geological history. Lyell says that the interval between the Upper Cretaceous and the Eocene must have been greater than that between the Eocene and the present. More recent investigations have shown that even in the north of Europe there are deposits of no great thickness that partly fill the gap between the two systems; while it is almost filled in the south of that country.

The conclusion applicable to the question being considered which I reach is that the magnitude of the break below the Arapahoe formation in the Denver basin has little or nothing to do with the determination of the boundary line between the Mesozoic and the Cenozoic. The position of this line is to be settled through the study of the organic remains found below and above the unconformity and the comparison of these with the fossils found at corresponding levels in regions geologically better understood. If the ensemble of the organisms found in the Arapahoe, the Denver, the Lance Creek and the Hell Creek beds, is essentially of Upper Cretaceous nature, on comparison with accepted standards, those beds belong to the Mesozoic, not to the Cenozoic, notwithstanding the great unconformity.

As has already been said and is well known, the base of the Eocene was established just below the Thanetian of England and its continental equivalents; and this line of separation of the Cenozoic from the Mesozoic has been recognized by practically all geologists since Lyell's time. Considering the great gap between the two systems, as known in Europe at that time, the separation did not appear to be at all an arbitrary one. In his "Text-book of Geology," edition of 1896, Geikie placed the Montian in the Eocene, but in the edition of 1903 this formation is restored to the Upper Cretaceous. Lapparent, too, draws the line above the Montian. Nor does this manner of division appear to arouse objections on the part of the paleontologists.

If, therefore, American geologists and paleontologists wish to have the boundary line between the Mesozoic and the Cenozoic of their country coincide with that of Europe, the type continent of the base of the Eocene, it will be necessary, unless there are compelling reasons for the contrary, to make the base of our Eocene the equivalent of the Thanetian of Europe. I believe that geologists and paleontologists generally will give assent to this proposition.

It is well understood that in the determination of the level of any geological formation not all kinds of fossils are of equal value; some are indeed of little value. It is agreed that the marine animals record most accurately the progress of geological time, because of their abundance, their wide distribution, the slow and steady changes which they undergo during geological periods, and the facility with which they become entombed in accumulating sediments. Furthermore, of marine species the pelagic forms are of greater value, because their remains are dropped indiscriminately into deposits of all kinds, thus enabling geologists to correlate formations widely separated and composed of very different materials. Terrestrial animals are of less value. They are subject to rapid and extreme changes in their environment through changes in climate and through sudden migrations. They suffer accordingly rapid modifications in their structure or sudden extinction. They are also less likely to be preserved in the rocks. Every shell in an oyster bed may be preserved, while from a million horses but a single tooth may escape destruction. In an interesting address at the meeting of the British Association at Montreal, in 1884, Blandford gave it as his opinion that determinations of

geological age based on terrestrial and freshwater faunas and floras only are extremely likely to be incorrect.

Unfortunately for us, the deposits in which we are now especially interested contain few or no marine organisms, but abundant freshwater and terrestrial animals and numerous plants. We must therefore reach our conclusions by somewhat indirect methods and must be on our guard against errors. Still more unfortunately for us, the paleozoologists and the paleobotanists have not attained the same results from their studies.

##### 5. THE VALUE OF PLANTS AS INDICES OF GEOLOGICAL DATES.

I trust that the paleobotanists will not charge me with trying to disparage their science when I proceed to show that, in the present case at least, their results are less to be depended on than those obtained by the paleozoologists. Without doubt, the plants have as interesting, as trustworthy, and as valuable a story to tell, when rightly deciphered, as do the animals. It seems, however, that in some cases, other than the one before us, the significance of fossil plants has not been rightly comprehended. In Blanford's address, cited above, he mentions two important cases in which the determination of the age of certain formations have contradicted those made from the marine animals. One case is found in the Gondwana system of India, where, as Blanford says, "we have a Rhaetic flora overlying a Jurassic flora and a Triassic fauna above both." Again he states that "in Australia we find a Jurassic flora associated with a Carboniferous marine fauna and overlain by a Permian freshwater fauna."

The following is quoted from Lapparent (*Traité*, p. 718) :

A plus d'une reprise, l'étude des flores terrestres a paru donner des indications contradictoires avec celles des faunes marines; et en dernière analyse la question a toujours été tranchée en faveur de ces dernières.

Geikie makes the following observation :

Certainly a number of instances are known where an older type of marine fauna is associated with a younger type of flora.

One reason why plants, at least those of the northern hemisphere, which have existed since the beginning of the Upper Cretaceous, seem to be of only secondary value in correlating formations is found in their apparently extreme conservatism. While the species have changed, the genera have changed little. As an illustration of this, one may take the list of plants published by Doctor Knowlton (*Wash. Acad. Sci.*, xi, 1909,

p. 219) as occurring in what he is pleased to call the Lower Fort Union, but which includes the Lance Creek and Hell Creek beds and their supposed equivalents. One might almost imagine it to be a list of plants found in a recently investigated corner of the world on the latitude of Louisiana. On page 225 it is stated that a number of species are yet living, while others are so obviously close to living species as to be separated with difficulty. Such inert organisms, subject also to all the vicissitudes of life on the land, can hardly be regarded as good indicators of the passage of time. Since that epoch the genera, families, and even orders of warm-blooded vertebrates have almost completely changed.

The opinion held by some distinguished geologists and paleontologists that the so-called Laramie beds, or all of these except the lowest, belong to the Tertiary appears to have rested until recently, at least, mostly on the statements of Professor Leo Lesquereux, the paleontologist of the Hayden Survey. He and Dr. Hayden at first regarded these deposits as belonging to the Miocene, but later as belonging to the lowermost Eocene. Passing over Lesquereux's earlier writings I refer to one of his latest utterances on the subject, found in the eighth volume of the monographs of the Geological Survey of the Territories, part three, published in 1883. On page 109 Lesquereux makes this statement:

The flora of the Laramie group has a relation, remarkably defined, with that of Sézanne.

Now, the flora of Sézanne, a town in France, comes from beds that belong to the Thanetian, at the very base of the Lower Eocene. Lesquereux's statement is followed by a table of the species which he supposed had been found in the Laramie at various localities. The beds at some of these localities are now known to be somewhat older than any Laramie, those at one or two localities a little younger than Laramie. In the table is a column in which are checked off the species of Laramie plants that Lesquereux believed to be identical with or closely related to species found at Sézanne; in another column the species that he supposed were found also in the Oligocene of Europe; in a third column those that he believed to occur also in European Miocene deposits. Naturally, one would expect, in view of Lesquereux's statement quoted above, that the identical and closely related species of the Sézanne column would outnumber those of the Miocene column. On the contrary, only three species were regarded by him as identical with Sézanne species, while twenty-

seven species are recorded as identical with European Miocene species. If we count in each case the plants that were supposed to be closely related to the European species, but not identical, we find twenty-five in the Sézanne column and thirty three in the Miocene column. Adding the identical and the related species in each case it is seen that there are in the Sézanne column twenty-eight species, sixty in the Miocene column. Therefore, it becomes difficult to understand how Professor Lesquereux derived his conclusion from his premises. What his table really proved was that the Laramie deposits belong to the Miocene. Had Cope and other paleontologists examined the table itself, instead of accepting the author's statement regarding it, they would either have distrusted the evidence from the plants more than they did or would have concluded that the dinosaurs ranged up into the Miocene.

It is not to be supposed that all paleobotanists accepted Lesquereux's views. These views were strongly opposed, especially by Newberry, as early as 1874 and as late as 1889. The following is quoted from Newberry (*Trans. N. Y. Acad. Sci.*, ix, 1889, p. 28) :

If Prof. Cope had not accepted Mr. Lesquereux's conclusion in regard to the age of the deposit [at Black Buttes], and had recognized the fact that there are no Tertiary plants in the true Laramie, he would have seen that there is no discrepancy between the testimony of the plant and animal remains.

It is to be taken into consideration here that Newberry believed that the Laramie was directly overlain by the Fort Union. The latter beds have usually been regarded as belonging to the Eocene. However, the following may be quoted from Lester F. Ward, who had studied especially collections of plants from the Fort Union deposits (*Bull. Geol. Soc. Amer.*, i, 1890, p. 531) :

In fact, the material from the Fort Union formation which is still in my hands inclines me to believe that there would really be, as I then stated, no inconsistency in assigning to the Fort Union an age as ancient as the closing period of the Cretaceous system.

#### 6. THE COMPLETENESS OF RECORD OF ANIMAL LIFE AS COMPARED WITH THAT OF PLANT LIFE.

There is, in the present state of knowledge, a great contrast between the incompleteness of the plant record above the Fox Hills formation and the fullness of the animal record. Plants are abundant throughout the

series that has been called Laramie and in the Fort Union. Again, they are found in the Green River beds, in the White River beds, and in the deposits at Florissant, Colorado. Otherwise, the record is mostly missing. On the other hand, the history of the vertebrates is quite full. Between the Fox Hills and the present time there are known probably nearly twenty distinct faunas and it has been found possible to correlate these in most cases closely with European faunas. With such a series at command, the extremes of which differ enormously, while the mean terms sometimes grade into their successors, at other times differ greatly from the next comers, the paleontologist need not go far astray in determining the proper level of each fossil-bearing deposit. It may be remarked that when the paleobotanist refers the Green River beds to the Oligocene, while the vertebrate paleontologists put them at the bottom of the middle Eocene, a serious dislocation of views is indicated.

#### 7. THE BEGINNING OF THE EOCENE IN EUROPE AND AMERICA.

When one comes to correlate formations in America with those of distant countries great difficulties are likely to be experienced. Interruptions in stratification are not likely to occur at the same time in America and Europe and Asia. On account of differences in the character of the deposited materials, the climate, the interposition of barriers, and other features of environment, the contained organisms must differ to a greater or less extent. In the case of the beds about which exists our dispute, they are neither of marine origin nor in contact with strata of purely marine origin. Hence they cannot be compared directly with either the typical uppermost Cretaceous deposits of Europe, the Danian, nor with the Thanetian, the lowermost European Eocene. The Lance Creek beds, the Hell Creek beds, and others related to them have been produced mostly through the action of fresh waters and they contain remains of land plants, freshwater mollusks and fishes, reptiles inhabiting the water and the land, and a few terrestrial mammals. In such a situation we must have recourse to indirect means of correlation.

In the vicinity of Rheims, France, in deposits belonging to the Thanetian, there has been found a considerable number of genera and species of extinct mammals, together with some birds, reptiles, and fishes. The mammals have been studied and described by Lemoine. On the strength of this fauna these Cernaysian beds were correlated with the Puerco at a

time when this term was applied to beds now separated and known as Puerco and Torrejon. There is thus furnished a means of beginning a correlation of our land and freshwater Tertiary deposits with those of Europe; but we need ever to keep in mind the possibilities of error.

I believe that any one who may carefully compare the Cernaysian fauna with the faunas of our Puerco and Torrejon must conclude that the Cernaysian corresponds more closely with that of our Torrejon than with that of the older Puerco. I find that Osborn had reached this conclusion in 1900 (*Ann. N. Y. Acad. Sci.*, xiii, pp. 9, 10); and in his latest matter on the subject he correlates the Torrejon with the Thanetian, or Cernaysian (*Bull. 361, U. S. Geol. Surv.*, p. 34). Indeed, it seems not improbable that the Cernaysian is a little more recent even than our Torrejon.

It has been demonstrated that at least a part of the Fort Union formation is the equivalent of the Torrejon. Hence, wherever the latter is put the Fort Union or some part of it must go. The base of the Tertiary being drawn in Europe at the bottom of the Thanetian, there appears to be no good reason why in our country it should not be drawn above the Puerco, possibly above the Torrejon and the Fort Union. Certainly, when geologists and vertebrate paleontologists have consented to include the Puerco and the Torrejon in the Eocene they have lowered the base of the latter formation to its extreme level. To include now in the Eocene the "Ceratops" beds, the Hell Creek beds, the Arapahoe and the Denver, would be to add to it some hundreds of feet of deposits which, in the opinion of vertebrate paleontologists, contains a considerably older fauna than that occurring in the Cernaysian beds, and which with equal confidence the invertebrate paleontologists refer to the Cretaceous.

#### S. RELATIONSHIP OF FAUNA OF LANCE CREEK EPOCH TO THOSE OF PUERCO AND TORREJON.

Inasmuch as those geologists and paleobotanists who favor the transference of a large part of the Laramie (as formerly understood) to the Tertiary insist that the fauna of the Lance Creek and the Hell Creek beds is more closely related to that of the Puerco and that of the Torrejon than to any Cretaceous fauna, this question must be considered. With regard to the relationships of the mammals of the Lance Creek beds to those of the Puerco and Torrejon extremely diverse views have been expressed. Marsh (*Amer. Jour. Sci.*, xliii, 1892, pp. 250, 251) says that the mammals of the Lance Creek deposits



are not transitional between the Mesozoic and Tertiary forms, but their affinities are with the former beyond a doubt; thus indicating a great faunal break. \* \* \* and the great break is between this horizon [the Puerco] and the Ceratops beds of the Laramie. \* \* \* It is safe to say that the faunal break as now known between the Laramie and the lower Wasatch [Puerco] is far more profound than would be the case if the entire Jurassic and the Cretaceous below the Laramie were wanting.

Cope (*Amer. Naturalist*, xxvi, 1892, p. 762), quoting from Marsh the words "the more the two [Laramie and Puerco] are compared the stronger the contrast between", adds:

It is true that no Ungulata have yet been found in the Laramie, while they abound in the Puerco, but we cannot be sure that they will not yet be found; the probabilities are that they existed during the Laramie and that it is due to accident that they have not been obtained. But the Multi-tuberculata of the two faunæ are much alike.

Osborn (*Bull. Amer. Mus. Nat. Hist.*, v., 1893, p. 311) writes:

This Laramie fauna is widely separated from the Upper Jurassic, and is more nearly parallel with the basal Eocene forms of the Puerco and the Cernaysian of France. \* \* \* These conclusions are directly the reverse of those expressed by Marsh in his three papers upon this fauna.

Cross (*Geology of the Denver Basin*, p. 220) concludes that this difference of opinion deprives the mammalian remains of much of their value in the present discussion.

To the present writer Marsh's opinion seems to be erroneous. Geologically, of course, the Jurassic mammals are much farther removed from those of the Lance Creek beds than the latter are from those of the Puerco, Torrejon, and Fort Union. The same remark may justly be made regarding the stage of development attained by the Jurassic mammals. Systematically considered, the case is different; and the solution of the problem depends on the systematic relationships of the Jurassic mammals to those of the Lance Creek beds and of the latter to the mammals of the Puerco and Torrejon. If it shall result that all, or nearly all, of the Lance Creek mammals belonged to the Marsupialia and the Monotremata, then Marsh's opinion will be in great measure justified. If, on the other hand, it shall be shown hereafter that a large number of the Lance Creek mammals were placentals and the near-by ancestors of the Puerco and Torrejon faunas the break between the former and the latter will not be a profound one; nevertheless more important than formerly supposed by Osborn.

It must be understood that our knowledge of the mammals of the Lance Creek and related formations is of a very unsatisfactory kind. With few exceptions, all that is known of these animals has been derived from their teeth, not found in place in the jaws, but scattered singly through the rocks. Better known are the Jurassic mammals, for of these many jaws have been secured. Recently considerable light has been thrown on the marsupials of the Lance Creek and Fort Union formations through the discovery of the skull and some parts of the skeleton of *Ptilodus* (Gidley, Proc. U. S. Nat. Mus., xxxvi, p. 611). The other genera await elucidation. Osborn's statement of the situation may be accepted (Evolution of the mammalian molars, 1907, p. 95) :

It is possible that, besides Marsupials, we find here Insectivores, primitive Carnivores, and the ancestors of ancient Ungulates; but it is obvious that the determination of relationships from such isolated materials is a very difficult and hazardous matter.

Notwithstanding this appreciation of the situation, Professor Osborn has ventured (op. cit., pp. 12, 22, 115) to refer his Trituberculata, Marsh's Pantotheria, to the infraclass Placentalia. No adverse criticism can be made on this procedure, in case its tentative character is understood.

Now, while this uncertainty reigns regarding the systematic relationships of the mammals of the Lance Creek and related deposits, the case is different as soon as attention is given to the mammals of the Puerco, Torrejon, and Fort Union. Some of them betray by their tooth succession and other characters that they are true placentals. Many of them may be referred with confidence to orders and families that continued long afterwards, some of them probably to the present day.

That a considerable gap existed between the mammals of the Lance Creek formation and those of the Puerco and Torrejon is evident from the state of development of the teeth. Osborn, speaking of the teeth of the Upper Cretaceous mammals [Lance Creek] says (Bull. Amer. Mus. Nat. Hist., v., 1893, p. 321) that in none of the molars hitherto described and in none of his collection of about 400 teeth and some jaws was there any trace of the hypocone, or posterior internal tubercle. Nor was any hypocone recognized in the genera described by him in 1898 (Bull. Amer. Mus., Nat. Hist., x, p. 171). Undoubtedly, however, the hypocone is sometimes present in a rather rudimentary condition, as I have observed in teeth shown me by Mr. Gidley, of the U. S. National Museum. Nevertheless,

the teeth of all the mammals of the Lance Creek stage, except those of the Allotheria, are triangular, showing that the possessors were either insectivorous or flesh-eating in their habits.

On the other hand, there are several genera of Puerco mammals that possess a well developed hypocone and internal cingulum. In some cases, where the hypocone had no great development, the hinder internal part of the tooth had swollen so as to reduce much the gap between the successive teeth and produce a broad triturating surface. In *Polymastodon*, which must have been a vegetarian, an extensive triturating surface was secured in another way. It presents a great advance over the teeth of any of the Lance Creek Allotheria. If it is considered how slowly changes in tooth structure had advanced during the Mesozoic era we must conclude either that a considerable interval had elapsed between the Lance Creek epoch and that of the Puerco or that the animals of the latter were not descendants of the former.

There are important differences between the mammals of the Lance Creek beds and those of the Puerco as regards the size attained. Most of the former are of insignificant proportions, resembling in this respect those of the Jurassic; while many of those of the Puerco are large. Furthermore, there was in the mammals of the Puerco a far greater variety of form, structure, and systematic relationships than among those of the Lance Creek mammals. Of the latter, there have been described about twenty-five genera and about forty-five species, most of them by Marsh. Osborn has regarded himself as justified in reducing these to about ten genera, these representing a very few families. From the Puerco Matthew (Bull. 361, U. S. Geol. Surv., 1909, p. 91) recognizes twenty-nine species, belonging to eighteen genera and nine families. To what extent this increased diversification of the mammalian life of the Puerco is due to immigration we can not now tell; but it does not seem to be necessary to assume that it was due to invasion of mammals from some other region. For, in view of the interval between the two formations that is indicated by the plants and reptiles, it is possible that the Puerco mammals are the direct descendants of those of the Lance Creek epoch.

In case there was no serious interruption in deposition between the Lance Creek beds and the Puerco and Fort Union, one might expect to find close relationships between the reptiles of the two levels. Crocodiles are not abundant in either and, so far as known, no species passes from

the one formation to the other. *Champsosaurus*, belonging to another order, is found in the beds of the Lance Creek region and at Hell Creek and also in the Puerco; but probably no species is common to the lower and the upper levels. This genus, like *Ptilodus*, serves to show that, though there may have been a considerable interval between the Lance Creek and the Puerco, it was not an enormous one. The dinosaurs, which were such a conspicuous feature of the Lance Creek epoch, appear to have disappeared completely before the time of the Puerco and Fort Union. Of turtles, some families passed from the one formation to the other, but probably no species. A pleurodire, representing a large group of turtles found now mostly south of the equator, was present in the "Laramie" of New Mexico; but no member of the group is known to have existed in North America after that time. Certain other genera of turtles (*Adocus*, *Eubaena*, *Thescllus*, *Basilemys*, *Helopanoplia*) are not known to have passed from the Lance Creek level into that of the Puerco and Fort Union; and other genera (*Alamoscymys*, *Hoplochelys*, *Conchochelys*, *Amyda*?) appear to have had their beginning in the Puerco. It may further be said that, while turtles were very abundant in the Lance Creek epoch, they appear to have been very rare in the Fort Union, though of more frequent occurrence in the Puerco.

As regards the mollusks I find this statement made by Doctor Stanton (Wash. Acad. Sci., xi, p. 264), where he is speaking of a Fort Union locality in Montana:

The Unios are all of simple type and do not include any of the peculiarly sculptured forms like those of Hell Creek, Converse County, and Black Buttes.

The plants, conservative as they are, testify even more strongly than do the animals to a considerable interval between the Lance Creek epoch and the Fort Union. According to Doctor Knowlton (Wash. Acad. Sci., xi, p. 221), out of 84 identified species found in the Lance Creek epoch ("Lower Fort Union") 68 occur in the Fort Union. Hence 16 species, nearly 20 per cent, appear to have failed to reach the higher beds. It is to be noted here that about 300 plants are known from the Fort Union and only about 200 from the Lance Creek beds. For a group of organisms that even then contained a considerable number of species yet existing, or very close to forms yet existing, the loss of a fifth of their forces, at a time when there appears to have been little change of climate, indicates the lapse of an important interval.

The base of the Eocene is usually regarded as containing a small per cent of the marine mollusks yet living; the beginning of the Miocene, about 17 per cent of yet existing species; and the beginning of the Pliocene about 36 per cent. If now plants have changed in species during the lapse of geological time with about the rapidity that marine mollusks have changed, the Fort Union beds ought to be arranged in the Lower Miocene. This would harmonize quite well with the idea that the Green River beds belong to the Oligocene.

#### 9. RELATIONSHIP OF LANCE CREEK FAUNA TO THAT OF THE JUDITH RIVER EPOCH.

Having demonstrated, as I think I have, that there was, between the time of the deposition of the Lance Creek beds and those known as Puerco and Fort Union, a nearly complete change in the fauna and a considerable change in the flora, I will endeavor to show that the fauna of the former beds is closely related to that of the Judith River, a formation now recognized as being well down in the Upper Cretaceous and separated from the lowermost Laramie by about 1,000 feet of marine Cretaceous strata (Stanton, Wash. Acad. Sci., xi, p. 256). This close relationship of the two faunas has been recognized, it may be truthfully said, by all paleontologists who have given attention to the subject. For a long time it misled geologists and paleontologists into the conclusion that all the deposits in question belonged to a single epoch. Mr. J. B. Hatcher, who had collected extensively both in the Judith River region and in the Lance Creek beds, and who had studied closely the vertebrates of both regions, writes (Bull. U. S. Geol. Surv., 257, p. 101):

When considered in its entirety, the vertebrate fauna of these beds [Judith River] is remarkably similar to, though distinctly more primitive than, that of the Laramie [Lance Creek beds]. Almost or quite all of the types of vertebrates are present, though, as a rule, they are represented by smaller and more primitive forms.

Doctor T. W. Stanton, paleontologist of the U. S. Geological Survey, who examined in company with Professor Hatcher the Judith River basin, and who has given especial attention to the invertebrate fauna, records in the same bulletin (p. 121) his opinion:

When full collections are compared it will usually be easy to distinguish between Judith River and Laramie from the brackish-water fossils alone, but if the collections are meager and fragmentary it may not be

practicable to do so. \* \* \* Taken as a whole, the fresh-water faunas of the Judith River and the Laramie are somewhat more distinct than the brackish-water faunas of the same formations, and with fairly complete collections it should not be very difficult to distinguish them in the laboratory.

When we come to compare the vertebrates of the Judith River beds with those of the Lance Creek deposits it becomes necessary practically to ignore the mammals, inasmuch as only two species of these have up to this time been discovered in the Judith River. These are *Ptilodus primævus* and *Borodon matutinus*, both described by Lambe from the Belly River beds of British America. The former of these fossils is related to species of the same genus found in the Lance Creek beds and in the Torrejón, the latter genus is of undetermined relationship.

*Fishes.*—Beginning with the fishes, there have been described from the Judith River beds eight species. In the Lance Creek beds, Converse County, Wyoming, Professor Williston (Science, xvi, 1902, p. 952) found materials which he refers to two of these species (*Myledaphus bipartitus*, *Lepisosteus occidentalis*). One of these fishes, *Myledaphus bipartitus*, seems to be a ray. The rays are almost wholly inhabitants of salt water; hence the persistence of this Judith River freshwater form is somewhat remarkable. A supposed sturgeon, *Acipenser alberteñsis*, found by Lambe in the Belly River beds, occurs, according to Williston, in the Lance Creek beds. From the Belly River beds Mr. Lambe described a remarkable species of fish which he called *Diphyodus*. Hatcher states that similar jaws are common both in the Judith River beds of Montana and in the deposits of Converse County, Wyoming. From the Hell Creek beds of Wyoming Mr. Barnum Brown has reported the discovery of another species of the same genus.

*Tailed Amphibians.*—Of the tailed amphibians, at all times rare fossils, Cope described from the Judith River region four species, all members of the genus *Scapherpeton*. Lambe believes that he has found one of these in the Belly River beds, a fact that shows the somewhat extended distribution of the genus at that epoch. Williston found one of the species in the Lance Creek beds and Brown reported a species from the Hell Creek deposits. While it is true that these fishes and amphibians are mostly represented by fragmentary remains, these remains are usually characteristic and capable of accurate comparison. That *Myledaphus* should reappear after an interval allowing the deposition of 1,000 feet of marine

strata and probably some hundreds of feet of freshwater strata, is remarkable enough; but that it should reappear in company with its old companions, the rare *Diphyodus* and *Scapherpeton*, not to mention the more highly developed fauna yet to be discussed, is very striking. Had there occurred at both levels only some pebbles of three peculiar forms or compositions, instead of the three genera, the conclusion would have been inevitable that there was some particular connection between the two formations.

*Champsosaurus, Crocodiles.*—Coming next to the reptiles, it may first be noted that species of *Champsosaurus* occur in the Judith River beds, in the Lance Creek beds, in those of the Hell Creek region, and in the Puerco. It is probable that the species vary from one formation to the other. The same statement can probably be made regarding the crocodiles. These genera, common to all three of the formations under discussion, may be left out of consideration; although it must not be overlooked that none the less they aid in binding together the formations in which they are found. As to the crocodiles, it may be mentioned that Williston recognized, in teeth and scutes found in the Lance Creek beds, Leidy's *Crocodylus humilis*, originally described from the Judith River region. From the Judith River beds of Alberta Lambe described *Leidyosuchus canadensis*. Mr. C. W. Gilmore will soon describe a second species of the genus, collected last summer in the Lance Creek beds of Converse County, Wyoming.

*Turtles.*—As regards the turtles, certain genera have already been mentioned as appearing not to pass the line between the Lance Creek formation and the Puerco and Fort Union. My study of the fossil turtles indicates that the species of these animals rarely pass from one epoch to another. If they have ever done so they passed from the Judith River into the Lance Creek epoch. There are five or six species of Judith River turtles which are represented in the Lance Creek and Hell Creek beds by turtles of identical or very closely related species. Most of these are marked by such peculiar sculpture that they are easily recognized and some of them likewise are represented by excellent materials. I shall take the pains to give some details.

*Compsemys? obscura* Leidy was originally described from beds probably belonging to the Lance Creek epoch and found at Long Lake, N. Dakota. Not much of it is known, but the sculpture is distinctive.

It was included by Cope in his list of Judith River vertebrates. Barnum Brown found what appears to be the same species in the Hell Creek beds.

*Compsemys victu* Leidy was described from the beds of Long Lake. Its sculpture is characteristic, resembling small, closely placed, pustules, that cover all parts of the shell, and appearing in no other turtles. It is fragmentary, but very common in the Lance Creek beds. Barnum Brown has collected it in the Hell Creek deposits. Cope included it in his list of Judith River vertebrates. He also found it in Colorado, in deposits that belong to either the Arapahoe or the Denver. I am able to say that the same genus is represented by an undescribed species in the Fort Union.

*Aspideretes foveatus* (Leidy) was described from the Judith River basin. Leidy had other specimens from Long Lake, N. Dakota. There are many fragments of the species in a collection made in the Judith Basin for Cope by Charles Sternberg. A nearly complete carapace was found in the Belly River beds by Lambe. Fragments indistinguishable from the type were secured by Barnum Brown in the Hell Creek region. The carapace is ornamented by a characteristic pitting.

*Aspideretes beccheri* Hay has for its type a specimen in Yale University which lacks little more than the head and a part of the neck. Mr. Hatcher collected in the Judith River beds two quite complete carapaces which I have examined, without being able to distinguish them from the type of *A. beccheri*.

*Adocus lincolatus* Cope is a turtle that is not well known, but fragments of what appear to be the same species are not uncommon. The sculpturing is peculiar. The type was found in Colorado, in probably the Arapahoe formation. Cope included it among the vertebrates of the Judith basin, and Lambe reported it from Belly River deposits in Alberta. Barnum Brown found in the Hell Creek beds what seems to be the same species.

The genus *Basilcmys* is represented by turtles of large size and an extraordinary form of sculpture. The type *B. variolosa* (Cope) has as its type a large part of the plastron and considerable parts of the carapace. This type was found in the Judith River basin. Members of the Canadian Geological Survey found good specimens of the species in the Belly River beds in British America. A second species of the genus has been discovered in beds of the Lance Creek epoch, in Custer County, Montana. The type is a complete shell. Had only fragments been found that did not



include distinctive parts, this specimen would have been regarded as belonging to *B. variolosa*. A species not certainly identified occurs in the Hell Creek beds. During the past season an undescribed, closely related species was discovered in the Lance Creek deposits in Converse County, Wyoming, by a member of the U. S. Geological Survey. Nothing resembling these turtles has ever been found in beds above those equivalent to the Lance Creek deposits. Indeed, all those turtles of the Upper Cretaceous which had the carapace and plastron sculptured in various ways, appear to have become extinct before the beginning of the Tertiary. Not long after the opening of the Tertiary, in the Wasatch, there came in the Emydidae and the Testudinidae, and these developed other styles of ornamentation of the shell.

Figures of all the species of turtles named above are to be found in the present writer's "Fossil Turtles of North America."

*Dinosaurs*.—Both in the Judith River beds and in those of the Lance Creek epoch the most abundant and the most conspicuous reptiles are the dinosaurs. Five families of these, belonging to four superfamilies and to two suborders, are represented in the Judith River epoch, and each of these families reappears in the Lance Creek epoch. Furthermore, many of the genera are common to the two formations and it is believed that the same is true of a considerable number of species. From the Judith River beds Cope described eight species of carnivorous dinosaurs that seem to come under the genus *Dryptosaurus*. Mr. Hatcher (Bull. U. S. Geol. Surv., 257, p. 86) mentions the occurrence of two of these, called by him *Deinodon explanatus* and *D. hazenianus*, in the Lance Creek beds. Another carnivorous dinosaur, *Deinodon horridus*, was originally described from the Judith River beds. Hatcher (loc. cit., p. 83, *Aublysodon mirandus*) believed that it was found likewise in the Lance Creek beds. Another, *Zapsalis abradens*, is thought (p. 84) to occur in both formations. The great carnivorous dinosaur described by Osborn, *Tyrannosaurus rex*, may be a descendant of Marsh's *Ornithomimus grandis*, of the Eagle formation, older still than the Judith beds.

In the herbivorous order Orthopoda are placed the remarkable reptiles called the Stegosauria. Two species, *Troodon formosus* and *Palæoscincus costatus*, are mentioned by Hatcher (loc. cit., pp. 83, 88) as being represented in the Lance Creek deposits by numerous teeth of size and pattern similar to the types, which were described from the Judith River

formation. In addition to these, Barnum Brown has described from the Hell Creek beds a large stegosaur, *Ankylosaurus magniventris*, the type of a new family. We can not doubt that some day a closely related form will be discovered in the Judith River beds; and indeed, its immediate ancestor may be Lambe's *Stereocephalus tutus*, from the Belly River deposits.

The large herbivorous dinosaurs, the Hadrosauridae, which were accustomed to walk about on their hinder limbs only, are, according to Cope's identifications, represented in the Judith River formation by about nine species. The Lance Creek and the Hell Creek beds furnish three or four species of the family, most of which are referred to the genus *Hadrosaurus*, or *Trachodon*. Whether or not there are species common to the two formations cannot now be definitely determined; but certainly their relationships are very close.

Of all the dinosaurs that are found in the formations in which our interest is now centered the Ceratopsia have received the most careful study. What the present state of knowledge is with regard to these remarkable reptiles, may be learned from Hatcher's monograph of the group, completed and edited by Dr. Lull (Mon. 49, U. S. Geol. Surv.). Unfortunately much needs yet to be learned about them, especially about those of the Judith River forms. Approximately nine species are known from the Judith River deposits of Montana and British America; and about fifteen species are credited to the Lance Creek beds, of Wyoming, and to the Arapahoe and the Denver, of Colorado. Hatcher and Lull conclude that those of the Judith epoch are somewhat more primitive than those of the beds higher up, being somewhat smaller, with a less completely developed nuchal frill, with the nasal horn relatively larger and the supraorbital horns relatively smaller than in the younger forms. It is, however, to be noted that the nasal horn of *Ceratops*, of the Judith River epoch, is not yet certainly known. For the most part the genera are based on the characters mentioned above. They may have the importance assigned to them, but they do not indicate radical differences. Such differences might easily have arisen during an interval of moderate duration. There can be no doubt that the Ceratopsia of the higher beds were derived directly from those of the lower.

The possibility may be fully granted that further investigations may prove that few or no species of vertebrates continued from the Judith

River epoch to that which witnessed the deposition of the Lance Creek and Hell Creek beds. Nevertheless, nothing can impair the force of the evidence that many species included among the fishes, the tailed amphibians, the turtles, the crocodiles, the champsosaurians, and the carnivorous and herbivorous dinosaurs are represented in both formations by closely related forms. The remarkable thing about the matter is that the faunas of the two formations, separated by so great a thickness of strata, should be so similar. We must conclude that deposition went on rapidly in that interval, so that it may not have been so long as otherwise might appear. There could hardly have been movements of the land in that region that produced any considerable changes of climate. During the Bearpaw epoch the sea probably quietly invaded a part of the territory that had previously been occupied by the Judith River animals; but around the border of this invading sea the turtles, the crocodiles, and the many genera of the dinosaurs continued their existence and their evolution undisturbed until that sea retired. And doubtless had all those animals in that region been destroyed there was an extensive territory, nearly the whole of North America as far as the Atlantic, that harbored similar forms, from which territory new recruits could swarm in. As far away as New Jersey there were living herbivorous and carnivorous dinosaurs not greatly different from those of the Judith River beds. This appears to be true, that whatever happened to the plants between the time of the Judith River and the Lance Creek beds, nothing of serious importance happened to the animals.

By those who insist on elevating the deposits of the Lance Creek epoch into the Tertiary, a persistent effort has been made to minimize or nullify the significance of the presence of dinosaurs. As long ago as 1880 Heer wrote thus (Arctic Flora, vol. 6, pt. 2, p. 7) :

Der *Agathaumas* von Black Buttes beweist daher keineswegs, dass dort eine Tertiär-Flora zu gleicher Zeit mit einer Kreide-Fauna gelebt habe, wie Prof. Cope dies behauptet, denn ein einzelnes Thier macht so wenig eine Fauna aus, als eine Pflanzenart eine Flora. Wir können daher Hrn. King nicht beistimmen, wenn er, mit Cope und Marsh, die Laramie-Gruppe zur Kreide bringt.

Mr. Cross and Dr. Knowlton have argued that the dinosaurs might have continued on into the Eocene, and in fact did so. As to the vertebrate paleontologists, it is not probable that any of them would have asserted that this was impossible and some of them have granted the possibility. In holding that the dinosaur beds belong to the Mesozoic, they

have reasoned that, inasmuch as these animals are characteristic of the Mesozoic and are not known to occur in the Tertiary of any other region, they probably did not exist during any part of the Tertiary of this country. And certainly, there is a mass of confirmatory evidence for this conclusion. The plants have appeared to furnish evidence against it; but, in view of the discrepancy between Lesquereux's conclusion and his premises, it seems that the paleozoologists were justified in their conservatism.

Mr. Cross writes (*Mon. U. S. Geol. Surv.*, xxvii, p. 251) :

If the dinosaurs of the Ceratops fauna did actually live in the Laramie epoch of Colorado they survived a great orographic movement and its accompanying climatic changes, and continued through the Arapahoe and Denver epochs so little modified that Professor Marsh has not detected any changes corresponding to the stratigraphic time divisions.

Since this was written it has been found that the Judith River beds, which contain so many dinosaurs, were deposited long before the time of the Laramie. We thus have proof that these dinosaurs and many other forms of vertebrates survived, without important changes, the orographic movement mentioned by Mr. Cross. It seems probable, therefore, that this movement was not so widely extended and so long continued as has been supposed. Why the dinosaurs died out finally we do not know, any more than we know why numerous other vigorous races of animals have perished from the earth. That the causes were not local is shown by the fact that in Europe likewise they became extinct just before the appearance of the Cernaysian fauna. It may be regarded as very reprehensible in them that they thus permitted themselves to perish before the Eocene came on, but we are compelled to believe the record.

In the preceding pages I have endeavored to show that the deposits of the Lance Creek epoch are well separated from those of the Fort Union, as indicated by both the fauna and the flora. In case a biological break is required between the Cretaceous and the Tertiary such a break seems to be present here. The stratigraphical break appears to be less conspicuous; yet unconformities are not absent and the character of the deposits appears to be such that there is seldom difficulty in separating the one formation from the other. Nevertheless, it seems that accurate correlation demands that the line between the Mesozoic and the Cenozoic in that region ought to be drawn at least above the Puerco and probably through or above both the Torrejon and the Fort Union. The exact position of the parting must be settled after further investigations.

## 10. CONCLUSIONS.

1. The answer that the writer would give to the question at the head of this paper is that the Lance Creek beds belong to the Upper Cretaceous.

2. In the Upper Cretaceous ought to be included also the Puerco and not improbably also the Torrejon and the Fort Union.

3. In case of a conflict between the evidence furnished by the flora and the fauna of the Lance Creek beds and those of the Fort Union respectively, the evidence obtained from the faunas is to be preferred, as being part of a more complete and better understood history. Present knowledge regarding plants seems to indicate that they were precocious, having reached something like their present stage of development long before the mammals attained anything like their present stage of differentiation. There are also indications that the floras of the western world were, during the Cretaceous, considerably in advance of those of Europe.

4. Even if it were conceded that the Fort Union belongs to the Tertiary, and that the fauna and flora of the Lance Creek epoch are more closely related to those of the Fort Union than they are to those of the Judith River, it does not follow that the Lance Creek epoch must be included in the Tertiary. A quarter before midnight on Monday is much nearer to Tuesday than it is to the previous six o'clock; nevertheless, it is not yet Tuesday.

U. S. National Museum,  
Washington, D. C.



## PALEONTOLOGY AND THE RECAPITULATION THEORY.

BY E. R. CUMINGS.

### I.

In reply to a severe critique of the recapitulation theory, or biogenetic law, by Hurst (30), Bather remarks that "If the embryologists had not forestalled them, the paleontologists would have had to invent the theory of recapitulation." (1) This may be considered as a fair sample of the general attitude of paleontologists of the Hyatt school, to which Bather belongs, toward the recapitulation theory.

Even the more conservative paleontologists, while inclined to use the theory *cum grano salis*, recognize the weight of evidence that Hyatt and his coworkers in the realm of paleobiology, have brought together, as is evidenced by the following quotation from Zittel (65): "Nevertheless embryonic types are not entirely wanting among invertebrates. The Paleozoic Belinuridae are bewilderingly like the larvae of the living *Limulus*. The pentacrinoid larva of *Antedon* is nearer many fossil crinoids than the full grown animal. . . . Among pelecypods the stages of early youth of oysters and Pectinidae may be compared with Paleozoic Aviculidae. Among brachiopods, according to Beecher, the stages which living Terebratulidae pass through in the development of their arm-skeleton correspond with a number of fossil genera. The beautiful researches of Hyatt, Württenburger and Branco, have shown that all Ammonites and Ceratites pass through a goniatite stage, and that the inner whorls of an Ammonite constantly resemble, in form, ornament and suture line the adult condition of some previously existing genus or other."

In violent contrast with this full acceptance, or this guarded acceptance of the theory on the part of the paleontologists, is the position of a considerable school of embryologists and zoologists. Perhaps no one has put the case against the theory more baldly and forcibly than Montgomery in his recent book on "An Analysis of Racial Descent" (42). He says: "The method is wrong in principle, to compare an adult stage of one organism with an immature stage of another." And again: "Therefore we can only conclude that the embryogeny does not furnish any recapitulation of the phylogeny, not even a recapitulation marred at occa-

sional points by secondary changes. . . . An analysis of the stages during the life of one individual can in no way present a knowledge of its ancestry, and the method of comparing non-correspondent stages of two species is wrong in principle." Equally sweeping is the statement of Hurst (30): "The ontogeny is not an epitome of the phylogeny, is not even a modified or 'falsified' epitome, is not a record, either perfect or imperfect of past history, is not a recapitulation of evolution."

It would seem as though two statements could not be more flatly contradictory than these of Hurst and Montgomery, and that of Bather quoted above. Nevertheless I venture to make the seemingly paradoxical assertion that both parties to the controversy may be right, for the simple reason that they are talking about quite different things. This has been nowhere better expressed than by Grabau (25). He says: "It has been the general custom to test the validity of the recapitulation theory by the embryological method; i. e., the comparableness of the changes which the individual undergoes during its embryonic period to the adults of more primitive types. Usually the comparison has been with the adults of existing types, since in most cases these alone were available for comparison. It is no wonder, then, that such comparisons have led to innumerable errors, if not absurdities, which have placed the recapitulation theory in an evil light and awakened in the minds of many serious investigators doubts as to the validity of the deductions based upon this doctrine. When, however, the *entire life history* of the individual is considered, instead of *only the embryonic period*, and when the successive stages of epembryonic development are compared with the adult characters of related types, in immediately preceding geologic periods, it will be found that the fundamental principle of recapitulation is sound, and that the individuals do repeat in their own *epembryonic* development the characters of their own immediate ancestors." (Italics mine.)

It is as a matter of fact true that the Hyatt school of paleontologists have based their phylogenies on epembryonic rather than embryonic stages—stages beginning with the nepionic or infantile—since in the nature of the case the true embryonic stages are scarcely ever accessible to the student of fossils. It is no less true that the severest critics of the theory of recapitulation have rested their case largely on the real or supposed lack of correspondence between the *embryonic* stages and the adult stages of assumed ancestors, or upon certain *a priori* considerations having to



do with the laws of development and inheritance. To the former class belong such critics as Von Baer, and to the latter class such as Hatschek, His, Hurst, Montgomery and others.

In making this statement I am aware that paleontologists sometimes compare true embryonic stages with adult stages of pre-existing types. As examples of this we might cite the comparison of the larval stage of *Antedon* with adult Paleozoic crinoids, as mentioned by Zittel; and the classic attempt of Beecher to reconstruct the ancestor of the Brachiopoda by a comparison of the phylembryonic stages of a representative series of genera of recent and fossil brachiopods. Nevertheless by far the greater number of comparisons that have been instituted by paleontologists have been between epembryonic stages of individuals and adult stages of older forms. Such comparisons are those of Hyatt, Branco, Karpinsky, Würtensburger, Buckman, Neumayr, Smith, Beecher, Clarke and others among the Cephalopoda; of Beecher and Schuchert, Raymond, Greene and Cumings among the Brachiopoda; of Jackson among the Pelecypoda; of Grabau and Burnett Smith among the Gastropoda; of Lang and Cumings among the Bryozoa; of Ruedemann among the graptolites; and of Beecher, Girty, Lang and others among the corals. To many of these researches I shall refer later.

I am also not unmindful of the fact that many of those who are not primarily paleontologists recognize the fact that development does not terminate with the completion of the embryonic stages, and that recapitulation may be legitimately looked for in epembryonic as well as embryonic stages, or that it may be sought in epembryonic stages, even though masked or falsified in embryonic stages. It is true, of course, that some speak of a comparison of *ontogeny* and phylogeny when, judging by the context, they mean a comparison between *embryogeny* and phylogeny. There arises here a question of definition: does the biogenetic law mean that the *ontogeny* is a recapitulation of the phylogeny, or does it mean that the *embryogeny* is a recapitulation of the phylogeny? If we take the general consensus of opinion we shall find for the former definition, and if we take the words of Haeckel, whose statement of the law is the one usually quoted, we shall again find for the former definition. I believe that, as a matter of fact, no one would maintain that the second definition is correct, however much he might forget in his studies to take the epembryonic stages into consideration.

Nor would I create the impression that the embryologists and zoologists have utterly deserted the paleontologists in their support of the recapitulation theory. Several recent papers give considerable aid and comfort to those of us who still believe in recapitulation. I shall introduce here the conclusions of three of these workers, more particularly because it will afford me an opportunity to correct what I hold to be another error of those who oppose the theory.

One of the most interesting pieces of evidence that has recently been adduced in favor of the idea that ontogeny recapitulates phylogeny is to be found in a paper by Griggs on "Juvenile Kelps" (28). It is not my purpose, however, to discuss the very interesting evidence which he has recorded, but rather to quote his remarks on the views of His and Morgan, and his general conclusions. His maintains that the reason why ontogeny seems to recapitulate phylogeny is because the stages in development are, as Griggs paraphrases it, "only the physiologically necessary steps for the formation of the adult body from its earliest stage, which in most cases is the egg." With the ideas of Morgan as expressed in his valuable book on "Evolution and Adaptation" we are all familiar. He holds that organisms repeat in their development, not adult stages, but only embryonic stages of their ancestors. To this idea he has given the name of "repetition."

On this point of the recapitulation of embryonic conditions Griggs makes the following pertinent statements: "In the toothless animals, the whale and the bird, the development of teeth in the jaws is entirely unnecessary \* \* \* it may even be said to hinder the attainment of the adult condition. The same is true of the mammalian gill slits and of most structures which have in the past attracted attention in connection with the recapitulation theory. As the ancestral period when such structures were fully developed in the adult becomes more and more remote, the tendency to inherit them becomes less and less, because of the cumulative impulses given to the heritage by the nearer ancestors. Consequently they are successively less and less developed. Any gradual loss of inheritance can, in the nature of the case, take place only from the mature condition backward toward the beginning of the life cycle; otherwise we should have adult structures with no ontogenetic history. Therefore we can understand why it is that in many cases only the embryonic stages of ancestral history persist in the ontogeny." In a foot note he says: "The cutting off of end stages in the development of organs has

given rise to the idea that the adult stages are 'pushed back into the embryo.' Such a misconception easily arose from the loose language in which the facts have often been expressed. Thus the embryogeny will be gradually shortened by the omission of more and more of the superfluous ancestral stages; and it will tend finally to retain only such stages as are necessary to the attainment of the adult form." Morgan and His, he maintains, have confused morphology and physiology. "The recapitulation theory has nothing to do with physiology; it is purely a matter of morphology."

In conclusion Griggs says: "Taking all the evidence into consideration, it seems to the writer that we are bound to conclude that though organisms are subject to adaptations at any stage of their life cycles and may gradually cut out superfluous stages, yet, except as some such tendency has operated to change the heritage, the development of the individual does recapitulate the history of the race \* \* \* recapitulation must take place if there is any force which tends to make offspring like parent, if heredity is of any importance in moulding the forms of organisms. On the other hand, if there is any variability of transmutation of individuals in stages other than the adult end stages of the life cycles, the recapitulation cannot be perfect, but must be marred at every stage where secondary change has taken place." I shall return later to some of the points raised by Griggs in the above statements.

Another eminent worker, Dr. Eigenmann, says at the close of a paper on the eyes of the blind vertebrates of North America (20): "We have seen in the preceding pages that the foundations of the eye [of *Amblyopsis*] are normally laid, but that the superstructure instead of continuing the plan with new material, completes it out of the material provided for the foundations, and that in fact not even all of this (lens) material enters into the structure of the adult eye. The development of the foundations of the eye is phylogenetic, the stages beyond the foundations are direct."

The third writer, Dr. Zeleny (64), in his paper on "Compensatory Regulation," in a discussion of the development and regeneration of the opercula in serpulids, says that the morphologic series is so complete as to make sufficient ground for the conclusion that the opercula arose in the course of phylogeny as modified branchia. The ontogenetic series, he says, *corresponds very closely with the probable phylogenetic series*. Speaking of the regenerative development he says: "The course of re-

generatory development is characterized by great condensation and directness of the development. There is no trace of the branchial stage, and the development of the two rows of processes of the terminal cup does not follow the ontogenetic order."

His final conclusion is as follows: "The data furnished, therefore, by the opercula of the serpulids give a fairly close agreement between the ontogenetic stages and the probable phylogenetic ones as determined by the usual criteria. The regeneratory development, however, follows a course which may be modified by the character of the operation that leads to the regeneration." By the "usual criteria" he means morphology, etc., so that he cannot be accused of the *circulus vitiosus*.

Those who wish to review the detailed evidence given in the above papers, bearing on the theory of recapitulation, will, of course, consult the original papers. My main reason for quoting them is, as stated above, because of their bearing on what seem to me to be grave errors in the reasoning of His, Morgan and Montgomery and others who have adopted similar views. The error seems to me to be, as pointed out by Griggs, in the confusion of morphology and physiology. The adult characters that are supposed to be recapitulated in the ontogeny, as well as the characters in ontogeny that are supposed to represent them, are morphological characters solely. It matters not what new function they may have come to serve, nor by what physiologic process they have come to make their appearance in the recapitulating organism. The confusion arising from this source colors all the argument of Montgomery, in which he endeavors to prove that new specific characters must have some representation in the ovum—a view which we must certainly agree with—and that therefore "the whole row" of cells from the ovum to the adult must be different. We grant that "The whole row" is different in some way, physiologically different, different in its play of energies; but it may conceivably be morphologically identical up to the very point where the new character is added. It is just as easy to conceive that the energy, or whatever we choose to call it, that is at a certain stage in development to produce a certain rib or spine or color-band on the shell of a gastropod, may be handed through the row of cells reaching up to the given stage, without producing a single recognizable morphologic change in the row, as compared with the individual that is not to possess the new character, as it is to conceive the opposite. The argument for the one view is just as certainly *a priori* as the argument for the other view. It

is also perfectly conceivable that the morphology of the *individual cells* in the row might differ after the acquisition of the new character (in so far as this assumption is required by recent cytological studies), and yet not a single organ or part of the organism be different up to the stage in ontogeny when the new character appears. Unless, therefore, a change in the energies of the cells *inevitably necessitates* a change in the morphology of all the cells or of all the organs which they compose, the argument of Montgomery proves nothing.

As to the argument of Hiss and others, that the supposedly ancestral stages are merely the physiologically necessary stages in the development of the individual; it again, as Griggs points out, confuses morphology with physiology, and is open to the further objection that it is directly opposed to the facts. Why, for example, should the condition of perfect blindness, with complete loss of all the essential structures of the eye, be attainable only by the round-about way of first developing the foundations of a normal eye? Why should a serpulid be able to regenerate a perfect operculum in a manner entirely different from, and even opposed to the ontogenesis of the organ, if there is any physiologically necessary way in which that particular individual or that particular organ must develop? The thing that makes it necessary for development to take a certain course in a given individual is the fact that the development has taken that same course in the ancestors. This species of coercion may, to be sure, be relaxed, and the development take some other course, but it is usually relaxed with extreme slowness, and after many generations have passed.

If inheritance were perfect, the individual would take exactly the same course in development as its ancestors. That it does not do this in all cases is, as Griggs points out, a more remarkable fact than that in other cases it should follow the ancestral mode of development so closely. Griggs explains the loss of inheritance as due to a progressive condensation of the ontogeny by the "omission of more and more of the superfluous ancestral stages." This is the well-known law of acceleration or tachygenesis. Like most embryologists, however, he misconceives the law, as shown by the foot-note quoted above. Embryologists are especially prone to limit the law of acceleration in development to the skipping or omission of steps, and the consequent shortening of development. This is not in keeping with the views of Hyatt, who first definitely formulated the law; and, as all paleobiologists know, it is not in keeping with the

facts. Hyatt (31) says: "All modifications and variations in progressive series tend to appear first in the adolescent or adult stages of growth, and then to be inherited in successive descendants at earlier stages according to the law of acceleration, until they either become embryonic or are crowded out of the organization and replaced in the development by characters of later origin." A more concise statement of the law is as follows: "The substages of development in ontogeny are the bearers of distal characters in inverse proportion and of proximal characters in direct proportion to their removal in time and position from the protocoel, or last embryonic stage" (31).

According to the definitions just quoted, acceleration involves not only the omission of characters, in some cases (and this is the only sort of acceleration that most embryologists seem to recognize), but it involves also condensation without omission, by crowding more into a given portion of the ontogeny, or again by "telescoping" of characters, as Grabau (25) calls it, so that characters that originally appeared in succession, come to appear simultaneously. In other words acceleration may be by *elimination*, by *condensation*, without change in the order of appearance of characters, or, third, by *telescoping*. The latter is condensation with change in the order of appearance, or as commonly expressed, unequal acceleration. It is probable that paleobiologists have erred in giving too much emphasis to the principle of earlier inheritance, involved in the law, just as embryologists and morphologists have erred in entirely neglecting this phase of inheritance. As conceived by the paleobiologist, the law of acceleration is an explanation of recapitulation, as well as an explanation of the failure to recapitulate.

Another factor in inheritance has been given the name of retardation by Cope (15). By the operation of this factor, characters that appear late in the ontogeny may disappear in descendants because development terminates before the given character is reached. In this way, it is conceived, the ontogeny may be shortened and simplified, and many ancestral characters lost entirely. The result of the continued operation of retardation would be retrogression. That is, the given form, if it continued to repeat the remoter ancestral stages in the early part of its ontogeny, and continued at the same time to drop off the later ancestral stages, by failing to proceed far enough in its development, would ultimately come to resemble the remote rather than the nearer ancestors. Manifestly the retarded forms do not recapitulate the lost characters, so

that here, also, as in the omission of characters in the earlier stages of ontogeny, the heritage is incomplete.

Of the complications of inheritance that arise from larval adaptations, intra-uterine adaptations, and special adaptations arising in later life, I shall not speak. All of these have been repeatedly discussed (see for example Smith 57), and are well understood. Against all of these the paleobiologist must be on his guard. All of these factors tend to make the parallelism between ontogeny and phylogeny inexact, as long ago pointed out by Cope (15). Yet in spite of the operation of these factors, the cases in which there is clear evidence of recapitulation are so numerous, and so well known to the paleobiologist, that were it not for the continually reiterated statements of certain embryologists that there is no such thing as recapitulation, I should hesitate to again point them out. I shall now take up the evidence according to the groups of organisms in which it has been ascertained; and I once more remind the reader that most of this evidence applies to the epembryonic and not to the embryonic stages.

## II.

*Cephalopoda*.—The only existing representative of the great group of Tetrabranchiata, the class to which nearly all of the fossil cephalopods belong, is the *Nautilus*. The genus *Nautilus* is a striking example of the persistence of a primitive type. It belongs to the more primitive branch of the tetrabranchs, from which, according to all the evidence, the marvelously complex ammonites, on the one hand, and the modern naked cephalopods are descended. *Nautilus* is the only tetrabranch of which the entire ontogeny, including the embryonic stages, is known.

This lack, however, in the case of the fossil genera is not as serious as might be supposed, for the reason that even in these ancient forms all of the growth stages from the latest embryonic (phylembryonic) stage to the adult are preserved in every complete individual shell. An inspection of the *Nautilus* shell makes this at once apparent, for the earlier stages of the shell are surrounded and protected by the later, and no part of the shell is lost or resorbed. In the straight and loosely coiled shells only, such for example as *Orthoceras*, *Cyrtoceras*, etc., is the case different; and even here, barring injury, or the dehiscence of the earlier chambers, every post-embryonic stage is preserved. From a study, therefore, of a single shell, we are able to make out perfectly all of the epembryonic de-

velopment in that part of the organism that was most vitally affected by the environment, and which must therefore indicate most perfectly the lines along which the evolution proceeded.

If the initial portion of the shell of *Nautilus* be examined, it will be found to be characterized by a scar or cicatrix. In the same region of the shells of ammonites and some Nautiloidea (*Orthoceras*), instead of this cicatrix, there is present a minute, bulbous or bag-like shell, attached to the apex of the shell proper. If in the case of *Orthoceras*, as shown by Hyatt (31), this bulb, or protoconch be broken away, there is exposed a scar (cicatrix) precisely similar to that of *Nautilus*. The initial shell or protoconch is therefore substantially the same in all of the Tetrabranchiata, and is supposed to point to a "septa-less and chamberless form similar to the protoconch" as the common ancestor of these two great divisions of the Tetrabranchiata: and possibly, as Hyatt suggests of the Cephalopoda, Pteropoda and Gastropoda (31). The protoconch represents the latest of the true embryonic stages, namely the phylembryo.

Succeeding this early stage are the stages of the shell proper.<sup>1</sup> In *Nautilus* the early nepionic portion of the shell, which includes the formation of the first three septa, is only slightly curved (cyrtoceraform). Up to the stage of the formation of the second septum, the shell is in fact nearly straight (orthoceraform). The first septum has an apically directed caecum, and the second septum an apically directed closed tube, the closed apical end of which fits into the caecum of the first septum. This tube is the beginning of the siphuncle. Since the tube fits closely into the caecum, the two together form a continuous tube, in which the apical end or bottom of the siphuncular tube forms a partition or septum, so that as Hyatt points out, the resemblance "of this early stage to the adult structures of *Diphragmoceras* becomes perfectly clear." (31)

In the later nepionic stages (i. e., after the formation of the third septum) the shell is rather sharply bent (the gyroceran curve), so that near the close of the first volution the whorl is brought back into contact with the apex of the conch. This manner of growth results in leaving an empty space or *umbilical perforation* between the two halves of the first volution. In the ancient coiled Nautiloidea there appears at the beginning of this (neanic) stage, when the whorls come into contact, a de-

<sup>1</sup> The stages from this point on are termed by Hyatt (31), and following him by practically all paleobiologists at the present time, the *nepionic*, *neanic*, *ephebic* and *gerontic* stages; meaning respectively, the infantile, youthful, mature and old age stages of growth.



pression or groove in the dorsum of the whorl, where it rests against the venter of the preceding whorl. This is the *impressed zone*. In the modern *Nautilus*, however, this furrow or impressed zone begins in the early nepionic stage, *before the whorls have come into contact*. This occurs also in the nautilian shells of the Carboniferous, Jurassic, Cretaceous and Tertiary.

Of this truly remarkable feature of cephalopod development, Hyatt says: "When one ascends in the same genetic series to the more specialized nautilian involved shells this purely acquired character becomes, through the action of tachygenesis, forced back, appearing as a rule in the nepionic stage before the whorls touch. It is therefore, in these forms entirely independent of the mechanical cause, the pressure of one whorl upon another, which first originated it. One need only add that this configuration of the dorsum is never found in the adults of any ancient and normally uncoiled shells, so far as I know, nor so far as have been figured." (31)

Without reviewing any of the further interesting details of the ontogeny of *Nautilus*, enough has been said to make it evident that if there is any truth in recapitulation, the development of *Nautilus* would indicate (disregarding the protoconchal characters) an ancestral line that contained, first straight or slightly arched, then loosely coiled, and finally closely coiled shells, and that the earliest of these possessed a septate siphuncle. That the geological series of shells indicates the same thing every paleontologist knows perfectly well. The development of *Nautilus* also affords one of the most perfect illustrations of the law of tachygenesis, in the earlier inheritance of the impressed zone, known in the whole animal kingdom.

One further illustration, from the Cephalopoda, of the parallelism of ontogeny and phylogeny must suffice. This illustration is drawn from the genus *Placenticeras*, one of the complex Ammonites of the Cretaceous. The development of this genus has been beautifully worked out by Professor J. P. Smith (58). The species *P. pacificum* comes from the Chico formation of the Upper Cretaceous. The following account applies to the development of this species and is drawn from the paper by Smith, cited above.

The earliest shelled stage was probably passed before the animal was hatched. This is the protoconch or phylembryo. It is a smooth, oval, bulbous body, similar to that of all the later ammonites. It probably rep-

resents an "adaptive form, due to life in the egg, and does not represent any ancient ancestral genus, for none of the early cephalopods were shaped like this."

"With the formation of the first septum, the young ammonite has taken its place among the chambered cephalopods, and has become, for the time being, a nautiloid, although it is not possible . . . . to correlate it with any special genus. . . . The first septum . . . . is nautilian in character, but the siphuncle begins inside the protoconch with a siphonal knob, or caecum, and the protoconch itself is calcareous. These are two characters that the nautiloids even to this day, have never yet acquired. . . . We have in this stage ammonite characters pushed back by unequal acceleration [telescoping], until they occur contemporaneously with more *remote* ancestral characters."

There is no sign of an umbilical perforation as in the *Nautilus*, described above, a fact which again shows the degree of acceleration of these ammonites.

With the second septum the ammonite characters are assumed. The shell at this stage is "distinctly goniatitic," but also possesses characters, introduced by acceleration, that belong to later genera. The evidence indicating the goniatitic as well as later stages to be mentioned, is mainly the character of the suture lines. "At about five-eighths of a coil . . . . the larva has reached a stage correlative with the goniatites of the Upper Carboniferous." This stage is quickly passed, and the goniatitic characters are lost and characters transitional to the ammonite stage make their appearance. "At one and one-twelfth coils the shell is transitional from the glyphioceran stage to what resembles closely the genus *Nannites* of the Trias." In regard to this stage Smith says: "If it had not been said that this was a minute shell taken out of an older individual, any paleontologist would refer it without hesitation to the Glyphioceratidae, and probably to . . . . *Pronannites*, of the Lower Carboniferous." This stage lasts about one-half revolution.

In the neanic stage, at one and seven-twelfths coils, the shell resembles very strongly *Oymbites*, or some related genus of the Lower Jurassic. The first signs of shell sculpture occur in this stage. In the next stage the sculpture becomes stronger, and the shell assumes a decidedly aegoceran appearance. From two up to two and one-quarter coils, the shell resembles in most respects the stock to which *Perisphinctes* belongs, and this is accordingly called the perisphinctes stage. During this

stage the sides of the shell become more flattened, and the abdominal shoulders squarer, the varices frequent, and strong intermediate ribs appear on the sides and abdomen.

In the next (*Cosmoceras*) stage "the ribs no longer cross the abdomen, but end in tubercles on the abdominal shoulders, forming well defined shoulder keels, with a furrow between them." Near the beginning of the fourth coil the ribs are reduced to mere faint undulations and fine sickle-shaped striae on the sides of the umbilicus, while the external tubercles become almost obsolete, forming mere notches on the continuous abdominal keels. Specific characters begin to appear here. This may be taken as the beginning of the *Hoplites* stage. The septa have not reached the complete development of the genus.

The umbilical knots begin at this stage, and growing stronger, become a characteristic feature of the adult *Placenticerus*. "*Placenticerus pacificum* at this stage is wholly unlike *P. californicum*, with which it is associated, being much more compressed and discoidal, with narrow abdomen, flatter sides, much less distinct sculpture, and narrower umbilicus, although in the earlier adolescent periods both species are very much alike." The shell passes from this stage by gradual changes into the adult *Placenticerus*.

Professor Smith's conclusions are of especial interest. He says: "The development of *Placenticerus* shows that it is possible, in spite of dogmatic assertions to the contrary, to decipher the race history of an animal in its individual ontogeny."<sup>1</sup>

<sup>1</sup> For further illustrations of recapitulation among the Cephalopoda, the student should consult the following papers: Branco, W., Beiträge zur Entwicklungsgeschichte der fossilen Cephalopoden, *Palaeontographica*, vols. xxvi, xxvii, 1879, '80. Buckman, S. S., Monograph of the Inferior Oolite Ammonites, *Paleontographical Society*, 1887-'96. Hyatt, A., Parallelism of the individual and the order among tetrabranchiate Mollusks, *Mem. Bos. Soc. Nat. Hist.*, vol. i, 1866; Fossil cephalopods of the Museum of Comparative Zoology, *Bull. Mus. Comp. Zool.*, vol. iii, 1872; Genesis of the Arictidae, *Smithsonian Contr. to Knowl.*, vol. xxvi, 1889; Phylogeny of an acquired characteristic, *Proc. Am. Phil. Soc.*, vol. xxxii; Cephalopoda, in *Text Book of Palaeontology* by Zittel (Eastman trans.), 1899. Hyatt, A., and Smith, J. P., Triassic cephalopod genera of North America, *U. S. Geol. Surv. Prof. Paper* No. 40, 1905. Karpinsky, A., Ueber die Ammonien der Artinsk-Stufe, *Mem. Acad. Sci. Imp. St. Petersburg*, vol. xxxvii, No. 2, 1889. Neumayr, M., Die Ammoniten der Kreide und die Systematik der Ammonitiden, *Zeitschr. der Deutsch. Geol. Ges.*, 1875; Ueber unvermittelt auftretende Cephalopodentypen im Jura Mittel-Europas, *Jahrb. d. K. K. Geol. Reichs. Wien*, vol. xxviii, 1878. Smith, J. P., The development of *Glyphioceras* and the phylogeny of the *Glyphioceratidae*, *Proc. Calif. Acad. Sci.*, (3) *Geol.*, vol. i, 1897; The Development of *Lytoceras* and *Phylloceras*, *Ibid.*, 1898; Larval stages of *Schloenbachia*, *Jour. Morphology*, vol. xvi, 1899; The Carboniferous Ammonoids of America, *Monog. U. S. G. S.*, No. xlii, 1903. Würtenburger, R., Studien über die Stammgeschichte der Ammoniten, Leipzig, 1880.

*Pelecypoda*.—The classic memoir of Jackson (32) on the phylogeny of the Pelecypoda brings together numerous illustrations of recapitulation among the members of this class of animals. Jackson's conclusions are well-known, and I shall therefore review them very briefly.

From a study of a large number of genera representing widely divergent members of the Pelecypoda, Jackson concludes that there is present throughout the group an embryonic shell, which he calls the "prodissoconch" (a term correlative with the term protoconch of the Cephalopoda and Gastropoda), and which is a simple bivalved, equivalve shell. At this (phylembryonic) stage of development there are two adductor muscles, even in genera in which the adult have only one adductor. That is, the prodissoconch is dimyarian even though the adult animal may be monomyarian. In the Aviculidae and their allies (*Ostrca*, *Avicula*, *Perna*, *Pecten*, *Plicatula*, *Anomia*) the prodissoconch very closely resembles in form the primitive genus *Nucula*. The anatomical characters of the prodissoconch also bear out this resemblance. It is therefore inferred that some such type as *Nucula* is the primitive ancestor of the Aviculidae, and possibly of the Pelecypoda. The paleontological and anatomical evidence supports this conclusion.

We have here, then, in the Aviculidae and their allies, a group of monomyarians, some of them, as *Ostrca*, *Plicatula*, and *Anomia*, of very aberrant form, the representation in the ontogeny of a dimyarian stage, which, from all the evidence, actually characterized the adults of the ancestors of the group. Whether or not *Nucula* is the actual ancestor of this group of pelecypoda, it is quite certain that the earliest pelecypods were of the same general form as the prodissoconch, and that they were dimyarian.

In the same paper Jackson has shown in a masterly manner that the ostreaform shape of the shell, which characterizes many more or less widely separated genera of pelecypods, is due to "the mechanical conditions of direct cemented fixation." These ostreaform shells are very variously derived, and should, if there is anything in the theory of recapitulation, each show in the young stages, before the valves have become fixed, the distinctive adult characters of its particular ancestor. In this case we are relieved from the danger of arguing in a circle by the fact that the genetic relations of most of the forms are fairly well known from lines of evidence other than the ontogeny. The following specific cases cited by Jackson are of especial interest.

*Mulleria lobata*, a member of the Unionidæ, "is so remarkably like an oyster (in the adult) that it has been called the fresh-water oyster. In the monomyarian adult . . . the shell is rough and irregular with a deep attached and flattish free valve, and a specimen in the Museum of Comparative Zoology is indistinguishable in shape from forms commonly found in *Ostrea virginiana*. . . . The young shell of *Mulleria* . . . is Anodon-shaped, equivalvular and dimyarian as described by authors."

*Hinnites* is another genus which has the ostreaform adult. "In the young it is free and pectiniform, but in the adult . . . so close is the likeness to an oyster that in the synonymy of the genus it has been named *Ostrea* and *Ostracites*." In *Hinnites cortesi* of the Tertiary, in the neanic stage, the right valve is purely pectiniform. "It has the well-developed ears, deep byssal sinus, and an evenly plicated shell which at this stage is nearly or quite equivalvular." With the period of attachment a most marked change in the valves takes place and the adult becomes deeply concave (in the right attached valve) and highly ostreaform. The byssal notch is filled up and "completely wiped out of existence."

In genera such as *Ostrea* and *Plicatula*, where fixation takes place at the close of the prodissoconch stage, the succeeding stages give very little indication of the ancestry, owing to the extensive modification of the shell as soon as fixation takes place. According to Dall *Ostrea* is derived from the Pteriidæ.

*Spondylus* is another genus in which cementation has caused extensive modification of the valves in the adult. Fixation takes place at the close of the nepionic period. Therefore this genus may be expected to afford some evidence of recapitulation. The first nepionic stage of *Spondylus* is decidedly pectiniform. It has a long hinge-line and a deep byssal sinus. After fixation, in the first stages of irregular growth, the byssal notch is soldered over, and eradicated in a manner similar to *Hinnites*.

Another illustration of recapitulation among the Pelecypoda is the case of *Pecten* itself. Of this genus Jackson says: "In the development of the modern *Pecten* we find in the first stages of dissoconch growth a form of shell . . . presenting characters which make it referable in ancestral origin to *Rhombopteria*, a member of the true Aviculidæ, later succeeded by a growth . . . bearing marked features referable in origin to an ancestral genus *Pterinopecten*. . . . Still later a stage

exists . . . which is referable in its inherited form to *Aviculopecten*, and finally the true *Pecten* features characteristic of the adult . . . are established. The geological sequence of these several groups is in the order indicated by the development of *Pecten*. We have, therefore, a clear case of the ontogeny of an individual illustrating the phylogeny of the group."

*Gastropoda*.—For studies of the Gastropoda in which growth stages have especially been taken into consideration we are indebted chiefly to Grabau (22, 23, 24, 25) and Burnett Smith (53, 54, 55, 56). My illustrations of recapitulation among the members of this class will be drawn, therefore, from the writings of these two authors.

It is commonly known that the apical whorl of the gastropod shell may differ materially from the succeeding portions of the shell (conch), being smooth and without ornament in cases where the conch is highly sculptured, or in some forms, as *Acmaca* and *Crepidula*, being coiled, although the adult shell is patelliform and non-coiled. To this apical whorl the name "protoconch" has come to be applied, a name which, as we have already seen, is also applied to the embryonic shell of the Cephalopoda. Grabau (22) has suggested the use of the name "protorteoconch" in place of protoconch for the initial shell of the gastropods.

The protoconch of the existing Gastropoda is more variable than that of the Cephalopoda, as would be expected from the highly specialized nature of most of the extant representatives of the class. In most cases there is no definite line of demarkation between the protoconch and the conch, but in a few cases, as in *Fusus*, etc., the "end of the protoconch is strongly marked by the existence of a pronounced varix and an abrupt change of ornamentation." (22) "The early whorls of the protoconch . . . are smooth rounded coils of the type found in adult *Natica*. . . . In the majority of cases the initial whorl is minute, while the succeeding ones enlarge gradually and regularly. In some types the initial whorl is large and swollen. . . . This type of protoconch has been termed 'bulbous' by Dall (19). The naticoid form of protoconch is in general umbilicated, and it is probable that at least the earlier portion of the protoconch is umbilicated in the majority of gastropods.

"From the characters of the initial whorls of the protoconch we may argue that the radicle of the coiled gastropods must have been a naticoid type with a well-marked umbilicus. Such a type is found in *Straparollina remota* Billings, one of the earliest coiled gastropods of the Etheonian

or Lower Cambrian of the Atlantic border province of North America. That it is not the most primitive type of gastropod is suggested by the consideration that the earliest stage . . . of the protoconch is not coiled, but rather cap-shaped like modern *Patella*. Such primitive types are found in Lower Cambrian species which have variously been referred to *Platycceras*, *Secnella*, or *Stenothecca*, owing to the want of sufficient characteristics to define their exact relations." (22.)

From the above it appears that the early protoconch stages indicate an ancestor of the simple, smooth shelled, umbilicated type exemplified by *Straparollina*, and that this is actually the only type of coiled gastropod characteristic of the basal Cambrian. It is also likely from paleontological evidence that the very earliest type of gastropod possessed a conical or cornucopia-shaped shell of the *Secnella* type.<sup>1</sup> Such an ancestry is, according to Grabau, suggested by the cap-shaped earliest stage of the protoconch.<sup>2</sup>

One of the most completely worked-out cases of recapitulation among Gastropoda that has come to my knowledge is that of the races of *Athleta petrosa* Con. and its allies. The phylogeny of this group of gastropods has been very fully studied by Burnett Smith (54), from whose paper the following account is drawn.

<sup>1</sup> Sardeson (50) suggests that the gastropod ancestor was an "asymmetrical long conical shell" of the pteropod type. He may be right, but even so, I do not see that his conclusion would in the least invalidate the conclusions of Grabau in regard to the phylogenetic significance of the protoconch, although Sardeson seems to think so. Grabau says very plainly that the coiled shell is probably not the most primitive type of shell, and he points out the fact (quoted above) that the initial portion of the protoconch is cap-shaped and may indicate some such remote ancestor as the Cambrian forms referred to the genera *Platycceras*, *Stenothecca*, and *Secnella*. Whether this patelliform ancestor was in turn derived from a long conical shell, or whether on the other hand the coiled type of shell was derived directly from the "long conical" shell without the mediation of a patelliform ancestor, does not materially affect the conclusions that at a very remote time a coiled gastropod radicle was established from which practically all modern gastropods were derived. To my mind the conclusion that the ultimate ancestor of the Gastropoda was a "long conical" shell is by no means established.

<sup>2</sup> Burnett Smith (55) concludes from a study of the Tertiary species of the genus *Athleta* that "we can say for this restricted normal group at least that the apex is not only a variable feature, but the most variable feature which the shells furnish." In a footnote he says "The author is thoroughly convinced that the features of the apex must be used in classification with great caution." The variations which he cites in this and other papers (54, 55, 56) seem to be chiefly in the size of the protoconch, and the degree to which acceleration has caused conchial characters to appear in the later protoconchal stages. His caution, however, in regard to the classificatory value of the protoconch, should put students of the gastropods on their guard against a too free use of this portion of the shell in the establishing of genera.

The species under consideration occur in the Gulf Eocene, extending nearly throughout it. They have heretofore been referred to the genus *Volutilithes*, but are placed by Smith (55) in the genus *Athleta*. Smith states that the material at his disposal was very complete, and enabled him to study large series of individuals, very carefully collected with reference to horizon. The stratigraphy of the formations from which they came is also well understood. These favorable conditions of study, it may be remarked, are especially important in the present connection, because they enabled Smith to trace out the evolution of the forms practically continuously from zone to zone, without being chiefly dependent on ontogeny for indications of their relationships. Another fortunate circumstance is the fact that this author is disposed to use the evidence from ontogeny with the utmost discretion, everywhere checking it by an appeal to the morphological and geological series.

In the forms under consideration, the first two or three whorls are smooth and rounded, constituting the smooth or protoconchal stage. "The first ornamental feature to appear on the smooth, rounded whorl is the transverse rib, that is, a slight elevation of the whorl which runs across it from suture to suture. These early ribs are invariably curved slightly, and each one is simple and uniform from suture to suture. The curved ribs persist as a rule for about a quarter or a half of a whorl, or even for a much less space. . . . The curved rib stage . . . has been found in every species and race dealt with in this paper. The curved ribs, after about one-third of a whorl, change abruptly into the straight ribs of what has been designated the cancellated stage."

"The cancellated condition is found more or less well developed in all the different races. In the primitive races it may persist as a constant feature to the end of the individual's life; but in most forms it covers only a few whorls and is more variable than the preceding curved rib stage." The end of the cancellated stage is much less definite than the beginning. It is followed by the "spiny stage." In this stage the shoulder tubercle is sharp and spine-like. Other tubercles have disappeared, and this portion of the shell is therefore no longer cancellated. Succeeding the spiny stage, there may be a senile stage.

In the base of the Eocene at Matthew's Landing, Alabama, occurs a species, *Athleta limopsis*, which from its primitive characters, and its position at the base of the Eocene, Smith regards as the ancestor of the races and species which he deals with in his paper. This form presents



no stages later than the cancellated stage. There is also very little individual variation. Associated with *A. limopsis* is the species *A. rugatus*. In its earlier stages this species very closely resembles *A. limopsis*, but "differs radically . . . from that form with the progress of its ontogeny." In its later whorls it presents evidence, though not extreme, of senility. It has no spiny stage.

The next species *A. petrosa*, represents an assemblage of races connected by many intergrading forms. These races range upward from the Nanfalia beds to the Jackson beds of the Eocene. Several of them are senile races, and in the adult strikingly different from the ancestral form, *A. limopsis*. Smith says, however, that the young of all the races "are remarkably uniform and constant. The early whorls indicate clearly that they are all descended from a canceled ancestor, and bear a strong resemblance . . . to the characters of *A. limopsis*." Some of the senile races of *petrosa* are profoundly modified in the adult, as for example, the Hatchetigbee race, derived from the main stock through the Bell's Landing and Wood's Bluff races. Yet their derivation from the main stock is shown by intermediate forms, and the young of the terminal races greatly resemble the ancestral form. In the Jackson race, which is the terminal member of the main stock, the last two whorls are spiny, and the last whorl shows some senile characters at its close. "This race shows a regular and even ontogeny." Acceleration has carried the curved rib stage back to the beginning of the third whorl, whereas in the ancestral *A. limopsis* this stage begins near the close of the fourth whorl.

Smith has graphically expressed the main developmental and phylogenetic changes in the following diagram:

	1	2	3	4	5	6	7	8	9	10	11	12
<i>A. limopsis</i> .												
Matthew's Landing race . . . . .			A	B				C				Lower Eocene.
<i>A. petrosa</i> .									D	D		
Gregg's Landing race . . . . .		A		B		C			and I	and I		E Slight.
<i>A. petrosa</i> .												
Jackson race . . . . .	A		B		C				D	D and E		E never extreme. Upper Eocene.

In the above diagram the figures across the top stand for the number of the whorl of the shell, and the letters indicate the different ontogenetic stages as follows:

- A—Smooth stage.
- B—Curved rib stage.
- C—Cancellated stage.
- D—Spiny stage.
- E—Senile stage.
- I—Individual variation.

The acceleration of the Jackson race is beautifully brought out in this diagram, and as its correlative, the recapitulation in the earlier ontogeny of the later races, of the adult characters of the ancestral race. The individual variations may occur on any part of the shell, but usually follow stage C.<sup>1</sup>

*Brachiopoda*.—Among the members of this class there is a wealth of illustrations of recapitulation. I can only select a few cases that have been worked out in such a way that the relationships of the forms are indicated by the morphological and geological series as well as by the ontogeny. The pioneer student of the correlation of ontogeny and phylogeny among the brachiopods was Beecher, whose refined researches in paleobiology have never been excelled and rarely equaled.

The developing brachiopod, in the later embryonic stages, secretes in the mantle on opposite sides of the body two shell plates, which by peripheral growth ultimately meet at the edges and form the initial shelly investment of the animal. This initial shell to which Beecher has given the name "protegulum" (6) is of very simple form, consisting substantially of two convex plates of semicircular plan, gaping at the posterior straight edges. Through this gap between the two valves the pedicle (organ of attachment) projects. At first the pedicle occupies the full width of the valves, but subsequent peripheral growth of the shell with-

<sup>1</sup> For additional studies of the gastropoda from the developmental standpoint see the following: Koken, E., Ueber der Gastropoden vom Cambrium bis zur Trias., *Jahrb. für Mineral. Geol. u. Pal.*, 1889, Beil. Bd. vi. Linden, Grafen M. von, Die Entwicklung der Skulptur und der Zeichnung bei den Gehäusschnecken des Meeres, *Zeitschr. Wiss. Zool.*, vol. lxi, 1896. Grabau, A. W., Studies of Gastropoda II, Fulgur and Sycotypus, *Am. Nat.*, vol. xxxvii, 1903; Phylogeny of Fusus and its allies, *Smithsonian Miscell. Coll.*, vol. xlv, 1904; Studies of Gastropoda III on Orthogenetic variation, *Am. Nat.*, vol. xli, 1907. Smith, Burnett, Phylogeny of the species of Fulgur with remarks on an abnormal specimen of Fulgur canaliculatum and sexual dimorphism in Fulgur carica, *Proc. Acad. Nat. Sci. Phila.*, vol. liv, 1902; Senility among Gastropods, *Proc. Acad. Nat. Sci. Phila.*, vol. lvii, 1905; Phylogeny of the races of Volutilithes petrosus, *Proc. Acad. Nat. Sci. Phila.*, March, 1906; A new species of Athleta and a note on the morphology of Athleta petrosa, *Proc. Acad. Nat. Sci. Phila.*, May, 1907; A contribution to the morphology of Pyrula, *Proc. Acad. Nat. Sci. Phila.*, May, 1907.

out corresponding enlargement of the pedicle. Leaves the latter restricted to a notch (delthyrium) in the posterior margins of the valves, providing the peripheral growth is about equal on all anterior and lateral radii. If the shell growth is greater in the anterior direction, the shell becomes pointed, the pedicle (posterior) end remaining of about the original width. If the shell growth is mainly in the lateral directions, the shell becomes wide, with a long straight hinge, of which the pedicle opening forms a very small proportion. Whatever may be the later growth of the shell, all the earlier stages are preserved, except in cases where the beaks are injured or resorbed by the encroachment of the pedicle in adult and senile stages. The growth of the shell is entirely by additions at the margins or on the inner surface. It follows that the protegulum may in exceptionally well preserved material be seen intact at the beaks of the adult shell. It is often seen at the apices of young shells.

Searching for the phylogenetic significance of the protegulum, Beecher (6) ascertained that certain of the earliest known brachiopods approximate very closely in form to the protegulum, and he selected the genus *Paterina* (*Iphidea*) as the radicle of the class. It has since been shown that *Paterina* is not the most primitive known brachiopod.<sup>1</sup> It is still true, however, that the most primitive brachiopods known are of the same general form and type as *Patcrina*, in fact they approximate more closely, if anything, than that genus, to the form of the protegulum. It may be very safely concluded, therefore, from the geological evidence, that the primitive brachiopod was actually of the type indicated by the protegulum.

Beecher says of *Patcrina*: "In mature specimens, all lines of growth, from the nuclear shell to the margin, are unvaryingly parallel and concentric, terminating abruptly at the cardinal line. In other words, no changes occur in the outlines or proportions of the shell during growth, through the nepionic and neanic stages up to and including the completed epebic condition. The resemblance of this form to the protegulum of other brachiopods is very marked and significant, as it represents a mature type having only the common embryonal features of other genera."

Among the Brachiopoda, as among the Pelecypoda there are a number of forms in which the condition of very close fixation or of burrowing has

<sup>1</sup> Walcott (62) seems to reserve this distinction for his genus *Rustella*. *Paterina* is by him made a subgenus of the genus *Micromitra*. These forms are all placed in the superfamily *Rustellacea*.

given rise to extremely aberrant types. One of the most extreme of these types is the genus *Proboscidella*. The adults of this genus bear a very marked resemblance to the Pelecypod genus *Aspergillum*. In the early neanic stages *Proboscidella* resembles an ordinary *Productus*, from which genus the type is known to have descended. *Orbiculoidea* is a genus originating in the Ordovician, and extending through the Mesozoic. The first stage is paterina-like, the second resembles *Obollla*, the third is like *Schizocrania*, and adult growth brings in the characters of *Orbiculoidea*. The geological order of these genera is the same as the ontogenetic order of *Orbiculoidea*.

Of *Orbiculoidea* and its allies Beecher (7) says: "The early stages of Paleozoic *Orbiculoidea* have straight hinge-lines and marginal beaks, and in the adult stages of the shell the beaks are usually subcentral and the growth holoperipheral. This adult discinoid form, which originated and was acquired, through the conditions of fixation of the animals, has been accelerated in the recent *Discinisca* so that it appears in a free-swimming larval stage. Thus a character acquired in adolescent and adult stages in a Paleozoic species, through the mechanical conditions of growth, appears by acceleration in the larval stages of later forms before the assumption of the condition of fixation which first produced this character."

In the higher genera of the Terebratellidæ, the ontogeny recapitulates the phylogeny with remarkable fidelity, as pointed out by Beecher (7). This example has become classic, so that it is scarcely necessary to repeat the details. I shall give Beecher's conclusions in his own words. He says: "In each line of progression [the austral and boreal subfamilies] in the Terebratellidæ, the acceleration of the period of reproduction, by the influence of environment, threw off genera which do not go through the complete series of metamorphoses, but are otherwise fully adult and even may show reversional tendencies due to old age; so that nearly every stage passed through by the higher genera has a fixed representative in a lower genus. Moreover the lower genera are not merely equivalent to or in exact parallelism with, the early stages of the higher, but they express a permanent type of structure, as far as these genera are concerned, and after reaching maturity do not show a tendency to attain higher phases of development, but thicken the shell and cardinal process, absorb the deltidial plates, and exhibit all the evidences of senility."

Raymond (46) has pointed out a number of interesting cases of recapitulation. The very common and well-known Devonian Spirifer, *S. mucronatus*, has the cardinal extremities in the adult very acute (mucronate), sometimes, indeed, drawn out into needle-like points; while the number of plications may be thirty or more. In the neanic stage these transversely elongated spirifers pass through forms corresponding to the adults of certain Niagara species. The adult of *S. crispus*, corresponds very closely in shape, number of plications, and shell index with these young specimens of *S. mucronatus*.

Shimer and Grabau (51) have shown that in the upper part of the Hamilton series of Thedford, Ontario, there occurs a variety of *Spirifer mucronatus*, which though not mucronate at all in the adult, is "extremely mucronate" in the neanic stage. At this stage also there is evidence of the median plication of the sinus, another characteristic of the adult of the normal *S. mucronatus*. In the adult of the Thedford variety this median plication has disappeared. The geological and morphological evidence of the derivation of this form of *S. mucronatus* is complete.

I have pointed out an exactly similar case in the variety *senex* of *Platystrophia acutilirata* (16). This variety occurs in the upper part of the Whitewater division of the Richmond series of Indiana and Ohio. *Platystrophia acutilirata*, as is well known, is very mucronate in the adult, resembling in its general outline, *Spirifer mucronatus*. It was in fact at first referred to the genus *Delthyris* (*Spirifer*). The normal form is shown by an unusually closely graded series of intermediate forms to be descended from *P. laticosta*, and it repeats the adult characters of the latter very faithfully in its late neanic stage, becoming always more mucronate as development proceeds. The upper Whitewater form, var. *senex*, frequently has entirely lost, in the adult stages, the acute angulation of the cardinal extremities, so that the lateral and cardinal edges make a right, or nearly a right angle. In the young (neanic) stages of *P. senex*, however, the shell is decidedly mucronate, so that these young shells exactly resemble the normal *Platystrophia acutilirata* of the lower Whitewater and Liberty formations. *P. senex*, it may be remarked, is a well defined form, and its derivation from *P. acutilirata* is beyond question, since it is connected with the latter by every gradation.

Another interesting case of recapitulation among the brachiopods has been worked out with great care by Mr. F. C. Greene (27). In this case also no pains was spared to ascertain the relationships of the various

forms by tracing them continuously from zone to zone, and by a comparison of the morphological characters of the adults. The group studied by Greene is that of *Chonetes granulifer*, from the Upper Carboniferous rocks of Kansas. Here the forms from the higher zones repeat in their ontogeny the characters of forms from the lower zones with great fidelity. The very young stages also recall very forcibly the species of *Chonetes* from the Devonian. *Chonetes granulifer* is also very interesting from the fact that the first hinge-spines appear very much earlier in the ontogeny than is the case in the Devonian species studied by Raymond (46), therefore showing a considerable degree of acceleration of this character during the interval from the Devonian to the Upper Carboniferous.

Other interesting cases of recapitulation among brachiopods have been pointed out by Beecher and Schuchert (12) in the development of the brachial apparatus in *Dielasma* and *Zygospira*.<sup>1</sup>

*Trilobita*.—Studies of the early stages of the development of trilobites have been published by Barrande (3, 4), Walcott (59, 60, 61), Beecher (8, 9), Matthew (39, 40, 41) and others, but for indication of the correlation of the ontogeny and the phylogeny in this class we are almost entirely indebted to Beecher. In his papers on "Larval Stages of Trilobites" (8), and a "Natural Classification of the Trilobites" (9), he has not only pointed out the remarkable way in which characters are recapitulated in this class, but has also proposed what is probably to be regarded as the most perfect example of a phylogenetic classification of a group of organisms, in existence.

The earliest developmental stage of trilobites that has ever been found (barring supposed trilobite eggs) is the larval stage or "protaspis," as it is called by Beecher (8). The protaspis is a minute body of ovate or discoid shape, and about a millimeter in length. This larval stage has

<sup>1</sup>For additional examples of recapitulation among the brachiopods see the following: Beecher, C. E., *Studies in Evolution* (a series of collected papers), Scribners, 1901. Beecher, C. E., and Clarke, J. M., *The Development of some Silurian Brachiopoda*, *Mem. N. Y. State Mus.*, No. 1, 1889. Beecher, C. E., and Schuchert, C., *Development of the shell and brachial supports in Dielasma and Zygospira*, *Proc. Biol. Soc. Washington*, vol. viii, 1893. Cumings, E. R., *The morphogenesis of Platystrophia; A study of the Evolution of a Paleozoic Brachiopod*, *Am. Jour. Sci.*, vol. xv, 1903. Raymond, P. E., *The developmental change in some common Devonian brachiopods*, *Am. Jour. Sci.*, vol. xvii, 1904. Greene, F. C., *The development of the Carboniferous brachiopod Chonetes granulifer*, *Owen, Jour. Geol.*, vol. xvi, 1908. Buckman, S. S., *Homeomorphy among Jurassic Brachiopoda*, *Proc. Cotteswold Nat. Field Club*, vol. xii, 1901.

been seen in a sufficiently representative series of genera to make it reasonably certain that it is the common larval type among the trilobites.

It is pretty well established that the eye of crustaceans has migrated from the ventral to the dorsal surface of the cephalon. At an intermediate stage in this process the eyes would appear on the margins of the cephalon. If this has been the history of the eye, the most primitive larvae should show no evidence of eyes on the dorsal surface, and since the eye is on the inner margin of the free cheek, there should be no evidence of the free cheek. This is exactly the case in the youngest larvae of *Ptychoparia*, *Solenopleura* and *Liostracus*, "which are the most primitive genera whose protaspis is known. The eye-line is present in the later larval and adolescent stages of these genera, and persists to the adult condition. In *Sao* it has been pushed forward to the earliest protaspis, and is also found in the two known larval stages of *Triarthrus*. *Sao* retains the eye-line throughout life, but in *Triarthrus* the adult has no traces of it, and none of the higher and later genera studied has an eye-line at any stage of development." This character according to Matthews, is characteristic of the Cambrian trilobites. In its phylogenesis in later trilobites it disappears first from the adult stages, and is finally lost from the entire ontogeny. The eyes appear on the margin of the cephalon in the last larval stage of *Ptychoparia*, *Solenopleura*, *Liostracus*, *Sao*, and *Triarthrus*. In the later genera the eyes are present "in all the protaspis stages, and persist to the mature, or ephebic condition, moving in from the margin to near the sides of the glabella."

According to Beecher (S) "A number of genera present adult characters which agree closely with some of the larval features [of later genera]. The main features of the cephalon in the simple protaspis forms of *Solenopleura*, *Liostracus*, and *Ptychoparia* are retained to maturity in such genera as *Carausia* and *Aconthcus*, which have the glabella expanded in front, joining and forming the anterior margin. They are also without eyes or eye-line. *Ctenocephalus* retains the archaic glabella to maturity, and likewise shows eye-lines and the beginnings of the free cheeks (larval *Sao*). *Conocoryphe* and *Ptychoparia* are still further advanced in having the glabella rounded in front, and terminated within the margin (larva of *Triarthrus*). These facts and others of a similar nature show that there are characters appearing in the adults of later and higher genera, which successively make their appearance in the protaspis stage, sometimes to the exclusion or modification of structures present in the most primitive

larvae. Thus the larvae of *Dalmanites* and *Proctus*, with their prominent eyes, and glabella distinctly terminated and rounded in front, have characters which do not appear in the larval stages of ancient genera, but which may appear in their adult stages. Evidently such modifications have been acquired by the action of the law of earlier inheritance or tachygenesis."

*Bryozoa*.—My studies (17, 18) were the first to show that there is in the bryozoan colony a definite recapitulation of ancestral characters, and that in this particular the colony behaves as an individual. This same fact was very clearly pointed out by Ruedemann (47) two years earlier in the Graptolites, and I take pleasure in quoting his very explicit statement. He says: "Furthermore the fact that the thecae within the same colony show a gradation from phylogenetically older to younger forms, and therefore analogous to the organ of a growing individual, pass through ancestral stages, as, e. g., do the septa of a cephalopod shell, demonstrates how closely the zooids of this colony were united into one organism, and that practically they were more the organs of an individual than the component of a colony. . . . If the graptolites so closely approached the morphologic value of an individual, it may be expected that, like an individual, the whole colony has its ontogeny and re-passed ancestral stages."

My studies, referred to above, brought out the fact that the bryozoan colony begins as a minute hemispherical body, the "protœcium" which is the earliest exoskeletal stage of the first individual of the colony. This protœcium (basal disc) is very conspicuous in the Cyclostomata, and also in the ancient Cryptostomata (as shown in *Pencstella*).<sup>1</sup> It can not be definitely asserted that the protœcium corresponds to any ancestral bryozoan, but the marked resemblance of the zoœcia of some of the ancient *Stomatopora* of the Ordovician to the protœcium is at least very suggestive.

The ancestrula, or first complete individual of the colony, has long been known to present characters more similar to those of ancestral forms

<sup>1</sup> I first used the term protœcium as the designation of the first individual of the colony, and in this sense it would be exactly equivalent to the term ancestrula of Jullien. In a later paper (18) I restricted the term to the basal disc (of Barrois) which is the calcified wall of the metamorphosed and histolyzed embryo in its earliest sedentary stage. Out of this basal disc the first normal individual arises by a process strictly analogous to budding. In this sense, therefore, the term protœcium is exactly correlative with the terms protegulum, protoconch, prodissoconch, etc.



than the characters of the ephebastic zoëcia (see Nitsche 44, and Pergens 45). I have succeeded in finding evidence (18) that this is true to a notable extent in the ancient *Fenestella*, where the tubular ancestrula bears a striking resemblance to the simple tubular ephebastic zoëcia of the Cyclostomata, from which group there is every reason to believe the Cryptostomata are descended.

It is also pointed out by Nitsche and Pergens (*loc. cit.*) that the earlier budding habit of the colony is similar to ancestral types. In my own studies I was able to show that the early budding habit is very uniform in the most diverse types of Bryozoa, and that it corresponds to the budding habit that prevails throughout the astogeny of the reptant stomatoporas.

In *Fenestella* my studies indicate that the earlier individuals (nepiastic) of the colony are very different from the adult (ephebastic) individuals and are strikingly similar to the ephebastic individuals of certain Cyclostomata that are on morphological grounds, as pointed out by Ulrich (63), probably ancestral. And again, the early neanastic zoëcia of the Devonian fenestellas studied are almost exactly like to the ephebastic zoëcia of the fenestellas of the Niagara series. Unpublished studies indicate that in the Fenestellas of the Upper Carboniferous the neanastic stage is more abbreviated, and that the adult type of zoëcia follows more closely upon the nepionic type.

Dr. Lang of the British Museum has published very interesting studies of the Stomatoporas and Eleids of the Mesozoic (35, 36, 37), and has come independently to exactly the same conclusions as the writer in regard to the development of the colony, and the relations of astogeny and phylogeny among the Bryozoa. He says (35), "The development of the colony is comparable with and follows the same laws as the development of the individual." And again: "Among Jurassic forms of *Stomatopora* and *Proboscina* it has been found that when any given character, such, for instance, as the ratio of the length of the zoëcium to its breadth, is followed from the first zoëcium to the last, that it has a progressive development, or anagenesis, reaches a maximum, or acme, and often may be seen to have a retrogressive development, or katagenesis, in the ultimate branches of the zoarium."

Lang has paid especial attention to the manner of branching in Jurassic stomatoporas. The nearly universal method of branching in the Jurassic members of this group is by dichotomy. This according to Lang may

be by one or other of three types as follows: In type I the two zoecia are separate throughout their entire length, only touching at their bases. In type II they are contiguous throughout their length, and in the intermediate type they are contiguous for part of their length. To a large extent correlated with these types of dichotomy is the angle of divergence of the branches.

In all the Jurassic stomatoporas and in a few proboscinae the first dichotomy is according to type I, and at a very wide angle ( $180^\circ$ ). The second dichotomy, in the majority of cases, is also according to type I, with an angle of  $120^\circ$ . The next is commonly only  $90^\circ$ , the next  $60^\circ$ , and the next  $45^\circ$ , all according to type I. "In primitive [Jurassic] forms the branching never gets beyond type I with a small angle. In the majority of forms, however, sooner or later the intermediate type of branching comes in, and in a great many forms this type is the final one. In a few cases of *Stomatopora*, and in all *Proboscina*, type II is at some time or other reached, and remains the ultimate form of branching of the zoarium. This sequence namely, Type I—Intermediate type—Type II, is invariably followed." (35).

In primitive *Proboscina* (a genus derived from *Stomatopora*) the first dichotomies are according to type I. "In the typical forms of *Proboscina* the early stages have been so condensed according to the law of acceleration (Tachygenesis), that the first dichotomy is formed on type II. . . . In the more advanced types of *Proboscina* . . . the arrangement of peristomes is irregular from the first." This is the typical arrangement for *Bernicea*, a derived genus of which *Stomatopora* and *Proboscina* are the first two terms. It is worthy of notice that while in the Jurassic forms of *Stomatopora* type II is not very common, it is extremely common in the Cretaceous forms.<sup>1</sup>

*Graptolites*.—The beautiful researches of Ruedemann in this group have shown us, as pointed out above, that the graptolite colony closely approaches the morphologic value of an individual, and that, like the individual, it presents definite ontogenetic (astogenetic) stages. Ruedemann (47) applies to the colonial development the terminology proposed by

<sup>1</sup>For studies in the zoarial development of Bryozoa see Cumings, E. R., The development of some Paleozoic Bryozoa, *Am. Jour. Sci.*, vol. xvii, 1904; Development of *Fenestella*, *Am. Jour. Sci.*, vol. xx, 1905. Lang, W. D., The Jurassic forms of the 'genera' *Stomatopora* and *Proboscina*, *Geol. Mag.*, Dec. v, vol. i, 1904; The Reptant Eleid Polyzoa, *Geol. Mag.*, Dec. v, vol. iii, 1906; *Stomatopora antiqua*, Haime, and its related Liassic forms, *Geol. Mag.*, Dec. v, vol. ii, 1905.

Hyatt (31). In a later paper, however, he approves the terminology introduced by me, and proposes to call the development of the colony the astogeny (48).

The embryonic stage of the graptolites is represented by the initial portion of the sicula (first zooid), according to Ruedemann; and Holm (29) asserts that the more pointed end of the sicula "corresponds to the original chitinous covering of the free zooid germ or embryo." This initial part of the sicula, according to Ruedemann, holds a position similar to the protoconch of the cephalopod shell.

In part I of his splendid monograph of the Graptolites (48) of New York, at page 530, Ruedemann says: "It has been pointed out in a former publication that not only did there exist in the graptolites ontogenetic growth stages in the development of the individual zooids. . . . but the rhabdosomes in toto and in their parts, the branches, seem also to pass through stages which suggest phylogenetically preceding forms."

Of the various ways in which these astogenetic stages express themselves, Ruedemann mentions the following: "The original direction of growth of the branches of the Dichograptidæ has been in the approximate continuation of the sicula, i. e., an ascending erect position as long as the rhabdosomes were sessile, on the ground. These became pendant when the graptolites attached themselves in a suspended position to seaweeds, as numerous hydroids do today. To restore to the zooids their original . . . erect position, the branches began now to recurve . . . [becoming progressively horizontal, reflexed, reclined and recumbent] . . . We find now in the majority of the Dichograptidæ with the above cited growth directions of the branches, that the latter still retain their original dependent direction, in the proximal parts in some species . . . while in others by the law of acceleration, the dependent proximal direction has already changed into a horizontal one . . . the change in direction becoming progressively more abrupt as the final direction of the branches becomes reclined . . . or recumbent. . . . The branches pass hence, in their development, through different directions representing ontogenetic stages that repeat stations in their phylogenetic development." (48.)

An analogous fact is found in the character of the thecæ. "A comparison of the form of the thecæ of the youngest dichograptid genera . . . with that of the older and presumably phylogenetically preced-

ing genera . . . . shows that in general the older genera have the more tubular, simpler thecae, with the less protected apertural margins. It is, hence, apparent that the stolonal or earlier thecae of the rhabdosomes represent indeed the older types of thecal form." (48.)

*Other Classes.*—The case of the larva of *Antedon* has already been referred to. As pointed out by Bather (1), the stem ossicles of the larval *Antedon* are of a complex and specialized type, and in a general way resemble the stem ossicles of the Bourgueticrinidae of the Upper Cretaceous. It is held by Bather that the structures of the adult ancestors have been pushed back by acceleration to the larval stages of the existing *Antedon*.

Recapitulation is also shown in the anal plate of *Antedon*. The anal plate appears between two of the radials and on the same level with them. Subsequently it is lifted out from between the radials, and the latter close beneath it. Still later the anal plate is resorbed entirely. That this is the recapitulation of an adult character and not of a larval character, as contended by Hurst, is shown by the fact that the oldest crinoids do not possess the anal plate at all. It appears from paleontological evidence that this plate first appeared above the level of the radials, that it gradually sank down between the two posterior radials, and that at a far later period (at about the close of the Paleozoic) it gradually passed upward again as it does in *Antedon*, and eventually disappeared.

Jackson has shown that there is good evidence of recapitulation among the fossil echinoids (33). In most regions of the echinoid the development is obscured by the more or less extensive resorption, but the plates of the corona may show by their position and number, the course of development. Jackson holds that the introduction of columns of plates, both interambulacral, and ambulacral, in *Melonites*, etc., indicates the stages of growth through which the individual has passed in its development. He shows that two columns of ambulacral plates "may be accepted as the usual characteristic of the whole class, which finds its representative in the majority of the adults, in nearly all young, and in the adult of the simplest and oldest known type, *Bothriocidaris*."

Interambulacral areas originate ventrally in a single plate. Only one genus is known, however, that has a single row of plates in the adult, namely *Bothriocidaris*. This is the simplest known and "perhaps the simplest conceivable echinoid."

In *Goniocidaris* the interambulacral plates of the adult are approximately hexagonal in form instead of pentagonal. "The relative form of the plates in young *Goniocidaris* is almost exactly the same as in the primitive type, *Bothriocidaris*."

"The early stage in which we find a single interambulacral plate, together with two ambulacral plates, in each area is so important that it is desirable to give it a name, the protechinus stage. The protechinus is an early stage in developing Echini, belonging to the phylembryonic period, in which the essential features of the echinoid structure are first evinced. . . . This protechinoid stage of Echinoderms is comparable as a stage in growth to a similar stage which is expressed in the protegulum of brachiopods, the protoconch of cephalous mollusks, the prodissoconch of pelecypods, and the protaspis of trilobites." (33.)

Miss Smith (Mrs. Alexander Shannon) has shown very conclusively the exact resemblance of the form of the young *Pentremites conoides* to the adult *Codaster* (52). In *Codaster* the conical form, narrowest at the base and enlarging upward, is maintained throughout life. In *Pentremites* only the early stages of growth have this form, while the adult is broadest at the base and narrowest at the top.

This evidence from development would, according to the theory of recapitulation, indicate that *Codaster* stands in an ancestral relation to *Pentremites*, and it is therefore of importance to the theory that Bather (2) from other evidence has independently reached the same conclusion as Miss Smith in regard to the relationship of the two forms.<sup>1</sup>

Among corals Beecher (5) has worked out the development of *Plicurodictyum lenticulare* and concludes that the first neanic stage, in the manner of growth and the structure of the corallum, is very suggestive of *Aulopora*, and should be given considerable significance." Girty (21) comes to the same conclusion from a study of *Favosites forbesi*, etc.

Bernard (14) has shown that the coral colony in similar fashion to the bryozoan colony and the graptolite colony behaves as an individual. In another paper (13) he has recognized as the first growth stage of the

<sup>1</sup>Bather's conclusion was published in 1900, and Miss Smith's paper in 1906. The latter, however, was not aware of Bather's views as to the relationships of these two forms, so that the conclusions of the two workers, arrived at independently and from different lines of evidence are all the more important and convincing. Bather says in a review of Miss Smith's paper that he considers *Pentremites* as the "extreme link in the series *Codaster*—*Phaenoschisma*—*Cryptoschisma*—*Orophocerinus*—*Pentremitidea*—*Pentremites*."

coral skeleton the "prototheka," or basal cup of the first individual of the colony.<sup>1</sup>

Lang (38) has written a very suggestive paper on growth stages of British species of corals, in which he points out the fact that the ontogenetic stages are repeated in each rejuvenescence (branching?), and suggests that we have here an example of localized stages in development (see Jackson 34). It may be remarked at this point that Ruedemann has also detected localized stages in graptolites (47, 48), and Lang in Bryozoa (36). Lang also, in the paper on corals, concludes that there is recapitulation in the coral genera studied by him, of ancestral characters, and he gives a table illustrating this.<sup>2</sup>

*Summary.*—Paleontologists almost universally accept the theory of recapitulation. Its chief critics have been embryologists. The reason for the difference in attitude is probably to be sought in the fact that the former ordinarily compare epembryonic stages with adult characters of geologically older species, while the latter too often compare embryonic stages with the adult stages of existing species. It is also to be noted that in recapitulation we have to do with morphological and not with physiological characters, and that the row of cells from the egg to the adult may be morphologically the same in two organisms, while being at the same time physiologically different. Until it can be shown that two organisms morphologically different in the adult must of necessity be morphologically different at all stages, the argument of Montgomery, Hurst and others proves nothing.

<sup>1</sup>The term *prototheka* was proposed simultaneously (January, 1904) by Bernard and myself for the earliest skeletal structure of the coral colony. We have used it, however, in a slightly different sense. Bernard applies it not only to the first individual of the colony, but also to the basal plates or cups of later individuals. I intended to restrict it to the basal cup of the first individual. The references are as follows: Bernard, H. M., The prototheka of the Madreporaria, with special reference to the genera *Calostylis*, Linds., and *Mosleya*, Quelch. *Ann. Mag. Nat. Hist.*, Ser. 7, vol. xiii, Jan. 1904. Cumings, E. R., The development of some Paleozoic Bryozoa, *Am. Jour. Sci.*, vol. xvii, Jan., 1904 (footnote, p. 74).

<sup>2</sup>This so-called rejuvenescence in corals appears to be a species of budding, in which the bud is directly superimposed upon the parent. It is fission occurring in a horizontal plane, as suggested by Bernard (14), and the new skeleton is in direct continuity with the old. This is the same idea exactly as that advanced by Ulrich some years ago (63) to account for the diaphragms of the Bryozoa *Trepstomata*. In the case of the *Trepstomata* the zoæcium is frequently operculate (ex. *Callopora*), and there is good evidence that the bud grows up through the operculum hence leaving it behind as the floor of the new individual.

In the Cephalopoda, Pelecypoda, Gastropoda, Brachiopoda, Trilobita, Bryozoa, Graptolites, Echinoderms and Corals, examples are pointed out in which there is clear and unmistakable evidence of recapitulation. In most of these cases it is the epembryonic and not the embryonic stages that are the basis of comparison.

Paleontological Laboratory,  
Indiana University,  
Bloomington, Indiana.

#### REFERENCES.

1. Bather, F. A.—The recapitulation theory in Paleontology. *Nat. Sci.*, ii, 1893.
2. ——— *Treatise on Zoology. Echinoderma*, 1900.
3. Barrande, J.—*Sao Hirsuta*. Barrande, ein Bruchstück aus dem "Système Silurien du centre de la Bohême." *Neues Jahrb. f. Min. Geol. u. Pal.*, 1849.
4. ——— *Système Silurien du centre de la Bohême.* 1-iere partie. 1852.
5. Beecher, C. E.—Development of a Paleozoic poriferous coral. *Trans. Conn. Acad. Sci.*, vol. viii, 1891.
6. ——— Development of the Brachiopoda. Part I, Introduction. *Am. Jour. Sci.*, (3), xli, 1891; Part II, Classifications of the stages of growth and decline. *Am. Jour. Sci.*, (3), xlv, 1892; Part III, Morphology of the Brachia. *Bull. U. S. Geol. Surv.*, No. 97, ch. iv, 1897.
7. ——— Some correlations of ontogeny and phylogeny in the Brachiopoda. *Am. Nat.*, xxvii, 1893.
8. ——— Larval stages of Trilobites. *Am. Geol.*, vol. xvi, 1895.
9. ——— Outline of a natural classification of the trilobites. *Am. Jour. Sci.*, (4), iii, 1897.
10. ——— *Studies in Evolution.* (Mainly reprints of occasional papers. The papers listed above are also contained in this collection.) New York, Charles Scribner's Sons, 1901.
11. ——— and Clarke, J. M.—The development of some Silurian Brachiopoda. *Mem. N. Y. State Mus.*, No. i, 1889.
12. ——— and Schuchert, C.—Development of the brachial supports in *Dielasma* and *Zygospira*. *Proc. Biol. Soc.*, Washington, vol. viii, 1893.
13. Bernard, H. M.—The prototheka of the Madreporaria, with special reference to the genera *Calostylis*, *Linds.* and *Mosleya*, *Quelch.* *Ann. Mag. Nat. Hist.*, Ser. 7, vol. xiii, 1904.

14. ——— British Museum Catalogue of Madreporarian corals, vol. vi, 1906.
15. Cope, E. D.—Origin of the fittest. New York, D. Appleton & Co., 1887.
16. Cumings, E. R.—The morphogenesis of Platystrophia. A study of the evolution of a Paleozoic brachiopod. Am. Jour. Sci., (4), vol. xv, 1903.
17. ——— Development of some Paleozoic Bryozoa. Am. Jour. Sci., (4), vol. xvii, 1904.
18. ——— Development of Fenestella. Am. Jour. Sci., (4), vol. xx, 1905.
19. Dall, W. H.—Trans. Wagner Free Inst., vol. iii, 1890, p. 67. (Quoted by Grabau.)
20. Eigenmann, C. H.—The eyes of the blind vertebrates of North America. Mark Anniversary Volume. Article ix, 1903.
21. Girty, G. H.—Development of the corallum in Favosites forbesi var. occidentalis. Am. Geol., vol. xv, 1895.
22. Grabau, A. W.—Studies of Gastropoda. Am. Nat., xxxvi, 1902.
23. ——— Studies of Gastropoda II. Fulgur and Sycotypus. Am. Nat., vol. xxxvii, 1903.
24. ——— Phylogeny of Fusus and its allies. Smithsonian Misc. Coll., vol. xlv, 1904.
25. ——— Studies of Gastropoda III. On orthogenetic variation. Am. Nat., vol. xli, 1907.
26. ——— and Shimer.—See Shimer and Grabau.
27. Greene, F. C.—The development of a Carboniferous brachiopod, Chonetes granulifer, Owen. Jour. Geol., vol. xvi, 1908.
28. Griggs, R. F.—Juvenile Kelps. Am. Nat., Jan. and Feb., 1909.
29. Holm, G.—On Didymograptus Tetragraptus and Phyllograptus. Geol. Mag., Dec. iv, vol. ii, 1895.
30. Hurst, ——— The recapitulation theory. Nat. Sci., ii, 1893.
31. Hyatt, A.—The phylogeny of an acquired characteristic. Proc. Am. Phil. Soc., vol. xxxii (Anniversary volume), 1894. (See other references to this author in the footnote at the close of the section on the Cephalopoda.)
32. Jackson, R. T.—Phylogeny of the Pelecypoda, the Aviculidae and their allies. Mem. Bos. Soc. Nat. Hist., vol. iv, 1890.
33. ——— Studies of Palechinoidea. Bull. Geol. Soc. Am., vol. vii, 1896.
34. ——— Localized stages in development in plants and animals. Mem. Bos. Soc. Nat. Hist., vol. v, No. 4, 1899.
35. Lang, W. D.—The Jurassic forms of the 'genera.' Stomatopora and Proboscina. Geol. Mag., Dec. v, vol. i, 1904.



36. ———Stomatopora antiqua, Haine and its related forms. Geol. Mag., Dec. v, vol. ii, 1905.
37. ——— The reptant Eleid Polyzoa. Geol. Mag., Dec. v, vol. iii, 1906.
38. ——— Growth stages in the British species of the coral Parasmilia. Proc. Zool. Soc., London, 1909.
39. Matthew, G. F.—Illustrations of the fauna of the St. John group continued: On Conocoryphea with further remarks on Paradoxides. Trans. Roy. Soc., Canada, vol. ii, sec. iv, 1884.
40. ——— Illustrations of the fauna of the St. John group, No. 4, pt. ii, the smaller Trilobites with eyes (Ptychoparidae and Ellipsocephalidae). Trans. Roy. Soc. Canada, vol. v, sec. iv, 1887.
41. ——— Sur le Development des premiers Trilobites. Ann. Soc. Malac. de Belgique, 1889.
42. Montgomery, T. C.—An analysis of racial descent. 1906.
43. Morgan, T. H.—Evolution and adaptation. 1903.
44. Nitsche, H.—Beiträge zur Kenntniss der Bryozoen. Zeitschr. für Wiss. Zool., Bd. xxi, 1871.
45. Pergens, E.—Untersuchungen an Seebryozoen. Zool. Anzeig., Jg. xii, 1889.
46. Raymond, P. E.—Developmental change in some common Devonian brachiopods. Am. Jour. Sci., vol. xvii, 1904.
47. Ruedemann, R.—Growth and development of Goniograptus thureaui, McCoy. Bull. N. Y. State Mus., No. 52, 1902.
48. ——— Graptolites of New York, Pt. I. Mem. N. Y. State Mus., No. 7, 1904.
49. ——— Graptolites of New York, Pt. II. Mem. N. Y. State Mus., No. 11, 1908.
50. Sardeson, F. W.—The phylogenic stage of the Cambrian Gastropoda. Jour. Geol., vol. xi, 1903.
51. Shimer, H. W., and Grabau, A. W.—Hamilton group of Thedford, Ontario. Bull. Geol. Soc. Amer., vol. xiii, 1902.
52. Smith, Essie (Mrs. Alexander Shannon).—The development and variation of Pentremites conoideus. Indiana Dept. Geol. Nat. Res., 30th Ann. Rept., 1906.
53. Smith, Burnett.—Phylogeny of the species of Fulgur with remarks on an abnormal specimen of Fulgur canaliculatum, and sexual dimorphism in Fulgur carica. Proc. Acad. Nat. Sci., Phila., vol. liv, 1902.
54. ——— Phylogeny of the races of Volutilithes petrosus. Proc. Acad. Nat. Sci., Phila., vol. lviii, 1906.

55. — New species of *Athleta* and a note on the morphology of *Athleta petrosa*. Proc. Acad. Nat. Sci. Phila., vol. lix, 1907.
56. — A contribution to the morphology of *Pyrula*. Proc. Acad. Nat. Sci. Phila., vol. lix, 1907.
57. Smith, J. P.—The biogenetic law from the standpoint of Paleontology. Jour. Geol., vol. viii, 1900.
58. — The development and phylogeny of *Placenticeras*. Proc. California Acad. Sci., (3), vol. i, No. 7, 1900. (For references to other papers by J. P. Smith, see the footnote at the close of the section on *Gastropoda*.)
59. Walcott, C. D.—Fossils of the Utica slate, and metamorphoses of *Triarthrus becki*. Trans. Alb. Inst., vol. x, 1879.
60. — Second contribution to the studies of the Cambrian faunas of North America. Bull. U. S. Geol. Surv., No. 30, 1886.
61. — The fauna of the Lower Cambrian or *Olenellus* zone. 10th Ann. Rept. U. S. Geol. Surv., 1888-9.
62. — Cambrian geology and paleontology. No. 4. Classification and terminology of the Cambrian *Brachiopoda*. Smithsonian Misc. Coll., vol. liii, 1908.
63. Ulrich, E. O.—Bryozoa. Geol. Surv. Ill., vol. viii, 1890.
64. Zeleny, C.—Compensatory regulation. Jour. Exper. Zool., vol. ii, No. 1, 1905.
65. Zittel, K.—Paleontology and the biogenetic law. Nat. Sci., vol. vi, 1895.

## THE TIPPECANOE AN INFANTILE DRAINAGE SYSTEM.

BY WM. A. MCBETH.

Streams first come into existence on a recently emerged or uncovered land surface, with enough rainfall to leave a surplus for runoff after the requirements for soil saturation and evaporation have been met. An uplift of part of the sea bottom, the drainage of a lake or the melting of an ice sheet may produce the new surface on which the streams begin their cycle of existence and work.

Most of the streams of northern Indiana are in the youthful stage. They came into being with the recession of the North American Ice Sheet from that part of the State. If parts of the region retained areas of marsh, pond or lake, the location of streams in such areas would be delayed until outlets could be made by the intrenchment of channels by outflowing waters to such depth that the impounded waters would be drained off, when stream lines would be laid out on such newly uncovered lands.

The Tippecanoe river between the abrupt bend on the northeast corner of Pulaski County and Monticello in White County, with its tributaries, furnishes a fine example of extremely young drainage. This section of the river evidently traverses the bed of a former temporary lake which was held in by a moraine at Monticello. Evidence of this lake remains in the sand ridges, some of which seem to be beaches and others dunes numerous in the region. The sudden change in the width and depth of the river valley above Monticello also is significant of such a condition. The valley at Monticello is almost exactly 100 feet deep, and from one-fourth to one-half mile wide, and at Buffalo ten miles north of Monticello the channel is about 25 feet deep and is without floodplain or bluffs. In brief, the channel is just cut deep and wide enough barely to carry the flood waters. The trusses of the highway bridges crossing the river in Pulaski County can be seen miles away across the level prairie. The bridge floor at Winamac is level with the streets of the town. The river has a steep slope through this part of its course, the fall from Winamac to Monticello being not less than 100 feet in thirty miles.

The tributaries to the main stream in this region are examples of still younger drainage. In following the road from Monticello to Buffalo the way is over level country, except that where streams making their way

west to the river are crossed, the road descends ten or fifteen feet to the bridge crossing the stream, then rises by the same distance to the level plain again.



The Drainage of Pulaski and White Counties, Indiana.

Persons going to Headlee, Pulaski or Winamac (see map) often turn east a short distance north of Monticello and going about three miles they

turn north again, following the range line road. (Between R. 2 and R. 3 W.) This road is much more level. The streams crossed in small valleys on the west or river road have no valleys where crossed by the range line road. Formerly they existed as broad sloughs or strips of marsh land, and where crossed stretches of corduroy road were used to enable teams and vehicles to cross without miring. Scarcely the beginning of a channel could be discovered threading its way through the lowest part of the marsh or slough. The drainage was by over wash or sheet streams spreading out many rods in width and slowly creeping away to the river. Within the last mile or two of their course the channel became gradually deeper and wider and the stream sped freely down a steeper slope into the river. These sheet streams are good examples of the primary drainage or runoff. They were interrupted frequently by ponds and broader widths of marsh, keeping large areas so wet as to make cultivation impossible—the land furnishing a poor quality of pasturage.

Within the last few years man has done by machinery what nature has not done and could not do in thousands of years. Starting at the head of the sloughs fifteen to twenty miles from the river steam dredges have been used to dig channels for these over wash waters and practically every slough on both sides of the river in all this region has been furnished a channel ample for its drainage.

Pike Creek, Keen's Creek, the Carnahan Ditch, the Ackerman Ditch and Indian Creek on the east side of the river, and the Monon Creeks, Honey Creek and others on the west side, furnish examples of infant drainage aged by the aid of man in pushing forward the work the waters were so tardily doing.



## A PAIRED ENTOPLASTRON IN TRIONYX AND ITS SIGNIFICANCE.\*

---

BY H. H. LANE.

---

There is no order of reptiles more distinctly circumscribed than the Testudinata. Even the fossil remains cast little if any light upon their affinities. That they are a highly specialized group need not be argued. Any point, therefore, which gives an indication of what may be considered to have been a primitive condition in the order, is of extreme interest and value.

Moreover, there has been much discussion as to the relative rank of the various suborders and families comprised in this order. A group concerning which there is much diversity of opinion is that now generally regarded as constituting a suborder, the Trionychia. Some have seen in their so-called "soft-shelled" condition, evidence of extreme specialization, and have therefore assigned them to a very high position in the order. Thus, Gadow (Cam. Nat. Hist., vol. viii, p. 406) asserts that "It is not open to much doubt that the characteristic features of the Trionychoidea are not primitive but secondary. This is indicated by the whole structure and behavior of the carapace and plastron. The softening of the whole shell, the loss of the horny shields, the reduction of the claws, are the direct and almost unavoidable results of life in muddy waters." Other authorities take exactly the opposite view, and from the same facts reach the conclusion that "the Trionychidae stand nearest to the general structural plan of the Reptilia" (Adolph Th. Stoffert, Structure and Development of the Shell of *Emyda ceylonensis*, Gray).

On account of this difference of opinion the writer has undertaken a study of the embryonic development of *Trionyx* with the view, *first*, of determining, if possible, the relative position of the Trionychia among the Testudinata, and, *second*, if it should prove to be a comparatively generalized type, to secure some hint as to the reptilian form from which the chelonian ancestry may have been derived. I present in this paper only one phase of the evidence furnished by the plastron, relative to the first of these two problems, although my material sheds some light upon both.

---

\* (Contribution No. 5, from the Department of Zoology and Embryology, State University of Oklahoma.)

No other terrestrial or freshwater tortoises possess so simple and perhaps so primitive a type of plastron as that found in the Trionychia. In the adult *Trionyx (Aspidochelys) spinifer*, the plastron (Fig. 1) is composed of nine elements, four paired and one unpaired, separated to a greater or less extent at first by three, and later sometimes by only two, large fontanelles. Different authors have proposed different theories relative to the homologies of these plastral bones, and along with these theories there has arisen a complex terminology. Each author has sought to give permanency to his own hypothesis by assigning to the plastral elements names indicative of his view. Thus the unpaired element is designated by G. St. Hilaire, Owen, Ruetimeyer, and others, who regard the plastron as the homologue of the amniote sternum, as the "ento-sternal"; Parker calls it the "inter-thoracic plate"; while Huxley gives it the noncommittal name of "ento-plastron," in which he is followed by most later writers. The four paired elements of the plastron have not fared any better. Thus, G. St. Hilaire, Owen and Ruetimeyer designate them as "episternal," "hyosternal," "hyposternal," and "xiphisternal," respectively; Parker, as usual, has his own set of terms, and calls them "praethoracic," "post-thoracic," "praeabdominal," and "abdominal" plates; while Huxley gives them the names of "epiplastron," "hyoplastron," "hypoplastron," and "xiphoplastron." In the present state of our knowledge it is best, perhaps, to use Huxley's terms, since they commit one to no special theory regarding the homologies of the elements to which they apply.

Among the various attempts that have been made to homologize the plastral plates with certain skeletal elements of other amniotes, one of the earliest was that of Cuvier (*Regne animal, Les Reptiles*, p. 10), who identifies them with the sternum of the Lacertilia and higher vertebrates. G. St. Hilaire (*Philosophie anatomique*, vol. i, p. 106) makes a detailed comparison between the several parts of the plastron and the osseous pieces of the avian sternum. Carus (*Von den Ur-Teilen des Knochen- und Schalengeruestes*, 1828), and Peters (*Observationes ad Anatomiam Cheloniorum*, Berolini, 1838), maintain that it is only partially equivalent to the sternum. Owen (*On the development and homologies of the carapace and plastron of the Chelonian Reptiles*, *Phil. Trans. London*, 1849), advances the idea that the paired plates correspond to haemapophyses of the ribs. Rathke (*Ueber die Entwicklung der Schildkröten*, Braunschweig, 1848), holds the plastron to be wholly dermal in origin and hence a structure not to be homologized with the endoskeletal elements of other groups. Many



of the more recent authorities, beginning with W. K. Parker (Structure and development of the shoulder girdle and sternum in the vertebrata, London, 1868), and Huxley (The Elements of Comparative Anatomy, London, 1864), consider the epiplastra and the entoplastron to be the homologues of the clavicles and interclavicle respectively, of other reptiles.

In form the entoplastron is quite as variable among the Testudinata generally, as are the paired elements associated with it. It is perhaps most frequently T-shaped or roughly triangular, with the apex of the triangle directed caudad. In *Trionyx*, however, it has an entirely different configuration, being in the form of a wide V with the apex or point directed cephalad (Fig. 1).

The other elements of the plastron have outlines and relationships characteristic of the family and can be easily identified by reference to the figure (Fig. 1), wherein the epiplastra (epi) are shown immediately cephalad of the entoplastron (ento), while the hyoplastra (hyo), hypoplastra (hypo), and xiphiplastra (xiph), lie caudad to that element in the order given.

In a *Trionyx* embryo with a carapace length of 14 mm., the elements of the plastron are all definitely laid down (Fig. 2). The nuchal plate of the carapace is a well marked and clearly defined dermal bone having as yet no connection with a vertebra. The ribs are fully laid down in cartilage, but there are no traces of costal plates, and neurals, likewise, are not present. The plastral elements are not only all present but they are also *all paired*. They are not preformed in cartilage but consist entirely of ossifications within the dermis. In shape and size they are clearly defined. As shown in the figure (Fig. 2) they form a series of five pairs of more or less rod-like structures, which are not in contact with one another, as is the case in the adult (Fig. 1), but on the contrary they are separated by comparatively large spaces in which the tissue of the dermis is clearly mesenchymatous and shows no trace of ossification. The position of the five pairs in two longitudinal rows and their absolutely similar origin as entirely dermal ossifications make it certain that, whatever their homology to structures in other forms may be, they must all be interpreted as serial homologues of each other. While it is agreed that the hyoplastra, hypoplastra, and xiphiplastra are the homologues of the abdominal ribs found in the Crocodile and Rhynchocephalia, the epiplastra and entoplastron are pretty generally regarded as representing the clavicles and interclavicle of other reptiles.

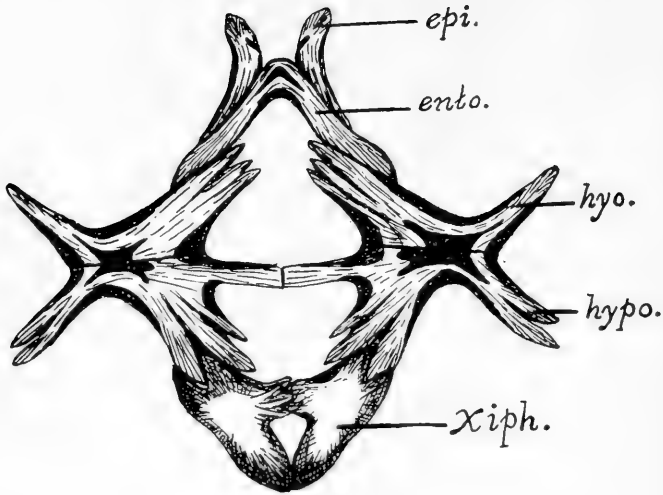

Fig. 1

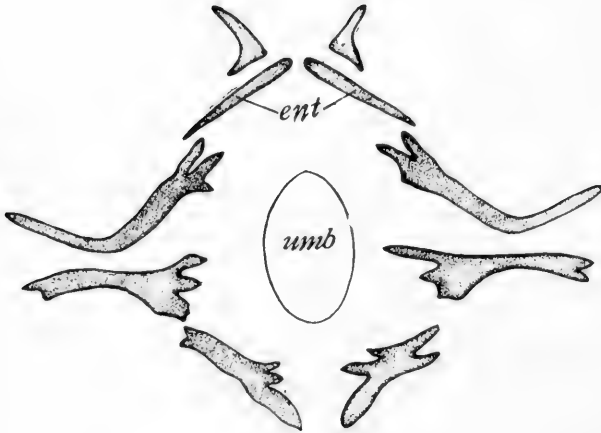

Fig. 2

## EXPLANATION OF THE FIGURES.

Figure 1 shows the form and arrangement of the plastral elements (reduced in size) of an adult *Trionyx spinifer*, epi., epiplastron; ento., entoplastron; hyo., hypoplastron; hypo., hypoplastron; xiph., xiphoplastron.

Figure 2 is a graphic reproduction, magnified ten times, of the plastral elements in embryo *Trionyx spinifer* with a carapace length of 14 mm. umb., umbilicus; ent., paired entoplastra.

Accepting merely for the moment the correctness of this homology, it is interesting to note how very rarely a paired interclavicle has been found in reptiles. So far as I have been able to discover Parker is the only one heretofore to report such an observation, and in his monograph on the structure and development of the shoulder girdle and sternum, cited above, describes the interclavicle of *Anguis* as developing from paired elements and says:

"Above the Ganoid Fishes, this is the only instance I can give at present of the primordial symmetry of the interclavicle; but a careful study of the development of this bone in embryo lizards would, very probably, show it to be not at all rare" (p. 99).

Examining the question of the homologies of the plastral elements a little more closely, however, one is led to doubt Huxley and Parker's identification of the epiplastra and entoplastron as clavicles and interclavicle respectively. In all other reptiles so far as known the clavicle is laid down, at least partially, in cartilage and in close connection with the other elements of the shoulder girdle. Even in the mammals, while its origin is still a matter for further investigation, it is definitely established that a portion at least of the clavicle is preformed in cartilage. In *Trionyx*, as in other of the Testudinata, the epiplastra, on the contrary, develop entirely without connection with the shoulder girdle, entirely outside the muscular layer of the body wall and within the much thickened dermis. They, in company with all the other plastral elements, are wholly without a cartilaginous preformation, and develop as direct ossifications in the dermal mesenchyme. Without further evidence it is very difficult to accept the view that the epiplastra are the testudinate homologues of the clavicles and the same arguments hold in regard to the identification of the entoplastron with the interclavicle. As is shown in this paper, the entoplastron in *Trionyx* is at first a pair of elements, so that there is nothing to prevent the interpretation of the entire series of plastral bones as the homologues of the so-called abdominal ribs so well known in *Sphenodon* and the Crocodylia.

Recurring to the question of the relative rank of the Trionychia among the Testudinata, the paired condition of the entoplastron, as it exists in this embryo (Fig. 2, ent) is especially important and instructive. As Rathke first pointed out, the entoplastron is wanting in *Sphargis*, perhaps on the whole the most specialized of all the Testudinata. It is reported by Stannius (*Handbuch der Anatomie der Wirbeltiere*, 1854) as absent

also in *Staurotypus*, while L. Agassiz (Contributions to the Nat. Hist. of the U. S. A., vol. I, p. 267) states that it disappears in old specimens of other Cinosternidae. With these exceptions the entoplastron occurs as a single median bone in all known species of turtles and tortoises both living and fossil, save where in some of the latter the fragments are too meagre to permit its presence or absence being positively determined. It is therefore phylogenetically a very old element in the testudinate skeleton, and was probably, in some form or other, a direct inheritance from the more generalized reptilian stock from which this order arose.

It follows, therefore, that we have in the paired entoplastron of the embryo *Trionyx*, a very primitive character, so primitive, indeed, that it occurs nowhere in the adult of any known species of Testudinata either living or fossil. It is therefore an indication that *Trionyx* is to be regarded as more primitive than any other known genus of the order. Were this the only evidence of primitiveness known to occur in *Trionyx*, one would not, perhaps, be justified in making so broad an assertion. But a considerable amount of corroborative evidence is also at hand. Thus in *Trionyx*, the atlas is temnospondylous, i. e., its three constituent parts, the neural arch, the centrum, and the intercentrum, are not ankylosed but remain loosely connected, there is no odontoid process on the second vertebra, the first centrum being freely movable on the second; the pubic and ischiadic symphyses are broad and are connected with each other by a longitudinal cartilaginous band, which is replaced in other testudinales, except *Chelone*, by a broad completely ossified plate (Gadow). In the young of all tortoises, but in the adult only in the Chelonidae and Trionychidae, the plastral plates are separated by large fontanelles (Fig. 1, f). And finally, as reported by Wiedersheim (Vergl. Anat. der Wirbelthiere, 5. Auflage, 1902) teeth rudiments also occur in the embryo of *Trionyx* and nowhere else among the Testudinata. I have not been able so far to corroborate this observation, but it is certainly, if correct, a most important argument in favor of the view herein set forth.

This conclusion regarding the Trionychia is not invalidated by certain secondary specializations, such as the flatness of the body and the webbed feet, all clearly adaptations to an aquatic habitat. However, these adaptations do show that *Trionyx* is in no sense directly ancestral to the other Testudinata; the Trionychia are to be regarded as an early offshoot of the main stem, which has retained certain of its primitive characters.

State University of Oklahoma,  
Norman, Oklahoma.

## NOTES ON PARASITES FOUND IN FROGS IN THE VICINITY OF ST. PAUL, MINN.

---

BY H. L. OSBORN.

---

(Abstract.)

Our knowledge of the parasites of even the commonest animals is very incomplete. Examinations of all the organs and at all seasons of the year and extended over a period of several years have never been made except, possibly, for a few of the domesticated animals where the information possessed an evident and immediate utilitarian bearing. Such studies of a number of common and abundant animals are much to be desired. If a body of such information were available it would be of great service to students of the trematodes and very likely make it possible to complete many life histories, only fragments of which are known at the present time. The present paper is a first step in an attempt to do this with reference to the common frogs in the neighborhood of St. Paul. Twenty-one frogs were examined in June, seven in September and nine in November. These numbers are found to be too small for anything but a preliminary survey of the ground and larger numbers will be examined next year. The walls of the cœlom, particularly in the dorsal and anterior regions, are infected by nearly mature encysted individuals of *Clinostomum marginatum*, Rud. This form has been reported hitherto only from fish and fish-eating birds. The pericardial cavity, especially in frogs during June, was found to contain oval cysts, sometimes grouped in masses, each cyst containing a distome so immature that its generic affinities cannot be determined from the data furnished by a study of its structure. It may turn out to be a missing early stage of some trematode whose later stages are already known. The urinary bladder in a considerable fraction of the frogs examined harbors a species much like, if it is not identical with, the *Gorgodeca attenuata* which Stafford has described from a similar location in the frogs of Canada. A member of the Amphistomidæ occurs occasionally in the urinary bladder but is more characteristically a parasite of the rectum, where it is found at all seasons. In one instance *Cephalogonimus* was found in the rectum and small intestines. In a few cases a

cestode was found in the small intestine, also in the cœlomic cavity beside the small intestines and in cysts on the surface of the liver. The lungs contain *Distomum lanceolatum* in a large percentage of cases and a nematode also in many instances.

Hamline University,  
St. Paul, Minn.

## THE MOCKING-BIRD AT MOORES HILL, IND.

---

BY A. J. BIGNEY.

---

The purpose of this brief article is to show how this bird acts on entering a new community, and to give evidence of its enlarging field of activity.

In Mr. Butler's catalogue of the Birds of Indiana<sup>1</sup> in 1897, they were reported in twelve counties in small numbers. In recent years they are migrating in large numbers into the counties of southern Indiana. In 1905, about April 1st, the first mocking-bird was seen in the outskirts of Moores Hill. It was rather shy, but made its whereabouts known by its incessant singing, not only in the daytime, but also during most of the night. Such singing had never been heard by our citizens. It continued this behavior for about ten days, then left the community. The next season a pair returned to the same place and the air was again filled with their music. Their usual imitation of the notes of other birds was a marked characteristic. This season they nested in the honeysuckle vine alongside a neighbor's house. They remained until late in the fall and then migrated southward. During this season one other pair was seen about two miles from town.

The following season several pairs were seen in and about town. The last two seasons the numbers have gradually increased, so that now they constitute one of our regular bird inhabitants.

The question naturally comes up, why have they begun their rapid advance into the north during the past few years? I can not answer this question. I have heard that a kind of ant is troubling them in their nesting and so they migrate to get rid of them. If any positive information can be given, I should be glad to know of it.

Moores Hill College,  
Moores Hill, Ind.

---

<sup>1</sup> Amos W. Butler. The Birds of Indiana. Twenty-second Annual Report of the Department of Geology and Natural Resources of Indiana, 1897.

## OBSERVATIONS ON WOODPECKERS.

---

BY JOHN T. CAMPBELL.

In May, 1883, I was surveying to build a levee along the east side of the Wabash River in Parke County, Indiana, from the mouth of Big Raccoon Creek southward to within a mile of the south boundary of the county—twelve miles long. Near the south end of this levee was a wide bottom, in which I had surveyed before it was cleared. Joseph J. Daniels, of Rockville, Indiana, bought this land, cut out the saw timber and deadened the remainder. In the spring of 1882, these deadened trees had decayed enough for the woodpeckers to bore holes for their nests. There were easily one thousand such trees on this seven hundred acres. Each tree had from three to twenty woodpecker holes. The marks of the great flood of 1883, in February, were very plain and could be recognized several years later. Of all those, probably ten thousand holes, not one was below the flood mark of the water of 1883. On the east side of the bottom the ground was very low, which made the flood marks about twenty feet above ground. The flood was twenty-eight feet above summer low water. Out west, near the river, the bottom was high, and the flood marks only about eight feet above the ground. Some of the holes were within two feet, but above the flood mark. The next year many holes were made below the flood mark, but whether they were kept above the top of the next and smaller flood, I did not think to notice. I ran the level over the land to grade it for assessment, and had a good opportunity to observe the holes. What is the explanation?

Lafayette, Ind.



## OBSERVATIONS ON CEREBRAL LOCALIZATION.

---

 BY JAMES ROLLIN SLONAKER.
 

---

Ever since Hitzig<sup>1</sup> in 1870 sent a voltaic current through the brain of a wounded soldier and noticed a certain movement of the eyes, numerous investigators have been busy furthering our knowledge of cerebral localization.

Fritsch and Hitzig followed this discovery with many experiments on the cerebral hemispheres of the dog and noticed that stimulation of certain areas produced definite muscular movements on the opposite side of the body.

These experiments started many other investigators, among whom may be mentioned Ferrier,<sup>2</sup> Munk,<sup>3</sup> Horsley and Schafer,<sup>4</sup> Heidenhain,<sup>5</sup> and Beever and Horsley.<sup>6</sup> The results of these and many later investigations have formed the basis of an exact cortical localization in the brain of man.

Numerous surgical operations and pathological observations have added to our fund of knowledge, so that now the cortical areas governing certain movements in man are quite definitely known. However, each new case will further prove and assist in making the localized areas in man more definite. With this in view I present the following data which I have gathered from the subject:

Mr. Ralph R. Laxton of Atlanta, Ga., met with an accident which fractured the skull near the median line in the Rolandic region. A portion of the bone was removed to relieve the pressure on the brain. As life was despaired of no metal plate was introduced, but the scalp simply closed over. The wound healed and the subject finally recovered. The external condition of the wound after recovery is that there is a more or less circular depression about one and a half inches across, due to the

---

<sup>1</sup> Hitzig, Reichert u. Du Bois-Reymond's Archiv., 1870.

<sup>2</sup> Ferrier, *The Functions of the Brain*, London, 1886.

<sup>3</sup> Munk, *Die Functionen der Grosshirnrinde*, Berlin, 1877-1880.

<sup>4</sup> Horsley and Schafer, *On the Functions of the Marginal Convolution*, Proceedings of the Royal Society, No. 231, March, 1884. Horsley, *British Medical Journal*, Vol. II, 1884.

<sup>5</sup> Heidenhain, *Pflüger's Archiv f. Physiologie*, 1881.

<sup>6</sup> Beever and Horsley, *A Record of the Results Obtained by Electrical Excitation of the so-called Motor Cortex and Internal Capsule in an Orang-Outang (Simia satyrus)*, Phil. Trans. Royal Soc., Vol. 181, B, 1890.

absence of bone. This depression lies as shown in Figures 1 and 2. These figures are shadowgraphs representing the side and back views respectively.



Fig. 1. Shadowgraph showing location of depression as seen from side.

From this it is readily seen that the depression mostly affects the anterior central gyrus. Also by consulting Fig. 2 it is observed that the depression is situated almost wholly on the left side, passing over only about a quarter of an inch onto the right side.

The schemes representing the localized areas in man are based on the results of observations on the monkey, on human pathological data and on experiments on man.

How Mr. Laxton's injury confirms our present knowledge of cerebral localization in man is shown in the following history of the case, a part of which I give in his own words:

"At the time of the injury, Nov. 25, 1892, I was 22½ years of age and weighed about 145 pounds. My height was about 5 feet 9 inches. At present I weigh 160 pounds and measure 5 feet 10 inches while standing on my left leg, and 5 feet 9 inches on my right.

<sup>7</sup> Deaver's Anatomy, Vol. II, p. 508.

<sup>8</sup> Reid, The Principal Fissures and Convolution of the Cerebrum, Lancet, 1884.

Various muscular troubles arose, indicating a disturbance of the motor region of the brain. A line drawn outward, downward and forward at an angle of 71.5 degrees with the median line and starting from a point one-half inch, or about one centimeter, behind a point midway between the glabella and the inion, will approximately follow the central fissure<sup>7, 8</sup>. With such a line constructed one can quite accurately sketch in the outline of the brain and its principal fissures. Such a sketch is shown in Figure 3.

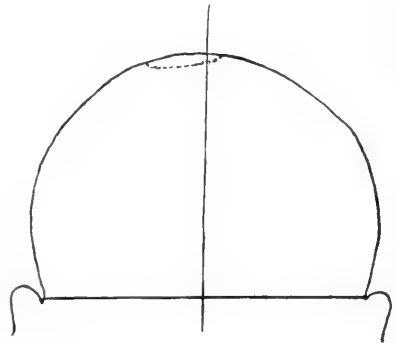

Fig. 2. Shadowgraph showing position of depression as seen from behind.

"In perhaps sixty seconds from the time of the blow I was conscious again, but I do not remember any sensation in my right leg at the time, except that it was very cold. I did, however, observe the progress of paralysis in the right arm. This began in the fingers and extended gradually up the arm. For some time after I was operated upon I was unable to find the way to my mouth with a glass of water. This paralysis was, I think, due to extravasation of blood, which was gradually absorbed later, as I have for more than twelve years been doing a good deal of work with the pen and some with the telegraph key. I think I may safely say that I have entirely recovered the use of the arm. At times, however, I feel the characteristic dull sensation in the muscles of the right side of the body up to the shoulder, and even in the upper arm itself. Then, again, the sensation is hardly apparent above the waist line, all of which tends to show that the area of depression is not sharply defined."

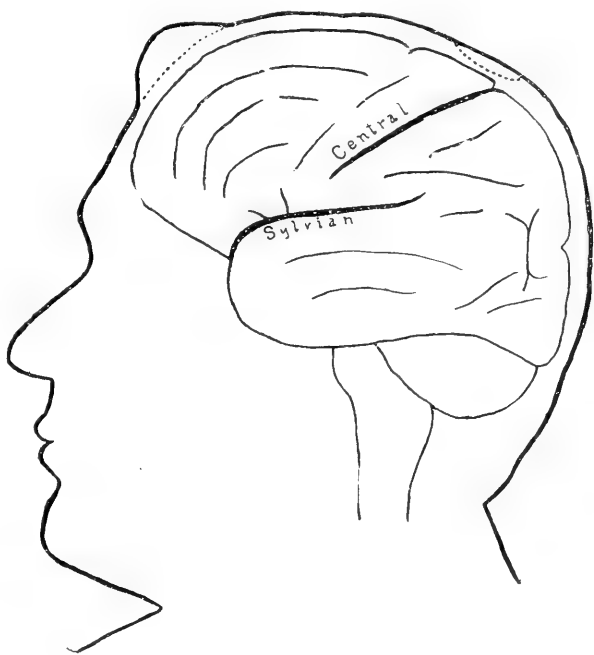

Fig. 3. Showing depression in relation to fissures of the brain.

The left arm was broken by the accident so he was unable to use it, but he states that it was not affected by the paralysis.

It would be interesting in this connection to know if the change in barometric pressure has any influence on the location of this dull sensation. Accurate observations in this respect are lacking. The only information Mr. Laxton can give on this point is as follows: "As regards baro-

metric effects, I have not been able to form any definite idea, though I have lived for ten months of the past year in southern Mississippi, where my office was just seven feet above the level of the Gulf of Mexico. I believe, however, that if the humidity of the atmosphere and the general condition of my system were exactly the same in both localities, I would find a difference between the sea level and a point three or four thousand feet above it. I have not had an opportunity to make observations in higher altitudes, but know that I am capable of more physical exertion in the mountains of western North Carolina than in the low country. I was on Lookout Mountain a few weeks ago, making the trip up the incline railway, but was not able to notice any change in feeling due to the rapid rise, of something like one thousand feet, from the city of Chattanooga to the top of the mountain. Just prior to a sudden change from dry to wet weather, I am apt to suffer from pains in the right leg, which I suppose are akin to rheumatism. As soon as precipitation begins the pains cease. This pain is most marked in the right hip joint."

In regard to stature, as has already been stated, he stands one inch higher on the left foot than on the right. The right leg also measures one inch less in circumference than the left, both in the thigh and the calf region. The muscles of the right leg, especially in the region of the calf, are less firm than those of the left. These conditions did not prevail before the accident. There is also a difference in the development of the two sides of the chest, which condition existed to a certain extent before the accident.

Concerning the resulting disturbances, Mr. Laxton says:

"There is a certain deficiency of sensation in the right leg and abnormal reflex action occurs. There is also an apparent deficiency of synovial fluid. There is almost an entire lack of control of the toes of the right foot, particularly the big toe (see Figs. 4 and 5). There is consequently a lack of balance in walking somewhat related to that observed in people who have lost one leg and use an artificial one. There are times when I feel for a few minutes as if the paralysis were entirely gone, but I have to be extremely careful not to feel too sure of myself and to follow the plan of not attempting a full length step with the right foot. The sensory paralysis extends very slightly to the bottom of the left foot." (Fig. 4.)

"I am just now experiencing considerable local irritation, the scalp even becoming, at times, sore on the outside. There are times when the

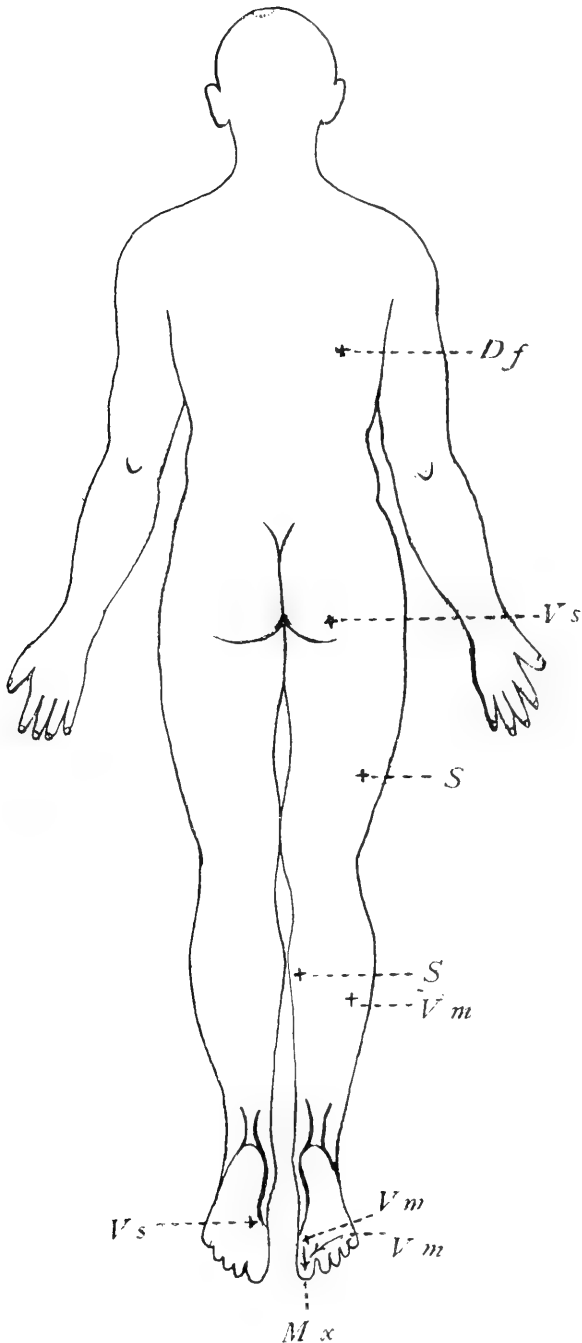

Fig. 4. Chart illustrating the positions of affected areas. Df, dull feeling; Vs very slight; S, slight; Vm, very marked; Mx, maximum.

under side of the scalp, the point of adhesion, has a feeling very similar to that of a vaccination scar just before the scab is ready to come off. Sometimes when I run my hand through my hair, I feel a slight tremor in the nerves of the calf of the right leg. The most sensitive part which gives rise to the tremor is the anterior edge of the depression."

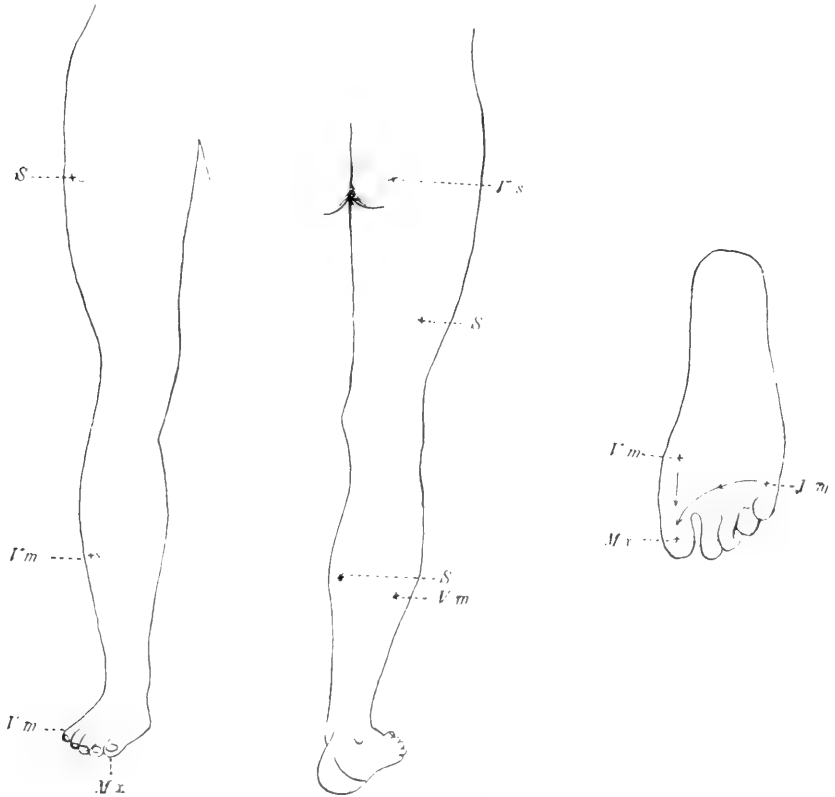

Fig. 5. Chart showing the position of affected areas in the right leg and foot Vs, very slight; S, slight; Vm, very marked; Mx, maximum. The arrows on the bottom of the foot indicate a continued but increasing disturbance.

In regard to the mental effect, Mr. Laxton says:

"There is no doubt that such an injury, so long as mechanical pressure continues, has at least a reflex bearing upon the mind itself, so that one suffering from it does not always feel like applying what he knows directly to the work in hand. If you will wear a brick fastened to your head con-

tinnally for a term of years, or undertake a journey of indefinite length on foot through a tunnel not quite high enough to stand upright in, you will get an idea of the feeling."

In Figs. 4 and 5 I have indicated the location of the areas affected as described to me by Mr. Laxton. These areas range from a "dull sensation" to "very marked" and "maximum." It is interesting to note that the disturbance becomes more and more marked toward the feet. That while there is a great disturbance in all the toes of the right foot, this disturbance increases from the little toe and the center of the bottom of the foot to the hallux, where it is maximum.

One observes, also, that with the exception of a small area on the bottom of the left foot, which is very slightly affected, the disturbed areas lie wholly on the right side of the body. This we would naturally expect, as the greater part of the depression is on the left side of the median line of the skull. Since the depression extends slightly across to the right of the median line, we would expect some disturbance on the left side of the body. The slight disturbance on the bottom of the left foot would indicate that the portion of the brain close to the median line controls the center of the foot. We would expect a greater disturbance in the corresponding part of the right foot, because the corresponding area of the brain lies more nearly under the center of the depression.

We may, I think, reasonably infer that the region of greatest disturbance is controlled by that part of the brain lying under the center of the depression. Therefore the motor area controlling the movements of the great toe would lie about the center of the depression, and that of the small toes and the center of the bottom of the foot, in close proximity. As we have already concluded that the cortical area controlling the center of the bottom of the foot lies adjacent to the median longitudinal fissure, that for the small toes would be farther removed from this region than the center for the great toe. I think we may also conclude that the parts less and less affected are controlled by portions of the brain lying nearer and nearer the margin of the depression. The movement of the hair near the anterior margin producing a tremor in the calf of the right leg, would indicate that the motor center for this region is at this point.

Since all the muscles of a given region, i. e., thigh or calf of leg, are not equally affected, one may infer that different muscles of the same region may have somewhat widely separated centers of control in the cortex,

or that some of these centers may be more deeply seated than others, and for this reason less affected.

From the foregoing, I think the following conclusions can be drawn:

1. If we have made no mistake in locating the central fissure with reference to the area of depression, this area lies mainly over the anterior central gyrus of the left side and extends very slightly across the median longitudinal fissure to the corresponding gyrus of the right side.

2. The area controlling the center of the sole of each foot lies in the anterior central gyrus at the margin of the median longitudinal fissure.

3. The area controlling the hallux lies a little more lateral, perhaps one-half inch, from the margin of the median longitudinal fissure.

4. The area controlling the other toes is in close proximity to that of the great toe. It may be anterior, posterior or more lateral from that of the great toe. Since the region controlling the muscles of the calf lies anterior, it is very probable that it is more laterally situated. This accords with the results of Beever and Horsley.

5. The areas controlling the muscles of the calf on the outside and on the inside of the leg, the thigh, rump and scapular regions are located in the order named at greater and greater distances from the center of depression. I have no doubt that the scapular region (possibly some others, also) is only indirectly affected.

6. Though the data are not quite sufficient to indicate accurately the position of the motor centers involved, it is very probable that they are arranged laterally along the anterior central gyrus from the median longitudinal fissure in the following order: a. Center of sole of foot. b. Center for great toe. c. Small toes. d. Calf muscles on lateral surface of leg. e. Calf muscles on mesial side of leg. f. Thigh muscles. g. Rump muscles. h. Scapular muscles. With the exception of the first-named area this arrangement agrees with the results of other investigations.

Leland Stanford Junior University,  
California.



## THE DEVELOPMENT OF INSECT GALLS AS ILLUSTRATED BY THE GENUS AMPHIBOLIPS.

MEL T. COOK.

The study of the development of insect galls involves more complicating factors than most problems of evolution, since the host plant is forced to give both nourishment and protection to its enemy. The result of this enforced action is the formation of a structure which is normal for the parasite and pathological for the host. The histology of these gall structures presents some very interesting questions involving the point of stimulation, the character of the stimulation and the evolutionary lines along which the various species of galls have developed. For some time we have recognized that the point of stimulation is in the meristomatic tissues, and that in most cases the stimulation is not due to a glandular secretion from the parent insect.<sup>1</sup> However, there appears to be abundant evidence that in most cases the stimulation comes from the larva, but whether mechanical or chemical, or both, or the former in some species and the latter in others, is a practically untouched problem.

In 1902 the writer<sup>2</sup> advanced the opinion that "the morphological character of the gall depends upon the genus of the insect producing it, rather than upon the plant upon which it is produced, i. e., galls produced by insects of a particular genus show great similarity of structure, even though on plants widely separated; while galls on a particular genus of plants and produced by insects of different genera show great difference." Further studies along this line have convinced the writer of the correctness of this view, and have also led to efforts to work out a system of classification based on the histological character of the galls which would be correlated with the classification of the insects. However, the completion of such a series of studies is largely dependent upon a more satisfactory knowledge of the taxonomic relations.

While it is true that the histological characters of the galls depend upon the insects rather than upon the host plants, it is also true that we find certain characters common to all groups. The first step in the forma-

<sup>1</sup> Adler & Straton. Oak Galls and Gall Flies. 1894.

<sup>2</sup> Galls and Insects Producing Them. Ohio Naturalist, II:7, p. 270. 1907.

tion of a gall is (1) the excitation of growth and cell division, (2) the failure of the cells of the affected part to differentiate into the characteristic tissues of that part, and (3) the differentiation into characteristic tissues of the gall. We also recognize certain similar lines of development in what we now consider well-defined genera. The explanation of the similarities and differences in these lines of development will depend largely upon future work in both taxonomy and histology.

It is the purpose of this paper to call attention to certain points above referred to in connection with the genus *Amphibolips*. The taxonomy of the insects of this genera have been very thoroughly studied and carefully described and arranged by Mr. Wm. Beutenmuller.<sup>3</sup> The writer has also studied the histology of several of the galls.

The genus *Amphibolips* belongs to the family Cynipidæ, is quite distinct, and stands high in the line of development. As previously stated, the galls originate as a result of stimulation of meristomatic tissue, resulting in growth and cell division. This is followed by a differentiation of this mass of cells into the tissues characteristic of the galls. In the cynipidous galls we have the four distinct tissue zones which have been referred to by many writers, viz: (1) the epidermal zone, or outside layer of cells, (2) the parenchyma zone, which may be quite thick, either dense or loose, and in which may be found fibrous tissue radiating from the center of the gall, (3) the protective zone, composed of sclerenchyma tissue and varying in thickness in different species of galls, (4) the nutritive zone of parenchyma cells, rich in protoplasm and immediately surrounding the larval chamber. The galls belonging to this genus have the four well-defined zones, but with variation in the parenchyma and protective zones by which they may be subdivided into the following groups:

#### GROUP A.

- Amphibolips conflucus*, Harris.  
 " *carolinensis*, Bassett.  
 " *longicornis*, "  
 " *acuminata*, Ashmead.

<sup>3</sup>The Species of *Amphibolips* and their Galls. Bulletin of the American Museum of Natural History, Vol. XXVI, Art. VI, pp. 47-66. 1909.

## GROUP B.

- Amphibolips inanis*, O. S.  
 " *ilicifoliae*, Bassett.  
 " *Coelebs*, O. S.  
 " *citriformis*, Ashmead.  
 " *melanocera*, "  
 " *cinerea*, "  
 " *cooki*, Gillette.  
 " *tinctoria*, Ashmead.

## GROUP C.

## Division a.

- Amphibolips spinosa*, Ashmead.  
 " *globulus*, Beutenmüller.

## Division b.

- Amphibolips nubilipennis*, Harris.  
 " *raccmaria*, Ashmead.

## Division c.

- Amphibolips prunus*, Walsh.  
 " *guinesii*, Bassett.  
 " *fuliginosa*, Ashmead.  
 " *palmieri*, Bassett.  
 " *trizonata*, Ashmead.

The writer has previously made studies of the histology of *A. conflucns*, *A. inanis*, *A. ilicifoliae*, *A. nubilipennis*, and *A. prunus*. Taking *A. conflucns* as a type of the group A, we find the parenchyma zone very thick and composed of cells which when mature have the character of a mass of colored cotton, and among which may be found fibro-vascular bundles. The parenchyma cells, when examined under the microscope, are found to be unicellular, long and threadlike. The protective zone is comparatively thin. The nutritive zone is prominent only in the young galls. The writer has not had an opportunity to examine the other three species of this group, but from the taxonomic discussion, they appear to coincide very closely with *A. conflucns*.

In group B the writer has studied *A. inanis*, *A. ilicifoliae* and *A. coelebs*, which, judging from Beutenmüller's description, are quite typical of the group. In these galls the parenchyma zone is characterized by large intercellular spaces. A part of the parenchyma cells remain attached to

the epidermal zone, another part to the protective zone and some to the well-defined fibro-vascular bundles which radiate from the central body to the outer part of the gall. These fibro-vascular bundles are in general much better developed than in the galls of group A. The protective zone is subject to considerable variation in the different species; it is quite prominent in *A. inanis* and practically absent in *A. coclebs*. The nutritive zone, as in the first group, is prominent only when the gall is young.

In group C the writer has studied *A. nubilipennis* and *A. prunus*. This group may be readily divided into three sub-groups as indicated above. The species of sub-group (a) because of the inner radiating and spongy substance, appear to be intermediate between group B and the other species of group C. The species of sub-group (b) are more succulent than the species of sub-group (c).

My studies of *A. nubilipennis* demonstrate a thick parenchyma zone of large succulent cells and very small fibro-vascular bundles which were most numerous near the surface of the gall. The protective zone consisted of a few layers of thin-walled cells. The nutritive zone was prominent in the young galls and persisted quite late.

My studies of *A. prunus* demonstrated a very thick parenchyma zone, much firmer and drier than in *A. nubilipennis*, and in which were very few small, fibro-vascular bundles. The protective zone was entirely absent. The nutritive zone well developed in the young galls.

In general it will be noted that in this genus we have (1) the galls originating and developing in the normal manner which results in the formation of the four zones; (2) the variation in the parenchyma and protective zones, which enables the above division and sub-divisions; (3) that group A may be considered the most highly developed and sub-group c of group C the lowest. The significance of this line of development cannot be determined until we know more about other genera of gall-makers and their galls. However, a study of the known geographical distribution of the species of this genus is interesting in connection with this study. In group A, *Amphibolips confucius* is very widely distributed over Canada, the Eastern States south to Georgia, and west to Colorado, while the other three species have much more limited ranges, two and possibly all three within the range of the first. In group B we find that *A. inanis* ranges from Canada and the Eastern States west to Iowa and south to North Carolina; *A. cooki* has almost the same range; *A. ilicifoliae*, *A.*

*coelebs* and *A. tinctoria* are included within the above range; and *A. citriformis*, *A. melanocera* and *A. cinerea* are reported from Florida. In group C, we find *A. nubilipennis* very widely distributed from New York west to Illinois and south to Pennsylvania, *A. prunus* from New England west to Colorado and south to Georgia; *A. spinosa*, *A. racemaria* in Florida, *A. fuliginosa* in Florida and Georgia, *A. globulus* in New Jersey, *A. gainesi* in Texas, *A. palmeri* in Mexico, and *A. triazonata* in Arizona.

Delaware College,

Newark, Del.



## APPARATUS FOR ILLUSTRATING BOYLE'S LAW.

---

BY F. M. ANDREWS.

---

The apparatus shown in Figure 1 illustrates not only Boyle's or Mariotte's Law, but also a combination of attendant phenomena which I shall describe presently: Figure 1 is about one-fourth the true size of the apparatus. It consists of an ordinary iron ring-stand E, by means of which the various glass tubes A, B, C, and D, are held in the proper position by means of clamps at F. At the base is situated a Woulfe bottle G, with which A, B, C, D, and E' communicate. The bottle G is about one-third filled with a concentrated aqueous solution of eosin. This solution is readily visible and on account of its intense red color is also seen at a considerable distance in the transparent glass tubes A, B, and C. Such an eosin solution has the additional advantage of being rather permanent in color, for in two years the solution I had used did not change perceptibly, and only a slight reddish brown precipitate was visible. It is also quite resistant in the presence of HCl, and even by the use of strong HCl a heavy precipitate results which is almost as red for a time as the original solution. The glass tubes A, B, and C extend below the surface of the eosin solution, while D merely projects through the rubber cork H. The connection of all the glass tubes A, B, C, D, E', and L are made air-tight by means of the rubber corks H, and the latter are held firmly in place by copper wires to prevent their being blown out of the pressure generated in I and G. By means of the glass tube E' the large glass bottle I is connected with G, and another glass tube connects I with the water-tap, air-pump or other contrivance for generating pressure. If the apparatus is connected as shown in the figure to water mains carrying a high pressure, and if then we open the valve O, the water will be forced into I. This will of course cause compression of the air in I, as well as pressure in proportion to the amount of water allowed to enter. Since G is connected with I by E', the same pressure will be generated in G as in I. As A, B, and C project below the surface of the eosin solution, and if the valves K and K' are closed and the water continues to enter I, in a few seconds the volume of air in the tube C, which is sealed at the top, will be compressed one-half its former volume by the eosin solution rising one-half the inside

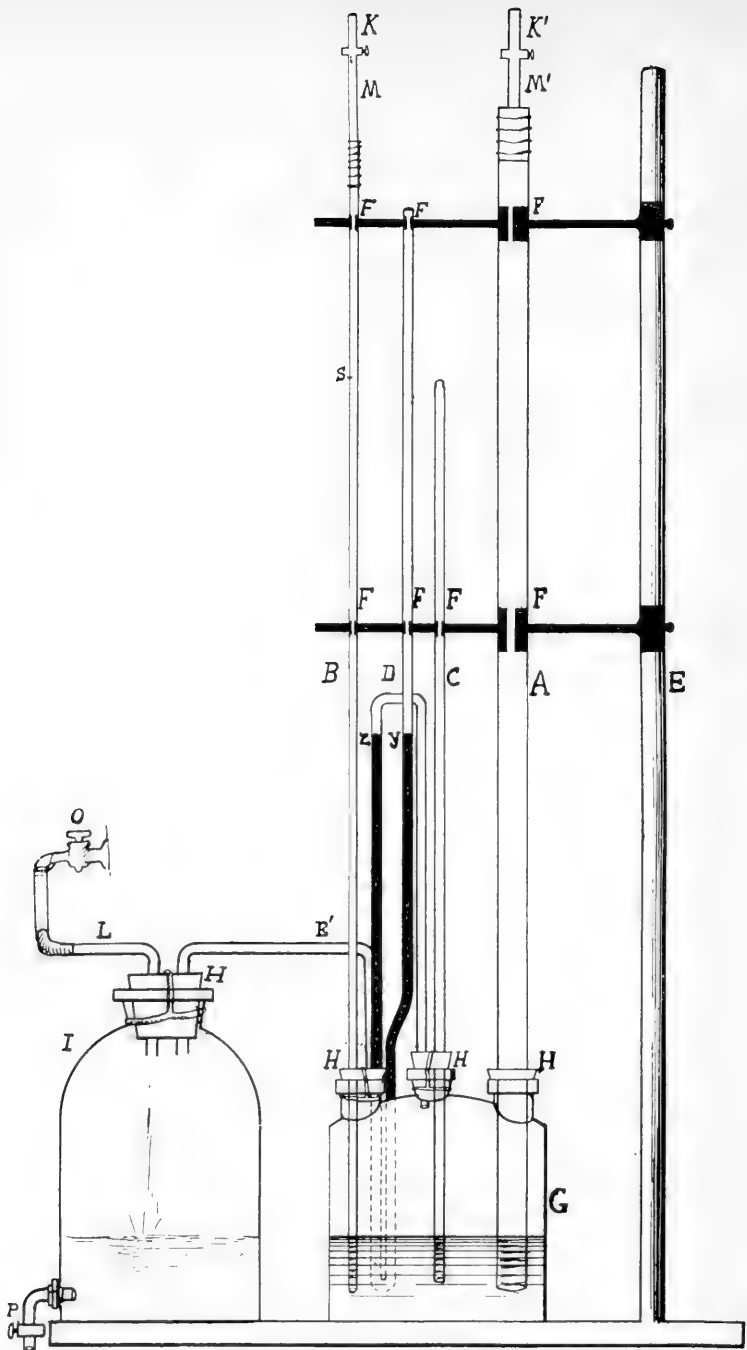

Apparatus for Determining Boyle's Law.



length of the tube when the pressure in G equals one atmosphere. This illustrates Boyle's Law by showing that the volume of gas in C varied inversely as the pressure brought to bear upon it. The same principle would be shown in A and B under similar circumstances if K and K' of the tubes M M', which are fastened to A and B by means of rubber tubing held by copper fire and sealing-wax, remained closed.

Again, when the air in A, B, and C is compressed one-half its volume by a pressure of one atmosphere, this will be shown by the manometer which the tube D forms. This tube has each of its two arms filled to a height of forty centimeters with mercury. The total height of the two columns is therefore equivalent to more than an atmosphere. When the pressure in G is zero, then the two columns of mercury X and Y are equal in height. When, however, the pressure in G is equal to one atmosphere, then the column X will sink and column Y will rise till the difference of their heights is 76 cm. Since, in estimating accurately the height of a mercury column both pressure and temperature must be considered, this may be done by the usual formula.

When it is desired to again reduce the pressure in G to zero and allow the water in I to escape, this may be done by closing O, opening P, and either K or K', or both. Unless I is interposed between O and G, water could not for obvious reasons be used. Air could, of course, be forced directly into G.

The apparatus can also be used to show that the height to which a liquid will rise in a tube is independent of its diameter. If we open O then, as mentioned above, the pressure developed in I and G will cause the eosin solution to rise with ease in A and B if K and K' are left open. When the eosin solution has risen to S, or to any other height in B, whose internal diameter is three millimeters, then if we notice A, disregarding the small effect of capillarity in B, the column of liquid will stand at exactly the same height in A, whose internal diameter is one cm., as in B.

If, finally, both A and B are rapidly filled with the eosin solution by quickly and strongly generating pressure in G, then it will be seen by carefully timed observations that the liquid in A will rise to an equilibrium of the pressure in G somewhat more quickly than the same equilibrium will be attained by the liquid in B, due to the greater friction produced by the smaller tube B. For the same reason if the pressure is rapidly reduced to zero by opening P, the eosin solution in B will require a slightly longer time to fall from a point, as S, and reach the level of the liquid in G, than would be required by the same height of a column in A.

State University, Bloomington, Ind.



## SOME MONSTROSITIES IN PLANTS.

---

By F. M. ANDREWS.

---

In the proceedings of the Indiana Academy of Science for 1905, pages 187 and 188, I have mentioned some interesting variations which I noticed in *Trillium*. Since that time I have been favored by the announcement of some additional monstrosities shown in *Trillium* by Prof. John M. Holzinger<sup>1</sup> of Winona, Minnesota, in a paper which he has been good enough to send me.

It occasionally happens that interesting monstrosities or variations occur in other plants. Such variations, although very common, are nevertheless often of great importance.

One of the most common foliar variations occurs in clover, and these I have found more or less abundantly, especially in *Trifolium pratense*. De Vries<sup>2</sup> states that he rarely observed clover individuals with more than one quaternate leaf. I have observed from time to time some specimens of clover which had one leaf of four leaflets, and in one instance found two specimens of clover, each of which had in addition to ten regular leaves of three leaflets, seven (7) other leaves, each one of which had four (4) leaflets. One of these quaternate leaves was beginning to form a leaf having five (5) leaflets by the splitting process. Again another plant of clover near this one having seven quaternate leaves, had in addition to the ternate leaves, one with five leaflets. Another specimen of clover had ten leaves of five leaflets each, in addition to several ternate ones. One of these leaves with five leaflets shows the origin of the supernumerary leaflets by the splitting process, as De Vries describes on page 342 of his "Species and Varieties. Their Origin by Mutation," 1905.

Another specimen of clover had in addition to the usual ternate ones, one leaf having six leaflets, and another plant of clover, one leaf having seven leaflets. These plants all grew close together in a yard and were the only ones thereabouts which showed, in the many other specimens of clover present, any of the above mentioned deviations.

---

<sup>1</sup> John M. Holzinger, *Plant World*. 4: July, 1901.

<sup>2</sup> *Species and Varieties. Their origin by mutation*, 1905, p. 340.

I have also noted deviations in the Buckeye tree where six and sometimes nine leaves occurred instead of five. Some plants, as the common blackberry, have at times flattened stems, and some have two periods of blooming in the same year, as the Weigelas and other plants.

Apparent deviations or monstrosities may sometimes be due to an injury, and therefore in deciding such points care is necessary.

State University.

Bloomington, Ind.

## A LIST OF ALGÆ.

(Chiefly from Monroe County, Indiana.)

BY F. M. ANDREWS.

The list of Alge given at the end of this paper includes about one hundred and seventy-five forms, most of which are from Monroe County, Indiana. Some few species of these Alge are from the Eagle Lake and Turkey Lake in the northern part of Indiana, while a few others have been obtained from other sources. The collection of these forms has extended over a period of several years, for a continuous effort to obtain the forms here mentioned was not made except in the case of the Alge found in the water works of this city in 1896. At this time some of the forms of Alge then to be found in the city water works of Bloomington were collected by Dr. George J. Peirce, now of the Leland Stanford Junior University, Mr. A. C. Life, and myself. A title of the work done by us conjointly appeared in the proceedings of the Indiana Academy of Science for 1896, on page 208, entitled: "A Microscopic Examination of Certain Drinking Waters."

In this work not only the forms at the surface and edges of the reservoir were obtained, but also those to be found at different depths in the water. On account of the lack of more elaborate instruments and means for doing this, we hit upon a very simple but sufficiently effective plan. This was done by securing a bottle of the proper size and shape, fitted with a stopper, to a heavy cord. The stopper also was attached to a cord. After rowing out into the reservoir, the water of which varied from fifteen to thirty feet in depth, this weighted bottle was lowered to the desired depth by one string and the stopper partly removed by the other string. After the bottle had filled with water, as could be told by the rising of bubbles, the stopper was allowed to slide back in place, thus reclosing the bottle. To prevent the stopper from being pulled out of the bottle and thus rendering it impossible to replace it before raising the bottle from the water, a string of the proper length was tied around the neck of the bottle and to the stopper. To be sure that the glass stopper would settle back into the bottle after filling, I found a band of rubber fastened around the neck of the bottle and the stopper to be effective in accomplish-

ing this end. It is always best to close the vessel used in such experiments to prevent the entrance of Algae not at the depth at which it is desired to take the samples or to keep some in the bottle from being lost in raising the bottle to the surface. In this way it is easily possible to obtain specimens that are floating from any part of the body of water. By this method, too, it was shown that numerous forms of Algae were distributed all through this body of water. The living ones were found in greater abundance at or near the surface, as would be expected, but they were also found in the deeper water as well. In some places the number of forms was often very small, but in order to make a study of the greater number from such a locality the following method was used: A suitable quantity of water was obtained in the above described way from the desired location, and this allowed to filter through a small surface. A funnel, the lower end of whose tube was closed with closely woven cloth, served quite well, and in this way enough forms would be obtained for a convenient study. Such concentration of forms, we may term it, also brings about a great saving of time in looking for forms that would otherwise be found only after much searching, and at the same time was more representative for any given depth.

The effectiveness with which various of the Algae forms could be removed by means of sand was attempted. This will vary with the kind of sand employed. The kind of sand here employed was very fine, white sand, especially employed for the microscopic examination of water. The following are some of the results:

Twenty-five ccm. of water from the bottom of the reservoir, in five cm. of this sand, required seven minutes to filter.

One thousand ccm. of water from the surface of the reservoir required forty-three minutes to filter, through a closely woven cloth tied over the end of a very small glass tube. A considerable depth of very fine, clear sand is necessary to entirely remove all of the smaller Algae forms from the water, for I found after only twenty-five ccm. of the water from this reservoir had been filtered through five cm. of fine sand, a considerable number of some forms came through. In one instance, in tap water, coming from this same source, some small forms came through four cm. of this fine, white sand, which to filter twenty ccm. it required one hour and twenty-five minutes.

In another case only eighty-five minutes was required to filter twenty-five ccm. of this water through four cm. of sand, due in this case to the less

quantity of sediment and forms than in the instance where one hour and twenty-five minutes was required for filtration. Some permanent slides were prepared in 1896 and part of these I still have, which show some of the various *Algae* forms obtained by the method above referred to. These slides were prepared by making a mounting fluid of the following substances:

Alcohol, 95% .....	10 ccm.
Glycerin .....	30 "
Distilled water .....	30 "
Acetic acid, 5% .....	30 "

Specimens mounted in this mixture should be sealed with balsam. The slide should be thoroughly cleansed and dry before ringing the cover-glass with balsam. The only danger from the loss of specimens so mounted is from the liability of the balsam to crack and allow the liquid under the cover-glass to evaporate. For this reason they had better have the balsam covered with a layer of dammar-lac or shellac, and be noticed from time to time and not kept in too warm a place.

Dilute glycerin seems also to be a good medium for mounting *Algae*. One specimen of *Pandorina* has been preserved and mounted in it fifteen years and is still apparently as green and as perfect as the day it was mounted. Camphor water<sup>1</sup> and glycerin also seem to give good results from the standpoint of preservation.

Other forms of the *Algae* of this list not found in the water works reservoir have been observed at different times and recorded as found. It is not supposed that this list of *Algae* here given is by any means complete, but gives an idea of a few out of an enormous number of forms that must be widely distributed. A good many of the forms here mentioned have been found by Mr. A. B. Williamson, one of the students in the Botany Department, and reported to me for the following list.

A list of the growing forms of plants in any locality is best made and more complete when extended over a series of years, so as to include those individuals which for various reasons or changes of conditions do not appear during one season.

<sup>1</sup> Stokes—Analytical Keys to the Genera and Species of the Fresh-water *Algae*, p. 20.

## A LIST OF ALGÆ.

Gleocapsa polydermatica.	Synedra Acus.
"    aeruginosa.	"    pulchella.
"    coracina.	Fragilaria capucina.
"    rupesstris.	Acanthes Hungarica.
"    sanguina.	
Chroococcus turgidus.	Cocconeis placentula.
"    coherens.	Emotia gracilis.
	"    pectinalis.
Spirulina Jenneri.	
"    duplex.	Amphora ovalis.
Gleotrichia pisum.	
"    natans.	Epithemia turgida.
	"    gibba.
Calothrix gracilis.	
Tolypothrix distorta.	Gyrosigma attenuatum.
"    tenuis.	
Rivularia Dura.	Spirogyra jugalis.
"    echinulata.	"    nitida.
Seytonema tolypothrichoides.	"    crassa.
"    myochrous.	"    decimina.
"    natans.	"    setiformis.
	"    gracilis.
Sirosiphon pluvinatus.	"    fusco-atra.
	"    communis.
Hapalosiphon tenuissimus.	"    quinina.
	"    longata.
Nostoc pruniforme.	Zygnema leiospermum.
"    verrucosum.	"    insigne.
"    sphaericum.	"    anomalum.
"    commune.	
Anabena inaequalis.	Zygonium decussatum.
Nitzschia sigmoidea.	Mougeotia divaricata.
"    constricta.	
"    acicularis.	Mesocarpus mummuloides.
	"    recurvus.
Cocconema lanceolatum.	"    robustus.



*Staurastrum arcticon.*  
 " *muticum.*  
 " *dejectum.*  
 " *incisum.*  
 " *alternans.*  
 " *cytocerum.*  
 " *arachne.*  
 " *gracile.*  
 " *vestitum.*  
 " *hirsutum.*  
 " *spongiosum.*  
 " *luteolum.*

*Pediastrum Boryanum.*  
 " *perforatum.*  
 " *tetras.*

*Sorastrum spinulosum.*

*Celastrum microporum.*  
 " *cambricum.*

*Scenedesmus obtusus.*  
 " *dimorphus.*  
 " *caudatus.*  
 " *acutus.*

*Pandorina morum.*

*Endorina stagnalis.*

*Volvox globator.*

*Sphaerella (Chlamydococcus)*  
*pluvialis.*

*Ulothrix subtilis.*  
 " *muralis.*

*Gonium pectorale.*

*Cladophora glomerata.*  
 " *fracta.*  
 " *crispata.*

*Oedogonium crassum.*  
 " *sexangulare.*  
 " *obtruncatum.*  
 " *fonticola.*

*Bulbochaete intermedia.*

*Colochaete irregularis.*  
 " *soluta.*  
 " *scutata.*

*Draparnaldia glomerata*

*Stigeoclonium nanum.*

*Cylindrospermum macrospermum.*  
*Cylindrocapsa geminella.*  
*Merismopædia glauca.*  
 " *convoluta.*

*Oscillaria chalybea.*  
 " *cruenta.*  
 " *tenuis.*  
 " *subfusca.*  
 " *natans.*  
 " *antliaria.*  
 " *limosa.*  
 " *percursa.*  
 " *princeps.*  
 " *Froelichii.*  
 " *brövis.*

*Navicula viridis.*  
 " *sphaerophora.*  
 " *serians.*  
 " *alpina.*

*Cymbella lanceolata.*

*Meridion circulare.*

*Diatoma elongatum.*

- Melosira arenaria.*  
 " *varians.*  
*Gomphonema geminatum.*  
 " *constrictum.*  
*Liemorphora flabellata.*  
*Tabellaria fenestrata.*  
 " *flocculosa.*  
*Pleurocarpus mirabilis.*  
  
*Cosmarium obsoletum.*  
 " *sexangulare.*  
 " *globosum.*  
 " *orbiculatum.*  
 " *cucumis.*  
 " *suborbiculare.*  
 " *benustum.*  
 " *quasillus.*  
*Closterium acerosum.*  
 " *cucumis.*  
 " *Ehrenbergii.*  
 " *acutum.*  
 " *attenuatum.*  
 " *Leibleinii.*  
  
*Hyalotheca dissiliens.*  
  
*Desmidiium Swartzii.*  
  
*Mesotenium Braunii.*  
  
*Spirotenia condensata.*  
  
*Docidium crenulatum.*  
 " *comatum.*  
 " *nodosum.*  
  
*Tetmemorus Brebissonii.*  
  
*Xanthidium armatum.*  
  
*Arthrodesmus convergens.*  
  
*Enastrum crassum.*  
 " *cuneatum.*  
 " *didelta.*  
 " *ansatum.*  
  
*Micrasterias radiosa.*  
 " *papillifera.*  
 " *truncata.*  
  
*Chaetophora pisiformis.*  
 " *elegans.*  
 " *tuberulosa.*  
  
*Pleurococcus viridis.*  
  
*Dactylococcus bicaudatus.*  
*Botryococcus Braunii.*  
  
*Hydrodictyon utriculatum.*  
  
*Conferva floccosa.*  
 " *fugacissima.*  
 " *affinis.*  
 " *vulgaris.*  
  
*Chlamydomonas pluviale.*  
 " *tingens.*  
  
*Dictyosphaerium reniforme.*  
  
*Tetraspora cylindrica.*  
 " *lubrica.*  
  
*Raphidium polymorphum.*  
 " *convolutum.*  
  
*Vancheeria sessilis.*  
 " *gemmata.*  
 " *terrestris.*  
 " *sericea.*  
 " *Dillwynii.*  
  
*Botridium granulatum.*  
  
*Batrachospermum moniliforme.*

ADDITIONS TO INDIANA STATE FLORA, NO. 4.

BY CHAS. C. DEAM.

I offer the following as additions to the Indiana State flora. The determinations have been checked by recognized authorities, and specimens are deposited in my herbarium:

*Andropogon scoparius*, var. *littoralis* (Nash) Hitch.

Lake County, on sand dunes near Indiana Harbor.

*Panicum tennesseense* Ashe.

Madison County, on dry, wooded bank of White River, about two miles north of Anderson.

*Bromus altissimus* Pursh.

Allen County, on alluvial bank of the St. Mary's River, about one-quarter mile south of Ft. Wayne.

*Bromus incanus* (Shear) Hitchc.

Wells County, in Jackson Township.

*Carex canescens*, var. *disjuncta* Fernald.

Steuben County, on low border of Graveyard Lake.

*Carex laxiculmis* Schwein.

Johnson County, in dry woods about two miles southeast of Morgantown.

*Carex siccata* Dewey.

Steuben County, in dry soil in clearing one-quarter mile north of Clear Lake.

*Carex stellulata*, var. *angustata* Carey.

Steuben County, on low, sandy border on west side of Graveyard Lake.

*Celtis occidentalis*, var. *crassifolia* (Lam.) Gray.

Allen County, on bank of St. Mary's River one-half mile south of Ft. Wayne.

*Thalictrum revolutum* DC.

Fountain County, on wooded alluvial creek bank near Veedersburg.

*Trifolium dubium* Sibth.

Kosciusko County. Well established in yards of cottages on north bank of Lake Wawasee.

*Sanicula canadensis* L.

Allen, Blackford, Clark, Madison, Marion, Morgan, Wabash, and Wells counties.

*Sanicula gregaria* Bicknell.

Dekalb, Fountain, Madison and Noble counties.

*Cephalanthus occidentalis*, var. *pubescens* Raf.

Clark County, on State Reservation.

*Vernonia illinoensis* Gleason.

Steben County, in prairie one-quarter mile east of Clear Lake.  
Clear Lake.

*Solidago juncea*, var. *scabrella* (T. & G.) Gray.

Wells County, in dry clay soil in clearing on east side of lakes in Jackson Township.

Indianapolis, Indiana.

## RIGHT AND WRONG CONCEPTIONS OF PLANT RUSTS.

---

BY J. C. ARTHUR.

---

The plant rusts have been known both popularly and scientifically from the earliest times. Their study took the usual course of development of all cryptogamic plants up to the time that DeBary demonstrated that pleomorphism existed in many species in a more striking manner than known in other fungi. He showed that most if not all members of the genus *Æcidium* as recognized at the time were only stages in the life cycle of species of *Puccinia* and *Uromyces*, and other investigators soon followed with similar demonstrations for such genera as *Rocstelia*, *Peridermium*, and *Cæoma*. It was in 1866 that he announced, with experimental proof, that one stage of a rust, as the *Æcidium*, often grows on a host wholly different from that on which the final stage grows, such rusts being called heterœcious.

Heterœcism, which was thus established by DeBary and confirmed by his contemporaries, was not generally accepted by mycologists for a score or more of years. That the *Æcidium poculiforme* of the barberry leaf, with its conspicuous cups filled with chains of verrucose spores, could not give rise to other similar cups on the barberry, but only to the powdery and echinulate spores of the red rust on wheat stems, as unlike the former as a caterpillar is unlike the pupa into which it is transformed, was such a strikingly new idea in botany, that when once it did find general credence, and was extended to many other species by culture work, it assumed undue prominence. This result was accelerated by the rather recent discovery of races, or so-called physiological species. When the well known *Puccinia graminis*, which has great economic importance by producing a destructive disease of cereals and grasses, became also one of the best illustrations of the division of a species into physiological strains or races, more or less well established, in some cases amounting to possible species, it assumed in the minds of many mycologists a typical position in reference to other rusts. It became common to speak of rusts as agreeing with *Puccinia graminis* in their life cycles and spore structures, or in showing a certain amount of deviation from it. This attitude has caused considerable distortion in the conception usually held

of the rusts, even by the foremost students of the order. It affects systematic work adversely, keeps the terminology in an antiquated and ambiguous form, and makes it difficult to institute legitimate comparisons between different genera, species, or spore structures.

One of the wrong conceptions, wrong when viewed in the light of present knowledge, is to make the genus *Puccinia* include all species that possess a two-celled, pedicelled and free teliospore (excepting those with teliospore imbedded in gelatinous matrix, separated under *Gymnosporangium*), irrespective of the other morphological characters, or of the complexity of the life cycle, and furthermore, as part of the same conception, to make the genus *Uromyces* include all species that possess the same kind of teliospore, only one-celled instead of two-celled. The writer believes that the length and nature of the life cycle, which is a more unvarying character in the rusts than the one or two-celled teliospore (recall the *Uromyces-Puccinia* species on *Allium*, *Sida*, and some other hosts), should be accepted as a character for genera, as it is now quite generally accepted for species. Recognizing this as a valid generic character, and taken in connection with other characters, the genus *Puccinia* can be separated into four genera (i. e., *Dicoma*, *Allodus*, *Bullaria*, *Dasyzpora*), and the genus *Uromyces* also into four (i. e., *Nigredo*, *Uromycopsis*, *Klebahnia*, *Telospora*). If other characters, as well as the life cycle, mostly now generally ignored, are taken into account, *Puccinia Pruni-spinosæ* and its allies should form a genus (*Tranzschelia*) near to *Ravenelia*, on account of the adherent pedicels of the teliospores and peculiar structure of the urediniospores; *Uromyces rosicola*, on account of its evident spore structure, will go into a genus (*Americis*) near to *Phragmidium*, but with a more limited life cycle; *Uromyces Terebinthi*, and its allies, on account of the remarkably distinctive characters of both urediniospores and teliospores, will form a genus somewhere between *Ravenelia* and *Tranzschelia*, while the similar *Uromyces effusus*, with a still more restricted life cycle, will go into another genus (*Discospora*). And in like manner quite a number of other species now commonly included under *Puccinia* and *Uromyces* could properly be separated and distributed to other genera, with much improvement in the nomenclature and great clarification of the systematic affinities. Other genera beside *Puccinia* and *Uromyces* could also be shown to be overburdened with species whose life cycle, or morphological structure, or both, entitle them to a different place in the systematic arrange-

ment, if the extent of the life cycle and characters other than those pertaining to the teliospore were called into account.

The third epoch in the study of plant rusts (the second one being ushered in by DeBary's demonstration of heteroecism and the first epoch preceding that time), may be considered to have started with the study of the nucleus and its behavior. This was begun by the work of Sappin-Trouffy and of Poirault and Raciborski some fifteen years ago, and ably continued by Blackman, Christman, Holden and Harper, Olive and others. The nuclear history in the rusts is still in a very incomplete state, and part of what has been gone over needs further substantiation. Enough has been demonstrated, however, to modify profoundly our ideas of the significance of the different spore forms, the relation of the spore structures, and the possibility of sexuality.

While it may be interesting to review the present knowledge of nuclear changes in the rusts and show the bearing on taxonomy, it will suffice for the present purpose to bring up briefly a few points. It has been rather clearly shown that the rusts possess well marked antithetic alternation of generations. The gametophytic generation has uninucleated mycelium, and gives rise to two kinds of spores, basidiospores and pycniospores, both uninucleated, and these are the only truly asexual spores formed in the life cycle. The sporophytic generation begins shortly after the pycnia mature, being inaugurated by a sexual fusion of cells. This act introduces the binucleated condition. In many species of rusts only one spore form (teliospore) is produced in the sporophytic generation. In other species there is an initial spore form (aeciospore), and usually a repeating form, in addition to the teliospore. All spores of this generation are binucleated. In the gametophytic generation all species behave essentially the same. It is in what follows during the sporophytic generation that the great diversity of the rusts is shown.

If the first binucleated spores arising after sexual cell fusion are teliospores, no other spore forms in this generation are produced, and the life cycle is a brief one. But if the first binucleated spores are formed in what has been called an *aecidium*, *ceoma*, or primary *uredo*, they are essentially of the same physiological nature, whatever form they may take. Any such sorus may be called an *aecium*, and the spores *aeciospores*, this being an extension in the previous application of the terms to cover the primary *uredo*. Possibly new terms would be less liable to introduce am-

bignity in subsequent discussions, but in this paper æcia will be understood to be the initial spore structures following the pycnia, when these structures are not telia. Such æcia are of varying complexity, the simplest being of the uredo-type with spores borne on pedicels and no peridium, intermediate forms being of the cœoma-type, with spores in chains and no peridium, and the most highly developed being of the æcidium-type with a well-formed peridium. There is a wide difference in complexity of structure between the lowest uredo-type of æcia (*c. g.*, those of the so-called *Chrysomyxa albida*) and the highest æcidium-type (*c. g.*, those of *Æcidium poculiforme* belonging to *Puccinia graminis*). But whatever the degree of complexity they are all strictly comparable in their relation to the life cycle of the different species to which they belong.

In most genera having species with initial æcia more rapid and extensive dissemination is brought about by means of repeating spores, often called summer spores. A few genera, like *Gymnosporangium* and *Calypsozona*, have no repeating spores in present known species. The repeating spore structures are either isomorphic with the æcia, and are known as secondary æcia and secondary uredinia, or they are heteromorphic, and are known simply as uredinia. In either case the repeating spores arise from an infection by initial æciospores, and are not immediately preceded by pycnia. Repeating spores are binucleated, but do not arise from fusing uninucleated hyphæ, as the initial æciospores do, for the mycelium on which they are seated is already binucleated, having been derived from a binucleated spore.

The accompanying chart enumerates the best understood genera of the rusts, arranged in such a way as to show the essential features in the life history of the species. It embraces about three-fourths of all genera of the Uredinales recognized at the present time. The chief value of the chart is to emphasize the need of taking into account the full life cycle in order to compare or to contrast genera. It will be seen that many genera, possibly a third of all known, have no æcia or repeating spores, but the formation of telia follows immediately upon the maturity of the pycnia. In the genera with æcia increasing complexity of development is shown by the presence of heteromorphic repeating spores, cupulate æcia with catenulate æciospores, and heterocœism while comparative simplicity of development is shown by isomorphic repeating spores, cœomate æcia with pedicelled æciospores, and autocœism.



## DIAGRAM

Showing life history of 59 best known genera of rusts.

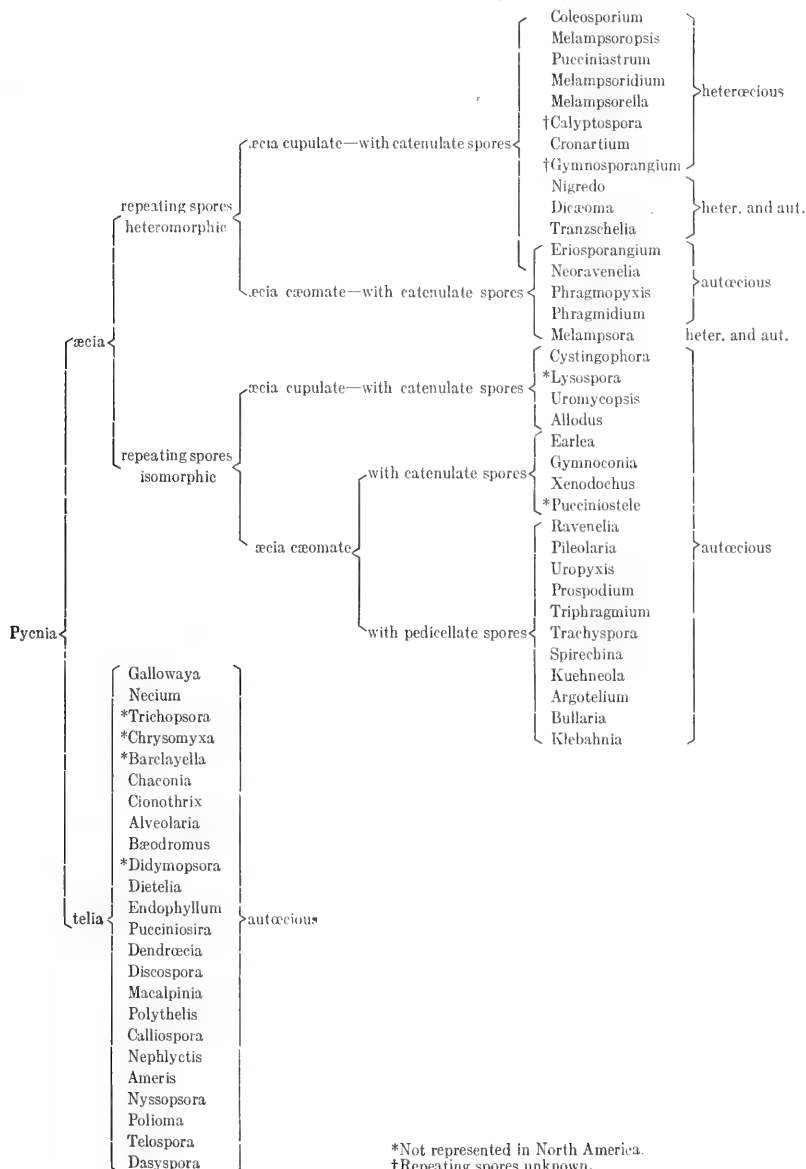

It is evidently a right conception, in view of the foregoing statement, to regard *Puccinia graminis* (a better name is *Dicwoma poculiforme*) as a representative of the highest development of rusts. But to regard it as typical of all rusts, or even of all rusts having aecia, is clearly asking too much of an illustration, and likely to involve grave misconceptions of structure and relative values. If the most essential features of the rusts were to be illustrated by the smallest permissible number of examples of common and well known species, I should select *Polythelis Thalictri* (*Puccinia Thalictri*) for the forms without aecia, *Kuchnocola albida* (often called *Chrysomyxa albida*) for the forms with aecia and isomorphic repeating spores, and *Dicwoma poculiforme* (*Puccinia graminis*) for the highly developed forms with aecia and heteromorphic repeating spores.

A wrong conception, which is doing much harm to the taxonomic study of the rusts, is the view that aeciospores and urediniospores are of the nature of conidia, that is, asexual spores, comparable to the conidia so abundantly produced by many ascomycetous fungi. Cytological studies show, however, that in the rusts the only truly asexual spores, other than the basidiospores, are the pycniospores, and to these only can the term conidia be applied with approximate accuracy. The sexual process begins by the fusion of uninucleated hyphal cells, which immediately, or almost immediately, develop some kind of binucleated spore-structure. If only one kind of binucleated spore is produced by the species, it is properly called a teliospore. Such a teliospore has two nuclei in each cell, derived by a short succession of divisions from the two nuclei of the fusing cells. These two spore nuclei fuse into one nucleus prior to germination of the teliospore, thus completing the sexual process. If more than one kind of binucleated spore is produced, the initial kind may be called an aeciospore, whatever the morphological structure in which it is formed. It has arisen as the consequence of sexual cell fusion, just as in the preceding case, and has the physiological character of greatly stimulated growth associated with sexuality. This initial aeciospore gives rise to a binucleated mycelium, which in turn generally produces binucleated repeating spores of the same or of a different form, and so on, until finally a teliospore is produced in which nuclear fusion takes place, as in the first instance mentioned. The sexual process in this class of rusts extends from the cell fusion at the base of the aecia through all the succession of hyphal cells and repeating spores to the fusion of nuclei in the mature teliospore.

All rusts at present known fall into one of these two classes: the sporophytic generation gives rise either to a single spore-form, or else to initial and final spore-forms, with usually intermediate repeating forms. Whether one or more than one spore-form arises between the cell fusion and final nuclear fusion, constituting the sexual period, all such spores, of whatever morphological structure, are of a sexual nature, the initial form (whether of the *æcidium*-type, *cœoma*-type, primary uredo-type, or when none of these is produced, the teleuto-type) being the one which most clearly shows the stimulus of fertilization.

The above facts, especially when taken in connection with the highly differentiated structures associated with the initial and repeating spores, often being quite equal or superior to those of the teliospores, show every reason that may be based upon morphology and development for considering the initial and repeating spores as practically of equal taxonomic rank with the teliospores. To illustrate, a genus founded upon a repeating stage, like the genus of imperfectly known fern rusts, *Milesia*, should be as valid as if founded on the telia. This genus has recently been rechristened *Milesina* on the ground that the original name, given in 1870, is invalid because it was only applied to the uredinia and not to the telia. Again, now illustrating with a specific name, the heterœcious rust which was first specifically called *poculiforme* was described in its *æcial* stage under *Æcidium*, and according to the preceding argument on the importance of the initial spores, this name having priority, although not at the time made to include the telia, should be used, whatever genus name be considered the best, as *e. g.*, *Dicœoma poculiforme* or *Puccinia poculiformis*, not *Puccinia graminis*.

From the foregoing it will be seen that for purposes of taxonomy names applied to the pycnia (spermogonia) may properly be ignored, on the ground that they apply to asexual or conidial structures, but that names applied to *æcia* and uredinia (*Æcidium*, *Cœoma*, *Peridermium*, *Uredo*, and other such forms) should have the same standing as names applied to telia (teleutospore stage).

I have tried to show that the main features in the life cycle of all rusts exhibit essential uniformity, there being two large groups, one with a single form of spore (teliospore) in the sporophytic generation, and the other with additional initial and (usually) repeating spores, and that the great diversity lies in the details of their structural development. It is

difficult to give a clear and concise account of the general features of the rusts on account of the inadequate and ambiguous terminology at present in use. It appears to be unquestionably established that the spore structures of the rusts are not to be homologized with those of the Ascomycetes, and that taxonomic practice in the rusts should not be influenced by what is correct or expedient in the Ascomycetes or other fungi with strongly marked conidial and sexual forms, but be based upon the unique characters of their own development.

Right conceptions of the rusts, according to the writer's position, are those based upon the full life histories of the species, taking into account all the present known facts, and wrong conceptions are based upon partial life histories, and on ideas derived from other fungi and formerly supposed to apply to the rusts but now known to be inapplicable and misleading.

Purdue University,  
Lafayette, Indiana.

## THE EFFECT OF PRESERVATIVES ON THE DEVELOPMENT OF PENICILLIUM.

BY KATHERINE GOLDEN BITTING.

---

In examining ketchup for the organisms present, it was noted that the hyphae of moulds in preserved ketchup were swollen and distorted. In many of the brands of ketchup, the mould present was the common blue mould, *Penicillium*. As this mould is apparently omnivorous in habit, thriving and fruiting on many media, has been used in many physiological investigations to determine the nutritive value of many compounds, grows normally in liquid media, and fruits normally in a saturated atmosphere, is regular in its germinative power, and, so far as known, constant in form, it was selected to determine the effect of sodium benzoate, used in varying quantities, on its structure and development. The media used in the experiments were tomato bouillon, tomato gelatin, and tomato pulp, and were selected because the tomato juice and pulp are present in ketchup, and also because they do not alter the toxic properties of the agents used toward the fungus. Afterwards the condiments used in ketchup were tested and also the ordinary food preservatives, though not so extensively as the sodium benzoate. In these latter experiments tomato bouillon was the only medium used.

The bouillon was made by adding to a can of tomatoes an equal volume of water, boiling for about half an hour, and then filtering. The filtrate is clear, and a good medium for growth. It has an acidity of approximately .2%, calculated as citric acid. For the tomato gelatin, 10% of gelatin was added to the tomato bouillon, cleared with egg, and filtered. The tomato pulp was obtained from a factory, and was made from whole tomatoes. To these media the sodium benzoate was added in the various amounts used in factory practice. Before sterilizing the media, calendered paper was tied closely over the cotton plug to prevent the distillation of the benzoate. After sterilization and cooling, the media were inoculated with spores from a vigorously growing culture of the mould. During development, the cultures were kept at room temperature, unless otherwise stated. The method of culture was by moist chambers and flasks for the bouillon and gelatin, and Petri dishes for the pulp. The moist

chambers had a few drops of the culture medium placed in the bottom, so as to keep the vapor tension unaltered.

The cultures were examined at regular intervals, as indicated in the tables, those in the flasks having specimens taken for examination with the microscope. The points noted were the swelling of the spores preceding germination, the length of hyphæ, and the earliest appearance of conidiophores, for the cultures in the moist chambers. For all other cultures a hand lens was used to determine the first appearance of germination. The appearance of the conidia was shown by the blue color, and the maturing by the change in color from the blue to green, and then to olive. The volume of mycelium and conidia was noted to determine the extent of development.

PENICILLIUM GROWN IN TOMATO BOUILLON 500 CC. 70° F.

Per Cent Sod. Benz.	Time to Germ. Hours.	Development.
—	24	Spores germinated. 48 hours—surface covered. 72 hours—spores developed, surface blue. Hyphæ uniform in outline, protoplasm homogeneous, many vacuoles. 120 hours—fully matured.
1-12	48	Thin ring at edge, small colonies submerged. 120 hours—surface covered, blue. Hyphæ, uneven outlines, protoplasm granular, walls broken easily 240 hours—fully matured.
1-10	48	Slightly less developed than in the preceding, otherwise alike. 240 hours—fully matured.
1-5	120	Thin interrupted ring at edge. 168 hours—spores swollen, irregular in outline, filled with coarsely granular protoplasm, walls broken by cover glass 336 hours—surface dotted with colonies, showing blue spots 348 hours—fully matured.
1-2	—	

The effect of the sodium benzoate on the development is shown in a retarded and abnormal development, these being accentuated as the amount of the salt was increased, to a point where no development occurred.

## PENICILLIUM GROWN IN 10% TOMATO GELATIN. 100 CC. 70° F.

Per Cent Sod. Benz.	Time to Germ. Hours.	Development.
—	24	White colonies dotting surface. 96 hours—surface covered, green, mature.
1-12	24	Same as control.
1-10	24	Same as control.
1-8	24	Same as control.
1-6	24	Less developed than control. 96 hours—surface covered, nearly all green. 432 hours—mycelium curled up round edges.
1-4	48	Small white colonies dotting surface. 96 hours—surface covered, nearly all green. 342 hours—mycelium curled from edges to center.
1-2	72	Small white colonies dotting surface. 96 hours—surface about two-thirds covered, center green. 342 hours—mycelium curled up so as to enclose the spores.

In this experiment in which a solid medium was used, the effect of the sodium benzoate on the development of the mould was not marked, except in the cultures containing the larger amounts. In these there was a slight retardation, and also a curling up by the mycelium from the substratum.

## PENICILLIUM GROWN IN TOMATO BOUILLON IN MOIST CHAMBERS. 70° F.

Per Cent Sod. Benz.	Time to Germ. Hours.	Development.
—	24	Short tubes formed. 48 hours—well developed colonies formed.
1-12	24	Short tubes formed. 48 hours—colonies smaller than in the control.
1-10	24	Tubes just forming. 48 hours—less development than in the 1-12th solution.
1-8	24	Less than in the 1-10th solution. 48 hours—less than in the 1-10th solution.
1-6	48	Spores germinate, shorter tubes than in the 1-8th solution.
1-2	96	Spores germinated, short tubes.

NOTE.—In 120 hours the control was exhausted, having empty hyphæ; the other cultures, with the exception of the 2% solution, have hyphæ with many vacuoles in the protoplasm, the conidiophores formed are apparently normal.

The effect of the antiseptic on the development of the mould grown in the moist chambers was not so pronounced as when a larger quantity of solution was used. Neither was the effect always uniform; sometimes the spores in the  $\frac{1}{4}\%$  and the  $\frac{1}{2}\%$  solutions merely swelled, but no development of hyphae occurred; in others short tubes developed from some of the spores, while still other spores showed no changes whatever.

To test the effect of the larger quantity of solution, inoculations were made into flasks containing 100 and 500 cc., respectively, of the solutions. The results indicated that the effect of the antiseptic on the mould development was greater when grown in the larger quantity of the solution.

PENICILLIUM GROWN IN TOMATO PULP, IN PETRI DISHES, 65° F.

Per Cent Sod. Benz.	Time to Germ. Hours.	Development.
—	72	White colonies dotting surface. 96 hours—spores formed. 192 hours—surface covered, green.
1-12	144	White colonies growing up on side. 192 hours—spores formed on one side, colonies starting in center.
1-10	192	Colonies started in center. 312 hours—spores formed.
1-8	144	White colonies growing up one side. 192 hours—spores formed.
1-6	—	—
1-4	—	—
1-2	—	—

The pulp used in the experiments was of fine quality, and without any added ingredients such as are used in ketchup, and was used so as to determine the action of the sodium benzoate alone in the pulp. During the early stages of development, the mould grows down into the pulp, so that the whole surface of the hyphae acts as an absorbent and would thus be affected to a greater extent than where only a part of the surface was in contact. This may serve to explain the more pronounced action of the sodium benzoate when in the pulp, and also the fact that after the mould has developed sufficiently to grow out of the pulp the development becomes more nearly normal.



The experiments were repeated many times and show slight variations, but the results as shown in the tables given are fairly representative.

#### BENZOIC ACID IN CRANBERRIES.

The occurrence of benzoic acid in cranberries has been cited so often, and in a manner that is often misleading, figures obtained by Lafar<sup>1</sup> on the low-bush cranberry, *Vaccinium Vitis Idaea*, being given for the common cranberries, *Vaccinium macrocarpon* and *Vaccinium Oxyccoccus*. *Vac. Vitis Idaea* is a common form in Europe, growing wild, and also in this country in Nova Scotia, and though it is imported into the United States, it is not the form which is used to any extent as compared with *Vac. macrocarpon*, the large cranberry and *Vac. Oxyccoccus*, the small cranberry. The amount of benzoic acid in *V. Vitis-Idaea*, as quoted by Lafar, varies from .64-.86 grams per liter.

Testimony<sup>2</sup> given before the committee on interstate and foreign commerce of the House of Representatives on the pure food bills in February, 1906, gave the amount occurring in raw cranberries as  $\frac{1}{3}\%$ , and that half of this was volatilized in the cooking. It was not stated which of the two American species was used for the determination. These figures have not been verified, so far as known to the writer, though diligent search has been made in many chemical and food journals.

There is undoubtedly an antiseptic present in cranberries, a fact known to any one who has made either cranberry jelly or sauce, as these can be kept without spoiling for a long time, even when exposed to the germs in the air.

Experiments were made to determine the effect of growth in cranberry juice on the development of the organism used in the previous experiments.

The cranberries selected were the small oval ones, said to contain the largest amount of the antiseptic and were tested in three ways:

1. 200 grams were crushed in a mortar, then covered with 200 cc. water, and allowed to stand for 12 hours, after which the juice was filtered.
2. 200 grams placed in an open vessel in the sterilizer and steamed until the cranberries were soft, after which they were crushed in a mortar.

<sup>1</sup> Lafar, F., Technical Mycology, Vol. I, p. 117, 1898.

<sup>2</sup> The Canner and Dried Fruit Packer, Vol. XXVI, No. 8.

had 200 cc. water added, then stood for 12 hours, after which the juice was filtered.

3. This was similar to 2, but the vessel was covered closely during the steaming.

For the experiments, 50 cc. of the filtrate from each set were placed in flasks. They were inoculated with the mould without any previous sterilization. The following table shows the time required for, and the effect on, development:

PENICILLIUM GROWN IN CRANBERRY JUICE.

MEDIUM.	Days to Germinate.	Development.
Raw juice.....	4	Short tubes. 7 days—only small white colonies.
Juice cooked, open.....	2	Short tubes. 7 days—colony green.
Juice cooked, closed .....	2	Surface nearly covered, white. 7 days—surface green.
Raw juice+10cc. water.....	3	Small white colony. 7 days—surface green.
Juice cooked, open +10cc. water .....	2	Surface nearly covered. 7 days—surface green.
Juice cooked, closed +10cc. water .....	2	Surface nearly covered. 7 days—surface green.

After two weeks' development, the color of the spores of *Penicillium* was a yellowish green, instead of the normal bluish green, and the mycelium was very scantily developed. The surface had a somewhat granular appearance, instead of the smooth, even appearance of a normal culture. The filaments, when seen with the microscope, were thin, shrunken, and clear, with distorted outlines. The cultures were kept for months, remaining scanty and granular looking, and a peculiar feature was that no development of bacteria occurred, even in the uninoculated ones, though no sterilization had been done, and the uninoculated were exposed to the

air at times. Sometimes the cultures become infected with yeast, which will develop in a normal manner, seemingly not affected as is the mould.

The antiseptic in the cranberries was weakened by the cooking, and it made little difference whether the vessel in which they were cooked was open or closed, development occurring in the same time in both. It is probable that the contained acid would evaporate to a greater extent if the cooking had been done on a stove, as they are cooked ordinarily, instead of in the enclosed sterilizer. It is also probable that some of the antiseptic property is due to the astringent present, which is said to be destroyed in the cooking<sup>1</sup>, and which gives the raw cranberry its unpleasant taste. This is further borne out by the fact that the effect produced on the mould is different from that produced by the benzoate, used either as a salt or acid.

In nearly all the experiments with other media, in which sodium benzoate was used, in the lesser amounts, the organisms though delayed in germination, and at first forming an abnormal development, apparently became accustomed to their environment, and later developed fairly normally, which is different from the result in the cranberry juice, in the latter the restrictive effect persisted.

#### CONDIMENTS.

The condiments used were those which are used in ketchup—salt, sugar, celery, cinnamon, cloves, garlic, ginger, mace, mustard, paprika, black, white, and red pepper, and vinegar. Along with these acetic acid and alcohol were also tested. With the exception of the cinnamon and cloves, the other spices showed slight antiseptic properties, so are not reported. They were tested in the form of infusions, made according to the method of the U. S. pharmacopœia<sup>2</sup>, also as acetic acid and oil extracts. The ordinary table salt and sugar were used. The quantities of the condiments used in the report were determined after a series of experiments had been made to locate their point of inhibition.

---

<sup>1</sup> Willis, C. R., Practical Flora, p. 174, 1894.

<sup>2</sup> U. S. Dispensatory, 19th ed., p. 651.

## EFFECT OF CONDIMENTS ON DEVELOPMENT OF PENICILLIUM.

Moist chamber cultures, capacity 1.23 cc.

SOLUTIONS.	20 Hours.		26 Hours.		48 Hours.		Description.
	Germination.	Hyphae, Length in $\mu$ .	Hyphae, Length in $\mu$ .	Germination.	Hyphae, Length in $\mu$ .		
Tomato bouillon	100%	56.0	—	—	—	—	—
Tomato bouillon + salt, 5%	—	—	—	100%	—	—	—
" " 10%	—	—	—	—	—	—	—
" " 25%	—	—	—	—	—	—	—
Tomato bouillon + sugar, 25%	15%	30.7	—	75%	—	—	Hyphae distorted, appear empty.
" " 50%	5%	24.0	—	75%	—	—	" " " "
" " 75%	—	—	—	—	—	—	" " " "
Tomato bouillon + cinnamon, 5%	100%	136.0	369.1	—	—	—	Nearly normal, spores blue, vertical sterigmata.
" " 10%	30%	40.0	230.7	—	—	—	Like the 5% but less development.
" " 25%	20%	32.0	200.0	—	—	—	" " " " 10%
Tomato bouillon + cloves, 5%	100%	88.0	569.1	—	—	—	Hyphae like the 5% cinnamon, heads close to germinated spore, few conidia formed.
" " 10%	25%	48.0	369.1	50%	—	—	Hyphae well developed, no conidiophores.
" " 25%	—	—	—	10%	722.8	—	—
Tomato bouillon + alcohol, 5%	—	—	—	100%	Swollen	—	—
" " 10%	—	—	—	10%	"	—	—
" " 15%	—	—	—	—	—	—	—
" " 20%	—	—	—	—	—	—	—

EFFECT OF CONDIMENTS ON DEVELOPMENT OF PENICILLIUM.

Flask cultures, 50 cc. medium; 70° F.

SOLUTIONS.	48 Hours.	72 Hours.	96 Hours.	120 Hours.
Tomato bouillon.....	Ring, heavy colonies, blue spots, many submerged colonies.	Ring $\frac{1}{4}$ " wide, older part blue.	Ring $\frac{1}{4}$ ", green, surface dotted	Ring thick, surface covered olive.
Tomato bouillon + salt, 5 %	Few small, submerged colonies.	Many small, submerged colonies.	Few surface colonies	Surface colonies curled, light green.
" " " 10 %	_____	_____	_____	_____
" " " 15 %	_____	_____	_____	_____
Tomato bouillon + sugar, 25 %	Thin ring at edge.....	Ring $\frac{1}{4}$ " wide, edge blue.	Small surface colonies	Ring thick, surface nearly covered, green.
" " " 50 %	_____	_____	Ring barely perceptible	Thin ring at edge, green.
" " " 75 %	_____	_____	_____	_____
Tomato bouillon + cinnamon, 5 %	Large colonies at edge.....	Colonies enlarged, blue center, many sub	Colonies increased in number, older ones green.	Surface nearly covered, thick, wrinkled, olive.
" " " 10 %	_____	One small colony.....	Colony enlarged, center green	More colonies formed, oldest one olive
" " " 25 %	_____	_____	_____	_____
Tomato bouillon + cloves, 5 %	Thin ring at edge.....	Ring $\frac{3}{8}$ ", edge blue, many sub. col.	Ring $\frac{1}{4}$ ", edge green.....	Ring thick, wrinkled, olive.
" " " 10 %	_____	Tiny colonies at edge.....	No change.....	Surface colonies.
" " " 25 %	_____	_____	_____	Tiny colonies curled
Tomato bouillon + alcohol, 5 %	Tiny colonies on surface.	Colonies slightly enlarged, many sub. col.	Few colonies $\frac{3}{8}$ ", curled.....	Colonies thick, wrinkled, blu.
" " " 10 %	_____	_____	_____	_____
" " " 15 %	_____	_____	_____	_____
" " " 20 %	_____	_____	_____	_____
Tomato bouillon + acetic acid, $\frac{1}{2}$ %	_____	_____	Few surface colonies.....	Slight increase
" " " 1 %	_____	_____	_____	_____
" " " 2 %	_____	_____	_____	_____

The tables show the germinative power and also the gross effect in development. The moist chamber cultures gave closer results on the germination and the earlier effects on growth, but were not as satisfactory as the flask cultures in showing the general effect on development. In the flasks the amount of development, the method of formation, and the color in maturing could be seen to better advantage.

The 5% salt had a retarding effect, and also induced an abnormal development, the growth being confined to a small amount of curled surface mycelium not spreading normally over the surface, and some submerged colonies. The sugar caused a delayed, stunted development, sometimes the growth in the 50% consisting of a scanty, submerged mycelium. In lesser amounts than 25% a thin surface mycelium forms, with a thick layer of spores. The cinnamon and cloves in the 5% solutions were stimulating, while stronger solutions retarded the development, the cloves being stronger in action than the cinnamon. In the 5% solution of alcohol in the moist chambers the conidia became swollen as they do previous to germination, but no further development took place. In the flask cultures the action of the alcohol was weaker, the conidia germinating and forming small colonies, which was probably due to the evaporation of the alcohol, causing the solution to become weaker on standing. The  $\frac{1}{2}$ % acetic acid retarded growth, and caused the mycelium to wrinkle. In all the flask cultures with the exception of the alcohol the effect of the condiment of corresponding per cent. was stronger than in the moist chambers.

#### PRESERVATIVES.

The preservatives are those which have been used in foods, and used in approximately the same amounts. The results show that they have a retarding effect on the development of the mould, even when in small amounts, and that most of them become inhibitive when the amounts are increased, the increase not exceeding the amounts which have been used in foods.

EFFECT OF PRESERVATIVES ON DEVELOPMENT OF PENICILLIUM.

Moist chamber cultures, 80° F.

SOLUTIONS.	21 Hours.		28 Hours. Hyphae, length in $\mu$ .	48 Hours. Hyphae, length in $\mu$ .	Description.
	Germination.	Hyphae, length in $\mu$ .			
Tomato bouillon.....	100%	307.6	999.7	$\infty$	Conidiophores formed.
Tomato bouillon + sodium benzoate, 1-10%.....	100%	46.1	169.2	$\infty$	Conidiophores formed.
" " " " 1-5%.....	—	—	30.8	$\infty$	Conidiophores starting. Only about 50% spores have developed.
" " " " 1-2%.....	—	—	—	—	" " " " " "
Tomato bouillon + benzoic acid, 1-10%.....	25%	30.8	46.1	$\infty$	Only about 35% spores have developed.
" " " " 1-5%.....	—	—	15.4	769.0	" " " " " "
" " " " 1-2%.....	—	—	—	—	" " " " " "
Tomato bouillon + borax, 1 10%.....	100%	276.8	461.4	$\infty$	Conidiophores formed.
" " " " 1-5%.....	100%	15.4	30.8	—	No change after 28 hours.
" " " " 1-2%.....	—	—	—	—	" " " " " "
Tomato bouillon + boric acid, 1-10%.....	50%	76.9	307.6	492.2	No change in hyphae after 28 hours. 50% spores swollen.
" " " " 1-5%.....	50%	15.4	30.8	—	About 10% of the spores swollen.
" " " " 1-2%.....	—	—	—	—	" " " " " "
Tomato bouillon + sod. salicylate, 1-10%.....	100%	46.1	307.6	$\infty$	Conidiophores formed, but have few sterigmata.
" " " " 1-5%.....	100%	123.0	169.2	$\infty$	Thin mycelium, conidiophores formed close to germinated spore
" " " " 1-2%.....	10%	15.4	76.9	$\infty$	" " " " " "
Tomato bouillon + salicylic acid, 1-10%.....	50%	30.8	123.0	$\infty$	Like the 1-5% sod. salicylate.
" " " " 1-5%.....	—	—	—	—	" " " " " "
" " " " 1-2%.....	—	—	—	—	" " " " " "

## EFFECT OF PRESERVATIVES ON DEVELOPMENT OF PENICILLIUM—Continued.

SOLUTIONS.	21 Hours.		28 Hours.	48 Hours.	Description.
	Germination.	Hypae, length in $\mu$ .	Hypae, length in $\mu$ .	Hypae, length in $\mu$ .	
Tomato bouillon + sod. sulphate, 1-10%.....	100%	30.8	92.3	769.0	Like the 1-5% sod. sulphyate.
" " " " " 1-5%.....				153.8	
" " " " " 1-2%.....					
Tomato bouillon + saccharin 1-10%.....	10%	15.4	61.5	x	Conidiophores formed. Conidiophores small, few.
" " " " " 1-5%.....			30.8	x	
" " " " " 1-2%.....			15.4	507.5	
Tomato bouillon + cep. sulphate, 1-10%.....	100%	30.8	169.2	x	
" " " " " 1-5%.....			15.4	276.8	
" " " " " 1-2%.....					
Tomato bouillon + sod. formate, 1-5%.....	10%	19.0			
" " " " " 2%.....		11.4			
" " " " " 1-2%.....					
Tomato bouillon + formic acid, 1-5%.....	2%	11.4			
" " " " " 2%.....		11.4			
" " " " " 50%.....					



EFFECT OF PRESERVATIVES ON DEVELOPMENT OF PENICILLIUM.

Flask cultures, 50cc. medium; 80°.

SOLUTIONS.	24 Hours.	48 Hours.	72 Hours.	18 Days.	*
Tomato bouillon.....	Tiny colonies at edge.....	Edge colonies $\frac{3}{8}$ ".....	Ring $\frac{3}{8}$ ", center blue, many sub. col.	Surface covered, wrinkled, olive. Liquid nearly black.	1
Tomato bouillon + sod. benzoate, 1-10 %	.....	Tiny colonies at edge, few submerged.....	Slight increase.....	Surface covered; wrinkled, olive. Liquid darkened.	2
" " " " 1-5 %	.....	.....	.....	Surface nearly covered, green, mycelium still growing.	8
" " " " 1-2 %	.....	.....	.....	.....	6
Tomato bouillon + benzoic acid, 1-10 %	.....	.....	.....	Surface nearly covered, wrinkled, green, mycelium growing	6
" " " " 1-5 %	.....	.....	.....	.....	1
" " " " 1-2 %	.....	.....	.....	.....	3
Tomato bouillon + borax, 1-10 %.....	Tiny colonies at edge.....	Edge colonies $\frac{1}{8}$ ", many submerged.....	Ring $\frac{3}{8}$ ".....	Surface covered, wrinkled, drab, thin spore layer. Liq. dark.	1
" " " " 1-5 %	.....	.....	Few tiny submerged colonies	Few surface col., curled, drab.	3
" " " " 1-2 %.....	.....	.....	.....	thin spore layer, many sub	3
Tomato bouillon + boric acid, 1-10 % ..	Tiny colonies at edge.....	Edge colonies $\frac{1}{8}$ ", many submerged.....	Few surface colonies curled.	Surface partly covered, curled, thin spore layer, many sub.	1
" " " " 1-5 %.....	.....	.....	Few submerged colonies	Same general appearance as 28, but less developed.	3
" " " " 1-2 %.....	.....	.....	.....	Tiny submerged colonies.	14
Tomato bouillon + sod. salicylate, 1-10 %	.....	.....	Few colonies at edge.....	Surface nearly covered, wrinkled, olive, liquid darkened.	3

\*No. days to germinate.

## EFFECT OF PRESERVATIVES ON DEVELOPMENT OF PENICILLIUM—Continued.

SOLUTIONS.	24 Hours.	48 Hours.	72 Hours.	18 Days.	*
Tomato bouillon + sod. salicylate, 1-5%		Few edge colonies, few submerged	Larger than the 1-10%	Same general appearance as the 1-10% but less devel. Liquid slightly darkened.	2
" " " " " 1-2%				Colony on side, green, many sub. Liquid darkened slightly.	2
Tomato bouillon + salicylic acid, 1-10%		Few edge colonies, few submerged	Colonies curled	Surface $\frac{3}{4}$ covered, dark olive. Liquid darkened.	2
" " " " " 1-5%				Like the 1-10% but less developed, liquid lighter	4
" " " " " 1-2%					
Tomato bouillon + sod. sulphite, 1-10%				Surface nearly covered, olive, many sub. col. Lig. darkened.	4
" " " " " 1-5%				Ring at edge 1", blue to olive, many sub. col. Lig. darkened.	10
" " " " " 1-2%				Few edge colonies, green, few submerged colonies	15
Tomato bouillon + saccharin, 1-10%	Tiny colonies at edge.	Edge colonies $\frac{1}{4}$ ", many submerged	Interrupted ring $\frac{1}{2}$ ", center blue	Surface nearly covered, wrinkled, olive. Lig. dark slightly.	1
" " " " " 1-5%		Edge colonies $\frac{1}{4}$ ", many submerged	Ring $\frac{1}{4}$ ", blue spots.	Slightly less development than the 1-10%.	2
" " " " " 1-2%		Tiny colonies at edge, many submerged	Interrupted ring, surface only curled.	Same as the 1-5%.	2
Tomato bouillon + cop. sulphate, 1-10%		Ring of colonies, many submerged	Surface nearly covered, older parts blue.	Surface nearly covered wrinkled, olive, many sub.	2
" " " " " 1-5%		Ring of colonies, many submerged	Surface nearly covered, older parts blue.	Surface nearly covered, wrinkled, olive, many sub.	2

"	"	"	1-2 C.	-----	Thin ring.....	Surface colonies curled.....	Enlarged blue spots, ring olive....	2
Tomato bouillon + sod. formate, 1-5 %...	"	"	1-2 C.	-----	White ring, few submerged..	Thick ring, blue at edge, many sub.	Surface covered, olive, many- submerged.	2
"	"	"	1-2 C.	-----	Thin interrupted ring, few submerged.	Many surface colonies.....	Surface covered, olive, many sub- merged.	2
Tomato bouillon + formic acid, 1-5 %...	"	"	1-2 C.	-----	Thin ring, few submerged colonies.	Ring enlarged, blue at edge.	Surface covered, olive, many sub- merged.	2
"	"	"	1-2 C.	-----	-----	-----	Surface nearly covered, green, many sub merged.	4

\*No. days to germinate.

The results indicate the acid to be stronger in its effect than the corresponding salt, though *Penicillium* is a plant which grows luxuriantly on acid fruits. The sodium sulphite bleached the solutions,  $\frac{1}{2}\%$  being a pale straw color. The copper sulphate solutions were also changed in color, the  $\frac{1}{2}\%$  solution was a decided green.

In all cases microscopic examination was made of material from the flask cultures, and indicated more conclusively than the gross appearance the effect on the development. Submerged colonies have been used for the reports in the table, as they are more uniform. The surface colonies have the characteristics of the submerged in their earlier growth, but as development proceeds and the hyphae grow away from the medium, the characteristics may change, sometimes more nearly approaching the normal, or they may develop characters more pronounced than the submerged. In a few instances, only submerged colonies, and in the raw cranberry and cinnamon solutions only surface colonies, developed. In making measurements the germinated spores were used, and only the average sizes; the extreme in size was avoided, as not giving a fair estimate of the effect of the preservative. Where only one measurement is given, it indicates that the spores were fairly uniform; where two measurements are given, the spores showed such strong variation that an average was taken of the smaller and also of the larger instead of taking the average of the two sets. The hyphae were measured but varied so much that it was thought a better estimate could be obtained from the photographs.

MICROSCOPIC APPEARANCE OF *PENICILLIUM* GROWN IN PRESERVATIVE SOLUTIONS.

PRESERVATIVE.	Size of		Characteristics of Development.
	Germinated	Conidia in $\mu$ .	
Control .....	8.5		Hyphae somewhat irregular in outline near germinated conidia, tapering tips, homogeneous protoplasm, many large round vacuoles.
Salt, 5% .....	7.6		Hyphae short, distorted, homogeneous protoplasm, no vacuoles, blunt tips.
Sugar, 50% .....	7.6		Hyphae shrunken, distorted, homogeneous protoplasm, vacuoles show as pink spots, giving a beaded appearance.

MICROSCOPIC APPEARANCE OF *PENICILLIUM*—Continued.

PRESERVATIVE.	Size of Germinated Conidia in $\mu$ .	Characteristics of Development.
Cinnamon, 10%	15.2	Hyphæ swollen, blunt tips, protoplasm finely granular, without cohesion, walls break with weight of cover-glass. Few septa in some, in others prominent. Few side branches. Hyphæ disorganized when placed in water.
Cloves, 10%	13.3	Hyphæ swollen, blunt tips thicker than older part, short thick side branches, finely granular protoplasm, not so badly disorganized as in cinnamon.
Cranberry, raw	7.6	Hyphæ shrunken, distorted, tendency to develop conidiophores close to germinated conidia.
Cranberry, cooked, open	6.7	Hyphæ thin, tapering, protoplasm finely granular.
Cranberry, cooked, covered	7.6	Hyphæ slender, tapering to threads, protoplasm reduced to lining of walls, coarse granules, many septa.
Alcohol, 5%	15.2	Hyphæ swollen, distorted, walls tough, protoplasm clear.
Acetic acid, 1-5%	11.4	Hyphæ enlarged, blunt tips, few septa, short side branches, protoplasm finely granular.
Sodium benz., 1-5%	15.2 38.0	Hyphæ and conidia swollen and distorted, no uniformity in formation of septa, some hyphæ, few, others many; protoplasm coarsely granular, filling tubes; walls break readily.
Benzoic acid, 1-10%	15.2 49.4	Hyphæ larger than in benzoate, more easily broken, distorted. Less swollen hyphæ have less distortion and less disorganization.
Borax, 1-5%	9.5 15.2	Hyphæ short, distorted or long and swollen, blunt ends, protoplasm clear, homogeneous or finely granular.
Boric acid, 1-5%	15.2 19.0	Hyphæ swollen, short thick side branches, blunt ends, protoplasm finely or coarsely granular.
Sodium salicylate, 1-5%	9.5 15.2	Hyphæ as wide as germinated conidia, few septa, granular protoplasm.
Salicylic acid, 1-5%	15.2 30.4	Hyphæ and conidia swollen, some of the conidia much elongated, hyphal ends blunt, few septa, protoplasm yellow, coarsely granular, protoplasm and walls disorganized.
Sodium sulphite, 1-5%	11.4	Hyphæ enlarged, few septa, protoplasm coarsely granular.
Saccharin, 1-5%	13.3	Hyphæ enlarged, some much swollen, slight distortion, clear, homogeneous protoplasm, thick, stunted conidiophores.
Copper sulphate, 1-5%	11.4	Hyphæ enlarged, slight distortion, protoplasm yellow, finely granular, dirty appearance.

## MICROSCOPIC APPEARANCE OF PENICILLIUM—Continued.

PRESERVATIVE.	Size of Germinated Conidia in $\mu$ .	Characteristics of Development.
Sodium formate, 1-5%.....	13.3	Hyphe swollen, coarsely granular protoplasm, short side branches, blunt ends, disorganized, or normal size with fine granules and many vacuoles, some cells empty.
Sodium formate, 1-2%.....	13.6	Hyphe swollen, coarsely granular, short side branches which do not develop, blunt ends, disorganized, break easily.
Formic acid, 1-5%.....	14.0	Hyphe swollen coarsely granular, blunt ends, many broken, or normal size, finely granular, many vacuoles.
Formic acid, 1-2%.....	11.4 41.8	Hyphe swollen, coarsely granular, yellow, distorted, badly disorganized, break easily. Nearly all germinated conidia broken.

The sugar and salt caused the hyphæ to shrink and to assume distorted shapes when in sufficient amounts to cause a retardation. The cranberry juice, both raw and cooked, also caused shrinkage, and the raw juice a distortion. All of the others caused the conidia and hyphæ to swell and some of them also caused a distortion. The mould grown in the alcohol solution had tough walls in spite of the swelling, and a clear, sharp appearance. The borax and boric acid also produced a clear appearance. The sodium benzoate, benzoic acid, sodium salicylate, salicylic acid, sodium formate, formic acid, acetic acid, and cinnamon produced swelling, distortion, a disorganization of both the protoplasm and cell wall, and a yellowing of the protoplasm. The cell wall had no elasticity nor toughness, so that the placing of the cover-glass gently on a mount was sufficient to break the walls of the more distended hyphæ and to allow the protoplasm to flow out. The protoplasm appeared to be without coherence: when the wall gave way, it flowed in all directions, as if it were composed of loose particles having no cohesion. The sodium sulphite, saccharin, cloves, and copper sulphate growths had similar characteristics to those enumerated for the other preservatives, but not so strongly developed.

In summarizing the results, there seem to be two different actions induced by the action of the substances on the protoplasm, in one case a plasmolyzing effect causing a shrinkage and distortion, as in the salt and sugar, and in the other case a toxic effect producing a disorganization of both the protoplasm and wall, and a discoloration of the protoplasm, the substances showing varying degrees of toxic power.

## GERMINATION FROM PRESERVATIVE MATERIAL.

To determine if there were a permanent deleterious effect produced on the plant through the toxic effect of the chemicals, inoculations were made from two weeks' old cultures into tomato bouillon. The result is shown in the table:

GERMINATION OF PENICILLIUM GROWN IN PRESERVATIVE SOLUTIONS  
14 DAYS.

PRESERVATIVE.	Number Days to Germinate.	Stage of Development in 5 Days
Control .....	1	Surface covered, green.
Sodium benz. 1-10% .....	2	Surface covered, green.
“ “ 1-5% .....	2	“ “ “
“ “ 1-2% .....	4	Thin ring, having blue dots.
Penzoic acid, 1-10% .....	2	Surface nearly covered, green.
“ “ 1-5% .....	4	Small surface colonies, blue.
“ “ 1-2% .....	-	-
Borax, 1-10% .....	2	Surface covered, green.
“ 1-5% .....	2	One surface colony, green.
“ 1-2% .....	-	-
Boric acid, 1-10% .....	1	Surface covered, green.
“ “ 1-5% .....	2	“ nearly covered, green in center.
“ “ 1-2% .....	5	Few submerged colonies.
Sod. salicylate, 1-10% .....	1	Surface covered, green.
“ “ 1-5% .....	2	“ “ “
“ “ 1-2% .....	1	“ “ “
Salicylic acid, 1-10% .....	1	“ “ “
“ “ 1-5% .....	1	“ “
“ “ 1-2% .....	-	-
Sod. sulphite, 1-10% .....	3	Colonies on surface, green.
“ “ 1-5% .....	2	Surface covered, “
“ “ 1-2% .....	-	-
Saccharin, 1-10% .....	2	Surface covered, green
“ 1-5% .....	2	“ “ “
“ 1-2% .....	1	“ “ “
Copper sulphate, 1-10% .....	3	Colonies on surface, green.
“ “ 1-5% .....	2	Surface covered, “
“ “ 1-2% .....	2	“ “ “

The germination and subsequent development indicate that the preservative affected the conidia deleteriously, as some were retarded, while the conidia from the solutions showing the strongest effects on the previous development, did not germinate, except from the  $\frac{1}{2}\%$  boric acid solution which formed a few submerged colonies, no surface development taking place. Lafar<sup>1</sup> states that the waterproof character of the conidial walls has a value in preventing the entrance of poisons to the protoplasm, but in the cases noted it is either dissolved by the chemicals or powerless to prevent their passage, for the results indicate that they exercised a decided toxic effect on the protoplasm.

#### SUMMARY.

Salt and sugar injure the plant by preventing normal action of the protoplasm through plasmolysis.

Alcohol hardens the protoplasm and walls and prevents development.

Cranberry juice, both raw and cooked, retards development and causes shrinkage, though not having the appearance of the shrinkage due to plasmolysis.

All of the other chemicals tested acted as poisons on the protoplasm, retarding development and causing abnormal swelling and disorganization of varying degrees of intensity on both the protoplasm and cell membrane.

Lafayette, Ind.

#### EXPLANATION OF PHOTOGRAPHS.

The photographs have the same magnification,  $\times 395$ , so that comparisons may be made as to the effect of the preservatives. The specimens were submerged colonies in all cases except the raw cranberry and cinnamon, and no submerged colonies developed in these solutions. The endeavor was to have all of the same age, but this was impossible, as some developed much more rapidly than others, and in those which were slow in developing it was impossible to determine the changes which the conidia may have been undergoing before the development had attained the colony stage. The submerged colonies were used as soon as they made their appearance. In some of the specimens that show little or no swelling the disorganization can be seen in the collapsed ends of the hyphae and the floating fragments of protoplasm.

<sup>1</sup> Lafar, F., *Technical Mycology*, Vol. II, Part 1, p. 40.





1. Control - conidiophore and hyphae.

2. Mycelium, grown in tomato pulp.

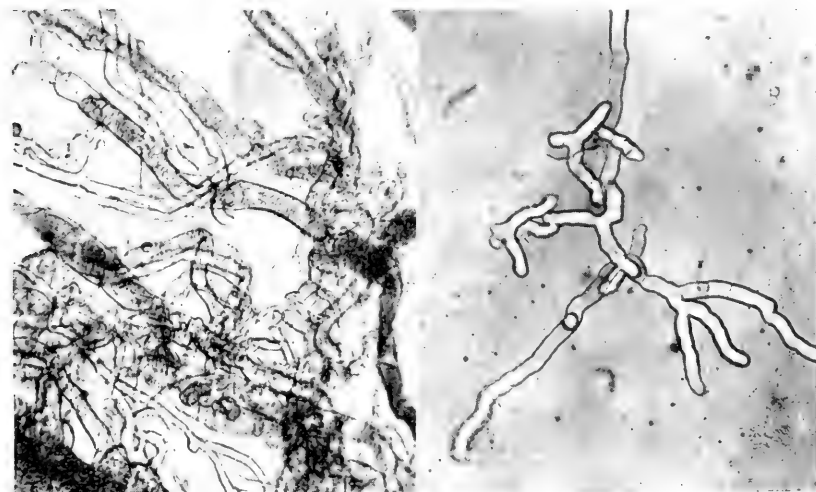

3. Hyphae from ketchup preserved with sodium benzoate. The label gave amount as 1-10%.

4. Mycelium from 5% salt solution.

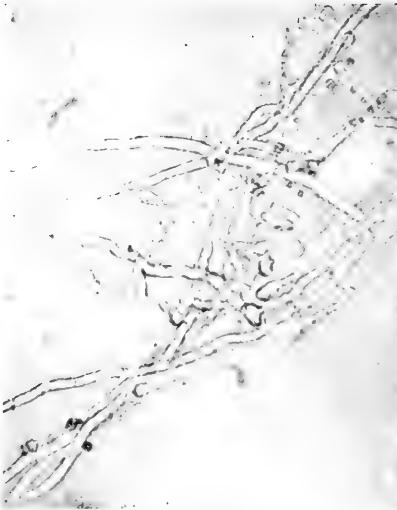

5. Mycelium from 50% sugar solution.



6. Mycelium and conidiophores from 10% cinnamon solution.



7. Mycelium showing disorganized hyphae from 10% clove solution.

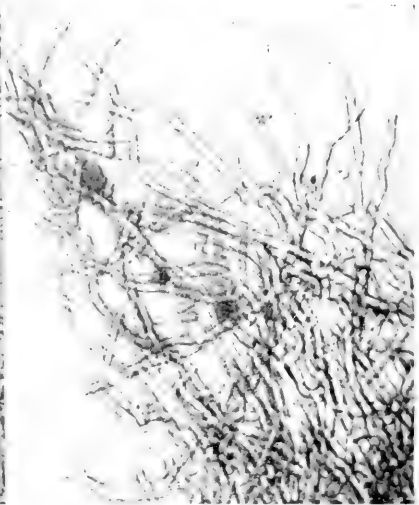

8. Mycelium from 10% vinegar (50 grain.)



9. Mycelium from 1.5% acetic acid solution.



10. Conidia from 9.6% alcohol solution.

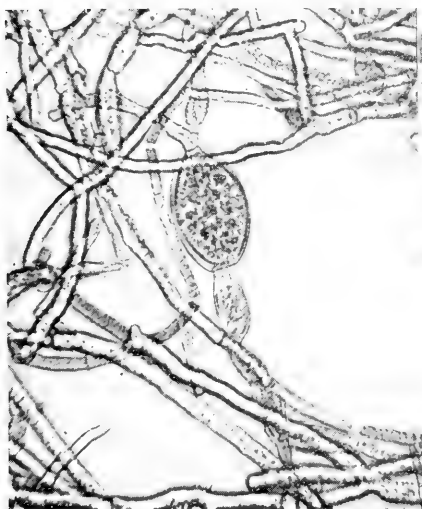

11. Mycelium and enlarged conidium from 1.5% sodium benzoate.

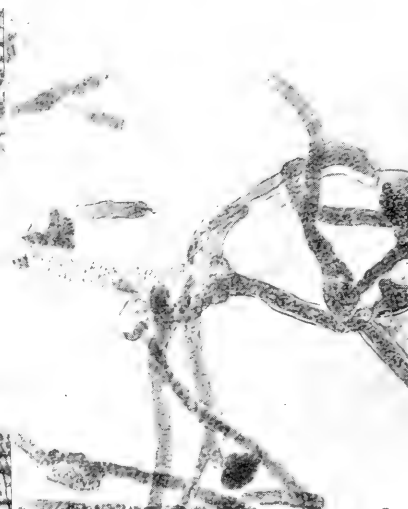

12. Mycelium swollen and disorganized from 1.5% benzoic acid solution.



13. Colony from raw cranberry solution.

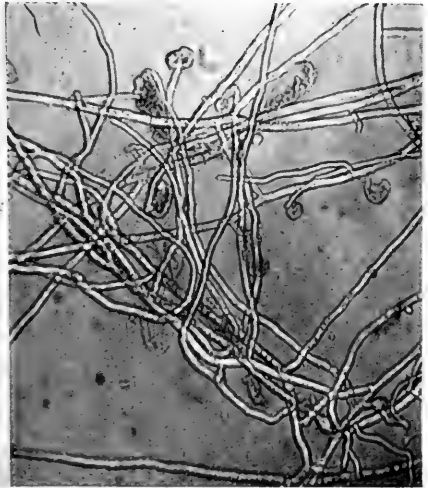

14. Mycelium with disorganized hyphal ends from cooked (open) cranberry solution.



15. Mycelium with swollen conidia from cooked (closed) cranberry solution.

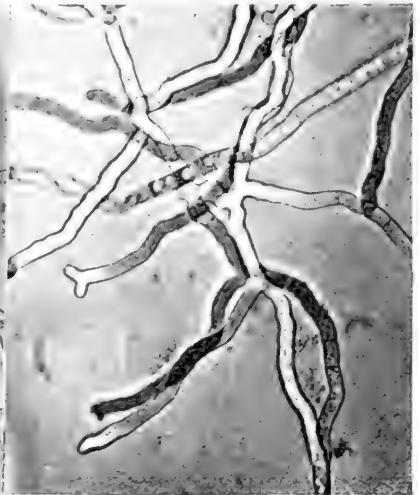

16. Mycelium from 1.5% borax solution.



17. Mycelium from 1.5% boric acid solution.

18. Mycelium from 1.5% sodium salicylate solution.

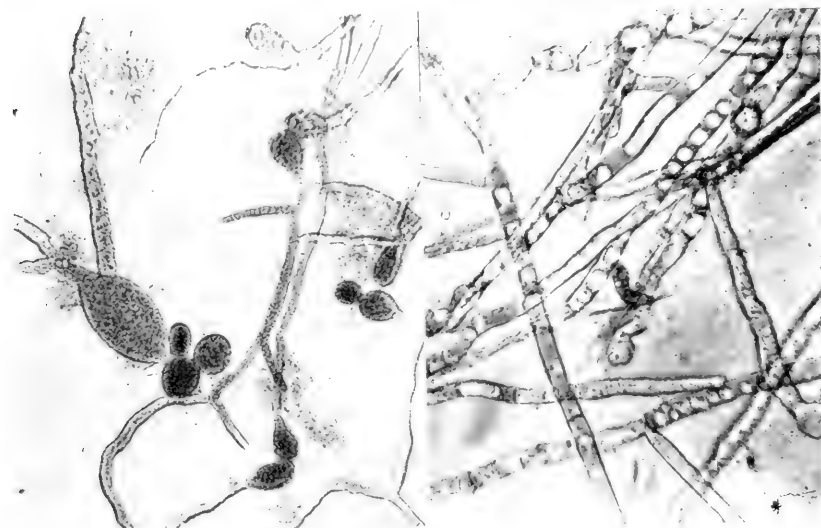

19. Germinated conidia and hyphae from 1.5% salicylic acid solution.

20. Mycelium from 1.5% sodium sulphite solution.

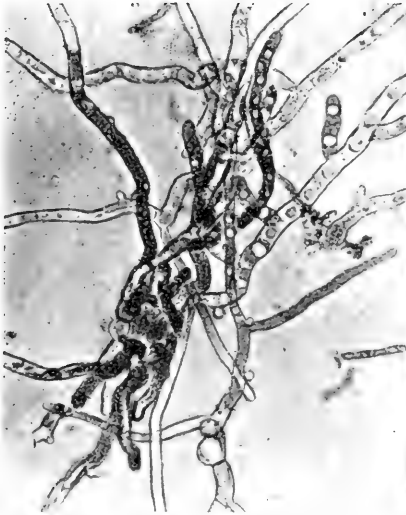

21. Mycelium from 1.5% saccharin solution.

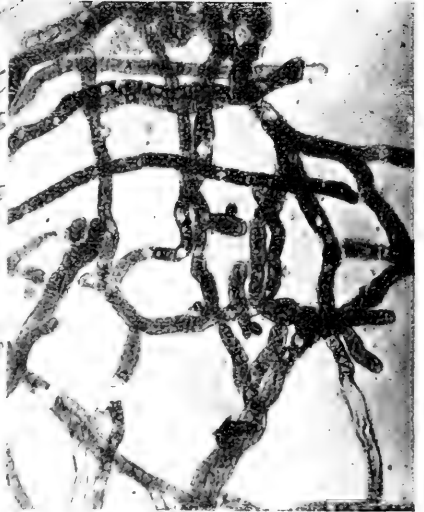

22. Mycelium from 1.5% copper sulphate solution.

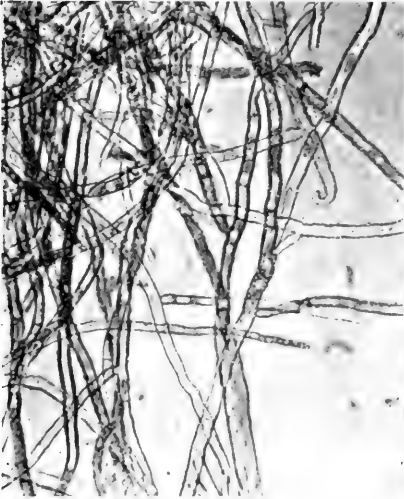

23. Mycelium with disorganized hyphal ends from 1.5% sodium formate.

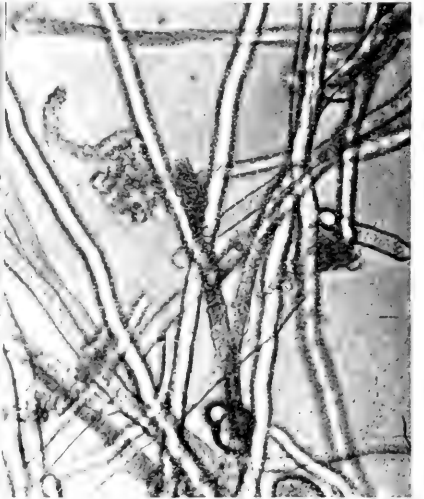

24. Mycelium with disorganized hyphae from 1.5% formic acid.

## FURTHER NOTES ON TIMOTHY RUST.

---

By FRANK D. KERN.

---

At the last meeting of the Academy, November 27, 1908, the writer presented a short paper on "The Rust of Timothy,"<sup>1</sup> in which the history of its occurrence in this country was discussed and its distribution at that time was given. The remark was made, although not incorporated in the paper, that this rust had not yet been reported from Indiana but that it was becoming more general in its distribution and might be expected here sooner or later. Since this prediction has come true within the year it is considered worthy of mention at this time. A collection consisting only of summer spores (urediniospores) was made in October, 1909, near Columbus, Indiana.<sup>2</sup> Last year the fungus was known in states both east and west of Indiana, so that while this report does not extend the range geographically, it is nevertheless of especial interest since it is the first definite information we have of its advent into the State. A second collection made in November at the same locality shows also a few winter spores (teliospores). It is of further interest to note that where the rust was found it was low ground with unusually rich soil. The place was originally a wet swamp but is now tile-drained. None was found on the high land adjoining. Low regions furnish more moisture in the atmosphere surrounding the plants, especially at nights, and this means better conditions for the germination of the spores.

In the paper read last year it was said that this rust was seemingly increasing in its distribution. The season of 1909 has proved the correctness of this prediction. A specimen was collected in September, 1909, in Maine by Dr. J. C. Arthur. This is the first collection that the writer has seen from the New England states. Last year Wisconsin was the most western state which had reported the rust. This year it has been found as far west as Minnesota, according to a report recently received from an official of the U. S. Department of Agriculture.

---

<sup>1</sup> Only an abstract of this paper appeared in the Proceedings of the Academy for 1908, p. 85, but it was published in full in *Torreyia*, a Journal of the Torrey Botanical Club, Vol. 9, pp. 3-5, Jan., 1909.

<sup>2</sup> This collection was made by Mr. C. G. Hunter, on his farm near Columbus, and communicated by him to the writer.

The present known range is from Maine west to Minnesota, south to West Virginia and Indiana. Collections from the following states have been examined by the writer and are represented by specimens in the herbarium of Dr. J. C. Arthur at Purdue University, where the writer has carried on the major part of his studies. The collectors' names are included in parentheses.

Delaware (*Jackson*).

Indiana (*Hunter*).

Maine (*Arthur*).

Michigan (*Arthur, Kern*).

New York (*Webber, Reddick, Edgerton, Stone*).

Ontario (*Arthur, Dearness*).

Pennsylvania (*Sunshine*).

West Virginia (*Sheldon*).

Wisconsin (*Davis*).

During the year no additional facts have been brought out which throw any light on the specific standing of the timothy rust. The writer is still of the opinion that it is not entitled to specific rank and would include it under *Puccinia poculiformis* (Jacq.) Wettst. (*Puccinia graminis* Pers.) The statement made last year could, perhaps, be somewhat modified. Rather than calling it a race, physiological species or form species, it might be better to consider it a variety or subspecies since it does, as previously pointed out, possess some slight morphological differences from the typical form, particularly in the smaller acial cups and the more delicate uredinial mycelium.

Purdue University,

Lafayette, Ind.



## THE WOODLOT FOR CENTRAL INDIANA.

By E. C. PEGG and M. B. THOMAS.

### INTRODUCTION.

The purpose of this paper is to show as accurately as possible with the information at hand the conditions of central Indiana woodlots and to make suggestions for their improvement and perpetuation.

### A SHORT HISTORY OF INDIANA'S FORESTS.

Early explorers of Indiana found a wilderness of giant trees. Upon the tops of hills and higher ground were such trees as beech, hickory, oak, hard maple, walnut, ash and tulip; in the richer lowlands were the elms, buckeye, basswood and soft maples; and tall sycamores and overhanging willows lined the banks of the streams. It was not uncommon to find trees nearly two hundred feet in height and twenty to twenty-five feet in circumference. Everywhere smaller trees, shrubs and herbaceous plants struggled for their requisite amounts of sunlight. A spongy mass of forest litter made a floor that held rainfall and fed the innumerable springs, which in their turn supplied the streams and rivers with a constant and uniform volume. Such was the unbroken forest.

*Clearing.*—It was soon discovered that Indiana's soil was well adapted to agriculture. The early settlers began the work of forest destruction by clearing their homesteads for agricultural purposes. Regular log-rollings were held at which tree after tree was cut down, piled in log heaps and burned. Such work at that time was justifiable because timber was very plentiful and because the ground thus cleared was necessary to furnish a living for the ever increasing population.

*Lumbering.*—For this reason much of the land was cleared. Official records, which begin in 1870, show an acreage of 7,189,334 acres in timbered lands. In 1880 only 4,335,000 acres were left. As Indiana became more thickly settled, better houses, cities, roads, railroads and factories were being built, each requiring a certain amount of timber for construction. And in additional ways the consumption steadily increased. The towns and cities afforded market places, the roads and railroads a means of transportation for lumber. Thus began the other chief influence in

forest destruction. By 1890 over 2,500,000 acres more were cleared, of which 75,000 acres became waste land. The timber supply of the East was falling, the demand increasing. Then Indiana ranked fifth with the states of the Union in the total output of lumber. In 1907 she ranked twenty-seventh.

At the present time there are probably less than a million acres of woodland in the State. This fact shows us the truth of the prophecy made twenty-five years ago that "At the present rate of consumption the forests of the State must soon cease to be commercially important." Very little now remains of the once seemingly inexhaustible supply of valuable timber, such as oak, walnut and yellow poplar.

*Formation and Evolution of the Woodlot.*—It is with this small remainder, especially that portion which lies in the central part of the State, that this paper deals. Formerly the farmer removed only the timber on the land he actually needed for agricultural pursuits. Gradually, as his needs increased, he extended the boundaries of his fields. The trees which he removed more than furnished him with firewood and other necessary timber. But when a market was opened up the owners began to cut the still vast forests for purely financial reasons. These became more and more exhausted until now very few acres of virgin timber, and comparatively few of any kind, remain. The farmer is at present apparently satisfied with his acreage of cultivated land, good timber is too scarce for extensive clearing or sale, and he is willing that a small portion of his farm should remain covered with a more or less depleted forest in order to provide wood for general purposes about the farm. These are the chief reasons for the presence of a woodlot today. Some timber was left because it was difficult to reach. Other tracts were left because of the pasturage they afforded in the grass which sprang up when the dense forest cover was partially removed. So, for one reason or another, or purely by accident, certainly not from choice, the woodlot of today occupies the position it does, oftentimes on the best land of the farm.

*Present Conditions.*—To get an idea of the present condition of these woodlots one need only travel a few miles in the country. In the distance he can see trees in a seemingly unbroken line. Closer examination, however, shows them to be in small, scattered patches ten to thirty acres in extent. After the best trees had been cut out and sold, the custom of cutting trees for special uses, such as handle stock and spoke material, led

to the removal of the next best. All the most valuable species, black walnut, yellow poplar, white ash and the best oaks, have been cut away, leaving only a few maples, beech, ironwood, buckeye and the like. Many of these are crooked, defective and otherwise undesirable. At no time has any care been exercised to protect the undergrowth of young seedlings. The floor also presents a very different appearance from what it once did. A dense bluegrass sod has taken the place of the undergrowth and rich forest litter destroyed by constant pasturage. A heavy growth of grass is in itself an enemy of trees, for it not only makes reproduction harder but also smothers the roots of those already growing and robs the soil of moisture so essential to good tree development.

Some may ask what it matters if the conditions are thus. Are not the farmers in better circumstances now than they were forty years ago, yes, even ten years ago? Financially they are, but with wise and proper management of their woodlots they could realize still larger profits from their farms.

## THE WOODLOT.

### USES.

There are many reasons why woodlots are valuable. They furnish timber for all farm needs, protect buildings and crops, shelter live stock and materially help in preventing erosion and in ornamenting the country.

*Firewood.*—Firewood comes first in the list of timber used for farm purposes. The early methods of using wood in a fireplace were wasteful. The introduction of stoves resulted in a great saving of fuel. But fuel production was not the only purpose served by the forest. Now lack of timber and the cost of getting crooked and knotty trees cut into firewood have compelled the use of a substitute. Most farmers would be glad to have again a plentiful supply of cheap fuel.

*Posts.*—The setting of 1,000,000,000 (estimated) fence posts per year shows us another very important use for timber. According to the last census 8,715,661 of these posts were produced from the regular logging camps of the country. The use of these posts as supports for woven wire fence is very economical when compared to the former practice of building rail fences, many of which were of black walnut, the most valuable timber Indiana ever produced. Their gradual displacement by wire or picket fences is a great step towards forest preservation.

*General Farm Uses.*—Then there are other innumerable general uses about the farm for poles, boards and lumber. After all these needs are satisfied there should remain some timber (logs and railroad ties) for market.

*Climatic Influences.*—The influence of woodlots on the climate makes their presence desirable. A great deal has been written about forests as a factor in rainfall, but it has never been satisfactorily proved that they increase the total amount. It is known, however, that about twenty-eight per cent. less of the annual rainfall is evaporated within the woods than outside of them, and that the mean annual temperature of forest soil is about twenty-one degrees lower than that of cultivated fields. In summer this cool soil tempers the air above, and by starting currents from the adjoining fields lowers their temperature. Besides, woodlots, if situated in favorable positions, check strong winds, in this way protecting farm buildings and preventing fruit trees and crops from being blown down.

*Shelter.*—A woodlot is invaluable for the shelter it affords to live stock in both summer and winter. Less food is required to maintain the body warmth of animals when they are well protected from the cold winter winds. Therefore the use of grain in fattening stock is much economized. The cool shade offered by a small portion fenced off from the best part of the woodlot prevents fattening animals from losing flesh during the hot weather.

*Aesthetic.*—But these uses are not all. Every one knows that a good strip of timber greatly increases the value of a farm, for by this means not only the beauty of individual farms but also that of the entire community is increased as much, if not more, than by more expensive improvements. For no other reason than this each farmer should strive to maintain a well managed woodlot.

*Water Supply.*—Forests at the head waters of streams regulate their flow. As has been said before, the amount of evaporation within the forest is much less than that outside because the loose litter offers little capillarity to the water content of the soil and also permits of a more rapid absorption of heavy rainfall. The water is then given out to the springs and streams in an almost constant supply.

*Erosion.*—The problem of erosion is a very perplexing one, especially in a rolling country. The unlimited removal of forests has left but little resistance to the flowing away of rainfall, for everywhere the soil is more

or less hard and compact. Water speedily runs over the surface, carrying soil and debris, which it deposits in the beds of streams. Places which wash badly are exceedingly common and cause the loss of much tillable land.

#### THE MODEL WOODLOT.

After a review of the reasons for maintaining woodlots it is well to consider the organization of a model woodlot.

*Number of Trees.*—It should contain the number of trees consistent with the most rapid development of the best timber. Trees should stand close enough in youth to stimulate growth in height and to produce long, clear trunks. As the stand approaches maturity more and more space is required for each tree until at last probably only one hundred and fifty to two hundred trees of the original three or four thousand remain per acre. Thinning is brought about naturally by the struggle for supremacy.

*Distribution and Soil Cover.*—Trees should be evenly distributed over the entire area, always close enough together to prevent many direct rays of the sun from reaching the ground in summer, since the large openings give grass, a very dangerous enemy of forests, a chance to grow. The ideal soil is loose, porous, rich in vegetable mould and is covered with a thick mat of leaves and leaf humus to the exclusion of all grass and light-demanding weeds.

*Forest Cover.*—The trees which should be found in a woodlot depend upon two factors—(1) the economic value and (2) silvical characteristics. Such trees as black walnut, black cherry, ash, oak, maple and poplar have the greatest economic values. The other factor has to do principally with the soil, moisture and light requirements. For example, sugar maple requires rich upland soil and very little sunlight for its best development, while sycamore will grow on any wet soil if it has plenty of light. Thus we shall find in a model woodlot the species best suited to the soil, water supply and the uses to which the timber is to be subjected. In no case should there be any worthless species.

*Reproduction.*—In order to maintain the desired acreage of our timber producing area some efficient method of reproduction is necessary. This is usually found in the presence of large and mature seed-bearing trees, which scatter their fruits over long distances until they find lodgment in places suitable for germination. Another method of reproduction is by

stump sprouts or coppice growth. However, the size and quality of the timber produced in this way is much inferior to that formed from seedlings. For quick reproduction, advantage of this sprouting tendency should be taken in trees like the oak, basswood, catalpa and hickory.

#### HOW TO REACH THE MODEL.

The next point to demand our attention is how to bring the existing woodlots into model conditions. The examination of this problem may be conveniently considered under three heads: (1) Protection, (2) General Improvement Cuttings, and (3) Improvement of Type Stands.

#### PROTECTION.

The necessity for protection arises from the loss occasioned by grazing, fire, insects, fungi, wind and careless work in the woods.

*Grazing.*—Grazing injures a forest in two ways—by browsing and by trampling. Domestic animals browse sprouts and young seedlings, break off shoots and buds and gnaw the bark of trees. By the destruction of herbage the sharp hoofs of sheep cause loose soil to become looser and stiff soil to become more compact. Cattle and horses are much less harmful than sheep about trampling, although their hoofs frequently tear away small rootlets. This disturbance of the soil and soil cover seriously interferes with its water supply. In general the results of grazing make it imperative to exclude all stock from the woodlot.

*Fire.*—Fire is another great enemy of forests. The leaf litter and humus, young growth upon which the future supply depends, and mature trees are all affected. A single fire does not usually seriously injure older trees but a series of fires either burns them up completely or leaves them in such a weakened condition that they are blown down by wind or attacked by insects and fungi, and then furnish a source of infection for other trees. But in this thickly settled region fires are easily handled, for they can readily be seen and extinguished.

*Insects.*—The following conclusions regarding insect injury have been drawn from a careful investigation of the existing conditions throughout the state:\*

(1) Insects causing the death of the tree:

(a) Found in extensive numbers and causing serious injury, as follows: Bark beetles on oaks, hickories and locust.

---

\*Report of State Board of Forestry, 1907.

- (b) Found in limited numbers and causing secondary injury as follows: Bark beetles on walnut, cherry, hackberry, elm, mulberry and ash; bark-boring grubs on oak and chestnut.
- (2) Insects not causing the immediate death of the tree:
- (a) Found doing serious damage to timber as follows: Carpenter worm on oak; wood borers on hickory; powder post borers on hickory.
- (b) Injury to foliage: Nearly all species of trees found affected by one or more of the following forms, of which all except the cottony maple scale cause little damage: Leaf eaters, leaf miners, leaf rollers, saw flies, scale insects and gall flies.

The bark and wood borers can usually be detected by pits or deposits of fine sawdust around the holes. About the only remedy is to remove the infected trees at such times as will prevent the hatching of the larvae. Damage due to leaf insects is usually so slight that it may practically be disregarded.

*Fungi*.—Fungi attack trees in several ways. Some kill the roots, others grow upward from the ground into the trees and change the sound wood of the trunks to a useless, rotten mass or leave only a hollow shell. The spores of others come in contact with every part of the tree as they float about through the air. These spores find a very suitable place for germination if they fall on wounds. By removing infected trees and destroying old logs fungous diseases may be fairly well controlled.

*Wind*.—Wind-blown timber frequently exists in open or unprotected stands and in moist places where root systems are shallow. Trees weakened by fire, fungous and insect attacks are easily broken off. Of course the mature trees may be partially or wholly utilized. The greatest damage is done to those for which there is no immediate use.

Woodlots which have been unprotected from the time they were comparatively small usually have their own windbreaks made by the development of numerous side branches. A strip a few rods wide along exposed margins of woods should always be kept as dense as possible. The development of brush and undergrowth should be encouraged. Unless there are others to take their places no trees should be cut in this protective area.

Should it be necessary to plant a windbreak it is best to employ two species, one a rapid grower to provide early protection, the other of slower growth to make a permanent and more efficient shield. Carolina poplar,

black walnut and catalpa are types of the first class, and any of the evergreens types of the second class. The spacing should be about four feet in rows six feet apart. At least half of the trees should be removed when they begin to crowd badly. When a good protection has been well established trees may be removed anywhere within the grove with practically no danger of windfall.

*Work in Woods.*—Another important thing to keep in mind is care while working in the woods. The object of management is to have new trees of the most desirable species to replace as soon as possible those which are removed. Therefore it is necessary to protect young growth. Care should be taken in felling trees not to injure others nor crush young seedlings. Brush should be piled in places where danger to timber from fire is reduced to a minimum.

#### IMPROVEMENT.

The second part of our examination, general improvement cuttings, deals with defective and infected trees, tree weeds and a general plan for harvesting.

*Defective and Infected Trees.*—Many woodlots contain stag-headed or entirely dead trees which are rapidly decreasing in value. They spoil the beauty of a grove as well as furnish a convenient place for beetles and fungi to live and propagate. They should be removed immediately.

*Tree Weeds.*—Tree weeds are another waste of our resources. A tree weed occupies space in a timber stand but has comparatively little value. Ironwood, water beech, dogwood, scrub oak, pawpaw and sassafras are examples. It is advisable to remove these as well as the dead, dying and infected trees at once unless by so doing large spaces are opened up in the forest cover which will not close before grass has a chance to start.

*Mature Cutting.*—One more general rule of improvement is in regard to cutting. Usually only such trees as have passed their maturity or the point where the amount of wood formed each year begins to decrease should be cut. And no more wood should be removed than is actually grown. Thus, if a woodlot is producing five cords of wood annually, it is better to cut five or only four cords than six. If a method like this is used and care taken to keep the ground fully stocked with thrifty young trees the woodlot may be kept up indefinitely.



*Coppice.*—In cutting the following suggestions should be kept in mind: Stumps should be cut low in order that the sprouts may become independent of the old root system as soon as possible; they should be cut smooth and slanting or have the sharp edges removed so as to prevent water from collecting on them, for in such cases they are apt to rot and infect the sprouts; care should be taken not to tear the bark from the stump since this often prevents buds from developing at the root collar; the sprout should be cut when the sap is down, early spring or late fall, for when cut in midsummer frosts are apt to kill the new sprouts which start up, before their growth is completed and their wood hardened.

#### MATURE OPEN STANDS.

*Character.*—Most woodlots are remnants of the original hardwood forest. The valuable straight grained and easy splitting trees have been cut for lumber or firewood. Those which remain have received no attention. They are mature, crooked, knotty or badly diseased and grow in clumps or are scattered over the lot. Few are of any value. Almost all these timbered tracts have been used for pasture, and as a result of constant grazing the ground is covered with a thick, heavy bluegrass sod to the exclusion of desirable young growth. If any reproduction does occur it is very irregular and is composed mostly of weed species.

*Treatment.*—The treatment of such stands depends upon the degree to which it has deteriorated, its location and the owner's need for timber. If it is on land better suited for agriculture and the farmer is more in need of fields than timber, probably the best thing to do would be to remove the timber completely and cultivate.

But if the lot is to be rejuvenated, the first step to take is to exclude all live stock. Should it be necessary to keep some of the woodland for pasture the thrickest portions should be fenced off and most of the trees removed from the remainder. More timber and more grass can be produced separately than together. The next step is to remove tree weeds and other trees whose value is decreasing. The remainder will furnish seed. In order that the seeds may have the best possible conditions for germination the sod should be broken up by means of a bull-tongue plow or disc harrow. A rank growth of briars and weeds will probably spring up as soon as the sod is removed, but these make a very good protection under which the young seedlings are to develop. Soon the new growth kills out

the weeds and briars and rapidly establishes a good stand. Should other species than those present be desired it is necessary to plant them. As soon as reproduction is well under way the mature trees may be cut. Still it is a wise plan to leave some of them for seed and to furnish timber while the new crop is growing.

#### IRREGULAR, UNEVEN-AGED STANDS.

*Character.*—It is from the irregular, uneven-aged stands that we expect the earliest good results. These are parts of the original forest retained in almost virgin condition. Some are dense, others more or less open. In them the soil is almost ideal, but not so with the forest. Fungous and insect hosts, old logs in various stages of decay, are scattered over the ground. Many of the trees are mature but in very poor condition. Some, however, are large and have long, smooth trunks and compact crowns. Increase in height has practically ceased and diameter growth is very slow. A young growth of various species, many of which are undesirable, fills up small openings made by fallen trees. On the whole the forest capital is slowly but surely decreasing, for the amount of timber produced annually is more than offset by death and deterioration of the overmature trees.

*Improvement.*—The first requirement for the improvement of this type is the same as for mature open stands; that is, the removal of tree weeds and the species undesirable for other reasons. The next process, thinning, is brought about naturally by shading. Trees which are crowded while young try to get their crowns into sunlight, and consequently produce long, slender stems. If, after a sufficient height has been reached, space is given for increased root and foliage development, an increase in wood production occurs. This increase takes place in diameter growth, since there is no longer any incentive for height growth. The purpose of artificial thinning is, then, to accelerate diameter growth as much as possible, to substitute for nature's wasteful struggle a systematic removal of weaker and inferior trees, leaving as many of the good ones as can develop without retardation for a given period.

*Thinning.*—This process requires considerable judgment and experience, for special attention is given to the trees which are to remain rather than to those which are to be cut. Of course the most valuable and rapid growing species take precedence over others. The following list will serve as a guide, although it is by no means invariable:

Species specially favored: oak, hickory, ash, black walnut.

Species of less value: yellow poplar, butternut, basswood, maple, elm, beech.

Species usually removed: ironwood, cottonwood, sassafras, water beech, etc.

The character of the tree is more important than the species. Tall, straight trees with well developed, thrifty top are left in preference to those which are spindling, weak-topped, crooked or unsound. In a group of equally good trees it is often best to remove one or more, for by so doing the remaining trees will produce more wood than all of them had they been left undisturbed. Trees with their crowns entirely exposed to sunlight are seldom removed unless a number of thrifty ones will be assisted. Those completely overtopped by others have ceased to be a factor in the growth of the stand and may be cut whenever their wood will pay for their removal. Another class of trees are those which receive sunlight from above but which have their sides shaded. It is in this class, where the struggle for existence is most severe and where the greatest economy of energy can be brought about, that most thinning is done. It is better to make light thinnings, never more than a fifth of the stand at a time, than to remove too many at once, for this opens up large patches of ground which dry out on exposure to sun and wind and furnish an excellent opportunity for the growth of grass and undesirable brush. It is not safe to say that this species must be removed to make room for that or that three sprouts must be cut from a group of six. All the improvement thinnings must be made upon the judgment of the operator.

In the woods which contain large open spaces here and there trees should be planted as in mature open stands. In any case growth of young trees and shrubs should not be hindered but rather encouraged on a strip at least two rods wide. A windbreak should be planted if necessary.

#### YOUNG STANDS.

*Character.*—The third type of woodlots is the young stand. The ground, seeded by the trees left after all merchantable timber was cut, has become covered with second growth trees four to twelve inches in diameter and twenty to fifty feet in height. Many of them are straight and thrifty, but many more are gradually being suppressed and are dying. Trees in little groups here and there which started from seed the same year are so evenly matched in size that growth is temporarily arrested.

*Care.*—The seed trees which determined the composition of the young stand are becoming useless through decay and other defects. Often there are grape vines, old fire-scarred snags and other material with which the lot could well dispense. These should be removed. At the same time a thinning could profitably be made if the stand is too thick. The aims and results of thinning have already been discussed.

#### PLANTING.

Under this subject the main points of planting and growing woodlots are mentioned for the benefit of those who wish to have more timber than can grow on the land already forested.

*Location.*—In general not less than one-eighth of a farm's total area should be in woodland. Some have more than this amount, but many others have practically not a single acre in woods. As has been said before, the woodlots existing at present have little, if any, relation to farm buildings. A little corner cut off by a stream or railroad, or land otherwise unfit for agriculture because of steepness, rocks, etc., furnish a place to plant a woodlot. It would be well if these so-called waste portions were so situated that timber growing on them could form a windbreak. This idea of protection should always come into consideration when preparing to plant.

*Species.*—Whatever the opinions of individual nurserymen may be regarding the species to plant, there will never be found trees better suited to any region than those which are natural to its soil. For central Indiana we recognize white oak, red oak and burr oak, ash, walnut, hickory, sugar maple, black cherry and elm as types for lumber; and osage orange, black locust, coffee tree, catalpa, etc., as types best suited for the production of posts, poles and ties. Careful examination of the soil should also be made, and only such species which will develop best under the existing conditions should be planted. These two points were brought out fully under the topic "Forest Cover" in "The Model Woodlot."

*Preparation of the Ground.*—The ground should be plowed, harrowed and worked into as good condition as for any agricultural crop in order to secure the best results. However, it is not necessary to prepare it so carefully. Planting has frequently been done with good results on burned over woodland according to the third method described below under "Planting." But trees growing on well prepared ground have as much

advantage over those on unprepared as has corn under the same conditions.

*Where to Procure Seedlings.*—The farmer may grow his own trees from seed, procure wild seedlings or purchase from a nursery. Wherever possible wild seedlings are much cheaper. They are weaker than nursery grown stock, and should be transplanted to a nursery for one or two years before being planted in the field.

*Care of Trees Before Field Planting.*—Trees should be planted with as little exposure of their roots as possible, for the root hairs, upon which the tree depends for taking in its food supply, will dry out and shrivel up when exposed to dry atmosphere for even a few minutes. Some of the broad-leaved species can withstand this drying out if they receive proper treatment afterwards. The best way to prevent this is by “puddling.” A “puddle” is a mixture of earth and water about as thick as cream. It may be mixed in buckets, tubs or barrels and drawn along where trees are being dug up so they can be plunged into it immediately, or, if the seedlings have been received from a nursery, as soon as they are unpacked. If planting is to take place at once the trees may be carried to the field in the “puddle.” But if some time is to elapse before planting they should be “heeled in” as they are “puddled.” For “heeling in”:

Dig a trench deep enough to bury the roots and part of the stem. The trench should run east and west, with its south bank at a slope of about thirty degrees to the surface of the ground. A layer of trees should be placed in the trench on its sloping side, the tops toward the south. The roots and stems should be covered with fresh earth dug from a second trench, in which a layer of trees is put and covered in the same way. The digging of parallel trenches is repeated and layers of trees put in until all have been “heeled in.”

*Time for Planting.*—The best time for planting is just before growth begins in the spring. At such a time the seedlings are apt to receive the least injury. In general the frost should be out of the ground. Frost is one of the chief dangers of fall transplanting, for the young trees are often heaved out of the ground as it freezes. It is also best to choose a wet or cloudy day for transplanting.

*Methods.*—After everything has been made ready for planting the ground should be marked out in rows four, six or eight feet apart, depending on the species, character of the soil and length of time cultivation is

to continue. The methods of planting are very simple. The best perhaps requires two men. One carries a bucket of "puddled" seedlings. The other carries a spade which he sets full length in the ground. He then pushes the handle forward, sticks a seedling, which the first man hands him, in behind the blade, withdraws the spade and then steps firmly with both feet on the ground around the tree. Another rapid method which often succeeds is to plow a furrow, lay the trees against the side of it, cover with a hoe and tramp firmly. The remainder of the furrow may be filled by means of a cultivator. A third way is to dig a hole with a grub hoe or mattock. This method is used only on unprepared ground. The size of the hole depends upon the size and character of the root system. Fine dirt is then thrown in next to the roots and the hole filled up, the earth being firmly tramped as before. All trees should be planted deep enough so that when the ground settles they are covered to the same depth they were before being transplanted.

*Cultivation.*—One of the great troubles with the plantings already made in central Indiana is that they have not received sufficient care. They have been plowed or hoed a few times and then left to take care of themselves. The methods and aims of cultivation in the state reservation are given in the following:

"The cultivation given the young trees growing in the regularly planted fields was of two forms, plowing in the same manner that corn is cultivated and by hoeing. In some fields the trees were plowed and hoed, while in others they were simply hoed without plowing. They were given two complete cultivations. One plan seems to be as successful as the other. The aim sought by the cultivation was to keep down weeds and other wild forms of growth that might overcome the young trees. In the fields where the soil around the young trees was kept loose and free from weeds for a short distance from the trees (eight to twelve inches) by hoeing, and the other forms of growth permitted to stand around them, the young trees seemed to do the best. The only reasonable opinion that can be given for this fact is that the other growth formed a mulch over the soil and prevented evaporation and also a forest condition of shade and protection which resulted in good to the trees, and by keeping a clear opening around them prevented them from any smothering out, as will occur where the weeds and other growths are permitted to grow up close around them. The young trees in such fields are larger and have better

boles formed than those growing in the fields where more complete cultivation was performed. Those growing in the more open fields and where the most complete cultivation as to keeping the soil cleaned of all forms of outside growth seemed to grow more bushy and to cease growing earlier in the summer than the others. The only reasonable opinion to be given for this fact is that they were more exposed to the heat of the sun, nothing formed a covering to the soil to prevent evaporation and the trees were deprived of any sort of shade protection. No forest influence was thrown around them. . . .

It must not be inferred from the discussion of the cultivation here given that no cultivation is needed. The young trees must be given cultivation necessary to protect them from weeds and other wild forms of growth immediately around them. . . . The trees at the reservation are given the cultivation that can be performed with the means supplied, and no more. If more means were provided they would be cultivated more and better results might accrue."

It can be seen that the Board of Forestry recognizes the fact that they are not caring for the young trees in the best possible manner. A crop of weeds is not the best way to prevent evaporation from the soil. The maintenance of a dust mulch by cultivation will do this and will not use food material stored in the soil. A disc harrow or a five-toothed cultivator run through between the rows after each rain during the summer will keep up the dust mulch and keep down the weeds. In other words, a forest crop should be cared for just as a corn crop, except that the period of cultivation is longer, sometimes three or four years.

*Thinning.*—The maximum number of trees per acre at maturity is about two hundred. It has already been shown why thinning is beneficial, so only this remains to be said: a few years after the plantation has become well established the process of thinning should begin. The weakest and poorest trees and those crowding better ones should be removed here and there to make room for their more vigorous neighbors. Gradually this process should continue, the material being utilized, until at maturity the woodlot has the requisite number of good trees and also has provided for a permanent supply.

## DOES A WOODLOT PAY?

The question naturally arises, Is a woodlot a paying proposition? If it is not, why are the most progressive farmers taking such an interest in forest planting and forest management? Timber is a necessity. In earlier times it was not so valuable, so the land was cleared. The remnants of the old forest may easily be improved at odd times. The cost is much reduced if the farmer does his own work. So it is with planted woodlots, especially if wild seedlings are used. Besides, the price of timber is advancing as the supply is diminishing. This alone encourages planting.

The following extract from a letter shows that with a little care a woodlot can be made to pay:

"I have logs enough cut now to make from forty to fifty thousand feet of lumber. These logs I cut from a ten-acre grove that was only a brush patch thirteen years ago. In addition to the logs the grove has supplied plenty of wood for from two to four stoves, and some for sale, besides posts and poles, all of which came from the thinnings. There are still enough trees on the land to make a good grove." The present generation may not reap the profits but the next one will.

## SUMMARY.

The following conclusions have been drawn from this study:

1. The present woodlots, only the remnants of the early forests, are in very bad condition.
  2. Well-ordered woodlots are valuable financially, climatically and aesthetically.
  3. Old woodlots may be improved and new ones planted successfully.
  4. Woodlots must be protected and well cared for in order to secure the best results.
  5. A woodlot is a paying investment.
- The one thing lacking is universal interest.

Wabash College,  
Crawfordsville, Ind.

## LIST OF USEFUL PUBLICATIONS.

- Record, S. J. Suggestions to Woodlot Owners in the Ohio Valley Region.  
U. S. Dept. of Agriculture. Forest Service. Cir. 138. Feb. 25,  
1908.



- Graves, H. S.; Fisher, R. T. The Woodlot. Bureau of Forestry. Bulletin No. 42. 1903.
- Green, W. J., and Waid, C. W. Forestry Investigations, I. Ohio Agricultural Experiment Station. Bulletin 158, 1905, and Bulletin 189, Jan., 1908.
- Jones, L. R. State Nursery for Forest Tree Seedlings. Vermont Agricultural Experiment Station. Bulletin 127, Apr., 1907.
- Pinchot, Gifford. U. S. Dept. of Agriculture. Farmers' Bulletin 173.
- Hall, Wm. L. Practicability of Forest Planting in the United States. Reprint from the Year Book of the Dept. of Agriculture for 1902.
- Forest Extension in the Middle West. Reprint from the Year Book of the Dept. of Agriculture for 1900.
- Card, F. W. Windbreaks. U. S. Agricultural Experiment Station of Nebraska. Bulletin 48, Apr., 1897.
- Sudworth, Geo. B. The Forest Nursery. U. S. Dept. of Agriculture, Division of Forestry. Bulletin 29, 1900.
- Miller, F. A. Insect Injuries to Forest Trees of Indiana. Seventh Annual Report of the Indiana State Board of Forestry.
- Freeman, W. H. Sixth Annual Report of the Indiana State Board of Forestry.
- Hawes, A. F. Chestnut in Connecticut and Improvement of the Woodlot. Conn. Agricultural Experiment Station. Bulletin 154.
- House, H. D. Improvement of the Woodlot. S. C. Agricultural Experiment Station. Bulletin 129.
- Kellog, R. S. Forest Planting in Western Kansas. U. S. Dept. of Agriculture, Forest Service. Bulletin 52.
- Thomas, M. B. Forestry in Indiana. Reprint from the Indiana Academy of Science. 1901.
- Publications of the Forest Service:
- Suggestions for Forest Planting in the Northeastern and Lake States. Cir. 100.
- How to Cultivate and Care for Forest Plantations on the Semi-Arid Plains. Cir. 54.
- How to Transplant Forest Trees. Cir. 61.

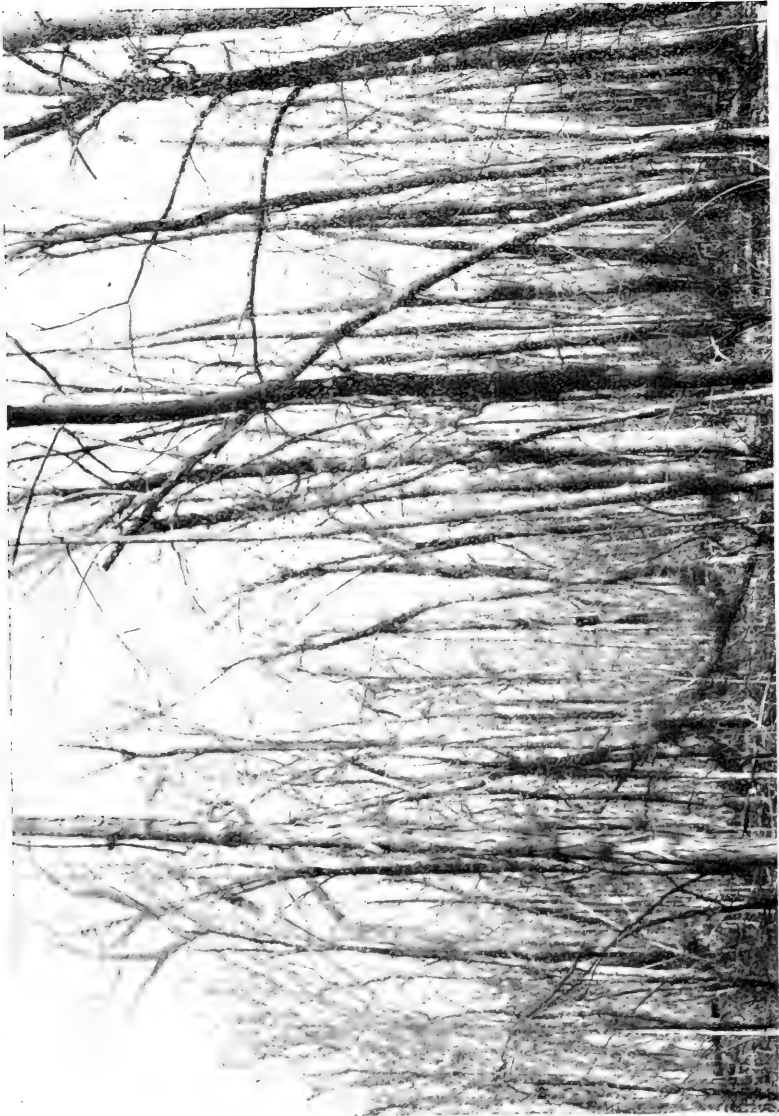

No. 1. An irregular stand in almost virgin condition. The owner will not allow a single tree to be cut. The fallen trees, decaying logs and accumulating underbrush indicate waste. This is not forestry, but neglect.

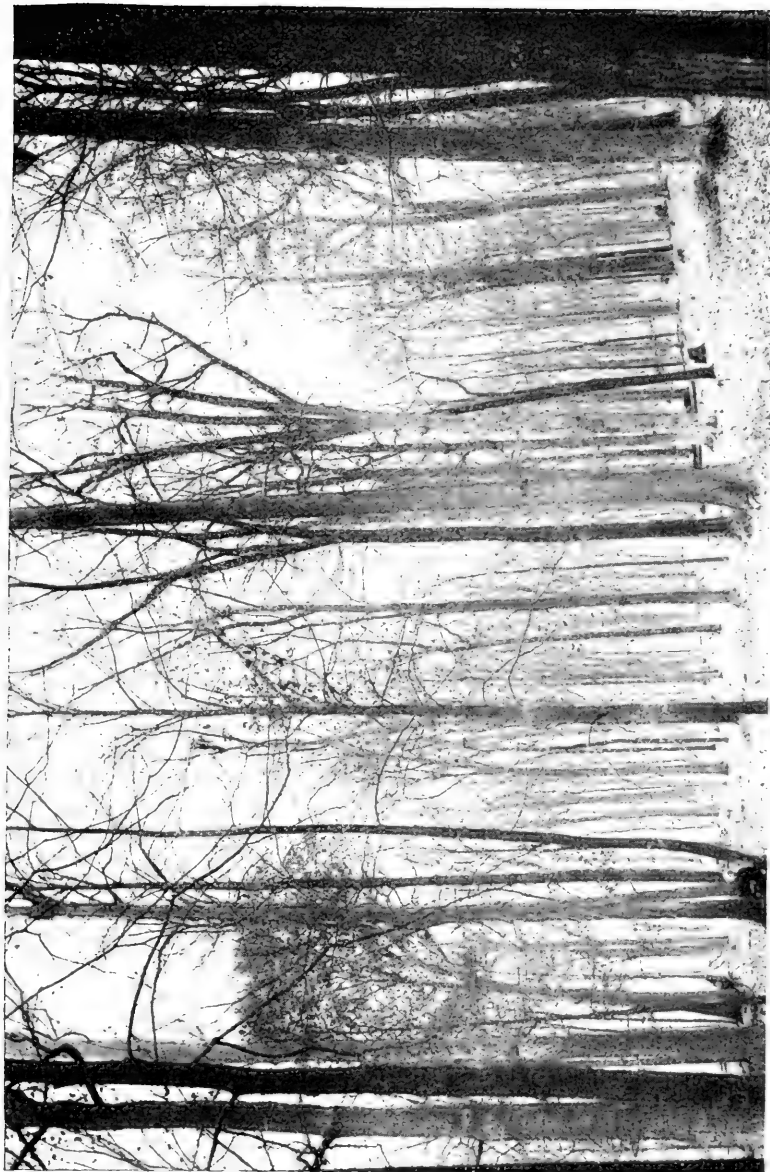

No. 2. A mature open stand. The ground is covered with a thick growth of grass, a great enemy of reproduction.

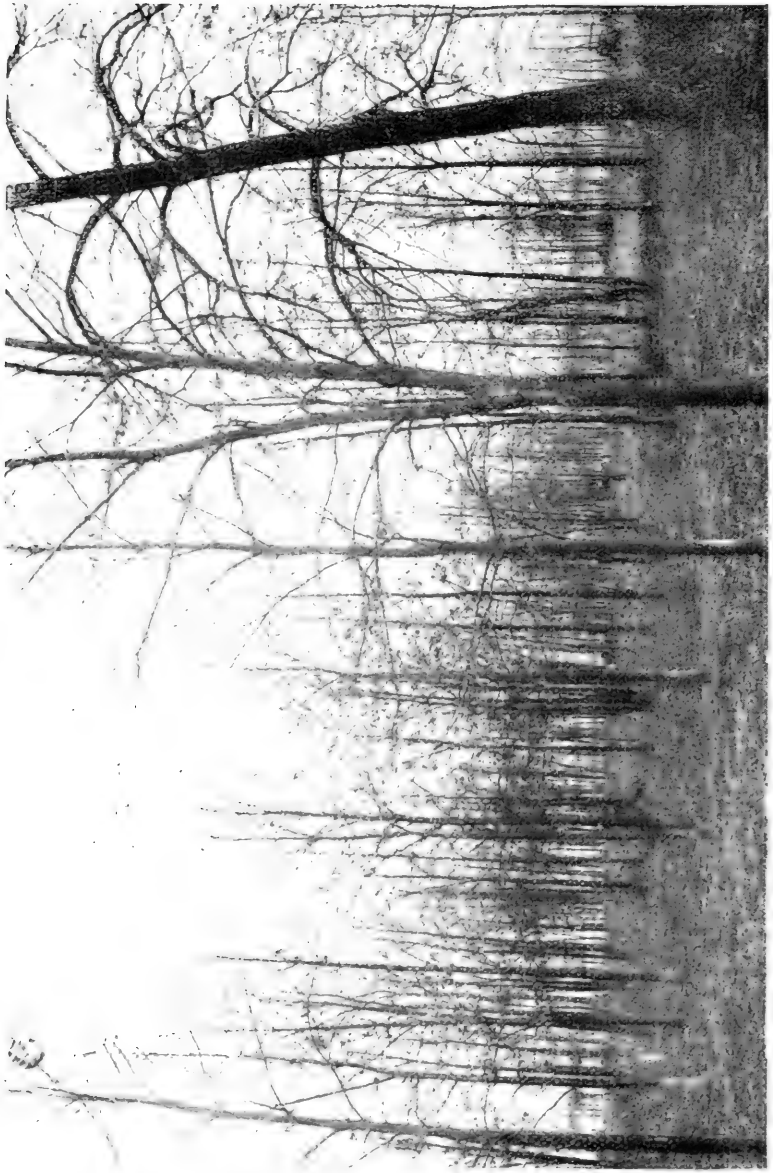

No. 3. A young stand of hickory about fifteen years old. All the grass has been tramped down and killed under the large black oak on the right. This would make a good grove if the cattle were excluded and the growth of seedlings encouraged.



No. 4. The usual evidence of neglect of the woodlot. Pasturing has destroyed the young growth. The mature trees not needed for seeding should be cut. The fallen timber should be taken out and saved. Unless the stand is thickened, the young growth will be low branched and worthless.



## RECENT WORK IN WOOD PHYSICS.

By WILLIAM KENDRICK HATT.

(Abstract.)<sup>1</sup>

The new series timber tests of the Forest Service, which constitutes the most important recent series of experiments, was begun in 1902 under the direction of Mr. Gifford Pinchot, Forester, Forest Service, United States Department of Agriculture. About 44,000 test pieces have been tested.

These timber tests are divided into two parts: Class (a). Tests on market products of actual size, in which characteristic defects occur, such as stringers, vehicle parts, railroad ties, of interest and value to engineers and manufacturers. These correspond to tests on riveted joints or built-up structures in metal testing. Class (b) includes so-called "scientific" tests of small, perfect specimens with uniform moisture content, representing material collected from the forest, in which the strength is related to the physical structure and position in the tree. These tests are of especial value to the botanists and foresters and aid the solution of silvicultural problems.

A summary of results obtained to date will be presented.

### INFLUENCE OF CONDITIONS OF TESTS UPON RESULTS.

(In these studies small, perfect specimens are used).

1. *Speed of Test.*—The strength of wood varies significantly with the speed at which stress is applied, increasing more rapidly as the speed increases. Tests are standardized for speed<sup>2</sup> on the basis of fiber strain per unit of time; and experimental factors obtained to adjust strength values from one speed to another. The adopted standards of fiber strain are as follows, expressed in inches per inch per minute:

Large beams .....	.0007
Small beams .....	.0015
Compression parallel to grain, small pieces .....	.003
Compression parallel to grain, large pieces .....	.0015

<sup>1</sup> Abstracted from paper by the author, read before the Copenhagen Congress of the International Society for Testing Materials.

<sup>2</sup> See Proceedings American Society for Testing Materials, Vol. 8, 1908, page 541. "The Effect of the Speed of Testing upon the Strength of Wood and the Standardization of Tests for Speed," by H. D. Tiemann.

Strength of wet or green wood is much more sensitive to changes of speed than is dry wood. At the speed adopted for official tests a change in speed of 50% may ordinarily be allowed without causing a variation in strength of over 2%.

2. *Temperature.*—Since wood is a more or less plastic substance it is sensitive to changes of temperature. Tiemann's<sup>3</sup> experiments show that soaking certain species in water at normal temperature does not affect their strength. It appears, however, that warm water has a marked weakening effect. The extreme condition is when wood is made pliable by boiling. Some woods are no doubt more sensitive than others to the effect of temperature of the water in which they are immersed. In recent tests made in winter weather on red oak (*Quercus Rubra*) ties at Purdue University, ties taken from the temperature of the storehouse (about 25° F.) were from 9 to 17 per cent stronger than those tested at the temperature of the laboratory (about 70° F.). Probably this marked difference in strength is to be found only in case of green or wet wood. The rupture work is not affected to the degree of the ultimate strength. Hickory seems specially sensitive to change of temperature. It is concluded that the ordinary temperature variations of the air of a laboratory are not important, but that the temperature of the storehouse may render it necessary to warm the wood. In fact, the effect of a given factor on the strength of timber, or difference of strength of two species, may at times be entirely masked by variations of temperature of timber at the time of test.

3. *Moisture.*—The effect of moisture on the strength of wood has been thoroughly investigated by Tiemann.<sup>4</sup> His material was small test pieces uniform in moisture content throughout the cross-section; and he determined the distinct "fiber saturation" point, above which increased moisture content did not affect the strength of timber and below which there was an increase of strength. Previous experiments, yielding a continuous moisture strength law, were apparently made with "case-hardened material."

<sup>3</sup> Bulletin 70. Forest Service, 1906. "Effect of Moisture on the Strength and Stiffness of Wood," by H. D. Tiemann.

<sup>4</sup> Bulletin 70. Forest Service, 1906. "Effect of Moisture on the Strength and Stiffness of Wood," by H. D. Tiemann.

Circular 108, Forest Service, 1907. "The Strength of Wood as Influenced by Moisture," by H. D. Tiemann.



## RELATION OF TESTS.

The relation between the strength under various kinds of tests, such as shear, bending, etc., and compression parallel to the grain, have not been determined yet by an analysis of the data. It is doubtful if any one test can be used to predict the strength of the material under other forms of tests when conditions vary with respect to previous heat treatment, moisture, drying or preservative treatment. For instance, brittleness induced by overheating is evident in impact tests, but this will not necessarily be evident from the compression test parallel to the grain.

An investigation of the effect of speed of test is a part of the general study of behavior of wood under three conditions of loading:

- (a) Dead or constant load.
- (b) Ordinary static test with increasing load.
- (c) Impact test.

(a) Dead load tests exhibit the plasticity of wood. Nearly all deformations increase with duration of load, but the deformed beams subsequently tested show no loss of ultimate strength. Deflection brought about by humid atmosphere is not recovered by subsequent drying. The question is often asked: "What per cent of the load, as determined by the ordinary static test, will break a beam if left on indefinitely?" This has no answer.

(c) Under impact loading, wood will submit to greater elastic deformation than under the ordinary static tests. Impact bending tests show elastic deformation largely in excess of those experienced under static load. The impact test is made under increasing height of drop.<sup>5</sup> The order of resistance of air dry woods at the ultimate failure strength, so far obtained is as follows:

Hickory, Longleaf Pine, Douglas Fir, Loblolly Pine, Chestnut, Spruce, Yellow Poplar, Western Yellow Pine, Western Hemlock, Sugar Pine, and Coast Redwood.

(d) *Abrasion Test.* The abrasion test is under study.<sup>6</sup> Wood is worn by sand-paper in the Dorrey Machine.

<sup>5</sup> Circular 38, Revised, Forest Service. "Instructions to Engineers in Timber Tests," by W. K. Hatt.

<sup>6</sup> See American S. for T. M., Vol. 7, 1907. "P. U. Impact Testing Mach.," by W. K. Hatt.

## INFLUENCE OF TREATMENT PREVIOUS TO TEST.

(a) *Drying in Hot Air, Steam, Saturated Steam, etc.* A research is under way to investigate the safe limits and the most advantageous conditions for the commercial processes of drying wood. The immediate strength after drying is of course usually greater because of the lessened moisture content. It is now apparent, however, that all processes of drying wood, even air-drying, are attended with weakening of structure, so that when the dried wood is resoaked there is a loss in strength of 10%, and generally more. The drying of white ash (*Fraxinus americana*), for instance, at 145° F. in either dry air or exhausted steam, or in superheated steam at 312°, caused no significant loss in strength in the air dry condition, but the resoaked wood was considerably weaker than the green wood. Under 20 to 30 pounds of steam applied during 1 to 4 hours, pine and ash suffer but little loss in static strength after the moisture from the steam is removed by air drying. At higher steam pressures (above 50 lbs.) large and permanent losses result. An equal amount of dry heat is less injurious to wood than moist air or saturated vapor, whenever the temperature exceeds 212° F. The hygroscopicity of the wood in the air-dry condition is reduced by the process of drying in steam, dry-air or saturated steam. Microscopic study shows that the cell walls split open because of the shrinkage of these walls when they begin to dry out.

The results from the Drying-Strength Study are not sufficiently advanced to allow complete conclusions.

(b) *Treatment with Preservatives.* Tests at the Louisiana Purchase Exposition<sup>7</sup> established the safe limit of steaming for seasoned loblolly pine to be 30 lbs. applied for 4 hours, or 20 lbs. applied for 6 hours. Burnettized loblolly pine ties exhibited some degree of brittleness under impact test. Creosote appeared to act upon the strength in the same way as water. It retards the seasoning of timber, with beneficial results to its physical condition. Present evidence points to steaming, or effect of heat in preliminary seasoning, as the only dangerous element of the treating process. The proper limits of heat should be determined for different species of timber.

In the case of bridge timbers, of coniferous species, of large size, incomplete evidence indicates that the desired penetration of creosote can

<sup>7</sup> Circular 39, Forest Service. "Experiments on the Strength of Treated Timber," by W. K. Hatt.

only be obtained by cylinder processes that reduce the strength of the timber. The unit stresses used in the design of creosote structures should, therefore, in these cases, be decreased below standards established for natural wood.

#### UNIT STRESSES FOR DESIGN.

The relation of strength of large sticks, involving defects, to small and perfect pieces, taken from the parent beam, is reported in Circular 115, Forest Service. The strength of large and small sizes is not a question of geometrical magnitude, but of the existence of defects in the large sticks such as knots, shakes, checks and the presence of inferior growth.

Study has been given to the failure of large beams under longitudinal shear. It is apparent that, in the case of large beams of seasoned timber, the failure is due to longitudinal shear rather than to bending. In green beams, also, this form of failure is frequent. Therefore, shearing stresses should be taken account of in the design. The result of later tests confirm the early results that the strength of large pieces is not increased by subsequent seasoning, except in case of select grades. In other words, unit stresses for design should usually be based upon strength of green timber.

#### NEW SPECIES AND SUBSTITUTES.

The eucalypts of California and the South have been tested. They are among the strongest of our woods. The quality of the various species differs greatly, varying in kiln dry state from 25,000 pounds per sq. in. to 13,000 pounds per sq. in. in modulus of rupture. Tests have been completed on tan-bark oak, which formerly was left stripped of its bark in the woods.

#### GENERAL STUDIES OF SPECIES.

Tests of red gum are completed.<sup>8</sup> Tests of various species of hickory collected from various site conditions have been made and the report completed. These latter tests established relations between rate of growth and strength, locality and strength, and species and strength. It appears that the most fundamental factor governing the strength of wood of any species is the specific gravity, or, in the conifers per cent of summer wood.

<sup>8</sup> Bulletin No. 58, Forest Service. "The Red Gum," by Alfred K. Chittenden.

*Technical Problems.*—The study of track fastenings, including common and screw spikes, and tie plates, and the relation of these to the strength of ties is in progress. Laboratory tests are supplemented by service tests in tracks of railroads under operation.

TECHNIQUE OF TESTS AND THE ORGANIZATION OF THE LABORATORY WORK.

The methods and records and organization are now well developed. The results of experience for the past six years are contained in Circular 3S, (Revised), entitled "Instruction to Engineers in Timber Tests." Recently a department of microscopic examination of wood has been added to study manner of failures in the tissues, changes in structure resulting from heat treatment, location of preservative fluids and allied problems.

Purdue University.  
Lafayette, Ind.

## FOREST CONDITIONS IN INDIANA.

BY STANLEY COULTER.

Certain economic statements may serve as a suggestive introduction to this study of Forest conditions in Indiana. Some of these will be more fully elaborated later in the paper, others need no comment since their mere statement is sufficient to call attention to existing conditions.

A reference to the Census report of 1880 will show that at that time Indiana ranked sixth in the list of lumber producing states. In 1908 it ranked twenty-seventh.<sup>1</sup> Not only had it fallen to this low position in the list of lumber producing states, but the cut of 1908 was very decidedly less than that of 1907. While some part of this latter loss may be attributed to the reduced demand for lumber in 1907, all of it cannot be so referred. As a matter of fact the cut made represented all of the high grade timber upon which lumbermen could lay their hands.

While certain regions of the state, notably in the southern counties, still appear to be heavily timbered, an examination shows that practically all forms of high value have been cut from them. They have been swept clean of their yellow poplar, white oak, black walnut, and cherry and are made up almost entirely of what may be regarded from an economic standpoint as second grade or inferior forms. It is these inferior forms that are furnishing the future forest, if indeed there is any promise of a future forest. The splendid forests of the past,<sup>2</sup> splendid not only in extent but in the quality of the timber they yielded, have disappeared and the forests that remain are infinitely inferior to them both in extent and quality. Present conditions indicate a still further deterioration unless prompt remedial measures are taken.

A rather careful examination of the existing areas, supplemented by the opinion of lumber buyers, leads to the conclusion that few extensive areas in the state will show a stumpage of desirable forms exceeding 2,500 feet board measure. My own judgment is that the average stumpage

<sup>1</sup> Forest Products No. 2. Lumber, Lath and Shingles, 1908. Bureau of the Census, issued November 15, 1909, p. 8.

<sup>2</sup> Stanley Coulter. The Forest Trees of Indiana, Trans. Ind. Hort. Soc., 1891, p. 8. A. W. Butler. Indiana: A Century of Changes in the Aspects of Nature, Proc. Ind. Acad. of Sci., 1895, pp. 32, 33.

is below this figure. In order to reach this estimate it has been necessary to include beech, elm, and sycamore, species which for various reasons are not to be classed with white oak, yellow poplar and black walnut. Indeed the eager search for beech and elm is a fairly conclusive evidence of the paucity of forms of higher quality in the forests of the state. Of course there exists here and there throughout the state small tracts showing a heavy stumpage of high grade species, but such areas are the exceptions that prove the rule.

A constantly increasing number of wood-working plants are shutting down because of inability to secure the needed raw material. The radius marking the limit from which this raw material can be drawn is very definitely limited by freight charges. I have received a statement, which may be considered as official, that fifty per cent. of the veneer plants of the state are shut down because they are unable to secure logs suitable for their work. What is true of the veneer industry is true in varying degree of other wood-working industries. This means, unless checked, loss of employment to hundreds or even thousands of men, and either a removal of capital to other states or its absolute loss. The reduction in the number of wood-working plants in the state within the last decade has been startlingly large and can only be explained by the rapidly waning supply of suitable raw material.

While the data in my hands are not yet complete, I have records of over five hundred thousand (500,000) acres of waste land in the state. This waste land, located in a very great measure in the southern portion of the state, is the result in almost every instance of destructive lumbering. Concerning this conclusion there can be no doubt. We have knowledge of former forestal conditions, and in many cases the history of the cuttings of specific tracts. These waste lands lie open and are absolutely waste; they are not used in agriculture or horticulture and have wasted to such an extent that they are completely abandoned. They yield revenue neither to the owner nor the state. The indications are that the amount of deforested land abandoned by the owners is constantly increasing. The surest, indeed the absolutely unmistakable sign of a decadent state from an economical standpoint, is a constant increase in the area of abandoned lands.

To counteract the conditions indicated in the preceding paragraphs, tree planting has been undertaken in the state on a fairly large scale within

the past few years. These plantings have been made by individuals and by corporations. The tree plantations run up into the hundreds and the number of trees into the hundreds of thousands. A careful inspection of sixty-nine of these plantings, embracing two hundred fourteen thousand (214,000) trees was made in 1908-09 by Messrs. U. C. Allen and H. C. Kennedy. The plantations examined covered the state with the exception of the southeastern counties and represented practically every type of soil and drainage conditions. Supplementing their records by my own observations and those of Secretary C. C. Deam of the State Board of Forestry, I am led to the conclusion that afforestation operations in the state have been, in a large measure at least, unsatisfactory. While there are occasional instances of successful and apparently profitable tree culture in the state, it is very certain that, taken as a whole, the results are not of such character as to give promise of any relief from present conditions in the immediate future. The plantings have been chiefly catalpa and black locust. Only in exceptional cases, and then rather as the result of chance than a definite purpose have other species been tried. A very few small plantings of black walnut and white ash practically represent the attempt in growing trees of high grade.

The reasons for these unsatisfactory results are not far to seek. They may be grouped under three categories:

1. Ignorance of the silvical qualities of the species.
2. Poor seed or seedlings which were not of the species desired.
3. Ignorance of the cultural requirements for securing rapid and healthy development.

Apparently in many of the plantations no question as to the fitness of the soil, or drainage, or exposure entered. In another large series of catalpa plantings the larger number of the trees were not the hardy catalpa (*speciosa*) but *C. bignonioides* or some hybrid. In more than one-half of the cases absolutely no attention was given after the planting, to cultivation, to pruning or to coppicing. A study of the conditions in these plantations is sufficient proof that afforestation operations will not be successful in Indiana until a much fuller knowledge of the silvical qualities and requirements of the species selected becomes common property.

Bad as the existing conditions are, the case is far from hopeless. The aggregate timbered area of the state is still large and while the stumpage is not heavy nor the quality all that could be desired, yet these areas

furnish not only the hope but the assurance of the future, if, *and only if*, they are intelligently managed. All of the timber lands in the state, with the exception of the State Forest Reservation, is held by private owners. As a rule these holdings are relatively small and our forests may be considered as made up of a large number of wood lots. It is a fact that cannot be too often repeated or over emphasized, that it is a much more certain and a much cheaper process to maintain and improve an existing stand of timber than to produce a new one by planting. Not only is it much surer and cheaper, but it is also much more rapid.

The problem of the future of the forests of Indiana is merely the problem of securing the proper handling and care of the wood lots and small timbered areas held by individual owners. If such areas are wisely handled and conservatively lumbered there is no reason why they should not for years yield a steady and increasing income and at the same time show a marked increase in quality and value. In other words the problem of the future timber supply in the state is very largely a problem of education. Owners of timbered tracts must be brought to a realization of the value of such holdings and trained in methods of management which will secure the results indicated. It must be shown also that such methods of management are profitable, for unless this can be done no method, however theoretically desirable it may be shown to be, will ever come into general use. The real peril lies in the fact that this process of education is a very slow one and that existing timber areas may be greatly reduced in value or completely destroyed before a knowledge of the better methods has become common property. An examination of a number of such tracts covering many counties of the state indicates fairly well what may be considered the average condition of the forests of Indiana today.

Almost without exception these timbered areas are used as pasture land, and have, in most instances, been so heavily overpastured as to practically destroy all prospects of the regeneration of the forest after the removal of the present trees. An examination of seventeen such wood lot pasture tracts during the past season which were distributed through twelve counties of the state, revealed the fact that in not a single one could any young seedlings or healthy, well formed saplings be found. Any system of management under such conditions is perfectly useless. Unless the condition of the wood lot areas is improved and the regeneration of the forests provided for by an abundant and vigorous growth of seedlings, the end of our forests is not far distant.



In most instances the withdrawal of the tract from pasturage will be sufficient to permit an immediate springing up of sufficient seedlings to care for the future of the tract. This withdrawal from pasturage should be absolute until such time as the young growth is beyond danger from browsing animals. After that time light grazing may not be injurious, although if grazing is permitted at all, there is the constant temptation to overgraze.

The effect of this overgrazing is very easily demonstrated by simply enclosing a tract which contains no seedlings, thus protecting it from cattle. Almost invariably a dense and abundant undergrowth representing many species of tree forms will spring up and in a few years will have provided a stand sufficiently dense to allow improvement cuttings and thinings, leading to the formation of a new forest.

In the State Reserve a large acreage was burned over the year before the State took possession of the tract. At the present time, some eight years after the fire, the tract which was burned over is densely covered with a growth of vigorous and healthy young trees, with valuable species represented in such large numbers as to give certain promise of a fine even-aged stand after the cleaning and thinning cuttings have been made. The area was regenerated from adjoining seed trees. No treatment of any kind was given the tract; it was simply freed from pasturage.

In the hill regions of the southern counties, and especially in localities where the hills faced the Ohio river, the forests were removed many years ago. For years such tracts were left unfenced and during those years the land wasted through erosion and no seedlings obtained a foothold. At a later period when laws forbidding stock running at large were passed and when wire fencing came into general use, these denuded hills were quickly covered with a dense growth of vigorous young trees. No planting had been done, the soil had received no treatment, but the tract as in the former case was freed from pasturage. Such instances could be multiplied almost indefinitely and from them can be drawn a conclusion of high economic value, namely, that very many of the denuded areas of the state could be afforested by the simple process of relieving them from the burden of pasturage. It is safe to say that 90% or more of the timber areas of the state are so heavily over-pastured as to preclude any possibility of their future improvement or growth. Until the owners of these small forest tracts realize the utter destructiveness of over-pasturage but little

can be done to improve forest conditions in the state. That these statements are not exaggerated is a matter of fairly easy demonstration by any person who will go through an average forest in his vicinity and make a close examination for the young trees which stand as a prophecy of the future forest. In almost every instance they will be found to occur in such small numbers as to indicate a constantly waning forest. Indeed, in very many cases not a single seedling or sapling of a desirable species can be found.

A further examination of these areas within our state shows that in by far too many cases they have suffered damage by fire. In very many instances these fires have spread into the timber tract from the right of way of railroads or from meadow fires which have been started for the purpose of cleaning and have escaped control. However they may have originated, their effect upon the forest has been two-fold. First, in a serious damage to the mature trees and second, in practically obliterating all the young growth which may have become established. As a result of the action of such fires, not only is the young growth killed but the soil is placed in such condition as to preclude a future growth for several years. The damage by forest fires in the state during the past year, which was by no means an exceptional one, amounted at a conservative estimate to at least \$100,000. A very large part of this loss could have been avoided by exercising ordinary care. Very much more of it could have been prevented by the rigorous application of the laws fixing the responsibility for the occurrence and spread of forest fires.

The value of these wood lots as they stand might also be very greatly improved in many cases if improvement cuttings of various kinds were undertaken. Almost all of them need "cleanings" in order to remove from them various undesirable forms. It must be remembered, however, that such cleanings must not be too vigorously undertaken lest too great an amount of soil be exposed to the action of the sun and the wind. Sudden changes in ecologic conditions are particularly fatal to young tree growth. Where the undergrowth or undesirable forms are at all dense, probably not to exceed 25% should be removed at any one time and the ground should not be cut over again in less than four or five years. In these cleanings the object should be to remove all forms the absence of which would improve the forest and give the trees left standing an opportunity for a more perfect development. In this cleaning should ultimately be removed

all trees, which, even if allowed to reach full maturity, would never have an economic value. It should also include all trees that are dead or dying, since such trees are not only deteriorating in value but also serve as centers from which various diseases destructive to the forest may spread, and because in addition they furnish natural breeding places for many species of harmful insects. When such dead or dying trees are infested with fungus diseases or injurious insects, they should be completely burned. The cleaning should also include all trees which are over-mature or for any cause are losing value. Trees which are undesirable in shape or from other causes do not promise to make a satisfactory growth should also be included in the cleaning. Special attention should be paid to seed bearing trees of undesirable species. These should be removed whenever found in order to prevent their seedlings from occupying the ground at the expense of the more desirable forms.

As has been suggested, these operations must not be carried on too vigorously since the young seedlings, which are to make the future forest, require shelter from the wind and from the sun during their earlier years and if the removal of these undesirable forms is made too completely at a single operation the object in view will be defeated. By the application of such methods not only may the condition of the wood lot be constantly improved so that in the end it will contain a vigorous and healthy growth of valuable forms, but at the same time much material which may be utilized for fuel and for other purposes will have been removed from the area. In almost every instance, if care is taken, these cleaning cuttings will more than pay for the expense required to make them. It is a conservative statement to say that over one-half of the existing wood lots in the state would be very greatly improved in value and in productive capacity by a series of judicious cleanings.

In addition to these cleaning cuttings, in certain regions "thinnings" seem to be required. Two trees of a valuable species may stand so close together that if both were allowed to remain, neither would develop into a good tree. One of them should be cut away. In almost every wood lot also, there are to be found clumps of trees which stand so close together that they have developed thin, weak stems instead of stout and sturdy trunks. Enough of these should be cut out to insure a healthy and vigorous growth on the part of the trees that remain. The thinnings differ from the cleanings in that, while the cleaning removes undesirable and injur-

ious forms only, the process of thinning removes desirable forms where they are wrongly placed in order that the trees left standing may have a better chance. There is scarcely a wood lot in the state in which manifold instances of the value which would result from careful thinning cannot be found.

The existing wood lots can be still further maintained in good condition by a more careful use of the material which is cut from them. There is a constant tendency to cut such trees as will work up most easily, whatever may be the purpose for which they are to be used. Good straight white oak of sufficient size to have a high value for lumber is cut for fire wood, or rails, or posts, when a score of other species which have no lumber value might serve these purposes as well if not better. In the same way large numbers of vigorous and straight young saplings are cut down for hoops, for poles, or for other of the manifold uses of the farm. Such wastefulness under present conditions is little short of criminal. The woods of high value should be allowed to come to their full size and development and the ordinary uses of the farm supplied from inferior timbers which are of less value and of less general usefulness.

Great care should also be taken in working up the tops of the trees cut in such a way as to utilize them as far as possible. Not only does such utilization reduce the number of trees that are cut from the tract, but it at the same time protects it from damage by fire, since the dry tops of trees burn fiercely and are always a great peril in case of fire. An examination of an ordinary cutting whether for wood or lumber or clearing will show that scarcely 50% of the tree is utilized.

It is very difficult to form any estimate of the amount of the present timber stand of the state. As contrasted with the past the average amount per acre has been very largely reduced. As examination of the sources of supply of wood manufacturing plants will show that a large proportion of the more valuable timbers which they use in their work are secured from without the boundaries of the state. As an illustration, information derived from certain veneering companies of the State may be given.

The Indiana Veneer and Lumber Company uses in its operation oak and principally white oak. Most of this is derived from the states between Ohio and Missouri, but not above 25% of it is secured from Indiana.

The Evansville Veneer Company cuts gum, poplar, white oak, red oak, sycamore and beech. They purchase these woods in Tennessee, Kentucky, and Mississippi, getting none from Indiana.

The Goshen Veneer Company uses bass wood, maple, ash, elm, sycamore, beech, poplar, oak and walnut. The oak they buy in Illinois and Kentucky; the poplar south of the Ohio river. As nearly as they can estimate, 60% of the material which they use comes from Indiana.

The Hoosier Veneer Company uses white oak very largely, with some red oak. About 35% of this material comes from the south and about 65% from Indiana.

Showers Brothers Company, Bloomington, cut only those woods that are native to the southern part of the state. They include in their work the different varieties of oak, poplar, beech, maple, sycamore, elm, ash, and hard gum with occasional logs of walnut and cherry. The last two are taken from southern Indiana. A direct quotation from the letter of their secretary is extremely suggestive. "There is yet quite a quantity of timber in this section of Indiana. It is, however, becoming very much scattered. The visible supply of veneering timber in Indiana is rapidly diminishing. In my opinion *within four or five years it will be necessary for the larger mills to draw from out of the state a large part of their logs.* The quality of southern Indiana logs, principally the oak varieties, is the best in the country for veneering purposes. The texture of the grain and of the figure being far superior for cabinet purposes to the southern varieties. We use in our veneering mill alone about 35,000 feet log measure of timber per week. It is my opinion that further development of the veneering industry will do more to save the diminishing supply of timber in this state than any other one thing, as in working timber into veneer an enormous saving in waste is effected."

The Diamond Veneer Company uses only quartered oak in its operations, buying flitches from the saw mills and not buying logs. The company estimates that about 90% of its stock comes from Indiana mills, but has no knowledge as to the sources of supply of the mills.

The Putnam Oak Veneer Company uses practically any of the native woods of Indiana. The woods principally used are white, burr, and red oak, ash, hickory, bass wood, soft elm, poplar, walnut, black gum and beech. "Probably 20% of the wood, such as gum, cottonwood, poplar, red and white oak, comes from our native forests, the balance comes from the

south, where the timber is better as to size and cheaper as to price than our own timber. In my judgment we do not furnish over 40% of the lumber consumed in the state, the balance comes from the south. As is a well known fact, Indiana oak is the finest grade of oak that was ever grown in this continent. It is beyond the power of any living man to produce the wonderful forests of oak, poplar, ash, and walnut that once covered this state of ours. We gather our supply from all over the state. Fifteen to twenty-five years ago we were able to buy bunches of oak timber in from 75,000 to 100,000 feet lots, but now we pick up a tree here and there where possible. The condition has been reached that the state is swept practically clean of all its native oak."

Mr. Howard I. Young, Secretary of the National Veneer Association, estimates that there is in the neighborhood of ninety million feet of oak veneer manufactured in Indiana annually. This output is classified broadly into two parts, quartered oak veneer amounting to about sixty-eight million feet, and rotary cut oak veneer, amounting to twenty-two million feet. While much of the oak material is secured from Indiana, Ohio, and Illinois, a very material quantity of oak logs are shipped from the southern states to fill the demand for this class of material.

These extracts indicate that for many years selective cutting has been practised and in fact has been increasing as the years have passed. Timber area after timber area has been swept clean of its black walnut, its yellow poplar, its white oak, its cherry, and other trees of high grade and large size. As a result the forests that are left are composed of less desirable forms, and it is these less desirable forms that are furnishing the forest of the future in so far as any such future is to be hoped for. It is very evident from this statement of facts that if the high reputation of Indiana timbers is to be maintained and that if Indiana continues to be able to provide material for its own wood manufacturing industries, some close attention is demanded along the lines of the regeneration of existing wood tracts with desirable species. This may mean planting in certain open places, but even in spite of the considerable expense involved in such a process, the results reached would far exceed in value the cost incurred. While the experimental period at the State Forest Reserve has as yet been too brief to furnish data for authoritative conclusions, the indications all point to the fact that high grade trees such as yellow poplar, black walnut, and ash will grow as rapidly as the catalpa and black locust.

Not only are the indications that they will grow as rapidly, but also that they will maintain themselves in a healthy state, in good form and be relatively free from insect attack and fungus disease. While it is true that the oaks which are at present in very high demand will not make such rapid growth, it has been found that they will make a sure and healthy growth and that in all probability a natural regeneration of the existing wood tracts with our native oaks and other high grade timbers would be easily within the range of possibility, were it not for over-pasturage, damage by fire and destructive lumbering.

All of this means that in the use of the wood lot or small timber tract the owner should have constantly in mind *its perpetuation in unimpaired value*. No tree should be cut unless there is evidence that its place will be quickly taken by another equally desirable form and this evidence is always at hand in the presence of an abundant young growth. If such a young growth is not present, cutting cannot be done without diminishing the value of the stand. In every case the owner should regard a stand of timber as an investment from which he should derive a constant revenue, while at the same time the investment remains unimpaired. The scarcity of high grade timber, the eagerness with which it is sought and the relatively high stumpage values all combine to tempt the owner to such an impairment of his investment, but a yielding to the temptation is an indication of poor business judgment.

It may be necessary in many instances to reinforce the relatively slow process of natural seed regeneration. This may be done cheaply and efficiently in many ways, which are self-suggestive, yet which will bear re-statement. The weeds and brush may be cut away from the immediate neighborhood of the "mother seed tree" in order that the seeds may come in closer contact with the ground when they fall, thus greatly increasing their chances of successful germination. If the soil is hard and compact it may be broken with a hoe or plow so as to furnish a more satisfactory seed bed. In some cases where the litter of leaves is quite deep it may be advisable to rake it off in order to expose the mineral soil and even in extreme instances to burn it off, although burning over a tract to reinforce natural seed regeneration is an extremely doubtful process in unskilled hands. The methods suggested do not cover wide areas and are the ordinary methods used in the management of other crops. Whatever form they may take the result sought is the same, an increase in the number of seeds germinating by improving the character of the seed bed.

It is very obvious from this résumé of conditions that unless the owners of existing wood lots attack the problem in an intelligent way the time is not far removed when practically all of the material used in our wood manufacturing plants will have to be shipped in from other states.

The conclusion to be drawn from the statements in the above paragraphs are all but obvious. Practically all of our forests are in private hands and it is very evident that the timber problem in Indiana is to be solved by private forestry. The obstacles to private forestry are summarized by Treadwell Cleveland, Jr.,<sup>3</sup> as fire risk, ill-devised taxation and cheap stumpage. The first two of these he suggests are "artificial obstacles" which may be removed by suitable state legislation. Concerning the third, Mr. Cleveland says: "Cheap stumpage is the chief material obstacle to the wide extension of private forestry. Forestry involves an investment in growing timber. If the investment is to show a satisfactory profit, the product must not sell too cheap. As long as the product sells cheap, expenditures will not be made to produce it, and the lumberman will continue to be the nomad and the speculator which past conditions have inevitably made him. In order to hold out inducements to private enterprise, forestry must offer a reasonable margin of profit above the cost of growing the timber.

"This obstacle to forestry is being steadily removed by the depletion of the virgin forests and the consequent rise in stumpage prices. Already the scarcity of supplies has resulted in a number of cases in the holding of tracts for more than a single crop."

It is evident that if the timber supply of the state be maintained there must be cooperation between the state and private owners. Just what form state laws for the encouragement of forestry should take is not perfectly clear. It is evident, however, that legislation should develop out of state conditions and until the resources of cooperation have been exhausted, definite legislation should not be enacted. An examination of State laws encouraging forestry shows that they may be grouped under two general heads. First, those which seek to stimulate tree planting by bounties or tax exemptions; second, those establishing Forest Commissions and, in late years, State Foresters charged with duties suggested by the conditions in the state creating these offices. The laws under the first group have been, almost without exception, ineffective and in very many

---

<sup>3</sup> Status of Forestry in the United States. Forest Service Circular 167, pp. 23-24.



cases have been repealed and in a considerable number of other cases declared unconstitutional. Such laws "have had some slight educational value, but they have led neither to the planting nor to the preservation of forests."<sup>4</sup>

Laws falling under the second group, on the contrary, seem to have greatly advanced the cause of forestry. This has been done mainly by gathering information, cooperating with private land owners and giving advice concerning the care of private holdings and tree plantings. In many states, state forests have been established and these have in every instance proved of high value. To quote directly from Mr. Cleveland:<sup>5</sup> "These State forests represent a line of state action which has been pre-eminently successful. New York leads the list in State forest area (1,611,817 acres), followed by Pennsylvania (863,000), and Wisconsin (253,573 acres.) The smaller attempts of Minnesota, Michigan, Connecticut, Massachusetts, New Jersey, Indiana, etc., are all important. The State forests speak for themselves. First, they furnish object lessons of great value; second, they form the nucleus of what some day must be the principal center of state forest work. It is a fundamentally sound policy for the State to own land, especially land which does not offer the conditions necessary for prosperous settlement."

Under existing conditions in our own state, the most important and immediate duty is an extension of knowledge concerning the significance of existing timbered areas in their relation to the future of the forests and of the wood working industries; of their value as investments; of methods of management and utilization which will secure the maximum revenue without deterioration of the stand; of the importance of reinforcing natural seed regeneration and of a more general practice of wisely considered afforestation methods. The most casual inspection of the present timbered areas would prove sufficient to convince the most skeptical of the importance of intelligent and persistent effort along the lines indicated. If, in addition, we consider the large area of land at present utterly unproductive, areas which are increasing in extent each year, some wisely planned and judiciously applied remedial measures seem absolutely imperative. The Academy of Science could do much as a body and through the efforts of its members to aid in this work. The problem is sufficiently acute to

---

<sup>4 and 5</sup> Status of Forestry in the United States. Forest Service Circular 167, September, 1909, p. 21.

indicate that the time for destructive criticisms of present attempts for its solution has passed, and that the time has arrived for cooperation in this work. If this cannot be given, the criticism should at least be constructive. In eight years of service on the State Board of Forestry, it has been my privilege to hear many sharp criticisms of its personnel and its work, but in all that time there has come neither to the board nor to any individual member of it a single suggestion as to how either might be improved.

It may be assumed without argument that a complete invoice of the present stand, as to amount, composition and distribution is absolutely necessary in order to secure results which are even approximately satisfactory. As a matter of fact, it has been demonstrated that with the present sources of information and with the present limitations as to the functions of the State Board of Forestry the collection of such data is absolutely impossible. Yet, it is evident that such a census of our forests and such knowledge of their composition and distribution are conditions precedent to any successful work looking to the maintenance of our timber supply. It is at this point that the state should cooperate with the National Forest Service. In many states, such a forest census has been or is being taken, the Forest Service detailing experts for the work and the state paying the expenses of the survey. Such cooperation gives the most complete, the most accurate and the most easily comparable results in the shortest time and at the least expense. If such cooperative work is impossible, then the Board of Forestry should as rapidly as its means will permit, collect and organize information covering these points. The slightest consideration of the future of the forests and of the wood-working industries of the state will show that the results of such a census would prove of the highest importance, not only in determining the policy of the state but in emphasizing the significance and value of existing timbered areas.

There is need also of much more exact and indeed of much additional knowledge in relation to the selection of species for planting in the different soil, drainage and exposure conditions of the state. There is need also of equally exact knowledge concerning the silvical qualities of these species, the most economical methods of propagation, their spacing in plantings, their cultivation and care and above all their rate of growth under variant conditions. The securing of such data is a matter of years of continuous experimentation and this work the state is properly under-

taking on the State Reserve. There is necessity, however, that the fact should be kept in mind that results sufficiently definite to prove of general application can only be secured as the results of large series of experiments continued through many years. In order, however, that such work may reach its highest value there should be close cooperation with individual land owners throughout the state. Cooperative experimental plats should be found in every part of the state. The seedlings should be furnished from the state reservation and should be planted and cultivated under regulations prescribed by the State Board of Forestry. Regular reports should be made by the owners to the Board and regular inspections of such plantings should be made by its Secretary. The conclusions resulting from observations covering a wide range of conditions and involving varying degrees of care and attention would evidently be of much greater value than those possible under present methods.

There is cause for congratulation in the fact that the state realizing the gravity of the problem confronting it is taking steps to avert the disaster which our rapidly waning timber supply seems to indicate. Caution in such matters is of course wise, but it should not be forgotten that as a rule a Fabian policy is ineffective in acute cases. There is every reason for confidence, however, in believing that no backward steps will be taken and that as the years pass the development of a wise forest management on the part of individual land owners, will under the guidance of the state be far more rapid than in the past. There is reason for hope also in the general observance of Arbor Day for it gives assurance that the next generation will have a fuller knowledge and a truer appreciation of the value of our forests than their parents ever possessed.

Summarizing; the present forestry conditions in Indiana being as stated, three great lines of work suggest themselves as immediately necessary if the timber supply of the state is maintained:

1. An educational propaganda emphasizing the importance of correct forest methods, the value and potentiality of existing wood lots, and of the importance of reclaiming waste lands by tree planting.
2. A census of the present timber stand, its composition and its distribution.
3. Cooperative experimental work on the part of the state and individual land owners, for the determination of suitable species for afforestation, their silvical qualities and their rate of growth.

Quite apart from any sentiment, no more acute problem nor one which directly affects more business and individual interests confronts the state. Others may be of greater magnitude, but certainly no other one touches so intimately such wide and varied interests.

Purdue University,  
Lafayette, Ind.

## INDEX.

	PAGE
Accelerometers, Direct reading.....	205
Act for the protection of birds.....	9
Act providing for the publication of the Proceedings.....	7
Algæ, A list of.....	375
Analytics, solid, Methods in.....	201
Andrews, F. M., Papers by.....	369, 373, 375
Appropriations for 1910 and 1911.....	8
Arthur, J. C., Paper by.....	383
Banquet addresses.....	54
Barnard, H. E., On plans for the Academy.....	50
Benton, Geo. W., Address of greeting by.....	39
Bigney, A. J., Papers by.....	163, 353
Bitting, Katherine Golden, Paper by.....	391
Botany, Recent progress in.....	101
Boyle's Law, Apparatus to illustrate.....	369
Bryan, A. Hugh, Paper by.....	165
Brossman, Chas., Address of greeting by.....	44
Burrage, Severance, Paper by.....	145
Butler, A. W., The beginning of the Indiana Academy of Science.....	35
Butter fat, A study of the chemical composition of.....	181
By-laws.....	15
Cadmium cells, Polarization of.....	229
Campbell, John T., Paper by.....	354
Cerebral localization, Observations on.....	355
Cogshall, W. A., On plans for the Academy.....	52
Cohesion of water as modified by certain dissolved salts.....	249
Committee on history of early science in Indiana.....	85
Committees, Regular.....	11
Concrete Building blocks, Notes on the strength of.....	225
Constitution.....	13
Cook, Mel. T., Paper by.....	363
Coulter, John M., Banquet address.....	63
Recent progress in botany.....	101
Coulter, Stanley, On plans for the Academy.....	48
Paper by.....	447
Culbertson, Glenn, Banquet address.....	61
Cumings, E. R., Paper by.....	305
Cyanogen compound, On a new complex.....	197

	PAGE
Darwin fifty years after.....	107
Deam, Chas. C., Paper by.....	381
Delta formation, Some features of.....	255
Dennis, D. W., Banquet address.....	55
Dryer, Chas. R., Paper by.....	255
Dryer, Chas. R., and Davis, Melvin K., Paper by.....	263
Dunn, J. P., Address of greeting by.....	41
Earp, S. E., Address of greeting by.....	40
Editor, Financial statement by.....	77
Endothermic gases, Determination of, by combustion.....	199
Ethyl amine, Conductivity of certain salts in.....	175
<i>Eupatorium perfoliatum</i> , The medicinal value of.....	163
Evermann, B. W., Banquet address.....	69
Federal control of international and interstate waters.....	119
Federal control of international and interstate waters.....	119
Financial report of Editor.....	77
Report of Treasurer.....	76
Foley, A. L., President's address.....	89
The tenacity of gelatine.....	243
Forest conditions in Indiana.....	447
Gelatine, The tenacity of.....	243
Greene, Chas. W., Abstract of address.....	125
Remarks at banquet.....	69
Greetings from State Associations to the Indiana Academy of Science.....	39
Hart, W. W., Address of greeting by.....	45
Hathaway, Arthur S., Papers by.....	201, 203
Hatt, W. K., Abstract of paper by.....	441
Hay Oliver P., Paper by.....	277
Hessler, Robert, Paper by.....	127
Hiawatha, That erroneous.....	161
Hot springs, Collecting area of the waters of the, at Hot Springs, Ark.....	269
Hunziker, O. F., and Spitzer, George, Paper by.....	181
Huston, H. A., Paper by.....	111
Hygiene of indoor swimming pools.....	145
Indiana Academy of Science, Resolution providing for the celebration of the twenty fifth anniversary of.....	33
Beginning of the.....	35
Plans for the future of the.....	48
Indiana flora, Additions to.....	381
Insect galls, Evolution of, as illustrated by the genus <i>Amphibolips</i> .....	363
International and Interstate waters, Federal control of.....	119

	PAGE
Investigation of a point discharge in a magnetic field . . . . .	233
Jordan, D. S., Banquet address . . . . .	58
Darwin fifty years after . . . . .	107
Kern, Frank D., Paper by . . . . .	417
Lane, H. H., Paper by . . . . .	345
Lance Creek ("Ceratops") beds, Where do they belong, in the cretaceous or tertiary? . . . . .	277
McBeth, W. A., Paper by . . . . .	341
Mahin, E. G., Paper by . . . . .	175
Mees, C. Leo, On plans for the Academy . . . . .	51
Members, active . . . . .	18
Fellows . . . . .	16
Non-resident . . . . .	17
Middleton, A. R., Papers by . . . . .	197, 199
Migration of salmon, Speed of, in the Columbia River . . . . .	125
Minutes of the Twenty-fifth Annual Meeting of the Academy . . . . .	73
Mocking bird, The, about Moores Hill, Ind. . . . .	353
Monstrosities, Some, in plants . . . . .	373
Moore, C. R., Paper by . . . . .	205
Moore, Geo. T., Remarks at banquet . . . . .	66
Moore, R. B., Address of greeting by . . . . .	42
Morrison, Edwin, Paper by . . . . .	249
Motion of n bodies . . . . .	203
Naylor, J. P., Address of greeting by . . . . .	43
Necrology, Thomas Gray, W. H. Ragan . . . . .	24
Noyes, W. A., Remarks at banquet . . . . .	68
Officers, 1909-1910 . . . . .	10
Past . . . . .	12
Osborn, H. L., Paper by . . . . .	351
Paleontology and the recapitulation theory . . . . .	305
Parasites found in frogs in the vicinity of St. Paul, Minn. . . . .	351
Paving blocks, concrete, Notes on the strength of . . . . .	225
Pegg, E. C. and Thomas, M. B., Paper by . . . . .	419
Penicillium, The effect of preservatives on the development of . . . . .	391
Physical Science, Recent developments in . . . . .	89
Physiographic survey of an area near Terre Haute, Ind. . . . .	263

	PAGE
Preservatives, The effect of, on the development of Penicilium.....	391
Program of the Twenty-fifth Annual Meeting.....	27
Purdue, A. H., Paper by.....	269
Ramsay, Rollo R., Paper by.....	229
Reagan, Albert B., Paper by.....	161
Recap tulation theory, Paleontology and the.....	305
Rust, timothy, Further notes on.....	417
Rusts, plant, Right and wrong conceptions of.....	383
Saccharene products, Refractive Index as a measure of dry substance in..	165
Sackett, R. L., Paper by.....	157
Scofield, H. H., Paper by.....	225
Sewage disposal, Indiana problems in.....	157
Silvey, Oscar W., Paper by.....	233
Slonaker, J. Rollin, Paper by.....	355
Soil testing, Methods and materials used in.....	111
Springer, Alfred, Banquet address.....	60
Stone, W. E., On plans for the Academy.....	50
Stuart, M. H., Banquet address.....	62
Summer meetings. Remarks on.....	84
Thought stimulation, under what conditions does it occur?.....	127
Tippecanoe, The, an infantile drainage system.....	341
Treasurer, Report of.....	76
Tryonix, A paired entoplastron in, and its significance.....	345
Wiley, H. W., Letter from, suggesting the preparation of a history of early science in Indiana.....	66
Wood physics, Recent work in.....	441
Woodlot, The, for central Indiana.....	419
Woodpeckers, Observations on.....	354
Woolen, William Watson, Address of greeting by.....	46
Wright, J. S., On plans for the Academy.....	48



506.977.2  
In 2

PROCEEDINGS

OF THE

**Indiana Academy**  
**of Science**

1910



# PROCEEDINGS

OF THE

# Indiana Academy of Science

## 1910

Y.

---

EDITOR . . . . . L. J. RETTGER

LIBRARY  
NEW YORK  
BOTANICAL  
GARDEN.

INDIANAPOLIS, IND.

1911

INDIANAPOLIS  
WM. B. BURFORD, PRINTER  
1911

THE STATE OF INDIANA,

EXECUTIVE DEPARTMENT.

March 26, 1911.

Received by the Governor, examined and referred to the Auditor of State for verification of the financial statement.

---

OFFICE OF AUDITOR OF STATE.

INDIANAPOLIS, May 5, 1911.

The within report, so far as the same relates to moneys drawn from the State Treasury, has been examined and found correct.

W. H. O'BRIEN.

*Auditor of State.*

---

MAY 5, 1911.

Returned by the Auditor of State, with above certificate, and transmitted to Secretary of State for publication, upon the order of the Board of Commissioners of Public Printing and Binding.

MARK THISTLETHWAITE,

*Secretary to the Governor.*

---

Filed in the office of the Secretary of State of the State of Indiana, May 5, 1911.

L. G. ELLINGHAM,

*Secretary of State.*

---

Received the within report and delivered to the printer May 5, 1911.

ED D. DONNELL.

*Clerk Printing Board.*

## TABLE OF CONTENTS.

	PAGE
An act to provide for the publication of the reports and papers of the Indiana Academy of Science.....	7
An act for the protection of birds, their nests and eggs.....	9
Officers, 1910-1911.....	10
Committees, 1910-1911.....	11
Principal officers since organization.....	12
Constitution.....	13
By-Laws.....	15
Members, Fellows.....	16
Members, non-resident.....	17
Members, active.....	18
Program of the Twenty-sixth Annual Meeting.....	31
Report of the Twenty-sixth Annual Meeting of the Indiana Academy of Science.....	25
Report of the Spring Meeting of 1910.....	29
Papers presented at the Twenty-sixth Annual Meeting.....	
President's Address. P. N. Evans.....	35
Plants and Man: Weeds and Disease. Robert Hessler.....	49
An outline Review of Indiana Municipal Water Supplies. Charles Bross- man.....	71
A New Building for the Department of Practical Mechanics at Purdue University. M. J. Golden.....	75
Features of Subterranean Drainage in the Bloomington Quadrangle. J. W. Beede.....	81
The Shi-Shi Cig. Albert B. Reagan.....	113
Notes on the Shaker Church of the Indians. Albert B. Reagan.....	115
The Wreck of the "Suthern". Albert B. Reagan.....	117
The Bois Fort Indian Reservation in Minnesota. Albert B. Reagan.....	121
Conservation Problems, in Indiana. Frederick J. Breeze.....	125
Some Conglomerate Beds of Post Glacial Origin. Glenn Culbertson.....	141
A Physiographic Survey of the Terre Haute Area: Report of Progress. Charles R. Dryer.....	145

The Work Done by Normal Brook in Thirteen Years. Charles R. Dryer and Melvin K. Davis.....	147
Paleolithic, Neolithic, Copper and Iron Ages of Shelby County, Indiana. F. W. Gottlieb.....	153
The Effects of Ice in Lakes upon the Shore Lines of the Same. Albert B. Reagan.....	119
A New Bed of Trilobites. Andrew J. Bigney.....	139
The Fauna of the Brazil Limestone. F. C. Greene.....	169
The Preparation of Ether. P. N. Evans.....	173
The Temperature Coefficient of the Surface Tension of Water. Arthur L. Foley.....	175
LaPlace's Theory of Capillarity. Arthur L. Foley.....	181
The Value at Low Temperatures of the Specific Heats of a Gas. C. M. Smith.....	183
Investigations Concerning the Reichert-Meissl Number and The Relation of Butter Fat Constants in Butter Analysis. George Spitzer.....	195
A Convenient Laboratory Device. J. P. Naylor.....	201
Some Anomalies in the Gametophyte of <i>Dryopteris stipularis</i> . Caroline A. Black.....	321
Indiana Fungi. J. M. Van Hook.....	205
<i>Steccherinum septentrionale</i> (Fr.) Banker in Indiana. Howard J. Banker.....	213
Disease Resistance in Varieties of Potatoes. C. R. Orton.....	219
An Ecological Survey of the Lower Whitewater Gorge. L. C. Petry and M. S. Markle.....	223
Report of Work on Corn Pollination II. M. L. Fisher.....	245
Crustacea of Winona Lake. John L. House.....	129
A Method by which Cover Glasses may be used on Golgi Slides. D. W. Dennis.....	135
A Tropical Reptile near Richmond. D. W. Dennis.....	137
Further Notes, on Timothy Rust. A. G. Johnson.....	203
An Investigation of a Point Discharge in Magnetic and Electrostatic Fields. Oscar William Silvey.....	247
The Preglacial Valleys of the Upper Mississippi and its Eastern Tributaries. Harry M. Clem.....	335
Determination of the Ratio of Specific Heats of Dry Air. E. K. Chapman.....	289

The Huron Group in Western Monroe and Eastern Greene Counties, Indiana. F. C. Greene.....	269
The Equipment of a High Temperature Measurement Laboratory. G. A. Shook.....	297
A Convenient High Potential Battery. R. R. Ramsey.....	295
Indiana Weeds, Their Control and Eradication. G. M. Frier.....	323
Gross Fertilization among Fishes. W. T. Moenkhaus.....	353
The Fauna of a Solution Pond. Will Scott.....	395



AN ACT TO PROVIDE FOR THE PUBLICATION OF THE REPORTS  
AND PAPERS OF THE INDIANA ACADEMY OF SCIENCE.

[Approved March 11, 1895.]

WHEREAS, The Indiana Academy of Science, a chartered scientific association, has embodied in its constitution a provision that it will, upon the request of the Governor, or of the several departments of the State government, through the Governor, and through its council as an advisory board, assist in the direction and execution of any investigation within its province, without pecuniary gain to the Academy, provided only that the necessary expenses of such investigation are borne by the State; and,

WHEREAS, The reports of the meetings of said Academy, with the several papers read before it, have very great educational, industrial and economic value, and should be preserved in permanent form; and,

WHEREAS, The Constitution of the State makes it the duty of the General Assembly to encourage by all suitable means intellectual, scientific and agricultural improvement; therefore,

SECTION 1. *Be it enacted by the General Assembly of the State of Indiana*, That hereafter the annual reports of the meetings of the Indiana Academy of Science, beginning with the report for the year 1894, including all papers of scientific or economic value, presented at such meetings, after they shall have been edited and prepared for publication as hereinafter provided, shall be published by and under the direction of the Commissioners of Public Printing and Binding.

SEC. 2. Said reports shall be edited and prepared for publication without expense to the State, by a corps of editors to be selected and appointed by the Indiana Academy of Science, who shall not, by reason of such service, have any claim against the State for compensation. The form, style of binding, paper, typography and manner and extent of illustration of such reports shall be determined by the editors, subject to the approval of the Commissioners of Public Printing and Stationery. Not less than 1,500 nor more than 3,000 copies of each of said reports shall be published, the size of the edition within said limits to be determined by the concurrent action of the editors and the Commissioners of Public Printing and Station-

ery: *Provided*, That not to exceed six hundred dollars (\$600) shall be expended for such publication in any one year, and not to extend beyond 1896: *Provided*, That no sums shall be deemed to be appropriated for the year 1894.

SEC. 3. All except three hundred copies of each volume of said reports shall be placed in the custody of the State Librarian, who shall furnish one copy thereof to each public library in the State, one copy to each university, college or normal school in the State, one copy to each high school in the State having a library, which shall make application therefor, and one copy to such other institutions, societies or persons as may be designated by the Academy through its editors or its council. The remaining three hundred copies shall be turned over to the Academy to be disposed of as it may determine. In order to provide for the preservation of the same it shall be the duty of the Custodian of the State House to provide and place at the disposal of the Academy one of the unoccupied rooms of the State House, to be designated as the office of the Academy of Science, wherein said copies of said reports belonging to the Academy, together with the original manuscripts, drawings, etc., thereof can be safely kept, and he shall also equip the same with the necessary shelving and furniture.

SEC. 4. An emergency is hereby declared to exist for the immediate taking effect of this act, and it shall therefore take effect and be in force from and after its passage.

#### APPROPRIATION FOR 1910-1911.

The appropriation for the publication of the proceedings of the Academy during the years 1910 and 1911 was increased by the legislature in the General Appropriation bill, approved March 9, 1909. That portion of the law fixing the amount of the appropriation for the Academy is herewith given in full:

For the Academy of Science: For the printing of the proceedings of the Indiana Academy of Science, twelve hundred dollars: *Provided*, That any unexpended balance in 1909 shall be available in 1910, and that any unexpended balance in 1910 shall be available in 1911.

AN ACT FOR THE PROTECTION OF BIRDS, THEIR NESTS AND EGGS.

SEC. 602. Whoever kills, traps or has in his possession any wild bird, or whoever sells or offers the same for sale, or whoever destroys the nest or eggs of any wild bird, shall be deemed guilty of a misdemeanor and upon conviction thereof shall be fined not less than ten dollars nor more than twenty-five dollars: *Provided*, That the provisions of this section shall not apply to the following named game birds: The Anatidae, commonly called swans, geese, brant, river and sea duck; the Rallidae, commonly called rails, coots, mud-hens, gallinules; the Limicolae, commonly called shore birds, surf birds, plover, snipe, woodcock, sandpipers, tattlers and curlew; the Gallinae, commonly called wild turkeys, grouse, prairie chickens, quails and pheasants; nor to English or European house sparrows, crows, hawks or other birds of prey. Nor shall this section apply to persons taking birds, their nests or eggs, for scientific purposes, under permit, as provided in the next section.

SEC. 603. Permits may be granted by the Commissioner of Fisheries and Game to any properly accredited person, permitting the holder thereof to collect birds, their nests or eggs for strictly scientific purposes. In order to obtain such permit the applicant for the same must present to such Commissioner written testimonials from two well-known scientific men certifying to the good character and fitness of such applicant to be entrusted with such privilege, and pay to such Commissioner one dollar therefor and file with him a properly executed bond in the sum of two hundred dollars, payable to the State of Indiana, conditioned that he will obey the terms of such permit, and signed by at least two responsible citizens of the State as sureties. The bond may be forfeited, and the permit revoked upon proof to the satisfaction of such Commissioner that the holder of such permit has killed any bird or taken the nest or eggs of any bird for any other purpose than that named in this section.

# Indiana Academy of Science.

## OFFICERS, 1910-1911.

### PRESIDENT

CHARLES R. DRYER.

### VICE-PRESIDENT

D. W. DENNIS

### SECRETARY

A. J. BIGNEY.

### ASSISTANT SECRETARY

E. A. WILLIAMSON.

### PRESS SECRETARY

MIL0 H. STUART.

### TREASURER

W. J. MOENKHAUS

### EXECUTIVE COMMITTEE

C. R. DRYER.	JOHN S. WRIGHT,	A. W. BUTLER
A. J. BIGNEY,	CARL L. MEES,	W. A. NOYES,
E. A. WILLIAMSON,	W. S. BLATCHLEY,	J. C. ARTHUR,
MIL0 H. STUART,	H. W. WILEY,	O. P. HAY,
W. J. MOENKHAUS,	M. B. THOMAS,	T. C. MENDENHALL,
P. N. EVANS,	D. W. DENNIS,	J. C. BRANNER,
A. L. FOLEY,	C. H. EIGENMANN,	J. P. D. JOHN,
GLENN CULBERTSON,	C. A. WALDO,	J. M. COULTER,
D. M. MOTTIER,	STANLEY COULTER,	D. S. JORDAN.
ROBERT HESSLER,		

### CURATORS

BOTANY.....	J. C. ARTHUR.
ICHTHYOLOGY.....	C. H. EIGENMANN.
HERPETOLOGY } MAMMALOLOGY } ORNITHOLOGY }	A. W. BUTLER.
ENTOMOLOGY.....	W. S. BLATCHLEY.

## COMMITTEES, 1910-1911.

## PROGRAM.

W. A. COGSHALL, R. S. HESSLER, D. BODINE.

## MEMBERSHIP.

M. B. THOMAS, R. R. RAMSEY, W. W. BLANCHARD.

## NOMINATIONS.

A. W. BUTLER, STANLEY COULTER, G. CULBERTSON.

## AUDITING.

L. J. RETTGER, F. B. WADE, F. J. BREEZE.

## STATE LIBRARY.

G. W. BENTON, W. S. BLATCHLEY, A. W. BUTLER.

## RESTRICTION OF WEEDS AND DISEASES.

R. HESSLER, J. N. HURTY, A. W. BUTLER,  
S. COULTER, D. M. MOTTIER.

## DIRECTORS OF BIOLOGICAL SURVEY.

STANLEY COULTER, J. C. ARTHUR, M. B. THOMAS,  
C. H. EIGENMANN, U. O. COX.

## RELATIONS OF THE ACADEMY TO THE STATE.

M. B. THOMAS, R. W. MCBRIDE, G. CULBERTSON,  
C. C. DEAM.

## DISTRIBUTION OF THE PROCEEDINGS.

J. S. WRIGHT, H. I. BRUNER, G. W. BENTON,  
A. J. BIGNEY.

## PUBLICATION OF PROCEEDINGS.

L. J. RETTGER, Editor, D. BODINE, D. M. MOTTIER.

## OFFICERS OF THE INDIANA ACADEMY OF SCIENCE.

YEARS.	PRESIDENT.	SECRETARY.	ASST. SECRETARY.	PRESS SECRETARY.	TREASURER.
1885-1886	David S. Jordan	Amos W. Butler			O. P. Jenkins.
1886-1887	John M. Coulter	Amos W. Butler			O. P. Jenkins.
1887-1888	J. P. D. John	Amos W. Butler			O. P. Jenkins.
1888-1889	John C. Branner	Amos W. Butler			O. P. Jenkins.
1889-1890	T. C. Mendenhall	Amos W. Butler			O. P. Jenkins.
1890-1891	O. P. Hay	Amos W. Butler			O. P. Jenkins.
1891-1892	J. L. Campbell	Amos W. Butler			C. A. Waldo.
1892-1893	J. C. Arthur	Amos W. Butler	Stanley Coulter }		C. A. Waldo.
1893-1894	W. A. Noyes	C. A. Waldo	W. W. Norman }		W. P. Shannon.
1894-1895	A. W. Butler	John S. Wright	A. J. Bigney		W. P. Shannon.
1895-1896	Stanley Coulter	John S. Wright	A. J. Bigney		W. P. Shannon.
1896-1897	Thomas Gray	John S. Wright	A. J. Bigney		W. P. Shannon.
1897-1898	C. A. Waldo	John S. Wright	A. J. Bigney	Cleo. W. Benton	J. T. Scovell.
1898-1899	C. H. Eigenmann	John S. Wright	E. A. Schultze	Cleo. W. Benton	J. T. Scovell.
1899-1900	D. W. Dennis	John S. Wright	E. A. Schultze	Cleo. W. Benton	J. T. Scovell.
1900-1901	M. B. Thomas	John S. Wright	E. A. Schultze	Cleo. W. Benton	J. T. Scovell.
1901-1902	Harvey W. Wiley	John S. Wright	Donaldson Bodine	Cleo. W. Benton	J. T. Scovell.
1902-1903	W. S. Blatchley	John S. Wright	Donaldson Bodine	Cleo. W. Benton	W. A. McBeth.
1903-1904	C. L. Mees	John S. Wright	J. H. Ransom	C. A. Abbott	W. A. McBeth.
1904-1905	John S. Wright	Lynn B. McMullen	J. H. Ransom	C. A. Abbott	W. A. McBeth.
1905-1906	Robert Hessler	Lynn B. McMullen	J. H. Ransom	C. A. Abbott	W. A. McBeth.
1906-1907	D. M. Mottier	Lynn B. McMullen	J. H. Ransom	Charles R. Clark	W. A. McBeth.
1907-1908	Glenn Culbertson	J. H. Ransom	A. J. Bigney	C. A. Abbott	W. A. McBeth.
1908-1909	A. L. Foley	J. H. Ransom	A. J. Bigney	C. A. Abbott	W. A. McBeth.
1909-1910	P. N. Evans	Cleo. W. Benton	A. J. Bigney	John W. Woodhams	W. A. McBeth.
1910-1911	C. R. Dryer	A. J. Bigney	E. A. Williamson	Milo H. Stuart	W. J. Moenkhaus.

## CONSTITUTION.

---

### ARTICLE I.

SECTION 1. This association shall be called the Indiana Academy of Science.

SEC. 2. The objects of this Academy shall be scientific research and the diffusion of knowledge concerning the various departments of science, to promote intercourse between men engaged in scientific work, especially in Indiana; to assist by investigation and discussion in developing and making known the material, educational and other resources and riches of the State; to arrange and prepare for publication such reports of investigation and discussions as may further the aims and objects of the Academy as set forth in these articles.

Whereas, The State has undertaken the publication of such proceedings, the Academy will, upon request of the Governor, or of one of the several departments of the State, through the Governor, act through its council as an advisory body in the direction and execution of any investigation within its province as stated. The necessary expenses incurred in the prosecution of such investigation are to be borne by the State; no pecuniary gain is to come to the Academy for its advice or direction of such investigation.

The regular proceedings of the Academy as published by the State shall become a public document.

### ARTICLE II.

SECTION 1. Members of this Academy shall be honorary fellows, fellows, non-resident members or active members.

SEC. 2. Any person engaged in any department of scientific work, or in original research in any department of science, shall be eligible to active membership. Active members may be annual or life members. Annual members may be elected at any meeting of the Academy; they shall sign the constitution, pay an admission fee of two dollars and thereafter an annual fee of one dollar. Any person who shall at one time contribute

fifty dollars to the funds of this Academy may be elected a life member of the Academy, free of assessment. Non-resident members may be elected from those who have been active members but who have removed from the State. In any case, a three-fourths vote of the members present shall elect to membership. Applications for membership in any of the foregoing classes shall be referred to a committee on application for membership, who shall consider such application and report to the Academy before the election.

SEC. 3. The members who are actively engaged in scientific work, who have recognized standing as scientific men, and who have been members of the Academy at least one year, may be recommended for nomination for election as fellows by three fellows or members personally acquainted with their work and character. Of members so nominated a number not exceeding five in one year may, on recommendation of the Executive Committee, be elected as fellows. At the meeting at which this is adopted, the members of the Executive Committee for 1894 and fifteen others shall be elected fellows, and those now honorary members shall become honorary fellows. Honorary fellows may be elected on account of special prominence in science, on the written recommendation of two members of the Academy. In any case a three-fourths vote of the members present shall elect.

### ARTICLE III.

SECTION 1. The officers of this Academy shall be chosen by ballot at the annual meeting, and shall hold office one year. They shall consist of a President, Vice-President, Secretary, Assistant Secretary, Press Secretary and Treasurer, who shall perform the duties usually pertaining to their respective offices and in addition, with the ex-presidents of the Academy, shall constitute an Executive Committee. The President shall, at each annual meeting, appoint two members to be a committee, which shall prepare the programs and have charge of the arrangements for all meetings for one year.

SEC. 2. The annual meeting of this Academy shall be held in the city of Indianapolis within the week following Christmas of each year, unless otherwise ordered by the Executive Committee. There shall also be a summer meeting at such time and place as may be decided upon by the Executive Committee. Other meetings may be called at the discretion of the Executive Committee. The past Presidents, together with the officers and



Executive Committee, shall constitute the council of the Academy, and represent it in the transaction of any necessary business not especially provided for in this constitution, in the interim between general meetings.

Sec. 3. This constitution may be altered or amended at any annual meeting by a three-fourths majority of the attending members of at least one year's standing. No question of amendment shall be decided on the day of its presentation.

---

## BY-LAWS.

---

1. On motion, any special department of science shall be assigned to a curator, whose duty it shall be, with the assistance of the other members interested in the same department, to endeavor to advance knowledge in that particular department. Each curator shall report at such time and place as the Academy shall direct. These reports shall include a brief summary of the progress of the department during the year preceding the presentation of the report.

2. The President shall deliver a public address on the morning of one of the days of the meeting at the expiration of his term of office.

3. The Press Secretary shall attend to the securing of proper newspaper reports of the meetings and assist the Secretary.

4. No special meeting of the Academy shall be held without a notice of the same having been sent to the address of each member at least fifteen days before such meeting.

5. No bill against the Academy shall be paid without an order signed by the President and countersigned by the Secretary.

6. Members who shall allow their dues to remain unpaid for two years, having been annually notified of their arrearage by the Treasurer, shall have their names stricken from the roll.

7. Ten members shall constitute a quorum for the transaction of business.

## MEMBERS.

## FELLOWS.

† A. Abbott.....	*1908	Fargo, N. D.
R. J. Aley.....	1898	Orono, Me.
J. C. Arthur.....	1894	Lafayette.
H. E. Barnard.....	1910	Indianapolis.
J. W. Beede.....	1906	Bloomington.
George W. Benton.....	1896	Indianapolis.
A. J. Bigney.....	1897	Moore's Hill.
Katherine Golden Bitting.....	1895	Lafayette.
W. S. Blatchley.....	1893	Indianapolis.
Donaldson Bodine.....	1899	Crawfordsville.
F. J. Breeze.....	1910	Lafayette.
H. L. Bruner.....	1899	Indianapolis.
Severance Burrage.....	1898	Lafayette.
A. W. Butler.....	1893	Indianapolis.
W. A. Cogshall.....	1906	Bloomington.
†Mel. T. Cook.....	1902	Newark, Del.
†John M. Coulter.....	1893	Chicago, Ill.
Stanley Coulter.....	1893	Lafayette.
U. O. Cox.....	1908	Terre Haute.
Glenn Culbertson.....	1899	Hanover.
E. R. Cumings.....	1906	Bloomington.
S. C. Davisson.....	1908	Bloomington.
C. C. Deam.....	1910	Indianapolis.
D. W. Dennis.....	1895	Richmond.
C. R. Dryer.....	1897	Terre Haute.
C. H. Eigenmann.....	1893	Bloomington.
Percy Norton Evans.....	1901	West Lafayette.
A. L. Foley.....	1897	Bloomington.
M. J. Golden.....	1899	Lafayette.
†W. F. M. Goss.....	1893	Urbana, Ill.
Thomas Gray (Died Dec. 19, 1908).....	1893	Terre Haute.

\*Date of election.

†Non-resident.

A. S. Hathaway.....	*1895	Terre Haute.
W. K. Hatt.....	1902	Lafayette.
Robert Hessler.....	1899	Logansport.
J. N. Hurty.....	1910	Indianapolis.
†H. A. Huston.....	1893	Baltimore, Md.
Edwin S. Johonnott.....	1904	Terre Haute.
Robert E. Lyons.....	1896	Bloomington.
W. A. McBeth.....	1904	Terre Haute.
†V. F. Marsters.....	1893	Santiago, Chili.
C. L. Mees.....	1894	Terre Haute.
†J. A. Miller.....	1904	Swarthmore.
W. J. Moenkhaus.....	1901	Bloomington.
Richard B. Moore.....	1910	Indianapolis.
D. M. Mottier.....	1893	Bloomington.
J. P. Naylor.....	1903	Greencastle.
†W. A. Noyes.....	1893	Urbana, Ill.
Rolla R. Ramsey.....	1906	Bloomington.
J. H. Ransom.....	1902	Lafayette.
L. J. Rettger.....	1896	Terre Haute.
David Rothrock.....	1906	Bloomington.
J. T. Scovell.....	1894	Terre Haute.
Albert Smith.....	1908	Lafayette.
†Alex Smith.....	1893	Chicago, Ill.
W. E. Stone.....	1893	Lafayette.
†Joseph Swain.....	1898	Swarthmore, Pa.
M. B. Thomas.....	1893	Crawfordsville.
†C. A. Waldo.....	1893	St. Louis, Mo.
†F. M. Webster.....	1894	Washington, D. C.
Jacob Westlund.....	1904	Lafayette.
†H. W. Wiley.....	1895	Washington, D. C.
W. W. Woollen.....	1908	Indianapolis.
John S. Wright.....	1894	Indianapolis.

\*Date of election.  
†Non-resident.

#### NON-RESIDENT MEMBERS.

George H. Ashley.....	Washington, D. C.
J. C. Branner.....	Stanford, University, Cal.

[2—26988]

M. A. Brannon	Grand Forks, N. D.
D. H. Campbell	Stanford University, Cal.
H. W. Clark	Washington, D. C.
H. B. Dorner	Urbana, Ill.
A. Wilmer Duff	Worcester, Mass.
B. W. Everman	Washington, D. C.
W. A. Fiske	Los Angeles, Cal.
C. W. Garrett	Pittsburg, Pa.
Charles H. Gilbert	Stanford University, Cal.
C. W. Greene	Columbia, Mo.
C. W. Hargit	Syracuse, N. Y.
O. P. Hay	Washington, D. C.
Edward Hughes	Stockton, Cal.
O. P. Jenkins	Stanford University, Cal.
C. T. Knipp	Urbana, Ill.
D. S. Jordan	Stanford University, Cal.
J. S. Kingsley	Tufts College, Mass.
D. T. McDougal	Tucson, Arizona.
L. B. McMullen	Valley City, N. D.
T. C. Mendenhall	Worcester, Mass.
J. F. Newsom	Stanford University, Cal.
A. H. Purdue	Fayetteville, Ark.
A. B. Reagan	Orr, Minn.
J. R. Slonaker	Stanford University, Cal.
Alfred Springer	Cincinnati, Ohio.
Robert B. Warder (Deceased)	Washington, D. C.
Ernest Walker	Fayetteville, Ark.
G. W. Wilson	Fayette, Ia.

---

*ACTIVE MEMBERS.*

C. E. Agnew	Delphi.
L. E. Allison	West Lafayette.
H. W. Anderson	Ladoga.
Paul Anderson	Crawfordsville.
H. F. Bain	San Francisco, Cal.
Walter D. Baker	Indianapolis.
Walter M. Baker	Redkey.

Edward Hugh Bangs.....	Indianapolis.
Howard J. Banker.....	Greencastle.
H. H. Barcus.....	Indianapolis.
W. H. Bates.....	West Lafayette.
Guido Bell.....	Indianapolis.
Ray Bellamy.....	Moore's Hill.
Lee F. Bennett.....	Valparaiso.
Thomas Billings.....	West Lafayette.
Harry Eldridge Bishop.....	Indianapolis.
Lester Black.....	Bloomington.
William N. Blanchard.....	Greencastle.
Charles S. Bond.....	Richmond.
A. A. Bourke.....	Edinburg.
Omer C. Boyer.....	Lebanon.
H. C. Brandon.....	Daleville.
Chas. Brossmann.....	Indianapolis.
E. M. Bruce.....	Terre Haute.
Wm. R. Butler.....	Indianapolis.
Edward N. Canis.....	Indianapolis.
E. Kate Carman.....	Indianapolis.
Lewis Clinton Carson.....	Detroit, Mich.
Herman S. Chamberlain (Deceased).....	Indianapolis.
E. J. Chansler.....	Bicknell.
A. G. W. Childs.....	Kokomo.
C. D. Christie.....	Cincinnati, O.
J. H. Clark.....	Connersville.
Otto O. Clayton.....	Portland.
H. M. Clem.....	Chicago, Ill.
Charles Clickner.....	Silverwood, R. D. No. 1.
Charles A. Coffey.....	Petersburg.
William Clifford Cox.....	Columbus.
J. A. Cragwall.....	Crawfordsville.
M. E. Crowell.....	Franklin.
Chas. M. Cunningham.....	Indianapolis.
Lorenzo E. Daniels.....	Laporte.
E. H. Davis.....	West Lafayette.
Melvin K. Davis.....	Terre Haute.
Charles C. Deam.....	Indianapolis.

E. M. Deem.....	Frankfort.
Harry F. Dietz.....	Indianapolis.
James P. Dimonds.....	Indianapolis.
Martha Doan.....	Westfield.
J. P. Dolan.....	Syracuse.
David A. Drew.....	Bloomington.
Hans Duden.....	Indianapolis.
Arthur E. Dunn.....	Logansport.
Herbert A. Dunn.....	Logansport.
M. L. (Durbin) Ellis, Mrs.....	Bloomington.
J. B. Dutcher.....	Bloomington.
Samuel E. Earp.....	Indianapolis.
A. A. Eberly.....	Nowata, Okla.
C. R. Eckler.....	Indianapolis.
Max Mapes Ellis.....	Bloomington.
H. E. Enders.....	West Lafayette.
Samuel G. Evans.....	Evansville.
William P. Felver.....	Logansport.
C. J. Fink.....	Crawfordsville.
M. L. Fisher.....	West Lafayette.
Mary A. Fitch.....	Lafayette.
A. S. Fraley.....	Linden.
George M. Frier.....	West Lafayette.
F. D. Fuller.....	West Lafayette.
Austin Funk.....	Jeffersonville.
John D. Gabel.....	North Madison.
Jesse J. Galloway.....	Bloomington.
Andrew W. Gamble.....	Logansport.
H. O. Garman.....	Indianapolis.
J. B. Garner.....	Crawfordsville.
Florence A. Gates.....	Toledo, O.
Robert G. Gillum.....	Terre Haute.
E. R. Glenn.....	Brookville.
Frederic W. Gottlieb.....	Morristown.
Vernon Gould.....	Rochester.
Frank Cook Greene.....	New Albany.
Earl Grimes.....	Russellville.
Walter L. Hahn (Died May 31, 1911).....	Springfield, S. D.

C. F. Harding.....	West Lafayette.
Mary T. Harman.....	Bloomington.
Walter W. Hart.....	Indianapolis.
Victor Hendricks.....	St. Louis, Mo.
L. R. Hessler.....	Crawfordsville.
John P. Hetherington.....	Logansport.
C. E. Hiatt.....	Philadelphia, Pa.
John E. Higdon.....	Indianapolis.
Frank R. Higgins.....	Terre Haute.
S. Bella Hilands.....	Madison.
John J. Hildebrandt.....	Logansport.
Geo. N. Hoffer.....	Lafayette.
G. E. Hoffman.....	Logansport.
Allen D. Hole.....	Richmond.
Lucius M. Hubbard.....	South Bend.
Martha Hunt.....	Indianapolis.
O. F. Hunziker.....	West Lafayette.
Roscoe R. Hyde.....	Terre Haute.
Harry M. Ibison.....	Marion.
J. Isenberger.....	Louisville, Ky.
C. F. Jackson.....	Durham, N. H.
D. E. Jackson.....	St. Louis, Mo.
A. G. Johnson.....	Lafayette.
H. E. Johnson.....	Greenfield.
A. T. Jones.....	West Lafayette.
W. J. Jones, Jr.....	West Lafayette.
O. L. Kelso.....	Terre Haute.
A. M. Kenyon.....	West Lafayette.
Frank D. Kern.....	Lafayette.
L. V. Ludy.....	West Lafayette.
R. W. McBride.....	Indianapolis.
Richard C. McCloskey.....	Chicago, Ill.
T. S. McCulloch.....	Crawfordsville.
N. E. McIndoo.....	
Edward G. Mahin.....	West Lafayette.
James E. Manchester.....	Minneapolis, Minn.
Wilfred H. Manwaring.....	New York City.
M. S. Markle.....	Richmond

William Edgar Mason.....	Borden.
Clark Mick.....	Indianapolis.
A. R. Middleton.....	West Lafayette.
G. Rudolph Miller.....	Indianapolis.
F. A. Miller.....	Indianapolis.
Chas. R. Moore.....	West Lafayette.
Geo. T. Moore.....	St. Louis, Mo.
Richard Bishop Moore.....	Indianapolis.
Herbert Morrison.....	Indianapolis.
Frank K. Mowrer.....	Marion.
F. W. Muncie.....	Crawfordsville.
Fred Mutchler.....	Bowling Green, Ky.
Leslie C. Nanney.....	Bedford.
Charles E. Newlin.....	Indianapolis.
J. A. Nieuwland.....	Notre Dame.
Clayton R. Orton.....	West Lafayette.
G. A. Osner.....	Crawfordsville.
D. A. Owen.....	Franklin.
Everett W. Owen.....	Indianapolis.
Ferman L. Pickett.....	Bloomington.
Rollo J. Pierce.....	Richmond.
Ralph B. Polk.....	Greenwood.
James A. Price.....	Ft. Wayne.
W. H. Rankin.....	Ithaca, N. Y.
C. A. Reddick.....	Crawfordsville.
C. J. Reilly.....	Syracuse.
Allen J. Reynolds.....	
George L. Roberts.....	Lafayette.
J. Schramm.....	St. Louis, Mo.
E. A. Schultze.....	Laurel.
Will Scott.....	Bloomington.
Charles Wm. Shannon.....	Brazil.
Fred Sillery.....	Indianapolis.
Oscar W. Silvey.....	West Lafayette.
Charles M. Smith.....	Lafayette.
C. Piper Smith.....	Logan, Utah.
Essie Alma Smith Shannon.....	Bloomington.
E. R. Smith.....	Indianapolis.



Geo. Spitzer.....	Lafayette.
Brenton L. Steele.....	Pullman, Wash.
Chas. Stoltz.....	South Bend.
J. M. Stoddard.....	
Milo H. Stuart.....	Indianapolis.
Julius W. Sturmer.....	Lafayette.
J. C. Taylor.....	Logansport.
Albert W. Thompson.....	Owensville.
A. D. Thorburn.....	Indianapolis.
Iro C. Trueblood (Miss).....	Greencastle.
William M. Tucker.....	Osgood.
W. P. Turner.....	West Lafayette.
Chas. A. Vallance.....	Indianapolis.
J. M. Van Hook.....	Bloomington.
W. B. Van Gorder.....	Lyons.
H. S. Voorhees.....	Ft. Wayne.
Frank B. Wade.....	Indianapolis.
Luther C. Weeks.....	West Lafayette.
Mason L. Weems.....	Valparaiso.
Daniel T. Weir.....	Indianapolis.
James E. Weyant.....	Indianapolis.
Virges Wheeler.....	Montmorenci.
A. E. White.....	Connersville.
Alfred T. Wianeko.....	Lafayette.
Kenneth P. Williams.....	Bloomington.
William L. Woodburn.....	Evanston, Ill.
John W. Woodhams.....	Indianapolis.
Herbert Milton Woollen.....	Indianapolis.
J. F. Woolsey.....	Cleveland, O.
G. A. Young.....	West Lafayette.
Jacob P. Young.....	Huntington.
L. E. Young.....	West Lafayette.
W. J. Young.....	Washington, D. C.
Lucy Youse.....	Terre Haute.
W. A. Zehring.....	West Lafayette.
Charles Zeleny.....	Urbana, Ill.

Fellows, resident.....	51
Non-resident.....	12
Members, active.....	197
Members, non-resident.....	30
Total.....	290



MINUTES OF THE TWENTY-SIXTH  
ANNUAL MEETING

INDIANA ACADEMY OF SCIENCE

CLAYPOOL HOTEL, INDIANAPOLIS, INDIANA.

NOVEMBER 24, 25, 1910.

---

The Indiana Academy of Science met at the Claypool Hotel, November 24-25, 1910.

The Executive Committee held its regular meeting at 8:00 p. m., November 24. The following members were present: P. N. Evans, President; C. R. Dryer, A. J. Bigney, J. S. Wright, A. W. Butler, W. S. Blatchley, George W. Benton, Robert Hessler, and W. J. Moenkhaus.

On proposal of the treasurer, W. J. Moenkhaus, the following resolution was adopted:

Resolved, That all accounts of the members of the Academy be regarded as paid up to and including the year for which their most recent receipt has been issued.

The State Library Committee, of which A. W. Butler was chairman, reported that the State Librarian was taking special interest in the publications coming to the Academy.

The general interests of the Academy were then discussed at some length.

The regular session of the Academy was held at 9:00 a. m. Friday, November 25, Professor P. N. Evans presiding.

The Program Committee reported their work completed as given in the printed program.

The Committee on Distribution of the Proceedings reported that their work had been performed under the direction of the State Librarian, Dr. Demarchus C. Brown.

The editor, H. L. Bruner, made the following report through the Secretary:

Work performed—

Cost of regular edition .....	\$1,070 27
Free reprints .....	183 55
	<hr/>
Total .....	\$1,253 82

The Treasurer reported as follows:

Balance from 1909.....	\$401 22
Receipts from dues, 1910.....	194 00
	<hr/>
Total .....	\$595 22
Expenditures during 1909 as per vouchers.....	271 58
	<hr/>
Balance, cash on hand November 25, 1910.....	\$323 64

W. J. MOENKHAUS, Treasurer.

Audited and approved.

L. J. RETTGER,

F. J. BREEZE.

Auditing Committee.

The President then appointed the standing committees.

After the completion of this business, Professor P. N. Evans, as President of the Academy, read his address on "The Place of Research in the Undergraduate Schools." Dr. Demarchus C. Brown was called upon to speak concerning the books that come to the Academy through his office. He called attention to three points:

1. That two consignments of books had been bound, one of 118 volumes and one of 119 volumes.
2. That he now had 300 volumes ready for the bindery.
3. That the list of domestic exchanges was very incomplete, and that there were now 114 foreign exchanges on the list. This list was also incomplete.

He asked that a special committee in Indianapolis be appointed to quickly decide all questions relative to the publications. This work was referred to the Committee on State Library.

The reading of the regular papers in general session was then taken up.

After Dr. Hessler's paper on "Plants and Man," he presented the following resolution, which was adopted:

Resolved, That the Indiana Academy of Science hereby endorses the establishment of a National Department of Public Health, such as is advocated by the Owens bill.

Papers were read until noon.

At 2:00 p. m. the Academy went into business session. M. B. Thomas, as chairman of the Membership Committee, reported the following persons for membership:

Kenneth P. Williams.

William M. Tucker.

Jesse J. Galloway.

Herbert Morrison.

Ray Bellamy.

Charles M. Smith.

George M. Frier.

F. D. Fuller.

Mary A. Fitch.

Clayton R. Orton.

H. H. Barcus.

M. S. Markle.

J. A. Price.

Harry M. Ibison.

David A. Drew.

They were elected.

The following persons were elected fellows:

F. J. Breeze.

C. C. Deam.

J. N. Hurty.

N. E. Barnard.

R. B. Moore.

The Auditing Committee reported the books of the Treasurer correct.

The Academy was then divided into the following sections for completing the reading of the papers:

A. Zoölogy, Geology and Geography.

B. Botany.

C. Mathematics, Physics, Chemistry.

At 8:00 p. m. the Committee on Nomination of Officers, A. W. Butler chairman, reported as follows:

President—Charles R. Dryer.

Vice-President—David W. Dennis.

Secretary—Andrew J. Bigney.

Assistant Secretary—E. A. Williamson.

Press Secretary—Milo H. Stuart.

Treasurer—W. J. Moenkhaus.

They were elected as read.

On motion of Stanley Coulter, it was decided that it is the sense of this Academy that hereafter the nomination for vice-presidents shall not carry with it the promotion to the office of president.

President P. N. Evans then asked Professor Stanley Coulter to introduce the speaker of the evening, Dr. D. T. MacDougal, of the Desert Laboratory, Tucson, Arizona.

Dr. MacDougal's subject was "Desert Days and Desert Ways." It was fully illustrated with numerous lantern slides. This lecture was one of great worth to every person present, and it was greatly enjoyed and appreciated.

## SPRING MEETING.

---

NASHVILLE, BROWN COUNTY, MAY 20-21, 1910.

---

The spring meeting of the Academy was held in Brown County on the above date. The program, as planned, was carried out successfully and members who were able to attend reported a pleasant time. The Indianapolis Southern Railroad gave us a special car from Indianapolis at 7:20 Friday morning, May 20th. We arrived at Helmsburg at 8:35, where we were joined by members of the Academy who came from Bloomington. The party was met by Joshua Bond, liveryman, with two hacks, and without delay, some riding and some walking, set out for Waltman's and Freeman's orchards and the Bear Wallow. A lunch of ham sandwiches and buttermilk was served here, and after a rest the route was followed down the ridge into the valley and along the road which follows Grease Creek, into Nashville, where we arrived at 2:45, tired but happy. We left Helmsburg in mud and mist, but the day gradually brightened until by the time we left Bear Wallow the sun was shining brightly.

The rest of the afternoon was spent in viewing historic and interesting sights in and about Nashville. Dinner at 5:30 at Pittman's Inn was followed by two hours of social chat upon the broad piazzas of this sanatorium. At 7:45 three additional members arrived, including Mr. Blatchley, who was unable to be present during the day and who was booked for the principal address of the evening.

The public meeting was held in the court house at Nashville. In the absence of President P. N. Evans and of Vice-President C. R. Dryer, past President D. W. Dennis, of Earlham, was asked to preside. Professor Dennis spoke of the work of the members of the Academy for the State and of the interest which the people should take in the Academy. He introduced Dr. Eigenmann, who spoke briefly on his South American fishing experiences. Following Dr. Eigenmann, Mr. Blatchley was introduced and gave his lecture on the "Indiana of Nature," illustrated by many charts showing the geological growth of the State. This address was enjoyed by the audience, which comfortably filled the court room.

Saturday morning the party separated into groups. Some of them returned on the early trains, others returned at noon, and still others stayed until the following day, visiting Weed Patch hill and other points of interest. The day started out rather threatening, but it gradually cleared. Altogether, considering the time of year, the weather was quite favorable and the roads unusually good. The following members of the Academy were present :

W. S. Blatchley,	G. M. Frier,
Donaldson Bodine,	W. C. Goble,
G. W. Benton,	Roscoe R. Hyde,
E. R. Cumings,	William A. McBeth,
G. W. Childs,	Robert W. McBride,
Charles C. Deam,	R. R. Ramsey,
David W. Dennis,	Charles Stoltz,
C. H. Eigenmann,	J. M. Van Hook,
Arthur L. Foley,	W. F. VanGorder,
E. S. Ferry,	J. S. Wright,

GEORGE W. BENTON, Secretary.



PROGRAM OF THE  
 TWENTY-SIXTH ANNUAL MEETING  
 INDIANA ACADEMY OF SCIENCE

CLAYPOOL HOTEL, INDIANAPOLIS, INDIANA.

November 25, 1910.

P. N. EVANS, President.	CHARLES R. DRYER, Vice-President.
GEORGE W. BENTON, Secretary.	A. J. BIGNEY, Assistant Secretary.
W. J. MOENKHAUS, Treasurer.	H. L. BRUNER, Editor.

*PROGRAM.*

FRIDAY, NOVEMBER 25.

*9:00 A. M., General Meeting.*

Business.

President's Address.

Plants and Man—Weeds and Disease, 20 minutes. . . . . Robert Hessler

An Outline Review of Indiana Municipal Water Supplies.

5 minutes . . . . . Charles Brossman

A New Building for the Department of Practical Mechan-

ics at Purdue University, 10 minutes. . . . . M. J. Golden

Features of Subterranean Drainage in the Bloomington

Quadrangle, 30 minutes. . . . . J. W. Beede

The Shi-Shi Cig, 3 minutes. . . . . Albert B. Reagan

Notes on the Shaker Church of the Indians, 5 minutes. . . . . Albert B. Reagan

The Wreck of the "Suthern," 5 minutes. . . . . Albert B. Reagan

The Bois Fort Indian Reservation in Minnesota, 8 minutes

Albert B. Reagan

Conservation Problems in Indiana, 12 minutes. . . . . Frederick J. Breeze

*2:00 P. M., Sectional Meetings.*

ZÖÖLOGY, GEOLOGY AND GEOGRAPHY.

Geology of Croy's Creek, Clay Co., Ind., 10 minutes. . . . . C. W. Shannon

The Properties and Reactions of Thrombin, 10 minutes. . . . . L. J. Rettger

Some Conglomerate Beds of Post Glacial Origin, 5 minutes .....	Glenn Culbertson
The Nature and Origin of the Fish Fauna of the Plateau of British Guiana, 15 minutes.....	C. H. Eigenmann
A Physiographic Survey of the Terre Haute Area—Reports of Progress, 10 minutes.....	Charles R. Dryer
The Work Done by Normal Brook in Thirteen Years, 20 minutes .....	Charles R. Dryer and Melvin K. Davis
Paleolithic, Neolithic, Copper and Iron Ages of Shelby Co., Ind., 10 minutes .....	F. W. Gottlieb
The Effects of Ice in Lakes Upon the Shore Lines of the Same, 3 minutes .....	Albert B. Reagan
A New Bed of Trilobites, 5 minutes.....	A. J. Bigney
The Fauna of the Brazil Limestone.....	F. C. Greene

MATHEMATICS, PHYSICS AND CHEMISTRY.

The Preparation of Ether, 5 minutes .....	P. N. Evans
The Temperature Coefficient of the Surface Tension of Water, 15 minutes.....	Arthur L. Foley
LaPlace's Theory of Capillarity, 10 minutes.....	Arthur L. Foley
A Derivation of Poisson's Equation, 10 minutes.....	Kenneth P. Williams
The Value at Low Temperatures of the Specific Heats of a Gas .....	C. M. Smith
Gaseous Fermentation in Sweetened Condensed Milk, 40 minutes .....	O. F. Hunziker
Investigations Concerning the Reichert-Meissl No. and the Relations of Butter Fat Constants in Butter Analysis..	George Spitzer
A Convenient Laboratory Device, 5 minutes.....	J. P. Naylor

BOTANY.

Some Anomalies in the Gametophyte of <i>Dryopteris stipularis</i> , 5 minutes .....	Caroline A. Black
The Flora of Eastern Nova Scotia, 10 minutes.....	Stanley Coulter
The Weed Problem in Indiana, 10 minutes.....	Stanley Coulter
The Heteroecious Rusts with <i>Aecia</i> on <i>Euphorbia</i> .....	Mary A. Fitch
An Example of Persistent Life, 2 minutes.....	D. A. Owen
Indiana Fungi, 5 minutes .....	J. M. Van Hook
<i>Steccherinum septentrionale</i> (Fr.) Banker in Indiana, 10 minutes .....	Howard J. Banker

The Water Balance of Desert Plants, 15 minutes.....	D. F. MacDougal
Disease Resistance in Varieties of Potatoes.....	C. R. Orton
The Laboratory Method of Determining the Fungicidal Value of Spraying Mixtures, 10 minutes.....	L. R. Hessler
The Black Knot of Plum, 10 minutes.....	H. L. Rees
Additions to the Indiana Flora, 3 minutes.....	Charles C. Deam
An Ecological Survey of the Lower Whitewater Gorge, 15 minutes .....	M. S. Markle and L. C. Petry
Report of Work on Corn Pollination II, 3 minutes.....	M. L. Fisher
8:00 p. m., Address, illustrated by stereopticon, by Dr. D. T. MacDougal, of the Desert Laboratory, Tucson, Arizona.	



## PRESIDENT'S ADDRESS.

BY PERCY NORTON EVANS.

### THE PLACE OF RESEARCH IN UNDERGRADUATE SCHOOLS.

The aim of this Academy is the encouragement of research along scientific lines by establishing and maintaining intercourse among those engaged therein, thus stimulating them by a consciousness of companionship in productive intellectual activity. In a small society, embracing in its scope all the sciences, one does not expect in these days of specialization to find others engaged in just the same field of investigation as himself; it is through inspiration rather than information that the investigator profits by these meetings.

It is now hardly necessary to emphasize, even to the non-scientific public, the importance of scientific research; to it mankind owes in a large measure not only his material prosperity, comforts, and conveniences, which is sufficiently obvious, but, what is even more important, his intellectual freedom. The changes that have taken place within the last century in our physical environment, with the innumerable applications of science to useful purposes, are no more profound than our intellectual advance and the growing pervasiveness of the scientific spirit in all lines of thought, and in the endeavor for human betterment, physical, social and moral. Our increasingly extensive and effective philanthropies, our giant strides in sanitary administration, and the tottering barriers between the sects of Christendom, are very tangible evidences of the spirit that is not satisfied with precedent or authority, but craves certainty as to the facts, and reasonable explanations for them, as well as aims at the application of all knowledge to the uses of man.

The membership of this Academy happily includes scientific workers in many fields. Some apply the results of research to the needs of the State in developing its resources and protecting its citizens against the injuries inflicted by ignorance and fraud; others make science the servant of industry and commerce; others, again, are active in applying it to the preserving and restoring of the health of our bodies. A large part of our

membership, however, is made up of those whose chief occupation is teaching.

While it has not always been the case, it is probably true at present that the most valuable contributions to human knowledge are made by those engaged in this profession of teaching. This is not surprising, for the nature of his calling demands that the teacher to be effective must ever continue to be a student, and the thorough study of any subject reveals the limits of our knowledge in that field and tempts the man of active intellect to the task of extending those boundaries; there is surely no keener pleasure than the learning by one's own search some truth, however inconspicuous, not previously known.

Not only does teaching tend to stimulate research, it also gives it balance by preventing the too exclusive attention to the comparatively narrow field under intensive cultivation; the necessity of presenting well-ordered information covering the broader subject, and the oral statement of original theories and conclusions, must have a broadening and clarifying influence on the intellectual activity of the investigator.

As teaching is a help to research, still more is research a vitalizer of teaching, particularly of the teaching appropriate for graduate students; indeed, the work of research is at least as important as that of instruction where advanced students are concerned, and the university should be a source of knowledge, where those desiring to devote themselves to the same high quest may be stimulated by the example and companionship of productive scholars.

The leading European nations have apparently realized more clearly than we the value of scientific research, and have provided more adequate rewards and more favorable environment for the investigator, with the result that the ratio of intellectual to material prosperity is higher there than here. Within the past generation, however, we have become more awake to these matters, and have determined in our strenuous way to make research "hum." The awakening has unquestionably been beneficial on the whole, but we have, it seems to me, failed to grasp certain fundamental distinctions between the needs of graduate and of undergraduate students; the hum of research has been allowed to drown the cries of the injured in many an undergraduate school, where teaching is sacrificed to research, and where too early specialization is encouraged and even forced upon the student.

We are not as yet in this country producing our proper share of scholars of the first rank. The reasons for this are many, including hasty preparation, premature specialization, insufficient rewards, and unfavorable environment.

As to preparation, those of us who contemplate academic careers are usually unwilling to invest sufficient capital of time and money; we expect to complete our scholastic education if uninterrupted at about twenty-five years of age and then enter upon an active career in which there is little time or opportunity for research or even very serious or intensive study, for the sake of the immediate pecuniary reward; in Europe, several more years are spent in subordinate positions as investigators, on a semi-independent basis both scholastically and financially. The European makes a larger investment and reaps a larger ultimate reward, not only in money but still more in the consideration accorded to intellectual eminence.

Concerning too early specialization and its shallow results, I shall speak later; let it suffice here to say that, for example, he is a poor chemist who is only a chemist.

The rewards at present offered for pure scientific work in this country are insufficient to attract the most vigorous, capable and ambitious men; not only, nor chiefly, are the financial returns here less than in Europe, in spite of our higher cost of living, but the public respect for intellectual distinction is far inferior in this country, on account of our commercialism and our acceptance of wealth as our standard evidence of merit.

The environment, too, is less favorable to the highest scientific work in that the numbers of those engaged therein are so few, and the national characteristic of haste rather than thoroughness pervades our activity. The value of real scientific attainment is still but dimly recognized by the industrial world; chemists are employed like clerks, without graduate training, and work like day laborers, but for less pay, at routine analysis, with neither the training nor the opportunity to attack the larger problems in a fundamental scientific way. Such chemists are not on the same plane as the higher chemists in the German manufacturing industries, who have supervision of the works as well as the laboratories. One result, then, of this lack of demand for highly trained men is the small number pursuing research in our universities, so that even our best qualified professors have a mere handful of research students, and many of these can

be induced to continue their higher education only by fellowships sufficient to pay their living expenses; if such aids were discontinued the numbers of our graduate students would be even less favorably impressive than at present, though in time the larger investment of those remaining would result in the larger salaries that would have to be paid to the men more difficult to find.

The keener competition in all walks of life in Europe has some advantages—only the thoroughly trained can hope for success, hence the desire for the most complete preparation. We consider ourselves fortunate in being protected against foreign competition, and in being able in consequence to make an equally good living with less effort; but are we really to be congratulated on our lower intellectual standard of living and on our dependence upon imported thought and intellectual products?

Another result of the limited scale on which scientific investigation is being conducted, and our "high standard of living," is that it is not worth while for home manufacturers to supply refined or unusual scientific material; if an American investigator needs, for instance, a special chemical, he must wait two or three months for its importation, while his European colleague could obtain the same in as many days or even hours, or, if manufactured here, two or three times the foreign price must be paid. The American artisan is more highly paid than his European brother, but not so the more eminent intellectual worker.

Naturally the realization of the value of intellectual things is found first among those engaged in the work of education, and our larger and better endowed colleges have within the last half century shown their appreciation of productive scholarship and have developed graduate schools to compare more favorably with the European universities, so that it is no longer necessary for our students to go abroad for the inspiration of working with men who are extending the boundaries of human knowledge. Once started, the fascination of research insures its continuance as long as a favorable environment exists.

The institutions that have been able by their large means to adequately maintain graduate departments have been so amply rewarded by their enhanced prestige, that many others, without sufficient means, have attempted to do the same thing; the result has been impaired undergraduate instruction with a more or less successful imitation of graduate work.

A graduate school should recognize as its most important possession the productive scholarship of its faculty, making the institution a center



of new knowledge, and all other matters should be arranged with a view to encourage and stimulate scientific investigation. A very moderate amount of class instruction and other duties should be demanded of the members of the faculty, and students should be sufficiently mature and earnest to work without compulsion and with little direction under the guidance and inspiration of the men who are doing real original work.

The case of the undergraduate school is fundamentally different. I believe that the prominence given to research in many undergraduate schools is a positive injury to the student; his instructors are chosen on account of their ability or promise as investigators instead of their qualifications as teachers, and even the student himself is encouraged or forced to undertake so-called research with entirely inadequate training, both as regards breadth and depth. The undergraduate years should be employed in acquiring a well balanced knowledge of the fundamentals of the student's specialty, and an acquaintance with the elements of many allied subjects, together with a working grasp of such tools as modern languages, to make professional literature accessible at first hand, and mathematics, for the mental training and grasp of the quantitative and statistical treatment of all studies, and every undergraduate student should give such attention to history, literature and economics as to make him an intelligent citizen and man of culture.

Only when this has been in a measure accomplished—and in looking back to our own college days we realize that a mere beginning had been made when we graduated—is the student in a position to profitably undertake research, with a proper appreciation of what he is doing and how to do it, so that it is really research for him and he is not merely a pair of hands under the direction of another's brain. The effectiveness of a scientific investigator is generally proportional to the thoroughness of his preparation; too many attempt to discover new truths before they have grasped those already discovered by others.

In many institutions one of the requirements for graduation is called a thesis, and such a tradition is difficult to dislodge, but I think the name is unfortunately pretentious and is apt to mislead the student into thinking himself more advanced than the facts justify; it savors of the same spirit that induces the high school to ape the college in so many ways, in its pernicious fraternities and even in having a "baccalaureate" service—doubtless to celebrate the fact that the boys about to graduate are still

unmarried; such unwholesome symptoms are usually most conspicuous in institutions with the least merit. The preparation of an undergraduate thesis may be a valuable item in the course if it is not so administered as to waste the student's time, narrow his mind, and swell his head. I believe its most valuable feature is its compelling him to go to original sources for information, namely, library work. Too many students graduate without this experience and with a knowledge of books limited to the prescribed texts employed in the course. To choose a subject of real interest to the student and of suitably narrow scope, and to find out by systematic search in the scientific journals all that is known about it, and then to write an essay in which the information is carefully arranged and well presented, is a task well worth the performance.

It is entirely laudable for every institution to aim at ever higher goals; not, however, by raising the entrance requirements beyond the reach of its natural constituents to meet, even at the dictation of some self-appointed board demanding uniformity under diverse conditions, and not by changing the object of its training—there would not be any necessary gain to the community at large should a school of pharmacy gradually become a theological seminary or even a medical college; a school of pharmacy is just as necessary as either of the others.

It is perfectly natural for any teacher or group of teachers to aspire to more advanced grades of work, but this should not be undertaken unless the more elementary and fundamental work is adequately cared for. We are suffering from too much ambition of this kind; too many trade schools attempt to be technical colleges, and too many colleges attempt to be universities, at the expense of their efficiency in their original equally important field. Let us imagine that every grade school gradually introduced more and more work of the high school, and that every high school gradually became a college, and that every college gave more and more of its energies to graduate students! Or let us imagine that every institution giving grammar school instruction attempted also to provide training through the high school, college and university curriculum! What a ridiculous and inefficient educational system must result. Roughly speaking, for every thousand grade schools we need about a hundred high schools, ten colleges and technical schools, and one graduate university.

Fortunately there is a supervision that prevents the transformation of grade schools into high schools, and separates the work of the two as soon

as numbers of pupils justify the step; it is a pity that there is no authority with power to insure similar efficiency on the part of undergraduate and graduate colleges and universities.

We are failing to appreciate the distinction between undergraduate and graduate work. In most ways there is little more in common between these than between that of the high school and of the college, and the university is injured in the attempt to make it a small part of a large college. Efforts have been made in this country to have universities unhampered by undergraduate departments; unfortunately, however, the country has declared itself not yet ready for such a logical and much to be desired arrangement.

The chief function of the undergraduate school is to give instruction in such a way as to insure mental development. For those few who are to proceed to graduate work, the soundness, breadth and depth of the foundation will largely determine the safety and usefulness of the superstructure of specialization to be erected later. The first qualification for membership in the teaching staff of an undergraduate school should be teaching ability together with a thorough knowledge of the subject to be taught.

This teaching ability is largely a natural gift, and if of a high order is not common. Let us recognize it, use it, and reward it as an asset of the highest value. It can not be created by the study of pedagogy any more than logical thinking by the study of logic; it is founded on the intuition of sympathy. Teaching is the keenest pleasure to some, the hardest drudgery to others; the student readily distinguishes the two. I would not, however, imply that even the best teacher can work effectively with the undergraduate who struggles to escape education or who is unwilling to make any effort for it because his interests are non-intellectual; such students have no proper place in an institution of higher learning, and we expend too large a part of our energy in forcing such material through to graduation. The fashionableness of going to college is by no means an unmixed blessing. Why does not some enterprising individual start a college with luxurious dormitories and means of recreation and dissipation, where work shall be optional and house parties continuous? Enormous fees could be charged, professional athletes employed, a suitable degree conferred after four years, and the working colleges protected from young men not desiring education?

Though the chief function of an undergraduate institution is instruction, and its faculty should be chosen with this in view, every such teacher, to attain his highest efficiency, should engage in some kind of research, that is, getting new information at first hand. This can not fail to have a vitalizing effect on his teaching, keeping clear the distinction between fact and theory, and maintaining his instruction abreast of the times.

There is widespread questioning of the value of much that is published as scientific research, and it is easy to criticize the spirit that piles up undigested data or adds to the number of chemical compounds for the sake of having something to publish; it is impossible to say, however, that any such information is and will continue to be valueless. I am less interested in discrediting such work because it now receives higher recognition from the indiscriminating in the educational world than it deserves, than in asking for recognition for a kind of labor, just as truly research, that now receives too scant credit from the public and from those responsible for the distribution of rewards to college teachers. I refer to what may be called pedagogical research—the labor involved in improving and constantly rejuvenating the instructional work. Any course that remains unchanged for many years is probably in need of repairs, but desirable changes usually involve much labor on the part of the instructor. The teacher whose heart is in his teaching and who carries the usual overload of duties is likely to be kept busy at just such work, and have no time left for the more conventional kinds of research; but his students will profit by his labors. The administrative officer who directly or indirectly puts pressure upon a college teacher to neglect his teaching is seriously injuring the college; yet this is by no means uncommon, intentionally or otherwise.

Research, of whatever kind, is largely a matter of inspiration, and can not be forced; as profitably might a poet be urged to become a painter as a scholar be pressed to undertake investigations foreign to his inspiration. Left to himself the investigator will do what he is most interested in and therefore likely to do most fruitfully; to attempt to force a teacher whose instincts are for pedagogical research to other kinds of investigation is likely to spoil a good teacher and make a mediocre investigator. The method of forcing commonly practiced is the indirect but very effectual one of recognition of published research by promotion and increased remuneration, while devotion to teaching and pedagogical research receive no such rewards.

Let us recall our own undergraduate experiences. Did we not in many cases get most stimulation and make most progress under teachers unknown in the professional journals? It is to be expected, indeed, that the teacher whose chief pride and interest are in his teaching, and whose chief reward is the advancement of his students, should be of more real value to those students, than the investigator whose hours of reflection are devoted to the problems of his research, and to whom the instruction of classes is incidental if not, as in many cases, an unwelcome interruption. Gifts of an equally high order for instruction and for investigation are not usually found in the same individual; let each give his main effort to what he can do best; let the investigator work with mature students and the teacher with the immature, and let the distributors of rewards make no invidious distinctions in the recognition of the two equally necessary and meritorious services.

While it is eminently desirable that a teacher should be also an investigator, in every faculty, some members have more pronounced ability than others in this direction, and it is proper that such should receive special consideration as to other demands upon their time and attention in order to enhance their productiveness by favorable conditions. To the others, whose bent is less marked in the direction of research, should be assigned the duties of administration and the committee work, with, if necessary, the high school commencement addresses. Neither should the more general business of the college be regarded as of any less value or importance than research, or less worthy of reward. To be sure it has not the same advertising value, but an institution of learning should be above adopting the motto "quick returns and small profits." The most enduring good accrues to the students, and therefore to the college, from inspired teaching and wise and careful administration.

It is the part of wisdom to provide as favorable conditions as circumstances will permit for the encouragement of research.

Several factors more or less obvious enter into this favorable environment and influence the productiveness of the investigator, but the real determining factor is in the man himself; he must have ideas, enthusiasm, and industry; he may even be a crank; he must have an accurate memory to retain the results of extensive reading, and as much as any one can profit by good health, to withstand the strain of concentrated and continuous effort; he must be absolutely honest with himself and the professional

world. If he has the necessary qualities it is very unfortunate if his circumstances do not permit their most fruitful activity; if he has not, let him serve his institution in other ways for which he is better fitted—ways of equal importance. Few men can spend several hours daily with classes, several more in administrative work, one or two more in committees, and have any vitality left either for research or professional growth.

The greatest need of most successful college teachers is more time to think. The evil effects of the prevalent rush become apparent only very slowly—in the course of years—in a gradually failing effectiveness for lack of mental nourishment. No one can use a few minutes now and then, snatched from the mere urgent duties of the moment, to do or even think real research; ideas do not come on demand, interruptions are often fatal to inspiration, experimental work often must be continuous to lead to results; investigation that is worth while is not a routine operation to be started and stopped by a gong; there must be mental growth as a background. It would probably be economical in the long run if the real teacher-investigator could be assured of uninterrupted privacy for half of every day.

In addition to time for thought, reading, experimentation and writing, the teacher of science needs space and material equipment. There is a temptation to spend money most freely in ways that lead to the most tangible results, and would-be benefactors may cause serious embarrassment by providing buildings without equipment or endowment; blessed be the liberal contributors to the "general fund," meaning equipment and, most important of all, competent men.

In the providing of suitable buildings with limited means, circumstances must decide how much can be devoted to what may be called luxuries and quality as against necessities and quantity; it is certainly desirable to have buildings as beautiful as possible, but not at the expense of adequate size and equipment.

Books are too often a crying need; they cost so much and they show so little; and yet without them research is impossible. The most serious lack is usually that of complete files of the scientific journals, which can *never* be purchased on a non-accumulating allowance of a hundred dollars a year. The value of the library habit to the student can hardly be overestimated, but to develop this plenty of books and an attractive place for reading them are almost indispensable. How welcome to the business manager of many

a college in straitened circumstances would be the professor who "did not read books but wrote them."

Turning now to the question of assistance, from the purely business standpoint a man should not be required to do what a cheaper man can do as well; the problem, however, is by no means solved by so stating it. The profitable use of assistants is a far from simple matter; their duties should be so assigned and supervised that their time may be spent to the advantage of the department and also to their own obvious profit. The men available have usually recently graduated and should realize that the salary is not the chief reward for their services, but that the time spent as an assistant in a well conducted department is valuable as a period of education and necessarily precedes any more advanced position in the college or university world. The assistant should welcome all such experience, even if some drudgery is included, as give him an insight into the teaching of his subject and the management of departmental business, such as the handling and ordering of supplies, the administration of classes, and the keeping of systematic records. To really review and extend his knowledge of the fundamentals of his subject so as to meet the needs of students entitled to his help is no slight task, but the assistant should use his utmost efforts towards progress in more advanced study and in research if his preparation is adequate. The assistant who shows the right qualities will not long fail to receive recognition and promotion; in the teacher's profession "everything comes to him as can wait" as far as he has the qualifications. Given the natural ability, industry and personality, thorough preparation will compel success; an assistant's position in a large and efficient department in association with successful men is better preparation for ultimate success in college or university work than the better paid positions in high schools open to men of equal training.

Those having charge of assistants should see to it that there is opportunity and encouragement for proper growth. It is through such assistants that the older teachers may hope to accomplish research, in doing which both are equally benefited. It is, however, something of a deception to call such assistants' positions "fellowships" if the duties of the department occupy any considerable part of the time.

It is certainly desirable that the more experienced teacher should delegate to assistants such of his work as can be properly done by them; it is very undesirable that he should cease to have direct and constant con-

tact with the work of students; the direction and development of courses should remain actually in his hands and the work of assistants be under constant scrutiny. When it becomes impossible for a course to continue actually under the direct management of a senior instructor it should be placed in charge of a qualified associate whose responsibility will be the incentive for his best work; the plan followed in some universities of having courses nominally in the hands of those for whom it is impossible to actually direct the work, which is really done by junior men, is essentially unfair to the latter in withholding from them the credit to which they are entitled, not conducive to the best results in that it fails to provide the incentive for devoted effort on the part of those actually planning and administering the work, and an imposition on the college and the public, who believe the courses to be really administered by the more widely known teacher. Many a student has been disappointed in finding that he has little or no contact with the man advertised as having the work in charge.

In growing institutions it is the usual experience of the teacher that other duties encroach more and more upon his instruction and research, the latter being first sacrificed. Some of these are indispensable, such as the keeping of accurate records of students' work, and as institution and department grow there is some unavoidable increase in the machinery for handling students; the red tape and machinery should be recognized as a necessary evil—a means not an end—and kept at a minimum; if the choice were imposed between good teaching with no records and good records with no teaching, the election would be simple. There may be a conflict of opinion on this subject, however, between the engineer of the beautiful machine and the poor laborer whose energies are consumed in feeding it with reports. I believe that we devote too large a part of our attention to the lazy and incompetent, to the detriment of the more energetic and able students on account of the struggle for the prestige accorded to numbers, which we may also charge with the use of colleges as lounging places for the sport and the intellectual dead-beat. It is surely unfortunate if a teacher has to spend his time in keeping elaborate records of and forcing the loafers instead of stimulating and satisfying the gifted.

The question of salary has an intimate bearing upon the efficiency of college teachers, and it is generally admitted that they are underpaid. The cost of living varies so widely in different college towns that a salary adequate in one would be entirely insufficient in another, so that it is



impossible to name a suitable figure. As a general principle, however, it may be accepted that the remuneration should be enough to attract men of energy and ability and make possible their best work. It is not desirable that teachers should vie with the commercial classes in display or in expensive amusements, and men of intellectual strength would not wish to; it is proper that they should receive enough to permit comfort without anxiety, membership in scientific societies and the attendance upon their meetings, books and other professional tools, and also travel, society, and the enjoyment of music and art, for the sake of their own broad development and consequent influence in society as well as with their students. The man who never sees anything but his home and his place of business is certain to be narrow. Many young men ruin their professional prospects by marrying on a very small income even before their education is complete; it is no evidence of a lack of sentiment for a man to postpone marriage until he is in a position to properly maintain a family. Further, it is surely the cause or the result of a second rate qualification as a college teacher to attempt to carry on another business with no bearing upon his professional pursuits for the sake of the increased income. Scarcely less valuable is the semi-professional routine of tutoring, commercial analysis, and even the preparation of uninspired text-books, for the same reason. These things do not give the best preparation for and naturally do not lead to the highest university positions, though they do bring immediate financial reward; better far devote the time to some research if there is any in the teacher, and qualify for advancement in the college or university world. In education as in business, both the teacher and the institution may expect to get what has been paid for; if the teacher gives less than his best efforts he may look for less than a full reward, and the institution that seeks bargains in teachers will probably get something cheap—and nasty; if first rate results are to be achieved the price of first rate ability must be paid, allowing for a long and expensive preparation.

The bearing of this upon the question of research is evident; to cultivate the vitality of the intellect it must be free—free from anxieties as to the necessities of life, free to proceed in broad and deep channels, with all the incentives of intercourse with things intellectual and asthetic.

The story is told of a college teacher who was conspicuous at prayer meetings, that it was his custom in closing a lengthy petition covering a large amount of detail to say, "And now, O Lord, to recapitulate," and so on.

Permit me, then, in conclusion to summarize the points I have tried to present. In undergraduate schools research has a very important place as a stimulator and vitalizer of the teaching; it is, however, a secondary calling and should not be allowed to interfere with the main function of the teacher, namely instruction. The selection of men for such positions should be based primarily on their qualifications as teachers, and research should not be undertaken until a broad and deep foundation has been laid. The value of research, however, makes it most important that men capable of doing it should be helped in their efforts by the most favorable environment possible.

## PLANTS AND MAN: WEEDS AND DISEASES.

BY ROBERT HESSLER.

Indiana may be divided topographically into three parts—the southern hilly, the central rolling, and the northern part flat and wet. With the exception of the northwest, the whole State was originally densely covered with forests. The wet lands are being drained more and more and the land brought under cultivation. The soil is rich and produces heavy crops. It is surprising to learn that along the Kankakee first year crops require practically no cultivation, because there are no weeds. The next year a few come in; many are found by the third year, and after that farming becomes mainly a contest against weeds.

Bringing the land, whether densely forested or marshy prairie, into cultivation means displacing the native flora by foreign plants. These latter are of two kinds—those brought in purposely, cultivated plants of all kinds, and those brought in unintentionally, mainly weeds. Today most of our worst weeds are foreigners that have come from all parts of the world, especially from Europe, where for ages weeds have been fought and where certain ones have developed resisting qualities. Weeds are introduced in imported seed and also largely in hay and straw, used in crating. In waste places about cities where trash is thrown one may expect to find "new weeds." Some are also brought in by the railroads, the seed lodging on cars and falling off. Some are brought down by rivers.

When man cuts down the forests, plows the prairies and drains the marshes, he is disturbing the "balance of nature," and animals and plants move about to find new, suitable homes. Animals, of course, move about very freely; if their homes are destroyed they seek new ones; every botanist knows that plants do the same. That is, seed is carried about and germinates here and there; if conditions are favorable the plant may thrive, become re-established. If conditions are unfavorable it may perish very quickly, or it may persist for a year or two. Thus at present some of our native plants may be seen in localities where they had not been seen the year before or where they had not been seen for many years. I have a number of notes of such "moving about" plants.

When the old style rail fences were still common, many plants found a home along them; they perished under wire fence conditions. Some species may flourish for several years in wet meadows until a dry season destroys them. On the other hand, dry soil plants may flourish until a wet season drowns them out. Some will grow in ungrazed pastures. A number of other factors might be mentioned, but it will perhaps be seen from the above why some plants are constantly on the move. Some people, like plants and animals, are also constantly on the move. We need only think of the frontiersman who feels crowded when a neighbor moves within a mile of him. But this type has almost disappeared.

For a number of years I have been going along the railways and rivers looking for new arrivals. It is surprising to note the number of new weeds that have come in and are still coming. The railways in many respects furnish ideal situations. Here and there the right of way is level, alternating with steep, dry and gravelly embankments and wet ditches, occasionally there is a little pond; all these furnish a variety of habitats for different species. One destructive factor, however, must be considered—the annual weed cutting, as required by law. This means that many plants cannot thrive; they are cut off about seed time. (By the way, in my observations the railways alone observe the State weed cutting laws; it is practically neglected by road supervisors.) In the Proceedings (Academy of Science) for 1893 I published a list of thirty-five immigrants, of which at least half a dozen subsequently became common weeds, to be found throughout the county.

When I made a tour through the West, in 1905, I was surprised to note how free the Yellowstone Park is from our common weeds; I saw only one or two; evidently they are just beginning to come in. On the other hand, in traveling through the West, I saw a number of plants that I had previously found as adventive plants along the railways here at home. I felt like greeting them as old acquaintances. I saw many plants that I felt sure would come to Indiana in the course of time; in fact, as those who keep track of plants well know, new ones are appearing from year to year.

One year at Longcliff (the Northern Indiana Hospital for Insane) we had a large field of Crimson Clover, the seed having been obtained from a seedsman. In passing it one day I noticed a number of strange weeds and I at once came to the conclusion that this Crimson Clover had been imported from Europe. A few years later, while in Germany, I saw these

same weeds in fields, and I then concluded that that seed had been imported from Germany. Moreover, while traveling through different countries in Europe I saw a number of weeds that I instantly recognized, because I had seen them at home as immigrants. There were many that I expected would come to Indiana in time—and they are coming; new ones appear every year. This summer, for instance, I found a little composite plant (*Galinsoga parviflora*)—it has no common name—about Longeliff. I had seen the plant about Berlin; the German botanics stated that it had been introduced from western South America. I have been wondering whether the plants at Longeliff had come from Germany or direct from western South America. It would be interesting to know the facts.

Several years ago I had as a patient an old farmer who came to an adjoining county when the country was first settled. He gave me many facts regarding early conditions; how the dense forest had to be cut down and clearings made; how the small truck patch required very little attention because there were no weeds, but in time weeds gradually came in and then the farmer had to fight weeds just as now in the Kankakee region. He also told of the coming in of pests and parasites of all kinds, including rats and mice, lice on animals, and blights and rusts on plants. He remembered when the peach blight first came, proving very destructive to peach trees. Unfortunately I kept no record of dates. I have often regretted that I did not make memoranda because these are matters for which we must rely more and more on what is already recorded in the books.

I live on a four-acre lot at the edge of town. In front of the house there is the lawn; in the rear along the river there is pasture; on one side there is the garden and on the other the orchard. Then there is the barn lot and also a neglected bit of land. (There are also two little plots, one for wild flowers and another for plants grown from seed brought from foreign countries.) There is a variety of habitats for plants and it is interesting to note how some flourish in one situation and some in another. The movement of plants is, of course, constantly interfered with by cultivation and weeding, notably in the garden and on the lawn. Some weeds are very resistant; in the barn lot, in spite of one or two cuttings every year, the Jimson weed and the Spiny Amaranth continue to grow; every year there are two or three plants. In the pasture again there is a small patch of Canada Thistles. This plot has been cut down and plants hoed down two or three times every year for the past eight years, and still the thistles

are able to maintain themselves. The garden, of course, requires constant weeding. Practically all the weeds on the place are foreigners.

I just referred to a neglected bit of land, to an idle plot of ground. This at first, eight years ago, was covered with Blue grass and grazed. The number of plants that have come in since is something remarkable. Equally remarkable is the absence of common weeds; they seem not to get a start in the dense covering of Blue grass. Barnlot weeds are never found in that patch, nor some of the common garden weeds. Among the plants to appear were a number of trees and shrubs. Unfortunately, three years ago, a cow got in and many of the plants were killed off, but the way the shrubby and woody plants spring up would indicate that in a short time there will be a forest and light-loving plants will be wholly crowded out.

It is interesting to note how in the South, old exhausted cotton land when left to nature grows up in pine forests, Old Field Pine, but the wood has so little substance that a tree, when cut, will wholly fade away in the course of a year. It certainly takes a long time for exhausted soil to regain its strength and for trees worth while to again get a foothold.

Besides tramping along railways in search of new arrivals, I frequently take strolls about neglected parts of the city to see whether any new weeds have come in and what changes have taken place among those already present. One day last summer I started out from the heart of the city where there is no vegetation, no grass and no trees, because streets and sidewalks are everywhere paved. I went along one of the neglected streets which is either deep in dust or in mud. This street has practically no trees at all. Along the gutters were found growing a number of weeds, practically all foreign ones, that seem able to resist the dense clouds of dust that are deposited on them. The plants are white with dust, or rather grayish, almost resembling desert plants. I passed several waste lots covered with weeds, nearly all of European origin. I finally reached Shanty Town, where weeds flourish among the human habitations. The people themselves, like the weeds, were of the neglected kind. A little farther on I came to the railway shop, with its large roundhouse, where an immense amount of dense black smoke arises. Now, since our prevailing winds are from the southwest and west, the smoke, of course, blows off in the opposite direction. I was surprised to see that all the trees to the east in line with the smoke were dead, a number of dead trunks were still standing. When I first came here, fourteen years ago, there were a num-

ber of trees in that neighborhood. The black smoke killed them off. I was reminded of the hills about Pittsburg, which, as some of you may have seen, are denuded of trees on account of the smoke. The same thing is seen about some of the western smelters, where vegetation may be killed for miles, and poisonous deposits, especially of arsenic and copper, cover vegetation for a still greater area.

From the roundhouse I walked along the Wabash river, still looking for plants. The river is shallow and has a limestone bottom. Once or twice a year there is high water and that means to wash out everything loose before it. Seed brought down may lodge along the banks, especially at the flood lines, and every now and then new plants may be found. Some may grow near the water, but the next flood is very apt to wash them out. There are no gravel banks and some plants characteristic of other places are absent, as, for instance, plants found along the White Water river, where I used to collect, such as *Saponaria officinalis*, *Polanisia graveolens* and *Cuphea viscosissima*. The former, however, is to be seen more and more frequently above high water mark; the second, *Polanisia graveolens*, is occasionally seen; but I have not seen *Cuphea* at all.

Leaving the river I went west along the Wabash railway. This at first runs on a high fill with gravelly sides, later becoming level and prairie-like. Here in the course of time I have found a number of adventive plants, both European weeds and western species, the latter as a rule lasting only a season or two and then disappearing. Lower down I crossed the river on the railway bridge and followed up the Vandalia track northward. This runs over a deep fill. At one place the steep embankment was covered with cinders. I was immediately reminded of the cinder and lava slopes of Vesuvius. I was not at all surprised to see only a single plant growing among the cinders, the sheep sorrel. At once my trip up the Vesuvius came vividly to mind. I had gone up on horseback with three companions and a guide. At first we passed through towns and highly cultivated fields, but we gradually left these behind and came to a desert region of black cinders and lava, going upward all the time. Finally all vegetation disappeared, the last plant to disappear being sheep sorrel. On the descent I made a collection of plants, beginning with the first one to re-appear, *Rumex*<sup>1</sup>. Next came a shrubby *Spartium*. Gradually

<sup>1</sup> Whether the species is *acetosella* or *scutatus* I do not know. My Italian botany, moreover, speaks of a variety under the last species that grows among volcanic scoriae.

other plants appeared, including a wild fig. Still further down came a small patch (one cannot say a field) of Lupines; probably that is the only cultivated plant that is able to thrive in the cinders. Next came a small vineyard and the cottage of a family. These people, like the plants on the slopes of the volcano, are in constant danger of being overwhelmed. Small plants are, of course, in danger on account of clouds of cinder dust, the wind at times being terrific.

All this came to mind vividly while standing at the cinder covered railway embankment. Then I mentally retraced my steps down to the river and to the plants that lead a precarious existence and are constantly threatened by high water. Then I thought of the people who live on the river front and especially on the little island, who, once or twice a year, are in danger of floods. Occasionally some must be rescued in boats. These, too, are reckless; prudent people likely would not be found under such surroundings. We all know how large cities with a river front are infested by a class of people known as "river rats," a highly undesirable class; human weeds, so to speak. When botanizing, we are frequently asked, What is the plant good for? One may also ask, What are weeds good for? Shall we also ask, What are some human weeds good for?

Continuing, I retraced my steps to the railway shops and the smoke. I recalled the sad-eyed women and sickly-looking children who exist in that atmosphere. The men, of course, are employed in the shops and I wondered how long they are able to hold out. It is well known that the city "takes it out" of strong and robust men—they soon fail. Large industrial cities have little use for a man after the age of about forty or forty-five. Now I knew that smoky air about the shops killed the trees and that only a few weeds were able to grow, and I wondered how long human life itself is able to endure under such conditions. Trees being fixed to the soil, live and die *in situ*; human beings are not fixed to the soil and so when they fall sick they generally remove to another neighborhood. If they are unable, on account of sickness, to pay the house rent, they are evicted and others move in. People removing from an unsanitary environment may regain health and perhaps again become self-supporting, but only too often they continue to fail and many die prematurely and the children become public charges. Who is to be blamed for premature deaths?

I further retraced my steps to Shanty Town. I recalled how the newspapers had frequent accounts of the prevalence of typhoid fever in that



section, how shallow wells were infected. The water from the wells is used because it is clear. People prefer clear, sparkling water to muddy hydrant water, although the sparkling water may be veritable poison. Where does the blame for typhoid fever rest?

Still retracing my steps, I came to the neglected street with its weeds and with its corresponding class of people, going on to the heart of the city, with its lack of trees and full of sickly people. Then I compared or contrasted the West End of town with the East End. The West End is the home of working people, while the East End is occupied mostly by tradesmen and the well-to-do. Now our prevalent winds, as already mentioned, are from the west, and that means that the people in the West End get air from the woods and fields, while those in the East End get the smoke and dust from the shops and from the heart of the city. This may explain why the East End Wind has such an evil reputation, and why towns having the "West End" properly located are more desirable as places of residence. These remarks will be better understood when we consider that people, like herbaceous plants, but unlike trees, are more or less constantly moving about. Some plants come and go, they are seen one year and then disappear, perhaps to re-appear later; those finding the habitat favorable may remain permanently. Common weeds find conditions favorable almost anywhere and flourish, especially in neglected places. Shall we say that human weeds also thrive almost anywhere, and shall we say that people who are well-to-do and able to move do move out if they find that the "West End" has not been properly located?

The subject may be considered a little further. Several years ago a patient with whom I had often discussed things like the above told me about meeting an old friend who had just returned from the Saskatchewan. The man gave a glowing account of the large crops of wheat, and the large potatoes, beets and turnips, all growing without weeds; he told how healthy the people were, they did not even have the common ailments; he ascribed it all to the "wonderful climate." Climate nothing! my friend exclaimed; weeds and ills and diseases are absent because they have not as yet been brought in. They will all come in time; just wait a few years.

I might again refer to my old patient who had told me of early Indiana conditions and the coming in of weeds and pests and parasites of all kinds. He had also told me how healthy the first settlers were until malaria came in; then nearly everybody became sick. Life now assumed a

serious aspect and there was much sickness until wet places were drained and chills and fever, that is malaria, became less and less prevalent; today malaria is a comparatively rare disease. At first, too, all the minor ills were absent. People did not even suffer from cough and colds. He told me how he used to go barefoot until the ground was covered with ice and snow and how he could wade through water that was cold enough to form ice and never "catch a cold". But he noticed that in time ailments and diseases came in. He referred to some affections as "new-fangled diseases".

When I called his attention to the analogy between weeds and diseases he readily understood. Before this was pointed out to him, however, he had expressed his belief that the race was degenerating. Referring to his long-lived family with many brothers and sisters, he said that all lived to old age, he himself being now in the eighties. He made the contrast between himself and his grandchildren, especially those living in the large city; he regarded them as "weaklings", requiring the attention of the physician more or less constantly. After I had pointed out the analogy between plants and man and weeds and diseases, he readily saw that his grandchildren were "weaklings" because they were living under an entirely different, an unsanitary, environment. The original Indiana inhabitants, the Indians, were healthy simply because not exposed to the cause of ill health and disease. People who are housed up in town are living hosts for the propagation of diseases, just as plants in hot-houses, which require constant attention to keep down diseases.

Moreover, the man himself was a living illustration of these changes, for he came to me on account of his own ill health, which he thought his home physician did not understand. He said the common country doctor is good enough for common country diseases, but "these here new-fangled diseases need men who have studied more". He referred to his own ill health as a "new-fangled disease", while as a matter of fact it was a very common ailment, one of the "diseases of civilization," nothing more than common catarrh. One did not have to seek far for the cause of his complaint. Until a year ago he always lived on the farm, very seldom coming to town; then he rented out his farm and removed to a small town, and now occupied a seat on the cracker barrel, that is, he spent much time loafing at the village store. Some of these stores are so dirty that they have required repeated notices from the State Food Inspector. Air conditions are espe-

cially bad. In a short time he began to react. He had catarrh and cough. On account of his cough he was inclined to be in the open air less and less and to house himself more and more, the very things he ought not to do. When I pointed out these things he promptly changed his mode of life and the reaction ceased. He was again "healthy".

It is undoubtedly true that all now common weeds and pests and parasites and diseases were restricted at one time to certain localities, from whence they have spread until they have become cosmopolitan. There are many data regarding first appearances. In our annual Proceedings, for instance, are a number of records for the first appearance of new plants and new animals, new in the sense of not having been found here before. The appearance of new diseases in the State is of course recorded in the medical journals, but imperfectly. The subject of the coming in of new pests and parasites and diseases is an important one and cannot be dismissed with a few brief paragraphs. I should like to give at least one illustration relating to the common potato.

The potato was carried from South America to Europe about the middle of the sixteenth century, and subsequently brought to our country, and now goes under the name of the Irish potato. Those of middle age can recall how, until in the seventies, the Colorado potato beetle was never seen in our potato fields. How this beetle came to us is an interesting story.

On the dry western plains there grows a species of spiny *Solanum* (*S. rostratum*), a near relative of the potato (*S. tuberosum*). This plant has a parasite, the beetle now commonly known as the potato bug. The plant grows very sparingly and that means that the beetle also occurs sparingly. A little reasoning will show why. If the bugs became abundant and would completely consume their food plant then they themselves would perish for want of food. On the desert the plants are far apart and many escape the attacks of the bugs and ripen seed, or if a single bug reaches a plant it will not injure it enough to destroy it.

Now when the common potato began its westward march it gradually reached the home of this beetle. The beetle found the new species more acceptable than the old and, since plants were close together, life conditions became easy and the potato beetle, now called the potato bug, at once increased enormously and traveled from one field to another, and in a short time overran the whole United States. I was surprised when in Germany to see the potato fields free from the potato bugs; authorities there are on

the lookout; they are keeping it out as our own authorities at present are keeping out cholera, the plague, yellow fever, etc. It need scarcely be said that between the potato plant and the potato bug there exists the relationship of host and disease. The potato bug in its destructive action on the plant may be considered the disease; it will destroy the plant just as the potato-rot destroys it. Before the cause of the potato-rot was recognized it was looked upon as a visitation, just as many of the human diseases were looked upon.

This fall the newspapers contained an occasional item regarding the spread of the potato-rot or potato disease. Just now the disease seems to be prevalent in some parts of Europe, destroying outright large potato fields in the course of a few days. Such an epidemic is a great calamity; it has been such in times past. It seems to be only a matter of time until the disease will reach our State. This disease seems to be at home originally in South America on the wild plants, but plants were few and far apart. When the potato is grown in masses this fungus disease naturally spreads very rapidly from one plant to another and from one field to another.

But it was noticed that after an epidemic a few plants survived. By taking these survivors and cultivating them a more and more resistant strain has been produced. One can thus speak of disease proof potatoes, just as we can speak of disease proof individuals, for instance, the negroes on the west coast of Africa, who are constantly exposed to malaria and are quite immune.

In the life of every individual there are periods that stand out. We need only think of such statements as "Before I went to college", or "Before I got married". Similar periods or landmarks stand out in the life of a community, as "Before we had paved streets" or "Before we had filtered water". We can likewise speak regarding the introduction of weeds and pests and parasites and diseases, as the days "before the potato bug".

Perhaps in tracing analogies one might mention the coming to our country of such diseases as Influenza and Asiatic Cholera. In earlier years, when the country was thinly settled, many escaped, and, on account of poor traveling facilities, diseases traveled slowly. Influenza has traveled more rapidly each time it appeared and attacked a greater number of people, because they are now living closer together. There are regions today, especially islands in the ocean, where some of our common diseases have not yet been introduced.

Our country was originally in possession of the Indians; European immigrants gradually displaced them. The early comers found a wilderness; they cut down forests and cultivated the land. They thrived exceedingly and built up towns and cities. Immigrants in large numbers have continued to come, but those who come today find all the land occupied. The poor immigrant no longer can or does settle in the country; he goes to the crowded cities where there is a demand for labor. Many of the present immigrants come from the open country; they are used to open air life, as their ancestors had always been. There has been little or no weeding out such as we find among people whose ancestors lived under city conditions. As a consequence, when these immigrants crowd into our cities—and of necessity they crowd into what are called slums rather than go to clean portions—they soon fail. Why is it that the children of the stolid immigrants are called neurotic?

Immigrants massed in cities need a change of environment. Country people thrive best under country conditions; many are wholly unadapted to city life with its many-sided contact with ill health and disease. Most immigrants are from country districts. No wonder the old farmer referred to his grandchildren as “weaklings”, and believed that the race is degenerating, and no wonder physicians find children with all sorts of abnormalities and defects and that many are neurotic. Children, like plants, need room to grow; if massed together they, like plants, become stunted—in the end it is, of course, a survival of the fittest.

This brings up the very practical question, Why do we allow slums to exist? Why do we allow people to live under slum conditions? European cities are driving out their slums, but we have scarcely made any effort.

I referred to a plot of ground that is “going back to nature”. Perhaps we can find analogies among men. In the first place, there are situations where we scarcely expect to find certain people. For instance, people who normally live in the slums are not to be found among the better class.

What do we mean by “the better class”? Do we not find a constant shifting about, some drop out, some rise and enter it? The old saying, *From shirt sleeve to shirt sleeve*, is very expressive. Very often, however, the dropping out is due to ill health.

Civilization, like farming and gardening, means a constant interference with nature. It is man against nature. When man gets back to nature old-time conditions never return, man again becomes strong and robust. We

hear much of Race Suicide today. Perhaps under a more simple and sanitary life the race would again become strong and healthy and prolific, just as soil left to nature returns to its former condition.

I referred to the fact that many of our plants are constantly on the move. We see this exemplified again in man. Some people are moving all the time, one might almost come to the conclusion that the old-time home is disappearing. People will move from one house into another, from one street to another, from one town to another, alternating perhaps between town and country and from one end of the country to the other. One wonders why people move so much. One important cause in my observation is on account of ill health. Many move into another house or into another town in the hope of having better health. When they do find a congenial place they are apt to stay, just as plants and animals stay.

It is interesting to study the movement of population, of towns as a whole or of certain streets or of certain buildings in the heart of the city, say a large store or office or bank. "Office boys" are both from city and country; many country boys go to the city to "try city life". Some succeed but many fail. We hear of the successes but we usually do not hear of the failures, although there may be only one successful man to a hundred or several hundred failures. I am reminded of the remark of an old merchant: "The new boy who cannot stand the work of sweeping out the store and running errands is not apt to make a good business man", meaning in this case a storekeeper. The merchant knew this as a fact, he did not attempt to explain it. I offered him this explanation:

The new boy when put to sweeping may or may not react to dust influences. If he reacts there will be more or less complaint of ill health and in time he will drop out; if he does not react he may gradually advance and in time become a business man. The merchant whose name appears in the city directory year after year may be regarded as an immune, as an individual able to live under unsanitary city conditions. The directory does not mention the numerous failures. The successful business man in the city must be regarded as the survival of the fittest. He does not move about; he remains fixed because he is able to bear the unsanitary environment. This moving about is, of course, seen at its best in large manufacturing establishments, where there is a constant influx of "new hands".

Looking over the books on diseases of plants, one is surprised at the analogy between plant diseases and human diseases. One finds plant

pathologists using the names of the human pathologist and the physician. They speak of "epidemics" and "endemics" among plants—those terms etymologically refer to people, meaning "upon the people" and "among the people". It seems rather incongruous to use such terms for diseases upon or among plants. But it is facts, not words, that scientists are after. Then there occur such names as chlorosis, icterus, atrophy, necrosis, and even cancer and consumption.

Plants are afflicted with diseases due to bacteria, to fungi (even to higher, flowering, plants), to animal and vegetable parasites of all kinds, to mites and worms, just as human beings. But, perhaps needless to say, the species are different. Although some of the common names current among physicians are used, yet the scientific names are wholly different. Another thing that impresses one on going through the books on plant pathology is the importance attached to cleanliness, as cleanliness about the orchard, destroying dead branches and leaves and keeping the ground and trunk clean, the necessity for spraying and fumigating, measures that physicians long ago learned but which the people are slow to adopt. That cities need as careful attention as orchards seems to be known to but few of the people. The old farmer must be told why his orchard does not flourish, why trees are sickly and ultimately die, just as many a community must be told why its people are sickly and why there is race suicide.

One day while botanizing I came across a field thickly overgrown with Iron Weed and Vervain. At one end it was wet and swampy, with pools of water. The farmer, who was plowing, overtook me. We engaged in conversation. I asked him why he allowed those weeds to grow. "The cows like weeds; they brush off mosquitoes and flies." He thought this sufficient reason for allowing weeds to grow. I pointed out how flies breed in his manure pile and that by giving a little attention the number of flies could be greatly reduced; that mosquitoes breed in wet places, as at the end of the field, and that with a little drainage the mosquito pest could be prevented; that with flies and mosquitoes absent there would be no need for the weeds; with fewer flies the cows wasted less energy in switching them and would give more milk; and in the absence of blood-sucking mosquitoes would gain in flesh. In the absence of weeds there would not be a constant cloud of seed blowing on to his cultivated fields and on to those of his neighbors.

He listened incredulously and when I finally told him how a certain mosquito transmitted malaria, he said, "Now do you really believe all that?" His own belief was that it was all nonsense.

What is the use of attempting to teach the old farmer? I thought. Perhaps if the school teacher told these things to the farmer's boys it would have some effect. They might see the need for cleaning up everywhere.

It is perhaps unnecessary to refer to the experienced florist or horticulturist whose knowledge enables him to tell from a plant's appearance that it is sickly and needs certain treatment, otherwise it will perish; or to the physician whose knowledge enables him to quickly recognize certain conditions in man and the need for a change.

Now resurveying the field, one comes to the conclusion that weeds and diseases and ill health exist mainly because we neglect to pay attention to cleanliness. When an epidemic threatens a large city then everybody gets busy and cleans up. There should be constant not periodical cleaning up. We should not allow the existence of waste places where weeds grow which will re-seed the whole country about. No matter how free from weeds a farmer or gardener may keep his own ground, seed are constantly brought in from the surrounding country. It takes a combined effort to fight weeds. As matters stand, farming and gardening are largely a warfare against weeds. The same is true in regard to communities and diseases. No matter how careful one individual may be the seed of disease constantly comes to him from those who are sick and diseased. He meets people on the street who come from neglected homes, from the slums where disease and ill health are endemic and from where diseases are carried to all parts of the city. By the way, nearly all the patent medicine testimonials we see in the newspapers are signed by people living in such localities.

We can look at the subject in another light. Many plants adapt themselves to their environment. Sensitive ones are readily killed off under conditions where weeds continue to flourish, just as many human beings are killed off or driven out where conditions are unsanitary. But we know to what extent some human beings can live under slum conditions; some must be regarded as human weeds, such as the **Juke and Ishmael** families. Like common weeds, they are undesirable. Cleaning up drives



out the slums; moreover, slum children, if removed, in time may become desirable citizens.

Why is it that "human weeds" are given such an undue amount of attention, asylums are erected for them where they have the best of attention, where they live on to old age? Why must a man wait until he becomes insane or a pauper or a criminal before being housed under sanitary surroundings?<sup>1</sup>

Why does ill health flourish so widely? Why are there so many quack remedies, as those advertised in newspapers? The newspapers of some small towns are overcrowded with nostrums for common ill health. Where should the attempt to make a change begin?

One day I was telling a teacher that in Germany children are taken out into the country on certain afternoons to study nature, the valleys and streams and underlying rocks, the plants and animals; that boys make collections of plants and bugs, etc. Perhaps later when as adults they go out into the country they really "see" something. He admitted that that was all very nice but that it required the teacher himself to know what to point out.

He mentioned that some of our teachers had the pupils to study newspapers. But that occurs only in isolated instances; when we investigate we find that the editorial page only is read and studied.

Now the editorial page of large city newspapers as a rule is the only page free from offensive advertisements and reading matter, of accounts of murders and all sorts of things that do not elevate mankind. Likely the back of the editorial page is full of murder news and crude pictures of the murderer, his victim and the places where the deed was committed; or the page is full of quack advertisements, of medical pariahs who claim to cure what no conscientious physician can cure; or of deceptive patent medicine advertisements for ills that no physician can cure, because they are a reaction to an unsanitary environment.

Now it would be a good thing for schools to study the newspapers, all their pages and all the papers, the high toned ones that leave comparatively little to be desired and the other kind called yellow. The re-

---

<sup>1</sup>This is not to be considered a criticism of our benevolent institutions; they are doing a good work, one in harmony with the spirit of the age. It took a long time to reach a high plane. Our leveling should be upward. As matters stand, the amount of attention given charitable institutions is wholly out of proportion to what is given worthy people not in institutions.

lationship of cause and effect should be traced. Do newspapers supply wants?

Is it reasonable to believe that the average newspaper publisher deliberately prefers to publish horrible murder accounts, nauseating and lying advertisements of all kinds, which he does not want his children to read? The editor himself has very little voice in the matter; he writes the high-toned editorials. It is the managing editor who must look for financial returns for the owner or rather for the publishing company; he gives the people what they want.

The matter of clean newspapers, clean cities and clean farms goes back to the community—there is room for the school teacher.

Every large city has a number of newspapers; some appeal to a certain class of readers only and go to certain sections of the city, some to the fine homes, some to the slums; others appeal to all sorts of readers.

Small communities may have only a single paper. By comparing the newspapers of small cities one can get a comparative idea of city conditions. Quacks and charlatans and patent medicine men do not thrive in clean communities.

The patent medicine men in their newspaper advertisements are still loud in their praise of our "valuable native medicinal plants." They evidently try to keep up the old-time belief that there is a plant for the cure of every disease.

In strolling about the country with a botany can, one frequently meets people who ask, What are the plants good for? Many have an exaggerated idea of the importance of plants, especially of common weeds, in medicine. Usually one does not attempt to explain. It may be said that as a rule plants play a very slight role in medicine today, only a few are used and then mainly to modify symptoms, less and less in the light of "curing diseases." Perhaps one can make distinctions between plants and their use, in this wise: Plants of least value, used to modify symptoms, are those that can be gathered readily, or which grow naturally as weeds, or which can be cultivated in gardens. Secondly, plants that must be looked for away from the haunts of man. One may say of these that if the individual in ill health will go and seek them out, using them under simple life conditions, likely he will regain health, as shown for instance in a little story by O. Henry, where the mere search for the rare plant in the mountains brought back health.

Just now we hear much about school gardening, having the children attend to a small plot of ground. We can readily see how a child may learn much regarding plant life, how the soil must be prepared, the seed planted at the right time, food and moisture supplied, and enemies of the plant held in check, weeds and animals of all kinds. The school boy learns that in proportion as attention is given to his plants and they are protected from destructive influences they thrive. By pointing out analogies between plants and man he can understand why man himself requires attention.

It is customary nowadays when any change is proposed to say, Teach it in the schools! Teach the Young! Just now there is a demand to teach agriculture in order to get away from old-time farming with its wasteful methods. Teach it in the schools! Teach the young! Now the same may be said regarding causes of common ill health. Teach it in the schools! Teach the young! The young learn readily and remember. Our schools already teach physiology but unfortunately it is largely if not exclusively a book study; often the book used is dry bone anatomy or dry as dust physiology and forced upon the children before they can grasp it. The new books on hygiene and sanitation are a great improvement but it is still only a teaching from books. If the teacher could take his pupils out and point out analogies between plants and weeds and diseases and if newspaper accounts were studied in the light of environmental influences, it would not take long until there would be a change for the better.

But in order that the teacher may be able to instruct the young, he must himself be taught. That means the colleges must take up the work, and since our Academy is mainly made up of college people, shall we say the work comes home to the Academy?

But, some will say, educating the people in regard to sanitary matters is work for the physicians, the physician should educate the people. That may be true theoretically but practically it is wholly false. Physicians treat sick people. Under present conditions that is all the people demand and all they are willing to pay for. Many have no use for the physician until they are actually disabled, sick or diseased, and then it may be too late to talk of education.

It may be asked, Why do not physicians at least call attention to these matters and to environmental influences, how people become sick and diseased on account of unsanitary surroundings? There are several

reasons. First, a financial one: physicians like everybody else do not take up a work unless paid. Second, when physicians do advocate sanitary measures they are almost invariably accused of working to their own interests. As a matter of fact, however, practically all the sanitary improvements that have been made and are taking place are due to the efforts of physicians. To see how measures intended for the welfare of the people are antagonized by "peanut politicians," we need only consider what takes place in the legislature at every session, and how long it takes sanitary measures to pass. Why many physicians do not take an interest may be seen by what occurs when physicians object to the coming of quacks and charlatans who herald their wonderful abilities in the newspapers—almost invariably the newspapers take the advertising quack's part and oppose the home physicians. As a result many physicians do not concern themselves with the subject, they have all the work they can do and the "fly by night" does not interfere with their practice. Another, a third and very important reason is this: The physician as a rule belongs to the "weeded out" class. He is an individual who does not react to ordinary unsanitary environmental influences and because he fails to react is why he pays little attention to common ills and minor maladies. The reason why physicians belong to the "weeded out" class is simple: The boy who intends to become a physician requires good schooling; he may even be required to take a preliminary college course, get an A. B. degree, before he is allowed to enter medical college. Now many of our schools are very unsanitary and the bright boy reacts; he has ill health. He may drop out entirely or attend school only at intervals, but finally manage to complete the grades; then he is ready to enter high school. This is often located in the heart of the city under highly unsanitary surroundings. Trees may not grow but children are expected to. The ventilation of the school house is usually bad. The boy reacts promptly. He is more or less constantly in ill health and soon drops out entirely. Unless his parents are well-to-do and able to send him to a private school he is not apt to become a physician.

One can go a step further. Many medical schools are located in large cities under surroundings about as bad as they can be. Some young men who were able to complete high school (and we know there are some sanitary high schools where boys pass through readily) are now weeded out in the medical college. They fail to get a medical degree. The boys

and young men who have "robust health" and are able to continue their education uninterruptedly are "the survival of the fittest." They can follow their profession in the heart of a city under the most unsanitary environment—and since they do not react they fail to understand the common ill health of their patients; they are apt to refer to some individuals as "imaginary ill." That may explain why the sick often go elsewhere and why faith and mind cures flourish. Now in regard to the latter it may be said that many individuals when they adopt some mind or faith cure change their habits, perhaps leading the simple life and remaining away from crowds. With this change comes about improvement in health.

The common doctor treats the common ill health and the common diseases of the common people, a fact pointed out by the Father of Medicine 2,500 years ago. It is rather anomalous that scientific physicians today should so largely be interested in well-defined diseases to the neglect of common everyday ill health. Every now and then we see a newspaper item under such a heading as "Conquering Disease." Newspaper reporters at times become enthusiastic and predict the conquering of all disease—but the less a man knows about the subject the more enthusiastically he may write. Be that as it may, we know that under present-day sanitation well-defined infective diseases are becoming less and less common every year. We need only think of what the introduction of pure water means to a city in such diseases as Asiatic cholera and typhoid fever. But although specific, epidemic, diseases are decreasing, common ill health is increasing, in spite of more and better doctors and better medicines—medicines that palliate but do not cure.

Now unfortunately there is no institution devoted to the study of common ill health, especially ill health dependent upon bad air conditions. The very common things of life are neglected—a fact which critics of the medical profession pointed out long ago. Until the people themselves take hold of the subject we need not expect much change.

Today we hear much regarding the role of well-equipped hospitals in city life. Many have an idea that the number of hospitals and their equipment are an index of a city's progress. The same individuals likely estimate a city's progress by the size of the smoke cloud overhanging it. As a matter of fact the opposite is true. A sanitary and well managed city has comparatively little use for hospitals, barring of course accident

and surgical cases. Many hospitals in a community indicate much sickness and especially sickness of preventable kinds. What our cities need is not more hospitals but a thorough cleaning up, and shall one add that our cities should also prevent smoke clouds? Smoke means waste, besides destruction of life, as already mentioned.

The plant breeder is constantly seeking to eliminate the unfit. But man can not proceed on the same plan regarding his own kind. He does not wilfully seek the destruction of those not adapted. He tries to make the environment favorable so those who are apparently unadapted will survive. Nature is of course constantly weeding out the unadapted and the mortality rate of crowded cities is something terrific compared with life under simple country conditions. By giving the inhabitants of the large city pure water, good food, good air and clean homes the conditions for existence are at once made favorable.

Every now and then we read of cities that are seeking a slogan; what they want is one to indicate that they are growing bigger. A good slogan for nearly all of our American cities would be, "Let us clean up," or, "Not bigger but cleaner." Perhaps the best reputation that any city could acquire is "A city that cleans up." When the people once realize what cleanliness means our cities will be radically different from what they are today.

From what is said above it may perhaps be seen that the cries of Race Suicide, Back to Nature, and Back to the Simple Life have a good foundation.

Our Academy has a Committee on The Restriction of Weeds and Diseases ("Diseases" was added on my recommendation). For the past two years I have been chairman of this Committee but, I am sorry to say, when at the annual meetings a call for reports was made I had nothing to report. Perhaps I ought to explain. For the past year and a half I have been working on a manuscript, in fact on two manuscripts, dealing with common ill health and the need for cleaning up. One of these volumes is intended for the public and the other for physicians. The problem I am especially interested in as most of you know is to give the people good air, air free from dust and smoke. Until these two volumes are out I do not feel like taking up the subject publicly. But I feel that this is a subject that should be taken up by the Academy, perhaps at first in a small way, gradually enlarging. We must interest the people. Sanitation can not be

forced upon them. It takes time. We need only think of measures to limit the use of alcohol and tobacco. If there is no public sentiment in a community laws are not enforced, and a law that is not enforced is worse than none at all. Many are skeptical about the present generation but expect much from the coming one. Perhaps the matter is largely in the hands of the school teachers, and since the Academy is made up mainly of men who instruct the teachers it comes back to the Academy.

In concluding I may say that we have a Federal Department of Agriculture which gives attention to plants and weeds, to animals and pests and parasites of all kinds, but it neglects the farmer himself and his children. We need a Federal Department of Public Health, a Department which will study the needs of the people and give them information regarding health and ill health and disease just as the Agriculture Department now gives information about animals and plants.<sup>1</sup>

---

<sup>1</sup> A resolution endorsing the establishment of a National Department of Public Health was passed unanimously.





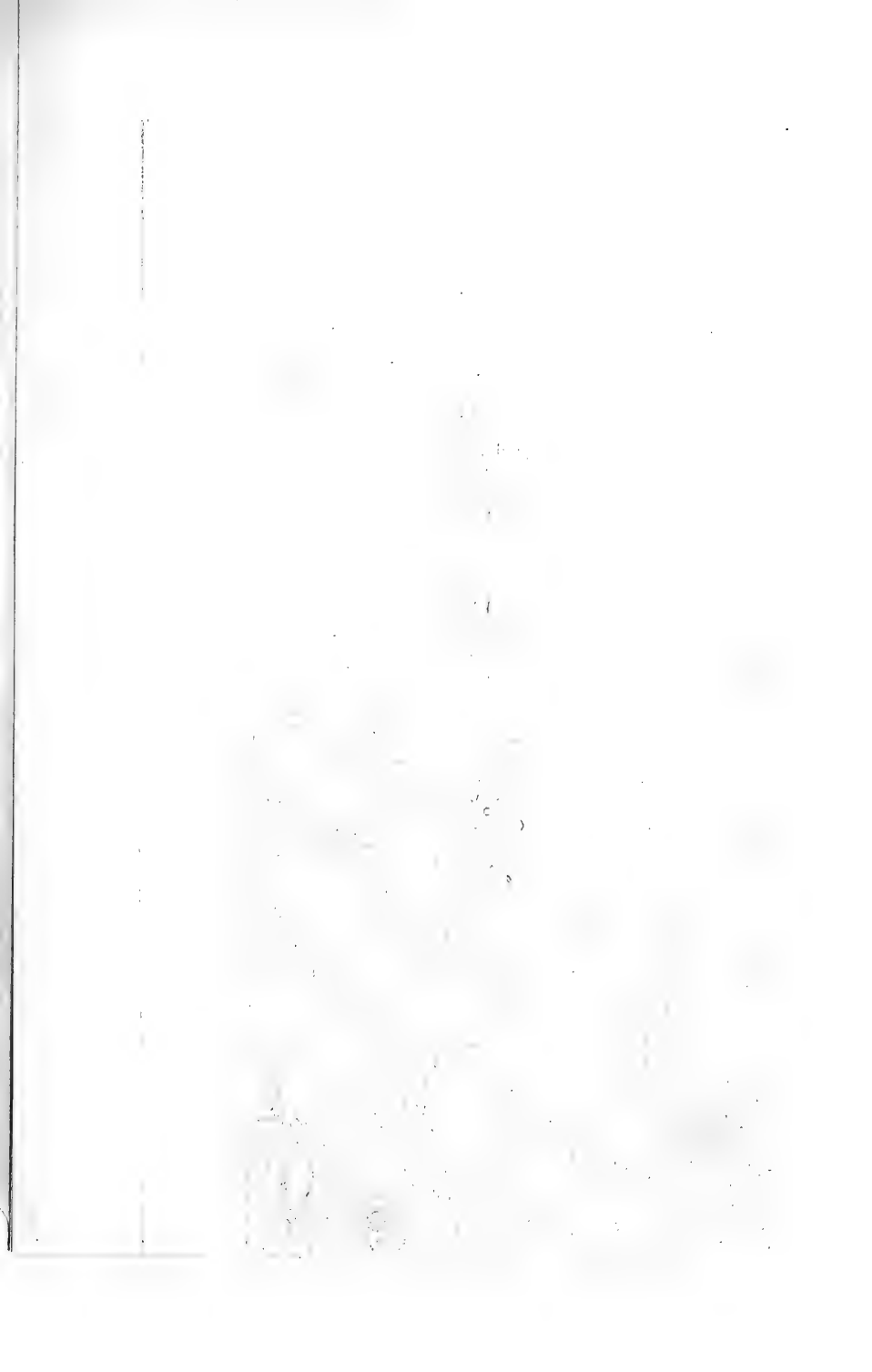

# LEGEND.

- WELL WATER
- FLOWING WELLS
- SURFACE WELLS
- RESERVOIR
- LAKE WATER
- RIVER WATER
- SPRINGS
- INFILTRATION
- MECH. FILTER
- SAND FILTER

- DEEP WELL PUMPS
- DIRECT ACTING
- CENTRIFUGAL
- AIR LIFT
- VACUUM PUMP
- OR STYPHON

- DRIFT-
- About 5' to 50'
- About 25' to 75'
- About 100' or more
- Rock (unquarried)

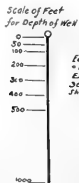

Depth of water below Surface

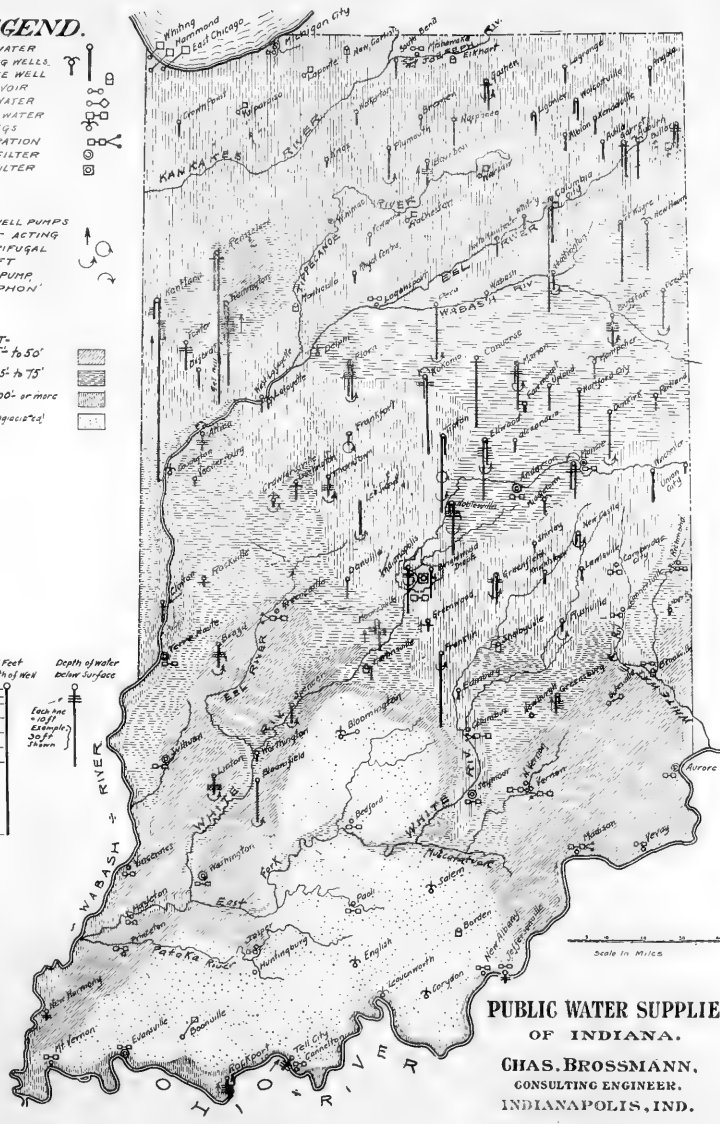

## PUBLIC WATER SUPPLIES OF INDIANA.

CHAS. BROSSMANN,  
CONSULTING ENGINEER.  
INDIANAPOLIS, IND.

## WATER SUPPLIES OF INDIANA.

BY CHARLES BROSSMANN.

More than 60 years have passed since the first Municipal Water Works of the State were installed at Madison, Ind. Since then, many plants have been erected. Our complex life and increasing population has necessitated new methods of living and caused new demands; the most important among them being good water. At present there are few towns of any size that do not have public water supplies.

In the year 1890 there were about 50 plants in this State and at the present time there are over 150 plants. It has not been possible to get information on all plants, but the figures represent a very healthy growth. The town pump and historic oaken bucket are being abandoned, and the more convenient and usually safer public supply is being gradually adopted. The supplies for public use as a rule are more carefully selected and situated and taken from a source less liable to contamination than are the individual surface wells of the householder.

The installation of a water works plant usually is followed by the installing of sewers, which is a great asset to the sanitary conditions of any locality.

Of the water works here charted approximately 65% are well systems, 15% river, and the balance springs, flowing wells, lakes, open wells, etc. About 60% of the plants are municipal plants and the balance operated by private companies.

The arrangement and method of charting the supplies has been undertaken with the hope that it may be the start of a more complete investigation and record, and that such contributions or additions may be made from time to time as will increase its value as a water supply record of the State. The author's studies in this line have taken into consideration the mechanical equipment of the plants using these supplies, but it is not the intention to go into this part other than to show on the map the method of procuring the subterranean supplies of water. The map of the State before mentioned shows the various sources of supply, the method of pro-

curing same, and how they are prepared for use. The well supplies are shown, giving the depth of well, the level of the water (where it has been possible to secure same), and roughly the depth of glacial drifts as found in that section; the drift depths are as given by the United States Geological Survey.

North of the Wabash river the depth of drift is approximately 100 feet or over, the best wells being usually in this material. Quite a portion in the western part is the region of extinct lakes. An interesting comparison occurring in this extinct lake region, is the supply of Kentland. This town formerly had its supply from a well about 1,200 feet deep, the water having a strong odor of sulphur. The water in this well stood 72 feet below ground about six years ago. Last year it was 120 feet below ground when pumping, and owing to this great lift caused much trouble and expense in pumping same.

This year a new plant was installed at Kentland. A new site was selected about one-half mile from the old well. The wells were drilled to a depth of 87 feet when rock was encountered. The last 15 feet of the well was in white sand, and produced a clear sparkling water without taste or odor. This installation is of interest as it shows such a difference in the two wells and their product.

From the south of the Wabash river to the Ohio the drift varies from 5 to 100 feet in depth, except for a triangular shaped section, with the apex below Martinsville, which is practically in the rock section. The water works of English in this region are of more than passing interest, as the supply of the town is secured from an elevation high enough to give pressure without pumping.

It will be noted on the map, that of supplies shown in the rock country, the majority are springs or river supplies. The procuring of water in quantities sufficient for public use is in some parts of this district a very difficult problem, especially in dry seasons.

The water of the State can be divided into two main classes, surface and subterranean supplies. The surface supplies comprise the river, lakes and large surface wells or reservoirs and may be divided into the filtered and unfiltered classes. The subterranean waters consist of the deep wells, flowing or unflowing, and springs.

The most noteworthy characteristic of the surface waters is that they are as a rule softer than the well waters and after filtration usually make a very satisfactory supply. The well waters as a rule are harder and in

numerous places give trouble from this cause, often making it impossible to use them satisfactorily for steam purposes.

Muncie uses well water. The raw water is heavily impregnated with iron which is treated by aeration, which puts the supply in a satisfactory condition.

An important condition found in the well supplies has been the information secured showing the lowering of the water level at various places. This occurs in a number of localities, some of which are herewith mentioned.

*Towns.*

Kentland (old gas well).....	48 feet drop in 5 years.
Elwood .....	40 feet drop in 12 years.
Greensburg .....	40 feet drop in 10 years.
Muncie .....	28 feet drop in (time not given).
Remington .....	8 feet drop in 10 years.
Marion .....	6 feet drop in 20 years (cause of the fall at Marion is given as due to waste from other wells).
Butler .....	4 feet drop in 10 years.
Bourbon .....	3 feet drop in $8\frac{1}{2}$ years.
Linton .....	Some wells show 30 feet drop in 6 years.
Kokomo .....	Some wells have dropped 15 feet since 1895.

It is a long step back to the time when there was nothing but water over what is now Indiana; but now, over that same area the procuring of water is an engineering problem of some importance.

The gradual receding of the water from the inundated area took place, of course, through a great length of time, but even after the waters became confined to their individual channels, such as our present day rivers, the point of saturation of the earth has been lowered by natural and artificial causes, such as deforestation, large drainage and reclamation works and the drainage of farm lands. Records from the weather bureau show that the rainfall for the past twenty years has not decreased. The question of run-off, however, is more important, as this undoubtedly has been, and is becoming more of an important factor each year.

A systematic method of recording all supplies in the State and tabulating all data pertaining to old as well as new supplies would be of great value. This could be best undertaken by one of the departments of the State and this information is here presented as a nucleus for the same.



## A BUILDING FOR THE DEPARTMENT OF PRACTICAL MECHANICS AT PURDUE UNIVERSITY.

BY M. J. GOLDEN.

The building was designed for the purpose of providing laboratories in which to teach students of engineering, shop practice and mechanical drawing, and is meant to accommodate three hundred students in the shops and three hundred students in the drawing rooms at one time. The mechanical drawing taught is the usual elementary drawing that precedes engineering design, and includes descriptive geometry. The shop practice includes manual training and practice in the methods employed in manufacturing where special tools and labor saving devices are used; this involving arrangements in the shops for demonstration work before groups of students.

The principal conditions necessary for the proper carrying on of such

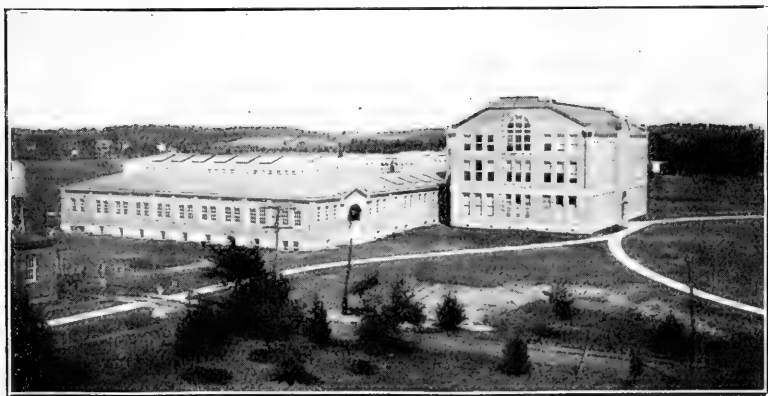
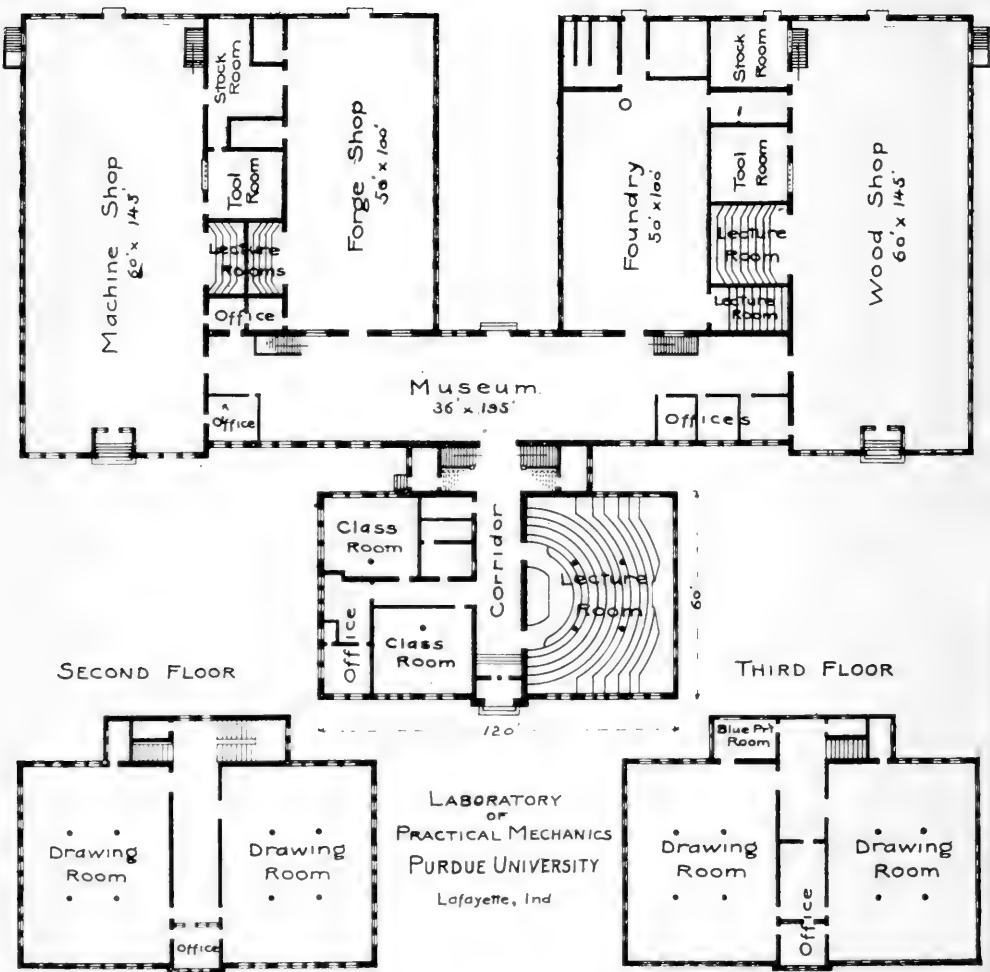

Fig. 1.

work are ample light, proper ventilation, and careful regulation of the temperature.

The building is of common brick with stone trimming and the design was purposely made to be as simple as possible, as befits a structure for such purpose. The general appearance is shown in Fig. 1.





It consists of a three story front in which are the drawing rooms, lecture and class rooms, and offices, and a series of one story rooms for the shops; the separate shops are bound together and to the front by a large corridor that serves also for museum purposes.

#### LIGHTING.

Considering the lighting first, the effort was to have as much lighting from the sky as possible; and as the large area of the roof made a troublesome accumulation of snow probable at times, a sloping roof with small pitch was taken and large skylights used to give the desired openings. These openings are glazed with a maze glass that is reinforced with wire netting, and this has been found to give a light distribution that is satisfactory. The saw-tooth form of roof was discarded in the design because of the possible snow accumulation in the valleys. The skylights are used in all the shops and for the drawing rooms in the third story of the front. In the rooms in the front where skylighting cannot be used, the windows are made to extend to the ceiling and to be as large as safe wall construction will permit.

The artificial lighting is principally by 60 C. P. incandescent lamps. In the drawing rooms these are arranged in groups of four close under a whitened ceiling. This arrangement is used also in the lecture rooms, the forge shop and foundry. In the machine shop the arrangement is supplemented by individual lights at the ends of arms made of flexible tubing, and in the wood-working room, mercury vapor arcs are used for the ceiling lights, with the individual lamps at the benches and lathes. In the wash and toilet rooms the light is distributed by individual ceiling lamps.

#### HEATING AND VENTILATION.

It was considered desirable that the heating and ventilating be by separate systems. The heating is done by radiation from steam heated radiators that have automatic control. These are coils of pipe that are suspended from the ceiling in some portions of the shops and wall radiators in other parts, and in the front portion of the building. The steam is generated in the central heating plant of the University, and is brought to the building in covered pipes in a tunnel.

The ventilation is accomplished by taking air from outside the building and after passing it over steam heated pipes in a chamber in the basement, where it is tempered to 67° F., forcing it through ducts in the walls

and distributing it over the building. In the shops the distribution is through sheet metal pipes that are suspended against the upper portion of the side walls. The temperature is controlled by a regulating device in the heating chamber. By this scheme the ventilating apparatus can be closed to any portion of the building not in use. It may be used also as a supplementary heating system in severe winter weather.

#### POWER.

The electric current used for power and lighting is generated in a plant that is about three hundred yards away from the nearest point in the shops. It is of the alternating kind and is brought to the building at a tension of twenty-two hundred volts and is then stepped down to two hundred twenty volts in a transformer that is placed just outside of, and in the rear of the shops. The portion used for power purposes is carried to a number of small motors that run groups of the machines or that run individual machines: there are seventeen groups in all besides the individually driven machines.

In the wood working shop it has been possible to place the motors in the basement, and this is especially desirable in wood working, as it tends to freedom from dust. This was not possible in the machine shop, because of the design of the driving heads of ordinary machine tools.

The general arrangement of the building is shown in Fig. 2, where the floor area devoted to the various purposes is shown, also.

Adjacent to every one of the shops there is a room for demonstration purposes. This is arranged so that a machine may be conveyed from its place on the shop floor and used during the exposition of its purposes. Power for this purpose is brought to these class rooms; and to furnish current for the projection lantern in the large lecture room, there is a separate set of wires from the power house, bringing a direct low tension current. This low tension current is carried at one hundred ten volts.

#### CONVENIENCES.

The basement under the main corridor has the locker and toilet rooms; a battery of forty wash basins supplied with hot and cold water, and rows of metal lockers are arranged at each end. There are individual lockers for eight hundred fifty students, in which they keep their work clothes. In the shops there are also separate lockers for eight hundred fifty students, in which the material on which they are working is placed when not in use.

The drawing rooms are furnished with corresponding lockers and other facilities for the apparatus used in drawing. In the third story are two rooms for blue printing and corresponding work. One room is arranged for sun printing and has sheets of plate glass in an exposing wall on one side. There are the usual printing frames. The other room has no outside wall and is fitted with a blue-printing machine in which exposure is made to a rise and fall electric arc. The washing and drying of the prints are done in the sun printing room.

There are two dark rooms for photographic work.



## THE CYCLE OF SUBTERRANEAN DRAINAGE AS ILLUSTRATED IN THE BLOOMINGTON, INDIANA, QUADRANGLE<sup>1</sup>.

BY J. W. BEEDE.

The Bloomington, Indiana, quadrangle<sup>2</sup> is the first topographic map to be completed in the cave region of Indiana. It is fifteen minutes square with contour interval of twenty feet and scale of 1/62,500, or about a mile to the inch. Careful inspection of the field shows it to be remarkably full and accurate in detail.

While the cycle of subterranean drainage, as here presented, had not been discussed between us, yet all the various phases of it have been discussed and similar conclusions independently reached by both Professor Cumings and the writer as the result of tramps and class excursions over the cave regions of Indiana. The cycle has also been given as lectures, illustrated with lantern slides, in our classes. This paper has also had the benefit of Professor Cumings' criticism.

The physiographic history of the Bloomington region is such as to make this map very interesting, both for the remarkable preservation of the older geographic features and for the recent modification of them. Not the least interesting, nor the least important of these, is the subterranean drainage. Indeed the fine preservation of the older features is due to the fact that the water has, figuratively speaking, soaked into the old peneplain much as it would into a sponge, confining its work to the solution and honeycombing of the rocks beneath the surface instead of concentrating its energies cutting it into ridges and valleys.

The whole of the quadrangle, excepting, perhaps, the northwest corner, lies in the driftless area of Southern Indiana. The larger streams, except

---

<sup>1</sup> The title of the paper as shown in the program was "Features of Subterranean Drainage in the Bloomington Quadrangle." After the title had been sent in it was realized that it would be impossible to treat the subjects in mind intelligently without outlining the cycle of subterranean erosion. This outline, of course, overshadows the minor details intended to be covered in the paper, and hence the change in the wording of the title.

<sup>2</sup> Price five cents. Apply to The Director, U. S. Geological Survey, Washington, D. C.

Clear creek, were effected by glacial waters which were one of the potent factors in producing the beautiful terraces of Beamblossom, Salt, Richland and Coon creeks. However, it is with the subterranean drainage that we wish to deal at this time.

#### GENERAL CONSIDERATIONS.

Before discussing the details of the underground drainage of the Bloomington region it is necessary to discuss some of the general features of the development of subterranean drainage under various conditions. Underground drainage is developed in two ways:

1. In a region of very soft, porous rocks, where jointing and bedding may play a somewhat minor role, the channels are determined to some extent by the varying degree of porosity of the rocks through which the water percolates. Under such conditions the caves are apt to be less regular in their forms and their courses less angular than would otherwise be the case. This also has a marked effect upon the origin of the sink-holes and cave openings. Under these conditions the sinks may be formed where the rock is somewhat more porous or where there was a slight depression originally. These factors are modified by the proximity of channels beneath the surface. In such cases, as has been pointed out by Sellards<sup>3</sup>, the sinks first appear as "cave-ins" of the soil and rock structure, the sink being first a hole of greater or less size, sometimes being larger below than at the surface. That is, the hole may be conical or "jug-shaped," as suggested by Eigenmann<sup>4</sup>. The caves of Cañas, Cuba, are of this type. Sinks of this kind are formed most abundantly where the surface of the region is but little elevated above tide or general drainage level and the caves or channels are close to the rock surface so that it is easily undermined. In cases where the caves are far beneath the surface the sinks will be determined—in the absence of surface irregularities—by the location of the more porous spots in the rocks near the subterranean channels and will be developed by solution from the top downward. It may be remarked here that the joints in some of the Cuban caves are inconspicuous.

2. The other condition under which caves are formed and free underground drainage developed is in the firmer limestones, usually well above sea level and the major drainage lines. The denser the limestone the

<sup>3</sup> Science, XXVI, p. 417, 1907. More fully, Bull. I, Fla. Geol. Surv., pp. 49-57, 1908.

<sup>4</sup> Bull. U. S. Fish Comm., 1902, pp. 211-236.

smaller the percentage of pore space, and the thinner the beds the greater is the tendency to form sinks and caves and the more sharply angular are the subterranean drainage courses. This is excellently illustrated in the cave region of Indiana. The Mitchell limestone is very dense, thin bedded and impervious for a limestone and is broken into small joint blocks. Here the subterranean flow is largely confined to the joints and bedding planes, thus concentrating the solution effected by the water to the immediate channels through which it flows. In this way channels are produced and enlarged with maximum rapidity.

On the other hand we may contrast this condition with that of the Salem limestone lying immediately beneath the Mitchell limestone. The Salem is nearly devoid of bedding planes, a rather soft and quite porous limestone, through which the water percolates with relative ease. The result is that caves in the Salem limestone are very rare. When they occur,



Fig. 1. Diagrammatic illustration of incipient subterranean drainage. The main stream is entrenched and the tributaries out of adjustment pitch over rapids to join it. Underground drainage has started through the joints. The vertical dotted line a b represents the original unbalanced static water head which started the circulation.

as at Mays cave, they may be formed by a cave passing down from the Mitchell limestone into it to reach the surface nearer the drainage level. The lack of frequent bedding planes is a strong contributory factor to this condition. Aside from its structure the opportunities for the formation of subterranean channels are as good as in the Mitchell limestone.

Again, the Harrodsburg limestone, lying immediately below the Salem limestone, is harder, less porous, more highly jointed and thinner bedded than the Salem and shows a correspondingly greater tendency to develop underground water channels. The Mitchell limestone possesses the extreme of these conditions and the extreme development of underground channels.

#### THE SUBTERRANEAN DRAINAGE CYCLE.

In either a coastal plain or an interior region which has been thoroughly baseleveled and reëlevated, what drainage there is to begin with is

surface drainage. It remains surface drainage until the rapids of the larger streams have deepened their valleys well across the plain, leaving their tributaries out of adjustment with them. At this stage underground drainage first takes place to a considerable degree. The rocks are saturated with ground-water and at the level of the larger streams is under an unbalanced static head equal to the difference in elevation of the surface of the tributary, and of the water table between the tributaries, and the



Fig. 2. Section of a funnel-shaped solution hole (enlarged joint) in limestone, illustrating the origin of solution sinks.

main stream. As this is slowly drawn off more is supplied from above and a subterranean circulation is begun. The development of sinks goes along with the development of the subterranean drainage channels. The cross-joints most favorably situated with respect to free circulation below and supply from above, soon begin to be enlarged by solution. This solution is most active where the water first comes into contact with the limestone and the upper part of the opening will be dissolved most rapidly, resulting in a funnel-shaped hole. The larger this funnel becomes the



more water it collects and the more rapidly it widens at the top and the larger the sink becomes. In this way the sinks develop at the same time that the subterranean channels do and in a region of mature sink topography where the channels are well below the surface, as in the Indiana



Fig. 3. A more advanced stage of subterranean drainage than No. 1. Sinks have developed and all the water of the stream passes beneath the surface and enters the larger stream as a great spring. It may be considered a sort of vertical self capture, a common occurrence. The underground channels have become enlarged and subterranean drainage has worked headward along the stream. At this stage the sinks will be developed over considerable of the surrounding land surface. It may be regarded as approaching maturity.

region, probably ninety-five per cent. of the sinks are formed this way.<sup>5</sup> It is certainly true of the Bloomington region and all the Indiana region as far south as Wyandotte that has come under the writer's notice. In some cases a sink may cover many acres and be as much as a hundred feet deep.<sup>6</sup> The first surface indication of the sink is frequently the collapse of the soil into the funnel which has been dissolved in the surface of the underlying rock. This has probably given rise to the popular notion that sinks are usually formed by the collapse of the roofs of caverns.<sup>7</sup> Incipient

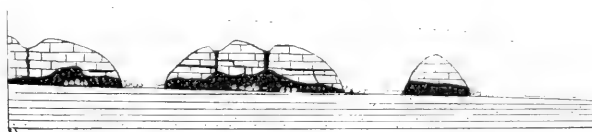

Fig. 4. An ideal section, similar to Nos. 1 and 2, in old age. Natural bridges are developed, much of the roof of the subterranean channel has collapsed, revealing the underground stream, and the mouth of the cavern has retreated by collapse and erosion. Dotted line indicates the old land surface.

<sup>5</sup> See Blatchley, 21 Ann. Rep. Ind. Dept. Geol. Nat. Res., p. 133, 1896.

<sup>6</sup> For a discussion of the solution of the Indiana limestones, see Cumings, Proc. this Acad., 1905, pp. 85-102, 1906. Caves, F. C. Greene, *idem*, for 1908, pp. 175-183, 1909.

<sup>7</sup> This does not seem to apply to the caves of Florida and some regions of Cuba where the channels are very near the surface and the roof soon becomes so weakened that it gives way, and the extreme porosity of the rocks does not concentrate the solution to the joints to produce solution sinks.

sinks and slightly developed underground drainage may be considered as characteristic of the youth of subterranean drainage. There will be no collapse sinks at this stage.

In the course of time the water of some of the streams may all pass below the surface and issue as great springs or subterranean streams in the channels of larger streams or in their own channels below where there may have been rapids or considerable fall in the beds. As time goes on this sinking of the water progresses headward along the stream, reducing



Fig. 5. Abandoned bed of Lost River, near Lost River station, north of Paoli, Ind. During floods this channel contains water. It is twelve miles long. The valley is very broad, with indistinct bluffs.

more and more of its course to underground drainage. The distance which streams may flow underground before reappearing at the surface depends upon the physical conditions in which they are placed. The distance that they are now observed to flow beneath the surface depends also upon the stage in the cycle of erosion in which they happen to be. Thus, in the Bristol-Standingstone region of Tennessee and neighboring country the distance seems to be about a mile. Lost river, in Indiana, flows about six miles in a direct line, or about double that distance by the old channel, before reappearing. Perhaps Lost river should be regarded as being in a somewhat later stage in its cycle than those of the region just mentioned,

since there is evidence that collapse has brought the present stream to the surface for some distance below the "Gulf" where it now escapes.

The collapse of the mouth of the cavern is brought about by the increased width and height due to solution and abrasion, the fall of slabs



Fig. 6. Stony Spring, Bloomington waterworks. During freshets the water flows out all around the foot of the hill shown in the picture and even farther to the left. The cavern containing the stream is here collapsed, blocking the outlet. When the cave fills with water it breaks out wherever it can find an opening. The water comes from the former drainage basin of Indian Creek and now enters the head of Clear Creek.

from the roof and by the lowering of the channel until the roof, unable to support itself, finally falls. This collapse of the lower portions of caverns bringing more and more of the subterranean stream to light may be, and frequently is, going on at the same time that the upper reaches of the stream are being converted from surface into subterranean drainage. This is true of nearly all the largest outlets of subterranean drainage in the Bloomington region. Stone spring at the Water Works, Shirley spring and Leonards spring, southwest of the Water Works, and Blairs spring, just northwest of Stanford Station, all show this phenomenon, while the upper

parts of the streams feeding them are still being more thoroughly taken under ground. A good example of this is seen in the sinks just east of the County Farm. The old sink is located in the angle of the road, while the stream now passes beneath the surface fully a quarter of a mile upstream to the northwest. Only the flood water now finds its way into the deeper sink below. The collapse of the mouths of caverns is excellently exhibited



Fig. 7. Shirley Spring (East Spring), S. E. of Leonard Schoolhouse. The cutlet of the stream entering the sinks east of the Poor Farm and the intervening sinks. For abandoned, higher cave, see Fig. 30. The condition of collapse is similar to that shown in Fig. 6.

in the Shawnee caves east of Mitchell, Indiana, while Lost river shows it still better. In both cases the roof has collapsed back for considerable distances and in each there are cases of collapse above the mouths of the caverns where either the cave or the stream is brought to light.

When this stage of the drainage has been reached sinks have developed over most of the region on the interstream spaces as well as near the streams and most of the drainage is subterranean in the stricter sense of the word. This stage shows the large sinks near the larger drainage lines,

surface or subterranean, and the smaller ones farther from them, as is illustrated in the plain southwest of Bloomington. When this stage has been reached—with sinks well developed over most of the region and collapse has begun at the exits of the cave streams—a region may be regarded as in its maturity. It is only after the mature stage of the cycle has been reached that sinks, due to the collapse of cave roofs, begin to appear in considerable numbers, and natural bridges, due to collapse of the cave roofs above and below a given point, begin to be developed. Solution



Fig. 8. Spring at Leonards Mill (house in deep gulch south of Leonards school), showing similar features as preceding. Note water escaping all around the foreground. A portion of the water from the main spring is shown in the extreme lower left corner of the picture. The outlet for the sinks south and northwest of Leonards school.

sinks that happen to be located above caverns may be, and frequently are, transformed into collapse sinks in the latest stages of subterranean erosion.

When these features of collapse become prominent and much of the drainage has been brought to the surface again and collapse sinks are numerous, old age has been reached.

The valleys produced by the collapse of caverns and the transformation of subterranean drainage to surface drainage have a characteristic form that at once distinguishes them from ordinary drainage valleys. They are rather sharply U-shaped, with steep sides like a young valley

but with a fairly wide bottom and a blunt, steep termination at their heads. In these respects they resemble miniature glaciated valleys. When well developed they may be shown on accurate topographic maps. Surface erosion begins modifying them at once and finally obliterates the evidence pointing to their origin. The final result of the subterranean drainage cycle is thus a surface drained peneplain.

There is a lack of subterranean drainage in the old age stage of the cycle in the Bloomington region. The whole sink hole plain of Indiana



Fig. 9. More distant view of Leonard's Spring. The main spring is seen back of the stone dam. The water is issuing from a hole in the dam in the middle foreground. Note the steep, blunt end of this collapsed-cave valley.

may be considered as in its maturity. However, there are exposed in the sides of the monadnocks west of Harrodsburg certain old solution channels which probably represent the very heads of the subterranean channels of the preceding cycles of erosion. Indeed it is not improbable that the streams tributary to Clear creek on the west and north of Harrodsburg owe their present position in some degree to the location of former sub-

terranean creeks. These in turn were profoundly influenced by the position of the previous Tertiary (?) surface streams.

In a coastal plain the details of the cycle will be somewhat different, but the essential features will be similar. The differences will be due to the physical characters and structure of the rock, the lack of previously established drainage lines and the relatively low elevation above sea level.



Fig. 10. Leonard's Spring, S. W. of Bloomington, showing valley with spring in distance.

#### PIRACY.

At the time when the subterranean drainage is at the maximum it is subject to the same accidents as surface drainage, except that the *modus operandi* is different. Subterranean piracy falls under two distinct heads, the capture of one surface stream by another through subterranean drainage, the easiest form to observe, and the capture of one subterranean stream by another. In each case there are minor varieties of capture such as one tributary by another, and self capture. Indeed these are probably much more common than the capture of one surface stream by another.

If a surface stream flows a long distance over a rather gentle grade to reach a certain level while a competitor flows a short distance to reach a similar level it may capture the headwaters of the former through subterranean drainage, leaving the divide between the valleys intact. This



Fig. 11. Emergence of cave stream, mouth of Shawnee cave east of Mitchell, Indiana. The roof of the cave at its mouth is well supported. Just back of this there are two large rooms connecting with the main cave, leaving a large area of roof unsupported. It has faulted down about six inches. The completion of this collapse might, in time, leave a natural bridge at the present mouth of the cave. The valley is a typical collapse valley.



tendency is accentuated when the pirate is favored by the dip of the rocks, but frequently occurs in spite of the dip in cases where the dip is gentle. It is probably true that the only essential of such capture is that two streams lie one higher than the other in a region of soluble rocks sufficiently close to each other to permit the final entrance of some of the water of the one to the other. Examples of such piracy are by no means wanting in the Bloomington region.

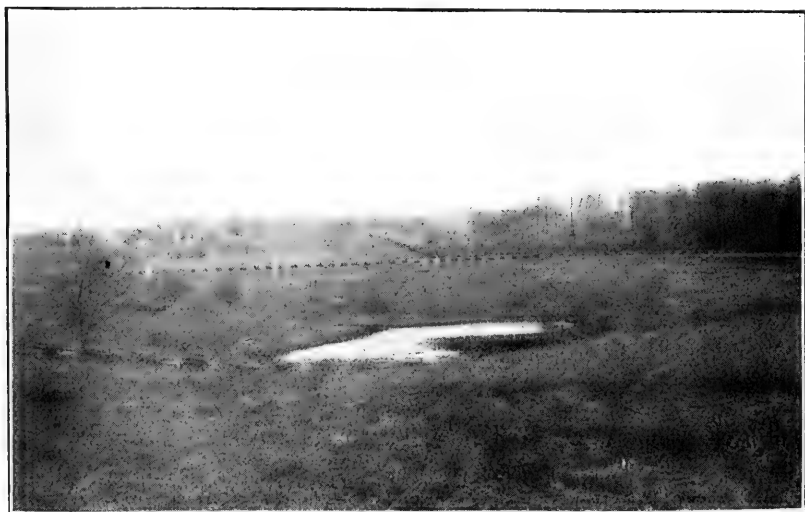

Fig. 12. A distant view of the Leonards Mill locality (Figs. 8 and 9), showing the form of the valley. The water from the Shirley Spring (Fig. 7) crosses the foreground.

In order to make these specific cases fully intelligible it is necessary to refer to some length to the physiographic history and conditions of the region. The well preserved plain west of Bloomington appears to be a very early Pleistocene peneplain. This plain extends at about the same altitude throughout the extent of the map, except that it is visibly beveled toward the major drainage lines, as will appear later. The peneplain is much dissected in the northeastern, southeastern, and western parts of the quadrangle. There are many monadnocks to be found along the old divides or near the headwaters of some of the minor streams, rising from a little over a hundred feet to two hundred feet or more above this old plain and

reaching elevations of from a little under 900 feet to 1,000 feet A. T. The ones south of Kirksville are the best preserved and appear to be remnants of the very old Tertiary peneplain or, perhaps, base level. It seems probable that the whole region covered by the map and the higher, rougher parts of southern Indiana are a part of the Lexington plain of Campbell, reaching from the Cumberland Plateau westward to the Tennessee river,



Fig. 13. A monadnock southwest of Bloomington. It rises 115 feet above the surrounding plain. It is surrounded by sinks, especially on the north, west and south.

the Indiana portion being a spur extending northwest from the type region at Lexington. It will be noticed that the elevation of the old plain and monadnocks (catoclines) is materially lowered as the western edge of the map is approached. This is due to the surface dip into the West Fork of White river basin. A similar beveling will be noted on approaching Salt creek in the southeast corner of the map, and Beanblossom in the north-eastern corner. Even in an extremely old peneplain this bevelling toward the main stream of the basin is the normal condition and should be expected to be found on a rejuvenated plain.

The physiographic history of the region may be briefly summarized as follows: When the Pleistocene peneplain had been developed the general level of the land was but slightly above the present level of the bottom lands of the larger streams. The streams flowed at about the level of the present larger streams, while the divides between them looked much as they do at present when viewed from the old peneplain west of Bloomington.



Fig. 14. The Mitchell peneplain<sup>9</sup>, about  $4\frac{1}{2}$  miles west of Bloomington. A part of the Indian Creek basin. The plain is here 160 feet above drainage level. Entire drainage subterranean.

ton. The valleys of even the small streams were wide and their bluffs indistinct. The landscape was wanting in angularity and was one characterized by gently flowing curves. All the streams seem to have meandered considerably upon their valley floors, the larger ones to a very great extent. Most of these features are well shown by the little streams in which

<sup>9</sup>The Sink-hole plain of Newsom. It is called the Mitchell peneplain since the country rock is the Mitchell limestone and it is typically developed at Mitchell, Ind., and southward.

the rapids have not yet reached the very headwaters and those which happen to be preserved just as they were upon the sink-hole plain.

The drainage was confined to the surface, since the streams and the water table were very near the general surface level. After this condition had been thoroughly established the whole region was uplifted without considerable tilting, to an elevation somewhat above that which it now possesses, an elevation amounting to upwards of 200 feet. Following this the



Fig. 15. View looking northwest from side of monadnock shown in Fig. 13. Closed sink in middle ground. Beyond is the plain of Indian Creek valley. Present drainage subterranean. The remnant of a monadnock (catocfin) interrupts the even sky line just at the right of the center of the background.

larger streams etched their channels to temporary base level, but soon afterward the region sank a little. As a result the streams flow at a level somewhat above the rock floors of their valleys. Other minor incidents occurred which have left their impress upon the region but which need not be discussed here. After the first elevation took place, rapids passed up the main streams cutting gorges in the valleys. As these rapids passed the mouths of the tributaries the latter were left out of adjustment with the master streams and reached them by rushing over high rapids and

falls. Some of the larger tributaries reduced the lower parts of their courses with sufficient rapidity to prevent the development of extensive subterranean drainage beneath them, but this was not true of the smaller ones lying on the limestone plain. When the larger streams left the smaller ones hanging high in the air, subterranean drainage began in earnest. The



Fig. 16. Weimer Spring, Bloomington Waterworks.

rocks were saturated with ground-water and near the mouths of these streams was under an unbalanced static head of about a hundred feet. This water gradually flowed into the deeper valleys and was in turn replenished by more from above, and active underground drainage began and continued in the manner already indicated.



Fig. 17. View from side of monadnock, showing great terrace deposits on about the level of the Mitchell plain a mile south and 4 miles west of Ellettsville. A somewhat interrupted monadnock divide forms the sky line in the distance.



Fig. 18. Gorge of the Cascade tributary to Rocky Branch north of Bloomington. This is a very small stream which has not reduced its whole valley to grade since the uplift. The valley profile is shown; the right side is clearest on account of the removal of the vegetation.

On turning to the Bloomington quadrangle some very peculiar drainage features will be seen. It will be noted that the headwaters of the western branches of Clear creek southwest of Bloomington and the eastern tributaries of Richland creek nearly west of Bloomington and north of Stan-



Fig. 19. View of the same valley, as shown in Fig. 18, looking in the same direction above the cascade, showing the old, wide valley with indistinct retreating sides. Were this valley developed in soluble limestones it is easy to see how the water might enter the ground above the cascade and appear as springs below it.

ford Station frequently lie in deep valleys with steep heads. On the plain between these two creeks is a region which is drained by great sinks opposite the heads of these streams. A little farther south Indian creek heads on this plain and continues a little west of south with gentle grade in its headwaters compared with the ones before mentioned. By following the valley at the head of Indian creek northward it will be discovered that the valley extends as far north as the race track west of the northern part of Bloomington, and that the water entering the large sinks just mentioned is really the water of the head of Indian creek. The same will be noted of the great sinks northeast and south of Blanche. The water, after entering these sinks, appears in the deeply incised heads of Clear creek and Richland creek instead of continuing down Indian creek. In other words, Richland creek and Clear creek have captured the waters of Indian creek by subterranean piracy.

This diversion of water was brought about by the location of the streams in question with respect to the rock structure of the region.<sup>5</sup> The strike of the rocks is nearly north and south. The lower rocks in the northeast and southeast part of the region are the soft, easily eroded "Knobstones." Salt creek, on account of its very large size, readily etched its lower course to grade and when the soft knobstone underneath the Mississippian limestone was reached it probably formed falls which rapidly retreated headward and permitted proportionally early deepening of many of its tributaries. Throughout the central part of the region the heavy, resistant, Mississippian limestones form the country rock, dipping westward, through which no drainage channels completely penetrated. The headwaters of Indian creek lie upon these rocks and nowhere do they cut through them. In a large part of its course the soft shales, sandstones and thin limestones of the Mississippian formations form the upland rocks. The result is that Indian creek with long and gentle grade could not compete with Clear creek, a branch of Salt creek, in deepening the channels of its headwaters. In the west part of the region the soft formations of the upper Mississippian and the basal soft sandstone and soft shales of the Coal Measures or Pennsylvanian rocks form the upland. The Mitchell limestone forms the beds and basal part of the bluffs of the streams in this part of the quadrangle. Richland creek for the most part lies in these soft formations and flows a short distance to the west fork of White river at Bloomfield, reaching about the same elevation as Indian creek flowing twice the distance to the east fork of White river north of Shoals, in Martin County. Richland creek being thus favored soon reduced the valleys of its headwaters below the level of Indian creek. This left the head of Indian creek 100 to 150 feet above the creeks on either side and its bed resting on soluble rocks. That is, Indian creek lay upon a table land of soluble rocks with lower streams on either side of it. The divide between Indian creek and Clear creek has been cut through and removed much of the way just southwest of Bloomington. Thus the headwaters of Richland creek northeast of Stanford Station are at a level of 680 to 700 feet above tide and were cut into the top of the Mitchell limestone which dips west from the Indian creek plain into Richland creek valley, while a west branch of Indian creek lay at an elevation of 800 feet but a half-mile or a little more to the eastward. The divide between the two is formed of the shales

<sup>5</sup> See geologic map accompanying 28th Ann. Rep. Ind. Dept. Geol. Nat. Res. 1904



and sandstones of the Upper Mississippian. The result of this condition was that the water in the western branch of Indian creek, a mile or more south of Blanche, sank and reappeared in a great spring in the head of Blair Hollow a half-mile farther west. A similar thing occurred less than a mile northeast of Blanche and again about a mile and a half farther northeast. These sinks are the largest, or most extensive, on the quadrangle. As we approach the heart of the plain farther east the sinks become smaller and less conspicuous, the smaller ones not being shown upon the map.

On the eastern side of Indian creek valley we have large sinks. One of these is just north of the Water Works pond. Here the drainage entering the sink flows into the pond through Stone spring a few hundred yards farther south, entering the Clear creek valley, being diverted from Indian creek into which the surface drainage once flowed. Southeast of this there is a large sink east of the County Farm which receives the drainage of a large region to the north which normally belongs to Indian creek drainage but appears at the surface as a large spring in the north side of the branch of Clear creek valley in the N. W.  $\frac{1}{4}$  of Sec. 24, nearly two miles south of the sink. The large sinks south and northwest of Leonards Schoolhouse have their outlet at Leonards Mill by the house in the head of the deep valley a half-mile south of the schoolhouse. Rags put in the upper sink are said to reappear at Leonards Mill.

From the foregoing it will be seen that the headwaters of Indian creek have been diverted into Richland creek and Clear creek by subterranean



Fig. 20. A somewhat diagrammatic profile of a section across the valley of Indian creek into a tributary of Clear creek on the right and tributary of Richland creek on the left. The high points on either side of the figure are the old divides between the three drainage basins. It illustrates the manner in which Indian creek has been robbed of its waters southwest of Bloomington. The dip of the strata has favored Richland creek.

piracy. On the west this piracy is favored by the dip of the limestone and on the east it has taken place against the dip, which is very gentle. The sinks near the outlets of the underground streams are large, while those more remote and younger are smaller. The smallest are not represented

on the map. There is another case of piracy in the sinks near Kirksville which is of the same type as that just described.

Other forms of piracy are probably much more common than the type described. That piracy occurs between adjacent subterranean streams seems very probable on account of the greatly varying levels occupied by them at different times and different parts of the same stream at the same time. This is facilitated by the fact that cave streams are below the level of the general water table and also because the falling of slabs from the roofs frequently clog the channels and temporarily fill the caves with water until further underground passages may be discovered and enlarged. It is impossible to cite specific cases at present because caves have not been explored with this object in view and because such cases will probably be difficult to recognize even under the most favorable circumstances.

Cases of subterranean self-capture, capture of one tributary by another, or by the main stream or the capture of the main stream by a tributary finding a short cut through a new channel are too common to be discussed at length here. A glance at Hovey's map of Mammoth cave is sufficient to suggest a most complex and interesting set of captures and changes of level for some one to work out.

#### RÉSUMÉ.

1. Extensive subterranean drainage is developed in interior regions only when they have been sufficiently elevated to allow rapid downward movement of the ground water and its easy access to drainage lines considerably below the general level of the land surface.

2. The conditions best facilitating subterranean drainage are regions well elevated with relatively impervious soluble rocks, well jointed and thinly bedded.

3. In regions of low elevation the sinks may be largely collapse sinks, and, in soft, porous rocks, the channels rather irregular.

4. The cycle of underground drainage may be stated as follows: It begins with surface drainage and in its youth develops subterranean drainage near the points of easy escape for the water. In its maturity there is the maximum of subterranean drainage and the lower parts of the caverns have begun to retreat by collapse while in the uppermost reaches of the stream the transformation from surface to subsurface drainage may still be in progress. Old age is shown by the more general condition of col-

lapse and the return to surface drainage. Briefly, it may be stated that the cycle is: surface drainage, partial subterranean drainage, and a return to surface drainage. The final state is peneplanation or base leveling.

5. In youth and maturity nearly all the sinks are solution sinks.

6. In old age many of the sinks are formed by collapse. Solution sinks may finally be transformed into sinks of collapse.

7. Surface streams resting on a plain of soluble rocks with streams at lower levels bordering them may have their waters diverted by subterranean capture.

8. Piracy probably takes place between subterranean streams and between parts of the same stream.

*Bloomington, Indiana.*

---

References to the "early pleistocene" peneplain in this paper should read "late tertiary (?)," since the cycle was interrupted at about the close of the tertiary or beginning of the pleistocene period.

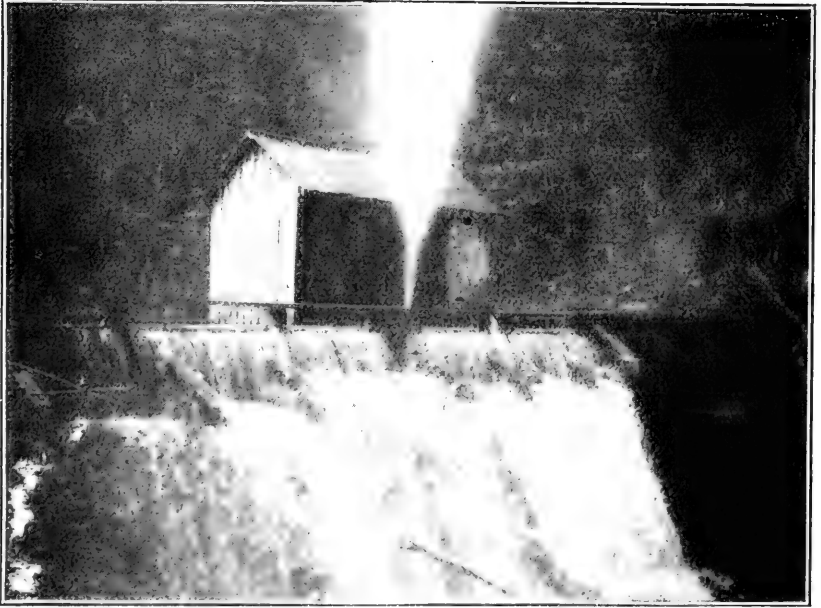

Fig. 21. Hamers Cave east of Mitchell, Ind. The water from this cave furnishes the supply for the two Lehigh cement plants at Mitchell. The picture shows the overflow from the dam. Water higher than usual.



Fig. 22. The "Gulf" of Lost river at Orangeville, Ind. Here the roof of the cave in which the river flowed has collapsed and the stream comes to the surface.

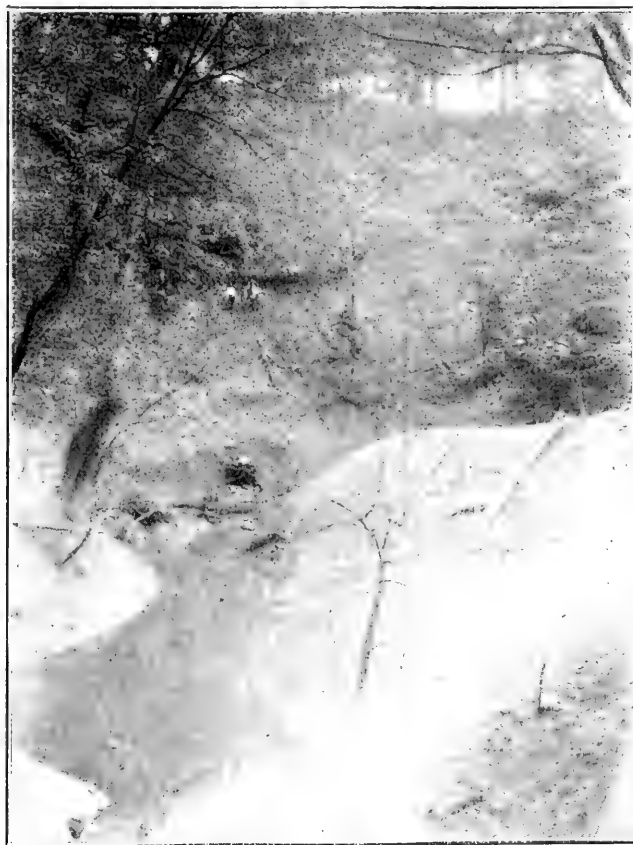

Fig. 23. A "Gulf" of Lost river above its outlet at Orangeville. The water rises to the surface at the right of the middleground of the picture and flows to the right and left, forming two streams, for a very short distance which sink and finally rejoin the subterranean channel. The little pond on the left side of the group in the middle background is a large cave, one of the abandoned subterranean channels of the river. The second, or present channel is considerably below the water shown in the foreground. Here a large area has collapsed blocking the lower channel and forcing the water to the surface, when it again finds new channels around or through the obstruction to its main channel again in which it continues.



Fig. 24. Abandoned channel of Lost river mentioned in explanation of previous figure.



Fig. 25. Phantom lake, near Toyah, Texas. A collapse sink where the subterranean stream is revealed. The roof, of Washita limestone, collapsed, filling the channel and forcing the stream to the surface—cave on the left—in a stream about six feet in diameter. It fills the depression formerly occupied by the roof with water and enters sinks in the immediate foreground to its channel below.

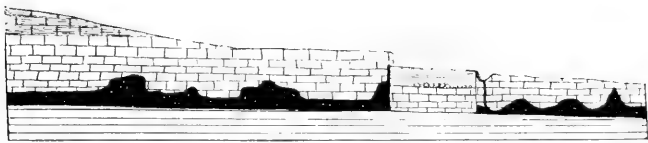

Fig. 26. A diagrammatic figure illustrating the origin of Phantom lake.

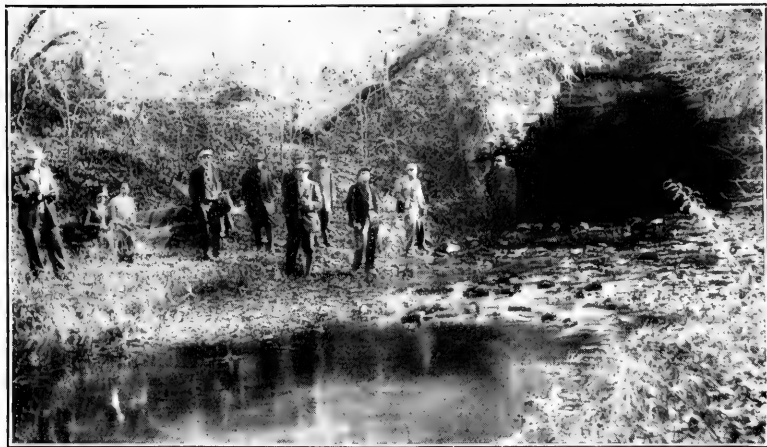

Fig. 27. Upper Dalton cave, part of Shawnee cave (Fig. 11) east of Mitchell, Ind. The location of cross caves and a sink at this point caused a collapse which brings the stream to the surface for several rods when it again continues in its subterranean channel.

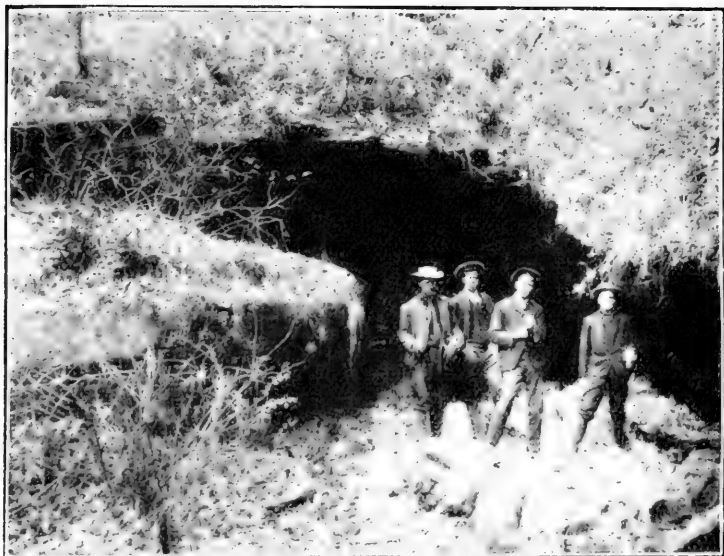

Fig. 28. Lower Twin cave (part of Shawnee cave) looking north. Here the roof collapsed at a right-angled turn in its course where it appears to have been joined by another cave from the south. The location of a sink here caused a collapse similar to the preceding case. The water formerly flowed from the upper cave toward the east and then turned north into this opening—does at present during high water—but now occupies a cutoff between the two caves.





Fig. 29. Spring west of the large sinks north of Blanche. This is one of the sinks draining the western part of Indian creek valley.

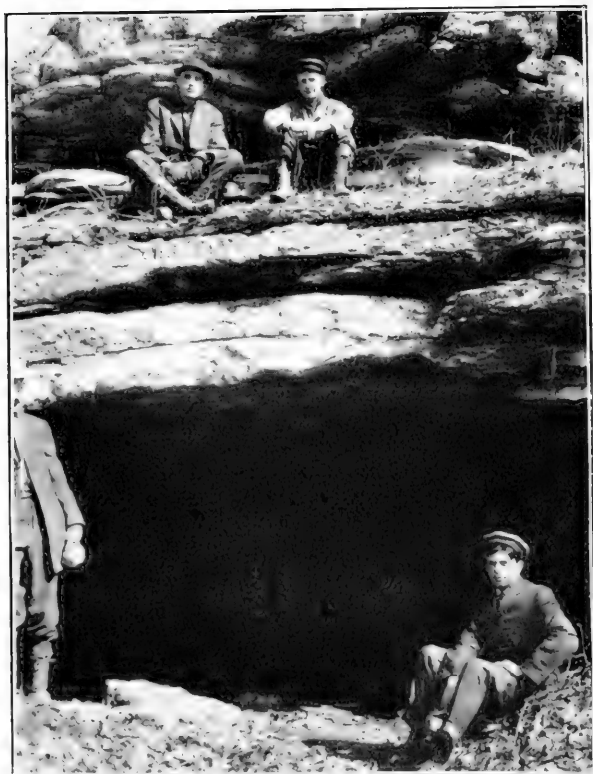

Fig. 30. Old channel of Shirley spring, above present outlet, as shown in Fig. 7.



Fig. 31. Mouth of Wyandotte cave, a former location of an underground stream.

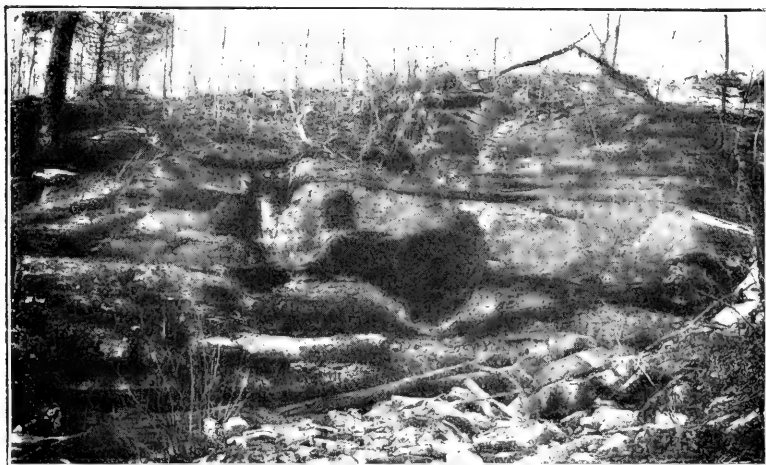

Fig. 32. Old opening to one of the large springs draining the Strongs cave sinks four miles west of Bloomington.

Figures 6, 7, 8, 10, 12, 13, 14, 17, 19, 21, 29, 30, 31, 32, from Professor Cuming's negatives.



## THE SHISHI GIG.

BY ALBERT B. REAGAN.

Among the Quileute Indians of the Olympic Peninsula, Washington, the little tots from four to twelve years of age dance a dance called the Shishi gig. What significance there may be in the name is unknown. In this dance the participants get their bodies into a stooped, almost sitting position and then dance a vigorous forward dance, as is shown in the accompanying cut. At feasts and on special dance occasions, a prize is given to the child who can dance the longest in this semi-sitting position. Sides are taken and coaches cheer their respective aspirants on to get them to keep up the dancing. At these times the excitement runs high. The dance is an amusing sight



SHISHI GIG DANCE.



## NOTES ON THE SHAKER CHURCH OF THE INDIANS.

BY ALBERT B. REAGAN.

(Continued from page 71. Proceedings, Indiana Academy of Science, 1908.)

The Shaker Indians of the West Coast are now taking steps to incorporate the Shaker faith in an organized church. Judge Giles of Olympia, Washington, is now working up the articles of incorporation for the Indians. Soon they will have an organized church, a church by Indians and for Indians only. Temperance is their watchword; and healing the sick through prayer and laying on of hands and "shaking" over them is one of their tenets. The church about to be incorporated is copied in part from several denominations, besides imbibing the doctor—"tomanawis" beliefs of the old times including a part of the "tomanawis" ceremonies. The Episcopal church furnishes the idea of chanting prayers<sup>1</sup>. The Catholic church furnishes the custom of burning candles during the service and the old custom of making the sign of the cross and the bowing of the knee when "Jesus-Man" is mentioned. The shaking, body-jerking, the contortions, the muscle-quivering, the wried face, and the hypnotic influence are derived from the shamanistic customs of the old times. Hypnotism and shamanistic influence in general are the leading powers and are the things which actuate the Indian to perpetuate the religion.

In talking with a "shaker," he will always tell you he has felt the "power" and that is why he shakes so hard. "It is the power of God taking hold of him that makes him shake," he affirms. From the start it was my opinion that the "power" the shakers felt when shaking is hypnotism. To satisfy myself I went in among the actors several times. At once I could feel the "power." There was no mistake about it. I had often felt the same "power" at the old style medicine singings and dances from the Pueblo and Apache country to the land of the Norman Lion.

<sup>1</sup>The chanted "doxology" in the church language of the Shakers is:

"Kwax tsnahs mahah' stee stah nah' stee tah' tsohn tohs pray' kloh mahahs' stee stah'."

Note.—The "stee" above is pronounced as though the first two letters were medium between "s" and "t," ranging between "st" and "ts" in pronunciation.

The accented words are much prolonged.

The power was undoubtedly hypnotism. The sensation produced was evidently that of hypnotic influence.

Once while I was attending one of these shaker meetings one of the actors was hypnotized. This was February 16, 1909. He had been standing with hands extended outward and upward for more than an hour while the shakers were dancing around him like the waves surging around a rock at sea in a stormy time. He was a novitiate at least for that night. He was trying to get the "power." He got it. He jumped up and down and stamped the floor in a circular movement, then for some minutes while his hands whirled, gyrated and his muscles quivered and jerked in a horrible manner. So hard did he stamp that he broke a hole through the floor. Soon he threw his hands up over his head and fell heavily to the floor. As he did so his muscles quivered as though he were in the dying stage. His flesh then became rigid. At this climax his pulse ran down to 57; five minutes later it was up to 60. Then as the spell was being broken twenty minutes later, it ran up to 76. The spell lasted forty minutes. Some of the Indians were scared, thinking the novitiate was dying, and rushed out of the hall. The performance over him was a complete hypnotic performance. The usual mode of removing hypnotic power was used. Hands were rubbed down his body and then the power thus gathered would be hurled to the four winds by a slapping, vigorous sliding of the hands across each other. When the "power" was removed so that consciousness was restored, the novitiate entered the dance vigorously again.

Effect of Shakerism upon the actors: The terrible shaking that has been mentioned here and in the previous article is bound to undermine the health of any person who will participate in it. Besides, the heating up of one's self as is done in the shaker halls and then the going out of doors immediately afterwards, tend to the giving of colds to the participants, especially in the winter months. This undoubtedly, will lead to pneumonia, consumption and death to many. Again, the horrid wrying and contorting of the faces will cause them to be wrinkled prematurely. The muscle-quivering and the hypnotic influence is bound, also, to have a damaging effect upon the nerves and mind of the actor; this dance is kept up all day every Sunday and from three to four hours every Thursday. Furthermore, in the doctoring of the sick the shakers are fanatical in the belief that shaking over the patient will cure it. "All shake—no medicine" has killed many an Indian and will in time decimate the tribes holding such beliefs.



## THE WRECK OF THE "SUTHERN."

BY ALBERT B. REAGAN.

About 1850 a revenue cutter (?), the "Sutherland" was damaged at sea in a storm; and, to save the crew, the captain ran the vessel ashore in the old mouth of the Quillayute River near what is now the Indian village



of LaPush, Washington. Immediately on grounding, the vessel was taken possession of by the Quileute (Quillayute) Indians. The savages boarded her and emptied her supply cargo into the sea. The dried fruits and the flour they knew not how to use as they had never seen such things before. So they emptied the fruit overboard to get the pretty boxes. They also poured the flour into the surging surf that they might get the sacks to make into clothes. The money of the ship also fell into their hands. It was gold. They had never seen gold before. They knew not its value or pur-

pose. So they rolled the double eagles around on the beach and used them as disks in their gambling games. They also made prisoners of the crew; and for a time all were ill treated very much. Finally, Chief Howeattle, who was up the river at the time of the capture, compelled the Indians to release them. By this time the storm had pounded the vessel beyond repair. At that time there was no communication from the Olympic peninsula with the outside world. So Chief Howeattle had houses built for his now guests. He also furnished the houses as best he could with his meager means. He also gave the single men of the crew Indian wives that they might be more contented in their forced home; two of his sisters married members of the crew. For a considerable time the strangers were compelled to stay there. At last a note was got out to civilization by an Indian messenger; and, finally, they were rescued by another government boat and taken to their respective homes, the men leaving their Indian wives behind with their own people.

Time passed, and years. Finally, another government vessel hove in sight. It anchored in the bay and from it many presents "from the Father in Washington" and the white people who had been stranded there were brought ashore and given to the good chief and relatives. The government also built Chief Howeattle a house and put a brick, fireplace in it for his saving the people of this vessel. They also furnished the house for him. But Mr. Howeattle was not permitted to enjoy his present long. A fire burned it to the ground. He, however, had the satisfaction of knowing that he had the good will of the white people and that he had done right.

The wreck of this old vessel can still be seen at LaPush. In summer it is covered with sea wash; but in winter the waves carry the sand far out to sea. Then, there exposed to view are the "irons" to remind one of the days of the wreck in that long ago and the change that has come over the country and the aborigines since that time.

## EFFECT OF ICE IN LAKE UPON THE SHORE LINE.

---

BY ALBERT B. REAGAN.

---

On coming to northern Minnesota last year, I visited several islands in Pelican Lake near Orr, in St. Louis County. The country in that region is very stony, mostly boulders of glacial origin. Around the borders of several of the islands, especially the low islands, there was a ridge of cobble stones and boulders, sometimes almost assuming the form of a stone fence. It struck my curiosity. It was spring, however, before I had solved the mystery. At the breaking up of the ice in the lake, a strong southwest wind drove the ice upon the islands on the wind-exposed sides to a height of over twelve feet in one case, a literal glacier being shoved inland. The ice being thus shoved forward and piled up on the land, shoved the loose rock of the shallow lake next the island inland so that the "moraine" thus formed was the stone wall I had noticed. It might also be added that some of the scratchings on shore rocks of lakes in this northern region may be due to the same local action.



## THE BOISE FORTE INDIAN RESERVATION IN MINNESOTA.

BY ALBERT B. REAGAN.

The Bois(e) Fort(e) Chippewa Indians live in northern Minnesota on a reservation of the same name surrounding the beautiful Nett Lake. The reservation covers one whole township and eight fractional townships. Its eastern part is in St. Louis County, the bulk of it in Koochiching County. It contains a total of 103,862.73 acres, exclusive of the area of the lake. Of this area, 55,646.43 acres are allotted to 693 Indians, 48,216.30 acres remain unallotted, and 434.64 is reserved for agency and school purposes. Of the 48,216.30 acres unallotted much of it has been reserved by the Government as pine lands and from time to time the timber on parts of the said lands has been sold under sealed bids, the closing out sale occurring September 15, this year. In all the timber on 9,533.70 acres has been sold, 3,233.77 being sold September 15, 6,299.93 having been sold previously. The other unallotted lands will be subject to settlement as homestead lands in the near future. There will also be something like 30,000 acres of Inherited Indian lands to be sold within the next two years.

Nett Lake is in the east central part of the reservation. It is more than half a township in area. It is in the shape of a giant lobster's hand with the claws pointing eastward, the large claw being the north digit. The lake is shallow and has a mud bottom. It is a rice field and a duck pond combined. In summer, it looks like a vast wheat field. In the fall it swarms with ducks and consequently is a sporting center for the hunters of all this northern country.

The lands included in the reservation are well timbered. The principal species represented are white and Norway pine, spruce, cedar, elm, cottonwood, oak, birch, and poplar. The latter two are the most abundant and will be of value some day as pulp wood.

The land of the reservation is very variable in condition of soil and possible fertility. One-half of it is swamp and is known to the Indians as "Muskeg" lands. Over this area there is a stratum of peat from six inches to five feet in thickness. When once drained this will be the best

land in the country. The non-swamp eastern part of the reservation is composed of rock-ridges flanked with lower land. These lower stretches are clay flats covered with black loam. On them grow birch and poplar forests; and when cleared they will make fine farms of the dairy type. Roots and grass do well on such lands. The ridge lands are the pine lands and will not be of much value, except for building sites and orchard locations.

The western part of the reservation that is not covered with "muskeg" swamp is a sand region. On it grew much pine in the old times; but when cleared it will be practically worthless, as is some pine lands east of the south lobe of the lake.

The region about Little Fork River is in the southwestern part of the reservation. It will make good farm land when cleared. Some open areas are fine meadows now.

The surface material, except that on the ridges, was left on the retreat of the glaciers. Its depth varies from nothing on the ridges to 200 feet in the pre-glacial intervalley spaces. The irregular dumping of this material and the partial filling of ancient valleys has produced the lakes of the country. In composition, this material varies very much. In the eastern part of the reservation it is composed principally of ground moraine material—a blue clay filled with boulders. Some of these are found to be of local origin; others to have been transported from a region far to the north. At other places on the reservation, the formation appears to be practically pure sand. On the rock ridges the glacial debris is entirely wanting, but instead the exposed rocks show the glacial scratchings.

The climate is very changeable in this part, ranging from 102 degrees above zero in summer to 60 degrees below in winter. The average summer is too cool for corn, and wheat has never been tried. Oats does fairly well.

The Indians have been allotted nearly twenty years; yet not one of them has ever made any effort to improve his allotment. As yet there is little inducement for them to improve them. There is no market where they could sell their produce. Furthermore it would cost \$100 per acre to clear the land, which is rather a big undertaking for a poverty-stricken Indian. In addition, there is rice growing in the lake and plenty of game in the woods and water fowl among the rice in the lake. Why should he labor to clear his land?

Below is a surface map of the reservation, showing the formations as they occur. (The original country rock is not shown.)

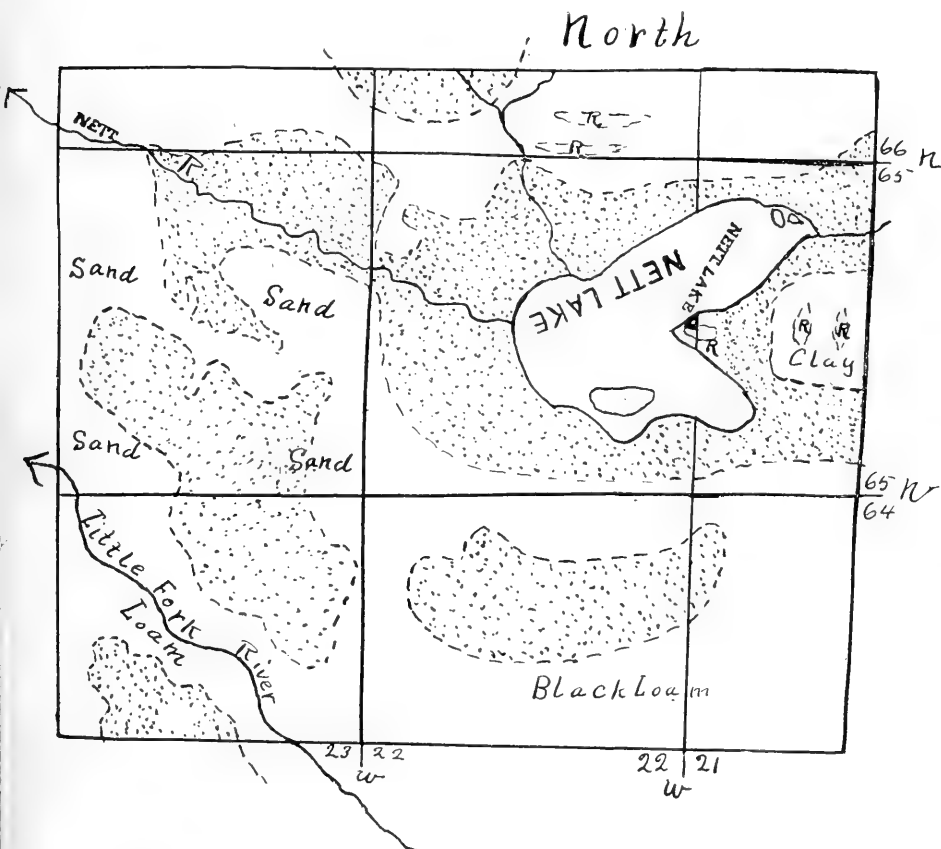

MAP OF THE BOIS FORT INDIAN RESERVATION IN MINNESOTA.

The dotted areas are swamp, or "Muskeg," to use the Indian term. "R" stands for rock ridge. The other kinds of land are designated on the map. Any one examining this map could not blame the Indians for petitioning the Honorable Commissioner to have lien lands allotted to them for their swampy allotments.





## CONSERVATION PROBLEMS IN INDIANA.

---

BY FREDERICK J. BREEZE.

When the organized movement toward the conservation of natural resources began with the White House Conference of Governors in 1908, very little attention was given it. But wide publicity was given to the new undertaking, and because of the people's faith in the integrity of purpose of its leaders, Roosevelt and Pinchot, the movement met with very general favor and enthusiasm. We had already seen the essential principles of conservation successfully applied in the management of the Federal forests and irrigation enterprises. Not only did the conservation movement stand out against the useless destruction and waste of natural resources, but also against the century-old policy of the government almost giving away its great resources of forests, water power, and minerals to corporations which were becoming gigantic monopolies. At once, conservation became a scientific and economic problem. The rapid reforms that followed the agitation for conservation struck terror to the monopolies and individuals who were getting control of our great national possessions; and conservation has been compelled to fight against the crafty, powerful and insolent onslaught of certain vested interests. The history of the past year is primarily a story of this struggle. The fight is by no means over; but the National Conservation movement has gained some very decisive victories, and today conservation enjoys a very marked degree of popularity. Already the close observer can see the tendency of certain classes of men to eagerly support the conservation policies in order to secure public favor for themselves. Other well meaning people are insisting on becoming leaders of the movement, whose enthusiasm surpasses everything except their deplorable ignorance of conservation itself.

In view of the recent beginnings of conservation activity in our own State, it may be well to briefly recall to your minds some of the conservation problems of Indiana.

Two natural resources are almost entirely depleted, our great virgin forests and natural gas. While the removal of our forests was necessary for agriculture and the demand for lumber, yet it must be admitted that deforestation has taken place to a greater extent than the actual needs

of agriculture called for. The criminal waste of natural gas is quite recent history; and the industrial consequences of its failure are painfully evident in the manufacturing cities of the gas belt.

Our natural gas and primeval forests belong to the past and are things therefore beyond the help of any conservation. But we have a great wealth of natural resources which need our most careful attention.

*Present Forests.*—Our existing forests are made up of limited areas of primeval forest, and second-growth timber of inferior quality on our stream bluffs and other waste lands, and in the farmers' wood lots. In the matter of afforestation there must be an improvement in the character of the growing trees in the wood lots, which can only be brought about by scientific forestal methods. Each farmer must be as competent in tree growing as in corn and wheat growing. In southern Indiana and along the streams of northern and central Indiana we have a large combined area of land too steep for successful field culture; and for the sake of soil protection, and for future lumber supply, these tracts should be kept in perpetual forests. In this matter of forests upon non-agricultural lands, there should first be a careful survey of such lands in order to form an accurate estimate of the total area, and to determine what species of trees are best adapted to make a rapid growth of valuable timber. It seems quite safe to say that the present woodland areas are of sufficient acreage to meet all the needs for lumber within our own State, if the quantity and quality of timber grown will be what it should be.

*Soil Fertility.*—The most valuable natural resource of our State is its soil, and the maintenance of its fertility is of paramount importance. The loss in fertility due to poor agricultural methods is beginning to be keenly felt. The loss due to soil erosion in southern Indiana was ably presented in the Presidential address of two years ago.

*Sewage Pollution.*—No conservation program can ignore the problem of keeping the state waters pure. Our streams must be brought back to their original purity. As our population becomes more dense, the need of a pure water supply becomes greater, and it becomes imperative that we stop polluting our streams with sewage. The turning of sewage and factory wastes into our streams is not only vicious from the standpoint of sanitation and aesthetics, but the carrying of sewage to the sea is a waste of certain elements of soil fertility which should go back to the land instead of being lost in the ocean.

*Coal Deposits and Other Mineral Wealth.*—In the matter of coal mining there must be a steady insistence that wasteful methods of coal mining must stop. In the mining of the best veins of coal, the layers of lesser value are left in such a condition that their removal in the future will be almost impossible. The securing of large dividends in the mining industry must not be at too serious a sacrifice of the future supply of coal. There also can be an enormous saving effected in the consumption of coal for heat and power by the general adoption of appliances for complete combustion.

*Water Power.*—In this State, water power is practically an undeveloped resource which is yet the property of the whole commonwealth and from the very nature of flowing water is not subject to private ownership. It is an outrage that our State laws enable individuals or corporations to get the control and profit of the available power of a stream simply by purchasing a power site and building a dam, without giving to the State one cent of revenue. There can be no more important thing in the conservation program than to insist on the passage of laws that will clearly establish the principle that water power belongs to the State, and that will provide for the leasing of water power rights for a definite term of years at a rental that will be fair to the power company and to the people of the State.

*Conservation of Public Health.*—The campaign for public health has been carried on so efficiently by our State Board of Health under the leadership of Dr. J. N. Hurty that it is not necessary to do more than suggest that this phase of conservation must always be of the very greatest importance.

*Scenic Beauty.*—Another phase of conservation should be the preserving of the natural beauty of the State. More and more will our State become crowded with artificial features; and the desire for beautiful natural features will be correspondingly greater. We must insist that the beauty of streams and hillside, trees and flowers, and songs of birds are worth while, and that the future development of our resources shall not destroy these things. I hope that the State Federation of Clubs will make this subject its chief conservation activity.

*Conservation Organizations.*—Within the last few months we have seen the formation of organizations to do special work along lines of conservation. The value of these bodies will depend very largely upon the

ability and fitness of the leading members to be leaders in conservation. Any organization that expects to obtain and hold the support of the people of the State must have as its leaders the men who are engaged in scientific work in soils, waters, forests, public health, and kindred subjects. Any association to conserve or develop a natural resource must be conspicuous in having as its leaders men who have first-hand knowledge of the natural resources involved; and not be conspicuous by the absence of such men. It must always be kept in mind that the most important conservation work must be done by the farmers, and that no organization which is promoted by a self appointed leader can win the attention or co-operation of the workers in whose hands must rest the burden of real and enduring conservation.

*State Agencies.*—Let us not forget that we have permanent governmental departments whose work is along important conservation lines, such as Geology and Natural Resources, State Board of Forestry, State Board of Health, etc. We should see to it that the people have a chance to become better acquainted with the splendid work of these scientific departments. Their usefulness is limited only by the amount of money appropriated for their use. We can do no better work than to insist that these conservational agencies of long-tried efficiency be given more money in order that they may render still better service to the State.

CRUSTACEA OF WINONA LAKE.<sup>1</sup>

---

BY JOHN L. HOUSE.

---

Two hydrographic maps of Winona Lake with descriptions have been published; one by Large (Proc. Ind. Acad. Sci., 1901) and another by Norris (Proc. Ind. Acad. Sci., 1901). The lake is situated in Kosciusko County, Indiana, about one mile southeast of the city of Warsaw. It is irregular in outline and has an average length of about one and one-eighth miles north and south and an average width of nearly three-fourths of a mile east and west with a large bay extending westward from the north end. There is comparatively only a small amount of shallow water in the lake as the bottom slopes off rapidly from the shores and reaches a maximum depth of eighty-one feet.

The fresh water crustacea are well represented in this lake both in variety of forms and in number of individuals. It is not probable that this list enumerates all the species to be found here.

The material for this report was collected during the months of July and August of 1908 and 1909 in connection with the work of the Indiana University Biological Station. Many thanks are due to Dr. C. H. Eigenmann, Director of the Station, for the many courtesies and suggestions received.

The Entomostraca were taken at about all hours of the day and night by means of the tow net, dip net and by pumping. The day catches showed very few forms near the surface even on cloudy days, but they were abundant near the surface from one to two hours after sunset until about sunrise. The nauplius forms were not numerous at the first of July, but became more abundant as the season advanced.

---

<sup>1</sup> Contributions from the Zoölogical Laboratory of Indiana University, No. 118.

The following list includes the species that have been identified:

CRUSTACEA.

Sub-Class Phyllopoda.

Order Cladocera.

Sididae.

- Sida crystallina* Mueller.
- Pseudo-sida tridentata* Herrick
- Daphnella excisa* Sars.

Daphnidae.

- Ceriodaphnia reticulata* Herrick.
- Ceriodaphnia scitula* Herrick.
- Ceriodaphnia lacustris* Birge.
- Scapholeberis mucronata* Mueller.
- Simocephalus vetulus* Mueller.
- Simocephalus serrulatus* Koch.
- Daphnia minnehaha* Forbes.
- Daphnia retrocurva* Forbes.
- Daphnia pulex* DeGreer.
- Daphnia hyalina* Leydig.

Bosminidae.

- Bosmina cornuta* Jurine.
- Bosmina longirostris* O. F. Müller
- Bosmina striata* Herrick.

Lyncodaphnidae.

Sub-family Eurycerinae.

- Eurycerus lamellatus* O. F. Müller

Sub-family Luceinae.

- Acroperus harpe* Baird.
- Alona quadrangularis* Müller
- Alona costata* Sars.
- Pleuroxus procurvus* Birge
- Procurvus denticulatus*.

Sub-Class Copepoda.

Order Eucopepoda.

Calanidae.

*Osphranticum labronectum* Forbes

*Diaptomus birgei* Marsh.

*Diaptomus oregonensis* Lilljeborg

*Diaptomus pallidus* Herrick.

*Episcura lacustris* Forbes.

Cyclopidae.

*Cyclops brevispinosis* Herrick.

*Cyclops leuckarti* Koch.

*Cyclops pulchellus* Koch.

*Cyclops signatus* Koch.

*Cyclops modestus* Herrick.

*Cyclops capilliferus* Forbes.

*Cyclops insignis* Claus.

*Cyclops serrulatus* Fischer.

*Cyclops fluviatilis* Herrick.

*Cyclops fimbriatus* Fischer.

*Cyclops prasinus* Fischer.

Order Siphonostomata.

Lernaepidae.

Specimen found on gills of the Black Bass (*Micropterus salmoides*), species undetermined.

Sub-Class Ostracoda.

Cyprididae.

*Cypridopsis vidua* O. F. Müller.

Sub-Class Malacostraca.

Order, Decapoda.

Astacinae.

*Cambarus diogenes* Girard.

*Cambarus propinquus* Girard.

*Cambarus immunis* Hagen.

Order, Amphipoda.

Orchestidae.

*Hyalella knickerbockeri* Bate.

## Order, Isopoda.

## Oniscidæ.

Porcellio rathkei Brandt.

## Asellidæ.

Asellus tomalensis Harford.

The economic importance of the smaller crustacea is well known. They form one of the most important food supply links between the lower plants and animals on the one side and the higher animals on the other. A small minnow about one inch long was kept for some time and fed on Amphipoda (*Hyalella knickerbockeri*). A small darter hatched from the egg and cared for by Mr. W. I. Lower was fed on Entomostraca, principally Ostracoda, until it was eighty-seven days old and was about three-eighths of an inch long.

As parasites the small crustacea frequently cause great mortality among fishes, but so far only one parasitic form has been found in Winona Lake and that in extremely small numbers on the gills of the Black Bass (*Micropterus salmoides*). Examination of other fish and of the clams in the lake failed to reveal other parasitic crustacea.

Three species of crayfish were found. *Cambarus propinquus* was abundant in the streams flowing into the lake and also in the outlet, but was extremely scarce in the lake. *Cambarus diogenes* and *Cambarus immunis* were found only in burrows along the shore and along the edge of the streams and in the adjacent low ground. The burrows are from two to three feet deep and contain six to eight inches of water at the bottom. Where the soil is homogeneous they extend obliquely downward in almost a direct course, but in the presence of stones and other obstructions they wind about sometimes to a considerable extent. In digging the holes the crayfish work head downward and bring the earth up between the chela and the first pair of walking feet and deposit it by the aid of the second pair of walking feet. Attempts were made to get the burrowers out of their holes by pouring strong salt solution and also formalin into them. But the crayfish would die before they would come to the surface. Traps at the surface were also resorted to without success and the only practical method of obtaining them was by means of a ditching spade which required no small amount of labor.

While the crayfish were always found in shallow water, under and among stones and sticks or in burrows, it was found that they could live



in deeper water. One pair each of *C. propinquus* and *C. diogenes* were placed in a wire cage in six feet of water at the mouth of Cherry creek July 21, 1908, and were fed from time to time. They were alive and in good condition when taken out August 24, 1908. It was found, however, that they would not live in extreme depths. One pair each of *C. propinquus* and *C. diogenes* were placed in a wire cage in forty-five feet of water and were in good condition two days later. But when placed in sixty-five feet of water they perished in less than twenty-four hours.



A METHOD BY WHICH COVER GLASSES MAY BE USED  
ON GOLGI SLIDES.

---

BY D. W. DENNIS.

---

It has been well known for many years that Golgi slides of the brain, spinal cord, etc., will go bad if a cover glass is put on them.

Several years ago serial sections of a mouse's brain were prepared by this method in the Earlham laboratory by Mr. Levi Peacock. Three years ago I concluded to sacrifice one of these slides in order to get a medium power photograph of some Purkinje cells, so the balsam was warmed and the cover glasses put on. Last summer the slides were still in excellent condition. I accordingly had cover glasses put on all the slides last winter and they are still all in good condition. How long a time must elapse after a slide is made before it will bear a cover glass without damage we shall now work out.



## A TROPICAL REPTILE NEAR RICHMOND, INDIANA.

---

BY D. W. DENNIS.

---

A large reptile, *Iguana tuberculata*, was taken three miles from Richmond, Ind., in October. The man who shot it, a negro, undertook to carry it home by the tail and broke off what he estimates was a foot and a half of the end of its tail. What remains is about three and a half feet long. As this is a tropic species, we suppose that it must have escaped from some traveling show or from some private collection. No clue has been found. The skin will be prepared for the Earham museum by Ward of Rochester.



## A NEW BEL OF TRILOBITES.

BY ANDREW J. BIGNEY.

It is conceded by those who have studied the rocks of Dearborn County that there are few sections in the country that are richer in invertebrate fossils. The Richmond formation is the outcropping stratum. In many places the streams have cut into the underlying Lorraine. During the past ten years the erosive action of the streams has been much greater than during any previous period of equal length of time. This is largely due to the removal of the forests from the hills and the cultivation of these lands for various crops. An examination of almost any stream shows the deep channels revealing new formations and rich beds of fossils, with interstratified clays.

It was in such a place as this, one mile northeast of Moores Hill, that I discovered a small bed of Trilobites of the species *Calymene* (species?). The bed does not measure more than three feet by four. The rocks are about three inches in thickness. It is of compact limestone, composed entirely of the trilobites, most of which have been partly dissolved and re-crystallized. Enough of the trilobites remain to enable one to recognize them. Nowhere in this section have there been so many trilobites found in any one place. Usually they are very scattering. Twenty-five years ago many specimens were found in various parts of the county, but I have never learned of so rich a find as this. In the same stream and not far away there are a few specimens to be found. This must have been an isolated portion of the ancient sea, especially favorable for the growth and accumulation of the trilobites.





## THE OCCURRENCE OF CONGLOMERATE AND SANDSTONE OF POST-GLACIAL ORIGIN IN JEFFERSON COUNTY, INDIANA.

BY GLENN CULBERTSON.

The city of Madison, Jefferson County, Indiana, has been built on a great sand and gravel bar. This bar is approximately three miles long, from a quarter to a half mile wide, and of varying depth up to sixty or eighty feet. It is composed quite largely of sand, gravel and pebbles of glacial origin, water worn and deposited by the Ohio river. The bar deposit was very probably formed contemporaneously with the "second bottoms" or the first terrace of the Ohio river, and during the time of flooded waters as the later glaciers were melting.

Crooked creek, a stream some eight or ten miles long, which in glacial or preglacial times emptied into the Ohio near what is now the upper part of the city was deflected by these deposits, and now flows approximately parallel to the Ohio river for some three miles, emptying into the larger stream at a distance below the pumping station of the Southeastern Hospital for the Insane.

It is along the banks and on the slope to the south of Crooked creek



Fig. 1.

Ideal cross section of gravel bars and conglomerate deposits. Width of bar a b equals one-fourth mile; height m n equals 60 feet.

(c) Bed of Crooked creek.

(d) Position of thickest conglomerate and sandstone deposits, irregularly placed.

(e) and (s) Other irregularly placed deposits of indurated rocks.

(a b) Low water mark Ohio river.

that the more important sandstone, gritstone and conglomerate formations may be seen. Their outcroppings are especially noticeable along the slope south of Crooked creek, and between the large fill of the Pennsylvania railroad and the bridge over Crooked creek on the Hanover road.

So far as determined from sections seen in a few short valleys, on the creek banks, and in a large gravel pit, the consolidated sands and gravel are more abundant on the side of the bar farthest from the river, and on the slope near the creek. Here the conglomerates and sandstones are in several irregularly placed layers which vary in thickness from a few inches up to six or more feet. The formations are not of uniform thickness, and grow thinner the farther they are from the creek and the exposed slope. The accompanying ideal cross section of the portion of the bar from Crooked creek on the north to the Ohio river on the south in the locality above mentioned shows the relative position and general character of the formations.

The cementing material, so far as tested, was found to be calcareous. Much of the stone is quite compact and firm, but a part of it is more or less friable. In general the upper portion of any layer is the more indurated. In a few limited areas the upper surface of the conglomerate appears to be cemented by material of stalagmitic character. By far the greater part of the formations, however, gives no evidence of the existence of cementing material of that nature or origin.

The formation is peculiar from the fact that the cementation and consolidation took place above the water and in the absence of any considerable pressure. In the opinion of the writer the cementation of the sands and gravels was the result of capillary action. The waters of Crooked creek, which flow throughout their course over limestone and calcareous shales become at times strongly impregnated with calcium carbonate. This was preëminently the case when the stream was low at the time of a drouth. On the arrival of the waters at the place of the present conglomerate formations, the slope of the stream and the character of the bed were such that the movement of the water was very slow. Hence much of the water with its content of calcareous material passed into the sandy and gravelly banks, and then was drawn up by means of capillary action through the firmer close-textured beds. On approaching the surface of the beds the water evaporated and left a residue of calcium carbonate. This

residue, on being deposited between the grains of sand, the particles of gravel and the pebbles cemented them together into the solid rock.

The character of the beds of material underlying the consolidated portions is such that capillary action was not only possible but highly probable. The greater abundance and the greater thickness of the indurated beds on the side of the gravel bar nearest the creek indicates that its waters were largely responsible for the presence of the cementing materials.

In explanation of the formation in places of material resembling stalagmite, it is probable that surface waters flowing over or through the more or less consolidated rock redissolved a part of the cementing material, and when such waters reached the surface of the soil or rock at a lower level they were evaporated and the calcium carbonate was again deposited in the form mentioned.



A PHYSIOGRAPHIC SURVEY OF THE TERRE HAUTE AREA—  
REPORT OF PROGRESS.

---

BY CHARLES R. DRYER.

---

The physiographic survey of the Terre Haute area reported last year has been continued during the past season and extended across the Wabash valley to the top of the east bluffs. A strip six miles wide, north and south, has been completed, and we have been brought face to face with the problem of the sand and gravel terrace, three miles and more in width, 50 feet above the river and more than 100 feet deep, which extends along the east side of the valley a distance of 30 miles. Within the area surveyed its generally level surface is traversed by several irregular north-south ridges, which rise to a nearly uniform height of 510 feet A. T. These are interpreted as being bars laid down by a loaded and probably braided stream. In some places these bars are capped by subsequent eolian deposits. The materials of the terrace are everywhere fairly well assorted and stratified, with frequent cross bedding, where the strata dip down stream and suggest local delta formation. The strata in vertical section often display a great variety and testify to frequent local changes in the velocity of the depositing stream. Boulders up to two or three feet in diameter are common and are attributed to the melting of floating ice.

The terrace heads 12 miles north of Terre Haute in Parke Co., where the Shelbyville moraine of the Wisconsin ice sheet crossed the Wabash valley. At this point the problem is complicated by the extension of the terrace up the valley of Raccoon creek to the northeast where it is more than a mile wide. The final solution requires the extension of the survey to the Shelbyville moraine and up the Raccoon valley to a distance not yet determined. This work has been begun, but is not yet completed. So far as studied, the terrace appears to be an outwash plain, or valley train, laid down by a constantly overloaded stream, or streams, which issued from the margin of the Wisconsin ice sheet. Whether this is the true interpretation, whether the train originally occupied the whole width of the valley, and, if so, what were the agencies and conditions of its removal from

the west side of the valley, are problems which we hope to attack in the future.

The margin of the east bluff is capped by a broad ridge of sand, standing 20 to 30 feet above the general level of the till plain to the east of it, and exhibiting in many localities characteristic eolian topography. The surface sands are underlaid by loess, and the whole deposit is interpreted as having been blown up by westerly winds from the valley below.

The small streams from the east which break through the bluff have wide flat-floored valleys opening upon the terrace with accordant grades. In their natural state, none of them ever extended their channels across the terrace to the river. Their waters, ponded in depressions between the bars, sunk into the sand or evaporated. The depressions are generally puddled with a thin coat of lacustrine silt.

## THE WORK DONE BY NORMAL BROOK IN THIRTEEN YEARS.

BY CHARLES R. DRYER and MELVIN K. DAVIS.

A small stream which enters the Wabash valley three miles east of Terre Haute attracted the attention of the senior author of this paper many years ago by its remarkable meanders. Within a length of 1,000 feet it presents most of the phenomena characteristic of the lower Mississippi, and it has been visited so often by geography and geology classes from the Normal school that it has acquired the name of Normal brook.

The stream rises by two principal forks which drain about a square mile of Illinoian glacial clay plain, cuts through the east bluff of the Wabash valley and is lost upon the great gravel terrace below, by percolation and evaporation. Along the edge of the bluff the clay overlaid by a belt of sand dunes about half a mile wide, and the most interesting part of the stream, is that where it passes through the dune belt. A hasty survey of this part of the valley was made in 1897 and a map of it was published in the *Inland Educator* for June, 1898. During the past season (1910) a second and more careful survey has been made and a comparison of the two maps shows the changes which have taken place in thirteen years. (See Figs. 1 and 2.)

The part of the valley shown measures along the median line 1,150 feet, while the stream, by its meanders measures 1,960 feet, an excess of 68 per cent. In the upper 650 feet of the valley the length of the stream is 1,360 feet, an excess of 109 per cent. The valley floor, 100 to 200 feet wide, is flat flood plain bounded by bluffs 25 to 40 feet high. The material exposed on the floor is wholly alluvial, mostly sand with occasional bars of fine gravel and beds of tough, blue clay. In the valley floor the stream has cut a channel 20-70 feet wide and three to six feet deep. The stream is perennial and in ordinary stages is a thread of clear water four or five feet wide and six inches to a foot deep, which is much more crooked than the channel. In times of flood it fills the channel, but has never, in seventeen years of observation, overflowed the valley floor.

Sharp zigzags, oxbow bends, cut-offs, caving banks on the outside and bars on the inside of the bends are numerous.

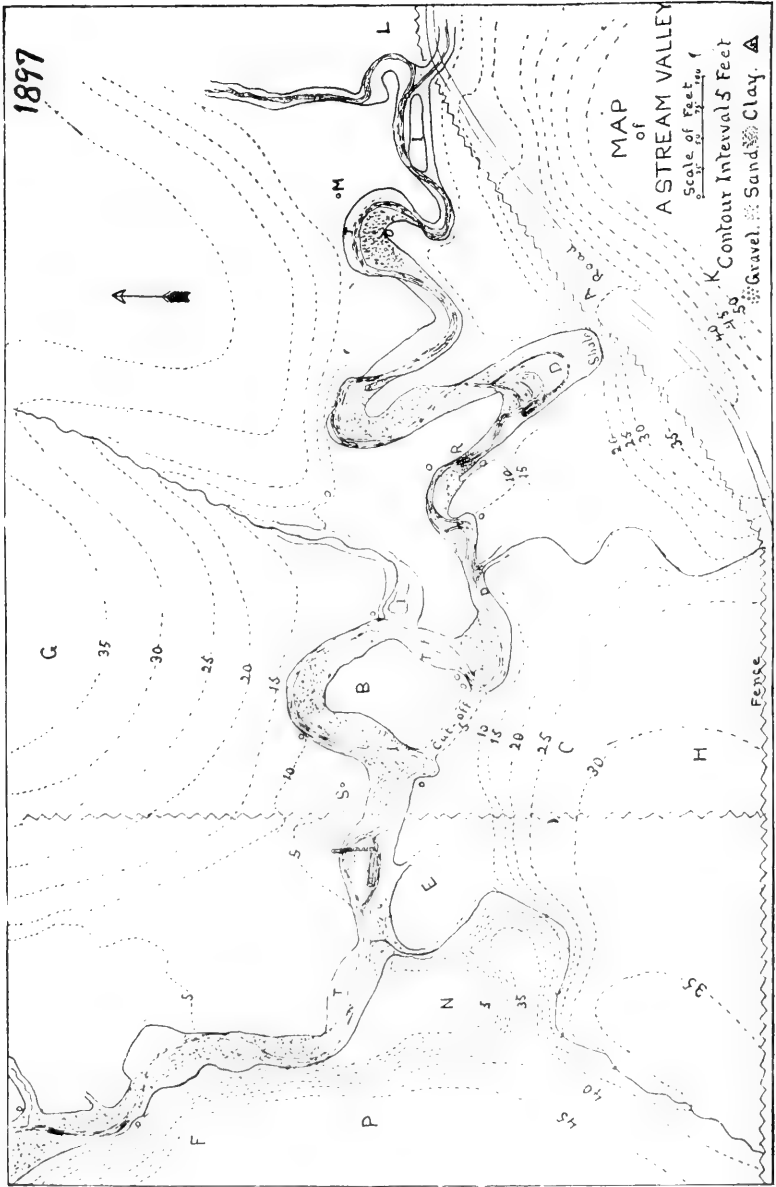

Fig. 1.  
NORMAL BROOK.





MAP  
OF  
NORMAL BROOK

SCALE  
20 FEET  
Drawn by M. K. Davis  
1910.

PROFILE X-Y

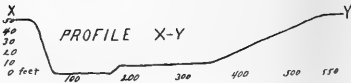

- |        |    |           |
|--------|----|-----------|
| GRAVEL | D  | TREE      |
| SAND   | B  | MAPLE     |
| CLAY   | S  | BEECH     |
|        | M  | SUGARMORE |
|        | K  | HICKORY   |
|        | L  | ELM       |
|        | NW | WATER HUT |
|        | AB | BASE LINE |

FIG. 2

A detailed description of some of these features and the changes which have taken place in thirteen years, as shown upon the two maps, form an interesting demonstration of stream work.

The island at I has disappeared. The horse shoe near M has been cut off, a beech tree removed from its center, and the whole area converted into flood channel. The next bend to the west has been widened and rounded (all done at two or three spring freshets), and the neck nearly cut through. The sharp bend at D has also been widened and the tongue shortened. The cut-off channel across the neck of bend B, a foot deep thirteen years ago, has not been enlarged, and the cut-off, then apparently imminent by overflow, is now likely to take place soon by lateral erosion of the neck. The south bank opposite S has been cut back twenty-five feet, including a large beech tree. West of S the north bank has been cut back forty feet including a large maple. Near P the stream strikes and undercuts a boulder clay bluff, turns to the north and ceases to meander. The general result is a notable enlargement of the area of the flood channel floor, which has become a new flood plain, leaving the old one as a terrace.



Fig. 3.

The valley floor and sides are occupied by an open, park-like forest, consisting of oak, maple, elm, beech, hickory, basswood and other trees, mostly from two to three feet in diameter. The smallest one is eighteen inches and one beech is nearly four feet. The area has never been under the plow, and has for many years been used as a pasture. Evidently the stream channel is shifting rather rapidly from side to side, and the alluvial material has not been deposited in thin layers over the surface, but has been transferred from one side of the channel to the other by lateral corrasion and deposit. The trees do not check the process of lateral shifting in the least. If the stream comes against one it undermines and tips it over as readily as it cuts away its bank elsewhere. There is only one tree in the valley more than about 100 years old and that stands near the foot of the bluff. Therefore the inference seems justified that a complete shifting of the channel from side to side and a working over of all the alluvial material takes place about once every century.

The most puzzling question about this stream is the obvious one, what makes it so crooked? At ordinary stages it carries almost no sediment, and at flood it does not appear to be overloaded except on the inside of the bends. The valley is straight, the flood water channel is very crooked and the low water channel is still more crooked. The fall of the stream in 1,900 feet of length is seven feet, or at the rate of 19 feet per mile, and in the upper 1,360 feet is 22.5 feet per mile, which equals the average fall of the Colorado river through the Grand Canyon. The fall in the lower 600 feet is 10.3 feet per mile. The slope of the valley floor in 1,150 feet is 32 feet per mile, but in the upper 650 feet is 42 feet per mile. Therefore the stream is most crooked where the valley slope is steepest. Its law seems to be, the crookedness varies directly as the steepness of valley slope. This supports the conclusion of Jefferson that "maturely meandering streams may be regarded as finding their slope too steep."<sup>1</sup>

It works in easily eroded material and the extraordinarily crooked portion of it is just where it crosses the belt of sand dunes. These facts indicate that a temporary and local excess of load may be one of the factors concerned in the problem.

<sup>1</sup> National Geographic Magazine, Vol. 13, Page 373.



Fig. 4.

Abandoned bends at high levels show that the stream has been meandering for a long period. The fact that it no longer overflows its valley floor, but only the channel floor, means that it is slightly entrenched, is making a new flood plain at a lower level, as the cross profile shows (Fig. 2), and leaving its former flood plain as a terrace. In entrenched meanders cut-offs are rare, because they occur only where a neck is cut through by lateral erosion. The cut-offs of Normal brook are made in this way and not by overflow across a neck. In such cases the meander belt has no self-limiting width, but is restrained only by the bluffs. In Normal brook the width of the belt is about thirty times the width of the low water stream and not more than five times the average width of the high water channel. The present base level for the brook is the surface of the gravel terrace in the Wabash valley. The brook once emptied directly into the river when it stood at a level ten or fifteen feet above the terrace. Therefore the brook has been subjected in post-glacial times to a fall of base level of that amount. Meanders acquired during a condition of higher base level and gentler slope may have been inherited and moderately entrenched by the present stream.



Fig. 5.



Fig. 6.

## THE PALEOLITHIC, NEOLITHIC, COPPER AND IRON AGES OF SHELBY COUNTY, INDIANA.

BY F. W. GOTTLIEB.

Exact date, I know not; but we will say at least 1,000 years ago. I will treat especially upon the mounds of Hanover township, known as Hog Back and Kinsley mounds. The former is 250 yards long, over 100 yards wide and was 65 feet at its highest point. As I study this prehistoric burial place I become convinced that it is a great deal of Nature's handiwork, dating back to the drift period, because of the large boulders imbedded in the great mass of choicest gravel. A valley between this mound and another very high ridge shows how the earth was taken therefrom and placed on top of the mound ridge, thereby forming a surface which caused the earlier white settlers to give it the name of Hog Back, much representing the razorback species. Old historic Big Blue River flows gracefully past the east side of the mound, which rises abruptly to the height of 65 feet. On the north end flows a spring of sparkling water, which has quenched the thirst of countless ages; even in this progressive period it is the camping and picnic ground for numerous persons each summer season.

The land where this mound is located was entered by a Mr. Chadwick in Freeport, a small isolated village near Morristown, where the South Illinois Indian trail crossed Big Blue River. There was at one time an appropriation made by the Indiana State Legislature for the improvement of Blue River up to this point, and on the opposite side of the river and a little below is a spot marked by the State Geologist where gold has been picked up, the retreat for many summers of Indiana's most famous author and poet, James Whitecomb Riley, and immortalized by him.

Some distance above the squat and burial-place of our pre-Columbian brethren which so beautifully overlooks the village lived a settler of pioneer fame by the name of Pougé, who is supposed to have been killed by the Indians that had stolen his horses, when he with his gun followed the trail northeast of Indianapolis to a stream which took its name after the



Hog Back Mound  
Freeport Ind



settler. At this point it is claimed that he overtook the Indians and was killed, as he was never seen afterwards. But some years later a skeleton was found in a pit where a tree had uprooted, which was supposed to be the skeleton of the settler, being the last reminder of the Indians who no doubt buried their dead in sitting postures in Hog Back, prepared originally by their predecessors, the Mound Builders.

The mound is in an enclosure of about six acres always covered with blue grass and was undisturbed until fifteen years ago. Several very large beech trees are still standing on the same, also very large stumps of blue poplar trees. After the land was sold, the new owner at once began to haul gravel and great destruction has taken place. Many skeletons have been taken out and their bones, along with the gravel, have helped to make the many good roads of Hanover township.

Seven large spears and many ornaments of bone, mollusk, shale beads, ornamented bear teeth, polished but not pierced, Beaver, Ground Hog and Wildcat teeth have been found.

EXHIBIT 1. The skull of this solon of the past is one of the most perfectly preserved specimens taken from Hog Back. Oh, if he could only tell what his cranium once possessed in knowledge! He was no doubt a Mound Builder; as he was found in nearly the middle of the great ridge and about seven feet under the surface. The carelessness of the gravel diggers was unfortunate indeed, as no other part of him was saved and what artifacts might have been buried with him were lost.

The soul of the man  
 The organ of thought—  
 Tell me, if you can,  
 What this man might have wrought.

2. This broken Femur—see how it was stoved and how firmly it welded together. I would like to know the name of the prehistoric surgeon! I took up a skeleton on the highest point twelve years ago of a man no doubt 90 or 100 years old, judging the age from the teeth. He was a very large man. His jaws were so huge that I could place them on the outside of my jaw and move my chin very freely. He had a broken left rib which was lapped together and healed very nicely.

3. This banded Slate Bird Amulet, being the first of the slate artifacts that were found in the mound, is what archaeologists term the Duck, or Lucky Stone, and was tied on the bow of the boat to insure success for the day's hunt and catch.

4. This Mollusk shell, pierced with three holes, was upon the breast when it was found with the skeleton.

5. This beautiful banded slate ceremonial was unearthed one month ago. It is a very valuable addition to archæological science. I contend that this specimen is not a ceremonial tomahawk, but the ancient game stone, similar to the game of Diabolo recently revived over the world. A heavy sinew from the deer, such as the early Indians used for their bows, was no doubt placed through the unusually large square hole and then tossed into the air by means of a wand and kept in motion by applied science or practice. It shows very plainly where the strings wore grooves on the four corners of the hole through the ceremonial.

This mound looks very sad today, as many hundreds of loads of gravel are hauled therefrom every year and soon the abode of early man will disappear. I will halt here long enough to say that Indiana is very slow in taking up the matter of preserving her Indian Mounds, a subject in which I am deeply interested, and I will make an effort to call the attention of the next session of the Legislature to this important matter.



Fig. A.

## Neolithic Age.

Showing the many different Banner stones, Gargets, and Ceremonials. The virgin and matrimonial stones in the center of the picture, the U shape being the virgin and the — the matrimonial. Pipes and bow-string makers, etc.



Fig. B.

## Paleolithic Age.

These are the crudest of the stone age. Nearly all these stones are as they found them and applied them to their use, with a slight improvement, such as holes or sharpened edges.

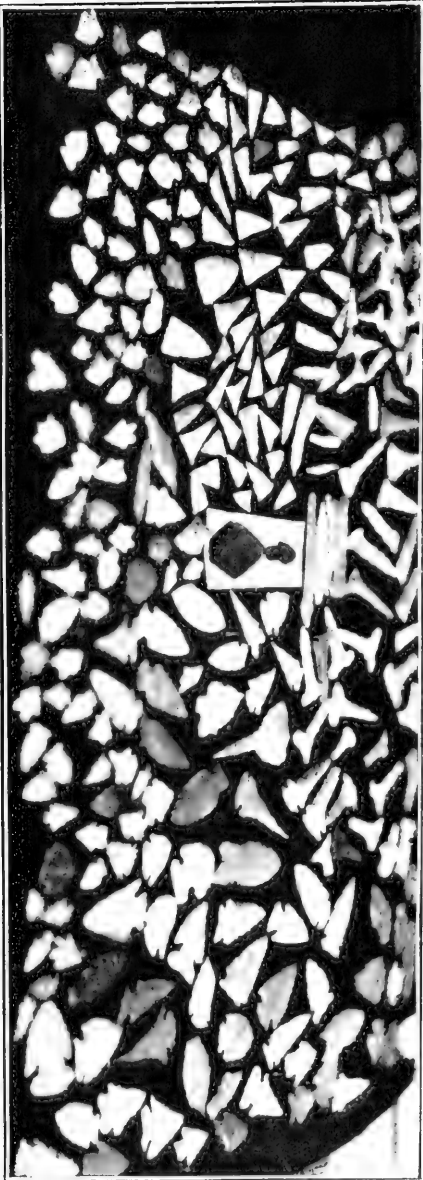

Fig. C  
Neolithic Age.  
Drills, spears, war arrows, etc.



Fig. D  
Neolithic Age.  
Showing the advanced stage of the stone art over the paleolithic. The tall stones are pestles used to grind their cereals; the long ones are mullers, used, no doubt, to roll out the dough, etc. Large spears, up to 7 and 8 inches, tomahawks, fleshers, tanners, etc.

## COPPER AGE.

### THE KINSLEY MOUND.

So named because an old gentleman by that name owned the land, which is now inside the corporation of Morristown, Indiana, Hanover Township.

We suspected this elevation to be a mound for years. Finally the land was sold and platted into town lots. Mr. Davis, who bought these certain lots began at once to haul gravel from the side of the mound, which is a perfect circle about 150 feet in diameter and not over seven feet high at the present, owing to the fact that it was under cultivation for many

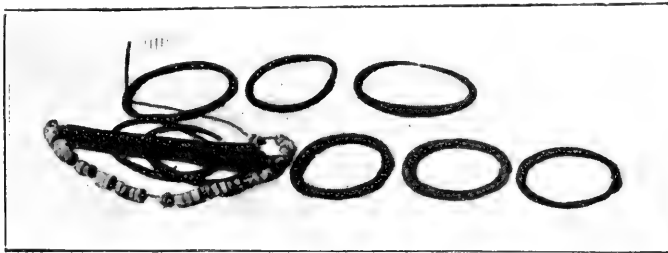

FROM KINSLEY MOUND.

years, which has worn it down several feet. Much to the surprise of the diggers, human bones began to appear, copper bracelets began to fall and tinkle, disclosing three bodies—that of a supposed Chief, his squaw wife and child squaw, having a total of 16 copper bracelets on their wrist-bones. (Of said number I possess 8 and show them to you.) Here are two wrist bones of the child, with two bracelets on them, as I found them myself. My companion obtained the other arm and the two bracelets, being a total of four that the child wore. We found over 200 beads of antler wampum in the dirt about the child's neck. (Of the same I show you over 50.)

Note the thickness of the bracelets about the wrists of the Chief, a size smaller about his no doubt conjugal squaw.

I have here some of the ash bed these bodies were buried in, which shows one inch thick in the soil. Also some splendid specimens of charcoal. The crania in general from this mound are in a miserable condition.

Just one-half of this conical mound has been destroyed. I may yet obtain more valuable information when the remainder has been destroyed. Would that I possessed the same; I would restore and fence it about, let blue grass reign supreme, erect a suitable monument to these solons of the copper age, which could be readily seen from the C. H. & D. R. R., being not over 100 feet from the track; but alas, there is too much profit in the gravel, and man of this flying machine epoch must have the cash.

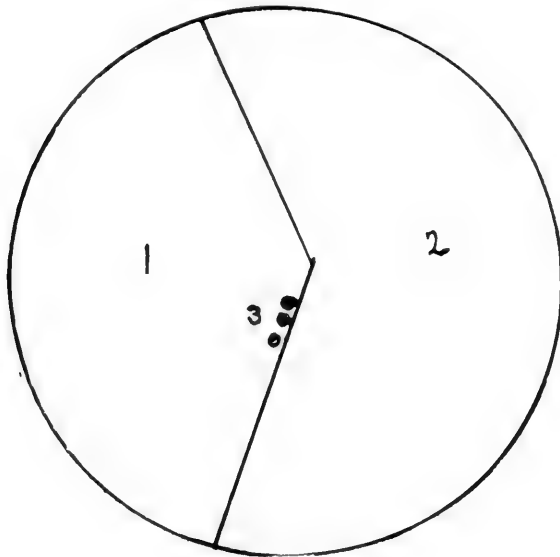

KINSLEY MOUND.

1. This part excavated.
2. This part left intact.
3. Three bodies were removed.

The International Society of Archaeologists, of which I am an ardent member, is taking up the Science of Archaeology and spreading it all over the world, enlisting support everywhere, and hope to do away with this wholesale destruction of the monuments, thus preserving them for the care and study of future generations.

Now one word or more, why we find so often three bodies buried together, of man, woman and female child. This is my second observation, and others have related like observations to me. Did they cremate, or put to death first the favorite wife and female child when the chief and father died, to be buried with him, or what? What do you think, you members of this splendid Academy?

---

## IRON AGE.

---

We are now in the Columbian era, when the Spanish and French and early English inhabited this section. The center weapon in the illustration is a very finely preserved Halberd, plowed up about ten years ago. An exact counter part of this Halberd mounted, with its original handle, I saw in the Cincinnati Art Museum, which was loaned to the said institution, having been handed down at least 250 years. It was used with great skill to spear, climb forts, chop away an opening through the then dense forests, etc.

The Spanish Bowie Knife was found recently in Morristown when digging for grading a hillside, by William Cremens.

The Squaw Ax and peace pipe Tomahawk were both plowed up years ago and were no doubt made for the early Red Skins in this section, who were Miami and Ben Davis Indians, by the men that no doubt lost the Halberd. The early settlers, when on friendly terms, would exchange these handmade implements of Iron with the Indians for furs, pottery, etc.

The two Spikes shown are from the first railroad built in Indiana, known as the Knightstown & Shelbyville Railroad. An old settler tells me that it is 52 years since he last rode on it. It was a flat bar system, wooden sleepers and a flat iron rail was spiked on with these spikes, which were found by my friend L. Cole on his farm in Hanover Township. The road crossed Main street in Morristown, where stood the old depot, and the two nails shown were taken from the building when it was torn down. My stepfather (deceased), Collins Wilmot Griffith, the first mill wrighter and pattern maker, that superintended the building of the first Flour Mills





and Foundries in this part of the State, in his years of retirement was the owner of the Stage line which operated between Knightstown and Shelbyville. He also conducted the Hotel at Knightstown. The sad affair of building and putting this fast Railroad into operation was such competition that he soon lost his fortune tied up in horses and stages. He continued to conduct the Hotel and many belated passengers were his guests for several days at a time until the mishap on this slow Railroad was corrected.

Thus I bring my Iron Age to a close. I have brought you from the prehistoric past into history and there I close, with a mention of the progression of 75 years—the Telephone, Electrical Achievements, Phonograph, Wireless Telegraphy, Flying Machine.

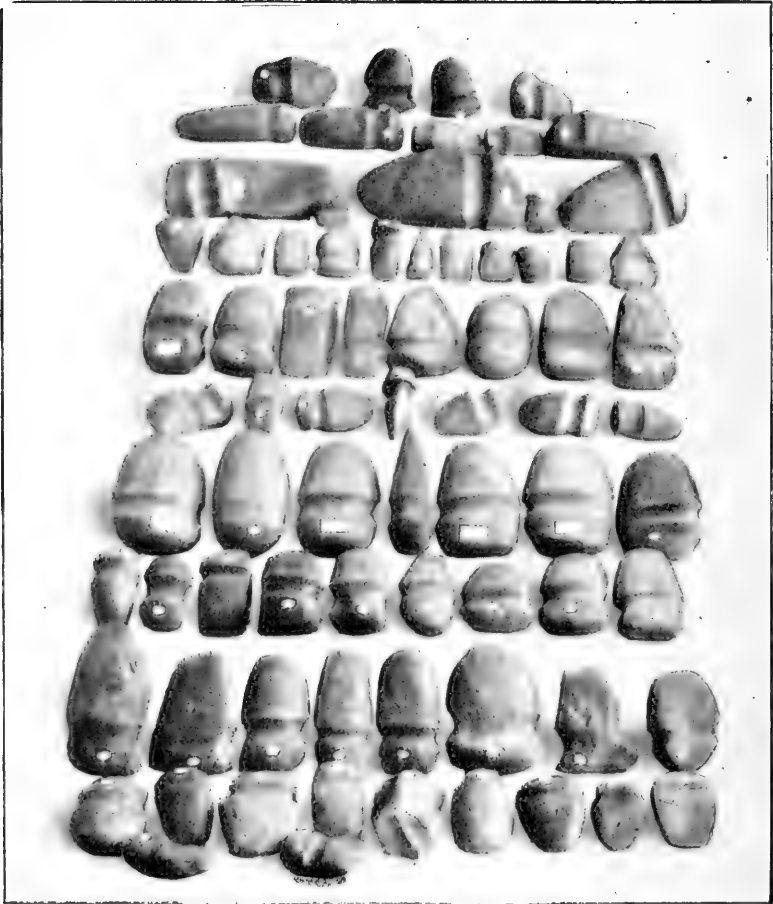

GROOVED AXES.

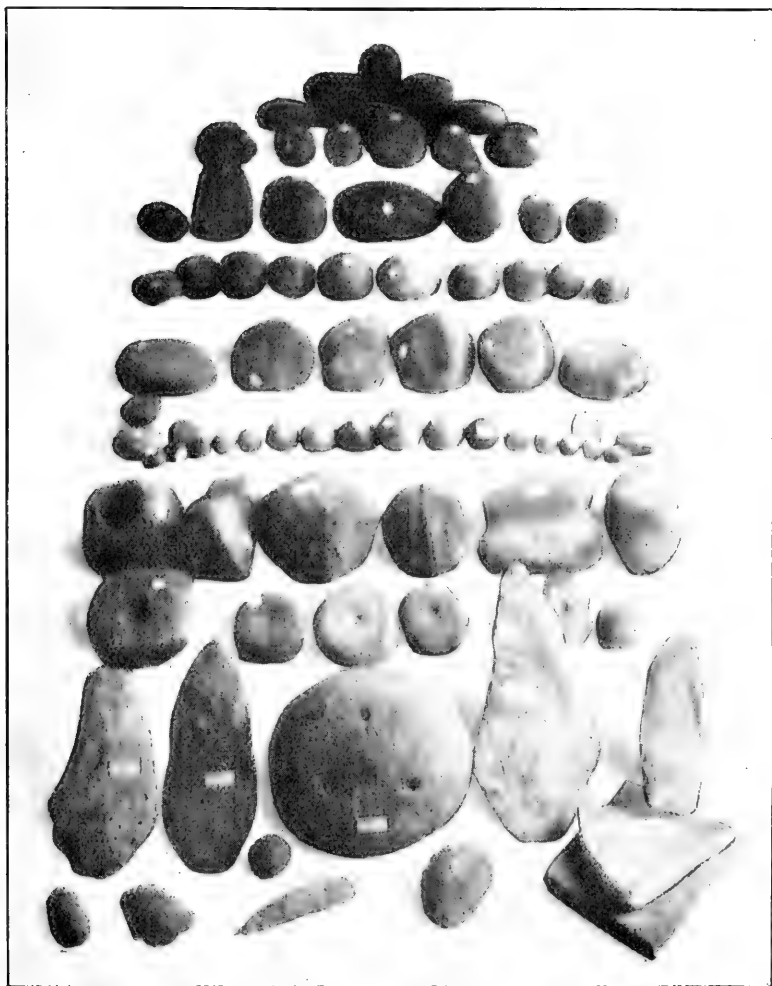

PITTED STONES, GROOVED MORTARS, HAMMERS, ALTAR STONE, HOES  
AND HEARTH STONES.

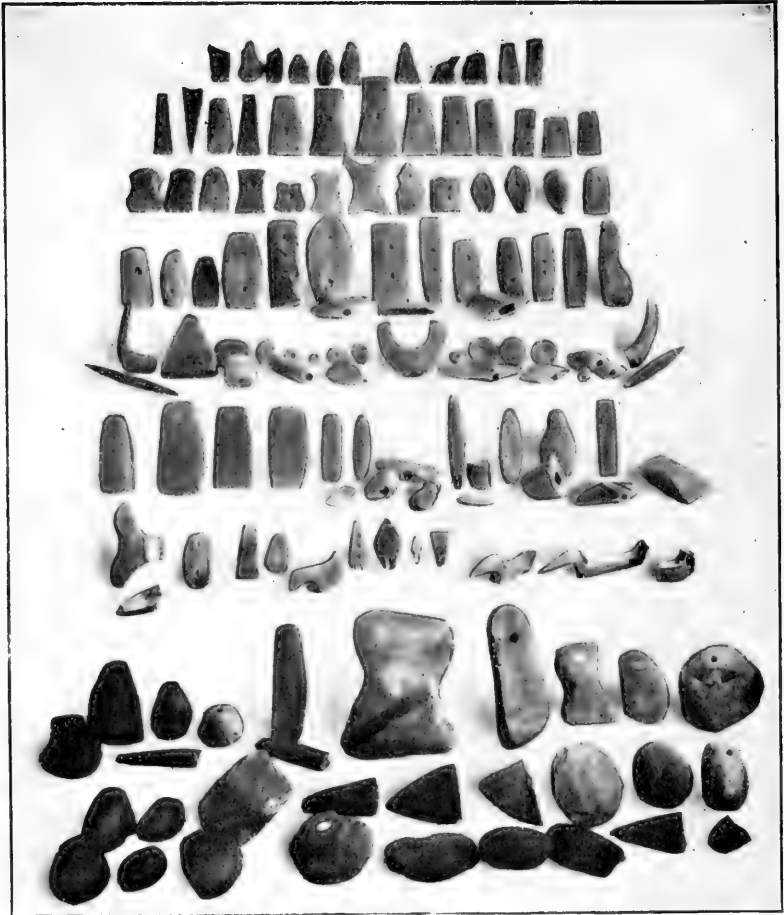

CEREMONIALS.

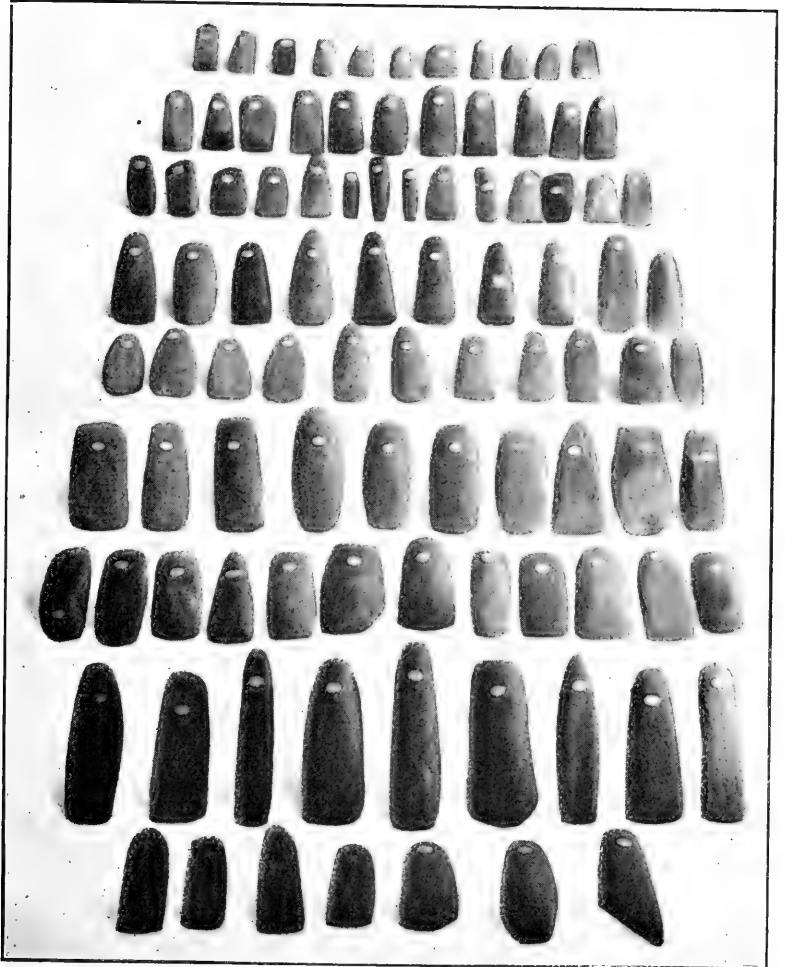

CELTS, GAGES, CHISELS.

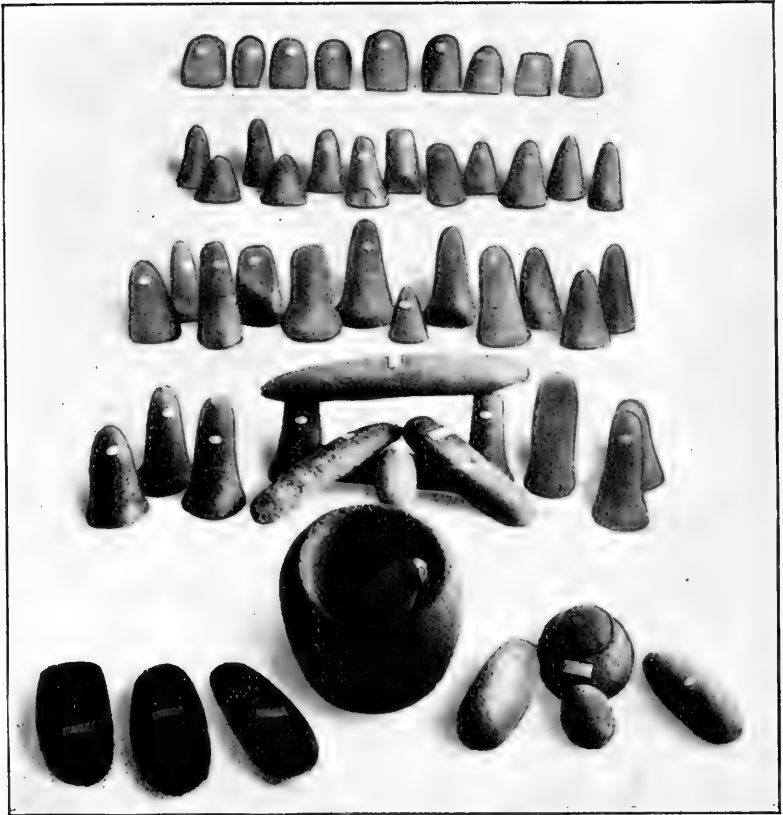

PESTLES, MULLERS, MORTARS.

FREDRICK W. GOTTLIEB.

## FAUNA OF THE BRAZIL LIMESTONE.

BY F. C. GREENE.

Prof. Chas. W. Shannon of Brazil sent to the State University a collection of fossils which he said came from a limestone just below the surface at that place. Later Dr. J. W. Beede of the State University and Mr. L. C. Snider sent in other collections from the same limestone at somewhat different localities in the same vicinity.

The stratigraphic chart in the 33rd annual report of this department shows this limestone as occurring in Division II of the Indiana Coal Measures. In the 23rd annual report of this department, Ashley gives the following sections from this locality:

	Brazil.		Ashley.	
	Sec. 29.		Sec. 31.	
	Ft.	In.	Ft.	In.
Sandstone .....	?	?	?	?
Limestone .....	17	0	11	9
Shale .....	4	0	6	0
COAL, good .....	3	4	1	6
COAL, bone .....	1	2	0	0
Fire-clay .....	?	?	0	0
Shale .....			16	9

In other places in this vicinity, the limestone is only seven feet thick or may be wanting, while the underlying shale varies from 0 to 8 feet in thickness. The limestone is a dark-colored, bituminous stone, having an irregular fracture and the fossils are mainly white or light-colored. It is sometimes overlain by very fossiliferous, dark-colored, calcareous shale from which finely preserved specimens may be washed.

### FAUNA.

1. *Fusulinella* Sp. Probably a new species.
2. *Lophophyllum profundum* M-E and H.
3. *Zeacrinus* sp. (plates).
4. *Eupachyrcrinus tuberculatus* Meek and Worthen.
5. *Eupachyrcrinus* sp. (fewer but larger tubercles).

6. *Archeocidaris* sp. (plates and spines).
7. Worm c. f. *Spirorbis anthracosia* Whitfield.
8. Worm sp. (represented by burrows in the shell of *Productus costatus*).
9. *Fistulipora nodulifera* Meek.
10. *Stenopora spinulosa* Rogers.
11. *Stenopora ohioensis?* Foerste.
12. *Stenopora tuberculata* Prout.
13. *Stenopora* c. f. *cestriensis* Ulrich.
14. *Stenopora* sp. Probably a variety of *S. spinulosa*.
15. *Stenopora* 2 species. Probably undescribed.
16. *Fenestella limbata* Foerste.
17. *Fenestella modesta?* Ulrich (reverse only shown).
18. *Polypora whitei* Ulrich.
19. *Polypora spinulifera* Ulrich.
20. *Polypora* sp. (resembles *P. cestiensis* somewhat but differing from it in having much longer fenestrules).
21. *Pinnatopora* sp. (reverse only shown).
22. *Septopora pinnata* Ulrich.
23. *Septopora biserialis* Swallow.
24. *Rhombopora lepodendoidea* Meek.
25. *Streblotrypa distincta* Ulrich.
26. *Cystodictya carbonaria* Meek.
27. *Cystodictya* sp. (resembles *C. inequimarginata* but has 5-6 rows of zoeecia).
28. *Prismopora sercata* Meek.
29. *Derbya crassa* M and H.
30. *Chonetes mesolobus* N and P.
31. *Productus cora* var. *americana* Swallow.
32. *Productus punctatus* Martin.
33. *Productus costatus* Sowerby.
34. *Productus wabashensis* N and P.
35. *Productus muricatus* N and P.
36. *Productus* sp.
37. *Dielasma bovidens* Morton.
38. *Spiriferina kentuckiensis* Shumard.
39. *Spirifer cameratus* Morton.



40. *Spirifer rockymontanus* Marcou.
41. *Reticularia perplexa* McChesney.
42. *Hustedia mormoni* Marcou.
43. *Seminula argentea* Shepard.
44. *Aviculopecten occidentalis* Shumard.
45. *Aviculopecten hertzeri*? Meek.
46. *Myalina recurvirostris* M and W.
47. *Macrodon carbonarius* Cox.
48. *Schizodus harii* Miller.
49. *Astartella varica*.
50. *Allorisma terminale*? Hall.
51. *Pelecypod* sp.
52. *Cephalopod* sp. (probably *Tainoceras occidentalis* Swallow).
53. *Griffithides scitula* M and W.
54. Fish tooth (fragment).

The Brazil limestone is probably to be correlated with the Fort Scott limestone of Kansas, since a similar fauna has been noted by the writer from this horizon (Henrietta limestone) of Missouri and southeast Iowa.



## PREPARATION OF ETHER.

BY P. N. EVANS.

It is commonly stated that in the preparation of ether by running alcohol into sulphuric acid kept at about 140 deg. Centigrade, while the operation is nominally a continuous one, the acid acting catalytically, the volume of ether obtainable amounts to only about six times that of the acid used before the action is seriously impaired, soon to cease altogether.

Various causes for this limitation have been suggested, including the accumulation of water formed in the main reaction, the formation of sulphuric and sulphonic esters rendering the acid unavailable, and the actual destruction of the acid by reduction to sulphurous acid by the organic compounds present. Little or no experimental evidence is given in support of any of these hypotheses, and the present difference of opinion leaves the question still open.

With the assistance of Miss Lena Sutton the writer is attempting to get more definite information as to the actual limits of the reaction and their cause or causes. At the time of writing the work has not proceeded far enough to provide the solution of the problem, but it has already been learned that instead of the efficient limit being reached when the volume of the ether amounts to about six times that of the acid used there is no diminution of efficiency at about fifty times the volume, when ordinary commercial alcohol and acid are employed. It has been found, too, that the accumulation of water formed in the reaction cannot be the inhibiting factor, for it has been learned that it is practicable to start with highly diluted acid and obtain the usual results, the acid evidently becoming concentrated to the necessary degree by loss of water at the temperature ordinarily employed.

In order to determine the proportions of ether, alcohol and water in the successive distillates, they are submitted to fractional distillation, and the results compared with those from known mixtures in the proportions possible under the conditions of the experiment, assuming the alcohol used to have undergone the reaction with varying degrees of completeness.

It is hoped to obtain further experimental evidence bearing upon the problem during the present academic year.



## THE SURFACE TENSION TEMPERATURE COEFFICIENT.

BY ARTHUR L. FOLEY.

Some fifteen years ago the author described a method of finding the surface tension of liquids by determining with a balance the force required to pull a frame of mica from the liquid.<sup>1</sup> A mica frame, cut in the form

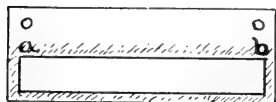

**Fig. 1.**

shown in Fig. 1 is suspended from one arm of a sensitive balance and the lower edge (a-b) of the upper strip of mica is brought into contact with the liquid. The liquid is then gradually lowered while the pointer of the balance is kept at the turning point by adding weights to the other pan. Eventually

the downpull of the liquid and film is exceeded by the weights on the other arm of the balance, the mica frame is pulled suddenly upward, and the film breaks. The frame is then weighed while still in the liquid. The difference between the two weights gives what is called the maximum weight, from which the method takes its name.

The surface tension is given by the equation

$$T = \frac{wg}{2(l-t)} + \frac{d^2t^2g}{4(l-t)} - \frac{ltg}{4(l-t)} \sqrt{d^2l^2t^2 + 4w(l-t)d}. \quad (1)$$

Where T=surface tension in dynes.

w=maximum weight.

l=length of frame (between legs).

t=thickness of frame.

d=density of liquid.

g=acceleration due to gravity.

When the frames are thin one may use the simple equation

$$T = \frac{wg}{2l}. \quad (2)$$

The maximum weight can be determined again and again with surprising uniformity. Even when one uses mica frames differing greatly in

<sup>1</sup> Proceedings of the Indiana Academy of Science, 1895, p. 67.  
Physical Review, Vol. 3, No. 5, 1896, p. 381.

thickness the values of the surface tension calculated by equation (1) are quite concordant. In the article already referred to the author gives results for frames ranging in thickness from .0013 cm. to .02067 cm., the greatest variation being less than six-tenths per cent. Equation (2) gave results with a maximum range of four per cent. the difference being greatest for thick frames. But in practice it is not necessary to use thick frames. In the case of the variation of the surface tension with temperature all the measurements may be made with a single frame. In this experiment the frame was .0102 cm. thick and 6.642 cm. long.

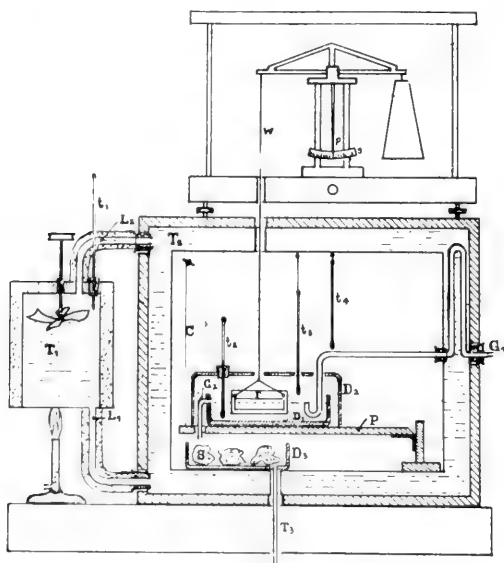

Fig. 2.

Fig. 2 shows the arrangement of the apparatus for measuring the temperature coefficient of the surface tension of water between room temperature and  $80^{\circ}$ . A mica frame  $F$  was hung on a wire  $W$  attached to one arm of a balance—sensitive, at this load, to .002 mg.. The balance itself rested on a wooden box shown in section. This box had a door in front (practically air tight) with a double glass window through which the apparatus inside could be seen and the thermometers read. The wooden box enclosed a double walled tin box or tank  $T_2$  with walls about

eight centimeters apart on all sides except in front of the glass door.  $T_1$  was a copper vessel or tank connected by lead tubes  $L_1$  and  $L_2$  to the tank  $T_2$ . Both tanks were filled with oil. The oil in the tank  $T_1$ , heated by one or more bunsen burners, passed through the tube  $L_2$  into the tank  $T_2$  and finally back through  $L_1$  into  $T_1$ . A stirrer, driven by an electric motor, aided in producing a rapid circulation of the oil. Tank  $T_1$  and tubes  $L_1$  and  $L_2$  were wrapped with several layers of asbestos paper.

From a flask not shown in the figure water was siphoned to and through the tube  $G_1$  into the evaporating dish  $D_1$ . An overflow  $G_2$  served to keep constant the depth of the water in the dish. The excess of water dropped on sponges  $S$  in an evaporating dish  $D_3$ , itself drained by the tube  $T_3$ . The sponges served to keep the space inside the box saturated with watery vapor, or nearly so. An inverted evaporating dish  $D_2$  served to enclose almost completely the frame and liquid and thus insure the saturation of the space about the film on which the measurements were made.

The dish  $D_1$  rested on a wooden platform  $P$  supported at one end by a hinge and at the other end by a cord  $C$  passing over a cylindrical metal rod which extended to the outside of the box. The height of the water surface was slowly raised or lowered by twisting the rod.

A thermometer  $t_1$  gave the temperature of the oil,  $t_2$  the temperature of the water,  $t_3$  the temperature of the space immediately above the water, and  $t_4$  the temperature of the space outside the inverted evaporating dish. No measurements were made when the thermometers  $t_2$ ,  $t_3$ , and  $t_4$  differed by more than a few tenths of a degree. This necessitated a wait of from one to five hours between readings at different temperatures. Three series of readings were taken, each requiring a continuous run of from ten to thirty-six hours—depending upon the number of observations made.

Owing to the condensation on the wire  $W$  where it passed through the opening in the tank  $T_2$  it was not practicable to carry the observations higher than  $80^\circ$ . An effort was made to prevent this condensation by driving gently through the opening a stream of warm air from the outside. But this interfered somewhat with the action of the balance and the saturation of the space inside. It did not occur to the writer at the time to try heating the wire by means of an electric coil.

For temperatures below room temperatures the asbestos was removed from the tank  $T_1$  and the tank was surrounded by a large vessel containing

water and ice, or ice and salt, depending on the temperatures required in the tank  $T_2$ .

The water used in this experiment was first distilled in the usual copper still, then with potassium permanganate in glass, then twice again in glass. Just before using the water was boiled for fifteen minutes to drive off absorbed gases, and then rapidly cooled by placing the flask in ice water. The water was siphoned from the flask through a glass siphon with a cock which permitted the flow to be adjusted at will. Before opening the cock the water in the flask was each time brought to approximately the temperature indicated by the thermometer  $t_1$ . It was then passed through the tube  $G_1$  (which had a length of some fifty centimeters inside the oil) into the dish  $D_1$ . Sometimes the measurements were made with the water in  $D_1$  at rest, sometimes with the water flowing very slowly from the tube, this giving a fresh surface as free as possible from absorbed gases or contamination of any kind.

The author feels sure of all his data except his temperature measurements. The thermometers used were bought for high grade instruments. It was the intention to calibrate them at the conclusion of the experiment. By accident they were placed with some others of the same kind and so could not be identified.

The results obtained in this investigation are given in the following table and are plotted in Fig. 3.

Temperature of the Water—	Tension in Dynes per cm.
1.0°	
1.4.....	.74.95
6.6.....	.74.176
10.7.....	.73.667
16.5.....	.73.087
21.8.....	.72.20
29.2.....	.70.795
37.3.....	.69.32
50.4.....	.67.36
51.0.....	.67.27
61.6.....	.65.50
67.5.....	.64.45
72.6.....	.63.71



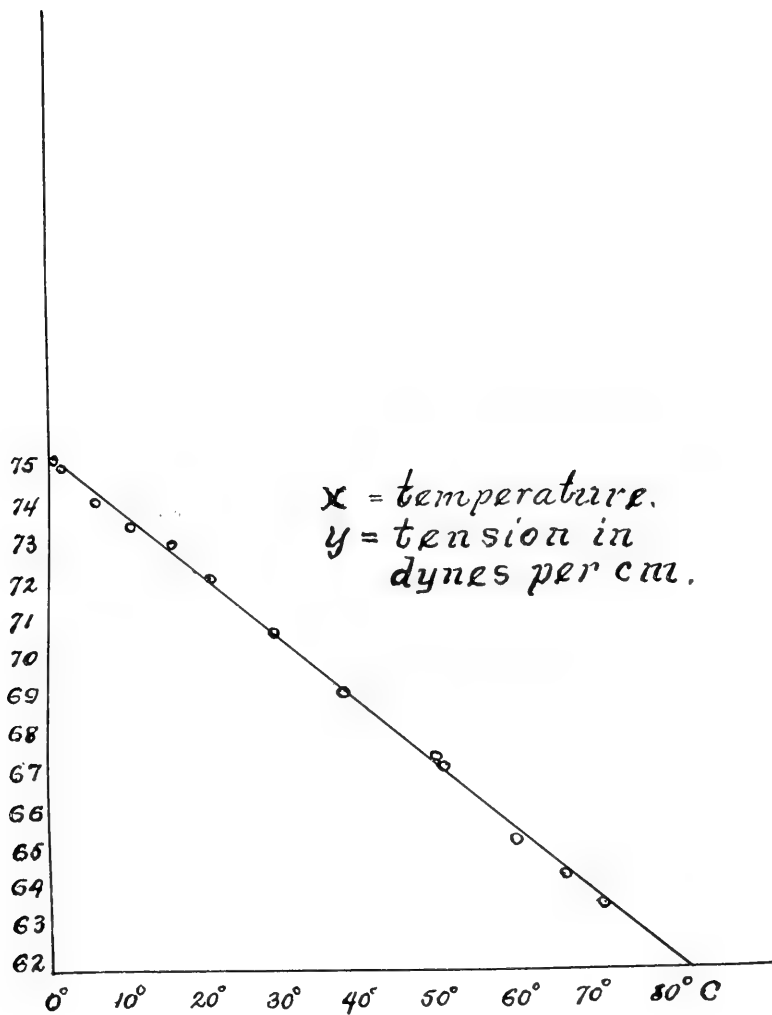

Fig 3.

From the plot one obtains the following values:

Surface tension at  $0^{\circ}$  C.=75.5 dynes per cm.

Surface tension at  $18^{\circ}$  C.=72.6 dynes per cm.

Surface tension of  $80^{\circ}$  C.=62.6 dynes per cm.

Temperature coefficient=.161 dynes per cm.

T. Proctor Hall<sup>2</sup> gives the following values:

Tension at  $0^{\circ}$  C.=75.48 dynes.

Tension at  $18^{\circ}$  C.=72.96 dynes.

Tension at  $80^{\circ}$  C. (calculated)=64.28 dynes.

Temperature coefficient=.14 dynes.

Hall tabulates the results of nineteen different investigations by fourteen investigators giving a mean of all of Tension=75.4 dynes at  $0^{\circ}$  C. and temperature coefficient ranging from .141 dynes to .204 dynes per cm. Hall adopts .14 dynes as the most probable value.

It will be observed that the author's result for the tension at zero temperature agrees with the results obtained by others, but that his values at higher temperatures are considerably lower, giving a much larger temperature coefficient. The differences are entirely too large and too regular to be attributed to experimental errors.

Hall claims that absorbed gases tend to raise the surface tension of water and to increase the temperature coefficient. He claims also that the surface tensions of different samples of water are not the same. The author rather inclines to the view that the smaller values obtained at higher temperatures in this investigation are due to the fact that the measurements were made on water in contact with air saturated with watery vapor, while the conditions under which most of the other investigations have been made give the tension of water in contact with moist air, but not saturated air. Perhaps the actual temperature of the film under such conditions is not given correctly by a thermometer placed in the liquid. Evaporation into the air lowers the temperature of the surface film—possibly considerably below the temperature of the body of the liquid. Whatever the actual magnitude of this effect may be, it tends always to give too high values for the surface tension at high temperatures—the drier the air the higher the values.

<sup>2</sup> New method of measuring surface tension. *Philosophical Magazine*, November, 1893, Vol. 36, p. 412.

## OBJECTIONS TO LAPLACE'S THEORY OF SURFACE TENSION.

(Abstract.)

---

BY ARTHUR L. FOLEY.

---

Laplace's Theory of surface tension attributes the contractile force of liquid films to the attraction of the molecules immediately below the surface of the liquid for those on the surface, producing a tendency for the surface molecules to move into the interior. The magnitude of this force would depend on the curvature of the surface and would be greater at a convex surface than at a flat or concave surface. Consequently the rise of water in a capillary tube would be due to the fact that the downward pressure of the film outside the tube is greater than the downward pressure of the film inside the tube.

This theory does not call for a negative pressure under the film inside the tube. It calls for a positive pressure, but slightly less than the downward pressure outside. The liquid then would be *forced up the tube by the outside film pressure*. It would appear then that any variation of the pressure either inside or outside the tube should be followed by a change in the height of the capillary column. Some simple experiments give results that are at variance with the theory.

Take a long capillary tube with its lower end extending some distance into the water and note the height of the capillary column. Drop some soap solution on the water outside the tube and thus lower the tension outside. If the liquid is supported by the excess of pressure outside the tube, the height of the capillary column should be lessened. On the contrary the height remains constant for some time—hours even—until the solution has had time to diffuse into the tube.

Repeat the experiment this time introducing the soap solution into the capillary tube by means of a very fine capillary tube. The tension inside the tube being reduced (demanding a reduced pressure inside) and the outer pressure remaining constant, it would seem that the excess of the outside pressure would be increased and that the water should therefore rise in the capillary. Instead of rising it immediately falls.



## THE VARIATION IN THE RATIO OF THE SPECIFIC HEATS OF A GAS AT THE TEMPERATURE OF LIQUID AIR.

BY C. M. SMITH.

INTRODUCTION.—The value of the ratio of the specific heat of a gas at constant pressure, to the specific heat at constant volume,  $k = \frac{C_p}{C_v}$ , has occupied the attention of physicists since the time of Newton. It was well understood by him that the values for the velocity of sound in a gas as calculated from his formula  $V = \sqrt{\frac{\text{elasticity}}{\text{density}}}$ , were not in accord with observed values, and being impressed by this discordance he was moved to make certain violent assumptions concerning the relative magnitudes of the gas molecules and the inter-molecular spaces, together with the relative velocities of sound in each. The true explanation of the discordance was first suggested by LaGrange, who pointed out that the elasticity of a gas might be augmented faster than its density, under compression, although it remained for LaPlace, in 1816, to develop the complete theory, and elucidate the necessity for regarding the adiabatic changes in volume, the modified equation being  $V = \sqrt{\frac{\text{elasticity}}{\text{density}}} \times k$ , where  $k$  is the ratio of the adiabatic and isothermal elasticities, likewise the ratio of the specific heats. Since that time more than a score of investigators have occupied themselves with the determination of the value of  $k^1$ , under the various conditions of temperature and pressure, and the importance attached to the determination of  $k$  will be apparent from the following considerations.

With a value of  $k$  assumed as known, its use in Newton's equation is convenient for studying various physical constants of a gas, and in small quantities of the gas, values of the velocity of sound and specific heats may be determined or compared. Furthermore a knowledge of the

<sup>1</sup> For an exhaustive review of the history of the problem, see Maneuvrier, *Jour. de Physique*, 4, 1895.

value of  $k$  is important because of its entrance into several of the fundamental equations of thermodynamics, and also because it furnishes an excellent criterion for the correctness of the assumptions made in the kinetic gas theory, concerning the distribution of the energy within the molecule. In view of these intimate correlations of the value of  $k$  with other fundamental factors it is important to study its variation under different conditions of pressure and temperature for the same gas.

For constant pressure Wüllner<sup>2</sup> found practically a constant value of  $k$  between 0° and 100° C., for air. Witkowski<sup>3</sup> has found evidence of a variation in  $k$  with both temperature and pressure, from theoretical considerations. Ludue<sup>4</sup> shows that  $k$  should decrease with rising temperature and with falling pressure. Stevens<sup>5</sup> finds a value of 1.34 for  $k$  at 1000°, and Kalähne<sup>6</sup> shows that  $k$  decreases with rising temperature, reaching a value 1.39 for 900°. S. R. Cook,<sup>7</sup> working with liquid air temperatures, finds the value of  $k$  for air to be 1.35 (nearly), and Valentiner<sup>8</sup> in an exhaustive study of the dependence of  $k$  in nitrogen upon pressure, at liquid air temperatures, finds the value of  $k$  to increase, approximately in proportion to the ratio of the pressure to the saturation pressure for the temperature used.

In this connection it was suggested to the writer by Professor Röntgen, that a study of the value of  $k$  should be undertaken for constant pressure and liquid air temperature, and under his direction the present work was carried out during the winter and spring semesters of 1901, in the Physical Institute at Munich. Two series of observations were carried through:

I. For constant pressure, the ratio of values of  $k$  for the temperatures of melting ice and boiling water was determined, the gas used being air, free from moisture and CO<sub>2</sub>. Values under these conditions had been determined by Wüllner (*loc. cit.*), and were here repeated as a means of checking the method.

II. For constant pressure, the same ratio was determined over a range of temperature from that of the room, about 20° C., to that

---

<sup>2</sup> Ann. der Physik 4, 1878.

<sup>3</sup> Sci. Abs. 3, 1900, p. 387.

<sup>4</sup> Sci. Abs. 3, 1900, p. 29.

<sup>5</sup> Sci. Abs. 4, 1901, p. 847.

<sup>6</sup> Ann. der Physik 11, 1903, p. 225.

<sup>7</sup> Phys. Rev. 23, 1906, p. 232.

<sup>8</sup> Ann. der Physik 15, 1904.

of liquid air, boiling freely under atmospheric pressure, about  $-190^{\circ}$  C., the gas in this series being pure nitrogen.

Values were calculated for both series using the simple relations given in equation (6), and for series I the results were in close agreement with those of Wüllner. The assumption that Gay Lussac's law holds for nitrogen at low temperatures was however regarded as questionable, and results for series II were not at that time published. Subsequently the density-pressure relation for low temperatures was investigated for nitrogen by Bestelmeyer and Valentiner<sup>9</sup> in the Institute at Munich, and resulted in the establishment of the following empirical relation between pressure volume and temperature:—

$pv = h_1T - (h_2 - h_3T)p$ , where  $T$  is the absolute temperature,  $p$  is the pressure, and  $v$  is the specific volume, the constants having values  $h_1 = 0.27774$ ,  $h_2 = 0.03202$ , and  $h_3 = 0.00253$ . This relation introduced into the general equations gives (13). Making use of (13) the data of series II have been recomputed, and the results are given in table IV.

Subsequent to the experimental work of I and II, Valentiner<sup>10</sup> has made use of the same apparatus used by the writer, with certain modifications and improvements, for investigating the dependence of  $k$  upon pressure, for nitrogen, at liquid air temperatures.

THEORY.—The method used was that of Kundt's dust figures. Two glass tubes, maintained at different temperatures, had set up in them systems of standing waves by means of the longitudinal vibrations of the same glass rod. The frequency of the waves was the same within both tubes, and from measurements of the wave lengths, as shown by the dust figures, the variations in  $k$  could be determined.

The velocity of sound in any homogeneous medium is given by the equation

$$V^2 = -v^2 \frac{\partial p}{\partial v} = 4n^2 l^2. \quad (1)$$

where  $v$  is the specific volume, and  $p$  is the pressure, the negative sign meaning that a decrease in pressure corresponds to an increase in specific volume. It must be remembered that the standing wave in the tube has a wave length half as great as that for the progressive wave of the same

<sup>9</sup> Ann. der Physik, 15, p. 61.

<sup>10</sup> Ann. der Physik, 15, p. 74.

frequency, and throughout  $\lambda$  will be used to mean the inter-nodal distance for the systems of standing waves. For a perfect gas the adiabatic equation ( $pv^k = \text{constant}$ ) must be used, whence

$$\frac{\partial p}{\partial v} = -\frac{pk}{v}. \quad (2)$$

Substituting this value in (1)

$$V^2 = \frac{v^2 pk}{v} = kpv = 4n^2 \lambda^2. \quad (3)$$

Let equation (3) refer to the tube B, Fig. 1, in series I, which contains air, and is at  $0^\circ \text{C.}$ , and let a similar equation with subscripts apply to the tube A in the steam bath.

$$V^2_1 = k_1 p_1 v_1 = 4n^2_1 \lambda^2_1. \quad (4)$$

Dividing (4) by (3) and solving for the ratio  $\frac{k_1}{k}$ ,

$$\frac{k_1}{k} = \frac{\lambda^2_1 v}{\lambda^2 v_1}. \quad (5)$$

From Gay Lussac's law specific volumes are directly proportional to absolute temperatures, whence

$$\frac{k_1}{k} = \frac{\lambda^2_1 T}{\lambda^2 T_1}. \quad (6)$$

From (6) the results given in table I are calculated.

For series II however, using nitrogen at liquid air temperature, the  $p$ - $v$ - $T$  relation to *Bestelmeyer and Valentine* was used,

$$pv = 0.27774 T - (0.03202 - 0.000253 T)p \quad (7)$$

Substituting in the fundamental equation

$$\left(\frac{\partial p}{\partial v}\right)_Q = k \left(\frac{\partial p}{\partial v}\right)_T \quad (8)$$

the value of  $\frac{\partial p}{\partial v}$  for constant temperature, as determined by differentiating (7),

$$\left(\frac{\partial p}{\partial v}\right)_Q = \frac{k p}{v + (h_2 - h_3 T)} \quad (9)$$

and substituting this in (1).



$$V^2 = \frac{v^2 k p}{v + (h_2 - h_3 T)} = \frac{k p^2 v^2}{h_1 T} = 4 n^2 \lambda^2 \quad (10)$$

Writing equation (10) with subscripts referring to the tube B Fig. 1, as used in series II with nitrogen, at a temperature of liquid air,

$$\frac{k_1 p_1^2 v_1^2}{h_1 T_1} = 4 n_1^2 \lambda_1^2 \quad (11)$$

Dividing (11) by (3),

$$\frac{k_1 p_1^2 v_1^2}{k p v} = \frac{4 n_1^2 \lambda_1 h_1 T_1}{4 n^2 \lambda^2} \text{ whence } \frac{k_1}{k} = \frac{p v h_1 T_1 \lambda_1^2}{p_1^2 v_1^2 \lambda^2} \quad (12)$$

For normal conditions  $p v = 76 (1 + a t)$ , whence

$$\frac{k_1}{k} = \frac{\lambda_1^2}{\lambda^2} 76 (1 + a t) \frac{h_1 T_1}{p_1^2 v_1^2} \quad (13)$$

The product  $p_1^2 v_1^2$ , referring as it does to nitrogen at liquid air temperature, must be computed from the empirical equation (7). Equation (13) is used for the calculation of results for series II, given in table IV.

DESCRIPTION OF APPARATUS AND METHOD.—A general view of the apparatus as mounted for use is shown in Fig. 1, the essential features of which are shown in Fig. 2. Two glass tubes, A and B, Fig. 2, about 3.2 cm. in diameter, were bent at right angles, about 30 cm. from the ends, the horizontal portions being about 80 cm. long. These were mounted on a rectangular frame of wood, a a a. This frame was hung with its plane vertical, and was capable of rotation about a pivot at the point O. The entire structure could be tilted forward slightly about an axis XX'. A glass rod e f g, 100 cm. long, with enlarged ends, was clamped at points  $\frac{1}{4}$  and  $\frac{3}{4}$  of its length from its ends, the supports for the rod at these points being of rubber, and serving at the same time to close the ends of the tubes. Through these rubber stoppers were passed small delivery tubes, for introducing the gas used. Adjustable pistons were inserted through similar rubber stoppers at c and d. The upper tube was surrounded by a double walled vessel made of tinned copper, and covered with a layer of heavy felt. This vessel had a closely fitting double cover, provided with mica windows through which the thermometers were read. It was also provided with inlet, outlet and drainage tubes, so that steam could be passed in and the temperature of boiling water indefinitely maintained about the enclosed tube A. A long trough was made of such dimensions that it could be raised up about the lower tube B, and when filled with

melting ice the temperature of B could be held at  $0^{\circ}$  throughout the necessary time interval. For the series II, a trough of special design to contain liquid air was used. This was made of three layers of thin sheet tin, with

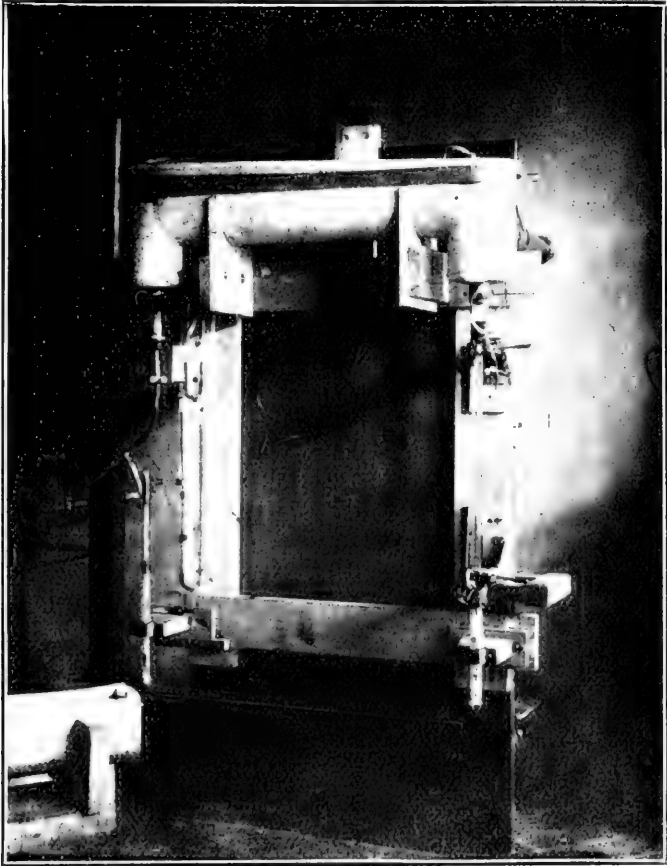

Fig. 1.

a U shaped cross section, nested together with thick layers of felt between. This is shown in the lower part of Fig. 1.

A small quantity of anhydrous quartz powder was placed in the tubes A and B, and uniformly distributed in a thin line along the bottom of the tubes by rocking the frame about O, and gently tapping the tubes with a

pencil. After this linear distribution of the powder the entire structure was tilted forward slightly about  $XX'$ , and the line of the powder was made to seek the lowest part of the tubes by gentle tapping. On tilting the frame back to its vertical position, the line of powder was raised slightly along the side of the tubes, and when the glass rod  $e f g$  was rubbed at its middle point with a piece of moistened flannel, its longitudinal vibration was communicated to the gas in both tubes, setting up systems of

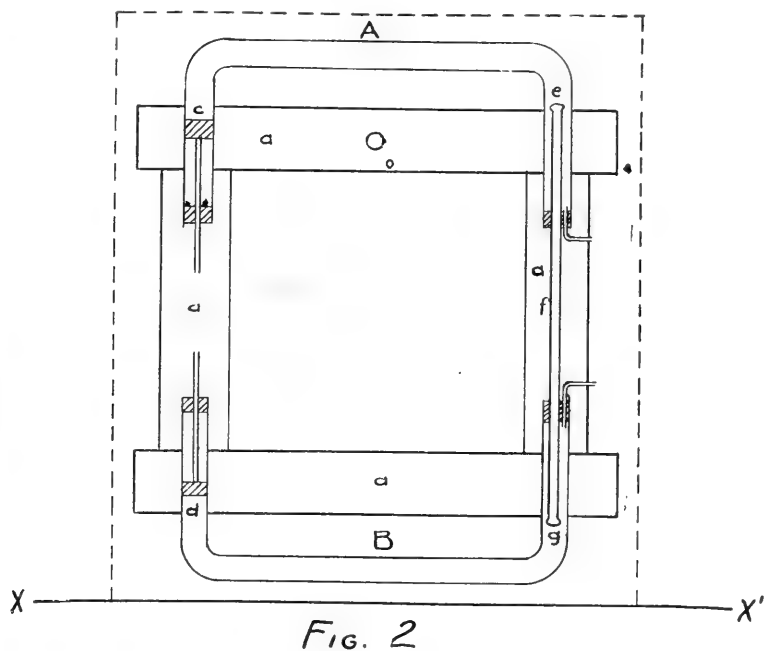

FIG. 2

stationary waves, and causing the powder to fall down at the points of maximum disturbance as shown in Fig. 3. These festoon like figures were sharp and uniform, and capable of accurate measurement, the inter-nodal distances giving the wave lengths of the standing waves within the tubes. Each of the tubes carried near the ends of the horizontal portions, a pair of felt covered brass rings. To the under side of these rings could be quickly attached by means of set screws, the brass meter scale for measuring the figures. A sliding sleeve which could be slipped over the tube was provided with a vernier reading to one-tenth mm., which played over the

brass scale beneath, and on the sleeve was a fiducial line, in the form of a fine black wire. Three independent settings were made on each nodal point, the mean being taken as the position of the node. Since the figures were formed at temperatures different from those at which they were measured, the corresponding corrections for the expansion and contraction of the glass tubes were applied.



Fig. 3.

From such a series of measured inter-nodal distances the most probable value of the wave length was calculated from the formula,

$$\frac{(n-1)(a_1 - a_1) + (n-3)(a_{n-1} - a_2) + \dots}{n(n^2 - 1)}$$

1. 2. 3

where  $n$  is the number of settings, and  $a_1, a_2, a_3$  are the respective settings.

The writer is indebted to Mr. P. P. Koch for a complete calibration of the brass scale used, in terms of the standard meter bar belonging to the Institute. Corresponding corrections have been computed and applied to all the measurements of both series.

PROCEDURE, SERIES I.—For this series of measurements the tube A was kept at steam temperature, while the tube B was packed in melting ice. The tubes were first carefully cleaned, washed with acid and alkali solutions, rinsed and dried, then mounted in place as in Fig. 2. Dry air free from CO<sub>2</sub> was drawn through them for some time, meanwhile gently warming them with bunsen burners. A small amount of the quartz powder, previously heated and cooled in a dessicator, was introduced, and the dry air suction continued for some time. The apparatus was then rocked and tilted as described above in order to effect a proper distribution of the powder, steam was admitted about A and the ice bath placed about B. After a period ranging from one to two hours, with both tubes open to the atmosphere through the drying train, the glass rod was rubbed, the temperatures and atmospheric pressure were observed and the steam and ice baths were withdrawn. After some hours the figures were measured in the manner above described. The thermometers used were frequently compared with standards, and the temperature in the steam jacket was constantly checked from standard barometer readings. One complete set of average wave length measurements is given in table I, and the data for eight such experiments, together with calculated values of  $\frac{k_0}{k_{100}}$  are given in table II.

<i>Tube A, in Steam.</i>		<i>Tube B, in Melting Ice.</i>	
	$\lambda$		$\lambda$
55.43	38.07	63.73	32.74
93.50	38.63	96.47	32.76
132.13	38.24	129.23	32.80
170.37	38.43	162.03	32.47
208.80	38.00	194.50	33.10
246.80	38.33	227.60	33.20
285.13	38.34	260.80	32.97
323.47	38.13	293.77	32.26
361.60	38.35	326.03	32.94
399.95	38.22	358.97	32.66
438.17	38.06	391.63	32.30
476.23	38.10	424.93	32.94
514.33	38.77	457.87	32.63
553.10	38.10	490.50	32.60
591.20		523.10	32.90
		556.00	33.17
		589.17	
Most probable value of $\lambda = 38.262 \text{ mm. } \pm 0.01,$ $e = 0.225 \text{ mm.}$		Most probable value of $\lambda = 32.838 \text{ mm. } \pm 0.01,$ $e = 0.279.$	

Table I.

From the mean value of  $\lambda$  from table II, it would appear that the value does not vary from unity by more than one-tenth of one per cent. An unfavorable combination of errors could affect the single values by three-tenths of one per cent.

<i>Tube A, in Steam.</i>				<i>Tube B, in Ice Bath.</i>			
Exp.	$\lambda$ meas.	$\lambda$ cor.	T. abs.	$\lambda$ meas.	$\lambda$ cor.	T. abs.	$\frac{k_0}{k_{100}}$
1	38.287	38.325	370.80	32.862	32.867	272.5	1.000758
2	38.262	38.299	370.76	32.838	32.842		1.000485
3	38.303	38.339	371.12	32.860	32.864		1.000707
4	38.234	38.271	370.49	32.846	32.851		1.001770
5	38.252	38.288	370.67	32.843	32.848		1.001180
6	38.275	38.312	370.87	32.807	32.811		0.998216
7	38.231	38.268	370.84	32.863	32.869		1.003972
8	38.291	38.328	370.91	32.865	32.869		1.001020
							mean 1.001013 $\pm 0.000376$

Table 2.

Procedure, Series II. For the second series of measurements the procedure was substantially the same as that for the first. Carefully dried and purified nitrogen was introduced into the tubes. The upper tube surrounded by cotton and enclosed in the double walled jacket, was allowed to assume the temperature of the room, its thermometer being read through the mica windows. The lower tube, 2.2 cm. in diameter, was immersed in the liquid air bath, the top of the tube being 2 or 3 cm. below the surface. Temperatures of the liquid air were read by means of a constantan-iron thermo-junction and a sensitive millivoltmeter, which was provided with a calibration curve from the Reichsanstalt. These temperatures were checked by evaporating samples of the liquid air, mixing with hydrogen and exploding by means of an electric spark in a eudiometer tube. From percentages of oxygen thus found temperatures were interpolated from Baly's curves.<sup>11</sup>

<sup>11</sup> Phil. Mag. 49, June 1899.

<i>Tube A, at Room Temp.</i>		<i>Tube B, in Liquid Air.</i>	
	$\lambda$		$\lambda$
44.88	34.30	179.12	
79.38	33.89	196.75	17.63
113.07	34.83	215.03	18.28
147.90	34.55	233.33	18.30
182.45	34.70	251.37	18.04
217.15	34.72	270.20	18.83
251.87	34.35	288.27	18.07
286.22	33.63	306.15	17.88
319.85	34.72	324.37	18.22
354.57	35.03	342.60	18.23
389.60	34.10	360.18	17.58
423.70	33.45	378.80	18.62
457.15	35.02	396.72	17.92
492.17	34.30	415.43	18.71
526.47	34.95	433.32	17.89
561.42		451.18	17.86
		469.55	18.37
		487.75	18.20
		505.75	18.00
		524.03	18.28
		541.97	17.94
		559.82	17.85
		587.15	18.35

Most probable value of  
 $\bar{\lambda} = 34.421 \pm 0.016,$   
 $e = 0.44.$

Most probable value of  
 $\bar{\lambda} = 18.152 \pm 0.007,$   
 $e = 0.32.$

Table 3.

<i>Tube A, in Liquid Air.</i>					<i>Tube B, in Room Temp.</i>				
Exp.	Vm.	T. abs.	$\bar{\lambda}$ meas.	$\bar{\lambda}$ cor.	T. abs.	$\bar{\lambda}$ meas.	$\bar{\lambda}$ cor.	p.	$\frac{k_1}{k}$
1	7.21	83.46	18.152	18.133	293.59	34.421	34.433	72.55	1.0477
2	7.23	82.85	18.096	18.076	294.84	34.502	34.514	72.4	1.0498
3	7.285	81.18	17.938	17.917	295.24	34.555	34.572	72.1	1.0553
4	7.225	83.00	18.011	17.994	296.84	34.704	34.706	72.0	1.0336
5	7.200	83.76	18.195	18.176	296.04	34.593	34.606	72.0	1.0464
6	7.200	83.76	18.237	18.118	296.64	34.608	34.623	72.5	1.0523
									mean 1.0475 $\pm 0.002$

Table 4.

About five liters of liquid air were required for an experiment. The tube was left in the bath for about one hour before the glass rod was sounded. Corrections were applied for scale errors and for the expansion of the tube prior to measurement. The coefficient of expansion<sup>12</sup> for glass at liquid air temperature was taken as 0.0000073.

One complete set of average wave length measurements for an experiment is given in table III, and the assembled data together with the calculated values of  $\frac{k_1}{k}$  are given in table IV. The subscripts relate to liquid air temperatures. All temperatures are referred to  $-273^{\circ}.04$  as the absolute zero<sup>13</sup>.

Any change in  $T$  will alter  $\frac{k_1}{k}$  inversely in about the same ratio. Temperatures were probably accurate to one-fifth of one per cent. An unfavorable combination of errors might invest  $\frac{k_1}{k}$  with an error of one-half of one per cent.

From the results in table IV it would appear that  $k$  for liquid air temperature is something more than four per cent greater than for ordinary temperatures, about  $22^{\circ}$  C.

<sup>12</sup> Phil. Mag. 49, June, 1899.

<sup>13</sup> Ann. der Physik 9, p. 1149.

*Purdue University, Dec., 1910.*



INVESTIGATION CONCERNING THE REICHERT-MEISSEL NO. AND  
THE RATE OF DISTILLATION OF THE VOLATILE  
ACIDS IN BUTTER FAT.

BY GEORGE SPITZER.

In 1906 J. Delaite and J. Legrand (Bul. Soc. Chim. Belg.) investigated the determination of the volatile acid. He found the R. M. No. to increase when saponification was continued from one-fourth to six hours. This they claimed was due to depolymerization.

In the regular work of the laboratory no such variation was observed in the routine work of determining the volatile acids. The time of saponification varied from one to one and one-half hours.

To determine the effect of continuing the saponification on the per cent. of volatile acids obtained by the Reichert-Meissl process, 10 determinations were made using the same butter fat and following the A. O. A. C. method. (p. 189, 1908), the saponification being carried out under method (a), under pressure with an alcoholic solution of potassium hydrate. The saponification flasks were completely submerged in a steam bath at a temperature of 105° C. This was done to insure a more uniform temperature during the time of saponification.

The time of saponification varied from 15 minutes to two and one-half hours. The quantity of butter fat taken was as near five grams as could be weighed accurately. The result calculated on the basis of five grams.

In distilling the volatile acids the conditions were kept as uniform as it was practical, the rate of distillation being so regulated that 110 c.c., the required amount was distilled in 30 minutes.

Ten determinations were made. The results are shown in the following table.

TABLE I.  
*Showing the Effect of Time of Saponification.*

Time in minutes.....	15	30	45	60	75	90	105	120	135	150
Reichert-Meissl No.....	28.32	28.25	28.35	28.29	28.29	28.28	28.35	28.32	28.28	28.31
Per cent. Vol. Acid as Butyric.....	4.93	4.97	4.99	4.98	4.98	4.67	4.99	4.98	4.97	4.98

Some allowance must be made in the time factor, slight saponification taking place before placing in the steam bath, also during the time of cooling after removing the flasks. But it will be observed that this factor was uniform for the 10 determinations.

From the figures in Table I. no such variations are indicated as reported.

Some of the factors which influence the Reichert-Meissl No.

Rate of distillation.

Failure to remove alcohol (when used).

Size of distilling flask.

Absorption of carbonic acid and quantity of fat taken.

All those factors are under the control of the operator and constant results are obtained by observing uniform conditions.

*The rate of distillation of the volatile acid by the Reichert-Meissl process, also the rate of distillation of the volatile acids by distillation with steam.*

In determining the rate of distillation of the volatile acids by the Reichert-Meissl process, the distillate was collected in fractions of 10 c.c. and titrated with  $\frac{N}{10}$  NaOH.

The number of cubic centimeters of  $\frac{N}{10}$  alkali required to neutralize each fraction are tabulated in Table II, also the per cent. acid calculated as butyric acid based on five grams of butter fat taken.

TABLE II.  
*Showing Rate of Distillation by the R. M. Process.*

No.	1.	2.	3.	4.	5.	6.	7.	8.	9.	10.	11.	Total
C. C. $\frac{N}{10}$ -NaOH.....	4.6	4.2	3.8	3.4	3.	2.6	2.2	1.9	1.5	1.3	1.0	29.50
Per cent. vol. acid as butyric....	.81	.74	.67	.60	.53	.45	.38	.35	.26	.23	.17	5.19

From Table II it will be seen that the first fraction of 10 c.c. of the distillate contains 15.6 per cent. of the total volatile acid, uniformly decreasing to the 11th fraction, which contains only three per cent. of the total volatile acid.

Plotting the above results, the volume distilled as abscissa and the number of c.c. of  $\frac{N}{10}$  alkali used to neutralize the distillate, we obtain the following graphical representation of the R. M. process of distillation.

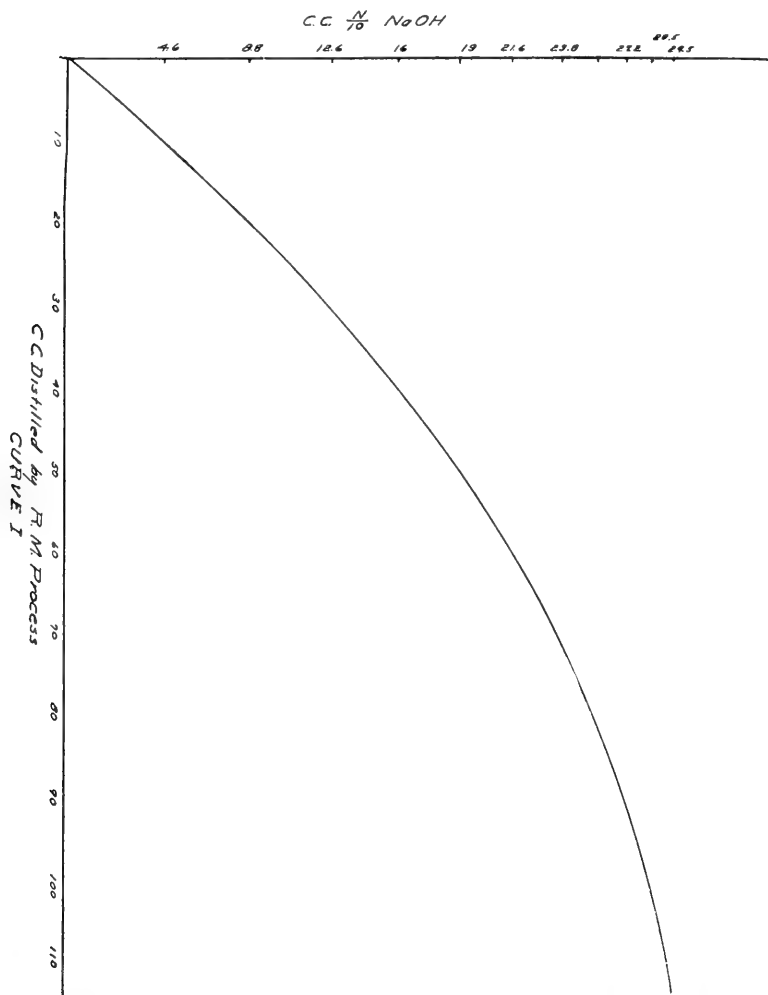

The total number of c.c. required to neutralize the volatile acid was 29.5 c.c. corresponding to 5.19 per cent. of acid calculated as butyric acid.

By the Reichert-Meissl process, we obtain only a certain fraction of the total volatile acids and which is fairly constant if carried out under standard methods.

To determine the relation of the volatile acids obtained from the R.-M. process of distillation to the total volatile acids, distillation was made with steam. By this means it is possible to estimate the total volatile acids. The usual method of saponification and precautions were taken as in the R.-M. process.

One thousand c.c. were distilled with steam and an alignment portion titrated which gave a total of 6.03 per cent. volatile acid as butyric acid. In the R. M. process, 5.19 per cent. of acid was obtained from the same butter fat. Thus we see that only 86 per cent. of the total per cent. of volatile acids were obtained by the R. M. process.

*The Rate at which the Volatile Acids Distill by Means of Steam.*

The same method was used as in the previous experiment in determining the total volatile acids. The distillation was collected in portions of 50 c.c. and titrated with  $\frac{N}{10}$  NaOH. Twenty fractions were titrated and the result shown in Table II.

TABLE III.

No.....	1.	2.	3.	4.	5.	6.	7.	8.	9.	10.	11.
C. C. $\frac{N}{10}$ -NaOH.....	12.7	8.48	5.53	3.66	2.4	1.52	1.00	.70	.60	.45	.30
Per cent. vol. acid as butyric.....	2.03	1.36	.89	.59	.39	.25	.16	.11	.08	.06	.047
<hr/>											
No.....	12.	13.	14.	15.	16.	17.	18.	19.	20.	Total	
C. C. $\frac{N}{10}$ -NaOH.....	.30	.25	.20	.20	.18	.15	.14	.13	.10	38.74	
Percent. vol. acid as butyric.....	.047	.04	.03	.03	.028	.023	.022	.021	.017	6.22	

The weight of butter fat taken for the experiment as shown in Table II was 5.50 grams. The per cent. of volatile acid and distillate is based on five grams of fat.

From Table II it is seen that the first fractions contained the greater part of the volatile acids, decreasing rapidly after the second fraction, and that the volatile acids are practically all distilled when 1000 c.c. have been collected.

Plotting the c.c. distilled as abscissa and the c.c. of  $\frac{N}{10}$  alkali required to neutralize the distillate as ordinates, we get a curve quite different from the one obtained by the Reichert-Meissl process.

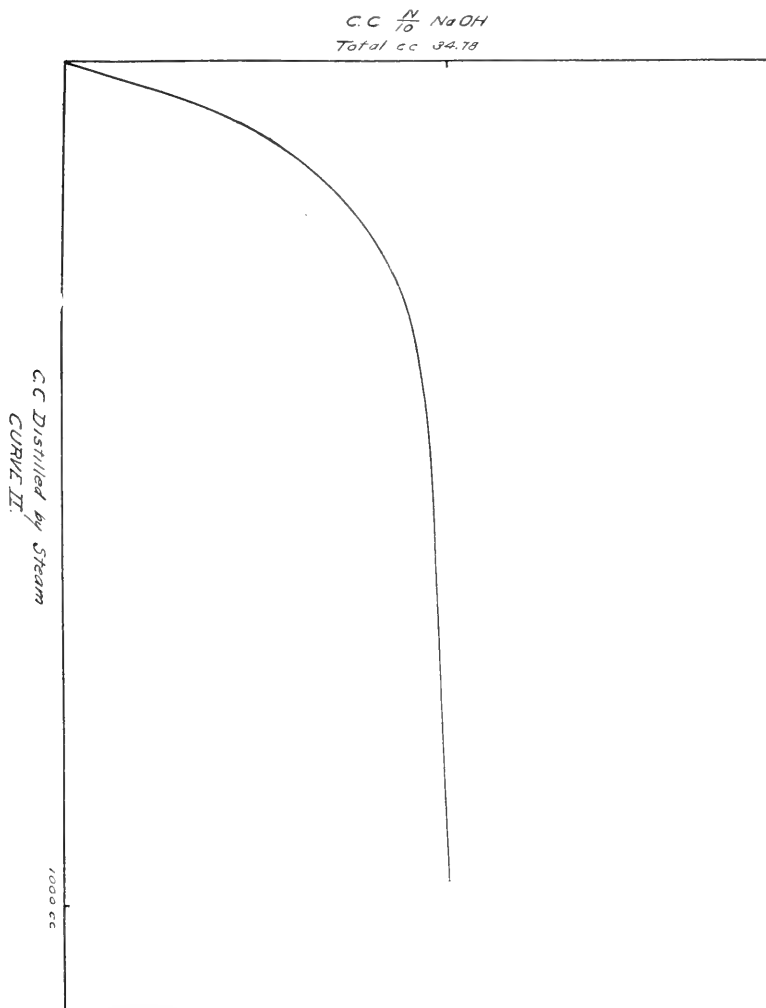

In distillation by the R.-M. process and distillation with steam, we meet with different conditions.

In neither case is the vapor saturated with the volatile acids of butter fat during the period of distillation and the liquids in the still are made up of water and the insoluble fatty acids.

The vapor pressures of the volatile acids differ and their solubility in water and fatty acids influence the water of distillation.

Of two acids having approximately the same vapor pressure, the one which is least soluble in the mixed liquid will distill the faster.

Combining the factors, solubility in water and in the fatty acids, a mathematical expression for the rate of distillation becomes only approximately true.

Theoretically,<sup>1</sup> if we do not keep the volume constant as is the case in the R.-M. process of distillation, that is by making no addition to the liquid in the still during distillation,

The equation is  $\frac{dy}{dx} = a \frac{y}{x}$  and integrating we get

$$\text{Log } y = a \text{ Log } x + c \text{ or } y = x^a.$$

y equals amount of volatile acids left in solution and x amount of liquid left in still, the original amount being taken as 1.

On the other hand, if the volume is kept constant as is the case in steam distillation x becomes constant.

In this case we consider the quantity of water removed to the quantity of volatile acids left in the still.

We then write equation  $-\frac{dy}{dx} = ay$ . Integrating we get the equation

$$-\text{Log } y = ax + c, \text{ or } y = \frac{1}{ax}.$$

y = amount of volatile acids left in solution, original amount being taken as 1; x = amount of water and volatile acids distilled.

The above equations do not take into account the condensation in the still.

<sup>1</sup> H. D. Richmond, Analyst, 1908.

S. Young, fractional distillation.

## A CONVENIENT LABORATORY DEVICE.

BY J. P. NAYLOR.

For the last year we have been using a little device at Minshall Laboratory that has proven serviceable in so many ways that it is thought that it might be of sufficient interest to other members of the physics Section to merit bringing it before you. Used in connection with the "Universal Supports," now so common in physical laboratories, the piece is so contrived as to be adapted to a large number of experimental purposes.

The apparatus consists of a four and one-half inch circle divided to half degrees, and supported by a hollow spindle or axle. The spindle is carried by a sleeve, about three inches long, having at one end a strong crossbar. This crossbar is fitted at one end with a vernier reading on the divided circle to three minutes of arc and at the other end with a slow motion screw and clamp arranged to act upon the circle. The hole through the spindle will take a ten millimeter rod which can be clamped, by means of a screw, at any desired point. To this rod are attached the various pieces that make it possible to use the device in so many different ways. In fact, it is in the hollow spindle that the adaptability and general usefulness of the apparatus lies.

Perhaps merely mentioning a few of the purposes for which it can be used will best suggest its adaptability in laboratory or investigation work. It can be used for measuring the torsion of wires by twisting, for the torsion head of an electro-dynamometer, for measuring the indices of refraction of plane parallel plates, for measuring the angles of prisms, for making up a Kohlrusch total-reflectometer, for measuring the indices of liquids by Wallaston's method, for arranging a Wallaston's goniometer, for making up a simple polariscope or sacharimeter, as a support for measuring the angular aperture of a microscope objective or photograph lens, and for many other purposes. In fact, the apparatus can be used in a large majority of cases where the measurement of an angle is an essential part of the work. The figure shows the use of the apparatus in making up a Kohlrusch total-reflectometer.

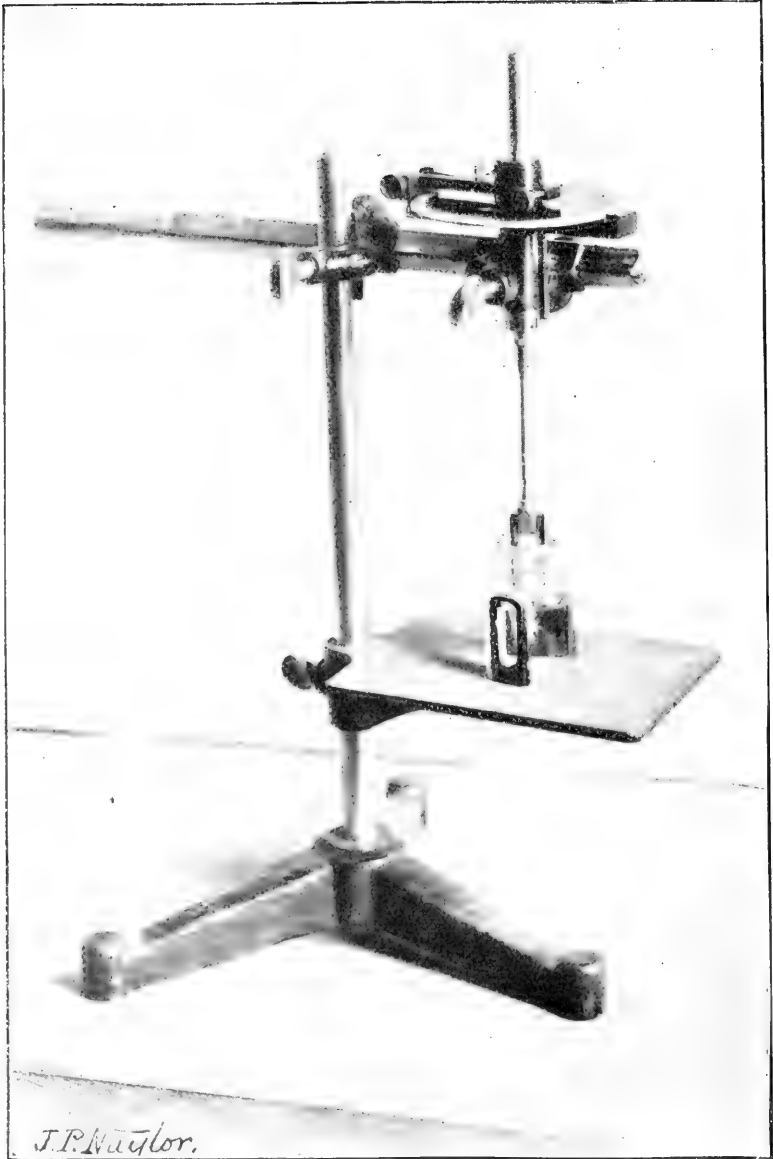

*J.P. Naylor.*



## FURTHER NOTES ON TIMOTHY RUST.

---

BY A. G. JOHNSON.

---

At the last two annual meetings of the Academy, papers on timothy rust, [*Puccinia puculiformis* (Jacq.) Wettst.], were presented by Mr. Frank D. Kern, and it is of interest to note at this time the present known distribution of the disease over the State as well as to record here the extension of its range into other States and provinces from which it has not been previously reported.

As was predicted in Mr. Kern's papers, the distribution of the rust has become more general. In this State it evidently occurs wherever timothy is raised. During the past season the writer has collected it at widely separated points, as follows: Mount Vernon (Posey Co.) on the southwest; Wirt (Jefferson Co.) to the southeast; Richmond (Wayne Co.), east central; Columbia City (Whitley Co.), Laketon (Wabash Co.), and Logansport (Cass Co.), north central; LaFayette (Tippecanoe Co.), west central. Besides these collections, specimens of the rust have been received from Mr. Guy West Wilson and Mr. C. D. Learn, both collections from Carmel (Hamilton Co.), central; and it was reported last year from Columbus (Bartholomew Co.). This covers the State in such a way as to lead one to be reasonably certain that the rust occurs throughout the State wherever its host does.

In addition to the states and provinces from which the rust has been previously reported, specimens have been received from Dr. E. W. Olive, collected at Brookings, S. Dak., who reports it as common there this year, although not previously seen; from Miss Irma A. Uhde, collected at Lake Okoboji, Iowa; and from Prof. W. P. Fraser, Pictou, Nova Scotia. These localities in addition to those noted in Mr. Kern's paper last year make the known distribution of this rust in North America as follows. S. Dakota, Minnesota, Iowa, Wisconsin, Indiana, Ontario, New York, Maine and Nova Scotia.

In most of the specimens seen, especially those from Indiana, the summer spores (urediniospores) were much the more abundant. Winter spores (teliospores) developed in some cases but not abundantly. In certain

places in Jefferson County, the rust in its uredinial stage was abundant this year. The rainy season in the southern part of the State favored the development of the fungus.

At LaFayette, on the Experiment Station farm, the uredinial stage of the rust is abundant in a timothy meadow, which was sown down this spring. The rust is most abundant in the low parts of the meadow, and even as late as at this writing (Nov. 22nd<sup>1</sup>) the rust sori are abundant on the green blades.

The vitality of the urediniospores, collected at LaFayette, Ind., Nov. 22nd, 1910, was tested by means of hanging drops in Van Tiegham cells. Spores were taken both from the green blades and from those that had been killed by the frost. While the former showed much the more vigorous germination, the vitality of the spores in both cases proved to be high. This shows that they have withstood the cold weather, thus far, very well, and points to the probability that the rust may be able to pass the winter here in the uredinial stage, as it is thought to do in Europe.

From the above conditions it seems evident that timothy rust is in North America to stay, and its abundance will doubtless vary with the varying conditions that favor or check its development. Some of the conditions that seem to favor the development of the fungus are a heavy, luxuriant growth of the host on ground that tends to hold moisture, along with rainy weather with cool nights and moderately still, warm, but not hot, days. Obviously, the opposite set of conditions tend to be unfavorable for the greatest development of the rust.

While the best possible attention to both air and soil drainage will no doubt lessen the attacks of the disease to some extent, yet its ultimate control doubtless lies in the field of the plant breeder. The production of a strain of timothy having a high resistance to rust, as well as having at the same time the best forage qualities, would be of vast importance.

*Purdue University Agricultural Experiment Station, Lafayette, Ind.*

---

<sup>1</sup> 18 F. is the minimum thus far (Nov. 22d) at Lafayette, according to the official reading of the U. S. Weather Bureau at this station.

## INDIANA FUNGI.

---

By J. M. VAN HOOK.

---

For many years fungous specimens have been collected at Indiana University and from time to time a few have been added to the herbarium. During the past four years, many more of these have been identified, while still others have been collected and determined. It occurred to the writer that a preliminary list of these might be of importance to certain members of the Indiana Academy of Science. It is our intention to add to this number as rapidly as possible, with the view of obtaining ultimately as complete a list for the State as possible. So far, previous lists have not been consulted. No species is included, which has not come under my personal observation. In a future paper, it is the writer's intention to revise and extend the list with dates of first mention in Indiana, or, the possible time and method of introduction into the State.

Practically all of the specimens have been collected in Monroe and Brown counties. The latter offers a fine field for mycological study, as some of the original forests still stand. A considerable number of specimens have been obtained in my home county—Clark. Its knobs with their deep hollows between, offer probably the best collecting ground in the State for fleshy fungi.

So far, about 1,500 specimens have been classified. These contain some 500 species distributed through approximately 175 genera. I am under obligation to Professor G. F. Atkinson, Dr. C. H. Peck and Dr. W. A. Merrill for identification or verification of some of the fleshy and woody forms.

No effort will be made to secure a long list of the rusts, as that work is already so thoroughly done by Dr. J. C. Arthur. The Myxomycetes will be studied in connection with the fungi.

In order to facilitate the work of a fungus survey of the State, we would kindly solicit specimens (especially of the Fungi Imperfecti group) accompanied with date, place of collection and host or substratum.

## PHYCOMYCETES.

- Albugo bliti (Biv.) O. Kuntze.  
 " candida (Pers.) O. Kuntze.  
 " ipomœa panduranæ (Schw.)  
 Swingle.  
 Mucor cucurbitarum B. & C.  
 Phycomyces nitens (Ag.) Kze.  
 Plasmopara cubensis (B. & C.) Hum-  
 phrey.  
 " viticola (B. & C.) Berl.  
 & De Toni.  
 Rhizopus nigricans Ehbq.  
 Sporodinia grandis Link.  
 Synchytrium decipiens Farl.

## USTILABINEÆ.

- Doassansia sagittariæ (Westend.)  
 Fisch.  
 Ustilago, levis Kell. & Swing.

## UREDINEÆ.

- Æcidium dracontii Schw.  
 Cœoma nitens Schw.  
 Gymnosporangium macropus Link.  
 Melampsora populina (Jacq.) Lev.  
 Puccinia asparagi DC.  
 " coronata Cda.  
 " graminis Pers.  
 " helianthi Schw.  
 " malvacearum Mart.  
 " podophylli Schw.  
 " sorghi Schw.  
 " violaceæ (Schum.) DC.  
 " xanthii Schw.  
 Uromyces appendiculatus (Pers.)  
 Link.  
 " caladii (Schw.) Farl.

- " euphorbiæ Cke. & Pk.  
 " howei Pk.  
 " trifolii (A. & S.) Wint.

## AURICULARIINEÆ.

- Auricularia auricula-judæ (L.)  
 Schroet.

## TREMELLINEÆ.

- Exidia glandulosa (Bull.) Fr.  
 Guepinia spathularia Fr.  
 Tremella albida Hud.  
 " mycetophila Pk

## THELEPHORACEÆ.

- Aleurodiscus oakesii (B. & C.) Cke.  
 Corticium coerulium (Schrad.) Fr.  
 " scutellare B. & C.  
 Craterellus cantharellus (Schw.) Fr.  
 " cornucopioides (L.) Pers.  
 Hymenochaete ferruginea (Bull.)  
 Mass.  
 Peniophora cinerea (Fr.) Cke.  
 Sebacina inerustans Tul.  
 Stereum bicolor (Pers.) Fr.  
 " complicatum Fr.  
 " fasciatum Schw.  
 " frustulosum Fr.  
 " hirsutum Fr.  
 " sericium Schw.  
 " sowerbei Mass.  
 " versicolor (Schw.) Fr  
 Thelephora palmata Fr.  
 " schweinitzii Pk.

## CLAVARIACEÆ.

- Calocera cornea Fr.

*Clavaria fusiformis* Pers.  
 “ *mucida* Pers.  
 “ *pistillaris* Linn.  
 “ *pyxidata* Pers.  
*Sparassis crispa* (Wulf.) Fr.

## HYDNACEÆ.

*Grandinia granulosa* Fr.  
*Hydnum adustulum* Banker.  
 “ *adustum* Schw.  
 “ *arachnoideum* Pk.  
 “ *caput-medusæ* Bull.  
 “ *carbonarium* Pk.  
 “ *combinans* Pk.  
 “ *coralloides* Scop.  
 “ *erinaceus* Bull.  
 “ *laciniatum* Leers.  
 “ *mucidum* Pers.  
 “ *ochraceum* Pers.  
 “ *pulcherrimum* Pk.  
 “ *repandum* L.  
 “ *septentrionale* Fr.  
 “ *spongiosipes* Pk.  
 “ *zonatum* Batsch.  
*Irpex cinnamomeus* Fr.  
 “ *obliquus* Fr.  
 “ *tulipifera* Schw.  
*Phlebia radiata* Fr.  
*Radulum orbiculare* Fr.  
*Tremellodon gelatinosum* (Scop.)  
 Pers.

## POLYPORACEÆ.

*Boletinus porosus* Berk.  
*Boletus affinis* Pk.  
 “ *alveolatus* B. & C.  
 “ *auriporus* Pk.  
 “ *bicolor* Pk.  
 “ *castaneus* Bull.

“ *conicus* Rav.  
 “ *edulis* Bull.  
 “ *felleus* Bull.  
 “ *frostii* Russell.  
 “ *indecisus* Pk.  
 “ *luridus* Schaeff.  
 “ *magnisporus* Frost.  
 “ *modestus* Pk.  
 “ *nigrellus* Pk.  
 “ *ornatipes* Pk.  
 “ *pallidus* Frost.  
 “ *purpureus* Fr.  
 “ *retipes* B. & C.  
 “ *scaber* Fr.  
 “ *separans* Pk.  
 “ *speciosus* Pk.  
 “ *subsanguineus* Pk.  
 “ *subtomentosus* L.  
 “ *subvelutipes* Pk.  
 “ *vermiculosus* Pk.  
*Dædalia ambigua* Berk.  
 “ *confragosa* (Bolt.) Pers.  
 “ *quercina* (L.) Pers.  
 “ *unicolor* Fr.  
*Favolus canadensis* Kl.  
*Fistulina hepatica* Fr.  
*Fomes appplanatus* (Pers.) Wallr.  
 “ *conchatus* (Pers.) Fr.  
 “ *connatus* (Pers.) Fr.  
 “ *fomentarius* Gill.  
 “ *graveolens* Cke.  
 “ *igniarius* Gill.  
 “ *ribis* (Fr.)  
*Glœporus conchoides* Mont.  
*Lenzites betulina* (L.) Fr.  
 “ *flaccida* (Bull.) Fr.  
 “ *sæpiaria* Fr.  
 “ *vialis* Pk.

*Merulius lacrymans* (Jacq.) Fr.

“ *rubellus* Pk.

“ *tremellosus* Schrad.

*Polyporus adustus* (Willd.) Fr.

“ *areularius* (Batsch.) Fr.

“ *brumalis* (Pers.) Fr.

“ *cinnabarinus* Fr.

“ *dryadeus* Fr.

“ *fissus* Berk.

“ *flavovirens* Berk. & Rav.

“ *focicola* B. & C.

“ *frondosus* Fr.

“ *fumosus* (Pers.) Fr.

“ *gilvus* (Schw.) Fr.

“ *perennis* Fr.

“ *perplexus* Pk.

“ *picipes* Fr.

“ *pilotæ* Schw.

“ *pubescens* Fr.

“ *radicatus* Schw.

“ *resinosus* (Schr.) Fr.

“ *spraguei* B. & C.

“ *sulphureus* Fr.

“ *unicolor* Schw.

*Polystictus abietinus* Fr.

“ *biformis* Klotzsch.

“ *cinnamomeus* Sacc.

“ *conchifer* Schw.

“ *hirsutus* Fr.

“ *pergamenus* Fr.

“ *versicolor* (L.) Quel.

*Strobilomyces strobilaceus* (Scop.)

Berk.

*Trametes peckii* Kalchbr.

#### AGARICACEÆ.

*garicus campestris* Schaeff.

“ *placomycus* Pk.

*Amanita cothurnata* Atk.

“ *floccocephala* Atk.

“ *phalloides* Fr.

“ *rubescens* Fr.

“ *solitaria* Bull.

“ *strobiliformis* Vittad.

“ *verna* Bull.

*Aminitopsis vaginata* (Bull.) Roz.

“ “ “ *var. alba.*

*Armillaria mellea* Vahl.

*Cantharellus aurantiacus* Fr.

“ *cibarius* Fr.

“ *cinnabarinus* Schw.

“ *infundibuliformis* Fr.

“ *minor* Pk.

“ *wrightii* B. & C.

*Claudopus nidulans* (Pers.) Pk.

*Clitocybe candida* Bres.

“ *laccata* Scop.

“ *illudens* Schw.

“ *infundibuliformis* Schaeff.

“ *monadelpha* Morg.

“ *multiceps* Pk.

“ *ochropurpurea* Berk.

“ *odora* Bull.

*Clitopilus abortivus* B. & C.

*Collybia atratoides* Pk.

“ *confluens* Pers.

“ *dryophila* Bull.

“ *maculata* Alb. & Schw.

“ *platyphylla* Fr.

“ *radicata* Rehl.

“ *velutipes* Curt.

*Coprinus atramentarius* (Bull.) Fr.

“ *comatus* Fr.

“ *ebulbosus* Pk.

“ *micaceus* (Bull.) Fr.

- Cortinarius alboviolaceus* Pers. " *insulsus* Fr.  
 " *obliquus* Pk. " *lignyotus* Fr.  
*Craterellus cantharellus* (Schw.) Fr. " *piperatus* (Scop.) Fr.  
 " *cornucopioides* Fr. " *plumbeus* (Bull.) Fr.  
*Crepidotus applanatus* Pers. " *pyrogalus* (Bull.) Fr.  
 " *calolepis* Fr. " *rufus* (Scop.) Fr.  
 " *dorsalis* Pk. " *serobiculatus* Fr.  
 " *mollis* Schaeff. " *serifluus* (DC.) Fr.  
 " *versutus* Pk. " *sordidus* Pk.  
*Entoloma griseum* Pk. " *subdulcis* (Bull.) Fr.  
 " *strictus* Pk. " *theiogalus* (Bull.) Fr.  
 " *subcostatum* Atk. " *trivialis* Fr.  
*Flammula betulina* Pk. " *uvidus* Fr.  
*Galera tenera* Schaeff. " *vellerius* Fr.  
*Hygrophorus ceraceus* (Wulf.) Fr. " *volemus* Fr.  
 " *coccineus* (Schaeff.) Fr. *Lentinus lepideus* Fr.  
 " *conicus* (Scop.) Fr. " *ursinus* Fr.  
 " *eburneus* Bull. " *vulpinus* Fr.  
 " *lauræ* Morg. *Lepiota angustana* Britz.  
 " *psittacinus* (Schaeff.) Fr. " *americana* Pk.  
 " *pudorinus* Fr. " *asperula* Atk.  
 " *puniceus* Fr. " *cepæstipes* Sow.  
 " *sordidus* Pk. " *granosa* Morg.  
 " " *morgani* Pk.  
*Hypholoma appendiculatum* Bull. " *naucinooides* Pk.  
 " *lacrymabundum* Fr. " *procera* Scop.  
 " *sublateritium* Schaeff. " *rubrotincta* Pk.  
*Inocybe fibrillosa* Pk. *Marasmius candidus* (Bolt.) Fr.  
 " *geophylla* (Sow.) Fr. *var.* " *cohærens* (Fr.) Bres.  
 " *lilacina* Pk. " *rotula* Fr.  
 " *rimosa* (Bull.) Fr. " *siccus* Schw.  
*Lactarius chrysorrhæus* Fr. *Mycena epipterygia* Scop.  
 " *corrugis* Pk. " *galericulata* Scop.  
 " *deceptivus* Pk. " *hæmotopa* Pers.  
 " *deliciosus* Fr. " *leajana* Berk.  
 " *distans* Pk. " *leptophylla* Pk.  
 " *gerardii* Pk. " *pura* Pers.  
 " *hygrophoroides* B. & C. *Naucoria semiorbicularis* Bull.

- Nyctalis asterophora* Frost.  
*Omphalia alboflava* Moy.  
     "    *campanella* Batsch.  
*Paneolus campanulatus* L.  
     "    *retirugis* Fr.  
     "    *solidipes* Pk.  
*Panus stipticus* (Bull.) Fr.  
     "    *rudis* Fr.  
*Paxillus panuoides* Fr.  
*Pholiota adiposa* Fr.  
     "    *æruginosa* Pk.  
     "    *caperata* Pers.  
     "    *flammans* Fr.  
     "    *marginata* Batsch.  
     "    *squarrosoides* Pk.  
     "    *togularis* Bull.  
     "    *unicolor* Vahl.  
*Phylloporus rhodoxanthus* (Schw.)  
     Bres.  
*Pleurotus applicatus* Batsch.  
     "    *abscondens* Pk.  
     "    *dryinus* Pers.  
     "    *ostreatus* Jacq.  
     "    *petaloides* Bull.  
     "    *sapidus* Kæhbr.  
     "    *serotinoïdes* Pk.  
     "    *ulmarius* Bull.  
*Pluteus cervinus* Schaeff.  
     "    *leoninus* Schaeff. *var.* *coc-*  
         *cineus* Cke.  
*Russula alutacea* Fr.  
     "    *basifureata* Pk.  
     "    *compacta* Frost.  
     "    *crustosa* Pk.  
     "    *decolorans* Fr.  
     "    *densifolia* Secr.  
     "    *emetica* Fr.  
     "    *fætens* Fr.
- "    *furcata* (Pers.) Fr.  
     "    *granulata* Pk.  
     "    *mariaë* Pk.  
     "    *nigricans* Fr.  
     "    *pectinatoides* Pk.  
     "    *variata* Banning.  
     "    *veternosa* Fr.  
     "    *virescens* (Schaeff.) Fr.  
*Schizophyllum commune* Fr.  
*Stropharia semiglobata* Batsch.  
     "    *viridula* Schaeff.  
*Tricholoma equestre* L.  
     "    *fumescens* Pk.  
     "    *personatum* Fr.  
     "    *russula* Schaeff.  
     "    *sejunctum* Sow.  
*Volvaria bombycina* (Pers.) Fr.  
     "    *pusilla* Pers.
- PHALLINEÆ.
- Dictyophora duplicata* (Bosc.) Ed.  
     Fisch.  
     "    *ravenelii* (B. & C.)  
         Burt.  
*Mutinus caninus* (Huds.) Fr.
- LYCOPERDINEÆ.
- Calvatia cœlata* Bull.  
     "    *cyathiforme* (Bosc.)  
     "    *gigantea* (Schaeff.) Batsch.  
*Lycoperdon gemmatum* Batsch.  
     "    *pyriforme* Schaeff.
- NIDULARIINEÆ.
- Crucibulum vulgare* Tul.  
*Cyathus stercorius* (Schr.) De Toni  
     "    *striatus* (Huds.) Hoffm.



## PLECTOBASIDIINEÆ.

- Scleroderma tenerum B. & C.  
 “ vulgare Hornem.

## ASCOMYCETES.

- Anthostomella ostiolata Ell.  
 Bulgaria inquinans (Pers.) Fr.  
 Chlorosplenium æruginosum (Æd.) de  
 Not.  
 Cordyceps herculea (Schw.) Sacc.  
 “ militaris (L.) Link.  
 Daldinia concentrica (Bolt.) Ces. &  
 de N.  
 Diatrype albopruinosa (Schw.) Cke.  
 “ stigma (Hoffm.) Fr.  
 “ virescens (Schw.) E. & E.  
 Diatrypella prominens Howe.  
 Dichæna ferruginea (Pers.) Fr.  
 Dimerosporium collinsii (Schw.)  
 Thuem.  
 Erysiphe cichoracearum DC.  
 “ graminis DC.  
 Exoascus deformans (Berk.) Fekl.  
 Glæoglossum gelatinosum (Pers.)  
 Durand.  
 Gibberella saubinettii (Mont.) Sacc.  
 Glonium simulans Gerard.  
 Gyromitra gigas (Krombh.) Cke.  
 Helotium citrinum (Hedw.) Fr.  
 Hypomyces lactiflorum (Schw.) Tul.  
 “ rosellus (Alb. & Schw.)  
 Tul.  
 Hypoxylon annulatum Schw.  
 “ atropunctatum (Schw.)  
 Cke.  
 “ coccineum Bull.  
 “ cohærens (Pers.) Fr.  
 “ fuscum (Pers.) Fr.

- “ howeanum Pk.  
 “ investiens (Schw.) Berk.  
 “ petersii B. & C.  
 “ turbinulatum Schw.  
 Hysteriographium gloniopsis (Ger.)  
 E. & C.  
 Lachnea erinaceus Schw.  
 “ scutellata L.  
 Læstadia bidwellii (Ell.) Viala &  
 Ravaz.  
 Leotia lubrica (Scop.) Pers.  
 Microsphaera alni (DC.) Wint.  
 “ elevata Burr.  
 Morchella conica Pers.  
 “ esculenta (L.) Pers.  
 “ semilebra DC.  
 Nectria cinnabarina (Tode) Fr.  
 “ ipomoeæ Hals.  
 Nummularia bulliardi Tul.  
 “ discreta (Schw.) Tul.  
 “ tinctor (Berk.)  
 Otidea aurantia (Pers.) Mass.  
 Peziza repanda Wahl.  
 “ succosa Berk.  
 “ vesiculosa Bull.  
 Phyllachora graminis Pers.) Fekl.  
 Phyllactinia suffulta (Reb.) Sacc.  
 Plowrightia morbosa (Schw.) Sacc.  
 Podosphaera oxycanthe (DC.) De By.  
 Pseudopeziza medicaginis (Lib.) Sacc.  
 “ trifolii (Pers.) Fekl.  
 Rhytisma andromadæ (Pers.) Fr.  
 Rosellinia aquila (Fr.) De N.  
 “ medullaris Ces. & De N.  
 Sclerotinia fructigena Pers.  
 Scorias spongiosa (Schw.) Fr.  
 Sarcocypha coccinea (Jacq.) Cke.  
 Sphærella fragariæ (Tul.) Sacc.

Sphærographium fraxini (Pk.) Sacc.  
 Sphærotheca pannosa (Wallr.) Lev.  
 Tuber rufum Pico.  
 Uncinula salicis (DC.) Wint.  
 Urnula craterium (Schw.) Fr.  
 Ustulina vulgaris Tul.  
 Valsa leucostoma (Pers.) Fr.  
 Venturia pomi (Fr.) Wint.  
 Xylaria castorea Berk.  
 " hypoxylon (L.) Grev.  
 " polymorph (Pers.) Grev.

## FUNGI IMPERFECTI.

*Sphærospidales.*

Actinonema rosæ (Lib.) Fr.  
 Ascochyta pisi Lib.  
 Cicinnobolus cesatii De By.  
 Cytospora persiciæ Schw.  
 Diplodia zeæ (Schw.) Lev.  
 Entomosporium maculatum (Cke.)  
 Sacc.  
 Darluca filum (Biv.) Cast.  
 Leptothyrium pomi (Mont. & Fr.)  
 Sacc.  
 Phoma polygramma (Fr.) Sacc. var.  
 Plantaginis. Sacc.  
 Phyllosticta ampelopsidis Ell. &  
 Mart.  
 " prunicola (Op.) Sacc.  
 Septoria graminum Desm.  
 " lycopersici Speg.  
 " piricola Desmz.  
 " podophyllina Pk.  
 " rubi West.  
 " trillii Pk.  
 Sphæronema fimbriatum (Ell. & Hals.)  
 Sacc.

Sphæropsis grandinea E. & E.  
 " malorum Berk.  
 Vermicularia circinans Berk.

*Melanconiales.*

Colletotrichum lindemuthianum  
 (Sacc. & Magn.) Bri. & Cav.  
 Cylindrosporium padi Karst.  
 Marsonia brunneum E. & E.  
 " ochroleuca B. & C.

*Hyphomycetes.*

Acrostalagmus cinnabarinus (Pers.)  
 Cda.  
 Alternaria brassicæ (Berk.) Sacc. var.  
 macrospora. Sacc.  
 " isolani (E. & M.) Jones &  
 Grant.  
 Botrytis vulgaris Fr.  
 Cephalothecium roseum Cda.  
 Cercospora apii Fres.  
 " beticola Sacc.  
 " condensata Ell. & Kell.  
 " viticola (Ces.) Sacc.  
 Cladosporium carpophilum Thuem.  
 Fumago vagans Pers.  
 Helminthosporium carpophilum Lev.  
 " inconspicuum C. &  
 Ell.  
 Piricularia grisea (Cke.) Sacc.  
 Polythrincium trifolii B. & C.  
 Streptothrix atra B. & C.  
 Stysanus stemonites (Pers.) Cda.  
 Tubercularia vulgaris Tode.  
 Zygodemus fulvus Sacc.

Indiana University,  
 Bloomington, Ind.

## STECCHERINUM SEPTENTRIONALE (FR.) BANKER IN INDIANA.

---

By HOWARD J. BANKER.

---

The fungus here considered is perhaps better known as *Hydnum septentrionale* (Fr.). Although a large and conspicuous plant it appears to have attracted very little attention if we are to judge by the references to it in literature. In the entire series of Just's Botanischer Jahrsbericht covering a period of more than twenty years I did not find a single reference to this species. As to size it possesses the unique distinction of being by far the largest representative of the family of the Hydnaceæ, if not indeed being able to lay claim to the first place in this respect in the entire fungal world. A specimen that recently came under the writer's observation and which is the occasion of this paper, after being damaged and a portion of it lost, weighed 35 lbs. The whole mass measured 30 cm. long, or in its projection from the substratum, 58. cm. wide, and 40. cm high. I should not be surprised if specimens were to be found considerably exceeding this in size.

The formation of the sporophore is somewhat peculiar. The mycelium emerges from the main trunk of the tree through some small opening such as the hole formed by a dead limb. In the case of the plant here shown it emerged under the base of the tree in a crevice formed by the divergence of buttress-like roots and where there was a small opening apparently into the heart of the tree. In every case that I have observed, the opening has not been over ten centimeters in diameter and is out of all proportion to the size of the sporophore. On emerging from the hole the mycelium apparently grows radially, spreading in close adhesion to the substratum and forming outwardly a series of overlapping or imbricate pilei. The first impression is that the mass is thoroughly rooted in the tree at all points and can be removed only by breaking it in pieces or by cutting out a portion of the tree. However, it will be found that no stronger implements than one's fingers are sufficient to remove the specimen intact, for its attachment to the bark is very slight and the fingers can easily be forced between the fungus and the tree, pushing it off until the small cord of mycelium which forms the real point of attachment is broken.



*Steccherinum septentrionale*, growing from crevice near base of living beech at Greencastle, Ind.  
Photograph by Paul Collins, magnified one-fifth.

For weeks after the removal of the fungus the spot on the tree where it had been can be detected by its lighter color, looking as if it had been cleaned. There are, however, no other external marks of the effect of the fungus and the tree appears to suffer little vital injury. Some six years ago a fine specimen was found growing on a beech at a height of 12 or 15 feet from the ground in the dooryard of Dr. Edwin Post in Greencastle. The tree is still living and apparently thriving. The top of the tree has been cut off or broken out, apparently many years ago and certainly prior to infection by the fungus. The plant does not seem to kill the tree, but such a fungal mass could hardly be produced without considerable injury. The fungus has been observed only on large trees a foot or more in diameter. The writer has not been able to examine the wood of a tree attacked by the fungus, but it seems probable that the mycelium may be confined to the heart wood, which would account for the little injury done to the growing tree, as well as the fact of its confinement to old trees.

It seems probable also that the sporophores are produced from small openings, because these offer a suitable path of exit through the sap-wood. It may appear, therefore, strange to speak of the plant as a parasite; but while its mycelium may be confined in its vegetative state to the non-living heart-wood, it is also true that the fungus appears to be confined to living trees and is never found on dead trunks, whether standing or fallen.

The plant seems to prefer the beech as its host. It has been reported as growing on maple and perhaps hickory in the East, where beech is not very abundant. I have never seen the plant *in situ* on the latter hosts, and illustrations suggest the possibility of the plant's being more or less distinct in character from the one found on beech. The original description and figure by Fries was from specimens found on beech in Sweden. These are in every respect typical of specimens found here in Indiana. I have seen no entire specimens of the European form on beech. At Upsala there is in the herbarium an entire specimen of extraordinary size that was found growing on Linden in the Botanical Garden of the University. Although the specimen is dried, it is evident at sight that the plant presents some striking differences from our Indiana plants. The pilei are much smaller, thinner, more numerous and more distinct, the color cinereous rather than creameus, and the teeth somewhat shorter. It is only after closer examination that one hesitates to pronounce it a distinct species. Fries makes mention of the plant's being found on elm in the same Bo-

tanical Garden, and names a variety, *hortense*, found on the latter host. So far as I know, the plant has never been observed in this country either on linden or elm. It is possible that the influence of the host may affect somewhat the growth of the plant, if these are all one species. This is a point that needs further investigation.

The immense sporophore is a single season's growth and it seems probable is produced very rapidly in the course of a few weeks in August and September, reaching maturity about the first of October. The form found on maple in the east has been observed to fruit several years in succession, and Fries speaks of the plant as growing annually on elm at Upsala. The beech in Dr. Post's yard two years later produced a small fungal growth, but too high up to be sure of its character, since which time no further growth has been observed. The tree on which the present growth was found gave no indications of any previous growths. Other observations lead me to believe that it is not usual for the beech fungus to fruit annually for a series of years. How long the mycelium lives in the tree is unknown.

The spores are produced in enormous numbers, but seemingly for only a few days. On my first visit to this plant, October 17, no spore fall was observed, but the matter was not especially tested. Two days later, on visiting the place, spores were observed rising from the mass in small clouds. These frequently streamed out from parts of the fungus like a puff of smoke for 10 or 15 seconds, then ceased and after two or three minutes began again. Such streams were emitted from different parts of the plant irregularly, so that from some part spores were escaping almost constantly. The day was pleasant and the air very quiet, yet occasionally a light puff of air passed over the plant. The streaming of the spores, however, appeared to be no more marked when the air stirred than when it was perfectly quiet. The plant was carefully removed from the tree, but being found too heavy to carry was left propped against the base where it had grown. Five days later the fungus was brought to the laboratory and found to be in good condition, but the outer edges of the pilei were beginning to darken and curl. Faint spore prints were obtained, but such as to indicate that spore discharge was practically over. Whether the removal of the plant from the tree shortened the time of spore discharge is not certain, but it is doubtful if the plant gives off its spores naturally for a period of more than a week or ten days.

According to Buller, visible spore-discharge in the hymenomyces is a rare phenomenon, and he cites the observations of Hoffman, Hammer, and von Schrenk. My own observation on *Steccherinum septentrionale* conform to Von Schrenk's description of the spore-discharge in *Polyporus schweinitzii*. Buller accounts for the intermittent clouds by tiny irregular air currents, and thinks the spores were in reality "falling continuously and regularly by their own weight." In the case of his own observation on *Polyporus squamosus* this view appears to be confirmed, and he likens the appearance to the steam arising from a cup of tea in irregular eddies or the curling of tobacco smoke from the bowl of a pipe. Had he observed the discharge in *Steccherinum septentrionale* I believe he would not have felt so confident of his explanation. The cloud-like discharge was more as the curling smoke of the tobacco when one breathes at intervals through the pipe. I doubt if the discharge is due to any propelling force as hinted by Von Schrenk, but it seems to me probable that over certain restricted areas there is a simultaneous liberation of great quantities of spores followed by a period of rest. That such intermittent spore release occurs in all hymenomyces is improbable, but it seems to account for the phenomenon as observed in *Steccherinum septentrionale* and *Polyporus schweinitzii*.

Whether the present fungus is to be regarded as an edible species can not be stated. No one appears to have tested its qualities. It would probably be found somewhat tough, especially when mature, but not more so than many forms that are recommended. In drying it gives off a very strong odor which would lead one to expect it to have a pronounced flavor. The taste of the raw plant is not inviting, and yet not particularly offensive. If any preparation of it would make it really comestible, a single plant is sufficient to furnish an abundant feast.

The plant is not rare and yet cannot be said to be common. It appears to be most abundant in Indiana and Ohio, perhaps because of the prevalence of the beech in this region. When the writer came to Indiana six years ago, he had not been in the State more than a couple of weeks when his attention was called by one of his students to the specimen previously mentioned in Dr. Post's yard. As there were three or four dried specimens observed lying about the laboratory, the impression was given that specimens could probably be readily obtained almost any time in season. Being at the time unusually busy organizing a new work, the opportunity for study of the plant was allowed to pass with a casual ex-

amination and the securing of the specimen. From that time until this fall, however, no more were seen except one or two old and badly weathered specimens. The plant is, therefore, not so abundant as was thought. Press of other work has again made it impossible to conduct as thorough an investigation of the problems suggested by this plant as one would like, but it has appeared worth while to call attention to this seemingly little noticed fungus.

*DePauw Univ.,*

*Greencastle, Ind.*



## DISEASE RESISTANCE IN VARIETIES OF POTATOES.

---

BY C. R. ORTON.

---

This report is the result of experiments conducted by the author, under the direction of Dr. L. R. Jones, while in the coöperative employ of the Vermont Experiment Station and the United States Department of Agriculture, Bureau of Plant Industry, during the fall of 1909-10.<sup>1</sup> In general, the work was the outgrowth of a series of experiments carried on by Professor William Stuart at the Vermont Station for several years previous to 1909, the results of which may be found in Bulletin 122, Vermont Experiment Station. In particular, it was the development of some research work of the previous winter on late blight. Professor Stuart conducted his experiments in the field upon over 150 varieties, with the idea of determining, if possible, the disease resistant qualities of both American and European varieties of potatoes, to the late blight, *Phytophthora infestans* (Mont) Bary, a fungus which causes the loss of many thousands of bushels of potatoes yearly in New England, especially in Maine and Vermont, and periodically the loss of one-half the entire crop or more in that section.

European potato growers have for years been breeding and testing potato varieties for the disease resistant quality, until they have developed a series of varieties which have proved by field trials to be highly resistant to fungous diseases. The processes as carried out by them necessitated growing the tubers for several years in succession and noting the amount of infection each year. This, of course, is at best a tedious operation, giving slow and often unsatisfactory results.

In 1908 Mr. N. J. Giddings, then of the Vermont Experiment Station, found that resistance to the late blight could be determined with some degree of accuracy by artificial inoculation of the tubers, with pure cultures of the fungus, under sterile conditions in the laboratory. The value of the laboratory method for testing varieties of potatoes for disease resistance is easily seen when we consider that it would permit us in two or three weeks to test the resistance quality of any variety, a process which

---

<sup>1</sup>The full results of these experiments are to be published in a forthcoming bulletin of the United States Department of Agriculture, Bureau of Plant Industry.

heretofore by laborious field experiments has taken as many years. The purpose in the trials of 1909 was to determine more fully the reliability of this method and its applicability for comparative trials with a large number of varieties.

In all, 76 varieties of potatoes, 46 of which Dr. Jones collected in Europe, were tested. Practically all of these were varieties of economic value in their respective localities. Most of the European varieties were of reputed disease resistant qualities. All had been grown on the Vermont Experiment Station grounds under as similar conditions as possible, for four years previous to these experiments.

The method used was, first, to prepare sterile test tubes by placing a small absorbent cotton wad in the bottom of each tube and adding to each one c.c. of water. The tubes were then plugged with ordinary cotton and sterilized in the autoclave. The next step was to place in each such tube a small sterile block cut from a raw potato. Considerable care was necessary to avoid contamination in this process. The work was all done under a transfer hood freshly washed out with corrosive sublimate solution. The potato tubers were first washed then immersed for about five minutes in a corrosive sublimate bath. They were then peeled with sterile knives and the sterile interior flesh was finally cut into several small blocks of such size, about  $1 \times 1 \times 4\frac{1}{2}$  cm., as would drop easily into the tubes. These tubes were then held 24 hours at about  $22^{\circ}$  C., in order that any contaminated tubers might be detected and discarded before the inoculations were made. The inoculations were made from pure cultures of *Phytophthora infestans* growing on lima bean agar and about 15 to 18 tubes of each variety were inoculated. About twelve varieties were run in each series, two of these varieties used as checks, being the same in all the series. For these checks Professor Wohltmann and Green Mountain varieties were used because they showed a very uniform growth all through and stood at the two extremes, the former being one of the most resistant varieties, the latter one of the most susceptible.

For each inoculation, a small piece of the fungus was transferred with a platinum needle from the agar to the block of potato and scratched into it to prevent its drying up before infection could take place. If proper care was taken in making this inoculation, a uniform growth was obtained on all the blocks of the same variety.

After inoculation the cultures were placed for incubation and growth in a temperature of about  $15^{\circ}$  to  $16^{\circ}$  C. It was found that at this tem-

perature they developed a fair growth of the fungus in about six days, and this reached a maximum on about the tenth day. All the tubes of each variety were then assembled and compared with the checks as to their relative amounts of growth. These results were judged by two or three observers independently of each other, and each judgment recorded. For purposes of comparison the relative growth was expressed in percentages. Although this was a somewhat arbitrary standard its usefulness is shown by the fact that these independent observations rarely varied more than five to ten per cent.

For the final results all these tests were made in duplicate and all the observations on any one variety were averaged. These averages may be grouped into three main classes. First, a highly resistant class, those exhibiting a growth of from 1-35 per cent. Second, a middle class, those exhibiting a growth of from 35-66 per cent, and third, a susceptible class, exhibiting a growth of from 65-100 per cent. It was found that those falling into class one were in every case those which were of tested disease-resistance and were practically all of European origin. Those falling into class two were largely of reputed disease-resistance and were also largely of European origin. Those falling into the third class were practically all of American origin and included many of our most important commercial varieties. Since these results, in the main, correspond to those obtained by Professor Stuart, in his field trials, we feel safe in drawing the conclusion, that thus far our American breeders of potato varieties have been developing types which stand for yield and quality regardless of disease-resistance, while European breeders have been developing disease resistant varieties. This, we believe, explains in a measure, the heavy loss occasioned by fungous disease in our American potato crop. Unfortunately the most resistant of the European varieties are not of the best quality and color for the American market. It therefore remains for the potato breeders of this country to develop varieties which combine the desirable qualities of the best American potatoes with the disease-resistant qualities of the hardiest European potatoes. In connection with this it will undoubtedly be the laboratory method here explained which will be used largely in testing the disease resistant qualities of new hybrids and seedlings in the attempts to develop this new ideal potato.

*Purdue University,*

*Lafayette, Indiana.*

...

## AN ECOLOGICAL SURVEY OF WHITEWATER GORGE,

By L. C. PETRY and M. S. MARKLE.

At Richmond, Indiana, the east branch of Whitewater River runs through a narrow rock gorge for a distance of about three miles. This miniature canyon is commonly called the Whitewater gorge. It varies in

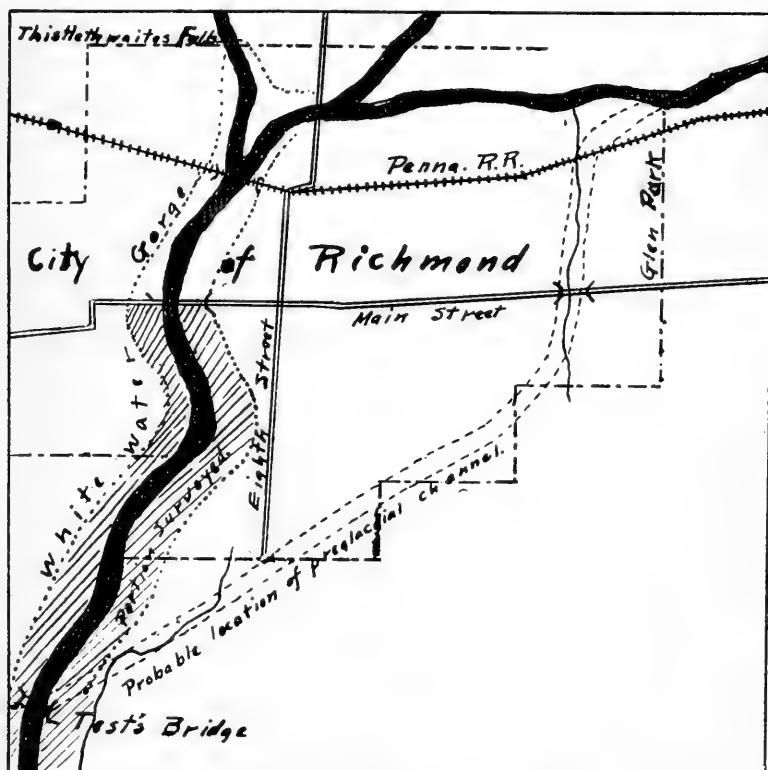

Fig. 1.

depth from 60 ft. to 120 ft. and in width from 200 ft. to 800 ft. on the floor. The gorge terminates rather abruptly at Test's Mills, about two

miles below Main street, Richmond, and from that point to its mouth the valley is generally broad.

This gorge was formed as a direct result of the glacial phenomena of the region. There is evidence that at the close of the Early Wisconsin ice sheet period, the river occupied a channel much to the eastward of its present course. Wells to the south of Glen Park, nearly three miles east of the present river channel indicate at that point an old channel now filled with drift. The streams in Glen Park seem to occupy this same old channel. From this and other evidence it seems probable that this old channel passes to the east of the city of Richmond, and connects with the present river valley somewhere below Test's Mills.

The advance of the Late Wisconsin ice sheet resulted in filling up this old channel with drift. There is evidence that this ice advance was from two directions, north-west and north-east, and that the terminal moraines of the two lobes did not come together. The river, forced out of its old channel, took up a new course between the two moraines. With the melting of the ice sheet, the volume of water discharged by the stream would be very large, and erosion of its channel correspondingly rapid. Since the retreat of the ice, it has carved the present gorge.

The rock of the gorge is Hudson River or Cincinnati limestone. This is a favorite collecting ground for paleontologists interested in this particular portion of the Lower Silurian beds. Trilobites are not numerous, though several species are found. *Calymene senaria* is commonest. *Rynchotrema capax*, *Zygospira modesta*, *Platystrophia biforata* and *Leptæna rhomboidalis* are the characteristic brachiopods. *Streptolasma* is extremely common.

The character of the rock is of extreme importance in the consideration of the ecology of the region. The rock is soft and very thin-bedded, and is rendered still more unstable by the alternation of thin beds of shale of a soft calcareous nature with the layers of limestone. The limestone itself is shaly and weathers very rapidly. Three inches is probably the average thickness of the rock layers. The amount of shale varies greatly, even within limited areas. In general, the shale makes up about one third of the total rock.

As a result of the nature of the rock, steep cliffs are maintained only where active erosion of the base is going on. As soon as river erosion ceases, the slope becomes gentler at once. There is a considerable amount

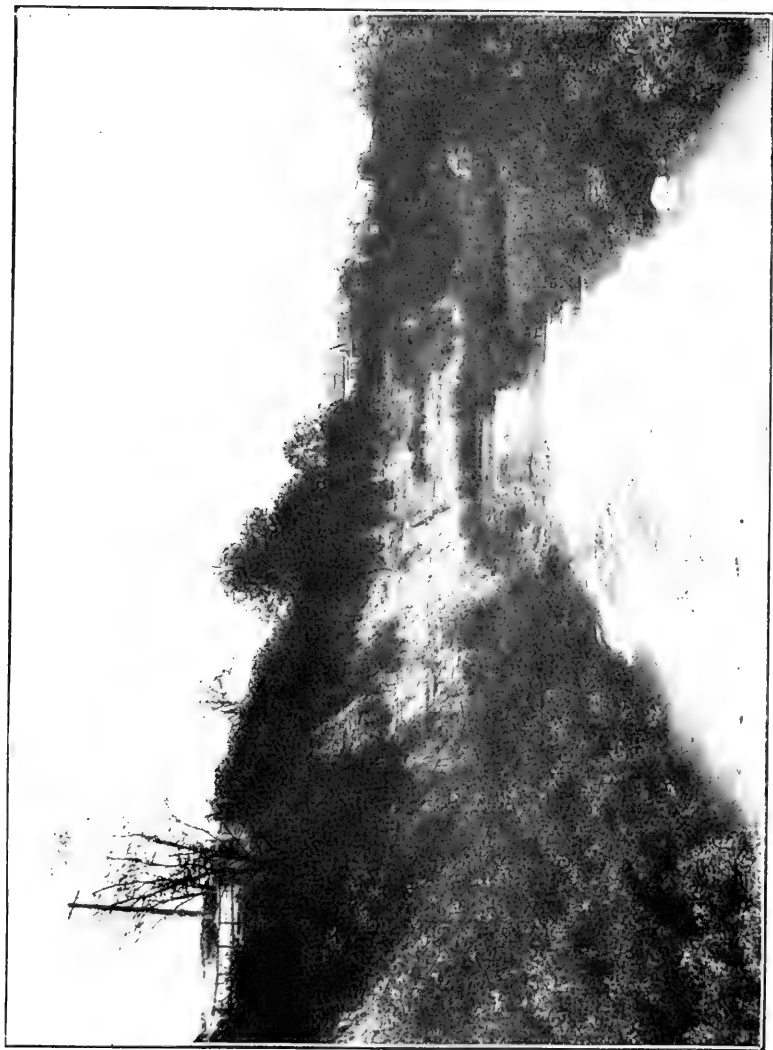

Fig. 2.  
An early stage in plant succession.

of seepage and slumping is frequent. A large talus quickly collects. This is composed of angular fragments of the limestone, embedded in a matrix of the fine mud produced by the weathering of the shale.

The stream through the gorge has a very high gradient. From Main street to Test's Mills, a distance of about 9,000 feet, the total fall is 47 feet, or about 1 foot in 200. This gradient is not at all uniform throughout the distance. In general the stream consists of a series of alternate ponded stretches and rapids. At some of the fall lines a difference of level of six or eight feet may occur. This condition is produced by a slight dip of the rock strata toward the up-stream end of the gorge. This dip is small, not more than a few inches to the hundred feet. Where a portion of the rock, harder than the surrounding rock or with less shale, comes to the surface, a fall line is produced. Fragments of rock carried down by spring floods accumulate at this point, and the portion of the stream immediately above becomes ponded. Some of these ponds are as much as 1,200 feet in length.

The annual rainfall in this region is about 40 inches. The average flow of the river is about 60 cubic feet per second. A series of measurements of the flow, made January-May, 1907, gave a minimum flow of 56 cu. ft. per second on February 20, and a maximum flood stage of 4,500 cu. ft. per second on March 13. Measurements made in August, 1908, indicated a flow of only 42 cu. ft. per second.

It is a deplorable fact that up to the present time the city of Richmond has seen fit to dispose of its sewage by the primitive method of dumping it directly into the river. Since this sewage flow amounts to 12 to 15 cubic feet per second, or one-fourth the total flow at low water stage, the condition of the river below the sewers may be imagined.

The region selected for study includes the floor and bluffs of the gorge between the Main street bridge and the bridge at Test's Mills, about two miles to the south. A survey by transit and stadia was made and from this a topographic map on a scale of 1 inch to 250 feet was prepared. On this the various data were recorded, and the conditions of the various portions of the area were indicated by tints. Considerable areas of the region have been disturbed by cultivation, building operations, etc., and no attempt to study these areas was made. Photographs to show the more striking features of the region were made whenever possible. The nomenclature used is that of Gray's Manual, 7th edition.



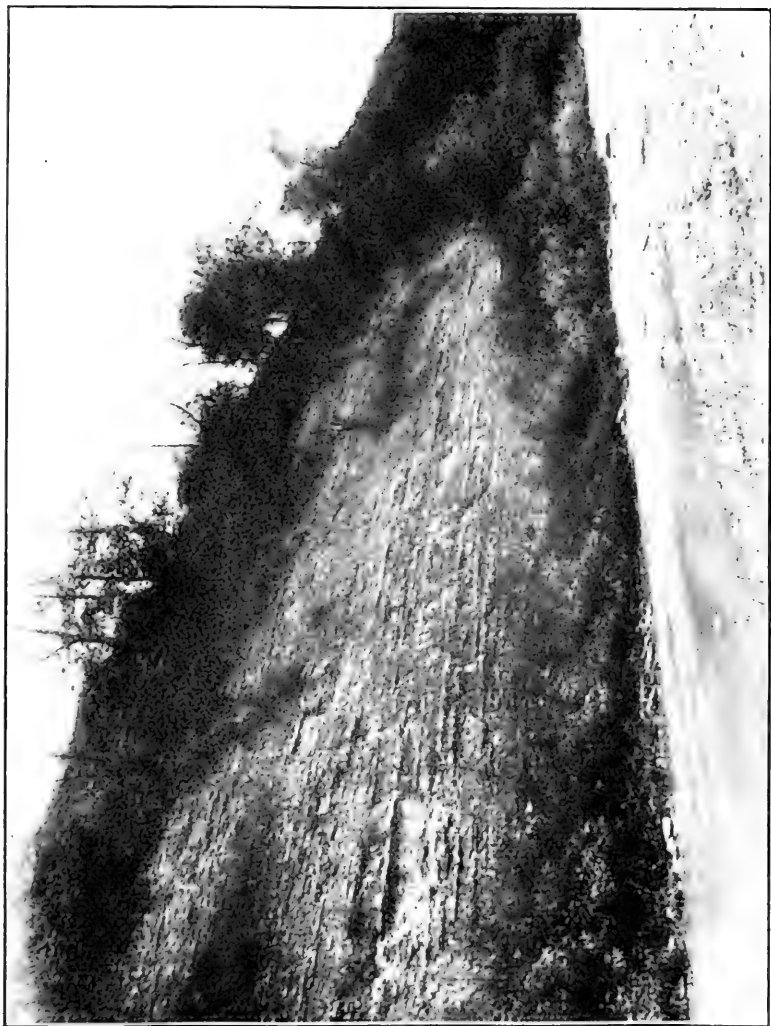

Fig. 3.

A slightly later stage than that shown in Fig. 2. Note shelf plants and texture of rock.

In this study, the various plant associations have been considered as members of a succession, and therefore, in general, transitional. The ultimate stage in this region, *i. e.*, the permanent association, is held to be a very mesophytic forest, dominated by *Fagus* and *Acer saccharum*. All other plant associations are held to be transitional stages between a plantless condition and this ultimate forest condition. The position of any given plant association in this succession may be determined accurately only by observation over a long period of time. The successive stages have been worked out carefully in many cases, however, and the usual succession for this region is well known. Two kinds of successions are recognized, namely, biogenic and physiogenic. A biogenic succession may be defined as one influenced only by plant and animal life, and therefore such a succession will occur only where the physiography is static. In physiogenic successions, physiographic changes are the controlling factors. In general we have endeavored to determine two points with regard to each plant association, namely, its place in the succession and whether the controlling factors of that succession at that stage are biogenic or physiogenic. Lists of species given are usually incomplete but as representative as possible.

The walls of the gorge and the ravine branching from it are quite favorable for the study of plant successions in such situations. Within the region studied, almost all stages from the bare plantless cliff to the ultimate mesophytic forest can be found. The stage of development of the vegetation on the walls of the gorge seems to be dependent largely upon the length of time that has elapsed since active erosion by the river ceased. The succession is very rapid for a rock cliff. This is explained by the very unstable nature of the rock, the abundance of shale and the favorable conditions of rainfall and climate. Very often stages that are usually successive occur combined, or telescoped, here. Lichens, which usually form the first vegetation on rock cliffs, are absent. No liverworts or ferns occur. The oaks, which commonly form a stage immediately preceding the ultimate forest, seem to be replaced by elms and black locust. *Juniperus* is the only conifer found.

The earliest stage of the succession occurs at one point where a cliff occupies the outside of a curve of the stream, and active erosion of its foot is going on. As a result of this condition, the cliff is very steep, even overhanging to a slight extent. The wall is bare of plants, except for algae

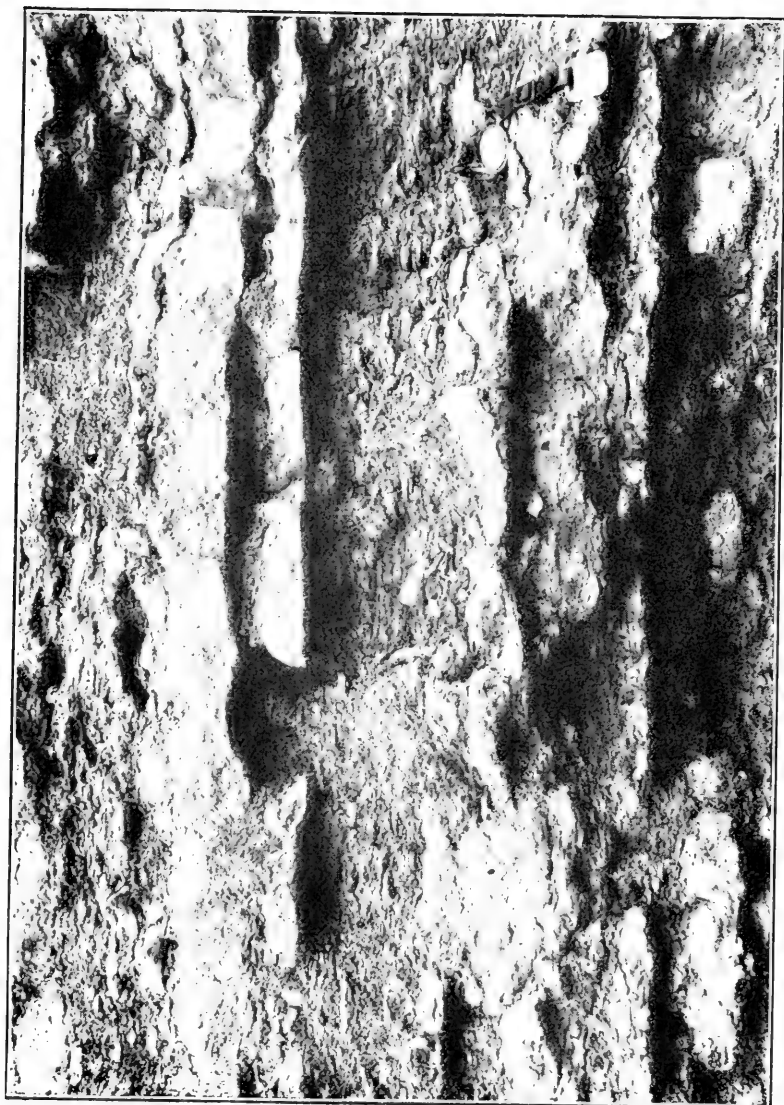

Fig. 4.

Detail of Fig. 3 showing character of rock in gorge. Note alternate layers of limestone and shale.

in places where seepage occurs. No lichens occur, though the rock is more stable than usual, with a smaller proportion of shale. Their absence is not due to smoke, as is sometimes the case, for they occur on trees near by. The rock does not contain bitumen which sometimes prevents their growth, notably on Niagara limestone. It seems probable that the weathering of the rock is too rapid for them to maintain a foothold. A few annuals grow on the talus which has accumulated since the spring floods. A few plants, such as *Psedera*, *Rhus toxicodendron*, *Vitis* and *Juniperus virginiana*, hang from the top of the cliff. This stage continues as long as active erosion by the stream is maintained.

The second stage is found at a point where the river erosion is not so strong. A considerable talus accumulates at the base of the cliff, and this is not swept away by the spring floods. The wall is not so steep as in the stage just described. It is in this stage that the first real plant associations appear. These pioneer plants occupy narrow shelves produced by the projecting ledges of limestone. Most of the plants are annuals. The following species are typical of such localities:

<i>Ambrosia artemisiifolia</i>	<i>Melilotus alba</i>
<i>Poa compressa</i>	<i>Allium canadense</i>
<i>Lactuca scariola</i> var. <i>integrata</i>	<i>Dipsacus sylvestris</i>
<i>Nepeta cataria</i>	<i>Aster</i> spp.
<i>Rosa humilis</i>	

After direct action by the river has ceased, the talus accumulates undisturbed. The shale layers change to soil very readily, and this is washed down by the rains. Projecting layers of limestone break off of their own weight. In these various ways, the slope is rapidly reduced. A larger number of plants gain a foothold and the cliff is covered with vegetation. Grasses and annuals are common. Xerophytic mosses appear. This may be called the herb stage. The pioneer plants mentioned above continue through this stage, while the following new species appear:

<i>Equisetum arvense</i>	<i>Melilotus officinalis</i>
<i>Aster novae-angeliæ</i>	<i>Cornus paniculata</i>
<i>Daucus carota</i>	<i>Verbascum thapsus</i>
<i>Heraclium lanatum</i>	<i>Elymus canadensis</i>

Up to this point, the succession has been almost entirely physiogenic. The plantless stage continues as long as the stream actively erodes the

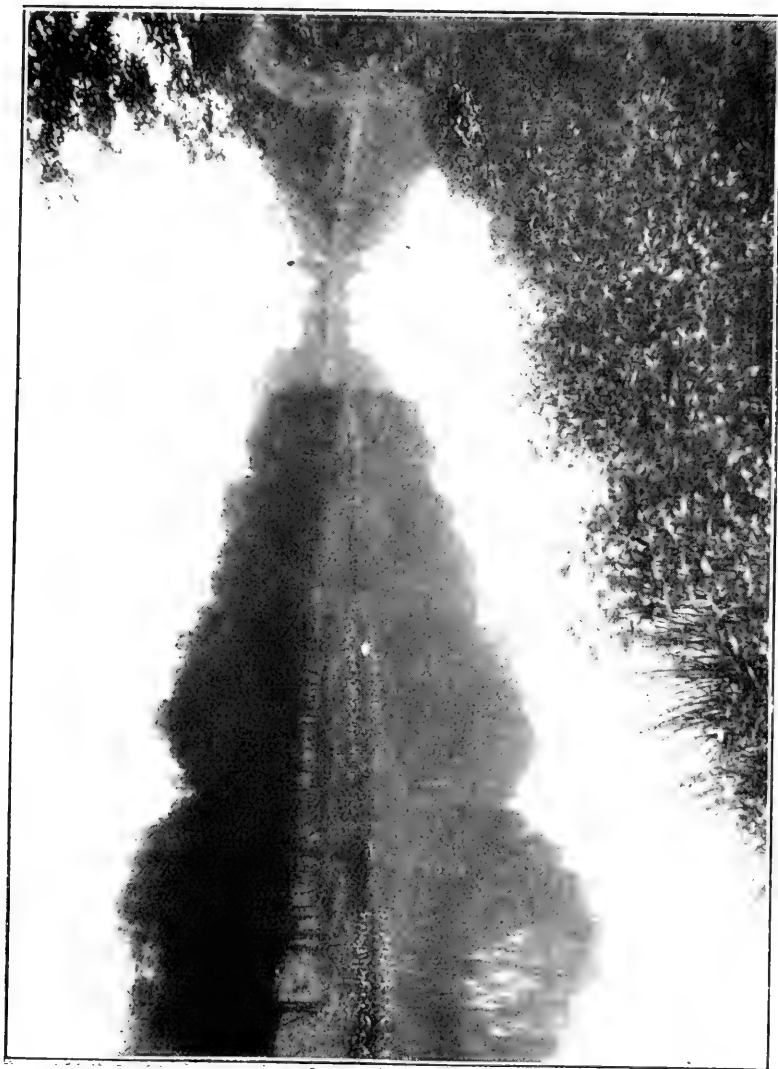

Fig. 5.

A ponded portion of the stream.

base of the cliff. After this erosion ceases, the plant succession is determined for a time by the slope of the cliff. At first, only shelf plants can gain a foothold. As the slope is reduced, the number of species is increased. After a time, though, when a soil of considerable depth has formed, the succession becomes biogenic. The plants hold the soil, and the reduction of slope proceeds very slowly, if at all, particularly after grasses become prominent. The slope of the gorge wall where it is covered with a mesophytic forest is but little gentler than that of the wall where only bushes occur. From the herb stage to the ultimate mesophytic forest, each plant stage prepares the way for the next in the succession by holding the soil, accumulating humus and furnishing shade.

The herb stage is succeeded by a bush stage. The most prominent species is *Rhus canadensis*, which often forms large colonies. *Cornus paniculata* and *Salix longifolia* are commonly associated with it. *Rubus*, *Ribes*, *Rhus toxicodendron*, *Vitis vulpina*, *Crataegus*, *Psedera*, *Ptelea trifoliata* and others occur, together with a number of species characteristic of the preceding stage, such as *Dipsacus sylvestris*, *Heracleum lanatum*, etc.

This shrub stage is probably very brief and pioneer trees soon appear. Two parallel tree stages appear. Considerable areas are found occupied by *Ulmus americana*, *Celtis occidentalis* and *Crataegus* spp. In other situations similar in all respects, *Cersis canadensis*, *Robinia pseudo-acacia* and *Prunus americana* dominate the vegetation. In both cases, the trees are accompanied by a large number of undergrowth herbs and shrubs, among them the following:

<i>Gleditsia triacanthos</i>	<i>Heracleum lanatum</i>
<i>Juglans nigra</i>	<i>Daucus carota</i>
<i>Cornus paniculata</i>	<i>Taraxacum officinale</i>
<i>Sambucus canadensis</i>	<i>Aster</i> spp.
<i>Ribes cynosbati</i>	<i>Verbascum thapsus</i>
<i>Vitis vulpina</i>	<i>Nepeta cataria</i>
<i>Psedera quinquefolia</i>	<i>Poa compressa</i>
<i>Menispermum canadense</i>	<i>Solanum nigrum</i>
<i>Dipsacus sylvestris</i>	

Following these two parallel stages appears the ultimate stage of the region, the mesophytic forest. This stage occurs only on the east bluff of the gorge, immediately above Test's Mills. That this forest is really

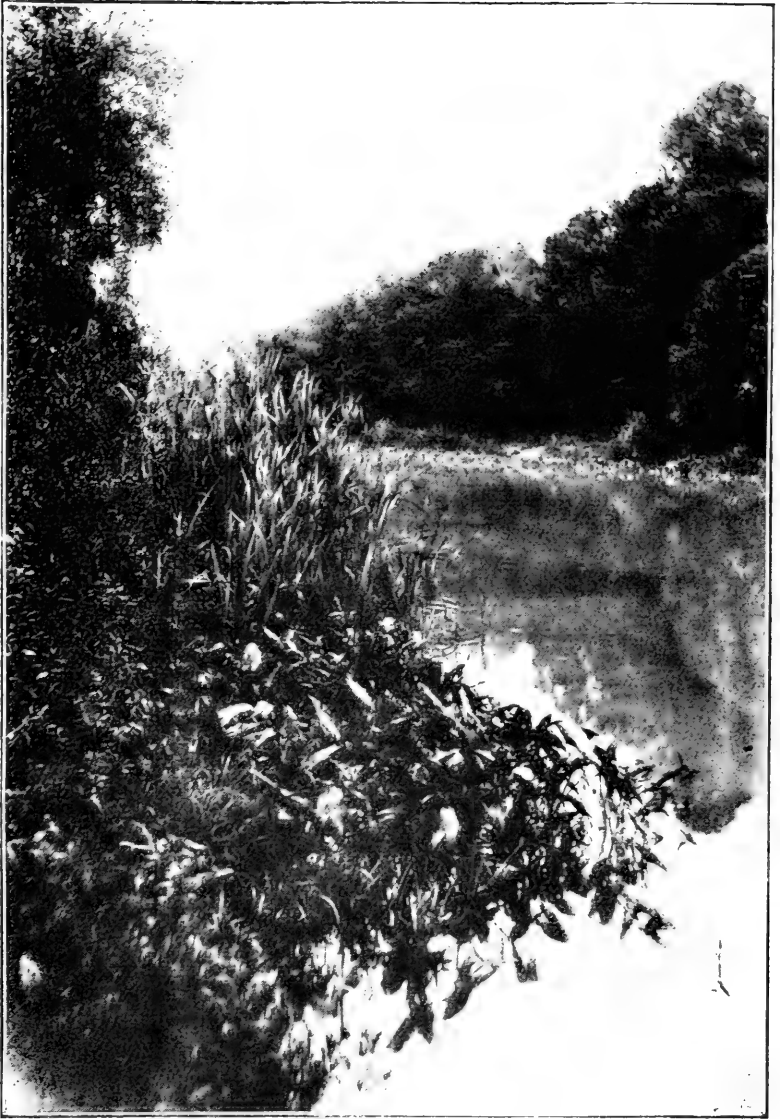

Fig. 6.

Border plants along ponded portion of stream.

mesophytic is shown by the presence of *Fagus grandifolia* and *Acer saccharum*, the latter being very abundant. This forest is rather open and this probably accounts for the absence of all ferns. *Polypodium* is found in similar locations in this region, however. Mosses are abundant on the ground and on fallen logs. The only liverwort is *Porella*, occurring abundantly on tree trunks near the ground.

In order to establish the fact that the forest represents the ultimate stage of the succession for this region, a primeval mesophytic forest near Williamsburg, Ind., about ten miles distant, was studied and a list of the species found there is given below. On this list, those species marked by an asterisk occurred also in the forest on the east bluff of the gorge at Test's Mills. A study of the list will lead to the conclusion that the ultimate stage of the succession has been reached here:

* <i>Carpinus caroliniana</i>	* <i>Carya ovata</i>
* <i>Fraxinus americana</i>	* <i>Ulmus americana</i>
* <i>Fagus grandifolia</i>	* <i>Ulmus fulva</i>
* <i>Aesculus glabra</i>	* <i>Tilia americana</i>
* <i>Ostrya virginiana</i>	* <i>Quercus alba</i>
* <i>Cornus florida</i>	* <i>Fraxinus quadrangulata</i>
* <i>Acer saccharum</i>	* <i>Celtis occidentalis</i>
* <i>Carya cordiformis</i>	* <i>Quercus rubra</i>
* <i>Ulmus racemosa</i>	<i>Aralia nudicaulis</i>
* <i>Asimina triloba</i>	* <i>Urtica gracilis</i>
* <i>Morus rubra</i>	<i>Polygonum virginianum</i>
* <i>Smilax hispida</i>	* <i>Bidens frondosa</i>
* <i>Psedera quinquefolia</i>	<i>Monotropa uniflora</i>
* <i>Ribes cynosbati</i>	<i>Epifagus virginiana</i>
* <i>Juniperus communis</i>	<i>Smilacina racemosa</i>
* <i>Vitis vulpina</i>	<i>Boehmeria cylindrica</i>
* <i>Rosa setigera</i>	* <i>Aristolochis serpentaria</i>
<i>Benzoin aestivale</i>	<i>Sanguinaria canadensis</i>
* <i>Rhus toxicodendron</i>	* <i>Solanum nigrum</i>
<i>Celastrus scandens</i>	<i>Polygonatum commutatum</i>
* <i>Menispermum canadense</i>	<i>Cryptotaenia canadensis</i>
* <i>Viburnum prunifolium</i>	<i>Actea spicata</i>
* <i>Sambucus canadensis</i>	<i>Viola pubescens</i>
<i>Mitchella repens</i>	<i>Monarda fistulosa</i>



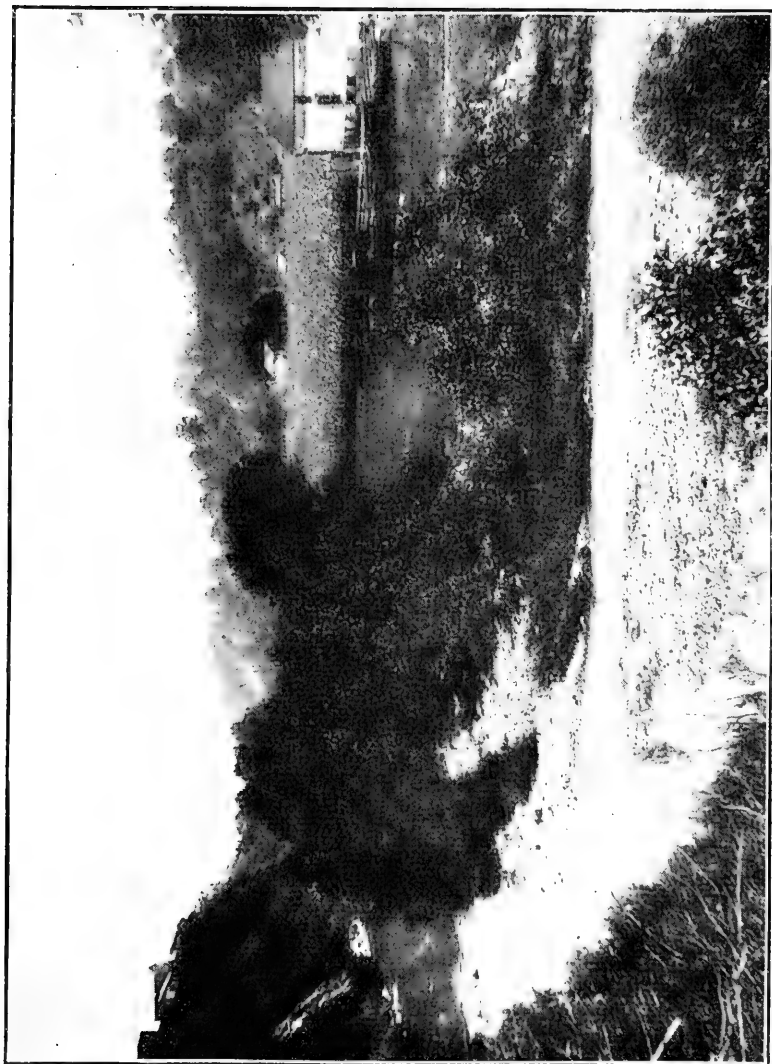

Fig. 7.

A. Xerophytic Floodplain.

<i>Hydrangea arborescens</i>	<i>Hepatica acutiloba</i>
* <i>Eupatorium urticaefolium</i>	<i>Arisema triphyllum</i>
* <i>Impatiens biflora</i>	<i>Botrychium virginianum</i>
<i>Impatiens pallida</i>	<i>Botrychium ternatum</i>
* <i>Galium</i> spp.	<i>Adiantum pedatum</i>
* <i>Viola cucullata</i>	<i>Polystichum acrostichoides</i>
<i>Aralia racemosa</i>	<i>Asplenium augustifolium</i>

In addition to the species indicated by asterisks, *Quercus prinus* and *Sedum ternatum* are prominent members of the vegetation of this stage of the bluffs.

Several narrow terraces occur along the sides of the gorge at various points. They vary in width from a few feet to as much as 200 feet, and one of these, on the east side of the river near the bridge at Test's Mills, is about half a mile in length. The origin of these was not investigated.

Rejuvenescence, that is, a return to pioneer conditions, may occur at any stage of the succession, if erosion of the base of the cliff is resumed by the river. In this case, the undercutting by the stream produces slumping, and the bare rock wall is soon exposed. This condition occurs at the foot of the east bluff, just below the small islands at the lower fall line. At this point the bluff had become mesophytic before erosion of the foot began again. We have here at the present time an extremely xerophytic bare rock face bordering directly upon a mesophytic forest. This xerophytic condition will continue as long as the stream erosion continues, and its area may even increase. When erosion ceases, the succession will begin again, and progress through the stages just described.

The ravines entering the gorge are small and comparatively few in number. The fact that the gorge is relatively young explains this in part. The smallness of the area draining into the gorge at this point is probably the principal factor, however. Clear Creek parallels the river on the west, and the divide between the two streams is less than half a mile west of the river. On the east, another small stream parallels the gorge at an even less distance. Accordingly the drainage of the area immediately around the gorge is largely accomplished by parallel streams which enter the river farther down. With two exceptions, the ravines are less than 200 yards in length, and are accordingly very steep. These two ravines have permanent streams, fed by springs. In the others, the rocks drip with seepage, but streams run through them only after rains.

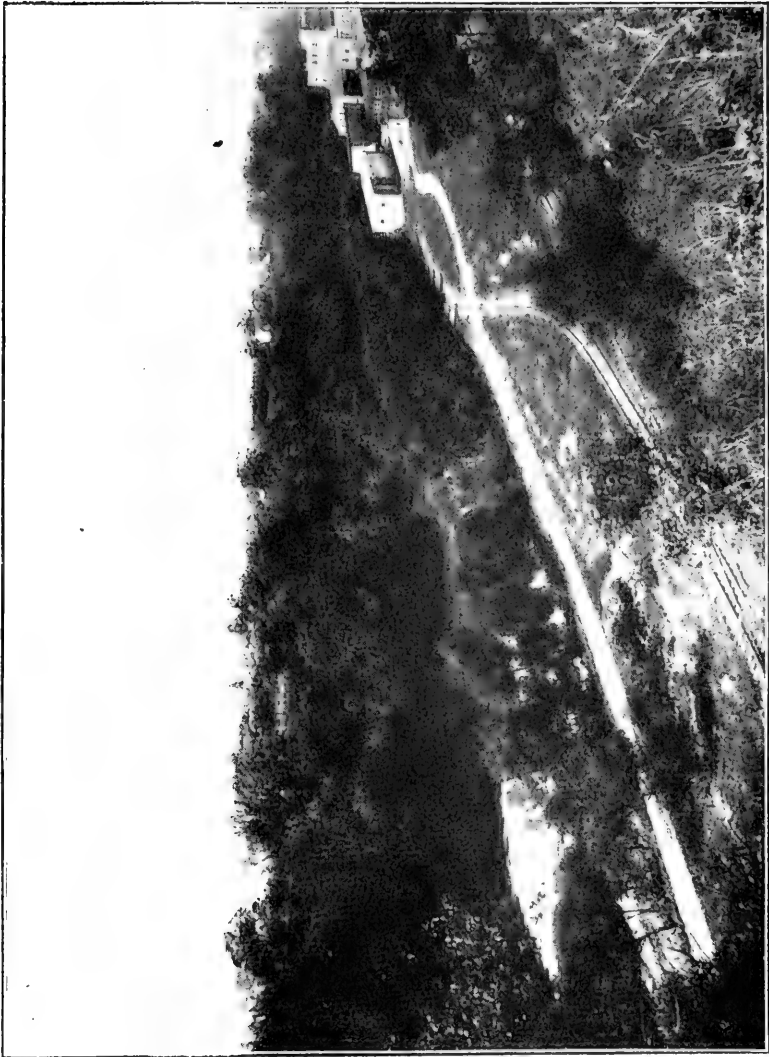

Fig. 5.

View across Gorge. Note nearly mesophytic forest on opposite bluff and border of *Salix nigra*.

All stages from young ravines, with conditions extremely xerophytic up to mature ravines with mesophytic vegetation are found.

The first stage of one of these ravines is merely a shallow groove down the side of the bluff, floored by the bare bedrock and partially choked by rock fragments. The debris accumulates as a cone at the foot. In this stage, a ravine is extremely xerophytic. Few if any plants grow within them, though a few appear upon the talus at the foot. The plants which do appear are the same as the pioneer plants on a cliff face.

The position of such a ravine seems to be determined almost entirely by the surface drainage outside the gorge. Wherever the topography of the surface outside the gorge causes the flood water to be discharged down the bluff, a ravine will be formed. Cleavage planes, which commonly determine the location of ravines in more massive rock, are absent. Seepage lines which often determine ravines in clay bluffs probably have little effect here, for they often occur on cliff faces where no tendency to ravine formation is evident. The rapidity with which a ravine will grow is of course dependent upon the water supply.

Older ravines are generally not regular in gradient, but become very precipitous in some parts, on account of the occurrence of occasional harder layers of limestone. This produces vertical faces from a few inches to six or eight feet in height, and these are usually wet with seepage or run-off from above. These ravines are usually quite deep and well shaded. Vertical faces of the kind described are commonly covered with *Cladophora* and *Vaucheria*. Where the water is contaminated by sewage, *Oscillatoria* replaces these. Mosses grow luxuriantly in these situations, but no liverworts grow anywhere in these ravines, with the single exception of *Porella*, which is common in mesophytic situations throughout the region. The absence of liverworts is difficult to account for, in view of the hydromesophytic conditions which prevail in such situations. *Fimbriaria* and *Fegatella* were found in abundance on damp rock shelves near Thistlethwaite's Falls, north of Richmond. *Aneura* and *Blasia* were found on clay in the same region. *Marchantia* occurs on rocks in similar localities near this point.

Why mosses should be so abundant and liverworts entirely absent in these ravines is difficult to explain. The finding of several genera of liverworts on similar rock shows that their absence is not due to the chemical nature of the rock. The older parts of the *Aneura* found on clay were stiff

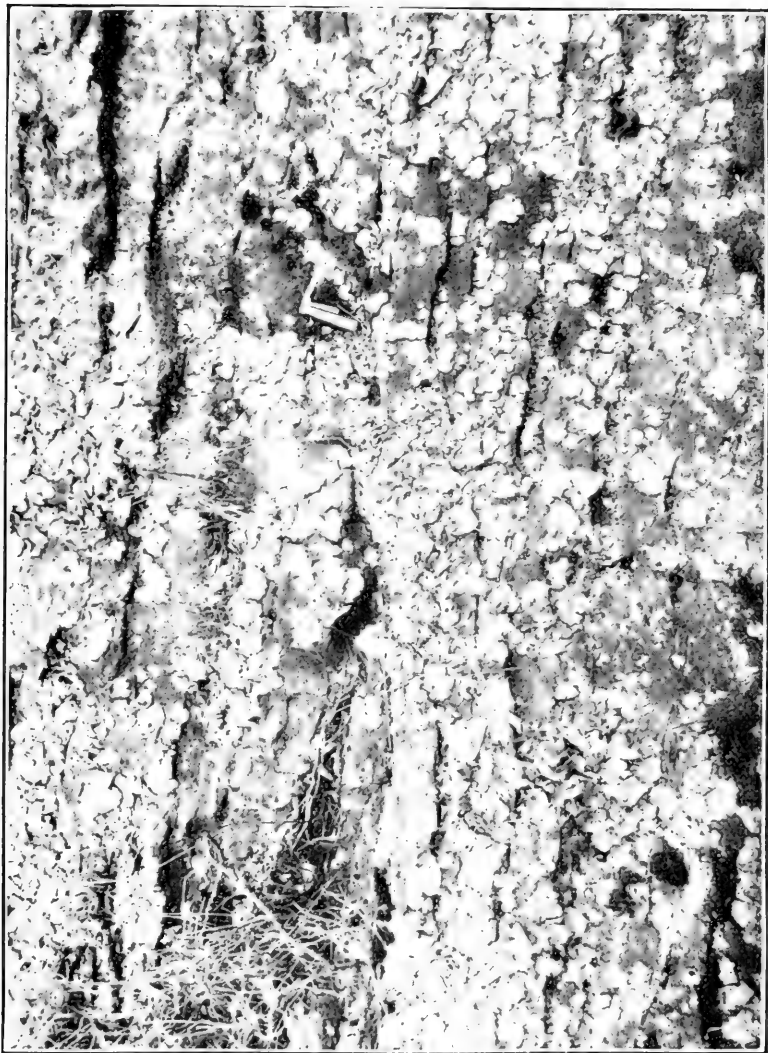

Fig. 9.

Niagara limestone at Elkhorn Falls. Compare character of rock and growth of lichens and mosses with that shown in Fig. 4

with incrustations of calcium carbonate from the seepage water. It is probable that the disintegration of the rock from weathering and stream erosion combined is too rapid to permit the liverworts to maintain a foothold.

The succession from the xerophytic first stage to the ultimate mesophytic stage is very rapid, more so than that of the bluffs. The narrowness of the ravines, the greater amount of shade, and the more constant water supply account for this. The stages passed through are essentially the same as in the case of the bluff.

It is to be noted, however, that until the ultimate mesophytic stage is reached the physiographic factors affect the succession, and that a purely biogenic succession never occurs. In this point the ravine succession differs from that of the bluffs, as already discussed.

That the ultimate stage of the ravine is mesophytic is indicated by the following list of species found in a typical ravine of the region.

<i>Acer saccharum</i>	<i>Vitis vulpina</i>
<i>Quercus prinus</i>	<i>Rhus Toxicodendron</i>
<i>Ostrya virginica</i>	<i>Rubus</i> sp.
<i>Acer negundo</i>	<i>Impatiens biflora</i>
<i>Fagus grandifolia</i>	<i>Impatiens pallida</i>
<i>Fraxinus americana</i>	<i>Ipomœa pandorata</i>
<i>Cercis canadensis</i>	<i>Lobelia syphilitica</i>
<i>Ulmus fulva</i>	<i>Sedum ternatum</i>
<i>Fraxinus quadrangulata</i>	<i>Ambrosia trifida</i>
<i>Gleditsia triacanthos</i>	<i>Viola cucullata</i>
<i>Celtis occidentalis</i>	<i>Eupatorium urticaefolium</i>
<i>Ulmus americana</i>	<i>Sambucus canadensis</i>
<i>Menispermum canadense</i>	<i>Hydrangea arborescens</i>

The successions of the gorge floor are quite as interesting as those of the bluffs and ravines. As already mentioned, the stream is ponded through a large part of the region studied. The conditions which have produced this result have been discussed. In the ponded portions, the water varies in depth from two to five feet, and consequently the current is very slow. As a result of this condition, a typical pond vegetation is found in a number of points within the area. *Sagittaria* and *Typha* are characteristic of this condition. *Scirpus americanus* occurs at a few

points. Submerged and floating plants are absent or unimportant. Below the sewers, *Oscillatoria* is the only form found. Above them, *Cladophora*, *Hydrodictyon* and *Potamogeton pectinatus* occur. Neither *Nymphæa* nor *Castalia* is found, probably because of sewer contamination, together with the rocky character of the bottom.

At a number of points, distinct zonation occurs. The succession may be described as composed of five stages, the first of which is always dominated by *Sagittaria*. *Typha* makes up the second stage, and is followed by *Bidens laevis*, which forms the third stage. Where zonation occurs this *Bidens* zone is always very definite, and usually extends from the edge of the water back two to ten feet. The fourth stage is represented by a zone dominated by *Ambrosia trifida* and *Eupatorium perfoliatum*. Other species are *Apocynum cannabinum*, *Bidens frondosa*, *Xanthium canadense* and *Verbena urticæfolia*. The final stage is represented by *Salix nigra*, *Platanus occidentalis*, *Vernonia noveboracensis* and *Aster novæ-angliæ*.

Where all five zones occur, they are very closely crowded together. In one instance all were clearly defined in a space of about fifteen feet. Telescoping of stages is common. In two instances, young willows were found in the midst of the zone of *Bidens laevis*.

The black willows form a very conspicuous feature of the floor of the gorge. They occur commonly in definite lines which parallel the stream at a distance of ten to fifty feet. A very striking example of this occurs just below the Starr piano factory, on the east side of the river. Other lines of trees of this species occur in similar locations farther down the river.

Hydrophytic flood-plains of the usual kind occur commonly in the floor of the gorge. These may be so low as to be covered by the river at every slight rise, or they may be above the level of the highest flood stage. At the main bend of the river lies a high flood-plain of very considerable size. Low hydrophytic flood-plains lie on both sides of the stream immediately at the Starr piano factory. These are narrow, being only a few feet in width at some places. These show a very characteristic vegetation, as shown by the following typical list of species:

<i>Salix nigra</i>	<i>Xanthium canadense</i>
<i>salix longifolia</i>	<i>Rudbeckia hirta</i>
<i>Populus deltoides</i>	<i>Bidens frondosa</i>
<i>Salix cordata</i>	<i>Polygonum virginianum</i>
<i>Ambrosia trifida</i>	<i>Helianthus strumosus</i>
<i>Impatiens biflora</i>	<i>Apocynum cannabinum</i>
<i>Impatiens pallida</i>	<i>Lobelia syphilitica</i>
<i>Rumex crispus</i>	<i>Cicuta maculata</i>

Later stages of the succession occur at other points. The succession is rapid, the flood-plains of this kind quickly become mesophytic. The large flood-plain at the bend of the river is thoroughly mesophytic, as shown by the vegetation of the undisturbed portions of it. It is to be noted, however, that the very narrow flood-plains of this type do not become mesophytic quickly, because of their submergence at every flood. By reason of the high gradient of the stream, the current is swift at flood time, and very little material is deposited. In this respect, these areas differ from the usual hydrophytic flood-plains.

A third feature of the gorge floor is the presence of numerous and well-defined flood-plains of a distinctly xerophytic nature. These occur commonly just below the fall lines, in distinction from those of the sides of the ponded stretches. The manner of their formation is easily seen. As already mentioned, the gradient of the stream is high, and at flood times the swift current carries considerable masses of rock and coarse gravel over the lower land immediately below the various fall lines. As a result, these flood-plains below the fall lines and at the curves of the stream are composed of gravel and rock fragments. The islands at the fall line near the lower end of the gorge are subject to the same conditions.

The vegetation of these areas is quite distinctive. On the upstream side, no plants occur for a considerable distance from the water's edge. This corresponds roughly to the bare lower beach of a lake or the ocean, and is the region that is covered by the slight rises of the river during the summer. The pioneer plants are usually *Xanthium canadense* and *Bidens connata*. Back of these occur *Salix longifolia*, *Platanus occidentalis* and *Populus deltoides*. Of these, *Platanus* is the typical species, and from the bluffs the xerophytic flood-plains may be picked out by the



occurrence of this tree, just as the mature hydrophytic flood-plains are indicated by *Salix nigra*.

Toward the downstream side of these areas, the horizontal succession proceeds rapidly toward mesophytic conditions. Soil accumulates around the trees and the bare rocks and gravel are soon covered. In these locations a rich mesophytic vegetation is found. The following species were noted in such a location :

<i>Salix nigra</i>	<i>Ambrosia artemisiifolia</i>
<i>Ambrosia trifida</i>	<i>Helianthus strumosus</i>
<i>Bidens frondosa</i>	<i>Eupatorium perfoliatum</i>

It is to be understood that the term "xerophytic" is here used in its broad sense, to indicate that the conditions of plant life are unfavorable in these areas. The extreme thinness of the soil will render water absorption difficult, however plentiful it may be. The range of temperature changes is larger than elsewhere. The trees and other plants are subject to partial submergence at every rise of the river. Perhaps the greatest actual injury comes from floating ice in the winter floods. Sycamores on a xerophytic flood-plain near the bend of the river were more than half cut in two by floating ice, and the upstream side of almost every trunk was dead. The willows commonly show a distinct leaning in the direction of the flow of the river.

We may summarize the results of the investigation as follows: Five distinct plant formations are recognized in the region studied, and each plant association may be referred to one of these five formations: (1) In the rock bluff formation, all stages of the succession from the bare, plantless cliff to a bluff covered by a mesophytic forest, are found within the area under consideration. (2) The same stages of the succession occur in the rock ravine formation. (3) A pond formation occurs at various points of the stream, and the stages of the succession from this condition towards mesophytism may be traced. (4) Definite hydrophytic flood-plains show the usual succession towards mesophytism. (5) Flood-plains of a xerophytic nature occur commonly. The succession to mesophytism in this formation is very rapid. In all of the formations, the trend of the succession is toward a mesophytic forest of the beech-maple type.



## REPORT OF CORN POLLINATION. II.

By M. L. FISHER.

The work reported in 1908 was continued in 1909. The seed from the different crosses reported in the Proceedings for 1908 was planted in 1909. In each lot a number of ears were self-fertilized by hand pollination.

d<sup>1</sup>. Boone County White, male; Reid's Yellow Dent, female.

Forty ears were pollinated. Four were pure yellow and thirty-six were mixed. In a count of 2,000 kernels from mixed ears, 204 showed pure yellow, 276 pure white, and 1,520 mixed white and yellow, often cream color. In this connection it is to be noted that it is difficult to tell when a kernel is pure white. The yellow tinge may be so faint that the most careful examination in a good light may not detect it.

d<sup>2</sup>. Stowell's Evergreen (Sweet), male; Reid's Yellow Dent, female.

Forty-seven ears were hand pollinated. None was pure sweet or pure dent. Thirteen showed earlier ripening than the others and were smaller in size. There seemed to be a larger proportion of sweet kernels on these ears. The stalks on which they grew were also earlier maturing and smaller in stature. A count of 2,000 kernels showed 322 white, 1,165 yellow, and 513 sweet. The sweet being recessive, the proportion agrees fairly well with Mendel's Law.

d<sup>3</sup>. Speckled, male; Reid's Yellow Dent, female.

Sixteen ears were pollinated. Four were pure speckled, twelve were not speckled. Most of those not speckled were pure red, and a few (3) were pure yellow. This also seems to be Mendelian.

d<sup>4</sup>. Reid's Yellow Dent, male; Boone County White, female.

The record of the number of ears pollenized has been lost or mislaid, but ears showed the same mixture of kernels as the reciprocal cross, d<sup>1</sup>. There were no pure ears. In 2,000 kernels there were 486 pure white, 1,306 mixed, and 208 pure yellow—a close resemblance to the results in d<sup>1</sup>.

Various selections were made from the above crosses for 1910 planting, but the data are not in readiness to report at this time.



## AN INVESTIGATION OF A POINT DISCHARGE IN MAGNETIC AND ELECTROSTATIC FIELDS.

By OSCAR WILLIAM SILVEY.

A year ago the writer<sup>1</sup> presented at the meeting of the Indiana Academy of Science a report of an investigation of the electric point discharge in a magnetic field of 1,500 gaussess. In this work it was found that the stream of air from the negative electrode was in no case deflected, and if the glow discharge existed between the points neither positive nor negative stream was deflected by a field of this strength.

The purpose of the present investigation was to repeat with a stronger magnetic field the work described in the previous report, to study the effect of an electrostatic field upon the path of the spark, and to determine if possible the nature and velocity of the particles composing the stream emitted from the points.

The apparatus used in this and the previous work was that constructed by Professor Foley and Mr. Haseman<sup>2</sup> for the investigation of interference fringes about a point discharge, air streams, and vapor streams. It consisted of a long wooden tube (Fig. 1), one part of which was made to telescope over the other part. This provided a means of separating the two parts for adjusting the points and magnet. Another portion (E, Figs. 1 and 3) containing a plate holder F was made to fit over the end. Black screens (Fig. 4) were placed at intervals throughout the tube so that no light would be reflected from the sides. The end of the tube was closed by a cap (C), which shut out all light except from a pinhole, as shown by Fig. 2. A circular disc with holes of various sizes provided a means of regulating the amount of light. A is a 90° arc light, the center of which is focused on the pinhole by means of the lens B.

Light was shut out of the tube by placing a piece of plack cardboard in front of the pinhole. When a photograph was to be taken, if the discharge was a glow or a brush, the slide S was drawn from over the plate, and after the tube had come to rest, the cardboard was removed until the

<sup>1</sup> Proceedings of the Indiana Academy of Science, 1909.

<sup>2</sup> Not yet published.

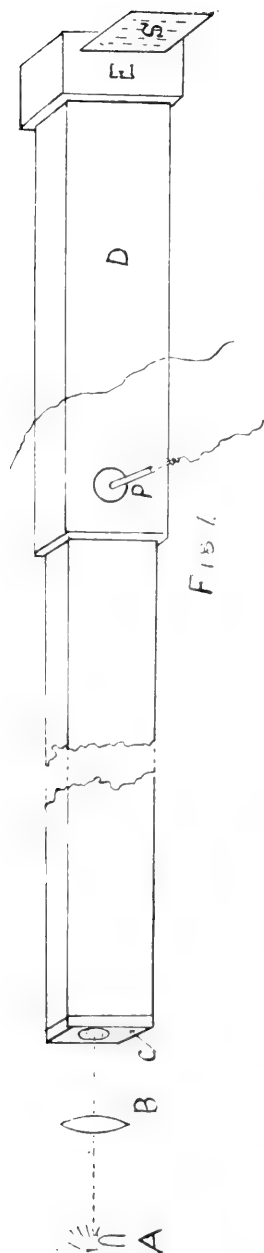
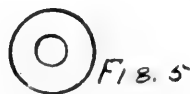
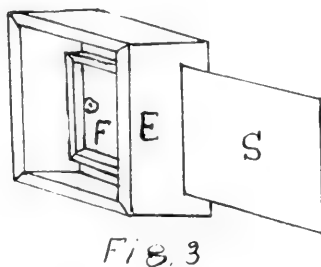
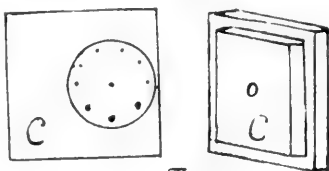

plate was sufficiently exposed. In case of the spark discharge which fogged the plate if exposed too long, the cardboard was first removed and the exposure made by withdrawing the slide.

The magnet used was of the Faraday type (photographs, Figs. 7 and 8), with pole pieces  $3\frac{1}{2}$  inches in diameter, and with a current of 22 amperes gave, midway between the pole pieces, when 49 mm. apart, a field strength of 6,400 gauss. Longitudinally through the cores and the pole pieces was a hole 2.54 cm. in diameter. If the holes were filled by placing in them an iron cylinder of the same material as the cores, and the air gap reduced to 1 mm., a field strength of 40,000 gauss for a current of 44 amperes could be produced. In most of the



following work the air gap was 49 mm. and the current 22 amperes. In order to obtain a photograph of the current which passed between the points transverse to the magnetic lines of force it was necessary for the

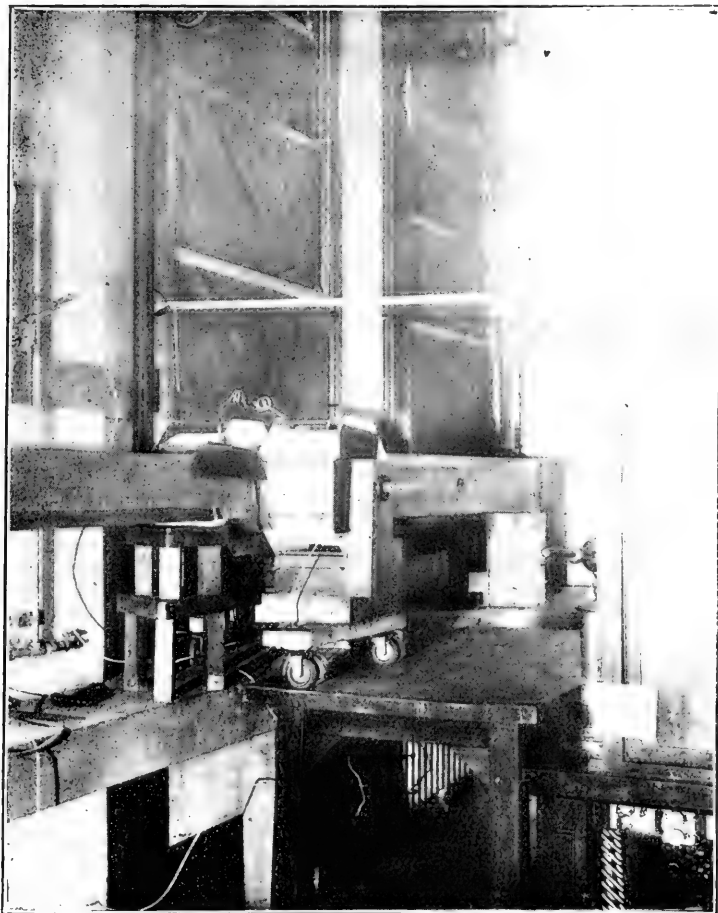

Fig. 7.

light from the pinhole to pass through the hollow cores of the magnet. This was accomplished by fitting the two portions of the tube against the magnet, as shown in photograph, Fig. 8. An auxiliary wooden tube 25 cm. square and 12.5 cm. long was placed between the coils of the

magnet to shut out all light except from the pinhole, and to hold rigidly the insulating glass tubes, which firmly held the rods containing the points. An opening was cut in the upper side of this auxiliary tube and a suitable

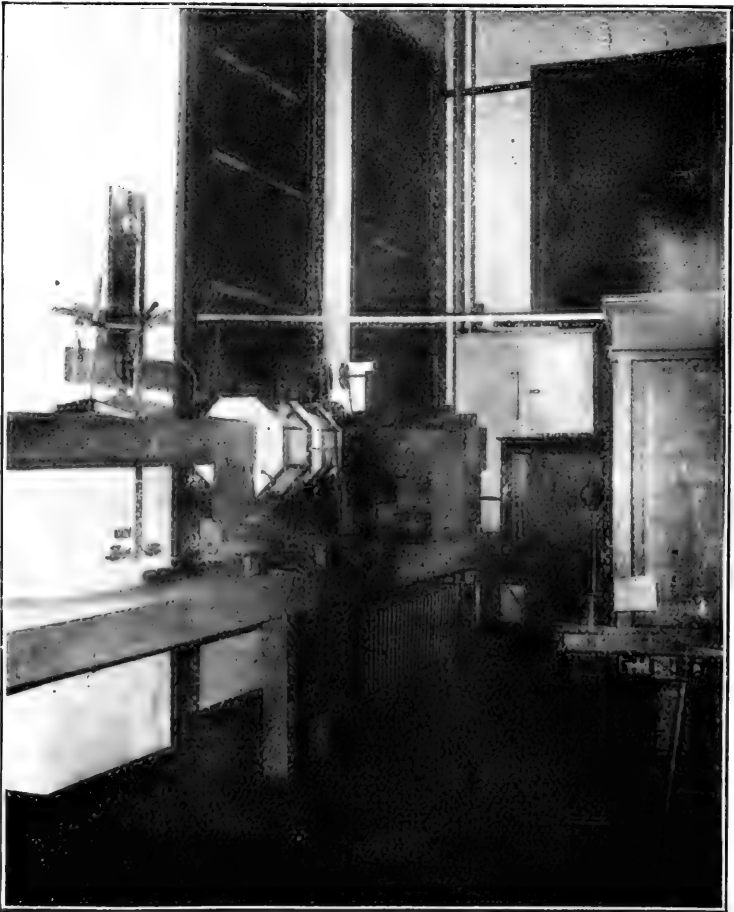

Fig. 8

cap provided, so that one could easily open it to adjust the points, or to observe the nature of the discharge. The inside of all portions of the tube and the inside of the hollow cores were painted a dead black.



When a photograph of the discharge parallel with the lines of force was desired, the magnet was turned with its axis perpendicular to the axis of the tube, and the glass tubes, held in position by corks in the hollow cores, provided insulation for the rods holding the points. In this case also an auxiliary tube 12.5 cm. square and 1 meter long was placed between the coils and telescoped into the two portions of the longer tube which were too large to fit between the coils. This small tube had a circular hole in each of two sides to receive the pole pieces of the magnet, and another in the upper side similar to the one in the first auxiliary tube described.

In all cases the magnet was electrically connected to earth and the wires bearing the current were separated from the walls of the room and from the camera by means of glass tubing, when they were too near for the air to insulate them. All metal parts used in the magnetic field, such as screws in the auxiliary tubes, were of brass.

When studying the deflection of the discharge due to electrostatic deflection, the tube was used as shown in Fig. 1. Two brass plates 8 by 5 cm. were placed one above the other below the points. They were held in position by brass rods soldered perpendicularly to them at the center. The rods were firmly fitted into glass tubes which passed through the upper and lower sides of the tube. For part of the work the plates were connected electrically in multiple circuit with the points, while for the other part they were charged by means of a small Holtz machine. The points were charged by a four-mica plate Wagner electrostatic machine, from which the Leyden jars had been removed. Both the Wagner and the Holtz machines were run by electric motors with rheostats in circuit for varying the speed. Sixteen different speeds were possible with the Wagner, and eight with the Holtz machine.

The points were made of brass pins 1.15 mm. in diameter and 4 cm. long. They were put in a lathe, sharply pointed by means of a carborundum stone, and made to slope 2.5 cm. from the end. They were soldered into the ends of brass rods 5.57 mm. in diameter.

#### TRANSVERSE MAGNETIC FIELD.

The apparatus was first adjusted with the points at right angles to the direction of the magnetic lines of force and the photographs of series A, B, C and D were taken.

PLATE I. TRANSVERSE MAGNETIC FIELD.

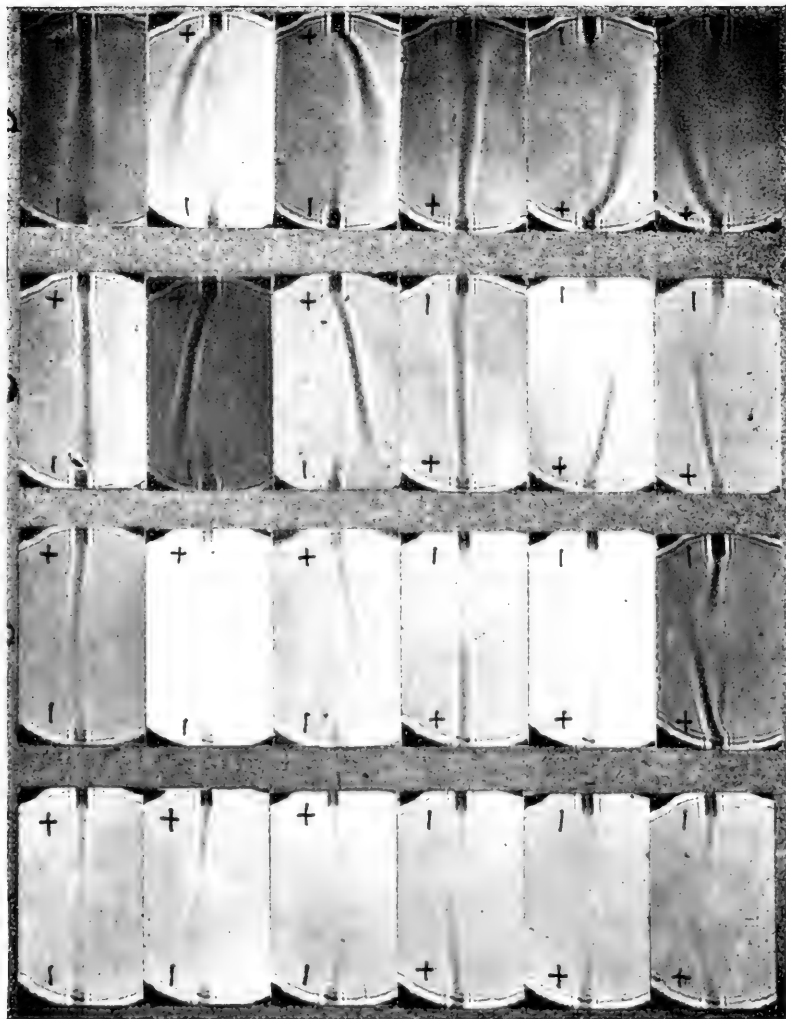

No. 1.

No. 2.

No. 3.

No. 4.

No. 5.

No. 6.

D

C.

A

No. 1. Current 1st, No. 4. Current 2nd direction, magnetism (none).  
 No. 2. " " " " " " " " 1st direction.  
 No. 3. " " " " " " " " 2nd " "

Series A is a glow discharge representing the lowest speed of the machine. (Nothing was visible between the points in the darkened tube. Each point showed a tiny bright speck.)

Series B is a brush discharge representing a higher speed. (A violet stream extended about 0.8 cm. from the positive point. The negative point showed only a bright speck.)

Series C is a visible spark discharge representing the lowest speed at which a visible spark is maintained. The spark was changed to brush when the magnet was excited.

Series D is a visible spark discharge representing the highest speed of the machine.

The six numbers of each series were taken in succession as rapidly as possible, it requiring 20 to 30 minutes to complete the series. In the photographs, the longer stream is the one from the positive terminal and the shorter one the stream from the negative electrode. If the positive stream is from right to left it is designated as the first direction; if from left to right as second direction. Nos. 1, 2, 3 then show current in the first direction, while Nos. 4, 5 and 6 show current in the second direction. If the magnet was excited so that the sense of the lines of force was from back to the front of the photograph (i. e., after correcting for the reversal in direction caused by printing from the plates), the magnetization is designated as first direction and those with the lines of force from front to back of the page are designated as magnetized in the second direction. Following then this plan, Nos. 2 and 5 show the current in a field of the first direction, while Nos. 3 and 6 show the current in a field of the second direction, and Nos. 1 and 4 show it when the magnet was not excited. It may be observed from the photographs that the streams in series A, B, C and D are deflected as if they were flexible conductors bearing a current in so far as direction of deflection is concerned, thus indicating that the stream is one of charged particles.

The magnetic field strength, measured by a bismuth spiral, was about 6,400 lines per sq. cm. in the region of the points. The points were 18.05 mm. apart. The potential of the points was the highest for series B and did not increase as the speed increased, as was suggested in the earlier work. The potential increased with the speed only until the sparks began passing, when it fell sometimes as much as 4,000 volts. When the speed was further increased, the current increased but the potential remained

practically constant. The following table shows the changes which occurred as the speed of the machine was increased:

Potential expressed in volts, current expressed in amperes. Distance between points, 18.05 cm.

TABLE I.

Speed	Voltage before magnet was excited	Voltage with Magnetism	Current no Magnetism	Current with Magnetism	Type of discharge Effect of magnetism on form of discharge
1	23000	24000	.00014	.00014	Glow discharge.
2	24500	24500	.00017	.00017	" "
3	25300	25300	.00021	.00021	Small brush at anode.
4	26200	26200	.00025	.00025	Increased brush at anode.
5	26500	26500	.00029	.00029	Occasional spark.
6	27000	28300	.00035	.00035	Spark changed to brush by magnetism.
7	25300	28300	.00037	.00037	" " " " " "
8	24000	28300	.00044	.00044	" " " " " "
9	23000	28300	.00052	.00049	" " " " " "
10	22800	28300	.00059	.00054	" " " " " "
11	22800	28300	.00058	.00056	" " " " " "
12	23000	28300	.00065	.00059	" " " " " "
13	22800	28300	.00072	.00069	" partially changed to brush by magnetism.
14	22300	26500	.00078	.00076	" " " " " "
15	22300	25000	.00083	.00083	Path curved but spark not stopped.
16	22300	25000	.00086	.00084	" " spark scattered.

In the above table, the current was measured by means of a Weston milli-ammeter, and the potential by means of an electro-scope. This electro-scope was made of two brass discs 10 cm. in diameter mounted in vertical planes on ebonite supports which were fitted to a common base. The distance between the plates could be varied by moving the supports. At the top of one of the discs was soldered a support holding a small needle upon which was suspended a brass vane which carried a pointer at the lower end. The pointer moved in front of a scale which was calibrated by connecting in multiple with the discs two No. 12 Thomas Harper needles (sharps), measuring the critical spark length between them and comparing with the table prepared by H. W. Fisher.<sup>3</sup> The position of the pointer was read through a telescope placed two meters in front of the scale. The potential read by this apparatus amounted to only a rough estimate, since it could not safely be trusted nearer than 150 volts. This was especially true when the sparks did not pass rapidly in succession because the vane

<sup>3</sup>H. W. Fisher, Transactions of International Electrical Congress, Vol. 2, pp. 294-312, St. Louis, 1904.

vibrated, rising almost to the critical spark potential, and falling almost to zero. In this case the mean position was recorded.

It may be observed from the above data that when the form of discharge was not changed by the magnetic field, there was no change in the current or the potential, and that when the form of discharge was changed there was an increase in the potential, and often a decrease in the current. The photographs of series A correspond to speed 1, B to speed 4, C to speed 6, and D to speed 16.

#### LONGITUDINAL MAGNETIC FIELD.

After taking the above data the magnet was turned through an angle of  $90^\circ$ , and four series of photographs taken of the discharge parallel with the lines of force. These are as follows:

E—silent glow discharge same as A.

F—brush discharge same as B.

G—spark discharge same as C.

H—spark discharge same as D.

Distance between points, 17.88 mm.

Of these photographs, none show a change of form except those of series H. In this case the rich spark was sometimes scattered, and sometimes transformed to a wide violet brush at the positive point when the magnet was excited. In the first case it generally consisted of a visible, undeflected central thread, with spiral thread encircling it like the threads of a tapering screw, the larger diameter of the spiral being at the positive point, and all merging together at the negative terminal. Sometimes, however, the central thread was absent and only the spiral showed. The sense of the rotation of the spiral was the same as that of the halo of luminous gases about the spark of an induction coil in a longitudinal magnetic field. In degree of deflection it was much less. In the case of the discharge studied here, the spiral was only a few millimeters in diameter in a magnetic field of 6,400 gausses, while the halo about the spark of an induction coil showed a spiral of four or five centimeters in diameter in a field of about 1,000 lines per square centimeter. Photographs 3 and 5 show the point discharge when the positive ions move in the same direction as the lines of force, while in Nos. 2 and 6 the magnetic field is in the opposite direction to that of the discharge. Unless there was a change of form of discharge, no change of potential nor of current occurred when the magnets were excited. Some changes of potential with transformation of form of discharge are as follows:



TABLE 2.

Speed	Voltage before Magnet was excited	Voltage with Magnetism	Type of discharge Effect of Magnetism on form of discharge
1	21500	21500	Glow.
2	22000	21850	Small brush.
3	22500	22000	Occasional spark.
4	20000	22500	Changed to brush by magnetism.
5	22500	22500	No change.
6	20000	22500	Changed to brush.
7	18800	26500	" " "
8	18800	24000	" " "
9	18800	23500	" " "
10	18800	18800	No change.
11	18150	25000	Changed to brush.
11	18150	18150	Not changed to brush.
12	18150	18150	No change.
13	18150	24000	Changed to deflected scattered sparks.
14	18800	25000	Changed to brush.
15	18800	24000	Scattered deflected sparks.
16	18500	25000	Changed to brush.

The above table shows that there is no regularity in the changes in the discharge due to the influence of the magnetism. In No. 11 the spark discharge was entirely changed to brush for a while, then broke into a spark again, changing sometimes two or three times per minute. When the exciting current was stopped the sparking was again resumed. In the many complete sets of readings similar to the above it was found that this change appearing in No. 11 occurred for any of the spark discharges, but the actual condition that caused it was not discovered. One could not foretell when the discharge would be altered by the influence of the magnetism. Series  $H_2$  shows photographs of the same sort of discharge as  $H_1$ , in which there was no change due to magnetism. These were taken twenty-four hours later than those of  $H_1$ , and on this particular day no change occurred in the discharge, when the current was in the direction shown in  $H_2$ , while on the previous day, with the same conditions in so far as apparatus was concerned, the spark was changed to brush every time the exciting current was closed, regardless of the direction of the magnetism. In series  $H_2$  the spark was changed to brush by the magnetism when the other point was made positive, the photographs being like the corresponding ones of series  $H_1$ .





## TRANSVERSE ELECTROSTATIC FIELD.

The magnet was then removed and the deflection of the discharge studied in an electrostatic field. With the apparatus as previously described and with the electrostatic plates, the points and the electroscopes shunted in parallel circuit, the four series of photographs I, J, K and L were taken. The following is a record of the potential and the current in each case, the forms of discharge for series I, J, K and L corresponding to those of A, B, C and D respectively:

Distance between points, 18.05 mm.

TABLE 3.

No. in Series	Charge on bottom Plate	Sign of Right hand point	Potential in Volts	Current in Amperes		
I	1	none	+	17850	.00019	
	2	+	+	17700	.00019	
	3	-	+	17600	.00016	
	4	none	-	16270	.00016	
	5	+	-	15150	.00015	
	6	-	-	16270	.00015	
J	1	none	+	18900	.00027	
	2	+	+	19425	.00036	
	3	-	+	19500	.00036	
	4	none	-	14700	.00026	
	5	+	-	17400	.00026	
	6	-	-	17250	.00026	
K	1	none	+	16800	.00039	
	2	+	+	17700	.00051	
	3	-	+	19200	.00052	Changed to brush.
	4	none	-	15600	.00052	
	5	+	-	17900	.00052	
	6	-	-	18370	.00051	Partially changed to brush.
L	1	none	+	16725	.00092	
	2	+	+	18000	.00089	
	3	-	+	17700	.00091	
	4	none	-	13950	.00088	
	5	+	-	16875	.00094	
	6	-	-	16800	.00090	

The variation of the potential and current in any series in the above table except for (3 and 6) K, was due to a decrease of speed of the motor. This was caused by a drop in potential when a large current was used in

some other part of the building. It required at least two hours to complete the four series. The current and potential were read just before the photographic plate was exposed.

## ELECTROSTATIC AND MAGNETIC FIELDS.

The magnet was again placed in the position so that the line of discharge between the points was transverse to the magnetic lines of force, and with the electrostatic plates above and below the points, an attempt was made to balance the effect of the electrostatic field against that of the magnetic field. In this work the plates were charged by a Holtz machine with plates 43 cm. in diameter. A ground glass placed in the end of the camera opposite the pinhole showed clearly the path of discharge. The speed of the Holtz machine and the strength of the exciting current of the magnet were then regulated until the stream under the action of both fields was the same as when no field influenced it; then, the ground glass was removed and was replaced by a photographic plate. Two series of these photographs are shown here, M, for the spark discharge which, under the influence of magnetism alone was changed to brush, and N for the rich spark. It was not difficult to balance the two fields in the case of the rich spark, but with the unstable spark they were not successfully balanced. Sometimes with this type a very low magnetic field seemed to predominate over the electric field. This, if true, conforms with the statement made in the previous report that the magnetic effect is greatest when the discharge is on the verge of changing from one form to the other. Data as follows:

Distance between points, 18.05 cm. H is the magnetic field strength in gausses.

TABLE 4.

	Distance between Plates in cm.	Potential Difference in Volts	Potential Gradient = X	H	Velocity of Ion	Form of Discharge	Values for $\frac{e}{m}$	
1	5.4	14600	2710	4300	$6.3 \times 10^7$	small brush	$7.8 \times 10^2$	Series M Series N
2	5.4	14600	2710	4300	$6.3 \times 10^7$	occasional spark	$7.5 \times 10^2$	
3	5.4	15000	2780	2550	$1.9 \times 10^8$	" "	$7.1 \times 10^3$	
4	5.4	15000	2780	3890	$7.4 \times 10^7$	rich spark	$1.2 \times 10^3$	
5	6.1	26830	4360	1600	$2.7 \times 10^8$	spark	$1.36 \times 10^3$	
6	6.1	26830	4360	1600	$2.7 \times 10^8$	rich spark	$1.36 \times 10^3$	

PLATE IV. ELECTROSTATIC AND MAGNETIC FIELDS.

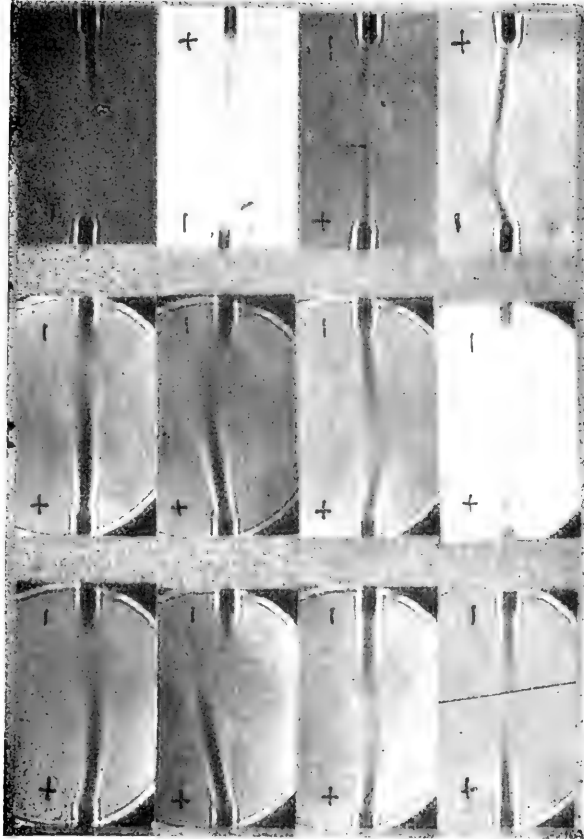

No. 1.

No. 2.

No. 3.

No. 4.

M

N

O

No. 1. (M and N) magnetic and electrostatic fields opposed.  
 No. 2. (" " " ) deflected by electrostatic field.  
 No. 3. (" " " ) magnetic " "  
 No. 4. (" " " ) neither magnetic, nor electrostatic field.  
 Nos. (1 and 3) O discharge undisturbed.  
 Nos. (2 and 4) O " deflected by air stream.

It seems probable that the speed of the ion might be calculated from the relative deflection of a similar form of discharge under influence of the magnetic and electrostatic fields separately. The distance between the points was the same in both cases and therefore the potential at the points would, no doubt, remain of the same order, even though there was some change. On the photographs a line may be drawn directly between the points, and a second line drawn through the extremity of the negative electrode perpendicular to the first line. If then a third line is drawn from the positive point in the direction of the deflected stream and extended to meet the second line, the distance to the intercept of the second and third lines from the extremity of the negative electrode should be proportional to the deflection. Taking the distance to this intersection for the upward deflection, we have:

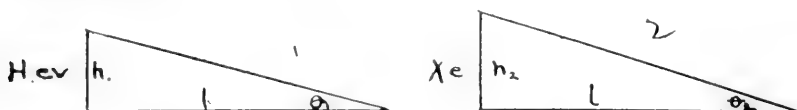

$Hev = K \tan \theta_1$ , in case of the magnetic effect where  $H$  is the magnetic field strength in gauss,  $e$  the charge on the ion,  $v$  the speed of the ion,  $\theta_1$  the angle of deflection, and  $K$  is a constant which depends on the potential drop along the path of discharge.

In case of the electrostatic deflection,  $Xe = K \tan \theta_2$  where  $X$  is the potential gradient between the electrostatic plates and  $\theta_2$  the angle of deflection.

Solving each equation for  $K$  we have

$$K = \frac{Hev}{\tan \theta_1} = \frac{Xe}{\tan \theta_2}$$

If the  $h_1$  and  $h_2$  are the distances from the negative point to the intercept in the two cases, and  $l$  the distance between the points, we have

$$(Hv \tan \theta_2 = X \tan \theta_1), \quad \frac{Hvh_2}{l} = \frac{Xh_1}{l}, \quad \text{and } v = \frac{h_2 X}{h_1 H}$$

Since the discharge does not always pass directly between the points when no transverse field exists, it would probably be more accurate to take the average value of  $h$  for the upward and downward deflection. Making

the suggested measurement in case of photographs 2 and 3 of series A and 2 and 3 of series I, we have

$$V = \frac{2.8 \times 17600 \times 10^5}{3.2 \times 5.1 \times 6400} = 4.7 \times 10^7 \text{ cm. per. sec.}$$

Values for other photographs calculated by the same method appear in Table 5.

The above values for the speed of the positive ions approximate those given for positive ions in rarefied gases. The highest value obtained by other investigators for the gaseous ion at atmospheric pressure, found recorded by the author, is by Helen E. Schaefer of  $5 \times 10^4$  cm. per second. Her value, obtained by use of a rotating mirror, is given as the average speed along the spark path, and not the initial speed obtained by the method used in this investigation.

The curved path of the stream in series D can not be considered in connection with the ordinary formula for centripetal force in solving for a value for the ratio of the charge to the mass, because here the ion is under the influence of the charge on the opposite point. If, however, the value obtained by the above method can be regarded as the initial speed of the positive ion the equation  $\frac{1}{2} m v^2 = Ve$  can be used to calculate the value for  $\frac{e}{m}$ . In the above equation  $m$  is the mass of the ion,  $v$  its speed,  $V$  the potential between the points and  $e$  the charge on the ion. Since  $v$  is the initial speed the two expressions for the energy are independent of the course taken by the ion between the points, and also independent of any subsequent speed. Some values of  $\frac{e}{m}$  calculated by means of this expression are as follows:

$$\text{Series A Nos. 2 and 3) } \frac{e}{m} = \frac{1}{2} \frac{v^2}{V} = \frac{1}{2} \frac{(4.7 \times 10^7)^2}{23000 \times 10^5} = 4.6 \times 10^2 \text{ cm. per. sec.}$$

TABLE 5.

Series.	Nos. in Series.	Speed $v$ in cm. per. sec.	$\frac{e}{m}$
A and I	2 and 3	$4.7 \times 10^7$	$4.6 \times 10^2$
A " I	5 " 6	$1 \times 10^8$	$2.17 \times 10^3$
B " J	2 " 3	$2.6 \times 10^7$	$1.3 \times 10^2$
C " K	2 " 3	$6 \times 10^7$	$6.7 \times 10^2$
C " K	5 " 6	$2.7 \times 10^7$	$1.3 \times 10^2$
D		$1.6 \times 10^8$	$5.12 \times 10^3$

The average speed of all results is used in determining the value of  $\frac{e}{m}$  given for series D. The values for  $\frac{e}{m}$  column 4 are calculated for series A, B, C and D only. The values for  $\frac{e}{m}$  given in table 4 are determined in the same manner as shown above.

A great variation exists in the calculated values of the speed, and consequently in the determination of  $\frac{e}{m}$ . One cause for this is, no doubt, the error introduced in measuring the potential. Also since the measurement of speed is determined by deflection, a large error may be introduced, due to convection currents, due to the heated air along the course of the spark, and to disturbances of the air due to rapid changes of pressure along the spark path.

It may be observed that the path of the stream from the point (except in case of the spark discharge in the magnetic field), is a straight line and not a curved path. There is very little if any bending to meet the opposite point. If we consider the stream as composed entirely of ions we might explain this phenomenon by supposing that the ions either lose their charge immediately after leaving the points, or by assuming that each ion is given a constant acceleration in two directions at right angles to each other. Another view may probably be taken in which the photographed stream is considered to be a mixture of ions and air molecules under different pressure than the surrounding air, hence having a different index of refraction. The ions start at a high speed from the point in a direction which depends on the influencing fields. They soon encounter molecules of air imparting their speed to a great extent to the air molecules. This bombardment on the air molecules tends to ionize them and to raise their temperature and the original ions, with the ionized and un-ionized molecules of air continue a short distance at least, in the original direction. The unionized air particles would continue along this line until scattered by encountering new molecules, while the ions, too much scattered, and with speed too much decreased to produce a well defined air current, travel by some other route to the opposite electrode.

This view explains the apparent contradiction that, although there must be a carrier of electricity between the points, the photographed stream does not terminate on the opposite point. In case of the rich spark,

which takes on more and more the form of an arc as the speed of the machine increases, the air insulation is broken down, the air is more highly heated and more highly ionized along the spark path, and a greater number of ions will travel along this narrow path with great speed and due to the outer ones encountering the air molecules, the stream will follow more nearly the curvature of the spark. Farther from the point their speed becomes so small and they become so much scattered, they do not set up a stream so well defined. This same hypothesis applies to the explanation of the scattered stream when it was deflected by an electrostatic field. The stream retains practically its original diameter past the opposite terminal for the magnetic deflection in case of the glow and brush discharge, and although scattered may be traced nearly to the opposite point in the spark discharge. In case of the electrostatic deflection, the discharge without the transverse field is quite as well defined as those of the magnetic deflected series, while with the transverse electrostatic field the stream is short and not so well defined. If the ions moving with great speed start from the point, and soon by their bombardment start a current of air, at the same time lowering their own speed, they will certainly be scattered, part of them going to the oppositely charged plates, and part to the opposite point.

If the majority of the negative ions are considered to be ordinary electrons and those from the positive point equal in mass to the hydrogen atom, the kinetic energy of the positive ions will be far greater than the negative. They will therefore carry with them a greater current of air. Perhaps it may be permissible to assume that the negative ions are not all single electrons, since it has been shown by J. J. Thomson<sup>4</sup> in case of discharge in rarefied gases, that negative ions exist nearly equal in mass to the positive ions, and have the same initial speed. The greater the per cent. of these large ions the greater will be the amount of air set in motion, the greater the velocity of the stream as a whole, and the more defined the stream. If, then, the assumption is made that the stream is produced by the larger ions, it explains the equal deflection of the positive and negative streams in case of the magnetic deflection.

A few of the photographs show peculiar characteristics. In some there are two streams from the positive point. It was not learned whether

---

<sup>4</sup>J. J. Thomson (Phil. Mag. Ser. 6, Vol. 16, pp. 657-691), 1908; also (Phil. Mag. Ser. 6, Vol. 18, pp. 821-844), 1909.

this was caused by two branches of the discharge, or by a change of direction of the discharge during the exposure, but the clear interference bands about the stream indicate that the former is correct. Another is the peculiar deflection of the negative stream of No. 6 F. Many photographs were taken and many observations were made with the ground glass in an attempt to secure a duplicate of this, but with no success.

In the previous work the negative stream was not deflected by a magnetic field of 1.500 gaussess, but in this the deflection was well shown where the stream is clear enough. The negative stream is in very few cases as long or as well defined as the positive. Also in the previous work, it was found that if the knobs of the electrostatic machine were placed sufficiently close together, a spark passed between them, while between the points there was a violet stream, which was not shown on the plate or perceptibly deflected by the magnetic field. An attempt to deflect this stream with a stronger field was not successful.

In repeating the work of Precht<sup>1</sup>, particular attention was given to his observation with the point cathode and the blunt wire anode, that the spark changed to brush and the potential rose when the magnet was excited. The writer found that this change occurred in a great majority of the observations made, but it was found to occur also in as great a per cent. of the observations, whether the discharge passed between the points, point anode and blunt wire cathode, or point cathode and blunt wire anode, whatever the sense of the magnetism with reference to the current. In a few cases a brush would break into a rich spark, but all attempts to determine the conditions which caused the changes were unsuccessful. In the previous report it was suggested that in case of the discharge between two points the change in type of discharge might be explained as a result of a change of the spark length, but after repeating the experiment it was concluded, as was suggested by Precht<sup>2</sup>, that although the length of spark path might be partly the cause, it was not the whole cause. No attempt was made to reproduce the exact condition of Precht's experiment either in the form or size of the point, but no doubt if these had been fulfilled the atmospheric and other conditions would have entered which would have made the results variable because with no part of the apparatus altered in any way entirely opposite transformations were found to exist on different days.

---

<sup>1</sup> J. Precht, Wied. Annalen (66-4, pp. 676-697), 1898.



As a final study three mg. of radium bromide were placed beneath the points, in an attempt to change the form of discharge, as described by A. E. Garrett<sup>6</sup>, for discharges between blunted wires. The radium, which was contained in an unstoppered glass tube, was held by an ebonite rod so that both  $\alpha$  and  $\beta$  particles might reach the air in the path of discharge. No effect was observed except that which could be produced by a glass rod in the same position.

#### SUMMARY OF RESULTS.

A summary of the results, as given in this and the previous report, is:

(1) The positive stream between the points for a spark or brush discharge was deflected by a magnetic field as low as 1,000 gauss, and both positive and negative streams for glow, spark and brush discharge were deflected by a magnetic field of 6,400 gauss. In all cases the direction of deflection was in accordance with electro-dynamical laws.

(2) In most cases a change of type of discharge, and an increase of potential between the points was caused by excitation of the magnet.

(3) The direction of the photographed stream for a spark discharge as it leaves the point is the same as the visible direction of the spark.

(4) The size of the stream at the points (measured with a micrometer microscope between the outer edges of the central dark band) is independent of the potential between the points.

(5) The stream was deflected by an air current, the negative being deflected more than the positive.

(6) The stream for the richer spark (i. e., for the higher speeds of the machine) increased in width as the distance from the point increased, while the stream for the glow discharge retained its original size as far as it could be traced.

(7) The stream was deflected by an electrostatic field, in which case it was shorter and more scattered than in case of the magnetic deflection.

(8) Values for the speed of the ion were calculated from the angle of deflection, in magnetic and electrostatic fields, and by placing the two fields in opposition. The average of these was  $1.6 \times 10^8$  cm. per second.

(9) From the kinetic energy of the moving ion and the product of the potential between the points and the charge on the ion values for  $\frac{e}{m}$  are calculated, the average value found being  $1.8 \times 10^8$ .

<sup>6</sup>A. E. Garrett, B. Sc.—The Phys. Soc. of London Proceedings, Dec. 1909, page 643.

(10) A suggestion is given that the stream consists of heated air molecules and ions, in which the latter soon lose their velocity, due to encountering air molecules, and travel to the opposite point with a speed too much decreased to set up an air current, along a route determined by the two fields, while the un-ionized air moves in the direction given it by the ions at the point.

The above investigation was suggested by Professor Arthur L. Foley, of Indiana University. I wish to thank him and Professor R. R. Ramsey for their helpful suggestions during the course of the investigation. I wish also to thank Professors A. T. Jones and C. M. Smith, of Purdue University, for their criticism during the preparation of this report.

*Physical Laboratory of Indiana University,  
Bloomington, Ind.*

## THE HURON GROUP IN WESTERN MONROE AND EASTERN GREENE COUNTIES, INDIANA.

By F. C. GREENE.

The opening of the right-of-way of the Indianapolis Southern Railway between Indianapolis, Indiana, and Effingham, Illinois, presented an unusual opportunity for the study of the so-called Huron group, west of Bloomington, Indiana, in western Monroe and eastern Greene counties. The Huron group is the youngest formation of the Mississippian of Indiana. The name Huron was first applied by Dr. Ashley in his paper on the Lower Carboniferous Area of Southern Indiana.<sup>1</sup>

The type locality is at Huron, Lawrence County, a station on the B. & O. S.-W. Railway. According to his definition, the boundaries of the Huron group are fixed at the base of the lowest sandstone in the group and the unconformity at the top which marks the division between the Mississippian and Pennsylvanian. The discussion of his reasons for so drawing the limits at these points may be found in his report and will not be repeated here. However, as the name Huron is preoccupied<sup>2</sup>, it must be replaced by another, and it is here proposed to substitute the name Chester, as the group can be correlated with the upper Mississippian of Illinois or Kentucky.

Blatchley gives a concise summary of the formation.<sup>3</sup> He says, "In Orange County, where the Huron group is perhaps the most typically exposed, it is represented by a lower limestone, a lower sandstone, a middle limestone, an upper sandstone and an upper limestone. . . . ."

The lower Huron limestone is a compact, smooth-grained, ash-gray to blue limestone, which varies from five to eight feet in thickness. In structure it is a close-grained, fine-textured, non-crystalline stone, breaking with a sub-conchoidal fracture. . . . .

<sup>1</sup> Ashley, G. H., Dept. of Geol. and Nat. Res. of Ind., 1902.

<sup>2</sup> In the Rept. of Progress in 1869, Geol. Survey of Ohio, Part I, p. 18, Dr. S. W. Newberry proposed the name Huron for a shale formation of the Devonian of Ohio.

<sup>3</sup> Blatchley, W. S., Thirtieth Ann. Rept. Ind. Dept. Geol. and Nat. Res., pp. 144-145.

The middle Huron limestone is usually a close-textured, semi-crystalline, gray fossiliferous limestone which varies in thickness from 5 to 30 feet, averaging about 16 feet. . . . .

The upper limestone averages about 15 feet in thickness, is more nearly crystalline in structure, varies from dark to light gray in color, and contains many crinoid stems and bryozoa. It takes a fine polish and resembles marble when so treated, but does not hold its polish when exposed to the atmosphere.

The general section in the area under discussion is:

		Ft.
	10 - Shale and sandstone of Pennsylvanian age, which is unconformable on the beds below. Huron (Chester) Group.	
Upper limestone.	9 Limestone and shale, calcareous, grading from brecciated limestone at bottom to shale at top; limestone composed largely of bryozoa with few foraminifera; locally known as marble.....	25
Upper sandstone.	8 Sandstone, a heavy bed of ferruginous, reddish, brown, or white, hard or soft, laminated.....	40
Middle limestone.	7 Limestone, crystalline, generally light colored, occasionally oölitic, foraminiferal.....	6-21
Middle sandstone.	6 Shale, argillaceous or arenaceous, weathers red in places .....	20-25
	5 Sandstone, similar to upper, except much more cross-bedded .....	25
	4 - Shale, dark, bituminous.....	0-12
Lower limestone.	3 Limestone, thin bedded, oölitic or lithographic.....	2-5
Lower sandstone.	2 Shale, arenaceous or sandstone..... Mitchell limestone.	1-12
	1 Limestone, white, finely oölitic.	

#### SUMMARY OF PREVIOUS WORK.

Cox, in a report on the geology of Greene County<sup>1</sup>, says:

"Sub-Carboniferous Limestone.—At the mouth of Fish Creek, in the northern part of the county, limestone belonging to the Chester group of the sub-carboniferous formation, outcrops in the bluff bank of the creek, and is exposed to the depth of 15 to 20 feet, and is at this place overlaid by drift, but at a short distance to the southwest it is increased by the addi-

<sup>1</sup> 1st Ann. Rept. Geol. Survey Ind., 1869, p. 87.

tion of 2 to 5 feet of shale, with an irregular thin bedded seam of Coal A and the Millstone Grit. Some of the layers contain a few fossils. The following comprise all that could be recognized: *Orthis umbraculum*, *Archimides wortheni*, *Athyris subtilita*, *Pentremites obessus*, *P. pyriformis*, *Spirifer incrassatus*, *Productus carbonarius*, *P. cora*, and an abundance of encrinite stems. It belongs to the upper member of the sub-carboniferous limestone, and is designated by Prof. A. H. Worthen in the Geological Report of Illinois as the Chester Group.

"The greatest development of this limestone seen in Greene County, is on Beech Creek, a branch of Richland Creek, on section 12, township 7, range 4, where it forms a great mural precipice, capped with sandstone of the Millstone Grit series. The following section was obtained at this locality:

"Brownish-gray sandstone, in thick beds which has the appearance of being most excellent building stone.....	25 feet 0 in.
Shale, which thickens up to many feet and in places contains	
Coal A .....	1 in.
Buff colored limestone in which I saw <i>Pentremites obessus</i> , <i>P. pyriformis</i> , and <i>Archimides wortheni</i> .....	20 feet
Gray silicious shale, partly covered.....	25 feet
Bluish limestone (in which I saw no fossils, with intercalations of sandstone, mostly covered by talus.....	50 feet
<hr/>	
Total .....	120 feet 1 in.

"At the junction of the sandstone and limestone at this locality, there gushes forth a mammoth spring of good cool water. . . . .

"The sub-carboniferous limestone makes its appearance at the base of the hills along this creek for a distance of several miles, and is overlaid by a few feet of shales and the massive sandstone at the base of the Millstone Grit. It also makes its appearance at the ore banks on Ore Branch of Richland Creek in section 28, township 7, range 4, and on the eastern border of the county line near the Virginia blast furnace along Richland Creek."

Professor Cox has probably mistaken the heavy sandstone above the middle limestone for the Millstone Grit (Mansfield sandstone), and has confused the limestones.

Ashley, in the coal report on Greene County<sup>5</sup>, says:

"Lower Carboniferous.—The Kaskaskia is well represented in this county by limestone and sandstone, with some shales.

"The uppermost limestone, which is not very persistent here, usually is found but a few feet below Coal I or the equivalent horizon. This limestone, while often absent, attains a thickness of 20 feet in places. Then comes a variable thickness of sandstones and shales, and below that still heavier beds of limestone. The lower limit of the Kaskaskia is somewhat in doubt, as by some it is drawn at the top of this lower limestone, by others part way down it. The lower part of this limestone is probably of St. Louis age, and extends down into the Mitchell limestone."

Paragraph 1258<sup>6</sup>. Section at William Sexton's spring, S. W. of S. E. of Sec. 16-6-3. (C. E. S.)

- |                                            |    |
|--------------------------------------------|----|
| 1. Massive buff sandstone (Mansfield)..... | 20 |
| 2. Heavy limestone (lower carb.).....      | 14 |
| 3. Bluish gray shale.....                  | 6  |

In the report on the road materials of Greene County, Blatchley says:\* "Huron Limestone—The rocks of the Huron group lie close to the surface over the greater part of Greene County, east of White River. On the highest ridges and hills they are capped with the Mansfield sandstone. For the most part the exposed Huron rocks are also sandstone, but several localities there are outcrops of hard bluish Huron limestone, which appear well adapted for road improvement.

"The principal one of these exposures visited was on the land of George Cox, southwest quarter of the northwest quarter of section 3 (7 N., 4 W.). At this point the Indianapolis Southern Railway Company was constructing a viaduct 2,215 feet in length and 147 feet in height across Richland Creek, and a quarry had been opened to secure crushed rock for the concrete work in connection therewith. In this quarry the blue limestone was exposed in fourteen layers, each four to thirty inches in thickness, and aggregating seventeen feet. This limestone was both overlain and underlain with a Huron sandstone, the overlying portion being three to seven

<sup>5</sup>Ashley, G. H., 23d Ann. Rept. Ind. Dept. Geol. and Nat. Res., 1898, p. 770, par. 1250.

<sup>6</sup>Op. cit. page 772.

\* Blatchley, W. S., 30th Ann. Rept. Ind. Dept. Geol. and Nat. Res., 1905, p. 894.

feet in thickness, which, with a foot of soil, had to be stripped. The limestone appeared to be very hard and semi-crystalline in structure. . . .

"Another exposure visited was on the land of George Shipman, north-east quarter section 15 (7 N., 4 W.), where a quarry has been worked for macadam road material. At this point the blue Huron limestone was exposed to a thickness of fifteen to seventeen feet, with four to seven feet of buff Huron sandstone overlying. Sufficient material to cover six miles of road had been secured at this quarry, the supply in sight being practically inexhaustible.

"The same stone outcrops at many points along Beech Creek, and especially in section 12 (7 N., 4 W.), where it forms part of a great precipice or perpendicular bluff, 120 or more feet in height, the upper portion of which is a massive bed of Mansfield sandstone."

This latter is evidently the same exposure as that measured by Cox.

Shannon, in the report on the iron ores of Greene County<sup>7</sup>, cites several instances of the replacement of limestone by iron as in section 6 below, but does not discuss the stratigraphy.

From the foregoing it will be seen that very little work has been done on the stratigraphy or paleontology of the Chester in this area.

#### SECTIONS.

The following sections were obtained along the right of way of the Indianapolis Southern Railway, with the exception of Number IX, which was taken at the locality mentioned by Cox and Blatchley on Beech Creek, being about three-fourths of a mile south of VIII. The sections are shown on the profile.

I.	5—Shale, sandy, and soil.....	15
	4—Sandstone, soft, reddish.....	22
	3—Shale, argillaceous, sandy in places and grading into sandstone at bottom.....	12
	2—Limestone, upper 2 in. oölitic and very fossiliferous, lower part with very few fossils beside forami- nifera .....	2
	1—Shale, argillaceous, to track.....	10-12
II.	7—Sandstone, soft, ferruginous, cross-bedded.....	20
	6—Limestone, hard, fossiliferous, oölitic in places....	6

<sup>7</sup> Shannon, C. W., 31st Ann. Rept. Ind. Dept. Geol. and Nat. Res., 1906, p. 373.

	5—Talus .....	3	
	4—Covered slope.....	30	
	3—Sandstone .....	17	
	2—Covered slope .....	27	
	1—Mitchell limestone (exposed).....	5±	
III.	4—Sandstone in cut .....	10	
	3—Covered slope to track .....	10±	
	2—Limestone with spring at base.....	10	
	1—Covered slope to creek.		
IV.	4—Sandstone and shale, with thin coal and iron-ore (Pennsylvanian).		
	3—Covered .....	12-15	
	2—Limestone, exposed .....	4	
	1—Covered .....	4	
V.	4—Covered to level of track.		
	3—Sandstone .....	40	
	2—Covered slope .....	20	
	1—Limestone, spring at base—exposed.....	7	
VI.	3—Clay, shale and sandstone.....	24	6
	2—Iron-ore (replaced silicious limestone).....		6
	1—Coal .....		6
VII.	4—Shale and sandstone, latter predominating.....	2	
	3—Sandstone, rather calcareous .....	1	6
	2—Shale, argillaceous or calcareous.....	12	
	1—Sandstone .....	0-5	
VIII.	17—Soil .....	4-5	
	16—Sandstone, thin-bedded .....	3-4	
	Unconformity.		
	15—Limestone, ferruginous, weathers to iron-ore.....		6
	14—Shale .....	4	
	13—Limestone, impure .....	3	
	12—Covered slope, fragmentary limestone and sandstone, but mostly shale.....	10	
	11—Limestone .....	1	6
	10—Shale .....		4
	9—Limestone like No. 7.....	1	



ELEVATION ABOVE SEA LEVEL

Scale of 1" = 100'

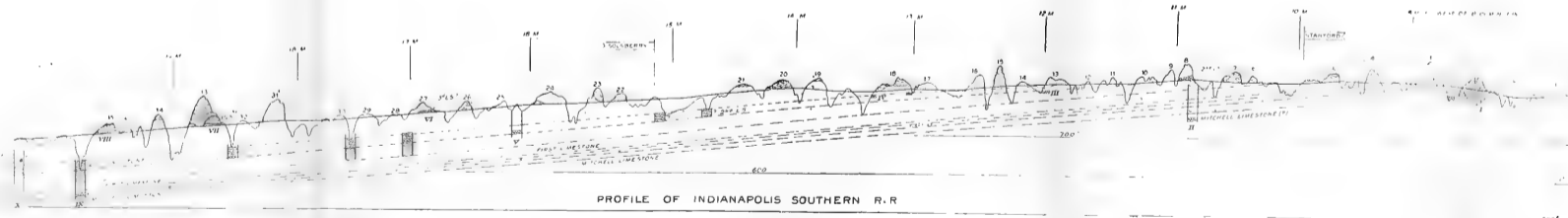

PROFILE OF INDIANAPOLIS SOUTHERN R.R.

100'

	8—Shale, olive .....	6	
	7—Limestone, hard .....	4	
	6—Shale, olive .....	8	
	5—Limestone, four layers, cross-bedded, hard crystal- line, fossiliferous .....	3	
	4—Limestone, cross-bedded and brecciated.....	2	
	3—Shale parting with a limestone lens.....		0-10
	2—Limestone, hard, fossiliferous, brecciated, so-called "marble" .....	3	9
	1—Sandstone, shaly .....	2	6
IX.	7—Sandstone, even bedded .....	40	±
	6—Limestone .....	20	
	5—Shale, sandy or argill., weathers red in places....	30	±
	4—Covered .....	25	
	3—Limestone, thin-bedded .....	5	
	2—Sandstone, thin intercalation .....		2-6
	1—Limestone, oölitic, probably Mitchell.....	10	
X.	3—Covered slope to track, sandstone in lower part and probably all sandstone.....	40	
	2—Limestone .....	17	
	1—Covered slope and sandstone to Richland Creek....	90	

#### DISCUSSION OF STRATIGRAPHY.

When the attempt to unravel the stratigraphy of the group was begun, some trouble was encountered: (1) the unconformity which limits the group at the top; (2) the deposit of glacial drift in the area bordering Richland Creek; (3) the solution of the underlying Mitchell limestone on the eastern border, developing large folds and the collapse of strata; (4) solution of the limestone layers in the Solsberry formation; and (5) the fact that the Solsberry sandstones and shales have a tendency to be more or less cross-bedded and lenticular, as would be expected of a shore deposit. These factors detract somewhat from the correct interpretation of the stratigraphy.

Sections in the underlying Mitchell limestone in the region studied show that in most cases the top of the latter formation consists of a very typical white oölitic, differing materially from that of the Chester. Ash-

ley<sup>8</sup> noted the occurrence of oölite in the Mitchell limestone in many places; it has therefore been thought safe to consider this oölite, in the area studied, of Mitchell age, especially as the stratigraphic relations seem to confirm this view.

At 1<sup>o</sup>, the Mitchell oölite is at the level of the track and is overlain by 8.5 feet of sandstone. West of this the Mitchell limestone forms the



Fig. 1.

surface rock so that sinkholes are a conspicuous feature, but sandstone fragments are found. The relations of the strata at 2 have been greatly disturbed by the solution of the underlying Mitchell limestone so that a synclinal fold has been developed. Section I was taken at this point in the eastern part of the cut. The lower limestone, No. 2 of the section, has been dissolved to such an extent that only isolated blocks remain in the

<sup>8</sup> Ashley, G. H., Carboniferous Area of Southern Indiana, 27th Ann. Rep. Ind. Dept. Geol. and Nat. Res. 1902, p. 82.

<sup>9</sup> Numbers refer to cuts on accompanying profile section.

eastern part of the cut, while it has entirely disappeared from the western end. It is likely that the layer is thicker than two feet, as other exposures seem to show. The area between cuts 2 and 3 is a large compound sink. On the north side of the track, the Mitchell is found about thirty feet below, with ten feet of hard, light-colored sandstone overlying. On the south side, fifteen feet below the track, three feet of the lower limestone out-



FIG. 2.

crop. Shale occurs below it, but most of the section is covered. In cut 3 the following section was obtained:

4—Soil .....	6 ft.
3—Sandstone, ripple-marked and cross-bedded.....	31.5 ft.
2—Shale, blue, soft, clayey.....	8-11 ft.
1—Limestone, lower, in ditch.	

In the eastern part of this cut the solution of the underlying Mitchell has again caused a synclinal folding of the beds. The shale No. 6 (of gen. sec.) first occurs in the top of the next cut 4 and continues in 5, 6, 7 and 8. It is a sandstone or arenaceous shale at the bottom, becoming more

shaly in the middle and finally a clay shale at the top, in cut 8. From the exposures in cuts 4 and 5 it appears that a slight local unconformity may exist below this shale. In the eastern part of 8, the middle limestone first appears. Section II shows it to be 77 feet above the Mitchell as exposed in the valley below, which conforms with the dip and thickness of the underlying beds. This limestone appears at nearly every point west of cut 8, where its level is reached and its lower limit is marked by a spring



Fig. 3.

horizon. The correlation is based on stratigraphic, lithologic and paleontologic evidence and on the presence of springs in a few instances. It thickens progressively to the west, and on the east bluff of Richland Creek a quarry in it furnished rock for the railway viaduct. The cuts 8 to 21, inclusive, are in the upper sandstone with the exception of 18 and 20. This sandstone forms one of the prominent features of the topography. It is a reddish, ferruginous, laminated stone, appearing soft in the cuts but generally weathering into a hard bluff-forming stone where the drainage has cut through it. At places shale appears at the level of this sandstone.

These places may indicate lenses in the sandstone or shale of the overlying unconformable Pennsylvanian rocks.

At 18 the cut shows the unconformity and a mass of bog iron ore, coal and purplish-drab shale, resting on the sandstone only a few feet above the upper limestone. In cut 20 and the top part of 21, Pennsylvanian shale rests unconformably on the upper sandstone.



FIG. 1.

Between Solsberry and the viaduct, the railroad grade is about on a level with the top of the upper sandstone so that nearly all the cuts are in Pennsylvanian rocks. At 27, section VI was obtained. The iron ore (replaced limestone) of this section appears to be correlative with the upper limestone from stratigraphic and faunal evidence, which, however, is rather meagre. Coal occurs beneath it, while the sandstone above is probably of Pennsylvanian age.

Owing to the fact that it is replaced, only casts of shells remain, and in many cases these are unidentifiable. In view of this the correlation with the upper limestone must be tentative.

Section VII was obtained in the eastern part of cut 33, known as the "Head Cut." The western part of the cut is Pennsylvanian, an unconformity occurring about half way through the cut and above the upper limestone, so that the limestone may have been thicker than now exposed. This limestone is undoubtedly to be correlated with that in cut 35 (see section VIII) on stratigraphic and lithologic relations as well as faunal evidence.



Fig. 5.

The lower layers of the limestone in section VIII are brecciated and the limestones in both sections VII and VIII contain fragments of a sandstone similar to the underlying upper sandstone, while many species appear for the first time. The intervening cut, 34, contains sandstone, probably of Pennsylvanian age, and obscures the relations of cuts 33 and 35.

From the foregoing it will be seen that there is an apparent unconformity between the upper sandstone and limestone, which may account for the peculiarities of section VI.

The stratigraphic relation of the middle and upper sandstones and the middle limestones are easily determined, but there is some doubt as



to the lower limestone and lower sandstone owing to the absence of exposures to the west. Section IX shows at the bottom of the slope, 15 feet of limestones, the upper 5 feet of which is thin bedded and contains fossils similar to the lower limestone in section I, except that the bryozoa are more conspicuous in the latter. The lower ten feet have a striking resemblance to the Mitchell limestone (oölite) both in appearance and fossil content, while between the two there is a thin intercalation of sandstone which is possibly the lower sandstone. The level of the rocks corresponds to the dip and thickness of the formation, but it is possible that the whole thickness belongs to either the Solsberry or Mitchell.

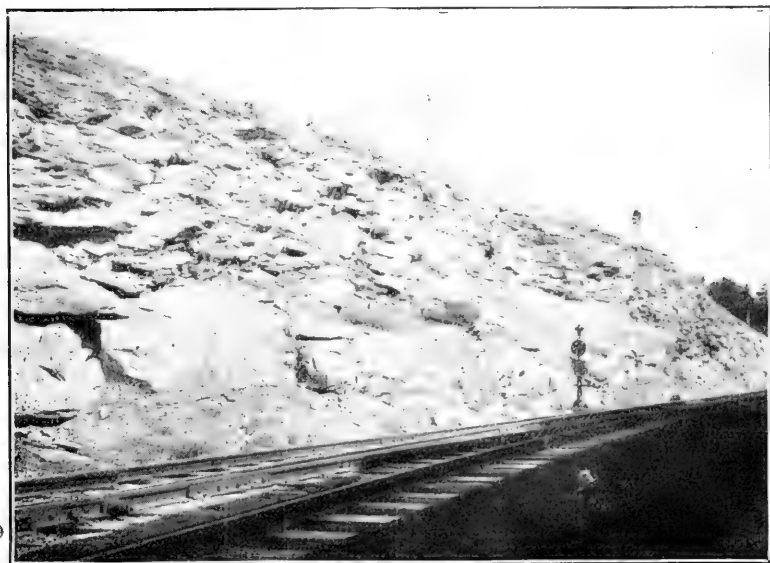

Fig. 6.

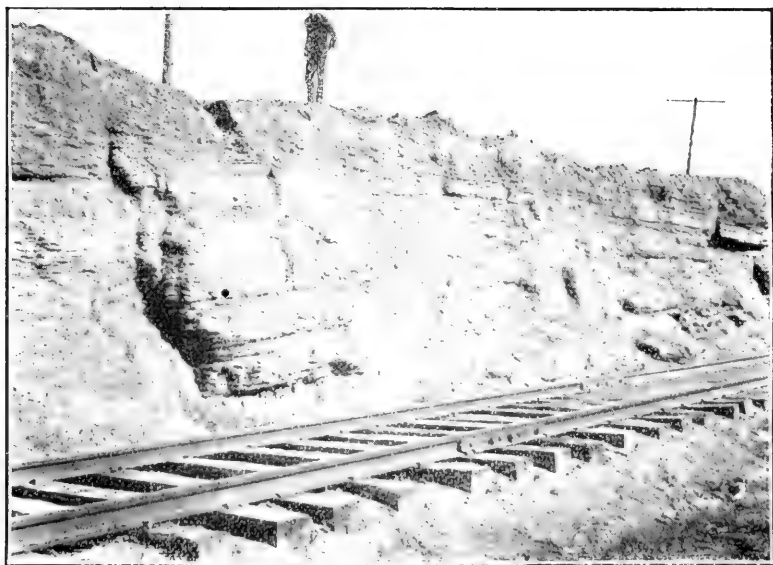

Fig. 7

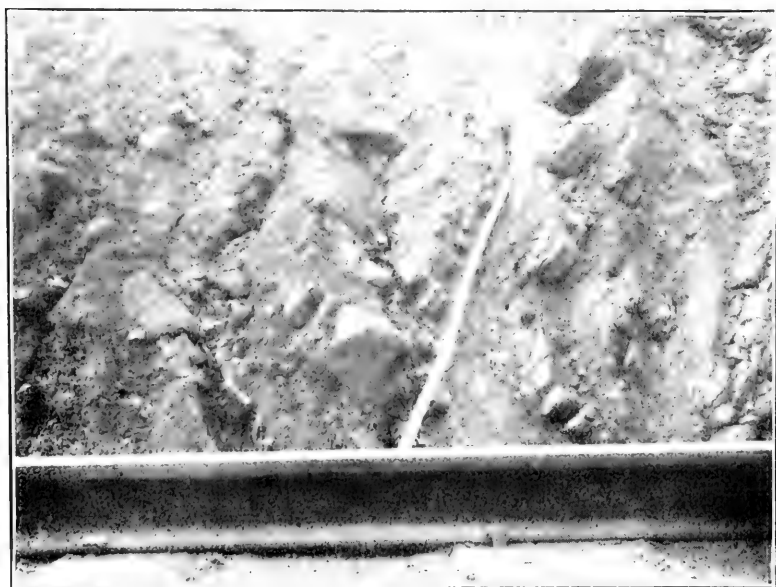

Fig. 8



FIG. 9.

## FAUNA.

The fauna of the limestones is rather large and well preserved, that of the sandstones and shale very meagre. The faunal lists follow<sup>10</sup>:

*Lower limestone in section I.*

Endothyra baileyi Hall.	Spirifer sp.
Zaphrentis sp.	Martinia contracta M. & W.
Echinocrinus sp.	Microdon subelliptica Hall.
Crinoidea 4 sp.	Pelecypod sp.
Batostomella abrupta ? Ulrich.	Pleurotomaria subglobosa Hall.
Fenestella sp.	Straparollus sp.
Dielasma sp.	Strophostylus carleyana? (Hall)
Productus burlingtonensis Hall.	Keys.
var.	Loxonema yandellana Hall.
Derbya sp.	Solenospira attenuata (Hall)
	Ulrich.

<sup>10</sup> Prof. R. M. Bagg, of Illinois University, has kindly consented to examine the foraminifera of the collection, which appear to be rather abundant. At this time, his examination has not been completed and this important part of the fauna must be omitted.

- Cyclonema leavenworthana Hall.  
 Bulimorpha buliformis Hall.  
 Microchelius stinesvillensis? Cum-  
 ings.  
 Bellerophon sublaevis Hall.  
 Orthonychia acutirostre (Hall)  
 Keyes.  
 Leperdita carbonaria Hall.  
 Griffithides bufo? M. & W.
- Mitchell ? limestone in section IX.*  
 Hemitrypa ?? sp.  
 Polypora sp.  
 Martinia contracta M. & W.  
 Productus burlingtonensis Hall.  
 var.  
 Dielasma turgida Hall.  
 Spirifer leidyi N. & P.  
 Derbya sp.  
 Bellerophon sublaevis Hall.  
 Orthonychia acutirostre (Hall)  
 Keyes.  
 Griffithides bufo M. & W.
- Lower limestone in section IX.*  
 Zaphrentis sp.  
 Crinoidea sp.  
 Streblotrypa nicklesi Ulrich  
 Cystodictya ocellata? Ulrich.  
 Intrapora undulata (Ulrich).  
 Stenopora tuberculata var. poly-  
 morpha Prout.  
 Fenestella tenax? Ulrich.  
 Fenestella sp. (reverse).  
 Batostomella abrupta Ulrich.  
 Rhombopora cf. nicklesi Ulrich.  
 Rhombopora sp.  
 Archimedes communis? Ulrich.
- Bryozoa sp.  
 Martinia contracta M. & W.  
 Spirifer leidyi N. & P.  
 Spiriferina sp.  
 Productus sp.  
 Straparollus sp.
- Middle limestone in section II.*  
 Endothyra baileyi Hall.  
 Zaphrentis sp.  
 Pentremites pyrimidatus Ulrich.  
 Echinocrinus norwoodi Hall  
 (spines).  
 Crinoidea 2 sp. (stems and calyx)  
 Lioclema? aranum Ulrich.  
 Rhombopora bedfordensis Cum-  
 ings.  
 Rhombopora sp.  
 Fenestella serratula Ulrich. ,  
 Fenestella compressa Ulrich.  
 Fenestella sp.  
 Hemitrypa proutana Ulrich.  
 Fistulipora spergenensis ? Ro-  
 minger.  
 Archimedes laxus? (Hall).  
 Polypora sp.  
 Dielasma turgida Hall.  
 Dielasma formosa Hall.  
 Martinia contracta M. & W.  
 Seminula trinuclea Hall.  
 Spirifer leidyi N. & P.  
 Derbya keokuk Hall.  
 Productus burlingtonensis Hall.  
 var.  
 Productus parvus? M. & W.  
 Productus cora? D'Orbigny.  
 Cypriocardinia indianensis Hall.  
 Microdon subelliptica Hall.

- Nucula shumardana* Hall.  
*Productus cestriensis* Worthen.  
*Conocardium meckanum* Hall.  
*Myalina?* sp.  
*Pelecypod* sp.  
*Pleurotomaria?* *wortheni* Hall.  
*Pleurotomaria?* *subgolbosa* Hall.  
*Loxenema yandellana* Hall.  
*Straparollus similis* M. & W.  
*Straparollus spergensis* (Hall).  
*Straparollus* sp.  
*Stropostylus carleyana* Hall.  
*Cyclonema subangulata* Hall.  
*Cyclonema leavenworthana* Hall.  
*Solenospira turritella* (Hall) Ulrich.  
*Solenospira vermicula* (Hall) Ulrich.  
*Solenospira* sp.  
*Bulimorpha caniculata* Hall.  
*Bulimorpha?* sp.  
*Holopea proutana* Hall.  
*Bellerophon sublaevis* Hall.  
*Orthonychia acutirostre* (Hall) Keyes.  
*Bairdia cestriensis* Ulrich.  
*Cytherella ovatiformis* Ulrich.  
*Griffithides bufo* M. & W.  
*Fish* 3 sp. (teeth).
- Middle limestone in section III.*  
*Fenestella serratula* Ulrich.  
*Fenestella* c. f. *multispinosa* Ulrich.  
*Anisatrypa solida* Ulrich.  
*Archimedes* sp.  
*Martinia contracta* M. & W.  
*Dielasma formosa* Hall.
- Productus parvus?* M. & W.  
*Productus cestriensis?* Worthen.  
*Productus cora?* D'Orbigny.  
*Spirifer leidyi* N. & P.  
*Griffithides bufo* M. & W.
- Middle limestone in section IV.*  
*Endothyra baileyi* Hall.  
*Martinia contracta* M. & W.  
*Bellerophon sublaevis* Hall.
- Middle limestone in section V.*  
*Fenestella* sp.  
*Martinia contracta* M. & W.  
*Productus cestriensis?* Worthen  
*Bellerophon sublaevis* Hall.
- Middle limestone in section X.*  
*Pentremites pyrimidatus* Ulrich.  
*Crinoidea* sp.  
*Archimedes* sp.  
*Productus cestriensis* Worthen.  
*Productus* sp.  
*Spirifer leidyi* N. & P.  
*Martinia contracta* M. & W.
- Upper ? limestone in section VI.*  
*Zaphrentis spinulosa?* M-E. & H.  
*Crinoidea* 3 sp. (segments).  
*Pentremites* sp. (one poral plate).  
*Stenopora* sp.  
*Fenestella cestriensis* Ulrich.  
*Fenestella* 2 sp.  
*Coelocoanus rhombicus?* Ulrich.  
*Polypora spinulifera* Ulrich.  
*Archimedes* sp.  
*Spirifer leidyi* N. & P.  
*Derbya kaskaskiensis?* Hall.  
*Dielasma turgida* Hall.  
*Spiriferina spinosa* N. & P.

- Eumetria marceyi* Shumard.  
*Productus parvus?* M. & W.  
*Productus cestriensis?* Worthen.  
*Productus cora?* D'Orbigny.  
*Orbiculoidea* sp. (cast).  
*Brachiopod* sp. (cast).  
*Pleurotomaria* sp. near *tabulata*  
     Conrad.  
*Pleurotomaria* sp. (cast).  
*Straparollus* sp. (cast).  
*Bellerophon sublævis* Hall.  
*Orthonychia chesterense?*  
     M. & W.  
*Gastropod* sp. (cast).  
*Bulimorpha* sp. (cast).  
*Pleurophorus minimus* Worthen.  
*Pleurophorus* sp.  
*Microdon* sp.  
*Nucula parva* McChesney.  
*Modiala illinoisensis* Worthen.  
*Schizodus?* sp.  
*Aviculopecten* sp.  
*Pelecypoda* 5 sp. (casts).  
*Primitia subæquata* Ulrich.  
*Psammodus* sp. (cast of tooth).  
*Cladodus spinosus?* M. & W.  
     (cast of tooth).
- Upper limestone in section VII.*  
*Pentremites godoni* DeFrance.  
*Pentremites florealis* Schlotheim.  
*Pentremites pyriformis* Say.  
*Pterotocrinus depressus* Lyon and  
     Cassiday (wing plates).  
*Acrocrinus shumardi* Yandell.  
*Hydreionocrinus armiger* M. & W.  
*Crinoidea* 6 sp. (plates and seg-  
     ments).
- Echinocrinus* sp.  
*Thamniseus furcillatus* Ulrich.  
*Fistulipora excelens?* Ulrich.  
*Stenopora tuberculata* Prout.  
*Stenopora rudis* Ulrich.  
*Lioclema araneum* Ulrich.  
*Coeleconus rhombicus* Ulrich.  
*Fenestella flexuosa* Ulrich.  
*Fenestella tenax* Ulrich.  
*Fenestella cestriensis* Ulrich.  
*Fenestella multispinosa?* Ulrich.  
*Fenestella elevatopora?* Ulrich.  
*Fenestella* 2 sp.  
*Polypora cestriensis* Ulrich.  
*Septopora subquadrans* Ulrich.  
*Streblotrypa nickelsi* Ulrich.  
*Batostomella spinulosa* Ulrich.  
*Rhombopora minor* Ulrich.  
*Rhombopora tenuirama* Ulrich.  
*Rhombopora* sp. near *tabulata*  
     Ulrich.  
*Archimedes meekanus?* Hall.  
*Ptilipora pauperi?* Ulrich.  
*Seminula trinuclea* Hall.  
*Eumetria marceyi* Shumard.  
*Cleiothyris sublamellosa?* Hall.  
*Spiriferina spinosa* N. & P.  
*Spirifer leidyi* N. & P.  
*Productus parvus* M. & W.  
*Dielasma turgida* Hall.  
*Reticularia setigera* Hall.  
*Trilobite* sp.
- Upper limestone in section VIII.*  
*Zaphrentis spinulosa* M-E. & H.  
*Pterotocrinus depressus* Lyon and  
     Casseday.  
*Hydreionocrinus armiger* M. & W.

Crinoidea sp. (segments).	Dielasma sp.
Pentremites sp.	Productus sp.
Rhombopora sp. near tabulata Ulrich.	Spiriferina transversa McChes- ney.
Rhombopora sp.	Spiriferina spinosa N. & P.
Stenopora sp.	Spirifer leidyi N. & P.
Fenestella cestriensis? Ulrich.	Eumetria marceyi Shumard.
Fenestella flexuosa Ulrich.	Brachiopod sp.
Fenestella sp.	Aviculopecten c. f. monroensis Worthen.
Polypora spinulifera Ulrich.	Orthonychia chesterense M. & W.
Polypora cestriensis Ulrich.	Spirorbis c. f. imbricatus Ulrich.
Lioclema araneum Ulrich.	Griffithides granulatus Weth- erby.
Streblotrypa nicklesi Ulrich.	Cladodus sp. (base of tooth).
Fistulipora excelens? Ulrich.	Fish sp. (spine).
Archimedes distans Ulrich.	
Archimedes sp.	

*Discussion of fauna.* From the foregoing lists, it will be seen that the fauna of the lower and middle limestones have many of the elements of the Salem fauna. This is particularly true at the eastern extensions of these beds where, in all probability, the shallow, lagoonal conditions favorable to this fauna, prevailed.

The lower limestone in section I has only two species which do not occur in the Salem limestone. These are *Martinia contracta* and *Batostomella abrupta*? The latter was not found in the middle limestone. The western extension of the lower limestone retains a few of the Salem species but indicates a condition of deposition farther from the shore-line. To the west it also contains *Batostomella abrupta*. In the collections from the lower layer, foraminifera are very scarce.

Collections from the middle limestone show that many Salem species continued to exist, but *Martinia contracta* is the most noticeable species, and *Pentremites* becomes a prominent member of the fauna. Thin sections from this horizon show under the microscope a great number of forms of foraminifera, and will undoubtedly yield many species, an element which will distinguish this limestone wherever found.

The faunal character of the upper limestone is entirely distinct from that of the two lower layers. It is of late Chester age and shows no distinct Salem forms.

If the limestone in section VI is to be correlated with the upper limestone, it shows what is probably a littoral phase of the layer, which to the west shows only deep water conditions.

#### CONCLUSIONS.

To briefly summarize, the Chester or Huron formation of western Monroe and eastern Greene counties consists of three limestones with separating sandstone and shale.

Dr. E. O. Ulrich, of the United States Geological Survey, has examined the lists of fossils given herewith and expressed the opinion that they represented the greater part of the Chester of Kentucky and southern Illinois. As the stratigraphy seems to confirm this, the following correlations are made:

CHESTER GROUP.	Upper (third) limestone.	Birdsville formation.	
	Upper sandstone.		
	Middle (second) limestone.	Tribune Limestone.	
	Middle sandstone.	Cypress sandstone.	
	Lower (first) limestone. Lower sandstone. Oolitic upper portion of Mitchell.	Ohara limestone member. Rosiclare sandstone member. Fredonia oolitic member.	} Ste. Genevieve Formation.
Remainder of Mitchell.	St. Louis limestone.		

The line of division between the St. Louis and the oolitic above has not been located in Indiana, but the latter is probably at least 30 feet thick.



## DETERMINATION OF THE RATIO OF SPECIFIC HEATS OF DRY AIR.

---

E. K. CHAPMAN.

---

The following method for determining the ratio of specific heats was suggested by some work in connection with an experiment in a fog chamber. It became necessary to know the temperature in a fog chamber on sudden expansion and consequent condensation of vapor. In order to measure this temperature a thermo-couple of Cu and Fe was introduced, and the deflection of a galvanometer connected in series with the couple was noted on the expansion of the saturated vapor. The couple was then graduated by keeping one junction at a constant temperature and noting the deflection of the galvanometer for a given change in temperature of the other junction. Knowing, then, the constant of the apparatus, the temperature in the fog chamber was easily determined.

The attempt was then made to use this method for finding the temperature in a chamber of air on sudden expansion, and thus determine the ratio of the specific heats.

To the stopper of a glass carboy was fitted a large valve that could readily be opened or closed by hand. One junction of the thermo-couple was introduced into the carboy through a rubber stopper fitted in a hole drilled in the side. The inner ends of the bent tube carrying the couple were then separated by twisting the tubes in the rubber stopper. The other junction was encased in a small glass bulb just outside the bottle and this kept at a temperature of the surrounding medium. Later in the work the entire apparatus, excepting the valve, was immersed in a bath which could be maintained at a constant temperature. Dry air was then pumped into the bottle and the whole was allowed to stand until it had regained the temperature of the surroundings. On opening the valve the temperature falls, due to the adiabatic expansion, and the galvanometer is deflected because of the difference in temperature of the two junctions of the couple. From this deflection it was hoped that the lowest temperature in the chamber might be calculated. A great deal of difficulty was experienced in trying to calibrate the couple, since the deflections due to a given difference in temperature varied considerably, and the degrees of accuracy desired

necessitated a more consistent calibration. After repeated efforts to obtain a constant deflection for a given difference in temperature the method was abandoned as not being sufficiently accurate.

The following scheme was then adopted :

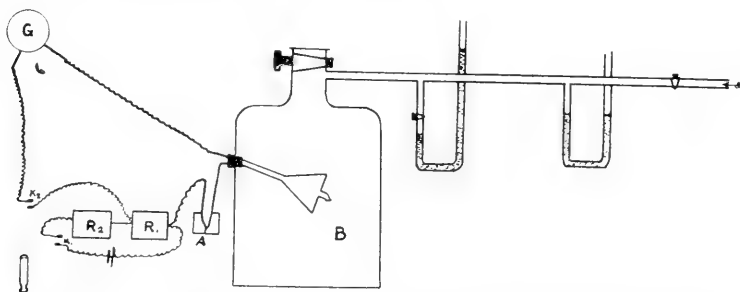

A battery of known E. M. F. was connected in series with two resistances,  $R_2$ , which was approximately 100,000 ohms, and in later experiments kept constant, and  $R_1$  was varied from one to eight ohms to suit the conditions of the particular observation.  $B$  is a carboy in the center of which one junction of the couple was located.  $A$  is a second junction which was kept at a constant temperature.  $G$  is a galvanometer in series with the couple and  $R_1$ . The air in  $B$  was compressed as before and allowed to cool to the temperature of the bath.  $K_1$  was then closed, then the valve was opened to the atmosphere and immediately  $K_2$  was closed and the direction of the deflection of the galvanometer noted. This process was repeated, varying  $R_1$  until a resistance was found such that on closing  $K_2$  there was no deflection of the galvanometer, until the air began to warm after the adiabatic expansion. This balanced condition meant that the P. D. across  $R_1$  just balanced that due to the difference in temperature of the two junctions of the thermo-couple.

In practice it was found better to set  $R_1$  at a given place, e. g., 5 ohms, and then vary the original pressure until a balance was obtained. In some of the earlier observations  $R_2$  was varied to secure a balance, but since it was not known to a sufficient degree of accuracy, the other method was used. It then remained to calibrate the thermo-couple. This was done by placing one junction, encased in a jacket, in a constant temperature bath, and the other, similarly encased, in a bath whose temperature was varied till a balance against a given resistance,  $R_1$ , was obtained. The difference in temperature of the two junctions was then noted.  $R_1$  was again varied

and the temperature of the bath changed until another balance was found. In this way a number of balances were obtained for different values of  $R_1$ . By plotting  $R_1$  against the difference in temperature of the two junctions a curve was obtained which gave the temperature for any resistance. The calibration was made with a number of different couples and the results were entirely consistent, no point being off the straight line thus found more than 1-20 of a degree centigrade.

The pressure in the bottle was measured by means of an oil manometer; as considerable time was consumed by the oil coming to a steady state, it was deemed desirable to place a stopcock between the manometer and the bottle, and after the pressure was determined cut off the manometer before expansion. The pressure for the following trial was adjusted approximately by an auxiliary mercurial manometer and the final adjustment was made with oil. The use of the oil manometer was necessary, as the errors introduced in the reading of the mercurial manometer were of a higher degree of magnitude than was permissible.

The delicacy of the apparatus was indicated by the fact that the observer could readily detect a difference in pressure of 2 mm. of oil, density .84.

The value of  $\gamma$  was determined as follows:—

From the adiabatic law,  $P V^\gamma = \text{a constant}$

From the law of Charles,  $PV = RT$

$$\text{or } P_1 V_1 = P_2 V_2;$$

$$\text{then } \left(\frac{V_2}{V_1}\right)^\gamma = \frac{P_1}{P_2}$$

$$\text{but } P_1 V_1 = RT_1$$

$$\text{and } P_2 V_2 = RT_2$$

$$\frac{V_2}{V_1} = \frac{P_1}{P_2} \frac{T_2}{T_1}$$

$$\left(\frac{V_2}{V_1}\right)^\gamma = \left(\frac{P_1}{P_2} \frac{T_2}{T_1}\right)^\gamma = \frac{P_1}{P_2}$$

$$\log \frac{P_1}{P_2}$$

$$\text{therefore } \gamma = \frac{\log \frac{P_1}{P_2}}{\log \frac{T_1}{T_2}}$$

The following table gives the results of the experiment :

$P_2$	$\Theta_1$	$R_1$	$R_2$	A	B	A-B	$P_1$	$\Theta_2$	$\gamma$
74.14	294.—	2.2	100100	94.6	25.—	69.6	78.44	289.4	1.3888
75.26	294.05	2.2	100100	95.9	24.—	71.9	79.70	289.35	1.3910
74.72	294.2	2.1	109500	89.5	30.—	59.5	78.39	290.34	1.3803
74.5	293.9	2.1	103800	89.7	30.—	59.7	78.19	289.81	1.4802
75.19	293.95	2.1	103800	90.9	29.2	61.7	79.—	289.71	1.4160
75.49	293.1	3.2	100300	145.—	46.4	98.6	81.58	286.6	1.4042
74.99	293.7	3.2	100500	145.—	47.—	98.—	81.04	287.47	1.3872
74.99	293.5	3.2	100500	144.7	46.3	98.4	81.07	287.1	1.3945
75.06	293.6	4.7	101200	169.—	22.1	146.9	84.14	284.3	1.3927
74.84	294.1	4.7	100700	170.—	21.8	148.2	84.00	284.51	1.4027
75.52	293.8	4.—	100000	158.1	33.6	124.5	83.21	286.2	1.3704
74.76	“	5.—	“	174.2	18.2	156.2	84.41	283.89	1.3938
74.76	“	4.—	“	159.0	33.5	124.5	82.45	285.81	1.3921
74.76	“	3.—	“	142.0	50.—	92.—	80.44	287.81	1.3911
74.71	“	6.—	“	195.—	7.—	188.—	86.33	281.96	1.3974
74.71	“	6.—	“	195.—	7.—	188.—	86.33	281.88	1.4013
74.57	“	5.—	“	178.5	29.3	154.6	84.12	283.86	1.4001
74.57	“	4.—	“	162.1	40.3	121.8	82.09	285.84	1.3997
74.57	“	3.—	“	146.5	57.3	89.2	80.08	287.84	1.4040
74.57	“	2.—	“	132.5	73.7	58.8	78.20	289.83	1.4005
74.44	293.82	1.—	“	118.2	88.8	29.8	76.25	291.83	1.3925
Average.....									1.3957
Av. for last 10.....									1.3973

$P_2$  is the reading of the barometer.  $\Theta_1$  is the original temperature of the bath. A and B readings of the oil manometer.  $P_1 = P_2 (A-B) d_1/d_2$  where  $d_1 =$  density of oil and  $d_2 =$  density of mercury.  $\Theta_2$  is the temperature as given by the thermo-couple required to secure a balance.

$\gamma =$  ratio of specific heats.

#### DISCUSSION OF RESULTS.

The limits of precision seem to be the precision of the resistance, the precision of the temperature reading as read by a thermometer, the precision of the temperature readings used to calibrate the couple, the consistency of the E. M. F. of the battery and the density of oil.

The precision of the resistance was none too good. The last ten observations were made with the best box available and  $R_2$  kept constant so that errors due to  $R_2$  were obviated. The maximum variation of the mean of these observations is less than  $\frac{1}{2}$  per cent., and shows remarkable constancy.

A new storage battery "duro," made by the Chicago Battery Co., was used and showed no variations in E. M. F. during the entire time.

The density of the oil was determined by a specific gravity bottle and found to be .8370.

The temperatures were read on a standard thermometer graduated to 1-10 degree.

As to the question of the accuracy of the thermo-couple in registering the instantaneous temperature we have to consider the couple itself, its behavior under known conditions, and the results obtained.

The couple was of Fe-Cu, one millimeter in diameter, so its heat capacity was very small. In calibrating it a deflection was regularly noted when the change of temperature of the bath was less than 1-100 of a degree. It was found that for small changes in temperature considerable time, several seconds, elapsed before there was any heating due to radiation, etc. This was due largely to the size of the vessel. Using a smaller one the time required to warm up was small.

The experiment is now being repeated under vastly better conditions. The temperature of the bath is regulated by an electric thermostat, the resistances, barometer and thermometer, have been checked up by the Bureau of Standards at Washington and the voltage of the "duro" cell tested immediately before and after each observation, by means of a potentiometer of the Leeds Northrup type and a standard Weston cell. The results from the new determination will be published later.

*Wabash College,*

*Crawfordsville, Ind.*



## A CONVENIENT HIGH POTENTIAL BATTERY.

By R. R. RAMSEY.

In work on radioactivity it is necessary to have a battery whose potential is 100 volts or more. If one has access to a direct current lighting circuit a storage battery made of test tubes with sheet lead strips for electrodes can be used. Fifty such cells arranged in a rack make a convenient battery when the lighting circuit is 110 volts. Such a battery requires a week or more for forming, and due to the small capacity of the cells they should be connected to the charging circuit all the time except when in actual use. When it is not convenient to make such a battery, or when the facilities for keeping it charged are not at hand, I have found that a battery can be made with little trouble and expense of tubular flash lamp batteries. The so-called  $3\frac{1}{2}$  volt flash lamp batteries consist of three small dry cells slipped into a pasteboard tube. The bottom of the cell is the negative terminal, while the central carbon has a projection extending through the top, which serves as the positive terminal of the cell. Thus the three cells when placed in the tube are in series. If the cells are slipped down through the tubes until the bottom ones project one-half their length the batteries can be placed one on top of another and form a long battery connected in series, the potential of which depends upon the length. The so-called  $3\frac{1}{2}$  volt battery when new has an E. M. F. of about 4.4 volts. Or twenty-five such batteries in series give 110 volts. Of course it is not necessary to connect all in one "stick." They can be placed in "sticks" or convenient length and placed upright in a box and connected in series by soldering wires to the ends, thus making connections which will give intermediate potentials. When new these batteries have very low resistance, and great care should be exercised to prevent short circuiting the cell. Like all dry cells the resistance increases with age and the potential at the terminals as shown by a voltmeter will decrease. But the E. M. F. of the cells as shown by potentiometer measurements remains constant until the cells are completely dried out. Since the battery in radioactivity work is

used for static potentials the high internal resistance of the cells will not cut any figure.

These batteries can be obtained from the electrical supply houses at 20 cents apiece. Thus a 110 volt battery will cost \$5.00.

*Physical Laboratory,*

*Indiana University, April 11, 1911.*



## THE EQUIPMENT OF A HIGH TEMPERATURE MEASUREMENT LABORATORY.

By G. A. SHOOK.

### MEASUREMENT OF HIGH TEMPERATURES.

The first attempt to measure temperatures with any accuracy seems to be due to the celebrated potter, Wedgewood, although he was not the first by any means to recognize the importance of temperature estimation and temperature control in kilns in order to reproduce a given effect. In the time of the Romans the working of iron had undoubtedly reached an advanced stage, but their methods and knowledge of the metallurgy of iron were entirely empirical. In the eighth century a writer, in outlining a method for obtaining high temperatures, called attention to the most difficult part of the problem, namely, that "fire is not a thing which can be measured." Even within recent years the temperature of a steel kiln was not known within 500 degrees C. and the values given for the temperature of the sun ranged from 1,500 to 1,000,000 degrees C. Today, however, with our advanced methods of radiation pyrometry, the student of physics can measure the temperature of the sun, the highest known temperature, with as much ease and accuracy as he can determine the specific heat of a piece of lead.

It has been known for several years that numerous industrial processes, carried out at high temperatures, require a temperature control of 20 degrees C. Mr. C. E. Foster<sup>1</sup>, in speaking of the successful production of finished castings, remarked that there are four main factors to be considered:

- 1—Composition of the material melted.
- 2—Atmosphere and surroundings.
- 3—Temperature.
- 4—Time.

The first two of these are taken care of by the chemist, but the third and fourth must be controlled by the man trained in pyrometry. It requires but a casual glance through the trade journals to convince one that the

---

<sup>1</sup> The Foundry, May, 1909.

men who are handling this problem in the industries are not sufficiently trained to appreciate the limitations of its practical application. Therefore the engineer or chemist must be trained along this line if he expects to do the most efficient work. High temperatures were, until quite recently, estimated by the trained eye of a workman, and while they acquired with practice a surprising accuracy, such a procedure is entirely inadequate for present day requirements. Moreover, the observer's estimate is influenced manifestly by a number of circumstances, such as the amount of light in the room, fatigue of the eye, physical condition of the observer, etc. The greatest disadvantage is that a skilled workman in Pittsburg can not gain anything from the experience of a workman in Birmingham. In times past numerous methods have been devised and used for temperature estimation and temperature control, but the temperature scales used were so discordant that about six years ago the Bureau of Standards<sup>2</sup> made a thorough investigation of the most available methods.

There are today four precise laboratory methods for measuring high temperatures, each of which is the basis of an industrial pyrometer:

*Electric-resistance Pyrometer.*—In this pyrometer use is made of the variation of the electric resistance of metals with change of temperature. Since resistance can be measured with extreme precision this method permits of very precise measurements of temperature up to 1000° C.

*Thermoelectric Pyrometer.*—This instrument utilizes the variation of the electromotive force with temperature, developed at the junction of two dissimilar metals. This pyrometer may be used for temperatures up to 1600° C. when the thermo-couple consists of wires of platinum and platinum-rhodium or iridium.

*Radiation Pyrometer.*—In this type of pyrometer the total radiation from hot bodies is taken as a measure of their temperature. This instrument requires a device for determining very small changes in temperature, and does not admit of very great accuracy, but is very convenient for very high temperatures.

*Optical Pyrometer.*—In the case of pyrometers of this class temperature estimation is made by means of a photometric comparison, for a particular wave length, between the radiation from some standard lamp and the radiation emitted from the body under observation. This is a very precise method and is available for the highest known temperature.

<sup>2</sup> Bulletin Bureau of Standards, Vol. 1, p. 189.

## TEMPERATURE SCALE.

The usual method of measuring temperature is by the expansion of some substance, such as mercury in the ordinary glass thermometer, or gas in the more refined work. With such a method, however, the magnitude of a degree will depend upon the nature of the substance employed, which is undesirable in scientific work. A theoretical thermometric scale, independent of any substance used, has been worked out by Lord Kelvin and is known as the "Thermodynamic Scale." Temperatures on this scale are measured by the work done in carrying a substance around a Carnot's cycle working between two sources at constant temperature.

Without attempting any proof here, the theory gives the following relation,

$$\frac{T_1}{T_2} = \frac{Q_1}{Q_2}$$

where  $T$  is the absolute temperature and  $Q$  is the quantity of heat, which can be measured in terms of energy since by the first law of thermodynamics heat is proportional to work. Hence the ratio of any two temperatures may be determined from purely mechanical considerations and will furthermore be independent of the substance used in the conversion of work into heat. Experiment has shown, however, that no known gas is perfect, and that, furthermore, no gas is satisfactory throughout the entire range of temperatures which are used in gas thermometry.<sup>3</sup> The practical standard is the international Normal Scale of the constant volume hydrogen thermometer. Hydrogen can be used for very low temperatures, but above 300° C. it is unreliable. Nitrogen, on the other hand, can not be used for low temperatures, but is suitable for high temperatures. In the absence of a perfect gas we have practical standard gas thermometers, such as hydrogen and nitrogen, for which thermodynamic corrections have been determined. In practice, however, the gas thermometer is never employed by reason of the difficulties inherent in its use and, furthermore, because there are numerous other thermometers more convenient which can be compared with the gas thermometer.

In exact work, it is necessary, therefore, to define temperature in the terms of the thermodynamic scale rather than the "Normal" or "Gas Scale." Especially is this true in the case of radiation pyrometry, where the laws and formulas developed have their foundation in the second law

<sup>3</sup> Bulletin. Bureau of Standards, Vol. 3, p. 237.

of thermodynamics. Consequently the "temperature" which occurs in the equations is the absolute thermodynamic temperature.

The standardization of pyrometers is generally made by means of certain fixed points, such as the fusion of platinum, palladium, gold, etc., and the ebullition of water, aniline, naphthaline, sulphur, etc., which have been carefully determined by means of the gas thermometer. The platinum thermoelectric pyrometer, on account of its ease of manipulation, convenience, and accuracy, has come into general use for temperature measurements between  $1200^{\circ}\text{C}$ ., the upper limit of the gas thermometer, and  $1600^{\circ}\text{C}$ . The thermo-couple may be directly compared with the gas thermometer up to  $1200^{\circ}\text{C}$ ., but beyond this we must rely on extrapolation up to  $1600^{\circ}\text{C}$ ., which is the limit of the thermo-couple. Beyond this range, the scale must depend upon radiation laws which have some theoretical support and can be tested within the range of the gas scale.

It is seen from the above that high temperature measurements may be made in terms of the thermodynamic scale, but that the actual precision is entirely subordinate to that of the various intermediate steps, which lead from the perfect gas thermometer to the radiation pyrometer.

#### APPARATUS.

*Electric-resistance Pyrometer.*—Pyrometers of this type are more or less familiar to persons who have had any experience whatever in Heat or Electrical Measurements' laboratories. To illustrate the application of resistance thermometry, in the laboratory, a number of pure metals such as nickel, iron, silver, and copper may be used for temperatures up to  $300^{\circ}\text{C}$ ., and there are several types of cheap, compact, serviceable instruments now on the market. For practical use and calibration the coil of wire used should be inclosed in a tube or stem of some suitable material, such as glass, iron, or porcelain, depending upon the temperature to which it is subjected. This stem should terminate in a head provided with binding post for making connections to lead wires. As the resistance of the lead wires will vary with the depth of immersion it is necessary to provide compensating leads which are put in the adjacent arm of a Wheatstone bridge. For all temperatures, from the lowest obtainable up to  $1000^{\circ}\text{C}$ ., and especially for the higher temperatures, platinum<sup>4</sup> is the most satisfactory. When used for high temperatures (up to  $1000^{\circ}\text{C}$ .) the platinum coil is generally wound over a mica frame and inclosed in an infusible porcelain stem.

*Thermoelectric Pyrometer.*—Numerous materials have been used around the laboratory for thermo-couples, but the cheapest and at the same time the most reliable is the copper-constantan. The latter metal is known in this country as Advance, or I<sub>a</sub> I<sub>a</sub>. This couple can be used up to about 900° C. An extended investigation of this thermoelement has been carried out by White,<sup>5</sup> who recommends it as a precision thermometer. For temperatures between 300° C. and 1600° C. platinum and some alloy of platinum must be used.

The choice of a couple depends entirely upon the conditions under which it is to be used. For high temperatures the platinum couple (Pt—Pt + 10%Rh) is perhaps the only one that is used with success, but for low temperatures, say up to 1000° C., a number of alloys are used in industrial processes with good success. For low temperatures it is necessary to choose metals that will produce a higher P.D. than that used at high temperatures. For temperatures below 100° C., the couple may be calibrated by direct comparison with mercury thermometer, but for high temperatures fixed points are necessary.

The method of measuring the P.D. depends upon the accuracy required. For precise work the cold junction should always be kept at constant temperature (generally melting ice) and the P.D. should be measured on a potentiometer, using a standard cell. For work when great precision is not necessary, a d'Arsonval galvanometer or even a sensitive millivoltmeter is sufficiently accurate. In industrial practice the outfit must be as portable and compact as possible so that a direct reading instrument is generally used, which is substantially a millivoltmeter calibrated to read direct in temperature °C. or °F. The cold junction in such cases is generally maintained at 25° C. or 75° F., and the instrument is calibrated to be correct at that temperature. Any slight variation will not cause a great error, but an approximate correction can always be made by adding to the indicated temperature the difference between the temperature of the cold junction and 25°, when the former exceeds 25°, and subtracting the difference when it is less than 25°. Correction can also be made by means of an automatic

---

<sup>4</sup> Bulletin Bureau of Standards, Vol. 6, p. 149.

<sup>5</sup> Phys. Rev., Aug., 1910, p. 135.

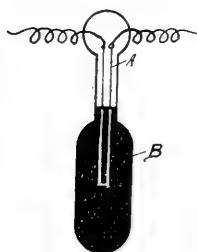

Fig. 1.

compensator as shown in Fig I. It consists of a fine platinum wire A, which is partially immersed in mercury B. When the bulb is heated the mercury in the capillary tube expands and short circuits the platinum loop, thus diminishing the resistance of the circuit. This balances a change in e. m. f., due to a rise of temperature of the cold junction.

All the contacts of the different parts of the circuit should be carefully made, and wherever possible this should be done by soldering. The hot junction of the wires used in the couple should be fused together. For easily fusible metals, such as copper, this can be done in the Bunsen flame, but for platinum oxygen is required. Platinum may also be fused in the electric arc. At the cold junction the lead wires should be soldered to the thermo-element wires. The wires composing the couple, which are subjected to high temperatures, should be insulated throughout their entire length by glass tubes or pipe stems. Asbestos thread may also be used for temperatures below 1300° C. Small fire clay tubes pierced by two holes may also be procured and are very convenient. For industrial work the couple should be inclosed by an iron or porcelain tube. The former should not be used for temperatures over 800° C.

*Radiation Pyrometry.*—From the fact that the intensity of light emitted from a body increases very rapidly with rise of temperature the optical method is well adapted to the measurement of high temperatures. For example, the luminous intensity of the red part of the light emitted by a body of 1500° C. is 130 times the intensity of 1000° C., and at 2000° C. it is more than 2100 times as great as at 1000° C. It thus appears that a comparatively rough measurement of the luminous intensity of an incandescent body would give a pretty accurate measurement of its temperature. This conclusion, however, is modified by the fact that different bodies at the same temperature emit very different amounts of radiant energy. The radiating power of a body depends not only upon the temperature but also the composition and nature of the surface. In order that the radiation and optical methods can be used for comparison of temperatures it is necessary that the effect of differences of surfaces be eliminated. This can be done by reducing the radiation from all surfaces to the radiation that would occur from some ideal surface arbitrarily taken as a standard of comparison.

A body that would absorb all the radiant energy incident upon it is called a perfectly black body. From a consideration of Prevost's theory of exchange it can be shown that a body inside an inclosure all parts of which are at the same temperature is a perfectly black body. Kirchoff has shown that the radiation from a perfectly black body depends only upon its temperature. For this reason the radiant energy emitted by a perfectly black body is taken as the basis for the comparison of high temperature. Radiation and optical pyrometers are calibrated by comparing a series of actual temperatures of a perfectly black body with the amounts of energy radiated at the respective temperatures. Two bodies are at the same black body temperature when they emit equal amounts of radiant energy. Two bodies at the same actual temperature, determined by means of a gas thermometer, will not be at the same black body temperature unless their surfaces have the same radiating power. For example, a piece of iron and a piece of porcelain each at an actual temperature of  $1200^{\circ}\text{C}$ ., if examined by means of an optical pyrometer calibrated in terms of the red rays emitted by a perfectly black body, would indicate  $1140^{\circ}\text{C}$ . and  $1100^{\circ}\text{C}$ . respectively. If, however, two bodies be placed inside a uniformly heated inclosure they will not only attain the same temperature, but they will also emit radiant energy equally. That is, they will have the same black body temperature. In other words, the actual temperature of a body inside a uniformly heated inclosure equals the black body temperature.

A pyrometer then, which has been calibrated by comparison with a black body, when sighted upon an incandescent body, reads not its true temperature (thermodynamic temperature), but its black body, which will be somewhat lower than its true temperature. The difference will depend upon the emission power of the body. If, however, the body sighted upon is a black body, for example a heated inclosure, then the pyrometer indicates its true or thermodynamic temperature. A few substances such as platinum black, carbon and iron oxide radiate approximately as black bodies, but as yet there is no known substance which is absolutely black. In using the term in this sense we must remember that the temperature must be involved as well as the emission and absorption powers. Thus, any body whose radiation is proportional to that of a black body, for all wave lengths, is considered *black* if its temperature is the same as a black body. If its true temperature is higher (it could never be lower) it is considered *gray*. A carbon lamp filament is gray because its spectral distribution is the same as

a black body, but not black because its true temperature is slightly higher than a black body.

A uniformly heated inclosure is the nearest approximation to our ideal black body.

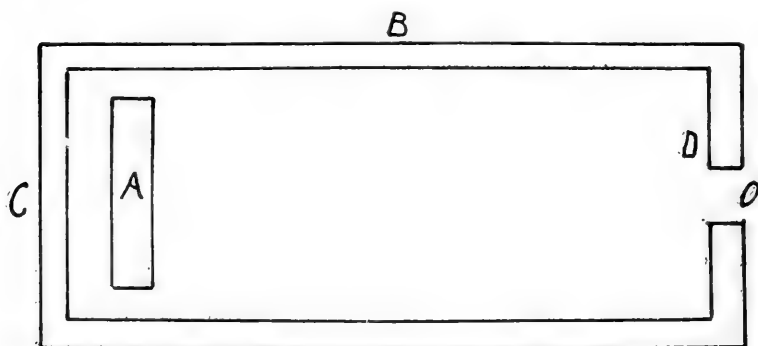

FIG. 2.

Consider a body A within a heated inclosure B, Fig. 2, both at the same temperature throughout. A receives a certain amount of thermal radiation from the wall of the envelope C and radiates to C an equal amount if they are in temperature equilibrium. Also A radiates a certain amount to D and receives the same amount, if D is at the same temperature. Since A, on the whole, neither gains nor loses it radiates to D the same amount it receives from C, consequently the radiation from A towards D is the same as that from C towards D. Not only is the quantity the same but also the quality, for the coefficient of absorption depends upon the quality (i. e., it is different for different parts of the spectrum), so that if C and A radiate the same amount they must radiate the same quality. If the spectral distribution of A were different from C its coefficient of absorption would be different and therefore it would not radiate the same quantity. Hence any other body within B and at same temperature would radiate the same as A so that no detail could be detected, i. e., the objects could not be distinguished from one another or the walls of the inclosure.

Moreover any body outside of B at the same true temperature could not radiate more energy than A, consequently, A is a *complete radiator* or a perfectly black body when within B, and it also follows that the interior of B radiates as a perfectly black body. A piece of polished



platinum and a piece of carbon would appear equally bright within B, if viewed through a small hole, but if quickly removed the platinum would appear less bright than the carbon, for it gives out less light that is proper to itself since it is a good reflector but a poor absorbent and consequently a poor radiator, while C gives out more light that is proper to itself since it is a poor reflector but a good absorbent and a good radiator.

Now if the wall D were partly removed or were cooler than the rest of the walls it could not radiate to A as much as C does because it receives less from D. In this case we would have a slight departure from black body conditions. Hence the general statement:

The true temperature as indicated by a thermo-couple, of all substances heated in an inclosure, is the same as the black body temperature, as indicated by a pyrometer, which has been calibrated against a black body. If, however, the walls of the inclosure, wholly or in part, are cooler than the radiating object, its true temperature will in general be higher than the black body temperature. However, if the walls are reflecting, but at the same time cold, the difference in the two temperatures is less. This difference will be still less if the objects considered are of carbon or platinum black, etc.

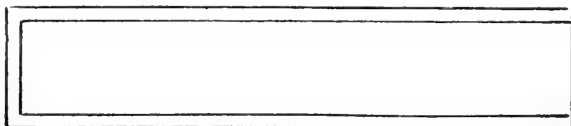

FIG. 3.

An experimental black body should therefore be as uniformly heated as possible and the aperture should be small, or if one end is entirely removed, as in Fig. 3, the length should be large compared with its cross-section.

It thus appears that in order to attain actual temperature by radiation methods the body whose temperature is desired must be made as nearly a black body as possible. In many cases this can be done with little difficulty. For example, if the temperature of an annealing oven is required, one could insert into the oven the closed end of a long metal or porcelain tube. The radiant energy coming from the bottom of this tube will be a close approximation to that of a perfectly black body. If black body conditions are not realized as an incandescent sheet of metal the tempera-

ture may be expressed merely as black body temperature, Kirchoff's absolute scale.

*Laws of Black Body Radiation.*—Stefan deduced from experiment, and Boltzmann deduced from thermodynamic considerations, the law that the total radiant energy emitted from a black body is proportional to the fourth power of the absolute temperature, or,

$$J = KT^4$$

where K is a constant.

The radiant energy emitted by a heated body is in the form of waves of diverse wave length. Most of the radiant energy is due to waves that are too long to affect the eye. As the temperature of the body is increased, the energy of all the emitted waves is increased, but the energy of the shorter waves increases more than that of the longer waves. That is, the distribution of energy among the waves of different lengths depends upon the temperature of the body.

Wien has also shown that the product of the absolute temperature T of some source and the wave length having maximum energy,  $\lambda_m$  in spectrum is a constant.

$$\lambda_m T = \text{constant} \quad A$$

This is generally known as the displacement law or Wien's First Law. Wien also combines his first law with the Stefan-Boltzmann Law giving his second law.

$$J_{\max} T^{-5} = \text{constant} \quad B$$

His most important investigation, however, was the investigation of spectral distribution of energy in the radiation of a black body in which he shows that for any particular wave length the relation between the energy emitted and the absolute temperature is as follows:

$$J = C_1 \lambda^{-5} e^{\frac{-C_2}{\lambda T}} \quad (1)$$

where J is the energy corresponding to wave length  $\lambda$  and T is the absolute temperature.  $C_1$  and  $C_2$  are constants and e is the base of the natural system of logarithms.

The working principles of the following experiments are based upon these two laws, i. e., the total radiation and spectral radiation laws. In the first case black body temperature is determined by measuring the total energy, as in a Fery pyrometer which allows radiations of all wave lengths to fall upon a sensitive thermo-couple connected to a direct reading galvanometer. In the second case some particular wave length is used and

the measurement of temperature is made photometrically by adjusting to equality two photometric fields produced by a standard source and the body to be measured. The intensity of radiation is varied by cutting down the objective aperture, as in Le Chatelier, or by a polarizing device, as in the Wanner, or by varying the intensity of the standard itself, as in the Holborn.

Since we are using mono-chromatic light a measure of the luminous intensity may be taken as a measure of the radiant energy. The intensity of radiation of a source may be defined as the ratio of the total energy emitted (including all wave lengths) to the energy falling upon unit surface. A part of the energy emitted by a heated body, however, may be luminous and both the luminous and total energy emitted by a body increases with temperature, but the total luminous energy is not proportional to the total energy emitted. The luminous energy of any particular wave length, however, is directly proportional to the total radiant energy emitted. Hence in any optical pyrometer when photometric comparison is made if mono-chromatic light is used the above radiation laws will hold.

*Wanner Pyrometer.*—It has been shown that the luminous intensities of two bodies may be taken as a measure of their temperatures, if mono-chromatic light is used, and since luminous intensities may be compared by the rotation of a Nicol prism we have a convenient means of measuring high temperatures.

In this method comparison is made between a standard lamp and the body whose temperature is sought. The standard used is a 6-volt incandescent lamp which is in turn compared with some primary standard as an amyl acetate lamp. For this work the primary standard is used merely as a check for the more convenient electric lamp and so long as it is reproducible so that the comparison lamp can always be brought to the same condition, we are not concerned with its intrinsic intensity or temperature. Photometric comparison is made of the comparison lamp and the unknown source by adjusting to equal brightness two halves of a photometric field by means of a polarizing arrangement, monochromatic red light being produced by a direct vision prism.

The intensity of the unknown source in terms of the comparison lamp, taken as unity, is

$$J = \tan^2\phi$$

where  $\phi$  is the rotation of the Nicol prism.

*Le Chatelier Pyrometer.*—Le Chatelier's optical pyrometer compares the luminous intensity of the red radiation from the body whose temperature is derived with the red radiation from a standard light source. The radiation from the body whose temperature is to be measured, traverses the diaphragm S, Fig. 4, and the objective O. A part of the radiation grazes the right edge of the mirror M and is brought to a focus at the focal plane of the eye-piece A. Light from the central portion of the flame of the comparison flame L traverses the objective O', is reflected from the inclined mirror M and is also brought to a focus in the focal plane of the eye-piece. Thus two images, one of the source whose temperature is sought, and one of the comparison flame, are found side by side, in the focal plane of the eye-piece. These two images are simultaneously observed by means of the eye-piece A provided with a piece of red glass for rendering

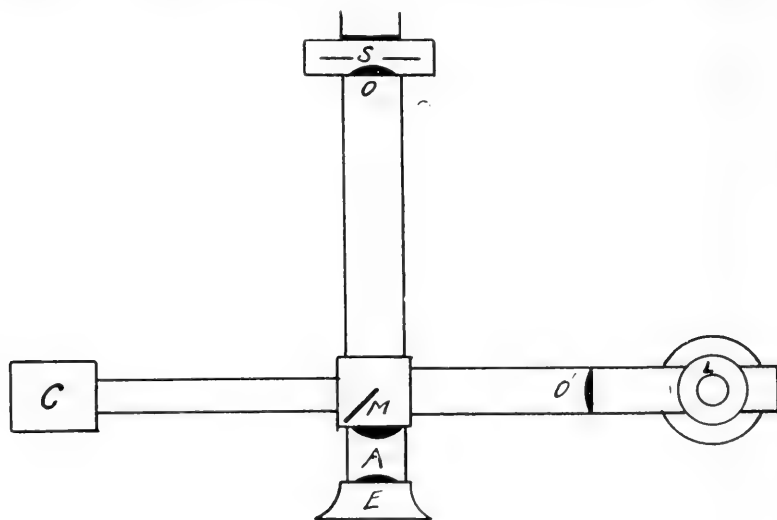

FIG. 4.

the radiations that enter the eye of the same wave lengths. By adjusting the size of the aperture in the diaphragm S, these two images can be brought to the same luminous intensity. The distance from the objective O to the focal plane of the eye-piece can be varied in order to focalize the radiation from the luminous source, and the distance can be read directly from a scale engraved on the draw tube. The aperture in the diaphragm S is square and the length of one side can be read directly from the screw head which operates it.

The intensity of the unknown source in terms of the intensity of the comparison lamp taken as unity, becomes

$$J = \left(\frac{1}{d}\right)^2$$

where  $d$  denotes the length of one side of the square aperture  $S$ . Due to the lack of monochromatism of the red glass this instrument is not so accurate as the Wanner.

*Holborn-Kurlbaum Pyrometer.*—In this method the luminous intensity of the comparison source is varied until a photometric balance is obtained between its image and the image of the incandescent object in question. In the H.-K. (Holborn-Kurlbaum) pyrometer shown in Fig. 5 a small electric lamp  $L$  is placed in the focal plane of the objective  $O$  and the same

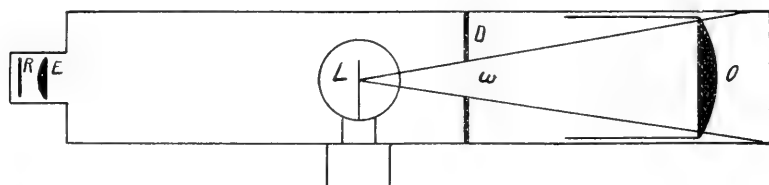

FIG. 5.

is viewed by means of an eye-lens  $E$ . In making an observation the pyrometer is focused upon the object whose temperature is sought, thus bringing the image of the object in the plane of  $L$ . The current through the lamp is adjusted by means of a rheostat until the lamp filament disappears against the bright background. The value of the current strength can be read direct from a milli-ammeter.

In order to measure temperature with this instrument it must be empirically calibrated by means of a black body. A curve may then be plotted with current in milli-amperes,  $I$ , and temperature,  $t$ , in degrees C. To determine an unknown temperature, it is only necessary to focus the instrument upon the object in question and adjust the current through the lamp until the filament disappears against the bright object. The pyrometer then indicates the black body temperature unless black body conditions are realized, in which case it indicates true temperature, i. e., thermodynamic temperature.

The reading of the ammeter will be independent of the distance of pyrometer from object so long as the solid angle  $\omega$ , Fig. 5, is constant. This is accomplished by means of the diaphragm  $D$ . When the instrument

is focused for distant objects, i. e., when O is drawn near L, the solid angle  $\omega$  would be increased if it were not for the diaphragm D.

The light which reaches the eye is rendered approximately monochromatic by a red glass R placed before the eye-piece but for temperatures below 800° C. this is not necessary and above 1,200° C. two glasses are generally used. For the extrapolation of the experimentally determined curve for high temperatures Wien's third law may be used. For these high temperatures beyond the safe limit of the lamp three different methods are used for cutting down the incident radiation a determinate amount; absorbing glasses, mirrors, and sector discs.

Since the absorbing power of the absorption glasses is different for different wave lengths, if there is any lack of monochromatism in the red transmission glasses, which is generally the case, Wien's law will not hold for high temperatures.

To overcome this difficulty Henning<sup>6</sup> has combined an H.-K. pyrometer with a Hilger constant deviation spectrometer so that homogeneous light may be used. This instrument has the further advantage that any part of the spectrum may also be employed. Dr. Mendenhall has recently devised a spectroscopic eye piece to accomplish the same purpose.

The H.-K. pyrometer is probably the most sensitive pyrometer now in use.

*Féry Total Radiation Pyrometer.*—From a consideration of the Stefan-Boltzmann radiation law we have seen that the energy radiated by a black body is proportional to the fourth power of the absolute temperature, or,

$$J = KT^4 \quad (2)$$

From this relation it is evident that a comparatively rough method of determining the energy radiated would yield fairly accurate results of temperature measurements.

The Féry radiation pyrometer is shown in detail in Fig. 6. Radiation from an incandescent body is focused upon a minute and sensitive thermocouple C, by means of a lens A'. In order to calibrate the pyrometer directly in terms of the Stefan-Boltzmann law the lens should be transparent for all radiations and this is best effected by using a fluorite lens which for temperatures above 900° C. does not absorb an appreciable portion of the incident radiation. F is a rack and pinion for focusing the radiation upon the thermo-junction. The screens C' and D protect the junction from

<sup>6</sup> Zeitschrift Für Instrumentenkunde, März, 1910.

extraneous rays. The diaphragm E provides a constant angle aperture, which is a necessary condition for the instrument to be independent of focusing. The thermo-junction leads are connected to the posts b and b', which are in turn connected to a galvanometer. In making a temperature measurement the image of the incandescent object is focused upon the

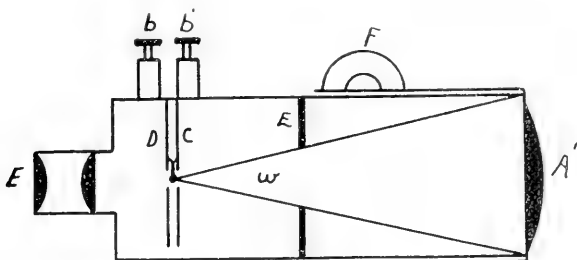

FIG. 6.

thermo-couple by means of the eye piece E, and care must be taken that the image is larger than the thermo-couple. It is evident from Equa. 2 that if the galvanometer has a uniform scale and the temperature  $T_1$  is known corresponding to a scale reading  $R_1$ , the temperature  $T_2$  for any other reading  $R_2$  may be found from the relation.

$$T_2 = T_1 \sqrt[4]{\frac{R_2}{R_1}}$$

When the limit of the scale is reached the calibration may be extended by means of a diaphragm placed before the objective or by shunting the galvanometer. In technical practice, however, a glass lens is used and the instrument is calibrated empirically against a black body whose temperature can be determined. This instrument is also made with a gold reflector instead of a lens. Féry<sup>7</sup> has recently brought out a new pyrometer which is similar to the above with the exception that the temperature of the incident radiation is measured by means of a minute expansion spiral consisting of two metals with dissimilar expansion coefficients. This mechanical device renders the instrument more robust but does not admit of so great accuracy as the thermoelement.

*Morse Thermo-Gage.* This is somewhat similar to the Holborn-Kurlbaum pyrometer in that it utilizes the disappearing filament principle but it is not nearly so precise since it is not provided with any lens system

<sup>7</sup> Engineering, May 14, 1909.

or monochromatic glasses. It is simply an incandescent electric lamp in a black tube and it is operated and calibrated in a similar manner to the Holborn instrument.

While there are a number of instruments, more or less reliable, which may be bought from scientific shops, the above list represents the ones in most common use. In the opinion of the author it is neither necessary nor advisable to equip a high temperature laboratory with an elaborate outlay of expensive commercial apparatus. The object of such a laboratory should be to teach the student the fundamental principles of the subject, the application and limitations of these principles to commercial instruments and to train the student in the use of a few types of instruments. After having mastered the principles of radiation pyrometry the student will have no difficulty in making a temperature observation by means of a direct reading Féry spiral pyrometer or any other similar instrument.

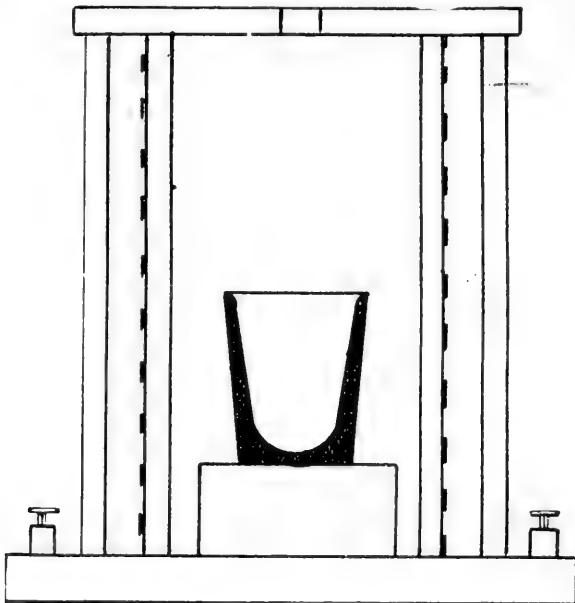

FIG. 7.

For the purposes of calibration or standardization of instruments the laborator should also include a boiling point apparatus for each of the fixed points, or if the fusion temperatures of the metals are used, a melting furnace.



To calibrate a platinum couple, the most convenient fixed points are the fusion temperature of copper, antimony and zinc. These metals may be melted in small graphite crucibles. The size of crucible chosen and the quantity of metal used should be such that at least 5 cm. of the couple may be immersed in the metal. The crucible may be heated in any suitable manner, but an electric resistance furnace is perhaps the most convenient. Fig. 7.

One form of furnace consists of two concentric cylinders of fire clay, or porcelain, placed upon a base of the same material. A suitable cover also is provided with a hole for admitting the couple. The inner cylinder is overwound with fine nickel wire or ribbon and the crucible, to be heated, is placed within this cylinder. It should be placed at about the center so as to be uniformly heated.

Another form of furnace which is less likely to get out of order, but which on the other hand is not so satisfactory for precise work, is shown in Fig. 8. This consists of a rectangular trough of brick work (a, Fig. 8).

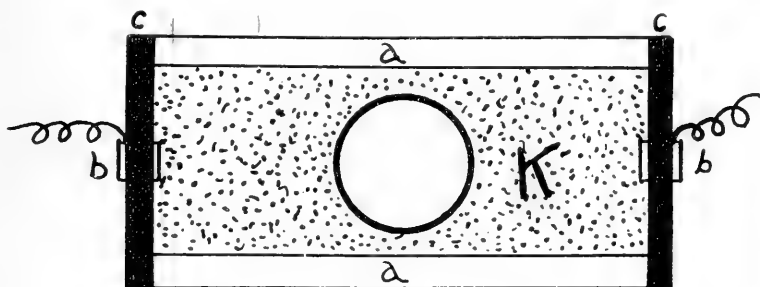

FIG. 8.

The inside width should be somewhat greater than the diameter of the crucible to be used and the depth slightly greater than the height of the crucible. The ends of the trough are closed with carbon plates *cc*, which carry binding posts *bb*, for the connecting wires. The intervening space *K* is filled with a granular resisting material, commercially known as "Kryptal." The connectors at *bb* are connected to some source of e.m.f. either DC or AC. The amount of current may be regulated by varying the density of the mass of kryptal used. Thus, when a large amount is used and when it is packed down well a large current will pass through the furnace. The top of the entire furnace should be covered over with bricks.

In order to calibrate or standardize a pyrometer it is necessary to have a luminous source whose black body temperature is accurately known. The primary standard must be some form of a heated inclosure whose walls can be maintained at a uniform constant temperature. Some means must also be used for determining the true temperature of the inside of the inclosure.

This is generally accomplished by some form of an electric resistance furnace, as shown in Fig. 9. It consists of a central porcelain tube overwound with thin platinum foil through which passes an electric current which can be adjusted to maintain any desired temperature up to about  $1,600^{\circ}$  C. Concentric with this tube are two shorter ones which, with the intervening air spaces, minimize the radiation. Some form of thermo-couple is placed in one end so that the hot junction is near the

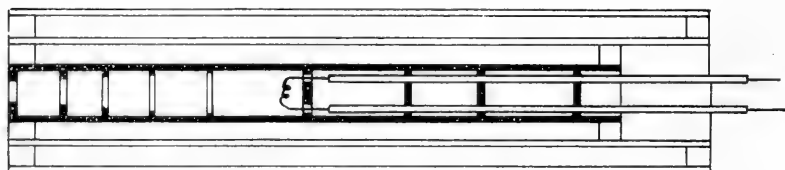

FIG. 9.

center of the tube. If there is a cold junction it should be placed in crushed ice. The thermo-couple may be either connected to a potentiometer or a sensitive potential galvanometer which reads millivolts, and by means of a previously determined calibration any temperature may be determined. Except in refined work the ice point is not necessary. The furnace is connected in series with a rheostat and 110 v. DC.

For the calibration of the Wanner or Le Chatelier pyrometer it is not necessary, as will be shown on the following pages, to know but one black-body temperature so that as a working standard any convenient luminous object such as a frosted globe incandescent lamp, which would give a uniformly illuminated area of about 1 sq. cm., might be used if its black-body temperature at some particular current strength were accurately known.\*

For pyrometers like the Holborn-Kurlbaum (H.-K.), however, which can only be calibrated empirically, it is necessary to have a black body

\* Physical Review, Vol. 31, No. 4, Oct., 1910.

whose temperature can be varied. This is generally done by means of an electric furnace, but when a Wanner, Le Chatelier, or a calibrated H.-K. is at hand it is easiest accomplished by direct comparison.

The comparison source may be a thin platinum strip, heated electrically or a wide filament incandescent lamp. The H.-K. may be sighted on one side of the strip and the calibrated pyrometer on the opposite side. The black body temperature of the strip can be determined by means of the calibrated instrument and at the same time the reading of the H.-K. comparison lamp can be taken.

In the case of a wide filament carbon incandescent lamp it has been shown that if it is properly aged for about 20 hours at 1,760° C. it will remain sufficiently permanent for a secondary standard for 15 or 20 hours.

If a lamp is calibrated in terms of black body temperature and current strength by means of a pyrometer it may be used as a standard of comparison for calibrating pyrometers just as a black body would be used.

#### CALIBRATION.

In the foregoing a number of instruments have been described for the estimation of high temperature, each class utilizing some effect of temperature such as the change of resistance, development of small electromotive force, change of luminous intensity, etc., and it now remains to indicate how each of these instruments may be calibrated to read in terms of temperature, °C.

*Electric-resistance Pyrometer.* A resistance pyrometer may be calibrated by comparison with a calibrated instrument or by a number of known temperatures such as the boiling points of liquids or fusion points of metals, and in general three points are quite sufficient to completely calibrate the pyrometer, but no simple equation can be given for all metals. For platinum, however, the case is somewhat different, as an extensive study has been made of platinum resistance thermometry.

Callender<sup>9</sup> defined platinum temperature Pt as follows:

$$pt = 100 \frac{R - R_0}{R_{100} - R_0}$$

where R = the observed resistance at the temperature t.

where R = the observed resistance at 0° C.

where R = the observed resistance at 100° C.

<sup>9</sup> Proc. Roy. Soc. 41, p. 231, 1886.

The relation between platinum temperature and centigrade temperature from  $-100$  to  $1,100^{\circ}$  C. is given by the equation

$$t - pt = \delta \left( \frac{1}{100} - 1 \right) \frac{1}{100}$$

where  $\delta$  is a constant depending upon the purity of the platinum. For pure platinum  $\delta$  is 1.50 and for impure it is somewhat higher. Such a pyrometer is usually calibrated by measuring its resistance at the melting point of ice ( $0^{\circ}$  C.), boiling point of water ( $100^{\circ}$  C.), and some other temperature, such as the boiling point of sulphur ( $444.7^{\circ}$  C.).

Temperatures measured on such a pyrometer will agree with the temperatures measured on the gas scale in the range 0 to  $1,100^{\circ}$  C. to within the degree of reproducibility of the latter.<sup>10</sup>

*Thermoelectric Pyrometer.*—It has been shown by a number of experimenters that in order to completely calibrate a thermo-couple, point by point comparison is unnecessary, but that three or four known temperatures or fixed points are sufficient. No general equation can be given that will accurately fit all thermo elements, but for most metals, at least within a limited region, the relation between the potential difference in millivolts and the temperature in degrees centigrade is sufficiently well represented by the general quadratic equation

$$e = a + bt + ct^2 \tag{3}$$

where  $a$ ,  $b$  and  $c$  are constants that can be determined if three temperatures are used. It can easily be determined by experiment how well this formula will hold for any given couple. Three points should be chosen which will cover the region for which the couple is to be used, and a curve drawn through these points. If the curve is nearly a straight line it can be represented by Equa. 3.

The fixed points are generally the ebullition of water, analine, naphthaline, sulphur, etc., or the freezing of such metals as tin, zinc, antimony, copper, silver, gold, etc. The former, with the exception of sulphur, are obtained with less difficulty than the latter, but are of value only for low temperatures.

For a copper-constantan couple the most convenient fixed points are the fusion temperature of antimony ( $630.7^{\circ}$  C.), zinc ( $419.4^{\circ}$  C.), and tin ( $231.9^{\circ}$  C.), and for a platinum couple zinc, antimony and copper ( $1,083^{\circ}$  C.).

<sup>10</sup> Bulletin Bureau of Standards, Vol. 6, p. 196.

*Radiation Pyrometers.*—Equa. (1) may be written in the form

$$\log_{10} J = K_1 - K_2 \frac{1}{T}, \quad (4)$$

where

$$K_2 = C_2 \frac{\log e}{\lambda}.$$

$C_2$  for a black body temperature equals 14,500 when  $\lambda$  is given in terms of  $\mu$ .

Equa. (4) may be applied to any pyrometer, using monochromatic light, in which the luminous intensity can be varied in a continuous and determinate manner as in the Wanner and Le Chatelier. Either of the instruments will, therefore, indicate temperature indefinitely high, but the limit of accuracy is reached at about 2,000° C., so that at higher temperatures the incident radiation is usually cut down by means of one or more absorption glasses. The amount by which it is cut down is determined as follows:

Let  $J'$  equal the luminous intensity of the incident radiation and  $J$  the value as indicated by the instrument when one glass is used, then

$$J' = JR,$$

where  $R$  is the absorption factor. For two absorption glasses

$$J' = (JR) R = JR^2,$$

and for  $n$  glasses

$$J' = JR^n \quad (5)$$

also

$$R = J'/J. \quad (6)$$

The general expression, then, for the relation between energy and absolute temperature, is from (4)

$$\log J' = K_1 - K_2 \frac{1}{T}.$$

From (5)

$$\log J + n \log R = K_1 - K_2 \frac{1}{T},$$

whence

$$t = \frac{K_2}{K_1 - \log J - n \log R} - 273, \quad (7)$$

where  $t$  is temperature in degrees C.

Equa. (7) is a general equation for connecting the relation between temperature  $t$  and luminous intensity  $J$  and can be applied to any pyrometer in which  $J$  can be determined theoretically. For the Wanner pyrometer  $J = \tan^2 \phi$ , where  $\phi$  is the angle of rotation of the nicol analyzer, and for the Le Chatelier  $J = (1/d)^2$  where  $d$  is the length of one side of the iris diaphragm.  $K_1$ ,  $K_2$  and  $R$  are constants and can all be determined without reference to any temperature observation.

*Wanner Pyrometer.*—This method of calibration will be made clear by an example. For a particular Wanner pyrometer the value of  $\lambda$  was  $0.656 \mu$ .

Therefore

$$K_2 = \frac{14,500 \times 0.4343}{.656} \\ = 9,600.$$

It is seen from (4) that if  $K_1$  were known, various values of  $\phi$  might be substituted in the equation and the corresponding temperatures calculated. Now by assuming some angle of rotation  $\phi$  for some particular temperature  $T$ , as in the above case,  $K_1$  may be found. For example, let

$$T = 1273 \text{ and } \phi = 45^\circ.$$

Then from (4)

$$K_1 = \log \tan^2 \phi + K_2 \frac{1}{T} \\ = 0 + \frac{9,600}{1,273} = 7.55.$$

For  $\phi = 10$ , and  $n = 0$ ,  $t$  may be calculated from (7),

$$t = \frac{9,600}{7.55 + 1.51} - 273 \\ = 787^\circ \text{ C.}$$

*Le Chatelier Pyrometer.*—The wave length for the red glass used on a Le Chatelier pyrometer was found to be  $0.649 \mu$ . The constant  $K$  then becomes

$$K_2 = \frac{14,500 \times 0.4343}{0.649} \\ = 9,700.$$

*Holborn-Karlbaum Pyrometer.*—Such an instrument must be calibrated empirically and the calibration will be different for every lamp used. It

has been shown<sup>11</sup>, however, that the relation between temperature and current through the lamp may be represented by the general quadratic equation

$$I = a + bt + ct^2,$$

so that three known temperatures are sufficient to completely calibrate the instrument. Such a pyrometer may be readily calibrated, without the use of a black body, by means of a standard pyrometer comparison lamp as explained above. If such a lamp is not properly calibrated in terms of temperature and current its black body temperature, for any value of current, may be determined by means of another calibrated pyrometer. A platinum ribbon may be used in the same way.

*Physics Laboratory,*

*Purdue University.*

---

<sup>11</sup> Bulletin, Bureau of Standards, Vol. I, p. 235.





## TWO PINE GAMETOPHYTES IN ONE OVULE.

By M. S. MARKLE.

In sectioning some pine material of unknown origin, I recently found one ovule that had in it two well-developed gametophytes, each of which had developed archegonia. This probably means that two megaspores functioned instead of the usual one. I understand that the abnormality has also been noticed by Miss Sargent. The two gametophytes occupied the positions shown by the accompanying sketch.

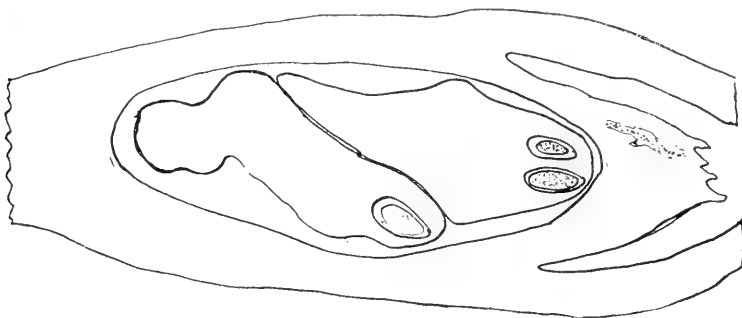



## INDIANA WEEDS—THEIR CONTROL AND ERADICATION.

By G. M. FRIER, B. S. A., Assistant Agricultural Extension,  
Purdue University.

The subject of weeds is one in which the people of Indiana are taking more and more interest each year. The farmers, who constitute a large percentage of the population of the State, are much concerned about the weed situation now confronting them. There are growing on the farms

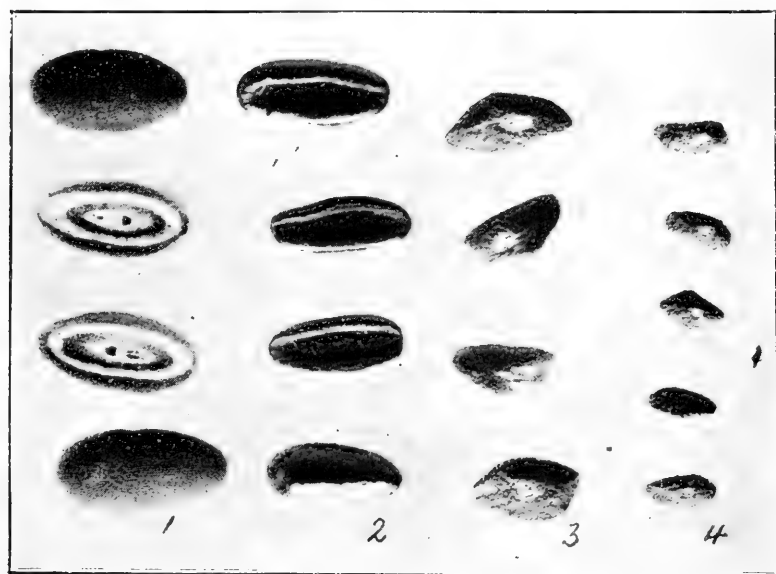

1. Bracted Plantain.
2. Buckhorn.
3. Black-seeded Plantain.
4. Common or Dooryard Plantain.

of Indiana today, scores of species of weed pests, and in many cases enormous numbers of each species. This results in smaller crops and smaller profits. Weeds are robbers in a very distinct and definite sense. To the citizens of our town and cities they are unsightly and offensive, disfiguring

as they do lawns, gardens, streets and vacant lots. There are being received at the Agricultural Experiment Station, in ever increasing numbers, inquiries concerning weeds of the farm, lawn and vacant lot, their time of flowering, time of seeding, distribution, method or methods of propagation, prolificacy, means of control, or eradication, and similar queries, showing



Dog Fennel or Mayweed.

that there is a general desire and demand on the part of our people for information along this line. The following paragraphs will therefore attempt to take up in a brief and condensed way some of the important phases of the weed problem as we have it in Indiana today.

## HOW WEEDS SPREAD.

Nature has provided in an interesting and wonderful way for the reproduction and dissemination of plants. A large number of common weeds, such as the dandelion, sow thistle, wild lettuce, groundsels, white-top, ironweed, boneset, joe-pye weed, true thistles, produce seeds to which are attached light, fluffy, parachute-like structures which very materially facilitate their dispersal by the wind. Other weeds, such as yarrow, ox-eye



Curled or Sour Dock.

daisy and curled dock, are either very light, or have light membranous attachments. There is a group of weeds, including old witch grass, Russian thistle, tumbling pigweed and others, which have the characteristic of breaking off when mature at or near the surface of the ground, and, rolling hither and thither, far and wide, over the fields, discharge thousands of weed seeds as they go, in this way inoculating our fertile soils with crop-reducing weed pests.

Another agency making for the spread of weeds, is water. The seeds or fruits of many plants, especially those growing in or near water, are

fitted for dissemination by this agency. Such fruits are those of narrow-leaved dock, showing a round, rough, spongy growth on the outside of each of the close fitting, persistent sepals; of the Asa-Gray sedge, with its inflated sack attached to the fruit; of the arrowhead, with its corky margined fruits which are able to float on the water.



Black-seeded Plantain

The seeds or fruits of many weeds are in one way or another carried by animals. Thus when slightly moist, the seeds of peppergrass, plantain, groundsel, dropseed grass, and many others, are sticky and will adhere to animals' feet or covering. Some sedges, chickweeds and catchflies have sticky glands, by means of which they cling to passing objects. The fruits of the avens, and the burs of the common burdock, are armed with hooks, and the fruits of the bidens or beggar's ticks with spines, by means of which

they cling to and are carried about attached to the covering of animals or the clothing of human beings. Similarly provided for are hounds-tongue, stick-tights, tick trefoil, bed-straw, cocklebur, sandbur, motherwort and many others. Further, birds and animals devour very large numbers of many kinds of weed seeds, not all of which are acted on by digestive juices to such an extent as to destroy their viability. These are scattered in bird and animal excrement, and grow into new and vigorous plants.

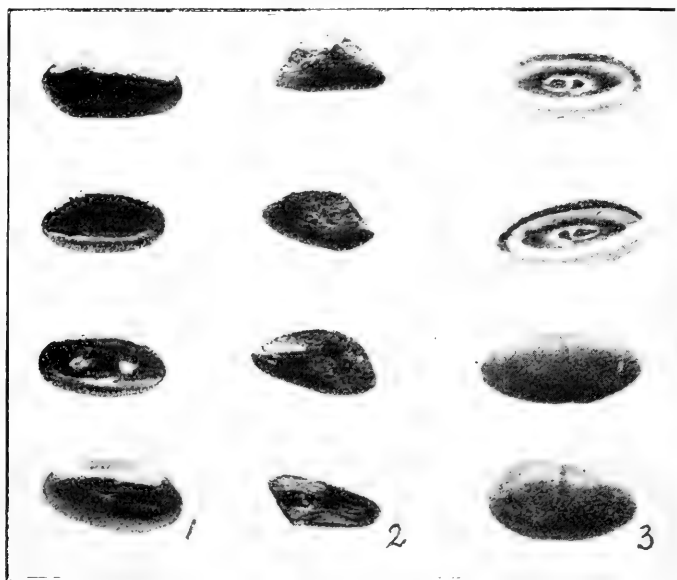

1. Buckhorn.
2. Black-seeded Plantain.
3. Bracted Plantain.

Noxious weeds are spread through the use on farms of manure and sweepings from stock and other cars, and by means of packing about merchandise and nursery stock. The moving of threshing and other machinery from place to place without first cleaning them out thoroughly, the use on farms of manure from livery stables in towns and cities, all help to spread noxious weeds. The use of impure and adulterated crop seed on our farms is responsible in a large measure for the spread of weeds. Much of the clover, alfalfa and grass seed used in Indiana today have

mixed with them considerable quantities of weed seed and other impurities, which, scattered on the land, means weedy fields and reduced crops. Many lawns are excessively weedy because of impure seed scattered on them.

THE INJURY WEEDS DO.

Indiana farmers are losing many hundreds of thousands of dollars each year because of the weed situation existing in this State. A continuous and strenuous effort to control weeds ought to be made, because—

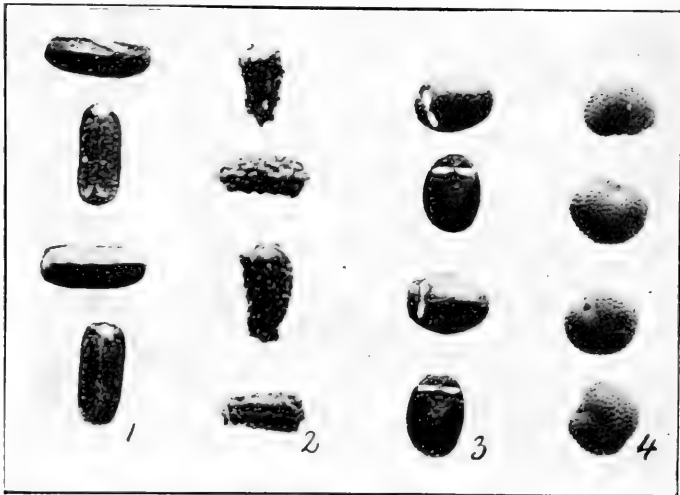

1. Vervain.
2. Mayweed or Dog Fennel.
3. Catmint.
4. Night Flowering Catchfly.

1. They rob crops of plant food and moisture. Plants feed as really as do horses or cattle. As growing crops remove plant food from the soil, the farmer must count on the necessity of returning an amount of plant food to the soil at least equal to that removed, if he expects to continue to grow crops abundantly and profitably. Weeds require approximately the same kinds of plant food as do farm crops, and they require them in approximately the same amounts. Crops suffer when weeds use up a large share of plant food. To put this plant food into the soil the farmer expended money, time and labor. Further, an adequate supply of moisture in the soil is indispensable for the successful growing of crops. Weeds, like



other plants, are constantly, during the growing season, pumping water from the earth. Much of this ultimately goes off into the air, and, as far as crops are concerned, is wasted. For the formation of every pound of dry matter in a corn crop, there are required 300 pounds of water. Oftentimes crops suffer seriously for moisture owing to the presence of weeds, and as a result these crops are much reduced in quantity and value.

2. Weeds choke out the desired crops. No field can produce excellent crops of corn or wheat and a heavy growth of weeds at the same time. This, in agriculture, is as impossible as in physics it is impossible for two bodies to occupy the same space at the same time. When a heavy growth of weeds is present, corn, vegetables or any other crop, are likely to be weak and spindling.

3. Weeds furnish a refuge and shelter for the protection and propagation of insect and fungus enemies of crops. Fruit, vegetables and field crops have very many more such enemies than is ordinarily realized. The keeping down of weeds and the removal or plowing under of refuse material, will in no small measure reduce insect and fungus enemies of crops.

4. The presence of weeds in considerable quantity makes every operation on the farm—plowing, harrowing, seeding, cultivating, harvesting, marketing, etc., more expensive. Further, on a farm where weeds are not intelligently and continuously combated, machinery is more short-lived, and repairs are needed oftener.

5. Property overrun with weeds is less attractive, and will not sell as high as property giving indication of thrift, intelligence, and successful management. Moreover, weeds are an offense to one's æsthetic taste, and an eyesore to all passers-by.

In view of these facts, it is very plain that weeds are distinctly robbers, and should be controlled and, where possible, eradicated. To deal effectively with weeds, it is necessary to know something of their characteristics, their life history—are they annual or biennial or perennial? How do they propagate? When do they flower? When do they seed? Do they produce large quantities of seed? Does this seed retain its vitality in the soil for a long time or but a short time? To facilitate the gaining of information on weeds from reading, lectures or conversation it is a decided advantage to know common weeds at least by their commonly accepted names. In these later days it is not difficult to obtain a working knowledge of our Indiana weeds. Books and bulletins covering the subject are available.

The Agricultural Experiment Station or the U. S. Department of Agriculture will gladly furnish bulletins on weeds or weed seeds, or name specimens of weeds or seeds sent in.

It is not possible in this brief article to take up a consideration of a



Dodder on Clover.

large number of individual weeds. It must of necessity suffice to consider the larger groups into which all our weeds fall—annuals, biennials and perennials. Annuals are those which grow from seed, and in turn produce flowers and seed, all within the one growing season. They are, as a rule, fibrous rooted and propagate by seed only. Many of them produce seed in

great abundance. The seeds of some annuals when buried in the soil retain their vitality for long periods. Mustard seed, for instance, has been known to lie in the soil for a quarter of a century and then when placed in a favorable environment, grow into vigorous plants. In this class we have such common weeds as dodder, foxtail, smartweed, Russian thistle, crabgrass, pigweed, lamb's quarters, dog fennel, barnyard grass, tickle grass, bracted plantain, ragweed, corn cockle, night-flowering catchfly, mustard and whitetop.



Buckhorn.

Biennials are those plants which spring from seed and produce only a cluster of leaves the first season. In these leaves are manufactured and stored large amounts of plant food for use during the second season of growth. During the second season, a flower stalk is sent up and many seeds formed, after which the plant dies. This group depends on seed for propagation. Here belong wild carrot, wild sweet clover, burdock and common evening primrose.

Perennials are those which live on indefinitely year after year, reproducing from seed, or, in addition, from buds near the crown of the plant, as in buckhorn, or from buds here and there along running underground parts as in Canada thistle. Many perennials are persistent and particularly



Twitch or Couch Grass.

noxious. Here belong horse nettle or sand brier, twitch or couch grass, sour dock, sheep sorrel, field bindweed or wild morning glory, ox-eye daisy, yarrow, wild barley, black-seeded plantain and others. Farmers and other property owners are urged to acquaint themselves with the common weeds, their names and characteristics, for on these latter in a large meas-

ure are based methods of control or eradication. The following suggestions in regard to weed control apply to all classes of weeds:

1. Buy seed which is the purest obtainable and of strong vitality.
2. Before buying, test a sample of it, or send a sample to the Branch Seed Laboratory, Experiment Station, Lafayette, to be tested for purity and germination. In this way only can any one learn the character of seed he proposes using, in regard to freedom from weed seed and in regard to viability.
3. As far as possible, prevent weeds about the farm from seeding. Pulling, the use of the scythe along ditches, roads, lanes and fences and about the yards and buildings and in the wood lot, as well as the use of the mowing machine where possible, will accomplish this in a large measure.
4. Thoroughly and repeatedly cultivate corn crops so as to keep weeds down.
5. Breaking weed-infested ground in the fall and harrowing at short intervals and repeating the harrowing in spring to encourage weed seed lying in the soil to germinate and to destroy the seedlings, is to be recommended.

For biennials repeated cuttings during the second season of growth, pulling or spudding where only a few plants are in evidence, together with the introduction of a hoed crop (corn or potatoes, say), are effective.

Perennials will need more extensive treatment than is indicated above. A treatment such as the following is suggested:

Plow in the fall and follow with frequent harrowings both in the fall and in the spring. About the end of May sow with rape in drills, or broadcast millet, cowpeas or Canada field peas and oats. When well advanced, use these crops for pasture, or feed in the yard to supplement other pasture crops. Animals, especially hogs and sheep, are very useful in destroying weeds on the farm. Plan to use them as extensively as possible. Follow the smoother crop (rape, millet, etc.) with wheat seeded heavily with clover. When wheat is off let a crop of clover grow up. Pasture this or plow it under. Follow this with a well-cared-for corn crop. This method is in addition to general suggestions given previously. Eternal vigilance, care and persistence is the price of a clean farm. That a clean farm, indicating thrift, intelligence and taste, is more attractive, satisfying and profitable than a weedy, carelessly operated one, there can be no question.

In cities and towns the least that can be done is to frequently cut weeds

with the scythe or other tools, so that they can not form seed. Street commissioners and other citizens possessed of a goodly amount of energy and civic pride can do much to create and maintain a "city beautiful" so far as neatness of streets, lanes, vacant lots, etc., are concerned. In connection with lawns, mention might here be made that it has recently been learned by experiment stations, that the use of iron sulphate on lawns and weedy areas is profitable, practicable, effective and cheap, if rightly applied. By it dandelions, plantain and other weeds can be controlled. It is coming into extensive use on farms in some parts of the United States. Suitable machinery is made for the application of iron sulphate either on a large or a small scale. The treatment of the subject of the use of iron sulphate can not be taken up in detail here, but the writer will be glad to furnish any information desired on the subject at any time.

## THE PREGLACIAL VALLEYS OF THE UPPER MISSISSIPPI AND ITS EASTERN TRIBUTARIES.

---

HARRY M. CLEM.

---

So far as the writer is aware, there has been no attempt to compile a map showing the results of researches upon the preglacial drainage of the region indicated in the title. The following paper addresses itself to that task, together with a brief discussion of the reason for believing that certain streams shown on the map were preglacial. Only the briefest outline can be given in this short discussion, which merely undertakes to pioneer the large field lying before it.

The attempt has been made to map accurately the preglacial channels of the area in question, but this may not always have been attained, for several reasons. The literature is not adequate in all the fields of the area, and often the statements made are not so clear as might be desired. The word "probable" is very frequently used and renders mapping difficult, if not impossible. Occasionally, authors differ, and in such cases the one which seemed to be the better authority is followed, and the dissenting theory mentioned in the text. No attempt has been made to give a critical discussion of the different theories. Any reader who may desire more detailed information than this paper furnishes can find all that is of importance in the accompanying bibliography,<sup>1</sup> or he may look there for correction or verification of any points in the discussion with which he may disagree.

The greater portion of the region covered in this paper is so deeply buried in drift that only the major details of the ancient preglacial topography are apparent. The multiplicity of minor topographic details that give final expression to the landscape are so completely buried from sight that it may never be known how the ancient surface appeared before the advent of the glacier. Only by a multiplicity of borings could a general idea of the details of that buried topography be obtained, and that is impossible except where some deep-seated natural resource induces men to sink deep wells. Thus innumerable small valleys have been obliterated and

---

<sup>1</sup>Not published here.

lost to history. The larger valleys generally remain sufficiently unobscured to enable geologists to trace their courses, either continuously or at intervals close enough together to enable a safe inference to be made concerning their previous courses. The larger the valley the better chance it had in general to leave behind itself traces of its former course, for, occupying the lowest part of the surface and carrying great quantities of water, it was automatically kept open by drainage from the melting ice. Yet even the largest river trenches were in imminent danger of defacement. Such an instance is found in Jay and Adams counties, Indiana, where there are signs of a huge valley whose bottom is buried beneath nearly 400 feet of drift and no traces left of its existence on the surface. Another case is that of the preglacial Mississippi where it turns southeastward to the Illinois valley just below Clinton, Iowa.

The map shows large hiatuses wherein there are no preglacial streams indicated, but they certainly exist buried in several hundred feet of drift. West and south of the basin of Lake Michigan and between that basin and the Lake Erie depression in northern Indiana and Michigan no details are shown, and only a few larger courses suggest probabilities of preglacial existence. The depth of the drift and the absence of deep-seated natural resources do not encourage the digging of a sufficiently large number of deep wells to permit the construction of a topographic map of the preglacial surface. Enough, however, is known to assure us that the ancient drainage lines were quite different in many details from the present systems.

Without further preliminaries we shall discuss the pros and cons regarding the claims of the streams shown on the maps to a preglacial ancestry. For the sake of convenience of treatment, the area is divided according to the several smaller drainage basins which make up the greater Mississippi basin. This will be found convenient because there are wide elements of correspondence between the present and the preglacial drainage basins, as a glance at the generalized map will show. The basin of the Great Lakes, which seems to cut out a portion of the Mississippi basin, and which is separated by a very low primary divide, over which the lakes drained in the Ice Age, is discussed briefly.

#### THE PREGLACIAL DRAINAGE OF THE UPPER MISSISSIPPI BASIN.

The preglacial divide of the northern side of the Upper Mississippi basin is not definitely determined. It can be pretty definitely located at



Huron, N. D., where there is a col and a constriction in the James river, a preglacial divide, over which the reversed headwaters of that stream now run southward. From Huron eastward its location is a matter of speculation backed up with slender evidence. From here it may have turned south across the present Mississippi valley somewhere near "military ridge," as Hershey (46) would have it, and then eastward, or it may have turned north some distance east of Huron along the east edge of the basin of the Red river, but this will be discussed more fully later. "Between the Rock river drainage line and Lake Michigan there is a somewhat less elevated belt of limestone, which extends curvingly in a direction east of south into western Indiana." (Leverett, 64:16.) Somewhere in eastern Illinois or western Indiana a spur ran south, probably near the present divide between the Wabash and Illinois system separating the preglacial as well as the present basins. The location of the divide north through Wisconsin is not well known, but there is no doubt that it was east of the present "driftless area."

Even if it were possible and profitable, space does not admit of a detailed discussion of secondary divides, which can generally be inferred from the location of the preglacial valleys. After calling attention to the fact that the present Mississippi river has evidently a system of drainage widely different from the system or systems which were operative in preglacial times within the region now drained by it, Leverett says: "Besides opening a new channel at each of the rapids, the stream apparently is occupying sections of two or more independent preglacial valleys." (64:461.)

As to the course of the Mississippi above St. Paul, Chamberlain suggested, in 1879, that it is post-glacial (19:253), but that it probably follows the preglacial channel in short stretches. Hershey, in 1897, agrees with the suggestion.

Hershey has the following to say concerning the preglacial valley above St. Paul: "The high upland area which trends north and south on its eastern side at some distance from its immediate border, continues without a change for many miles to the north, passing to the east of Lake Phalen. Although deeply covered with drift, it is undoubtedly based on an upland area of rock. To the west of it, and in the direct line of continuation of the old Mississippi valley, there is a topographical depression which trends for many miles to the northwest. It is occupied in places by lakes, the most important of which is lake Phalen. This, in my opinion,

will probably be found to be the ancient course of the Mississippi river. That it is the position of a preglacial valley is indicated by a deep well at the St. Paul Harvester Works, situated in the present topographical depression, which penetrated rock at 235 feet beneath the surface or 628 feet above the sea, which is 55 feet beneath the present low-water level of the Mississippi river at St. Paul. The lake Phalen depression is separated from the head of the Mississippi cañon valley by a moraine which is evidently based on a comparatively low surface, for it does not rise nearly as high as the drift to the east or west. As seen from the opposite side of the valley, its escarpment or bluff at the head of the old cañon valley shows such topography as is usually produced by the erosion of drift. In short, all the evidence favors this lake Phalen depression as the position of the pre-glacial continuation of the Mississippi cañon valley." (46:263.)

From the southeastern corner of St. Paul to Leclair, Hershey believes with other geologists that the valley is pre-glacial. In the vicinity of Dubuque, however, he thinks that the valley is proportionately too small for the stream which it carries, that the preglacial stream flowing past Dubuque could not have been larger than the present Rock river, or possibly no larger than the Peconica. The valley is cañon shaped and narrow and the rock floor is about 300 feet below a deep filling of drift. The divide is suggested to be somewhere between La Crosse and Prairie du Chien, particularly where "military ridge" is traversed by the present river. (46:266.)

Hershey believes that the stream north of this supposed divide flowed toward central Minnesota instead of away from it, but that the reversal came early, before the Ice Age, probably at the end of the Ozarkian, by an uplift in the north, or, as an alternative view, it may have "resulted from the disturbance of other drainage systems by the accumulating northern ice. For instance, it is quite possible that the Kansan ice-sheet had advanced across the outlet of the supposed northwardly flowing ancestor of the upper Mississippi river, obstructing its flowage, and after the production of a great extra-glacial lake, turning the drainage of the entire region over the lowest point on the divide which intervened between it and the headwaters of the southwardly flowing central Mississippi river, long before it glaciated the country south of the 'driftless area.'" (46:267.)

Leverett accepts this hypothesis, or at least he quotes it and offers no objections. (64:461-2.)<sup>1</sup>

The question of the preglacial course below Clinton, Iowa, is not yet fully settled. Leverett discusses the problem fully in his writings (58, 60, 62, 63, 64), and lately Carmen has spent some time in the Clinton region, but his paper is not yet published (16). The number of wide channels between Clinton and Muscatine, and the depth of drift renders the problem very complex.

A quotation from Leverett (Monograph 38, pp. 466-7.) will give a fair idea of the location of the preglacial course below Clinton: "Udden's special investigation has led him to the conclusion that the praeglacial line must have been along one of two courses, either southeastward through the Meredosia slough and Green river basin to the Illinois at the bend near Hennepin, or directly westward through the Wapsipinnicon basin to the mouth of Mud creek, and thence southwestward along the Mud creek sag to the Cedar; thence the course may have been by way of the present Cedar and lower Iowa, or more directly southward to the Mississippi just west of the meridian of Muscatine. Udden has collected well data along the Mud creek sag showing that a buried channel occurs there whose rock floor is more than 100 feet below the level of the Mississippi river at Clinton, and perhaps sufficiently low to have carried the drainage of the preglacial stream whose valley has been traced southward to Clinton. The data are scarcely sufficient to fully establish the connection of this channel across the Wapsipinnicon basin, for there are very few deep wells in the basin. Another feature which throws some doubt upon this connection is the narrowness of the deep portion of the channel along the Mud creek sag.

"Turning to the southeastward course, one finds a broad depression or lowland tract leading from Clinton through to the Illinois river. This lowland, except at the outer moraine of the Wisconsin drift in Bureau County, stands only a few feet above the level of the Mississippi, and yet apparently carries a heavy accumulation of drift. The drift is largely sand and there has been no necessity for sinking wells entirely through it.

---

<sup>1</sup> It may be well to say here that such constrictions in the valley of the Mississippi occur wherever the river crosses resisting strata of rock, such as the Lower Magnesian, and the Galena, Trenton and Niagara limestones, and it may be possible that the river has always been running south, being unable to cut its valley so wide in the more resistant beds. Hershey's theory is interesting but not well established.

They have, however, penetrated 40 to 50 feet without striking rock. The bed rock gradually descends from each side toward the middle of the lowland, and some of the creeks coming into the lowland occupy large and deep channels which have been only partially filled with drift. This rather throws the balance of evidence in favor of the view that the preglacial stream flowed southeastward into the Illinois.

"It should be observed that in case the southwestward route proves to have been the course of the Mississippi, the present line of the stream departs from it only a few miles and enters the same old valley below Muscatine, which it occupies above Clinton. But in case the southeastward route proves to have been the preglacial course from Clinton, the preglacial valley above Clinton finds its continuation down the Illinois instead of down the Mississippi, and the present Mississippi passes from one drainage system to another in its course between Clinton and Muscatine."

Carmon gives many more interesting details, but he concludes with Leverett and Udden: "It is quite possible that in one or the other of these courses the preglacial Mississippi flowed. Both appear to have rock floors to carry the waters of the streams which excavated the Mississippi valley above Clinton, but the data are not complete enough to allow us to decide which of these two courses was the real one" (16). Carmon gives an interesting discussion of the changes produced by each ice invasion upon the Mississippi and a reading of this will help detract from the complexity of the situation in this region.

From Muscatine southward the Mississippi is flowing in a broad preglacial channel except for a few miles above Keokuk, Iowa, where it is flowing in a post-glacial gorge known as the Lower Rapids (63). The old drift-filled valley which has been studied by C. H. Gordon (41), is about twice as wide and 100 feet deeper than the present valley, and lies to the westward in Lee county, Iowa<sup>2</sup> (Fig. 1). Below Keokuk the Mississippi follows the preglacial channel.

Not much space can be devoted to a discussion of the tributaries because the map shows the ones that can be mapped with any certainty, and the reference in regard to each one are full.

Regarding the preglacial history of the Minnesota valley, Upham says (131): "There is evidence . . . in the terraces of modified drift

---

<sup>2</sup> Leverett also gives a map and cross sections of this channel. See bib. 62, 63, 64; also J. E. Todd, 114.

along the Minnesota valley, that in large part its erosion was effected in preglacial time and during stages of retreat and readvance of the ice-sheet previous to the final departure." In an earlier article he says that the valley was eroded in the Lower Magnesian and Calciferous formations, before the Cretaceous subsidence, was re-elevated, and, in the first principal epoch of glaciation, covered with a "thick, unbroken, moderately undulating expanse of till" and partly re-excavated by an interglacial stream which, guided by the slope determined by preglacial erosion, coincides along much of its way with the old valley eroded in these strata before the Ice Age (119:109).

The St. Croix river has been discussed by Berkey, R. T. Chamberlin (18), Elftman (30), and Upham (121, 132) and others. Chamberlin thinks the preglacial course from the Dalles of the St. Croix was east to the preglacial Apple river; while the other writers would have it to the westward. The streams of the driftless area in Wisconsin, Minnesota, Iowa and Illinois are preglacial (20, 45-47, 64).

The Wisconsin river is in the preglacial channel below Prairie du Sac. Below Kilbourn City, according to Salisbury and Atwood (89), the preglacial course is east of the present stream, through the Lower Baraboo Narrows, and the Devils Lake Gap of the quartzite ridges on either side of Baraboo, Wisconsin. According to Fenneman (33), a preglacial tributary of the Wisconsin passed northwest through Kegonsa and Mendota lakes. Fenneman finds sections of preglacial channels marked out by the lake basins in southeastern Wisconsin, as shown on the map.

In Illinois, outside of the thick Wisconsin drift which obscures the preglacial valleys of the northeastern part of the State, the preglacial valleys can be fairly easily traced. Outside of the triangular area whose vertices are at Clinton, Hennepin and Rockford, the directions of the present and the preglacial drainage systems are coincident. In this triangular area, the changes have been considerable (62, 64). The preglacial valley of Rock river from Janesville, Wisconsin, to the edge of the Wisconsin drift southward is easily traced, but beyond that the drift rises 100 feet above the preglacial bluffs and its course can be traced only by borings. Its bed is found to be a little lower than that of the Mississippi to the west, descending 210 feet in a distance of 100 miles south from the Wisconsin border. It probably was tributary of the preglacial Mississippi if that river joined the present Illinois.

Chamberlin (19), Upham (125, 128), and Spencer (94) have postulated a preglacial outlet of Lake Michigan through Illinois to the Mississippi, but no such channel has been found. Cache basin in southern Illinois is interesting, because it may be a portion of the preglacial Ohio, as deposits of clay indicate, but why or when it was abandoned is not known (64).

A glance at the map of Iowa shows a correspondence in location and direction between the preglacial and the modern drainage lines. The geological survey of the State of Iowa is not yet completed. The breaks in the preglacial valleys on the map indicate either that the river is not running in a preglacial channel or that it has not been studied. Space will not permit a detailed statement as to which of these two facts is indicated, but a study of the references will make it clear.<sup>3</sup> In the eastern part of the State the preglacial drainage has been obscured by drift and the flow of the temporary interglacial Mississippi across them, while in the northwest the drift alone has defaced the ancient valleys.

In Missouri but little study has been devoted to the preglacial conditions of the State. J. E. Todd (111) has given the following summary of the preglacial drainage in the Missouri Geological Survey: "The Kansas River may have flowed at a higher level, which is indicated by the Weston rapids, and it may be guessed that its course was eastward as far as Chariton County, then possibly northward by the buried channel found in Linn County and Putnam County, although that channel may not be deep enough. All that is now known is that there were deeper channels in Iowa whose beds are lower than the bottom of the present channel of the Missouri river near New Frankfort. Reference is made to the Washington channel discovered by Calvin, and further discussed by Bain. The La Mine and its tributaries may have flowed north and joined it. The Osage and Gasconade may have similarly gone northeast into the valley of the Illinois, the former by way of the valley of the Auxvasse or Big Muddy to the valley of the Salt River and northeast, passing somewhere near Quincy, the latter by the lower course of the Missouri. It may be considered more likely by some that the Kansas river passed Moberly and joined the Osage, or that all these streams may have had nearly their present courses to the present junction of the Osage and Missouri!"

<sup>3</sup> See bibliography, 7, 12, 15, 41, 71, 81, 90, 103, 118, 139.

<sup>4</sup> For references on the tributaries of the Mississippi see: 1, 2, 3, 7, 8, 14, 15, 18, 25, 30, 33, 41, 44, 45, 46, 57, 58, 62, 64, 68, 70, 71, 81, 90, 103, 118, 146.



# PREGLACIAL VALLEYS

## WABASH & LOWER OHIO DRAINAGE BASINS

PREGLACIAL VALLEYS 

EDGE of WISCONSIN DRIFT 

EDGE of ILLINOIS DRIFT 

COMPILED BY

**HARRY M. CLEM.**

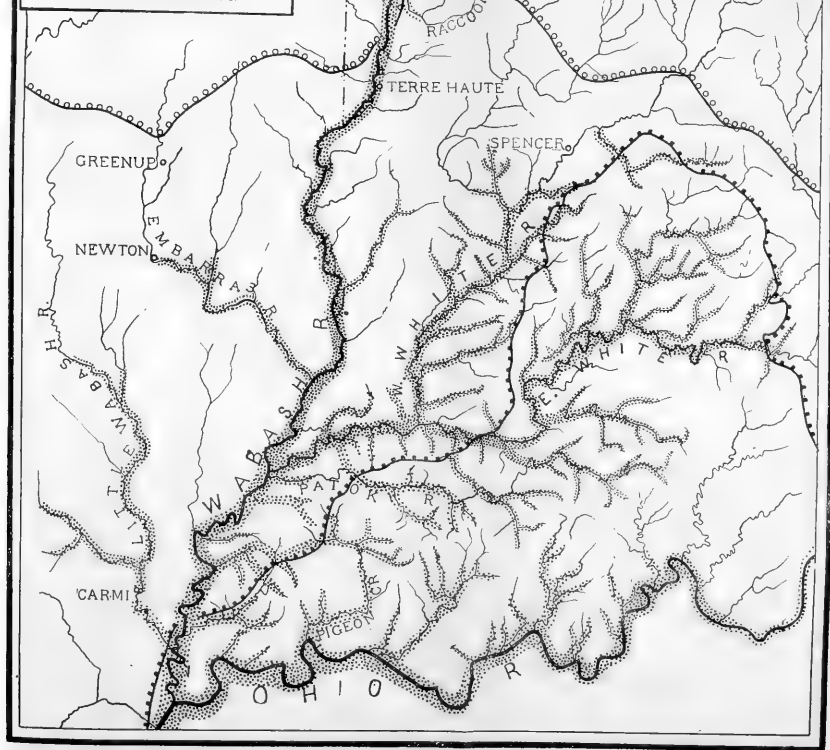



## THE PREGLACIAL DRAINAGE OF THE BASIN OF THE WABASH AND LOWER OHIO.

About one-half of the drainage basin of the Wabash river is so deeply buried under glacial deposits that there is very little similarity between the modern watershed and the watershed of the preglacial streams that discharged through the lower course of the Wabash. The preglacial rock surface was probably very rough, for the drift varies within short distances from a few feet to over 200 feet in depth.

The Wabash river at Lafayette is flowing in its original channel. Below Lafayette the preglacial channel runs westward and then southward, meeting the present Wabash at Covington. Below Covington the present river follows the ancient channel. Nothing is known of the upper portion of the preglacial Wabash above Lafayette. A study of the drift covered rocks reveals a divide extending south along the west side of Lake Michigan, and curving to the east into Indiana. It is from 100 to 200 feet above Lake Michigan and is deeply sculptured by preglacial streams and thoroughly drift covered. It has been suggested that the Lake Michigan basin was the headwater portion of the Wabash in preglacial time. On this point Leverett says (62): "The headwater portion of the Wabash stream forming the preglacial Wabash may prove to have been in the Lake Michigan basin. But if so the connection with the Wabash is through a very much narrower trough than that occupied by Lake Michigan. Borings at both North Judson [497 ft.], Winamac [490 ft.] and Monticello [467 ft.], Indiana, situated near the line connecting the heads of Lake Michigan with the preglacial valley at Lafayette, go to a level about 100 feet below the surface of Lake Michigan before entering rock. But within a few miles east of this line rock ledges have an altitude as great as the surface of Lake Michigan, while immediately west of this line they rise 90-125 feet above that level. This trough can not have, in the vicinity of Monticello, a breadth of more than ten miles. Monticello is situated near the middle of the trough. The probabilities are, therefore, against the existence of a much deeper channel in it."

Leverett (65) suggests that the old channel which passes into Grant County from Ohio may be a headwater portion of the preglacial Wabash. The modern Wabash has not completely excavated the ancient valley to its full width above Terre Haute, but below that city the excavation is more nearly complete.

Not much need be said about the tributaries of the Wabash, for Leverett has very fully discussed them. The details have not been worked out, and what is known was that most easily determined. Usually it is the lower portions of these streams and the lower portions of their tributaries that are well known, the headwaters being usually post-glacial and the preglacial valleys covered with drift.

The course of White river below the north line of Greene county, with slight exception, is so completely covered with drift that the course of the preglacial stream can not be ascertained. For a few miles below Martinsville the present stream follows a preglacial valley. The river below Spencer flows for a few miles in a narrow, shallow channel among the hills and ridges, there being no definite preglacial drainage lines to control its course. It occupies a preglacial valley from the mouth of Raccoon creek down to Worthington, where it joins a wider valley two to two and one-half miles wide, which trends south. From this point to its mouth, the course of the stream is nearly coincident with a broad preglacial line.

Bean Blossom creek, which Leverett has not included in his map of the preglacial drainage of Indiana, is undoubtedly preglacial. This is the conclusion of Dr. E. R. Cummings and V. F. Marsters, both of Indiana University, who have worked in this region (69).

The Patoka is very interesting on account of the fact that it is a composite of the headwaters of four different stream systems. For short distances it follows a preglacial channel and then it suddenly crosses rock surfaces which were formerly cols between the preglacial streams. The three upper stream systems emptied northward in preglacial time into the White river. During the advance of the Illinois ice-sheet the mouths of the stream were dammed, and lakes were formed. The water in the upper or eastern lake flowed into the next west over some low sag in the divide and this into the third. Whether the lake drained south over a sag into the Ohio or drained westward to the Wabash through some sub-glacial channel is not settled, but Leverett inclines to the latter (64: 101-2).

The Ohio river (65; 183) below Madison is thought to be preglacial through its entire course along southern Indiana, except probably for a short distance at Louisville, as J. Bryson (12) and C. E. Siebenthal (91) have discovered. This is Leverett's conclusion also, but he says further, "A course about as direct is found in a line leading west from Madison, Indiana, along the Muscatatuck, to the East White and White rivers and

thence down the Wabash to the Ohio. That there was an ancient westward drainage along the East White river is shown by the presence of Tertiary gravel near Shoals, Indiana, that was brought from the east. But the East White has a smaller channel than the neighboring part of the Ohio, and no channel has been discovered near Madison to connect the Ohio with the Mascatatuck Valley. It, therefore, seems a less favorable course than that down the Ohio" (65: 112).

Both Tight and Leverett agree in placing the head of the preglacial lower Ohio near Madison, Indiana, thus making it a very humble stream compared with the conditions of today.

#### THE PREGLACIAL DRAINAGE OF THE BASINS OF THE UPPER AND MIDDLE OHIO.

Much work has been done in this basin, and much has been written about it, and maps of local areas have been made to cover most of the State, but no general map has ever been compiled. The bibliography, as is apparent, contains a great many excellent references to this region. Leverett (65) and Tight (109) give the most complete discussion of the subject, and several other geologists have carefully discussed limited areas of the basin; and in view of the fact that so much has been written on the subject only a few necessary points will be given here.

The Ohio river is remarkable in many respects, for it presents much variety in width, depth and other characteristics. The valley varies in width from six miles, where the walls are low and gentle, to one mile, where steep bluffs enclose it, and its depth ranges from less than 100 feet to 800 feet. Its bed presents a succession of riffles where its channel runs over rock and shoals where the bed is upon a filling often 75 feet deep. The number of narrow places where the bluffs are steep is remarkably large, as is shown on the maps (Pls. IV, V) by the term "col" and at such places the valley is young. Between the cols the present valley is frequently crossed by old, wide valleys that extend for miles on either side. Many of the tributaries, especially below Portsmouth, enter in opposite directions to their general course and many that rise close to the main river, flow around for miles before entering, a fact indicating the recent origin of the Ohio (109: 34). Much of the same may be said of many of the tributaries, such as the Muskingum, Hocking, and the Allegheny, for they are, too, "things of shreds and patches," having been produced by the union of portions of various stream systems.

The location of the primary divide, if the preglacial drainage lines have been established correctly, can be followed in a general way by a glance at the maps (Pls. IV, V). The portion of the divide, and the most important portion, between the Wabash and Erie basins has not yet been satisfactorily located. Upon its accurate determination depends most of our knowledge of the outlet of the drainage of southern and southeastern Ohio. Some general facts concerning it will appear in the following discussion. From near Mt. Vernon east and southeast to New Martinsville the divide is well located, and the area northeast and north drained to the northward. The present Ohio is seen to fall into two divisions on this basis.

The portion of the Ohio above New Martinsville reached some northern outlet by three different streams (Pl. V). These are easily located, with a few minor exceptions, for the preglacial cols are usually apparent. Carll (17) called the attention to a narrowness of the Allegheny valley at Thompson's gap and shows that the rock floor of the valley, now covered with drift, sloped northward from the divide, and he concluded that the headwaters of the Ohio once drained northward by this valley. He concluded that the outlet was through the Cassadaga valley, but Chamberlin and Leverett made later studies, found the Cattaraugus creek valley the deeper and more direct route to Lake Erie and concluded that the outlet was by that valley (65: 129-30; 21: 101: 159-60).

Another prominent col just north of Parker separates another section of the Allegheny which included the Allegheny to a little below Oil City. French creek reversed to Meadville and an old valley continuing northward to some preglacial valley in the Erie basin were the main stream in the system, for here is an old, wide rambling valley in which Cussewaga creek flows south to join French creek. Leverett accepts this outlet, showing that the drainage could not have been up French creek above Martinsville, because of a col in French creek valley a few miles northeast of Meadville (65: 134-8).

The next lower section of the preglacial system, whose main stream was the Beaver reversed, and the Grand, is variously known as the Spencer (35), Old Lower Allegheny, Pittsburg (109) and Grand river (21). It has been well studied and most authors agree upon its course. The drift is deep north of the source of the Beaver; but the old gradation plain slopes north to Sharon and then upward farther north. A depression

descends westward to Youngstown on the Mahoning. Borings at Niles and Rome reached level at 70 feet above Lake Erie, showing that the old Grand valley grows deeper in the north (65: 149-51).

They are marked off by the meridians of New Martinsville and Columbus and include a mass of detail that, in most cases, is very difficult to map from the text. The area south of a line between New Martinsville and the mouth of Newark river has been studied thoroughly by Tight and mapped in detail (Pl. V and 109) and well discussed. The changes here are quite profound but they can be read with little difficulty.

The Muskingum has offered much difficulty to its own solution, especially within the deeply drift-covered areas. Leverett (65: 158-65) gives the most concise summary of the preglacial conditions of the basin, but Tight (109, Pl. I) gives a similar general outline, and with local writers discusses the region.

The Blue Rock col is sufficiently plain to separate that part of the present stream into north flowing and south flowing portions. The north flowing part might have gone north along the present Muskingum or northwest up the Licking, but Leverett favors the latter (65: 161). Tight is especially responsible for the section drained by the Licking reversed and the preglacial Newark (104: 152, Pl. I; 91: 160) and of Vernon river.

Much difficulty was experienced in determining the location of the preglacial channel which carried the drainage of the present Muskingum after it reaches the headwaters of the present Rocky river. Todd (117), a local writer who has a paper on the preglacial drainage of the Rocky basin and an area south, favors an outlet down the preglacial Rocky, but Leverett (65: 165) believes that it flowed east into the old Cuyahoga (Pl. IV), although he admits that the evidence of a slope in the rock floor in that direction is meager. He also favors the idea that the upper Tuscarawas was continuous with the preglacial Cuyahoga.

The system of preglacial drainage (Pls. IV, V) collected into Portsmouth river—the lower Scioto reversed—is fully discussed by Tight, Leverett and others and is established. Newark, Vernon and Portsmouth rivers united somewhere southwest of Columbus, but it is not well known just where. After the union of these rivers the direction of their united valleys is not yet determined. Leverett (65: 103-4) says on the question: "Four possible courses were suggested for the discharge from the southern end of the Scioto basin: First, southward, down the Scioto from Waverly

to the Ohio and thence down the Ohio; second, northward, along the axis of the Scioto basin to Lake Erie; third, northwestward across western Ohio, along one of the several deep valleys brought to light in that region by the oil and gas wells, eventually to the low tract on the lower course of the Wabash or the basin of Lake Michigan; fourth, northeastward past the Licking reservoir and an old valley east of Newark to the Muskingum at Dresden, and thence northward along or near the present valley of the Muskingum, Tuscarawas, and Cuyahoga to the basin of Lake Erie at Cleveland." (65: 102-4.) Leverett later found an oxbow channel at Lucasville, which seemed to testify strongly against a southern discharge, and a divide now crossed by the Tuscarawas between Zoar and Canal Dover, which renders a northeast discharge impossible. It seems worth while to quote Leverett concerning the difficulties of the other two routes: "The northward route along the axis of the Scioto basin encounters a general rise in the bordering plain of about 200 feet in the 100 miles between the south end of the basin, near Chillicothe, and the continental divide near Marion, north of which there is an even greater descent to the Lake Erie basin. If the course of drainage was northward across the divide, and if the divide has not suffered recent uplift, there must have been channeling in it to a depth of about 300 feet. That an axis of uplift exists in this part of the continental divide is shown by the arching of the rock formations over it; but its extent and its date are not yet determined.

"The northwestward route leads across the limestone belt on the west side of the Scioto basin, whose general level is about 200 feet above the continental divide at the north end of the basin and 500 feet above the gradation plain near Chillicothe. To pass through that region the channeling would be so much greater than is required for a northward course along the axis of the basin, that one can scarcely resist ruling out the northwestward course. Yet from what is found on the lower Ohio, where the stream passes directly across the low Devonian shale area into the knobstone and sandstone formations that now stand much higher, such a ruling may be unwarranted. The presence of the low basin occupied by Lake Erie offers an additional argument in favor of the northward route. This basin would be reached by that route in less than half the distance required to reach a similar low track in the Wabash region, or the Lake Michigan basin by the northwestward route. Each of these routes falls within regions so heavily covered with glacial deposits that the course of the channels can be

traced only by means of borings, and these are so few and so poorly distributed as to be inadequate to our needs."

Tight favors a northwestward discharge of the Portsmouth river and so maps it in Plate I, Professional Paper, No. 13 (109).

Bownocker has studied the deep borings of west central Ohio and finds evidence of a deep channel running from Anna to Celina, north to Rockford and west into Indiana, as far as Grant county, where no borings by which it may be traced are found (10, 11). This old channel may be a continuation of the preglacial stream in question (Portsmouth river), and Leverett suggests that it may be a tributary of the Wabash (65: 183-4; see 109, p. 23 and Pl. I), but adds: "The size of the valley indicates that it drained at most only a few counties of western Ohio."

Between Manchester, Ohio, and Madison, Indiana, the Ohio crosses three cols, which means that it is the united parts of four basins. The Licking and Kentucky rivers are thought by both Bownocker and Fowke to have been united to form a single stream at Hamilton. Fowke and Tight think that from Hamilton it flowed northward along the Great Miami reversed. Leverett, who opposes the idea, states, "It is probable that the old drainage south from the latitude of Dayton followed nearly the course of the present line to the Ohio. . . . The old Ohio was entered by the Great Miami near Hamilton. The latter stream makes slight departures from the line of the old Ohio below Hamilton, the old Ohio channel being in part farther west than the Great Miami." (65, p. 184.)

Fowke believes that the old channel between Hamilton and the mouth of the Kentucky was eroded by the Kentucky river, instead of the Ohio. He says: "In other words, that stream, instead of following the present Ohio as it does now, or flowing across Indiana, turned to the east and north and joined the Licking at Hamilton. There is no other channel through which it could have gone. . . . From Hamilton northward the old river bed is filled with drift and has not been traced. There can be no doubt, however, that it joined the old Kanawha (Chillicothe) north of Dayton, probably in the neighborhood of Piqua." (36). The preglacial head of the Ohio is by this theory placed at Madison, Indiana.

The present course of the Ohio is due to the action of the ice-sheet which dammed the north flowing streams, forming lakes in the basins which overflowed at the lowest point in the divides between basins to the next lower neighboring basin. The lakes endured sufficiently long for the present Ohio to establish itself in the course which it now follows (36, 109).

## THE PREGLACIAL DRAINAGE OF THE BASIN OF THE GREAT LAKES.

The Great Lakes have been so closely connected with the glacial history of the Mississippi basin, their origin is so closely connected with the preglacial Mississippi basin that it seems well to add a chapter to present briefly what is known about their preglacial history.

Newberry was one of the earliest writers to state the theory now so universally believed, that the antecedent of the Great Lakes was a great river system. According to him the first suggestion of the notion was given by deep borings in the valley of the Cuyahoga at Cleveland, which is a deep valley filled with drift (79). As early as 1882, in a summary of his work, Newberry mentioned, among other points, that he believed that "an extensive system of drainage lines which once traversed the continent, had been subsequently filled up and obliterated by the drift of the ice period." (79.)

Newberry thought the outlet of the lakes through Ontario was through a preglacial valley now occupied by the Mohawk river, and so mapped it in 1878. Spencer took exception to this idea, saying, "The Mohawk course will not answer, as the geological survey of Pennsylvania has shown that at Little Falls, Herkimer county, the Mohawk flows over metamorphic rocks." (79.) Lesley added that this rock divide was 900 feet above the floor of Lake Ontario.

Spencer began the study of the connection between Lake Erie and Lake Ontario before 1880, and in 1881 announced that he had found that the connection was through the Dundas Valley (94), and Newberry at once declared that he himself had prophesied the location of the connection where Spencer found it. Spencer thought that the outlet of the preglacial valley occupied by Lake Ontario could not be the St. Lawrence river, because the bed of the St. Lawrence river is of solid rock (94), nor the Mohawk, because of the rock divide at Little Falls. The channels through northern New York were unimportant and would not answer. The Seneca basin and the Susquehanna seemed available at first, for the deepest part of Lake Ontario is north of Seneca Lake, but too much subsidence would be required (94). After studying the beaches about Lake Ontario and noticing that they were tilted to the west, Spencer announced that the preglacial outlet was down the St. Lawrence (97, 100). Later he worked out the system of



channels which is shown in Fig. 4 (100, 101). Spencer suggested that Lake Michigan had a preglacial outlet to the south or southwest (93).

Upham (125, 128) took exception to Spencer's interpretation of the direction of the Laurentian preglacial drainage, and offered the theory that "A great trunk stream flowing south along the bed of Lake Michigan drew its chief tributaries on one side from the basins of Lakes Huron, Erie and Ontario, and the other side from the basin of Lake Superior." He held that during the latter half of the Cretaceous period nearly all the drainage area which now forms Minnesota and the drainage basin of the Missouri river was depressed and covered by the sea, while the contiguous area forming the Great Lakes region was dry land and continued so up to the coming of the Ice Age. The divide separating this area from the basins draining to the Atlantic, extended "along the Allegheny mountain belt and directly onward northeasterly to the Adirondacks, turning thence northwesterly across the Ontario highlands . . . to the present height of land north of Lake Superior." Spencer's preglacial stream system was, therefore, probably limited to the headwater streams now represented by the Lake Champlain basin and the Saguenay and Ottawa rivers.

Lately Grabau (43) has interpreted the preglacial drainage of the Great Lakes region in a manner different from Spencer and Upham. His theory briefly stated is this: The old surface of the pre-Cambrian rocks was worn away by long continued erosion and there were laid down upon them horizontally, but unconformably, the newer beds of Ordovician and Silurian rock. Then followed an uplift greater in the north, tilting the new beds southward with a dip of about 25 feet per mile. Following the uplift was a period of erosion, wherein the region "suffered an enormous amount of denudation, having been brought to the condition of a low nearly level tract or peneplain a little above sea level." Then the surface was submerged and beds of Devonian limestone, shales, and sandstones were laid down over it. The sea bottom became dry land and another cycle of erosion began. The uplifted beds formed a "broad essentially monotonous" coastal plain sloping gently southward. Consequent streams flowed southward down the slope. The great master streams developed were the Saginaw, Dundas and Genesee rivers, and probably some of the Finger lake valleys. As erosion proceeded, the sloping harder beds endured and cuestas were formed, having their steeper slopes to the north. Along the foot of the escarpments the subsequent streams flowed to the master streams. The Buffalo,

the Tonawanda and other large tributaries coming in at right angles to the consequent streams are the subsequent streams and some of their valleys are now the basins of the Great Lakes.

Short gullies, or tributaries to the subsequent streams, called obsequent streams, worked headward into the cliffs of the cuestas. Such a stream was the St. David's gorge, which, however, was not the preglacial Niagara, as was once believed by Scovell, Pohlman (84) and others.

The direction of preglacial drainage postulated by the theory above is in accord with the theories of Upham (128), Westgate (137), Russel (88), and also A. W. G. Wilson, who has worked the preglacial drainage of the region east and north of Lake Ontario in detail (140) (Plate VI).

## CROSS FERTILIZATION AMONG FISHES.

BY W. J. MOENKILAU, INDIANA UNIVERSITY, BLOOMINGTON, INDIANA.

### CONTENTS.

	PAGE
Introductory.....	353
Historical.....	354
Methods.....	355
Description of Crosses.....	356
Summary of Experiments—	
Introductory.....	378
Character of Impregnation.....	378
Percentage of Fertilization.....	378
Development.....	379
General and Theoretical Considerations—	
Selective Fertilization.....	384
Degree of Development and Systematic Relations.....	385
Summary.....	391
Literature Cited.....	392

### INTRODUCTORY.

In the following pages I wish to record the more important results of my experiments in the cross-fertilization of fishes. These have been in progress more or less continuously since 1898. These experiments were originally undertaken with quite another object in view, namely, for inheritance and cytological studies. A survey of available nearly related forms was made that would successfully hybridize for variation and inheritance studies. Another purpose was the hybridization of forms with different shaped chromosomes, so that the behavior of the latter could be followed in development. It soon developed that the possibility of cross-fertilizing fishes was very much greater than had hitherto been supposed. This led me to seek all possible combinations of species of whatever relationship

that happened to be spawning at the same time, and note the possibility and character of impregnation, the development of the hybrids and the fate of developing embryos.

The writer wishes to express his sincere thanks to Prof. Charles B. Davenport for privileges enjoyed at the Miami Laboratory, Cold Spring Harbor; to Hon. Geo. M. Bowers and Supt. Francis B. Sumner for privileges at the United States Fish Commission Laboratories at Woods Hall, and to the trustees of the Elizabeth Thompson Science Fund for a grant that made it possible incidentally to gather some of the data included in this report.

#### HISTORICAL.

With one exception, to be noted later, it is possible to impregnate the eggs of any of the species tried, with the sperm of any other species tried, although they belonged to widely separated orders. Isolated instances of equally, or even more distinct crosses have been recorded. Appellöf ('94) made the following crosses among fishes:

$$\begin{array}{c}
 \text{Pleuronectes platessa } \zeta \\
 \times \\
 \text{Gadus morhua } \sigma \\
 \text{Labrus rupestris } \text{♀} \\
 \times \\
 \text{Gadus morhua } \sigma
 \end{array}$$

In each of these the species belong to distinct orders. A portion only of the eggs were impregnated. A few showed irregularities in cleavage, and were presumably polyspermic. The European Amphibia have been extensively hybridized by Pflüger ('82) and by Born ('83). The former succeeded in impregnating the eggs of *Rana fusca* with the sperm of both *Triton alpestris* and *Triton taeniatus*, i. e., an Anuran with a Urodele. The segmentation, however, was irregular so that all the eggs were probably polyspermic. Morgan ('93) succeeded in impregnating the eggs of *Asterias* with the sperm of *Arbacia*. He obtained normal cleavage, the larvæ developing to blastulae and gastrulae. His experiments were carefully repeated by Driesch ('98) without result. Mathews ('01) believed Morgan's results were due to parthenogenesis induced by shaking the eggs. Loeb ('03), working with the Pacific Coast Echinoderms, found it impossible under normal condition to fertilize the eggs of *Strongylocentrotus purpuratus* with the

sperm of any of the starfish. However, by changing the constitution of the sea water he succeeded in getting impregnations (in some cases 50 per cent.) between *S. purpuratus* ♀ and *Asterias ochracea*. Segmentation was normal; the larvæ developed into blastulæ and gastrulæ, some showing the differentiation of the intestine. Many other experiments in hybridizing fishes have been recorded. These, however, were all between nearly related species, mostly among the domesticated salmonidæ and cyprinidæ. It would not be to the point to pass these in review here. For a good summary of these the reader is referred to Ackermann ('98).

#### METHODS.

The method of effecting the crosses and the precautions taken to prevent contamination with other sperms, were in all cases essentially the same. The sexes of the same species were kept in separate aquaria. The eggs were expressed into well sterilized watch glasses after which the milt was added. Before adding the milt a sufficient number of eggs were taken from the lot and placed in a fingerbowl of water, as a control. The fertilized lot was also placed in a fingerbowl and allowed to develop there. After the per cent. and character of impregnation was determined and the development well along in segmentation, changes of water sufficiently frequent to insure normal conditions for development were made.<sup>1</sup> All dishes, pipettes, etc., were thoroughly sterilized, first with hot water and then with 95 per cent. alcohol. Notwithstanding the fact that it was found that little danger of contamination existed, the precautions were strictly observed. In not a single instance was there any suspicion that the eggs were not fertilized by the desired sperm.

---

<sup>1</sup> I wish to call attention to one defect in the methods of rearing the hybrid eggs. It may be objected that while the rearing of the eggs in the fingerbowl may be satisfactory for *Fundulus* and some other species it is not normal for a hybrid egg having a sperm from a species that has, for instance, pelagic mode of life during its developmental stages. This unnatural condition may, therefore, in part at least, be responsible for the failures in the development, or even the particular stages at which development ceases. This objection, so far as we know, may or may not be of value. I see no way to avoid this experimental error, since it is not practicable to cater to the demands of one of the parent species without, theoretically at least, infringing on the other. It may be said, however, that many of the species, especially those on which most stress has been laid, have been successfully reared by this method, e. g., all the species of *Fundulus*, the two species of Sticklebacks, and the two species of *Menidia*. It is the belief of the writer that this objection may be disregarded.

## DESCRIPTION OF CROSSES.

In the following detailed description of the various crosses only such details are included as seemed valuable. Certain of the crosses were kept under observation much more closely than others, and these are more completely considered. It seemed desirable, however, to list the other crosses made, giving brief notes when such seemed worth while. A complete list of all the crosses made is included in Table 9.

*Fundulus heteroclitus*, female,

×

*Menidia notata*, male.

This cross was made more frequently and studied more completely than any of the others. A description of the chromosomal behavior has been published by the writer ('94). I included there also a brief description of the development. For the sake of completeness this may be incorporated here. The percentage of eggs fertilized varies from 70 to 93. Actual counts were not made in all the experiments. The percentages in four determinations were as follows:

Experiment	24b.....	87 per cent.
"	25b.....	80 " "
"	24b.....	93 " "
"	126.....	70 " "

Of the eggs impregnated, approximately 50 per cent. are quite constantly dispermic. Very few are polyspermic so far as can be ascertained by the mode of cleavage. The dispermic eggs never go further than to the close of cleavage. The normally impregnated eggs go through the cleavage stages in a perfectly normal fashion. This is true both for the form and the rhythm of cleavage. In the following table is given a comparison of a lot of hybrid eggs with a lot of normals. The eggs were taken from the same female, fertilized at the same moment and kept under similar conditions. The observations were made at the same time on both lots of eggs and the stage at which each was found was recorded as accurately as possible.

TABLE 1.

TIME OF OBSERVATION.	FUND. × FUND.	FUND. × MEN.
9.10 P. M., June 26. <sup>1</sup>	In 2 cells.	In 2 cells.
9.40 P. M., June 26.	Beginning 4 cells.	Beginning 4 cells.
10.00 P. M., June 26.	Completion 4 cells.	Completion 4 cells.
10.15 P. M., June 26.	Beginning 8 cells.	Beginning 8 cells.
10.20 P. M., June 26.	Well begun on 8 cells.	Well begun on 8 cells.
10.30 P. M., June 26.	In 8 cells.	In 8 cells.
11.00 P. M., June 26.	Beginning 16 cells.	Beginning 16 cells.
9.00 A. M., June 27.	Well along in segmentation.	Well along in segmentation.
9.00 P. M., June 27.	Well begun on gastrulation.	First trace of gastrulation.
9.00 A. M., June 28.	$\frac{3}{4}$ +over the yolk.	$\frac{1}{2}$ or less over the yolk.
3.00 P. M., June 28.	Blastopore closed.	$\frac{3}{4}$ over the yolk.
5.30 P. M., June 28.	Blastopore closed, the embryo long and narrow.	Blastopore closing or nearly closed; embryo much shorter than normal.
9.00 A. M., June 29.	Embryo with optic vesicle.	Blastopore closed, embryo short, no optic vesicle; apparently dead.

<sup>1</sup>Eggs fertilized at 7 P. M., June 26.

From this table it will be seen that the hybrids fall behind the normals in their development. This becomes apparent only in the later stages. In the latter stages considerable irregularity in the rate of development obtains. Usually in a lot of eggs most of which have the blastopore just closed, some eggs may be found that have just entered upon the germ-ring stage. Others may be variously further along. The number of such tardy eggs is usually small. These eggs may stop their development at various stages with consequent shortened embryos and incomplete blastopore closure. In this aborted condition they may live for days, forming pigment both in the embryo and in the yolk. This mass of cells may even develop a heart and ear vesicles. The heart beats for days without, however, handling any blood. From such condition to one where the embryo seems at first to be practically normal there are all stages. The great majority of the embryos die at a condition where the blastopore is closed, the embryo is laid down, though somewhat short, with pigment developed but no heart, eyes, etc.

Some of the embryos, under favorable conditions, develop considerably further. In the more successful of these the yolk becomes highly pigmented with both kinds of chromatophores. The same is true of the embryo. There is an attempt at pattern formation, showing bilateral symmetry but lacking

any marked uniformity in the different embryos. A small proportion of the embryos may show only the reddish-brown pigment cells with complete absence of melanophores. Such embryos are of a strikingly brilliant reddish-brown color. The black pigment may be deposited in the eyes, however. The body of the embryo becomes considerably elongated, though never as long as the normals. The muscle segments are well developed; the vacuolated notocord can be seen and the indications of the vertebral spines can in some cases be made out from a surface view. I have not seen the dorsal and caudal fin-folds developed, except in a very rudimentary way; the pectorals, on the other hand, may be present, and in some embryos are larger than normal. The eyes are at first normally formed, showing as normal optic cups and a well developed lens, and having the normal size. Pigment begins to be deposited much as in the normal, but does not become as abundant. The eye does not keep pace, however, with the normals, so that it finally becomes too small, too slightly pigmented and often lying too low as well as too far forward. The ear vesicle may become very large, appearing as a prominent bulb on either side. The otoliths can be plainly seen. I have seen no indication of a mouth. The brain vesicles form in the earlier stage of the development of these hybrids. Later the brain shows cavities varying in size and regularity, but quite different from the normals. The peri-cardial cavity usually becomes quite large with a volume one-fourth or one-third the size of the whole yolk sphere. The heart becomes often much drawn out. In other cases it is relatively short and may show regions of differentiation. This pulsates vigorously, the wave going in the proper direction. I obtained a single embryo that succeeded in establishing a circulation so that blood was handled by the heart and circulated through the embryo and over the yolk. This circulation lasted for three days, when the vessels became clogged. The heart continued, however, to beat without moving any blood. The usual condition is to have no circulation established. Isolated regions on the yolk show capillaries with colored contents, but no movement of the latter obtains. In the embryo, likewise, lakelets of blood form, a favorite place being in the median ventral part of the tail just posterior to the yolk. I have kept embryos alive for twenty-nine days. The yolk may become reduced to one-half or more in amount. The embryo will not hatch.



*Medinia notata*, female.

×

*Fundulus heteroclitus*, male.

The reciprocal of the preceding cross was made four times. The percentage of impregnation does not seem to run as high as in the reciprocal cross. Thus:

Experiment 23b. ....	14 per cent.
" 27 .....	Small per cent.
" 130 .....	.88 per cent.

It is probable that the lower percentages of impregnation in experiments 23b and 27 have no significance. The experiments show that under favorable conditions a very high per cent. of impregnation is possible—a condition probably varying but little from the normal.

The condition of dispermy present to such a large extent in the reciprocals does not obtain in this cross.

The rate of development during the earlier stages was the same as that of the normal. The process, however, showed a slowing during the later cleavage stages, as was shown by the normals pretty generally entering upon the germ-ring stage, earlier than the hybrids. Inspection of Table 2, in which the stages of the normals and hybrids are placed in parallel columns, will show that from this point the developmental processes were considerably slowed. Thus, when the blastopore is closed, and the eyes are present in the normals at 4 p. m. 6/15, the hybrids have reached only the stage where the embryo has crept  $\frac{1}{3}$  to  $\frac{2}{3}$  over the yolk.

TABLE 2.

TIME.	MENIDIA NOTATA × MENIDIA NOTATA.	MENIDIA NOTATA × FUNDULUS HETEROCLITUS.
6.05 P. M., June 12.	Fertilization.	Fertilization.
7.35 P. M., June 12.	Begin. 2 cells.	Begin. 2 cells.
7.35 P. M., June 12.	Close of 2 cells.	Close of 2 cells.
8.50 P. M., June 12.	Begin. 4 cells.	Begin. 4 cells.
9.15 P. M., June 12.	Close of 4 cells.	Close of 4 cells.
9.26 P. M., June 12.	Begin. 8 cells.	Begin. 8 cells.
10.08 P. M., June 12.	Close 8 cells.	Close 8 cells.
10.20 P. M., June 12.	Close 16 cells.	Close 16 cells.
10.35 P. M., June 12.	Close 16 cells.	Close 16 cells.
11.05 P. M., June 12.	Close 32 cells.	Close 32 cells.
5.55 A. M., June 13.	Early cleavage.	Early cleavage.
9.00 P. M., June 13.	Germ ring.	Late cleavage and germ ring.
9.00 A. M., June 14.	Germ ring to $\frac{1}{2}$ over yolk.	Early gastrula.
1.30 P. M., June 14.	Begin. gastrula to close of blastopore.	Early gastrula to $\frac{1}{2}$ over yolk.
4.00 P. M., June 15.	Blastopore closed and eyes present.	$\frac{1}{3}$ to $\frac{2}{3}$ over yolk.
2.00 P. M., June 17.		Emb. incompletely formed, optic ves. showing.
2.00 P. M., June 18.		No further along.

The development during the cleavage stages, similar to the reciprocal cross, proceeds normally. It is only in the subsequent stages that the effect of hybridization manifests itself. This shows itself for one thing in the great irregularity of the stages at a given moment. At a time when some of the eggs have proceeded as far as they will go, the greater number of the eggs are in all stages, back to the close of cleavage. This is much more marked than in the reciprocals. It is possible, however, that this is a function of the egg, since even the normals show a considerably greater number of stragglers than do the normal *Fundulus* eggs. The eggs of this species are evidently less hardy and thus may lend themselves less perfectly to the methods used in rearing them. When development finally ceases the embryos are, for the most part, nearing the closure of the blastopore, the more successful ones showing an embryo with the optic vesicles, but with the body shorter than the normals. The conditions are not essentially different from that described for the reciprocals, except that, as a whole, the development gives out at a somewhat earlier period. This, as already indicated, is possibly due to the less hardy condition of the *Menidia* egg.

*Fundulus heteroclitus*, female,

×

*Menidia gracilis*, male.

*Menidia gracilis* is distinguished with difficulty from *Menidia notata*, except in its smaller size. Three experiments were made with this cross.

The percentage of eggs impregnated was as follows:

Experiment 119	93 per cent.
" 501	About 5 per cent.
" 503	81 per cent.

In experiment 501 the wet method was employed which probably is responsible for the low percentage. The controls with normal *Fundulus* eggs showed a correspondingly low per cent. of impregnation.

The number of dispermic and polyspermic eggs was considerably less than in the cross with *Menidia notata*. In experiment 503 the per cent. was thirteen, about two-thirds of which were dispermic.

The rate of development and the stage at which it stops is similar to that of the cross with *Menidia notata*. As a whole the number of eggs that successfully effect the closure of the blastopore is greater and the embryos vary considerably less in their lengths, approaching more nearly to the nor-

mals. The rudiments of the eye are present. The reciprocal of this cross was not attempted.

In this cross many of the eggs stop their development at the closure of the blastophore with the main axis of the embryo laid down. Many of the eggs continue their development to a varying degree and with varying normality. None of them, however, are developed in a perfectly normal manner. Among these embryos which live for a week or ten days, the most grotesque features appear. The yolk and embryo become pigmented, often very heavily, though not normally. On the yolk the pigment cells may be quite large, or quite finely branched, and they are likely to congregate in certain places, instead of having a distribution such as is found on the normal embryo. A favorite place for such congregation is on the surface between the very large pericardial cavity and the yolk where the pigment cells may densely cover the area. In the embryo the distribution of the pigment may be more or less regular. Thus along the dorsal side two rows may appear in the anterior portion, one on either side, these converging into a single median band running well out towards the posterior end. Both kinds of pigment cells, red and black, are well represented.

The heart is always developed in these embryos and usually pulsates quite vigorously. The excessive development of the pericardial cavity which usually appears as a large clear vesicle—sometimes one-third the size of the yolk—has the effect of stretching the heart out to a great length. As a consequence a curious series of modifications obtain in the different embryos, from a relatively normal heart, although always more or less elongated, to strikingly aberrant conditions, in which the pulsating portion of the heart has become associated with the yolk bordering on the lower portion of the large pericardial cavity, and is a mere mass of cells without apparent structure, and connected with the upper border of the pericardial cavity near the embryo, by an extremely slender protoplasmic thread. No lumen can be detected in either portion and the only effect of the rythmical and vigorous pulsations of the lower yolk portion is to stretch this filament, and pull the yolk upwards so that the latter rocks continually. The usual thing is for the heart to develop a cavity in the interior and the peristaltic pulsations pass in the right direction, *i. e.*, toward the embryo. Out of hundreds of such hearts, many of them relatively normal, which I have examined, I have never seen one carrying blood, certainly not blood containing red corpuscles. In regard to the rest of the circulatory system there is very

little to say since it fails to develop. I have never seen any indication of bloodvessels, either in the embryo or in the yolk so far as these could be made out by circulating blood. There is now and then an embryo that shows what seems, from surface view, a little lakelet of blood. No corpuscles, however, can be seen, and I think they are only accumulations of a pigment of some sort. Nevertheless a considerable portion of the yolk substance is absorbed. This is transferred to the embryo by probably the same method as is employed prior to the development of the vascular system.

The body of the embryo is always much too short and appears heavy. The tail may develop to a considerable length, and in the more successful individuals may show the caudal fin-folds with fine radiations. The body lacks regularity of form and outline. Muscle segments develop, plainly marked off by the brown pigment deposits along their borders. The muscle segments are active, shown by the frequent movements of the tail.

The eyes may be developed to varying degrees, or in many embryos there is no indication of an eye. A quite common condition is the appearance of only a single eye. Some of the embryos show an accumulation of pigment cells either in two patches or one, which because of their location and the fact that they are in rather well-circumscribed patches, probably represent the eye. Two eyes are formed in many. These are always located far forward, so that they seem set into the anterior surface of the head. These may be quite large, well pigmented and showing a lens, or they may be smaller, varying to a condition where merely two small pigment areas are located on the very extreme anterior tip of the pointed head.

The ear vesicle is usually formed. In the place where the vesicle should be there is commonly formed, in the older embryos, an enlarged vesicular structure. This, in some cases, is beyond doubt the enlarged ear vesicle.

The embryos gradually die, but the better formed ones have lived for me for ten days after the normals had hatched.

*Fundulus heteroclitus*, female,

×

*Tautoglabrus adspersus*, male.

This cross was made five times. The percentage of impregnation may be almost normal, as shown in experiment 36 in the following table:

Experiment 25b.....	65 per cent.
" 34b.....	17 " "
" 36.....	90 " "
" 102b.....	35 " "

Practically all of the eggs were normally impregnated, a very few of the eggs fell directly into four and six cells. The rate of development was the same as the normals, until the later stages, when the hybrids fell behind, as shown in Table 3. The table would indicate that the hybrids were a little slower in their cleavage, but this is so slight that no value can be placed on it, considering the difficulty in telling exactly the moment when a new set of furrows begin.

Many of the eggs go far enough to form the embryonic ring and the embryonic shield. The protoplasm continues to spread over the yolk until it is encompassed about two-thirds the way, or nearly closed. The embryo, however, does not form in the shield as it should. I have seen many eggs forming the germ ring and embryonic shield perfectly. The protoplasm continues to grow over the yolk, but the embryo fails to develop perfectly. It is usually much too short and often with the blastopore about closed, there has failed to develop any embryo at all in the shield, the latter remaining a mere mass of cells.

TABLE 3.

	FUNDULUS × FUNDULUS.	FUNDULUS × TAUTOGLABRUS.
Fertilization.	9.30 A. M., July 4.	9.30 A. M., July 4.
Begin. 2 cells.	11.17	11.17
Compl. 2 cells.	11.35	11.35
Begin. 4 cells.	11.50	11.46
Comp. 4 cells.	12.20	12.10
Begin. 8 cells.	12.25	12.15
Compl. 8 cells.	12.45	12.40
Begin. 16 cells.	12.50	12.45
Late segment	12.30 P. M., July 5.	12.30 P. M., July 5.
½ over yoke.	12.00 M. July 6.	12.00 M., July 6.
Blast. closed.	12.00 M. July 7.	Had stopped in previous stage. No embryo differentiated.

*Tautoglabrus adpersus*, female.

×

*Fundulus heteroclitus*, male.

This cross was attempted but once and the development followed to the 16-cell stage. Sixteen per cent. of the eggs were impregnated. The rate of development compared with the normals is given in the table below:

TABLE 4.

TIME.	TAUTOGLABRUS × TAUTOGLABRUS.	TAUTOGLABRUS × FUNDULUS.
9.30 P. M., July 4.	Fertilized.	Fertilized.
10.30 P. M., July 4.	Two cells.	Two cells.
10.45 P. M., July 4.	Begin. 4 cells.	Close of 2 cells.
10.50 P. M., July 4.	Well along in 4 cells.	Begin. 4 cells.
11.00 P. M., July 4.	Close of 4 cells.	Well along in 4 cells.
11.10 P. M., July 4.	Well begun on 8 cells.	Close of 4 cells.
11.15 P. M., July 4.	Well along in 8 cells.	Begin. 8 cells.
11.30 P. M., July 4.	Begin. 16 cells.	Close of 8 cells.
11.55 P. M., July 4.	16+cells.	16+cells.

*Fundulus heteroclitus*, female.

×

*Tautoga onitis*, male.

The percentage of eggs fertilized in the three experiments made was as follows:

Experiment 104.....	66 per cent.
" 108.....	40 " "
" 506.....	26 " "

It is not probable that with perfectly fresh milt the percentage would be higher. I have observed, the sex products of both sexes in this species materially deteriorate upon confinement of the fish, even for a short time. In experiment 506 good eggs were used and perfectly fresh milt in abundance was used. Practically all of the fertilized eggs are normally impregnated. In experiment 506 every impregnated egg was normal.

The development proceeds in the same manner as in the cross between *Fundulus* and *Tautoglabrus*. Most of the eggs form a definite embryonic rim and an apparently normal embryonic shield, but even though they may go to the closure of the blastopore, the embryo is always much too short, never exceeding one-half the normal length. They are mostly shorter than this, a mere thickened mass of cells developed in the embryonic shield. In some cases the blastopore is practically closed, surrounded by a broad embryonic rim with the embryonic shield devoid of any embryo.

*Fundulus heteroclitus*, female.

×

*Gasterosteus bispinosus*, male.

The percentage of eggs impregnated may be nearly normal, thus:

Experiment	26d.....	.86 per cent.
"	105d.....	18 " "

A very few of the eggs may be polyspermic. The details of the development of the hybrid and the normals occur in the table following. It will be noticed that the developmental processes keep apace until the close of cleavage. During the formation of the embryo the hybrids fall perceptibly behind. Most of the eggs go to the closure of the blastopore, although this is accomplished in many eggs only imperfectly. The embryos are largely shorter than the normals. The details of development are itemized in Table 5.

TABLE 5.

TIME.	FUNDULUS × FUNDULUS.	FUNDULUS × GASTEROSTEUS.
2.40 P. M., June 30.	Fertilization.	Fertilization.
5.00 P. M., June 30.	Well along in 2 cells.	Well along in 2 cells.
5.12 P. M., June 30.	Begin. 4 cells.	Begin. 4 cells.
5.57 P. M., June 30.	Still in 4 cells.	Begin. 8 cells.
6.03 P. M., June 30.	Just begin. 8 cells.	Mostly well along in 8 cells.
6.05 P. M., June 30.	Mostly well along in 8 cells.	Well along in 8 cells.
11.00 A. M., July 1.	Toward close of segmentation.	Toward close of segmentation.
12.30 P. M. July 1.,	Late segmentation.	Late segmentation.
1.30 P. M., July 1.	Begin. gastrulation.	Begin. gastrulation.
9.00 P. M., July 1.	½ over yolk.	¼ over yolk.
11.00 A. M., July 2.	¾ + over yolk.	Mostly ½ + over yolk.
12.00 M., July 4.	Embryos formed, brain vesicles, etc.	Embryos formed but no indication of brain vesicles, etc.
12.00 M., July 7.	Eyes formed; tall.	About same as in previous stage.

*Gasterosteus bispinosus*, female.

×

*Fundulus heteroclitus*, male.

This cross was made three times, and in one case all the eggs were impregnated. There is the same high mortality usual during gastrulation in these hybrids. Those eggs that laid down the embryo showed the latter very much shortened and the head end very much thickened, many of the embryos appearing to be only head. Rudimentary eyes may form. Details

of the development rate, etc., in the normals and hybrids are included in Table 6.

TABLE 6.

TIME.	GASTEROSTEUS × GASTEROSTEUS.	GASTEROSTEUS × FUNDULUS.
1.05 P. M., June 4.	Fertilization.	Fertilization.
4.00 P. M., June 4.	Two cells.	Two cells.
4.30 P. M., June 4.	In 4 cells.	In 4 cells.
4.45 P. M., June 4.	In 4 cells.	In 4 cells.
4.55 P. M., June 4.	Begun on 8 cells.	Begun on 8 cells.
5.15 P. M., June 4.	Close of 8 cells.	Close of 8 cells.
5.25 P. M., June 4.	Begin. 16 cells.	Begin. 16 cells.
6.05 P. M., June 4.	In 32 cells.	In 32 cells.
9.15 A. M., June 5.	Late segmentation. Disk begin. to spread.	Late segmentation. Disk less spread than in normals.
11.40 A. M., June 5.	Germ ring well formed.	No indication of germ ring.
2.00 P. M., June 5.	Germ ring and embryonic shield.	No indication of germ ring.
7.00 P. M., June 5.	$\frac{1}{2}$ over yolk.	Germ ring and shield well developed.
6.30 A. M., July 6.	Blastopore closed. Embryo formed.	$\frac{1}{2}$ to $\frac{2}{3}$ over yolk.
8.00 A. M., June 7.	Embryo developed with eyes, brain, etc.	$\frac{1}{2}$ over to closure of blast. Embryo short and completely formed.

*Fundulus heteroclitus*, female.

×

*Stenostomus chrysops*, male.

In this cross there is always a fairly large proportion of the eggs fertilized. The per cents in four experiments were as follows:

Experiments 103b	70 per cent.
" 106	40 " "
" 122	30 " "
" 508	58 " "

There is usually a considerable proportion di- and poly-spermic. This amounted to 18 per cent. and 20 per cent. in two experiments in which the count was made. The eggs would develop to the closure of the blastopore with the embryo too short though considerably better formed than in the cross *Fundulus heteroclitus* and *Tautoglabrus adspersus*. The embryo in some cases may be two-thirds normal length, with the blastopore remaining a rather large oval or slit. Quite a variety of conditions in blastopore closure obtain here, but do not merit detailed description. The relative rate of development for the normals and hybrids is detailed in Table 7.



TABLE 7.

TIME.	FUNDULUS × FUNDULUS.	FUNDULUS × STENOSTOMUS.
10.50 A. M., July 11.	Fertilization.	Fertilization.
11.37 A. M., July 11.	Begin. 2 cells.	Begin. 2 cells.
11.55 A. M., July 11.	Compl. 2 cells.	Compl. 2 cells.
12.05 P. M., July 11.	Begin. 4 cells.	Begin. 4 cells.
12.35 P. M., July 11.	Compl. 4 cells.	Compl. 4 cells.
12.40 P. M., July 11.	Begin. 8 cells.	Begin. 8 cells.
1.00 P. M., July 11.	Compl. 8 cells.	Compl. 8 cells.
1.05 P. M., July 11.	Begin. 16 cells.	Begin. 16 cells.
11.00 P. M., July 12.	Late cleavage.	Late cleavage.
1.25 P. M., July 12.	Well developed germ ring and shield $\frac{1}{2}$ over.	Some begin. of germ ring.
3.30 P. M., July 12.	$\frac{1}{2}$ over yolk.	$\frac{1}{2}$ over yolk.
7.20 P. M., July 12.	$\frac{2}{3}$ over yolk.	$\frac{1}{2}$ over yolk.
8.00 A. M., July 13.	Blast. closed.	Most nearly closed. Embryos too short.
1.00 P. M., July 13.		No further along.

*Fundulus heteroclitus*, female,

×

*Eupomotis gibbosus*, male.

This cross was attempted six times, only three of which were successful. The number of eggs impregnated each time was very small. I do not think this was due to the condition of the milt, because an abundance of apparently good milt was used. The dry method was used and the eggs kept in fresh water.

Experiment 7.....	Less than 1 per cent.
" 8.....	" " 1 " "
" 21.....	" " 1 " "

The eggs were followed to about one-third to one-half over the yolk when they stopped development. An embryonic ring and shield were developed, but the protoplasm did not look normal even in earlier stages of gastrulation showing a relatively opaque appearance compared with normal eggs.

The reciprocal of this cross was not attempted owing to a failure to get ripe eggs of the sunfish.

*Fundulus heteroclitus*, female.

×

*Fundulus diaphanus*, male.

*Fundulus diaphanus* was obtained from a fresh water lake, and was crossed many times in both directions with *Fundulus heteroclitus*. In the present cross I was never able to get a higher degree of impregnation than 80 per cent. Often I failed altogether and usually there was only an occasional fertilized egg—less than 1 per cent. This may have been due partly to the difficulty of getting enough good milt. In one instance I found about one-half of the eggs polyspermic. The eggs develop along in a normal fashion, going somewhat slower in the later stages, and hatch. I have reared some of the embryos for two weeks and they seemed perfectly active and otherwise normal. The eggs were reared in both fresh and sea water.

*Fundulus diaphanus*, female.

×

*Fundulus heteroclitus*, male.

When *Fundulus diaphanus* is used as the female nearly all of the eggs may be impregnated. Thus:

Experiment 6b.....	Nearly 100 per cent.
" 13a.....	" 62 " "
" 18a.....	" 91 " "

The eggs are practically all normally fertilized and hatched. These I have reared for twenty-two days after hatching.

*Fundulus heteroclitus*, female,

×

*Cynoscion regalis*, male.

The eggs of *Fundulus* are fertilized as perfectly with the sperm of the Squetegue as with its own milt. Thus:

Experiment 513.....	.92 per cent.
" 514.....	.90 " "

Only about 2 per cent. of the eggs are polyspermic. A tabulated outline of the development compared with the normal is as follows:

TABLE 8.

TIME.	FUNDULUS × FUNDULUS.	FUNDULUS × SQUETEQUE.
3.40 P. M., July 17.	Fertilization.	Fertilization.
5.50 P. M., July 17.	2 cells.	2 cells.
6.35 P. M., July 17.	4 cells.	4 cells.
7.25 P. M., July 17.	8 cells.	8 cells.
7.45 P. M., July 17.	Begin. 16 cells.	Begin. 16 cells.
8.10 A. M., July 18.	Late cleavage.	Late cleavage.
12.20 P. M., July 18.	Begin. germ ring.	Begin. germ ring.
7.00 P. M., July 18.	$\frac{3}{4}$ over yolk.	Germ ring; $\frac{1}{4}$ to $\frac{1}{2}$ over.
8.15 A. M., July 19.	Blast. closed; optic vesicles plainly formed.	Blast. closed; optic vesicles poorly formed notocord; somites. Behind normals.
2.15 P. M., July 19.	Optic vesicles and lens; brown parts showing. Hatched.	Optic vesicles showing; behind normals. No further along.

The embryos may continue their development to a stage where the eyes, heart, ear vesicles, tail, etc., are more or less well formed. At this stage they remain alive until about the time that the normals hatch.

None of the embryos are formed even approximately normal. The individual differences are so great that a description of different forms would be of no avail. A brief description of one of the poorer embryos is as follows: The embryo may form a mere mass of cells so far as external appearances go. This embryo becomes pigmented with many pigment cells which are highly branched. It is bilaterally symmetrical in form, but the distribution of the pigment cells only slightly indicates this. In this embryo there was no definitely differentiated heart, but beneath and about one-third the distance back from the anterior end, a mass of cells could be seen regularly pulsating. Just above the heart-mass a vesicle occurred which I take to be the ear. There was no indication of a tail. I repeatedly observed the embryo bend itself from side to side so that there were probably muscle tissues formed on both sides. This particular embryo died nine days after fertilization.

One of the best formed embryos may now be described. Two eyes are formed, although much too small, poorly pigmented, without a lens and set into the anterior surface. Extending out on either side is a large vesicle which is probably an hypertrophied ear vesicle. A pretty well developed

tail is shown. Notocord and muscles are developed. A long tubular heart extends across the rather large pericardial sac. The body shows many finely divided pigment cells. These show, in general, a bilateral distribution. Even this embryo is considerably too short. The contractions of the body are vigorous and frequent. The heart beats considerably slower than the normal. This embryo lived until the normals had hatched.

The development of eyes, as in the preceding embryo, is uncommon. There are often pigmented areas which are probably the representatives of this organ, but no definite vesicles or cups. In many of the embryos the anterior end is occupied by enlarged vesicles which is more or less heavily pigmented.

All the embryos are too short, many of them mere short masses of cells without any caudal elongation at all. They are all highly pigmented, the prevailing color being a reddish-brown. These cells are as a rule very finely divided. The dark pigment cells are relatively few in number and are, as a whole, much less finely branched. I have never been able to see any bloodvessels that were carrying blood. In a few instances irregular lakelets, reddish in color, appeared, but I have been unable to detect any corpuscles in them.

In addition to the above crosses it seems worth while to include the other crosses effected. To these much less attention was given so that in a description of them only such points as seem relevant will be given.

*Crosses with Gasterosteus bispinosus.*

Besides the crosses already described between *Gasterosteus bispinosus* and *Fundulus heteroclitus*, the following were attempted:

*Gasterosteus bispinosus*, female,

×

*Apeltes quadracus*, male.

In the single attempt to make this cross, only 17 per cent. of the eggs were impregnated. The eggs from a single female were used. It is probable that further attempts with more favorable females would yield a greater per cent. of impregnation. The fertilized eggs were normally impregnated. After the cleavage stages the hybrids fell behind the normals so that while the latter had closed the blastopore, the hybrids had encompassed the yolk about three-fourths of the way. Seven embryos were hatched and were in an apparently normal condition. These were kept alive for four days.

A smaller proportion of the embryos failed to emerge from the membranes. These were helped out but showed the coiled tail so common among fish embryos that seem to have thrived poorly. The hybrids, however, appeared less healthy than a lot of normals that were fertilized at the same time, and kept under the same conditions. These mostly lived three and four days longer. As far as can be judged from this single experiment, it is doubtful whether many of these hybrids, even with the care and proper conditions supplied, could be successfully reared.

*Apeltes quadracus*, female,

×

*Gasterosteus bispinosus*, male.

Two tests were made. In one of them 18 per cent. of the eggs were impregnated. The embryos showed the usual slowing in the rate of development after close of cleavage. The development went to the stage of hatching, two emerging but showing little vigor. They died after the second day of emergence. The embryos that failed to emerge, for the most part lived as long as the two which had hatched. The success of this cross is probably the same as that of the reciprocal.

*Gasterosteus bispinosus*, female,

×

*Menidia notata*, male.

The eggs of this stickleback are practically all impregnated when placed with *Menidia* sperm. In the two experiments tried, 100 per cent. and 70 per cent. were fertilized. A small per cent. of these are polyspermic. The development keeps well apace with the normals until toward the closure of the blastopore. The embryo is laid down, the eyes are formed, but the anterior region of body is quite heavy. Pigment forms and the heart is developed. I have never seen fins form in these hybrids. The embryos soon die, owing possibly to the fact that the eggs even normally do not do well in a fingerbowl of water.

*Menidia notata*, female,

×

*Gasterosteus bispinosus*, male.

This cross was made but once. All of the eggs were fertilized. The development was followed to the closure of the blastopore. They doubtless

developed further since my notes, at this stage, show them to be in a good condition.

*Gasterosteus bispinosus*, female,

×

*Menidia gracilis*, male.

In two of the three experiments made with this cross, practically 100 per cent. of the eggs were normally impregnated. The eggs develop at the same rate as the normals until the latter half of gastrulation, when the hybrids fall behind. Most of the eggs form embryos. These are short, with heavy anterior portion. The posterior one-half or one-third of embryo remains quite rudimentary. The anterior enlarged end develops eyes that in the earlier stages are apparently normal. The heart is formed and pulsates. I have kept these embryos alive for five days.

*Gasterosteus bispinosus*, female,

×

*Tautoga onitis*, male.

Practically 100 per cent. of the eggs were normally fertilized in the single cross made. The eggs show the usual slowing in development at the close of segmentation. About 50 per cent. of the embryos died at a stage when gastrulation was from one-third to one-half completed. The remainder more or less completely closed the blastopore. The anterior portion of embryo is heavy. No eyes and heart were observed. The embryos died three days after closure of the blastopore.

*Gasterosteus bispinosus*, female,

×

*Tautoglabrus adspersus*, male.

Seventy-four per cent. in one experiment and practically 100 per cent. in the other were normally impregnated. The embryos developed more successfully than when *Tautoga* was used as the male. A large per cent. of the eggs attempted to close the blastopore. The anterior end of embryo was large, eyes and heart were developed but not normally. The embryos lived for five days in this condition.

*Menidia notata*, female,

×

*Tautoga onitis*, male.

Eighty per cent. of all the eggs were normally fertilized. The embryos

were followed to the closure of the blastopore. The embryos were shorter than normals.

*Vautoga oinitis*, female.

×

*Menidia notata*, male.

In this cross 60 per cent. of the eggs were impregnated. Some dispermy and polyspermy occurred. There was a heavy mortality at the germ ring stage and subsequently. The ring spread about two-thirds over the yolk in some of them, when owing probably to bad conditions, all died.

*Fundulus diaphanus*, female.

×

*Eupomotis gibbosus*, male.

The cross between the fresh water *Fundulus* and *Eupomotis* is from the standpoint of impregnation, much more successful than when the egg of *Fundulus heteroclitus* is used. The percentage of eggs fertilized may be as high as 70 per cent.

Experiment 12 .....	56 per cent.
" 17a.....	11 " "
" 18b.....	70 " "
" 22a.....	23 " "

I have always found a considerable number of imperfect eggs which accounts in a measure for the usual low per cent. of eggs fertilized. A particularly large number occurred in Example 17a. A few of the eggs are polyspermic in each experiment, probably, however, not many more than in the normals, where there may be as many as 5 per cent. polyspermic. The development stops when the protoplasm has spread about one-half over the yolk. Embryonic ring and shield are formed, but very little evidence of embryonic differentiation being shown in the shield. The protoplasm looks granular and opaque instead of clear, as in the normals.

*Opsanus tau*, female.

×

*Fundulus heteroclitus*, male.

In the one experiment made, twenty-one out of thirty-seven eggs were found in the 2 and 4-celled stage eight hours and twenty-five minutes after fertilization. A few of the eggs were polyspermic. They were followed to later cleavage.

*Opsanus tau*, female.

×

*Tautogolabrus adspersus*, male.

One out of thirteen eggs was impregnated in the single experiment. The rate of cleavage was the same as in the above cross.

*Opsanus tau*, female,

×

*Menidia notata*, male.

Thirteen out of seventeen eggs were impregnated. None of the eggs were polyspermic. The cleavage rate was the same as the *Opsanus* X *Fundulus* cross listed above.

The reciprocals of the above named three crosses with *Opsanus tau* eggs were attempted but without success. This was doubtless due to the unripe condition of the *Opsanus tau* milt, since I was also unsuccessful in obtaining normals.

In addition to the crosses detailed above the following were also effected (See Table 9):

*Fundulus heteroclitus* ♀ × *Apeltes quadracus* ♂.

*Tautoga onitis* ♀ × *Tautogolabrus adspersus* ♂.

*Tautogolabrus adspersus* ♀ × *Tautoga onitis* ♂.

*Coregonus clupeiformis* ♀ × *Argyrosomus artedi* ♂.

*Argyrosomus artedi* ♀ × *Coregonus clupeiformis* ♂.

*Cristivomer namaycush* ♀ × *Salvelinus fontinalis* ♂.



TABLE 9.

CROSS.	FAMILY.	ORDER.	NUMBER OF CROSSES MADE.	PER CENT. OF IMPREGNATION.	REMARKS.
<i>Fundulus heteroclitus</i> ♀ <i>Fundulus diaphanus</i> ♂	Pœciliidæ Pœciliidæ	Haplomi Haplomi	8	0-80	Hatched.
<i>Fundulus diaphanus</i> ♀ <i>Fundulus heteroclitus</i> ♂	Pœciliidæ Pœciliidæ	Haplomi Haplomi	10	62-100	Hatched.
<i>Fundulus heteroclitus</i> ♀ <i>Fundulus majalis</i> ♂	Pœciliidæ Pœciliidæ	Haplomi Haplomi	1	78	Hatched.
<i>Fundulus majalis</i> ♀ <i>Fundulus heteroclitus</i> ♂	Pœciliidæ Pœciliidæ	Haplomi Haplomi	1	90	Up to hatching.
<i>Fundulus heteroclitus</i> ♀ <i>Menidia notata</i> ♂	Pœciliidæ Atherinidæ	Haplomi Acantlopteri	10	70-93	
<i>Menidia notata</i> ♀ <i>Fundulus heteroclitus</i> ♂	Atherinidæ Pœciliidæ	Acantlopteri Haplomi	4	14 to nearly 100	
<i>Fundulus heteroclitus</i> ♀ <i>Menidia gracilis</i> ♂	Pœciliidæ Atherinidæ	Haplomi Acantlopteri	3	About 100	
<i>Fundulus heteroclitus</i> ♀ <i>Gasterosteus bispinosus</i> ♂	Pœciliidæ Gasterosteidæ	Hoplomi Hemibranchii	3	18-86	
<i>Gasterosteus bispinosus</i> ♀ <i>Fundulus heteroclitus</i> ♂	Gasterosteidæ Pœciliidæ	Hemibranchii Haplomi	3	45-100	
<i>Fundulus heteroclitus</i> ♀ <i>Apeltes quadracus</i> ♂	Pœciliidæ Gasterosteidæ	Haplomi Hemibranchii			

				Less than 1%
Fundulus heteroclitus ♀ Eupomotis gibbosus ♂	Perciliidae Centrarchidae	Haplomi Acanthopteri	6	
Fundulus heteroclitus ♀ Tautoglabrus adspersus ♂	Perciliidae Labridae	Haplomi Acanthopteri	5	17-90
Tautoglabrus adspersus ♀ Fundulus heteroclitus ♂	Labridae Perciliidae	Acanthopteri Haplomi	1	16%
Fundulus heteroclitus ♀ Tautoga onitis ♂	Perciliidae Labridae	Haplomi Acanthopteri	3	40-66½
Fundulus heteroclitus ♀ Stenostomus chrysops ♂	Perciliidae Sparidae	Haplomi Acanthopteri	4	30-70
Fundulus heteroclitus ♀ Cynoscion regalis ♂	Perciliidae Sciaenidae	Haplomi Acanthopteri	10 Many	20-92 17-92
Fundulus diaphanus ♀ Eupomotis gibbosus ♂	Perciliidae Centrarchidae	Haplomi Acanthopteri	4	23-70
Gasterosteus bispinosus ♀ Apeltes quadracus ♂	Gasterosteidae Gasterosteidae	Hemibranchii Hemibranchii	1	17
Apeltes quadracus ♀ Gasterosteus bispinosus ♂	Gasterosteidae Gasterosteidae	Hemibranchii Hemibranchii	2	17½
Gasterosteus bispinosus ♀ Tautoglabrus adspersus ♂	Gasterosteidae Labridae	Hemibranchii Acanthopteri	2	74-100
Tautoga onitis ♀ Menidia notata ♂	Labridae Atherinidae	Acanthopteri Acanthopteri	1	60
Menidia notata ♀ Tautoga onitis ♂	Atherinidae Labridae	Acanthopteri Acanthopteri	1	80+
Gasterosteus bispinosus ♀ Tautoga onitis ♂	Gasterosteidae Labridae	Hemibranchii Acanthopteri	1	100

TABLE 9.—Continued.

CROSS.	FAMILY.	ORDER.	NUMBER OF CROSSES MADE.	PER CENT. OF IMPREGINATION.	REMARKS.
Gasterosteus bispinosus ♀ Menidia gracilis ♂	Gasterosteidae Atherinidae	Hemibranchii Acanthopteri	3	50-100	
Tautoga onitis ♀ Tautoglabrus adspersus ♂	Labridae Labridae	Acanthopteri Acanthopteri	2	95	
Tautoglabrus adspersus ♀ Tautoga onitis ♂	Labridae Labridae	Acanthopteri Acanthopteri	1	Large per cent.	
Gasterosteus bispinosus ♀ Menidia notata ♂	Gasterosteidae Atherinidae	Hemibranchii Acanthopteri	2	70-100	
Menidia notata ♀ Gasterosteus bispinosus ♂	Atherinidae Gasterosteidae	Acanthopteri Hemibranchii	1	100	
Opsanus tau ♀ Menidia notata ♂	Batrachoididae Atherinidae	Plectognathi Acanthopteri	1	87%	
Opsanus tau ♀ Menidia notata ♂	Batrachoididae Atherinidae	Plectognathi Acanthopteri	1	76	
Opsanus tau ♀ Tautoglabrus adspersus ♂	Batrachoididae Labridae	Plectognathi Acanthopteri	1	33½	
Coregonus clupeiformis ♀ Argyrosomus arctedi ♂	Salmonidae Salmonidae	Isospondyli Isospondyli	2	Large per cent.	Hatched.
Argyrosomus arctedi ♀ Coregonus clupeiformis ♂	Salmonidae Salmonidae	Isospondyli Isospondyli	2	Large per cent.	Hatched.
Cristivomer namaycush ♀ Savelinus fontinalis ♂	Salmonidae Salmonidae	Isospondyli Isospondyli	1	Large per cent.	Hatched and reared to fingerlings.

## SUMMARY OF EXPERIMENTS.

## INTRODUCTORY.

In the preceding detailed account of the various crosses effected are included combinations between forms of teleosts, ranging from closely related species within the same genus to species belonging to widely separated orders. Their relationships are summarized below, the figures set opposite each indicating the number of different combinations made in each group:<sup>1</sup>

Between different species of same genus.....	2
"    "    genera of same family.....	4
"    "    families of same order.....	1
"    "    orders of same class.....	17

A number of interesting facts appear from the above table and from a closer inspection of the more detailed Table 9. In all the crosses attempted with the exception of the cross in which *Opsanus tau* was used as the male, impregnation was possible. The sperm of the single *Opsanus tau* specimen used was not ripe in the three combinations attempted, so that it is impossible to say whether these crosses are possible.

## CHARACTER OF IMPREGNATION.

In many of the crosses the impregnation was wholly normal. In some there was in addition to the normally impregnated eggs, a varying number of dispermic and polyspermic impregnations. Among the abnormally impregnated eggs the dispermic was very much more common than the polyspermic condition. In the dispermic eggs the protoplasmic disc, as is well known, falls at once into four cells. Sections of these conditions show that two male pronuclei fuse with the egg pronucleus; whether additional spermatozoa enter such eggs, but remain functionless so far as early cleavage is concerned, I am not able to say. In the polyspermic eggs the protoplasm falls at once into six or more cells. The cases coming under my observation in which many cells at once appeared, have been rather rare.

## PERCENTAGE OF FERTILIZATION.

A striking fact is the large percentage of eggs impregnated. In fully two-thirds of the crosses this ran above 50 per cent., and in many of the combinations it ran above 75 per cent. A glance at Table 9 will show that this is not in any way correlated with the nearness of relationship.

<sup>1</sup> This is represented in more detailed form in Table 9.

The low percentage of impregnation, on the other hand, must be regarded in most cases, I feel sure, as due to unfavorable conditions of the milt, and in some cases to the unripe condition of the eggs. Males that have passed the height of their breeding season, or which may have been less able to endure the conditions of confinement in aquaria usually show a reduced fertilizing power compared to perfectly fresh and ripe individual. The testes were in all the experiments cut out, so that it is quite probable that in many cases imperfect milt was used. I was, furthermore, not able to establish any constant difference in the percentage of impregnations in reciprocals. Allowing for the influence of the condition of the milt in determining the percentage of impregnation, in all cases where a fair trial was made in reciprocal crossing of two species it was approximately as high in one direction as the other. It is interesting to note here that Kammerer '07 using fresh water fishes, found, among the few forms he used, two crosses, *Perea fluviatilis* x *Acerina schraetser* and *Lucioperca sandra* x *Perca fluviatilis*, in which it was possible to impregnate when the first named in each case was the male, but not if female. It is also impossible to fertilize the eggs of *Aspro zingel* with the milt from the following nearly related forms: *Perca fluviatilis*, *Lucioperca sandra* and *Acerina* sp?, but was able to fertilize them with the milt from the distantly related form *Cottus gobio*. It would seem from these experiments that fresh water fishes lend themselves less generally to hybridization than the marine species.

Kammerer's statement that the eggs of *Aspro zingel* are fertile to the sperm of the distantly related form *Cottus gobio* when they were immune to the three nearly related forms above indicated, because *Cottus* had a similar habitat, and had with this also acquired the power to fertilize this species is, of course, a mere fancy. If he had tried to cross this form with other distantly related forms he would probably have found that they, too, would fertilize the eggs regardless of their habitat relationship.

#### DEVELOPMENT.

In my study of the development of these various hybrids I have not attempted to get a complete morphological picture, nor have I paid much attention to the inheritance aspect. I have regarded development rather from a physiological standpoint. The main points of interest, therefore, have been, first, how generally and within what limits can the sex-products of the various forms of teleosts be grafted upon each other, so to speak,

and start development. Second, How far will development proceed in the various combinations, and in what respects are the processes normal and abnormal?

In every combination effected the earlier phases of cleavage are passed through in a perfectly normal manner. The same is true of the later stages of cleavage excepting the rate of development. This will be further considered below. From the late cleavage on, the history of the different hybrids becomes much more varied. In those hybrids resulting from species nearly related—belonging to the same genus or to closely allied genera—most of the embryos may complete their development to the point of hatching, or beyond. Even among these, however, a number variable but much greater than in normal embryos, may show abnormalities along the course of their development, such as occur more abundantly in the hybrids between more distantly related forms. Hybrids between species more distantly related than above indicated, so far as my experiments go, never complete their development to the point of hatching. The stage to which they will go depends again upon the nearness of their relationship. In the more successful of such distant crosses *Fundulus-Menidia* hybrids, many of the embryos may go far enough to form fairly well developed eyes, ear vesicles, tail, muscles, central nervous system, heart, color pattern, fins, etc., but many of these structures in the later stages are variously abnormal. A large proportion of all the embryos, however, fail to reach such advanced stage. From these hybrids we have almost every condition to such as obtains in the hybrids between *Fundulus heteroclitus* x *Tautoglabrus adspersus*, where none of the embryos go much beyond the closure of the blastopore, and where it is not possible to speak of the formation of organs. The more characteristic and striking abnormalities appearing beyond the cleavage stage in these various hybrids may be briefly considered.

In the last stages of cleavage and during the earlier phases of germ ring formation it is usually not possible to distinguish the hybrids from the normals excepting in the stage of advancement. In some combinations, such as *Fundulus heteroclitus* x *Tautoglabrus adspersus*, etc., one can very commonly see the formation of a rather large clear area under the blastodisc which is filled with a clear fluid. I have followed such eggs and they do not bring their development to as advanced a stage as those eggs of the same lots that do not show this abnormality. They may form a very good embryonic ring and shield and may overlap the yolk for a third of the way

and there die. In a few cases the vesicle was observed to be so large as to act as the yolk ball so that the protoplasm attempted to encompass it.

Embryonic shield might form and even lay down the axis of the embryo. These, like the above, soon died. In all hybrid eggs, but particularly those obtained from distantly related species, the period of gastrulation is one of great mortality. The embryos usually enter upon the germ ring and shield stage rather normally and simultaneously, but from this period to the closure of the blastopore the greatest variation in stages obtains. In some of the less successful crosses most of the eggs never succeed in properly closing the blastopore, but come to a standstill so far as this process is concerned at various stages, and continue the rudimentary formation of an embryo in the embryonic shield.

These aborted embryos may in some cases remain alive for days, developing pigment, a rudimentary heart, pericardial cavity, etc.

A very common deformity in the more successful embryos is the failure of the tail to bud out so that the embryos, very generally, are too short. A striking instance of this fact appeared in the hybrids between *Savelinus fontinalis*, female, and *Cristivomor namaycush*, male. This cross is quite successful, and the writer has succeeded in rearing 2,300 of them to fingerlings. Among this lot, a very large per cent. were deformed, and in every instance the deformity occurred in the region posterior to the anus. The portion anterior to the anus was normal in every way so far as proportions are concerned. The same is true of the caudal fin. But the region between this and the anus showed all degrees of shortening, the extremes appearing as if the caudal fin were directly set into the body of the fish. The anal fin was often wanting altogether, even in some that had the caudal peduncle otherwise normally developed.<sup>1</sup> This process of the elongation of the caudal end of the embryo seems evidently a difficult one, giving rise to the common abnormalities in this region. In those crosses where a portion of the embryos succeed in laying down the fundamental organs such as the eyes, ears, brain, heart, muscles, etc., promise well to carry their development to completion. In every instance, however, regardless of how normal the organogenetic processes may at first be, they show a very clearly defined abortive influence in a short time. This begins to show itself shortly after the time when the circulation is established in the normal embryo. This fails to develop properly in all these hybrids that fail to complete their de-

---

<sup>1</sup> A detailed description of these hybrids are reviewed in a separate paper.

velopment. The heart usually differentiates and a pericardial cavity forms which commonly distends to enormous proportions. This has the effect of deforming the heart usually into a much elongated structure. The yolk and the embryo may in some instances differentiate blood vessels, but I have only in one instance observed either the heart or blood vessels handling any blood. The result of this is that the embryo which may up to this period be quite normal in its developmental processes, has its food restricted to what may be directly absorbed from the yolk through other agents than the blood. That the embryo does thus obtain some food is evident from the progressive reduction of the yolk and the increased size, and the long continued life of the embryo.

The eyes in rare cases may be quite normal. From this condition all degrees of abnormalities obtain. The eyes are commonly too small, located too far forward and too low down. Often an eye is developed only on one side. The eye may be rudimentary to the extent of being only a large black pigmented area in the region of the forebrain. A large proportion of the embryo develop no indication of an eye.

The ear may develop as a vesicle which in some cases shows otoliths. Commonly this vesicle becomes much distended, appearing as a prominent projection on either side. The ear less frequently appears than the eye.

The central nervous system may be laid down, the brain even showing some of the primary divisions in the more successful embryos.

The notocord is commonly present. The embryos may develop a varying number of somites, and quite commonly when these are present, some of the cells become contractile so that the whole embryo undergoes movements.

The fins rarely appear, but in some instances the pectoral fins may be much larger than in the normal fish.

If an embryo is laid down at all it rarely occurs that pigment does not develop, both on the yolk and in the body of the embryo. In some cases this may be quite heavily developed, showing accumulations of large and highly branched chromatophores. In the better developed embryos a simple pattern may develop showing varying degrees of bilateral symmetry.

The rate of development of the hybrid egg compared with that of the egg species, was noted in many instances. Comparative tables are given above in the detailed descriptions of the various hybrids.

The earlier cleavage stages in every case was that of the species from which the egg was taken. This is true whether the rate of cleavage from the



sperm species is more rapid or slower than that of the egg species. Thus, reference to Table 3, where *Fundulus heteroclitus* was the egg species and *Tautogolabrus adspersus* was the male species, the rhythm of cleavage follows exactly that of *Fundulus*, although that of *Tautogolabrus* is very much faster. The reciprocal shown in Table 4 shows that the rate again is that of the egg species—*Tautogolabrus*. This is true all the way through, but attention is called to the hybrids with *Opsanus tau*, where the cleavage rhythm is relatively so extremely slow. (Page 373.) These facts are in accord with many observations made by others, especially Driesch ('98) on Echinoderms. Newman ('08, '10) obtained the same results in his *Fundulus heteroclitus*—*Fundulus majalis* hybrids. Fischel ('06), on the contrary, maintains that the influence of the sperm in some of the Echinoderm hybrids, makes itself felt even in the first cleavage. It is important to note, however, that such influence as he can detect is always to slow the development. This is what I find everywhere, as will appear further on, but I have not been able to detect it during the early cleavage stages. This slowing of the developmental processes is to be looked upon as pathological, a sort of incompatibility of the two germinal substances in such cases as it occurs. If it is permissible, as some authors do, to speak of the rhythm of cleavage as a character of the organism, then all my experiments most clearly show that the rate of earlier cleavage of the embryo is uninfluenced by the sperm, and may be regarded as wholly determined by the egg.

In later cleavage and all subsequent stages, the influence of the strange sperm becomes apparent in all the cases that I have carefully watched. It should be said here that hybrids between the nearly related species were not studied in this particular, but only those between the more distant forms. The influence of the strange sperm was in every case to retard development, usually to a marked degree, regardless of whether the developmental processes in the sperm species was much more rapid or slower than in the egg species. Thus *Tautogolabrus adspersus* takes only from twenty-four to thirty-six hours to hatch, while *Fundulus heteroclitus* takes from ten days to fourteen days, the hybrids, using *Fundulus* as the egg species, are slower in their development than *Fundulus* itself. The tendency, then, among fish hybrids obtained by combining distantly related species, is to develop slower after their earlier cleavage stages, than the egg species. It is, therefore, interesting to note Newman's result where

he found a distinct acceleration in the later cleavage stages and subsequently in the hybrids between *Fundulus majalis*, female x *Fundulus heteroclitus*, male.

## GENERAL CONSIDERATIONS AND THEORETICAL.

### SELECTIVE FERTILIZATION.

In a general consideration of these experiments, perhaps the most striking fact that appears is the uniformity with which it is possible to cross-fertilize the various species of teleosts. The percentage of eggs fertilized is in practically all cases a high one—fifty per cent., and, in the majority of cases, seventy-five per cent. or over. When one reflects upon the reason for one's astonishment at this, he finds it in the fact that we have all, those of us who have given the matter any thought at all, allowed ourselves to grow into the belief that there is a sort of specific affinity or adaptation existing between an egg and the spermatozoön of the same species. This assumption may or may not be true. So far as the writer has been able to determine, there is extant no evidence that this is the case in the animal egg. A possible exception is to be found in the experiments of Dungen (01), who finds that in the eggs of the starfish there is a substance which is poisonous toward the sperm of the sea urchin, but not vice versa. It is easy to see that under such conditions the spermatozoa of the starfish would be favored.

On the other hand, we have experiments by Buller on all the groups of Echinoderms which seem to show that there exists no specific affinity, chemical or otherwise, between the egg and its own spermatozoön.

The writer is elsewhere publishing a detailed account of his experiments on selective fertilization in fishes. It may be proper, however, to briefly call attention in this connection to a few of the results he obtained. First. The fact above stated, that among these fishes it is possible so uniformly to cross-fertilize the different species lends no support to the "specific adaptation" theory. Second, When a lot of *Fundulus heteroclitus* eggs are given a chance at a mixture of two sperm, one of which is their own and the other a strange species (*Menidia*, for instance), the eggs do not necessarily show any preference for their own sperm. In the case above mentioned, for instance, the great majority of the eggs prefer the *Menidia* sperm to their own. In other combinations the proportion is about equal. In still others the eggs may select more of their own sperm. The factor

seems not to be the relationship of the sperm, but its vitality and fertilizing power. Third, Experiments with various egg extracts and the like on the behavior of spermatozoa give no evidence of any attraction of an egg for its own sperm or any toxic influence upon the strange sperm. It seems, therefore, that in the case of these teleosts there is no evidence of any specific adaptation of the egg for its own spermatozoön.

How can we account for these varying degrees of failure in development in these various hybrids? This question is as old as our knowledge of the common infertility of hybrids. Why should an animal or plant hybrid carry its development in a perfectly normal and healthy manner up to the final stage of sex product formation, and yet at this point so commonly fail? To this question we have up to the present time no definite answer whatsoever.

#### DEGREE OF DEVELOPMENT AND SYSTEMATIC RELATIONSHIP.

In following the development of the various hybrids hereunder discussed there appears one period in the development to which we might ascribe the failure of development, more than any other: this is the defective development of the circulatory system. Development in most crosses proceeds often in a relatively normal manner up to the period of the differentiation of the heart, blood vessels and the blood. In all the hybrids here considered that succeed in forming a circulatory system at all may begin to develop the heart more or less normally, so that it regularly and vigorously pulsates but fails to differentiate the blood and blood vessels. As a result the heart manipulates no normal blood and, as a consequence, the food absorption of the embryo must occur through other channels than the blood. Following this period the embryos invariably begin to lag behind, the organs fail to properly differentiate, resulting in the stunted, sickly-looking, starved hybrid. It would seem that if it were possible in some way to help the hybrids to properly complete this system, development might be carried much further, perhaps up to the point of hatching. But in the case of some hybrids none of the embryos form a heart and a varying percentage of all hybrids fail to develop the heart at all, even though the more successful ones complete development. Furthermore, it often happens that the circulatory system is apparently properly established and the development carried to the point of hatching, or even beyond, but they soon die. Thus while it is undoubtedly true that the establishment of the cir-

ulation is a vital stage in the proper progressive development of the embryo and is followed in normal embryos by a period of rapid growth, the question still remains, why does the circulatory system fail to develop properly? Why do we have so many embryos stop their development before the period of heart formation, and why do we have so commonly failures to emerge from egg, or die shortly after, when in the latter the circulation, at least to all appearances, has been normal? If we consider the experiments tabulated in Table 9 from the view point of the correlation between the degree of development and the relationship of the species combined, we see at once that only those species that belong to the same genus, or to very closely related genera, will produce hybrids that develop to the point of hatching. Even within this group a difference in this respect can be observed between species very closely related, and species more distantly related. Thus *Fundulus heteroclitus* combined in either direction with *Fundulus diaphanus* will produce a large proportion of free swimming embryos. These two species, although the former is a marine and the latter fresh water, are structurally very closely allied. *Fundulus majalis* is much less closely related to *Fundulus heteroclitus*, although belonging to the same genus. When the latter is taken as the female a large proportion of vigorous fry are obtained. The reciprocal has never yielded me embryos that would emerge from the egg, although, with the exception of the yolk bag, normal in appearance. Then the species used belong to separate genera the proportion of embryos that emerge normally is, as a rule, much smaller than in the preceding condition.

All species that are more removed from each other than closely related genera, fail to produce hybrid embryos that will complete development to the point of hatching. Among this latter group of hybrids the stage to which development is carried varies considerably in the different combinations. This, too, can be roughly correlated with the relationship of the species combined, so that two species belonging to distantly related orders like *Fundulus heteroclitus* x *Tautoglabrus adspersus* give rise to hybrids that can not go much beyond the closure of the blastopore, while if the same form is crossed with its nearer relative, *Menidia notata*, development proceeds very much further although stops far from the point of hatching. This will be further taken up below.

We produce, then, among fishes a series of hybrids that range in success from those in which none of the embryos develop very much be-

yond the "blastopore" stage though intergradations to those in which the embryos hatch normally and grow into adults, probably fertile creatures, and this series is correlated with the systematic relationship existing between the two species crossed.

The work of Guyer ('00) on the spermatogenesis of hybrid pigeons suggests that in the final formation of the sex products, difficulties arise in the synopsis of the male and female chromatin material, resulting in abnormal spermatozoa. Stated in more general terms in the final formation of the sex cell the developmental and hereditary substances from the two parents, fail to work harmoniously, giving rise to abnormal development. It is conceivable that an analogous process takes place in those hybrids that are arrested much earlier in their development. Indeed, the prevailing habit of thinking of developmental and hereditary determinants in terms of units of some sort, suggests at once to our minds some such picture as above indicated. In two nearly related species the developmental mechanisms are so nearly alike that no serious conflicts, so to speak, arise except possibly in the very last stages, namely, the formation of the sex cells. As a result, the development may be completed or all but completed. When, however, two distinctly related species are combined we have to do with two developmental mechanisms that are more divergent, and the conflict develops early in the life of the organism with the consequent modification of development, varying with the relationship. It is difficult to find any appearances in my hybrids that specifically support this view. It would seem that at least occasionally there would appear specific modifications to the influence of the sperm over the egg species. Thus it should be expected that the mode and rate of cleavage, the time and method of gastrulation, etc., should vary in a manner to be in a measure at least due to the specific characteristics of the developmental mechanisms of the sperm species. But this is just what one does not find. The whole process of hybrid development presents the picture of a pathological embryo, such as one sees when they are subjected to an unfavorable condition, such as foul water, insufficient oxygen, unnatural chemical media and the like. It is simply an arrest with subsequent gradual deterioration of the tissues. Thus the monocular condition is likely to result if the optic vesicles fail to form properly and the anterior brain-vesicle becoming pigmented in the cyclopic eye, or only one side develops the vesicle and becomes pigmented. The slender strangulated heart may

be accounted for by the abnormally large pericardial cavity which develops, across which it becomes stretched. The large pericardial cavity may be the result of the abnormal method of yolk absorption due to the failure of the blood vessels to differentiate.

I have for three or four years looked upon these phenomena in my own hybrid experiments as a process akin to that which obtains in the transfusion of blood of strange species. The well known results of Landois ('75), Friedenthal ('99) and others bring out the important fact that the hæmolytic power of the bloods of two species varies in intensity with the nearness of relationship of the species. In general two very closely related animals will permit the transfusion of their bloods with no or relatively slight hæmolytic action. As the forms become divergent in relationship the toxic action becomes progressively greater. In a similar manner it has been shown that other tissues than blood act toxically. Among these are spermatozoa. The process in hybridization may be conceived something as follows: When the sperm brings its material into the strange egg in fertilization it brings with it the substance capable of poisoning the egg substance or vice versa. We may suppose that the toxic action does not manifest itself at once because of the relatively small proportion of the sperm substance compared to that of the egg. Consequently early cleavage stages are in all cases passed through in a normal manner. As, however, the nuclear material grows and becomes more generally distributed through the cytoplasmic mass as cleavage proceeds, the toxic action becomes manifest in the retardation of the cleavage and subsequent developmental processes. The intensity of the effect will vary with the degree of toxicity existing between the two species concerned. In the cases of fishes where cross fertilization is so generally possible it should be possible to get a measure of this in the faithfulness with which the embryo reproduces the normal developmental processes in the earlier stages, and the stage at which these become arrested.

In the transfusion of bloods we have seen that the toxicity varies rather closely with the systematic relationship of the animals. My experiments so far as they go, show that this same law holds in hybridization, and when taken in connection with what is already well known about the production of so-called "successful" hybrids, I think, may be interpreted as furnishing evidence for this view.

In order to obtain a somewhat more definite idea of the influence of a strange sperm upon the developmental processes, I have made a somewhat careful comparison of the final stages of a series of hybrids all of which had the same species, *Fundulus heteroclitus*, for the female but different species for the male, these latter varying in their nearness of blood relationship to the egg species. These males fall into four separate groups of two species each. The male species in each group are closely related, but the different groups vary in their relationship to the egg species from that of the same genus to that of most widely separated orders. These groups are as follows:

Group 1	{	<i>Fundulus heteroclitus</i>	×	<i>Fundulus majalis</i> .
		"		" diaphanus.
Group 2	{	"		<i>Menidia notata</i> .
		"		<i>Menidia gracilis</i> .
Group 3	{	"		<i>Gasterosteus bispinosus</i> .
		"		<i>Apeltes quadracus</i> .
Group 4	{	"		<i>Tautogolabrus adspersus</i> .
		"		<i>Tautoga onitis</i> .

In group 1, *Fundulus majalis* and *Fundulus diaphanus* will hybridize and bring their development to hatching. The same is true of the two species of *Menidia* in group No. 2. In group No. 3 the two species of sticklebacks will cross and hatch, although I have been able to rear the embryos for only a very short time. The Cunner and *Tautog* of Group No. 4 will likewise cross and, although many abnormalities occur, some of the embryos will hatch in a normal manner. When, however, these forms are crossed with *Fundulus heteroclitus* very divergent results are obtained, although in every case most of the eggs are impregnated. In the first group the embryos largely hatch and may be reared. Among the normals may be found various abnormalities, but these are relatively rare. In the remaining groups the embryos never hatch, although in some cases may remain alive in the egg for three or four weeks. But each of these groups go to a characteristic stage of development and show characteristic abnormalities. In all of the last three groups the mortality is great during the period from the formation of the germ ring to the closure of the blastopore.

In group 2 a varying number may go far beyond this stage forming normally the early stages of the eye, ear, heart, notocord, somites, etc. Although the early stages in the formation of these organs may be normal, it soon becomes apparent that the further processes becomes aborted. The blood vessels do not properly differentiate, the pericardial cavity be-

comes very large and the heart is commonly drawn out to a filamentous form. This continues to beat until the death of the embryo, but does not handle any blood. The eyes do not attain their full size, and may be poorly pigmented. They often are abnormally set so that they occupy the forepart of the head. This may fuse into a median single eye or may be present on one side only. The ear vesicles often become large and inflated, giving rise to a large rounded prominence on each side. The pigment cells are very finely developed, show a tendency to a pattern and bilateral symmetry, but there is a lack of uniformity in this in the different embryos. The embryos are shortened and may develop abnormally large pectoral fins. It is not necessary to give more than a general description at this place.

Even within this group it is very easy to distinguish between the hybrids in which the *Menidia notata* is used as the male from those in which the *Menidia gracilis* is the male. The development of the former is more successful in those that pass the blastopore closure stage, although my experiments show that the mortality is greater at this point. The pigmentation is better developed and the various organs above mentioned are laid down much more normally. As a consequence fewer and less pronounced abnormalities occur. In the *Fundulus-Menidia gracilis* cross it is not uncommon to have only one eye formed. This may be lateral or may be median. The eyes are commonly set much further anterior so as to occupy the front of the head than in the nearly related cross.

In the crosses of group 3 we obtain quite a different series of hybrid embryos. None of these will develop as far along as those in group 2. There is the usual large mortality preceding and at the blastopore closure stage. The more successful embryos are much shorter, the pigmentation is much less perfect, the black usually predominates, the eyes are never normal, and often altogether wanting, and the life of the embryo is shorter. The heart and pericardial cavity is much the same as in the *Menidia* hybrids, although I have seen no attempt to develop vessels on the yolk. Their embryos show in every way that the developmental processes have deteriorated much earlier than in the *Menidia* crosses.

When we come to group 4 we have a still more pronounced abortion of the developmental processes. Many of the embryos close the blastopore after a fashion, but the embryo is always much shortened, usually being a mere streak of protoplasm. These embryos do not lengthen to form a



tail, they form no eyes. Occasionally one or two poorly developed ear vesicles show; pigment is irregularly and rather sparingly developed on both the embryo and the yolk. These cells are practically all black with a few small, poorly developed brownish ones. The heart may develop into a protoplasmic pulsating mass showing no definite form. The pericardial cavity is poorly developed or wanting. These embryos may remain alive for a week or ten days, but never as long as the hybrids of the two preceding groups.

We can see from the foregoing that within the narrow limits of the species covered, that the more distantly two species are separated in their blood relationship when crossed, the earlier the developmental processes come to a standstill. The writer, of course, thoroughly appreciates that the foregoing facts are not necessarily evidence in favor of the view taken. He desires merely to emphasize the analogy existing between the conditions of hybridization and the known conditions of blood transfusion and the like. His belief that this analogy is a significant one has been strong enough to lead him into further, more direct experiments along this line. The writer may even be permitted to express a hope of his that it may be possible to control the processes of hybridization in a manner similar to that which has already been brought about in the field of immunity.

#### SUMMARY.

1. The eggs of any of the species of teleosts tried may be impregnated by the sperm of any other species tried.
2. The number of eggs fertilized is usually great, i. e., 75% or more. This bears no relation to the nearness of relationship of the two species concerned.
3. Normal impregnation is the rule, di- and polyspermy being the exception.
4. Development in its early stages proceeds normally, the deleterious effects of the two strange sex products upon each other showing only at later cleavage or subsequently.
5. The rate of development in the early cleavage stages is always that of the egg species. Any effect of the strange sperm upon the rate of development shows itself by slowing the process regardless of whether the rate of the sperm species is faster or slower than the egg species.
6. A period of great mortality in the developing hybrids is gastrula-

tion. If the heart is formed, although it pumps no blood, the embryo may remain alive for a considerable period, yolk absorption taking place to a varying degree. If the heart handles blood and bloodvessels are differentiated, the embryo is likely to develop to the point of hatching.

7. The numerous abnormalities appearing in the hybrid embryos are due to a deterioration in the developmental processes, resulting probably from the poisonous action of the sex products upon each other.

8. The success of the hybrids, i. e., the stage to which any given hybrid will develop, is correlated with the nearness of relationship of the two species used.

9. The mixing of unrelated sex products is looked upon as analogous to the transfusion of unrelated bloods, the more distantly related the two species concerned the greater their toxicity.

#### LITERATURE CITED.

Ackerman, K. 1898. Tierbastarde Theil 2. Die Wirbelthiere. Kassel. Appellöf. 1894. Ueber einige Resultate der Kreuzungsbefruchtung bei Knochenfischen. Bergens Museum Aarbog, No. 1, pp. 1-19.

Born, G. 1883. Beitrage zur Bastardirung zwischen den einheimischen Anurenarten. Pflüger's Archiv, Bd. 32, pp. 453-518.

Buller, A. H. Is Chemotaxis a Factor in Fertilization of Animal Eggs? Quart. Journ. Mic. Soc., Vol. 46.

Driesch, H. 1898. Ueber rein-mutterliche Charaktere an Bastardlarven von Echiniden. Roux Archiv, Bd. 7, pp. 65-102.

Dungern, E. F. von. 1901. Die Ursachen der Specificität bei der Befruchtung, Centralbl. f. Physiol. Bd. 15, pp. 1-4.

Dungern, E. F. von. 1901. Neue Versuche Zur Physiologie der Befruchtung. Zeitsch. f. Allgemein, Physiol. Bd. 1, pp. 34-55.

Fischel. 1906. Ueber Bastardierungsversuche bei Echinodermen. Roux' Archiv, Bd. 22, pp. 498-525.

Friedenthal, H., und Lewandowsky, M. 1899. Ueber das Verhalten des tierischen Organismus gegen fremdes Blutserum. Arch-f-Anat. u. Phys., Phys. Abt., pp. 531-545.

Guyer, M. 1900. Spermatogenesis of Normal and of Hybrid Pigeons. Chicago, Ills.

Kammerer, P. 1907. Bastardierung von Flussbarsch (*Perca fluviatilis*) und Kaulbarsch (*Acerina cernua*) Roux' Archiv, Bd. 23, pp. 511-550.

Landois. 1875. Die Transfusion des Blutes. Leipzig.

Loeb, J. 1903. On a Method by Which the Eggs of a Sea Urchin (*Strongylocentrotus purpuratus*) Can Be Fertilized with the Sperm of a Starfish (*Asterias ochracia*). Univ. Cal. Pub. Vol. 1, pp. 1-3.

Mathews. 1901. The So-called Cross Fertilization of *Asterias* by *Arbacia*. Amer. Journ. Physiol. Vol. 6, pp. 216-218.

Moenkhaus, W. J. 1894. The Development of the Hybrids Between *Fundulus heteroclitus* and *Menidia notata*, with Especial Reference to the Behavior of the Maternal and Paternal Chromatin. Journ. of Anat. Vol. 3, pp. 29-65.

Morgan, T. H. 1893. Experimental Studies on Echinoderm Eggs. Anat. Anz. Vol. 9, pp. 141-152.

Newman, H. H. 1908. The Process of Heredity as Exhibited by the Development of *Fundulus* Hybrids. Journ. Exp. Zoöl. Vol. 5, pp. 504-559.

Newman, H. H. 1910. Further Studies on the Process of Heredity in *Fundulus* Hybrids. 1. The Influence of the Spermatozoön on the Rate and Character of Early Cleavage. Journ. Exp. Zoöl. Vol. 8, pp. 143-162.

Pflüger, E. 1881. Die Bastardzeugen bei den Batrachiern. Pflüger's Archiv. Bd. 29, pp. 48-75.



## THE FAUNA OF A SOLUTION POND.

By WILL SCOTT.

	PAGE
Introduction.....	395
The Pond—	
Location.....	396
Formation.....	396
Destruction.....	401
Methods.....	402
Faunal List.....	405
Plankton List.....	419
Ecological Relations—	
(a) of the fauna to similar habitats (migration).....	420
(b) of the fauna to this habitat	
Level.....	424
Temperature.....	427
Light.....	432
(c) of the species to each other—	
Food Relations..	432
Relation to Lakes and Rivers.....	437
Relation to Cave Plankton.....	439
Unsolved Problems.....	440
Bibliography.....	440

### INTRODUCTION.

In 1909 I gave an account of the plankton of the subterranean stream in the caves of Indiana University's cave farm. Among other things it was found that the plankton is composed of epigean forms and is derived from ponds in such sink-holes as have an opening above their lowest points. A study of the fauna of the ponds furnishing the cave plankton became desirable.

<sup>1</sup>Contribution from the Zoölogical Laboratory of Indiana University No. 119.

Ponds of this kind form a fresh water "unit of environment" typical for an area covering a part of twenty counties of southern Indiana, a strip of Kentucky and a part of Tennessee. Instead, however, of making a general study of the fauna of many of these ponds, a typical pond one-half mile northeast of the campus of Indiana University has been studied intensively. Its fauna has been determined, its physical factors and environment analyzed, and the processes at work determined in part, at least.

Observations on this pond extend from October, 1908, to June, 1909, and from September, 1909, to September, 1910, with occasional visits from September, 1910, to May, 1911. It was visited weekly or more often during all but the summer months. No observations were made during the summer of 1909, but the pond was visited monthly during the summer of 1910 (June 15, July 16, August 12).

Many other ponds have been examined, but detailed data concerning them have not been collected. The observations on these have been incorporated in this paper when they made clear facts that could not be determined from this pond alone.

Aside from presenting a picture of the conditions in this pond, I hope the data collected may furnish a basis for comparison with the larger bodies of fresh water (glacial lakes and rivers), so many of which have been under observation in recent years.

#### THE POND.

The form of the pond may be seen by reference to the map, No. 1. It is oval in shape and has a maximum length of 70 feet and width of 57 feet. Its greatest depth is 46 inches, but this is attained only during the heavy rains of spring. The south, east and north slopes are quite gentle, but the west slope is so abrupt that within one foot of the shore, on the north end of the west side, a depth is attained which is only six inches less than the greatest depth of the pond. The bottom is covered with plant debris mixed with a little fine clay derived from the wash from the slope above the pond. This silt is small in quantity, the slope being slight, the area drained small, and a narrow zone of grass surrounding the pond.

Location.—The location of this pond may be determined by examining the Bloomington Quadrangle of the United States Topographical Survey. It is 940 feet above sea level and about 150 feet above the floor of the valleys one mile distant. It is about 16 feet below the crest of an old

monadnock, probably a remnant of the tertiary peneplain and near the level of the pleistocene peneplain which forms the "skyline" in this region.

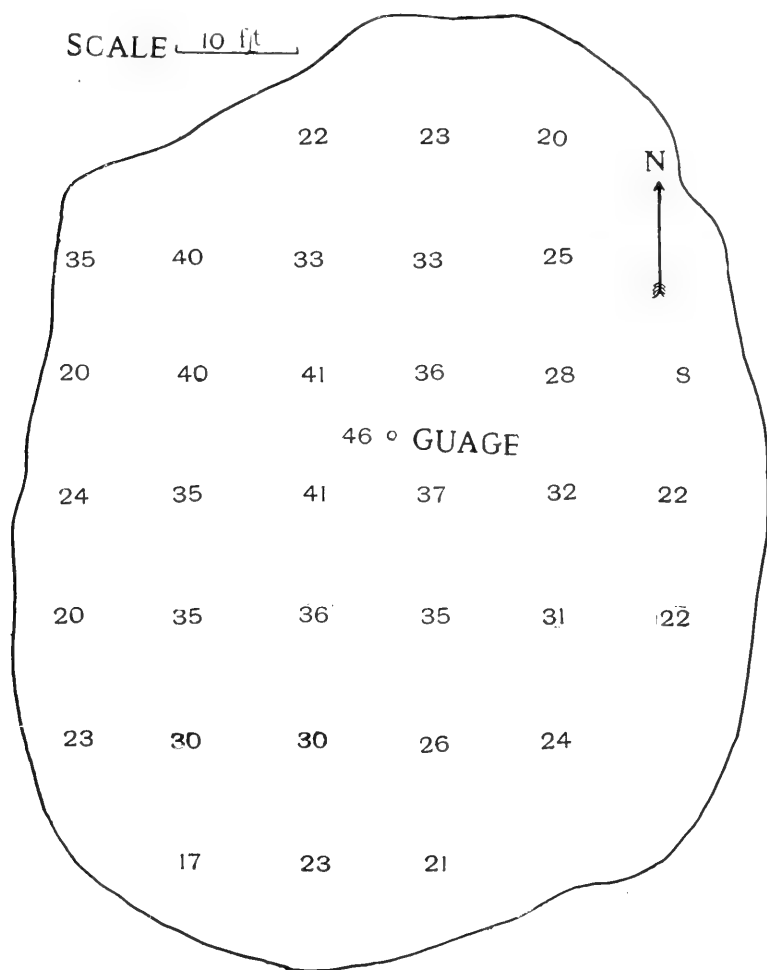

Fig. 1. Map of Hill Pond, showing depth in inches at 10-ft. intervals when at the overflow point.

The pleistocene peneplain is very much dissected in this locality. This particular monadnock is completely isolated, valleys having cut into its

sides from three directions, viz., south, west and north. The valley to the north empties into Griffey Creek, a part of the drainage system of the West Fork of White River. The valleys to the west and south empty into Clear Creek, a part of the drainage system of the East Fork of White River.

No similar pond is nearer than two miles. The nearest perennial water is in springs .33, .56 and .66 miles distant, and 100, 146 and 165 feet respectively below the level of the pond. The accompanying profiles indicate these slopes graphically. Fig. II. These statements indicate the isolation of the pond.

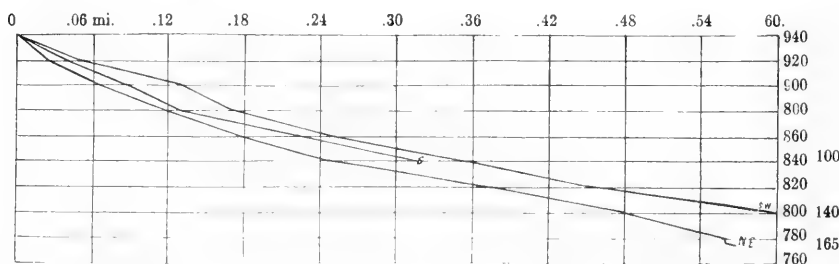

Fig. 2. Profiles of valleys leading away from hill on which pond is located, from pond to closest permanent water in each valley.

The pond is formed by solution in the Mitchell limestone which caps the hill to a depth of 50 feet and overlies the Bedford limestone, both being formations in the Mississippian series. The details of the formation of this pond are not different from those of any other of this region, consequently a general discussion will probably be more enlightening.

The development of sinkholes is coincident with that of subterranean drainage systems. Both depend upon two conditions: First, the presence of soluble rock, usually limestone; second, the movement of the solvent (meteoric water, containing as it always does, carbonic acid), through the rock.

In order to have a movement of meteoric water through the rock, it is necessary to have an outlet below the general level of the country. This is secured by the invasion of surface drainage. A study of the topography of a limestone region shows that in general the sinkholes are formed on the periphery of the valleys.



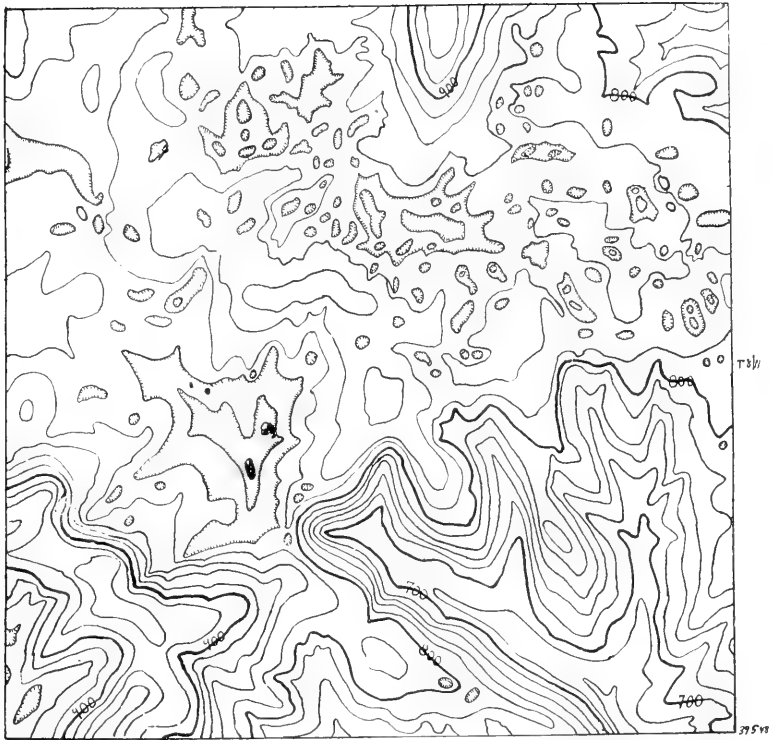

Fig. 3. Map showing the formation of sink holes on the periphery of a valley.

The accompanying map (Fig. III) beautifully illustrates this point. It is based on data from the Bloomington quadrangle of the United States Topographic Survey. A deep gorge from the southeast cuts well into the old peneplain, thus tapping the water table. The water on plain around the periphery of this valley "sinks" into the limestone and comes to the surface near the bottom of the gorge.

In the area under discussion, the Ohio river and its tributaries supply the surface drainage. Although any sort of limestone may develop sinkholes, the Mitchell is the sinkhole and cave-forming limestone par excellence. Its qualities in relation to cave formation have been discussed by Green ('08). He summarizes them as follows:

"The Mitchell limestone, otherwise known as the St. Louis, barren, or cavernous limestone, is a bluish or grayish, hard, compact, even-grained stone, generally having a conchoidal fracture. It is so compact as to make it rather impervious. Intercalated layers of blue-gray shale are frequent. Large concretions of chert are characteristic of certain horizons. When the stone weathers, these masses of chert do not dissolve, but break into more or less angular fragments which strew the ground over the Mitchell area. In Indiana the formation is also characterized by the common presence of a genus of corals known as *Lithostrotion* or *Lonsdaleia*. In some places, such as western Monroe or southern Crawford County, there is a typical white oölite found near the top of the formation.

"Analysis shows the Mitchell to be a very pure calcium carbonate, and at Mitchell, Lawrence County, from which place the formation received its name, it is extensively quarried for making lime and cement.<sup>2</sup>

"The Mitchell limestone has long been known as the Cavernous limestone. Both the Wyandotte Cave of Indiana and the Mammoth Cave of Kentucky occur in its strata. In three counties in the vicinity of Mammoth Cave, over five hundred caves are known to exist. These facts lead us to investigate the general adaptability of this limestone to cave formation.

"The reasons of this adaptability are numerous. Besides the bedding planes, two sets of vertical joint-planes exist, one set having a general east and west direction and the other a north and south direction. Vertical joint-planes are probably more numerous in this than any other of the Mississippian limestones. Owing to the fact that the Mitchell is rather impervious and often of a lithographic nature, the down flowing water is forced to follow the joint and bedding planes. The underlying Salem limestone contains joint-planes but is porous enough to become thoroughly saturated instead of confining the water to joint-planes."

The presence of joint-planes, its impermeability and its solubility, are the qualities of the Mitchell limestone which make it favorable to the development of caves and sinkholes. It is obvious that if a stone is impermeable and has joint-planes, the water will trickle down through these joints instead of being absorbed by the rock. If the rock is soluble and the

---

<sup>2</sup> In the southern part of the State it reaches a thickness of 350 to 400 feet; in the central part of its area, that is, in Lawrence and Monroe counties, the thickness is from 150 to 250 feet, and from here gradually thins toward the north."

water contains carbonic acid gas in solution, as all meteoric water does, cavities will be formed in it.

The regions in which sinkholes occur were originally covered with deciduous forests and as a result the surface was covered with decaying vegetable matter. It is well known that this condition reduces the surface *run off* and allows more water to sink into the ground. Shaler ('91) has also shown that this decaying humus produces a large amount of carbonic dioxide, so that the water, passing through it, is always saturated with this acid. From these facts, it is probable that the formation of caves and sinkholes formerly occurred more rapidly than at present.

What causes a sinkhole to develop at a particular point is somewhat conjectural. Something occurs which increases the rate of solution at a particular point. There may be a place in the stone which is more soluble than the surrounding rock. It has been suggested that fault-lines may be the initial cause of at least some of them. There is a fault near the mouth of Shawnee cave in the Mitchell limestone but no line of sinkholes has developed along it.

It is quite possible that the tap roots of some of the walnuts, oaks and similar trees of the original forests may have determined the location of some of these depressions. These tap roots undoubtedly reached bed rock in many places. When they decayed they left a funnel shaped opening in the soil, filled with their own decaying stems. This funnel would conduct meteoric water immediately to bed rock and charge it with  $\text{CO}_2$  as it did so.

Cummings ('05, page 87) explains this formation as follows:

"Where two joints intersect, the enlargement is apt to be greatest, giving origin to funnels, narrowing gradually downward, and showing in a beautiful way the formation of sinkholes, which are only such funnels of solution grown large."

Whatever may initiate this process, after connection is once established with a subterranean system, the processes of weathering, erosion, etc., enlarge the funnel in every direction. The funnel is really a valley whose source or upper end is the perimeter of the cone and whose mouth or outlet is the opening in the center. The sides of a young sinkhole are usually very steep and its area limited, while those of an older one are more gentle, with a much larger area. At any stage in the development of a sinkhole,

its outlet may become obstructed. The result is the formation of a pond. If a young sinkhole is obstructed, a small and relatively deep pond results. The obstruction of an old sinkhole results in the formation of a shallow pond of considerable area.

*Destruction.*—The ponds are no sooner formed than their destruction begins by means of those factors which destroy all such topographic forms. Few of them overflow, and these only for a short time. Plant deposition and the deposition of silt are the two principal factors operating for their destruction. A pond formed in a young sinkhole which is located at or near the summit of a hill, i. e., near the level of an old peneplain, does not have as much silt washed into it as does a pond formed in an older sinkhole or one that is located on the lower slope of a hill. Plants are relatively a much greater factor in the destruction of the former than in the latter.

Our pond belongs to the first class. It has some clay deposited in it, but plant debris forms the major part of its sediment. The rate of its destruction is known approximately for a period of 24 years. In 1887, it was about eight or nine feet in depth ("deep enough to swim a horse"). It is now slightly less than four feet, a difference of four feet, or one-fifth foot deposition per year. So far as I know, this is the only case where the rate of plant deposition is reducible to even approximate figures.

The water is usually clear. A scum of iron oxide was found on the surface April 1, 1910. On August 12, 1910, the water had a dark purplish tinge, due to the decay of organic matter. The only time the pond was seen to be muddy was after the rain of July 14. On this date it was quite opaque and of a yellowish tinge, from the suspended silt. Silt is carried into the pond only after very heavy rains, for reasons previously stated.

#### METHODS.

For collecting insects, insect larvæ, algæ, amphibian larvæ, etc., ordinary insect nets and dip nets made of bobbinet and scrim, were used. A very useful net for collecting micro-organisms, when quantitative work is not demanded, is a sampling net, manufactured by the Simplex Net Company, Ithaca, New York. It is made of bolting cloth No. 20, is three inches in diameter, twelve inches long, and is operated by being thrown out into the water and then drawn in. The ring is quite heavy so that it will sink

if properly handled. The depth at which the net moves can then be regulated by the rate at which it is drawn through the water.

The only difficulty experienced in operating this net was that the ring carried the open end under at once, thus catching enough air in the net to float it. To obviate this difficulty, a 25x80 mm. glass shell partially filled with water was fastened to the apex of the net by means of a cork stopper. This carried the net under at once, and when the catch was made, the cork was loosened and the collection dropped into the bottle.

For quantitative work, on such plankton as was present, the following variation of the pumping method was used: The whole apparatus had to be light enough to be portable. Some difficulty was experienced in getting a satisfactory pump. The pump used is known in the trade as the Barnes hydroject pump, manufactured by Barnes Mfg. Co., Mansfield, Ohio. It has a brass cylinder and throws one-fourth liter per stroke. Its general appearance is shown in Fig 4. To this was attached a net of bolting silk (Dufour No. 20) and a detachable bucket. (Windows covered with wire cloth, 200 meshes to the inch.) A three-quarter inch hose (inside measurement) was used. The end was closed with a cork and an opening made in the side of the hose just above the cork, so that the water from a given level might be secured with greater accuracy. The end of the hose was fastened to a float, so that the collection could be taken from any depth desired. By means of a rope and pulley, this float could be placed at any point in the pond.

Material was killed in a 4% solution of formalin. All organisms were counted in every collection except two. In investigating a small area, I believe that greater accuracy is secured by filtering a small amount of water and counting all the organisms than by filtering a large amount and counting a fraction of it. The amount counted in either case must be large enough to include samples of all the organisms present.

The source of error in the first case is the uneven distribution of organisms at a given level. In the second case, the error is due to the difficulty of thoroughly mixing organisms having a different specific gravity.

The soundings were taken when the pond was covered with ice. The ice was ruled at ten-foot intervals, holes bored at the intersections, depth measured through these openings and entered on the map of the pond. A gauge was set December 21, 1909. From the readings of the gauge, the depth at any point at any time could be determined.

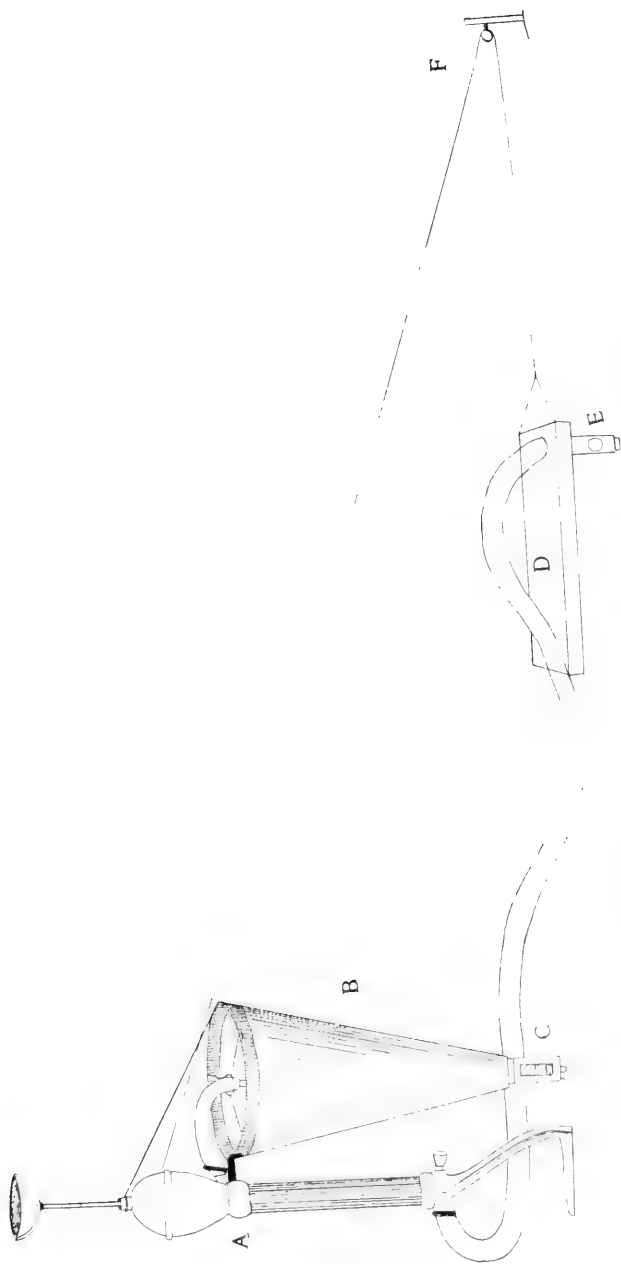

Fig. 4. Plankton outfit used on pond. A, pump; B, net of bolting silk; C, detachable bucket; D, float; E, tackle for placing float.

The data concerning elevation were taken in part from the United States relief map of the Bloomington quadrangle, and in part from averages of the barometric readings. The bench mark established by the survey on the university campus rendered exact correlation possible.

The following annotated list of species gives a fairly complete picture of the life in this pond. The list of flagellates and desmids is not exhaustive. The diatoms were not identified because of the inadequacy of accessible literature. However, it may be stated that the diatom flora consists of bottom inhabiting forms.

*Rhizopoda*—

PROTOZOA.

*Diffugia globulosa* Dujardin.

This was the most common protozoan in the pond. It was found at all seasons but was more common in 1910 than in 1909. It is reduced in numbers during the winter but when the temperature begins to rise in the spring, this species begins to increase in numbers. In 1910 this increase was very regular from March to August. The *Diffugia* in the quantitative plankton collections of that year belonged for the most part to this species. In these collections the number per 100 liters varied from 28 on February 8 to 39,780 on August 12.

*Diffugia oblonga* Ehrenberg.

This variable species was a common form in 1909 but not so plentiful in 1910.

*Diffugia acuminata* Ehrenberg.

Not common.

*Diffugia urceolata* Carter.

Common in the winter of 1909-'10. Greatly outnumbered by *D. globulosa* in the spring and summer. In plankton material killed in formalin, I found a typical individual of *urceolata* with the mouth of its shell closely appressed to that of a specimen of *D. Globulosa*. Whether this was a case of fission, an animal building a new shell or an accident, I am unable to state. I am inclined to the belief that the animal was dividing. The rounded shell was slightly smaller than the spined one. If this be true, the distinction between the two forms is of course not specific.

*Diffugia corona* Wallick.

Observed occasionally.

*Diffugia lobastoma* Leidy.

Rare.

Many variations in the nature and form of the test have been observed. The studies of Penard ('02), Averintzev ('06) and others have resulted in more than forty species being referred to this genus. The many variations observed in the *Diffugia* in this limited habitat make evident the value of studies on the effect of age and environment upon the form of the test. Such studies would certainly define the species more clearly than they are at present. The difficulties of such experiments are obvious.

*Lesquerensia spiralis* Schlumberger.

Rare.

*Pontigulasia compressa* Carter.

Nov. 9, 1909.

*Arcella vulgaris* Ehrenberg.

This species was very common on the bottom and in the vegetable debris during the year 1909 but it was very much reduced in numbers the next year. In the collections taken with the pump from Jan. 5 to Aug. 12, it occurred but once.

*Centropyxis aculeata* Stein.

Occurred rarely. Taken Jan. 5, 1909.

*Actinophrys sol.* Ehrenberg.

It was not found until May 28, 1910, when the water temperature was 20° C. It was quite common on that date and during the following month.

*Flagellata*—

*Euglena viridis* Ehrenberg.

Always present, but reaching its maximum development in Aug., '10, when 27,560 per 100 liters of water were taken by filtering with No. 20 bolting silk. This filter undoubtedly allows some to pass through.

*Phacus pleuroneetes* Müller.

*Phacus pyrum* Ehrenberg.

Both species were present among the filamentous algae at all seasons but never in great quantity. The former was much the more common. On account of their association with the algae they were always more plentiful in the margins of the pond.

*Peridinium tabulatum* Ehrenberg.

A form that was referred to this species was observed in some material brought into the laboratory Jan. 18, 1910. This material consisted of debris and water. It was kept in a clean glass jar covered with glass.



Ordinarily this species develops in swarms but it never occurred in quantity in the pond.

*Trachelomonas annata* Ehrenberg.

Obtained Jan. 18 and Feb. 2 by the same method as *Peridinium*, already described.

#### *Ciliata*—

*Halteris* sp.

Common among algæ at south end of pond, Apr., 1910.

*Vorticella*.

This genus occurred sporadically during the warmer months. Specific identification was not made every time it was observed.

It was present as late as Nov. 25, 1909, and reappeared in May. The most common form was referred to *V. microstomata* Ehrenberg. *V. campanula* Ehrenberg was present in large quantities Oct. 26, 1910, when the water temperature was 13.6° C.

*Epistylus* sp.

A ciliate belonging to this well marked genus was taken March 11, attached to the edge of the thorax (usually near the posterior angle) of an aquatic beetle. It is not referable to any species to whose description I have access. The zooids, when completely expanded, are 1/5 mm. long by 1/12 mm. wide. The stems branch dichotomously and are segmented at the base of each branch. The planes of successive branchings are usually at right angles to each other. The branches are from 30 to 40  $\mu$  long and from 20 to 30  $\mu$  wide. From this method of branching the colony tends to form a spherical sector of increasing size. The outer surface of this sphere is formed by the zooids, which when contracted in a well developed colony, touch each other forming a continuous surface. The cell walls are fairly firm and a limited surface is exposed. Some water is probably retained among the stalks below the zooids. This seems to enable them to prevent desiccation in a degree. The following observations support this inference: A well developed colony attached to a bit of the thorax of a beetle was left on a slide under a cover glass at 4:20 p. m., room temperature about 70°. The water under the cover soon evaporated. At 7:50 a. m. the following day, the slide was examined. The outlines of the contracted zooids were still discernible. The colony was removed to tap water in a stentor dish. At noon, about 20% had revived and were actively feed-

ing. The amount of drying to which they had been subjected seems to be near the limit for the species. They do not recover if completely desiccated. The relation of this to distribution will be noted subsequently.

#### PLATYHELMINTHES.

##### *Trematoda*—

##### *Diplodiscus* sp.<sup>3</sup>

Young trematodes belonging to this genus were taken from the alimentary tract of the larvæ of *Rana catesbiana* Shaw during Feb., '11.

They were free in the intestine of the amphibian larvæ. The contents of the digestive tract of the worm seemed to be derived from the surrounding medium, i. e., the food material in the intestine of the "tadpole." Sexually mature individuals were taken from larvæ of the same frog about one month later (Mar. 20, '11). I have been unable thus far to determine the invertebrate host of this trematode in this pond. The most numerous mollusc is *Luccinea retusa* Lea. But many dissections have failed to reveal trematode infection.

The following intermediate stages taken with the plankton catches in the open water have been noted. One cercaria on each of the following dates: May 5, '09; Jan. 11, '10; Apr. 15, '10.

A ciliated larva was taken May 28, '10. The only evidence that these are the developmental stages of *Diplodiscus* is that *Diplodiscus* is the only trematode known from this pond.

#### TROCHELMINTHES.

Ten rotifers were identified from the pond. Others were observed occasionally but were not identified. Their rare occurrence, and the fact that the methods used in the preservation of the material were not especially adapted to rotifers, often rendered exact identification impossible.

Of the ten rotifers, three, *Anuraea aculata* Ehrenberg; *Hydatina senta* Ehrenberg, and *Monostyla umaris* Ehrenberg, occurred in quantity in the open water of the pond. The first was common in 1908, the other two in 1910. The other five were never common.

<sup>3</sup>Identified by Prof. H. B. Ward.

*Anuræa aculeata* Ehrenberg.

Found Nov. 25, 1908, two days after the rain which ended the drouth of that year. It was quite numerous that fall and was present the following year until December, but not in such numbers. It was absent entirely in the collections of 1910.

*Cathypna luna* Ehrenberg.

May 15, 1910. Not common.

*Diurella tenuior* Gosse.

Spring 1907. Rare.

*Pedalion mirum* Hudson.

Present in considerable numbers during May and June, 1909.

*Rotifera tardus* Ehrenberg.

April 15, 1911.

*Anuræa cochlearis* Gosse.

In quantitative collection of April 14, 1910. One specimen; spines well developed.

*Hydatina senta* Ehrenberg.

Appeared rarely in spring of 1910. First observed April 14. It did not develop in any quantity until July. On July 15 there were 1,560 per 100 liters of water. Aug. 12, this had increased to 1,625.

*Monostyla lunaris* Ehrenberg.

Appeared April 19, 1910. On that date there were 88 per 100 liters. It reached its maximum development in July with 1,463 per 100 liters.

*Monostyla cornuta* Ehrenberg.

Aug. 15, 1910. This form may have been counted with preceding but partial re-examination of material did not show this to be true.

*Diglema forcepata* Ehrenberg.

Occasionally from Feb. 4 to Aug. 15, 1910.

## ANNELIDA.

*Oligochæta*—*Limnodrilus* sp.

An oligochæte worm belonging to the family Tubificidæ was referred to this genus. Its complete anatomy has not yet been worked out. It occurs in great numbers among the roots and about the root stalks of *Typha*. In this pond, this is its exclusive habitat. The alimentary tracts

of these worms are always filled with decaying vegetable matter. They are ravenously eaten by *Amblystoma* larvæ and *Diemyctylus*. These two facts probably account for their occurrence in this limited habitat.

## CRUSTACEA.

*Arthropoda*—*Daphnia pulex* DeGeer.

Occurred twice, in March and April, 1909, and in May, June and July, 1910. Its maximum occurrence was on June 15, 1910, when there were 80 per hundred liters of water. In towing collections, often but a single specimen was taken.

*Simocephalus vetellus* Mueller.

The most conspicuous crustacean of the pond. It is numerous at all seasons among the plants and plant remains. It is rarely taken in the open water of the central part of the pond. Adults were taken two days after the rain which terminated the drouth in 1908. It was found that in cultures it takes from 10 to 12 days for adults to develop. From these facts, it appears that this crustacean was able to survive the drouth as an adult. To do this, it must have worked its way down through the vegetable debris to the water level. It is present at all periods of the year, producing a maximum of 25 young in a brood. It makes a slight diurnal vertical migration. This is difficult to demonstrate quantitatively because of its habitat. If the surface of the water be "skimmed" with a fine meshed net during the day, very few if any individuals are taken. However, many individuals are taken by this operation at any hour of the night during the summer months.

*Alona quadrangularis* Müller.

Appeared in March, 1910. Taken with young in brood chambers. Never more than 120 per hundred liters until May 28, when 696 per hundred were taken. It varied during June, July and August from 500 to 780 per hundred liters, the maximum occurring on Aug. 12. Eggs were present in brood chambers in a large per cent. of them from April till August of this year.

*Cypridopsis vidua* Brady.

Appeared as soon as the pond began to fill with water in Nov., 1908. During the following winter and spring it was one of the most conspicuous forms. No attempt was made to estimate its numbers, but a small quan-

tity of water dipped from any part of the pond during this period always contained them. They could be seen feeding at any time on vegetable debris, Typha stems and algae.

During the spring of 1909 the number began to decrease, and in the autumn they disappeared. They were never observed in 1910, although the pond was examined for them many times. This fact has an important bearing upon the general problem of distribution, as will be pointed out later.

*Cypris virens* Jurine.

This form has been present at all times but never developed in great quantity. Its greenish color and the fact that it is more closely confined to the substratum than *Cypridopsis vidua*, render it less conspicuous.

*Cyclops serrulatus* Fischer.

Taken March 17, 1910, with eggs. Numerous in the shallower parts of the pond during the latter part of the month.

*Cyclops bicuspidatus* Claus.

The typical form was present during the spring of 1910 but did not occur in great numbers.

Most females taken were carrying egg sacks. During July and August as noted in the discussion of the plankton, this species occurred in great numbers, the maximum being on August 12, when 704,600 per 100 liters were present. However, the individuals were smaller and the stylets shorter and relatively thicker than in the spring forms.

Pearse ('05) reports this species as occurring in the spring in Nebraska. In the Illinois River, it is reported as a winter form, Kofoid ('03). In Lake Michigan it is a summer form, Forbes ('82). In Wisconsin lakes it is active in the cooler parts of the year and passes the summer in a gelatinous cocoon. The seasonal distribution in different habitats of this variable form offers an enticing problem.

*Cyclops phaleratus* Koch.

Taken during March, 1910. Numerous April 15, 1911. Found among Typha and near the edge of the pond.

#### TARDIGRADA.

*Macrobiotus*.

A form which was referred to this genus was taken in the spring of 1910. They occurred in quantity on April 23, and for about one month

thereafter, in the gelatinous matrix around the eggs of the mollusc *Succinea retusa* Lea. They did not occur in egg masses recently laid. As the eggs develop, the matrix gradually disintegrates and a large number of minute flagellates develops in the matrix during this process of disintegration. This, in part, accounts for the presence of the Tardigrada, for they were feeding on the flagellates, the disintegrating matrix or both.

On May 15, one was taken containing 10 eggs which almost filled the specimen. June 15, one was taken with 11 eggs. Others taken at this time also contained eggs.

None was taken after June 15. Those taken on this date were captured with a silk net in open water.

*Hexapoda*—

*Notonecta* sp.

This backswimmer emigrated from the pond when it dried up, if it had been present previously. It was not observed during the spring of 1909, but since that time it has been abundant.

*Limnobates lineata* sp.

Frequent near the margin of the pond.

*Hygrothechus* sp.

This water strider was first observed March 7, 1909. They appear soon after the ice melts and remain until the freezing weather. Adults hibernate. They are primarily the scavengers of the surface, yet the rapidity with which they perform their work makes observation difficult, as the following example indicates: On Mar. 24, 1910, an ichneumon fly accidentally fell into the water. Instantly it was punctured by three of these water-striders. In spite of its larger size and powerful struggle, the ichneumon was soon reduced to practically an empty shell.

*Cnemidotus 12-punctatus* Say.

Always present on plant stems and debris. Noted by Blatchley as more common in northern part of State than in southern. Hibernates.

*Cnemidotus muticus* Leclerc.

Occurs with preceding species. Rather more common. Hibernates.

*Hydrocanthus iricolor* Say.

Present in considerable numbers throughout the year.

*Laccophilus maculosus* Say.

*Laccophilus fasciatus* Aube.

Both species present in about equal numbers. Hibernatae

*Hydrovatus pustulatus* Melsh.

About the southern limit of its range. Present throughout the year but not numerous.

*Coptotomus interrogatus* Fabricius.

One of the common beetles in the pond. Could be taken in numbers at any season.

*Graphoderes liberus* Say.

Blatchley notes concerning this beetle: "Putnam and Lawrence counties, frequent in woodland ponds." In this pond I have taken but one specimen and have seen no other. This was taken June 6, 1910. It is quite probable that it had just immigrated.

*Dineutes assimilis* Aube.

Present from April to October in characteristic groups on the surface of the pond.

*Tropisternus mixtus* Leclerc.

The most common beetle in the pond. Could be seen beneath the ice in winter.

*Berosus peregrinus* Herbst.

Not common.

Of the four families of beetles found in this pond, the Gyrinidae are confined to the surface, the Haliplidae occur at the bottom "crawling" over the plant stems and sticks, while the Dytiscidae and Hydrophilidae occupy the intervening space as well as surface and bottom. The surface supports one species, the bottom two, while eight species are more generally distributed. The Dytiscidae are represented by six species, the Hydrophilidae by two. The Dytiscidae are much stronger swimmers and more voracious feeders than the Hydrophilidae, which facts may account for their more successful occupancy of the pond.

*Heterina americana* Fabricius.

Taken flying over pond Aug. 12, 1910.

*Lestes congener* Hagen.

Taken Sept. 1, 1910. On that date they were numerous over pond.

*Ischnura verticalis* Say.

Emerging June 18.

*Anax junius* Drury.

A single specimen Aug. 12.

*Sympetrum vicinum* Hagen.

Two specimens taken June 18.

*Libellula pulchella* Drury.

June 18, July 16, Aug. 12. Emerged from nymphs in aquaria during June and July. Nymphs of this form were the most numerous of the group.

*Libellula lydia* Drury.

Flying over pond Aug. 12.

*Corethra*.

*Corethra* larvæ either had never been in this pond before 1909, or had been exterminated by the drying up of the pond in the autumn of 1908. The latter proposition seems to be the correct one.

As stated previously, no collections were taken during the summer of 1909. In the autumn when observations were resumed, *corethra* larvæ were present in enormous numbers. Their numbers have not appreciably decreased since. The reappearance of the larvæ may be accounted for either (1) by eggs having lain dormant during the dry period and winter, and then hatching as the temperature increased the following spring, or (2) adult imagoes may have migrated to the pond during the spring and summer of 1909. I think that the first proposition is untenable because on May 25, 1910, larvæ 3 mm. long were present that had been hatched from the eggs of that year. It is not likely that larvæ of that size could have escaped observation the previous spring. If the species was re-introduced into the pond by the imago, it necessitated a migration of over a mile. Wind doubtless influences these flying forms, so that their migration was partially passive.

*Chironomus* sp.

Larvæ occurred rarely.

## MOLLUSCA.

*Gastropoda*—*Succinea retusa* Lea.

The most common mollusc of the pond. Eggs laid in April, May and June. Hatched in about 15 days. This period probably varies with temperature. At 12°-14° C., eggs laid April 8 hatched April 23.



*Tebennophorus dorsalis* Binney.

This slug is common in Indiana. However, only a single specimen was taken in the pond, Oct. 16, 1910, in the debris at the bottom. (It seems to have been recently introduced.)

*Ancylus tardus* Say.

Not uncommon. This shell is reported by Call ('99) to be common in the Wabash, Ohio and Maumee rivers. In all references that I have been able to find, it is recorded from streams. But most expeditions that were for the special purpose of collecting molluscs, were made along streams. The forms from the land-locked pools have been collected more incidentally. These facts, together with the small size of the species, account for the oft repeated statement of its distribution.

*Vertebrata*—

## AMPHIBIA.

*Amblystoma jeffersonianum* Green.

The adult of this form has not been taken in the pond, but is known from the ravine to the north. Egg masses, referred to this species, were present March 17, 1910. One mass contained 19 eggs and another 29. March 24, 1911, a mass was observed containing 24 unhatched larvæ. Diameter of outer envelope, 13 mm. Diameter of total mass, 60 mm. Length of larvæ, 13 mm. Fastened to grass 13 cm. below surface.

*Diemyctylus viridescens* Rafinesque.

Common. Six taken in an area about one foot square in February, 1911. Its habits have been worked out in detail by Gage ('91) and Jordan ('93).

*Hyla pickeringii* Holbrook.

Three. Numerous. Appeared March 24, 1910. Eggs in May.

*Rana catesbiana* Shaw.

Common. Nine specimens taken during May, 1910. Egg-laying period, June and July. Recently laid eggs as late as July 15. Reduction in level kills many eggs.

## AVES.

*Anas discors* Linnaeus.

A duck was flushed from the pond April 21, 1909. Identification was made while the bird was on the wing. It circled three times, coming quite near. The identification is probably correct. This bird has the greatest

range of any individual organism found on the pond. The A. O. U. check list, 1910, gives its range as: North America in general, but chiefly the Eastern Province north to Alaska and south to West Indies and northern South America; breeds from northern United States northward.

It is altogether probable that other water birds visit this pond. I have seen various species of ducks and sand pipers on similar ponds in this region. On the water works reservoir, a small artificial lake about three miles distant, ducks, loons, grebes, etc., may be seen almost any time during their migration period. McAtee ('05) lists 44 water birds from this region, 20 of which he marks as regular migrants.

*Agelaius phoeniceus* Linnæus.

Red winged blackbirds were first seen on the pond May 5, 1909. Two pairs nested during the summer of 1909 on the south part of the pond. The nests were attached to the *Typha* stems over the water. Three pairs nested near the same place in the pond in 1910.

Many other birds were seen near the pond or perched on the *Typha* stems. The most common of these were: Turtle Dove, *Zenaiduro macroura* L.; Quail, *Colinus virginianus* L.; Tree sparrow, *Spizella monticola* Gmelin; Fox sparrow, *Passerella iliaca* Merrem; Field sparrow, *Spizella pusilla* Wilson; Junco, *Junco hyemalis* L.

#### FLORA.

##### *Alga*—

*Closterium diane* Ehrenberg.

April 1, 1910. Common among filamentous algae.

*Cosmarium botrytis* Menegh.

Common, spring 1910.

*C. tetraophthalmum* Kuetzing.

Rare.

*Docidium crenulatum* Rabenhorst.

This and other species of this genus occurred sparingly in most collections.

*Spirogyra majuscula* Kuetzing.

During the winter of 1909-10. This alga developed in considerable quantity in the southern part of the pond.

*Zygnema stetlum* Agardh.

A few filaments observed Nov. 23, 1909, Jan. 9, 1910. Never observed in fruit.

*Oedogonium undulatum* Brebisson.

The most abundant alga in the pond. It is present throughout the year. It was observed fruiting sexually on Nov. 16, 1909, and April 13, 1910. After the sexual season in the spring the plants decline in vigor. There are enormous numbers of oospores present in the water at this time.

*Chaetophora pisiformis* Roth.

Common at all seasons on stems.

*Typha latifolia* L.

This is the most conspicuous plant in the pond. It covered the shallower two-thirds of the pond in 1908 and has since increased to about three-fourths of the total area. It is from this plant that most of the vegetable debris on the bottom of the pond is derived.

In 1910 shoots appeared from the stolons Mar. 24. Seeds began germinating April 8, flowers were formed in June and seeds were ripe early in September.

The seeds which fall in the water are usually blown to the lee side of the pond where they collect in dense masses. This results in very weak seedlings during germination. A slight reduction of level is fatal at this period. Besides this, the margin where these seeds germinate is already occupied by parent plants. From these facts, it is evident that the seeds of *Typha* are very inefficient in increasing the number of plants in a pond where it is already established. The increase is derived chiefly from buds from the stolons. The seeds, while ill adapted to this function, are very efficient in securing the introduction of the species into ponds unoccupied by it. On a spike 150 mm. long, I have estimated the number of seeds to be 27,000. How far they may be carried by wind is conjectural, and on that account this efficiency can not be reduced to figures. The chances of introduction of any wind-blown seed is inverse to the distance from the center of distribution, but the proportion is unknown. Certainly it is greater in the direction of the prevailing winds than in any other. It may be observed that if the seeds were distributed evenly over a circle whose radius is one mile (the distance to the nearest pond) a seed from each spike would have approximately five chances in six of hitting a pond of that size (70 ft. in diameter) placed anywhere in this circle.

TABLE NO. 1.  
*Table Showing the Number per 100 Liters of the more strictly Plankton organisms present January-August, 1910.*

SPECIES.	DATE.											
	1/25/10	2/8/10	2/26/10	3/17/10	3/31/10	4/14/10	4/28/10	5/14/10	5/28/10	6/15/10	7/16/10	8/12/10
<i>Euglena acus</i> Ehr. (?)	140	2,860	3,712	18,240	25,680	132						
<i>Euglena viridis</i> Ehr.	280	2,552	7,880	4,184	548	17,616	1,316	488	736	848	300	27,560
Phacus	12	4			36	16		32	56	40	2,792	
Diflagella	72	28	36	76	840	1,548	368	2,244	3,960	7,440	17,772	39,780
Polyarthra							246	5,612	27,564	7,468	184	
Monostyla							88	240	604	368	1,467	1,040
Hydrina								16			6,240	6,500
Nauplii				68	236	408	20	52			2,136	80,860
Cyclops				4	28	52	8	4	8	80	1,048	70,460
<i>Daphnia pulex</i>								16	12	80	60	
<i>Alona quadrangularis</i>						8	24	120	696	500	600	780

*Alisma Plantago aquatica* L.

Occurs sparsely at the margin of the pond.

Covers the bottom between the *Typha* stalks on the north and east sides of the pond.

These three phanerogams occur in the pond. Near the margin of the pond occur *Bidens* and *Carex*, whose principal relation to it is that they cause the deposition of much of the silt before it reaches the pond.

#### PLANKTON.

The accompanying table records the observations on the more abundant and more strictly plankton organisms in the pond from Jan. 25 to Aug. 12, 1910. The most apparent fact is the dearth of organisms in the open water during the extremely low temperature of January and February, *Euglena virides* Ehr., and *Euglena acus* Ehr. being the most abundant. A few rotifers were observed during the winter, but no marked development of this class was observed until the latter part of April. *Polyarthra* reached its maximum on May 28, and *Monostyla* in August. *Hydatina* is strictly a summer form.

Wesenberg-Lund ('08, p. 255) states: "Rhizopoda are, so far as my experience goes, of quite secondary importance in the pond plankton." This pond certainly differs from those of Denmark, for the development of *Difflugia* is constant and fairly regular from February to August, when 297,800 per cu. m. were present. *Actinophrys* was very common near the margins during May.

There are two pulses of cyclops. A very slight one in April and an enormous one in August. It is possible that some of the cyclops were able to avoid the intake of the collecting apparatus. This of course would make the members in the table too low. In April the cyclops were quite evident in the shallow water near the shore. However, it was difficult to apply quantitative methods to this region. During the August pulse, none was seen near the shore. This may have been due to the fact, noted elsewhere, that they were smaller than *C. bicuspidatus* usually is.

#### ECOLOGICAL RELATIONS.

In the ecology of any association of organisms, two complicated problems or sets of problems present themselves. These are (1) how was each of these organisms introduced, (2) what factors condition their continu-

ance? Without presuming to give a final answer to these questions, I shall present such facts as bear on the distribution and interrelations of the organisms of this pond.

On the basis of methods of dispersal, these organisms fall into two groups, active migrants and passive migrants. The active migrants include the vertebrates and insects, which are limited, for the most part, to the American continent, while the passive migrants include all the other forms which are practically cosmopolitan in their distribution. To discuss the distribution of the active migrants would involve a consideration of their relationships and phylogeny which is not within the province of this paper.

Of the passive migrants, the crustacea, rotifera, protozoa, and most of the algæ are known from both Europe and America. Some of the forms have a much wider distribution. *Difflugia*, for example, is recorded by Bütschli from all the continents except Africa (where it doubtless exists). Recently Edmonson ('10) has reported *Difflugia pyriformis* from Tahiti. The presence of this form on a recently formed isle, geologically speaking, 4,000 miles from a mainland, certainly makes probable its worldwide distribution.

The cosmopolitan distribution of the passive migrants can, I think, be explained by an analysis of the agencies by which they are carried. Of these agencies, the principal ones are birds, beetles and wind.

Of the birds, only the water birds need be considered as the relation of land birds to aquatic organisms is accidental.

De Guerne ('88) established that water birds do carry a great variety of small aquatic organisms. In examining the fresh water fauna of the Azores, he discovered that the micro-organisms belonged to species found in France. This suggested water birds as a distributing agency. He took a wild duck (*Anas boschas* L.) and made cultures from the dried particles of slime from its bill, feathers and feet. From these cultures he obtained protozoa, rotifera, nematoda, algæ, cladocera, ostracoda, bryozoa and insect larvæ.

Zacharias ('88) points out the feces of these birds as an additional source of micro-organisms. I have seen but two water frequenting birds on this pond, but it is occasionally visited, in all probability, by those in whose migration path it lies. Of the twenty-two water birds which are regular migrants or residents (including the blue winged teal, the kildeer

TABLE No. 2.

Showing the Water Birds Which Are Common in the Vicinity of the Pond at Some Time During the Year.

SPECIES.	Regions Over Which They Are Distributed.							
	U. S. A.	Canada.	Mexico.	Central America.	South America.	West Indies.	Europe.	Greenland.
1. Horned grebe, <i>Colymbus auritus</i> Linn.....	+	+	+	+	.....	+	+	.....
2. Pied billed grebe, <i>Podilymbus podiceps</i> Linn.....	+	+	+	+	+	+		
3. Loon, <i>Gavia imber</i> Brännich.....	+	+						
4. American merganser, <i>Merganser americanus</i> Cass.....	+	+	+	+		+		
5. Hooded Merganser, <i>Lophodytes cucullatus</i> Linn.....	+	+	+			+	+	
6. Mallard, <i>Anas platyrhynchos</i> .....	+	+	+	+		+		
7. Green winged teal, <i>Nettion carolinense</i> Gmelin.....	+	+	+	+		+		
8. Blue winged teal, <i>Querquedula discors</i> Linn.....	+	+	+	+		+	+	+
9. Shoveller, <i>Spatula clypeata</i> Linn.....	+	+	+	+		+		
10. Pintail, <i>Dafila acuta</i> Linn.....	+	+	+	+		+	+	
11. Wood duck, <i>Aix sponsa</i> Linn.....	+	+						
12. Canvas-back, <i>Marila vallisneria</i> Wils.....	+	+	+	+		+		
13. Lesser scaup-duck, <i>Marila affinis</i> Eyt.....	+	+	+	+		+	+	+
14. American golden eye clangula, <i>Clangula americana</i> Bonap.....	+	+	+			+	+	+
15. Canada goose, <i>Branta canadensis</i> Linn.....	+	+	+			+		
16. American bittern, <i>Botaurus lentiginosus</i> Montag.....	+	+				+	+	
17. Great blue heron, <i>Ardea herodias</i> Linn.....	+	+	+	+	+	+		
18. Wilson's snipe, <i>Gallinago delicata</i> Ord.....	+	+	+	+	+	+	+	
19. Pectoral sandpiper, <i>Picobia maculata</i> Viell.....	+	+	+	+	+	+	+	+
20. Solitary sandpiper, <i>Totanus solitaris</i> Wils.....	+	+	+	+	+	+	+	+
21. Spotted sandpiper, <i>Actitis macularia</i> Linn.....	+	+	+	+	+	+	+	
22. Killdeer, <i>Egialitis vocifera</i> Linn.....	+	+	+	+	+	+	+	
Total.....	22	22	19	16	7	20	11	5

and the twenty marked by McAtee ('05) as common), all are found in the United States and Canada. 19 reach Mexico, 16 Central America, 7 South America east of the Andes, 20 the West Indies, 5 Greenland and 11 are reported from Europe. (See Table No. 2.)

Of the 24 other water birds listed as rare or occasional from this region, three reach Chili and one Greenland. The range of no individual bird is as great as that of its species, but many of the water birds are gregarious at some season, so that the organisms which they carry would soon be distributed over their entire range. This does not necessarily mean that these organisms would develop over the entire area.

The following examples show how the area may be connected with the rest of the globe. Besides the four, indicated in the table as occurring more or less regularly in Europe, others appear accidentally (Headley, '95). The Turnstone (Headley l. c.) migrates from Greenland across Europe to Australia. Holboell's Grebe (*Colymbus holboelli* Reinh) is distributed over North America, Greenland, Eastern Siberia, south to Japan, thus connecting America and Asia. These forms all breed inland so that they are related strictly to the fresh water fauna. The list may, of course, be extended almost indefinitely. Marine birds, such as the albatross have a much wider range but they rarely come inland.

Birds are the chief agencies in the distribution of crustacea (cladocera, copepoda), whose eggs are too large to be wind-blown. The reduction in the number of water birds which has taken place in the last half century certainly has reduced the chances of a crustacean reaching a pond at the period suitable to its development. In the larger bodies of water this relation is not so evident nor so patent because they are much more static.

Insects migrate very short distances compared with birds. However they do carry organisms from one pond to another in a limited locality. The aquatic beetles and some Hemiptera are the most efficient agencies because the imagoes spend most of their life in the water where algae and protozoa become attached to them. Occasionally, however, they leave the water, as is attested by the fact that they collect around a light at some distance from their habitat.

In this pond I have often noted beetles with vorticellae and other ciliates attached. The attachment of stalked ciliates to beetles is mentioned by Stein ('54) and others. Migula ('88) having found a single beetle associated with algae in a pool 20 cm. in diameter near the summit of Biskiden



mountains, concluded that the beetle had carried the algae. Later he examined six beetles belonging to three species, from five different habitats and found attached to them twenty-three species of algae.

These ciliates and algae, however, were attached to beetles *in the water*. When the beetles leave the water these attached organisms are suddenly transferred from an aquatic to an aerial environment. This new environment differs from the old one in temperature and humidity. How long these organisms can resist these changed conditions and how long the beetles stay out of water are facts that must be known before the role of insects in the distribution of attached organisms can be accurately determined. The fact that aquatic beetles fly at night reduces the harmful effect of evaporation. Experiments are planned to solve these problems.

In the notes on *Epistylis*, I have indicated that that species of this genus can remain out of water for some time without fatal results. The colony referred to remained on a slide under cover in a room with low relative humidity for more than fifteen hours without it being fatal to all of the zooids. While a colony of this species attached to the thorax of a beetle making a nocturnal migratory flight would not have the protection against evaporation of the two glass plates, this would be compensated in some degree by the more humid and cooler night air.

That wind is responsible for the distribution of many protozoa and rotifers is a fact which is familiar to any one who has ever made a hay infusion. The presence of these organisms and of tardigrada in the pond, is probably due to wind distribution. Just how far an organism can be transported by wind depends upon the size and specific gravity of its spores, eggs or cysts, and upon its power to resist drying, extreme temperature, etc. These facts are, in a large number of cases, unknown.

Cysts of *Euglena* are common in almost every culture, but it does not follow that this is the form in which they are wind-blown. Assuming a constant specific gravity, it is certain that the buoyancy of a cyst increases as the reciprocal of its diameter. As an adaptation to this law, many organisms form extremely minute spores.

It is rendered very probable by Calkins ('07) that in *Amœba proteus* very minute spores are formed. From his figures I have determined the diameter of the tertiary nuclei (which with a bit of cytoplasm are presumed to form the spore), to be  $1\ \mu$  or less. Comparing these spore nuclei in Calkins ('07), Fig. 14, with the amœba figured in his earlier papers,

Calkins ('04), it certainly becomes evident that there is an efficient adaptation to wind distribution.

Attention may be called to the analogous transportation of volcanic dust which has been known to drift round the world. Volcanic dust has a higher specific gravity than that of protoplasm but, on the other hand, it is blown to a very high altitude, while organic spores usually start from the surface.

The exact nature of the spore while in the air must be known before its distribution by wind can be even approximated by direct methods.

Distribution.—Of the complicated set of factors that condition the existence of these organisms, only four can be discussed at this time. These are level, light, temperature and food relations. The chemical composition of the water and its variations have not been determined. The determination of the dissolved oxygen, carbon dioxide and ammonia will probably yield valuable results in a comparative study of several ponds.

Level.—The factor that affects the organisms in this pond most vitally is the extreme changes in level. The level varies from zero to 46 inches above the lowest point. So far as ascertained, its level has been reduced to zero (i. e., it has dried up) but once in its history and that was in the late summer and early autumn of '08. It did not overflow until the following March. From March, '09 to August, '09, the lowest observed level was 35½ inches. The summer of '08 was the dryest in 13 years (local records are not available before 1896). That of '09 was rather wet, 4.75 inches of rain falling on July 14. For these two rather extreme years, the minima have been 35.5 and 0; or to put it another way, the level has decreased 25% and 100% from the maximum. This point will be discussed more fully later. As the destructive forces gradually elevate the bottom of the pond, it is probable that in future the pond will go dry more often. Level is determined by precipitation and evaporation. The extreme variability of these factors in this pond and similar ones in this region is indicated by the weather records of the local station and those from Indianapolis. Records of sunshine, wind velocity and relative humidity are not available for any station nearer than Indianapolis (56 miles distant).

In the accompanying table I have compiled all the climatological data available for this locality.

TABLE 3. CLIMATOLOGICAL DATA.

BLOOMINGTON, MONROE COUNTY, IND.—Elevation, 800 feet.

*Precipitation.*

Year.	Jan.	Feb.	Mar.	Apr.	May.	June.	July.	Aug.	Sept.	Oct.	Nov.	Dec.	An- nual.
1887	2.50	6.35	3.35	3.48	1.25								
1888	1.18												
1895												3.47	
1896	1.06	2.60	2.10	T.	5.12	3.52	7.78	7.49	4.16	1.35	4.36	0.90	40.44
1897	3.17	3.35	10.63	6.02	2.37	6.27	2.62	0.59	0.72	1.33	7.42	3.24	47.73
1898	6.42	2.15	10.30	1.88	3.94	3.03	2.69	4.43	7.28	4.00	3.13	2.90	52.15
1899	4.06	4.10	4.71	1.96	4.18	2.34	1.60	1.20	0.48	2.91	3.58	3.68	34.80
1900	2.25	3.55	3.35	1.14	4.79	5.73	3.54	1.64	2.54	4.00	3.30	2.05	37.88
1901	2.15	2.15	5.42	3.81	1.00	4.49	0.77	2.63	0.99	4.03	0.95	4.75	33.14
1902	0.90	2.50	2.89	2.86	4.40	5.02	4.19	4.64	4.06	3.40	4.51	5.28	44.65
1903	4.44	6.05	4.75	4.23	2.22	2.55	3.90	5.46	1.50	2.70	2.11	2.91	42.77
1904	5.50	4.05	9.86	2.80	3.67	4.44	2.20	1.60	4.84	1.30	1.00	6.10	47.36
1905	3.05	2.82	3.30	4.81	5.55	2.67	4.27	8.05	2.15	7.35	1.73	3.30	49.05
1906	4.61	2.05	9.31	2.15	2.45	3.39	2.30	7.38	2.99	1.08	4.90	4.94	47.55
1907	9.74	0.74	6.48	3.11	3.98	3.79	4.35	3.12	2.52	4.80	4.20	4.10	50.93
1908	1.50	7.85	5.26	5.51	8.91	1.93	1.81	2.06	0.83	0.29	2.65	2.05	40.65
Means	3.57	3.59	5.84	3.13	3.84	3.78	3.23	3.87	2.70	2.96	3.37	3.55	43.43

	Length of record.	January.	February.	March.	April.	May.	June.	July.	August.	September.	October.	November.	December.	Annual.
Average number of days with 0.01 inch or more precipitation	13	8	7	10	8	10	10	7	7	6	5	7	8	93
Maximum temperature	13	70	68	84	87	93	97	103	98	100	88	78	72	103
Minimum temperature	13	-11	-20	0	22	29	42	51	50	28	22	5	-10	-20
Mean temperature	13	30.7	29.3	43.3	51.0	61.5	71.9	76.6	75.1	68.6	57.4	44.2	33.2	53.8

TABLE 3—Continued

INDIANAPOLIS, IND.

	Length of record.	January.	February.	March.	April.	May.	June.	July.	August.	September.	October.	November.	December.	Annual.
Relative humidity (percentage)...	21	79	77	73	66	67	68	65	67	68	68	73	77	71
Sunshine (percentage).....	12	41	47	40	51	53	62	68	63	66	61	52	40	54
Average hourly wind velocity (in miles).....	12	11.7	11.5	12.1	11.3	9.9	8.9	8.2	7.4	8.3	9.4	10.4	11.5	10.0

During the period Nov.—June, the level of the pond is not rapidly reduced. September and October are on the average the driest months of the year. July and August are the hottest. It is during this period (July—Oct.) that the level is reduced most rapidly and the stress on the organisms is most acute. In this period occurs the minimum precipitation, lowest relative humidity and smallest number of rainy days (i. e., .01 inch or more precipitation), the maximum temperature and the greatest sunshine percentage. All of these factors tend to reduce the level of ponds by evaporation. The lower wind velocity tends to reduce the evaporation to a slight degree.

The amount of stress produced by a reduction of the level varies in different years. In thirteen years of precipitation records for Bloomington, the minimum for four months, July—October, was in 1908. The maximum occurred in 1896. In 1908 the amount of precipitation for the four months was 4.99 inches. In 1896 the maximum was 20.78 inches. The average for the entire thirteen years for these months was 12.66 inches. To state it another way: the minimum for this period was 39+% of the average and 23.5+% of the maximum. That is, between four and five times as much rain fell during this period of one year as fell during the same period of another year. This irregularity, more than any other factor, prevents the fauna of this pond and all *small* solution ponds from becoming even relatively static. In the larger ponds the effect is less acute.

The drying up of the pond in '08 killed all the amphibian larvæ, the corethra larvæ and caused the emigration of some of the aquatic beetles.

(I am informed that *Dytiscus marginalis* Linn was formerly obtained from this pond in quantity for laboratory dissection material.) I have never taken a specimen from the pond. What other forms may have been eliminated by this "drying up," I do not know, because I began to study it at this period.

Not only were the conditions during this period of low level very different from those preceding it, but the conditions after the dry period were also very different.

When the pond began to fill with water in November, '08, the decaying amphibian larvæ and other organic matter developed conditions favorable to the production of an enormous number of flagellates. This decaying organic debris and possibly the flagellates furnished an immense amount of food for some of the crustacea, especially *Cypridopsis vidua* Brady. The algæ are eaten by both the amphibian larvæ and *Simocephalus vetellus*. The elimination of the former greatly increased the food material of the latter.

The dragon fly nymphs and possibly Corethra larvæ feed on on both of these crustaceans. Thus the conditions at this period furnished the crustacea an enormous food supply and few enemies. The result was a very great development of crustacea. Especially was this true of *Cypridopsis vidua* Brady. Since the winter of 1908, conditions which I have not been able to determine have resulted in the entire elimination of this form. It is evident that variations in the level may result in the elimination of a species or its abnormal development.

*Temperature.*—The seasonal development of different forms as indicated in the list and table, is probably due directly or indirectly to changes in temperature. The temperature in the water of the pond varies from 27.8° C to 0 at the surface (ice) and to 1.3° C at the bottom.

Except for the first few weeks the temperatures were taken with a centigrade thermometer graded to 1/5ths. The winter of 1908-1909 was fairly open. Ice formed December 2, lasting until January 20. Ice was present the latter part of February but there was none after March 3. The maximum thickness of ice for this year was 2.5 inches. The winter of 1909-1910 was very severe for this latitude. Ice formed December 7 and lasted until March 2 and had a maximum thickness of 9 inches on January 11. During the first winter, the temperature of the water a few inches under the ice, varied but slightly from the greatest density temperature.

The long period of low temperature during the winter of '09-'10 reduced the temperature of the water appreciably.

In order to determine the difference in temperature between the water immediately under the ice and that near the bottom, the following simple apparatus was used. A large mouthed bottle with a glass stopper was laced firmly to a stick of convenient length and a cord was tied to the stopper. The bottle was lowered to the level desired and the stopper removed by means of the cord. The bottle was thus filled with water of approximately the same temperature as that surrounding it. The thermometer was then lowered into the bottle and the whole apparatus was made fast to the ice for about an hour. The bottle with the thermometer in it was then raised and the reading made. The error resulting from this manipulation was very slight. The following readings were recorded:

Jan. 11, 3 inches under ice, 2.2; near bottom, 3.1 C.

Feb. 1, near surface, .8; near bottom, 2.8 C.

Feb. 26, lower surface of ice, .1; near bottom, 1.3 C.

These data indicate that after the pond is sealed with ice, the temperature of the water gradually approaches zero. This lowering of the temperature and the establishment of a difference between the upper and lower strata is due to surface radiation.

Another condition which reduces the temperature of the water is the partial melting of the ice. As has been stated, the pond has *Typha* growing in it near the edge. The *Typha* stems project through the ice all winter. When the ice begins to melt, the heat absorbed by these stems, melts holes through the ice around them. The pond then has a zone of openings at its periphery. On January 18, 1910, the ice was partially melted; five inches of solid ice remained. This was covered with four inches of water. The holes had formed around the *Typha* stems. A stiff wind was blowing from the west. The result was a movement of water from west to east above the ice, and from east to west below the ice. As the temperature of the water above was approximately that of melting ice, its circulation below the ice must have lowered the temperature of the water. (See Fig. V.)

Another factor which may have a slight influence on the temperature of the lower strata, is the decay of organic matter which covers the bottom. This, of course, goes on very slowly at low temperatures.

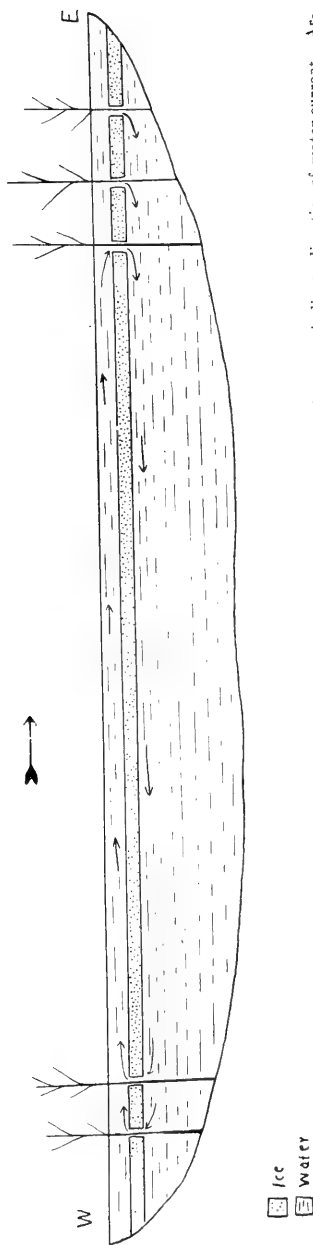

Fig. V. Showing the movement of water caused by wind when the ice is partially melted. Arrows in water indicate direction of water current. Arrow above indicates the direction of wind. Typha stems are indicated diagrammatically near the periphery.

The observed maximum (27.8° C.) is probably not the real maximum as no continuous series of summer temperatures was taken, and the diurnal change in temperature was very great during the variable periods of autumn and spring. The greatest observed variation for twenty-four hours being 10° C. on Oct. 11-12.

Temperature above 4° C. does not seem to affect the forms which are found in the pond throughout the year, i. e., beetles, *Corethra* larvæ, amphibian larvæ, etc. Below this temperature, however, their activity is decreased and below 2° C. they are quite passive. For some time after the ice formed in the winter of 1909-1910, the *Corethra* larvæ could be found in all parts of the pond. Amphibian larvæ came to the surface when the ice was cut, and the beetles could be seen crawling on the *Typha* stems beneath the ice. On Jan. 11, 1910, the upper layers of water (three inches under the ice) had a temperature of 2.2° C. The lower layer (24 inches under the ice) was 3.1° C. There were few *Corethra* larvæ in the upper layer and these were quite inactive. Near the bottom of the pond in the deepest part, they were present in great numbers and were much more active than those in the upper layers. Larvæ from either region became more active when the temperature was raised. Many dead larvæ were found just below the ice. It may be concluded then that a temperature below 4° C. reduces the activity of *Corethra* larvæ. At 2° they become quite passive and temperature lower than 2° may prove fatal.

Amphibian larvæ were active and could be captured in quantity during December and most of January. On Feb. 1, 1910, the central, *Typha* free part of the pond was carefully dredged for amphibian larvæ but none were captured. Holes were then cut in the ice nearer the margin of the pond. Two larvæ were captured ten feet from the north end. These were in the debris among the *Typha* stems. They were rarely captured until the ice disappeared in March. On March 3, the ice had disappeared and the larvæ were much in evidence. The temperature just under the ice on Feb. 1 was .8° C. and near the bottom was 2.8.

It seems that the formation of ice on the surface does not cause a quiescent stage in amphibian larvæ but a temperature of about 2° C. does reduce their activity. It may be, in both these cases, that it is the *continued* low temperature that causes these stages of inactivity. However, in the winter of 1908-1909, the water was not above 4° C. from Dec. 2 to Jan. 27 and no period of inactivity was observed in these forms.



TABLE 4. MONTHLY AVERAGE OF TEMPERATURE FOR THE PERIOD NOV., 1909—APRIL, 1910.

Month.	Temperature near Surface.	Temperature near Bottom.
November.....	13.25° C.	
December.....	4° C.	
January.....	3.4° C.	
February.....	.3.....	2.05° C.
March.....	6.7° C.	
April.....	15.4° C.	

Temperature records are not complete for warmer months, but those taken indicate that the temperature of the water approximates closely the average diurnal temperature of the air, which data are given in detail on page 425.

Most of the aquatic beetles of this pond hibernate as imagoes. After the freezing weather comes they are to be found in the plant remains that cover the bottom of the pond. Their movements are very slow, and usually consist in crawling rather than swimming. On Jan. 13, 1909,  $\frac{1}{2}$  inch ice, 5 inches snow, water temperature 2.2° C., a beetle (*Tropisternus mixtus* Lec.) was watched for 20 minutes. It was crawling on a *Typha* stem and during this time left it but once, swimming away a few inches and then returning.

It may be argued that this quiescent state of the larger forms in the pond is due to the reduction in the amount of oxygen rather than to low temperature. I have not determined the amount of oxygen present during different seasons of the year. However, the filamentous algae which are present all winter certainly produce some oxygen and it is highly probable that the *Typha* stems allow some gaseous interchange to take place between the air above the ice and the water below it. I have made the following simple experiment with beetles (5 species), *Corethra* larvae, and *Notonecta*. Two glass jars which were exactly alike, were filled with water to the same level. An equal amount of *Typha* stems was placed in each. In one, the stems were completely submerged, while in the other one, the end of each stem was allowed to protrude from the water. An equal number of organisms was introduced into each jar. The surface of

the water was then covered with a mixture of paraffine and beeswax. The animals in the jar where the stems protruded through the seal invariably lived longer. The periods for the beetles were about 1 and 3 days respectively.

*Light.*—The pond is fairly well lighted throughout its entire depth during the day except when it is covered with snow. The light is reduced considerably by the growth of *Typha*. Kofoid ('04) found that, with the development of phanerogams in one of the backwater ponds tributary to the Illinois River, there was a marked reduction in the plankton. Some comparative observations were made on a pond about five miles west of this one. It has about the same area and depth but there is no *Typha* growing in it. Although no quantitative methods were applied, cladocera, copepoda, and chlorophyceae were much more in evidence in it during September, '09, than in the pond under discussion. It seems probable that the reduction of the light by the *Typha* growth has resulted in fewer species and individuals developing in this pond.

On Jan. 11, 1909, the ice was partially melted. Openings had formed in the ice around the *Typha* stems and about 2½ to 3 inches of water stood above the remaining ice sheet. *Cyclops* was quite abundant in this upper layer of water which was certainly due to their being phototactic. It was the only organism detected. A lowering of the temperature under such conditions would certainly destroy many individuals. Thus an adaptation presumed to be beneficial under one condition becomes destructive under certain other conditions.

*Food Relations.*—Regarding the nutrition of aquatic organisms there are two theories, which, although not mutually exclusive, are essentially different.

The older one is that the ultimate source of food is chlorophyl bearing plants and the various forms of bacteria which produce nitrates and nitrites. The materials thus elaborated or their derivatives are ingested into food vacuoles, gastrovascular spaces, or alimentary tracts of animals, where they are acted on by secretions of the animal, reduced to a solution and absorbed. This theory has been assumed by most zoölogists in their discussions of food relations, and it is the most fundamental assumption in the investigations now being prosecuted by the International Fishery Organization.

The second theory is that proposed by Pütter ('08). He holds that the nutrition of many aquatic forms is essentially different from that of land animals. He shows that water contains large amounts of carbon compounds in solution and demonstrates experimentally that this is the source of nutrition for a sponge, *Suberites domuncula* and a holothurian (*Cucumaria grubei*). In this paper and two subsequent ones, he extends his theory to include representatives of every phylum of aquatic animals.

Possibly foreseeing the difficulty offered by the fact that in general, waste compounds of animals are less complex than their food, he suggests that a photochemical process may take place in aquatic animals, analogous to that of chlorophyll bearing plants. "Ob die gelösten Stoffe, die den niederen Tieren als Nahrung dienen, soviel Energie enthalten, dass der Abbau durch Spaltungen und Oxydationen allein hinreicht, um den Energiebedarf der Tiere zudecken, oder ob hier in einer weiteren Analogie mit dem Stoffwechsel der Pflanze strahlende Energie ausgenutzt wird, um durch photochemische Prozesse aus den aufgenommenen gelösten Stoffen Substanzen von höherem Energiegehalt herzustellen, das ist eine Frage von so hoher prinzipieller Bedeutung, dass die wenigen Erfahrungen, die zu ihrer Erörterung gegenwärtig beigebracht werden könnten, nicht hinreichend zur Entscheidung sind."

With the exception of *Simoccephalus retellus*, the methods of Pütter have not been applied to species found in this pond. Wolff, '09, was able to show that *Simoccephalus retellus* could develop in a medium free from nutrition in the form of solids (geformte Nahrung).

Without denying the possibility that aquatic animals derive some food from the water by direct absorption of nutrient solutions, it may be stated with certainty that the higher animals of this pond for the most part utilize solid food. This statement is based on observations on feeding and the examination of alimentary tracts.

In this discussion of the food relations of these animals, I shall ignore Pütter's alternative. If it be subsequently proven that the ingestion of food is merely incidental, it will also establish their complete independences so far as food relations are concerned.

I have tried to express in the accompanying diagram some of the important food relations between the organisms of the pond. These relations are very complicated because of the omniverous habits of some of the

forms. Many of the forms derive their nutrition in part from the dead organic matter in the pond, to which all of the forms contribute. The ultimate food sources in the pond are (1) water; (2) carbon dioxide in solution in the water (derived from the air above the water); (3) nitrogen, free and in simple compounds, such as ammonia; (4) foreign organisms accidentally falling into the pond, e. g., insects. The formation of nitrates from simple nitrogen compounds was established by the well known work of Winogradsky ('89). He demonstrated two kinds of bacteria, one forming nitrous acid, another changing this to nitric acid which is neutralized by carbonates already present. This process may be assumed to form the first step in the proteid synthesis in this pond.

These bacteria and those present in the decaying organic matter of the pond are eaten by the flagellates and ciliates. The ciliates also use the flagellates for food. The carbohydrates of this group are derived from the dead organic matter in the pond. The synthesis of carbon dioxide and water into carbohydrates is of course due to chlorophyl bearing plants. These plants consist of desmids, diatoms, filamentous algae and phanero-gams. The inclusion of diatoms and the smaller desmids by *Diiflugia* has been demonstrated by observation. *Simocephalus* is the only animal in the pond that is dependent wholly upon algae for food. It may be able to adapt itself to some other food, but in this habitat its alimentary canal contains nothing else. It has not been demonstrated that any organism eats the living *Typha* plants except that the snails sometimes eat the more tender shoots. *Limnodrilus* lives among the roots but its alimentary tract contains rather finely comminuted material, some of which is clearly decaying plant stems. *Cypridopsis vidua* Brady feeds on the material which forms a slimy layer over the *Typha* stems, sticks, etc. Of course, this layer includes some organisms; however, their inclusion is accidental. I am sure they do not select algae. *Simocephalus*, *Limnodrilus* and ostracoda are eaten by dragon fly nymphs. Naturally this is difficult to observe in the pond. In order to eliminate the unnatural instincts that develop in an aquarium, a deep soup plate was kept at the pond, into which dragon fly nymphs and other forms were introduced immediately on being taken from the pond. The white background made observation easy and accurate, and one may be reasonably sure that the feeding instincts exhibited were natural. The nymphs experimented with belonged to the family Libellulidæ. The preference of the dragon fly nymphs is indicated by the order

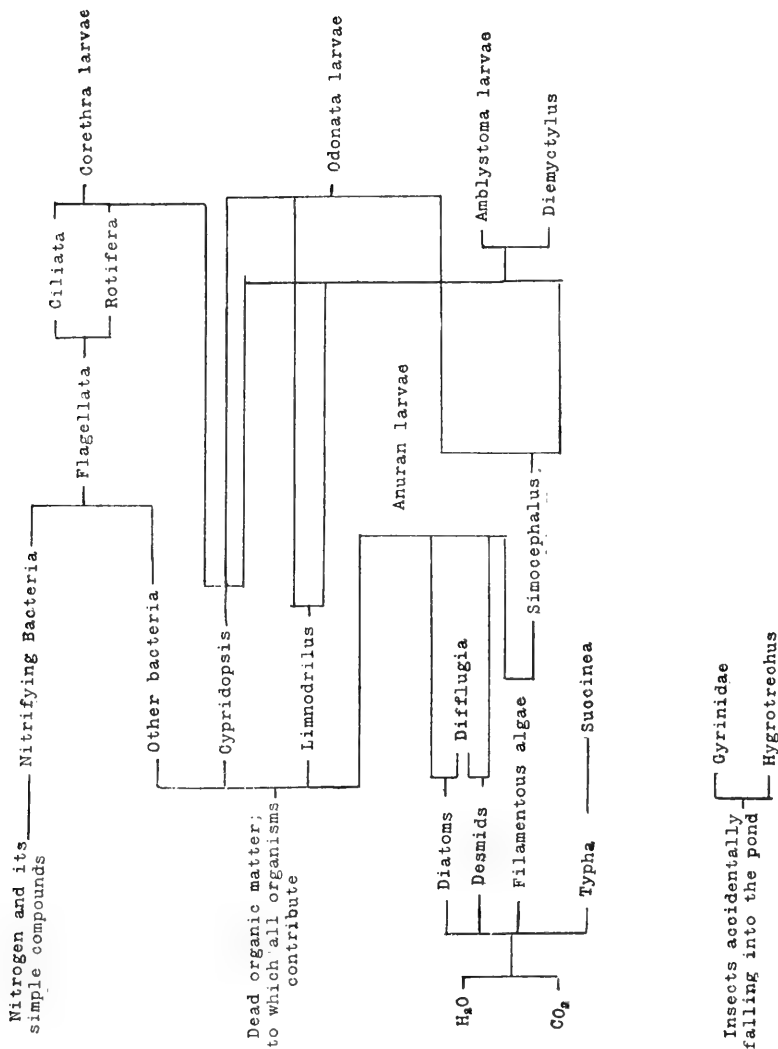

FIG. VI. Indicating the principal food relations existing between the organisms in the pond.

in which the forms are named. *Limnodrilus* is eaten voraciously by the *Amblystoma* larvæ and by *Diemystylus*. *Diemystylus* has been observed a few times to take *Simocephalus*.

The insects that accidentally fall into the pond are captured by the Gyrinidæ and *Hygrotrachus*.

The *Corethra* larvæ feed on ostracoda and possibly other forms in this pond. Miall ('95, page 115) says, "Corethra larvæ feed upon small aquatic animals such as Ephemera-larvæ, Daphnia, or Cypris." The Hydrophylidæ feed on the decaying organic matter. The Dytiscidæ have not been observed feeding in this pond, although they are known to be carnivorous, Kellogg ('04, p. 258). The larvæ of the Anura of this pond are rather omnivorous. They eat filamentous algae, desmids, diatoms, protozoa, ostracoda and decaying organic material. There seems to be very little if any discrimination in the selection of food. Not all of the material eaten contributes to the nutrition of these larvæ. The rate of digestion in cold blooded vertebrates has been shown by Riddle ('09) to vary directly with temperature. However, at ordinary temperatures many organisms pass through their alimentary tracts unchanged. In the faeces of larvæ placed in tap water, *Oedogonium*, *Closterium* and *Doccidium* are common. From the alimentary tracts of larvæ kept for 5 days in water, which had been previously boiled, have been taken *Euglena*, *Phacus*, *Spirogyra*, *Oedogonium*, *Closterium*, *Doccidium*. The filamentous algae and *Closterium* were in part disintegrated. The *Euglena* were very active. In another series that was kept 10 days, Ostracoda (Candona?) were found alive in the large intestine of six specimens. These facts indicate that the nutrition is derived from dead organic matter (filamentous algae and *Closterium*) and that the inclusion of other, living organisms is accidental.

In connection with food relations may be mentioned the mechanical comminution of plant debris. When plants die in the pond, they stand for a time, then fall on the surface of the water where they float for a while and then sink. During this period they are being softened by the processes of decay. Their comminution is due to the action of the Ostracoda, especially *Cypridopsis* and the aquatic beetles belonging to the families Hydrophylidæ and Dytiscidæ. The specific gravity of the former is slightly greater than water and that of the latter slightly less. A piece of floating plant stem is covered with Ostracoda. A bit of the stem is often torn off by one of these ostracods. The ostracod remains attached to it until it

reaches the bottom when it is released. The process is reversed in the case of the beetles. They clasp a bit of sunken plant stem in order to keep them at the bottom. A part of this often separates and is carried toward the surface. It is by the innumerable repetition of these processes that the mass of finely comminuted particles at the bottom of the pond is formed.

#### COMPARISON WITH LAKES.

The fundamental difference between this pond and a lake is that of dimension. It has a smaller area and is not so deep. A pond has no abyssal region but has some of the characters of the littoral and pelagic regions of lakes. From this fundamental difference, secondary differences arise. The changes in level affect the relative depth much more in ponds than in lakes. The lowering of the level of a lake one-half meter would not affect its fauna to any marked degree, while the same difference in level occurring in a pond whose depth was a meter or less would profoundly influence the organisms inhabiting it.

The temperature in all parts of the pond is near that of the atmosphere above it. In this it resembles closely the shallow littoral region of some lakes, e. g., "barren shoals" of Walnut Lake (Hankinson, '07). So far as observed the difference in temperature in different parts of the pond at any given time has not exceeded 2° C. It is practically holothermous, the thermocline and associated phenomena are absent.

Forel ('04) has shown in the case of Lake Geneva, that the littoral region is one of variety. This fact is perfectly familiar to all students of lakes. In the same lake, one part of this region may be covered with rushes (*Scirpus*), another by water lilies (*Nymphaea*), another by *Potamogeton*, while another may be barren sand or rock or an equally barren marl bed.

An individual pond lacks this variety. It is in this particular that this pond and others like it differ most from the littoral region of lakes. (It is more nearly comparable to a limited section of a lake shore.) If *Typha* is introduced, it soon spreads over the whole area, limiting the light, excluding other phanerogams, and developing very uniform conditions over the entire pond. If a pond is developed on the side of a hill so that silt is carried into it, a muddy, barren condition exists over the whole area. Ponds in the woods rarely develop aquatic seed plants; the leaves from the

surrounding trees cover the bottom so that a very distinct but uniform condition is developed. Besides their limited area, a second cause of this uniformity is their sudden formation. During the summer of '08, four miles east of Mitchell, Indiana, an open sinkhole containing several acres became sealed. With the first rain a pond with an area of about one acre was formed. This is the typical phenomenon in the formation of solution ponds. It may take a very long time for the solution cone or sinkhole to form, but when the opening at its base becomes sealed, the pond reaches its maximum depth quite suddenly. The result is that an aquatic habitat is formed with no aquatic fauna. The first forms introduced into a pond at this stage have no competition and soon take possession of the entire area, thus making it more difficult for a related form to establish itself. Another difference between these ponds and lakes (which seems to be due to their fundamental difference in size) is the paucity of species in the former when compared with the latter. It seems probable that, other things being equal, the larger the lake, the greater the variety in the fauna. Forel ('04) reports 22 species and 10 varieties of cladocera, 9 ostracoda and 12 gastropoda from Lake Geneva, while from the smaller Plöner See, Zacharias ('93) reports 20 species and varieties of cladocera, one ostracoda and 10 gastropoda. Burchardt ('00) observes that the plankton of the Alpenacher See contains fewer species than the Vierwaldstädtersee. Dr. W. Halbfass collected from a number of lakes in northern Germany and sent the material to Zacharias for examination. The lists show only one cladoceran from Dölgensee bei Neustettin, a very small body of water, while Wilmsee, a much larger lakelet, contained six. The faunal list for any lake that has been explored with care, is much greater than that of this pond.

This is due to the uniformity of conditions that prevails over the entire area of a given pond at a particular period, and to the fact that the pond after its formation, changes very rapidly, thus making it suited for a particular species for a relatively short period. If the species is not introduced during the period in which conditions are adapted to it, it can never develop.

In a lake, conditions are relatively static and a large per cent of the forms capable of developing in it at a given stage in its history, succeed in reaching it, while in a pond this per cent is much smaller. Forel ('04, p. 408) states that the similarity of the microfauna (i. e., passive migrants) of one lake to that of another is due to the "reaction reciproque d'un lac a



l'autre." It is evident that this can occur only when similar conditions (e. g., pelagic) are present in the different lakes. In lakes this similarity may exist in certain parts during the major part of their existence. In ponds the period for this reciprocal reaction is very limited.

Although a single pond contains relatively few species, all the ponds in an area of several square miles show a much greater variety.

Many ponds have been examined but detailed data concerning them have not yet been collected. However, the following note will illustrate what is meant. On Jan. 11, 1910, pond No. 1 P contained *Cyclops bicuspidatus*, *Chydorus sphaericus*, *Cypridopsis vidua* and alona. Pond No. 2 T contained *Cyclops serrulatus*, *C. leuckarti*; and an unidentified Daphnid. Pond No. 6 P contained a few *Cyclops serrulatus* and an enormous number of *Bosmina cornuta*. Other groups of organisms show an equal variety.

#### RELATION TO CAVE PLANKTON.

This variety in the fauna of different ponds has an important bearing upon the relation of pond plankton to that of caves. That the plankton of the cave streams of this region is derived from certain of these ponds is well established. Only a small number of the organisms in any pond are able to withstand the inimical cave conditions. I have never found all the species reported from the Shawnee Cave stream in any one pond.

These facts indicate that the cave plankton is a composite of such organisms of the contributing ponds as are able to withstand cave conditions. It is probable that the greater the number of contributing ponds, the richer will be the fauna at the outlet of the cave stream.

The relation of these solution ponds to a cave stream is quite comparable to the relation of backwater lakes, bayous, oxbow cutoffs, etc., to the river in whose valley they lie. Kofoid ('03, p. 546) states concerning the Illinois River, "The plankton indigenous to the channel itself is of small volume as compared with that contributed from the backwaters." There is, however, this difference. In the cave the processes of growth and reproduction are very much inhibited, while in the river they continue or may even be increased. Kofoid (1c) has shown that during periods of low water, the river may contain more plankton than the contributing waters. This condition never exists in cave streams and obviously never can exist.

## UNSOLVED PROBLEMS.

This study, while it gives a fairly complete picture of a particular pond and establishes some general notions concerning ponds of this type, is to be regarded as opening up a new corner in the field of freshwater biology, rather than exhausting any part of it. The fauna of solution ponds needs to be more carefully and generally explored. The life history of many of the species is quite unknown. Experimental studies on the effects of varied conditions upon some of the organisms are certain to yield results. The details of the mode of dispersal are very imperfectly known in many forms.

The most important general investigation, it seems, is to carefully select a series of ponds having different combinations of environmental factors, i. e., area, depth, shade, plant growth, wash, etc., and to make a series of simultaneous observations extending over at least one year. Then by a process of elimination, determine the effect of these factors.

I desire to express my obligations to Prof. C. H. Eyenmann and Prof. Charles Zeleny for their valuable suggestions and criticisms.

## BIBLIOGRAPHY.

A. O. U. check list of N. A. birds. Third edition, '10.

Awerinzew, C., '06. Die Süßwasser Rhizopoden. Travaux de la Société Imperiale des Naturalistes de St. Petersburg, Vol. 3,336, Livr. 2.

Banks, N., '04. A Treatise on the acarina, or mites. Proc. U. S. Nat. Mus., Vol. 28, pp. 1-114.

Blatchley, W. S., '10. Coleoptera of Indiana. Bull. No. 1 Ind. Dept. of Geol. and Natural Resources.

Burchardt, C., '06. Quantitative Studien über das Zooplankton des Vierwaldstättersees.

Mitteil d. Naturf. Ges. Luzern, '00. Heft 3, pp. 129-434.

Bütschli, '87. Protozoa. Klassen und Ordnung des Thier-reichs. Band, 1, p. 229.

Calkins, G. N., '04. Evidences of a Sexual Cycle in the Life History of *Amarba proteus*. Arch. of Protistenk. V, '04, pp. 1-16.

—————, '07. The Fertilization of *Amoeba proteus*. Biol. Bull. 13, pp. 219-28.

Call, R. E., '99. A descriptive illustrated catalogue of the Mollusca of Indiana. 24th Annual Rep. Ind. Dept. of Geol. and Nat. Res.

Church, Verne H., '10. Summary of the climatological data for the U. S. by sections. Sec. 68. U. S. Dept. of Agri. Weather Bureau.

Cummings, E. R., '05. On the weathering of the subcarboniferous Limestones of Indiana. Proc. Ind. Acad. Sci., 1905, pp. 85-100.

Edmonson, C. H., '10. A report on the freshwater protozoa of Tahiti. Science N. S., Vol. XXII, No. 819, p. 349.

Forbes, S. A., '82. On some Entomostraca from Lake Michigan and adjacent Waters. Am. Nat., Vol. XVI, p. 640.

Forel, F. A., '04. Le Leman, Monographie Linnologique. Tome Troisieme.

Gage, S. H., '91. Life History of the Vermilion Spotted Newt. Am. Nat. Vol. —, p. 1,084, Dec. '91.

Greene, F. C., '08. Caves and Cave Formations of the Mitchell limestone. Proc. Ind. Acad. Sci., 1908.

Guerne, Jules De., '88. Sur les dissemination des organismes d'eau douce par les Palmipedes. Extrait des Comptes Rendus hebdomadaires des seances de la Societe de Biologie 1888 T. 48 eme Serie.

Hankinson, Thos L., '08. A Biological Survey of Walnut Lake, Michigan. Rep. Biol. Survey of State of Mich., 1907.

Headley, F. W., '95. Structure and Life of Birds.

Jordan, Edwin O., '93. The Habits and Development of the Newt. (*Diemyctylus viridescens*) Jour. Morph., Vol. VIII.

Kellogg, V., '04. American Insects.

Kofoed, C. A., '03. Plankton of the Illinois River. Bull. of the Ill. State Lab. Nat. Hist., Vol. 6, Art. 2.

Migula, W., '88. Die Verbreitungsweise der Algen. Biol. Cent. B. 13, Proc. Ind. Acad. of Sci., ———.

Miall, L. C., '95. The Natural History of Aquatic Insects.

Migula, W., '88. Die Verbreitungsweise der Algen. Biol. Cent. B. 13, p. 514.

Pearse, A. S., '05. Contribution to the Copepod fauna of Nebraska and other states. Studies from the Zool. Lab. Univ. of Nebraska.

Penard, E., '02. Faune Rhizopodes du bassin du Leman.

Pütter, August, '08. Die Ernährung des Wassertiere Zeitschrift f. Allgemeine Physiologie, Vol. 7, pp. 20-283.

—————, '08. Der Stoffaushalt des Meers. *ibid*, pp. 321-368.

—————, '09. Die Ernährung der Fische. *ibid*, Vol. 9, pp. 147-242.

Riddle, O., '09. The rate of digestion in cold blooded vertebrates—the influence of season and temperature. *Am. Jour. Physiol.*, Vol. 24, No. 5.

Scott, W., '09. An ecological study of the plankton of Shawnee Cave, with notes on the cave environment. *Biol. Bull.*, Vol. 22, No. 6.

Shaler, N. S., '91. Origin and Nature of Soils. 12th Annual Rep. U. S. Geol. Sur., Part 1, pp. 219-344.

Stein, F., '54. Die Infusionsthierie.

Wesenberg-Lund, '08. Plankton investigations of the Danish Lakes. Danish Freshwater Biological Laboratory, p. 5.

Winogradsky, '89. Recherches sur les organismes de la nitrification. *Annals de l'Institute Pasteur*, 4.

Wolcott, R. H., '05. A review of the genera of the water mites. *Studies from the Zool. Lab. Univ. Neb.*, 66.

Wolf, Max, '09. Ein einfacher Versuch zu Pflüchten Theorie von der Ernährung der Wasserbewohner. *Int. Rev. Hydrob. u Hydrog.* B. 2 heft 3-4.

Zacharias, Dr. Otto, '88. Über die Verbreitung niederer Wassertiere durch Schwimmvögel. *Biol Centralblatt Band 8 No. 12*, p. 368-9.

—————, '93. Fauna des grossen Plöner See's. *Forschungsberichte aus der Biologischen Station zu Plön. Theil 1*.

—————, '02. Über die natürliche Nahrung einiger Süßwasserfische. *Forschungsberichte aus der Biologischen Station zu Plön Teil 9*, p. 62-69.











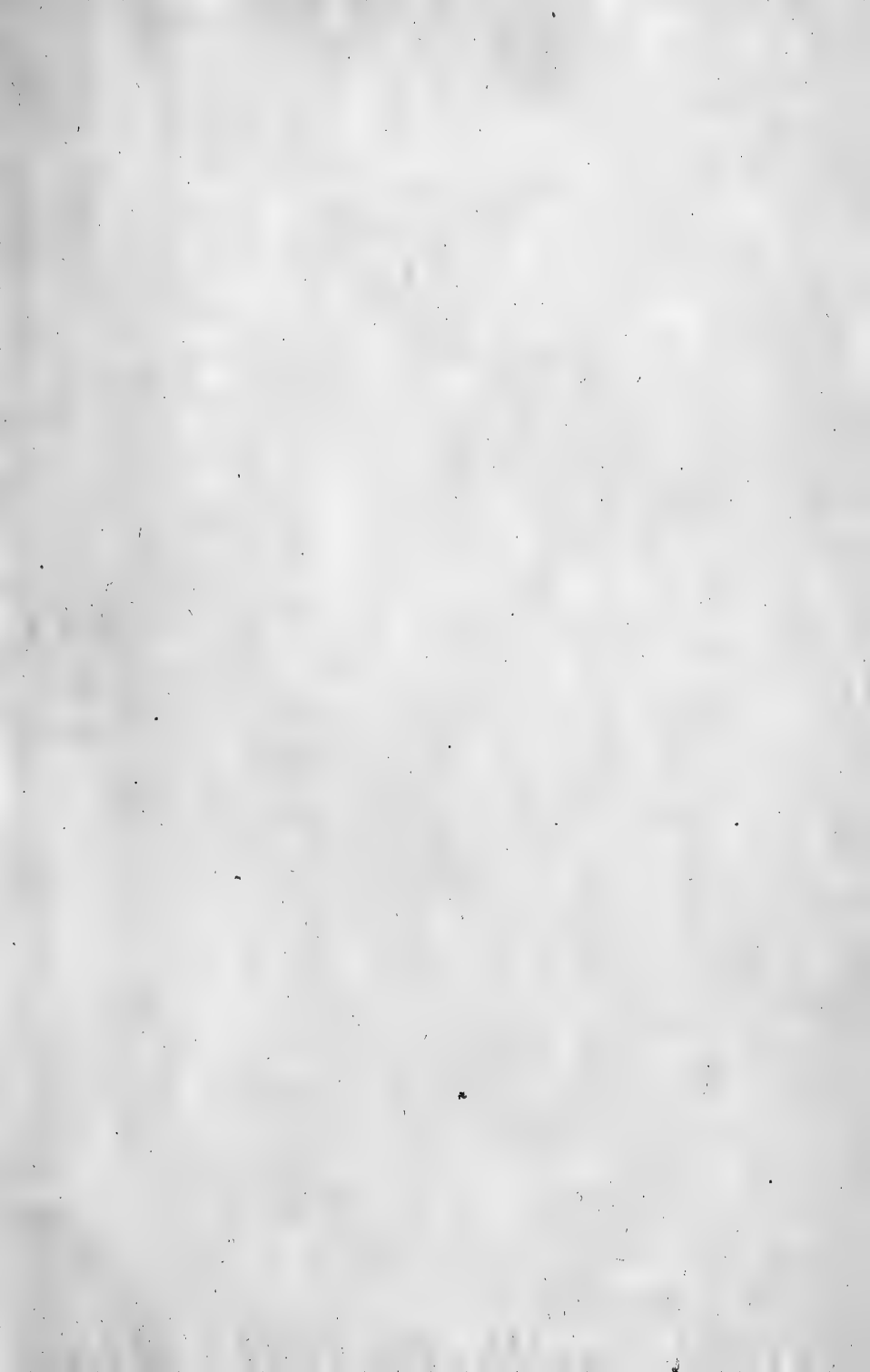







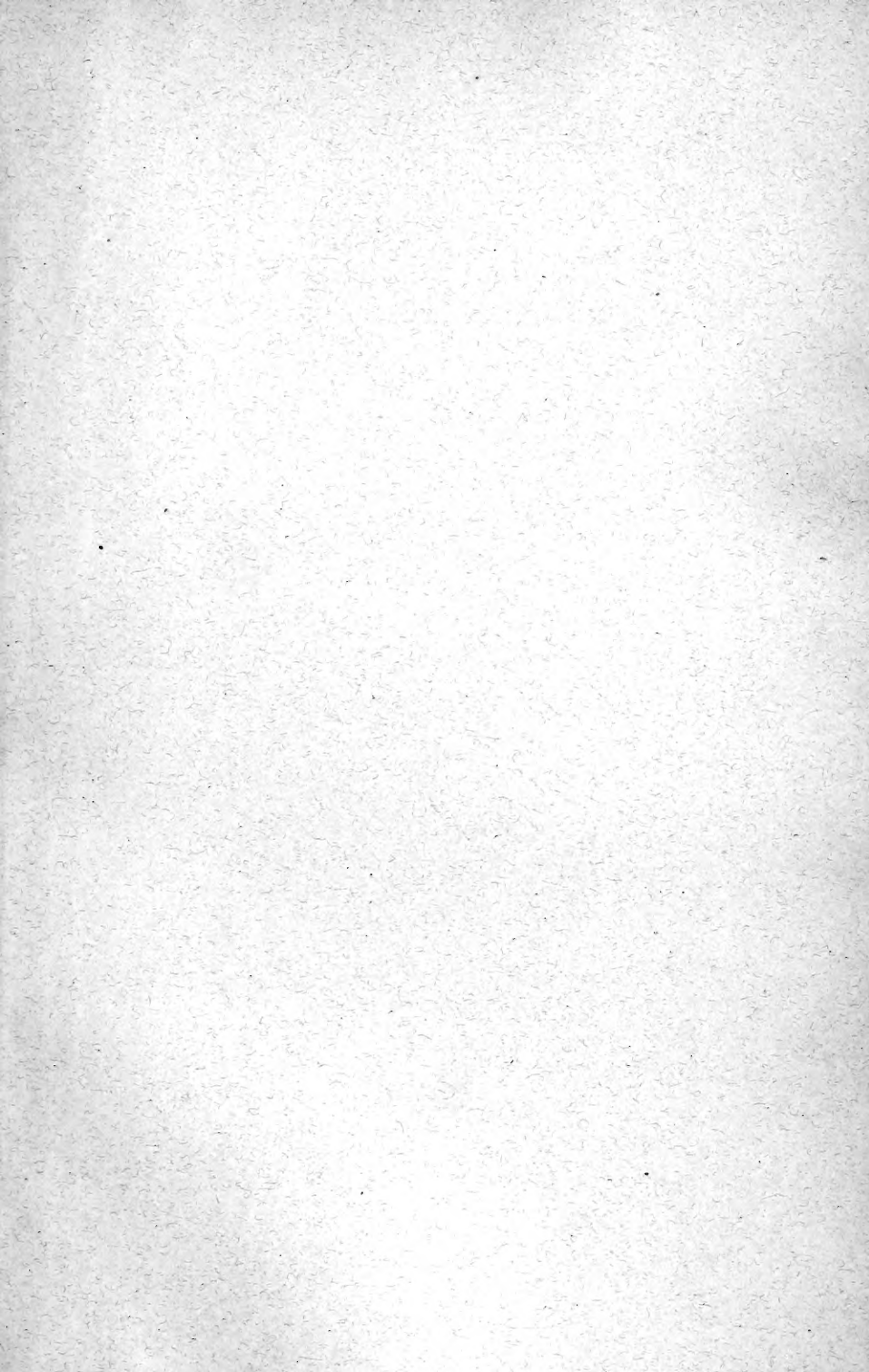

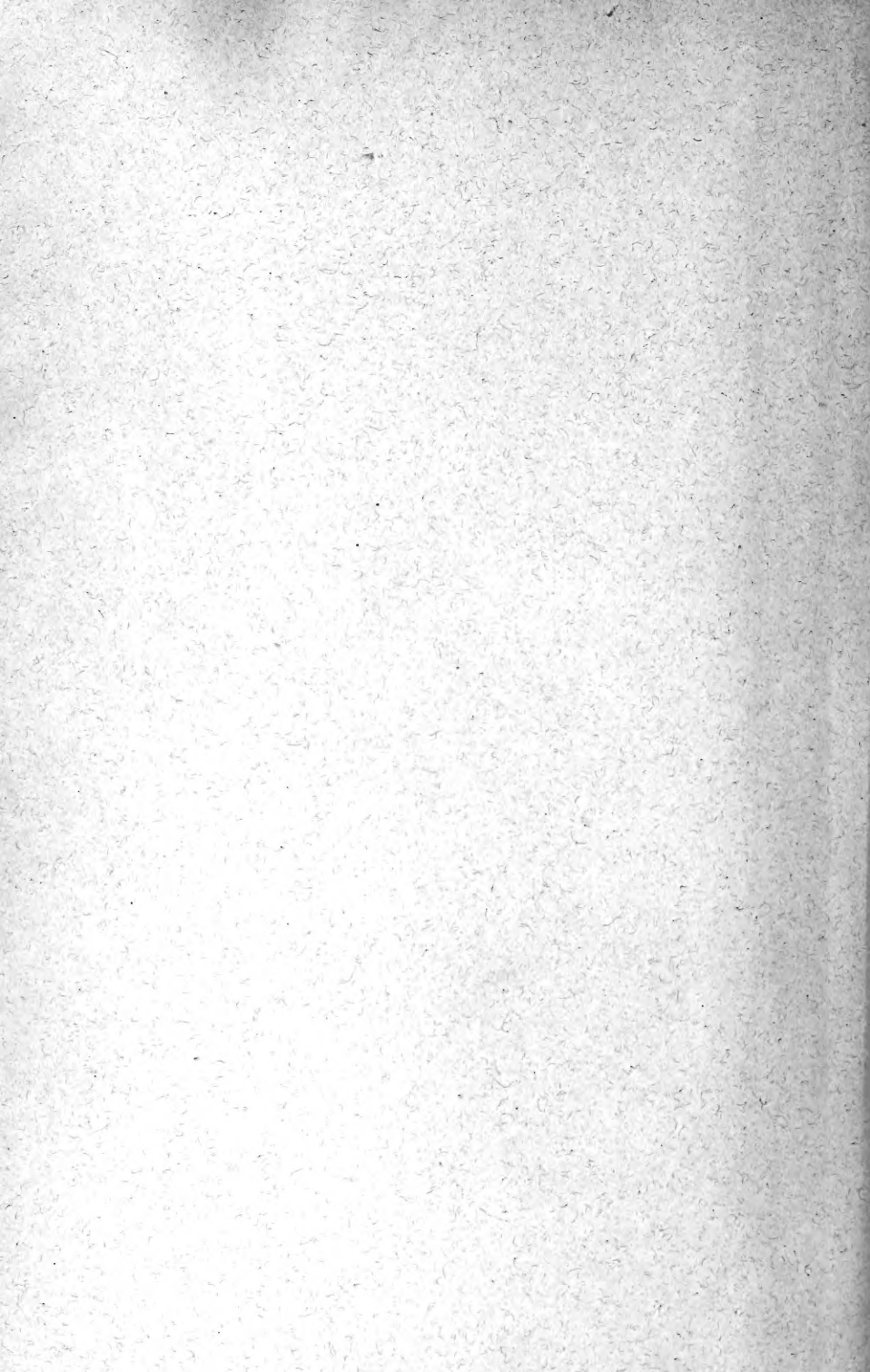

New York Botanical Garden Library



3 5185 00278 2587

