

FOR THE PEOPLE
FOR EDUCATION
FOR SCIENCE

LIBRARY
OF
THE AMERICAN MUSEUM
OF
NATURAL HISTORY

Bound at
A. M. N. H.
1924

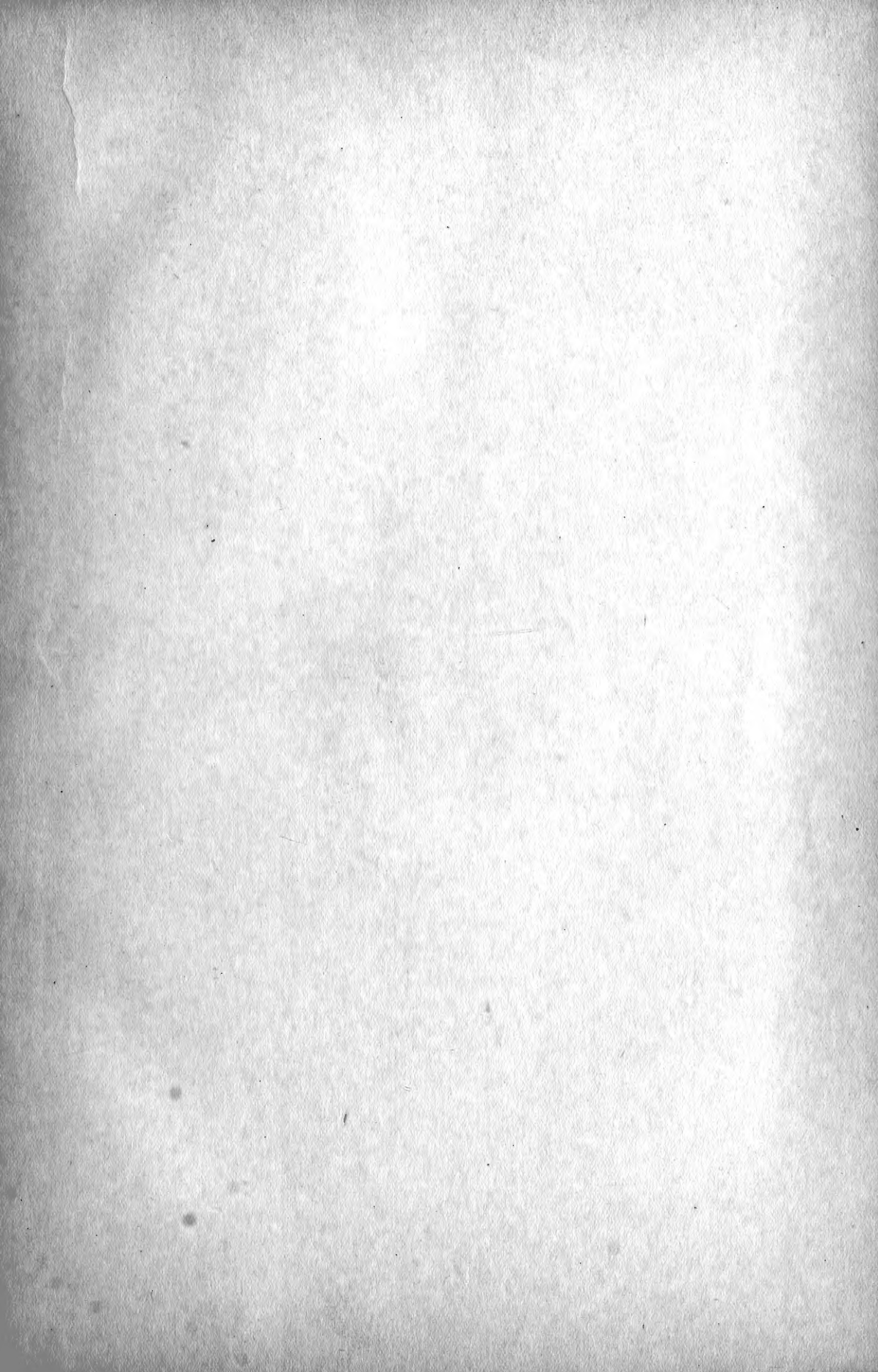





KONINKLIJKE AKADEMIE
VAN WETENSCHAPPEN
-:- TE AMSTERDAM -:-

PROCEEDINGS OF THE
SECTION OF SCIENCES

5.06 (49.2) A 5
2 ✓

VOLUME XXIV
— (Nos. 1—7) —

PUBLISHED BY
"KONINKLIJKE AKADEMIE VAN WETENSCHAPPEN", AMSTERDAM
MARCH 1922

LIBRARY
OF THE
AMERICAN MUSEUM
OF NATURAL HISTORY

24-94309 March 15

(Translated from: „Verslagen van de Gewone Vergaderingen der Wis- en
Natuurkundige Afdeeling” Dl. XXX).

CONTENTS.



Proceedings Nos. 1, 2 and 3	1
„ Nos. 4 and 5	145
„ Nos. 6 and 7	205



KONINKLIJKE AKADEMIE VAN WETENSCHAPPEN
TE AMSTERDAM.

PROCEEDINGS

VOLUME XXIV

N^{os.} 1, 2 and 3.

President: Prof. F. A. F. C. WENT.

Secretary: Prof. L. BOLK.

(Translated from: "Verslag van de gewone vergaderingen der Wis- en
Natuurkundige Afdeling," Vol. XXX).

CONTENTS.

- TH. WEEVERS: "Concerning the Influence of Light and Gravitation on *Pellia epiphylla*" (Communicated by Prof. F. A. F. C. WENT), p. 2.
- JAN DE VRIES: "Involutional Correspondences (2,2) of the First Class", p. 12.
- D. TOLLENAAR and A. H. BLAAUW: "Light- and dark-adaptation of a plant cell", p. 17.
- E. D. WIERSMA: "Psychical Inhibition", p. 33.
- I. K. A. WERTHEIM SALOMONSON: "Simple and alternating footclonus". p. 47.
- A. PANNEKOEK: "The local starsystem". (Communicated by Prof. W. DE SITTER), p. 56.
- H. GROOT: "Gravity and Pressure of Radiation". (Communicated by Prof. W. H. JULIUS, p. 64.
- W. H. VAN DEN BOS: "The Orbit of Bu 6832 = Σ 1834. (Communicated by Prof. W. DE SITTER). p. 72.
- Miss L. KAISER: "Muscle Sound in Birds". (Communicated by Prof. G. VAN RIJNBERK), p. 78.
- Miss L. KAISER: "A Simple Method to obtain a Curve of the Contraction of the *M. arrectores pilorum*". (Communicated by Prof. G. VAN RIJNBERK), p. 81.
- JASPER TEN CATE: "Regarding Automatic Movements of the Isolated Iris". (Communicated by Prof. G. VAN RIJNBERK), p. 84.
- A. SMITS and C. J. DE GRUYTER: "The Electromotive Behaviour of Aluminium". III. (Communicated by Prof. P. ZEEMAN), p. 86.
- J. P. WIBAUT: "On the Behaviour of Amorphous Carbon and Sulphur at High Temperatures and on Carbon-Sulphides". (Communicated by Prof. A. F. HOLLEMAN), p. 92.
- C. A. REESER and R. SISSINGH: "An Extension of the Theory of BABINET's Compensator". (Communicated by Prof. H. A. LORENTZ), p. 102.
- C. A. REESER and R. SISSINGH: "The Optical Investigation of Surface Layers on Mercury and a More Refined Method of Observation with BABINET's Compensator." (Communicated by Prof. H. A. LORENTZ), p. 108.
- ERNST COHEN and H. R. BRÜNS: "The Use of the ZEISS Waterinterferometer (RAYLEIGH-LÖWE) for the Analysis of Non-Aqueous Solutions", p. 114.
- J. H. ZALMANN: "Concerning an Isolated Muscle of the Ciliary Body of the Pigeon's Eye, Situated near the Eye-split". (Communicated by Prof. J. BOEKE), p. 123.
- J. G. VAN DER CORPUT: "On an Integral Notion of DENJOY". (Communicated by Prof. DENJOY), p. 131.

Botany. — “Concerning the Influence of Light and Gravitation on *Pellia epiphylla*.” By Dr. TH. WEEVERS. (Communicated by Prof. F. A. F. C. WENT.)

(Communicated at the meeting of April 30, 1921.)

Recent investigations concerning the influence of light and gravitation on the growth and the curvature of plants have been undertaken only with some particular objects. Although this yields the advantage that such investigations may be complementary to each other, it yet seemed to me that the study of quite another object might open up new points of view, or might give rise to new questions.

I considered *Pellia epiphylla* Corda to be a suitable object, as it offered various advantages, notably for the study of the growth of sporogonia under the influence of stimuli of light and gravitation. To my knowledge nothing has been published on this point ever since 1874, when ASKENASY¹⁾ dealt with it in a few paragraphs.

After the cell-division has taken place, the sporogonia of *Pellia* come to a period of rest in winter. At its close the rising temperature brings about a growth of the stem-cells, slow at the beginning, afterwards more rapid; this process does not require illumination, an increased content of water of the soil accelerates it. The sporogonium-stem begins to grow within 3—5 days, only the base remains enclosed by the calyptra. The length of the stem increases from 2 or 3 mm. to 6 or 8 cm. The number of cells remains unchanged, so does the diameter approximately, but their length is increased from 25—30 μ to 800—900 μ , their volume becomes about 30 times as large again. The inner cells are torn up and the stem becomes hollow, finally dextro-torsion ensues. The starch, which fills up the cells completely during the winter-rest, is entirely lost during the growth of the cells; the chlorophyl-granules also disappear more and more, so that the green colour of the tissue in the fullgrown parts becomes transparent; only the oily bodies²⁾ or elaioplasts³⁾ in the outer cells remain unchanged.

The osmotic pressure, which prior to the longitudinal growth is

¹⁾ ASKENASY 1874. Botan. Ztg. 32.

²⁾ W. PFEFFER 1874, Die Oelkörper der Lebermoose Flora.

³⁾ J. H. WAKKER, Pringsh. Jahrb. Bd. 19.

extremely high towards the end of March, about 63 atmospheres (determined through plasmolysis with 17 % KNO_3 (weight mol.), isotonic coefficient 1.69¹⁾) diminishes gradually, with the increase of volume, to ± 7 atm. in the fully developed cells. The length of the cells used for our experiments varies from 15 to 25 mm.; the osmotic pressure from 13 to 16 atm.

The starch, when being consumed for the formation of cell-walls, is converted into sugars; a sugar (probably glucose) reducing a FEHLING'S solution, was demonstrable in the young, in the growing cells and to a smaller quantity also in the fully developed cells.

This growth of cells does not occur simultaneously in all places; it begins and ends first in the middle parts; in the apical and especially in the basal part, enclosed by the calyptra, the growth continues longest; finally the length of the cells is nearly the same everywhere. We subjoin an instance (the measurements were marked with Indian ink).

24 March at 8 a.m.	1	1	2	2	2	2	Total 10 m.m.
25 „ „ „	3	3	3	3	3½	3	3 4 „ 25½ „
26 „ „ „	8	6	5	5	5	5	6 „ 45 „
27 „ „ „	12	7	6	5½	6	5½	6 8 „ 56 „
28 „ „ „	16	7	6	6	6	6	9 „ 62 „

These values point to a not markedly pronounced large period in the total growth; the figures expressing the growth per hour also depend, however, on temperature and light. The slightly higher day-temperature ($= 11^\circ\text{--}14^\circ$ C., room facing the North) accelerated the growth. Calculated per 12 hrs the successive values for another object are:

1st day 2; 1st night 4; 2nd day 6; 2nd night 6; 3rd day 11; 3rd night 10; 4th day 14; 4th night 9; 5th day 5 mm.

Light also exerts an influence; in the dark the stems become on an average 1—2 cm. longer than by daylight, which is chiefly attributable to a prolongation of the growth; light, then, shortens the grand period.²⁾

The average daily increments of 6 specimens were in the dark: 2, 6, 10, 14, 15, 9, 3 mm.; in the light: 3, 8, 10, 15, 12, 2 mm., the circumstances being, for the rest, approximately the same; the 1st 59 mm. in 7, the 2nd 50 mm. in 6 days.

¹⁾ H. FITTING, Jahrb. f. Wiss. Bot. 1919.

The decrease of the length is only slight in the plasmolytic solution; the correction for it may be neglected.

²⁾ Cf. H. SIERP, Biol. Zentralblatt 1920, also J. H. v. BURKOM Thesis Utrecht 1913.

Phototropism (Heliotropism): As appears from observations in nature, the growing sporogonium-stems are very sensitive to phototropic and geotropic stimuli. Illuminated by unilateral clear daylight the long-stems curve distinctly already after ± 10 minutes, in the sunlight after 5 minutes.

The following observations were made in the dark room of the Botanical Laboratory of Utrecht ¹⁾, where gas is absent; "laboratory air" caused no trouble; the objects, it is true, displayed many nutations, but this was quite the same in the open air. The temperature was 13° — 15° C.; the observations were made with red light (electric lamp with safranin-bell). A preliminary test, in which the light was acting for hours at a distance of 1 or 2 d.m., proved that only a very slight curvature was brought about. This curvature was, moreover perhaps partly thermotropic.

The material, almost a pure culture, taken from the shady side of a ditch near Amersfoort, was cut into pieces with a sharp knife. These pieces just filled the ordinary boxes generally used for Avena. Subsequently these boxes were kept in the dark for a week at the very least, before they were used for the experiments. Only those objects which had stems of 15—25 mm. were used for the experiment, the larger ones were too feeble. Many of the sporogonia had to be removed before the experiment began, because they were crooked or displayed nutations; only the vertical stems were used, 20 of them serving as objects in every experiment ²⁾.

The curvatures were observed macroscopically; the black sporogonium indicated the deviation distinctly. In order to preclude any influence of chance nutations on the result, the time after which 10 out of the 20 objects displayed the curvature was considered as the experimental reaction time ³⁾. Unless the contrary appears from the experiment itself, the material was placed on the klinostat after the excitation (rotation time ± 6 minutes).

The candle-power of the various electric light-sources was measured with WEBER's photometer; some oscillations may have been caused by a modification of the net-tension. These, however, did not affect the principle of our research.

¹⁾ Owing to the kindness of Prof. WENT this research could be continued during the holidays, which removed the difficulty that the growth of all the stems is completed in a few weeks.

²⁾ Material grown specially for the experiment, would have yielded better results no doubt. This is in course of preparation.

³⁾ W. H. ARISZ (Onderzoekingen over fototropie. Diss. Utrecht 1914) considers the "experimental reaction time" to be the time required for a curvature just noticeable to the unaided eye.

M. C. S.	M. C.	S.	Reaction	Exp. reaction time in minutes.
85	85	1	0	
170	85	2	0	
340	340	1	? 6 of 20+	
425	170	2 ^{1/2}	? 9 of 20+	± 150
425	85	5	+ ? 11 of 20+	135
510	340	1 ^{1/2}	+	130
510	85	6	+	135
612	0,01	612000	+	
850	85	10	+	130
1360	340	4	+	110
3400	340	10	+	105
7900	0,1	79000	+	
13600	1360	10	++	90
13600	3400	4	++	85
19600	11200	1 ^{3/4}	++	
27200	1360	20	++	80
33000	2200	15	+++	
34000	8500	4	+++	70
38250	2125	18	+++	70
40800	340	120	+++	
42000	700	60	++	
42000	2800	15	++ (a.c.o.)	70
56000	2800	20	++ (a.c.o.)	65
68000	340	200	++	
180000	50	3600	+	± 60
204000	3400	60	+	50
510000	8500	60	+ ?	
1020000	8500	120	+ ?	
1260000	700	1800	- ?	
2240000	11200	200	0	
3360000	2800	1200	at first + afterwards ?	25
7560000	6300	1200	" + " ?	20
± 13,5 million	11200	1200	" + " +	20
20 "	11200	1800	" + " +(w)	
31,5 "	17500	1800	" + " +(a.c.o.)	18
63 "	17500	3600	" ++ " +	15

The light from the source of 0.1 C.p. was dimmed by paper.

Control-experiments were made with a continuous illumination of 85 M.C., in which within an hour (55 or 60 minutes) a positive reaction was achieved. Then we ascertained the effect of several quantities of light-energy. The results are shown in the annexed table; they have been arranged according to the rising quantities of energy. The experimental reaction-time is expressed in minutes, the reaction is indicated by the symbols: 0 = no reaction; ? = doubtful reaction, curvature in fewer than 10 out of the 20; +? = faint positive reaction; + = distinct reaction; ++ = strong reaction, +++ = very strong reaction; -? = doubtful negative reaction.

In the experiments designated with (a.c.o.) the rays were transmitted through a dish filled with ammoniacal cupric oxide, (the walls of the dish running parallel) in the experiments designated with (w) the rays went through a dish filled with water.

As appears from the table the experimental threshold-value¹⁾ lies in the neighbourhood of 400 M.C.S.; this value might be determined with greater accuracy if the material were more homogeneous, and in that case it would perhaps prove to be lower. At any rate the sensitivity is here much smaller than in *Avena*.

The table also shows us the "product rule" for the threshold value²⁾, further that the quantity of energy is invariably the decisive factor. Likewise it substantiates ARISZ's conclusion that to every quantity of energy belongs a maximal curvature of definite magnitude and shape.

The large decrease of the experimental reaction-time with increasing energy is very striking here; for the threshold-value it is ± 150 minutes; for the highest quantities of energy it is only 15 min. (± 15 million M.C.S.). With long stems and unilateral clear daylight the time is ± 10 min., in the sunlight even less, viz. 5 min. The decrease of the exp. reaction-time is pretty regular, but in the neighbourhood of the weak reactions the duration is difficult of determination, or in *Pellia* this time might be broadly considered as an index of the strength of the stimulus. Whereas in *Avena* the shortest experimental reaction-time appears already between 50 and 100 M.C.S., it does not manifest itself here under 15 million M.C.S. Pronounced negative reactions were not noticeable in *Pellia*. We did observe, however, a retrogression of an appearing positive reaction (not past the 0-position, however), viz. at 3—7 million M.C.S. Between the strong positive reactions at 40000 and 15 million

¹⁾ ARISZ l.c. and Rec. d. trav. bot. neerl. Vol. XIII 1914—1915.

²⁾ BLAAUW A. H., Die Perzeption des Lichtes Rec. d. trav. bot. neerl. 1909.

M.C.S. there also lies a field of no, or doubtful negative reaction at 1—2 million M.C.S. Lower down we shall endeavour to get a somewhat better insight into these facts, but for this it is necessary to study the photogrowth reaction, which after BLAAUW's research ¹⁾ constitutes the basis upon which an interpretation of the phototropic phenomena has to be built up. Then the curvature is to be conceived as the resultant of the effects which the unilateral illumination has on the growth of the anterior and the posterior side. Beforehand I will communicate some other results of the phototropic examination.

First of all that with an illumination of 30000—45000 M.C.S., at which the reaction is strongest, almost hoop-shaped curvatures appear after 3 or 4 hours whether on the klinostat or not. Similar curvatures were observed by BLAAUW ²⁾ in *Phycomyces*, still more similar ones by ARISZ in *Avena* (l.c. Pl. I fig. 4). It would seem that in that case all the parts of the stem, which, as appeared above are all growing, although in various degrees, partake in the curving, evoked by the phototropic stimulus. After 16 hrs these curvatures have fairly disappeared also in the klinostat. This is the consequence of the autotropism, which VAN DE SANDE BAKHUYZEN ³⁾ looks upon as the consequence of the obscuration, which renders the process of growth-retardation, caused by the illumination reversible.

When a part of the stem is darkened by reed covered with tin-foil, the curvature is much less marked and occurs only in the lighted part. It proved impossible to illuminate the sporogonia alone; the tip of the stem was always lighted along with the other parts and displayed curvatures. When the sporogonium was darkened and the stem alone was lighted, a curvature appeared all the same. It follows then that when the sporogonium has been amputated, the stem does not react or reacts slightly phototropically, this is a consequence of the traumatic stimulus; there is no question here about conduction of the stimulus, which makes matters much simpler than in the case of *Avena*.

Here also the phototropically active part of the spectrum are the blue rays; when a glass dish filled with an ammoniac cupric oxide solution was placed as a screen before the light source, the effect was not altered appreciably, the experimental reaction time was about the same as when the dish is filled with water ⁴⁾.

¹⁾ BLAAUW A. H., Licht und Wachstum I. Zeitschr. f. Botanik 1914.

²⁾ Die Perzeption des Lichtes p. 345.

³⁾ H. L. v. D. SANDE BAKHUYZEN, Analyse der fototropische stemmingsverschijnselen. Diss. Utrecht 1920.

⁴⁾ The minimal influence of the red rays has been shown above.

The photogrowth-reaction: The space of time in which experiments with *Pellia* could be made, being very limited, I could make only few observations on photogrowth-reaction. They were performed with an energy of light of 75 M.C., the light falling from above through 4 mirrors arranged at an angle of inclination of $\pm 45^\circ$. It was directed horizontally at 4 sides of the object, which was placed exactly in the centre of the 4 pencils of rays. In order to watch the growing object with the horizontal microscope, we could illuminate the field of vision by a fifth mirror arranged in the axis of the microscope behind the object, also at an angle of inclination of 45° .

The observations were always made with red light, so that no curvature could be effected when the various sides were differently illuminated. The black upper rim of the sporogonium was clearly distinguishable; unfortunately mutations most often caused difficulties again, because then crooked growth made the measurements unreliable. It appeared to be impossible to continue our observations longer than an hour.

The illumination lasted 5 or 10 minutes (Energy 22500 and 45000 M.C.S.). We chose this energy because it produced with unilateral illumination a strong positive curvature.

I will at once mention that with this quantity of energy *Pellia* yields a distinct photogrowth-reaction, provided the objects have been standing in the dark for some time. This also accounts for the phenomenon "disposition" (German "Stimmung"), that with unilateral illumination of 45000 M.C.S. objects, which have not been previously placed in the dark, or only for a short interval, do not yield a distinct curvature or yield only a very slight one, whereas the more sensitive objects (vide supra) react very strongly on it. ARISZ l.c. was the first to conceive this phenomenon of "disposition" as a reaction-process and afterwards v. D. SANDE BAKHUYZEN assumed the "disposition" to be a difference in the slope of the growth-retardation curves, manifesting itself in every process in which the reaction does not increase rectilinearly with the stimulus. When the object was lighted omnilaterally with 2800 M.C.S. for six minutes (on the klinostat), and was subsequently exposed for 20 seconds to a unilateral after-illumination of the same energy, no reaction ensued, while a strong reaction does ensue, when a unilateral illumination with 56000 M.C.S. is applied, in which there is an equal difference of energy between the anterior-, and the posterior side.

Reverting to the photogrowth-reaction we observe after the addition of 4×22500 or 4×45000 M.C.S. in 5 or 10 minutes a distinct retardation of growth, appearing mostly during the illumination,

sometimes some minutes later. The mean retardation of 6 observations amounted to 35 % (min. 25 %, max. 47 %); the rate of growth seems to rise very slowly to the mean value before the illumination. Whether it rises beyond this value later on, was difficult to ascertain, since owing to the nutations the observations could be continued for an hour only.

1 st object	12 ^h —12 ^h 10 ^m dark	growth	85 μ	2 nd object	dark	70 μ
	12 ^h 10 ^m —12 ^h 20 ^m „	„	87 μ		„	73 μ
	12 ^h 20 ^m —12 ^h 25 ^m light	}	66 μ		light	63 μ
	12 ^h 25 ^m —12 ^h 30 ^m „				dark	
	12 ^h 30 ^m —12 ^h 40 ^m dark		64 μ		„	40 μ
	12 ^h 40 ^m —12 ^h 50 ^m „		74 μ		„	63 μ
	13 ^h 50 ^m —1 ^h „		75 μ		„	66 μ

With unilateral illumination the anterior side of the still growing green parts is illuminated more intensely than the posterior side, which is due to absorption into the tissue. This was made out by photographs taken with sensitive paper of the silhouette¹⁾. The stronger retardation of growth at the anterior side, to which the unilateral illumination has assigned more energy, will therefore engender a positive curvature, in other words: the case of *Helianthus hypocotylidons*²⁾. Only in *Pellia* the sensitivity is not so great and as yet no rise in the rate of growth beyond the normal has been detected during the oscillations, which may be called forth by the illumination³⁾. To consider the first growth-retardation caused by the illumination as not belonging to the photogrowth-reaction (as SIERP⁴⁾ does in *Avena*) makes no sense here, where conduction of stimulus is out of the question and the curvature may appear much quicker.

The results of the phototropic observations: the initial slow rise of the positive reaction up to ± 45000 M.C.S., the succeeding slow fall down to 1 or 2 million M.C.S., with a long stage of indifference without distinct negative reactions, where anterior and posterior side react alike, all this points, in my opinion, to a very gradual course of the growth-retardation curves. Probably the latter will show a

1) Absorption is insignificant in the fully developed clear stems, but here also the curvature is slight.

2) A. H. BLAAUW. Licht und Wachstum II. Zeitschr. f. Botanik VII 1915.

3) That also in *Pellia* the photogrowth-reaction must be accelerated after the growth-retardation might be inferred from the autotropism, the straightening in the dark.

4) H. SIERP. Zeitschr. f. Botanik XIII 1921.

very slow rise, then proceed horizontally over some length, (may be with slight falls), succeeded by an ascending portion. For the present it is impossible to give an accurate description¹⁾, which requires a detailed examination, with omnilateral fore-illuminations, succeeded by unilateral ones. I purpose to examine this more closely later on. Perhaps then also negative reactions will become evident.

Geotropism: Only few experiments were made regarding geotropism; in nature it is negative in the stems. When the excitation was prolonged with vertical position of the thallus (stem horizontal), the experimental reaction time was 80—90 min. So we see that the difference in the rate of photo- and geotropic reaction is not so great as in *Avena*.

The experimental threshold-value for geotropism was ± 10 min., the experimental reaction-time 150 min.

By experiments with the centrifuge I tried to ascertain whether in geotropism the experimental reaction-time was equally dependent on the quantity of energy. The object appeared however unsuitable for this purpose, the flaccid stems are bent too much out of shape. Also the dishes proved impractical for this object. In experiments, on an inclined plane of 45° I found however, a much longer reaction-time.

Finally I wish to add a few remarks about the mechanical side of the curvature-process and the photogrowth-reaction in objects like *Pellia*, in which there is no question about conduction of excitation, and its progress, therefore, can be simpler than in *Avena*. When we try to find an explanation for the growth and the curvature of multicellular plant-parts, two factors may be considered; viz. change of the turgor-pressure or of the cell-wall. At one time the first was believed to be the chief factor, at present the second²⁾. The turgor-pressure is, indeed, a necessary condition for the growth, but the changes of the cell-walls must be looked upon as the principal factors. This is borne out by the fact that during the winter-rest the osmotic pressure of the stem-cells is high in *Pellia* and still no growth reveals itself. On the contrary it begins and reaches its culmination point on the apex of the great period, when the osmotic pressure is regularly decreasing. It thus appeared that in comparing the convex and the concave sides of stems, which had just been curved, there was no difference in osmotic pressure worth mentioning. Nor does a distinct curvature brought about by unilateral

¹⁾ The slope of the growth-retardation curves is sure to decrease slowly, since with fore illumination the threshold value becomes higher.

²⁾ W. PFEFFER *Physiology*, II. Cap. XIII.

daylight go back through plasmolysis already half an hour after the commencement of the stimulation. It follows then that here a modification in the nature of the cell-wall is answerable for the more or less considerable growth, which fact is quite in keeping with the explanation of the curvature of unicellular organs.

BLAAUW l.c. demonstrated in *Phycomyces* that photogrowth-reaction reveals itself only when the growing topzone of about 3 or 4 mm., is lighted. From this also he concludes that the light does not act through change of turgor.

The question now arises whether that change of cell-wall is primary or secondary, in other words: is the sensitive system to be found in the cell-wall or in the protoplasm. The latter is the more likely supposition, but it should be borne in mind that an investigation of R. HANSTEEN CRANNER¹⁾ lately informed us that the cellwall of the living cells is much more complicate than had formerly been suspected, viz. a complex colloid system which also contains lipoids. The whole problem of the growth of the cellwall, formerly interpreted through opposition and intussusception, will now have to be looked upon from a colloidochemical point of view.

More evidence has been produced, however, for the assumption that the sensitive system lies in the protoplasm, perhaps in the stable boundary layer. DREYER and HANSEN's²⁾ research showed that proteins coagulate under the action of rays of light of short wavelength. This action is a reversible process, as has been seen also heretofore for growth-reaction.

Be this as it may, in either case it is the chemistry of colloids which has to deepen our knowledge of the photo-chemical phenomena governing the photogrowth-reaction.

¹⁾ R. HANSTEEN CRANNER, *Jahrb. f. Wiss. Botanik* 1914.

²⁾ G. DREYER and O. HANSEN, *Compt. Rend. T.* 145, 1907.

Cf. also F. SCHANZ *Ber. d. d. Bot. Ges.* 1918.

Mathematics. — “*Involutorial Correspondences (2,2) of the First Class*”. By Prof. JAN DE VRIES.

(Communicated at the meeting of April 30, 1921).

§ 1. An involutorial correspondence (2,2) of the *first class* is characterized by the property that an arbitrary straight line contains *one* pair of associated points P, P^* . If we associate to each other the straight lines joining a point P to the two homologous points P_1 and P_2 , also the field of rays is arranged in an involutorial (2,2). At the same time there arises a null system, if we associate to P the straight lines PP_1 and PP_2 ; each straight line has in this case two null points, each point has two null rays.

If the point P describes the straight line r , its null rays envelop a curve (r) of the fourth class that has r as a double tangent. The six points V in which $(r)_4$ is cut by r , are evidently *branch points* of the (2,2). The *branch curve* (V) of the (2,2) is therefore a curve of the order *six*.

We shall now suppose that the locus of the coincidences $P \equiv P^*$ is a curve of the order n . If P describes the line r , the points P_1, P_2 associated to P , describe a curve q , which has the n coincidences on r and the pair of associated points on r, P, P^* , in common with r .

Through this correspondence r is therefore transformed into a curve q^{n+2} of the order $(n+2)$.

Let us now consider the curves q_1^{n+2} and q_2^{n+2} corresponding to the straight lines r_1 and r_2 . Besides the two points associated to $S \equiv r_1 r_2$ they have the points P in common for which P_1 lies on r_1 and P_2 on r_2 ; the other common points are *singular*, i.e. each of them is associated to ∞^1 pairs P_1, P_2 .

The curves $(r_1)_4$ and $(r_2)_4$ corresponding to the straight lines r_1 and r_2 , have in the first place the two null rays of the point S in common. The line r_2 cuts \hat{q}_1^{n+2} in $(n+2)$ points P_2 , which are associated to as many points P_1 on r_1 and accordingly define $(n+2)$ common tangents. The other $(12-n)$ common tangents are evidently *singular straight lines*; each of them bears ∞^1 pairs of points P, P^* .

Let us also consider the locus of the pairs of points P, P^* which are collinear with a point O . Let O_1 and O_2 be the points conjugated to O through (2,2); the curve in consideration ω is touched at O

by OO_1 and OO_2 ; it is therefore a *nodal* curve ω^4 . Through O there pass six of its tangents; according to a theorem found by BERTINI the six points of contact, coincidences of the (2,2), lie on a conic¹⁾. The bearers of the *coincidences* of the (2,2) envelop consequently a curve of the *sixth class*.

§ 2. We arrive in the following way at a (2,2) for which $n=2$. Let the conic a^2 and the pencil of conics (b^2) be given. To the point P we associate the points P_1 and P_2 in which the conic b^2 through P is cut by the polar line p of P relative to a^2 . On a straight line r , (b^2) defines an involution; as a rule this has *one* pair of points in common with the involution on r of the pairs of points that are harmonically separated by a^2 . This (2,2) belongs accordingly to the *first class*.

The points of a^2 are evidently the coincidences of this (2,2). The straight line r is transformed into a *nodal* φ^4 , which has the pole R of r as double point. For when P moves along r , its polar line p revolves round R and bears the two points P_1, P_2 associated to P .

The base points B_k ($k=1, 2, 3, 4$) of (b^2) are *singular points*. On the polar line b_k of B_k (b^2) defines ∞^1 pairs of points P_1, P_2 which are associated to B_k . If P gets into the intersection of b_k with r , one of the points associated to P coincides with B_k ; hence φ^4 passes through the four points B_k .

The conic b^2 through R cuts r in two points R_1, R_2 , which are associated to R ; hence φ^4 has a double point in R .

The six tangents of φ^4 meeting in R bear double points $P_1 \equiv P_2$; from this it follows again that the *branch curve* is a $(V)^6$. It has double points in the base points of (b^2) ; for the involution of the pairs of points on b_k associated to B_k contains two double points for which B_k is a branch point.

With a b^2 $(V)^6$ has four points in common besides the double points B_k ; they are the branch points of the correspondence (2,2) on b^2 . The curve $(V)^6$ touches a^2 in the six coincidences of the involution I^4 in which (b^2) cuts a^2 .

§ 3. Any point A of a^2 is a coincidence of the (2,2), but it is also associated to the point A' which the tangent a at A has further in

¹⁾ Relative to this conic ω^2 as an invariant curve, ω^4 is transformed into itself by a central quadratic involution (inversion) with centre O of which the other two fundamental points lie on the polar line of O relative to ω^2 ; this straight line contains the points of contact O_1, O_2 of O . (See J. DE VRIES, *La quartique nodale*, Archives Teyler, série II, tome IX, § 12).

common with the b^2 through A . Of the locus a of the points A' a b^2 contains four points besides the base points B ; they are defined by the points of intersection of b^2 with a^2 . On each of the two tangents a through B_k , A' coincides with B_k ; hence a has double points in B_k .

Consequently the curve in question is an a^6 . As it corresponds point for point to a^2 and is therefore rational, it must have six more double points. There are therefore six points A' each corresponding to two points A ; the b^2 through such a point A' cuts a^2 in the two points A which it has in common with the polar line of A' .

The straight line b_k is transformed by (2,2) into a β^4 with *triple point* β_k . When P moves along b_k the polar line p continues to pass through β_k , so that always one of the points P_1, P_2 associated to P , coincides with β_k . If also the second point is to coincide with β_k , p must touch the b^2 through P at β_k . Now any straight line p through β_k touches one b^2 ; if we associate the points Q_1, Q_2 which this b^2 defines on b_k , to the pole P of p , there arises a correspondence (1,2) between P and Q . Hence Q coincides three times with P ; but then the curve β_k into which b_k is transformed, has a threefold point in B_k and is therefore a *rational* β^4 .¹⁾

§ 4. We shall now try to find the locus of the *double points* $P_1 \equiv P_2$. It has in the first place *threefold points* in B_k . On each b^2 there lie besides the base points four more points of the curve in question, namely the double points of the (2,2) in which the points of b are arranged. Consequently it is a d^6 . As it corresponds point for point to the branch curve $(V)^6$ it is just as the latter of the genus six; hence it must have *three* more *double points*. These we find in the double points of the three pairs of lines belonging to b^2 .

The bearers of the double point $P_1 \equiv P_2$ envelop a curve of the sixth class (§ 1) of the same genus as the branch curve, hence with four double tangents; these we find in the straight lines b_k .

For the points where b_k is touched by two of the conics b^2 , correspond as double points to the branch point B_k .

¹⁾ On b_k there lie 2 points that are associated in the (2,2) to each other and at the same time to B_k , and which therefore together with that point form a polar triangle of a^2 . The b^2 containing them is consequently circumscribed to ∞^1 polar triangles so that on it the (2,2) has been transformed into a *cubic involution*. In this involution *each* base point B is associated to the points of intersection of b^2 with the polar line of B .

If we define the pencil (b^2) by two conics, each circumscribed to a polar triangle of a^2 , each b^2 bears a cubic involution and the whole correspondence (2,2) is transformed into a system of ∞^1 involutorial triplets.

§ 5. Each straight line $B_k B_l$ is evidently *singular*, for it bears ∞^1 pairs of points that are harmonically separated by a^2 .

A straight line would also be singular if the involution in which it is cut by (b^2) , coincided with the involution of the pairs of points that are harmonically separated by a^2 . And this will be the case when this straight line is touched in its two points of intersection with a^2 by conics b^2 .

Now the straight lines t that touch b^2 at its points of intersection with a^2 , envelop a curve of the class *six*. For the points of contact of the tangents out of any point to the conics b^2 lie on a cubic and this meets a^2 in six points, each of which defines a straight line t . This envelope is *rational*; it has therefore *ten double tangents*; to them belong evidently the six straight lines $B_k B_l$.

Hence there are, besides these, *four more singular straight lines*, s_k .

The straight line s_k is transformed through (2,2) into the system of s_k and a nodal cubic that has its double point in the pole of s_k . The straight line $B_k B_l$ is transformed into the system of $B_k B_l$, $B_m B_n$, b_k and b_l .

§ 6. The points P_1 and P_2 associated to P in the (2,2), correspond to each other in another (2,2), which may be called the derivative of the former. This (2,2)* is likewise of the *first class*; for on a straight line p there lies only the pair in which p cuts the conic b^2 passing through the pole P of p .

Also this (2,2)* has singular points in B_k ; for if P describes the polar line b_k , P_1 remains in B_1 and P_2 describes the above mentioned rational curve β_k^4 .

The curves ϱ_1^4 and ϱ_2^4 corresponding in the (2,2) to the straight lines r_1 and r_2 , have (§ 1) 10 points P in common for which P_1 lies on r_1 , P_2 on r_2 . Hence P_2 describes a curve ϱ^{10} when P_1 describes the straight line r_1 . This ϱ^{10} has *quadruple points* in B_k , for r_1 cuts the curve β_k^4 in four points P_1 .

Each branch point of the (2,2) is at the same time a branch point of the (2,2)*; accordingly they have also *the same branch curve* $(V)^6$. The *coincidences* of the (2,2)* are the *double points* of the (2,2); the *curve of coincidence* is therefore the above mentioned σ^8 , which passes three times through B_k , twice through the double points of the pairs of lines. We find the points of intersection of r with ϱ^{10} in the eight points which r has in common with σ^8 and in the pair of points P_1, P_2 on r .

The four singular straight lines (§ 1), of the (2,2)* are found in the straight lines b_k .

§ 7. In the following way we arrive at a (2,2) for which $n = 3$. Let a^3 be a cubic, p^2 the polar conic, p the polar straight line of P . To P we associate the two points of intersection F_1 and P_2 of p^2 with p . The correspondence (2,2) arising in this way, is involutorial, because P and P_1 may be considered as threefold elements in a cubic involution where the points of intersection of PP_1 with a^3 form a group¹⁾, or as the double points of the cyclic projectivity defined by this group. The *class* of this (2,2) is therefore *one*.

If P gets on a^3 , P_1 and P_2 coincide with P ; P is in this case a branch point coinciding with the corresponding double point. If on the other hand P gets into a *point of inflexion* B , p is a part of p^2 , so that B is a *singular point* and the stationary tangent is a *singular straight line*.

If P gets on the *Hessian* H^3 of a^3 , p passes through the double point of p^2 , also lying on the Hessian, and P_1 coincides with P_2 , so that P is a branch point. The *branch curve* (V)⁶ consists therefore of a^3 and H^3 and these curves are at the same time the locus of the *double points*.

When P describes the straight line r , p^2 describes a pencil and p envelops a conic. In each base point of (p^2) there lie therefore two points associated to P . As a p^2 contains moreover the two points of intersection with the corresponding p , the straight line r is transformed into a *quadrinodal curve* q^5 . This contains the nine points of inflexion of a^3 , as these correspond to the points in which r cuts the stationary tangents. Consequently q^5 touches a^3 in the three points of intersection of a^3 with r .

The derivative of this (2,2) is of the *fourth class*. For a straight line p has four poles and contains therefore the four pairs P_1, P_2 in which it is cut by the corresponding four polar conics p^2 .

¹⁾ KOHN, *Zur Theorie der harmonischen Mittelpunkte*. (Sitz. ber. der Akad. der Wiss. Wien, Bd. LXXXVIII, S. 424).

Botany. — *Light- and dark-adaptation of a plant cell.* By Dr. D. TOLLENAAR and Prof. A. H. BLAAUW.

(Communicated at the meeting of April 30, 1921).

Now that it has appeared that the growth in length of vegetative organs as a rule shows a very characteristic response to the light-stimulus, we possess in this response of growth to light an excellent criterion for the elementary study of sensitiveness to light. In this research of which all experiments have been made by Mr. TOLLENAAR, we have carried on the study about the way in which the light sensitiveness of an individual cell, the sporangiophore of *Phycomyces nitens*, reveals itself in the response of growth. The progress of the reactions is already known in case that fixed quantities of light of $\frac{1}{4}$ M.C.S. to 2 mill. M.C.S. are applied in a short time to cells that are kept in the dark (see Licht u. Wachstum I). Likewise how the response of growth is, when the cell already adapted to the dark is exposed to permanent light, e.g. of 1,64 or 4000 M.C. (see Licht u. Wachstum III). In 64 M.C. for instance we see acceleration- and retardation of growth interchange and gradually brought into equilibrium. When after this adaptation to light the growth has become constant again, its progress appears in 64 M.C. some percentages quicker than in the case of the cell adapted to the dark.

I. *Conversely, does the growth become some percentages slighter, when the cell after adaptation to light has been completely re-adapted to the dark in $1\frac{1}{2}$ or 2 hours?*

All experiments in this research have been made at 16° C. with horizontal and 4-sided illumination. For the cultures + stems were used.

Experiments of control. These are required, because the growth of the cells may somewhat change its speed in the course of 2 hours, even though the illumination remains constant, in consequence of chance causes or e.g. because the growth is still increasing or already decreasing. With cells that have been adapted to 64 M.C. the rate of growth differed after two hours, respect.: — 1, + $3\frac{1}{2}$, + 1, — 1, — $7\frac{1}{2}$, + $7\frac{1}{2}$, — $2\frac{1}{2}$, — $1\frac{1}{2}$, — 7, — 5, + 3, 0, + 1, + $1\frac{1}{2}$, + 4% . average — 0,27%, i.o.w. after adaptation to 64 M.C. (in 2 hours) the average growth remained the same in the next 2 hours in 64 M.C.

Experiments. 4 cells adapted to 64 M.C. and then left in the dark (after $1\frac{1}{2}$ — 2 hours) a change in growth of -6.0% (± 0.53): 14 cells from another series of experiments -7.5% ($\pm 1,2$). With one of these 18 cells the growth had increased after a 2 hours' stay in the dark, with two the growth was the same, with 15 decreased.

The cells from the dark, adapted after a few hours to light of

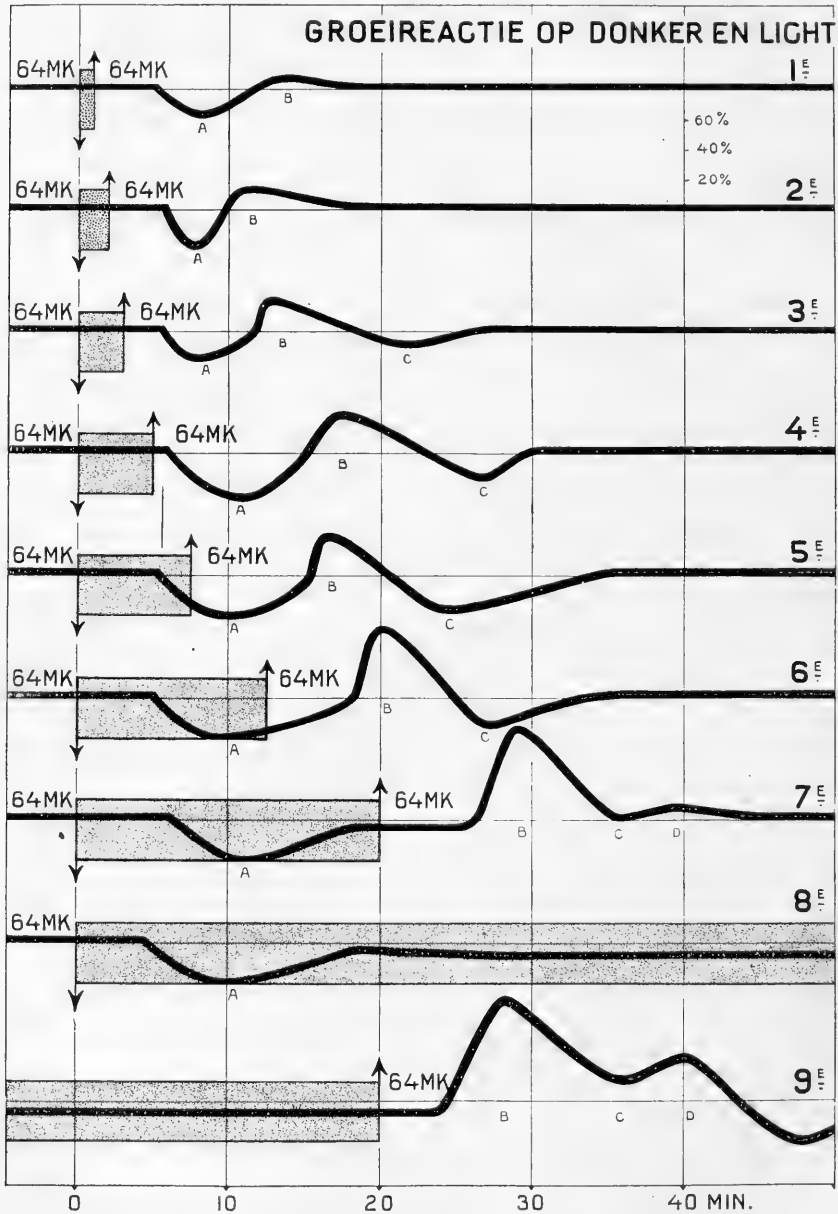

Fig. 1. Response of growth to dark and light.

64 M.C., grow some percentages quicker than in the dark; when left again in the dark, they constantly grow 4—10%, more slowly after dark-adaptation.

II. *Does the dark call forth a response of growth in a cell adapted to light, i.o.w. does the dark work as a stimulus, or is this decrease of growth of 4—10%, in the dark quite gradual?*

Experiments. When the cell adapted to 64 M.C. is made permanently dark a decrease of growth sets in after $3\frac{1}{2}$ — $5\frac{1}{2}$ min., so that after 8 — $11\frac{1}{2}$ min. the rate has decreased to $\pm 73\%$; next there follows an increase, by which after $15\frac{1}{2}$ — $18\frac{1}{2}$ min. the rate is about recovered ($98\frac{1}{2}\%$) in the light to decrease again a little and become gradually constant at $\pm 93\%$ of the rate of growth in 64 M.C. (See fig. 1, curve 8).

So a disturbance of equilibrium takes place in consequence of the stoppage of the energy-supply, so that a typical response to stimulus ensues, which is contrary to the response of growth to light. If after the darkening the growth had *gradually* decreased to its dark-value, we could hardly have spoken of a response to stimulus. Now that there always occurs a reaction-time of $3\frac{1}{2}$ — $5\frac{1}{2}$ min., just as with the response of growth to light and in consequence of the dark-fall an evident *disturbance of equilibrium* takes place, showing itself in *fluctuation of growth*, we may talk here of a typical *response to stimulus*.

For a cell adapted to constant light the dark (sudden stoppage of light-supply) works as a stimulus. For some minutes the rate of growth in the light is maintained in the dark, then a sudden reaction follows, contrary to that which light causes.

Responses to dark and to decrease of light have already been ascertained by SIERP for *Avena*. The response of growth to light of *Avena* is mainly a retardation of growth; the reactions observed by SIERP on dark- and light-decrease were accelerations of growth. It seems suitable to me to use the name of *dark-growth-response* for this phenomenon, as SIERP proposes with some reserve, provided an ample meaning is attached to the conception light- and dark-growth-response, viz. a response of growth to increase, resp. decrease of light.

Man states the result of the light-energy on the retina by himself much quicker through his impressions of brightness, than we can read the result of the light-stimulus on the metabolism in that cell in consequence of its change of growth. Moreover those processes

take place here at 16° C., with man at 37° C. Yet we are of opinion that we have every reason to see similarity between the way of reacting of the plant cell *to dark* and the appearance of a positive after-image, followed by the appearance of *negative after-images* in definite circumstances in the eye. There too after the fall of the dark a fluctuation of the impression of brightness, by which the impression of brightness or rather of darkness, with the negative after-image, may fall in the beginning *below* the normal darkness (or so-called intrinsic light of the retina) of the eye adapted to the dark. In this way the after-images are to be taken as a disturbance of equilibrium of the sight-apparatus adapted to light through the coming of the dark (= the stoppage of the energy-supply). Especially these negative after-images, which appear in our eye 2—4 minutes after strong prolonged illumination should be noted.

III. *What is the process of this dark-growth-response, when the cell has not been adapted to 64 M. C. but to slighter intensity?*

Experiments. Experiments were made in 8—1— $\frac{1}{8}$ — $\frac{1}{64}$ and $\frac{1}{512}$ M.C. In 8 M.C. the average minimum of growth was 67 %. It further appears, that the growth also after slighter intensities of 1 and $\frac{1}{8}$ M.C. decreases to about the same value, viz. to ± 75 %. To be sure the reaction — just as with the common light-growth-response after weaker stimuli — appears *later*. The maximal decrease is from 8 $\frac{1}{2}$ —11 min. after 64 M.C. and 8 M.C., shifted to 11—14 min. after $\frac{1}{8}$ M.C. After still slighter intensity of $\frac{1}{64}$ M.C., the growth decreases only to ± 85 %, after $\frac{1}{512}$ M.C. to ± 89 %. Therefore only after these slight intensities the dark-growth-response becomes clearly smaller, while the minimum remains just as after $\frac{1}{8}$ M.C. at 11—14 min. after the beginning of the darkening.

It is evident in these and other experiments as before, that the moments at which maxima and minima occur in the experiments with the various individuals are exceptionally constant. Especially with threshold-determinations when we can hardly say with certainty whether from a greater or smaller number an increase resp. decrease of growth may be inferred, the constancy of the points of time, at which the phenomena occur is a great aid in stating the appearance or non-appearance of an actual response. We want to point out in this connection, that GRÜNBERG (1913) in his study on negative after-images was also struck with the uncommon constancy of the moments at which the after-images appear.

IV. *When the cell after adaptation to 64 M.C. is not permanently*

put in the dark, but the light is interrupted for a short time, what will be the process of the dark-growth-response?

Experiments. The light of 64 M.C. was in the various experiments interrupted by dark for 1, 2, 3, 5, 7½, 12½, and 20 minutes. A summary result is found in the following table, in which the principal moments have been given, while fig. 1 curve 1—7 shows the average process.

TABLE I. Response of growth of cells adapted to 64 M.C., in consequence of different times of darkness.

Darkening for	Beginning of response in min. after beginning of darkening	Minimum growth		Max. growth		2nd min.	
		after	in perc. of the growth in 64 M.C.	after	in perc.	after	in perc.
1 min.	4 — 6½	7 — 9	85½ perc.	11½—14	103½ perc.	—	—
2 min.	5 — 6½	7 — 8½	77½ "	10 — 12	112 "	—	—
3 min.	4½—6½	7 — 9	83½ "	11½—13	118 "	19½—23	93 perc.
5 min.	5 — 7	10 — 12	74½ "	15½ 18½	124 "	25 — 28	85 "
7½ min.	4½—6½	8 — 10½	70 "	15 — 17	126 "	22½—24½	79 "
12½ min.	4 — 6½	8 — 10	72 "	19 — 21	145 "	26½—28	84 "
20 min.	5 — 7½	10½—12½	74½ "	28 — 29½	163 "	34½—37½	99 "
<i>Perman.</i>	3½—5½	8½—11	75 "	(15½ - 18½)	(98½ ")	± 94 perc. perman.	

In connection with fig. 1 the following may be observed. *Short times of darkness also call forth a typical dark-growth-response.*

With the short darkening of 1, 2, 3 minutes we were already struck with the fact, that after the minimum a constantly increasing maximum follows. (See esp. the table). When the cell remained in the dark, there was to be stated after the minimum also an increase of growth till just above the definite rate of growth in the dark, as had already been *previously* ascertained. But now that we darkened *for a short time* a maximum occurred, that becomes the greater according to the longer duration of the darkening, i.e. according as we put off the return of light.

It appeared that a temporary darkening causes two successive reactions resp. a dark-growth-response and a light-growth response.

In the successive experiments the *dark-growth-response* is mainly to be found on the same spot (see fig. 1 and table I) after 8—12 minutes. Only where the darkening after 1, 2, 3 minutes, i.e. very

speedily is superseded by light, the dark-growth-response cannot fully develop: the retardation of growth is earlier changed into increase of growth, so that the minimum is slighter ($77\frac{1}{2}$ — $85\frac{1}{2}$ %, instead of 70—75 %) and *consequently seems to be a little earlier* (after 7—9 min. instead of 8—12 min.). The beginning and the maximum of the light-growth-response on the contrary show themselves later with longer darkening, demonstrating in that way that it is the response to the return of light. The maximum was found with 1, 2, 3, 5, $7\frac{1}{2}$, $12\frac{1}{2}$, 20 minutes of darkening, resp. at $10\frac{1}{2}$ —13, 8—10, $8\frac{1}{2}$ —10, $10\frac{1}{2}$ — $13\frac{1}{2}$, $7\frac{1}{2}$ — $9\frac{1}{2}$, $6\frac{1}{2}$ — $8\frac{1}{2}$, 8— $9\frac{1}{2}$ minutes after the return of light, while this maximum with complete adaptation to the dark (see Licht u. Wachstum III p. 102) has also been found at 7— $8\frac{1}{2}$ minutes after the beginning of 64 M.C. This latter reaction has been added for comparison as 9th curve to fig. 1. This shows that the first maximum, even the successive sinking and a second maximum observed at one time (1918) in permanent 64 M.C., now 1920 showed itself again after a darkening of only 20 minutes. The successive curves demonstrate, how by taking the dark periods longer and longer, we are able to *analyse the response to a short darkening in a dark-growth-response (A) result of dark-fall, and a light-growth-response (B—C—D), result of subsequent exposure to light.*

Meanwhile SIERP (1921) has considered with *Avena* the response of growth in short periods of dark. In this summary we can but refer to this. Though the transition from dark to light (64 M.C.) in the successive experiments is in a physical sense every time equally great, this transition causes an ever greater maximum in the growth (resp. $103\frac{1}{2}$ —112—118—124—126—145 and 163 %), according as the cell has been darkened longer. By this it is already shown, that the cell adapted to 64 M.C. has greatly lost its sensitiveness and that the sensitiveness after the darkening increases very rapidly already from the first minutes. *This dark-adaptation* (= disappearance of light adaptation) is further shown by the following experiments.

V. *The adaptation to the dark of a cell used to light* may be demonstrated in two ways: *A.* by applying an equal quantity of light at different times after the darkening and considering how the response to this light-stimulus increases according as the cell has been longer in the dark; *B.* by determining how great the threshold of stimulation is at different points of time after the darkening.

Experiment A¹: A quantity of 256 M.C.S. (in 4 sec.) applied was

to cells, adapted to 64 M.C. at different times after the beginning of the darkening. See Table II and Fig. 2 curves 1, 2, 3, 4, 5. The first ± 15 min. after the darkening 256 M.C.S. has no effect on

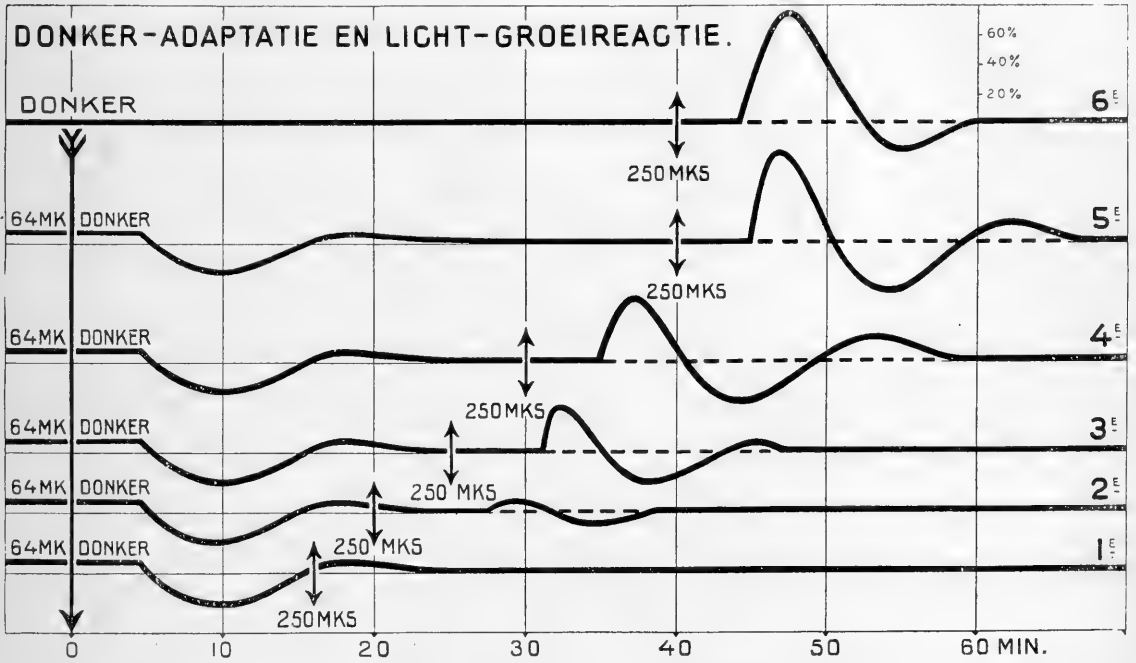

Fig. 2. Dark-adaptation and light-growth response.

the growth (curve 1), whereas this quantity does cause a maximal response by dark-adaptation (curve 6).

TABLE II. Response to 256 M.C.S. of cells, adapted to 64 M.C., at different points of time after darkening.

250 M.C.S. applied after:	Beg. of resp. in min. after exposure to 250 M.C.S.	Maximum		Minimum		2nd max.	
		after min.	in perc. of the growth in dark	after	in perc.	after	in perc.
20 min.	6 $\frac{1}{2}$ —8 $\frac{1}{2}$	8 —10 m.	107 $\frac{1}{2}$	13 $\frac{1}{2}$ —15 $\frac{1}{2}$	96	—	—
25 min.	5 $\frac{1}{2}$ —7	6 — 7 $\frac{1}{2}$ "	132	12 $\frac{1}{2}$ —14 $\frac{1}{2}$	83	19 —21 $\frac{1}{2}$	105
30 min.	4 — 6	6 $\frac{1}{2}$ — 8 "	144	12 $\frac{1}{2}$ —15 $\frac{1}{2}$	74	21 $\frac{1}{2}$ —24 $\frac{1}{2}$	116
40 min.	4 — 6	6 — 7 $\frac{1}{2}$ "	160	12 $\frac{1}{2}$ —15	69 $\frac{1}{2}$	20 —23 $\frac{1}{2}$	112 $\frac{1}{2}$
2 hours (full adap- tation)	4 —5 $\frac{1}{2}$	6 $\frac{1}{2}$ — 8 $\frac{1}{2}$ "	176	14 —16	83 $\frac{1}{2}$	—	—

Table II and fig. 2 clearly show the increasing adaptation in

consequence of the increase of response after longer darkening. Fig. 2 of course first shows the dark-growth-response, which has been left out in Table II.

Will the reaction begin earlier than by 256 M.C.S. by exposure to 1400 M.C.S.? This cannot be said with certainty, for cells adapted to the dark respond to 256 M.C.S. for the eye in growth more than to 1400 M.C.S. Moreover the question is, whether in the period of the dark-growth-response a light-response may be excited.

Experiments A². In the first ± 5 min. after the darkening 1400 M.C.S. has no effect (see curve 1 of fig. 3), so that the response to the dark takes place as usual. But applied after 6 $\frac{1}{2}$ min., light-growth-response already occurs, setting in therefore during the dark-growth-response.

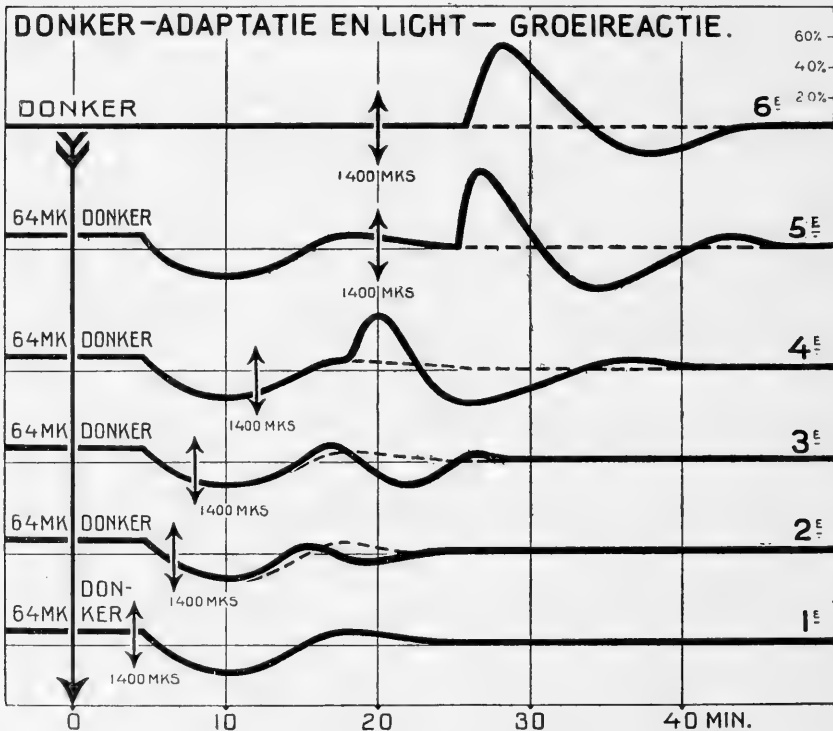

Fig. 3. Dark-adaptation and light-growth response.

See further fig. 3 and Tab. III. From this it appears in the same way as by application of 256 M.C.S., that the reaction grows stronger according as the cell has been further adapted to the dark. In fig. 2 and 3 the process of the growth is dotted, in case the latter light-stimulus had not been applied. Especially striking is the sudden sharp transition to the light-growth-response (see 3rd and 2nd curve).

After a darkening of 20 min. the response to 1400 M.C.S. has already much approached the response of cells adapted to the dark, which has been added for comparison in the 6th curve of fig. 3.

TABLE III. Response to 1400 M.C.S. of cells, adapted to 64 M.C. at different points of time after the darkening.

1400 M.C.S. applied after:	Beg. of resp. in min. after exposure to 1400 M.C.S.	maximum		minimum	
		after	in perc. of the growth in dark	after	in perc.
6½ min.	5½—7½	7½ 9½ min.	102	11½—13½ m.	98
8 "	6 —8	7 —10 "	110	13 —15 "	86
12 "	5 —7	6 —8 "	133	12 —14 "	78½
20 "	4½—6½	5½—7½ "	148	12½—15 "	73
2 hours (full adaptation)	5 —7	7¼—9¼ "	152	17 —19½ "	85

In the experiments of Tables II and III the process of the dark-adaptation — increase of sensitiveness — has *to some extent* been graphically represented by the percentages of the maxima of growth attained. Yet the quantitative proportion of the *sensitiveness* at different points of time of the adaptation-process has *not* been expressed in them, but the increase of the reaction-energy, being the result of that increased sensitiveness. But it is more important to express quantitatively the increase of the sensitiveness itself, and for that it is necessary to determine the quantities of light, causing an *equal effect* at different points of time of the adaptation-process, in order to make the sensitiveness inversely proportional. For this we prefer to choose the minimum effect, which is still perceptible to us, i.e. the limit or minimum-quantity, by which the light-growth-response occurs or with the classical term, the thresholds of stimulation.

Since it seems quite evident, that the effect of the light-energy in the cell with increasing stimuli gradually appears as response of growth and increases, we should be with this stimulus-process — and probably a great many others — careful with the tendency, lying in the word threshold. For convenience' sake we shall use the word here with that reserve.

Experiments B. In order to draw a comparison with the sensitiveness of the cell still completely adapted to 64 M.C., the threshold of stimulation was determined in cells being in 64 M.C.

When an additional 2000 M.C.S. was applied, no trace of a response

was found; when 3000 M.C.S. was administered (500 M.C. \times 6 S.), in one of the 6 experiments a faint response was observed; with 4000 M.C.S. (1000 M.C. \times 4 S) all 5 cells show a distinct response. *For 64 M.C. therefore the threshold lies between 3000 and 4000 M.C.S., i.e. at \pm 3500 M.C.S.*

Next there were applied in the dark 2000 M.C.S. (500 MC. \times 4 S); 256 M.C.S. (64 M.C. \times 4 S), 32 M.C.S. (8 M.C. \times 4 S), 4 M.C.S. (1 M.C. \times 4 S) $\frac{1}{2}$ M.C.S. ($\frac{1}{8}$ M.C. \times 4 S), $\frac{1}{16}$ M.C.S. ($\frac{1}{80}$ M.C. \times 5 S) and determined at what points of time these quantities are threshold-values. Moreover the threshold-value was determined for complete dark-adaptation. We had noticed that this was a good deal lower than the smallest quantity ($\frac{1}{4}$ M.C.S.) which was used before (see Licht u. Wachstum I).

The limit or threshold-value for the photo-growth-response of these cells adapted to the dark is at about $\frac{1}{100}$ M.C.S. This is a quantity much smaller than was hitherto used for stating vegetative reactions. By smaller quantities a reaction was sometimes perceived, but in the dark the limit is very difficult to fix, because with strongly decreasing quantity of stimulation the effect of growth decreases but slowly, about according to the cube-root of the quantity of stimulation (see L. u. W. I, which point we will further develop). So it already appears *that the cell in the dark is \pm 350.000 times more sensitive for the light-stimulus than when adapted to 64 M.C.*

Table IV gives a survey of the process of adaptation from 64 M.C. to the dark.

TABLE IV. Process of adaptation or increase of sensitiveness after discontinuance of exposure to 64 M.C.

	Limit	Proportion of sensitiveness
In 64 M.C.	\pm 3500 M.C.S.	1
after 5 Min.	2000 "	1.75
" 13 Min.	256 "	13.6
" 10 $\frac{1}{2}$ Min.	32 "	109
" 12 $\frac{1}{2}$ Min.	4 "	875
" 14 Min.	$\frac{1}{2}$ "	7000
" 15 Min.	$\frac{1}{16}$ "	56.000
Adapted to the dark (after 90—120 min.)	\pm $\frac{1}{100}$ "	350.000

In the first place it appeared, that also after the dark-growth response is finished and the growth after ± 30 min. has grown fairly constant, internally in the metabolism the dark-equilibrium has not been attained by far and will recover itself only after one and a half to two hours.

During the adaptation process the points of time may be defined fairly exactly for a fixed light-portion as threshold. For instance 32 M.C.S. gave after 25, after 26, after 27 min. no reactions, after $28\frac{1}{2}$ min. three responded, one did not. In connection also with fig. 2 and 3 on the further increase of the reaction we see that the response of growth "turns up" quickly, when once the adaptation has sufficiently advanced for that light-portion. When however the dark-adaptation has for the greater part been attained, those time limits are fainter, since the sensitiveness does not increase so rapidly as during the full adaptation-process.

The rate at which the sensitiveness increases and rises to the end- or dark-sensitiveness, may be imagined by observing in the table that from 5 — 70 min., thus *during by far the greatest part of the adaptation-process, respect. in 13, $10\frac{1}{2}$, $12\frac{1}{2}$, 14 and 15 min. the sensitiveness becomes every time 8 times greater.* Between 18 and $28\frac{1}{2}$ min. the geometrical rise appears to be strongest, between 0 and 5 min. it is geometrically yet a little slighter than between 5 and 18 min. By representing in a system of coördinates the times as abscissae, as ordinates the logarithms of the values of sensitive-

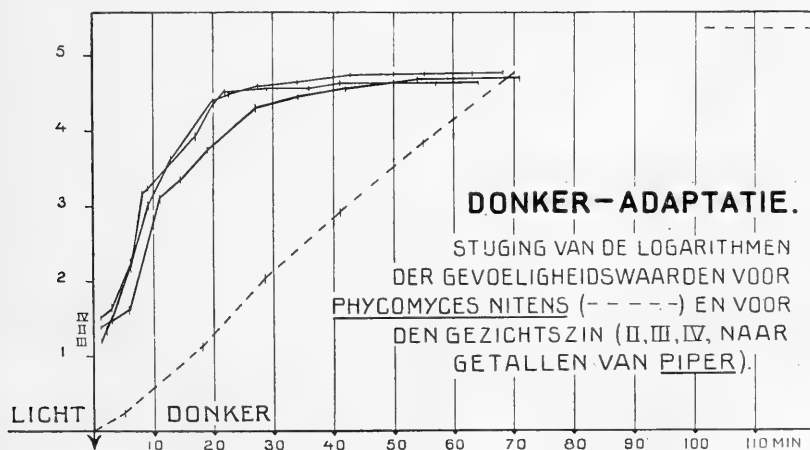

Fig. 4.

Dark-adaptation. Rise of the logarithms of the values of sensitiveness for *Phycomyces-nitens* (....) and for the sense of sight (II, III, IV according to figures of Piper).

ness (see fig. 4), a good image may be got of the geometrical increase of the sensitiveness during the adaptation. In this figure the logarithm of the value of sensitiveness has also been represented, which is finally reached after complete dark-adaptation after $1\frac{1}{2}$ — 2 hours. When however as ordinates the sensitiveness itself is represented, the ascent of the curve shows the rate of the arithmetical increase of the sensitiveness as PIPER (1903) carries it out and discusses it for the adaptation of the sense of sight.

When therefore we would graphically represent the adaptation of these cells in the way of PIPER, it would give the impression (see Table IV), that there is but a very slight adaptation in the first 30 min., that after 70 min. only $\frac{1}{7}$ of the dark-adaptation is finished, and only after that the adaptation progresses fastest (curve steepest). If PIPER's adaptation-curves are converted, by representing the values of sensitiveness instead of the sensitivenesses themselves, and if they are compared with the same representation for the cell, the strongest rise of sensitiveness in man is found earlier than in PIPER's report and only then it becomes quite clear that the adaptation-process of our sight-impression is mathematically not so simple as with these cells. For three curves with an average course (II, III and IV of PIPER's observers) the logarithm of the values of sensitiveness has been represented in fig. 4. In the main 4 phases may be distinguished: a rather rapid one (first 3—6 min.), a very rapid one (3—6 to 8—12 min.) a rather rapid one (8—12 to 20—27 min.) and a very slow one (after 20—27 min.). When comparing we get the impression, that with the cell-adaptation we have to deal with a simpler process, though the same phases may be faintly distinguishable.

We have still to add that we determined the thresholds in these cells with fixed *quantities* of light, while for the human eye only *intensity*-thresholds have been determined. That makes the comparison more difficult. Determination of quantity-thresholds for the eye might picture the adaptation-process differently and more accurately. Moreover PIPER is wrong in not giving *the exact intensity* to which the eye was previously exposed, in beginning his first observations only after about 1 min. dark without an observation *in* light and in taking this first observation as *zero* in his curves.

Finally we may observe, that the width of adaptation with these cells is 1 : 350.000. With man it is according to PIPER only 1 : 2 to 8000; in consequence of the measuring of the intensity-threshold, and the mis-stated initial intensity a perfect comparison is not possible,

though it seems a great deal slighter than with the *Phycomyces*-cells.

VI. After it had already appeared in the research on the adaptation to dark, that the sensitiveness to light being in 64 M.C. is 350.000 times less than in the dark, we could further consider the course of adaptation when the cell has been previously adapted to fainter or stronger light. For the present however we had to restrict ourselves to the question: *How much changes the tone or degree of sensitiveness, when the cells have been adapted to different intensities of light?*

Experiments. After a stay of at least 2 hours in different intensities it was determined, what quantity of light was just able to call forth a light-growth-response, while the cells remain in that intensity. In Table V the result of these experiments is briefly summarized.

TABLE V. Proportion of sensitiveness after adaptation to different intensities.

Adapted to	Limit	Proportion of sensitiveness.
64 M.C.	3000—4000 M.C.S.	1
8 "	200—400 "	8,75—17,5
1 "	25—50 "	70—140
$\frac{1}{8}$ "	3—6 "	580—1160
$\frac{1}{64}$ "	0,4—0,8 "	4375—8750
$\frac{1}{512}$ "	0,1—0,2 "	17.500—35.000
Dark	$\pm 0,01$ "	± 350.000

Now it appears, that for intensities of $\frac{1}{64}$ M.C. to 8 M.C. the sensitiveness decreases proportionally to the intensity to which the cell has been adapted. In 64 M.C. the sensitiveness seems to have lessened still more than would be expected according to this rule. To the very lowest intensities this rule could not hold good, because then the sensitiveness would become infinitely great in the dark. So we see after all that in $\frac{1}{512}$ M.C. the sensitiveness in comparison with $\frac{1}{64}$ has not increased 8 times, but only 4 times more. Yet it is already striking that it holds good to $\frac{1}{64}$ M.C.

One would be inclined to simply accept that one had to deal here with the law of WEBER. Yet we should be careful in making a comparison. We have here the very elementary case of one single cell, for which we have demonstrated as follows:

When the growth of *Phycomyces*-cells has been adapted to intensities of $\frac{1}{64}$ to 8 M.C., the quantity of light still calling forth a response of growth (the threshold of stimulation) rises proportionally to that intensity.

In verifying the law of WEBER two stimuli are compared with each other, which are unequal but applied in the same way, and the proportion is determined which is still observed as different. Here however the cell has been adapted to an intensity and we simply determine the *quantity* of stimulus which — applied in a short time — is threshold of stimulation with that adaptation. The cell therefore has been adapted to one stimulus, while the other stimulus is quickly applied as a portion. In fact this is another and more elementary experiment than the comparison of two intensities. As however the rule obtained so much resembles the law of WEBER for the comparison of two intensities, it is very probable that in point of principle we have to deal with the same phenomenon. Not in that sense that with the sensitiveness to light of this single cell there would be question of any psychical condition or power of discrimination, but conversely that these psycho-physical rules for the human perceptive faculty are at bottom based on simpler reactions in the individual cells to which those rules are already applicable.

It further deserves attention, also with a view to experiments and placing in so-called weak light, *that in a so slight intensity as $\frac{1}{64}$ meter-candle* these cells are already ± 15 times less sensitive than in the dark.

After these quantitative measurements of the adaptation or tone-change we have still to emphasize what follows. While the growth e.g. in 64 M.C. is only 6 or 7 % more than in the dark, so that for the rest such a cell at its growth cannot be distinguished at all from a cell in the dark, there is inwardly after adaptation to light quite a different condition, a different "*tone*". For that appears directly from the quantity of light that is wanted to induce such a cell adapted to light to a light-growth-response. The tone (condition of adaptation or degree of sensitiveness) is quite different and especially in this response of growth the phenomenon of adaptation appears in much purer form than in phototropical movements. The phenomena of tone already appearing in phototropical reactions and the subject of much study [see e.g. BLAAUW (1909), PRINGSHEIM (1909),

especially ARISZ (1915), BREMEKAMP (1918), v. D. SANDE BAKHUYZEN (1920),] occurring in consequence of longer exposures must not be exclusively taken as a consequence of the progress of the responses of growth.

It is perfectly true that part of the phototropical "tone"-phenomena may be solved as a result of the process of growth at the front and backside (see v. D. SANDE BAKHUYZEN). But it should not be forgotten, that there is also a real change of tone which has a deeper base and is much more important in principle. In prolonged exposure real changes of tone (= phenomena of adaptation, i.e. changes in the degree of sensitiveness to light) *principally act a very important part* in part of *those* processes, which *underlie* the growth and *precede* the result of the growth. *The result* of this altered sensitiveness appears to us in the response of growth as an external symptom. We had better not use the word sensitiveness *of growth* (as we previously did occasionally, see L. u. W. III), because it might be easily forgotten, that at bottom sensitiveness to light rests with part of those deeper processes of metabolism, from which the growth secondarily results. Yet for convenience' sake we may call the growth (as well as the whole plant) "sensitive to light" as it is generally done in physiology with a number of phenomena of sensitiveness; provided we remember, that in most cases but some primary fraction of the larger complex is really sensitive to that factor and perceives it, while all the rest of the phenomena are only resulting reactions.

We have had to restrict ourselves to a summary of our research. The full data and a further discussion of the results and the literature will be published later on, while the researches on responses of growth are being continued.

Wageningen, March 1921.

LITERATURE.

ARISZ, W. H., Untersuchungen ü. d. Phototropismus. Rec. d. Trav. Bot. Neerl. 1915. 12.

BLAAUW, A. H., Die Perzeption des Lichtes. Rec. d. Trav. bot. Néerl. 1909. 5. — Licht und Wachstum I (Zeitschr. f. Bot. 1914. 6), II (Zeitschr. f. Bot. 1915. 7), III (Meded. v. d. Landbouwhoog. 1918. 15).

BREMEKAMP, C. E. B., Theorie des Phototropismus. Rec. d. Trav. Bot. Neerl. XV 1918.

GRÜNBERG, K., Unt. ü. d. Period. d. Nachbilder. Z.schr. f. Biologie. 1913. 61.

PIPER, H., Ueber Dunkeladaptation. Z.schr. f. Ps. u. Ph. der Sinn. 1903. 13.

- PRINGSHEIM, E., Stud. z. heliotrop. Stimmung. Cohns Beitr. 1909. **9**.
- SANDE BAKHUYZEN, v. D., H. L., Analyse d. Fototrop. Stemningsversch. Diss. Utrecht 1920.
- SIERP, H., Ein Beitr. z. Kenntnis des Einfl. d. Lichts auf d. Wachstum d. Koleopt v. *Avena sativa*. Z.schr. f. Bot. 1918. **10**. — Ber. d. D. Bot. Ges. 1919. **37**. — Zeitschr. f. Bot. 1921. **13**.
- VOGT, E., Ueber d. Einfl. d. Lichtes a. d. Wachstum der Koleopt. v. *Avena sativa*. Zeitschr. f. Bot. 1915. **7**.
-

Experimental Psychology. — "*Psychical Inhibition*". By Prof
E. D. WIERSMA.

(Communicated at the meeting of June 25, 1921).

From daily experience we know that simultaneous sensations have an inhibitory influence on one another. During the day the light of the stars is not observed. Soft sounds, distinctly audible in the dead of night cannot be heard during the randomness of day time. The weak stimuli of the skin are nullified by the stronger. The psychical inhibition, under which is to be understood, that one psychical complex influences the other, so that intensification of the one entails a weakening of the other, was investigated by HEYMANS some twenty years ago. By numerous and careful experiments he determined the underlying principles. Although it is evident that the inhibitory process does not limit itself merely to sensations, it is important to determine experimentally that also other psychical complexes are subjected to similar laws. It is not easy to express this in definite measurements for all other complexes of consciousness, as ideas and emotions; but for volitional acts it is very well possible.

The investigation was carried out as follows: The individuals experimented upon were young, students and assistants. They were instructed to write down the numbers 1 to 25 as quickly as possible. The time was accurately registered by means of a $\frac{1}{5}$ second-metre. Repeatedly after approximately a quarter of an hour, when fatigue was out of the question, these experiments were repeated three times, once while a dynamometer was squeezed as tightly as possible, a second time while a foot was pressed against a fixed resistance, and thirdly while the teeth were firmly clenched. In all these experiments the dynamometer was held with the left hand to equalize the relations as much as possible.

The inhibitory influence from the movement of the left arm, the right leg and from the clenching of the teeth is obvious. The movement of the left arm inhibits most strongly, the clenching of the teeth less, and the movement of the right leg least of all. (See table).

In writing down successive numbers, an associative activity, which

was excluded in the following proofs, takes place beside the motion function.

Number of seconds with resistance in percentage of that without inhibition.

Subject.	Dynamom. Pressure	Foot Pressure.	Clenching the teeth.
H.	120.0	100.0	106.7
	128.6	107.1	114.3
	100.0	100.0	94.1
	118.8	100.0	100.0
D.	140.0	106.7	120.0
	135.8	100.0	100.0
	118.8	108.3	106.3
	131.3	106.3	106.3
G.	123.5	105.9	111.8
	111.1	94.4	105.6
	117.6	105.9	105.9
	123.5	105.9	111.8

The subject was requested to make as many strokes as possible. The number of strokes in 15 seconds was counted. These experiments were repeated twice, on the first occasion the dynamometer was squeezed continuously as tightly as possible, and the pressure was accurately registered on a kymograph; in the third instance the dynamometer was continuously pressed forcibly with the right foot, and the pressure was registered once more. To secure the same conditions the dynamometer was constantly held in the left hand, in each case including those in which it was not squeezed. In this way it is possible to ascertain, whether a disturbing influence affects the pressure of the hand, and the foot on the dynamometer in writing down strokes, and whether this pressure disturbs the latter. The disturbing influence of the pressure movement can reveal itself in the diminished number, but also in the irregular pressure. This can be registered by making use of the pen of HENRI with which the pressure of each stroke act can be measured.

Experiments were performed on three individuals on nine successive days.

Number of strokes during disturbance in percentage of these in rest.

Percentage of strokes. Squeezing.	Percentage of strokes. Legpressure.	Percentage of strokes. Squeezing.	Percentage of strokes. Legpressure.	Percentage of strokes. Squeezing.	Percentage of strokes. Legpressure.
W.		H.		Ha.	
92.1	98.4	93.2	97.4	91.8	98.8
92.1	95.4	89.3	96.2	98.8	95.1
93.7	97.0	94.9	92.6	89.4	95.3
95.2	95.5	93.9	89.8	87.7	93.8
93.1	95.2	92.8	97.5	93.8	95.1
94.2	98.5	94.2	93.1	95.2	94.0
93.1	91.9	94.0	96.4	90.8	91.9
94.2	96.1	88.5	87.8	94.0	91.9
94.7	89.2	86.5	91.0	89.3	96.4

From the experiments it is apparent that no disturbing influence on the stroke test reveals itself in the pressure, which is practically always constant. On the other hand there is a marked disturbance in the number of strokes, and the left hand pressure constantly causes a more distinct disturbance than the leg pressure.

Moreover the stroke test causes a distinct inhibition on the squeezing of the dynamometer and on the foot pressure. The irregularity and the slow decline of the curve show this clearly. (See figures).

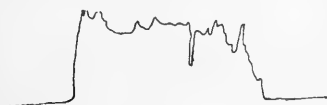

Fig. I. Foot pressure on dynamom. during stroke test.



Fig. II. Foot pressure on dynamom. apart from stroke test.

Further it was investigated to what extent a simultaneous, continuous exertion of the left hand inhibits the squeezing effect of the right hand. It appears that the will-impulse from the left hand influences inhibitorily the squeezing effect of the right hand, when the former keeps in equilibrium a weight of 8 kg., which can be moved up and down over a pulley. The dynamometer was squeezed five times at intervals of 15 seconds each. At first the dynamometer was squeezed without disturbing influences, then with disturbing influences, and after a quarter of an hour the experiment was

repeated in reversed order. The percentages obtained under simultaneous will-impulses show clearly an inhibition during the three days on which the experiment was performed.

	Percentage of squeezing force during inhibition.
O.	86.2
	84.8
	89.7

After this result it was to be expected that the extent of inhibition would also reveal itself in the squeezing force. Therefore the same experiments were repeated on different individuals under an inhibiting pressure of 3 kg., 6 kg., and 8 kg.

Subjects.	Percentage during inhibition of		
	3 kg.	6 kg.	8 kg.
O.	95.4	91.4	82.8
	89.8	88.2	86.9
	96.9	95.4	89.3
Ha.	98.4	93.3	88.6
	97.7	91.7	82.5
	95.4	86.8	82.3
	93.2	90.1	85.3
K.	94.5	90.3	91.0
	91.0	89.0	87.5
D.	93.7	92.2	92.2
	100.0	96.2	96.2
G.	100.0	93.3	84.1
	100.0	102.7	94.6

From the above table it is evident that two simultaneous will-impulses exert an inhibitory influence upon each other, as was already determined for the sensations.

The question therefore arises, whether similar rules are applicable to subconscious psychical complexes. By numerous experiments it has been determined that the total contents of our consciousness embrace far more than we are aware of at a definite moment. Practice depends upon subconscious after-effects. It would be impossible to read and understand a book or to follow a lecture without such after-effects. Tact and experience are manifestations of subconscious psychical after-effects. Some experiments personally performed, and which exemplify the mutual influence of central consciousness upon subconsciousness, and of subconsciousness upon central consciousness I shall annex here. For these investigations hypnotic states are most suitable.

I instructed two individuals in hypnotic state to re-read six pairs of meaningless syllables, so often till they could repeat the paired syllable when only the first was mentioned according to the "treffer" method.

Subject.	Number of repetitions.		Percentage Gain.	Number of repetitions. Awake without previous hypnosis.
	Hypnosis.	Awake.		
C.	14	7	50	23
	15	9	40	21
	17	9	47	24
	22	10	54.1	20
	12	7	41.7	
	12	6	50	
	12	5	58.3	
	15	7	53.7	
F.	14	7	50	20
	17	8	52.9	23
	15	9	40	21
	14	9	35.7	22
	15	6	60	
	17	8	52.9	
	18	10	44.5	

Both subjects were in a state of somnambulism and could recollect

nothing of the experiment in a wakened state. An hour later I repeated the experiment in a wakened state with the same syllables. It appeared that the syllables could then be memorised with considerably less difficulty. This experiment was repeated several days every time with different pairs of syllables. To avoid the objection that one possibly memorises better in a wakened state, I made them learn by heart different syllables, in the same state during four days, at the same time of the day, and it appears that these must be read far more often in a wakened state.

The influence of subconscious psychical complexes is clear from the considerably diminished difficulty. Another clear proof of the influence of subconscious psychical complexes upon the consciousness is afforded by the following case. A patient in a rather advanced state of tuberculosis of the lungs complained of bilious colic which necessitated an operation. Some twenty years previously I had often treated the patient hypnotically, and therefore my colleague Koch consulted with me as to the possibility of performing the operation under hypnosis. We agreed to have everything prepared for narcosis in order to make immediate use thereof in case of insufficient effect of hypnotic suggestion. Fortunately this was not necessary. During an hour and a quarter the patient was kept under hypnosis, insensibility being suggested all the while. The operation complicated by synechia of the gallbladder was completed without the least disturbance. The patient did not give the slightest sign of pain for a single moment. Some time after the operation the patient awoke and recollected nothing of the operation. Nevertheless all that had happened during the operation appeared to be present in his subconsciousness, for brought under hypnosis anew he very well recollected that Prof. Koch had said: "Keep the hands off". "Here I have a stone". "Here is another". And no more had been said during the operation.

From this the existence of the subconscious psychical complexes is evident, but their influence upon the consciousness appeared clearly from another experiment. On account of his tuberculosis his doctor had forbidden him to smoke, but he seemed so addicted to it that he smoked all day. To rid him of this habit I suggested to him under hypnosis that he had lost all desire to smoke, and since then (\pm one year) the patient does not smoke any longer. He has lost all inclination. He is unaware of the imparted suggestion, which he only recollects in hypnotic state and not in a wakened state. From this the influence is therefore evident of the subconscious suggestion upon consciousness.

Between conscious and subconscious psychical complexes there

exists merely a comparative degree of difference. The fluctuations in the attention have taught that weak sensations lie at times above and at times below the threshold of consciousness. One can voluntarily raise the degree of consciousness by removing the inhibitory influences. Differences in degree also exist between the conscious psychical complexes. If we have our attention concentrated upon a definite word, while we read, then we see this word distinctly, while we hardly observe the other letters.

Similarly we may assume that differences in degree also exist between subconscious psychical complexes. Some impressions still lie immediately below the threshold of consciousness, while others have sunk deep into subconsciousness. As the principle differences between conscious and subconscious psychical complexes are slight we may assume that the same rules may be applied to them. The inhibitory effects which have been determined for sensations and acts of volition will then be applicable to the subconscious afferent and efferent impulses.

From experience we know that cough and sneeze reflexes are greatly under influence of consciousness.

In case of a severe cold coughing and sneezing are usually immediately arrested when the mind is preoccupied during a lecture. It is remarkable that one coughs and sneezes much less in states of diffuse consciousness as during sleep. In the former case the threshold of the afferent stimulus is raised by the competition of other synchronous complexes of consciousness, in the latter by division of the psychical energy amongst numerous ideas.

Similarly the annoying secretion of mucus caused by a catarrh of the nose, in which the afferent stimulus remains altogether subconscious disappears or is appreciably lessened during intense pre-occupation, and during diminution of consciousness.

A newly born child makes sucking movements as soon as the lips, or the soft palate are touched. This reflex afterwards disappears altogether, when the tongue and lips are used for other purposes. The sucking reflex has however not disappeared, but is merely inhibited, for under circumstances under which the inhibition of the voluntary movements disappears, as in an advanced state of *Dementia Senilis* or *Dementia Paralytica* the sucking reflex reappears.

The palm reflex of small children which is elicited, when the palm of the hand is touched, disappears at a higher age, when voluntary movements are more and more developed. This palm reflex reappears, when the inhibitory action of these voluntary movements is diminished, as, for instance, in the case of the greatly

lowered consciousness of Dementia Senilis and Dementia Paralytica. This also occurs when a lesion of the pyramidal tract disturbs the transmission of voluntary movements.

Pathology teaches us the same with regard to lacrimal secretion. The melancholicus, who is occupied by his dismal thoughts, hardly sheds any tears.

The above cases show clearly that consciousness has a constant influence upon certain reflexes. Other experiments bring clearly to light an inhibitory influence of synchronous efferent impulses.

A very young child shows the reflex of BABINSKI when the sole of the foot is stimulated. Later, when the child begins to walk, the toes are voluntarily flexed at each step, in order to stand firmer on the ground. Here voluntary movements become afterwards a reflex movement and by each stimulus of the foot sole a bending is elicited. Here too, the original sign of BABINSKI is not annihilated, but simply superseded, for in all cases, in which the efferent impulses of the plantar reflex cannot be elicited, and in which therefore their inhibitory influence has disappeared, the sign of BABINSKI is observed.

This is the case when the Pyramidal tract is disturbed and also in the case of diminished consciousness as normally in deep sleep of children up to the age of 13 years, and pathologically, for instance, in epileptic coma.

Since the mutual inhibition of conscious complexes is also applicable to mutual inhibition of subconscious psychical phenomena, the question is, in my opinion, justifiable, whether similar circumstances are not active in the cases of inhibition thus far poorly explained.

It is known that inhibitory influences are exercised upon the knee jerks by the cerebrum. Are there therefore synchronous motor impulses which inhibit the knee jerks? I should say the answer must be confirmative. A flux of impressions transmitting information as to the position of the limbs continuously travels from the periphery to consciousness. Consequently the easiest and pleasantest position is constantly assumed. At first that movement will probably be voluntary, but in course of time it becomes an involuntary and a reflex movement. We could therefore speak of the position reflexes, which are constantly present, and which must have an inhibitory action on synchronously elicited knee jerks. If it is true, that the position-reflexes exercise a disturbing influence, then the knee jerks must be higher, when the position-reflexes are absent or diminished. This actually appears to be the case, for the knee jerks of young children, where the position-reflexes do not yet exist, are exaggerated.

Only during later life, when the position-reflexes develop, the knee jerks gradually diminish. Further, a diminution in the position-reflexes is accompanied by exaggeration of the patellar tendon reflexes. The position-reflexes can be diminished under two circumstances. Firstly, the degree of consciousness of the centripetal stimulus can become weaker, and, secondly, the centrifugal motor impulse can be disturbed in its transmission. In both cases the inhibitory influence on the knee jerks will be diminished. The former occurs during strong pre-occupation, so that for instance the knee jerks are exaggerated in cases of hysteria, melancholia, or states of anxiety. Moreover, the centripetal stimuli will also be perceived less during a general relapse of consciousness as occurs normally during deep sleep or fatigue. Pathological relapses as Neurasthenia and states of dementia are usually accompanied similarly by exaggerated reflexes. The motor impulse of the position-reflexes will be disturbed in its transmission by lesions of the pyramidal systems, through which consequently the inhibitory influence upon the knee jerk is also absent.

In accordance with these facts, the knee jerks are diminished when strong impressions from without, emotions or other preoccupations, are as far as possible excluded. Then the adaptation to these perpetually centripetal impulses is greatest.

Other inhibitory influences upon the patellar tendon reflexes are also of great importance. SHERRINGTON has shown that each voluntary and each reflex muscle-contraction is accompanied by a synchronous relaxation of the antagonists. Here too, I should think the question must be raised, whether this relaxation of the antagonists is not to be regarded as an inhibitory influence from the simultaneous contraction of the agonists. A muscle is in a state of a certain tension, which is caused by a stimulus originating in the muscle itself. This muscle therefore is in a reflex tonus-state, which will diminish — analogous to the inhibition of simultaneous sensations or of simultaneous will-impulses, — when synchronous competing afferent stimuli arise, as these originating during the stimulus of the knee jerks, or when the simultaneous efferent impulses of the knee jerks are present. It appears to me, that the simultaneous relaxation of the antagonists during contraction of certain muscle-groups, which SHERRINGTON drew attention to, should be regarded in this manner. It is not even necessary that the agonists contract in order to acquire this relaxation of the antagonists. The arm of a patient with complete paralysis of the radial nerve was brought into such a position, that the slight tonus of the flexors maintained this position, and that without this tonus the arm would be extended by the force of

gravitation. If then the patient tried to extend the hand, this movement immediately took place. From this it is quite evident, that by the will-impulse to move the paralysed extensors the tonus of the flexors diminishes.

Would it not be possible that similar restraining phenomena accompany the act of micturition? In the bladder we have two muscles working antagonistically, the detrusor and the sphincter vesical. The empty bladder is shut off by a reflex closure of the sphincter. As soon as the quantity of urine, gathered in the bladder, is so large as to cause an efficient stimulus by distension of the bladder, the muscle fibres of the detrusor come into contraction. Simultaneously with this contraction of the detrusor, the sphincter relaxes. Here, therefore we have an inhibitory influence of simultaneous reflexes, just as for the patellar tendon reflexes. In this manner micturition sets in at regular times for newly born children. The reflex contraction of the detrusor can also be promoted by cold, and by other cutaneous stimuli, by emotions, etc. At a later age the peripheral stimulus is perceived as a desire, and as the child is brought up the attention is directed upon it. The desire can be voluntarily diminished or increased by distracting or concentrating the attention, and this is accompanied by the weaker or stronger reflex contraction of the detrusor and reflex relaxation of the sphincter. Micturition is therefore voluntary only in as far as the feeling of desire can be voluntarily increased or diminished to a certain extent by the concentration of the attention.

The influence of consciousness upon micturition is experimentally easily determined. During some days the quantities of urine were measured of some psychical normal and of some psychical abnormal individuals. The object of the experiment was kept cautiously secret. Only the quantities discharged simultaneously with defaecation, were not measured. (See tables following pages).

From these tables it is evident that during preoccupation and during diminution of consciousness, almost always greater quantities of urine are collected in the bladder. Due to distraction the desire is diminished, and consequently the contraction of the detrusor is retarded, and the restraining action of the sphincter is postponed.

When as a result of lesions of the spinal cord the desire is no more felt, and the micturition can no more be regulated, due to more or less concentration of the mind, then the bladder is again emptied regularly after certain filling. The quantities of each involuntary discharge of urine of a patient with total transverse lesion of the spinal cord is given below: (See Table)

ABNORMAL PERSONS.

Melanch. C.	Melanch. Mrs. Pr.	Hysteria. Miss T.	Psychasth. Mrs. K.	Praecox, Stupor. Mrs. v. d. B.	Hysteria. Miss F.	Praecox, Stupor. Mrs. S.	Stupor. J. V.
	700	600	340	750	800	500	810
700	900	360	500	500	260	750	800
600	490	250	810	600	400	1650	820
1000	510	580	350	100	1000	600	770
750	1000	470	230	750	600	490	830
1150	400	730	550	750	270	750	960
1100	1100	340	350	450	800	740	630
1000	980	400	130	650		1000	570
990	1300	400	170	250		1300	490
910	1510	320	770	350		1550	620
	910	750	360	750		650	440
	890	400	90	650		500	
		80	610	600		1250	
		650		675		1100	
		560		700		750	
		600		700			
		700					

100	150	150	150	100	120
150	200	200	200	195	200
150	150	100	200	150	160
100	100	200	150	205	200
150	50	150	200	75	150
150	100	150	150	155	200
100	50	150	150	160	90
150	150	100	50	150	
100				160	

Must, therefore, all inhibition-processes be ascribed to synchronous competing influences? For this purpose a separate investigation into each phenomenon is necessary. I should like to touch upon one more, viz. the inhibitory influence upon the function of the heart through vagus stimuli. In 1845 the phenomenon was for the first time described by the WEBER brothers. Of this GLEY says: "Mais quelle est la nature intime de cette action? On dit que c'est un phénomène d'inhibition ou d'arrêt. Jusqu'à la découverte des frères WEBER l'idée d'excitation fut en physiologie étroitement liée à celle de mouvement; après cette découverte il fallut bien admettre que l'excitation d'un nerf centrifuge peut arrêter un mouvement. Alors la notion des phénomènes d'arrêt s'étendit peu à peu et elle établie aujourd'hui sur de nombreuses preuves. Mais nous ignorons toujours en quoi consiste exactement l'action inhibitoire". If this heart-inhibition is to be considered in the same manner as the above inhibition-processes, then there would have to be present two simultaneous motor impulses too. ROSENZWEIG, BOTTAZZI and GASKELL showed that in the auricle of the tortoise there is a muscle-layer directly beneath the endothelium, quite different from the rest of the cordiac muscle. By stimulation of the vagus the slow, rhythmical contraction of this muscle is intensified, while the rest of the cordiac muscle is weakened in its action. And, on the contrary stimulation of the sympathetic accelerates the heart action and inhibits this involuntary muscle-layer. Here therefore the inhibitory influence upon the heart by means of simultaneous efferent stimuli, exists in the same manner as in the case of the bladder function, the knee jerks etc. May we then assume the same for higher vertebrates? Here the circumstances are different, for we miss a so distinctly developed muscle-layer beneath the endothelium.

But it is however known that there exists another muscle-layer besides the cordiac muscle, viz., the bundle of HIS-TAWARA, which is found beneath the endothelium and ends in the fibres of Purkinje. In order to ascertain whether this bundle can contract the hearts of just previously slaughtered sheep were brought from the abattoir to the laboratory in their blood and warmly packed, on three occasions. In the laboratory a piece of cordiac muscle was immediately removed and placed in a chamber of ENGELMANN through which flowed defibrinated serum, previously oxygenated and kept at a temperature of 37° C. By means of an electrical stimulus a definite contraction in the cordiac muscle could be observed in this way. In two of the three cases it appeared histologically that a few cordiac muscle fibres were still present, but in the last experiment

these were wanting altogether. We may therefore assume that this tissue can contract. If we could ascertain that this bundle is innervated by the vagus nerve, we should have precisely similar circumstances as in the tortoise-heart. This however cannot be ascertained. The distribution of sympathetic and vagus nerve in the heart seems histologically uncertain.

I should think that for the mammalian heart we have reason to assume the possibility that here too the inhibition must be ascribed to simultaneous efferent impulses, in analogous manner as described for the knee jerks. Even if the vagus stimulus elicits but a slight contraction of the muscle bundle of HIS-TAWARA, it is still very well possible, that this is the reason to which inhibiting influence upon the contraction of the heart is due.

Medicine. — "*Simple and alternating footclonus.*" By Prof. I. K. A. WERTHEIM SALOMONSON.

(Communicated at the meeting of May 28, 1921).

In ORDENSTEIN'S thesis, written under CHARCOT and published in 1863, the first exact description of footclonus is to be found. Since then it has been the subject of much investigation and of many publications. From these last it would seem that the mechanism as yet has not been fully elucidated. We know that footclonus is produced by rhythmical contractions of the calf-muscles, but there is some doubt about the behaviour of the anterior muscle group. Are these muscles at rest during the clonus, or is clonus caused by alternate contractions of the tibialis anticus group and the triceps surae? Is the clonus a simple or an alternate one? DUBOIS, working under CHARCOT, described it in 1868 as an alternate phenomenon. In 1875 it was represented as a simple clonus solely caused by the action of the triceps surae by ERB and by WESTFAHL. BLOCQ and ONANOFF are of opinion that the tibialis anticus actively participates in the movement. PETITCLERC says the same, but he thinks that the tibialis contractions cannot be felt (?). STERNBERG vindicates an alternating character only for the spontaneous footclonus, the ordinary footclonus being caused by rhythmical contractions of the soleus-group only. CROCQ is of the same opinion.

The observation of a patient in whom I was able to elicit a perfectly isolated clonus of the musc. extensor longus hallucis and likewise an isolated clonus of the m. tibialis anticus, caused me to construct an apparatus for graphically recording the contractions of the separate muscles of the leg. Once fixed to the leg, the apparatus could be used whilst the limb performed the most violent movements during a footclonus. A pair of metallic clamps were fastened on the leg, one resting on the upper part of the tibia, the other on the malleoli. A thinwalled brass tube connects the clamps. This tube proved to keep its position in relation to the tibia during any movements of the foot or of the leg itself. I could therefore use the tube as a support for two MAREY receiving capsulae, each bearing a small pelotte, which pressed on the muscle, the contractions of which were to be recorded. The thickening of the muscle was inscribed

in the ordinary way on a rotating smoked drum, at the same time as a time curve giving 0.1 of a second. The recording MAREY-tambours gave a magnification of the muscle thickening of only 3 times; the

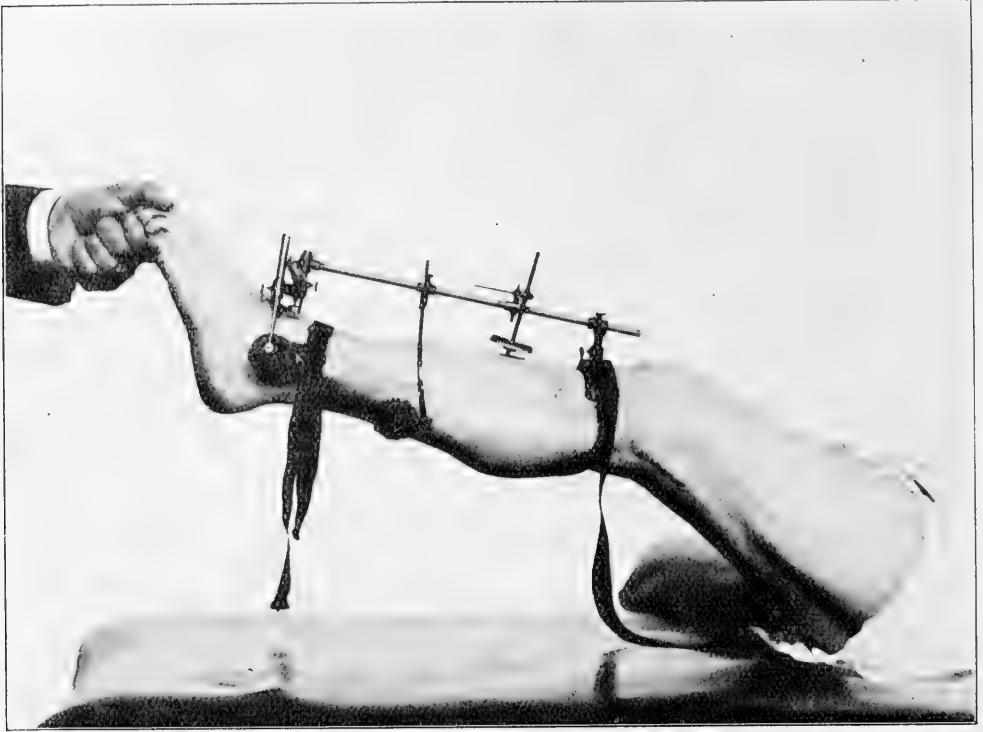

Fig. 1.

recording levers weighed about 11 milligrams, their length being 7 centimeters.

With this apparatus (fig. 1) a great many records of footcloni were taken. As a matter of fact a visual and tactile examination was first made, and a graphical record was only taken either to make sure in a doubtful case, or more often to have a permanent record of some fact otherwise observed. In by far the most cases the apparatus was not needed, as during the clonus not the slightest contraction could be either seen or felt in the dorsal extensors of the foot or their tendons. Palpation in these cases is a very reliable mode of examination, especially if the hand be rested on the edge of the tibia. In the commencement of my series of experiments I made a good many records, just to make sure that a clonus was only a simple one. But I soon found that if no contractions could be felt, the recording lever invariably made a straight line.

In a few cases the tibialiscurve showed slight oscillations as in fig. 2. We easily find that these are not caused by real muscle

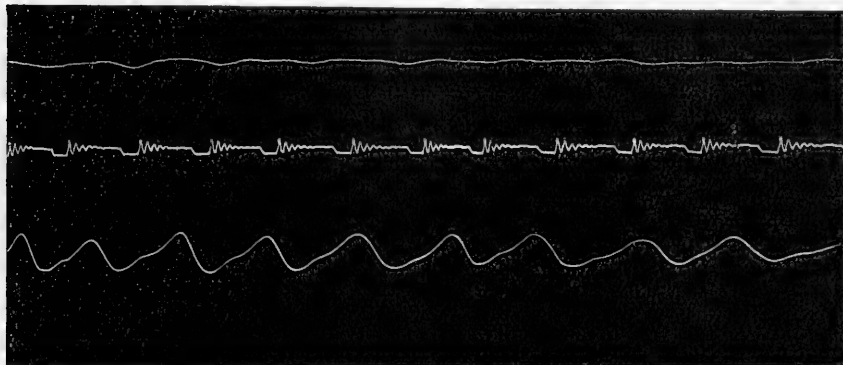

Fig. 2.

contractions, but by passive stretching of the muscle substance, the fascia and of the skin. The tibialis seems to thicken at exactly the same moment that the gastrocnemius contracts; this would mean isochronous contraction in the antagonistic muscles, which a priori would seem to be improbable. But the experiment shows that also a very slow passive flexion of the foot stretches the skin, the fascia and even the tibialis muscle itself, so as to cause a pelotte placed on the muscle to rise a little, at least if the pelotte be placed too near the knee. If it were placed too far away from the knee, much farther than the thickest part of the muscle, I obtained curves as in fig. 3, in which the passive extension of the tibialis shows itself by a slight downward movement of the recording lever. Between these two positions we are always able to find an area where the receiving tambour may be placed so as not to be disturbed by passive movements of the foot, whereas contraction of the tibialis anticus are faithfully recorded.

The placing of the receiving tambour on the gastrocnemius must also be done with the greatest care.

At first I placed it laterally upon the muscle; afterwards I preferred to apply it exactly in the middle line, slightly above the thickest part of the muscle. With the pelotte against the lower part of the muscle or even against the tendon it is impossible to get satisfactory records.

In contrast to numerous cases of simple footclonus we find every now and then a rare case in which inspection and palpation immediately show a participation of the anterior muscle group. Records of such cases of alternating clonus are shown in fig. 4—7. In all

these records the instrumental magnification is about the same, viz. about 3 times. The tracings show strong contractions, just as we feel them to be. We see from the curves that the contractions of

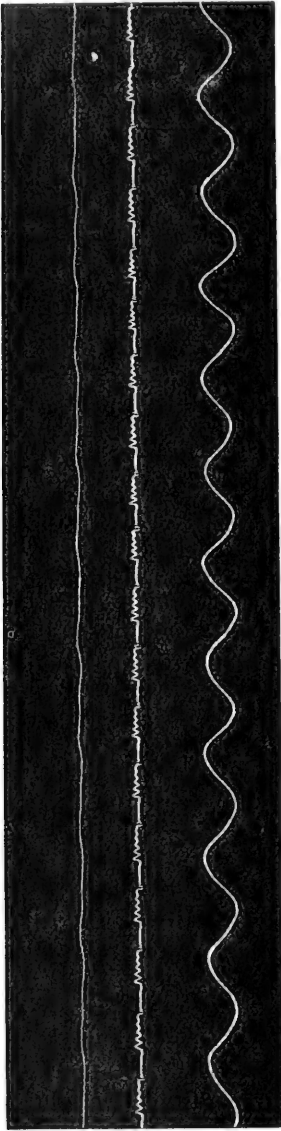

Fig. 3.

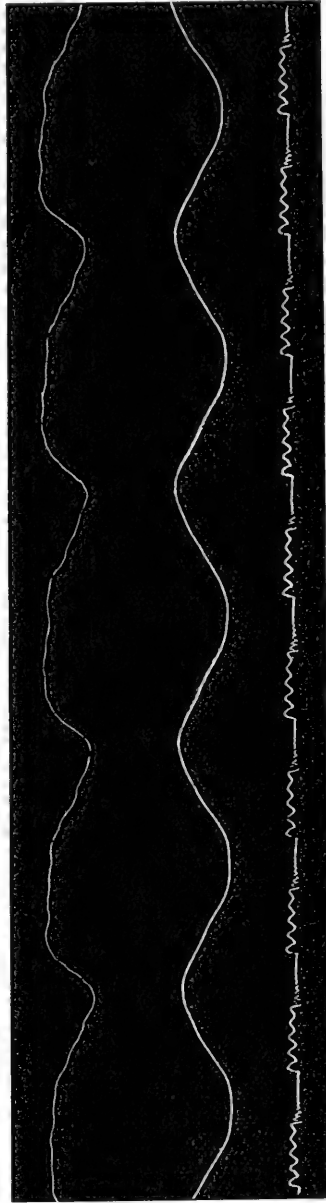

Fig. 4.

the calf-muscles alternate indeed with those of the tibialis anticus: the contractions of one group relax during the contractions of the other group.

The curves of the contraction of the anterior muscles as well as those of the gastrocnemius show a few peculiarities. The curve of

the gastrocnemius in fig. 4 — as in all the other figures the lower one — somewhat resembles a sinusoidal line. The contraction- and relaxation-times are nearly equal, lasting about 0.08 second. At the highest point of the curve the m. tibialis abruptly begins to contract. The steep ascending part takes only 0.047 second, which is only about half the contraction time of the gastrocnemius. The tibialis contraction continues and remains constant for 0.096 second, after which relaxation sets in, occupying 0.076 second. The whole cycle takes 0.21 second, the clonus being an extremely slow one, of only 4.7 vibrations per second.

The difference in form and character of the gastrocnemius and tibialis curve is still more pronounced in fig. 5, in which the ascending period of the triceps curve lasts 0.077 second against 0.021 second only for the ascending part of the tibialis anticus curve. The frequency in this case is 7.3 per second. These figures found for the time occupied in the ascending and descending periods in the individual contractions do not agree very well with those generally found in simple muscle twitches. Yet the ascending part in tracings of simple twitches of the human tibialis anticus is always very small as compared with the relaxation time, whereas in curves of the triceps surae the difference is always much less noticeable. But may we compare a simple muscle twitch with a part of a clonus-curve? During a clonus the muscles are working under more or less abnormal conditions which do not resemble those under which records of "normal" muscle twitches are generally taken. During the footclonus we generally have to exercise a certain amount of pressure against the footsole. This means that, roughly considered, the gastrocnemius group are working against constant pressure, i.e. they contract isotonicly.

The contractions might even be considered to be as nearly as possible isotonical ones, if the action of the anterior muscles could be excluded. This is more or less the case with the simple footclonus in which the soleusgroup for practical purposes may be said to work isotonicly, as the disturbing influence of the mass of the patient's foot and the examiner's hand and arm will be hardly noticeable. The use of ETTORE LEVI's apparatus would bring us still a little nearer to perfect isotony. In cases of alternating footclonus we find that the passive tension on the triceps surae is rhythmically enhanced by the regularly occurring contractions of the tibialis group. Yet this influence of the tibialiscontractions on the triceps-curve is generally not very conspicuous, the gastrocnemius-group being many times stronger than the footextensor. Hence we may

expect that the inverse action of the contracting calf-muscles on the form of the muscle twitches of the tibialis anticus will be rather considerable. The tibialis anticus works against a tension which

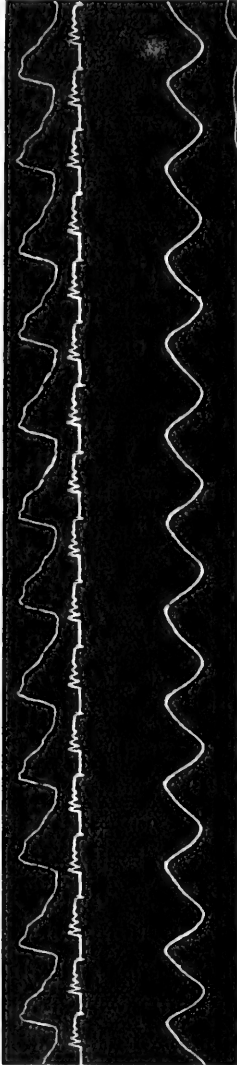

Fig. 5.

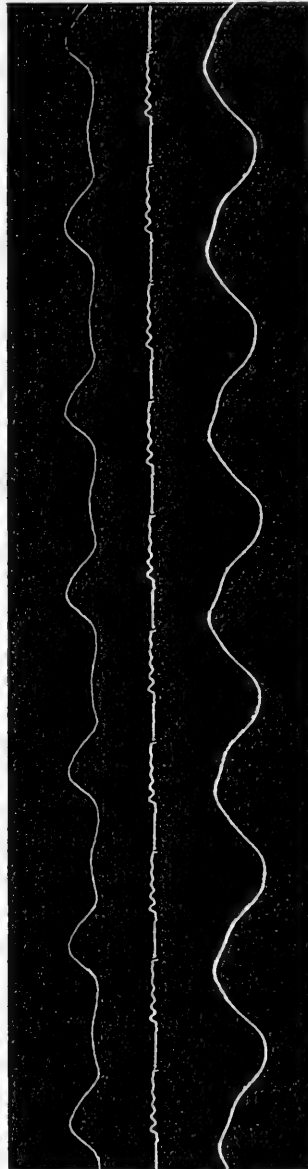

Fig. 6.

varies over a much larger amount, which may even become negative. The latter never happens with the triceps muscle. Consequently we expect the tibialis curve to be much more deformed than the gastrocnemius curve. On looking at our curves, we see that this is generally the case; but we also find that the influence of the two muscle groups on each other can easily be traced, though generally the action of

one group on the other dominates. In fig. 6 we see that the tibialis curve shows two successive tops. The first and larger one is the twitch of the tibialis proper, the second is caused by passive tension

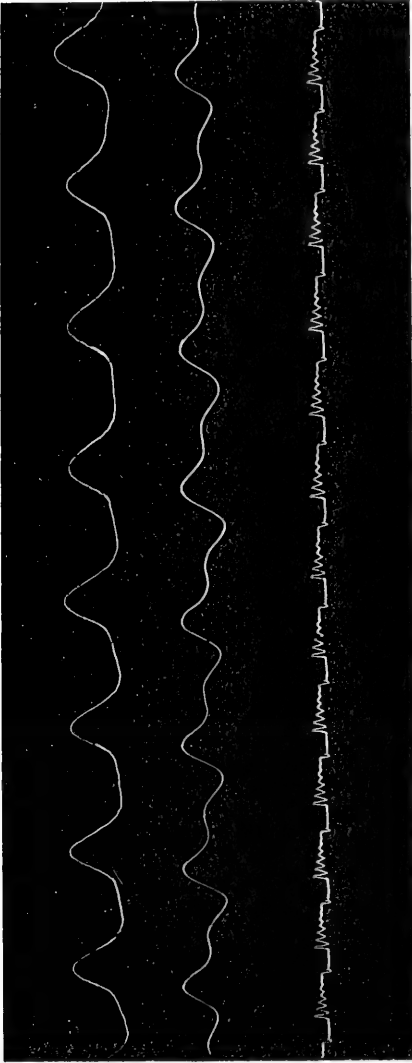

Fig. 7.

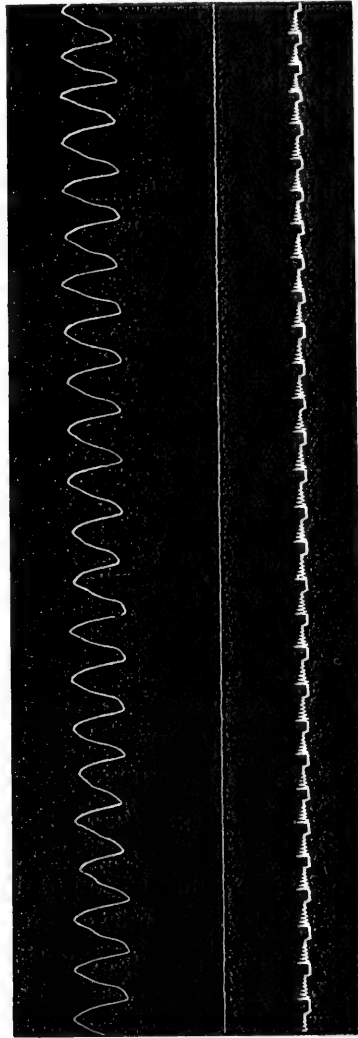

Fig. 8.

of the tibialis by the contracting triceps surae. In the triceps curve we see a slight elevation in the descending part of the curve caused by the triceps contraction.

In fig. 7 the tibialis curve is nearly undeformed as compared with an isotonic tibialis twitch; but the lower curve has in this case two clearly defined elevations, the higher of the two being the contraction proper, the lower one being caused by the tibialis contraction. How is the difference between the curves 6 and 7 to be explained? In both cases the apparatus had been correctly applied.

The difference was explained by considering the difference in force of the tibialis and the gastrocnemius contractions. In fig. 6 we have a clonus which is caused by the rhythmical contractions of the triceps surae and in which the tibialis anticus slightly participates. In fig. 7 it is the tibialis group that entertains the clonic movement which is but slightly assisted by the gastrocnemius. We conclude this from the way in which in both cases the clonus was elicited. In the case of fig. 6 the foot had to be forcibly pressed upwards. In the case of fig. 7 no pressure at all was necessary. I could start the clonus as well by a rapid passive extension of the foot as by a quick passive flexion. I may add here perhaps that in two patients I could elicit a clonus of the tibialis anticus alone, the triceps surae remaining completely at rest (fig. 8). With this record the pelotte for the gastrocnemius was placed on the middle and thickest part of gastrocnemius, in which I could not find the slightest trace of a contraction neither by inspection nor by palpation. The clonus could easily be started by a short passive plantar flexion of the foot. Both patients showing this clonus happened to suffer from incipient general paralysis. In one of them I also obtained an isolated clonus of the extensor hallucis longus.

The occurrence of a real alternating clonus as described in this paper is rather rare. I think that hardly more than 2 or 3% of the cases of footclonus are such; we nearly always find a simple footclonus. My patients with alternating clonus suffered from multiple sclerosis, encephalomalacy or cerebrospinal syphilis; I also saw a few cases with apoplexia cerebri, braintumor, general paralysis, syringomyelia and atactic paraplegia. I do not think that I exaggerate in stating that every year I see about a dozen cases of alternating clonus against many hundreds of simple clonus. In complete medullary paraplegia I never saw alternating clonus. If we find it, it is always unilateral and invariably at the side of the lesser paralysis. The changes in the central nervous system were generally in both hemispheres and found to consist of multiple foci. No adequate explanation could be gathered from the localisation of the foci.

I have tried to explain the alternating clonus, starting from some facts about cerebral innervation stated by SHERRINGTON. Stimulation of a cortical motor centre causes a contraction of a definite set of muscles as well as a relaxation of the antagonists. The centre performs a rather complicated function. About a few of these centres we even know that their function is still more complicated, probably on account of the action of secondary centres: we find this with the movements of walking, standing etc. Probably on walking

a simple cortical impulse is given from a cortical centre to a lower one — probably in the thalamus — from which synchronous impulses are given to both extremities. For each step an impulse is necessary and in walking we get a succession of impulses alternately from the right and the left hemisphere, but each of them working on muscles of both legs. We may suppose that one centre innervates the contra-lateral extensors as well as the homolateral flexors. This means that a stimulation of the cortical centre causes a tetanic contraction of the contralateral extensors, hypotony of the contralateral flexors and hypertony of the homolateral flexors. Destruction of a centre of this kind is followed by hypertony of the contralateral extensors and also of the homolateral flexors. With a one-sided focus the muscles of the contralateral gastrocnemiusgroup are strongly hypertonic, the flexors slightly hypotonic but the muscles of the tibialisgroup of the homolateral side are also appreciably hypertonic. I think that this also causes the appearance of the shortening-reflex, described in a former paper. But at least we have also one condition favourable to the appearance of a tibialis clonus. As a rule it will not be possible to obtain a tibialis clonus as the large muscular mass of the leg and foot acts as a strongly damping factor, which immediately checks any commencement of a tibialis clonus. Only exceptionally, when a second focus in the other hemisphere has caused the appearance of a slight hypertonic state of the calf muscles, a commencement of tibialis clonus may be strengthened by a triceps clonus, or to an existing triceps clonus may be added a rhythmic clonic contraction of the tibialis group. If the second focus be an extensive one, the hypertony of the gastrocnemius group generally grows so as to entirely suppress the action of the anterior muscles. In all my cases the hypertony of the calf muscles was very slight. With a strongly hypertonic gastrocnemius I never succeeded in obtaining an alternating clonus. This sufficiently explains the rarity of the occurrence of alternating clonus.

Astronomy. — “*The local starsystem*”. By Dr. A. PANNEKOEK. (Communicated by Prof. W. DE SITTER).

(Communicated at the meeting of May 28, 1921).

I.

If $A(m)$ denotes the number of stars of magnitude m , Δ the space density of the stars, which for a given line of sight is a function of the distance r , $\varphi(M)$ the luminosity-function, and if for the distance r we introduce $\varrho = 5 \log r$, thus making $M = m - \varrho$, then $\Delta(\varrho)$ can be found from $A(m)$, if both may be represented by quadratic-exponential functions. Thus if we put

$$\begin{aligned} \log \Delta(\varrho) &= h' + k'\varrho - l'\varrho^2; & \log \varphi(M) &= p + qM - rM^2; \\ \log A(m) &= a + bm - cm^2 \end{aligned}$$

we have:

$$\begin{aligned} h' &= a - p + 3.786 - \frac{1}{4} \frac{(b-q)^2}{r-c} - \frac{1}{2} \log \frac{r-c}{r} \\ k' &= q - 0.6 + (b-q) \frac{r}{r-c}; & l' &= \frac{cr}{r-c}. \end{aligned}$$

By these formulae (in a somewhat different form) KAPTEYN and VAN RHIJN have deduced the distribution of density in the starsystem surrounding our sun, representing it by a series of flattened surfaces of revolution.¹⁾

Here the function Δ has been found as a whole from the function A . But the observational data determine this function A for a certain extent of m only. Now the question arises, whether the value $A(m)$ for a given m determines the value $\Delta(\varrho)$ for a certain ϱ . The differential quotients

$$\begin{aligned} \frac{\partial}{\partial b} (h' + k'\varrho - l'\varrho^2) &= -\frac{1}{2} \frac{b-q}{r-c} + \frac{r}{r-c} \varrho \\ \frac{\partial}{\partial c} (h' + k'\varrho - l'\varrho^2) &= - \left\{ \frac{1}{2} \frac{b-q}{r-c} - \frac{r}{r-c} \varrho \right\}^2 + \frac{\log e}{2(r-c)} \end{aligned}$$

show, that for $\varrho_0 = \frac{b-q}{2r}$ a variation of b causes not any, a variation of c causes only a slight variation of Δ , so that $\Delta(\varrho_0)$ depends nearly wholly on $a = A(0)$. If we count m and (in order to keep

¹⁾ J. C. KAPTEYN and P. J. VAN RHIJN. On the distribution of the stars in space . . . , *Astrophysical Journal* LII. 289.

the same $\varphi(M)$ also ϱ from the zero point m_0 , this means, that in the formula

$$\log A(m) = a + b(m - m_0) - c(m - m_0)^2$$

the first term $a = \log A(m_0)$ determines $\Delta(\varrho_0)$ for

$$\varrho_0 = m_0 + \frac{b - q}{2r}.$$

Assuming that the observations determine the values for $A(m)$ of VAN RHIJN from $m = 4$ to $m = 16$ we find, by applying this formula, that they determine the Δ computed from them for $\varrho_0 = 10$ to 17 in the Milky Way (i.e. for $r = 100$ to 2500 parsec) and for $\varrho_0 = 9.5$ to 15 in the polar regions (i.e. for $r = 80$ to 1000 parsec).

As m_0 and ϱ_0 are conjugate values, it is only rational to take ϱ_0 as the zero point in the formula for Δ . If we put

$$\log \Delta(\varrho) = h + k(\varrho - \varrho_0) - l(\varrho - \varrho_0)^2,$$

we have

$$\varrho_0 = m_0 + \frac{b - q}{2r}; \quad \frac{1}{l} = \frac{1}{c} - \frac{1}{r}; \quad k = b - 0,6;$$

$$h = a - 0,6m_0 - p + 3,786 - \frac{(q - 0,6)^2}{4r} + \frac{(b - 0,6)^2}{4r} + \frac{1}{2} \log \frac{r^2}{r - c}.$$

If we insert now the values $p = -2,394$, $q = +0,186$, $r = +0,0345$ ¹⁾, we get:

$$\varrho_0 = m_0 + \frac{b - 0,186}{0,069}; \quad \frac{1}{l} = \frac{1}{c} - 29; \quad k = b - 0,6;$$

$$h = a + 4,937 - 0,6m_0 + \frac{k^2}{0,138} + \frac{1}{2} \log(l + 0,0345).$$

If over a limited extent of m the number of stars $A(m)$ may be represented by a quadratic-exponential formula it determines $\Delta(\varrho)$ over a limited extent of ϱ also. An adjacent extent of m affording a formula for A with other constants determines another part of the curve for $\Delta(\varrho)$. In case of an irregularly fluctuating course of $A(m)$ and $\Delta(\varrho)$ we may divide them into separate parts and represent each of them by such formulae, thus using the quadratic-exponential formula in an interpolatory manner. It may be noticed that in this case the coefficients c and l (which become zero together) may be negative, if only $l + r > 0$. Of course this solution of the problem to find Δ from A is not rigid, but only a practical and approximate one. If c approaches r very nearly, small errors in c cause enormous deviations in l , making Δ wholly uncertain; if c has a great negative value the result has no real meaning. If c surpasses the value $1/2$,

¹⁾ KAPTEYN and VAN RHIJN, l.c. p. 297.

the solution becomes impossible; this points to discontinuities in the stardensities, (voids in the star masses, influence of distant starclouds) which we will not consider at this moment.

II.

By applying the above-mentioned formulae, in the following research we have tried to determine the shape of our local starsystem. The galactic zone between $\pm 20^\circ$ latitude was divided into 12 sectors of nearly 30° longitude. The only sources giving sufficient data on the numbers of stars are the Durchmusterung Catalogues; we have used the counts of STRATONOFF ¹⁾, giving the density per square degree for fields of 5° square according to the *Bonner Durchmusterung* (to 0° decl.), the *Südliche Durchmusterung* of SCHÖNFELD (to -20° decl.) and the *Cape Photographic Durchmusterung*. As class 9.1—9.5 in all these catalogues is incomplete, only the numbers up to magnitude 6.5, 8.0 and 9.0 were used in our computations. The details of the extensive researches that were necessary to find the relation between these empirical scales and the photometric magnitudes will be given elsewhere; the resulting limiting magnitudes are for the different zones of declination of the N. hemisphere:

Decl.	$0^\circ-10^\circ$	$10^\circ-20^\circ$	$20^\circ-40^\circ$	$40^\circ-60^\circ$	$60^\circ-80^\circ$	$80^\circ-90^\circ$	
6.55 DM =	6.37	6.69	6.72	6.75	6.75	6.62	
8.05 „	7.97	8.15	8.26	8.29	8.23	8.10	all $-0.005 (D-15)$
9.05 „	9.38	9.35	9.48	9.47	9.24	9.29	„ $-0.012 (D-15)$

For the *Südliche Durchmusterung* we found

$$6.48-0.014(D-15); \quad 8.14-0.018(D-15); \quad 9.39-0.025(D-15)$$

where D denotes the number of stars per square degree up to 9.5 (not up to 10). To reduce these magnitudes to the scale, adopted in our computations, viz. the scale of *Groningen Public. 18*, corrected by the values, given by VAN RHYN in *Groningen Publications 27* (G.P. 18 c.), we must still add to our results the values $-0,17$, $-0,08$, $+0,02$ for the three limiting magnitudes. For the C.P.D. for the galactic zone the values

$$5,76 \quad 7,86 \quad \text{and} \quad 9,46 \quad (\text{scale G.P. 18 c.}),$$

were adopted; but these are much more uncertain than for the catalogues of Bonn.

From these $N(m)$, the number of stars from the brightest to the limiting magnitude m , the numbers $A(m)$, running nearly parallel

¹⁾ W. STRATONOFF. Etudes sur la structure de l'univers. Publications de Tachkent. Nr. 2 et 3. (1900, 1901).

with them, may be got by the relation $A(m) = \frac{d}{dm} N(m)$.

Putting

$N(m) = 10^{\alpha + \beta m + \gamma m^2}$ we get $A(m) = 1/\log e (\beta + 2\gamma m) 10^{\alpha + \beta m + \gamma m^2}$, or

$\log A(m) = \alpha + \beta m + \gamma m^2 - \log \log e + \log \beta + \log \left(1 + \frac{2\gamma}{\beta} m\right)$, thus

$$a = \alpha - \log \log e + \log \beta; \quad b = \beta + \frac{2\gamma}{\beta} \log e; \quad c = -\gamma + \frac{2\gamma^2}{\beta^2} \log e.$$

For the mean magnitude m_0 was taken 8.0.

Further data are given by the *Selected Areas* of KAPTEYN; for each of the 6 Northern sectors the mean was taken of all selected areas lying in it. The numbers per half magnitude from 11,0 to 14,5 (for the greater part after the counts of VAN RHYN, kindly communicated to me), were doubled in order to represent the values $A(m)$ for $m = 11,25$ to $14,25$. They could be represented by linear formulae without perceptible curvature. In these formulae $\log A(m') = a' + b'(m' - 12,75)$ the m' denote photographic magnitudes; as for these faint classes the reduction of photographic to visual magnitude may be represented by $m - m' = -0,62 - 0,05(m' - 12,75)$, we have

$$\log A(m) = a + b(m - 12,13), \quad \text{where} \quad a = a', \quad b = \frac{20}{19} b'.$$

III.

The results of the Durchmusterung catalogues are collected in the next table, where the first column gives the mean galactic longitude of each sector and n the number of fields of STRATONOFF of 23 square degrees on the average.

long.	n	a	b	c	Q_0	h	k	l
15°	49	0.236	0.478	+ 0.0086	12.23	9.812	- 0.122	+ 0.011
45	57	351	510	+ 0059	12.70	857	- 090	+ 007
75	48	312	480	+ 0171	12.26	971	- 120	+ 034
105	52	198	475	+ 0121	12.19	810	- 125	+ 018
135	56	147	446	+ 0212	11.77	932	- 154	+ 055
165	49	182	548	- 0126	13.29	540	- 052	- 009
190	38	246	556	- 0246	13.36	548	- 044	- 014
225	68	303	488	- 0017	12.38	793	- 112	- 002
255	48	264	481	+ 0030	12.27	793	- 119	+ 003
285	52	272	503	+ 0032	12.59	9.767	- 097	+ 004
315	68	277	440	+ 0271	11.68	0.204	- 160	+ 127
350	37	102	466	+ 0049	12.06	9.771	- 134	+ 006

For the sectors 315° , 135° and (in a lesser degree) 75° the great positive value of c , approaching r , giving a great value of l that raises also the value of h , causes a strong maximum for Δ , rapidly decreasing on both sides; so we find here a condensation of stars in space. The empirical data upon which it depends, consist in a strong curvature of the A -curve, i.e. a strong increase of the stars of the 8th magnitude, not continuing in the same manner for the 9th magnitude. As in this case small variations in c bring about great variations in Δ , it is necessary to examine the reality of these condensations as to the uncertainty of the starnumbers N , which have by chance distribution a mean error $\mu = \sqrt{N}$. Therefore for these sectors corrections corresponding to this uncertainty were applied in the direction of diminishing c and then the computation has been repeated ¹⁾. Now the results are:

<i>long.</i>	<i>a</i>	<i>b</i>	<i>c</i>	Q_0	<i>h</i>	<i>k</i>	<i>l</i>
75°	0.304	0.489	+ 0.0095	12.39	9.869	— 0.111	+ 0.013
135	0.138	0.455	+ 0.0134	11.90	9.803	— 0.145	+ 0.022
315	0.266	0.446	+ 0.0219	11.77	0.062	— 0.154	+ 0.060

The condensation at 135° has wholly disappeared; the great density at 75° joins the dense parts in sector 45° ; the condensation at 315° , however, remains evident and does not disappear even by greater corrections to $\log N$. Unless, perhaps, the scale of magnitudes strongly deviates here from the mean galactic zone, this condensation must be considered as real.

A deviation in opposite sense is shown by the sectors 165° , 190° and (in a smaller degree) 225° , where c and l are negative. Because the number of stars increases from the 8th to the 9th magnitude at an unusual rate — it is known that on this side of the sky the stars of magnitude 9—10 are strongly condensed over a fourth of the galaxy — we find that the space density at first, in the vicinity of the sun, decreases rapidly, but at a greater distance ceases to do so; whether it increases afterwards, cannot be decided by these data.

The results of the *Selected Areas* for the 6 Northern sectors are collected in the next table, where n denotes the number of the areas used (each being $\frac{1}{4}$ square degree).

¹⁾ The coefficient c will be diminished, if $N(6,5)$ and $N(9,0)$ are increased, $N(8,0)$ is diminished. A small calculation showed that we get an even chance if for the value of this increase or diminution we take $0,6\mu$.

<i>long.</i>	<i>n</i>	<i>a</i>	<i>b</i>	ρ_0	<i>h</i>	<i>k</i>
15°	7	2.045	0.360	14.65	9.391	— 0.240
45	7	2.195	354	14.56	562	— 246
75	6	1.991	301	13.80	567	— 299
105	7	1.981	387	15.04	238	— 213
135	5	1.845	358	14.62	197	— 242
165	7	2.094	352	14.54	468	— 248

While the Durchmusterung Catalogues determine Δ on the average for ρ from 11,5 to 13,5 ($r=200-500$ parsecs) the *Selected Areas* determine it between 13,5 and 16 ($r=500-1600$ parsecs). In the main the values for Δ from the *S.A.* fit close to the values from the *D.M.* An exception is made by sector 165°; here the Δ curves intersect for $\rho=14,4$, $\log \Delta=9,5$, but they show a different course: according to the *S.A.* the density is strongly, according to the *D.M.* it is hardly decreasing. In this sector the number of stars shows a discontinuity, as the strong increase for the magnitude 9—10 does not continue in the lower magnitudes of the *S.A.* Presumably this is caused by the influence of a remote galactic stream, which must be studied in another way.

IV.

In order to find from these results the distribution of stardensity along the galactic section of the local system, values of ρ were deduced from our formulae, for which $\log \Delta$ gets the values 0,0 9,9 9,8 etc. In order to have no more irregularities in the resulting figure than are probably real, the results of the second computation were used for the sectors 75°, 135° and 315°. The values falling beyond the limits of the formula are placed in parentheses.

(See table following page).

These values have been used for the construction of the figure showing curves of equal density, decreasing with 0,1 for $\log \Delta$ (at the curves the values of Δ itself are put down); where ρ is not determined by the data, but has been extrapolated, the curves are dotted.

On the Southern hemisphere, where the density could not be found at greater distances than 500 parsecs, we perceive in sector 315° (Scorpio) the condensation, mentioned above, at a distance 100—200 parsecs, where the density surpasses 1,25. For the rest the central mass with density 1 extends farthest in the direction $l=60^\circ$; at greater distances the maximum density lies in the sector 45° (Cygnus), where a starstream seems to issue from the system.

$long. \log \Delta =$	0.1	0.0	9.9	9.8	9.7	9.6	9.5	9.4	9.3	9.2	9.1
15° $\rho =$	(10.4)	11.5	12.4	13.1 13.4}	13.8	14.2	14.6	15.0	15.4	15.8	
45	(10.7)	12.2	13.4	14.0	14.4	14.8	15.2	15.6	16.0	(16.4)	
75	(11.0)	12.1	13.0	13.4	13.7	14.0	14.3	14.6	15.0	(15.3)	
105	(10.0)	11.4	12.3	12.9	(13.4)	13.8	14.3	14.7	15.2	15.7	
135	(10.0)	11.2	12.0	12.6	(13.1) (13.0)}	13.4	13.8	14.2	14.6	15.0	
165				(11.1)	12.2 14.0}	14.4 14.4}	14.8	15.2	15.6	(16.0)	
190				(11.4)	12.4						
225	(9.8)	10.6	11.5	12.4	13.2	(14.1)					
255	(9.6)	10.4	11.4	12.2	13.0	(13.8)					
285	(10.0)	11.1	12.2	13.3	(14.3)						
315	11.4	12.1	(12.6)								
350	(10.2)	11.1	11.9	12.6	(13.3)						

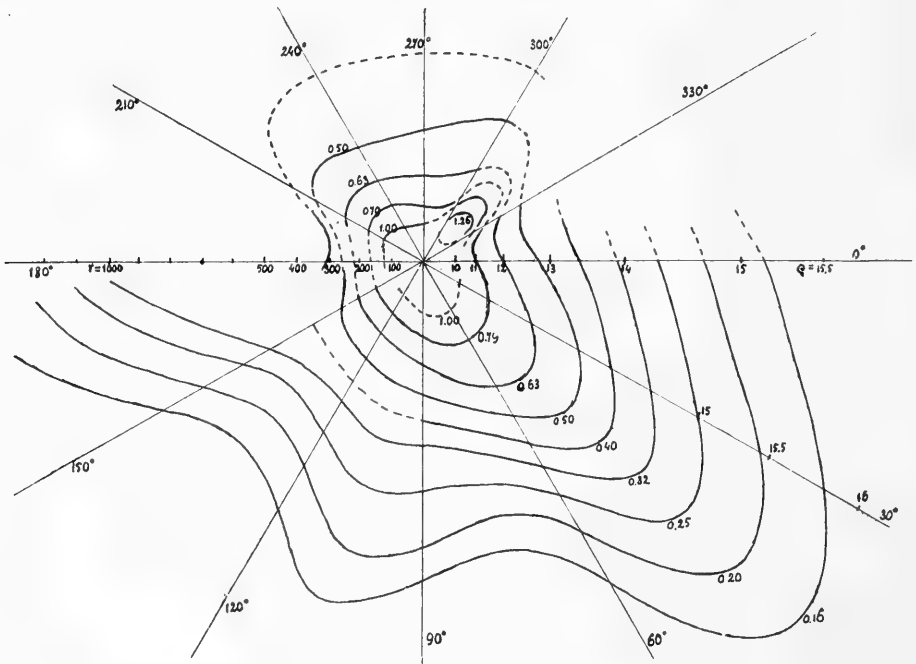

Whether the remote fluctuations between 75° — 150° are real, is not certain; perhaps the inward bending of the curves in sector 135° and 350° is caused by the absorbing nebulae in Taurus and Ophiuchus. Also in the direction 180° the starsystem extends to a great

distance; but here the discontinuity already spoken of, and the lack of counts for fainter stars makes the explanation of the data uncertain.

Of course the results of this first investigation have only a provisional character, and that for two reasons. In the first place by the incompleteness of the data: while up to the 9th magnitude the *Durchmusterung* Catalogues afford a rather complete though coarse material (by the uncertainty of the reduction to the photometric scale), we have hardly any data for the 10th and 11th magnitude. For the fainter classes the Selected Areas form an excellent but very limited material, while it is uncertain in what degree the local irregularities vary the average values for greater regions. Thus we do not know the whole course of $A(m)$ from the 6th to the 14th magnitude, which would be necessary to remove all doubts on the course of $\Delta(\varrho)$.

In the second place it must be emphasized that by taking together extended space-sectors with artificial boundaries the real irregularities in the distribution of the stars, with perhaps wholly different boundaries may be partly effaced, partly changed in their character. Moreover by regarding the influence of near absorbing nebulae and of remote galactic objects on the number of stars the results for space density may still be modified.

Physics. — “*Gravity and Pressure of Radiation.*” By H. GROOT.
(Communicated by Prof. W. H. JULIUS.)

(Communicated at the meeting of June 25, 1921).

§ 1. In 1910 LEBEDEV succeeded in experimentally showing pressure of radiation on *gases*, and measuring the value of the pressure. Since then attempts to take this force into account in astro-physical researches have not been wanting.

Particularly EDDINGTON¹⁾ and JEANS²⁾ have reached highly remarkable results concerning the structure of “giant stars” by introducing besides gravity, also pressure of radiation into their equations. They come, among other things, to the conclusion that through the influence of this pressure, the gravity in the interior of a star can be considerably diminished, and this the more as the density is smaller.

One is naturally led to extend this investigation to states as will probably be met with in nebulae. And this the sooner as different authorities advocate the hypothesis that the law of NEWTON is not valid during the nebulous stage of a star, i.e. during the period that the star is being formed from primitive nebular matter.

KAPTEYN³⁾ and CAMPBELL⁴⁾ tried to account in this way for the surprising fact that the proper motions of the stars increase as a more advanced spectrum type is examined. The latter indicates a possible pressure of radiation as a force that might partially neutralize gravity.

Also F. NÖLKE⁵⁾ in his cosmogonic considerations has recourse in numerous places to the pressure of radiation to render the not being constant of gravity plausible.

An estimation of the *extent of the possible effect* is, however, nowhere found. And so long as this is wanting all conclusions which are exclusively based on qualitative speculations, remain unreliable — as but too clearly comes to light in the different cosmogonies.

¹⁾ M. N. 77, (1916—17), p. 16 and p. 596; *Astrophys. J.* 48, (1918).

²⁾ M. N. 79, (1919), p. 319.

³⁾ J. C. KAPTEYN, *Astrophys. J.* 1910 (April).

⁴⁾ CAMPBELL, *Lick-Observ., Bulletin.* Vol. VI N^o. 196.

⁵⁾ „Das Problem d. Entwicklung unseres Planetensystems”, 2^{te} Ausgabe (1919) Berlin; A. N. 188, (4509).

What follows may be taken as an attempt to get some insight into the quantitative relations.

Here three different problems present themselves, which we will discuss successively:

A. To what pressure of radiation is a nebula subjected from the stars scattered around it (system nebula-star)?

B. What pressure does an absorbing body (planet) experience from the radiation of an extensive nebula in the neighbourhood?

C. Can the parts of a nebula repel each other appreciably through mutual radiation?

§ 2. *The system: nebula-star.*

When we wish to make an estimation of the relation between the attractive forces, to which a nebula is subjected from the surrounding stars, and the repulsive forces caused by the radiation of these same stars, we may begin by remarking that it is independent of the scattering in space of the stars considered. For the two forces are in the ratio r^{-2} , hence their ratio is not influenced by the distance. As not all the stars of the same absolute magnitude have the same mass, it would practically be necessary for the determination of the resultant of the active forces to know the nature of each of the stars concerned accurately. This is, of course, impossible. In our investigation we shall assume that on an average all the stars have an equally large mass, and radiate equally strongly as our sun. On this simplified supposition the ratio of the attraction of the whole stellar system to the repulsion caused by the radiation of the same system, is equal to that of the same forces exerted by one star at any distance.

With a view to the hypothesis of KAPTEYN and CAMPBELL mentioned before¹⁾ we will examine the following case more closely.

A star with a mass equal to that of the sun may be at 1 parsec distance from a spherical²⁾ nebulous mass of a radius of 15000 astronomical units. Seen from the star, the nebula occupies the 0.0014th part of the sky.

Let us assume in order to find an *upper limit* of the pressure of radiation to which the nebula is subjected, that *all* the radiation received from the star, is absorbed. (We know that in reality the absorbed fraction is exceedingly small). The star emits as much

¹⁾ Compare also the view of H. SHAPLEY, *Astrophys. J.* **50**, (373), 1919.

²⁾ I choose the spherical form to simplify the calculations; one should not think here of a *planetary nebula*, which is known to show on the other hand very quick proper motion.

radiation as our sun, i.e. $4,2 \cdot 10^{32}$ ergs per second. The energy absorbed by the nebula per second is $5,1 \cdot 10^{29}$ ergs. The pressure of radiation can be calculated in this case with the well-known formula:

$$D = \frac{S}{c} \dots \dots \dots (1)$$

in which $S =$ quantity per second of received radiation in ergs, $c = 3 \cdot 10^{10} \frac{\text{cm}}{\text{sec}}$, $D =$ pressure of radiation in dynes.

This yields in our case:

$$D = 1,7 \cdot 10^{19} \text{ dynes.}$$

Putting the mass of the nebula, like that of the star, about equal to that of the sun, i.e. $2 \cdot 10^{33}$ gr., we find for the maximum acceleration through pressure of radiation:

$$a = 0,8 \cdot 10^{-14} \frac{\text{cm}}{\text{sec}^2},$$

for that of the attraction:

$$a' = -1,4 \cdot 10^{-11} \frac{\text{cm}}{\text{sec}^2}.$$

Accordingly by the side of the attraction the pressure of radiation, even when calculated on exceedingly favourable suppositions, is almost negligible. As the same ratio must be valid with regard to the whole stellar system, we conclude:

The attraction of the stellar system on a nebula is not appreciably modified by pressure of radiation. Deviations from the law of Newton in such nebulae as we have considered, cannot be accounted for by the counteraction of the pressure of radiation.

Of course this consideration no longer holds when the dimensions of the nebulae become hundreds of times greater. But for the problem in question we were obliged to assume that the nebula from which the new star is being formed, had already conglomerated to the stated dimensions.

§ 3. *The system: nebula-planet.*

In view of some cosmogonic considerations on the origin of the solar system, it may be of interest to examine how great the pressure of radiation is which can be exerted on a newly formed planet by the mother nebula.

We begin by solving the question: what is the pressure of radiation which a spherical nebula of constant density ρ and radius R

exerts on a planet P , which absorbs all the received radiation, and which is at a distance Δ from the centre of the nebula.

An element $d\tau$ of the nebula emits in the direction OP a quantity of radiation given by:

$$\frac{S e^{-\mu \rho s} \cos \psi}{x^2} d\tau$$

when μ = absorption coefficient, x = distance from $d\tau$ to planet, s = length of the path passed over by the radiation inside the nebula, S = the intensity of radiation, which we shall assume to be constant inside the nebula (see figure).

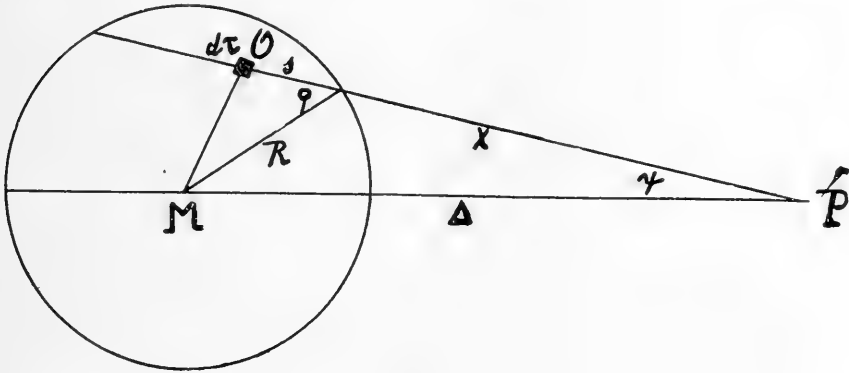

Fig. 1.

When $d\tau$ is taken = $x^2 dx \sin \psi d\psi d\omega$, and r_1 = radius of the planet, the radiation of the whole nebula on the planet is:

$$A = \pi r_1^2 S \iiint dx d\psi d\omega \sin \psi \cos \psi e^{-\mu \rho s} \dots (2)$$

When we introduce φ instead of ψ (see figure) through:

$$\Delta \sin \psi = R \sin \varphi$$

and when we take $dx = ds$, (2) passes into:

$$A = \frac{\pi r_1^2 S R^2}{\Delta^2} \int_0^{\frac{1}{2}\pi} d\varphi \int_0^{2R \cos \varphi} ds \int_0^{2\pi} \sin \varphi \cos \varphi e^{-\mu \rho s} d\omega \dots (3)$$

Integration yields¹⁾:

$$A = \frac{\pi r_1^2 \cdot 2\pi R^2 S}{\Delta^2} \cdot \frac{1}{\mu \rho} \left[\frac{1}{2} - P^{-2} + P^{-1} e^{-P} + P^{-2} e^{-P} \right] \left. \vphantom{\frac{1}{\mu \rho}} \right\} \dots (4)$$

$$P = 2\mu \rho R$$

¹⁾ Compare: BOTTLINGER, "Die Gravitationstheorie und die Bewegung des Mondes", Bayerische Akademie, 1912.

When $M =$ mass of the nebula, $m =$ mass of the planet, then by making use of:

$$M = \frac{4}{3} \pi R^3 \rho \quad , \quad m = \frac{4}{3} \pi r_1^3 \rho'$$

we may write:

$$A = \frac{Mm}{\Delta^2} \cdot \frac{9S}{4c\rho\rho'r_1} [\frac{1}{2} P^{-1} - P^{-3} + (P^{-2} + P^{-3})e^{-P}] \quad . \quad (5)$$

The pressure of radiation experienced by the planet when it absorbs all the radiation received, is again calculated with the formula:

$$D = \frac{A}{c}$$

The NEWTONIAN attraction must be diminished by this amount in order to find the resulting force K .

This becomes therefore:

$$K = f \cdot \frac{Mm}{\Delta^2} \left[1 - \frac{9S}{4fc\rho\rho'r_1} (\frac{1}{2} P^{-1} - P^{-3} + P^{-2}e^{-P} + P^{-3}e^{-P}) \right] \quad (6)$$

Can this diminution be great enough to bring about appreciable disturbances?

To investigate this, the following hypothetical case may be considered:

We assume that the solar nebula, after the formation of Neptune, has withdrawn to within the orbit of Uranus. We suppose Neptune itself to be still gaseous, though considerably denser than the solar nebula, and with a radius a 100-times larger than at present.

We further disregard the fact that the solar nebula in all probability must have had already a pretty great central condensation, a circumstance which has an unfavourable influence on a possible effect of pressure of radiation.

We base our calculation on the following numerical values:

Radius of Uranus orbit	$R = 2,868 \cdot 10^{14}$ (cm.).
Present solar radius	$R_0 = 6,96 \cdot 10^{10}$ (cm.).
„ solar density	$\rho_0 = 1,4$.
„ Neptune radius	$r_0 = 2,8 \cdot 10^9$ (cm.).
„ density of Neptune	$\rho'_0 = 1,1$.
Gravitation constant	$f = 6,66 \cdot 10^{-8}$.
Absorption exponent ¹⁾	$\mu = 0.0002$.

Thus we find:

$$K = f \frac{Mm}{\Delta^2} (1 - 2800 S).$$

¹⁾ Cf.: EMDEN, „Gaskugeln“, p. 285.

The value of S is still a doubtful point.

If we should assume that the nebula emits black radiation, S would already be $= \frac{1}{2800}$ at a mean temperature of not quite 1500° , hence attraction and repulsion would be about equally great.

This is undoubtedly erroneous; the radiation has been smaller than is calculated on the strength of STEPHAN-BOLTZMANN'S law. On the other hand the nebula will have emitted other radiation ¹⁾ besides temperature-radiation, which again partly compensates the deficit.

In our opinion the result of this research may, therefore, be summarized as follows:

On account of the uncertainty which prevails with regard to the quantity of energy emitted by the nebula, it is difficult to make an accurate estimation of the amount by which the attraction of the mother nebula on a newly separated planet must be diminished in virtue of the pressure of radiation. In consequence of the contraction, both of planet and of nebula, the effect in question will continually diminish, and in general it will also have been greater for the larger and more remote planets. Taking everything together it is not excluded that the said diminution, had a quite appreciable amount, at least for the large planets.

If, therefore, in our solar system particularities should occur which can be accounted for as the result of such a change of gravitation, there is every reason to accept this explanation. And this seems actually to be the case, among others with the small inclinations and small eccentricities of the large planets. (See among others NÖLKE loc. cit.). To enter more fully into this, would lead us too far.

§ 4. Gravitation and pressure of radiation in a nebula.

Departing from our considerations in the preceding §§ we shall now consider the more irregular nebulae, which present two or more condensations, as e.g. the Dumbbell nebula. Most nebulae have dimensions which are probably to be measured in thousands of Neptune orbit radii. Not much is known about their masses. But when we assume that a multiple star will be formed out of such a nebula, we must assign to each of the parts of the nebula a mass of the same order of magnitude as our sun has. In order to effect a rough estimation of the acting forces, we shall more fully discuss the following system.

¹⁾ The light of the tails of comets, and probably of most nebulae, arises besides through temperature radiation, through other processes, which are not yet entirely known.

Two nebular spheres, each with a mass of 7.10^{33} gr. and a radius of 200 Neptune orbit radii have centres which are at a distance of 1000 Neptune orbit radii from each other. The density, like the intensity of radiation, is again considered constant inside the nebula.

The quantity P , which occurs in the formulae (5) and (6), may be written:

$$P = 2\mu \varrho_0 R_0 \left(\frac{R_0}{R} \right)^2 \dots \dots \dots (7)$$

in which μ , ϱ_0 and R_0 have the same value as in the preceding §, in which R_0/R is, however, ± 300 times smaller. Then the value of P becomes so small that we may write instead of (5):

$$A = \frac{\pi r_1^2 \cdot \frac{4}{3} \pi R^3 S}{\Delta^2} \dots \dots \dots (8)$$

Assuming that of this quantity of radiation, which one nebula sends to another, the n^{th} part is absorbed by the latter sphere, this experiences a pressure of radiation which may be written after some reduction:

$$D = f \frac{M_1 M_2}{\Delta^2} \cdot \frac{S}{n} \cdot \frac{3R^3}{4fc\varrho_0^2 R_0^6} \dots \dots \dots (9)$$

When numerical values are introduced, we get:

$$K = f \frac{M_1 M_2}{\Delta^2} \left(1 - 3.10^{15} \frac{S}{n} \right).$$

Even on the assumption that only $\frac{1}{100.000.000}$ of the received radiation is absorbed, the value of S need not be more than $0,3.10^{-7}$ to render the effect of the pressure radiation as great as that of gravitation. In the case of black radiation, a temperature of some tens of degrees above the absolute zero would already suffice to bring it about. The real temperature will on an average certainly be higher, besides in this case considerable luminiscence should also be taken into account, so that we come to the conclusion:

There is every reason to expect that in nebulae with some condensation nuclei the gravitation of the different parts on each other has greatly diminished, if it is not quite exceeded by the mutual pressure of radiation.

For the rest it should be pointed out that this diminution of gravitation only refers to the *internal* gravity. Towards the outside the ordinary Newtonian attraction remains valid.

S U M M A R Y.

After having adduced some grounds in § 1 why it seems desirable to study the effect of pressure of radiation in nebulae, we examined the *system nebula-star* in § 2. In this case the value of the pressure of radiation remains so small that even under favourable conditions no effect can be expected. Treating in § 3 the *system nebula-planet*, we saw that it is not excluded that in the first time of their formation from solar nebula the large planets were subjected to a strong pressure of radiation, and this may perhaps be responsible for some peculiarities in the system.

In the investigation of the system formed by *two or more nebulae* in § 4 we came to the conclusion that if anywhere, the pressure of radiation must manifest itself here.

Bussum, April 1921.

Astronomy. — “*The Orbit of Bu 6832 = Σ 1834*”.

By W. H. VAN DEN BOS. (Communicated by Prof. W. DE SITTER).
Communication from the Observatory at Leiden.

(Communicated at the meeting of June 25, 1921).

In the present investigation a preliminary orbit is determined of Σ 1834. It is as yet scarcely possible to derive reliable orbital elements for this double star.

The difference in magnitude being very small, the quadrant becomes doubtful about the time of periastron-passage. The same difficulty occurs in the well-known binaries ξ Scorpii and ζ Boötis, the first of which has been investigated by T. N. THIELE (*Astr. Nachr.* 1199, Bd. 50), the second independently by AITKEN (*Publ. Astron. Soc. Pacific*, Vol. XXVIII N°. 165) and HERTZSPRUNG (*Astr. Nachr.* 4871, Bd. 203).

In both cases however the binary character of the motion was certain, whereas in the case of Σ 1834 the assumption of uniform rectilinear motion has been investigated only three years ago by Prof. DOOLITTLE (*Astr. Journ.* Vol. XXXII Nr. 746), though LEWIS in his volume on the Struve-stars already pointed out the probability of orbital motion. DOOLITTLE finds both curvature of the path and acceleration along the path.

At present there can no longer be any doubt, that the companion is again in the second quadrant. In Vol. XXXI, Nr. 180 of the *Publ. Astr. Soc. Pacific* Prof. AITKEN gives measures of the pair, confirming the binary character. He says, that in the best two nights the following star seemed to be somewhat fainter. I noticed the same on a splendid night this year. But we must not have too much confidence in such statements. There are however more serious objections against the supposition, that the companion is still in the fourth quadrant at present.

If we plot the position-angles and distances up to 1892 against the time, and derive normal places for 1830, '40, etc. 1890 by a graphical adjustment, these places not only exhibit a distinct curvature and acceleration, but also show the impossibility of placing the recent observations in the third and fourth quadrant. Moreover, if we consult the measures between 1893 and 1914, we see that

the pair must have been very close in 1897 (BRYANT: "round", LEWIS: "possibly elongated"), that there are tolerably concordant measures by BRYANT and AITKEN about 1903, and that the pair is single again in 1904 (HUSSEY) and 1906 (AITKEN). Because of their large discordances the measures between 1893 and 1914 have been omitted in the computation of the orbital elements, though it will be of interest to see how they are represented.

The observed distances, plotted against the time, show symmetry about the epoch 1904.8. Therefore I assumed as a first approximation, that the major axis and the line of nodes are coincident, so that we have: $T = 1904.8$. and $\omega = 180^\circ$. Provisional values for the other elements were derived graphically, the period by measuring the areas of two sectors. These values are:

$$P \ 280 \text{ years } e \ 0.83 \ a \ 0''89 \ i \ \pm \ 77^\circ6 \ \Omega \ 107^\circ7.$$

They give already small residuals for the reliable measures, but a marked systematic deviation of the angles between 1866 and 1893 shows, that the assumption $\omega = 180^\circ$ is erroneous. Normal places for the epochs 1830, '40, '50, '60, '70, '77, '84, '90, 1915 and 1921 are derived from interpolation-curves of angles and distances, and a solution by the method of least squares, using COMSTOCK'S formulas (The Orbit of Σ 2026, Astr. Journ. Vol. XXXI N^o. 725) and giving half weight to the distances, gives the elements:

T	1901.73
P	295.6 years
e	0.823
a	0''93
ω	169.2
i	$\pm \ 82^\circ04$
Ω	110.6

angles increasing.

The measures of the next decade will give a better definition of the present half of the orbit, and consequently a closer approximation of the elements.

The hypothetical parallax, $aP^{-2/3}$, is 0''021. If we adopt the mean value for the sum of the masses, given by AITKEN in The Binary Stars, 1.76 \odot , the parallax will be 0''018 and the mean distance 52 astronomical units. The maximum difference in radial velocity is then 17 km. per second. The spectrum is F8 according to the Draper Catalogue, and the photographic magnitude of each component is 8.5. The pair should have been observed with a large spectroscope in the neighbourhood of periastron. The absolute magnitude of each component is $8.5 + 5 \log 0.018 = +0.1$, in good agreement with the value to be expected from the spectral-type.

MEASURES AND RESIDUALS (observed — computed).

The columns give respectively the date, the observer, the aperture of the instrument in inches, the observed position-angle, reduced to 1925, the observed distance, the number of nights, remarks by the observer, and finally the residuals in angle and distance.

1829·74	Σ	9·6	113°0	1"36	2		+ 1°4	— 0"01
30·28	h	5	104°0	1"09	3·2		— 7°6	— 0"27
32·32	h	5	112°2	1"20	2·1		+ 0°5	— 0"14
·66	Σ	9·6	113°4	1"37	2		+ 1°7	+ 0"03
40·60	Da	7	111°6 1)	1"14	2		— 0°5	— 0"11
41·53	OΣ	15	112°6	1"21	2		+ 0°4	— 0"03
43·23	Ma	9·6	113°5	1"37	2·1 2)		+ 1°2	+ 0"15
48·99	Da	7	111°5	1"07	2		— 1°1	— 0"07
51·51	OΣ	15	113°0	1"00	1		+ 0°2	— 0"11
57·57	Se	9	114°5	0"92	2		+ 1°3	— 0"09
66·44	Δ	7	113°0	0"87	3·2		— 1°1	+ 0"01
·49	Tal.	10 3)	110°6	0"87	1		— 3°5	+ 0"01
71·21	Du	9·6	115°2	0"68	4		+ 0°5	— 0"07
·53	Gl	9·3	115°0	0"6 (tax.)	1	uncertain	+ 0°3	— 0"15±
72·54	OΣ	15	116°2	0"95	1		+ 1°3	+ 0"22
874·42	WS	8 1/4	113°4	0"6 (tax.)	3		— 1°8	— 0"09±
75·48	OΣ	15	115°4	0"65	1		0°0	— 0"01
79·47	Hl	26	114°6	0"46	3		— 1°7	— 0"11
80·94	Big	12 4)	116°8	0"47	2		+ 0°1	— 0"06
81·53	Smith	8 1/4 5)	124°3	0"6 (tax.)	1		+ 7°4	+ 0"09±
·54	H.Pt.	12 1/4 4)	119°5	0"59	1		+ 2°6	+ 0"08
·55.	Sk	8 1/4	124°3	0"5 (tax.)	2·1		+ 7·4	— 0"01±
83·61	En	7 1/2	117°2	0"51	6		— 0°4	+ 0"06
84·70	Sk	8 1/4	112°4		2·0	doubtful, very close	— 5°9	
85·53	Hl	26	118°4	0"42	3		— 0°1	+ 0"02
92·17	β	36	124°9	0"26	2		— 1°0	+ 0"08
93·47	Lew	12 3/4	145°3	0"39	1		+ 15°0	+ 0"22
·58	Com	15 1/2	113°4	0"25 (tax.)	1		— 16°9	+ 0"08±
95·53	"	15 1/2		single				

1897·51	Lew	28	may be elongated at	166°3			— 82·2
·63	B	28	round			comp. dist. 0''06	
99·40	Brown	26	270°±	0''20±	1		— 8·7± + 0''09±
·45	B	28	200°	elongated	1		— 78°7
1900·49 6)	B	28	209°1	0''22	1		— 75°2 + 0''08
·54 6)	Bow	28	206°7	0''25	1		— 77°6 + 0''11
1·16	Lew	28	201°9	0''23	1		— 85°8 + 0''07
·31	B	28	219°3	0''18	3	not separated	— 68°4 + 0''02
·50	Lew	28	178°9	0''1 (tax.)	1		+ 71°2 — 0''06±
2·73	B	28	298°1	0''29	1	elongated	+ 6°0 + 0''12
3·60	A	36	276°2	0''12	1		— 18°5 — 0''04
4·34	Hu	36	round		1	comp. dist. 0''15	
6·43	B	28	2°1	0''14	1	elongation very slight	+ 54°7 + 0''03
·61	A	36	no elongation		1	comp. dist. 0''11	
7·32	B	28	343°1	0''13	2	slightly elongated	+ 27°9 + 0''04
8·38	Do	7¼	52°5	0''35 (tax.)	1		+ 79°3 + 0''29
·51	Do	7¼	14°5	0''30 (tax.)	1		+ 41°3 + 0''24
9·59	B	28	may be elongated at	110°			+105°8
·60	B	28	108°6	0''09	1	definition bad, doubtful	+104°4 + 0''04
1909·76	B	28	104°3	0''15	1	not separated	+100°1 + 0''10
10·28	B	28	98°6	0''22	2		+ 71°4 + 0''17
11·43	B	28	102°1	0''16	3		+ 44°0 + 0''09
·49	Bow	28	61°0	0''19	2		+ 2°9 + 0''12
·49	A	36	83°7	0''17	2		+ 25°6 + 0''10
12·46	B	28	91°0	0''16	3		+ 19°8 + 0''07
·53	Bies	15	65° ?	< 0''25	1	plutot simple	— 6°2 < + 0''16
14·50	Gr.Obs.	28 8)	102°9	0''15	2		+ 18°7 + 0''01
14·58	A	36	85°9	0''22	2	good	+ 1°3 + 0''07
15·44	Gr.Obs.	28 8)	97°4	0''20	3		+ 9°9 + 0''03
16·38	A	36	87°0	0''28	2	good	— 3°0 + 0''09
19·62	Gr.Obs.	28 8)	94°9	0''28	1		— 0°1 + 0''00
21·36	v.d.Bos	10½	92°3	0''37 (tax.)	2 7)		— 4°3 + 0''05
·41	Gr.Obs.	28 8)	98°2	0''39	3		— 1°5 + 0''07

- 1) I reject a single angle, noted by DAWES: "very bad".
- 2) DOOLITTLE gives: 3 nights. MAEDLER gives: 2 nights in "Untersuchungen über die Fixstern-systeme", but in the Dorpat Observations there is but a single position-angle.
- 3) DOOLITTLE gives a measure by BARCLAY. This is probably an error, for a correction of precisely 2 years in the time and of 10° in the angle makes it identical with TALMAGE's measure, which is given in "Leyton Observations", but noted BARCLAY there (DAWES' measures are called "Bishop").
- 4) Not in DOOLITTLE's list.
- 5) Called "Seabroke" by DOOLITTLE.
- 6) Given by LEWIS in Mem. R. A. S. LVI; I could not find them, neither in the Monthly Notices, nor in the Greenwich Observations.
- 7) My separate results are

1921-341	92°5	0'35 (tax)	splendid definition.
379	92°1	0'40 (tax.)	definition good.
- 8) These measures have been communicated to me by Mr. JACKSON; they were received after the computation had been finished, but they are very well represented. The separate angles for 1921 are $93^\circ 3$, $100^\circ 0$ and $101^\circ 3$, fairly indicating the degree of uncertainty adhering to the measures even now.

My search for other recent measures has unfortunately been in vain. Up to 1893 the measures are well represented. Only in 1914

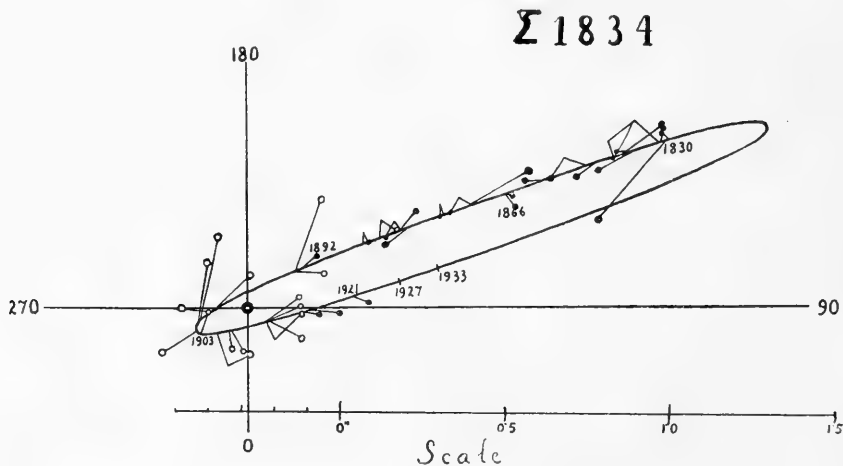

the observations become reliable again. Even in 1911 AITKEN's measures on two nights differ by $7^\circ 4$ in angle, and the observations by BRYANT and BOWYER at the same time differ by about 20° from AITKEN's. It is probable, that a large part of the measures between 1893 and 1914 are merely optical illusions. In the diagram the measures used in the computation are given by dots, the others by white circles, and every measure is joined with the computed place by a thin line.

Ephemeris.

1923 ⁵⁰	98°2	0''37
25 ⁵⁰	99°2	0''42
27 ⁵⁰	100°1	0''46
29 ⁵⁰	100°8	0''51
31 ⁵⁰	101°4	0''55
33 ⁵⁰	101°9	0''59

Leiden, Observatory, 1921 June 23.

Physiology. — “*Muscle Sound in Birds*”. By Miss L. KAISER.
(Communicated by Prof. G. VAN RIJNBERK).

(Communicated at the meeting of April 30, 1921).

Concerning muscle sound and action currents in birds I found no data except a provisional communication by WEISS¹⁾, which as far as I know has not been followed by a more ample one. WEISS recorded the sound of the m. pectoralis of a pigeon by means of a very thin membrane, the pigeon being poisoned with strychnine. He so obtained a curve in which the distance between two crests varied from $\frac{1}{80}$ to $\frac{1}{165}$ second. The action current of the same muscle in similar conditions showed waves of a duration of $\frac{1}{85}$ to $\frac{1}{170}$ second, which agrees perfectly with the values mentioned above. SCHWARZKOPF²⁾ found, as other investigators (MAREY, RICHET, and EXNER) had found before him, that the number of stimuli necessary to produce complete tetanus for pigeon muscle is 70 to 125 per second. PÜTTER³⁾ mentions 70 to 80 per second as the greatest number of separate contractions possible in bird's muscle.

EWALD⁴⁾ has described a vibration, which he observed in pigeons and in a few other birds at the upper edge of the orbita and at the eyeball. He supposes a simultaneous contraction of both the m. obliqui to be the cause of this vibration and calls the phenomenon “Augenschwingen”. By means of a lever, attached to the head of the pigeon and resting upon the upper edge of the orbita, as well as by means of a double needle with writing apparatus fixed into the eyeball, EWALD succeeded in recording this phenomenon. The curves obtained by these two methods practically confirm each other, the rate of the waves being 25 to 30 per second.

The same phenomenon was further examined by the author.

The vibration, which may be observed by touch, over the whole head of the bird, is also very evident to the ear. A phonendoscope placed upon the head of the pigeon conducts to the ear a low sound, in which a tone of a low pitch may be distinguished.

1) Centralblatt f. Physiol. Bd. 26. 1912.

2) Pflüger's Archiv. Bd. 121. 1908.

3) A. PÜTTER, Vergleichende Physiologie, 1912.

4) Archiv. f. experiment. Pathol. u. Pharmakol. Suppl. 1908. Festschrift SCHMIEDEBERG.

Even without any apparatus, by holding the head of the bird to the ear, the sound may be perceived sufficiently.

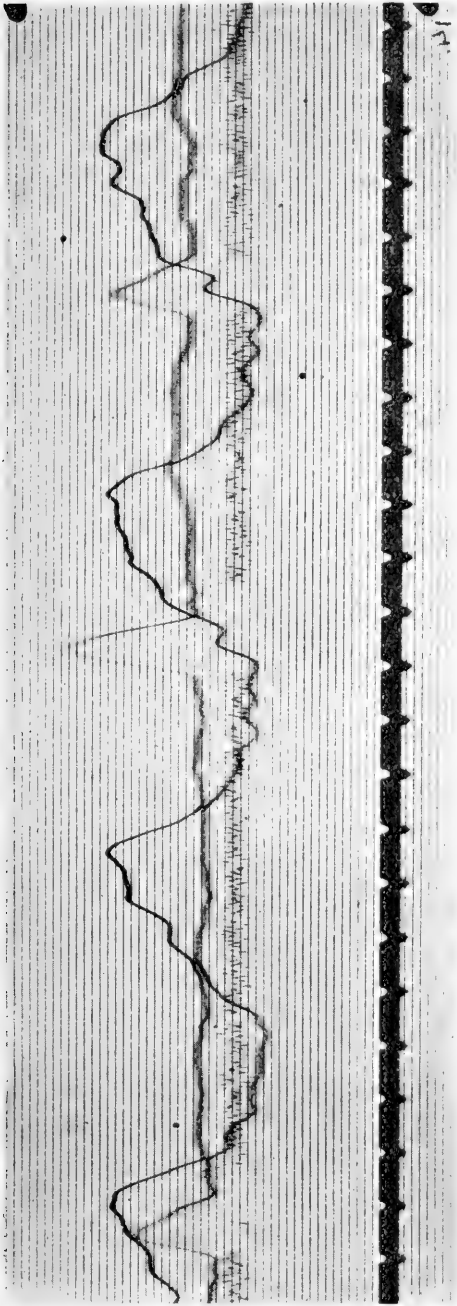

A.
O.
S.

T. $\frac{1}{6}$ "

Figure 1.

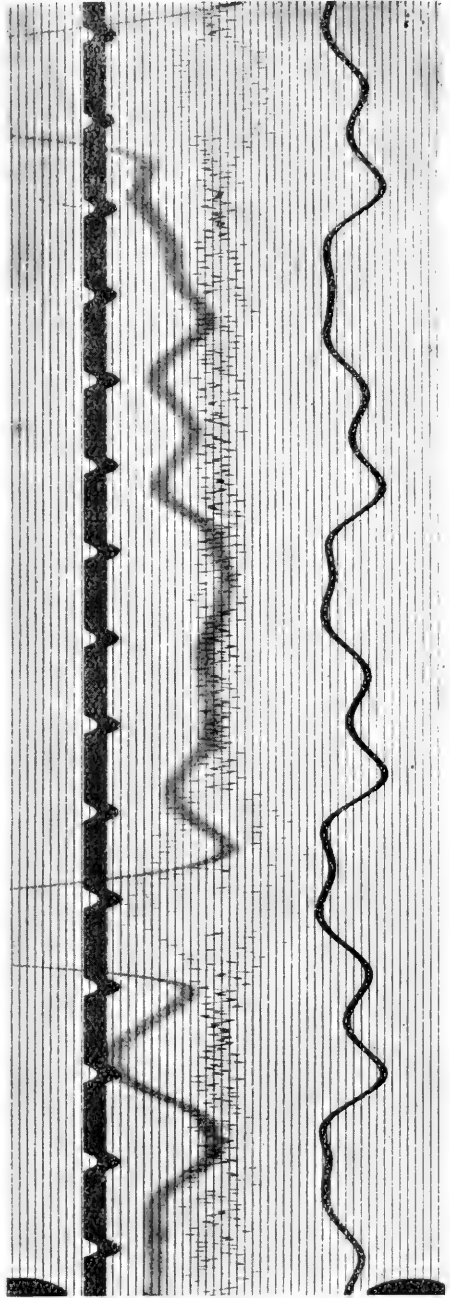

T. $\frac{1}{6}$ "

O.
S.

A.

Figure 2.

These curves were obtained by conducting the sound by means of a microphone to the string of the string galvanometer (Fig. 1 and 2).

Besides the movement of the string, *S*, the respiratory movement, *A*, and the movement of the upper eyelid, *O*, were recorded. In these figures appears a distinct relation existing between the sound and the movement of the eyelid, whereas no constant relation between the sound and the respiratory movement may be detected. As will be exposed in the *Archives Néerlandaises de Physiologie*, the sound is caused probably by a simultaneous contraction of all extrinsic eyemuscles, which coincides with the going down of the upper eyelid. As may be seen in the figures the curve of the string was regular and distinct. The rate of the vibration was always about 17 in one fifth second, that is about 85 per second.

Apart from the fact that there is no agreement between the different authors concerning the relation between the pitch of the muscle tone and the number of stimuli applied to the muscle nor concerning the number of stimuli necessary to produce complete tetanus and the number of impulses in voluntary contraction, in this case the number 85 agrees very well with the statements of SCHWARZKOPF and PÜTTER concerning the number of stimuli needed by bird's muscle to go into tetanus and also with the values found by WEISS in the case of contraction by strychnine.

Physiology. — “*A Simple Method to obtain a Curve of the Contraction of the M. arrectores pilorum*”¹⁾. By Miss L. KAIBER. (Communicated by Prof. G. VAN RIJNBEEK).

(Communicated at the meeting of June 25, 1921).

When placing the tail of a cat before the slit of a camera with a vertically moving plate, so that the dorsal side of the tail is directed towards the middle of the slit, we obtain on the sensitive plate a rather well-defined shadow. When stimulating the sympathetic chain, by which process the hairs are elevated, this elevation is imaged on the plate as a broadening of the shadow. The outer border of this shadow being, indeed, a rather sharp line, it affords a curve of the contraction of the *M. arrectores pilorum*, illustrating various features of this contraction, such as duration of the latent period, duration and shape of the crescent, etc. as the figure shows.

By this method I made several records. In all cases the sympathetic chain was stimulated with the tetanic current of an ordinary induction-coil. The curve, then, represents a tetanic contraction and not a simple one. We ascertained the average duration of the latent period, and its variations by altered strength of the stimulus, by fatigue, etc. We also determined the duration and the steepness of the ascending part of the curve under different conditions. Finally also the height of the contraction was estimated.

From this height the real shortening of the *M. arrectores pilorum* might be derived. Mr. WOERDEMAN furnished me with some necessary data, which he found by measurements in a microscopic preparation of a cat's skin. Let the distance from the insertion of the *M. arrectores* into the hair to the turning point of the latter be 400μ , and let the length of a hair be $2\frac{1}{2}$ cm., then, at the extremity of the hair the magnification of the contraction will be $\times 60$. The projection caused an additional enlargement of $\times 1.2$, so that the entire magnification must be fixed at about $\times 75$. An average broadening of the shadow of 2,5 cm, as found in my curves, points, therefore, to a shortening of the muscles of 250μ .

¹⁾ After experiments made in the Laboratory for Physiology of the Amsterdam University.

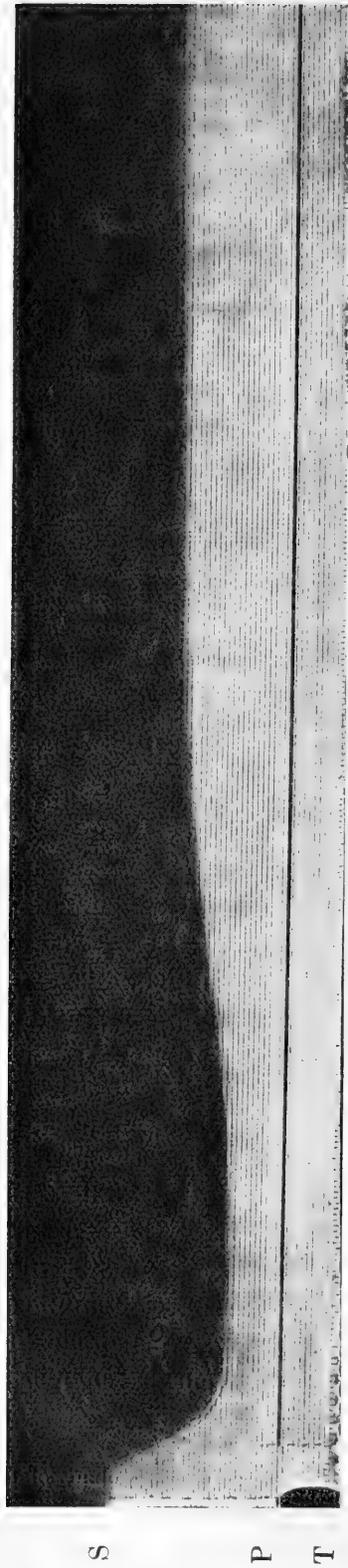

duration
of the
stimulation

S = the shadow of the tail retaining its original breadth for some time after the beginning of the stimulation (latent period) then broadening rather rapidly, in order to narrow again very slowly.

P = sign marking the stimulation.

T = the time in $\frac{1}{4}$ seconds.

This shortening amounts to about half the length of the muscle in rest, as found in the above preparation of the *M. arrectores*.

It goes without saying that with this method, as well as by writing a contraction curve on a rotating drum, we obtain an imperfect image of what really takes place. The error made in this way is easily reduced to a minimal value, and is moreover easy of calculation, so that the true curves can be deduced from those obtained.

Since, to my knowledge, LEWANDOWSKY¹⁾ is the only researcher who has written curves of a smooth muscle in warm-blooded animals, contracting by indirect stimulation, it seems to me that valuable data may be obtained by using the method here described.

¹⁾ DU BOIS REYMOND's Archiv. 1899.

Physiology. — “*Regarding Automatic Movements of the Isolated Iris*”¹⁾. By JASPER TEN CATR. (Communicated by Prof. G. VAN RIJNBERK).

(Communicated at the meeting of June. 25, 1921).

After SERTOLI's description of automatic rhythmic movements of the *M. retractor penis* (1882), numerous other organs with nonstriated muscle-cells have been investigated with regard to this phenomenon. It has been proved that the stomach, the guts, the ureters, the uterus, the arteries, the spleen, the bladder, the gall-bladder, and the oesophagus, in cold- as well as in warm-blooded animals, exhibit rhythmic contractions when surviving outside the body under favourable circumstances. In his researches MAGNUS has demonstrated that, as regards the gut, this faculty resides in the local nervous apparatus of AUERBACH's plexus. Since all the organs mentioned also possess local nervous plexus, it seems likely that also in the case of these organs the rhythmic contractions are attributable to an automatic function of those local nervous apparatus. Besides our knowledge of these facts justifies the assumption that other organs, provided with smooth muscle-cells, local nervous plexus and ganglia, are also capable of performing automatic rhythmic contractions. This induced me to experiment on the iris. This organ with an abundance of smooth muscles, also possesses a well-developed apparatus of ganglia, as has been made out by the uniform results of the most recent histological inquiries (LAUBER 1908, SCHOCK 1910, POLLACK 1913). There was good reason to suppose, therefore, that also the isolated iris should be capable of executing automatic rhythmic movements. However, the muscles of the iris being very feeble we had to cast about for a technique which, with least friction, should permit a registration of the result as much enlarged as possible.

With this view I made the following contrivance: A blade of straw was fixed to a glass bar for a lever. The fulcrum was constituted by a thin slightly twisted silk thread attached to the two prongs of a glass fork. The iris pulled at the end of the glass lever. The magnification of the displacement of the free end of the straw

¹⁾ After experiments made in the Physiological Laboratory of the Amsterdam University.

was $\times 16$. Registration took place by arranging the contrivance before the slit of a camera with vertically moving plate, in the pencil of light emitted by a projection lantern.

I experimented chiefly on the cat's iris. The eye was rapidly enucleated and preserved in Tyrode-solution of $37\text{--}38^\circ\text{C}$. Glucose soon appeared to have an unfavourable action, so that tyrode was used without glucose. When oxygen was administered the isolated iris shortened considerably, but the spontaneous movements were much feebler than without the perfusion of O^2 . In the latter case the iris relaxed and spontaneous contractions soon followed. They were stronger but of shorter duration than when oxygen had been supplied. I found the optimal temperature to be $37^\circ\text{--}38^\circ\text{C}$. All these conditions being fulfilled, it was not difficult to establish two sorts of movements in the iris-preparation. First: movements that were comparatively strong, very slow and apparently analogous to those known in the literature as "tonus-oscillations". Secondly: movements that were much weaker and more frequent, bearing a distinct resemblance to what are generally termed: "spontaneous rhythmic movements" of isolated organs. They were not exactly regular, as is the case with other organs: their rhythm, as far as we could ascertain, varied in normal relations, in Tyrode, from 16 to 29 contractions per minute. Nevertheless our findings have established the capacity of the isolated iris of executing spontaneous, automatic, rhythmic contractions.

Furthermore, I have dealt with a few pharmacological problems viz. that pilocarpin and cholin reinforce these movements as well as the tonus-oscillations, whereas adrenalin weakens them and atropin inhibits and ultimately abolishes them. Under the influence of pilocarpin the rhythm is accelerated up to 25—38 contractions per minute. In the presence of adrenalin the frequency falls to 4—18.

Chemistry. — “*The Electromotive Behaviour of Aluminium*”. III. ¹⁾.

By Prof. A. SMITS and C. J. DE GRUYTER. (Communicated by Prof. P. ZEEMAN).

(Communicated at the meeting of May 28, 1921).

1. In a previous communication on the same subject we already pointed out that the *E-X*-diagram of the four-component system $\text{Al}^{+++}-\text{Hg}^{++}-\text{Anion}-\text{H}_2\text{O}$ must be classified among the type in which the potential corresponding to the three-phase equilibrium, lies between the potentials of the two metals. Hence the potential of aluminium in an Al-salt solution might be expected to become less negative on addition of a mercury salt, whereas it was the reverse that was found. Already at the beginning of the study on the electromotive behaviour of aluminium we expressed the opinion that this remarkable phenomenon shows that as a rule the pure aluminium is passive, i.e. is greatly disturbed in noble direction, and that small quantities of mercury, dissolved in aluminium, exert a positive catalytic influence on the establishment of the internal equilibrium, so that the disturbance disappears.

In order to examine the influence of mercury on the aluminium potential more closely, measurements were carried out, in which the aluminium electrode was placed in an aqueous aluminium salt solution, to which a mercury salt solution was added at intervals. It should still be stated that to prevent the action of air-oxygen, the experiment was made in a nitrogen atmosphere, the solution being vigorously stirred.

Then the interesting result was found that at first the potential of the aluminium became less negative, then reached a minimum, after which it rose to a strongly negative value, and at last a maximum appeared. Finally a great decrease was observed, during which the potential descended to near that of mercury.

To past the just-mentioned maximum the aluminium electrode was covered with a greyish precipitate, but during the last stage the aluminium electrode was mercurized to a shiny surface.

Before proceeding to the further discussion of the study of this

¹⁾ These Proc. Vol. XXII, N^o. 9 and 10, p. 876.

” ” Vol. XXIII, N^o. 7, p. 966.

phenomenon it seems desirable first to indicate the significance of this course of the potential.

2. At first the aluminium electrode was immersed in the aqueous solution of $\text{Al}_2(\text{SO}_4)_3$, and then a solution of HgCl_2 was added. Directly after this addition aluminium goes into solution, and mercury is deposited, which will have been preceded by the discharge of Hg^{2+} to Hg^0 .

As has been said the equilibrium- E, X -diagram of the system Al-Hg-electrolyte must belong to the type in which the potential of the three-phase equilibrium Al-phase-electrolyte-Hg-phase lies between the potentials of the two metals (in internal equilibrium), i.e. on addition of a mercury salt the solubility product of the aluminium decreases more greatly in the formula:

$$E = -\frac{0.058}{3} \log \frac{L_{\text{Al}}}{(\text{Al}^{+++})} - 2,8$$

in consequence of mercury dissolving in the aluminium, than the relative concentration of the aluminium-ions in solution, which remains even practically constant.

Now it is clear that a certain time is required for the solution of mercury in the aluminium, and that in the very first moments there will be pure aluminium, on which mercury has precipitated.

Hence at first L_{Al} will not have been changed by dissolved mercury, and as also (Al^{+++}) has practically remained the same, it might be expected that in the beginning E does not change. In this reasoning an important factor has, however, been overlooked, viz. the fact that the aluminium is attacked! Electrons and ions are withdrawn from this metal with great rapidity when mercury is precipitated, and non-activated aluminium being a very inert metal, disturbance in noble direction can then occur. But this disturbance can only be observed for a short time, for the precipitated mercury will soon dissolve somewhat in the aluminium, and give rise to activation, which according to the more recent view means a conversion in the direction of the internal equilibrium.

Hence a change of the potential in noble direction is followed by a minimum and a great change in base-direction. When once the aluminium has been activated, and has more or less reached the state of internal equilibrium, the equilibrium between the stable mixed crystal phase, the liquid mercury phase, and the electrolyte in the boundary layer will soon have been established, and the potential will remain constant for some time.

As, however, the electrolyte in the boundary layer practically

contains no mercury, but the solution outside the boundary layer does, the precipitation of mercury will continue, and at last the mixed crystal phase *s* in the surface will have been entirely converted to the mercury *l* (see Fig. 2). At this moment the electrode will be perfectly shiny, but the deposition of mercury has not stopped yet, so that now a fall of the potential of the liquid mercury phase will occur, till the electrolyte and the liquid mercury phase are in equilibrium, or in other words, the process continues till practically all the mercury from the electrolyte has been precipitated, and the end-potential will have approached the mercury potential the more as the surface liquid phase contains less aluminium.

In order to represent this interesting change of the electrical potential of aluminium through mercury in the most striking way, we have first modified the experiment somewhat, and then registered the phenomenon photographically.

3. The modification in the experimentation consists in this that the aluminium electrode was directly immersed in an aqueous solution of an aluminium salt, to which a little of a mercury salt was added. This solution was brought into contact with the same solution, but without mercury salt by means of a siphon, and this solution also contained an aluminium electrode, so that the potential of the experimental electrode was measured with respect to aluminium. Pure nitrogen was led through both solutions, which prevented the very troublesome disturbance which always accompanies attack by oxygen.

Fig. 1 gives a clear representation of the first part of the phenomenon. The line *ab* indicates the position of the light image, when

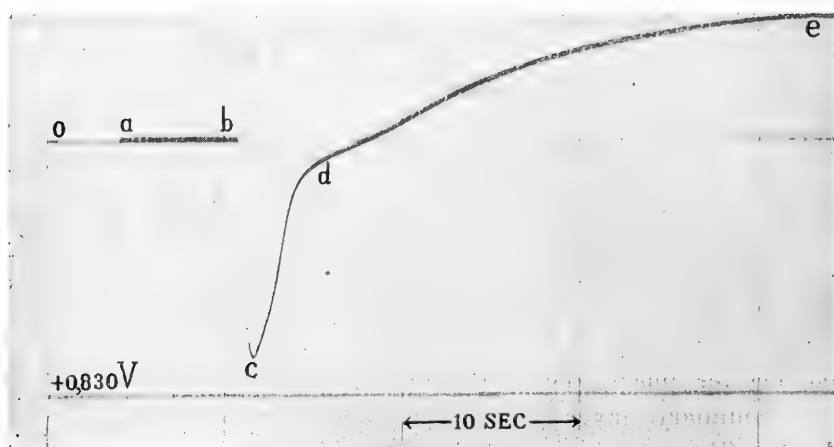
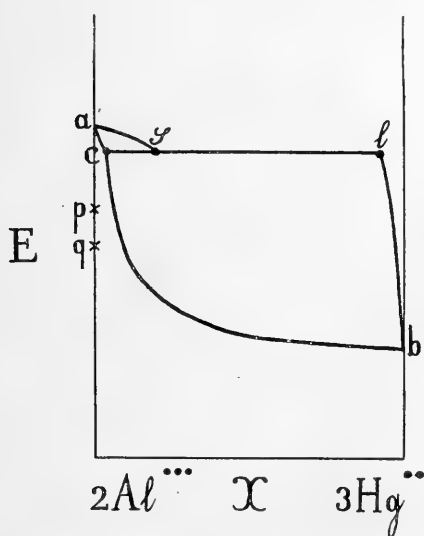

Fig. 1.

the aluminium cell is not yet closed, or what comes to the same thing, when the aluminium experimental electrode is immersed in the same pure aluminium sulphate solution in which the aluminium measuring electrode is placed.

In *b* the experimental electrode was suddenly immersed in the solution of aluminium sulphate + sublimate. On being attacked the potential of the experimental electrode is immediately greatly disturbed. The amount of this disturbance may be inferred from the place of the gauging line, which corresponds with a potential difference of + 0.830 Volt.

In consequence of the evidently strong catalytic action of the mercury dissolved in the metal surface, this disturbance not only rapidly diminished in *c*, but the potential rises to a much more negative value than that of the aluminium in the initial state. This shows, therefore, that the aluminium has passed into a much less noble and more active state through the dissolved mercury, which means in other words that the mercury here enormously accelerates the conversion in the direction of the internal equilibrium, notwithstanding the fact that under the given circumstances this conversion is attended with a stronger attack. At *e* the potential reaches its most negative value, and remains there constant for some time. As the aluminium is here covered with finely divided mercury, which gives the electrode a greyish colour, this constant potential, when at least the same state prevails throughout the metal surface, corresponds with the three-phase equilibrium *c, s, l*, i. e. with the



heterogeneous equilibrium between the activated mercury-containing aluminium mixed crystal phase, the aluminium-containing liquid mercury phase, and the electrolyte in the boundary layer.

Accordingly summarizing we may say that when we start from a potential at the same level as the point *p*, this potential at first descends to a value at the level of e. g. point *q*.

When activation has taken place, and the three-phase equilibrium has been established, the potential is indicated by the line *c, s, l*,

which lies much higher. In virtue of the mercury content of the

aluminium mixed-crystal phase, which at the ordinary temperature is only a few atom percentages, and in virtue of the fact that the electrolyte c practically contains no mercury, it may be expected that the line s, l, c is situated only exceedingly little lower than the point a . But when as here in these investigations the electrolyte is a solution on which the activated aluminium acts, and the metal is, therefore, attacked with separation of mercury, the potential will yet be found too little negative either through disturbance or through change of the concentration of the metal phases, unless the state of formation of the hydrogen could annul this effect.

As, however, the coexisting electrolyte of the three-phase equilibrium lies certainly very strongly one-sided on the aluminium side in the system Al-H-electrolyte, the state of formation of the hydrogen can here exert no appreciable influence on the potential. Our conclusion is, therefore, that the observed maximum negative potential will be less strongly negative than that of the pure aluminium in the state of internal equilibrium. If the electrode has already been entirely mercurized locally, the potential will of course be found much too little negative. The most negative potential was found by immersion of an Al-electrode activated with mercury in a pure $\text{Al}_2(\text{SO}_4)_3$ -solution. This was $-1,58$ with respect to the 1N calomel electrode or $E_H = -1,29$. Pure aluminium is always disturbed in noble direction, and to this we owe the usefulness of this metal for all kinds of technical and domestic purposes. Pure aluminium in the state of internal equilibrium would, indeed, be as unsuitable for these purposes as magnesium and calcium.

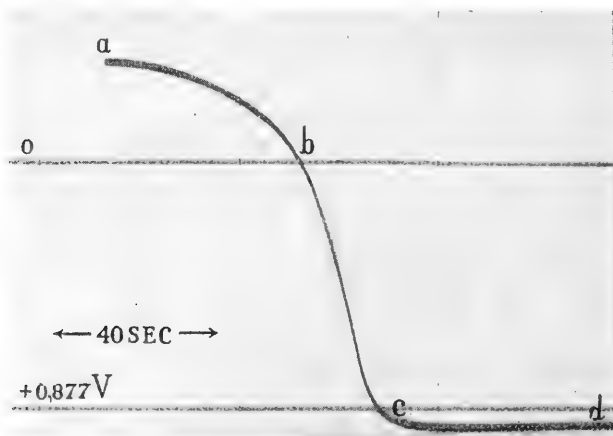

Fig. 3.

The further course of the potential after the maximum negative

value has been reached, is represented on the photo, Fig. 3. As the subsequent process is much slower, the velocity of revolution of the drum of the registering apparatus was chosen smaller here. We see that the potential remains constant for some time, and then proceeds to positive values with ever increasing rapidity. The initial point of this change coincides with the moment at which the grey mercury deposition makes room for the liquid shiny mercury phase.

In a following communication we shall, among other things, state the results obtained when other aluminiums and mercuri-salt solutions were used.

*Laboratory of General and Anorganic
Chemistry of the University.*

Amsterdam, May 8th 1921.

Chemistry. — “*On the behaviour of Amorphous Carbon and Sulphur at High Temperatures and on Carbon-Sulphides*”. By Dr. J. P. WIBAUT. (Communicated by Prof. A. F. HOLLEMAN).

(Communicated at the meeting of May 28, 1921).

§ 1. *Introduction.* In 1919 Dr. A. STOFFEL and the author of this paper published an inquiry into the sulphurous compounds of coal ¹⁾. The result was briefly as follows:

A method was elaborated to determine the sulphur combined with iron (pyritic sulphur) and the sulphur present as organic compounds separately. It was then examined how these anorganic and organic sulphur compounds dissociate during the coking of coal, i.e. the heating with exclusion of air at temperatures of 1000° and higher. It then appeared among other things that during the coking the organic sulphur compounds partly yield sulphuretted hydrogen and volatile organic sulphur compounds, but that a large proportion of the organically bound sulphur from the coal is retained in the coke in the form of a sulphur-carbon compound, which does not lose its sulphur content at the temperature of 1000°. In gas coke, which mostly contains 1—1,5% of sulphur, this sulphur appeared to be present for the greater part in the form of a carbon-compound, and only for a smaller part to be fixed by the anorganic components (ash components) of the coke. Comparative experiments on the coking of ash-containing coal-samples and of coal-samples that had been freed from mineral admixtures (ash), taught that during the coking of coal, part of the sulphur which is combined with iron as pyrite in the coal, is fixed by carbon in the coke. It seems, therefore, that carbon can combine with sulphur in some way or other at high temperature.

This find was very surprising, and not devoid of importance for the technics of coke-manufacture. About the same time PARR and POWELL ²⁾ published a research on the same subject, which did not appear as a magazine article, and did not come under our notice until later. The investigators followed another method of research; their results on the whole agree with ours. In two recent papers

¹⁾ Rec. trav. chim. **38**, 132 (1919).

²⁾ A Study of the Forms in which Sulfur occurs in Coal. University of Illinois Bulletin. Vol. XVI. N^o. 34 (1919).

POWELL¹⁾ communicates the result of further researches. In this the behaviour of the sulphur compounds during coking is examined in details for different kinds of coal, in which the already mentioned results were confirmed and extended.

It seems, however, to me that also questions of more general importance present themselves in connection with these reactions. In what way is this compound of sulphur and carbon formed, in which evidently a complex is formed that is very resistant with regard to heating? A preliminary experiment had already taught me that through quick heating of sugar carbon with sulphur a carbon-like sulphurous substance is obtained, which can be made red-hot without losing its sulphur content. Accordingly the mutual behaviour of two simple substances as sulphur and carbon is not yet known in detail. Hence I have begun an investigation purposing to examine the behaviour of amorphous carbon and sulphur on heating, and study more closely the products that arise from these two components. Though this investigation is not yet entirely completed, I feel obliged in view of POWELL's publications, to communicate already now the experiments carried out by me.

§ 2. In order to obtain reproducible results, it was desirable to experiment with an amorphous carbon as pure as possible, which was obtained in a well-defined way.

Finely powdered sugar-carbon obtained through moderate heating of sugar, was extracted with boiling hydrochloric acid, after which the ash-content was 0.30 %. Through extraction with hydrofluoric acid this ash-content is only little diminished. This carbon was heated at 900—1000° in a porcelain tube for 7 hours. The generated gases were pumped off by means of an oil-pump, in a vacuum of $\pm 1,7$ mm. This preparation was analysed, and then again heated at 970—1020° for three hours in a vacuum of 0.6 mm.; during the last hour of this heating experiment there was no generation of gases any more. The evacuation was continued during the cooling. The analysis of this carbon was performed as follows: a weighed quantity of substance was heated in a porcelain boat at 400—450° and 1 mm. for one hour; after having been cooled in vacuum, the boat was quickly placed in a weighing bottle, reweighed, and at once conveyed to the combustion tube. Such amorphous carbon is very hygroscopic; the content of absorbed water determined in this way, was 1.83 %. The analysis of this carbon dried in vacuum

¹⁾ Journ. Ind. and Engin. Chem. **12**, p. 1069, 1077 (1920).

at 400° showed 98,35 % C. 0,75 % H., and 0,30 % ash. After one hour heating at 600 — 660° at 2 mm.: 98,68 % carbon, 0,53 % hydrogen, 0,30 % ash. When the rest is estimated as oxygen, and when this content of oxygen is attributed to absorbed water, which has not been removed in spite of the heating at 600° in vacuum, the dried preparation has the following composition: ash 0,30 %, carbon 98,68 %, absorbed water 0,49 %, hydrogen (chemically bound) 0,48 %.

Even after prolonged heating at 1000° in vacuum a small quantity of hydrogen is retained in this preparation. This hydrogen content lies, however, near the limit of the errors of the analysis. Apart from the ash-content, the preparation consists, therefore, practically of amorphous carbon. The ash almost entirely dissolved in hydrochloric acid, and contained but very little iron-oxide.

The following experiments were made with this amorphous carbon K_1 : 24 grammes of K_1 were mixed with 8 grammes of pure sulphur; the mixture was placed in a porcelain tube, which was shoved horizontally into an oven heated at 510° C. The temperature of the oven was raised in an hour to 760° , and in the following 90 minutes to 975° . From 600° to the end of the experiment there developed some sulphuretted hydrogen. After cooling much sulphur was found in the colder part of the tube, which had been condensed there. The black carbon-like mass was again placed in a porcelain tube, and this was slowly heated in a vertical oven. At 800° very little sulphuretted hydrogen began to develop; the temperature was carried up to 1000° in two hours, and kept at 1000° for half an hour, then the H_2S -generation had ceased and the heating was discontinued. A sulphur determination in the carbon-like powder showed: 1,98 % S.

16 grammes of P_1 were extracted for a long time with boiling toluene; after evaporation of the toluene no sulphur remained behind. 2,03% was found for the sulphur content of the extracted product. Hence extraction with toluene does not reduce the sulphur content of P_1 . Extraction with carbon disulphide did not lead to the purpose, as it appeared impossible to remove the last rests of carbon disulphide from the extracted product.

I then tried whether through heating in vacuum, in which the receiver was cooled with liquid air to condense gaseous compounds that might possibly be formed, a sulphurous substance could be isolated from this preparation. It appeared, however, in several experiments that even prolonged heating in vacuum reduced the sulphur-content of P_1 hardly perceptibly; hence a volatile sulphur

compound is not formed. The following figures give an idea of the course of such an experiment.

A porcelain boat with 3.09 grammes of P_1 was placed in a porcelain tube, which was open on one side, and was connected there with the oil-pump. The tube was heated in an electrical oven (thermo-element on the outside of the tube).

Time	Temp.	Pressure	
1.30	620°	1.5 mm.	} There is formed a little sulphuretted hydrogen.
3.15	840	1.7 "	
3.45	910	1.5 "	
5.10	1010	2 "	
5.45	900	2 "	

Left to cool with evacuation; the sulphur-content of the thus obtained product P_2 was 1.94 %.

2.38 grammes of P_2 heated anew in vacuum:

11.15	400°	1 mm.	
2	940	1 "	
3	980	1 "	
4	1030	1.5 mm.	there still arise traces of H_2S .
5	1060	1.5 "	
6.10	990	1 "	

Left to cool with evacuation. The product P_3 thus obtained contains 1.87 % of sulphur.

It appears from these experiments that the sulphur content of P_1 decreases very little by prolonged heating at about 1000° C. and 1.5 mm., the decrease of the last experiment lies near the limit of the errors of the analysis. The total analysis of the preparation P_1 , which had been dried at 600° and 2 mm. for an hour gave: 0.27 % ash, 96.1 % C, 0.33 % H, 2.00 % sulphur, together 98.70 %.

Besides absorbed water this preparation contains, therefore, still a hardly appreciable quantity of hydrogen.

§ 3. Behaviour towards oxidizers and towards hydrogen. In order to get a better insight in the nature of this compound of carbon and sulphur the behaviour of this preparation towards oxidizing and towards reducing agents was examined.

2 grammes of P_1 were shaken with 100 cc. of water and 3 cc. of bromine for four hours on the shaking apparatus at the ordinary temperature. After this operation 3.6 mgr. of sulphur was oxidized

to sulphuric acid, hence 9% of the sulphur present in the 2 grammes of P_1 . In a duplicate experiment 13.5% of the sulphur was oxidized. In this product the sulphur was, therefore, oxidized only for a small part or at least very slowly by bromine water at the ordinary temperature. When on the other hand a mixture of charcoal with 2% sulphur was treated in the same way with bromine, the sulphur present was quantitatively found back as sulphuric acid, as was to be expected.

Behaviour towards hydrogen.

In a preliminary experiment 0.90 gramme of P_1 were spread out in a thin layer in a porcelain boat, and slowly heated in a current of pure dry hydrogen. Up to 500° no formation of sulphuretted hydrogen could be found; this began at about 550° . In two hours the temperature was raised from 550 to 750° ; in this temperature range sulphuretted hydrogen was slowly but regularly developed. About $\frac{1}{3}$ of the sulphur originally present in the P_1 was converted to sulphuretted hydrogen.

In a second experiment 2 grammes of P_1 were heated in a hydrogen current; at 430° sulphuretted hydrogen began to evolve. When 650° was reached, this temperature was kept constant, till the regular generation of sulphuretted hydrogen diminished. The heating at 650° had then been continued for 5 hours. The temperature was then raised to 750° , which gave rise to the formation of some more sulphuretted hydrogen. After the heating at 750° had been continued for four hours, only very little sulphuretted hydrogen was slowly developed, after which the experiment was stopped. The quantity of sulphuretted hydrogen formed corresponded to 0.0281 gr. sulphur or 70% of the quantity present in 2 grammes of P_1 . 1.945 grammes of carbon were recovered, which contained 0.47% sulphur. Hence 23% of the sulphur present in P_1 has remained behind in the carbon that is left.

In a third experiment 2 grammes of P_1 were heated for some days in a hydrogen current. The temperature was between 500 — 700° for 9 hours, and between 700 — 800° for 11 hours. Throughout the experiment sulphuretted hydrogen was regularly generated. The remaining carbon still contained 0.29% sulphur; it is, therefore, possible to convert practically all the sulphur from P_1 to sulphuretted hydrogen by prolonged heating in hydrogen at 500 — 800° .

To verify whether really a particular action of hydrogen should be assumed here, 1 gramme of P_1 was heated in a current of pure dry nitrogen at 900 — 990° for 8 hours; this appeared to have reduced the sulphur content only little. The percentage of sulphur found

in the remaining product was 1,75 %. It follows from this last experiment that the formation of sulphuretted hydrogen does not take place in this manner, that primarily sulphur vapour is split off, which reacts with the hydrogen. For if the sulphur combined with the carbon had an appreciable vapour tension at 900°, the generated sulphur vapour would be carried along by the nitrogen current, and then it would be possible to remove nearly all the sulphur from the carbon by heating in a nitrogen current, which is not the case. In the action of hydrogen on P₁ we have, therefore, to do with a specific action of the hydrogen, hence with a chemical reaction.

§ 4. I then examined more closely the conditions under which, and the temperatures at which this fixation of sulphur by amorphous carbon takes place. These experiments have not yet led to a satisfactory insight into the proposed problem, and should, therefore, be considered as provisional. A series of experiments was arranged as follows:

1.5—2 grammes of a mixture of 75 % amorphous carbon K₁ and 25 % sulphur was put in a porcelain boat, this boat was placed in a porcelain tube, which was in an oven heated beforehand at a definite temperature. The oven was then kept at this temperature for an hour, pure nitrogen flowing through the tube during this time; then the tube was cooled in a nitrogen current. This experiment was made at different temperatures (all above the boiling-point of sulphur), viz. at 500—510°, at 610—590°, 670—710°, 900—940°.

Most sulphur distilled from the boat for the greater part already at the beginning of the experiment. In the experiment at 500—510° no H₂S-formation was observed; it was, however, observed in the experiments at 610—590° and at the higher temperatures.

In all these cases the carbon recovered after the experiment had fixed no sulphur or very little. Compare with this the preparation of P₁ (§ 2), in which a larger quantity of mixture of carbon + sulphur was placed in an oven heated at 510°, which temperature was slowly raised to 975°; in this latter case the contents of the porcelain tube will have assumed the temperature of 510° less rapidly, and the sulphur could, therefore, be fixed by the carbon, before all the sulphur had been distilled out from the mixture.

The temperature at which the fixation took place in this experiment, cannot be ascertained. In the series of experiments mentioned in § 4 the small quantity of substance quickly assumed the temperature of the heated tube, the sulphur evaporated almost immediately after the boat had been pushed into the oven, the time during

which the sulphur vapour was in contact with the heated carbon was evidently too short for the fixation of sulphur by carbon to take place. For this reason some experiments were made in which the sulphur vapour was longer in contact with the carbon heated at a definite temperature.

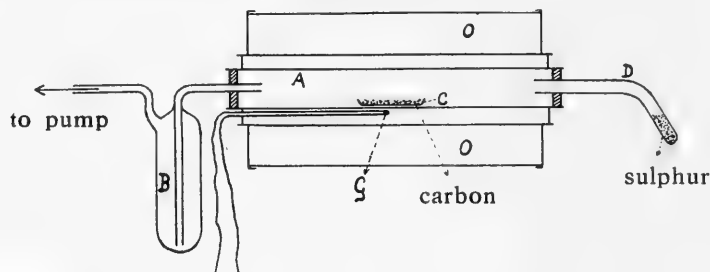

In the middle of a porcelain tube *A* there is a boat *C* with about 2 grammes of amorphous carbon. The junction *G* of a thermocouple is on the outside of the porcelain tube at a level with the boat. *O* is an electrical oven. On one side a tube of sparingly fusible glass *D* was fastened air-tight in the porcelain tube. The bent part of this tube was partly filled with sulphur. On the other side the tube was in connection with a receiver *B*, which could be cooled during the experiment, and which was also connected with the vacuum pump. First the whole apparatus was evacuated to $\pm 2\text{mm.}$, and then the heating was started. When the desired temperature had been reached, it was kept constant and — while evacuation was continued — the tube *D* was heated, so that the sulphur began to distill through the porcelain tube. In this way sulphur vapour flowed over carbon that was heated at a definite temperature. After the sulphur had been distilled over, the apparatus was left to cool in vacuum.

I. Carbon heated at 550° . ± 6 grammes of sulphur distilled over during 30 min. Original weight of carbon found back: it contained 0.91% sulphur.

II. Carbon heated at 885° . ± 4 grammes of sulphur distilled over during 15 min., the product obtained contained 1.53% sulphur. In these experiments most of the distilled sulphur condensed in the colder part of the tube, a little in the receiver which was cooled in carbonic acid and alcohol. Formation of carbon disulphide (CS_2) was not observed. If any was formed which did not condense at -80° and 2 mm., the quantity must have been very small, because the greater part of the carbon was found back.

It accordingly appears from these experiments that sulphur is

fixed by carbon both at 550° and at 885° . The influence of time and temperature will be decided by further experiments.

5. The experiments described may be interpreted in different ways. The sulphur may have been absorbed by the carbon or fixed by chemical forces. Let us first consider the former case more closely. Amorphous carbon is an exceedingly efficient absorbent for various gases¹⁾, why should not sulphur vapour be absorbed? By absorption is understood a reversible phenomenon; the absorbed gas is condensed on the absorbent, and has remained unchanged in its chemical properties.

The fact that the carbon does not lose its sulphur-content at 1000° and 1 mm. pressure is not conclusive against the assumption of absorption. For if the absorption-isotherm has an asymptote in the axis of coordinates, it is possible that the last rests of absorbed substance (in this case 2% sulphur) are practically not to be removed. The influence of the temperature and the time during which the sulphur vapour is in contact with the carbon, on the quantity of sulphur which is fixed, will have to be studied more closely to render it possible to draw a definitive conclusion in this respect. The behaviour of the fixed sulphur towards hydrogen, however, seems to me an argument in favour of the sulphur being fixed to the carbon by chemical forces. By the action of hydrogen on the sulphur-carbon complex sulphuretted hydrogen is formed. In this reaction it must be assumed that the hydrogen reacts with the solid phase. For the sulphur vapour tension of the sulphur-carbon complex is still very small at 900° , otherwise finally all the sulphur would be expelled in gaseous form by heating in a nitrogen current at that temperature. For the same reason the sulphur cannot be assumed to be in the carbon in a solid solution having a certain vapour-tension. In this case, too, it would be incomprehensible why the sulphur could be expelled by hydrogen, and not by nitrogen.

Also the fact that by treatment of the product P_1 with bromine water only a small part of the sulphur is oxidized, is difficult to reconcile with the idea of absorption.

I assume for the present that the sulphur is bound to the carbon by chemical forces, and propose to designate the carbon-sulphur compound formed in this way for the present by the name of carbon sulphide. Nothing can be concluded with regard to the composition

¹⁾ This holds at least for charcoal, animal charcoal and such substances. Whether also pure amorphous carbon is a good absorbent, does not seem to have been decided as yet.

of this carbon sulphide from the experiments described. A priori it does not even seem established that there is question here of one or more compounds of constant composition. Besides it seems possible that a fixation by chemical forces has to do something with surface phenomena. In LANGMUIR's experiments ¹⁾ on the fixation of oxygen by heated filament of carbon or tungsten one has to do with a very thin layer of oxygen, which is retained at the surface of the carbon or tungsten filament by chemical forces.

LOWRY and HULETT ²⁾ have shown that amorphous carbon (in their case not entirely pure) can fix oxygen at 25° in another way than by absorption. Even at 180° this oxygen could not be pumped off from the carbon, at higher temperatures the oxygen split off as CO and CO₂. Some years ago, RHEAD and WHEELER ³⁾ have shown that oxygen can be fixed by amorphous carbon at temperatures between 250° and 500°, and that on heating of this carbon-oxygen complex CO and CO₂ is formed. In these researches it has been established beyond doubt that the fixation of oxygen to the carbon takes place by chemical forces. The quantity of oxygen fixed in this way in LOWRY and HULETT's experiments, was 1.7—3.75 of the weight of the carbon, a quantity which is, therefore, of the same order of magnitude as in the sulphur-carbon complexes. An analogy between these solid carbon-oxides and the carbon-sulphides described in this communication is undeniable. Whether these carbon sulphides also on still higher and more prolonged heating split off the sulphur as volatile carbon-sulphide compounds, would have to be decided by further experiments.

It is possible that the sulphur atoms are bound by rest-valencies of the carbon atoms which have remained unsaturated after the combination of the carbon atoms to amorphous carbon. This rest-affinity will possibly not be the same for different preparations of amorphous carbon, but depend on the way in which the amorphous carbon has been obtained.

Led by this idea I have made similar carbon sulphides starting from sulphur and from sugar-carbon, which had been purified by being heated successively in a current of chlorine, a current of hydrogen and in vacuum. In this way similar, but quantitatively different, results were obtained. By heating of charcoal with sulphur first a large quantity of sulphuretted hydrogen was developed, and finally a carbonsulphide resulted containing 3,5 %.

¹⁾ Journ. Amer. Chem. Soc. **37**, 1154 (1915) and **38**, 2271 (1916).

²⁾ Journ. Amer. Chem. Soc. **42**, 1408 (1920).

³⁾ Journ. Chem. Soc. **101**, 831 (1912), **103**, 461.

sulphur; this sulphur-content could be reduced to 2,7 % by heating in vacuum, but remained then constant. Its behaviour towards oxidizers was perfectly analogous to that of the carbon sulphide described in § 2. These experiments, which are still to be confirmed by a new series will be described later.

§ 6. These carbon sulphides obtained synthetically present a close resemblance with coal-coke, for so far as the sulphur-content is considered. The sulphur fixed to carbon in coal-coke is very resistant to oxidizers and cannot be expelled by heating.

In a recent research POWELL.¹⁾ has shown that the sulphur content of coke can be considerably reduced by leading hydrogen over the coke at 500—1000°, which caused the sulphur fixed to carbon to be transformed into sulphuretted hydrogen for a large part. His statement²⁾ that sulphur-free coke can combine with sulphur when heated in a mixture of hydrogen and sulphuretted hydrogen, and that there is equilibrium between the carbon-sulphide and the sulphur vapour, cannot be judged until the experiments have been further described.

In conclusion I will mention the product that STOCK and PRAETORIUS³⁾ obtained in their research on the carbon-sulphide (C_3S_2). This carbon-sulphide polymerizes to a black mass of unknown molecular weight. On heating this carbon-like substance to dark redness CS_2 and C_3S_2 escaped; but there remained a carbon-like mass that contained 39 % sulphur. A closer examination of such a product and its behaviour at prolonged heating will be of interest.

¹⁾ Journ. of Ind. and Engin. Chem. **12**, 1077 (1920).

²⁾ Ibid **13**, 34 (1921).

³⁾ Ber. **45**, 3569 (1912).

Physics. — “*An Extension of the Theory of BABINET’s Compensator.*” By C. A. REESER and Prof. R. SISSINGH. (Communicated by Prof. H. A. LORENTZ.)

(Communicated at the meeting of June 25, 1921).

1. For an examination of elliptically polarized light, BABINET’s compensator must satisfy the condition that the principal planes of the two wedges are at right angles to each other. Besides, if this elliptically polarized light arises from reflection, one of the principal planes must coincide with the plane of incidence of the mirror. For this purpose one of us has used the dark line in the field of polarisation of the nicol, which was first observed as band by LANDOLT, and afterwards studied by LIPPICH¹⁾. In an experimental investigation on the true optical constants of mercury, carried out by REESER, it appeared, however, that phenomena, which had not been observed before in the compensator, can successfully be used in the adjustment of the compensator, which leads to greater accuracy²⁾. The phenomena in question have first been experimentally studied, and then theoretically confirmed.

2. The above mentioned phenomena are obtained by means of a cylindrical beam of rays, which is not perfectly achromatic. For this purpose a spectrum is thrown on the slit of a collimator, and the beams of light, issuing from it, are made to traverse a compensator placed on a goniometer between two nicols. Let the compensator at first contain only one wedge. The front plane of this wedge is at right angles to the beam of rays.

The analyzer is placed behind the wedge and also a telescope, which is adjusted for parallel rays. The change of direction, which the rays of light undergo in their passage through the polarizer, has been for the greater part neutralized by the aid of two glass wedges³⁾. The polarisation-planes of the two nicols are about normal to each other and the wedge is adjusted so, that the illumination of the

¹⁾ LIPPICH, Wiener Sitz. Ber., 85, 1882; 91, 1885. SISSINGH, Proefschrift, Leiden, 1885; Arch. Néerl., 20. 1886

²⁾ C. A. REESER. Proefschrift, Amsterdam. 1921.

field, i.e. of the image of the slit in the telescope, is a minimum. One of the planes of polarisation of the nicols is then about parallel to and the other normal to the principal plane of the wedge.

3. The collimator-slit takes a part out of the spectrum, the wave-length of which varies a little in a direction normal to the slit. Thus different cylindrical beams of light issue from the collimator, which differ somewhat in wave-length, and the axes of which form small angles with each other. The image of the slit in the telescope is, therefore, part of a spectrum. In this image there are seen some black lines, parallel to the longitudinal direction of the slit. In our case the number, depending on the width of the collimator-slit, was three. By experiment the following properties of these lines were found :

a. The lines arise from the extinction of definite colours. They become sharper as the purity of the spectrum increases and more numerous with greater width of the slit.

b. The wedge-form of the quartz wedge is without influence, as a slit before the quartz wedge does not change the phenomenon.

c. For one analyzer-position there are found two polarizer-positions, for which a system of black lines is observed. The lines of one system lie between those of the other. The angle between the two polarizer-positions is smaller as the principal plane of the wedge coincides more with the plane of polarisation of the polarizer or is normal to it. The middle-plane between the two polarizer-positions forms an angle of 0° or 90° with the principal plane of the wedge. One of the two polarizer-positions is only normal to the analyzer, independent of the position of the principal plane of the wedge.

d. When the plane of polarisation of the analyzer makes an angle of 0° or 90° with the principal plane of the wedge, the dark line in the polarisation-field of the two Nicols (§ 1) is visible in the slit-image. Supposing that this is about at right angles to the edges of the slit, the two systems of black lines are visible at the same time, one above, the other under the nicol line. This forms so to say, a transition between the two systems. The lines seem thickened there.

e. On rotation of the polarizer from one to the other of the two positions, mentioned in *c*, the lines first become fainter, then they rapidly move through the field to those of the second system, in which the latter become very black.

c suggests immediately a mode of procedure to place the wedge so, that the principal plane of the wedge coincides with the polarisation plane of one of the nicols, and is normal to that of the other. This position is obtained with successive approximations.

A simple consideration shows immediately, that one system of lines is formed by the rays, in which the phase difference in the wedge is $2k\pi$ ($k = \text{integer}$), the other by those with a phase difference $(2k + 1)\pi$. The properties mentioned in *c* and *d* follow immediately from this.

4. When all the rays of the broad incident beam are supposed to pass over an equally long path in the wedge, an idea of the state of polarisation behind the wedge is obtained in the following way. Let the angle between polarizer and principal plane of the quartz plate be α , between analyzer and principal plane ψ . From the wedge issues elliptically polarized light. Let one of the axes form an angle θ with the principal plane. Let $\cos \mu t$ be the light vector in the incident light and $A \cos (\mu t - \chi)$, $B \sin (\mu t - \chi)$ that according to the axes of the elliptically polarized light, issuing from the wedge. Let δ denote the difference of phase between the ordinary and the extraordinary ray in the wedge. Then:

$$\cos \alpha = A \cos \chi \cos \theta + B \sin \chi \sin \theta \quad (1)$$

$$\cos \delta \sin \alpha = A \cos \chi \sin \theta - B \sin \chi \cos \theta \quad (2)$$

$$0 = A \sin \chi \cos \theta - B \cos \chi \sin \theta \quad (3)$$

$$\sin \delta \sin \alpha = A \sin \chi \sin \theta + B \cos \chi \cos \theta \quad (4)$$

From this set of equations follows:

- I. $A^2 + B^2 = 1$, II. $\cos 2\alpha = (A^2 - B^2) \cos 2\theta$, II_a. $AB = \sin 2\alpha \sin \delta$,
 III. $\tan 2\theta = \tan 2\alpha \cos \delta$, IV. $\sin 2\chi = \tan \alpha \sin \delta \sin 2\theta$.

It is a consequence of the supposition, that nowhere light is absorbed. The light issuing from the wedge is polarized rectilinearly, when $A = 0$. Hence there appear black lines, if:

$$A = 0, \text{ therefore } B = 1, \text{ for } \alpha = \frac{1}{2} \pi + \theta \quad \delta = 2k\pi$$

$$\text{or } \alpha = \frac{1}{2} \pi - \theta \quad \delta = (2k + 1)\pi.$$

A special solution is $A = 0$, $\alpha = \frac{1}{2} \pi$, δ indefinite.

In this way the properties in *a-d* have been found back.

5. From the analyzer issue two rays of light with amplitudes $\cos \alpha \cos \psi$ and $\sin \alpha \sin \psi$, with difference of phase δ , so that the intensity is

$$I = \frac{1}{2} (1 + \cos 2\alpha \cos 2\psi + \sin 2\alpha \sin 2\psi \cos \delta).$$

This expression shows again, that there are two systems of dark lines for $\delta = 2k\pi$ and $\delta = (2k + 1)\pi$. The transition of one system to the other is such, that one system of lines becomes brighter, the other darker. A shifting, as described in *e*, does not take place

however. In order to explain this, the wedge-form of the quartz plate should be taken into account.

6. The distance of the lines in the field of the compensator with two wedges, placed in opposite direction, having equal angles and their principal planes perpendicular to each other, shows that the difference of phase in the wedge varies from one rim of the beam to the other by π , the width of the incident beam being about 8 mm. The angle of the wedges is $15'$. Call this ε , then for two rays with mutual distance x , the change of the difference in the paths in the wedge becomes $d_1 - d_0 = \varepsilon x$ and the change of the phase-differences is determined by $\sigma_1 = \sigma_0(1 + \varepsilon_1 x)$, in which $\varepsilon_1 = \varepsilon : d_0$. In this d_0 is the path, that one of the rays passes over in the wedge. Let α be $= \frac{\pi}{2} + \Delta$. Let ε_1 and Δ be taken as infinitely small. Let further the amplitude of the beam of light in the focal plane of the object lens behind the wedge be called 1, when the incident beam is 1 mm. wide. Then from the equation in (4) follows, with neglect of quantities of the 2nd order:

$$A = -\Delta \sin \sigma_0 (1 + \varepsilon_1 x); \quad B = 1 - \frac{1}{2} \Delta^2 \sin^2 \sigma_0 (1 + \varepsilon_1 x);$$

$$\theta = \Delta \cos \sigma_0 (1 + \varepsilon_1 x); \quad \chi = -\frac{1}{2} \pi + \sigma_0 (1 + \varepsilon_1 x).$$

From the analyzer issue beams of light with amplitudes $A \cos(\psi - \theta) dx$ and $B \sin(\psi - \theta) dx$ and phases χ and $\frac{1}{2} \pi + \chi$. In order to obtain the value of the light-vector in the focal plane, these amplitudes must be composed, and then we have to integrate over the width x of the beam. We can, however, immediately write down the components of the total amplitude in two directions at right angles to each other, viz.

$$X = \int_0^x [A \cos(\psi - \theta) \cos \chi - B \sin(\psi - \theta) \sin \chi] dx$$

$$Y = \int_0^x [A \cos(\psi - \theta) \sin \chi + B \sin(\psi - \theta) \cos \chi] dx.$$

By substitution of the values A, B, χ , and θ indicated here, and neglect of quantities of the 2nd order, we get for the intensity of the light:

$$I = x^2 \left[\Delta^2 + \Delta_0^2 - 2 \Delta \Delta_0 \cos \sigma_0 \left(1 + \frac{\varepsilon_1 x}{2} \right) \right].$$

In this:

$$\Delta_0 = \frac{2\psi}{\varepsilon_1 \sigma_0 x} \sin \frac{\varepsilon_1 \sigma_0 x}{2}.$$

There appear black lines, if $X = Y = 0$, so that :

$$d_0 \left(1 + \frac{\varepsilon_1 x}{2} \right) = 2k\pi, \quad \Delta = \Delta_0$$

or

$$d_0 \left(1 + \frac{\varepsilon_1 x}{2} \right) = (2k_1 - 1)\pi, \quad \Delta = -\Delta_0.$$

It thus appears, that $\frac{1}{2}\pi + \Delta_0$ and $\frac{1}{2}\pi - \Delta_0$ are the azimuths of the two polarizer-positions, for which black lines appear.

The wave-lengths, for which minima appear at given polarizer-positions, follow from $dI : d\delta_0 = 0$. This yields $\Delta = C\Delta_0 : (C \cos \varphi + \varphi \sin \varphi)$, hence :

$$C = 1 - \frac{\varepsilon_1 d_0 x}{2} \cot \frac{\varepsilon_1 d_0 x}{2} \quad ; \quad \varphi = d_0 \left(1 + \frac{\varepsilon_1 x}{2} \right).$$

$\varepsilon_1 d_0 x$ varying little with the wave-length, C is independent of it. The difference of phase in the quartz wedge for a thickness d_1 is $d_1(n_g - n_b) : \lambda$, in which $n_g - n_b = 0,009$, $\lambda = 6 \times 10^{-4}$. For $d_1 = 3$ mm., which value is certainly not exceeded, the difference of phase is $45 \times 2\pi$. Further $\varepsilon = 15'$, or in radians $1 : 240$, $\varepsilon_1 = \varepsilon : d_0$ about $1 : 720$, hence for $x = 8$ mm., $\varepsilon_1 d_0 x$ smaller than π . Thus C is always smaller than 1.

For $\Delta = \Delta_0$ the minima appear at $\varphi = 2k\pi$, and I then being $= 0$, they are perfectly black. It appears from the foregoing, that k is about 45.

When we start from perfectly black bands, $\Delta = \Delta_0$, $\varphi = 2k\pi$, $I = 0$, and let φ increase by $\Delta\varphi$, so that $C + \varphi \operatorname{tg} \varphi = 0$, then $\Delta\varphi = -C : 2k\pi$, and Δ has risen to a very great value, likewise I , which depends on Δ^2 . It appears from this, that the dark bands get very much fainter on increase of the azimuth $\frac{1}{2}\pi + \Delta_0$ of the polarizer, but are hardly displaced at all. When now φ is increased by a very small amount $\Delta\varphi = C : 2k\pi$, so that $\varphi \operatorname{tg} \varphi = C$, then Δ is $= \frac{1}{2}\Delta_0$, $I = \frac{1}{4}\Delta_0^2$. Accordingly the dark bands are very little displaced, when the azimuth of the polarizer decreases from $\frac{1}{2}\pi + \Delta_0$ to $\frac{1}{2}\pi + \frac{1}{2}\Delta_0$. If the bands have to shift to places for which $\varphi = (2k + \frac{1}{2})\pi$, Δ must decrease to $C\Delta_0 : (2k + \frac{1}{2})\pi$, or about $\Delta_0 : 300$, for $C = 1$, $k = 45$. In order, therefore, to displace the minima over a fourth of their distance, Δ must decrease to a very small fraction of Δ_0 . The bands, which at first seem to remain in their places, when the polarizer is rotated, afterwards move through the field with great rapidity. Theory thus explains the phenomena given in 3e. We have further examined, what happens to the bands at the places for which $\varphi = (2k + 1)\pi$ at $\Delta = -\Delta_0$.

The results, however, are not recorded, because the phenomena take place at such small values of Δ , that they are difficult to observe experimentally.

7. Similar results, as have been described in § 3 for one wedge, are observed with both compensator-wedges.

a. In the slit-image black bands can appear for suitable nicol-positions; only one position of the polarizer, however, corresponds to a definite position of the analyzer. Compare 3c.

b. These positions of the nicols are confined to a region, which becomes smaller, as the angle between the principal planes of the wedges departs less from 90° .

From this follows a new criterion for the adjustment of the true position of the wedges (angle 90° between the principal planes), viz. that the black bands disappear on the slightest displacement of the polarizer.

We may refer for the theoretical explanation to a thesis for the doctorate by C. A. REESER, Amsterdam, 1921. In this the phenomena corresponding to 3e, which REESER termed fading-phenomena, i.e. in which the dark bands are fading away, were left out of consideration as exceedingly complicated. The theory is therefore restricted to the occurrence of perfectly black bands.

Physics. — “*The Optical Investigation of Surface Layers on Mercury and a More Refined Method of Observation with BABINET’S Compensator.*” By C. A. REESER and Prof. R. SISSINGH.
(Communicated by Prof. H. A. LORENTZ.)

(Communicated at the meeting of June 25, 1921).

1. This research was made with the same apparatus as HAAK used¹⁾. It will, therefore, only be mentioned here, what modifications have been made in it. In order to obtain a greater light-intensity and to have greater certainty, that the wave-length of the light used was not modified during the observations, the monochromator, placed before the goniometer, was omitted. The light, which must be monochromatic as much as possible, was now obtained by means of colour-filters or a mercury lamp of HERAEUS (3,5 A, 35 V). As source of light we finally returned to the self-regulating arc-lamp of 18 Ampères²⁾. The collimator-axis was in the right direction of incidence, so that the mirror behind the collimator could be omitted.

2. As is known, the nicols with oblique end-planes give, besides a displacement, also a change of direction to the beam of rays in consequence of errors in the construction. It is about $\frac{1}{3}^\circ$ in the nicols used. This gives rise not only to a change in the direction of incidence, but, in using a monochromator, also to a shifting of the compensator line. The collimator slit takes out of the spectrum a small portion, the wave-length of which varies in the direction of the width of the slit. In consequence of the deviation by the polariser not always the same part nor light with the same wave-length falls between the threads of the compensator. In the most unfavourable case a shifting of the line took place in the compensator in consequence of this, corresponding to a phase-difference of $0,02 \times 2\pi$.

In order to eliminate this difficulty Mr. REESER applied the following expedient. Two glass wedges with refractive angles of 1° were placed before the polariser. The angle between the planes, perpen-

¹⁾ J. J. HAAK. Proefschrift Amsterdam, 1918; These Proc., Vol. XXI., No. 5, p. 678 (1918).

²⁾ Compare for further particulars. C. A. REESER Proefschrift. Amsterdam 1921.

dicular to their refractive edges, could be given any value. When by this means the same deviation is given to the ray of light thrown on the polariser, as is caused by the polariser itself but in opposite direction, the deviation is neutralized.

3. For the observation of the lines in the compensator, a slit is placed before it and the threads, to shut off the strong light, that passes on the side of the threads through the compensator. A slit of 1 mm. is sufficient. A narrower slit gives troublesome diffraction phenomena. A shifting of this slit before the compensator gives a change in the position of the compensator-lines. Therefore the slit must always be symmetrical with regard to the threads. As, however, slit and threads are not in the same plane, this symmetrical position is disturbed, when the rays run no longer in the direction of the axis of the telescope behind the analyzer. Thus before every determination of the position of the compensator-lines the telescope must be carefully placed in the direction of the reflected rays. If this precaution is observed, the positions of the compensator lines in the different polariser positions differ at most so much as corresponds to a phase-difference of $0,0013 \times 2\pi$, the limit of observability being $0.0006 \times 2\pi$.

4. Finally Mr. REESER has still applied the following expedient to make the method of observation more precise. With a telescope behind the compensator, focussed for parallel rays, we see besides the direct slit image, two more side images, formed through internal reflection in each of the wedges. By focussing on the compensator lines, hence on the threads, the side images coincide, however, with the central, direct one. It is self-evident that this is not conducive to an accurate measurement of phase-difference and the ratio of the components of the examined elliptically polarized light. When the rays of these side-images are shut off by a screen with a slit in the focal plane of the object-lens of the telescope, the compensator line becomes perfectly black, narrower and more sharply defined. The accuracy of only one determination of the position of the line corresponds to $0.0006^5 \times 2\pi$; the accuracy of the restored azimuth, which was before about $20'$ for 64 adjustments, now amounts already to $5' - 9'$ for 16 adjustments. We have found this increased accuracy to be absolutely necessary for the investigation of the surface-layers.

5. In order to prevent vibrations of the mercury surface, the mercury vessel is mounted on a small adjustable stand, free from the goniometer. The displacements of the nicols and the compensator can then take place without danger of vibrations of the liquid surface.

When once the goniometer axis has been put at right angles to the normal of the mercury surface, this is the case for each new surface¹⁾. The two following criteria, derived by DRUDE, refer to the purity of a mercury surface: *a.* surface layers increase the reading of the compensator. *b.* increase the restored azimuth at not too small angles of incidence²⁾. To this the following criterion, found experimentally, may be added. For a pure mercury surface, which as such gives the lowest value, both for the phase-difference and for the restored azimuth, the reading of the compensator in the air may vary only slowly. If the mercury is not perfectly pure, a clearly perceptible rise of the compensator-reading, corresponding to a phase-difference of $2\pi:150$, is observed soon after the formation of the mercury surface, even in a space of greatly rarefied air. That this rise does not take place through formation of an adhering layer of air, appears also from this, that it proceeds incomparably much more quickly than is the case with that in consequence of an air-layer, which forms slowly, according to a relation given and tested by HAAK³⁾. The only conceivable explanation is the coming to the surface of impurities. No sufficient improvement is attained by rubbing off the mercury-surface with cotton wool, so that the upper layer is removed. Addition of clean mercury influences the surface-layer only to a very small degree. This experience leads to the conclusion that RÖNTGEN'S pouring-out method and that of the communicating vessels of DRUDE cannot give a sufficiently pure mercury surface. Better is the method that WERNICKE applied to crystals and glass, in which a solution of collodion in ether is poured over the surface and the film, which is formed after half an hour, is detached from the side of the mercury vessel, and slipped off over the mercury. This procedure, however, also fails several times, and is often less successful on repeated use of the same glass and mercury. The best results were obtained by conveying double distilled mercury after filtering through a paper funnel into a glass vessel with a fine, drawn-out point. This vessel fits with a ground rim into a cylinder glass, which is also filled with mercury through the fine point. The vessel itself is closed by means of a ground-in stopper. From the vessel the mercury is run into a glass dish with flat bottom and small depth, which had been carefully cleaned previously. The dish is kept between filter paper and never touched. Alcohol is never used for the cleaning, for fear of impurities and oxidation of the mercury.

¹⁾ C.f. for the centering HAAK, loc. cit.

²⁾ DRUDE, Wied. Ann., 39, 492. 1892.

³⁾ HAAK, Thesis, p. 32.

6. The observations have been carried out with four light-filters. The wave-lengths of the maxima of the transmitted narrow spectral regions are successively $669 \mu\mu$; $637 \mu\mu$; $558 \mu\mu$ and $482 \mu\mu$. Besides, the yellow, green, and blue mercury lines have been used by the aid of the quartz mercury lamp. Its wave-lengths are $578 \mu\mu$, $546 \mu\mu$ and $436 \mu\mu$. For the way in which the angle of incidence and the lowest compensator reading is obtained, compare the thesis for the doctorate of Mr. REESER. Let us call the lowest compensator reading for a mercury mirror without surface layer c' , the observed reading c , ψ' and ψ the corresponding values of the restored azimuth, then $(\psi' - \psi) : (c' - c)$ can be calculated with the formulae in § 8, so that ψ' and c' can be derived from the observations.

7. First the optical constants, principal angle of incidence I and principal azimuth H , also n_0 and k_0 , index of refraction, and coefficient of absorption in a direction normal to the boundary plane have been determined for a pure mercury surface. The phase-difference φ and the restored azimuth ψ is determined with each of the colours for five or six angles of incidence. From this $n \cos \alpha$ and k are calculated for every angle of incidence, in which n and k are index of refraction and coefficient of absorption corresponding to the angle of incidence, and α represents the angle of refraction. The mean is calculated from the different values of $n \cos \alpha$ and k for the same angle of incidence, and thus I and H according to the relations

$$\operatorname{tg} 2H = \frac{k}{n \cos \alpha}, \quad \operatorname{tg} \bar{I} = \frac{n \cos \alpha}{\cos 2H \sin I}$$

The second equation gives I through successive approximations¹⁾. Here follow the values of I , H , n_0 and k_0 for three colours, viz. the yellow, green, and blue mercury lines.

yellow mercury line	$I = 79^\circ 28'$	$H = 35^\circ 50'$	$n_0 = 1,693$	$k_0 = 4,934$	$\lambda = 578 \mu\mu$
green	$78^\circ 56'$	$36^\circ 16'$	1,538	4,696	$= 546 \mu\mu$
blue	$76^\circ 21'$	$38^\circ 2'$	0,995	3,754	$= 436 \mu\mu$

The accuracy of I is for the different colours from $3'$ to $8'$, for H from $6'$ to $8'$, for n_0 from 1% — 2% , for k_0 from $1/2\%$ to 1% . The values here obtained are compared with those of earlier investigators, and it is shown that in most of them the mercury had a surface layer¹⁾.

¹⁾ See for further information the thesis for the doctorate of C. A. REESER, Amsterdam 1921.

8. The surface layers of smoke, air, and oil upon mercury have been examined by means of the more delicate method of observation (see 2, 3, and 4). For a surface layer which is so thin, that the index of refraction may be considered as constant, the following equations may be derived from DRUDE's theoretical considerations ¹⁾:

$$\frac{\psi_2 - \psi_1}{c_2 - c_1} = \frac{27}{x} \sin 2\psi \frac{a'}{\cos^2 i - a} (1 - n^2 \cos^2 i)$$

$$c_2 - c_1 = \frac{400 x}{\lambda} \cos i \sin^2 i \frac{\cos^2 i - a}{(\cos^2 i - a)^2 + a'^2} \left(1 - \frac{1}{n^2}\right) (l_2 - l_1).$$

In this ψ' and ψ are the restored azimuths for a clean mercury surface and one with a surface layer, c' and c the corresponding compensator readings, x the compensator displacement for a phase-difference $\frac{1}{4}$, i the angle of incidence, n the index of refraction of the surface layer, $l_2 - l_1$ its thickness, a and a' are determined by:

$$a = \frac{\cos 4H}{\sin^2 I \operatorname{tg}^2 I}, \quad a' = \frac{\sin 4H}{\sin^2 I \operatorname{tg}^2 I}.$$

Seven surface-layers of smoke have been examined. Two have been obtained by blowing more smoke on to an already existing smoke layer. Smoke is blown into a pipette, provided with a bulb, which ends above the mercury in a fine point. The determinations of phase-difference and restored azimuth with compensator and polarizer (the azimuth of the analyzer is always 45°) are carried out successively on pure and smoked mercury under circumstances, which are the same down to the minutest particulars. The values of l obtained for the different colours with the same layer do not diverge too much. $10^3 l : \lambda$ varied from 3,15 for the thinnest to 34,4 for the thickest layer. The values of n range for every colour with increasing thickness of the layer from about $4 \rightarrow 5$ to $2 \rightarrow 2.5$. The graphical representations point to the existence of a maximum for a definite value of l . For all layers l remains below the limiting value, about $0,03 \lambda$, for which the formula may still be applied.

Two layers of air have been examined. In these circumstances the mercury was protected by a glass plate, so that particles of dust and fat are excluded. The thicknesses of the layers were 2.2×10^{-6} and 3.4×10^{-6} mm., n ranges for the different colours from $2.6 \rightarrow 4.4$ to $3.4 \rightarrow 5.5$.

Besides bone-oil has been communicated to the mercury-surface and the spreading of the oil has been examined. The results have been

¹⁾ DRUDE, Wied. Ann., 39. 1890, 488.

compared with FISCHER'S observations on mercury ¹⁾ and DEVAUX' observations on water ²⁾. By means of the compensator it can be shown, what FISCHER suspected, that a small quantity of oil on mercury immediately spreads on the surface in a very thin layer. The thickness of the very thin layer is 1—2 $\mu\mu$. FISCHER calls it the "vorauselende Schicht".

The thickness of the thinnest layers of smoke, air, and oil are 1.6 $\mu\mu$; 2.05 $\mu\mu$, and 1.07 $\mu\mu$. The values obtained for the index of refraction in all layers always point to a very great density of the layer at the mercury surface.

Whereas with capillary phenomena, as the cessation of the movements of the camphor particles on water, the thinnest layer that can be observed, is 1 $\mu\mu$, it appears that the presence of a layer of 0.3 $\mu\mu$ can very well be verified with the compensator. The optical method is, therefore, more minute, which was also found by RAYLEIGH. In conclusion it should be pointed out that in the calculation of the thickness of the layers from the number of milligrammes, the greater density of the layer at the surface is, as a rule, left out of account.

All the observations have been made by the former of us.

¹⁾ FISCHER. Wied. Ann., 68, 436. 1899.

²⁾ DEVAUX. Journ. de phys. (5), II, 699, 1912.

Chemistry. — “*The Use of the ZEISS Waterinterferometer (RAYLEIGH-LÖWE) for the Analysis of Non-Aqueous Solutions*”. By Prof. ERNST COHEN and H. R. BRUNS.

(Communicated at the meeting of June 25, 1921).

1. Among the methods for a quantitative determination of the concentration of solutions, the optical methods excel the others in many cases in accuracy and rapidity of execution. With very careful regulation of the temperature (constant down to $0^{\circ}.01$) it is possible to determine with the most practical measuring instrument, the refractometer, indices of refraction accurate to 1 or 2 units of the fifth place of decimals, which about corresponds in aqueous salt solutions with an error in the determination of the concentration of 0.02 %.

In some cases, e.g., for the analysis of exceedingly diluted solutions, this accuracy is, however, not sufficient. An instrument, which is eminently fit for such determinations, is the waterinterferometer according to RAYLEIGH-LÖWE, put on the market by the firm ZEISS. It enables us to measure the index of refraction of a solution down to 2 units in the 7th place of decimals, corresponding to an error in the determination of the concentration of at most 0.0002 %.

This interferometer is, however, as its name indicates, constructed for the use of water as solvent, and all the investigations which have been executed by the aid of it up to now, concerned aqueous, or very diluted alcohol, solutions.

In connection with an investigation, of which we hope soon to give further details, it was necessary to carry out accurate analyses of exceedingly diluted solutions in organic liquids. It then appeared that if the interferometer is to be used also in this case, a number of precautions must be observed, which will be set forth more at length in what follows.

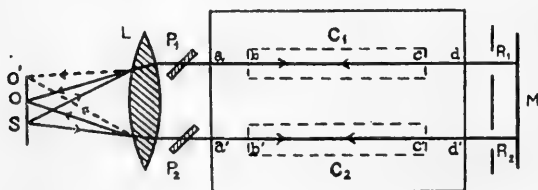

Fig. 1.

We will, however, first give a short description of the interferometer with the aid of figures 1 and 2¹⁾.

2. Fig. 1 gives a schematic representation of the instrument. The rays furnished by a source of light S , made parallel by lens L , pass through the identical vessels C_1 and C_2 filled with the same liquid, and then through a screen provided with two slits R_1 and R_2 , are reflected as two separate beams by mirror M , and after having been united again by lens L , they form an interference image in O . When white light is used this image consists of a central bright band bounded by two dark ones; the bright bands following on them on either side have coloured edges. When now C_1 is filled with a solution which has a greater index of refraction than the pure solvent in C_2 , this interference image is displaced in consequence of the lengthening of the optical path, e.g. to O' . It can be brought back to the zero position O by turning the compensator plate P_1 (P_2 is immovable), through which the optical path is again artificially shortened. The angle, over which P_1 has been rotated, is a measure for the difference of index, hence indirectly for the concentration of the solution in C_1 .

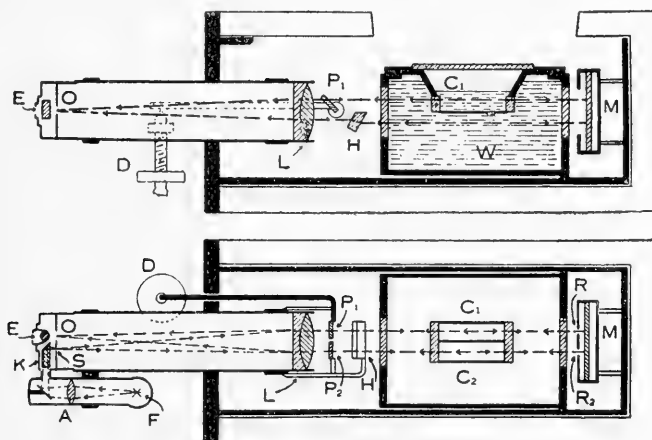

Fig. 2.

Fig. 2 represents a horizontal and a vertical cross-section of the interferometer more in details. The white light of an Osram lamp F is concentrated by lens A and prism K , on the very narrow slit S , which forms the secondary source of light. The passage of the

¹⁾ A fuller description is found in the following places:

F. LÖWE, *Zeitschr. für Instrumentenkunde* 1910, 321; F. LÖWE, *Physikalische Zeitschr.* 11, 1047 (1910).

P. HIRSCH, *Fermentforschung* 1, 33 (1914).

L. H. ADAMS, *Journ. Amer. Chem. Soc.* 37, 1181 (1915).

rays is further quite as in fig. 1. The lower part of the beam leaving lens L, however, does not traverse the vessels, but passes under them through the water in reservoir W, which serves as "Temperier bad" of the vessels. Also these rays of light interfere in O, where they form a fixed image lying below the former, separated from it by a narrow line, and serving as "point de repère" of the zero position. Both images are examined by means of the greatly magnifying cylinder ocular E. The compensator plate P_1 is rotated by means of a lever, which is worked by a micrometer screw with drum D; on this drum a scale is drawn of a hundred divisions. With the instrument used by us one interference band corresponds to 21 scalar divisions. The uncertainty in the adjustment with regard to the coinciding of the two interference images is, after some practice, about half a scalar division.

For the analysis of solutions one has only previously to construct a gauging curve comprising the concentration region used. On the shifting of the central band which seems to take place in this case, compare ADAMS¹⁾.

3. When it is tried to analyse in this way solutions in organic liquids (for which, of course, the use of so-called "säurefest verschmolzen" vessels consisting entirely of glass, is necessary) the following phenomena are in general observed in the interferometer. The upper interference image is blurred and shifted with regard to the lower one. The bands are permanently oblique and curved, or for a long time. Shaking of the liquid in the vessel (by tapping against the interferometer) indeed promotes the rapidity with which the image is formed, but reproducible results cannot be obtained, and after some time the lines become again shifted and curved.

The causes of these deviations, which render an accurate measurement of course impossible, appeared to be due to the following circumstances:

- A. the nature of the bath-liquid.
- B. the influence of the temperature on the index of refraction of the solvent;
- C. evaporation and distillation against the glass covering-plates of the vessels;
- D. absorption of water during the conveying and the staying of the liquid in the vessels.

4. Ad A. *The nature of the bath liquid.*

Compared with by far the majority of the organic liquids the

¹⁾ ADAMS, Journ. Amer. Chem. Soc. **37**, 1181 (1915).

water used as bath liquid possesses a very small index of refraction. For the substances examined by us we have e.g. at 20° :

tetrachlorethane	: $n_D = 1.496$
benzene	: $n_D = 1.501$
whereas for water:	$n_D = 1.333$

It is easily seen that on use of such solvents with greatly deviating indices of refraction, an exceedingly small departure from the parallel position of the plane-parallel front and back wall of the vessels, brings about a very great displacement of the upper interference image. Let us call the index of refraction of the bath liquid n_1 , that of the liquid in the vessel n_2 ; let further the path in the bath-liquid (a b + c d in fig. 1) passed over by the beam of light which passes C_1 , be l_1 , that in the vessel l_2 . The optical path is then for vessel C_1 , the beam passing over the path twice¹⁾:

$$2(n_1 l_1 + n_2 l_2).$$

With perfect parallelism of the plane-parallel plates, this path has the same length for the other beam. If, however, the length of vessel C_2 is e.g. σ more than that of C_1 , the optical path is here: $2[n_1(l_1 - \sigma) + n_2(l_2 + \sigma)]$.

Accordingly the difference in optical path is:

$$\Delta = 2\sigma(n_2 - n_1),$$

and the displacement of the interference image brought about by this and expressed in bands:

$$N = \frac{\Delta}{\lambda} = \frac{2\sigma(n_2 - n_1)}{\lambda},$$

if λ represents the wave-length of the light used.

In the case of water and tetrachlorethane $n_2 - n_1$ is = 0.16.

From this follows for $\lambda = 0.00058$ mm.:

$$N = 550 \sigma, \text{ or expressed in scalar divisions:}$$

$$N' = 21 \times 550 \sigma = 11550 \sigma \text{ scalar divisions.}$$

If the deviation from the parallel position σ is e.g. 0.001 mm., the shifting amounts to no less than ± 12 scalar divisions. The displacement observed with the vessel used by us appeared to be about 40 scalar divisions. Besides this displacement also the imperfect form of the upper image is partly due to the non-parallelism of front and back wall of the vessels.

5. To obviate this difficulty, a liquid must be chosen as "Tempe-

¹⁾ We may disregard here the thickness of the plane-parallel plates, the result not being affected by this.

rierbad", whose index of refraction lies as close as possible to that of the liquids to be investigated. Aqueous solutions with strong refractivity (e.g. of cane-sugar or cadmium salts), which are preferable to organic substances, because they do not attack the cement with which the windows are fastened in the reservoir **W**, proved unsuitable, on account of their high viscosity. After also a number of mixtures of little volatile organic liquids (paraffin-oil-methylsalicylate and methylonyl-ketone-methylsalicylate) had been tried, in which, however, difficulties also presented themselves, tetrachlorethane itself was taken for it. Previously the rims of the windows had, however, to be protected, for which purpose a layer of an aqueous glue appeared to be very effective, and the paint had to be removed from the reservoir.

6. *Ad B. The influence of the temperature on the index of refraction of the solvent.*

The strong and always recurring curvatures of the bands are partially owing to the great value of the temperature coefficient of the index of refraction in organic liquids, accompanied with a very small specific heat.

From KANONNIKOFF's determinations¹⁾ $\frac{dn}{dt} = -0.0005$ may e.g. be calculated for tetrachlorethane at $\pm 20^\circ$.

Benzene has $\frac{dn}{dt} = -0.00065$ at 20° .

A change of temperature of 0.01° gives, therefore, rise to a change in the index of refraction of 6 units in the 6th place of decimals, which when a 2 cm. vessel is used, corresponds to a displacement of 10 scalar divisions. For water these values are about eight times smaller

Exceedingly slight temperature disturbances through addition of heat from outside, which occur especially on a prolonged stay of the observer in the neighbourhood of the apparatus, give much sooner rise to curvatures and displacements of the bands in such liquids than in water.

7. To prevent this:

1. the interferometer was surrounded by a large thermostat, filled with water.
2. a stirrer was placed in the bath liquid.

¹⁾ Journ. für prakt. Chemie, 32, 520 (1885).

This last improvement at the same time also greatly accelerates the exchange of heat between vessel and bath, so that already after 10 or 15 minutes the reading can take place. To prevent currents in the liquid during the measurement, the stirrer was always stopped a minute beforehand.

8. *Ad C. Evaporation of the liquid in the vessels.*

Only in more concentrated solutions is the error brought about by evaporation, greater than the error of measurement. If e.g. from 2 cc. of a 0.1 N.-solution of $C_2H_2Br_4$ in $C_2H_2Cl_4$ 2 mgr. of $C_2H_2Cl_4$ evaporates, this gives rise in our apparatus to an error of 1.6 scalar divisions. Greasing of the rim of the glass cover can, however, prevent such an evaporation. Another source of errors, however, still continues to exist, viz. distillation against the glass cover. This can often be observed already soon after the filling of the vessel; the liquid which is distilled moves between glass cover and vessel rim on account of surface tension, and attacks the vaseline. To prevent this it is to be recommended¹⁾ in aqueous solutions to keep the temperature of the "Temperierbad" always some degrees lower than that of the room; in an investigation of more volatile liquids this is, however, not sufficient.

9. It is, however, possible, to avoid this source of error entirely by using for the closure of the vessel, instead of glass plates, massive closing bodies, which occupy the whole vapour space. For this purpose brass blocks were constructed provided with a flat rim, which fit very tightly in the vessel, and leave only a space of ± 2 cc. for the liquid. This is then conveyed to the vessel by the aid of a pipette of 2 cc. capacity, provided with a long capillary passed through a hole bored through the closing block. After the filling the bored hole is closed by a copper ground-in needle. Greasing of the rim of the vessel is now unnecessary; no evaporation takes place through the remaining capillary slits.

10. *Ad D. The influence of the water absorption.*

Dry, organic liquids absorb water vapour from the atmosphere exceedingly rapidly. On account of the great difference in index of refraction between water and those substances, added to the sensitiveness of the method of measurement, however, the presence of exceedingly small quantities of water causes already errors in the

¹⁾ HIRSCH, *Fermentforschung* 1, 38 (1914).

determination which exceed the error of measurement many times. Also when the liquids have not been previously expressly dried with a view to P_2O_5 , but when they have only been repeatedly fractionated after preliminary drying with $CaCl_2$ (which was the case with the substances used by us) they show already a strong absorption of water-vapour. Especially for $C_2H_2Cl_4$ this appeared to be the case, but though in a less degree, benzene gave also greatly varying values.

When the determinations are carried out with quite the same precautions as are observed for aqueous solutions, two successive determinations executed directly after each other, already in consequence of this source of error alone, yield greatly deviating values, which e.g. for $C_2H_2Cl_4$ can sometimes differ inter se no less than 40 scalar divisions. In order to ascertain the influence of the water content on the interferometer reading a previously weighed solution of 5 mgr. water in 35 gr. of $C_2H_2Cl_4$ dried on phosphoric acid was measured against this same $C_2H_2Cl_4$. The displacement was 85 scalar divisions. From this follows that the presence of 0.005 mgr. of water in 2 cc. of $C_2H_2Cl_4$ already causes an error of a scalar division.

11. It is self-evident that with such sensitiveness the utmost care should be taken to prevent any contact of the liquid that is to be examined and water-vapour, if an accuracy is to be reached comparable with that in solutions in water. Therefore the liquids were always preserved over phosphoric acid which had been heated

at 160° for some days. The storing bottles had the shape as indicated in fig. 3. The conveyance into the vessel took place with the aid of pipettes J, which had been cleaned with benzene, heated, and filled with dry air.

These were filled from A by fastening them with a rubber tube on to the tube E, and pressing in dry air at F. The solutions were prepared by weighing in flasks B, which had also been previously rinsed with benzene, heated with evacuation, and filled with dry air. The small quantities of $C_2H_2Cl_4$ were conveyed into them by the

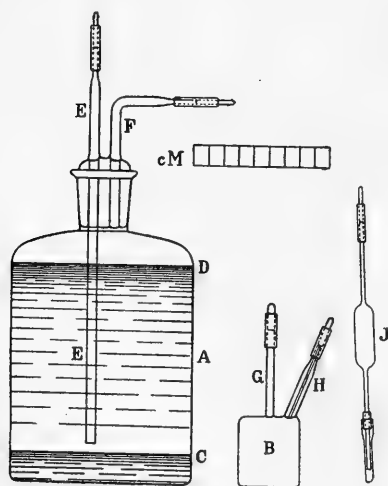

Fig. 3.

aid of a glass capillary. The solvent was directly pressed over from the storing bottle into B, after the tubes G and E had been connected

by means of a siphon-shaped tube. The filling of the pipettes J with the solution from B took also place by pressing in of dry air through tube H, after the capillary of the pipette had been immersed through G in the solution; a rubber ring, put round the capillary, ensured air-tight closure.

When the pipette is closed in the way as is seen in the figure, it is possible to preserve the liquid quite unchanged for 12 hours.

The vessels were always cleaned with benzene instead of alcohol and ether, because the latter causes water-vapour to condense on the glass in case of quick evaporation. Before the filling with liquid the vessels were filled with dry air.

The brass closing blocks also protect the liquid sufficiently against absorption of water-vapour from the atmosphere, so that the interferometer position does not appreciably change during the time taken up by a determination. It is true that in the course of some hours the zero position is slightly displaced in consequence of absorption of water by the pure solvent in vessel C₂; this displacement can, however, easily be determined and taken into account.

12. Only when the precautions described here are observed, is it possible to obtain an accuracy and reproducibility, almost equal to that which is reached for aqueous solutions.

In conclusion we may give a series of measurements referring to solutions of C₂H₂Br₄ and C₂H₂Cl₄ of different concentrations. With every solution two independent measurements were made (also the zero-position was determined every time anew). The measurements are reduced to vacuum. Just as before a vessel of 2 cm. was used.

concentration in percentages (weighed in)	observed number of scalar divisions		mean	corrected	concentration calculated (in percentages)
	1st measurement	2nd measurement			
0.1256	131.0	129.2	130.1	130.1	0.1262
0.1490	176.3	175.3	175.8	154.8	0.1500
0.2925	346.5	345.1	345.8	303.8	0.2920
0.3208	374.9	375.6	375.3	333.3	0.3199
0.4699	556.9	557.1	557.0	494.0	0.4700
0.5409	655.9	654.9	655.4	571.4	0.5413
0.7166	869.8	869.3	869.6	764.6	0.7166

In this table the concentration is expressed in grammes of $C_2H_5Br_4$ present in 100 gr. of solution. The values given under "corr." are the means, diminished by the correction for the shifting of the central band; it occurs here every time after ± 150 scalar divisions.

Under "calculated" are given the values satisfying the interpolation formula:

$$p = 0.0009772 n - 0.0000000523 n^2,$$

which has been calculated from the observations according to the method of least squares. In this p represents the concentration (expressed in percentages), n the corrected number of scalar divisions.

Hence it appears that the reproducibility of the measurements is ± 1 scalar division, corresponding to 0.0009 per cent.

SUMMARY.

The causes of the difficulties met with when it is tried to use the ZEISS waterinterferometer for the analysis of solutions in organic liquids, were discussed and the precautions were mentioned required to carry up the accuracy of the measurements to the same order as can be reached with aqueous solutions.

Utrecht, June 1921.

VAN 'T HOFF-*Laboratory.*

Anatomy. — “Concerning an Isolated Muscle of the Ciliary Body of the Pigeon’s Eye, Situated near the Eye-split”. By J. H. ZALMANN. (Communicated by Prof. J. BOEKE).

(Communicated at the meeting of June 25, 1921).

When making a sagittal section of the pigeon’s eye we soon reach, after the cornea and the iris, the eyesplit situated in the basis of the iris and in the basement membrane of the corpus ciliare.

In the ciliary body peripheral to this eyesplit we are then particularly struck with a stout muscular fascicle which, in virtue of its firm structure, projects into the spaces of Fontana and is distinguished from the other ciliary muscles by its peculiar form.

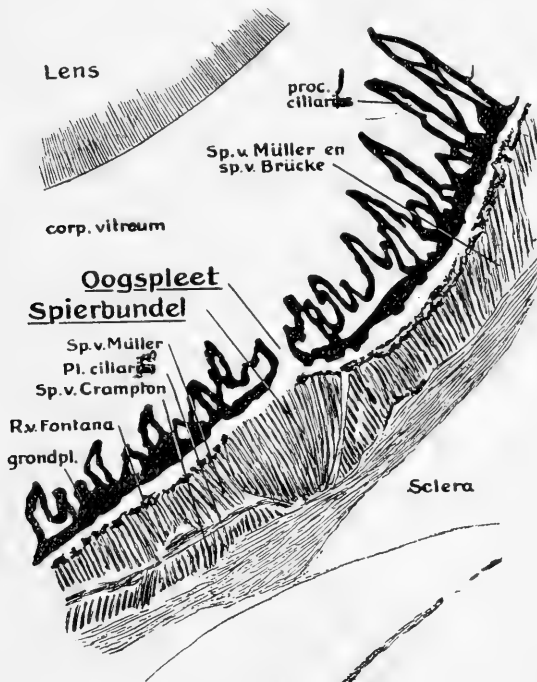

Fig. 1.

- Sp. v. Müller = Muscle of Müller.
- Sp. v. Brücke = „ „ Brücke.
- Oogspleet = Eyesplit.
- Spierbundel = Muscular fascicle
- Sp. v. Crampton = Muscle of Crampton.
- R. v. Fontana = Spaces of Fontana.
- grondplaat = basement membrane.

For convenience' sake we will term the plane through the beak and the middle of the two pupils: the horizontal plane. The two halves of the bulbus oculi separated by this horizontal plane we will term the lower (nearest to the jaw) and the upper half (nearest to the cranial plane). In the same way the frontal plane through the middle of the two pupils, divides the bulbus into a nasal and a cerebral half.

Now, when we make horizontal sections in the inferior nasal quadrant, we come obliquely upon the above-mentioned eyesplit and muscular fascicle. When making a radial section at an angle of $\pm 45^\circ$ to the horizontal plane, we pass along the muscular fascicle in its whole length, and are thus in a position to determine its anatomic relations.

Besides the method of fixation, embedding in celloidin and the making of sections, there is another, viz. preparing the uvea under the binocular microscope.

To this end the posterior, median, half of the bulbus of a fresh, enucleated eye, was removed.

Along with the anterior stratum of the retina the retinal cell-layer of the processus ciliares was pulled off, in which process also the Zonula of Zinn and the corpus vitreum were removed without injuring the basement membrane of the corpus ciliare. Also the lens, held firmly in its capsule, could now be detached from the processus ciliaris without any harm to the latter.

Now, when we subsequently take up the exposed periphery of the iris and make some cuts in the iris, we can tauten the lig. pectinatum by laying back interiorly — towards the median plane — the sectors formed. With a sharp knife the fibers of this ligament are split close to the basement membrane; then the basement membrane of the corp. cil. is to be laid back still further, the spaces of Fontana are completely open and the medial side of the ciliary muscles is laid bare.

When examining the nasal-inferior quadrant of the urea, before treating it in the manner just described, we observe that the processus ciliares diverge from their radial course at the spot where we should look for the eye-split. They bend round in the direction of the nasal tangent. They make an impression as if they run over an arched sublayer.

Now, when opening in this quadrant the spaces of Fontana, we notice some details, just peripheral to the spot where the processus ciliares bent their course.

At the place of insertion of MÜLLER'S muscle into the interior

lamella of the cornea, this muscle is separated from the spaces of Fontana by a pigmented fascia-layer. About halfway this nasal-inferior quadrant this pigmentation is interrupted, and is sharply demarcated from the rest by a pigmented curved line.

When the basement membrane is stretched opposite to this region, a break will be seen in the connecting line between basement membrane and musc. ciliares, formed by the insertion of the tensor chorioideae. The basement membrane bridges the non-pigmented part of the ciliary muscles. (See Fig. 2).

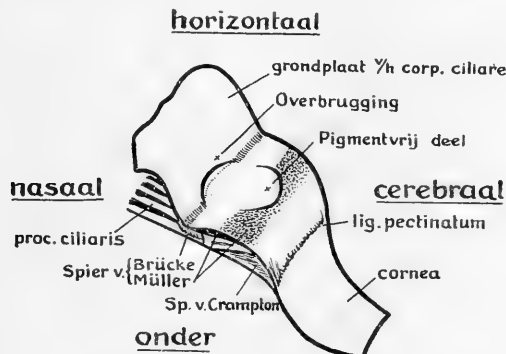

Fig. 2.

Horizontal

- grondpl. etc. = basement membr. of the corp ciliaire
 Overbrugging = Bridging
 Pigmentvrij deel = Non-pigmented part.
 nasaal = nasal
 cerebraal = cerebral
 Spier van = Muscle of
 onder = Inferior

As is shown in a reconstruction of the sections the form of a non-pigmented spot of the corpus ciliare corresponds with the form of the muscular fascicle. Moreover, the peculiar bridging effected by the basement membrane seems to be related to the modified insertion of the M. tensor chorioideae. In Fig. 1 the absence of pigment on the muscular fascicle is also noticeable.

Between the horizontal plane and the part of the corp. ciliaire that displays the details alluded to, the ciliary muscles present a regular structure.

From the sclera arise two muscles: CRAMPTON'S muscle towards the interior lamella of the cornea and BRÜCKE'S muscle as a peripheral part of the tensor chorioideae to the basement membrane of the corp. ciliaire. The other part of the tensor chorioideae, MÜLLER'S muscle, extends between the inner cornea-lamella and the basement

membrane of the corp. ciliare. The insertion of this muscle into the basement membrane lies slightly more towards the cornea than the insertion of BRÜCKE'S muscle. The two parts of the tensor chorioideae are separated from CRAMPTON'S muscle by the plexus ciliaris.

When the eyesplit in the basement membrane has been cut into, a muscular fascicle develops in the spaces of Fontana close against MÜLLER'S muscle. We now turn away from the horizontal plane and first come upon the place of insertion. The muscular fibers terminate in a tendon, which bends round the compartment of CRAMPTON'S muscle, first in conjunction with MÜLLER'S muscle and afterwards by itself, and subsequently reaches the inner-lamella of the cornea where the lig. pectinatum takes its origin.

In further sections we see MÜLLER'S muscle grow thinner and its tendon elongate in relation to the thinning out of the muscular tissue, ultimately disappearing entirely. The new muscular fascicle has now in part replaced MÜLLER'S muscle and partly juts out into the spaces of Fontana.

Hereafter the structure of CRAMPTON'S muscle is intensified.

BRÜCKE'S muscle shrinks and reduces its place of origin on the sclera, thus making room for the new muscular fascicle. Just where MÜLLER'S muscle decreases in size and disappears, this new muscular fascicle imparts twice running a considerable part of its muscular fibers to the basement membrane, which fibers consequently perform the function of tensor chorioideae.

The rest, by far the majority of the muscular fibers, have their origin on the sclera, between that of the muscle of BRÜCKE and that of CRAMPTON.

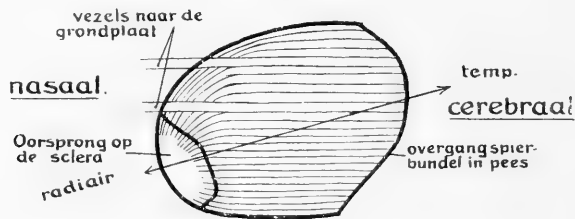

Vezels naar de grondplaat = fibers towards the basement membrane.

Nasaal = nasal.

Oorsprong op de sclera = origin of the sclera.

Radiair = radial.

Cerebraal = cerebral.

Overgang spierbundel in pees = transition of muscular fascicle into tendon.

Origin and insertion end approximately in the same radial section, from which it appears that the insertion is much longer than the place of origin. The muscular fascicle is somewhat fan-shaped, diverging from origin to insertion. The muscular fibers remotest from the horizontal plane do not run quite radially, but divert slightly in the direction of the horizontal plane. The course of the muscular fibers nearest to the horizontal plane is initially diverting from the radial direction towards the perpendicular of the horizontal plane. Thereafter they curve in temporal direction, parallel to the remotest muscular fibers. In fig. 1 we also observe a curvature of the muscular fibers and likewise the fan-shape of the muscular fascicle.

Now let us consider the course of the muscular fascicle in a radial plane, vertical to the sclera. The most lateral fibers, — closest to the sclera — proceed linearly from the origin to the insertion. The fibers which help in walling off the spaces of Fontana run in a curve, viz. from the origin first perpendicularly to the sclera, then curving round in the direction of the insertion.

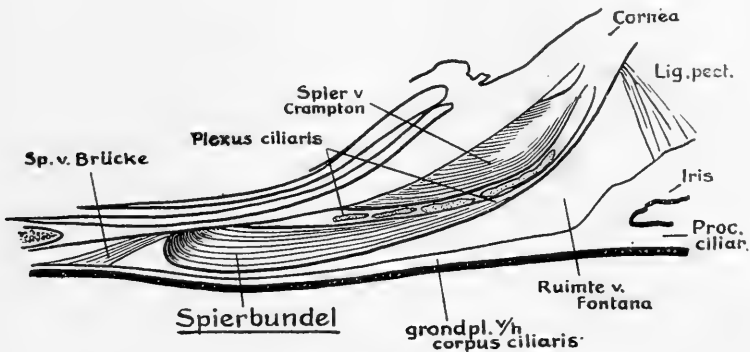

Fig.4.

Spier = muscle.

Spierbundel = muscular fascicle.

Grundvl. v/h = basement membrane of the

Ruimte v = spaces of

Among these curving fibers there are a few which run along a straight line from the place of insertion to the basement membrane. They extricate themselves from the other fibers at the place where the latter change their course, and sometimes in succession where MÜLLER'S muscle ceases to exist and the muscular fascicle takes its origin on the sclera.

In fig. 5 the points in the normal corpus ciliare have been marked which in a number of succeeding radial sections have been connected by lines. We here give an explanation of the signs used:

- the most peripherally located origin of CRAMPTON'S muscle.
 XXXXX insertion and transition into tendon of MÜLLER'S muscle.
 -.-.-.- Origin and insertion of BRÜCKE'S muscle.
 _____ Boundaries of the muscular fascicle described, with hatched place of origin.

Now let us consider again the structure of the corpus ciliare in sections farther removed from the horizontal plane.

Directly when the origin of the muscular fascicle is left uncut, the available space on the sclera is at once encroached upon by BRÜCKE'S muscle. Its origin again pushes on in the direction of the cornea right against that of CRAMPTON'S muscle and its muscular fibers push off like a wedge between the sclera and the rest of the muscular fascicle that has been cut into.

Likewise MÜLLER'S muscle takes up its old position again. Now, farther and farther away from the horizontal plane the two parts

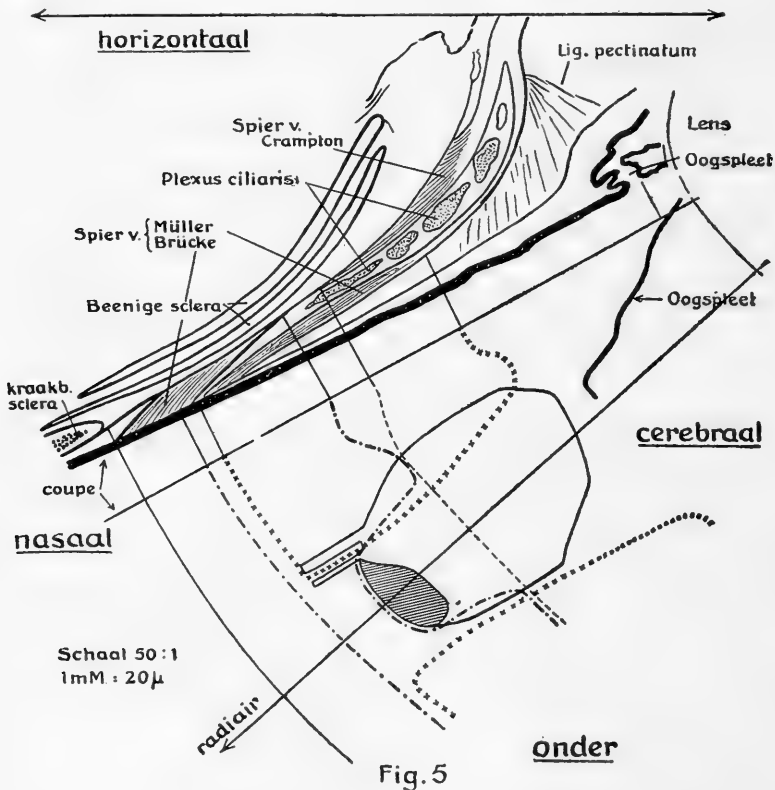

horizontaltaal = horizontal
 spier van = muscle of
 Beenige = osseous
 kraakbeenig = cartilaginous
 coupe = section

nasaal = nasal
 schaal = scale
 oogspleet = eyesplit
 cerebraal = cerebral
 onder = inferior.

of the tensor chorioideae present an alternation in their strongest development. BRÜCKE's muscle and MÜLLER's muscle in turn disappear completely. When BRÜCKE's muscle loses ground CRAMPTON's muscle avails itself of the free space on the sclera to fasten its fibers more backwards.

When summarizing the above we see that in the pigeon's eye there exists near the eyesplit in the nasal-inferior quadrant a muscular fascicle, situated medially to the plexus ciliaris, running from the sclera to the inner lamella-medial part of the cornea. This origin and insertion exclude the muscle from the known types of ciliary muscles of the bird's eye. At that spot CRAMPTON's muscle is strongly developed, BRÜCKE's muscle is only slightly developed, while MÜLLER's muscle has completely disappeared.

In the preparation of the uvea the absence of this muscle accounts as well for the absence of the pigment as for the absence of the bridging by the basement membrane.

The innervation also is furnished by the plexus ciliaris. D. TRETJAKOFF (1906) describes the *M. protractor lentis* in the salamander's eye. This muscle, like our muscular fascicle lies near the eyesplit in the inferior half of the corpus ciliare. This musc. protractor lentis is not related to the *M. tensor chorioideae*. TRETJAKOFF's¹⁾ muscle extends downward from its origin and bends temporally towards the corneo scleral border.

The difference from the discussed muscular fascicle in the pigeon's eye, lies in the fact that contrary to the *M. protr. lentis* this fascicle extends upwards to bend round temporally afterwards, anyhow as far as those of its fibers are concerned that are nearest to the horizontal plane; also in this that some fibers act like the tensor chorioideae. For the rest there are many points of similarity. Among the eye-split-rests in the deep-sea fishes also a muscle, the *M. retractor lentis* may be discerned.

This muscular fascicle does not occur in the fowl. NUSSBAUM (1897²⁾ does not mention this peculiarity in the corpus ciliare for the simple reason that he describes the eyesplit in the fowl.

Method of fixation and treatment was as follows. Fixation by means of perfusion of the bloodvessels of the head upwards from the truncus arteriosus cordis and subsequently through submersion into the fixative employed. The fixatives were of low concentration

¹⁾ D. TRETJAKOFF 1906 „Der Musc. protract. lentis im Urodelenauge". *Anatom. Anzeiger*. B. 28.

²⁾ M. NUSSBAUM 1897 „Die pars ciliaris des Vogelauges. B. 57, p. 346.

in order to prevent as much as possible dislocation of the retina, viz. formalin 5%, glacial acetic vinegar $1\frac{1}{2}$ — $\frac{3}{4}$ %.

Subsequently the head was deprived of skin, beak, lower-jaw and occiput, frozen on the freezing-microtome and cut through parallel to the horizontal plane as far as the middle of the two pupils. It was then thawed, dehydrated in alcohol, decalcified and embedded in celloidin or parts of it in paraffin. The sections measured 10—30 μ in thickness.

From the Anatomical Institute of Leyden.

Mathematics. — “*On an Integral Notion of DENJOY.*” By J. G. VAN DER CORPUT. (Communicated by Prof. ARN. DENJOY).

(Communicated at the meeting of April 30, 1921).

In this paper small Roman letters represent real numbers, Greek letters points in n -dimensional space, R_n , and Roman capitals n -dimensional sets of points; an exception is only made for the letters F, f, Φ and φ , which will always represent functions. The letters a, b, x indicate the products of the coordinates resp. of α, β, ξ . By $\xi\eta$ the point is indicated of which each coordinate is the product of the corresponding coordinates of ξ and η ; if E is formed by the points ξ , $E\eta$ represents the set of the points $\xi\eta$. When the coordinates of η are all different from zero, each coordinate of $\frac{\xi}{\eta}$ is equal to the ratio of the corresponding coordinates of ξ and η ; $\frac{E}{\eta}$ indicates the set of the points $\frac{\xi}{\eta}$, where ξ is again an arbitrary element of E . When the coordinates of every point ξ of E are different from zero, $\frac{1}{E}$ represents the set of the points $\frac{1}{\xi}$. Finally, when the coordinates of α, β, ξ, η are positive, A, B, X, Y represent the sets of the points of which each coordinate is positive and less than the corresponding coordinate resp. of α, β, ξ, η .

We form a net of cells of n dimensions, i.e. an enumerable sequence of separate, open, connected sets of points $G_i (i = 1, 2, \dots)$, measurable (J), so that every point of R_n lies in one of the cells G_i or on its boundary. Of the projection of G_i on each coordinate-axis it is assumed here that when g_i indicates the upper limit, g'_i the lower limit of the distances from the origin to the points of this projection, $\frac{g_i - g'_i}{g'_i}$ approaches to zero at the same time as $\frac{1}{g'_i}$. In each cell G_i or on its boundary we choose further a point η_i and we shall indicate the measure of G_i by m_i .

Let $f(\eta)$ be defined for all η in R_n ; let p be an arbitrary number between 0 and 1 and let us put

$$\varphi(\xi) = x \sum m_i f(\xi \eta_i)$$

in the points ξ with positive coordinates where the right hand member has meaning; the sum extends over all i for which each coordinate of η_i taken absolutely is more than p . As an extension and a slight alteration of the integral-definition (C) given by Prof. A. DENJOY ¹⁾ I shall say that $f(\eta)$ is integrable (C) and that the integral has the value l when the approximate limit of $\varphi(\xi)$ exists and has a value l , independent of the choice of p , the net of cells and the points η_i . We write this:

$$\text{appr. lim.}_{\xi=0} \varphi(\xi) = l;$$

this means that an enumerable set V can be found for which $\lim_{\xi=0} \varphi(\xi) = l$, and the metric density of V at the origin is 1 (here each coordinate of every element of V is considered to be positive). We say that V has a metric density d at the origin, if for each positive number $e < d$ a point a with positive coordinates can be found so that all the points β in A have the property that the measure of the subsets of V in B lies between $(d-e)b$ and $(d+e)b$. Hence $0 \leq d \leq 1$. The following auxiliary theorem is of importance, of which the proof, given by Prof. DENJOY ²⁾ for linear sets, can be extended at once to more dimensional sets.

Auxiliary proposition 1: If for every positive $q < 1$ a point a with positive coordinates and a measurable set V can be found for every point ξ of which $|\varphi(\xi) - l| < q$, while for every point β in A the subset of V in B has a measure $> (1-q)b$, we have

$$\text{appr. lim.}_{\xi=0} \varphi(\xi) = l.$$

For $n = 1$ Prof. DENJOY has found the proof of

Proposition 1: Every summable function is integrable (C) and the integrals are identical.

We shall precede the proof of this theorem for an arbitrary n by an auxiliary proposition.

¹⁾ *Sur l'intégration riemannienne; Comptes Rendus*, 169, (1919); p. 219—221. Prof. DENJOY gives the definition only for $n = 1$. The alteration in the two definitions for $n = 1$ consists chiefly of this, that in the original definition the length of each interval G_i is supposed to be less than 1, whereas we assume only that this length divided by the distance from G_i to the origin, approaches to zero for $i \rightarrow \infty$. Prof. DENJOY gives at the same time two more integral definitions, which he indicates by (A) and (B). Mr. T. J. Boks studies in his thesis for the doctorate (not yet published) the integral notion (B) and derives the two properties of them, corresponding to the properties 1 and 2 of this paper. Probably this thesis (written at Utrecht) will appear in the *Rendiconti di Palermo* (1921).

²⁾ *Sur les fonctions dérivées sommables, Bulletin de la Société Mathématique de France*, tome 43 (1915); p. 161—248; cf. p. 165—168.

Auxiliary proposition 2: Suppose $0 < q < 1$. If β represents a point with positive coordinates, if the non-negative function $f(\eta)$ is summable and has a sum $< q^3$, the points ξ in B with $\varphi(\xi) \geq q$ form a set with measure $< hbq$, where h only depends on the choice of p and the net of cells.

Proof: Let R_n' be the part of R_n that has positive coordinates. Let there be associated to each point ξ of R_n' the function $F(\xi)$ indicating the sum of the measures m_i of all the cells G_i of which the point η_i lies in X and each coordinate is more than p . If $F(\xi)$ is positive, each coordinate of ξ is more than p . In accordance with the condition made for the net of cells, we can now determine a number h only dependent on the choice of p and the net of cells, so that the point η the coordinates of which are $\sqrt{h-1}$ times as much as those of ξ , has the property that the cells G_i of which the sum of the measures has been called $F(\xi)$, all lie in Y . Hence $F(\xi) \leq (h-1)x$.

For any point a in B we have

$$(h-1) \int_{R_n'} f(a\xi) d\xi \geq \int_{R_n'} F(\xi) \frac{f(a\xi)}{x} d\xi = \sum' m_i \int_{(\eta_i)} \frac{f(a\xi)}{x} d\xi,$$

where the sum has to be extended over all i for which each coordinate of η_i is more than p and where in the last integral each coordinate of ξ exceeds the corresponding coordinate of η_i . The second member is in this case

$$\sum' m_i \int_{(\alpha)} \frac{f(\eta_i \xi)}{x} d\xi = \int_{(\alpha)} \frac{d\xi}{x} \sum' m_i f(\eta_i \xi).$$

A similar reasoning gives the analogous expressions for the other parts into which R_n is divided by the coordinate planes and from this there follows through addition

$$(h-1) \int_{R_n} f(a\xi) d\xi \geq \int_{(\alpha)} \frac{d\xi}{x} \sum m_i f(\eta_i \xi) = \int_{(\alpha)} \frac{\varphi(\xi)}{x^2} d\xi.$$

From

$$\int_{R_n} f(a\xi) d\xi = \frac{1}{a} \int_{R_n} f(\xi) d\xi < \frac{q^3}{a}$$

there follows therefore

$$\int_{(\alpha)} \frac{\varphi(\xi)}{x^2} d\xi < (h-1) \cdot \frac{q^3}{a}.$$

If $\Phi(\beta)$ and $\Phi(a)$ represent the measures of the sets, formed by the points with the property $\varphi(\xi) \geq q$ lying resp. in B and A , then $\Phi(a) \leq a$, and if $B-A$ indicates the set of the points lying in B but not in A , then

$$\begin{aligned} q(\Phi(\beta) - \Phi(a)) &\leq \int_{B-A} \varphi(\xi) d\xi \leq b^2 \int_{B-A} \frac{\varphi(\xi)}{x^2} d\xi \\ &\leq b^2 \int_{(a)} \frac{\varphi(\xi)}{x^2} d\xi < (h-1) \frac{b^2 q^3}{a}, \end{aligned}$$

hence, if we assume $a = bq$

$$\Phi(\beta) < a + (h-1) \cdot \frac{b^2 q^3}{a} = hbq.$$

Proof of proposition 1: It is known¹⁾, that it is possible to find a limited set E with an exterior measure (J) for every number q between 0 and 1 and for every summable function $f(\eta)$, so that $f(\eta)$ is limited and continuous on E and the integral of $|f(\eta)|$ extended over the complement of E , is less than q^3 . Let β be an arbitrary point with positive coordinates. If on E we assume $F(\eta) = 0$, outside E , $F(\eta) = |f(\eta)|$ and further

$$\Phi(\xi) = x \sum m_i F(\eta_i \xi),$$

the points ξ in B with the property $\Phi(\xi) \geq q$ form according to the afore mentioned auxiliary proposition a set with measure $< hbq$.

The points ξ in B with the property $\Phi(\xi) < q$ form therefore a set with measure $> (1-hq)b$.

Let us further assume

$$\bar{\Phi}(\xi) = x \sum m_i f(\eta_i \xi),$$

extended over all i for which $\eta_i \xi$ lies on E . According to the condition made for the net of cells, the dimensions of the cells G_i for which $\eta_i \xi$ lies on the limited set E , approach together with ξ to zero. As on the limited set E with exterior measure (J), $f(\eta)$ is limited and continuous, $f(\eta)$ is integrable on E according to RIEMANN and in accordance with the definition of the integrals of RIEMANN we have in this case

$$\lim_{\xi=0} \bar{\Phi}(\xi) = \int_E f(\eta) d\eta.$$

1) Cf. e.g. C. CARATHÉODORY, *Vorlesungen über reelle Funktionen*, 1918, p. 469, proposition 12.

We can therefore find a point α with positive coordinates so that for any point ξ in A

$$|\bar{\Phi}(\xi) - \int_E f(\eta) d\eta| < q,$$

hence

$$|\bar{\Phi}(\xi) - \int_{R_n} f(\eta) d\eta| < q^2 + q < 2q.$$

As $|\varphi - \bar{\Phi}| \leq \Phi$ all points ξ in A for which $\Phi(\xi) < q$, satisfy the inequality

$$|\varphi(\xi) - \int_{R_n} f(\eta) d\eta| < 3q,$$

so that any point β in A has the property that the points ξ in B for which this inequality holds good, form a set with measure $> (1 - hq)b$. According to the first auxiliary proposition we have now

$$\text{appr. lim.}_{\xi=0} \varphi(\xi) = \int_{R_n} f(\eta) d\eta,$$

which was to be proved.

A simple application of property 1 is e.g.:

If E indicates a measurable set with finite measure m , $F\left(\frac{E}{\xi}\right)$ the number of points of E with integer coordinates not lying in one of the coordinate planes, we have

$$\text{appr. lim.}_{\xi=0} \frac{1}{x} F\left(\frac{E}{\xi}\right) = m.$$

We may here replace $F\left(\frac{E}{\xi}\right)$ by all the points on $\frac{E}{\xi}$ with integer coordinates, among others when the intersection of E with each coordinate plane is limited.

It appears from the first property that the integral of DENJOY is at least as general as that of LEBESGUE; from the following proposition (where $n = 1$ is assumed), the correctness will appear of Prof. DENJOY's supposition that the new integral notion is already more general for $n = 1$.

Proposition 2: If $f(-\xi) = -f(\xi)$, if $f(\xi)$ does not increase with increasing positive ξ , if $f(\xi) = 0$ for $\xi > 1$ and $\lim_{\xi=0} \xi f(\xi) = 0$, $f(\xi-1)$ is integrable (C) and the integral is 0.

Two auxiliary propositions precede the proof of this theorem.

Auxiliary proposition 3: If $0 < q < 1$ and the segment S_j ($j = 1, 2, \dots$) does not contain the origin, has one point in common with the segment $\delta_j \delta_{j-1}$ and has a length $\leq q (\delta_{j-1} - \delta_j)$, where $\delta_{j-1} > \delta_j > 0$ and $\lim_{j \rightarrow \infty} \frac{\delta_{j-1} - \delta_j}{\delta_{j-1}} = 0$, the set formed by the segments S_j has at the origin a metric density $\leq q$.

Proof: We shall assume that for $j \rightarrow \infty$ δ_j approaches the origin because else the auxiliary proposition would be evident. Let ξ be an arbitrary point to the right of the origin and let u be the smallest value of j for which S_j contains the point ξ or a point to the left of it. Then

$$\delta_{u-1} = \delta_u + (\delta_{u-1} - \delta_u) \leq \xi + \text{length } S_u + (\delta_{u-1} - \delta_u),$$

hence

$$\delta_{u-1} \leq \xi + (1 + q) (\delta_{u-1} - \delta_u) \dots \dots \dots (1)$$

The subset of the segments S_j lying between the origin and ξ , has therefore a measure which after division by ξ is not more than

$$q \frac{\delta_{u-1}}{\xi} \leq q + q(1 + q) \cdot \frac{\delta_{u-1} - \delta_u}{\xi} \dots \dots \dots (2)$$

When ξ approaches the origin, u increases unlimitedly; $\frac{\delta_{u-1} - \delta_u}{\delta_{u-1}}$ approaches therefore to zero and according to (1) the lower limit of $\frac{\xi}{\delta_{u-1}}$ is not less than 1. The last term of (2) approaches to 0, so that the metric density of the set formed by the segments is at the origin $\leq q$.

Auxiliary proposition 4: When $\lim_{\xi \rightarrow 0} \xi f(\xi) = 0$ and when to any point to the right of the origin a number i is conjugated, so that $\frac{1}{\xi}$ lies in G_i or on its boundary, we have

$$\text{appr. lim.}_{\xi \rightarrow 0} \xi m_i f(\eta_i \xi - 1) = 0.$$

Proof: For $\xi \rightarrow 0$, $i \rightarrow \infty$, hence according to the condition imposed on the net of cells

$$\eta_i \xi - 1 = \frac{\eta_i - \frac{1}{\xi}}{\frac{1}{\xi}} \rightarrow 0, \quad \frac{m_i \xi}{\eta_i \text{ measure } \frac{1}{G_i}} \rightarrow 1, \quad (\eta_i \xi - 1) f(\eta_i \xi - 1) \rightarrow 0. \quad (3)$$

Suppose $0 < q < 1$; let E be the set of the points in $\frac{1}{G_i}$ ($i = 1, 2, \dots$,

omitting the value or values of i for which the origin lies in G_i or on its boundary) the distances of which to $\frac{1}{\eta_i}$ are more than $\frac{1}{2}q$ measure $\frac{1}{G_i}$. According to the preceding auxiliary proposition (where the points d_j indicate the endpoints of the sets of points $\frac{1}{G_i}$, if necessary after reversal of the direction of the ξ -axis), the complement of E has at the origin a metric density $\leq q$, hence E itself has a metric density $\geq (1-q)$. For any ξ on E we have $\left| \xi - \frac{1}{\eta_i} \right| \geq \frac{q}{2}$ measure $\frac{1}{G_i}$, hence according to (3)

$$\xi m_i f(\eta_i \xi - 1) = \frac{m_i \xi}{\eta_i \text{measure} \frac{1}{G_i}} \cdot \frac{\text{measure} \frac{1}{G_i}}{\xi - \frac{1}{\eta_i}} \cdot (\eta_i \xi - 1) f(\eta_i \xi - 1) \rightarrow 0.$$

As this holds good for any q between 0 and 1 the theorem in question follows from this in connection with the auxiliary proposition 1.

Proof of proposition 2: The relation to be proved is:

$$\text{appr. lim.}_{\xi \rightarrow 0} \xi \sum m_i f(\eta_i \xi - 1) = 0 \dots \dots \dots (4)$$

As f' is zero to the left of the point -1 , i takes in this sum only values for which the whole or part of G_i lies to the right of the origin. If ω is an arbitrary point to the right of the origin, every term in (4) with such i that the whole or part of G_i lies to the left of ω , approaches to zero with ξ and the number of these terms is limited, so that in (4) we need only take into account those values of i for which the cells of G_i lie to the right of ω . We shall indicate those cells, arranged from left to right, by $\theta_{j-1} \theta_j$ ($j = 1, 2, \dots$). As $\lim_{j \rightarrow \infty} \frac{\theta_j}{\theta_{j-1}} = 1$, we can choose ω in such a way that always $\frac{\theta_j}{\theta_{j-1}} < 2$. According to the preceding auxiliary proposition, for $\xi \rightarrow 0$ the approximate limit of the term or the terms in (4) with such i that $\frac{1}{\xi}$ lies in G_i or on its boundary, is zero. We can therefore skip this value or these values of i and we shall indicate this by an accent to Σ , so that it is sufficient to prove

$$\text{appr. lim.}_{\xi \rightarrow 0} \Phi(\xi) = 0, \quad \text{where} \quad \Phi(\xi) = \xi \sum_{j=1}^{\infty} m_j f(\eta_j \xi - 1).$$

With a view to this we shall first prove

$$\text{appr. lim.}_{\xi=0} F(\xi) = 0, \quad \text{where} \quad F(\xi) = \xi \sum_{j=1}^{\infty} m_j \{f(\theta_{j-1}\xi - 1) - f(\theta_j\xi - 1)\}.$$

As $f(\xi)$ does not increase for increasing ξ when it does not pass the origin, the terms of the latter sum are ≥ 0 .

If q represents an arbitrary number between 0 and $\frac{1}{2}$, $\frac{1}{\theta_j} = \delta_j$ and $l_j =$ the length of the segment (σ_j, σ_{j-1}) , $\frac{\sigma_{j-1}}{\sigma_j} < 2$ hence $ql_j < l_j = \left(\frac{\sigma_{j-1}}{\sigma_j} - 1\right) \delta_j < \delta_j$, so that if each of the segments (σ_j, σ_{j-1}) is produced at both ends with an interval of length ql_j , none of these productions contains the origin. According to the auxiliary proposition 2 the metric density of the set formed by these productions, is at the origin at most $2q$. Now let β be an arbitrary point to the right of the origin and let E be an arbitrary measurable set to the right of β which has no point in common with any of these productions. Let us first consider the terms in $F(\xi)$ for which $\xi \geq \sigma_j$; the accent excludes the case $\sigma_j \leq \xi \leq \sigma_{j-1}$ and the production $\sigma_{j-1} < \xi < \sigma_{j-1} + ql_j$ does not occur in E , hence

$$\int_E \frac{f(\theta_{j-1}\xi - 1) - f(\theta_j\xi - 1)}{\xi} d\xi \leq \int_{\sigma_{j-1} + ql_j}^{\infty} = \int_{q^{\theta_{j-1}l_j}}^{\infty} \frac{f(\xi)}{1 + \xi} d\xi - \int_{(1+q)\theta_{j-1}l_j}^{\infty} = \int_{q^{\theta_{j-1}l_j}}^{\infty} \leq \int_{q^{\theta_{j-1}l_j}}^{\infty} f(\xi) d\xi. \quad (5)$$

In the remaining terms of $F(\xi)$, $\xi < \sigma_j$, hence for these, because the production $\sigma_j - ql_j < \xi < \sigma_j$ does not occur in E , we have

$$\left. \begin{aligned} \int_E \frac{f(1 - \theta_j\xi) - f(1 - \theta_{j-1}\xi)}{\xi} d\xi &\leq \int_{\beta}^{\sigma_j - ql_j} = \int_{1 - \theta_{j-1}\beta}^{\frac{(1+q)\theta_{j-1}}{1 - \xi}} d\xi - \int_{1 - \theta_j\beta}^{\frac{q^{\theta_{j-1}l_j}}{1 - \xi}} \\ &= \int_{q^{\theta_{j-1}l_j}}^{(1+q)\theta_{j-1}l_j} - \int_{1 - \theta_j\beta}^{1 - \theta_{j-1}\beta} \leq \int_{q^{\theta_{j-1}l_j}}^{(1+q)\theta_{j-1}l_j} \leq 4 \int_{q^{\theta_{j-1}l_j}}^{\infty} f(\xi) d\xi, \end{aligned} \right\} \quad (6)$$

for from $\xi \leq (1+q)\theta_{j-1}l_j = (1+q)\left(1 - \frac{\theta_{j-1}}{\theta_j}\right) < \frac{3}{4}$ there follows $1 - \xi > \frac{1}{4}$.

As $\lim_{j=\infty} \theta_j l_j = 0$ and $\lim_{\xi=0} \xi f(\xi) = 0$ we can choose v_j (only dependent on the function f and the net of cells) in such a way

that $\lim_{j \rightarrow \infty} v_j = 0$ and that the inequality $f(\xi) < \frac{v_j}{5\xi}$ follows from $0 < \xi \leq 2\theta_j l_j$.

In this case

$$\int_{q^{\theta_{j-1}l_j}}^{2\theta_j l_j} f(\xi) d\xi < \frac{v_j}{5} \log \frac{2\theta_j}{q\theta_{j-1}} < \frac{v_j}{5} \log \frac{4}{q}.$$

If therefore u indicates the greatest value of j for which $\theta_{j-1}\beta - 1 \leq 1$ we have according to (5) and (6)

$$\int_E \frac{F(\xi)}{\xi^2} d\xi < \log \frac{4}{q} \sum_{j=1}^u v_j (\theta_j - \theta_{j-1}), \dots \dots \dots (7)$$

because $f(\theta_{j-1}\xi - 1)$ and $f(\theta_j\xi - 1)$ are zero for $j > u$ owing to $\xi \geq \beta$. The aforesaid inequality holds for any measurable set E to the right of β which has no point in common with any of the productions of the segments (θ_j, θ_{j-1}) . We shall now assume that this set E lies to the left of a point γ and that for any point ξ of E the inequality $F(\xi) \geq q$ holds good. In this case the left-hand member of (7) is not less than $\frac{q}{\gamma^2}$ multiplied by the measure of E .

Now we can choose γ so close to the origin that the measure of the subset between 0 and γ of the productions is $< 3q\gamma$. The set between 0 and γ of the points ξ for which $F(\xi) \geq q$, has therefore a measure less than

$$3q\gamma + \beta + \text{measure } E < 3q\gamma + \beta + \frac{\gamma^2}{q} \log \frac{4}{q} \sum_{j=1}^u v_j (\theta_j - \theta_{j-1}) \dots (8)$$

For $q < \frac{1}{2}$ the right-hand member is less than $6q\gamma$, if γ lies close enough to the origin and β is chosen properly. With a view to this we assume $\beta = q\gamma$; if γ lies close enough to the origin, u is so great that for any $j > u$

$$v_j < \frac{q^3}{4 \log \frac{4}{q}};$$

In this case we can therefore define an integer number $w \leq u$ independent of γ , so that this inequality holds good for any $j > w$. Finally we choose γ so close to the origin that

$$\frac{\gamma}{q} \log \frac{4}{q} \sum_{j=1}^w v_j (\theta_j - \theta_{j-1}) < q$$

In this case:

$$\begin{aligned} \frac{\gamma^2}{q} \log \frac{4}{q} \sum_{u \geq j > w} v_j (\theta_j - \theta_{j-1}) &< \frac{1}{4} \gamma^2 q^2 \sum_{u \geq j > w} (\theta_j - \theta_{j-1}) \\ &\leq \frac{1}{4} \gamma^2 q^2 \theta_u < \frac{1}{2} \gamma^2 q^2 \theta_{u-1} < \gamma^2 q^2 \cdot \frac{1}{\beta} = \gamma q. \end{aligned}$$

The second member of (8) is then $< (3 + 1 + 1 + 1) q \gamma = 6q\gamma$, so that the set of the points ξ between 0 and γ for which $F(\xi) \geq q$, has at the origin a measure $< 6q\gamma$. The points ξ between 0 and γ with $F(\xi) < q$ form therefore a set with measure $> (1 - 6q)\gamma$. This holds good for any q between 0 and $\frac{1}{2}$; according to the first auxiliary proposition the non-negative function $F(\xi)$ has in this case for $\xi \rightarrow 0$ an approximate limit 0. By the aid of this we shall prove that also $\Phi(\xi)$ has an approximate limit 0 for $\xi \rightarrow 0$. From the aforesaid,

$$f(\theta_{j-1} \xi - 1) \geq f(\eta_j \xi - 1) \geq f(\theta_j - 1)$$

and

$$m_j f(\theta_{j-1} \xi - 1) \geq \int_{G_j} f(\eta \xi - 1) d\eta \geq m_j f(\theta_j \xi - 1)$$

follows

$$\text{appr. lim.}_{\xi=0} \left\{ \Phi(\xi) - \xi \sum_{j=1}^{\infty} \int_{G_j} f(\eta \xi - 1) d\eta \right\} = 0. \quad (9)$$

The values ξ for which $\frac{1}{\xi}$ lies on the boundary of one of the cells G_j , form an enumerable set so that we need only consider the case that ξ lies inside a cell G_i . If λ_i indicates the left extremity, ρ_i the right extremity of this cell, we have owing to $f(-\xi) = -f(\xi)$

$$\begin{aligned} \xi \sum_{j=1}^{\infty} \int_{G_j} f(\eta \xi - 1) d\eta &= \xi \int_{-\infty}^{\lambda_i} f(\eta \xi - 1) d\eta + \xi \int_{\rho_i}^{\infty} f(\eta \xi - 1) d\eta = \\ &= \int_{-\infty}^{\lambda_i \xi - 1} f(\eta) d\eta + \int_{\rho_i \xi - 1}^{\infty} f(\eta) d\eta = \int_{\rho_i \xi - 1}^{1 - \lambda_i \xi} f(\eta) d\eta. \end{aligned}$$

The difference of the positive numbers $1 - \lambda_i \xi$ and $\rho_i \xi - 1$ is less than their sum $\xi(\rho_i - \lambda_i)$; $f(\eta)$ is absolutely taken $\leq f(\rho_i \xi - 1) + f(1 - \lambda_i \xi) = f(\rho_i \xi - 1) - f(1 - \lambda_i \xi)$, hence the absolute value of the latter integral is less than $\xi(\rho_i - \lambda_i) \{f(\rho_i \xi - 1) - f(1 - \lambda_i \xi)\}$ and

the approximate limit of this is according to the auxiliary proposition 3, equal to zero. As appears from (9) also the approximate limit of $\Phi(\xi)$ is in this case equal to zero for $\xi \rightarrow 0$ and herewith proposition 2 has been proved.

This property gives measurable functions that are integrable (C) but not summable. These functions are all unlimited at the upper side as well as at the lower side. That this is also necessary appears from

Proposition 3: If a measurable function $f(\xi)$ is integrable (C) and limited at the upper or at the lower side, this function is summable.

Proof: Assume for instance that $f(\xi)$ is limited at the lower side; let us put $f_t(\xi) = f(\xi)$ or $= t$ according to whether $f(\xi) \leq$ or $> t$. The limited function $f_t(\xi)$ is summable, hence integrable (C), and the integrals are equal. Let this common value be called s_t . For increasing t s_t does not decrease and from $f_t(\xi) \leq f(\xi)$ follows that s_t is not more than the integral (C) of $f(\xi)$. The integrals s_t are therefore limited, hence $f(\xi)$ is summable.

Some properties holding good for the integrals of LEBESGUE, remain valid, others do not. From proposition 2, for instance, appears that the following two properties of the integrals of LEBESGUE are lost: When a function is summable, its absolute value is also summable. When a function is summable in a set, it is also summable in any measurable subset.

Finally we shall discuss three more properties that remain valid.

Proposition 4: When a function $f(\xi)$ is integrable (C), the points for which $f(\xi)$ is infinite, form a set with measure zero.

Proof: We shall show that a function with the property that the points ξ for which the coordinates are positive and $f(\xi)$ is infinite, form a set E with positive exterior measure, is not integrable (C); we can confine ourselves to a very simple net of cells, namely to the net of cells of which every cell consists of an n -dimensional cube of which the sides have a length 1 and are parallel to the coordinate-axes, and of which the centre coincides with a point with integer coordinates. In an analogous way each of the $2^n - 1$ other parts into which R_n is divided by the coordinate-axes, may be treated.

The exterior measure of E being positive, there exists a beam H of which the coordinates of the angular points are positive and the sides are parallel to the coordinate-axes, while a subset D of E in H at a positive distance from the boundary, has a positive exterior measure. By enlarging the beam, if necessary, we can attain that if α and β represent the angular points of H , resp. with the least and with the largest coordinates, the coordinates of β are twice those

of α . Now let the exterior measure of D be w times the volume of the beam H . If η describes the sequence of points of which the coordinates are powers of 2 with integer non-negative exponents, the beams $\frac{H}{\eta}$ occupy together exactly the set of points B . The set $\frac{D}{\eta}$ lies in $\frac{H}{\eta}$ at a positive distance from the boundary and the exterior measure of $\frac{D}{\eta}$ is w times the volume of $\frac{H}{\eta}$. The exterior measure of the set formed by all $\frac{D}{\eta}$ is therefore wb . Any measurable set containing all the sets $\frac{D}{\eta}$ has accordingly at the origin a metric density $\geq w$. In each of the sets $\frac{D}{\eta}$, $\varphi(\xi)$ contains at least one term which is infinite, so that $\varphi(\xi)$ is there infinite or indeterminate; any measurable set where $\varphi(\xi)$ has a definite finite value, has therefore at the origin a metric density $\leq 1-w$, so that $f(\xi)$ is not integrable (C).

Proposition 5: If $f_1(\xi)$ and $f_2(\xi)$ are integrable (C) and e_1 and e_2 represent two arbitrary finite numbers, a function coinciding with $e_1 f_1(\xi) + e_2 f_2(\xi)$ when this expression has meaning, is integrable (C) and the integral is e_1 times the integral of $f_1(\xi)$, augmented by e_2 times the integral of $f_2(\xi)$.

Proof: Two functions are called equivalent if they coincide except perhaps in a set with measure zero. It appears from the preceding proposition that any function which is integrable (C), is equivalent to a finite function, from the first proposition that two equivalent functions are either both or neither integrable (C). As the above mentioned proposition for finite functions follows immediately from the definition of the integral notion (C), the property holds generally, because, if necessary, the functions can first be replaced by the equivalent finite functions.

Proposition 6: For a monotone series of measurable (C) functions $f_t(\xi)$ ($t = 1, 2, \dots$) approaching to $f(\xi)$, the series of the integrals is likewise monotone. Further the limit function is integrable (C) only when the series of the integrals is limited. If this is the case, the integral of $f(\xi)$ is equal to the limit for $t = \infty$ of the integral of $f_t(\xi)$.

Proof: If $f(\xi)$ is integrable (C), the integral is not less, resp. not more, than that of $f_t(\xi)$, so that the non-decreasing, resp. non-

increasing, series of integrals is limited. Now let s_t be the integral (C) of $f_t(\xi)$ and $s = \lim s_t$. The function $f_t(\xi) - f_1(\xi)$ is either always \geq or always ≤ 0 and integrable (C), hence according to proposition 3 it is summable with $s_t - s_1$ for sum. As the monotone series $s_t - s_1$ has $s - s_1$ for limit, $f(\xi) - f_1(\xi)$ is summable with $s - s_1$ for sum. From this it ensues that $f(\xi) - f_1(\xi)$ is integrable (C) with $s - s_1$ for integral, so that $f(\xi)$ is integrable (C) with s for integral.

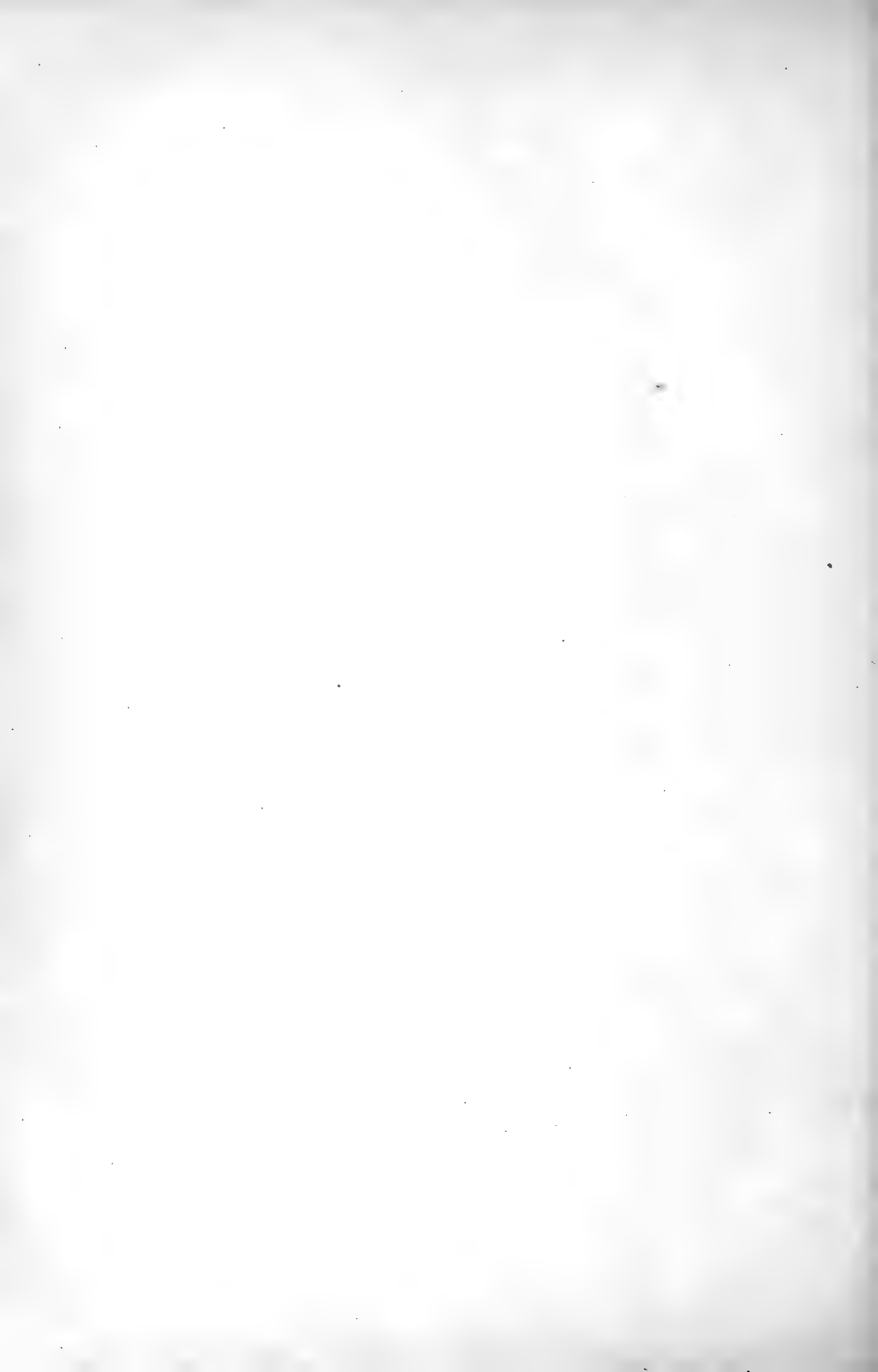

KONINKLIJKE AKADEMIE VAN WETENSCHAPPEN
TE AMSTERDAM.

PROCEEDINGS

VOLUME XXIV

N^{os.} 4 and 5.

President: Prof. F. A. F. C. WENT.

Secretary: Prof. L. BOLK.

(Translated from: "Verslag van de gewone vergaderingen der Wis- en
Natuurkundige Afdeling," Vol. XXX).

CONTENTS.

- J. A. SCHOUTEN and D. J. STRUIK: "On Curvature and Invariants of Deformation of a V_m in V_n ". (Communicated by Prof. JAN DE VRIES), p. 146.
- W. H. KEESOM: "On the calculation of the molecular quadrupole-moments from the equation of state". (Communicated by Prof. H. KAMERLINGH ONNES), p. 162.
- C. H. HINS: "On a change with the declination in the personal equation in meridian-observations." (Communicated by Prof. W. DE SITTER), p. 168.
- C. E. B. BREMEKAMP: "On Anti-phototropic Curvatures occurring in the coleoptiles of *Avena*." (Communicated by Prof. G. VAN ITERSSEN JR.), p. 177.
- S. DE BOER: "On the Action of the Novocain on the Tonus of the Skeletal Muscle". (Communicated by Prof. I. K. A. WERTHEIM SALOMONSON), p. 185.
- W. VAN DER WOUDE: "On the Path of a Ray of Light in the Field of Gravitation of a Single Material Centre". (Communicated by Prof. J. C. KLUYVER), p. 187.
- P. GILBERT RAHM: "Weitere physiologische Versuche mit niederen Temperaturen", p. 192.
- J. W. N. LE HEUX: "Explanation of some Interference-Curves of Uni-axial and Bi-axial Crystals by Superposition of Elliptic Pencils" (Second paper). (Communicated by Prof. HENDRIK DE VRIES), p. 195. (With one plate).
- J. BÖESEKEN (In collaboration with Messrs. CHR. VAN LOON, DEX, and HERMANS): "The Condition of Motion of the Molecules in Space", p. 198.
-

Mathematics — “*On Curvature and Invariants of Deformation of a V_m in V_n .*” By Prof. J. A. SCHOUTEN and D. J. STRUIK. (Communicated by Prof. JAN DE VRIES).

(Communicated at the meeting of October 29, 1921).

§ 1. *Introduction.*

In the theory of curvature of a V_m , imbedded in a V_n , a great number of theorems can be deduced with the aid of the quantity of order three $\overset{3}{\mathbf{H}}$ without use of the RIEMANN-CHRISTOFFEL quantity of order four of the V_m^{-1} and the V_n , $\overset{4}{\mathbf{K}}$ and $\overset{4}{\mathbf{K}'}$. We have developed these theorems in detail in another paper²⁾ and we will indicate them here only as far as is absolutely necessary. Other theorems, e.g. those concerning the invariants of deformation, depend on the mutual relations of the quantities $\overset{4}{\mathbf{K}}$ and $\overset{4}{\mathbf{K}'}$. This paper will treat the most important theorems of this kind for the most general case, which is not yet investigated sufficiently.

§ 2. *V_m in V_n , absolute, relative and normal curvature of a congruence.*

Suppose a congruence \mathbf{i}^2) in a V_m in V_n . The fundamental tensor of the V_n be $\mathbf{g} = \mathbf{a}\mathbf{a} = \mathbf{b}\mathbf{b} = \dots$, the fundamental tensor of the V_m being $\mathbf{g}' = \mathbf{a}'\mathbf{a}' = \mathbf{b}'\mathbf{b}' = \dots$. In the V_n choose n mutual orthogonal congruences $\mathbf{i}_1, \dots, \mathbf{i}_n$, in such a way that V_m is built up by curves $\mathbf{i}_1, \dots, \mathbf{i}_m$. We suppose that the suffixes i, j, k, l may get the values $1, \dots, n$; a, b, c, d the values $1, \dots, m$ and e, f, g, h the values $m + 1, \dots, n$.

When

$$\mathbf{a}'' = \sum_e \alpha_e \mathbf{i}_e \tag{1}$$

hence

¹⁾ V_p means in this paper a p -dimensional manifold, whose linear element is represented by the square root of a general quadratic differential form, S_p means such a manifold with constant RIEMANN-curvature, R_p such a manifold with euclidean linear element.

²⁾ 22. 1.

³⁾ The notations used in this paper are developed in detail in 21. 1, shorter also in 21.2.

$$\mathbf{a} = \mathbf{a}' + \mathbf{a}'' \quad (2)$$

we have

$${}^2\mathbf{g} = \sum_j a_j \mathbf{i}_j = \sum_a a_a \mathbf{i}_a + \sum_e a_e \mathbf{i}_e = {}^2\mathbf{g}' + \mathbf{a}'' \mathbf{a}' \quad (3)$$

It is obvious that

$$a_a a_b = \begin{cases} 1 & \text{if } a = b \\ 0 & \text{,, } a \neq b \end{cases}, \quad a_e a_f = \begin{cases} 1 & \text{if } e = f \\ 0 & \text{,, } e \neq f \end{cases}, \quad a_a a_e = 0 \quad (4)$$

and thus

$$\mathbf{a}' \mathbf{a}'' = \mathbf{a}'' \mathbf{a}' = 0. \quad (5)$$

The quantity ${}^{2p}\mathbf{g}'$ is defined by

$${}^{2p}\mathbf{g}' = \mathbf{a}'_1 \dots \mathbf{a}'_{p'} \mathbf{a}'_{p'} \dots \mathbf{a}'_1, \quad (6)$$

so that by complete transvection of \mathbf{v} with ${}^{2p}\mathbf{g}'$ we get the V_m -component of \mathbf{v} . If then ∇ be the differential operator in the V_n , ∇' in the V_m , the equation holds:

$$\nabla' p = {}^2\mathbf{g}' \cdot \nabla p, \quad (7)$$

where p is an arbitrary scalar field in the V_m , and

$$\left. \begin{aligned} \nabla' \mathbf{v} &= \{ \nabla' (\mathbf{a}' \cdot \mathbf{v}) \} \mathbf{a}' = \{ \nabla' (\mathbf{a}' \cdot \mathbf{v}) \} \mathbf{a}' = \\ &= {}^2\mathbf{g}' \cdot \{ \nabla (\mathbf{a}' \cdot \mathbf{v}) \} \mathbf{a}' = \mathbf{g}' \cdot \nabla \mathbf{v}, \end{aligned} \right\} \quad (8)$$

where \mathbf{v} is an arbitrary vector field in the V_m .

Hence:

If \mathbf{v} is a vectorfield in V_m , $\nabla' \mathbf{v}$ is the V_m -component of $\nabla \mathbf{v}$.

The same holds, as is easy to see, for each field \mathbf{v} in V_m .

The curvature vector $\mathbf{u} = \mathbf{i} \cdot \nabla \mathbf{i}$ of the congruence \mathbf{i} in V_m with respect to V_n , or the absolute curvature vector of \mathbf{i} can now be decomposed in the following way:

$$\left. \begin{aligned} \mathbf{u} &= \mathbf{i} \cdot \nabla \mathbf{i} = \mathbf{i} \cdot \{ \nabla (\mathbf{a}' \cdot \mathbf{i}) \} \mathbf{a}' = \mathbf{i} \cdot \{ \nabla (\mathbf{a}' \cdot \mathbf{i}) \} \mathbf{a}' = \\ &= \mathbf{i} \cdot \{ \nabla (\mathbf{a}' \cdot \mathbf{i}) \} \mathbf{a}' + \mathbf{i} \cdot \{ \nabla' (\mathbf{a}' \cdot \mathbf{i}) \} \mathbf{a}'' = \\ &= \mathbf{i} \cdot \nabla' \mathbf{i} + \mathbf{i} \cdot (\nabla' \mathbf{a}') \cdot \mathbf{i} \mathbf{a}'' + \mathbf{i} \cdot (\nabla \mathbf{i}) \cdot \mathbf{a}' \mathbf{a}'' = \\ &= \mathbf{u}' + \mathbf{i} \cdot (\nabla' \mathbf{a}') \mathbf{a}'' \end{aligned} \right\} \quad (9)$$

in which formula \mathbf{u}' is the relative curvature vector of \mathbf{i} with respect to V_m .

When we write:

$$\mathbf{H} = (\nabla' \mathbf{a}') \mathbf{a}'' \quad (10)$$

we have:

$$\mathbf{u} = \mathbf{u}' + \mathbf{i} \mathbf{i}^2 \overset{3}{\mathbf{H}} = \mathbf{u}' + \mathbf{u}'' \quad (11)$$

In this equation $\mathbf{u}'' = \mathbf{i} \mathbf{i}^2 \overset{3}{\mathbf{H}}$ is a vector perpendicular to V_m , \mathbf{a}' containing but $\mathbf{i}_{m+1}, \dots, \mathbf{i}_n$. We call \mathbf{u}'' the *forced curvature vector* (erzwungener Krümmungsvektor) with respect to the V_n and $\overset{3}{\mathbf{H}}$ the *curvature affinor* of the V_m with respect to the V_n ¹⁾. We thus have the theorem:

The absolute curvature vector of a curve in the V_m is the sum of the relative curvature vector²⁾ and the forced curvature vector with respect to the V_m .

\mathbf{u}' vanishes for a curve, geodesic in V_m , thus \mathbf{u}'' is the absolute curvature vector of a curve, geodesic in V_m , with the same tangent vector as the given curve. If \mathbf{u}'' vanishes, the curve is called *asymptotic line of first order* of the V_m . Hence a geodesic line in V_m is then and only then geodesic in V_n , when it is an asymptotic line of first order of the V_m .

§ 3. Theorems concerning the quantity $\overset{3}{\mathbf{H}}$.

Because of

$$(\nabla \mathbf{a}) \mathbf{a} = 0 \quad (12)$$

we also have

$$(\nabla \mathbf{a}) \mathbf{a}'' = 0 \quad (13)$$

and thus we can give to $\overset{3}{\mathbf{H}}$ the following form:

$$\overset{3}{\mathbf{H}} = \overset{4}{\mathbf{g}'}^2 (\nabla \mathbf{a}') \mathbf{a}'' = - \overset{4}{\mathbf{g}'}^2 (\nabla \mathbf{a}'') \mathbf{a}'' = - \overset{4}{\mathbf{g}'}^2 \nabla \mathbf{a}'' \mathbf{a}'' \quad (14)$$

Since however

$$\nabla \mathbf{a}'' \mathbf{a}'' = \nabla^2 \mathbf{g} - \nabla^2 \mathbf{g}' = - \nabla^2 \mathbf{g}' \quad (15)$$

we can get another form for $\overset{3}{\mathbf{H}}$:

$$\overset{3}{\mathbf{H}} = \overset{4}{\mathbf{g}'}^2 \nabla^2 \mathbf{g}' \quad (16)$$

From (14) still another form can be deduced:

$$\overset{3}{\mathbf{H}} = - \overset{4}{\mathbf{g}'}^2 \nabla \sum_e \mathbf{i}_e \mathbf{i}_e = - \sum_e \overset{4}{\mathbf{g}'}^2 \nabla \mathbf{i}_e \mathbf{i}_e = - \sum_e \overset{4}{\mathbf{g}'}^2 (\nabla \mathbf{i}_e) \mathbf{i}_e \quad (17)$$

¹⁾ $\overset{3}{\mathbf{H}}$ corresponds with the expression Ω_{rtj} in Voss, 80, 1, with $b_{\alpha\beta\gamma}$ in Ricci 03, 2 and with $k_{fg}^{(r)}$ in KÜHNE, 04, 1.

²⁾ Ricci, 02,1 calls this vector "curvatura normale relativa a V_n ".

³⁾ 21. 1 p. 71.

Thus the equation of an asymptotic line of first order

$$ii^2 \overset{3}{\mathbf{H}} = 0 \tag{18}$$

is equivalent to the $n-m$ equations:

$$ii^2 \nabla i_e = 0. \tag{19}$$

Since i_e is perpendicular to V_m , ∇i_e is symmetrical in $i_a i_b$, and hence we conclude from (17) that $\overset{3}{\mathbf{H}}$ is symmetrical in its first two ideal factors.

When each geodesic line in V_m is also a geodesic line in V_n , V_m is called *geodesic* in V_n . If $\overset{3}{\mathbf{H}} = 0$, this is certainly fulfilled. This condition however is also necessary, because $ii^2 \overset{3}{\mathbf{H}}$ vanishes in this case for every choice of i , and $\overset{3}{\mathbf{H}}$ is symmetrical in the first two ideal factors.

We thus have the theorem:

A V_m in the V_n is then and only then geodesic, when $\overset{3}{\mathbf{H}}$ vanishes in every point of the V_m .

If $\overset{3}{\mathbf{H}}$ vanishes only in one point P of the V_m , the V_m is called *geodesic in this point*. This case occurs e.g. if the V_m is built up by geodesic lines of the V_n all going through P .¹⁾

If in a point of the V_m the curvature vector $ii^2 \overset{3}{\mathbf{H}}$ has the same direction for every choice of i , the point is called *axial*. For $m = n-1$ all points are axial.

A special case occurs, when $\overset{3}{\mathbf{H}}$ has the form:

$$\overset{3}{\mathbf{H}} = \overset{3}{g} \mathbf{U}. \tag{20}$$

A point, where this occurs, is called an *umbilical point* of the V_m . \mathbf{U} is called the *umbilical vector*. All curves through an umbilical point have in this point the same forced curvature vector, and this vector is equal to \mathbf{U} .

For $m = n-1$ $\overset{3}{\mathbf{H}}$ has the form:

$$\overset{3}{\mathbf{H}} = -\overset{4}{g} \nabla (\nabla i_n) i_n = -\overset{2}{h} i_n. \tag{21}$$

The symmetrical quantity $\overset{2}{h}$:

$$\overset{2}{h} = \overset{4}{g} \nabla i_n \tag{22}$$

¹⁾ BIANCHI 99, 1, p. 572 calls a V_2 in the V_n in this case already a geodesic V_2 .

is the *second fundamental tensor* of the V_{n-1} ¹⁾. It is obvious that in general

$$\nabla \mathbf{i}_n = {}^2\mathbf{h} + \mathbf{i}_n \mathbf{u}_n, \quad (23)$$

where $\mathbf{u}_n = \mathbf{i}_n \cdot \nabla \mathbf{i}_n$ is the curvature vector of \mathbf{i}_n . If we choose \mathbf{i}_n geodesic, the formula is simpler:

$${}^2\mathbf{h} = \nabla \mathbf{i}_n \quad (24)$$

$$\overset{3}{\mathbf{H}} = - {}^2\mathbf{h} \mathbf{i}_n = - (\nabla \mathbf{i}_n) \mathbf{i}_n. \quad (25)$$

The forced curvature vector

$$\mathbf{u}'' = - \mathbf{i} \mathbf{i}^2 {}^2\mathbf{h} \mathbf{i}_n \quad (26)$$

has for $m = n - 1$ always the direction of \mathbf{i}_n and gets an extreme value in the principal directions of ${}^2\mathbf{h}$. Hence these principal directions are also the directions of principal curvature²⁾. When \mathbf{i}_a , $a = 1, \dots, n-1$ are unit vectors in these directions and R_a the principal radii of curvature, with positive sign when the curvature vector has the sense of \mathbf{i}_n , we have

$${}^2\mathbf{h} = - \sum_a \frac{1}{R_a} \mathbf{i}_a \mathbf{i}_a \quad (27)$$

and from this we get the theorem:

The degree of nullity³⁾ of the second fundamental tensor is equal to the number of vanishing principal radii of curvature.

If all principal radii of curvature in a point of the V_{n-1} are equal, and only in this case, ${}^2\mathbf{h}$ is a multiple of the fundamental tensor of the V_m :

$${}^2\mathbf{h} = - \frac{1}{R} {}^2\mathbf{g}' \quad (28)$$

and $\overset{3}{\mathbf{H}}$ thus assumes the form (20). Hence the point is an umbilical point.

§ 4. Relations between the RIEMANN-CHRISTOFFEL affinors of the V_m and the V_n .

For the V_n the RIEMANN-CHRISTOFFEL affinor has the form⁴⁾:

$$\overset{4}{\mathbf{K}} = 2 \{ (\nabla \frown \nabla) \mathbf{a} \} \mathbf{a} = 2 \{ \nabla (\mathbf{a} \cdot \mathbf{c}) \frown \nabla (\mathbf{b} \cdot \mathbf{c}) \} (\mathbf{a} \frown \mathbf{b}) \quad (29)$$

¹⁾ We can find indeed: $h_{\lambda\mu} = 1/2 \mathbf{i}_n \cdot \nabla g_{\lambda\mu}$. Compare e.g. BIANCHI 99. 1, p. 601 and SCHOUTEN—STRUİK 19. 1, p. 207; 19. 2, p. 601.

²⁾ First defined by KRONECKER 69, 1, V_{n-1} in R_n .

³⁾ The degree of nullity of a tensor of second order in V_p is the degree of nullity of the matrix of the p^2 components.

⁴⁾ Comp. 21.1, p. 73.

and for the V_m :

$$\overset{4}{K'} = 2 \{ \nabla' (a' \cdot c) \frown \nabla (b' \cdot c') \} (a' \frown b'). \quad (30)$$

Dividing a, b and c as in (2), we get:

$$\begin{aligned} \overset{8}{g'} \overset{4}{K} &= 2 \overset{4}{g'} \overset{2}{g'} \{ \nabla (a' \cdot c') \frown \nabla (b' \cdot c') \} (a' \frown b') + \\ &+ 2 \overset{4}{g'} \overset{2}{g'} \{ \nabla (a' \cdot c') \frown \nabla (b'' \cdot c'') \} (a' \frown b') + \\ &+ 2 \overset{4}{g'} \overset{2}{g'} \{ \nabla (a'' \cdot c'') \frown \nabla (b' \cdot c') \} (a' \frown b') + \\ &+ 2 \overset{4}{g'} \overset{2}{g'} \{ \nabla (a'' \cdot c'') \frown \nabla (b'' \cdot c'') \} (a' \frown b'). \end{aligned} \quad (31)$$

The first of the four terms on the right in (31) is equal to $\overset{4}{K'}$, the second and third terms are equal, because they pass into each other by changing a and b .

The three last terms can all be expressed in $\overset{3}{H}$. For on one side we have with respect to (14):

$$\overset{3}{H} = \overset{4}{g'} \overset{2}{g'} (\nabla c') c'' = \overset{4}{g'} \overset{2}{g'} \{ \nabla (a \cdot c') \} a c'' = \overset{2}{g'} \overset{1}{g'} \{ \nabla (a' \cdot c') \} a' c'' \quad (32)$$

and on the other side with respect to (5):

$$\begin{aligned} \overset{3}{H} &= - \overset{4}{g'} \overset{2}{g'} \{ (\nabla a'') \cdot c a c \} = - \overset{4}{g'} \overset{2}{g'} \{ \nabla (a'' \cdot c) \} a' c = \\ &= - \overset{2}{g'} \overset{1}{g'} \{ \nabla (a'' \cdot c'') \} a' c = - \overset{2}{g'} \overset{1}{g'} \{ \nabla (b'' \cdot d'') \} b' d. \end{aligned} \quad (33)$$

When now we write:

$$\overset{3}{H} = H_1 H_1 H_2 = {}^1H_1 {}^1H_1 {}^2H_2, \quad (34)$$

which is permitted, $\overset{3}{H}$ being symmetrical in the first two factors, we have

$$\begin{aligned} (H_1 \frown {}^1H_1) (H_1 \frown {}^1H_1) (H_2 \cdot {}^2H_2) &= - \overset{4}{g'} \overset{2}{g'} \{ \nabla (a' \cdot c') \frown \nabla (b'' \cdot d'') \} (a' \frown b') (c'' \cdot d'') \\ &= - \overset{4}{g'} \overset{2}{g'} \{ \nabla (a' \cdot c') \frown \nabla (b'' \cdot c'') \} (a' \frown b') \end{aligned} \quad (35)$$

and also

$$\begin{aligned} (H_1 \frown {}^1H_1) (H_1 \frown {}^1H_1) (H_2 \cdot {}^2H_2) &= \overset{4}{g'} \overset{2}{g'} \{ \nabla (a'' \cdot c'') \frown \nabla (b'' \cdot d'') \} (a' \frown b') (c' \cdot d') \\ &= \overset{4}{g'} \overset{2}{g'} \{ \nabla (a'' \cdot c'') \frown \nabla (b'' \cdot c'') \} (a' \frown b'), \end{aligned} \quad (36)$$

hence we get:

$$\boxed{\overset{8}{g'} \overset{4}{K} = \overset{4}{K'} - 2 (H_1 \frown {}^1H_1) (H_1 \frown {}^1H_1) H_2 \cdot {}^2H_2} \quad (37)$$

This is the *Gaussian curvature theorem*, generalized for V_m in V_n ¹⁾.

When we write

$$g'^2 \nabla i_e = {}^2h_e = h_e h_e = {}^1h_e {}^1h_e, \quad (38)$$

we can give to (37) on account of (17) the following form:

$$g'^4 K = K' - 2 \sum_e (h_e \wedge {}^1h_e) (h_e \wedge {}^1h_e) \quad (39)$$

The second term on the right in (37) and (39) vanishes e.g., when the V_m is geodesic in P . Hence the theorem holds:

The RIEMANN-CHRISTOFFEL affinor of a V_m in V_n , geodesic in a point, is in this point the V_m -component of the RIEMANN-CHRISTOFFEL affinor of the V_n .

The second term on the right vanishes also in a V_m with only axial points, when the degree of nullity of the tensor 2h , belonging to the favoured normal direction, is one.

If the V_n is an S_n (comp. p. 146):

$$K = 2 K_0 {}^2g \wedge {}^2g \quad (40)$$

and the V_m is geodesic in P , the term on the left in (37) and (39) passes into

$$g'^4 K = 2 K_0 {}^2g' \wedge {}^2g' \quad (41)$$

Hence $2(\mathbf{H} \wedge {}^1\mathbf{H}_1)(\mathbf{H}_1 \wedge {}^1\mathbf{H}_1)\mathbf{H}_2 \cdot \mathbf{H}_2$ in this case depends only on the linear element of V_m , the m -direction of the V_m in the considered point and on K_0 . If the V_n is an S_n and if the V_m contains only umbilical points, we derive from (39) that the V_m is an S_m . This holds consequently also in the particular case that the V_m is geodesic.

§ 5. *Absolute, relative and forced curvature of a V_m in V_n .*

Transvecting (39) totally with $-\frac{1}{m(m-1)} \mathbf{a}'\mathbf{b}'\mathbf{b}'\mathbf{a}'$, we get:

$$-\frac{1}{m(m-1)} g'^4 K = K'_0 + \frac{2}{m(m-1)} g'^4 \sum_e (h_e \wedge {}^1h_e) (h_e \wedge {}^1h_e). \quad (42)$$

We call $K'_0 = -\frac{1}{m(m-1)} \mathbf{a}'\mathbf{b}'\mathbf{b}'\mathbf{a}' g'^4 K'$ the *absolute curvature* of the V_m , it is the curvature of V_m considered as a manifold for its

¹⁾ LIPSCHITZ, 70, 1 p. 292, V_m in V_n ; VOSS, 80, 1 p. 139, V_m in V_n ; RICCI, 02, 1, p. 359, V_m in V_n ; KÜHNE, 03, 1, p. 309, V_m in V_n ; comp. also e.g. BIANCHI 99, 1, p. 602, V_{n-1} in V_n ; SERVANT, 02, 3, p. 94, V_2 in R_4 .

²⁾ 21. 1 p. 76.

own. It is an invariant with eventually possible deformations of the V_m in the V_n .

The quantity on the left is the curvature of the V_m tangent to the V_n in P and geodesic in this point, in particular thus of the V_m built up by the geodesic lines of the V_n tangent to the V_m in P . We call this quantity *the forced curvature* K_z of the V_m :

$$K_z = -\frac{1}{m(m-1)} g'^4 K. \quad (43)$$

The last term with negative sign is the curvature of the V_m , if the linear element of the V_n were euclidean, or the *relative curvature* K_r of the V_m :

$$K_r = -\frac{2}{m(m-1)} g'^4 \sum_e (h_e \frown h'_e) (h_e \frown h'_e). \quad (44)$$

Hence we have the theorem:

The absolute curvature of a V_m in V_n is an invariant of deformation and equal to the sum of the relative and the forced curvature.

When the V_n is an S_n , we have

$$K_z = -\frac{1}{m(m-1)} g'^4 K = K_r, \quad (45)$$

consequently K_z is independent of the situation and the linear element of the V_m . Hence in this case K_r is also an invariant of deformation. In the general case K_r is an invariant of deformation in P for all deformations of the V_m , with which $g'^4 K$ is an invariant, thus in particular for the deformations with which the m -direction of the V_m in P remains unaltered.

The relative curvature of the V_m with respect to the V_{m+1} built up by a direction i_e continued in some way in the V_n , is:

$$K_{re} = -\frac{2}{m(m-1)} g'^4 (h_e \frown h'_e) (h_e \frown h'_e). \quad (46)$$

We thus have:

$$K_r = \sum_e K_{re}, \quad (47)$$

(in words:

When we pass through a V_m in an arbitrary way $n-m$ mutual $\frac{1}{m+1}$ -perpendicular V_{n+1} , the relative curvature of the V_m with

¹⁾ Voss, 80, 1. p. 172.

²⁾ The names absolute and relative curvature are introduced by Ricci, 02, 1, p. 361.

respect to the V_n is the sum of the relative curvatures with respect to these V_{n+1} ¹⁾.

§ 5. *The relations of the relative curvature to the principal radii of curvature and the simplest invariants of deformation.*

For $m = n-1$ we have:

$$\begin{aligned}
 K_r &= -\frac{2}{m(m-1)} g'^4 (\mathbf{h} \curvearrowright \mathbf{h}) (\mathbf{h} \curvearrowleft \mathbf{h}) \\
 &= -\frac{2}{m(m-1)} \sum_{ab} i_a i_b i_b i_a^4 (\mathbf{h} \curvearrowright \mathbf{h}) (\mathbf{h} \curvearrowleft \mathbf{h}) \\
 &= -\frac{2}{m(m-1)} \sum_{ab} i_a i_b (i_b \curvearrowright i_a)^4 \mathbf{h}' \mathbf{h} \mathbf{h}' \mathbf{h} \\
 &= -\frac{1}{m(m-1)} \sum_{ab} (i_a i_b^2 \nabla i_n) (i_b i_a^2 \nabla i_n) - (i_a i_a^2 \nabla i_n) (i_b i_b^2 \nabla i_n)
 \end{aligned} \tag{48}$$

Choosing the i_a in the principal directions of curvature, we have:

$$\left. \begin{aligned}
 i_a i_b^2 \nabla i_n &= 0 \quad , \quad a \neq b \\
 i_a i_a^2 \nabla i_n &= -\frac{1}{R_a}
 \end{aligned} \right\} \tag{49}$$

and we get:

$$K_r = \frac{1}{m(m-1)} \sum_{a,b}^{a \neq b} \frac{1}{R_a} \frac{1}{R_b} \tag{50}$$

in words:

The relative curvature of a V_{n-1} in a V_n is the mean value of the twofactorial products with different suffixes of the principal curvatures.

Hence for a V_{n-1} in S_n this sum is an invariant of deformation, for a V_{n-1} in V_n with $K_a = 0$ it is equal to the negative forced curvature.

For arbitrary values of m we have:

$$K_r = -\frac{1}{m(m-1)} \sum_e \sum_{a,b}^{a \neq b} (i_a i_b^2 \nabla i_e) (i_b i_a^2 \nabla i_e) - (i_a i_a^2 \nabla i_e) (i_b i_b^2 \nabla i_e) \tag{51}$$

Now choose the i_a in different ways for each value of i_e and each time in the directions of principal curvature with respect to the normal vector i_e .

¹⁾ KILLING, 85, 1, p. 247, V_m in S_n ; BERZOLARI 98, 1, p. 697, V_m in S_n , (both authors use projections); RICCI, 02, 1, p. 361, V_m in V_n .

We then have

$$K_r = \frac{1}{m(m-1)} \sum_e \sum_{a \neq b} \frac{1}{R_{ea}} \frac{1}{R_{eb}}, \tag{52}$$

in words:

The relative curvature of a V_m in the V_n is the sum of the mean values of the twofactorial products of the principal curvatures with different suffixes with respect to $n-m$ arbitrary mutual perpendicular normal directions of the V_m .

Thus for a V_m in S_n this sum is an invariant of deformation and for a V_m in V_n it is invariant with all deformations with which $\mathbf{g}'^4 \mathbf{K}$ is invariant in P , in particular with all deformations with which the m -direction of the V_m in P remains unaltered. For a V_m in the V_n with $K_a = 0$ it is equal to the negative forced curvature.

§ 6. Other invariants of deformation of a V_m .

Now we consider the sum of the four-factorial products with different suffixes of the principal curvatures with respect to the normal \mathbf{i}_e . Since

$$\begin{aligned} \mathbf{g}'^8 \mathbf{h}_e^4 \widehat{\mathbf{h}_e^4} &= \mathbf{g}'^8 (\mathbf{h}_e \widehat{\mathbf{h}_e} \widehat{\mathbf{h}_e} \widehat{\mathbf{h}_e}) (\mathbf{h}_e \widehat{\mathbf{h}_e} \widehat{\mathbf{h}_e} \widehat{\mathbf{h}_e}) = \\ &= \sum_{abcd} \mathbf{i}_a \mathbf{i}_b \mathbf{i}_c \mathbf{i}_d (\mathbf{i}_d \widehat{\mathbf{i}_c} \widehat{\mathbf{i}_b} \widehat{\mathbf{i}_a})^8 \mathbf{h}_e \widehat{\mathbf{h}_e} \widehat{\mathbf{h}_e} \widehat{\mathbf{h}_e} \mathbf{h}_e \widehat{\mathbf{h}_e} \widehat{\mathbf{h}_e} \widehat{\mathbf{h}_e} = \\ &= \frac{1}{2^4} \sum_{abcd}^{abcd \neq} (\mathbf{i}_a \mathbf{i}_a \widehat{\nabla} \mathbf{i}_e) (\mathbf{i}_b \mathbf{i}_b \widehat{\nabla} \mathbf{i}_e) (\mathbf{i}_c \mathbf{i}_c \widehat{\nabla} \mathbf{i}_e) (\mathbf{i}_d \mathbf{i}_d \widehat{\nabla} \mathbf{i}_e) = \\ &= \frac{1}{2^4} \sum_{abcd}^{abcd \neq} \frac{1}{R_{ea} R_{eb} R_{ec} R_{ed}}, \end{aligned} \tag{53}$$

this sum is equal to $\mathbf{g}'^8 \mathbf{h}_e^4 \widehat{\mathbf{h}_e^4}$. In the same way we can prove that for the sum $\sigma_{\alpha e}$ of the α -factorial products with different suffixes of the principal curvatures, $\alpha \leq m$, with respect to the normal direction \mathbf{i}_e the equation holds:

$$\sigma_{\alpha e} = (-1)^{\frac{\alpha(\alpha-1)}{2}} \mathbf{g}'^{2\alpha} \mathbf{h}_e^{\alpha} \widehat{\mathbf{h}_e^{\alpha}}, \tag{54}$$

We now form the series of quantities:

$$\begin{aligned} \mathbf{H} &= (\mathbf{H}_1 \widehat{\mathbf{H}}_1) (\mathbf{H}_1 \widehat{\mathbf{H}}_1) \mathbf{H}_2 \widehat{\mathbf{H}}_2 \\ \mathbf{H} &= (\mathbf{H}_1 \widehat{\mathbf{H}}_1 \widehat{\mathbf{H}}_1) (\mathbf{H}_1 \widehat{\mathbf{H}}_1 \widehat{\mathbf{H}}_1) \mathbf{H}_2 \widehat{\mathbf{H}}_2 \widehat{\mathbf{H}}_2 \\ &\vdots \\ \mathbf{H} &= \mathbf{H}_1^\alpha \widehat{\mathbf{H}}_1^{\alpha} \mathbf{H}_2^\alpha \widehat{\mathbf{H}}_2^\alpha \end{aligned} \tag{55}$$

When we want to write out the powers, we have to introduce equivalent factor systems $\mathbf{H}_1, \mathbf{H}_1, \mathbf{H}_2, \dots, \mathbf{H}_1, \mathbf{H}_1, \mathbf{H}_2$, etc. \mathbf{H} is symmetrical in the last α factors, just because all α systems are equivalent, and contains in these factors only the units $\mathbf{i}_{m+1}, \dots, \mathbf{i}_n$. We then have:

$$\mathbf{h}_e^{\alpha} \mathbf{h}_e^{\alpha} = \mathbf{H}^{\alpha} \mathbf{i}_e^{\alpha} \tag{56}$$

and:

$$\sigma_{\alpha c} = (-1)^{\frac{\alpha(\alpha-1)}{2}} \mathbf{g}'^{2\alpha} \mathbf{H}^{\alpha} \mathbf{i}_e^{\alpha} \tag{57}$$

The mean value $\bar{\sigma}_{\alpha c}$ of the values of $\sigma_{\alpha c}$ belonging to all possible directions \mathbf{i}_e can be obtained by transvecting $\mathbf{g}'^{2\alpha} \mathbf{H}^{\alpha}$ with the mean value of all quantities \mathbf{i}_e^{α} . Now it can be easily calculated that this latter mean value vanishes for α odd and >1 , and is equal to $(\mathbf{g} - \mathbf{g}')^{\mu}$ save a numerical factor for α even, $\alpha = 2\mu$. So we have e.g.:

$$M. value \mathbf{i}_e \mathbf{i}_e \mathbf{i}_e \mathbf{i}_e = \frac{3}{(m-n)^2 + 2(m-n)} (\mathbf{g} - \mathbf{g}')^2 \tag{58}$$

$$M. value \mathbf{i}_e^6 = \frac{15}{(n-m)^3 + 6(m-n)^2 + 8(m-n)} (\mathbf{g} - \mathbf{g}')^3 \tag{59}$$

Since \mathbf{H} is symmetrical in the last α factors, we thus have for $\alpha = 2\mu$:

$$\bar{\sigma}_{\alpha c} = \lambda_{\mu} \mathbf{g}'^{4\mu} \mathbf{H}^{2\mu} \mathbf{g}^{\mu} \tag{60}$$

where μ is a positive integer, λ_{μ} a numerical factor only depending on $n-m$, and in which expression \mathbf{g}^{μ} may be replaced by every permutation of the 2μ ideal factors of the μ factors \mathbf{g} .

Now $\mathbf{H}^{2\mu} \mathbf{g}^{\mu}$ can be built up by the ideal factors of $\mathbf{H}^6 \mathbf{g}$, but since on account of (37):

$$2 \mathbf{H}^6 \mathbf{g} = -\mathbf{g}'^8 \mathbf{K} + \mathbf{K}' \tag{61}$$

we see that also $\mathbf{H}^{2\mu} \mathbf{g}^{\mu}$ only depends on $\mathbf{g}'^8 \mathbf{K}$ and \mathbf{K}' . Hence $\bar{\sigma}_{\alpha c}$ only depends on $\mathbf{g}'^8 \mathbf{K}$ and \mathbf{K}' . Consequently it has the same invariance as \mathbf{K} .

Now choose $\alpha + \beta$ even, $\alpha + \beta = 2\mu$ and consider the quantity

$$\mathbf{J} = \mathbf{H}_1^{\alpha} \mathbf{L}_1^{\beta} \mathbf{H}_1^{\alpha} \mathbf{L}_1^{\beta} \mathbf{H}_2^{\alpha} \mathbf{L}_2^{\beta} \tag{62}$$

built up of \mathbf{H} and \mathbf{L} , \mathbf{L} being equivalent with \mathbf{H} . When we want to write out the powers we have to introduce α equivalent systems $\mathbf{H}_1, \mathbf{H}_1, \mathbf{H}_2, \dots, \mathbf{H}_1, \mathbf{H}_1, \mathbf{H}_2$, etc. and in the same way β systems $\mathbf{L}_1, \mathbf{L}_1, \mathbf{L}_2, \dots, \mathbf{L}_1, \mathbf{L}_1, \mathbf{L}_2$, etc. We then have:

$$h_e^\alpha \widehat{h_e^\beta} \widehat{h_e^\alpha} \widehat{h_e^\beta} = J_{2\mu}^{2\mu} i_e^{2\mu} \tag{63}$$

and

$$\sigma_{\alpha e} \sigma_{\beta e} = (-1)^{\frac{\alpha(\alpha-1)}{2} + \frac{\beta(\beta-1)}{2}} g'^{4\mu} J^{2\mu} i_e^{2\mu}. \tag{64}$$

Hence the mean value of all quantities $\sigma_{\alpha e} \sigma_{\beta e}$, $\overline{\sigma_{\alpha e} \sigma_{\beta e}}$ is equal to

$$\overline{\sigma_{\alpha e} \sigma_{\beta e}} = (-1)^{\frac{\alpha(\alpha-1)}{2} + \frac{\beta(\beta-1)}{2}} g'^{4\mu} J^{2\mu} (i_e^{2\mu})_m, \tag{65}$$

in which $(i_e^{2\mu})_m$ is the mean value of all quantities $i_e^{2\mu}$.

In order to transform this expression, we consider the ideal quantity

$$P = ((\beta)a \dots (\alpha)a) ((\alpha)b \dots (\beta)b), \tag{66}$$

in which the \mathbf{a} and \mathbf{b} are equivalent ideal factors of 2g :

$${}^2g' = {}^1a {}^1a = \dots = {}^{(\beta)}a {}^{(\beta)}a = {}^1b {}^1b = \dots = {}^{(\alpha)}b {}^{(\alpha)}b. \tag{67}$$

This quantity arises from

$${}^{(\beta)}a \dots {}^1a {}^{(\alpha)}b \dots {}^1b \tag{68}$$

by replacing two definite systems of α , resp. β ideal factors by their alternating product. Such an operation is called a *simple alternation*¹⁾. In the general case a simple alternation $s_1 \dots s_t A$ replaces t definite systems of s_1, s_2, \dots, s_t factors by their alternating product. s_1, \dots, s_t is called the *permutation-number* of the alternation. Every alternation is apparently a multiple sum of permutations. The alternations with different permutation-number can be ordered according to their permutation-number and then get a suffix on the right. So e.g. we have for $2\mu = 6$:

$$\left. \begin{aligned} {}_0A &= A_1, {}_2A = A_2, {}_{2,2}A = A_3, {}_{3,2}A = A_4, {}_3A = A_5, {}_{3,2}A = A_6 \\ {}_{2,3}A &= A_7, {}_4A = A_8, {}_{4,2}A = A_9, {}_5A = A_{10}, {}_6A = A_{11} \end{aligned} \right\} \tag{69}$$

The number of the different possible permutation-numbers be k . For $2\mu = 6$ we have therefore $k = 11$. The different alternations with the same permutation-number can be distinguished by a suffix high on the right. So there are e.g. for $2\mu = 6$ 15 different alternations A_6 :

$$A_6^1 \dots A_6^{15}.$$

The sum of all alternations A_u with the same permutation-number divided by its number, is called the *general alternation* \bar{A}_u . Now we can show that there are k operators ${}_uI$ such that

$${}_uI_v I = \begin{cases} {}_uI & \text{if } u = v \\ 0 & \text{,, } u \neq v \end{cases} \tag{70}$$

and

¹⁾ For the development of the theory of these operators and their application to the expansion of quantities and forms in series see 19, 3, English 19, 4.

$${}_u I A_v = A_v {}_u I = \begin{cases} 0 & \text{if } v > u \\ \neq 0 & \text{,, } v \leq u \end{cases} \quad (71)$$

the sum of all ${}_u I$ being the identical operator. \bar{A}_v can be written as a multiple sum of the operators ${}_v I, \dots, {}_k I$:

$$\bar{A}_v = \sum_w^{v, \dots, k} \frac{1}{\delta_{vw}} {}_w I \quad (72)$$

When now we write

$${}_{\beta, \alpha} A = A_v \quad , \quad {}_{\beta, \alpha} \bar{A} = \bar{A}_v \quad (73)$$

and

$${}_{\mu, 2} \bar{A} = \bar{A}_u, \quad (74)$$

we have for $\alpha + \beta > 4$ and for $\alpha + \beta = 4, \alpha \neq \beta$ certainly $u < v$, while $u = v$ for $\alpha + \beta = 4, \alpha = \beta$. For $u < v$ however we have:

$${}_{2\mu} P = A_v {}_{2\mu} P = A_v \sum_w^{v, \dots, k} {}_w I {}_{2\mu} P = \sum_w^{v, \dots, k} {}_w I A_v {}_{2\mu} P = \bar{A}_u \sum_w^{v, \dots, k} \delta_{uw} {}_w I A_v {}_{2\mu} P. \quad (75)$$

while for $\alpha + \beta = 4$ and $\alpha = \beta$ we have $u = v$:

$${}_{\beta, \alpha} A = {}_{2, 2} A. \quad (76)$$

Hence ${}_{2\mu} P$ is for $\alpha + \beta \geq 4$ always a sum of quantities all alternating in μ systems of two factors. Their number is the number of simple alternations ${}_{\mu, 2} A$. We consider of these quantities an arbitrary one and call the corresponding operator, of which this quantity is built up from ${}_{2\mu} P : O_\gamma$. Then:

$$\left. \begin{aligned} O_\gamma &= A_\mu^\gamma \sum_w^{v, \dots, k} \delta_{uw} {}_w I A_v \quad \text{if } \alpha + \beta > 4 \text{ or } \alpha + \beta = 4, u \neq v \\ O_\gamma &= A_\mu^\gamma \quad \text{if } \alpha + \beta = 4, u = v. \end{aligned} \right\} \quad (77)$$

We then have:

$$({}^{(\beta)}\widehat{\mathbf{a}} \dots \widehat{\mathbf{a}}) ({}^{(\alpha)}\widehat{\mathbf{b}} \dots \widehat{\mathbf{b}}) ({}^{(\beta)}\widehat{\mathbf{a}} \dots \widehat{\mathbf{a}}) ({}^{(\alpha)}\widehat{\mathbf{b}} \dots \widehat{\mathbf{b}}) = \sum_\gamma (O_\gamma P) P \quad (78)$$

Since, however, the \mathbf{a} and \mathbf{b} are all equivalent, we apparently have for each simple alternation

$$({}_{2\mu} A_v P) P = P ({}_{2\mu} A_v P) = ({}_{2\mu} A_v P) ({}_{2\mu} A_v P) \quad (79)$$

and in consequence, since ${}_w I$ can be written as a multiple sum of alternations:

$$({}_{2\mu} O_\gamma P) P = ({}_{2\mu} O_\gamma P) ({}_{2\mu} O_\gamma P). \quad (80)$$

Now we have according to (65) and (66)

$$\begin{aligned}
 \overline{\sigma_{\alpha e} \sigma_{\beta e}} &= (-1)^{\frac{\alpha(\alpha-1)}{2} + \frac{\beta(\beta-1)}{2}} \frac{2^\mu 2^\mu}{\mathbf{P} \mathbf{P}^{4\mu}} \mathbf{H}_1^{\alpha-1} \mathbf{L}_1^{\beta-1} \mathbf{H}_1^{\alpha-1} \mathbf{L}_1^{\beta-1} \mathbf{H}_2^\alpha \mathbf{L}_2^\beta 2^{2\mu} (i_e^{2\mu})_m \\
 &= \lambda_\mu \frac{2^\mu 2^\mu}{\mathbf{P} \mathbf{P}^{4\mu}} \mathbf{H}_1^{\alpha+\beta} \mathbf{H}_1^{\alpha+\beta} \mathbf{H}_2^{\alpha+\beta} 2^{2\mu} {}^2\mathbf{g}^\mu = \\
 &= \sum_\gamma \lambda_\mu (O_\gamma \mathbf{P}) O_\gamma \frac{2^\mu 2^\mu}{\mathbf{P}} {}^4\mathbf{H}_1^{\alpha+\beta} \mathbf{H}_1^{\alpha+\beta} \mathbf{H}_2^{\alpha+\beta} 2^{2\mu} {}^2\mathbf{g}^\mu
 \end{aligned} \tag{81}$$

in which formula ${}^2\mathbf{g}^\mu$ may be replaced in each term by every arbitrary permutation of ideal factors of the μ factors ${}^2\mathbf{g}$, each term now being on its own symmetrical in the last 2μ factors. Since further

$$O_\gamma \mathbf{P} {}^{2\mu} \mathbf{H}_1^{\alpha+\beta} = O_\gamma \mathbf{P} {}^{2\mu} A_\mu^\gamma \mathbf{H}_1^{\alpha+\beta} \tag{82}$$

and A_μ is an alternation with μ systems of two factors, we can build up every term of $\overline{\sigma_{\alpha e} \sigma_{\beta e}}$ by the ideal factors of μ quantities ${}^6\mathbf{H}^2 {}^2\mathbf{g}$ and 2μ quantities ${}^2\mathbf{g}'$. Hence $\overline{\sigma_{\alpha e} \sigma_{\beta e}}$ depends only on ${}^2\mathbf{g}'$, ${}^8\mathbf{g}' {}^4\mathbf{K}$ and ${}^4\mathbf{K}'$.

Hence we have got the following theorem.

In a definite point P of a V_m in V_n we consider the sums $\sigma_{\alpha e}$ of the α -factorial products of the principal curvatures with different suffices with respect to a definite normal direction i_e of the V_m . We then form the mean values $\overline{\sigma_{\alpha e}}$ and $\overline{\sigma_{\alpha e} \sigma_{\beta e}}$, $\alpha + \beta \geq 4$ of all quantities $\sigma_{\alpha e}$ resp. $\sigma_{\alpha e} \sigma_{\beta e}$ with respect to all possible normal directions. Then $\overline{\sigma_{\alpha e}}$ resp. $\overline{\sigma_{\alpha e} \sigma_{\beta e}}$ vanish for α resp. $\alpha + \beta$ odd, and for α , resp. $\alpha + \beta$ even they depend only on the linear element of the V_m and on the V_m -component ${}^8\mathbf{g}' {}^4\mathbf{K}$ of the RIEMANN-CHRISTOFFEL affnino ${}^4\mathbf{K}$ of the V_n . Hence these quantities are invariants of deformation for a V_m in S_n and for a V_m in V_n they are invariant with all eventually possible deformations of the V_m in V_n that leave ${}^8\mathbf{g}' {}^4\mathbf{K}$ unaltered, in particular with all deformations with which the m -direction of the V_m in P remains unaltered¹⁾.

¹⁾ LIPSCHITZ has first proved (70, 1) the invariance of the $\overline{\sigma_{\alpha e}}$ for α even and for V_m in R_n , afterwards (76, 1) that of $\overline{\sigma_{\alpha e} \sigma_{\beta e}}$ for $\alpha + \beta$ even and $\geq n + 1$. KILLING has (85, 1) given the proof for all $\overline{\sigma_{\alpha e}}$ and $\overline{\sigma_{\alpha e} \sigma_{\beta e}}$ for V_m in S_n , he also gives the geometrical interpretation of these expressions. MASCHKE has (06, 1) proved the invariance of σ_{n-1} for V_{n-1} in R_n with the aid of his symbolic calculus, BATES (11, 1) that of σ_α $\alpha > 1$ for V_{n-1} in R_n . BATES has not succeeded in expressing the $\overline{\sigma_\alpha}$ in ${}^2\mathbf{g}'$, ${}^4\mathbf{K}$ and ${}^8\mathbf{g}' {}^4\mathbf{K}$ for V_m in V_n , though he finds expressions for σ_α . These, however, contain still the $n-m$ functions that, equalled to zero, form the equations of the V_m .

For a V_{n-1} in the V_n $\overline{\sigma_{\alpha e}}$ passes for a even into σ_α and $\overline{\sigma_{\alpha e} \sigma_{\beta e}}$ passes for $\alpha + \beta$ even into $\sigma_\alpha \sigma_\beta$. Hence in this case all quantities σ_α for $n > 3$ and all quantities σ_α , $\alpha > 1$ for $n = 3$ are only dependent on the linear element of the V_{n-1} and on $\mathbf{g}'^8 \mathbf{K}^4$. This theorem can be proved in a simpler way for $n > 3$. After (39) ${}^2\mathbf{h}$ is the vector-tensor belonging to the bivector-tensor $\frac{1}{2} (\mathbf{K}' - \mathbf{g}'^8 \mathbf{K}^4)$. Now a vector-tensor is then and only then uniquely determined by its corresponding bivector-tensor, when its degree of nullity is n , $n-1$ or $n-2$. For $n > 3$ ${}^2\mathbf{h}$ is thus in general uniquely determined by $\mathbf{K}' - \mathbf{g}'^8 \mathbf{K}^4$ and consequently also all principal curvatures and all quantities σ_α . From this follows that a V_{n-1} in R_n or S_n , in which $\mathbf{K}' - \mathbf{g}'^8 \mathbf{K}^4$ only depends on the $(n-1)$ -direction of the V_{n-1} in P , cannot in general be deformed¹⁾. We can observe that for the same reason a V_m in R_n or S_n with only axial points cannot in general be deformed in such way that its points remain axial. In a deformation of a V_m in V_n also an axial point remains in general not axial.

LITERATURE.

1869. 1. KRONECKER, L. Ueber Systeme von Functionen mehrerer Variablen. Monatsber. Berl. Ac. 159—193, 688—698, Werke I, p. 175—212, 213—226.
1870. 1. LIPSCHITZ. R. Entwicklung einiger Eigenschaften der quadratischen Formen von n Differentialen. Crelle 71, 274—287, 288—295.
1875. 1. BEEZ. R. Zur Theorie des Krümmungsmasses von Mannigfaltigkeiten höherer Ordnung. Zeitschr. Math. u. Phys. 20, 423—444, 21, 373—401 (76.1) and 24, 1—17, 65—82 (79.1).
1876. 1. LIPSCHITZ. R. Beitrag zur Theorie der Krümmung. Crelle 81, 230—242.
1880. 1. VOSS. A. Zur Theorie der Transformation quadratischer Differentialausdrücke und der Krümmung höherer Mannigfaltigkeiten. Math. Ann. 16, 129—178.
1885. 1. KILLING. W. Die nicht-euklidischen Raumformen in analytischer Behandlung. Teubner, Leipzig.
1898. 1. BERZOLARI. L. Sulla curvatura delle varietà tracciate sopra una varietà qualunque. Torino Atti 33, 692—700, 759—778.
1899. 1. BIANCHI. L.-LUKAT. M. Vorlesungen über Differentialgeometrie. Teubner, Leipzig, 659 p.
1902. 1. RICCI. G. Formole fondamentali nella teoria generale delle varietà e della loro curvatura. Rom. Ac. Linc. Rend. Ser. V, 11¹, 355—362.
2. SERVANT. M. Sur une extension des formules de Gauss. Bull. Soc. Math. de Fr. 30, 92—100.

¹⁾ BEEZ, 79.1, p. 76; V_{n-1} in R_n .

1903. 1. KÜHNE. H. Die Grundgleichungen einer beliebigen Mannigfaltigkeit. Arch. f. Math. u. Phys. 3. Reihe, 4, 300—311.

2. RICCI. G. Sulle superficie geodetiche in una varietà qualunque e in particolare nelle varietà a tre dimensioni. Rom. Acc. Linc. Rend. Ser.V, 12, 409—420.

1904. 1. KÜHNE. H. Ueber die Krümmung einer beliebiger Mannigfaltigkeit. Arch. f. Math. u. Phys. 3. Reihe, 6, 251—260.

1906. 1. MASCHKE. H. The Kronecker-Gaussian curvature of Hyperspace. Transact. Am. M. Soc. 7. 81—93.

1911. 1. BATES. W. H. An application of symbolic methods to the treatment of mean curvatures in hyperspace. Transact. Am. M. Soc. 12, 19—38.

1918. 1. SCHOUTEN. J. A. Die direkte Analysis zur neueren Relativitätstheorie. Verh. Kon. Akad. Amsterdam. Deel 12, No. 6, 97 p.

1919. 1. SCHOUTEN. J. A. en STRUIK. D. J. Over n -voudig orthogonale stelsels van $(n-1)$ -dimensionale uitgebreidheden in een algemeene uitgebreidheid van n afmetingen. Versl. Kon. Ak. v. Wet. Amsterdam, 28, 201—212, 452—463.

2. SCHOUTEN J. A. and STRUIK. D. J. On n -tuple orthogonal systems of $(n-1)$ -dimensional manifolds in a general manifold of n dimensions. Proc. Kon. Ak. v. Wet. Amsterdam, 22, 596—605, 684—695.

3. Over reeksontwikkelingen van ko- en kontravariante grootheden van hooger grad bij de lineaire homogene groep. Versl. Kon. Ak. v. Wet. Amsterdam, 27, 1277—1292.

4. On expansions in series of covariant and contravariant quantities of higher degree under the linear homogeneous group. Proc. Kon. Ak. v. Wet. Amsterdam, 22, 251—266.

1921. 1. SCHOUTEN. J. A. Ueber die konforme Abbildung n -dimensionaler Mannigfaltigkeiten mit quadratischer Maszbestimmung auf eine Mannigfaltigkeit mit euklidischer Maszbestimmung. Math. Zeitschr. 11, 58—88.

2. SCHOUTEN. J. A. und STRUIK. D. J. Ueber das Theorem von Malus-Dupin und einige verwandte Theoreme in einer n -dimensionalen Mannigfaltigkeit mit beliebiger kwadratischer Maszbestimmung. Rend. Circ. Mat. Palermo 45, 313—331.

1922. 1. SCHOUTEN. J. A. und STRUIK. D. J. Ueber Krümmungseigenschaften einer V_m , die in einer V_n eingebettet ist. Rend. Circ. Mat. Palermo 46.

Physics. — “*On the calculation of the molecular quadrupole-moments from the equation of state.*” By Prof. W. H. KEESOM. (Communication N^o. 9 from the Laboratory of Physics and Physical Chemistry of the Veterinary College at Utrecht). (Communicated by Prof. H. KAMERLINGH ONNES).

(Communicated at the meeting of September 24, 1921).

§ 1. *Introduction.* When the potential in the field of the electric charges in a rotational symmetric homopolar molecule is developed in a series of powers of r^{-1} , the first term may be regarded as being due to a zonal quadrupole.

As far as is evident from the investigation of the equation of state especially for hydrogen, the molecular attraction in diatomic homopolar gases may be regarded to a first approximation as due to such a quadrupolar term in the field of force of the molecule, at least for a high temperature and in a diluted gaseous state. That finally an attraction results must be ascribed to two causes: 1st that two molecules when approaching each other will try to direct each other in such a way that attracting forces arise between them, and 2nd that in two approaching molecules the charges are displaced by their mutual influence thus that this gives rise to an attraction.

As far as this DEBIJE¹⁾ and the author²⁾ agree. Their opinions

1). P. DEBIJE. Physik. ZS. **22**, p. 302, 1921. Very interesting is the application made by DEBIJE of these considerations to monatomic gases, where the mutually directing influence of the molecules mentioned under 1st becomes zero, so that only the attraction due to the polarisation of the molecules mentioned under 2nd remains. See for this also F. ZWICKY, Physik. ZS. **22**, p. 449, 1921. As to this, we may remark however the following. The application of the above to a quadrupole term in the field of the monatomic molecules gives us a mean value of the potential energy of two such molecules proportional with r^{-8} (a dipole term would give r^{-6}), while on the contrary the observations for argon are more in favour of r^{-4} or r^{-5} (hydrogen below the BOYLE-point r^{-4}), see Leiden Suppl. N^o. 26 § 3, these Proceedings October 1912, p. 643.

2) Comm. N^o. 6b, these Proc. Vol. XXIII, N^o. 6, 1920. Physik. ZS. **22**, p. 129, 1921.

differ however on the magnitudes of the quadrupole moments¹⁾ that are to be ascribed to the molecules of the gases in question (hydrogen, oxygen and nitrogen) on account of the data of the equation of state.

The author has deduced these quadrupole moments²⁾ from the experimentally found second virial coefficients for the above mentioned gases at selected temperatures by comparing them with the dependency of the second virial coefficient on the temperature as deduced for fixed quadrupoles and thus without attending to the displacement of the charges mentioned under 2nd. Afterwards³⁾ he has proved that at those temperatures the influence of the displacibility of the charges is only small compared with that of the attraction due to the fixed quadrupoles. From this it is evident, that the values for the quadrupole moments derived from the experimental data do not undergo considerable changes by the displacibility of the charges.

Following another way of calculation however DEBIJE finds considerably higher values for the quadrupole moments and on several grounds he prefers these higher values.

In this communication will be shown that the author cannot adhere to this opinion and by further calculation he will investigate the influence of the polarisability of the molecules on the value found for the quadrupole moment. Then, as might be expected, this influence will be found to be small.

§ 2. *Rectification.* In the first place it may be mentioned here, that at the last moment a calculation error has been made in my former calculation of the quadrupole moment of hydrogen. From the values for σ and ν given in Leiden Suppl. N^o. 39a § 5 we find for the quadrupole moment of the hydrogen molecule:

$$\mu_2 = 1,17 \times 10^{-26} \quad [\text{e.s.e.} \times \text{cm.}^2],$$

instead of the value that was given there⁴⁾.

As by his calculation of the quadrupole moment of hydrogen DEBIJE found the value

$$\mu_2 = 2,14 \times 10^{-26},$$

¹⁾ For a molecule which is not rotationally symmetric (and which has no dipole-moment) this is replaced by a mean quadrupole moment, comp. DEBIJE l. c.

²⁾ Leiden Suppl. N^o. 39a. These Proc. Vol. XVIII, p. 636. These Comm. N^o. 6a, these Proc. Vol. XXIII N^o. 6 p. 939.

³⁾ l.c. p. 162, note 2.

⁴⁾ In note 1 p. 15 l.c. we must read therefore $0,70 \times 10^{-8}$ instead of $0,92 \times 10^{-8}$. As to the remark in § 1 of Comm. N^o. 6a, these Proc. Vol. XXIII p. 940 on the agreement between the values of the quadrupole moment deduced from the equation of state and from the model of BOHR-DEBIJE, this loses its sense.

the two methods of calculation are evidently leading to considerably different results for hydrogen too.

§ 3. His opinion that the polarisation of the molecules caused by their mutual influence, is of great importance, is based by DEBLJE principally on the values of the coefficients of the *mean* reduced equation of state. This mean equation of state has been given by KAMERLINGH ONNES for a systematic summary and discussion of the material of observations and of the deviations from the law of corresponding states. At the same time, however, he declared emphatically ¹⁾ that for no substance this mean reduced equation of state will coincide with the real reduced equation of state. It would only do so, when the substances the data of which have been used in the derivation of the mean reduced equation of state, strictly obeyed the law of corresponding states. Now this is by no means the case, especially not for hydrogen compared with nitrogen and oxygen, which gases gave the data for the higher reduced temperatures, which are of most interest for our question. This is a.o. evident from the following fact. When for the great volumes and for the dominion of reduced temperatures corresponding to the temperature interval in which AMAGAT has made measurements on O_2 and N_2 , we want to make the reduced equations of state of H_2 correspond with those of O_2 and N_2 , we must choose as critical reduction temperature for H_2 ²⁾ 43, whereas however the critical temperature of H_2 is 33. Now in the mean reduced equation of state the reduced second virial coefficient \mathfrak{B} is represented as a function of the reduced temperature t that is obtained by combining the values taken from H_2 with those of O_2 and N_2 , etc. and reduced as well for H_2 as for O_2 and N_2 by means of the experimental values of T_k . And it is evident that this function can show a quite different character from that which corresponds to the behaviour of each of the substances.

For the discussion of questions as those considered here, we do better not to use the mean reduced equation of state.

It would be preferable to start from the *special* reduced equation of state of hydrogen ³⁾. In the above question however the special equation of state would lead to trustworthy results only then, when it was fitted to high temperatures. But this is not the case.

¹⁾ See e.g. Leiden Comm. N^o. 74 § 4, 1901.

²⁾ H. KAMERLINGH ONNES and C. BRAAK. Leiden Comm. N^o. 97b, p. 39.

H. KAMERLINGH ONNES and W. H. KEESOM. Die Zustandsgleichung. Math. Enz. V 10. Leiden Suppl. N^o. 23, note 399.

³⁾ See Leiden Comm. N^o. 109a, § 7, 1909.

The special equation of state deduced from measurements of KAMERLINGH ONNES and BRAAK gives e.g.

$$B_{\infty} = 0,000893,$$

a value higher than might be expected from direct graphical extrapolation of the individual values of B from the measurements of KAMERLINGH ONNES and BRAAK. Therefore this special equation of state too would also give a too high value for the quadrupole moment when the method of calculation of DEBIJE was used.

It seems to me preferable to proceed as was done in my preceding communications viz. to work out the theoretically deduced development of B until¹⁾ it extends over a sufficiently wide dominion, to compare then this development with the experimental data and to deduce in this way e.g. the value of the quadrupole moment.

§ 4. *Further development of the second virial coefficient for spherical polarisable quadrupole molecules.* In order to take into consideration the influence of the polarisability of the molecules in the deduction of the quadrupole moment, the development started in Comm. N^o. 6b § 3 has been extended by a few terms. Thereto the formulae given in Leiden Suppl. N^o. 39a may be of use. By multiplying equation (11) from the paper by

$$\chi = \sin^4 \theta_1 + \sin^4 \theta_2 + 4 \cos^4 \theta_1 + 4 \cos^4 \theta_2 (1)$$

(Comm. N^o. 6a equation (10)), we find, following the notations of Leiden Suppl. N^o. 39a:

$$\begin{aligned} [\psi^n \chi] = 2\pi [A^n \chi] + \binom{n}{2} [A^{n-2} B^2 \chi] [\cos^2 \varphi] + \binom{n}{2} [A^{n-2} C^2 \chi] [\cos^2 2\varphi] + \\ + \binom{n}{3} \binom{3}{1} [A^{n-3} B^2 C \chi] [\cos^2 \varphi \cos 2\varphi] \text{ etc. } (2) \end{aligned}$$

With

$$\sin^4 \theta_1 + 4 \cos^4 \theta_1 = A_1^2 + 4B_1^2 (3)$$

(see Leiden Suppl. N^o. 39a equation (9)) we find:

$$\begin{aligned} [A^p B^{2q} C^r \chi] = 2^{p+8q+1} [A_1^p B_1^{2q} C_1^r] \{ [A_1^{p+2} B_1^{2q} C_1^r] + \\ + 4 [A_1^p B_1^{2q+2} C_1^r] \} (4) \end{aligned}$$

¹⁾ Of course I acknowledge the objections made by DEBIJE in § 5 of his cited paper. They show that the results obtained in the above mentioned way can only be accepted with some reserve as has been specially stated in Comm. N^o. 6a § 4. On account of all this accurate measurements on the second virial coefficient at higher temperatures are very necessary. In the meantime however it seems to me of some importance that such a good agreement with the experimental data that are at our disposition is obtained by using the mentioned simplifying suppositions (quadrupolar action, no quantum deviations as yet, collisions as of solid spheres).

Applying then equations (14), (15) and (16) of Leiden Suppl. N°. 39a and substituting in equation (16) of Comm. N°. 6b, we finally obtain :

$$B = \frac{1}{2} n \cdot \frac{4}{3} \pi \sigma^3 \left\{ 1 - 1.0667 (hv)^2 + 0.1741 (hv)^3 - 0.4738 (hv)^4 + 0.6252 (hv)^5 \dots \right. \\ \left. - 2,4 \frac{\alpha}{\sigma^2} hv [1 + 1.0667 (hv)^2 - 0.3641 (hv)^3 + 0.2267 (hv)^4 \dots] \right\} \dots (5)$$

§ 5. *Hydrogen*. Substituting for hydrogen $\frac{\alpha}{\sigma^2} = 0,0640$ (Comm. N°. 6b § 4) we find :

$$B = \frac{1}{2} n \cdot \frac{4}{3} \pi \sigma^3 \{ 1 - 0.1536 hv - 1.0667 (hv)^2 + 0.0103 (hv)^3 - \\ - 0.4179 (hv)^4 + 0.5904 (hv)^5 - 0.2360 (hv)^6 + \\ + 0.1355 (hv)^7 - 0.1079 (hv)^8 + 0.0593 (hv)^9 \dots \} \dots (6)$$

This gives for the JOULE-KELVIN point of inversion for small densities (comp. Leiden Suppl. N°. 39a § 4):

$$hv_{inv(\rho=0)} = 0.503 \dots (7)$$

From this we derive for B expressed in terms of $\frac{T}{T_{inv(\rho=0)}} = t_{(inv)}$:

$$B = B_\infty \{ 1 - 0.0773 t_{(inv)}^{-1} - 0.2699 t_{(inv)}^{-2} + 0.01311 t_{(inv)}^{-3} - \\ - 0.02675 t_{(inv)}^{-4} - 0.01901 t_{(inv)}^{-5} - 0.00382 t_{(inv)}^{-6} + \\ + 0.00110 t_{(inv)}^{-7} - 0.00042 t_{(inv)}^{-8} + 0.00011 t_{(inv)}^{-9} \dots \} \dots (8)$$

$\frac{T}{T_{inv(\rho=0)}}$	$\frac{B}{B_\infty}$	$\frac{B}{B_{inv}}$
0.6	0.160	0.246
0.75	0.426	0.650
1	0.655	1
1.5	0.829	1.266
2	0.895	1.366
3	0.944	1.411
4	0.963	1.470

In this way we reach an accuracy of about 1% (of B_∞ at $T=0,6 T_{inv(\rho=0)}$). The preceding table gives some of the calculated values.

In fig. 1 these values have been plotted together with the

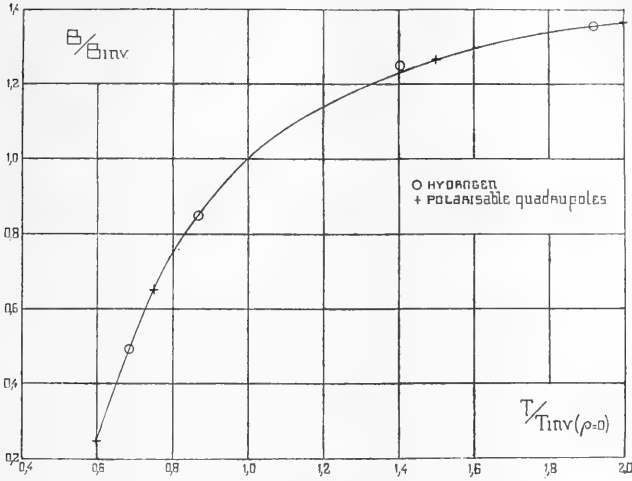

Fig. 1.

experimental data according to KAMERLINGH ONNES and BRAAK. Over the whole range of temperature that is considered, the agreement proves to be very good.

As in Leiden Suppl. N°. 39a § 5 we find further:

for σ the same value as was given there, but

$$v = 1.34 \times 10^{-14}$$

and the quadrupole moment:

$$\mu_2 = 1.10 \times 10^{-26} \text{ [e.s.e.} \times \text{cm.}^2\text{]}.$$

As to the quadrupole moment of H_2 we thus really find, as was expected in Comm. N°. 6b § 4, a value deviating only little from that deduced by the calculations of Leiden Suppl. N°. 39a (see this Comm. § 2).

Further we deduce still easily for μ_2 the following relation

$$\mu_2^2 = 9.19 \times 10^{-17} \cdot \sigma^4 T_{inv}(\rho=0) \dots \dots (9)$$

For the reasons discussed in § 3 this equation seems to me preferable to equation (6) of DEBIJE i.e.

§ 6. *Oxygen and nitrogen.* For oxygen we may also apply equation (8). For nitrogen the coefficient will be a little different.

For the moment however we omit a more detailed calculation of the quadrupole moments of these gases as these may only be deduced with little accuracy because of the relatively small temperature interval in which for these gases data on B are at our disposal (Comm. N°. 6a § 2). For this reason the small alteration introduced by attending to the polarisability of the molecules would be of no importance.

Astronomy. — “On a change with the declination in the personal equation in meridian-observations.” By C. H. HINS. (Communicated by Prof. W. DE SITTER).

(Communicated at the meeting of September 24, 1921).

In the preliminary reduction of the R.A. in the current programme of the Leyden meridian circle, the question arose as how to deal with the clock rate.

The first difficulty that arises is that the registering clock KNOBLICH is not the same as the principal clock of the observatory, HOHWÜ 17.

We shall therefore first give a brief account of how the reduction was made in former observations.

Before the beginning and after the end of the observations the beats of HOHWÜ 17 were registered for one and a half minute, with intervals of three seconds, on the slips upon which the KNOBLICH clock registers every two seconds. In this way the value of the difference of time Kn.—H. 17 was obtained at two epochs. Even when these comparisons were made three or more times in one evening, they were always represented by a straight line. (See PANNEKOEK, Annals of the Leyden Observatory Vol. X part I).

At regular intervals of about ten days determinations of time were made which gave the daily rate of the clock HOHWÜ 17. This “rough” rate observed in the interval between two determinations of time was reduced by the formula:

$$p = \text{daily rate} - 0^s,0153(b - 760^{m.m}) + 0^s,0263(t^\circ - 10^\circ) - 0,37(t - t')$$

to the so called *reduced daily rate* p at $t = 10^\circ$, $b = 760^{m.m}$ and $t - t' = 0$.

In the above formula

b represents the mean barometer in the interval.

t the mean temperature in the interval.

$t - t'$ the mean difference of the temperatures at the top and the bottom in the case of the clock.

daily rate: the rough rate as explained above.

From this *reduced daily rate* the actual rate of H. 17 during the observations was derived by the above formula and the observed values of b , t and $t - t'$.

All transits expressed in the time of the Kn. clock could be reduced to H. 17 time by means of the interpolated difference Kn.—H. 17, or, which comes to the same thing, from the observed relative rate

Kn.—H. 17 and the calculated absolute rate of H. 17 the absolute rate of the Kn. clock was derived.

By this method the observed transits of the fundamental stars give only the mean clock correction at a mean sidereal time and did not give any data for finding the rate of the clock.

The question now arose, whether it would not be possible, excluding the clock H. 17, to derive from the registered transits of the fund. stars not only the mean clock correction, but also the rate, both expressed in time of the Kn. clock.

In order to arrive at a solution of this question I here give the postulates underlying each of the methods.

I: (by means of H. 17).

1. The times of transits of the fund. stars must be sufficiently accurate to give a reliable clock correction by their mean.

2. The relative rate Kn.—H 17 obtained must be accurate, from which it follows that:

a. The rate of the Kn. clock must be constant during the observations.

b. The registering of the beats of H. 17 must be accurate.

c. There must not be a systematic difference between the registration of these beats before and after three or four hours of observations.

3. The rate of the H. 17 clock must conform to the formula given above, not only in the mean for several days, but must do so without any retardation, in other words it must react immediately to every change of temperature and barometer.

II: (without the H. 17 clock).

1. The transits of the fundamental stars must have sufficient accuracy to give by their mean a reliable clock correction and at the same time a reliable clock rate.

2. The rate of the Kn. clock must be constant during the observations.

A comparison of the two groups of postulates shows that II, 2 and I, 2*a* are the same.

The only difference between II, 1 and I, 1 is that in the second method the observations of the transits of fund. stars require a higher degree of refinement and the question is reduced therefore to the following:

What conditions must be laid down for observations to make them suitable for the deduction of a clock rate?

In the first place it is desirable that the stars of the observation programme should all be included between fundamental stars, so

that nowhere an extrapolation of the clock rate takes place; the night's work therefore should always begin and end with a number of fund. stars.

In the second place it is necessary that the fund. stars, or rather their groups, be at a sufficient distance from each other, so that the accidental errors in the times of transits shall have as little influence as possible.

Theoretically it is always possible to fulfil these requirements by a well chosen programme of observations. Only on nights interrupted by clouds it lies outside the power of the observer to fulfil them.

It is, therefore, necessary to examine more closely the accuracy of the times of transits obtained.

The clock corrections as derived from the separate stars are affected by two kinds of errors, accidental and systematic.

Of the influence of the first an idea can be obtained by computing the mean error of the time of transit derived from the transits of the separate threads (in Leyden numbering eleven). Generally speaking this error will not exceed $\pm 0^s.024$. If we had two groups of four fund. stars separated by an interval of two hours, the mean error of the clock rate, due exclusively to the accidental errors would thus be about

$$\pm \frac{\sqrt{0.012^2 + 0.012^2}}{120} = \pm 0^s.00014.$$

The second category of errors plays, however, at least as important a part and it is therefore necessary to make the times of transit as completely independent of them as possible.

Under these errors we include:

1. The magnitude equation.

By a suitable use of gratings it is possible to confine this error within narrow limits. What remains must be removed as much as possible by deriving the magnitude equation of the various observers and correcting for it.

2. The errors in the assumed positions of the fundamental stars. Since it is practically impossible to confine oneself to the small number of accurately established fundamental stars, it is necessary to use as fund. stars some that are of doubtful value, so that these errors must have a great influence not only on the mean clock correction, but even more on the rate of the clock as derived from the observations (see the large probable errors given by Boss' P. G. C. for various stars for the epoch 1910,0).

3. Personal errors of the different observers.

Assuming that the error mentioned under 1. be removed, I shall

endeavour to avoid as much as possible those mentioned under 2. and 3., beginning with 3. From the whole of the observations of all the observers, freed from their individual personal errors, it will then perhaps be possible to estimate those given under 2.

A brief account of the Leyden programme may precede. The stars of the programme are, as far as possible, divided into zones, whence in view of the somewhat restricted material (1600 stars distributed over 24 hours of right ascension and declination -2° to 52° , and the distribution in R.A. still very irregular) it was impossible to take the zones very narrow.

In general the zones are chosen with the limiting declinations of $0^\circ-20^\circ$, $20^\circ-30^\circ$, $30^\circ-40^\circ$ and 40° -zenith, but it was often necessary to include in a zone stars of slightly different declination. The fund. stars are so chosen that they lay below, in and above the zone so that their mean declination was as much as possible at the middle of the zone.

As, therefore, fundamental stars differing by 25° in declination are sometimes observed on the same night, the question arises, whether the different observers registered stars with such different declinations, i. e. of different velocities, all in the same way.

If a systematic difference of this kind existed, it would be desirable to reduce the times of transit of the separate stars to a hypothetical star with a declination equal to the mean declination of the fund. stars used. The times of transit of the programme stars could then be reduced also to the same hypothetical star, and by a purely differential reduction the results of the programme stars would be freed from this systematic error.

For this purpose the separate nights of the different observers are treated in the following way:

Let observer X on one night observe n fund. stars.

Times of transit $T_1 \dots T_n$, mean T

Declinations $\delta_1 \dots \delta_n$, mean δ

Clock correction derived from each star $a_1 \dots a_n$, mean a .

As unknowns may be taken the rate of the clock $= x^s$ per minute and the possible influence of the declination on the time of transit $= +y^s$ per 1° deviation from the mean declination.

Every night gives n equations of the form:

$$(T - T_i) x^s + (\delta - \delta_i) y^s = (a^s - a_i^s) \quad i = 1 \dots n$$

From these n equations the unknowns x and y have been solved by least squares.

The x as found in this solution can be regarded as a first approximation to the rate of the clock.

We will now consider the values of γ , which are obtained from different nights for the same observer.

Observer H.

The table below gives the results for γ from 39 nights during the years 1920 and 1921. The list is arranged according to increasing mean declination of the fund. stars used.

1st column date of observation.

2nd " mean declination of fund. stars used.

3rd " result for γ .

1920 March 21	3° .9	+0 ^s .00147	1920 Febr. 8	21° .8	+0 ^s .00065
" " 29	3° .9	+0.00123	" " 15	23° .9	+0.00274
" May 23	10° .0	+0.00263	" March 21	27° .6	+0.00151
" " 13	11° .8	-0.00160	" Febr. 21	29° .3	+0.00304
1921 Febr. 23	13° .2	+0.00235	1921 March 3	29° .4	+0.00319
1920 " 14	14° .4	-0.00163	1920 Febr. 11	29° .9	+0.00268
" July 14	16° .3	+0.00250			
" " 15	16° .3	+0.00307			
" May 18	18° .8	-0.00030			
1920 Jan. 21	30° .6	+0 ^s .00181	1920 May 16	40° .4	+0 ^s .00312
1921 Febr. 20	30° .7	+0.00283	" " 13	41° .0	+0.00387
1920 " 17	32° .5	+0.00544	1919 Dec. 15	41° .6	+0.00863
1921 March 10	32° .8	+0.00169	1920 Jan. 25	41° .8	+0.00597
1920 Aug. 14	34° .4	+0.00162	" March 21	43° .0	+0.00519
1921 Febr. 14	34° .8	+0.00317	" Febr. 23	43° .2	+0.00620
1920 April 23	35° .9	+0.00430	" Jan. 14	43° .5	+0.00642
" Febr. 6	35° .9	+0.00343	" Febr. 20	43° .6	+0.00638
" May 3	35° .9	+0.00145			
" " 21	36° .5	+0.00149			
" April 16	37° .9	+0.00247			
" March 29	38° .4	+0.00356			
" " 18	38° .9	+0.00203			
" April 10	39° .2	+0.00322			
" Febr. 26	39° .7	+0.00465			
" " 19	39° .9	+0.00504			

Observer Z.

List of results for y , obtained and arranged in the same way as for observer H.

1920 March 22	5° .0	+0 ^s .00159	1920 June 10	31° .2	+0 .00339
„ Febr. 23	11° .1	+0.00167	„ Febr. 3	32° .2	+0.00222
„ May 12	11° .3	-0.00013	„ June 8	32° .5	+0.00314
„ Febr. 18	14° .0	+0.00077	„ Aug. 27	32° .6	+0.00547
„ May 15	18° .4	+0.00095	„ Febr. 24	34° .3	-0.00017
„ „ 21	18° .4	+0.00041	„ „ 23	36° .8	+0.00535
1920 Febr. 12	22° .4	-0.00275	1920 June 21	40° .0	+0.00132
„ „ 5	23° .6	+0.00377	„ Aug. 17	42° .0	+0.00315
„ Oct. 28	25° .6	+0.00288	„ Jan. 9	42° .2	+0.01195
„ Nov. 19	28° .0	+0.00209	„ Febr. 19	43° .2	+0.01142
„ „ 8	28° .6	+0.00505			

The separate results give the following means :

Zone 0°—20°	13° ,0	+ 0 ^s ,00088	± 28
„ 20°—30°	25° ,6	+ 0 ^s ,00221	± 133
„ 30°—40°	33° ,3	+ 0 ^s ,00324	± 86
„ 40°—zenith	41° ,8	+ 0 ^s ,00696	± 276

Owing to the smaller number of nights, the mean error is much greater, although the same influence is fairly marked.

Treated as above, y can be represented by the formula :

$$y = + 0^s.00497 \tan \delta \sec \delta.$$

The residuals $O-C$ for the four zones are :

$$-0^s,00030, \quad -0^s,00043, \quad -0^s,00068, \quad + 0^s,00100$$

The correction z becomes :

$$z = + 0^s.285 (\sec \delta_i - \sec \delta).$$

For observer Z. we find the same phenomenon, that stars of high decl. are registered too early, those with small decl. too late.

Observer G.

List of the separate results, arranged as before.

1920 Febr. 17	4° .9	+0 ^s .00022	1920 Febr. 7	35° .7	+0 ^s .00123
1921 Jan. 14	6° .7	-0.00158	" " 26	35° .9	+0.00095
1920 March 4	9° .6	+0.00260	1921 " 19	36° .2	-0.00207
" " 26	9° .7	-0.00018	1920 May 10	36° .7	+0.00105
" Febr. 6	11° .3	-0.00261	" " 9	40° .3	+0.00285
" " 15	11° .9	+0.00070	" June 15	41° .0	+0 ^s .00012
1921 " 24	13° .3	+0.00090			
" " 26	13° .3	+0.00143			
1920 May 14	13° .4	-0.00075			
1920 Febr. 18	22° .4	+0.00113			
" May 28	27° .2	-0.00174			
" June 9	30° .1	+0.00068			
1921 March 15	30° .7	-0.00461			
" Febr. 22	31° .2	-0.00201			
1920 " 3	32° .0	-0.00269			
" May 19	33° .8	-0.00072			
1921 March 11	34° .2	-0.00263			
1920 Jan. 23	33° .9	+0.00297			
" July 17	34° .4	-0.00043			
" March 18	34° .9	+0.00036			

As the different declinations are spread more irregularly over the separate nights, I have arranged the y 's in somewhat different groups.

Zone 0°—20°	10° .5 + 0 ^s .00008 ± 53
" 20°—35°	31° .3 — 0 ^s .00088 ± 64
" 35°—zenith	37° .6 + 0 ^s .00069 ± 50

Since these means are all nearly equal to or smaller than their m.e., we may conclude that for observer G. no influence of the declination on the time of transit exists.

The explanation of the effect may perhaps be sought in the fact, that the observers H. and Z. endeavour to make the contact of the signal key coincide with the moment that the star passes a thread, which is in agreement with their own statement as to their method of registering, while the observer G. begins with the movement of registering at the moment that he observes the star to be bisected by a thread.

That actually this difference in the method of registering exists between G. and Z. is confirmed by special observations, made for the determination of their relative personal equation, which is found to be positive in the sense G.—Z.

The observers H. and Z., therefore, will be influenced in their registering by the velocity c . sec. δ , with which the star *approaches* the thread, the observer G. will be independent of it.

As it is always possible in zone-observations with differential reduction to limit the influence of the magnitude-equation by using different gratings, while in practice it is often necessary to take the range of the zones relatively large, it will always be desirable for an observer who is aware that he follows the first method of registration, to test his observations of transits for a dependence on the declination. Perhaps we may see in this result once more an argument in favour of the impersonal micrometer.

Finally we give a table, which shows that the correction reaches quantities, which are by no means negligible.

Mean decl. fund. stars	Decl. programst.	Correction to the time of transit	
		Observer H.	Observer Z.
20°	10°	—0 ^s .011	—0 ^s .014
20°	15°	— 0.007	— 0.008
20°	25°	+ 0.009	+ 0.011
20°	30°	+ 0.021	+ 0.026
30°	20°	— 0.021	— 0.026
30°	25°	— 0.012	— 0.016
30°	35°	+ 0.015	+ 0.019
30°	40°	+ 0.035	+ 0.043
40°	30°	— 0.035	— 0.043
40°	35°	— 0.019	— 0.024
40°	45°	+ 0.025	+ 0.031
40°	50°	+ 0.058	+ 0.071

July 1921.

Leyden Observatory.

Botany. — “*On Anti-phototropic Curvatures occurring in the coleoptiles of Avena*”. By Dr. C. E. B. BREMEKAMP. (Communicated by Prof. G. VAN ITERSON Jr.).

(Communicated at the meeting of October 29, 1921).

In a paper published some years ago¹⁾ I discussed at some length the relation between the nature of the phototropic curvatures occurring at the tip of the *Avena* coleoptiles and the way in which those organs are illuminated. I pointed out that the origin and the growth of those curvatures may be interpreted satisfactorily with the aid of a few suppositions which present themselves rather naturally. To this end it should be assumed that the organs in question consist of elements furnished with a photo-sensible system, and that the changes which the system undergoes under the influence of illumination are followed after some time by changes in the rate of growth. The value of the latter will surely not be equal to that of the changes which would occur if each element could react independently of the adjoining ones. As a matter of fact between the various elements a levelling will take place²⁾. In the second place it should be assumed of those elements that they are equal, or approximately so, and lastly that the changes in the rate of growth are proportionate to the changes in the photo-sensibility.

The first-named supposition will no doubt remain hypothetical for the time being, since no method has been brought forward as yet to demonstrate the existence of those elements. However, the results obtained with illumination of isolated strips lend support to it. As to the second hypothesis it must be remarked that the elements alluded to are most likely not perfectly equivalent. The inner elements are circumstanced differently from those lying immediately

¹⁾ C. E. B. BREMEKAMP, *Theorie des Phototropismus*. Rec. d. Trav. bot. Néerlandais. Vol. XV. 1918.

²⁾ It should be borne in mind, however, that owing to this levelling tensions must arise by which presumably the growth of the elements will be affected indirectly. In the case of the coleoptiles of *Avena* the value of these tensions will probably be insignificant, as the distribution of the light in the interior of the plant is, owing to the repeated reflections, rather diffuse here. It is a moot point, however, whether these tensions may be neglected also with organs such as the sporangium-bearer of *Phycomyces*, in which the differences of intensity in the interior of the plant are much larger.

under the surface¹⁾. It is highly questionable, therefore, whether their growth will be similarly influenced by the same causes. In case these differences are not too great, they may readily be neglected, since for making our calculations it is not necessary, as will be seen lower down, to know the reaction of each separate element, but only the joint-reaction of the elements in the anterior, and of those in the posterior side. If the light in these two halves were distributed quite symmetrically, these differences would not avail. In the given circumstances they also neutralize each other, however, for the greater part, and in this way much of their significance is lost. Whether the third hypothesis gives a correct representation of the relationship between the sensibility to light and the rate of growth, might be ascertained experimentally. To this end one would have to compare the sensibility to light and the rate of growth in the tip of omnilaterally lighted plants. Such experiments have, however, not been made thus far.

In order to calculate the curvatures on the basis of these hypotheses we have to know how the light is distributed over the two halves whose antagonism brings about the curvature, what changes the sensibility to light undergoes in those halves, and what is the relation between the changes in the rate of growth and those in the sensibility to light.

The distribution of the light over the two antagonistic halves may be deduced from the position of either the optimum or the maximum of the curve which represents the strength of the curvature as a function of the energy. With the optimum the difference in sensibility in the two halves must be greatest,²⁾ with the maximum smallest. As the difference in sensibility increases so long as the inclination of the curve representing the sensibility of the frontal part is steeper than that of the curve representing the sensibility of the posterior part, it will be greatest when the difference between the inclinations of the two curves vanishes, and it will be smallest when the sensibility in both parts is lost. In order to determine the changes of the sensibility in the anterior, and in the posterior side separately we,

¹⁾ It is supposed here that the sensibility to light is distributed rather diffusely over the whole organ. This is, however, not certain. If it could be demonstrated that the sensibility was restricted to a single layer, the elements could be regarded as perfectly equal.

²⁾ This is stated roughly. A given difference in sensibility will, as is shown in my paper, bring about a larger curvature according as the average sensibility is smaller. In this case, however, the mean sensibilities differ so little that this factor does not carry weight.

therefore, have to know 1st either the optimum or the maximum of the curve representing the strength of the curvature, and 2nd in what way the sensibility can be represented as a function of the energy.

When we have found out what changes the sensibility in the anterior, and in the posterior side undergoes, it will at once be clear how the light is distributed over those two halves. Since more data are available relative to the optimum than to the maximum I started in my calculation from those relative to the optimum. The accurateness of the latter is, however, also very small, so that the value found for the proportion should be taken only as a first approximation.

The changes in the sensibility to light could be deduced from the data obtained by ARISZ¹⁾ in his experiments on phototropic disposition. As most important among those changes I may mention 1st that the sensibility undergoes a gradual decrease in consequence of the illumination and is ultimately entirely destroyed; the required quantity of light should, however, be supplied within a fixed time (cf. 2nd); 2nd that the sensibility is ere long augmented again, the rate of the increase being greater according as the intensity of the illumination is smaller, the sensibility reaching at last a higher value in weak illuminations than in strong ones; 3rd that this is also the case after the light has been put out and that in this case the sensibility regains at last its original value; and 4th that the velocity of the increase reaches its highest value only after some time has elapsed. In order to determine the relation between the changes of the sensibility to light and those of the rate of growth we need only to compare, in a given case, the changes undergone by the difference in sensibility in the antagonistic sides with the growth of the curvature.

From the foregoing it may be concluded: 1st that the magnitude of the curvature at a certain moment, is determined by the changes undergone by the difference in sensibility of the anterior and the posterior side from the beginning of the illumination up to a point of time which is separated from the chosen moment by the length of the latent period, i.e. the interval between the beginning of the illumination and the initiation of response; and 2nd that the direction of the curvature is determined by the sign of this difference in sensibility. It follows from this that an antiphototropic curvature will appear if the sensibility at the anterior side exceeds that at the

¹⁾ W. H. ARISZ, Untersuchungen über den Phototropismus. Rec. d. trav. bot Néerlandais. Vol. XII. 1915.

posterior side. We will now ascertain under what conditions this will be the case.

As has been pointed out the direct result of the illumination is a decrease of sensibility, which is the greater according as the intensity of the illumination is stronger. It follows that under the influence of this factor the sensibility of the posterior side can never fall below that of the anterior side.

It has also been pointed out, however, that after some time the sensibility increases again at first slowly, then quicker and quicker, until after some time a velocity of increase is reached in agreement with the magnitude of the then existing sensibility. We should have to know now when the increase of the sensibility begins, and how long it lasts before it has reached its proper rate. This, however, has been investigated only in a single case. Meanwhile we are probably justified in supposing that these initial stages will be gone through the quicker according as the decrease of the sensibility has been greater. If this supposition is correct, then the increase of the sensibility in the anterior side must commence before that in the posterior side, at least when the sensibility in the latter is not wholly destroyed. If, therefore, the illumination is discontinued at a moment when the rate at which the sensibility increases has not yet reached its highest value in the posterior side, then the sensibility in the anterior side, if not too much below that in the posterior side, must soon prevail. This condition will then persist until the sensibility in both sides has reached once more its original value. If this view is right, the antiphototropic curvature can never be followed by a second normal curvature. In my own experiments, I may state such a second normal curvature could never be detected.

With highly intense light the antiphototropic curvature is not preceded by a normal one. If in this case the sensibility at the close of the illumination is still greater in the posterior side than in the anterior side, this difference does not persist long enough to express itself in a curvature of appreciable magnitude. Such antiphototropic curvatures are seen in the figures 11 and 12 of my paper cited above, which show the effects of an illumination respectively with 50 M.C. and with 250 M.C. They are most conspicuous with an exposition time respectively of $3\frac{1}{2}$ minutes and 40 seconds.

With a less intense light, on the other hand, the antiphototropic curvature is preceded by a normal one. The sensibility of the posterior side remains in this case long enough above that in the anterior side to express itself in a curvature.

Of course this curvature will be stronger according as the light

is weaker and the illumination lasts longer. Because the normal curvature has already shifted downwards a little way before the antiphototropic one becomes visible, the plants here assume the well-known *S*-shape. This case is illustrated in fig. 10 at an illumination of five minutes with 12.5 M.C.

With a light of still less intensity no more antiphototropic curvatures appear. We do find here after some time with the light-quantities that otherwise would have evoked an antiphototropic curvature, a considerable retardation in the velocity with which the curvature increases. When after the illumination these plants are not placed on the clinostat, they show the geotropic counter-curvature sooner than plants do that have been lighted for a longer or for a shorter period, and with which consequently this retardation does not occur. In fig. 9, which shows the effects of an illumination with $2\frac{1}{2}$ M.C. this curvature is seen at an exposition time of 10 minutes.

This proves that, in order to effect an antitropic curvature it is in the first place necessary to destroy the sensibility in the anterior as well as in the posterior side entirely or nearly so, a process dependent on the supplied energy; but in the second place to enable the sensibility in the anterior side to gain an advantage over the sensibility in the posterior side, a process that can take place only if the sensibility in the anterior side has vanished sooner than in the posterior side. If, therefore, the antiphototropic curvatures appear only in the manner described, they cannot appear with illuminations of very short duration. We shall presently inquire whether this conception is correct (see below).

That time is indeed an important factor in the process here discussed, is proved indubitably when we compare the effect of a unilateral illumination which is preceded by an omnilateral one with the effect of the same unilateral illumination, when it is followed by the omnilateral one. If it were only a question of the light-quantities in the antagonistic halves, the result would be the same in either case. This, however, is not so: whereas in the first case antitropic curvatures are seldom found and are never conspicuous, they appear regularly in the second case and are then generally well developed.

The second case is easy of explanation with my theory: As the sensibility at the anterior side is completely, or almost completely destroyed by the unilateral illumination, there will be a gradual increase of it during the omnilateral after-illumination; at the posterior side, on the contrary, the sensibility will still be more or less considerable at the end of the unilateral illumination, and it will,

therefore, still decrease during the omnilateral illumination. It follows, then, that it will reach in this side its lowest value only after some time has elapsed, and meanwhile it will have reached at the anterior side a higher value, and, as the advantage will remain with this side till the original sensibility in both sides will have been restored, it is to be expected that an antitropic curvature of some importance will arise. If a unilateral illumination is preceded by an omnilateral one (apart from those cases in which the omnilateral fore-illumination is very weak) the occurrence of an antiphototropic curvature would, on the contrary not be in keeping with my theory. I was, therefore, originally inclined to call in question the reports concerning the occurrence of antitropic curvatures under these circumstances, the more so as these reports are extremely doubtful: under almost the same conditions under which in one case curvatures were found, they could not be discovered in the other. In view of the results, to be recorded lower down, the possibility of their accuracy may, however, be admitted, at least in a certain number of cases.

If, besides the cause discussed here, there should be still another to call forth antiphototropic curvatures, it must manifest itself, as stated above, if the time-factor is eliminated as much as possible, i.e. if the duration of the illumination is shortened as much as possible. The advantage in the anterior side will then gradually decrease, and consequently the antiphototropic curvature also. To settle this question I made some experiments, which need not be described in detail, as the way in which they were performed did not differ from that used in my earlier experiments. Suffice it to say here that in some experiments the quantity of light amounted to 9000 M.C.S. and the period of illumination to $\frac{3}{4}$, 3, 12, 48, and 192 seconds, while in other experiments an amount of 12000 M.C.S. was used, and a period of illumination of 1, 4, 16, 64, and 256 seconds. After the illumination was concluded the plants were put on the clinostat on which they remained for 3 or 4 hours. Subsequently the curvatures were compared. It now appeared that everywhere antiphototropic curvatures came forth and that their magnitude differed only very little. It would seem indeed, as if the curvatures occurring with longer periods of illumination were generally slightly stronger, but the differences were so insignificant that they did not afford any certainty in this respect.

The experiments described go to show that there must be indeed still another factor by which antiphototropic curvatures can be brought about. Since the factor of time had been eliminated as much as possible, we must have to do here with a direct result of the

illumination. We must conclude then that the latter can occasion a retardation as well as an acceleration of the rate of growth. Most often we do not notice anything of the acceleration as it is concealed by the much more considerable retardation which is always present at the same time. Only when the value of the latter is the same on either side, a difference in acceleration will become visible in a curvature.

If the above is correct, then it must also be possible to obtain an antiphototropic curvature with plants that have first been submitted to omnilateral fore-illumination. If this illumination is such that a further retardation of the growth cannot be obtained by a prolongation of the illumination, then an antiphototropic curvature must be obtained with a comparatively weak after-illumination. However, it should seem that thus far the exact strength of the fore-illumination has not been hit upon in similar experiments. Anyhow, the antitropic curvatures obtained were slight, and required moreover a rather intense after-illumination.

In order to determine the retardation and the acceleration of the growth rate separately the processes should be severed. It is conceivable that we have to do here with the influence of light on two different photo-sensible systems. As the sensibility of the two systems would not be equal in the different parts of the spectrum in this case, an analysis could perhaps be performed by using light of different colours. It is very well possible, however that there is only one photo-sensible system, and that it is not the light itself but a product originating as a result of the illumination, which exerts its influence upon two different systems. In that case the separation of the two processes might be rendered possible by a study of the influence of the external conditions.

In connection with the last-mentioned supposition it is interesting to point out that according to the theory of BOSE¹⁾ disturbances of equilibrium in the living organism manifest themselves in a contraction, which is accompanied by an expansion in the adjoining tissue. The water expelled with contraction, would heighten the turgor of the adjoining tissue and thus occasion there a temporary quickening of the growth. In our case, then, the antiphototropic curvature of the tip might result from the occurrence of a normal curvature more downwards. The investigations of ARISZ make it probable that under the conditions of our experiments normal curvatures may have

¹⁾ J. C. BOSE, *Plant Response*, London 1906; *Life movements in plants*. Vol. II. Calcutta 1919.

occurred in the basal portion. These curvatures are slightly noticeable in the photographs of my experiments. However, as they extend over a considerable portion of the coleoptile, they are not very conspicuous.

In ARISZ's experiments the normal curvature of the basal portion was not accompanied by an antitropic curvature of the tip. This may be accounted for by the fact that the tip was protected here against the influence of the light. The turgescence of this part of the coleoptile, therefore, did not undergo any change, and was, therefore, perhaps unable to absorb the water expelled in the regions below.

According to this the occurrence of the antiphototropic curvature depends in this case on the sensibility being completely or almost completely destroyed in the tip, and only partially in the basal portion. With an equally intense illumination of the tip the appearance of an antitropic curvature could therefore not be expected when the basal portion of the coleoptile was not illuminated at all, or when it was illuminated so strongly that its sensibility was completely destroyed, as in neither case a normal curvature could appear. I have, however, not had an opportunity as yet to make these experiments.

Physiology. — “*On the Action of the Novocain on the Tonus of the Skeletal Muscle*”. By Dr. S. DE BOER. (Communicated by Prof. J. K. A. WERTHEIM SALOMONSON).

(Communicated at the meeting of October 29, 1921).

When a subcutaneous injection of 5 or 10 drops of 1% novocain is administered to a frog, the muscles will soon become entirely atonic. The stimulus-threshold of the N. Ischiadicus is then still unchanged and likewise the sensibility of the skin. According to the hypothesis of ERICH MEYER and L. WEILER this atony is due to intoxication of the accessory nerve-endings of BOEKE. ALMS and also LILJESTRAND and MAGNUS ascribe it to intoxication of the sensibility of the muscle. The experimental investigation of FRANK and his co-workers corroborate MEYER and WEILER's conception.

When FRANK published his experience my inquiry had been in progress for some time. It is known that a small dosis of nicotin applied at the ingress of the nerve, produces a contracture. In order to obtain this effect by acting on the muscle-substance a much larger dosis must be used (LANGLEY). This result is not altered by a previous denervation: five weeks after cutting the N. Ischiadicus I succeeded in evoking contractures in denervated muscles on administration of a subcutaneous injection of a minimal dosis of nicotin.

When I injected into an intact frog first 5 or 10 drops of 1% novocain subcutaneously, a complete atony of the skeletal muscles ensued after 15 minutes. Subsequently 10 drops of 1% nicotin were given subcutaneously, which did not engender a trace of a contracture.

In another series of experiments I injected into the muscles of the hind-leg 3 drops of 1% novocain to 1 cc of NaCl 0.65%, by which these muscles lost their tonus. I then administered 10 drops of 1% nicotin subcutaneously; the muscles of three limbs then displayed marked contractures; those of the hind-leg that had been poisoned with novocain remained quite flaccid. Similar experiments were carried out with a foreleg. The result was the same when I injected into the muscles of one of the non-poisoned limbs only 0.65% NaCl solution.

When the excised rectus abdominis is placed in 40 gr. of NaCl 0.65% and 1 drop of 1% nicotin is added, a marked contracture will ensue. This will not take place, however, when first 40 gr. of NaCl 0.65% + 4 gr. of 1% novocain is allowed to act on it for 20 minutes.

When allowing this weak nicotin solution to act on the nervous aequator of a gastrocnemius without novocain, a marked contracture will appear, which will not be the case when the solution is made to act on the conical end. In order to achieve a contracture then a much stronger solution is required.

We conclude, therefore, that novocain can obviate contractures originating from the nervous aequator.

After this I used some substances that enhance the tonus, such as calcium-chloride and rhodan-sodium. For each of these I ascertained the weakened solution just yielding a distinct contracture of an excised skeleton-muscle. I then substituted the tenth part of such a solution by 1 % novocain. A frog's muscle was then submerged in it after the muscle had first been attached to a lever and after it had been for 20 minutes in 1 % novocain.

NaCNS yielded similar results to those obtained with nicotin. The contractures occurring after CaCl_2 -poisoning, could not be obviated by a previous intoxication with novocain. Just as large doses of nicotin CaCl_2 would also yield contractures through an action on the tonus-substrate itself.

When in a frog hemisection of the med. oblongata proximal to the exit of the Nervus VIII is performed, there results a typical forced position. The ipsilateral foreleg is bent and adducted. The foreleg on the other side is abducted in a stretched position. The hind-legs display similar positions, but they are less pronounced. The head and the trunk are turned to the side of the lesion. Now when injecting into the muscles of the stretched and abducted foreleg two drops of 1 % novocain to 1 c.c. of NaCl 0.65 % the stretched position persists (in an uninjured frog such an injection produces a complete atony of the muscles of the foreleg). It appears then that the stretched position is evolved by a tetanic contraction, sustained under the influence of the ordinary cerebro-spinal innervation.

It appears, therefore, that an equally active dosis of novocain leaves the cerebro-spinal innervation intact, while the tonus of the skeletal-muscles is abolished by it. Now since novocain abolishes a muscle-contracture that has been evoked from the nervous aequator (receptive substance), we are justified in concluding that the tonus of the skeletal-muscles is destroyed by novocain through a poisoning of the receptive substance of the tonus-substrate. Moreover it has been proved once more that in the skeletal-muscles two kinds of contractions can be evoked, viz. clonic and tonic contractions.

Mathematics. — “On the Path of a Ray of Light in the Field of Gravitation of a Single Material Centre.” By Prof. W. VAN DER WOUDE. (Communicated by Prof. J. C. KLUYVER).

(Communicated at the meeting of October 29, 1921).

1. Starting from the line element of the field of gravitation of a single material centre proposed at the same time by SCHWARZSCHILD¹⁾ and DROSTE²⁾, I wish to demonstrate in this paper:

1. the path of any ray of light is (with allowable neglect) a hyperbola of which the sun is one of the foci; all these light paths have equal major axes;

2. by these geometrical data 8 hyperbolas are defined passing through 2 given points; from physical considerations however it appears easily that only one of the 8 hyperbolas connecting in this way the earth to an arbitrary star, is a path along which the light starting from the star, reaches the earth.

To this I add a remark on the determination of the magnitude of the deviation.³⁾

2. The line element of SCHWARZSCHILD—DROSTE has the following expression:

$$ds^2 = \left(1 - \frac{\mu}{r}\right) dt^2 - \frac{dr^2}{1 - \frac{\mu}{r}} - r^2 (d\theta^2 + \sin^2 \theta d\varphi^2), \quad . . \quad (1)$$

or, after the substitution

$$r = \varrho \left(1 + \frac{\mu}{4\varrho}\right)^2,$$

$$ds^2 = \left\{1 - \frac{\mu}{\varrho \left(1 + \frac{\mu}{4\varrho}\right)^2}\right\} dt^2 - \left(1 + \frac{\mu}{4\varrho}\right)^4 \{d\varrho^2 + \varrho^2 (\sin^2 \theta d\varphi^2 + d\theta^2)\} \quad (1')$$

¹⁾ K. SCHWARZSCHILD: Sitzungsberichte der Kön. Preuss. Akad. der Wissenschaften, 1916.

²⁾ J. DROSTE: Het zwaarteveld van een of meer lichamen volgens de theorie van EINSTEIN. Thesis for the doctorate, Leiden, 1916.

³⁾ For a prior discussion of the path of light in this field cf: W. DE SITTER: On EINSTEIN'S Theory of Gravitation (Monthly Notices R. A. S., vol. LXXVI, p. 717).

A. S. EDDINGTON: Report on the Relativity Theory of Gravitation (p. 53—56).

H. VAN DER LINDEN: La Trajectoire d'un rayon lumineux dans le champ de gravitation d'EINSTEIN-SCHWARZSCHILD (Académie royale de Belgique, Bulletin, t. VI, 1920, p. 90—97).

Here μ is the mass of the centre of gravitation C .

Concerning the "space-coordinates" r (or ρ), θ , φ , it is assumed that θ and φ have the same values as would be ascribed to them by an observer who made his observations and calculations in the conviction that space is Euclidian; for the rest neither r nor ρ need be exactly equal to the distance R measured from C on Euclidian suppositions, but r and R or ρ and R are supposed to be univalent functions of each other, so that $\frac{r}{R}$ and $\frac{\rho}{R}$ differ so little from 1 that, at least for not too small values of R , $\left(\frac{r}{R}\right)^2$ and $\left(\frac{\rho}{R}\right)^2$ may be neglected relatively to unity.

The units of length and time are assumed such that the light covers the unit of length in the unit of time, so that we may for instance consider 1 km. and $\frac{1}{3 \cdot 10^8}$ sec. as those units; finally the mass μ is expressed in gravitation-units. If e.g. we consider the centre of the sun to be the centre of gravitation, we have $\mu = 1,47$, and already immediately outside the surface of the sun $\frac{\mu}{\rho}$ will be very small; in the field outside the sun we may therefore, as a first approximation, neglect the second and higher powers of $\frac{\mu}{\rho}$ and replace (1') by

$$ds^2 = \left(1 - \frac{\mu}{\rho}\right) dt^2 - \left(1 + \frac{\mu}{\rho}\right) \{d\rho^2 + \rho^2 (\sin^2 \theta d\varphi^2 + d\theta^2)\} \quad (2)$$

3. In the space (2) the propagation of light occurs along a minimum line, i. e. along a line for which

$$ds = 0,$$

or for which

$$\left(1 - \frac{\mu}{\rho}\right) dt^2 = \left(1 + \frac{\mu}{\rho}\right) \{d\rho^2 + \rho^2 (\sin^2 \theta d\varphi^2 + d\theta^2)\};$$

as the nature of the field makes it at once clear that the path will lie in a "plane" through C , we may here put $\theta = \frac{1}{2}\pi$, so that for the path of the light we have:

$$\left(1 - \frac{\mu}{\rho}\right) dt^2 = \left(1 + \frac{\mu}{\rho}\right) (d\rho^2 + \rho^2 d\varphi^2) \quad \dots \quad (3)$$

It is *assumed* that even now the path between 2 points A and B in three dimensional space may be found by making the condition that the first variation of the integral:

$$I = \int_A^B dt = \int_A^B \sqrt{\frac{1 + \frac{\mu}{\varrho}}{1 - \frac{\mu}{\varrho}} (d\varrho^2 + \varrho^2 d\varphi^2)}$$

must be equal to zero. Neglecting the same quantities as before we may therefore say that we must determine φ as such a function of ϱ that

$$\delta \int_A^B \sqrt{\left(1 + \frac{2\mu}{\varrho}\right) \left[1 + \varrho^2 \left(\frac{d\varphi}{d\varrho}\right)^2\right]} d\varrho = 0 \quad \dots \quad (4)$$

In order to solve this problem we point to another, which from a purely analytical point of view is equivalent to it. If in space, now thought to be Euclidian, a planet with the unit of mass moves according to NEWTON'S law in the field of gravitation of the sun, according to the principle of least action its course is given by

$$\delta \int \sqrt{2\left(\frac{\mu}{\varrho} + h\right) \left[1 + \varrho^2 \left(\frac{d\varphi}{d\varrho}\right)^2\right]} d\varrho = 0,$$

where h is the constant of the living force.

From this it appears that the solution of (4)

$$\varphi = f(\varrho)$$

represents at the same time the orbit of a planet round the sun, where $h = \frac{1}{2}$, and that also the reverse is true.

Now each of these orbits of a planet is a conic section. However it would not be *quite* exact to say that the light path in three dimensional space is a conic section (unless we define a conic section in a non-Euclidian plane by a curve that has the same polar equation as a conic section; in differential geometry, however, the names ellipse and hyperbola are already given to different curves); by means of

$$\varphi = \varphi_1, \quad \varrho = \varrho_1 \quad \dots \quad (5)$$

it is represented in a Euclidian plane by a conic section, where φ_1 and ϱ_1 are polar coordinates.

It is of some importance to remark that the formulas (5) represent the plane with the line element

$$ds^2 = \left(1 + \frac{\mu}{\varrho}\right) (d\varrho^2 + \varrho^2 d\varphi^2)$$

conformly on the Euclidian plane as the coefficients of the two fundamental forms are proportional.

If therefore it appears that in the image plane the tangent at B

to the light path AB makes with the radius vector CB a larger or a smaller angle than the straight line AB , it does not only follow from this that indeed according to EINSTEIN's theory out of B the point A will be seen in a different direction from that which was to be expected from the former theories, but also that the numerical value of this deviation may be read directly from the image.

Notwithstanding the objection just mentioned, confusion being excluded, we shall not hesitate henceforth to call the curve $\varphi = f(\varrho)$ in the EINSTEIN-plane a conic section; we only wanted to point out that for the final conclusion an appeal to the characteristic of conform representation is necessary.

4. Let us first consider once more the paths of material points moving with the unit of mass according to NEWTON's law in the field of gravitation of the sun C , thought to be Euclidian, while for all those paths the constant h has the same value; it is already certain that all those paths form a system of conic sections with a common focus C . It is further known that the semi major axis of such a conic section is determined by:

$$a = -\frac{\mu^{-1}}{h}$$

Hence all the conic sections have equal major axes; the sign of the axis indicates whether we have to do with an ellipse, a hyperbola or a parabola.

Applied to the problem in question this means:

The course of any ray of light is a hyperbola of which the sun is one of the foci; the length of the semi major axis is always equal to 2μ ($= \pm 3$ k.m.).

5. Now we shall determine the path of the light between 2 given points A and B .

With a view to this we describe out of C a circle γ with a radius 2μ and out of A and B two circles touching γ ; the points of intersection of γ with AC and the produced part of AC are called resp. A'' and A' ; B'' and B' are defined in the same way. Each point of intersection of one of the circles with centre A and one of the circles with centre B forms together with C the foci of a hyperbola through A and B , the major axis of which is 4μ . To begin with we find therefore 8 hyperbolas; let us now examine which of them gives a possible light path between A and B .

If S_1 is a point of intersection of the circles AA'' and BB' , we have

¹⁾ Cf. e.g. P. APPELL: *Traité de Mécanique rationnelle*, I p. 393.

$$AC - AS_4 = 4\mu = BS_4 - BC,$$

i.e. A and B lie on different branches of the hyperbola having C and S_4 for foci. This hyperbola is therefore a light path, but not one from A to B ; neither is this the case with the two hyperbolas that have a focus in one of the points of intersection of the circles AA' and BB'' .

The two circles AA'' and BB'' can have imaginary points of intersection; but it is also possible that these points of intersection are real. If on the latter supposition S_3 is such a point, we have

$$AC - AS_3 = 4\mu = BC - BS_3,$$

i.e. A and B lie on that branch of the hyperbola having C and S_3 for foci, that is not curved towards the sun, hence just on that branch that is not a light path.

If however S_1 and S_2 are the points of intersection of the circles AA' and BB' , C and S_1 as well as C and S_2 are the foci of a hyperbola of which the same branch, the branch curved towards C , passes through A and B .

Of the 8 hyperbolas through A and B which have C for a focus and of which the semi major axis is equal to 2μ , there are only two that give a possible light path; indeed, both are light paths, if only the branch on which A and B lie, does not intersect the sun.

Here the question arises:

Let B be a point of the path of the earth and C the centre of the sun; can we place A in such a way that B is reached by 2 rays of light from A ?

We call S_2 that point of intersection of the circles AA' and BB' that lies on the same side of AB as C ; we put $\angle A'SB = \sigma$. It is clear that now CS_2 is less than CP , if P is the point of intersection of the tangents at A' and B' to γ ; hence

$$CS_2 < 4\mu \cotg \frac{1}{2} \sigma.$$

The point S_2 lies therefore inside the sun (as $2\mu = \pm 3$) and the hyperbola with C and S_2 for foci will not be a light path connecting A and B , unless perhaps if σ is very small.

We shall therefore assume, in order to give CS_2 as great a value as possible, that A lies on the production of BC at infinite distance. We find

$$CS_2 < BS_2 = \sqrt{8\mu \times 2BB'} = \pm 6 \times 10^4 \text{ km},$$

so that even now S_2 lies inside the sun. Accordingly: *It is impossible to see a point in 2 different directions out of a point of the path of the earth.*

Cryo-Biology. — *„Weitere physiologische Versuche mit niederen Temperaturen“*¹⁾. By P. GILBERT RAHM. (Versuche im physikalischen Laboratorium der Universität Leiden und der cryobiologischen Versuchsstation des Niederländischen Kälte-Vereins, Leiden Comm. Suppl. N^o. 46a). (Communicated by Prof. J. P. KUENEN).

(Communicated at the meeting of October 29, 1921).

I. Versuch mit flüssigem Wasserstoff.

Zunächst wurden Versuche mit flüssigem Wasserstoff (— 253° C.) ausgeführt. Die Versuchstiere — es handelte sich wieder um Tiere der bryophilen Moosfauna d. h. Tardigraden, Nematoden und Rotatorien — waren mit dem Moos, in dem sie etwa drei Monate im Trockenschlaf zugebracht hatten, angefeuchtet und bald nach dem Erwachen zum aktiven Leben in einen Dewarschen Becher gelegt worden, der mit flüssigem Wasserstoff nach und nach gefüllt wurde. Die Tiere befanden sich in einem Reagenzglaschen, das mit einem leichten Wattestopfen abgedichtet ward. Der Versuch sollte 35 bis 40 Stunden dauern. Leider explodierte nach etwa 30 Stunden das Gefäß, in dem der flüssige Wasserstoff aufbewahrt worden war. Die sofortige Untersuchung der Moosprobe ergab ein negatives Ergebnis. Keines der Versuchstiere erwachte nach dem Auftauen zum Leben. Wahrscheinlich verschuldete die Explosion den Tod der Tiere und nicht die Kälteeinwirkung; denn bei früheren Versuchen blieb ein grosser Prozentsatz der Versuchstiere am Leben²⁾, sofern die Kälte langsam einwirkte.

II. Versuch mit flüssigem Helium.

Versuchstiere: Moosfauna (Tardigraden, Nematoden, Rotatorien und Protozoen) im Trockenschlaf. Das Moos war von einem Dache in Monreal (Eifel) gesammelt und drei Monate lang lufttrocken aufbewahrt worden.

Verlauf des Versuches: Die Moosprobe wurde acht Tage lang im Vakuum (3 mm., zuletzt 24 Stunden 0,1 mm.) gelassen. Hierauf

¹⁾ P. G. RAHM, „Einwirkung sehr niederer Temperaturen auf die Moosfauna“. These Proceedings, Vol. XXIII, pp. 235—248.

²⁾ S. l. c.

füllte man Heliumgas ein, in dem die Moosprobe etwa 3 Tage lang verblieb. Am dritten Tage wurde mit der Abkühlung des Heliumgases begonnen. Nach dreistündiger Abkühlung ward das Heliumgas bei 4° K. flüssig. (= — 269° C.). Nach 2 Stunden und 10 Minuten wurde reduziert; die Temperatur betrug zeitweilig 1½ bis 2° K. (= — 271 bis — 271,5° C.).

Das Heliumgas blieb 8 bis 9 Stunden flüssig. Hierauf stieg die Temperatur ganz langsam. Nach 12 Stunden war noch flüssiger Wasserstoff im Beirohr vorhanden. Die Moosprobe wurde sogleich herausgenommen und nahm in kürzester Zeit Zimmertemperatur an.

Ergebnis der Untersuchung: Leider konnte die Untersuchung Verhältnissehalber nicht sogleich an Ort und Stelle vorgenommen werden, sondern erst 14 Tage nach dem Versuch zur Ausführung gelangen.

Alle Versuchstiere — von Tardigraden auch die gepanzerten Echiniscus-Arten, Nematoden (Plectus-Arten), Rotatorien (Callidina-Arten) und Protozoen, deren Gattung leider noch nicht festgestellt werden konnte, erwachten bald nach dem Anfeuchten. Ein mehrmaliges Wiedereintrocknen und Anfeuchten ertrugen die meisten Tiere (bis 5 ×) schadlos ¹⁾.

III. Versuche mit flüssiger Luft.

A. Mit Coleopteren. (Carabiden, Tenebrioniden und Curculioniden).

Lebende Coleopteren wurden den Dämpfen der flüssigen Luft ausgesetzt. Die Temperatur betrug anfangs — 20 bis — 30° C. Alle Versuchstiere gingen nach 5 bis 10 Minuten zu Grunde, obwohl alle Vorsichtsmassregeln beobachtet wurden. Es gelang auch nicht, die Tiere künstlich in Winterschlaf zu versetzen, wohl aus dem Grunde, weil die Versuchstiere zu dieser Zeit — die Experimente wurden im Sommer ausgeführt — noch keine Reservestoffzellen ausgebildet hatten und deshalb nicht die nötige Widerstandskraft besaßen. Ein ausführlicher Bericht hierüber soll an anderer Stelle veröffentlicht werden.

B. Mit Insekteneiern.

Durch die Güte des Herrn POLAK, Leiter des Insektariums der 'Artis' in Amsterdam, erhielt ich Eier von Dixippus morosus, der bekannten Stabheuschrecke, von Sphinx ligustri, dem Ligusterschwärmer, von Attacus edwardsii aus Assam und Samia cecropia aus Nordamerika.

¹⁾ Diese Versuche werden fortgesetzt und in der Zeitschrift für Allgemeine Physiologie, FISCHER, Jena veröffentlicht.

Verlauf des Versuches: Die Eier wurden in einer Federspule, die mit einem Wattepfropfen leicht verschlossen war, langsam über den Dämpfen der flüssigen Luft abgekühlt. Die Temperatur betrug anfangs -10 bis -20° C. Nach je 5 Minuten wurden die Versuchseier tieferen Temperaturen ausgesetzt, indem die Federspulen langsam der Kältelösung genähert wurden. Erst nach $1\frac{1}{2}$ Stunden tauchten die Eier in die flüssige Luft ein. Die Temperatur betrug -190° C., die $3\frac{1}{2}$ Stunden einwirkte. Nach dieser Zeit wurden die Eier aus der Flüssigkeit gehoben, blieben aber noch den kalten Dämpfen ausgesetzt, bis sie nach und nach Zimmertemperatur annahmen.

Ergebnis der Versuche: Die Eier von *Dixippus morosus* haben zu 30% ihre Lebensfähigkeit bewahrt, doch bis heute (3 Monate nach dem Versuch) ist noch kein Tier geschlüpft. Aus den Lepidopteren-Eiern schlüpfen bald nach dem Versuch *Samia cecropia* (etwa $\frac{1}{3}$). Die Eier waren 12 Tage alt, also dem Schlüpfen nahe. Die andern Lepidopteren Eiern scheinen alle abgestorben.

Zum Schlusse muss ich auch wieder an dieser Stelle dem Leiter des Kryogenen Instituts, Herrn Prof. Dr. KAMERLINGH ONNES, für das überaus freundliche Entgegenkommen meinen allerherzlichsten Dank aussprechen. Nicht geringen Dank schulde ich ferner den Herrn Prof. Dr. EHRENFEST, Dr. CROMMELIN, VAN EECKE Herrn Mechaniker FLIM und Herrn SPANJER.

Mathematics. — “*Explanation of some Interference-Curves of Uni-axial and Bi-axial Crystals by Superposition of Elliptic Pencils.*” (Second paper). By J. W. N. LE HEUX. (Communicated by Prof. HENDRIK DE VRIES).

(Communicated at the meeting of October 29, 1921).

In a former paper¹⁾, it is shown, that the interference-curves of some crystals — without regard to the isogyres — may be considered as the “moiré”-images of two concentric elliptic pencils, each containing the curves of intersection of the two parts of the successive wave-surfaces with the upper side of the crystal plate.

These wave-surfaces were supposed to be homothetic and so, the velocities in directions, normal to the wave-fronts, were uniform.

From experimental results it is seen, that this supposition explains the phenominae, observed in a polarisation-microscope, only at some distance from the centre, not immediately around it (fig. 1 and 2). For the characteristic black cross, which appears around the centre with uni-axial and bi-axial crystals, is in those figures indistinctly to be seen.

It is proposed in this paper to give an account of some further experiments, which enable us to obtain the black cross in the centre with a fair accuracy and so to find some further conditions as to the elliptic pencils.

Consider first the figure of the hyperbolas (fig. 1). If the inner curves were not little circles, but ellipses, ending in short, coincident, straight lines, this image would become much better. For in this way, a nearly sufficient effect was obtained by superposing two excentric sets of ellipses, as is shown in my first paper.

By causing two of the four pendulums of the former described apparatus to begin a very short time after the two others, the ending-curves of both unissons are short, coincident, straight lines and the results are indeed more satisfying, but not yet wholly right.

There is another condition to be fulfilled, as was remarked with the following experiment.

The name of unisson was given — according to LISSAJOUS — to the figure, described by two equal pendulums, with this extension, that the whole family of ellipses, described by altering the phase-difference from $\frac{\pi}{2}$ to 0, was also called unisson.

¹⁾ Proc. Royal Acad. XXIX, p. 1114—1117.

The beginning-curve was the circle, inscribed in the square upon the amplitudes, the ending-curve was a diagonal of this square.

A further extension is given by continuing the figure (the diagonal being run through), till another circle is described, with smaller radius, in consequence of the decrease of amplitudes, due to friction.

We will call this figure „continued unisson” — it shows a superposition of a larger and a smaller unisson and therefore interference-curves, which prove to be ellipses with their major axes in coincidence with those of both unissons (fig. III).

This set of interference-ellipses is altered in a remarkable way, when the resistance of *one* of the composing movements increases. This may be obtained, with the apparatus used, by means of the screw-weight at the end of a ruler.

Successively, the ellipses are transformed into a flame-shaped image (fig. IV), then a black cross is formed around the centre (fig. V) and at last a set of hyperbolas appears (fig. VI), which is most plain, when the angle between the major axes of the beginning- and the ending-ellipse is between $\frac{\pi}{4}$ and $\frac{\pi}{2}$.

Increase of resistance of one of the composing movements induces a faster decrease of one of the amplitudes and so, the ellipses are no longer inscribed in squares but in rectangles. The major axis of each ellipse coincides with the diagonal of the circumscribed rectangle. In this way, a rotation is caused around the centre, joined to the alteration in shape, already mentioned.

When the continued unisson is considered as a superposition of two common unissons, the rotations of the latter are in an opposite sense.

The principle of rotation arises immediately from the mathematical interpretation of the phenomenon.

In my first paper is already said, that in a superposition of two concentric pencils, the ellipses result from four vibrations.

Each pencil being given by

$$x = r \cos (\varphi + \alpha) + r \cos (\varphi + \gamma)$$

$$y = r \sin (\varphi + \beta) + r \sin (\varphi + \vartheta)$$

or by

$$x = 2r \cos \frac{\alpha - \gamma}{2} \cos \left(\varphi + \frac{\alpha + \gamma}{2} \right)$$

$$y = 2r \cos \frac{\beta - \vartheta}{2} \sin \left(\varphi + \frac{\beta + \vartheta}{2} \right)$$

and considering, that generally $\alpha - \gamma \neq \beta - \vartheta$, the ellipse with the

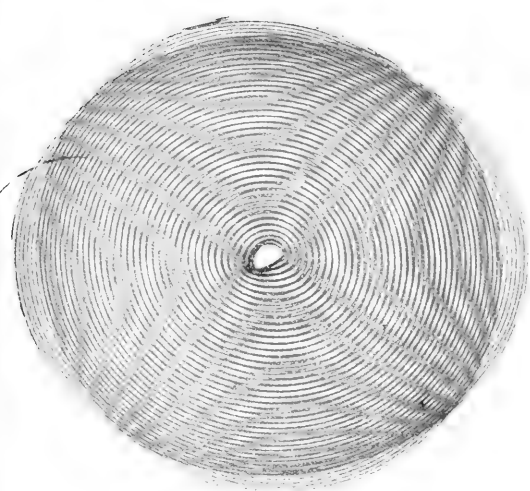

Fig. 1.

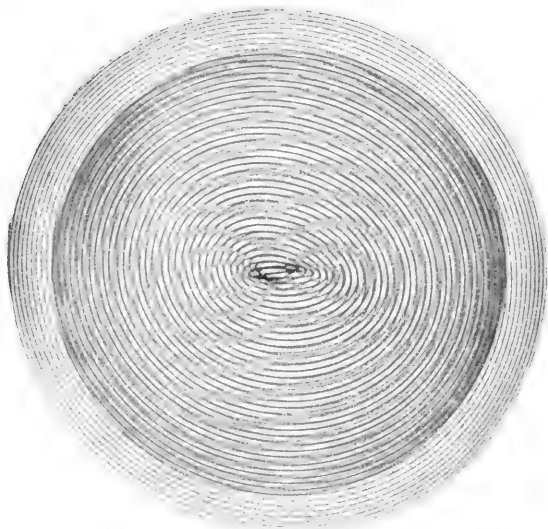

Fig. 2.

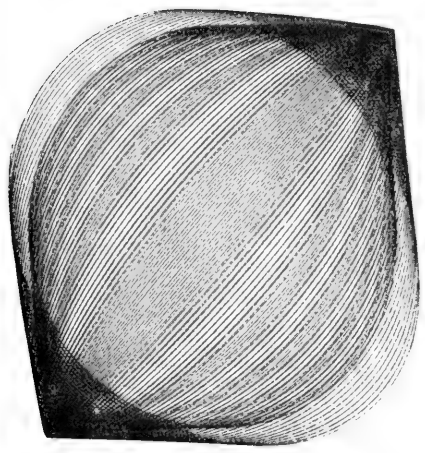

Fig. 3.

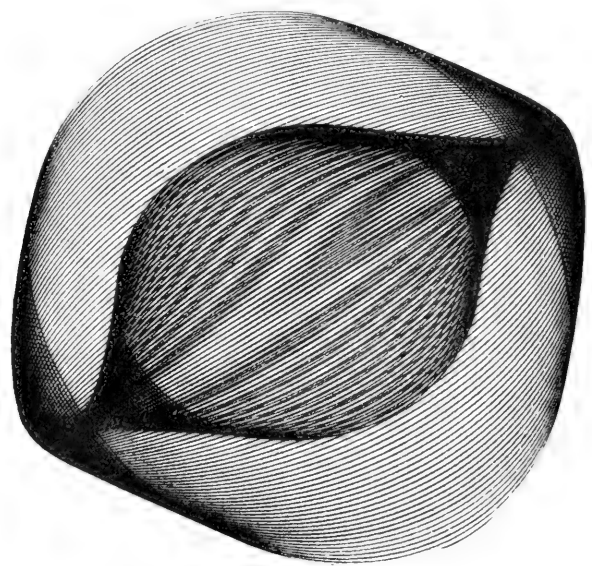

Fig. 4.

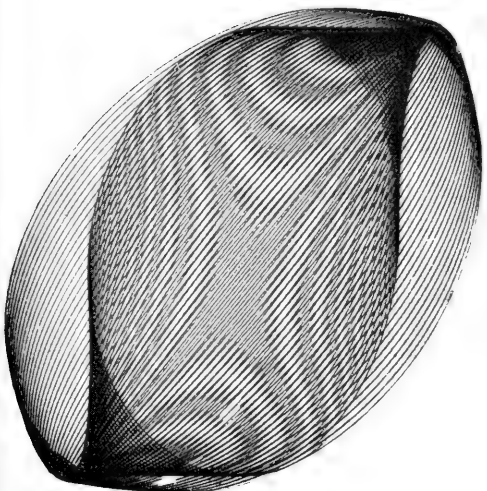

Fig. 5.

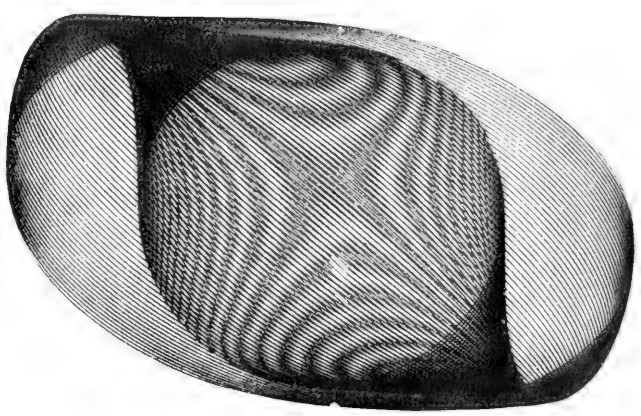

Fig. 6.

variable difference of phase $\frac{\alpha - \beta + \gamma - \vartheta}{2}$ is inscribed in a variable rectangle with sides $4r \cos \frac{\alpha - \gamma}{2}$ and $4r \cos \frac{\beta - \vartheta}{2}$ and therefore will rotate around the centre.

This rotation of the singular ellipses may not be confounded with the rotation of the whole unisson around the centre.

In this case, interference curves are also seen by superposing a unisson and the same figure after rotation. — the image shows however slightly curved, parallel lines, cutting orthogonally the bisectrix of the angle between the axes, when the latter is about 15° .

At last, it is evident, that a sufficient result will be obtained in combining all the conditions, above mentioned, that is: The image of the hyperbolas proceeds from the superposition of two concentric pencils of ellipses (each ellipse resulting from four vibrations). The beginning-curves of these pencils are an ellipse and a circle, having common tangents in the extremities of the minor axis of the ellipse; the ending-curves are short, coincident, straight lines. The curves between show both a regular alteration in shape and a rotation.

The latter has an opposite sense for both pencils, but good results were also obtained in the case of rotation of one of the pencils only.

When these conditions are not observed, great differences become immediately visible.

So, the figure of the hyperbolas degenerates into a Maltese cross, when there is but a small angle between the ending-ellipses. The four arms of the cross point to the extremities of the major axes. Such a cross is also formed, when these ellipses (straight lines) are coincident, but differ too much in magnitude.

The rotation of the ellipses being too fast, the "asymptotes" of the hyperbolas are curved in the same sense; when the two pencils have but a slight difference besides, the figure shows a pencil of curved radii.

If both ending-ellipses are coincident, but too large, the figure of the hyperbolas is exactly formed, but the upper and the lower part are translated in opposite sense.

The same remarks are applicable to the black cross around the centre in the image of the lemniscates.

The here described method of moiré figures to explain interference curves needs not to suppose (as is done with the commonly used method of isophase-surfaces of BERTIN), that both broken normals to the wave-fronts follow the same way in the crystal.

Chemistry. — “*The Condition of Motion of the Molecules in Space.*” By Prof. J. BÖESEKEN. (In collaboration with Messrs. CHR. VAN LOON, DERX, and HERMANS).

(Communicated at the meeting of October 29, 1921).

In a paper on the configuration of the tartaric acids (BÖESEKEN and COOPS)¹⁾ the conclusion was drawn from the behaviour of these acids and their esters towards boric acid, that the carboxyl groups, both when substituted and when not substituted, were as far apart as possible.

The amides and ethyl-amides, however, presented deviations, so that this simple assumption did not suffice. The great influence which these substances have on the conductivity of boric acid, points to a favourable situation of the hydroxyl groups with regard to each other, which can only satisfactorily be accounted for, when there are *attractive* actions between these groups and the substituted or non-substituted amide groups.

Further for a comparatively large number of α -glycols no influence on the conductivity of the boric acid was found; these OH-groups must, therefore, lie far apart, which could again be explained by mutual repulsion. At any rate it appeared from these investigations that atoms that are not directly bound to each other, also exert an action on each other, and we may expect that the state of equilibrium of a molecule will be the result of all the forces in that molecule, both the attractive and the repulsive ones.

I have already pointed out²⁾ that every change in the position of the atoms, however slight, must give rise to re-arrangements, through which the position of *all* the parts of the molecule will not remain exactly the same.

In the molecule-halves of active and inactive tartaric acid e.g. the comparable groups will no longer be perfectly identical; hence the principle of the optical superposition cannot be valid.

In consequence of the action of these forces, molecules which up to now have been considered as symmetrical, as the anti-tartaric

¹⁾ Versl. Kon. Ak. Wet. **29**, 368 (1920). Has not yet appeared in English.

²⁾ " " " " **29**, 562 (1920). " " " " " "

acid, will no longer have mirror images that cover each other, which can easily be demonstrated by means of the well-known carbon models.

Only two positions of the anti tartaric acid are symmetrical, viz. that in which the equal groups lie on the same side of the axis of the central C-atoms as close as possible to each other and that in which they lie on both sides as far from each other as possible. It would be quite accidental, that one of these positions should be the most stable state of equilibrium under all circumstances.

This seems in conflict with experience. We should, however, bear in mind the following considerations. In view of the limited number of isomers it has already long been assumed that the molecule halves can move round the single bonds as axes in opposite direction or with different velocities.

When we supplement this necessary condition with the hypothesis that these movements also continually take place in this sense that the most stable position of all the positions possible at the moment will occur most frequently, and that, therefore, the molecule executes irregular rotations or oscillations round this position, there is no longer any contradiction with experience.

When we consider these rotations round the bond of the central carbon atoms of the anti-tartaric acid, we see that in one full rotation of one part with regard to the other, the molecule will twice pass a symmetric position.

At these moments the molecule is optically inactive, and since now the chance has become equally great that the stable asymmetric-position will be reached by a movement in the direction of the hands of a clock or in opposite direction, a continual racemisation will take place.

Though the state of equilibrium is asymmetric, we shall probably never observe the optical activity in liquid or dissolved state.

This dynamic representation, which is forced upon us by the inactivity of the anti-tartaric acid, applies, of course, to all saturated molecules. Our observations of the behaviour of the α -glycols towards boric acid and acetone can be explained most simply in this way.

The saturated non-cyclic α -glycols do not increase the conductivity of the boric acid; we have drawn the conclusion from this that the hydroxyl-groups are not favourably situated, and have accounted for this by the assumption that the OH-groups repel each other, through which they can get as far as possible from each other owing to the mobility of the molecule.

According to the dynamic representation this position will be the

most stable state of the molecule, but all the other positions will also be realized, albeit less frequently, and the more rarely as the state deviates more considerably from the most stable.

Of the α -glycols there are cyclic acetone-compounds known, which are formed with excess of acetone, to which a little HCl or H₂SO₄ has been added, and which are stable, when there is not a trace of these last catalysts present.

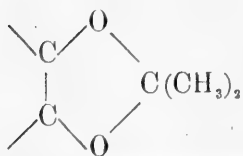

There is every reason to assume that there is the greatest chance that these compounds are formed when the OH-groups are situated in the plane with the C-atoms to which they are bound, and on the same side of them. When the OH-groups repel each other, this will seldom take place, but by taking a very great excess of acetone, we shall yet be able to obtain a pretty large quantity of the cyclic compound, which can be retained by removal of the catalyst, and which can be freed from the acetone by fractional distillation.

When the OH-groups cannot get into the most favourable position, or near it, as in some cyclic trans 1.2-diols, where the free rotation through the ring is prevented, no acetone-compounds will be formed. This now has been found, and this renders a firm support to this dynamic representation (see below).

The saturated glycols can, however, always assume the most favourable position, though it be only rarely; the relative frequency of this case may be judged from the state of the equilibrium:



By determination of the constant of equilibrium:

$$K_t = \frac{C_{\text{glycol}} \times C_{\text{acetone}}}{C_{\text{comp.}} \times C_{\text{H}_2\text{O}}}$$

a measure is supplied for this frequency, and so also a measure for the situation of the hydroxyl groups in the most stable position of the molecule.

Here follows a summary of the constants of equilibrium of some glycols: ¹⁾

¹⁾ In his thesis for the doctorate (Delft 1919, p. 59) "over de Stereochemie der cyclopentaandiolen 1.2 en hydrindeendiolen 1.2". Mr. CHR. VAN LOON was the first to point out that the study of these equilibria would probably bring to light minuter differences in the configuration of the molecules than the boric acid method. The measurements were carried out by Mr. P. HERMANS.

	K_{18°
ethylene glycol	0.14
propane diol 1.2	0.44
" 1.3	0.026
α -monochlorhydrine	0.28
glycerine	0.77
cis-cyclohexanediol 1.2	0.15
trans- " 1.2	0.000

The study of the cyclic glycols has supplied an important support to the efficiency of the dynamic representation.

In the cyclo-pentane-diols the five carbon atoms lie in one plane almost without tension when we assume that the directions of affinity make an angle of $109^\circ 28'$ with each other. In the cis-isomers the OH-groups lie almost in one plane with the C-atoms, to which they are bound, hence very favourably for boric acid and acetone, as has appeared from VAN LOON's investigation.

In the trans-diols the position is very unfavourable. In consequence of the five-ring the position of these OH-groups can never become favourable without the ring being broken. Indeed there was no question of the formation of an acetone compound.

The absence of the acetone-compound in this trans-diol and in the trans-hydrindene diol 1.2 is also the proof that when the OH-groups are prevented from getting from time to time into or almost into one plane, no five-ring is formed. (see above).

At the time it was found that cis-cyclohexane diol 1.2 has no influence on the conductivity of the boric acid. This had led me to conclude already then that this six-ring must be assumed to have a certain suppleness, through which the hydroxyl groups would get somewhat further from each other than would have been expected, if the six atoms of the ring lay permanently in a plane.

The equilibrium: glycol + acetone \rightleftharpoons acetone compound + water corroborated on one side this view, as its position is almost as unfavourable as with the ethylene glycol (see above).

On the other hand it corroborated our dynamic view: The acetone compound is formed; hence the hydroxyl groups must now and then lie in or almost in the same plane as the adjacent C-atoms.

A complete rotation, as is the case with the saturated non-cyclic glycols, is not possible here, as this would mean a continual transition from *cis*- into *trans*-diol, and vice-versa, which does not take place; besides, the *trans*-diol gives no trace of an acetone compound.

How can we now form an idea of the movement in the cyclohexane diol?

In 1890 an extensive study was published by SACHSE¹⁾ on the position of the C-atoms in the saturated ring systems starting from the premise that the directions of affinity form angles of $109^{\circ}28'$ with each other. He proves for the three-, four-, and five-rings that the atoms must be situated in one plane, and that a tension is inevitable, which is, however, insignificant for the five-ring. (VON BAYER'S ring tension). He shows for the six-ring that the molecule can escape a tension in two ways. First of all the C-atoms can lie three in one plane, and three in another, so that the bonds between the C-atoms form a zig-zag line. It is, however, also possible that four atoms lie in one plane, and two (e.g. 1 and 4, 2 and 5 or 3 and 6) outside it.

To bring the molecule out of the first position, a certain resistance must be surmounted; the second position is pliable.

It has been pointed out on different sides that these positions of the molecule could not form the image of the stable situation of the atoms, because the number of isomers, and particularly of optical isomers would then have to be much greater.

ASCHAN²⁾, however, remarks, that these positions *are* possible when they are considered as the successive phases of a system in motion.

This view, indeed, has been confirmed by our boric acid measurements and the study of the acetone-compounds.

When we accept the view that the molecules of the six-rings move through space as undulatory surfaces, the OH-groups of the *cis*-diol get from time to time into the same plane with and on the same side of the C-atoms to which they are attached, and the frequency of this occurrence will depend on the most stable state of the molecule.

It is clear that in these undulations repeatedly a symmetric position is passed, so that, though the most stable situation is an asymmetric one, the separation of optical isomers in liquid state is not very well possible; for racemisation will continually set in for

¹⁾ Berichte **23**, 1363 (1890). Zeitschr. f. physik. Chemie **10**, 228 (1890).

²⁾ "Chemie der Alicyclischen Verbindungen", pag. 328—331.

the same reason as with the movements of the anti-tartaric acid. In the trans-cyclohexane diol the OH-groups always remain very far apart; indeed, we have not been able to obtain an acetone-compound, nor has an influence been observed on the conductivity of the boric acid.

Another confirmation was furnished by the cis- and trans-cycloheptane diols.

When SACHSE's calculations are applied to them, the OH-groups, both in the cis- and in the trans-diol, get in their movements into, or nearly into the same plane with and on the same side of the C-atoms, which they adjoin. Now acetone compounds have actually been obtained, and increase of the conductivity of boric acid has been observed, *both in the cis- and in the trans-diol*; accordingly our measurements are in perfect harmony with what is to be expected in the movements of this system as undulatory surface.

According to this view there is, therefore, no tension in the six- and sevenring-systems, even less than in the five-ring, and in fact, we knew this already from the measurements of the heats of combustion of the cyclo-paraffins. The very accurate determinations by STOHMANN, ROTH, and ZUBOW leave no room for doubt that the increase of the heat of combustion per CH_2 -group of C_5H_{10} , C_6H_{12} , C_7H_{14} does not amount to more than has been found in the paraffins, which ought to have been the case with increasing tension.

This result seems to be in conflict with the experiences obtained about the ring-closures. When there is no ring-tension present in the saturated rings with more than six atoms, why are not they formed as easily as the five-rings, and why are they also clearly less widely spread in nature?

This more difficult formation is, indeed, strikingly illustrated by the very low constant of equilibrium of the system propane diol 1.3 + acetone, especially when compared with the corresponding propane diol 1.2 + acetone, the difference of which rests on six-ring closure against five-ring closure (see above).

An answer is easy to give also here.

The probability that the two OH-groups in the propylene glycol 1.2 assume a favourable position with regard to the acetone molecule is so much greater than for the 1.3 isomer. In the propane diol 1.2 a rotation of the molecule parts round a single bond suffices, whereas in the propane diol 1.3 the paths of the OH-groups are much more involved and intricate, so that in the same space of time they will certainly assume a favourable position much less frequently.

We may summarise the result of this study as follows:

1. Also atoms that are not directly bound to each other, exercise an action on each other in the same molecule.

2. The saturated non-cyclic molecules execute, among others, movements in which the parts of the molecule revolve in opposite direction or with different velocities round the single bonds as axes.

In case of not uniform load, as is the case in by far the most molecules (excepted are only H_2 , O_2 , N_2 , etc. C_2H_6 , C_2Cl_6 , perhaps oxalic acid, etc.) the movements are irregular, because the most stable position of the atoms will be passed most frequently.

3. In the saturated ring-shaped molecules with six and seven carbon atoms the ring-forming atoms are not fixed in one plane, but they lie tension-less in a curved surface, which travels through space in undulatory movements.

Delft, October 1921.

KONINKLIJKE AKADEMIE VAN WETENSCHAPPEN
TE AMSTERDAM.

PROCEEDINGS

VOLUME XXIV

Nos. 6 and 7.

President: Prof. F. A. F. C. WENT.

Secretary: Prof. L. BOLK.

(Translated from: "Verslag van de gewone vergaderingen der Wis- en
Natuurkundige Afdeeling," Vol. XXX).

CONTENTS.

- G. C. DIBBETZ Jr. and P. ZEEMAN: "An Interference Phenomenon Due to the Introduction of Sodium Vapour into one of the Paths of the FIZEAU-MICHELSON Interferometer-Arrangement", p. 206. (With one plate).
- V. J. KONINGSBERGER: "A method of recording growth under various external influences". (Communicated by Prof. F. A. F. C. WENT), p. 209.
- CHR. VAN GELDEREN: "On the development of the sternum in reptiles". (Communicated by Prof. L. BOLK), p. 221.
- K. LANDSTEINER: "On the formation of heterogenetic antigen by combination of haptens and protein". (Communicated by Prof. C. H. H. SPRONCK), p. 237.
- F. ZERNIKE: "A moving coil galvanometer of high sensitivity". (Communicated by Prof. H. HAGA), p. 239.
- H. ZWAARDEMAKER: "On Superficial and Internal Processes", p. 246.
- W. E. DE MOL: "On Hypotriploid Dwarf-hyacinths derived from Triploid Dutch Varieties through Somatic Variation". (Communicated by Prof. J. C. SCHOOTE), p. 251.
- H. BOSCHMA: "On Budding and coalescence of Buds in *Fungia fungites* and *Fungia actiniformis*". (Communicated by Prof. C. PH. SLUITER), p. 257.
- C. A. PEKELHARING: "On the Movement of Pepsin in a protein-containing or protein-free Gel of Agar-agar", p. 269.
- L. J. J. MUSKENS: "The Myoclonic Reflexes". (Communicated by Prof. H. ZWAARDEMAKER), p. 280.
- B. G. ESCHER: "On the hot "Lahar" (mud flow) of the Valley of Ten Thousand Smokes (Alaska)". (Communicated by Prof. G. A. F. MOLENGRAAFF), p. 282.
- J. J. VAN LAAR: "On the Equation of State for Arbitrary Temperatures and Volumes. III. On the Law of Force between the Molecules of Mon-atomic Substances". (Communicated by Prof. H. A. LORENTZ), p. 294.
- EUG. DUBOIS: "On the Cranial Form of *Homo Neandertalensis* and of *Pithecanthropus Erectus*, Determined by Mechanical Factors", p. 313. (With one plate).
- H. A. LORENTZ: "Double refraction by regular crystals", p. 333.

Physics. — “*An Interference Phenomenon Due to the Introduction of Sodium Vapour into one of the Paths of the FIZEAU-MICHELSON Interferometer-Arrangement*”. By G. C. DIBBETZ Jr. and Prof. P. ZEEMAN.

(Communicated at the meeting of November 26, 1921).

When sodium vapour is introduced into one of the paths of light of the interference-arrangement used in FIZEAU'S experiment, surprising shifts of interference fringes may be observed. In order to observe these shifts we must arrange that the sodium vapour acts as a prism, and that by means of a spectroscope the change of the distance of the interference fringes with wavelength can be watched by projecting the interference fringes on the slit of the spectroscope.

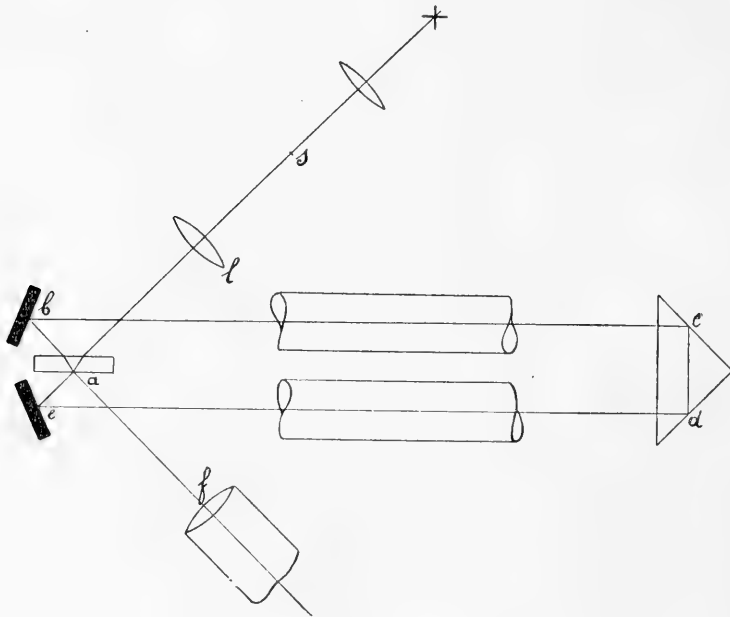

The above figure is reproduced from an earlier paper¹⁾ on FRESNEL'S convection coefficient for light of different colours in water, in which use is made of MICHELSON and MORLEY'S interferometer. In *a* the ray meets MICHELSON'S slightly silvered mirror. There the

¹⁾ ZEEMAN. These Proc. Vol. XVII p. 445 (June 1914).

incident beam sla is divided into a reflected and a transmitted one. The reflected one follows the path $abcdeaf$, the transmitted one the path $aedcbaf$. In some experiments the flame of a MEKÈR-burner, in which a platinum spoon with common salt was placed, was put between e and d . In another case a greater gradient of density of the sodium vapour was obtained by introducing sodium into an iron tube connected with an air-pump and closed on both sides with glass plates. By heating this tube at the bottom and cooling it at the top, the desired density distribution could be obtained.

With the flame between e and d the phenomenon was observed reproduced on the Plate in Fig. 1.

Fig. 2 represents the interference phenomenon with a sodium prism of greater density. Both photos were taken with a spectroscope with one glass prism; the first is enlarged 7 times, the second 4 times. In Fig. 1 the two absorption D -lines are visible. In fig. 2 the whole region round the D -lines has disappeared.

It will not be attempted here to give a full explanation; it would claim more space than we can afford to give it. Even without the sodium vapour the explanation of the dependence of the interference fringes on the mutual position of the five reflecting planes and on the thickness of the slightly silvered mirror is a rather complicated problem, which has not been treated in detail as yet for so far as we know.

We shall confine ourselves to a few remarks on circumstances that play a rôle in the appearance of the phenomenon.

A point to which we draw attention is the particularity that the rays which travel in opposite directions, are deflected by a different amount after their passage through the sodium prism. For if the vapour prism is placed between e and d , ray aed will have to travel over the long path $dcbaf$, before it reaches the object glass of the telescope; $abcd$ on the other hand only the short path eaf .

In this connection we may still mention that nothing has ever appeared of a dependence of the velocity of propagation of light on the intensity. We assume that this does not exist, else this dependence would already give rise to phase differences in our experiment, because one ray is weakened at the beginning of its way, another at the end.

The following auxiliary experiment is also of importance. We introduce a screen with a narrow aperture between l and a in order to insulate as, it were, a ray of light. In the principal experiment an image of the interference fringes was thrown on the slit of the spectroscope by the aid of the lens f ; now, however, we increase

the distance between l and the plane of the slit. When, as in the experiment, the path of the light between the slightly silvered mirror and the lens is about 600 cm., we can by a displacement of 4.5 cm. (focal distance of the projecting lens 50 cm.), observe two sharp, coherent image points lying vertically above each other, in the image plane. The distance of the image points is a function of the wavelength. When they are projected on the slit of the spectroscope, the dependence of image distance and colour is directly observed. Fig. 3 represents a positive photo obtained with the tube of sodium under the said circumstances. The dark line on the left side and the dark line on the right side originate from one luminous point, the faint lines from the other. The difference of intensity of the lines was caused by this that the two luminous points were not thrown on the slit exactly under each other. The lines of Fig. 3 could not be observed in the neighbourhood of the absorption D -lines. In the lefthand part of the figure our lines are both curved upwards, in the righthand part both curve downwards. It is further noteworthy that the lines in the lefthand part intersect, whereas in the righthand part they diverge more and more from each other.

When we focus again the interference fringes upon the slit of the spectroscope we see the interference figure of Fig. 2 in the spectroscope.

Now it seems rather plausible that the existence of Fig. 2 is due to the shape of the lines of Fig. 3. We then expect a shift in the central part of the figure of the whole system of fringes, on the left upwards, on the right downwards. Further we expect interference fringes close together where the lines of Fig. 3 diverge greatly from each other, widely apart where the distance of these lines is small. No interference fringes are expected where the lines intersect. Thus the typical rhombic central part would arise in the figure.

It should still be pointed out that there is a narrow dark horizontal line in Fig. 2, this is due to a particle of dust on the slit. The vertical shadows in the lefthand part of the figure are the first indications of the absorption band spectrum of sodium.

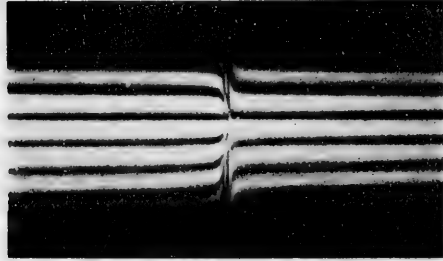

1

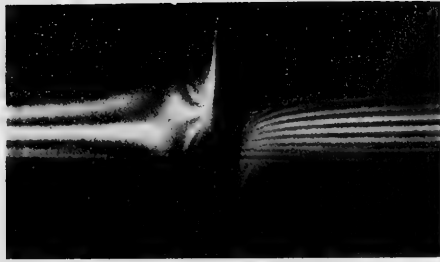

2

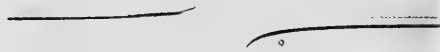

3

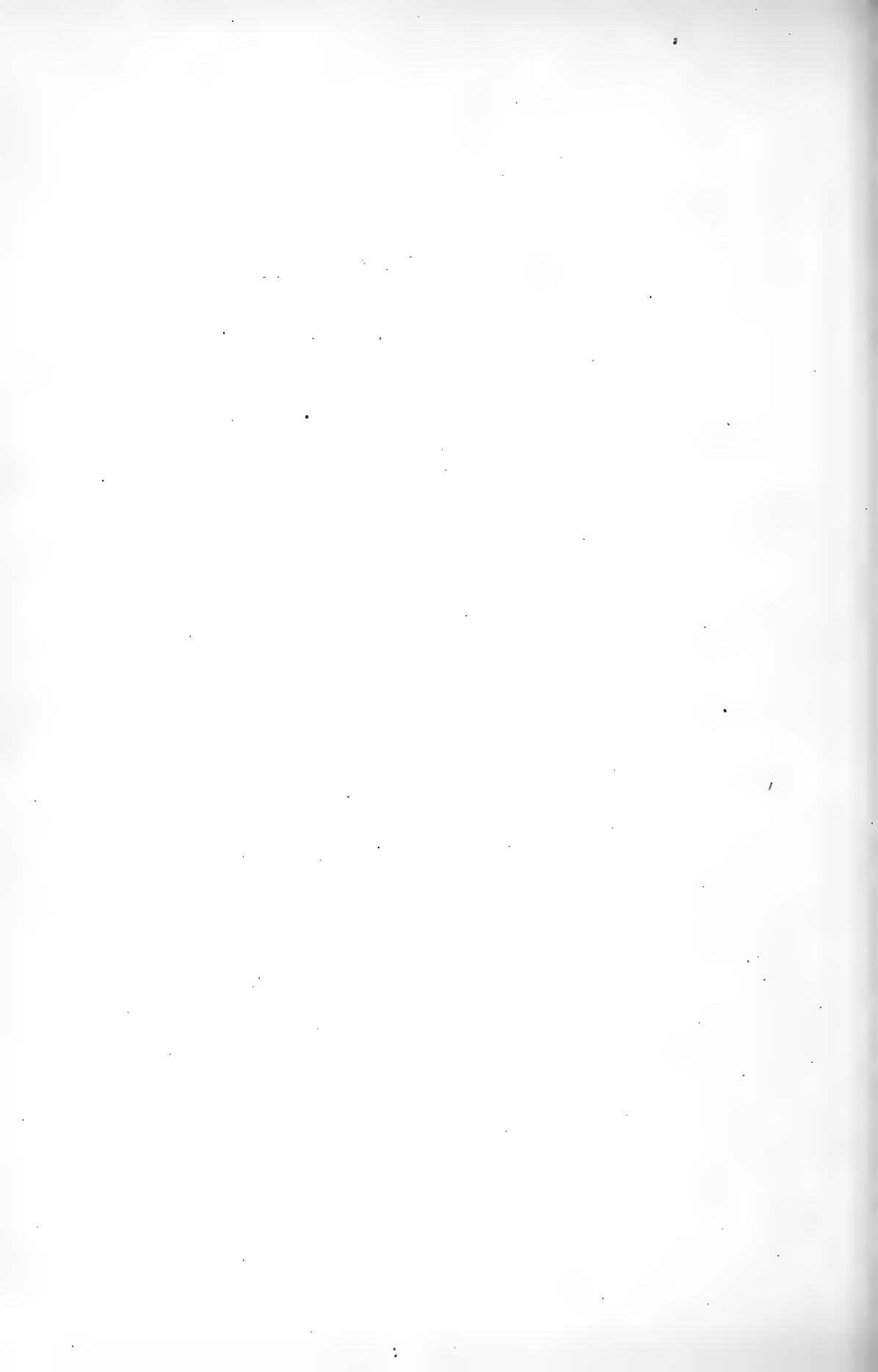

Botany. — “*A method of recording growth under various external influences*”. By V. J. KONINGSBERGER. (Communicated by Prof. F. A. F. C. WENT).

(Communicated at the meeting of November 26, 1921).

Introduction. Since the researches of BLAAUW¹⁾ the problem of the influence of “stimulus” on growth has called the attention of the investigators. Hitherto BLAAUW’s experiments have only been affirmed and extended by others on the base of the “photo-growth-reactions”. BLAAUW’s own method was always used i.e. determining growth by means of a horizontal microscope in weak red light, other external conditions being kept as constant as possible. That even this method is not quite perfect has been shown lately by Miss CL. ZOLLIKOFER²⁾, who found that weak red light too exerts its influence upon growth.

Moreover the method of microscopical measurement would fail entirely for research concerning the influence of gravity upon growth as, e.g., with this method, accurate definition of growth on a clinostat is impossible.

Preliminary experiments, done with the same apparatus with which Miss ZOLLIKOFER has worked (magnifying power 90 ×) made it clear, that even errors, due to physical causes (vibrations; etc.) are not excluded. Since irregular values in measuring growth of an *Avena*-coleoptile were obtained, the latter was replaced by a micrometer-slide. Having focussed the microscope at a fixed line on this micrometer, the position of this line was determined every three minutes. Instead of an unvariable position, the following variations were found during half an hour:

+ 12; + 8; — 15; ± 0; + 3; — 10; + 7; + 15; — 12; + 7 μ .

A small horizontal adjustment of the microscope, necessary at this enlargement at the slightest nutation of the seedling, led to errors varying from + 52 to — 68 μ .

The impossibility of measuring growth on a clinostat and in full darkness with this set of apparatus is clear. Moreover the larger

¹⁾ A. H. BLAAUW. Zeitschr. f. Bot. 1914, **6.**, id. 1915, **7.**, Meded. v. d. Landb. Hoogeschool, Wageningen, 1918, **15.**

²⁾ CLARA ZOLLIKOFER. Proc. Kon. Akad. v. Wet. Amst. Vol. XXIII. 1920, N^o. **4.**

or smaller, but inevitable, observational errors must be added to the occurrence of physical disturbances.

These considerations have given rise to the planning of an auto-graphical method.

In literature only one apparatus, used for these purposes, occurs; namely that of Bose and Das ¹⁾, who transmit growth on a smoked plate, moved on by clockwork, by means of a lever-system at a magnification of 1000 to 10000 times. This crescograph can only record growth for a very short time, but the authors are not concerned with this factor, as the growth is so highly magnified. That observation-time is, however, of great importance may follow from the fact that the changes in velocity of growth, caused e.g. by light, are extended over a very long region of time. Further the test-plant is fixed on the elaborate lever-system by means of a thread, whereby the chance of physical disturbances is enlarged.

Moreover, this apparatus too is not adapted for use on the clinostat. So another kind of auxanometer was constructed in order to evade the errors mentioned above.

The principle of the apparatus. The growing test-plant closes a very weak electric circuit, by means of a refined contact, mounted on a micrometer-screw. This screw has a pitch of 0,5 m.M.; at its end is fixed a cogwheel with 100 teeth. The weak current, closed by the plant goes through a relais of high sensibility, which closes a stronger circuit. This stronger current moves on the cogwheel one, two or more teeth by means of an electro-magnet.

The screw is turned in this way $\frac{1}{100}$, $\frac{1}{50}$, etc. around its axis, the contact thus is raised resp. 5, 10 or more μ . The plant has to grow 5, 10 or more μ before it closes the circuit again.

Meanwhile a recording-pen on a rolling carriage-frame is moved on with a velocity of 1 m.M. a second by an electric clockwork (connected with a second-pendulum) along a non-moving recording-drum. The pen thus writes a straight line. At the instant of contact-making by the plant, the pen leaps back and arriving on its starting-point the drum is turned over a distance of 1,5 m.M. and directly the pen begins to write again with the same velocity. In this manner a series of lines will arise, while the length of each of them, measured in m.M. gives the time, in seconds, needed by the plant for growing 5, 10 or more μ . The curve, connecting the tops of these lines reproduces the course of growth. The machine records

¹⁾ Sir J. C. BOSE and G. DAS. Proc. of the Royal Soc. of London, Series B, Vol. XC, 1919.

how long a time is wanted for a certain increase, in contrast with the "microscopical" method, where direct growth in a certain lapse of time is measured.

When this apparatus was practically constructed, my attention was called to a paper by BOVIE¹⁾, who has already put into practice the same device for an auxanometer. His method has several disadvantages. In the first place the linkage by means of an invar-thread is detrimental to the plant and in the second place the connection between plant and apparatus is by no means a rigid one. The chief disadvantage, however, lies in the fact that the plant itself closes the circuit, which effects the upward movement of the contact. This current, activating an electro-magnet, must be of a rather high voltage. Therefore it, inevitably, will emit sparks at the opening of the circuit. These sparks will burn the contact-metals, causing an inconstancy in the place of contact. BOVIE's auxanometer records on a drum, revolving at a velocity of 1 m. M. a minute. At each contact a pen makes a check on the drum. The distance between two checks thus corresponds to the time, wanted for a certain growth. Apart from the tedious counting of checks and measuring their distances, the slow movement of the drum leads to high errors in taxation.

Moreover, BOVIE didn't design his machine for our purposes; it meant to be a precision-machine for demonstration. Some years afterwards he describes²⁾ a simplification of his apparatus, whereby, however, it has lost much of its accuracy.

To obtain a high grade of accuracy, many obstacles had to be overcome. The whole apparatus has been constructed by Mr. P. A. DE BOUTER, mechanic at the Botanical Laboratory of the University of Utrecht, from whose knowledge of engines the writer owes many ideas. The writer wants to render him his best thanks for the constant energy, with which he carried out his work.

The Auxanometer is mounted on a working-axis (1) (See fig. 1), 18 c.M. in length, that may be fixed on a clinostat-table (2). In order to revolve the plant vertically in regard to its revolving-axis, a side-axis (3) may be fixed on the working-axis (1). The test-plant, growing in a little pot of zinc (3 c.M. high and 4 c.M. diameter) may be fixed on a movable little table (4) by means of a handle (6) of the cover.

This handle (6) is fixed by a single screw (7), so that there is an unmovable connection between plant, pot and table.

1) W. T. BOVIE. Bot. Gazette, 1912. 53.

2) W. T. BOVIE. Am. Journal of Bot. 1915. 2.

This table (4) may be fixed on the auxanometer by the upward movement of handle (5). There is an opening in the cover for the plant and on that cover three little mirrors have been fixed for

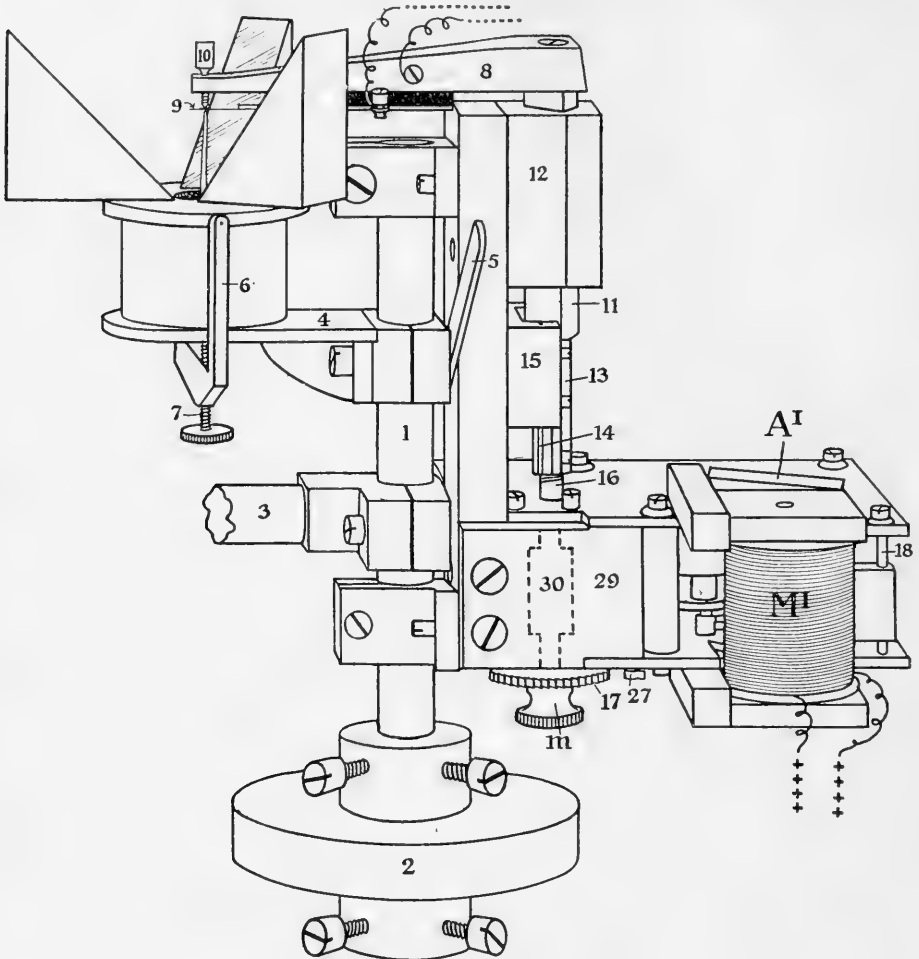

Fig. 1. The auxanometer.

exposition to light. The plant is drawn up exactly under the centre of the contact-device (9). On the brass piece (8) a small plate of brass has been mounted, isolated by ebonite, at which has been soldered a thin platinum strip (9). On this platinum strip lies a minute piece of polished gold, just opposite to a screw (10) in the brass piece (8) in the end of which has been soldered a fine point of platinum. This apparatus has been carefully made. It is an imperative condition that the platinum strip should yield very lightly to pressure and yet be elastic. If the screw (10) is at the minimum distance from the golden plate, without making contact, a weight of 2 mgr. on the platinum strip is sufficient (in inverse position) to

close the circuit. Furthermore the experiment must be stopped, as soon as the plant makes nutations, or grows in a wrong way. Therefore the platinum strip is narrow and allows but an excursion of the plant-top, less than 1 m.M.

The brass piece (8) has been mounted on a hexagonal brass prism (11) that runs true up and down in a well-fraised closed bearing (12). This prism (11) is linked by means of an internal strong spiral spring with a split-nut (13). In order to get a straight up and down movement this nut (13) runs by means of side-wings (14) in slits (15). The precision-micrometer-screw (16) runs in the nut (13). In the direction of the screw is saved a cylinder of larger diameter (30). Both screw-axis and cylinder (30) fit in a block (29). The turning of the screw-axis will raise split-nut (13), prism (11) and the brass piece with contact-device (8). At the lower end of the screw-axis under the block (29) a cogwheel has been mounted with 100 teeth (17) at such a rate that the contact is raised, when the wheel is turned in the direction of the sharper edges of the teeth.

In the beginning stage of the work, an energetic electro-magnet

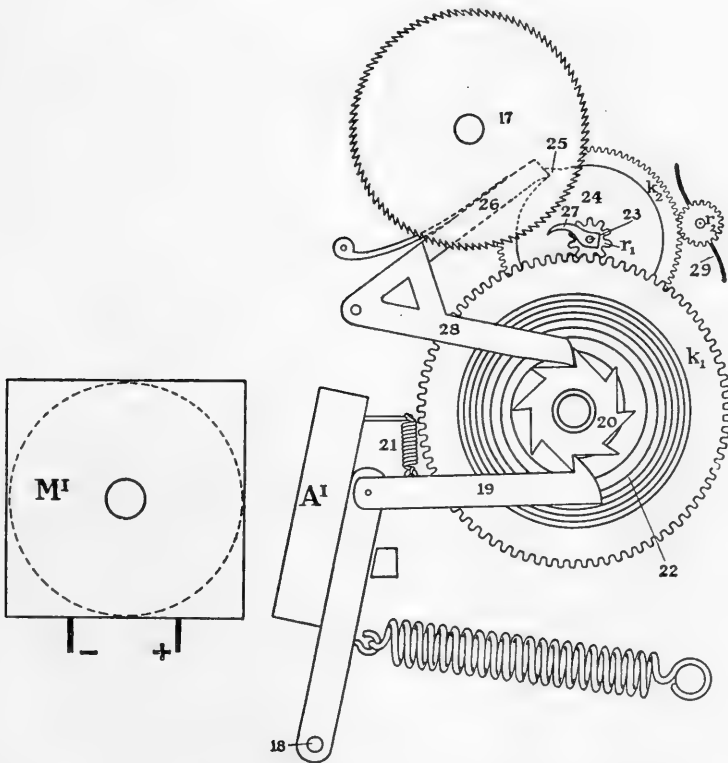

Fig. 2. Explanation in the text.

pulled on this cogwheel by means of an armature with a pawl. A spring drew back this armature just as far that, with the next closing of the circuit, the cogwheel should go on one, two or more teeth. This simple method, however, was not reliable, as the wheel sometimes turned too far, after the shocklike movement.

This error could only be eliminated by a rather complicated mechanism, ingeniously devised by Mr. DE BOUTER. Each time, when a current passes through the coil of electro-magnet (M^I) the armature (A^I) is attracted. This armature turns around an axis (18). (See fig. 2). On the armature is fixed a lever with a tooth (19), pressed against cogwheel (20) by means of spring (21). On the axis of cogwheel (20) is fixed a spiral-spring (22) which is wound up, when the armature (A^I) is attracted. This spring tries to relax itself on a little clockwork, consisting of some toothed wheels (k_1 , r_1 , k_2 and r_2). On the axis (23) of toothed wheel (k_2), however, is fixed an escapement-wheel (24) with a single tooth (25), which is held up by an escapement-lever (26). On the same axis (23) is fixed a little bolt (27) which, when revolving, should catch a tooth of cogwheel (17) of the auxanometer.

The escapement-lever (26) is one with the lever (28) that prevents the direct relaxing of spring (22). When the armature (A^I) is attracted and spring (22) is wound up, the lever (28) makes way, slipping over a tooth of cogwheel (20). In the mean time, the escapement-lever (26) makes way and relaxes the tooth of escapement-wheel (24), at the moment when the lever (28) slips over the top of the tooth. The escapement-wheel (24) makes one revolution, bolt (27) too, implicating in its revolution cogwheel (17) over a certain distance. By means of changing the length of bolt (27), one can adjust very accurately the number of teeth that cogwheel (17) shall turn. Two teeth ($= 10 \mu$) proved to be the most practical arrangement.

The gradual movement of the cogwheel (17) warrants a high accuracy. The proportions of the teeth-number on the wheels (k_1) and (r_1) is chosen in such a way, that the clockwork is relaxed exactly as much as it is wound by the attraction of the armature (A^I). ($k_1 : r_1 = 8 : 1$). The relaxation-velocity of the clockwork is moderated by a fan (29).

The auxanometer described is capable of recording a total increment of the test-plant of 3,5 c.M. This is a considerable amount for seedlings. After each experiment, the contact-device is put down into its lowest position by turning the nut (m). The machine has been tested by the micrometer-screw of a Zeiss I A microscope. It has been placed in a room for constant temperature and shortly

will be mounted on the axis of a VAN HARREVELD'S clinostat. The electric connections will be secured, in that case, by sliding-contacts on the clinostat-axis.

As BOVIE (l.c.) has already mentioned, it is a great advantage that the test-plant may be as far as desirable from the recording apparatus. In our case, the latter has been placed in quite another part of the building.

The relais. As remarked above, a weak current is closed by the plant. In order to eliminate sparking at the interruption of the current, a condenser or a resistance (parallel to the contact) could be inserted into the circuit. In the latter case, the resistance ought to be less than the atmospheric resistance, but large enough to prevent the relais to react. It can, however, be eliminated more safely by using a current of very low voltage, led through a fit relais. This relais has been found in the form of a galvanometer, with two coils of 4000 windings each. On the mirror of this galvanometer an iron electrode (31) (see fig. 3) is fixed, on which two platinum tips have been soldered. When the mirror (with the electrode) turns, these platinum tips are moved into two small cups, filled with mercury (32), whereby a second circuit is closed.

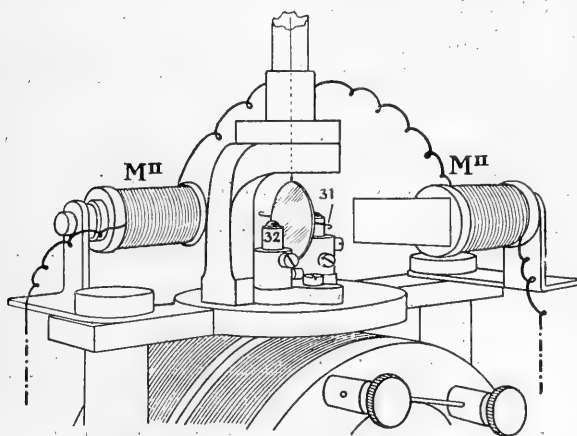

Fig. 3. The galvanometer, transformed into a relais.

This galvanometer, transformed into a relais, has the following advantages:

First. It has an extraordinary high sensitiveness.

Second. As there is no iron pith, in contrast with other kinds of relais, the self of the current is so small, that at the opening no spark will occur.

Third. The turning of the mirror takes a rather long time; the relais having a great inertia. Short current-pulses, as will result from vibrations, do not possess enough turning-power, to make the electrode (31) reach the mercury (32). In order to obtain this result, the circuit is to be closed at least for $\frac{1}{6}$ second.

In this simple method the influence of vibrations is efficiently eliminated.

The mirror gives a full excursion at a current, obtained from an accumulator (I) (see fig. 4) and diminished by a resistance (II) of several hundreds of Ohms. The intensity of the current is about 1 milliampère. This current, which affects the galvanometer (III) (.....) closes a second circuit (-----) derived from the same accu. This circuit passes through a second relais (IV). There a third circuit (-----) is closed. The current for this circuit (and for others, that will be mentioned below) is derived from the central-net. The voltage (220 volts direct current) is diminished by resistance-lamps. These lamps pass $\pm 0,6$ amp.

This current has three things to do:

First. It affects a third relais (V) which closes the circuit (+++++) activating the auxanometer-magnet (M^I). In this way, the contact-device is raised.

Second. When the platinum-tips of the galvanometer penetrate into the mercury, a rather large power is required to turn the mirror back, as the surface-tension of the mercury is considerable. The terrestrial magnetism doesn't generate enough power, to warrant this safely. Therefore two little magnets (M^{II}) have been placed perpendiculary to the iron rod (31). When the current affects these magnets, the electrode will be pulled energetically out from the mercury; the swinging movement is to be damped by strips of paper, glued on the magnet-piths.

Third. It has to activate magnet (M^{III}) of a turn-over switch (VII) which is an essential part of the:

Recording-Apparatus (see fig. 4 and 5). By means of a simple clockwork the pen, mounted on a carriage-frame (34), is drawn along the paper. Two electro-magnets (M^V and M^{VI}) regulate this movement. The carriage (34) is connected, by means of silk-threads, at one end with a wooden cylinder (33), at the other end with a weight (35). The cylinder (33) is mounted on the same axis as the cogwheel (36), which turns to the right, when the metal device (37), with a pawl (38), moves down.

Every second a circuit (.....) is closed by a second-pendulum (IX) which affects a relais (VI). This relais activates by circuit (+++++) magnet (M^V) which attracts the device (37) as its armature (40) is mounted on this device.

With device (37) pawl (38) is pulled down and the latter involves cogwheel (36) in its movement; i.e. cogwheel (36) is turned one tooth and cylinder (33) winds up the silk-thread; the carriage (34) advances 1 m.M. A spiral-spring (42) pulls back the device (37) till it is arrested by a metal block (43), just when pawl (38) catches

the next tooth of cogwheel (36). A contra-pawl (41) prevents the rolling back of the carriage during this moment; this pawl (41)

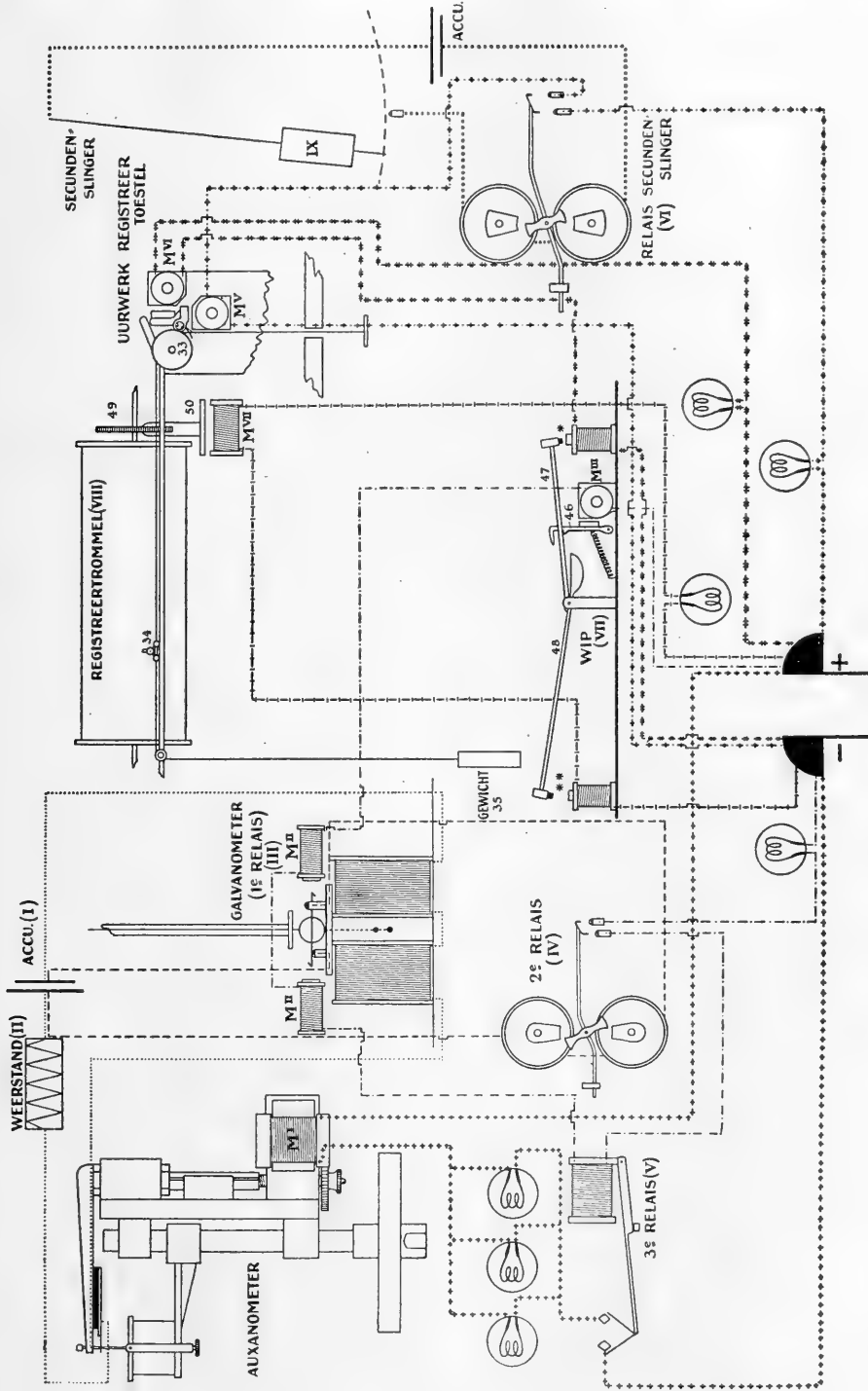

Fig. 4. Explanation in the text.

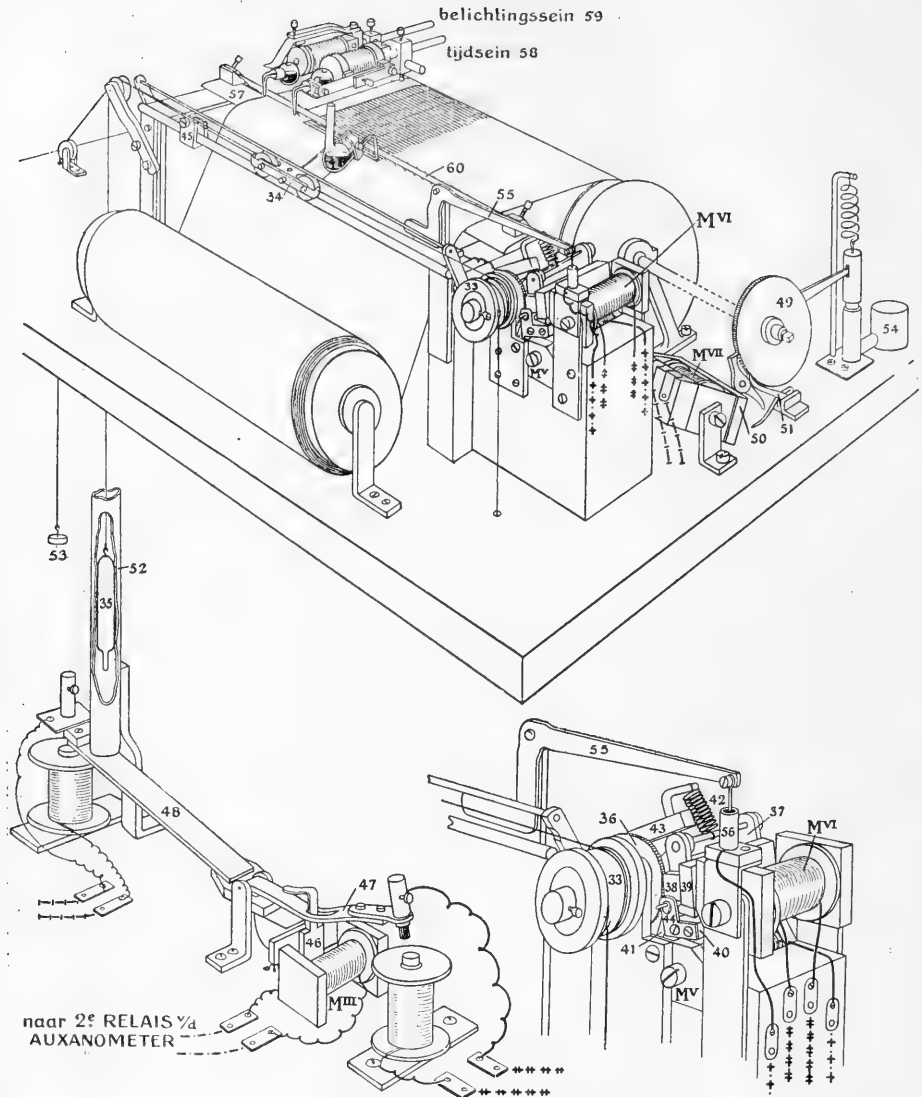

Fig. 5. The Recording Apparatus.

projects with a little bar through a metal ring (44) of device (37). On the same device is fixed a second armature (39), belonging to magnet (M^{VI}). When a current activates this magnet, the whole device (37) is attracted to the right. The contra-pawl (41) is also attracted, as it projects through ring (44). In this way cogwheel (36) and cylinder (33) come free and carriage (34) rolls back, pulled by the falling weight (35).

The magnet (M^{VI}) will be activated by the switch, for the circuit closed by the second relais (IV) passes through the coil of magnet (M^{III}). The armature (46) of this magnet is attracted and the support

of lever (47) is taken away. This lever closes at *) the circuit (*****), which affects magnet (M^{VI}).

When weight (35) has fallen down straight (in a metal tube (52) it presses down lever (48), that lifts by its shorter arm lever (47) and opens the circuit of magnet (M^{VI}). Instantaneously the device (37) is relaxed from magnet (M^{VI}) by a spring (invisible on fig. 5) and the second-pendulum begins again to draw up the carriage.

As the drum is a non-moving one, a second line would be drawn on the same spot as the first. Therefore the fallen weight closes a circuit at **) (-----), which affects magnet (M^{VII}).

Armature (50) is attracted and a pawl with it. The pawl pulls on cogwheel (49) that is mounted on the axis of the drum (VIII).

The latter is turned 1,5 m.M. The new line thus will be drawn 1,5 m.M. from the preceding one. As the drum has a great inertia and the system was moved on some times more than agreed with one tooth of the cogwheel (49), the movement is moderated by an oil-pump (54), whereas a contra-pawl (51) prevents the turning back of the drum. When weight (35) rises again, the circuit is opened, as lever (48) is lifted by a weight on its shorter arm.

In this way a registration has been obtained, at which the length of each line expresses in m.M. the time in seconds which the plant needs for an increase of 10 μ . As the lines are drawn 1,5 m.M. apart, 15 c.M. of the paper corresponds to 1 m.M. growth (100 lines).

Several precautions have been arranged to secure a safe record. In the first place, the record has to be stopped automatically, when the plant grows in a wrong way, i.e. when it ceases to make contact. In that case, the carriage (34) is drawn up entirely and pulls at the end on lever (55). The current, which affects magnet (M^V), passes through this lever (omitted in fig. 4) and a small cup (56) with mercury. When the lever is lifted out of the mercury by the pressing carriage, the circuit is opened.

To obtain a record over a long lapse of time, the use of several yards of paper is necessary. These have been rolled on a second drum and laid over a metal plate (57). So the pen has to write on the same level, while the drum (VIII) increases in bulk.

In order to get a straight abscissa the carriage has to stop always at the same starting-point. This is obtained by a metal block (45) and a small plate, connected with cylinder (33). The under-side of the table stops this plate, when the carriage reaches block (45). A second weight (53) has to pull the carriage, when the power of weight (35) is broken on lever (48).

To prevent the tedious burning of the contacts on the switch

(VII) the principle of coil-contacts has been put into practise; the self of the current blowing away the opening-spark.

The space-marking on the paper is arranged, by using the fact that the ink (a solution of eosin in water and some glycerin) remains wet for some time. On a metal strip (60) stiff bristles have been glued, at distances of 5 mM., which drag over the wet ink and make checks in the lines.

An electro-time-sign (58) draws a straight line parallel to the abscissa of the record and makes checks e.g. every 10 minutes. As the lines are drawn 1,5 mM. apart, the distance in mM. between two time-checks (devided by 1,5) gives the increase in 10 minutes. As it may happen that a check falls just before the carriage will be driven back, and the next check just after this moment, the maximum error that may occur will be 20μ . In this way a simple method has been found, to compare the results with those of other investigators.

Lastly a second time-sign (58) can be put into action from the experiment-room. One can, by pressing a bell-push, put a point on the paper at the moment, when light is dosed or when the auxanometer has been put on the clinostat, etc.

Next figure 6, a little reduced in size, gives the record of 1 mM.

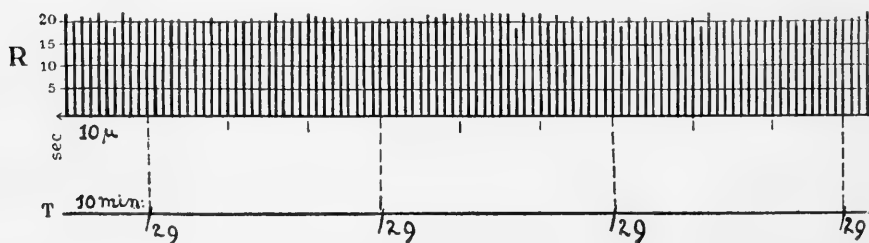

Fig. 6. Record of 1 mM. growth. Each line at R gives the time needed for 10μ growth; T = time-line; every 10 minutes the increase is constantly 290μ .

growth, belonging to a paper of 4,05 M. in length, containing the record of 27 mM. growth, in the dark.

Utrecht, November 1921.

Botanical Laboratory.

Anatomy. — “*On the development of the sternum in reptiles*”. By
CHR. VAN GËLDEREN. (Communicated by Prof. L. BOLK).

(Communicated at the meeting of June 25, 1921).

Comparative anatomy generally indicates as sterna those parts of the skeleton that lie in the ventral median line of the trunk-wall. In the reptiles, which will be discussed in this paper, we have to distinguish between episternum and sternum s. strictiori. The sauria and crocodilia possess a sternum s. str.; with the exception of the rhiptoglossa they have an episternum besides. Considering the uncertainty existing about the development of the above named sterna, for the present only the histological build of the adult reptiles may be named as the only difference between the two. The episternum consists of bone, the sternum s. str. of cartilage, which is often calcified. This communication only concerns itself with the development of the sternum s. str.

We owe to RATHKE the first data about the development of the sternum, in reptiles as well as in birds and mammals¹⁾. He found in *Lacerta agilis*, that in early embryonic stages the sternum consisted of two entirely separated parts. Each part was a strand of tissue consisting of a dense mass of cells, which connected the ventral ends of the future vertebro-sternal ribs. Afterwards the two sternal parts fused in cranio-caudal direction. In *Anguis fragilis*, on the contrary RATHKE found that the sternum developed apart from the ribs. Later²⁾ on RATHKE published his experiences in embryos of crocodiles. They were entirely in accordance with those in *Lacerta*. One cannot conclude from RATHKE's works whether he saw any fundamental difference between the two ways of development of the sternum described above, separated from the ribs in *anguis* connected with the ribs in *lacerta* and *crocodilus*; neither can one conclude whether in his opinion there is a genetic relation between the sternum and the ribs in *lacerta* and *crocodilus*, in other words, whether the sternum is a product of the ribs inserted into it.

¹⁾ H. RATHKE. Ueber den Bau und die Entwickl. des Brustbeines der Saurier Königsberg 1853.

²⁾ H. RATHKE. Ueber den Körperbau und d. Entwickl. der Krokodile. Braunschweig 1866.

GÖTTE¹⁾ examined the development of the sternum in *Cnemidophorus spec.* and in *Anguis fragilis*. In *Cnemidophorus* the first formation was paired and consisted of a triangular widening of the ventral end of the first (future) vertebro-sternal rib. This primitive formation developed caudally only so far as further ribs attached themselves to it, so not independently. Moreover GÖTTE thinks it probable that the last cervical rib, which in the further development is more and more removed from the sternum, has also taken part in the first formation of the sternum. In *Anguis* the sternum was formed out of the widened end of the first rib, which soon after this was loosened from the sternum.

Apparently the embryos examined by RATHKE were too old for the purpose. The results of WIEDERSHEIM'S²⁾ examinations of *Lacerta* and *Anguis* agree very well with GÖTTE'S experiences. Only he thinks it probable, that also the last but one cervical rib takes part in the formation of the sternum. Also in *crocodilus biporcatus* the sternum, according to WIEDERSHEIM, is formed by the ribs.

SCHAUINSLAND³⁾ describes the sternal formation in *Sphenodon*, first connected only with one rib, afterwards with three. Out of these one has to think the sternum has been formed. And, lastly, according to BOGOLJUBSKI⁴⁾ the paired first sternal formation in *Lacerta* and *Anguis* is formed without any original connection with ribs, is therefore an autochthonic formation. In short, according to the generally prevailing opinion the sternum of the reptiles is formed out of the ribs⁵⁾. Only BOGOLJUBSKI supposes the sternal formation in the reptiles to be autochthonic.

It is advisable to mention here that there are some more theories on the development of the sternum of higher amniota, the mammals. According to PATERSON⁶⁾ the first formation of the sternum consists of an unpaired, dense mass of mesoblastcells, lying in the median line. Later on one finds two sternal bands because the median part has become poorer in cells. The relation between ribs and sternum is secondary, on the other hand there is a primary connection between the median formation and the shoulder girdle. WHITEHEAD and WADDEL⁷⁾ suppose the mammalian sternum to be built out of

¹⁾ A. GÖTTE. *Archiv. f. mikrosk. Anat. Bd. XIV, 1877.*

²⁾ R. WIEDERSHEIM. *Das Gliedmaszenskelett der Wirbelthiere. Jena, 1892.*

³⁾ H. SCHAUINSLAND. *Archiv. f. mikrosk. Anat. u. Entw.gesch. Bd. LVI, 1900.*

⁴⁾ S. BOGOLJUBSKI. *Zeitschr. f. Wissensch. Zool. Bd. 110, 1914.*

⁵⁾ O. HERTWIG'S *Handb. d. vergl. u. experim. Entwickl.lehre. Jena.*

⁶⁾ A. M. PATERSON. *Journ. of Anat. and Physiol. Vol. 35. 1900.*

⁷⁾ R. H. WHITEHEAD and WADDEL. *Americ. Journ. of Anatomy. Vol. 12, 1911.*

two autochthonic sternal bands, and moreover out of a third, also autochthonic, median formation. This median formation is independent of the sternal bands, and also of the shoulder girdle. This appears most clearly by the fact that the median formation is present also there where the clavícula is absent, so where the shoulder girdle does not reach the sternum. HANSON¹⁾ sees in the median formation part of a large blastema with the shape of a horse-shoe, out of which the two shoulder girdles and the cranial part of the sternum are formed.

All biologists who examined the development of the reptilian sternum agree that the sternal bands are fused after their becoming cartilaginous. And after that, calcification may follow.

In order to get an opinion founded on personal observation I examined a number of sauria-embryos. My experiences may follow here.

For this examination I had at my disposal a dozen embryos of *Gongylus ocellatus*, sectioned into series, and two of *Ptychozoon homalocéphalum*. Besides, transversal series were made of some

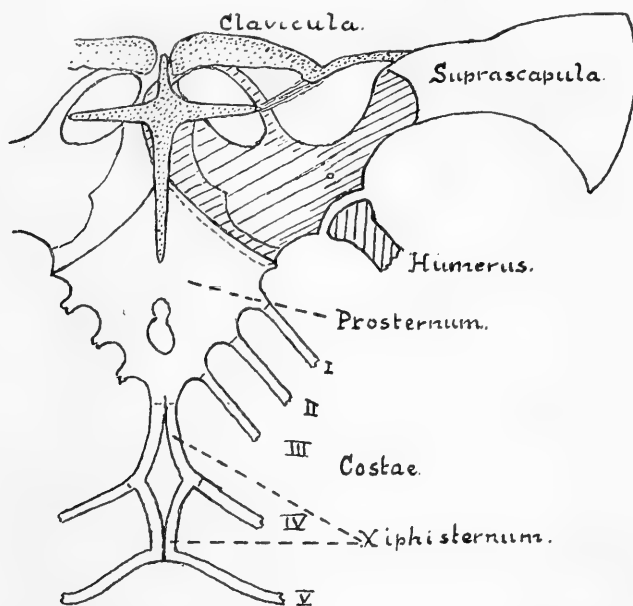

Fig. 1. Sternum and shoulder girdle of *Lacerta agilis*.

sixteen embryos of *Lacerta agilis*. All series had been sectioned $10\ \mu$ thick, most of them had been coloured with haematin. The development of the sternum could be very well observed in this series of

¹⁾ F. B. HANSON. Americ. Journ. of Anatomy. Vol. 26, 1919.

embryos of *lacerta*, which was sufficient in all respects. Therefore I shall begin with a description of my experiences with *lacerta*.

For further elucidation the shoulder girdle and sternum of an adult *lacerta agilis* have been drawn from nature in diagram 1. The whole complex has been drawn in a plane. One may observe that at both sides of the prosternum three ribs are inserted by syndesmoses, and that the xiphisternum supports two ribs. It would be better to speak of two xiphisterna here, as at the level of the fifth rib there is only a syndesmotic connection in the median plane. Prosternum and xiphisternum are also connected by syndesmoses. Coracoideum (hatched) and sternum are connected by a diarthrosis; the coracoideum fits in a groove, sulcus articularis coracoideus, of the sternum. Clavicula and episternum, which are further left out of consideration, are dotted.

In the prosternum we find a fontanel closed by membrane.

The youngest embryo at my disposal, *Lacerta* ag. D. (N.T. ¹⁾ about 22) had not yet any sternal formation. Neither was there anything to be found of the shoulder girdle as yet. Only in the extremity a thickening of the mesenchym, the first formation of the humerus, was found.

The next embryo, *Lacerta* ag. S. (N.T. about 24) differs from the preceding one in so far that the formation of the shoulder girdle, continuous with that of the humerus, is visible. As this shoulder girdle is as yet very vaguely outlined, one can hardly distinguish any shape in it, at most a ventral coracoidal part and a dorsal scapular part. Now if one looks more in a caudal direction, one finds in the sidelong wall of the trunk a densening of the mesenchym, which is unconnected with any other skeleton-formation. This is the first formation of the sternum, which as yet consists exclusively of blasteme, dense mesenchym. In diagram 2 a transversal section has been drawn, in which there is a sternal formation. The section is not quite transversal; in the lower part we see the humerus, in the upper part radius and ulna. Still the left hand as well as the right hand sternal formation are present in the section. This proves that the sternal formation has already been extended in cranio-caudal direction. It is not possible to demonstrate in pictures of transversal sections the independences of the sternal formation of the humeral zone (in casu the coracoideum). As will appear later on the more obliquely sectioned series of *Gongylus ocellatus* are better suited for this purpose.

¹⁾ Normentafel. *Lacerta agilis* von K. PETER.

The next stage is represented by the embryos *Lacerta ag.* E and F (N.T. about 26), which show nearly the same stage of development. The outline of the shoulder girdle has become clearer. The coracoidal and the scapular part can very well be recognized. In

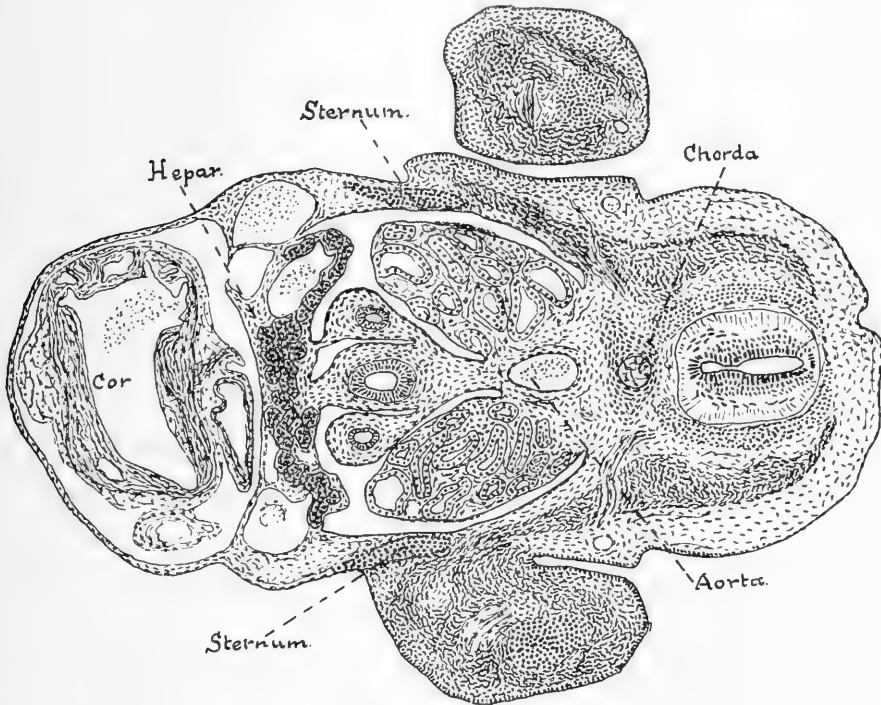

Fig. 2. *Lacerta agilis* S. transversal.

the humeral diaphysis praechondrium is found. In comparison with embryo D there is a further progress in the increased size of sternum and shoulder girdle. Sternum and shoulder girdle have grown in each other's direction. This has caused the layer of undensened mesenchyme, ab origine found between them, to become less clear.

A considerable progress in development may be stated in the embryo *Lacerta ag.* I (N.T. about 28). In the humerus we here find for the first time cartilage. In their further growth sternum and coracoideum have come so near to each other that they appear together in transversal sections. It has become almost impossible to outline them clearly with respect to each other. In the accompanying diagram we see an only slightly lighter zone of partition. If the embryos described above had not been examined, the sternum would, on the ground of this embryo, certainly have been declared to be a product of the coracoideum, and this stage would have been interpreted as the first stage of the sternum being cut off its matrix, the coracoideum. The ribs have approached the sternal formation

up to some distance, so that the length of the sternal forman to can now also be indicated with respect to the ribs. In caudal direction the sternum reaches to the level of the third rib. Between the sternal formation and the ventral ends of the ribs we find everywhere loose mesenchyme.

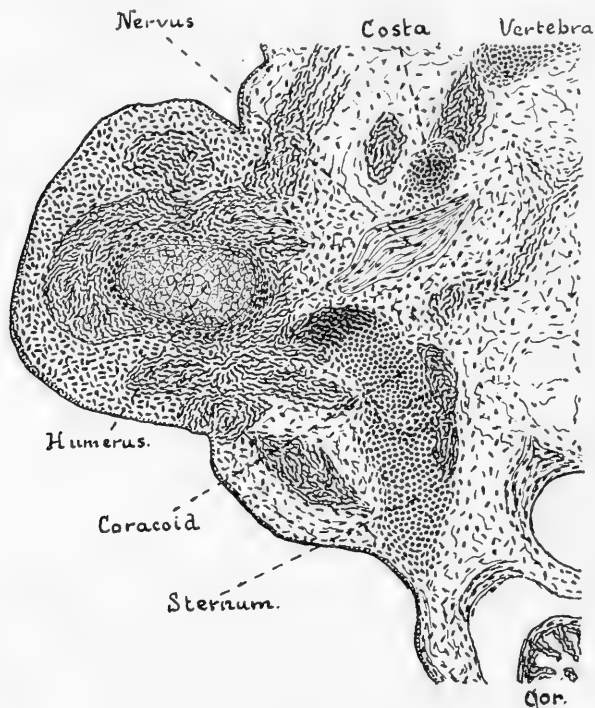

Fig. 3. *Lacerta agilis* I. transversal.

In the embryo *Lacerta agilis* K (N.T. about 29), which is only slightly older than the preceding one, again a clear partition of coracoideum and sternum is present, a fact which strikes one also in studying the embryo *Lacerta ag.* G., which represents the same stage of development as the embryo K. The zone of partition, here again present, is nothing else than the formation of the later sterno-coracoidal articular cavity. Both the embryos G and K have a paired sternal formation, reaching caudally to the level of the third rib, and separated from the ribs by loose mesenchyme.

In the embryo *Lac. agilis* H (N.T. about 30) a considerable progress is noticed. This progress concerns the form of the parts of the skeleton as well as the histological differentiation. In the vertebral arches we find cartilage, round the cartilaginous humeral diaphysis we find a thin coat of perichondral bone. Diagram 4 brings us one half of a transversal section in which the ventral end of the first thoracic rib (the first future vertebro-sternal rib) is found. The purpose of the

diagram is to demonstrate the relation between the first rib and the sternal formation. In this embryo, which has reached a rather advanced stage of development, as is proved by the advanced histological differentiation, still all connection between sternum and ribs

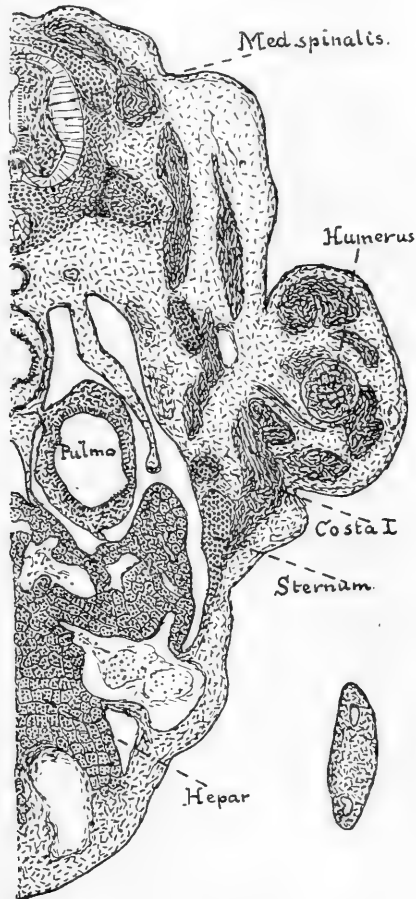

Fig. 4. *Lacerta ag. H. transversal.*

is wanting. The second and third ribs namely behave exactly in the same way as the first.

The next embryo, *Lacerta ag. J.* (N.T. about 31) is distinguished from all those described above by the possession of a sternal formation, which extends in a caudal direction past the third rib. The sternal formation here consists of one larger cranial part, in which praeochondrium is found and with which three thoracic ribs are connected by moderately dense mesenchym, and a small caudal part, which has the appearance of an offshoot of the former. This offshoot is still purely dense mesenchym and ends at a short distance

of the ventral end of the fourth rib, separated from the latter by loose mesenchym. At the description of the embryo *Gongylus ocell.* L. one finds entirely similar relations made clear by two frontal sections (diagr. 6).

Embryo *Lacerta* ag. L. (N.T. about 31) shows little progress as compared with embryo J. The principal point is that the two sternal ridges are here connected with three ribs by entirely densened mesenchym. The relation between the fourth rib and the sternum has not undergone any change. The extension of the praechondrium in the sternal formation has increased. The caudal offshoot is still entirely free from praechondrium. If one compares diagrams 2 and 4, one sees that the sternum in diagr. 4 is still found at the same place as in diagr. 2 viz. in the lateral trunk-wall. Shifting towards the ventral median line has not yet taken place. In the older embryos following, this shifting becomes clearer and clearer. One might suppose some connection to exist between this shifting and the longitudinal growth of the ribs with which the sternal formation is now connected. It seems to me better to take the relative decreasing of the heart-bulge for the only cause of this. For though in *Anguis* the sternum and the only vertebro-sternal rib are soon definitively separated (WIEDERSHEIM), still the sternal halves shift towards the median line to grow into one whole there.

In embryo *Lacerta* ag. N. (N. T. about 32) we find a beginning of important phenomena of development. In the first place a densening of mesenchym has appeared here between the end of the fourth rib, and the still blastematal end of the sternum. Here is as yet no question of complete joining, as the intermediate zone has not yet reached the same state of density as the sternal formation. The ventral end of the fifth rib, the last of the future vertebro-sternal ones, is situated thirteen sections caudally (130μ) to the insertion of the fourth rib to the sternum in the straight ventral muscle.

In the second place I have to mention here that, in spite of its further development in comparison with embryo L, the sternal formation does not reach caudally past the insertion of the fourth rib.

From various circumstances it appears that embryo *Lacerta* ag. N. (N. T. ab. 33) is further developed than the preceding are. As regards the sternal formation, here too the fourth rib is connected with the blastematic caudal end of the sternum by completely densened mesenchym. The end of the fifth rib is situated only eight sections (80μ) caudally to the insertion of the fourth rib to the sternal band. Consequently the fifth rib has been lengthened, and has grown in the direction of the sternal formation. But, conversely,

the sternal formation has not been lengthened past the fourth rib in the direction of the fifth. I think I have to conclude from this that the autochthonic sternal formation does not reach further caudally than up to the insertion of the fourth rib. The two sternal bands in this embryo have come cranially within a very short distance of each other. Neither here nor in any of the younger embryos there could be observed anything like a median formation that was also to grow into one whole with the sternum. Still the sternal ridges are here found immediately before the beginning of the growing together in the median line, as appears from the following embryo.

I found a somewhat older stage in the embryo *Lacerta* ag. Q. (N. T. about 33). The sternal bands, which here were cartilaginous, had already fused in the most cranial part. Caudally to the later breastbone-fontanel as yet no joining had taken place in the median line. All five ribs were joined by means of cartilage to the sternum, which was also cartilaginous; so they formed together one large continuum of cartilage. Moreover the syndesmoses are wanting, which in the adult lizard separate the xiphisterna from the prosternum.

In the embryo *Lacerta* ag. Q. (N. T. ab. 33—34) the sternal bands have fused cranially, as in embryo P; then follows the region of the breastbone-fontanel; still more caudally, on a level with the insertion of the third rib, the sternal bands are again situated close to each other. A thin layer of blastema proves that no fusion has as yet taken place here. Caudally to this part the sternal ridges diverge, never to reach each other again (c. f. diagr. 1).

Still completer is the fusion of the sternal bands in embryo *Lacerta* ag. R (N. T. ab. 34—35), while in embryo Q there was only a blastematic connection in the median line, in embryo R a cartilaginous connection is formed caudally to the fontanel. Moreover the two xiphisterna have joined on the level of the fifth rib. So in this embryo, the oldest examined by me, the adult form has been reached, at least in the main. A difference is still formed by the absence of all syndesmoses. They have to be formed secondarily in places where cartilage existed first. Therefore these syndesmoses have no morphological value; they are not lines of division to which, strictly taken, any importance may be attached. They have only a mechanical importance.

Of *Gongylus ocellatus* I had eleven embryos at my disposal. Older stages, like the embryos P, Q and R of *lacerta* were wanting. Neither did I possess an adult specimen, nor an image of the adult sternal apparatus. So I can only give a few data established in

literature concerning the structure of the latter. In *Gongylus*, as in *Lacerta*, three ribs are fixed to the Prosternum. To the xiphisternum, too three ribs are fixed (HOFFMANN¹), PARKER²), FÜRBRINGER³). With the exception of this difference, which had no importance for the study of my material, the relations agree with those of *Lacerta*.

The embryo *Gongylus ocellatus* F. and G. agree in their stage of development with the embryo S. of *Lacerta*. They contain a blastematic sternal formation, which is clearly unconnected with the formation of the coracoideum.

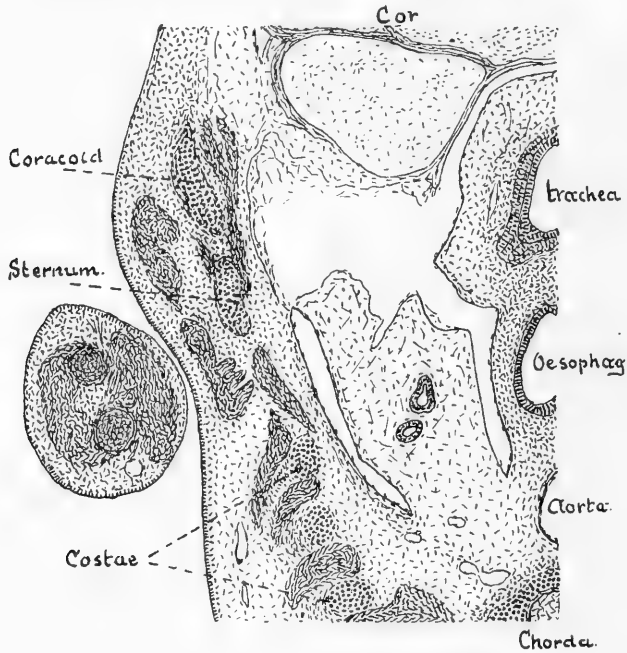

Fig. 5. *Gongylus ocell.* F. obliquely frontal.

Thanks to the oblique direction of sectioning it was possible to draw the abovesaid relation between sternum and coracoid in diagr. 5, which represents part of such an oblique section. Also by the peculiar direction of sectioning, in this section the sternum is situated dorsally to the coracoideum. Between the two we find a small layer of loose mesenchym. In the diaphysis humeri we find already some praechondrium.

A following stage is represented by the embryos *Gong. ocell.* A and B. They are similar to the embryos E and F of *lacerta*. The

¹) C. K. HOFFMANN in BRONN's Klassen u. Ordn. des Thierreichs. Reptilien.

²) W. K. PARKER. Monogr. on the Struct. a. developm. of Should. g. and Stern. Ray Soc. 1868.

³) M. FÜRBRINGER. Jenaische Zeitschr. Bd. 34, 1900.

sternal formation is not clearly separated from that of the coracoideum; the cause of this state of things lies in the fact that the two have grown in each other's direction. The humerus is here for the greater part built up of cartilage. The ribs are still separated from the paired sternal formation by loose mesenchym.

Still further developed are Gong. ocell. C and D. They have a breastbone formation that is clearly separated from the coracoideum by a thin dividing layer, the formation of the diarthrose. The stage in which the division of sternum and coracoid was almost impossible, is over here. The three ribs, which end within a short distance of the sternum are still entirely unconnected with A. The sternal formation does not reach further caudally than the third rib.

The embryos E and J of Gong. ocell., too represent one and the same stage. As a basis for description I take embryo E. Sternum and coracoid are definitively separated. Three ribs are connected with the praecondral prosternum by mesenchym that is moderately dense.

A caudal blastematic offshoot of the sternal ridge grows in the direction of the fourth rib, but is still entirely unconnected with it. As some few sections were wanting I could not with certainty fix the relation between all prosternal ribs separately and the sternum. Undoubtedly the above said observations can be generally applied, as is proved by Gong. ocell. I. In this embryo there is one and the same relation between each of the three ribs and the sternum, viz. that of a still less clear connection than in embryo E. The caudal offshoot of the sternal formation, too, is smaller here. On the other hand the relation towards the coracoid is the same.

Embryo Gong. ocell. L. corresponds with embryo lacerta J. On both sides three ribs are joined to the sternal formation by completely dense mesenchym. An offshoot grows in a caudal direction towards the fourth rib, as is shown in diagr. 6. In this diagram two consecutive sections out of this series have been partly drawn. The direction of sectioning was here frontal to the thorax. The sternal formation has here to a large extent shifted in medio-ventral direction

In embryo K, lastly, the one furthest developed, the fourth rib, too, is joined blastematically to the sternum. For want of older embryos the development of the xiphisternum in *Gongylus* could not be followed any further. From what precedes it appears that the results obtained in *Gongylus* are a confirmation of the experiences in *Lacerta*.

Finally, I had an opportunity to study two series of young embryos of *Ptychozoon homalocephalum*.

In the embryo *Ptychoz. hom. A* we find a very early stage. A blastematic paired sternal formation, unconnected with any other skeleton-formation, is found in the lateral trunk-wall.

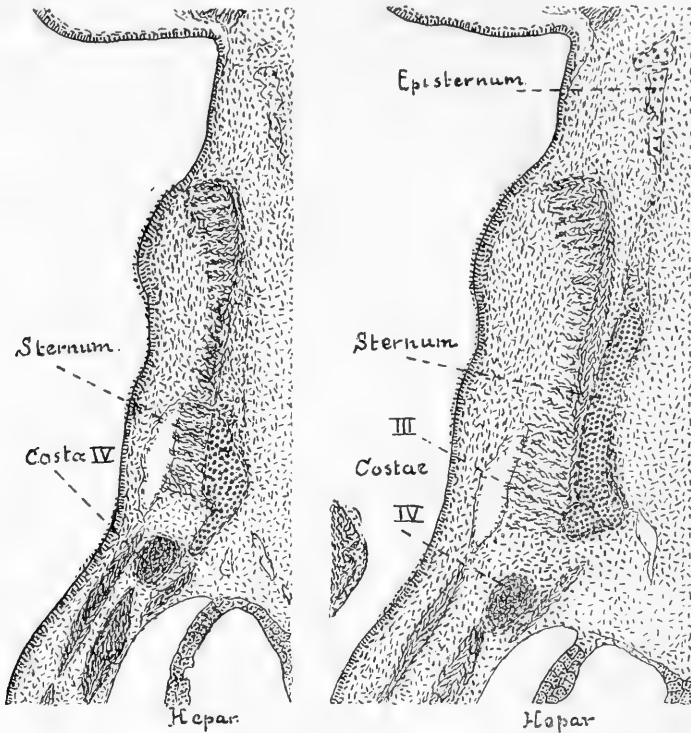

Fig. 6. *Gongylus ocell. L. frontal.*

If one sees the smallness of the ribs, and that in the humerus no cartilage is as yet present, one may conclude that the maximal approach of sternum and coracoideum has not been reached by a long way, in other words that the zone of division does not represent the formation of the articular cavity. So this embryo corresponds on the whole with embryo *S.* of *lacerta*.

The embryo *Ptychoz. hom. B* is much older. On both sides one finds a sternal formation to which three ribs have been joined.

In the preceding words my experiences in studying some thirty embryos were rendered separately. We shall now consider what conclusions they enable us to draw.

In the first place: the youngest formation of the sternum is paired and autochthonic; in so far I quite agree with BOGOLJUBSKI. If one has come to this conclusion, one has to ask oneself this question: What part of the definite thorax-skeleton was formed out of this

autochthonic sternal formation, or in other words: where are the divisions between the autochthonic breastbone and the ribs situated? With regard to the first three vertebro-sternal ribs the answer is easy. Here the abovesaid divisions correspond with the definitive syndesmoses sterno-costales. With regard to the fourth and fifth ribs, in order to get certainty there, one has partly to take for basis magnitudinal relations such as are represented in diagram 7. In diagr. 7*d* the little crosses indicate the situation of the definitive sternocostal syndesmoses. It appears from the diagram that the place where the fourth rib has placed itself against the autochthonic sternal band (7*c*) is not the same as that where later on the syndesmoses sterno-costalis IV is found, but that the latter is situated at the place of the later division between prosternum and xiphisternum. One

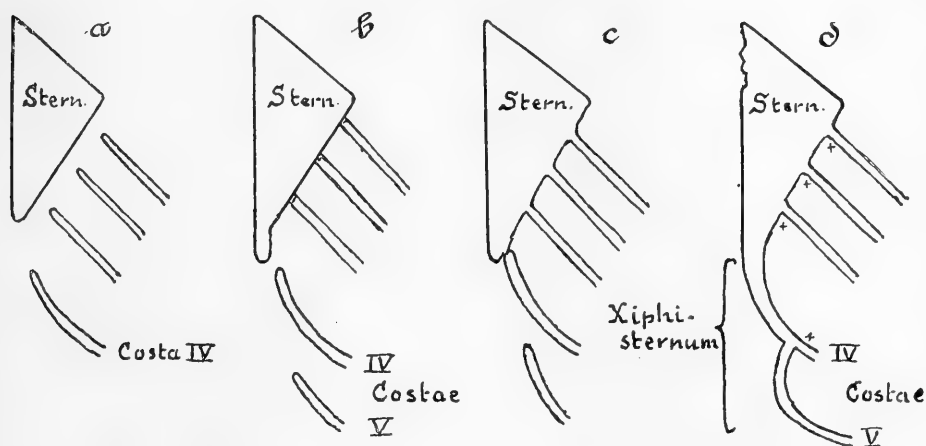

Fig. 7. *Lacerta agilis*. Outlines of the development of the Sternum.

may be reminded again of the fact that all syndesmoses in this region of the thoracic skeleton have been formed secondarily in places where first (7*d*) there was cartilaginous continuity. A consequence of this is also that one will never be able to tell exactly where in adult reptiles the autochthonic sternum ceases, where the ribs begin. I never saw the autochthonic sternal formation reach further caudally than the insertion of the fourth rib. On the other hand I did not see either that the fifth rib placed itself against the fourth, while the latter did not yet form a cartilaginous continuity with the sternal band. Consequently one has again to take for basis the magnitudinal relations of diagr. 7 in order to come to the conclusion, probable for an abovesaid reason as well, that the fifth rib tries to come into contact with what was formed out of the fourth rib, and not with the autochthonic sternal

formation. So, *summa summarum*, the sternum of the sauria consists of an autochthonic (paired) prosternum and the costal, also paired, xiphisternum, which often continues to be two xiphisterna. Of the two the autochthonic prosternum is formed first. The xiphisternum is not formed until the paired formation of the prosternum has become partially unpaired (by cranial fusion). The whole process of development of the sternum is rendered in *diagr. 7*; in each part of this figure the sternal formation of only one half of the body was drawn, in *diagr. 7d* half of the sternum, which is already unpaired cranially.

Now we have to consider what comparative anatomical conclusions we are brought to by the foregoing embryological facts.

According to the well known manuals on comparative anatomy by GEGENBAUR, WIEDERSHEIM and BÜTSCHLI the sternum of the tetrapode vertebrates occurs in two entirely different forms, viz. in Amphibia we find a sternum to the formation of which the very short vertebral ribs have certainly not coöperated, and in Amniota there is only a costal sternum, formed by the fusion of two so-called sternal bands, which in their turn were formed by the fusion of the ventral ends of the (vertebro-sternal) ribs. Howes¹⁾ designated the sternum of the amphibians as archisternum and the sternum of the amniota he called neosternum. So in amniota the archisternum has disappeared without leaving any trace and been replaced by the neosternum. (In passing I remind the reader of the episternal elements that may have been fused with the latter). So it is a generally acknowledged fact that the amphibious sternum has another genesis than that of the amniota.

Between the sternum of the amphibians and the shoulder girdle there are various relations. In Urodela and the Anura arcifera the sternum on both sides absorbs the coracoid by diarthrosis in a sulcus *articularis coracoideus*, just as in the Sauria. In the Anura firmisternia on the contrary the two coracoids are joined to the sternum by synarthrosis. The two epicoracoidea, too, are here fixed to each other, so that the sternum here behaves like a caudal appendix to one solid complex, which consists of the shoulder girdles on each side. Researches into the development of the sternum of the amphibians have been made by GÖTTE and WIEDERSHEIM. According to GÖTTE²⁾ the first formation of the sternum is originally paired. Afterwards it fuses into one whole with the point of the arch of the abdominal ribs.

¹⁾ HOWES. „Nature”. Vol. 43. N^o. 1108, p. 269.

²⁾ GÖTTE. *Entwickl.gesch. der Unke*. Leipzig 1875.

The sternum of the Ranidae is supposed to have been formed out of the aforesaid paired first formation. At another place GÖTTE sums up his theories in the following way: the amphibians have no costal sternum. Its place is taken up by skeleton-parts of various origin, viz. 1°. by cartilage, formed in the linea alba abdominis and in the tendinous band of the m. rectus abdominis, which has to be considered as homologous with ventral ribs, and 2°. by cartilage formed in the membrane interepicoracoidea, there where the latter is inserted to the part spoken of sub 1°. the sternum of urodela and that of Bombinator (arcifera) consists of both parts. The sternum of the Ranidae (firmisternia) is supposed to have been formed only out of the part named sub 1°. the part formed in the membrane interepicoracoidea is considered by GÖTTE as belonging to the humeral zone.

The results of WIEDERSHEIM's researches may be summed up as follows. In the formation of the (paired) sternal formation neither in Anura nor in Urodela the humeral zone has any share. The whole development of the sternum takes place in, resp. between the muscles of the wall of the body. In the Amphibians, too, one has to speak of a costal sternum, for why should ventral parts of the myocommata that are becoming cartilaginous have to be considered from another morphological point of view than the ribs lying near the spinal column?

Let us sum up the facts found by GÖTTE and WIEDERSHEIM. In the first place the sternum is formed pairedly and in the second place it is formed loose from any previously existing skeleton-formation, in so far the theories agree. Only the interpretation of the facts is partly different. GÖTTE as well as WIEDERSHEIM speak of ventral ribs. WIEDERSHEIM brings back the whole of the amphibian sternum to ventral ribs. GÖTTE is in favour of a coracoidal origin for a large part of the sternum of the Urodela and that of Bombinator (arcifera), as well as for the whole sternum of the Ranidae (firmisternia), only because it grows in the membrana interepicoracoidea. But after all neither of these interpretations can explain away the fact that the first formation of the sternum of all amphibians is formed quite independently, in other words that it is autochthonic.

Consequently there is a genetic similarity between the sternum of the amphibians and the prosternum of the sauria; so they are homologous. The costal xiphisternum of the sauria is the ontogenetically as well as phylogenetically later formed sternal element. The value of this homology is not diminished by the fact that afterwards

in the sauria a varying number of ribs comes into contact with the prosternum, neither is it diminished by the fact that in the anura firmisternia the sternum becomes secondarily connected with the shoulder girdle. In this, as well as in the lately formed costal xiphisternum of the sauria one has to see adjustments to the further development of the anterior extremity as organ of locomotion and of support, a fact which is connected with the transition to landlife.

I am unable to find, aided by the study of the literature relating to this, further points of connection in crocodilia, aves and mammalia for the thesis developed in the preceding words.

RECAPITULATION.

1. The prosternum of the sauria is autochthonic and formed pairedly. A varying number of ribs becomes secondarily connected with the prosternum.
 2. The xiphisternium of the sauria is costal and is also formed pairedly. To its formation cooperate those ribs that follow after those fixed to the prosternum.
 3. The prosternum of the sauria is homologous with the sternum of the amphibians. Phylogenetically and ontogenetically it is older than the costal xiphisternum, developing in the sauria.
-

Physiology. — “*On the formation of heterogenetic antigen by combination of hapten and protein*”. By K. LANDSTEINER
(Communicated by Prof. C. H. H. SPRONCK).

(Communicated at the meeting of November 26, 1921).

In former communications,¹⁾ which also contain references of the literature on the subject, the author came to the conclusion, that the peculiar properties of heterogenetic antigen very likely can be explained as follows.

These antigens consist of two different parts, one an alcohol soluble part (perhaps of lipoid nature) and one a protein. The alcohol soluble-part has the property of reacting specifically in vitro, but is devoid of antigenic properties (similar substances have been called by the author hapten) whereas only the entire complex (hapten + protein) acts as an antigen. Since that time, the same opinion has been expressed by TANIGUCHI.²⁾

The author deemed it desirable to confirm this view by direct proof and therefore he undertook to investigate whether it would be possible to obtain an artificial antigen by combining the hapten with a protein which as such contains no heterogenetic antigen.

It was doubtful at the onset whether this endeavour would be successful, since similar phenomena are not yet known. The experiment however gave positive results. Each of 5 groups of rabbits was injected intraperitoneally with one of the following substances.

I. Pig serum ten times diluted with 0,9 percent saline.

II. Alcoholic-extract of 15 gr. horse kidney emulsified with 100 c.c. 0,9 percent of saline.

III. As I, but heated for a $\frac{1}{2}$ hour at 80° C.

IV. The extract of horse kidney emulsified with ten times diluted pig-serum.

V. As IV but heated for a $\frac{1}{2}$ hour at 80° C.

The rabbits were injected with 5 c.c. of these solutions six times,

¹⁾ Meeting of the “K. Akad. v. Wetensch. te Amsterdam” of Februari 26, 1921. Biochem. Zeitschr. **119**. 294 (1921).

²⁾ Journ. of Path. a. Bact. **24**. 253, 254. Juli 1921.

each time with an interval of one week. After the addition of $\frac{1}{4}$ percent phenol the solutions were kept in the icebox.

A week after the last injection the hemolytic action of these sera on sheep-blood was examined.

The technique used in these experiments and the indication of the results are the same as in the former communication (m. tr. = minim trace). In the table given below the results of hemolysis are indicated.

Injection of preparation	I				II				III			IV			V				
	0	0	0	m. tr.	0	0	0	tr.	0	0	0	c.	d.	f.	m. tr.	tr.	m.	f.	a. c.

The experiments will be published extensively elsewhere.

The results obtained encourage further research on the possibility of obtaining antigenic actions by combining various non antigenic substances with proteins.

Physics. — “*A moving coil galvanometer of high sensitivity*”. By Prof. F. ZERNIKE. (Communicated by Prof. H. HAGA).

(Communicated at the meeting of October 29, 1921).

Introduction. The problem to determine the conditions for which a moving coil galvanometer reaches maximum sensitivity, has been frequently discussed in the literature of the subject¹).

The result attained is in short as follows: for any fixed period of oscillation the sensitivity varies inversely as the root of the *moment of inertia* K of the moving system.

Now the *torque* D of the suspension cannot be decreased beyond the limit determined by the smallest dimensions of suspension strip available, which limit until recently was 0,2 C.G.S. Hence K , which is proportional to D , cannot be decreased indefinitely.

In recent years several galvanometers have been constructed with much smaller torques. Even if there was no limit to the smallness of D , the sensitivity would still be restricted as K cannot be indefinitely decreased because of the presence of the *galvanometer-mirror*. Indeed it is very remarkable that in the above mentioned discussions this important detail of the instrument has hardly been taken into account. Only EINTHOVEN²) has laid stress upon the fact that by judging the sensitivity of galvanometers the size of the mirror ought to be taken into account. As is well known, his studies led to the construction of another type, the stringgalvanometer, hence do not answer the question which we put: *how to make a reflecting galvanometer with moving coil as sensitive as possible*.

To solve this question I will start with a given mirror. Up till now the mirror was considered to be a detrimental though a necessary addition, because it increases the moment of inertia. Indeed I found the moment of inertia of the mirror to be from 1 to 3% of the whole system in different commercial instruments. I will invert this

¹) See i.a. W. JAEGER, Z f. Instrumentenk. **23**, 261 en 533 (1903).

W. P. WHITE, Phys. Rev. **19**, 305 (1904).

W. J. H. MOLL, these Proc.

Discussed at length by W. JAEGER, Elektrische Messtechnik, Leipzig 1917, pg. 204 sqq.

²) W. EINTHOVEN, Ann. d. Physik **12**, 1062 (1903).

and state: the coil is a detrimental though a necessary addition to the mirror, and one should take care that the total moment of inertia does not become much greater than that of the mirror.

The following formulae will show clearly what may be attained in this respect. Afterwards I shall prove that for the technical construction according to these principles one can calculate every detail of construction about in the same way as an engineer calculates a dynamo, at the same time I shall give the data of actually constructed galvanometers, as they are put on the market by KIPP and Sons Ltd., Delft.

Calculation. For the voltage sensitivity we have

$$P = \frac{Hf}{Dr} \dots \dots \dots (1)$$

as condition for the limit of aperiodicity

$$\frac{H^2 f^2}{2r} = \sqrt{DK} \dots \dots \dots (2)$$

and for undamped oscillations

$$D = \frac{4\pi^2}{T^2} K \dots \dots \dots (3)$$

Here and further on the letters have the following meaning:

P rotation in consequence of unit e.m.f. in the circuit,

H intensity of the magnetic field,

f winding surface of the coil,

D torque for unit angular displacement,

K moment of inertia of the whole system,

*K*₀ moment of inertia of the coil,

r resistance of the whole circuit,

*r*₀ resistance of the coil,

T complete period of the undamped oscillations,

m = *H*/*H*_{min},

in which all quantities are to be expressed in electromagnetic C.G.S. units.

Eliminating *Hf* and *D* from (1), (2) and (3) we get:

$$P^2 = \frac{T^2}{4\pi^2 K r} \dots \dots \dots (4)$$

for the voltage sensitivity. Now it is well known that the current sensitivity of any galvanometer is proportional to \sqrt{r} , the voltage sensitivity inversely proportional to this. Therefore the power sensitivity (Watt-sensitivity) is independent of the resistance. It is apparent from (4) that we can only increase this power sensitivity

by reducing K or by increasing T . The latter alternative, however, would soon render the galvanometer less fit; therefore I prefer to introduce at once the maximum value of T which we will allow in any special case. So we must try to find the maximum of (4) for fixed T , mirror and external resistance. Moreover I'll assume H to be given. From the result it will then be clear in which way the resulting sensitivity depends upon H . From (2) and (3) we find:

$$H^2 = \frac{4\pi}{T} \cdot \frac{Kr}{f^2} \dots \dots \dots (5)$$

Now suppose the coil to be short circuited and the mirror removed by which $Kr = K_0r_0$, thus assuming its minimum value for the coil in use.

From (5) we then derive the minimum value of H with which the galvanometer can be made aperiodic. The importance of this minimum magnetic field, which I shall represent by H_{min} , lies in the fact that this quantity appears to be independent of the dimensions of the coil, the diameter of the wire etc. Indeed, taking only the vertical part of the windings into account, it will be easily found that:

$$\frac{K_0r_0}{f^2} = s\sigma$$

i.e. the product of the density and the specific resistance of the metal. The horizontal part of the circuit of the coil, the insulation etc. can only *increase* the value found here and consequently H_{min} . The following relations therefore hold:

$$H_{min} = \frac{4\pi}{T} \frac{K_0r_0}{f^2} = \frac{4\pi s\sigma}{T} \dots \dots \dots (6)$$

so that H_{min} must be considered as a constant in finding the maximum sensitivity.

(5) and (6) give:

$$\frac{H^2}{H_{min}^2} = \frac{Kr}{K_0r_0} = m^2 \dots \dots \dots (6a)$$

in which thus m is a known number > 1 . Representing K/K_0 by k , $r/r_0 = m^2/k$. Instead of (4) we can write:

$$P^2 = \frac{T^2}{4\pi^2(K-K_0)(r-r_0)} \cdot \frac{1}{m^2} (k-1) \left(\frac{m^2}{k} - 1 \right)$$

In this expression only the two last factors are variable. Their product is a maximum for $k = m$. Hence the conditions for maximum sensitivity are:

$$\frac{K}{K_0} = \frac{r}{r_0} = \frac{H}{H_{min}} \dots \dots \dots (7)$$

and thus the maximum sensitivity:

$$P^2 = \frac{T^2}{4\pi^2 (K-K_0) (r-r_0)} \cdot \frac{(m-1)^2}{m^2}.$$

From this we derive that m should be made as large as possible. $K-K_0$ is the moment of inertia of the mirror, $r-r_0$ is the given external resistance (rather + the resistance of the flexible leads which is a known quantity in any special case). The greatest though in practice unattainable sensitivity is thus:

$$P_{max}^2 = \frac{T^2}{4\pi^2 K_{mir} r_{ext}} \dots \dots \dots (8)$$

whilst the ratio P/P_{max} might be called the efficiency of the galvanometer. Hence one generally finds for this efficiency:

$$\frac{P}{P_{max}} = \frac{1}{m} \sqrt{(k-1) \left(\frac{m^2}{k} - 1 \right)} \dots \dots \dots (9)$$

As m can be e.g. 10 the conditions (7) mean that one should not only — as is known from former researches — reduce the resistance of the galvanometer compared with the external resistance, but that also the moment of inertia of the coil should be small in comparison with that of the mirror.

Technical construction. We are going to make use of the above mentioned formulae for the further calculation of galvanometers with two different periods of 3 resp. 8 sec. For the circular mirrors which may be used we have:

Diameter	12	10	8 millimeters
Moment of inertia	0,0055	0,0026	0,0011

for a thickness of 0,20 mm. Mirrors thinner than this are mostly insufficiently plane, besides they warp too easily in mounting.

The attainable value of H depends not only on the size of the permanent magnet which is used but also on the dimensions of the airgap. For various existing galvanometers I found for H values near 700; once I found 1100. The small coils with only few turns of wire, which are needed according to our calculations, allow to increase H considerably, provided one places an iron core inside the coil. I use for example a core of 6.8 mm. diameter and 15 mm. height, and an airgap of 1.2 mm. round it. The coil then consists of rectangular turns of wire of 8×16 mm. With a simple steel-magnet the magnetic field proved to be

$$H = 2000$$

I am going to accept these values for the following. From (6) we

derive for copper with $T = 3$ resp. 8 sec., $H_{min} = 250$ resp. 150. Taking however the horizontal pieces of the wire into account, the resistance increases $\frac{1}{2}$ times, the moment of inertia $\frac{7}{6}$ times, whence:

$$H_{min} = 330 \text{ resp. } 200$$

$$m = 6 \quad ,, \quad 10$$

Not to make the coil too thin and mechanically too weak, I'll not take in accordance with (7) $K/K_0 = m$, but $= 3$. Then according to (9) the efficiency will still be 78 resp. 80 % whereas it is 83 and 90 % in the most favourable case.

When we choose for the faster galvanometer a mirror of 8 mm., for the other a mirror of 10 mm. we get:

$$K_0 = 0,0005 \text{ resp. } 0,0013$$

and

$$D = 0,0070 \quad ,, \quad 0,0025$$

These are about the utmost values which we can use, so that smaller mirrors would hardly produce a greater sensitivity. We have namely up till now neglected *the airdamping* in our calculations. This appears to be already quite perceptible here. By further reducing the product KD which is $10 \cdot 10^{-6}$ here, we should cause the galvanometer to be already aperiodically damped on open circuit. By using a smaller coil one could get somewhat further.

To complete the calculation the resistance must be known. As an example I choose 100Ω for the total resistance. From (6a) we derive:

$$\frac{r}{r_0} = 12 \text{ resp. } 33 \text{ and } r_0 = 8,3 \text{ resp. } 3,0 \Omega$$

and f' from

$$\frac{K_0 r_0}{f'^2} = \frac{7}{4} s \sigma = 2,6 \cdot 10^{-5}$$

$f = 13$ in both cases.

As one winding has an area of $1,2 \text{ cm}^2$ we must take 11 windings with a length of wire of 51 cm. From the resistance and the length we find for the diameter of the wire 0.035 resp. 0.06 mm. The first of these two values is rather too small. We can remedy this 1st. by taking a smaller coil of 5×12 mm. e.g. thus increasing the number of turns and the length of the wire. The diameter then becomes 0.043 mm. 2nd. By not taking $k=3$ but e.g. $k=2$. Then we find $K_0 = 0.0011$, $r_0 = 5,6 \Omega$ $f' = 15.3$ diameter 0.046. A combination of both methods gives the appropriate thickness of 0.055 mm.

From (4) we derive the voltage sensitivity. For the deflection P'

per microvolt in scale divisions at a distance of 1000 divisions we find the general formula

$$P' = 0,57 T^{3/2} K^{-1/2} r^{-1/2}$$

and in the two cases which have been calculated:

$$P' = 8 \text{ resp. } 21 \text{ mm}/\mu\text{V}$$

I have actually attained sensitivities of this order, also the three-fold sensitivity in the case of 10Ω total resistance. By providing the galvanometer with a magnetic shunt, which can be moved by a screw, I was able to make H continuously variable, between the greatest value mentioned and $1/3$ of it. By the aid of this shunt we are able to use one single instrument for resistances from 11 to 100Ω e.g. and to bring the instrument at once in the aperiodic condition for any resistance within these limits. For the weaker magnetic fields got in this way m will be reduced to 2 or 3. All the more reason not to take K/K_0 greater than 3.

Remains a very important matter viz. how it is possible to realize the required very small restoring torque. For a strip with rectangular section of sides a and b and length l , which is twisted, we have

$$D = \frac{G}{3l} ab^3$$

when b is small with respect to a . G is the torsion modulus.

One might try to cut small strips of metal foil in order to get b very small. The ordinary silver foil for instance has a thickness of $0,2 \mu$. Experiments showed that these strips cause a many times greater torque than that calculated from their dimensions. Apparently the beaten metal departs too much from the simple shape supposed in calculating the formula, its thickness being very uneven and its surface very rugged.

Therefore I have made silver foil of $0,4$ to $0,7 \mu$ thickness by electrolysis, for instance by precipitating the metal on zinc and afterwards dissolving the zinc in a weak acid. By means of a razor attached to a dividing engine, one is able to cut narrow strips of this foil, if necessary even of $0,02$ mm. width.

For a silver strip $0,5 \mu$ thick, $0,1$ mm. wide and 10 mm. long the formula gives $D = 0,00012$. Two of these strips would thus give a torque of only one tenth of the smallest one required. Repeated experiments showed that by very careful treatment one gets with such strips a torque which is 2 or 3 times the calculated one. From the dimensions mentioned one finds further for the resistance 3Ω

which is low enough even for galvanometers of small resistance. Of course one can also use wider strips.

It is not possible to use these thin strips as a suspension, for they show the small torsional rigidity only when unstretched. Therefore I use a quartz fibre suspension taking care that this produces 80 or 90 % of the required torque. As a consequence the elastic after-effect of the strips which is otherwise considerable, is of little or no importance. The metal strips — probably copper is in some respects to be preferred to silver — hang loosely on both sides of the quartz fibre.

Finally I will mention the fact that the very light moving systems of my galvanometers appear to be little sensitive to tremors. Surely this is at least partly due to the relatively strong air-damping which makes the vibrations about horizontal axes decay pretty quickly.

Groningen.

Physical Laboratory of the University.

Physiology. — “*On Superficial and Internal Processes*”. By Prof.
H. ZWAARDEMAKER.

(Communicated at the meeting of December 23, 1921).

In 1908 (1) I discussed, in collaboration with M. C. DEKHUYZEN, the hypothesis that animal tissues are to be conceived as a system of co-existent phases. Phases have been defined there as a condition of the substance homogeneous at a given moment. In life the stationary current of metabolism with its periodic fluctuations passes through such a system. Once every 24 hours the condition approaches nearly the equilibrium during profound sleep.

In such a system it is especially the boundaries of the phases that are important, for directly when action sets in chemical processes manifest themselves near the boundaries. This may be expected a priori and is proved a posteriori by the great importance physiology has to attach to surface-tension and to membrane-potentials.

Such important phase-boundaries in a tissue are, generally speaking:

- a. the cell-surfaces,
- b. the contours of the nucleus,
- c. the contours of the mitochondriae,
- d. the mantle-, and contact-planes of double-refracting pieces of fibrils,
- e. the contact-planes of the neurobions of Cajal.

Also in the phases themselves processes occur, as physiology usually assumes. To these processes belong i. a. stationary metabolism, just now alluded to, heat-production, growth.

A general physiology of the phases has to distinguish between superficial and internal processes.

I have had many occasions to occupy myself with the first category, since *all* processes in which animal radio-activity comes into play, belong to the sub-superficial processes, while the second category i. e. the internal processes comprises *all* processes to which BAAS BECKING (3) has lately applied the theory of PERRIN in such a signal way.

This should not tempt us to generalize prematurely and to advance the hypothesis that in nature all superficial processes have corpuscular radiations for catalyzator, and all internal processes electromagnetic vibrations, and that beyond these radiations there are no other biological catalyzators. We do not feel justified in deducing

such bold conclusions, since we are completely in the dark about the oligodynamic actions of the elements Ferrum, Calcium, Magnesium. Positive facts, however, prompt us to assume that the stimulating effect of the radiations, already discovered, play a prominent part.

Most of all our knowledge of the cell-surface as a phase-boundary has increased. A lipid-layer is generally assumed there. Some hold this to be an illustration of GIBBS's theorem, according to which substances always aggregate on a boundary-layer, which lower the surface-tension in situ. This deduction is not admissible, for nothing is known about the power of lipid to lower the surface-tension protoplasm—tissuefluid. The data concerning the boundary-layer water—air are not immediately applicable to other boundary-layers. The determinations made in my laboratory concerning the boundary-layer oil—water have shown great differences with the boundaries water—air. Therefore, the hypothesis of a lipid boundary-layer can only be admitted as a working-hypothesis not as a deduction. If, furthermore, this layer is assumed to be one single layer of molecules, after LANGMUIR (4), then with a small amount of lipid some spots will remain intact. In this way the so-called mosaic-hypothesis has been explained physically.

For a long time already charges have been assigned to cell-surfaces. J. LOEB and BRUTNER made valuable researches in this direction and some time ago J. LOEB and his co-workers reduced all to equilibria of DONNAN. Quite a different theory was set forth by T. P. FEENSTRA (6) in my laboratory. He abandons the membrane-conception, and imagines the elements Na, K, Ca aggregated in the form of fixed, non-ionised compounds, on a large number of points of the cell-surfaces. In that case a solution-potential must be generated on these spots according to NERNST's theory. From these points some atoms will pass into the surrounding tissue-fluid in the form of cations. Consequently the loss of positive charge will originate on those spots a negative potential, which will increase until the escaping cations are in equilibrium with those of the same sort which are already present in the tissue-liquid. The various metal points can be of the same potential only when the cations in the tissue-fluid are present in a certain ratio. From experimental data he calculated this ratio for the three elements $\frac{\text{Na} + \text{K}}{\text{Ca}}$ and found that it agreed with the long known ratios of the balancing ions in sea-water and in the solutions of S. RINGER. In this striking quantitative concordance he sees an affirmation of his theory.

Suppose in the interstices between the metal-spots lecithin and cholesterol to be aggregated in a layer of LANGMUIR, then it will be easy to imagine the quantity $\frac{\text{lecithin}}{\text{cholesterin}}$ present to such an amount that here again the same potential is reached, as has been forced upon the metal spots by the tissue-fluid. Only then will the potential of the cell-surface be considered equal everywhere, and will the condition for electric rest be satisfied.

Now from the cell-surfaces, thus equipped, a number of actions proceed which depend on corpuscular radiation. To these belong:

a. A number of automaticities such as 1° the automaticity of the heart of cold-blooded animals (7) (frog, toad, eel); 2° the automaticity of the heart of a warm-blooded animal (8) (rabbit); 3° the automaticity of the muscle fibres of the gut (rabbit, cat, mouse) (9); 4° the automaticity of the esophagus (10); 5° the automaticity of the muscular fibres of the uterus (11);

b. The synapsis-effects between vagus and cardiac muscle (12), between vasomotors and muscular coats of the arteries (13);

c. The permeability of the capillary endothelia for water (14);

d. The permeability of the glomerulosepithelia for glyucose (15);

e. The synapsis-effect between motory nerve and voluntary muscle (16) (on this occasion the *distal* contact-plane appeared to be sensitive to radio-activity).

All these actions are subject to the law of aquiradio-active substitution (17) and that of radio-physiological antagonism (18).

When, in typical cases, these actions are brought about from some distance by free radiation (19), it appears that they possess a rather long latent period and a rather long after-effect, but when called forth materially by radio-active elements, the process is rapid and there is no time for penetrating of the ions or micella (20) into the interior of the cell. In that case there can only be question of a superficial process.

The dosages of the added radio-elements, required for the action, may be modified by sensibilizators (21), some of them working through modifications of the adsorptions. This holds for fluorescein and eosin, as well as for adrenalin and cholin. The first two substances can supersede each other in a schematical experiment; talcum venetum figures as an absorbent. Likewise eosin can supersede fluorescein. The reverse, however, is not possible (22). Also adrenalin and cholin are mutually antagonistic (23). In the heart-cells these substances are related just as in the schema: the supersession eosin-fluorescein is biologically one-sided, the supersession

adrenalin-cholin is biologically reciprocal. The sensibilization through adrenalin and cholin with its peculiar properties in respect of both kinds of corpuscular radiators has thus far been observed, besides for the heart, also for the synopsis between vasomotors and vascular muscle-wall. Another part of the substances, which in oligo-dynamic addition can bring about a sensibilization of some duration, have the character of cytolisins: (in a higher concentration they cause hemolysis). Most often cytolysis is attributed to dilution of the boundary-layer. When we endorse this hypothesis, also this form of sensibilization is acknowledged as a form of superficial effect (24). FEENSTRA has demonstrated that for some of the radio-active elements, which can replace potassium, the proportion relative to Na and Ca which is required to satisfy the balancing-equilibrium, can be calculated. This proportion appears to fall within the concentration-latitude, in which the replacement may be applied. For other substitutes calculation is impossible as they are colloidal in the modified Ringer-solution. In this case, however, there can be no question about interior action: their activity can be interpreted only by adsorption to the cell-surface. So long as they are in suspension in the circulating fluid they can evidently not exert any raying-effect worth mentioning.

Beneath the cell-surface, to which we suppose the radio-active elements to be attached as metal-points in fixed protein-composition, or to be adsorbed in colloidal or atomic composition, the electric phenomena are at work. This appears from the fact that the electrocardiogram of a uranium-, thorium-, or ionium-heart, is not distinguishable from that of a potassium-, resp. rubidium-heart. Anyhow not in the beginning. Also the electrocardiogram of a heart, which pulsates with S. RINGER's solution without calcium, and whose cells must therefore be imagined devoid of calcium metal-points, remains unchanged in the beginning. Since the hypothetical lipid-layer can never be continuous, and therefore can never represent a perfect dielectricum, the old theory of ENGELMANN is still intact, according to which the transmission of the stimulation into the mass of the heart-muscle is brought about by the transmission of the current from cell to cell.

In this paper there is no opportunity for a further exposition of the surface-hypothesis for other cases than those round the heart muscle-cells. It cannot be expected that all cell-surfaces have their own electric charges, nor need the hypothetical catalysators occur on all contact-planes.

REFERENCES.

1. H. ZWAARDEMAKER en M. C. DEKHUYZEN, Ruhende tierische Zellen und Gewebe; ein verwickeltes System koexistierender Phasen. Int. med. Kongr. Budapest 1908.
2. H. ZWAARDEMAKER, *Erg. der Physiol.* 1906, Bd. 5, S. 125.
3. L. B. BECKING, *Radiation and vital Phenomena*. Thesis, Utrecht 1921.
4. J. LANGMUIR, *Amer. Chem. Soc.* Vol. 38 & 39, 1916, 1917.
5. LOEB and BEUTNER, *Bioch. Ztschr.* Bd. 59, S. 195. 1914.
6. T. P. FEENSTRA, *Ionenbalanceering* Diss. Utrecht 1921. *Onderzoekingen Physiol. Lab.* 6e Reeks. Vol. II, s. 1.
7. H. ZWAARDEMAKER, *Kon. Akad. v. Wetensch.*, Amsterdam, 30 Sept. 1916.
8. E. H. JANNINK en T. P. FEENSTRA, *Ned. Tijdschr. v. Gen.*, 1920, II, N^o. 15.
9. E. H. JANNINK, *De invloed van het kalium op de beweging van den darm*. Diss., Utrecht 1921.
10. C. E. BENJAMINS, *Physiologendag* 1920. (Not yet published in extenso).
11. To be published.
12. H. ZWAARDEMAKER en J. W. LELY, *Arch. néerl. de Physiol.* 1917. II, p. 745.
13. K. F. A. HALBERTSMA, *Physiologendag* 23 Dec. 1921.
14. I. GUNZBURG, *Arch. néerl. de Physiol.* 1917, T. II, p. 404. (Compare also *Ned. Tijdschr. v. Gen.* 1917, T. II, N^o. 14).
15. H. J. HAMBURGER en R. BRINKMAN, *Kon. Akad. v. Wetensch.*, Deel 26, blz. 952.
16. I. GUNZBURG, *Nat. en Geneesk. Congres*, 's-Hage 1917.
17. H. ZWAARDEMAKER, *Am. Journ. of Physiol.* Vol. 45, p. 147, 1918. (Compare *Kon. Akad. v. Wetensch.*, Amsterdam, 20 Sept. 1916).
18. H. ZWAARDEMAKER, *Kon. Akad. v. Wetensch.*, 24 Febr. 1917, 31 Maart 1917, *Pflüger's Archiv.*, Bd. 169, S. 122, 1917.
19. H. ZWAARDEMAKER, C. E. BENJAMINS en T. P. FEENSTRA, *Ned. Tijdschr. v. Geneesk.*, 1917, II, blz. 1923.
20. H. ZWAARDEMAKER, *Pflüger's Arch.*, Bd. 173, S. 51, 1918.
21. H. ZWAARDEMAKER, *Kon. Akad. v. Wetensch.*, Amsterdam, 29 Sept. 1917.
22. A. M. STREEF, *Onderz. Physiol. Lab.* (5), Deel XIX. (Compare also *Pflüger's Arch.*, Bd. 173, S. 60).
23. J. B. ZWAARDEMAKER, *Physiologendag*, Amsterdam, 22 Dec. 1921.
24. The experiments on sensibilization through cholin and adrenalin will be published in extenso later on by Mr. NYHUIS. For sensibilization in connection with the law of aquiradio-activity, see H. ZWAARDEMAKER *Arch. Intern. de Physiol.*, T. 18, p. 282, 1921.

Botany. — *On Hypotriploid Dwarf-hyacinths derived from Triploid Dutch Varieties through Somatic Variation.*” By W. E. DE MOL. (Communicated by Prof. J. C. SCHOUTE).

(Communicated at the meeting of December 23, 1921).

I. *Introduction.*

Among the varieties of Dutch hyacinths, which in my cytologic investigation I found to be heteroploid, there are a couple which produced a comparatively large number of budvariations: varying in *form* as well as in *colour*. They are the single triploid varieties *Grand Maître* (colour: pure mauve), and *King of the Blues* (colour: \pm like Prussian-blue).

In my publication: “*De l'existence de variétés hétéroploïdes de l'Hyacinthus orientalis L. dans les cultures hollandaises*” I made mention of a large, elongated form of *Grand Maître*, termed by me *Grand Maître gigantes* whose morphological aspect of chromosomes, so far as could be made out, is exactly the same as that of the parental variety. Furthermore, I pointed out that small bulbs also agreed in number, shape and size of the chromosomes, so that this growth-retardation had to be ascribed to external circumstances.

As to the variety *King of the Blues* I reported only parenthetically, that morphological change was observed with a vegetative increase. In the autumn of 1920 and in 1921 I was in a position to establish, without sacrificing all my anomalous plants, that what I had wrongly presumed regarding *Grand Maître*, proved to be a fact, viz. that through vegetative increase dwarf-plants could arise independently of each other, characterised by a smaller number of chromosomes in the root-cells, which number was still the same after years of vegetative propagation.

Many conjectures may be made as to the cause why it is just the *Grand Maître* and the *King of the Blues* which are characterised by marked budvariations: 1. that these varieties are heterozygous triploid; 2. that they are grown in large numbers; 3°. the mentioned facts combined.

II. *In which respect do the dwarf-plants differ in their outward aspect from the mother-variety?*

It was quite a matter of chance that I came into possession of my dwarf-hyacinths: When inspecting in flowering-time the deep-blue spikes of *King of the Blues* one will sometimes detect plants whose inflorescence is of a dark pink colour entirely or partially i.e. in a larger or smaller sector. This budvariation occurs repeatedly. Commercially it is termed *Queen of the Pinks*. The number of chromosomes agrees with that of *King of the Blues*.

Now I observed, in different places, in two separate batches of *King of the Blues*, quite apart from each other, somatic varieties, which were conspicuous for a carmin-red colour of the flower, i.e. a darker colour than that of *Queen of the Pinks*. I consequently cultivated them. As they were growing among small, young plants of *King of the Blues* the small dimensions did not strike us at once. Only after some years did these differences manifest themselves. As to *forms* they resemble exactly *King of the Blues* and *Queen of the Pinks*. As to *dimensions*, however, they are much smaller. The flowerspikes, the separate flowers and their parts, the position of the flowers upon the peduncle, the narrow, stiff stalk-leaves, so characteristic of these varieties, in all the *shape* is the same, the *size* is different.

The flowering-times agree. The foliage withers simultaneously. How great the quantitative differences of the fullgrown bulbs are, may be best gathered from the following table. In succession the circumference, the weight and the volume of the bulbs of *King of the Blues*, *Queen of the Pinks*, *dwarf n^o. 1* and *dwarf n^o. 2*, are determined.

<i>King of the Blues</i>	23 c.M.	149 G.	150 c.M. ³
<i>Queen of the Pinks</i>	23,5 "	161,5 "	160 "
<i>Dwarf n^o. 1.</i>	12 "	28,5 "	26 "
<i>Dwarf n^o. 2, 1st bulb</i>	11 "	20 "	20 "
<i>id</i> , 2nd bulb	10,5 "	19,5 "	20 "
<i>id</i> , 3rd bulb	10 "	20 "	20 "

But besides these quantitative differences the difference in the *rate of vegetative propagation* is also remarkable. It is safe to say that *King of the Blues* and *Queen of the Pinks* propagate vegetatively ten times quicker than the dwarfs, whether they multiply

in a natural way, or whether they are urged to rapid production of bulbils through crucial incisions in the discus.

I know of no variety that grows so slowly. That is why of the 2nd dwarf I possess only 20 bulbs after eleven years' careful cultivation. The 1st dwarf is still slower in its growth.

The roots of the dwarfplants are thinner than those of the parent-variety. Never did I come across hyacinth-species with roots as thin as those of *dwarf n^o. 2*.

III. Cytological inquiry into the two dwarf-shapes.

In the autumn of 1920 and in 1921 I have fixated repeatedly the root-tops of 1 bulb of *dwarf n^o. 1*, in 1921 the root-tops of 3 bulbs of *dwarf n^o. 2*. The fixation was performed with Flemming's solution and glacial acetic vinegar. My wife has performed the rest of the technical work.

The investigation of the root-sections showed very distinctly that the *somatic nuclei of dwarf n^o. 1 consisted of 18 chromosomes and*

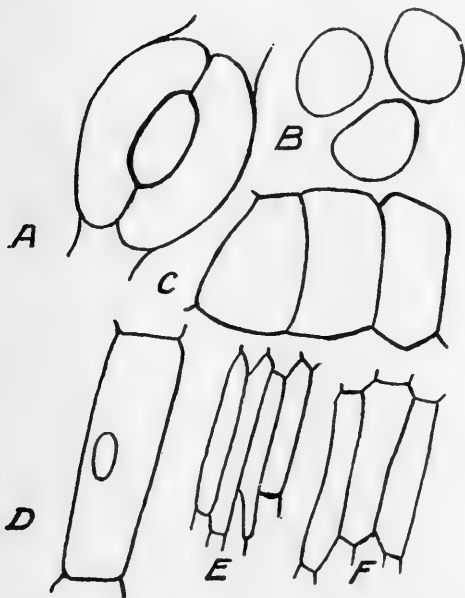

Fig. I. *Dwarf n^o. 1*: a, stoma (Oc. 4, Obj. D, Zeiss.); b, pollengrains (Oc. 2, Obj. D); c, subepidermal cells of the tepals (Oc. 2, Obj. D); d, epidermal cell of the tepals (Oc. 2, Obj. D); e, cells of the outer bulb-scales Oc. 2, (Obj. D). *Dwarf n^o. 2*: f, cells of the outer bulb-scales (Oc. 2, Obj. D).

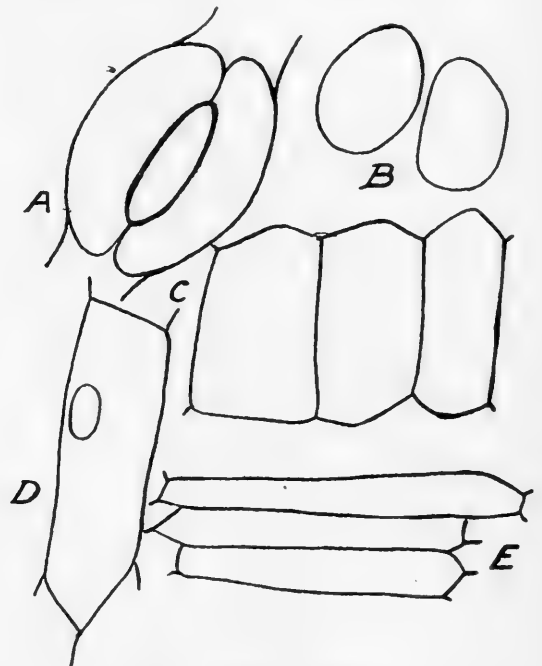

Fig. II. *Queen of the Pinks*: a, stoma; b, pollengrains; c, subepidermal cells of the tepals; d, epidermal cell of the tepals; e, cells of the outer bulb-scales. Magnification as in fig. I.

those of dwarf n°. 2 of 21 chromosomes, consequently of resp. 6 and 3 chromosomes less than the nuclei of *King of the Blues* and *Queen of the Pinks*. Likewise the number of nucleoli in the nuclei of the dwarfs is smaller. The dimensions of the chromosomes and of the nucleoli have not altered. The cells of pleroma, periblema and dermatogen of the roots are strikingly small, notably those of dwarf n°. 1, which renders the determination of the number of chromosomes extremely difficult.

From the above we may fairly conclude that the volume of these cells has relatively decreased much more than that of the nuclei, so that the difference between the magnitude of the cell and the nucleus of *King of the Blues* and of dwarf n°. 1 is not quite the same as R. HERTWIG's nucleus-plasma relation (1903).

Stomata, pollengrains, cells of the leaf, the tepal and the bulb-scale have been measured and sketched by me. Every time the difference in the magnitude of the cells of the dwarfs and of *King of the Blues* and *Queen of the Pinks* revealed itself distinctly.

This leads to two remarkable conclusions: The first is that it must be owing to the smaller magnitude of the subepidermal tepal-cells of the dwarfs that the dissolved anthocyanin is of a carmin-red tint instead of dark pink, as in *Queen of the Pinks*. The anthocyanic pigment will be of similar chemical composition, but in the tepals of the dwarfs it will be present in a higher concentration. The difference of tint is also very well distinguishable microscopically. The higher concentration of the anthocyanin in the dwarfs shows itself clearly in the cells of the outer bulb-scales, immediately after digging-time. Then the anthocyanin occurs in them in markedly plasmolyzed vacuoles or in greater and smaller conglomerates of crystals, as MOLISCH (1905) pictures them of *Pelargonium*. It is evident, therefore, that in their smaller cells the dwarfs possess an amount of anthocyanin as great as that in the larger cells of *Queen of the Pinks*, so that the hereditary factors, which determine the chromogen and its oxydase for the two dwarfs and *Queen of the Pink*, are presumably identic.

The second conclusion concerns the fertility of the pollengrains of *King of the Blues*, *Queen of the Pinks* and of the dwarfs. For several years in succession I found that *King of the Blues* and *Queen of the Pinks* have a percentage of sterile pollengrains, which, under seemingly normal circumstances, varies between 30 and 50. Under similar conditions the percentage of sterile pollengrains of dwarf N°. 1 is much smaller. It does not exceed 10 %.

Researches into the dying-off of pollen-grains after the reduction-division in the hyacinth have taught me, that this is most likely due to the fact that the protoplasm present, is too small for such large pollen-grains as *King of the Blues* and *Queen of the Pinks* possess. Now it seems to me that the greater fertility of *dwarf n^o. 1* is directly related to the quantum of protoplasm at its disposal, which will probably be sufficient for its smaller pollengrains. I have not yet been in a position to examine the fertility of the 2nd dwarf.

In the literature I know of no instances of dwarf-forms among the higher plants, arisen through somatic variation, that can be differentiated cytologically. It is an unshakable fact, that these dwarfs descend from *King of the Blues*, but particulars about the true cause of these dwarf-plants are still lacking. First of all the injuries evolved by crucial incisions might be made answerable for it. The interpretation of the observed phenomena would then accord with the opinion of SAKAMURA (1920), that no autoregulative reduction of the chromosomes in somatic hyperchromosomal cells takes place. Secondly the cause might be looked for in the fact, that the mother-plant is triploid; this may induce something like a regulating process, which, when tending to full advantage, would result in the diploid condition.

In that case the phenomena, appearing with the nucleus-division in the soma of the plant, would run parallel with those occurring with the heterotypical division of the pollen parent-cells. I refer to my description of the reduction-division of the 27-chromosomal variety *J'Innocence*.

When assuming moreover with WINKLER (1916 page 522), that according as the number of chromosomes exceeds more and more the diploid number, the chances of disturbances in the process of the somatic nucleus-division will increase, *then there is besides the reason mentioned in my publication "Nieuwe banen, etc.", still another argument that justifies my warning not to go on exterminating the old, valuable diploid Dutch hyacinth-varieties.*

It seems probable to me that dwarf-hyacinths occur not unfrequently through somatic variation of heteroploid species, but that they are generally not observed, or are thrown away as being unfit for cultivation. I know for certain that from the heteroploid pink-coloured variety *Moreno* a darker dwarf-form is derived, which however got lost before I was able to examine it. About six years ago a variegated plant was derived from the heteroploid variety *Queen of the Blues*. The bulb of this plant (which is in my possession)

remains of very small dimensions in spite of the best culture-conditions.

Throughout this investigation my interest in the cytological research into somatic varieties has increased especially in connection with the details discovered in the two dwarf-plants, and in connection with the question of the influence of the chromosomes.

Perhaps what WINKLER reported about his further experiments with *Solanum* (cf. SIRKS (1921)) in the 1st. meeting of the "*Deutsche Gesellschaft für Vererbungswissenschaft*", very nearly approaches the phenomena observed by me. It should be borne in mind, however, that WINKLER observed the reduction of the number of chromosomes after propagation *through seeds*, whereas I established this reduction during the *vegetative* propagation. The plants of WINKLER are *homozygous*. My plants are *heterozygous*.

R E F E R E N C E S.

R. HERTWIG, 1903, Ueber Korrelation von Zell- und Kerngrösse und ihre Bedeutung für die geschlechtliche Differenzierung und die Teilung der Zelle, Biol. Centralbl., Bd. XXIII, S. 49.

W. E. DE MOL, 1921, De l'existence de variétés hétéropléïdes de l'*Hya-cinthus orientalis* L. dans les cultures hollandaises, Arch. Néerl. des Sciences exactes et naturelles, série III B, tome IV, p. 18.

W. E. DE MOL, 1920, Nieuwe banen voor het winnen van waardevolle varieteiten van bolgewassen. Overgedrukt uit het Weekblad voor Bloembollencultuur, nos. 37, 41 en 44—48 van den 31^{en} jaargang.

H. MOLISCH, 1905, Ueber amorphes und kristallisiertes Anthokyan. Bot. Ztg., Bd. LXIII, S. 145.

TETSU SAKAMURA, 1920, Experimentelle Studien über die Zell- und Kernteilung mit besonderer Rücksicht auf Form, Grösze und Zahl der Chromosomen, Journ. of the Coll. of Science, Imp. Univ. of Tokyo, Vol. XXXIX, Art. 11.

M. J. SIRKS, 1921, „Deutsche Gesellschaft für Vererbungswissenschaft“, Genetica, Deel III, Afl. 3 en 4, blz. 412.

HANS WINKLER, 1916, Ueber die experimentelle Erzeugung von Pflanzen mit abweichenden Chromosomenzahlen, Zeitschr. für Botanik, Bd. 8, S. 417.

HANS WINKLER, 1921, Ueber die Entstehung von genotypischer Verschiedenheit innerhalb einer reinen Linie, Deutsche Gesellschaft für Vererbungswissenschaft. Bericht über die Gründung und die erste Jahresversammlung, S. 16. Leipzig, Borntraeger, 1921.

*From the Laboratory for the Physiology of Plants of
Prof. ED. VERSCHAFFELT. Hortus Botanicus, Amsterdam.*

Zoology. — “On Budding and coalescence of Buds in *Fungia fungites* and *Fungia actiniiformis*.” By H. BOSCHMA. (Communicated by Prof. C. PH. SLUITER).

(Communicated at the meeting of November 26, 1921).

Budding in adult corals of the genus *Fungia* was first described by SEMPER¹⁾ in a specimen which had most likely been thrust upside down fortuitously. In their further growth the septa had bent round the border and in various places new mouths had arisen on the original underside, round which the later formed septa were arranged more or less radially.

From this SEMPER concludes: “Es geht daraus hervor, dass alle diese Polypen ohne Ausnahme die Fähigkeit besitzen, an ganz beliebigen Stellen ihres Körpers neue Individuen zu erzeugen, wenn durch irgend eine Ursache — physiologisch-chemische oder rein mechanische — ein besonderer Anstoss zum Hervortreiben plastischer Massen gegeben ist.”²⁾

Judging from the figure (Taf. XXI, fig. 3) some at least of these buds are to be considered as calicular buds as they are lying entirely on the curled-up border. Of course, it is within the bounds of probability that they are lateral buds generated through the broadening of a number of spines into septa, a process easily to be watched in the ordinary lateral budding.

Lateral budding (at the underside of the disc, which side corresponds to the lateral side of other corals) is of rather frequent occurrence in *Fungia fungites* (L.).³⁾ This mode of asexual reproduction has been described at length by DÖDERLEIN.⁴⁾ However, he does not assign a cause for this budding, probably because DÖDERLEIN did not work with fresh material. In a large number of *Fungia fungites*,

¹⁾ C. SEMPER. Ueber Generationswechsel bei Steinkorallen und das M. Edwards'sche Wachsthumsgesetz der Polypen. Zeitschr. f. wiss. Zool. Bd. XXII. 1872.

²⁾ l. c. pag. 275.

³⁾ SEMPER reports also a case of budding at the underside of a specimen of *Fungia Linnaei* Val. (= *F. repanda* Dana) (l.c. pag. 275, note 1.)

⁴⁾ L. DÖDERLEIN. Die Korallengattung *Fungia*. Abh. der Senckenb. naturf. Ges. Bd. XXVII, 1902.

which I collected near the island of Edam in the Bay of Batavia, we could detect at the underside buds in various stages of development; they are seen nearly always in the immediate vicinity of part of the parent-coral which is overgrown profusely with algae. It frequently happens that a bud appears at the underside, just beneath that portion of the upperside that is grown over with algae. When a *Fungia fungites* is partly attacked by sea-weeds, the latter impart a stimulus to the adjacent tissue, which consequently displays a more energetic growth-activity. This greater activity is also manifested in an increased Skeleton-production, resulting in the formation at the underside of larger spines, which are sometimes branched out, or even in the formation of buds; at the upper side this intensified growth engenders new septa, which are often of an irregular shape, while in some cases buds are formed.

DÖDERLEIN already suspected that calicular budding occurred also in *Fungia fungites* but he could not prove it. In a few specimens of this species found near Edam, rather distinct buds were formed at the upper-side of the disc; one of these specimens was very conspicuous. In this *Fungia* (Fig. 1) part of the disc is grown over with sea weeds of various kinds and with case-worms, which causes the tissues of the polype to be destroyed at this spot.

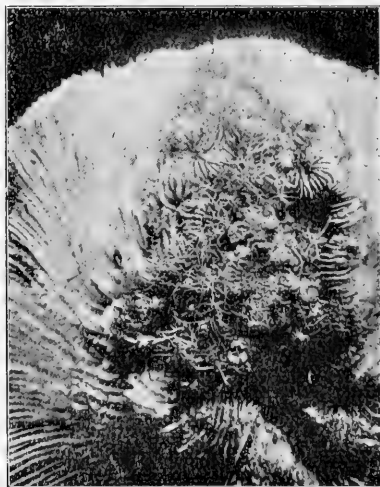

Fig. 1. *Fungia fungites*. Upper-side. Calicular budding around a part grown over with seaweeds and other organisms. $\frac{3}{5}$ nat. size.

An abundant growth of algae is also observed over the mouth. Greater growth-activity is shown round the attached part which generates new septa everywhere at the borders of the destroyed

tissue. At the intact side mouths have originated by the side of these new septa, so that ultimately instead of the old lost mouth the *Fungia* possessed about twenty new, small orifices around the algae-covered zone. A few of these mouths are environed by new septa (see the upperside in the figure); these buds therefore present a more regular aspect than the others, in which the mouth is at one side surrounded by a semicircle of new, young septa, which unite at the other side with the unattacked septa of the parent¹⁾.

Also at the border of the disc of *Fungia fungites* buds may arise by constricting off part of the septa of the parent-polyp and by the formation of a new mouth. This, then, is also a case of calicular budding. In its initial stage it is seen in the specimen which is represented partially in fig. 2.

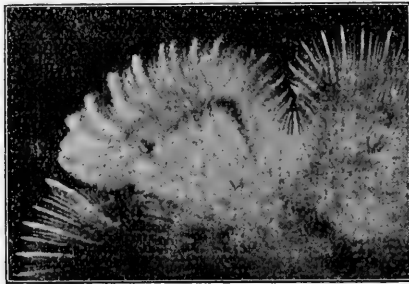

Fig. 2. *Fungia fungites*. Underside. Part of the border is grown out towards the underside. $\frac{3}{5}$ nat. size.

At its underside a groove is noticeable at some distance from the border. This may be a scar of an old wound and the border may have been renewed at this spot through regeneration. At the periphery part of the border has curved downwards, the border has, so to speak, doubled up here and parts of the septa are lying at the underside of the disc. For the rest this *Fungia* looks quite normal. Now when this curved portion is cut off, we obtain a bud here also, a calicular one at the underside of the parent-coral.

This budding is seen further developed in another specimen (fig. 3).

¹⁾ In this specimen the algae-parasitism has proceeded right across the disc as far as the underside (in *F. fungites* the disc is provided with pores), which also here has given rise to a number of lateral buds, although only a small portion of the tissue of the underside has been destroyed. These buds are rather large (the largest is 32×25 mm.), the oldest have already a broadened border, as may be distinctly seen, so that they are attached to the underside by a stem.

Here the border has bent down at one place, just as in the preceding case, but here the septa do not merge into those of the

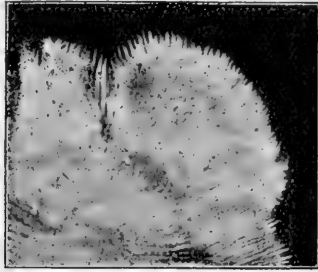

Fig. 3. *Fungia fungites*. Underside. Calicular budding at the border. $\frac{3}{5}$ nat. size.

mother-coral, the bud having become more or less independent. A mouth has already been formed, completely encircled by septa, so that a separation of the bud from the parent has already been established. The part belonging to the bud is already easy to distinguish from that belonging to the parental coral, which was not practicable in the case previously described. Now when this separation becomes more evident, the whole aspect is that of a bud at the underside. Such a bud would then be considered as a lateral bud, although ab origine it was a calicular one.

In this way may have arisen some of the buds of SEMPER's specimen alluded to above, since in the figure the septa of the old coral touch those of the buds.

The buds above-described are all either devoid of a stem, or provided with a short stem. In one specimen I found at the underside a bud with a longer stem, such as are generally found at an anthocormus. The upperside of the disc of the *Fungia* under discussion is quite normal, while the underside differs from that of normal specimens (fig. 4). The central part is rather sharply isolated from the border, while part of it is defunct. We are impressed with the idea that when this coral had a diameter of about 3 cm., the tissues of the one moiety died off for some reason or other, while from the other half a regeneration was started, which caused the coral to ultimately grow up to 8 or 9 cm. and after this to present a normal aspect. But the defunct portion maintained itself and leans on the living portion like a scale. Attached to this defunct portion we observe a stemmed young bud 6 mm. in diameter, while the stem itself is 8 mm. in length. The extremity has not yet broadened into a disc.

This case slightly reminds us of the aspect (in *F. agariciformis* = *F. fungites*) of a number of young stemmed Fungiae on the

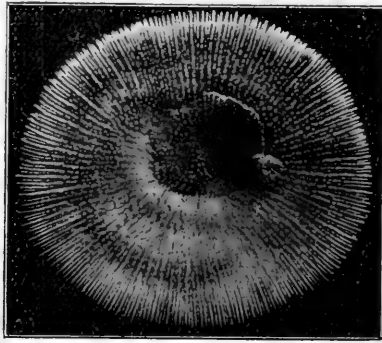

Fig. 4. *Fungia fungites*. Underside. Stemmed bud at a defunct part in the middle. $\frac{1}{2}$ nat. size.

defunct disc. of a coral of the same species, as described by STUTCHBURY.¹⁾ The same aspect was presented by some of the Fungiae I found near the island of Edam. At the underside of one of them residues of living tissue were distinguishable, but all the softer parts of these corals were vanished and here and there seaweeds and *serpulids* had settled. At the border of all the specimens there are a large number of buds, while in a few of them buds have also been formed near the central part of the underside. Of the latter the stem has a uniform breadth everywhere, in contradistinction to many at the border, whose stem has broadened at the upperside into a disc-shaped young Fungia. The stem of many buds adhering to the border of the underside, has bent round, so that the disc of the young Fungia is seen at the upperside of the border of the old coral. Some of these young corals are overgrown with algae, most of them are fully alive and look quite normal.

STUTCHBURY²⁾ considers the occurrence of young corals on a defunct disc of the same species to be something accidental. ("I consider the cases in which young Fungiae are found fixed to the underside of others of the same species, to arise from the accidental attachment of the young polype"), whereas SEMPER holds that these young corals have arisen in situ through budding of the coral; the

¹⁾ S. STUTCHBURY, An Account of the Mode of Growth of Young Corals of the Genus Fungia. Trans. Linn. Soc. London, Vol. XVI, 1833.

²⁾ l. c. p. 497.

genesis of the budding has then to be looked for in an alteration of the natural position.

MOSELEY¹⁾ in studying *Fungia fungites*²⁾, found a portion of a very large defunct *Fungia* quite covered with numerous young colonies of various ages. According to MOSELEY they arose from larvae which had attached themselves to the expired *Fungiae*.

SAVILLE KENT also describes these *Fungiae* with young stemmed specimens (in *F. discus* = *F. fungites*) and gives us a picture of one of these with 13 stemmed young corals at the upper-side (Plate XXIV, fig. 1).

Although he does not dictate either the one or the other conception, he deems it most probable that we have to do here with a case of budding: ("It is a moot point whether this luxuriant colony of Nursestocks arose fortuitously from different sources, or in a single embryonic swarm from some more distant corallum, or whether they may not represent the product of the expiring vital energy of the defunct adult corallum to which they are united. The latter interpretation appears to be the most reasonable"³⁾).

According to DÖDERLEIN the occurrence of colonies of young *Fungiae* on defunct corals of the same species has nothing to do with budding; these young corals he believes to have arisen from extraneous larvae.

The specimens I collected near Edam all lay in a normal position, orifice upwards. They exhibit some peculiarities which point to true budding. The specimens alluded to (cf. fig. 5) deviate from those described by STUTCHBURY, MOSELEY and SAVILLE KENT, in that young polypes occur only at the border of the upperside of the disc and not in the centre. Nor do these buds attain the size of those of the *Fungia* illustrated by SAVILLE KENT.

Each specimen is provided with a great number of these young corals, one of them with as many as 73 buds. We deem it highly probable that this is a case of true budding. The following arguments lend support to our view:

1. The rest of the parent-coral is quite defunct or nearly so. Budding is considerably promoted by algae-parasitism, as has been pointed out above. Here it arose most likely as the final manifestation of vitality of a doomed individual.

2. These stemmed buds are found only at the border, and not

¹⁾ H. N. MOSELEY, Notes by a Naturalist on the Challenger. London, 1872.

²⁾ Determined by QUELCH as *Fungia discus* (= *F. fungites*). (J. J. QUELCH, Report on the Reef-Corals. Challenger Exp. Zoology, Vol. XVI, 1886).

³⁾ W. SAVILLE KENT, The Great Barrier Reef of Australia. London 1893, p. 38.

farther on, at the upperside. If larvae had given origin to these young corals, they would not have been disposed so regularly in one row along the border.

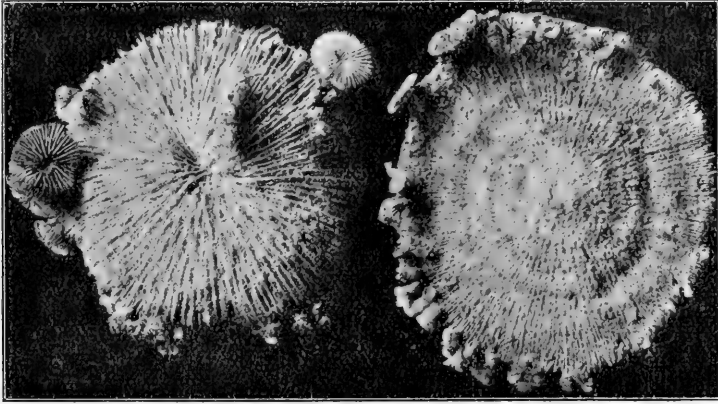

Fig. 5. *Fungia fungites*. The left specimen seen from above, the right one from below. Budding at the border of individuals almost entirely overgrown by parasites.
 $\frac{3}{8}$ nat. size.

3. Also at the underside some buds are noticeable, rather removed from the border. When a *Fungia* is attacked by algae, the tissue of the underside keeps intact longer than any other part, because the weeds have to force their way through the disc in order to attack it also.

This is why the tissue at the upperside may be entirely destroyed by algae, while rests of soft parts may still exist at the underside, which may induce the growth of buds.

These buds do not develop so well as those at the border, their extremity is not broadened into a disc, which is probably due to the absence of light. The development of these very buds goes against the hypothesis that they should have originated from larvae which had attached themselves here. The old *Fungia* lies flat at the bottom, even the borders are still covered with sediment¹⁾. Owing to this the underside is isolated from the environment, so that no larvae can settle there, putting aside the very unpropitious position occupied by these buds with respect to the light.

¹⁾ A living *Fungia* continually removes the sediment that falls on the upperside, by enclosing it in a layer of mucus, which is removed from the centre onward over the border.

4. I found these stemmed young Fungiae only on the disc of the defunct Fungia and not on the defunct coralfragments in the neighbourhood. If these young polypes had arisen from a swarm of larvae, which had settled down at the same time or at different epochs, a few would no doubt have found a base of attachment in the neighbourhood.

Colonies of fixed young Fungiae (Anthocormus) are especially known of *Fungia fungites*. Of *Fungia actiniformis* Q. et G. fixed young corals have been described by STUDER¹⁾. Afterwards no more mention is made of anthocormus-formation in this species. Still, it seems to occur occasionally; as I found on the reef round Edam about 24 young colonies of *Fungia actiniformis*. The number of buds at every anthocormus differs largely. One of these specimens possesses 48 buds or stems from which the young coral has detached itself. Upon a number of these stems, a new bud is already developing. The largest young Fungia, found fixed to an anthocormus, has a diameter of 5 cM.

Besides the budding at the anthocormus, also lateral budding occurs in *Fungia actiniformis*. The method of lateral budding, occurring so frequently with *F. fungites* when the tissues of this species are partially destroyed by algae, seems to be very rare in *F. actiniformis*. I found only one specimen, exhibiting this mode of budding. Three fourths of this Fungia was defunct. Only the remaining fourth was covered with living tissue and bore tentacles. There is a bud about midway between the border and the centre at the underside on the boundary between the defunct and the living part, still in the latter. The septa of the bud, arranged radially, are modified spines, but much larger than those of the environment and distinctly flattened. The septa are over their full length attached to the underside of the parent-coral, a stem has not yet been formed.

Another very peculiar mode of budding seems to occur rather frequently in *F. actiniformis*; I found near Edam 10 specimens which exhibited it.

These buds occur at the underside, attached to the scar by which the coral had been fixed in its young state to the stem of the anthocormus (fig. 6). This scar is covered with living tissue, which proceeds into the tissue of the bud. Tentacles are distinctly noticeable

¹⁾ TH. STUDER, Uebersicht der Steinkorallen aus der Familie der *Madreporaria aporosa*, *Eupsammia* und *Turbinaria*, welche auf der Reise S. M. S. Gazelle um die Erde gesammelt wurden. Monatsber. K. Preuss. Ak. der Wiss. Berlin 1877.

in the buds, which for the rest produce a normal impression, only the soft parts are of a lighter colour than those of the upper side

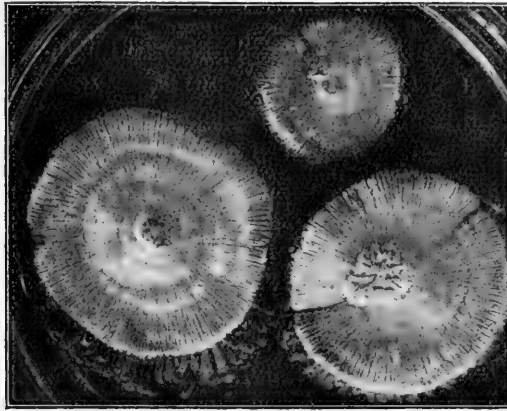

Fig. 6. *Fungia actiniformis*. Underside of three living specimens with budding at the scar.

of the parent. Since the buds occur at the underside, they are shut off from the light, to which the lighter colour of their tissue is perhaps to be ascribed. This budding generally presents one bud at the scar, sometimes two. With the older buds of this kind the upperside is already distinctly broadened into a disc, so that they have short stems. The structure of the skeleton is regular like that of the young buds of anthocormus, but it is very thin and fragile. It is difficult to account for the origin of these buds; the specimens in which they occur are already mature, with a transverse diameter of more than 5 cm. and for the rest look quite normal. Neither have they suffered from algae-parasitism, which consequently cannot have given rise to this budding. Maybe these buds are loosened later on, and are located under the disc of the parent-coral, which brings about a very unfavourable condition.

Excepting the formation of buds at the anthocormus budding in *Fungia fungites* and *F. actiniformis* is ever an abnormal phenomenon. In nearly every case in which buds could be observed, they could be shown to originate from an increased growth of the tissue owing to seaweeds or other organisms which established themselves here. Only one category of buds forms an exception viz. the buds on the scar of *F. actiniformis*.

This scar, in fact, is the place of an old wound, but even very young Fungiae, recently dropped from the stem, have covered this cicatrice again with living tissue. It is, therefore, difficult to account

for the origin of this renewed activity of growth at the scar, which induces the formation of these buds. Though their aspect is normal and regular, they are in unfavourable conditions for further development.

The most successful mode of budding in adult Fungiae is no doubt that from the remains of the living tissue of a disc of *F. fungites* that is almost entirely overgrown with seaweeds or other organisms.

Here the buds have been formed as normally as those of an anthocormus. On this account many researchers consider these buds to have directly arisen from larvae.

At an anthocormus a large number of buds are massed together within a short time. Most of them form new buds laterally to their stem. Now when the anthocyathus of the buds gradually enlarges, this broadened extremity often leans against the disc of a neighbouring young Fungia, which inhibits further broadening in those places. In this way originate anomalous young Fungiae, as may be seen from many colonies. Hereby the anthocyathus is elongated in many cases in one direction or is angular with many flattened sides.

This close contiguity may also cause the undersides of two young Fungiae to coalesce, the buds then drop simultaneously and remain twinned. At an anthocormus of *Fungia actiniformis* I found two of these young buds, the underside of one of which was at one place grown together with the other. The septa of the one anthocyathus are still separated from those of the other. During the transport these buds got loose from their stems but they were not severed from each other.

Not unfrequently do we find old Fungiae, which clearly show their origin through coalescence of two buds as is evident from two scars at the underside of such twin-specimens. When these twins have arisen from the intergrowth of two Fungiae of about the same age two mouths with the surrounding septa are to be observed at the upperside, the septa being grown together anomalously at the plane coalescence between the two individuals.

Now the occurrence of two or more mouths at the upperside of a Fungia would not warrant the conclusion that such a coral has arisen from several individuals, for when, for some reason or other, a stronger growth appears in one part of the border than in the other part, folds will make their appearance which may extend upwards over a pretty long distance, as a doubled up border. If this folding process continues up to the mouth, it often results in a

splitting of the primary mouth into smaller ones, while the septa formed afterwards then arrange themselves radially round these new mouths. Near Edam I found similar specimens of *F. fungites*

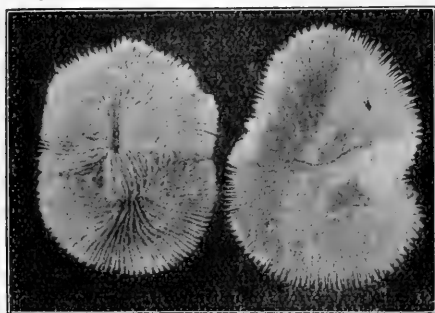

Fig. 7. *Fungia fungites*. Twins, the result of coalescence of two buds of an anthocormus. To the left a specimen seen from above; to the right a specimen seen from below. $\frac{2}{5}$ natural size.

as well as of *F. actiniformis*, but when examining the underside we clearly see that only one individual is concerned here, as only one scar is observable.¹⁾

Rather considerable divergencies in the size of the intergrowing buds may produce formations which remind us of budding at the underside of an adult individual, as is very beautifully typified in a specimen of *F. actiniformis* that I found near Edam. At the underside of this *Fungia* of 10 cm. diameter a young coral of the same species of 4 cm. diameter is partially grown together with it.²⁾

The septa of the smaller *Fungia*, facing the centre of the larger one, are ill-developed as they touched the ground. The other side possesses well-developed septa and in a living state, bore long tentacles, so that the mouth is rather remote from the centre. The larger *Fungia* has developed into a normal individual, the smaller one was covered by it entirely and was moreover partly overgrown with sea weed, which also blunted the sharp edges of the scar.

In *Fungia actiniformis* there is generally at the underside in the centre a truncated conical platform, of which the flattened surface constitutes the most often sharply outlined scar of attachment to

¹⁾ QUELCH (l. c. page 131) also records the occurrence of similar abnormal individuals.

²⁾ The ribs of the smaller *Fungia* are grown together at the indicated place with those of the larger one: if this were a case of budding, these ribs would grow by themselves.

the anthocaulus. Now we sometimes observe a specimen with stemmed buds by the side of this coniform part. I found one of 43 mm. in diameter; which bore laterally to the platform, at the underside, two buds respectively 3,5 and 3 mm. in diameter; the peripheral portion of the stem had not yet broadened into a disc. From the basis to the septa these buds measured respectively 6 and 5 mm. These buds completely resemble young Fungiae of an anthocormus; they usually occur at the stem of an older bud as lateral branches. In normal cases they are seen below the spot where afterwards the young Fungia will drop from the stem, so that they can develop further, when this takes place. The instance described goes to show that sometimes the tissue above the preformed cicatrix also engenders buds, which however, stick to the underside of the young Fungia, when the final bud drops from the anthocaulus and which are hereby impeded in their further development. The above interpretation seems to me more plausible than the hypothesis which represents the problem as a lateral budding, arisen after the young Fungia has detached itself from the anthocormis. The size of this coral points to its having only just dropped from the stem.

In *F. actiniformis* the scar has a sharp edge, the boundary between the scar and rest of the underside remains sharp also with older specimens of this species. In *F. acitiformis* this facilitates the decision whether an apparently coalesced specimen has originated from two buds or through abnormal growth of one specimen. The scar of *F. fungites* becomes obscured in older specimens, in little ones it is mostly easy to distinguish. In the specimens of Fig. 7 the scars could easily be noted, so that this is an indubitable case of coalescence on the anthocormus. Fixed, stemmed coalescent anthocyathi of *F. fungites* I have not been able to discover.

From the Treub Laboratory Buitenzorg, Aug. 1921.

Physiology. — “*On the Movement of Pepsin in a protein-containing or protein-free Gel of Agar-agar*”. By Prof. C. A. PEKELHARING.

(Communicated at the meeting of November 26, 1921).

In an earlier paper¹⁾ presented to this Academy I dwelt on a peculiar protein obtainable from the gastric mucous membrane, which could be procured in a purer condition from a dog's gastric juice that is neither contaminated with swallowed matter nor with the constituents of the intestinal contents, so that the elementary analysis did not bring forth greater differences than are generally found with purified proteins. This peculiar protein evinced the properties of pepsin in such a marked degree and the digesting power was in different preparations so constant, that I felt justified in supposing that this protein could be the enzyme itself. Subsequent investigations have repeatedly confirmed this view.

However, in discussing the nature of enzymes with our fellow member BEIJERINCK he raised an objection against this conception. According to his experience pepsin, or chymosin (which enzymes I hold to be identical) diffuses in agar-agar about as quickly as albumoses.

This was, indeed, a serious objection. The pepsin, as I prepare it, is split while being rapidly heated in an acid solution to the boiling point, so that albumoses which remain in solution, are liberated, while a considerable precipitate is being formed, from which, on heating with potassium hydrate, part of the sulphur is freed together with substances yielding a biuret-reaction. With acid a precipitate of a new protein can now be obtained from the alkaline fluid, which protein possesses comparatively energetic acid properties and is soluble in alcohol. This pepsin, then, is of a much higher composition than the simple proteins grouped under the name of albumoses. If my conception were correct, pepsin would surely not diffuse so easily as albumose in a gel of agar-agar.

However, I put myself the question whether the movement of the enzyme is indeed to be ascribed entirely to diffusion. Might

¹⁾ Proceedings of the Meeting of 25 Jan. 1902, p. 450,

there not be another cause, if the pepsin were to find in the gel protein which it could attack?

It has long been known that enzymes are capable of binding other substances, not only substances which can be decomposed under the influence of the enzyme, but also substances of quite a different nature, on which the enzyme does not exert any influence at all. Pepsin e.g. combines not only with proteins but also with carbon.

In a concise review on the nature and the action of enzymes¹⁾ I have endeavoured to show that this combination is effected in various ways. First of all there is adsorption. If, as in the case of pepsin, the enzyme and the substance bound by it are both colloidal substances and consequently a difference in surface-tension is of little importance for the adsorption, it is especially the difference in the electric charge of the molecules that comes into play. Owing to this the particles of one substance aggregate as closely as possible on the periphery of those of the other substance. In an acid solution pepsin is charged negatively, protein positively.

The compound thus formed is to a large extent independent of the nature of the two substances. Just as finely divided carbon can bind pepsin as well as all sorts of other enzymes, trypsin also combines not only with protein but also with starch and compounds have been obtained of amylase not only with starch, but also with casein. Adsorption promotes the action of the enzymes by increasing the concentration of the substrate in the immediate neighbourhood of the enzyme or the concentration of the enzyme in the immediate environment of the particles of the substrate. This action is, however, only of a promotive character. For a chemical change the enzyme must combine with it in a manner that depends on the molecular constitution of the substrate as well as of the enzyme. As E. FISCHER has put it: the enzyme must fit to the substrate, or what BEYERINCK terms the "zymotele", like a key to a lock. Only when this kind of combination is effected, can the decomposition of the substrate, generally with addition of water, take place. In this process the enzyme is detached from the substrate in order to combine again with other still intact particles of it. Consequently a small amount of the enzyme can continually decompose new particles of the substrate, unless the enzyme itself is destroyed by noxious influences, as e.g. is the case with trypsin by alkaline reaction of the solution, which however aids the action of the enzyme.

¹⁾ Some Remarks on Enzymes. *Recueil des Trav. Bot. néerl.* XVI, 207.

In this connection we are induced to suppose that the particles of the enzyme are continually moving, while incessantly particles of the substrate are being decomposed. So, when a certain amount of pepsin is going to spread into the protein-containing gel through diffusion, the particles of the pepsin will first be bound to the protein-molecules by adsorption, through the difference in the charge. If only adsorption should come into play, a large number of the pepsin-molecules would be detained, without undergoing or causing any change, while the subsequent diffusion would be inhibited rather than accelerated. It makes a great difference, however, if in virtue of their constitution the molecules of the enzyme also grasp the protein-molecules and they attach themselves to new intact protein-molecules with which they come into contact, after the splitting of the protein and, consequently, because free protein-particles are lying on the periphery, they move towards the periphery, and — seemingly — quicken the diffusion.

Now in the experiments which gave rise to BEIJERINCK'S objection the agar-gel contained protein. The question, therefore, was, whether in such a gel, *ceteris paribus*, the spreading of the pepsin would be quicker in the presence of protein than in a gel without protein, in which only true diffusion would take place.

— To my friend and successor Prof. W. E. RINGER I feel greatly indebted for his highly appreciated help in my endeavours to find an answer to this question in his laboratory. The inquiry was conducted as follows:

25 mgrs of purified pepsin from the pig's gastric mucous membrane was put in a test-tube, dissolved at body-temperature in 2,5 cc. 0,2% HCl, and subsequently 2,5 cc. 3% agar-agar in water was added. By rapid shaking the pepsin was evenly mixed up with the heated agar-agar and immediately after cooled down in melting ice. The small clots of coagulated agar sticking to the wall of the tube consequent on the shaking, were whisked cautiously away and, in order to destroy all the pepsin that might be left behind in the tube above the coagulated column, the tube was filled with 1% NaHO, then emptied after some moments and washed out a couple of times with water and afterwards with 0,1% HCl. After this 10 cc. of a mixture of 5 cc. agar-agar 3% and 5 cc. 0,2% of HCl to which protein was added or was not, was put into the tube. Then the tube was cooled down again in ice. In each experiment four tubes were filled in this way, two with and two without protein. They were then closed with a cork stopper, placed vertically in an incubator that was kept at 27° C.

The amount of pepsin in the lower part of the tube was very considerable (25 mgr.), while 0,1 mgr. of this enzyme in 10 cc. 0,2% HCl dissolves in METT's tubes from 5 to 6 mm. of coagulated white of a hen's egg in 24 hours at 37° C. What was lost of it in mixing the pepsin with the heated agar (which was directly after cooled down in ice) and what was lost in the washing of the tubes with sodium-hydrate, through which of course also a little of the pepsin at the surface of the pepsin-agar column was attacked, could only be very insignificant in relation to that considerable amount of pepsin. It was assumable, therefore, that the concentration of the enzyme in the reservoir sufficed to prevent in the several tubes considerable differences in the degree of the rise of the enzyme in the agar-column above the pepsin-agar.

After a few days every time two tubes were opened, one with and one without protein. To this end a circular incision was made into the glass just on a level with the boundary between the pepsin-agar and the column above it and the glass was broken by touching it with a heated rod. The lower part of the tube could then readily be removed and the whole content be slid out and put on filter-paper.

It might be that the fluid in the capillary spaces between the agar and the glass should have taken up more or less pepsin from the pepsin-agar: a possibility which deserves the more consideration as occasionally it could be observed at the free surface of the column that some fluid had been pressed out, which could dissolve fibrin, though it be in a very small degree. That is why after the reservoir of pepsin had been cut off from the agar-column, this column was immersed for some moments in 1% Na_2CO_3 , then washed immediately in 0,1 % HCl and dried by cautiously rolling it along filterpaper.

We now had to determine the level to which the pepsin had penetrated into the agar-column. With a view to this we proceeded as follows: after cutting off a layer of 2 mm. thickness, there where the column had been in direct contact with the pepsin-agar, the column was divided into three cylinders of equal length, mostly 13 mm. in length, sometimes 15, if the diameter of the tube had been somewhat smaller, and if the whole column had consequently been somewhat longer. In this division we started from the bottom, so that the layer nearest to surface could be rejected. The cylinders were weighed, rubbed down in a mortar with 5 cc. 0,1% HCl. For every one of these fluids we now determined the time in which 1 cc. coagulated 5 cc. of milk at 27° C. We ascertained the com-

parative proteolytic power, after the method of GRÜTZNER¹⁾ by mixing 1 cc. of the fluid with 9 cc. 0,1% HCl to which, at least 10 minutes before, 50 mgrs of finely divided carmin fibrin had been added, then turning the tube once every minute, filtering the contents after a certain time through glasswool and establishing the intensity of its colour with the aid of GRÜTZNER's colorimeter against a solution of carmin fibrin in pepsin hydrochloric acid.

First of all the proceeding of the enzyme was compared in agar-agar with and without fibrin. With a view to this in each of two tubes, containing agar-agar, 10 CC. was added of a mixture of equal portions of 3% agar and 0,2% HCl, and in two others 10 CC. of a mixture of 3% agar and 0,2% HCl with carmin-fibrin that had been rubbed down very finely and had swollen in this acid.

After three days one of each couple of tubes was opened and examined in the manner described. Just as in all the following experiments **I** designates the lowermost cylinder, the one nearest to the pepsin-agar; **II** the one next to it and **III** the topmost cylinder.

The result was to this effect:

	Weight (grms)	Milk clots in	Division mark Colorimeter	Weight (grms)	Milk clots in	Division mark Colorimeter	Weight (grms)	Milk clots in	Division mark Colorimeter
with fibrin	I 2.04	2 min.	1.2	II 2.14	15 min.	0.5	III 2.0	30 min.	not measurable
without >	I 1.8	4 >	1.2	II 1.5	no clotting	0	1.5	no clotting	0

After 6 days the other two tubes were opened. Now we found:

with fibrin	I 2.48	3½ min.	1.7	II 2.54	10 min.	0.8	III 8.24	90 min.	not measurable
without >	I 2.04	4 >	1.0	II 2.04	no clotting	0	III 2.0	no clotting	0

The 2nd experiment was conducted in the same way. Result after 4 days:

with fibrin	I 1.80	2 min.	4.1	II 1.95	17 min.	1.1	III 2.00	40 min.	0.5
without >	I 2.10	2½ >	3.1	II 2.00	18 >	0.5	III 2.00	no clotting	not measurable

After 13 days:

with fibrin	I 1.20	1¾ min.	2.8	II 1.54	4 min.	2.4	III 1.60	17 min.	1.2
without >	I 1.66	2¼ >	2.6	II 1.94	14 >	1.2	III 1.90	60 >	0.1

¹⁾ Vide GESELSCHAP, Zeitschr. f. Physiol. Chem. XCIV, 205 and Onderz. Physiol. Laborat. Utrecht, 5e R. XVI, 198.

I have desisted from a determination of the absolute pepsin amount of the several columns, though this could be done by comparison with a solution of pepsin of known strength, since the pepsin in each column was not divided evenly, but lessened considerably from the bottom upwards. The values given show distinctly enough, that the enzyme rose in the agar without protein as well as in the agar with protein, but in the latter more considerably. Only after 13 days could it be demonstrated that the enzyme had reached the upper column in the protein-free gel.

As regards the absolute value of the figures it will not do to compare the results obtained on various days, because the milk used was different every time and for comparison in the colorimeter every time another solution of carmin-fibrin was taken.

Similar results were achieved with clotted white of a hen's egg:

White of a hen's egg, diluted with 10 times its volume of water, was beaten up and coagulated by boiling under addition of acetic acid to a very weak acid reaction. The flaky precipitate was filtered off and washed with water. Part of this was put in 0,2% HCl and evenly distributed in the fluid by rapid shaking. In each of two tubes with pepsin-agar was added 5 CC. of this protein-containing acid, mixed with 5 CC. 3% agar in two other tubes 5 CC. 3% agar with 5 CC. 0,2% HCl.

Two tubes examined after 3 days:

	Weight	Clotting	Colori- meter	Weight	Clotting	Colori- meter	Weight	Clotting	Colori- meter
with protein	I 2.64	1 ³ / ₄ min.	2.2	II 2.56	22 min.	0.4	III 2.35	40 min.	very light red
without >	I 2.70	2 >	2.0	II 2.56	130 "	not meas- urable	III 2.40	none	0

The second set of two tubes got lost.

In every tube so much hydrochloric acid had been put, that the content of the gel was 0,1% over the whole tube. Here, however, we had to consider that in the tubes containing the protein, the acid was partly bound, so that the concentration of the H-ions in the agar-protein gel was undoubtedly lower than in the agar gel without protein. The observed differences could, however, hardly be attributed to it. If the movement of the enzyme depended exclusively upon diffusion, it might presumably be promoted by an acid reaction, considering that, during the sojourn of the tubes in an environment of 27° C., the acid attacks and softens the agar. In every experiment therefore, the protein-containing agar was more solid than the protein-

free agar, nay in some experiments the protein-free agar had become so soft that it could not be divided into three small cylinders so that comparison with the protein-containing agar was impossible.

In accordance with this we also found, that the enzyme proceeds in agar with casein more rapidly in acid-, than in neutral reaction.

A 3% neutral solution was made of pure casein prepared after HAMMARSTEN by addition of NaHO. A part of this was diluted with an equal volume of water, another part with an equal volume of 0.4% HCl. The precipitate arising primarily on the addition of hydrochloric acid was dissolved again in the excess of acid.

Of this neutral solution 5 CC was put in two tubes filled with pepsin-agar, and was mixed with 5 CC 3% agar. In two other tubes 5 CC of the acid solution mixed with 5 CC 3% agar.

After 3 days:

	Weight	Clotting	Colorim.	Weight	Clotting	Colorim.	Weight	Clotting	Colorim.
acid	I 2.27	3 min.	4.5	II 2.30	none	0.6	III 2.24	none	not meas- urable
neutral	I 2.25	2 "	5.6	II 2.30	none	0.3	III 2.30	none	0

After 4 days:

acid	I 2.32	1 $\frac{1}{4}$ min.	4.4	II 2.30	10 min.	1.6	III 2.33	13 min.	1.3
neutral	I 2.30	1 $\frac{1}{2}$ "	4.2	II 2.33	none	0.3	III 2.30	none	0

In both sets of tubes, then, there was a balance in favour of the acid solution. After 4 days pepsin could even distinctly be observed in the top cylinder of the acid gel.

Also with a neutral reaction the movement of the enzyme through the gel was aided by the presence of protein, as appeared from an experiment with milk.

Of 4 tubes containing pepsin-agar two were supplied with 3 CC milk mixed with 7 CC 3% agar; the other two with 3 CC 1% NaCl mixed with 3 drops of 1% CaCl₂ and 7 CC 3% agar.

We observed that also globulin from blood-serum and from edestin had a favourable action on the movement of pepsin through the agar-gel.

Finally I report some more experiments which I carried out to verify the supposition from which I started, viz. that the advance of the pepsin in the protein-containing gel is promoted, because besides

After 3 days:

	Weight	Clotting	Colorim.	Weight	Clotting	Colorim.	Weight	Clotting	Colorim.
with milk	I 2.24	2 min.	3.0	II 2.24	4 min.	2.1 not meas- urable	III 2.20	9 min.	0.5
without "	I 2.20	4 "	2.1	II 2.40	2 ³ / ₄ hour		III 2.30	none	0

After 4 days:

with milk	I 2.25	2 min.	1.7	II 2.36	3 min.	1.5	III 2.40	20 min.	0.8
without "	I 2.50	2 ¹ / ₂ "	1.6	II 2.50	1 hour	0.4	III 2.25	none	not measurable

through adsorption it combines with the protein still in another manner in consequence of the chemical structure of the molecules. When this compound breaks down, in which process the action of the enzyme manifests itself, the liberated enzyme is supposed to attach itself to other still intact protein molecules which are lying on the periphery and to advance in this way in the direction of the diffusion-current. If this supposition is correct, the movement of the pepsin must also be promoted by albumoses, which it is still able to attack; not, however by amino-acid freed from the protein which pepsin cannot attack and which, in contradistinction to albumoses, it cannot grasp¹⁾ in an electric field.

To this end we mixed, in the manner described above, first, primary and secondary albumoses, prepared by digestion of fibrin with gastric juice, and then a mixture of pure amino-acids approximately in the relation in which they are contained in fibrin, in a solution of 0.2 % HCl, with the same volume of 3 % agar-agar.

The primary albumoses contained a considerable amount of heteroalbumose, the secondary ones were freed as much as possible from primary ones by repeated half-saturation with ammonium-sulfate and by filtration.

Primary albumoses. Two tubes each with 100 mgrs. of albumose, two without albumose, prepared as usual.

It appears then that, while the primary albumoses largely promote the movement of the enzyme, the action of the secondary ones, which are much less attacked by pepsin, though it cannot be entirely denied, is much less significant.

Nothing, however, could be detected of an action of the amino-acids, as is shown by the following experiment:

¹⁾ Vide RINGER, Zeitschr. f. Physiol. Chem. XCV, 195 etc. Onderz. Physiol. Laborat. Utrecht. 5de R. XVI, 252.

After 3 days:

	Weight	Clotting	Colorim.	Weight	Clotting	Colorim.	Weight	Clotting	Colorim.
with album.	I 2.35	1 min.	3.3	II 2.40	7 min.	2.1	III 2.40	22 min.	1.0
without >	I 2.20	1 $\frac{1}{4}$ >	3.2	II 2.20	35 >	1.0	III 2.15	none	0

After 4 days:

with album.	I 2.05	50 sec.	3.5	II 1.95	2 min.	3.2	III 1.98	4 min.	2.5
without >	I 2.04	1 min.	3.1	II 2.00	6 >	1.2	III 2.08	none	0

Deutero-albumoses, 100 mgrs.

After 2 days:

with album.	I 2.40	1 $\frac{1}{4}$ min.	5.5	II 2.44	15 min.	2.5	III 2.44	1 hour	1.0
without >	I 2.40	1 $\frac{1}{2}$ >	4.5	II 2.34	1 hour	1.0	III 2.30	2 hrs	0.6

After 3 days:

with album.	I 2.24	1 min.	3.0	II 2.10	2 $\frac{1}{2}$ hour	0.5	III 2.14	none	0
without >	I 2.20	1 $\frac{1}{4}$ >	3.0	II 2.34	none	0.2	III 2.20	none	0

The solution contained in 11 CC 0.2% HCl, 75 mgrs. tryptophan, 7.5 mgrs. of cystin, 40 mgrs. of histidin, 70 mgrs. of tyrosin and 30 mgrs. of alanin. On heating to 40° C. the solution was almost clear. Of this solution 5 cc. and 5 cc. of 3% agar was put in each of 2 tubes. In the other 2 tubes 5 cc. of 0.2% HCl was put, together with 5 cc. of agar.

In the tube heated for 4 days at 27° C. the gel without amino-acids, which, therefore, had been more exposed to the action of the acid, was very soft. Perhaps it is owing to this that the pepsin has penetrated farther than is generally the case in the agar without protein.

It might be surmised, that from the experiments described it does not even follow that pepsin is indeed competent to diffuse in pure agar, seeing that a gel of this agar prepared in the usual way, will always contain nitrogenous substances, which may belong to the group of proteins. I believe this is an unjustifiable assumption. It is difficult to ascertain whether the agar-gel or sol contains protein' because sensitive reactions on protein cannot be successfully applied

After 3 days:

	Weight	Clotting	Colorim.	Weight	Clotting	Colorim.	Weight	Clotting	Colorim.
with am.-acids	I 2.27	1 min.	5.5	II 2.28	22 min.	0.5	III 2.80	none	0
without >	I 2.10	2½ >	3.1	II 2.20	none	0	III 2.16	none	0

After 4 days:

with am.-acids	I 2.35	1½ >	3.5	II 2.30	2 hour	0.3	III 2.30	none	0
without >	I 2.16	1 >	4.5	II 1.85	8 min.	1.7	III 1.70	25 min.	0.8

here, owing to the dark colour caused by the action of strong mineral acids on the carbohydrate. It is possible, however, to remove the greater part of the nitrogenous substances by warming the agar-sol during 24 hours at about 50° C. The nitrogenous substances will then separate in flakes, so that they can be filtered off. In this way I obtained from an agar-sol a sol which was scarcely opalescent and remained almost clear also after the clotting. The agar-sol had been prepared in the usual way by warming it just sufficiently and then filtering it through cotton-wool. It contained 1.6 % N of the solid substance. In the sol there was only 0.39 % N after heating during 24 hours and filtering through compressed paper pulp at about 50° C. This gel was now compared in the usual way with the one that had been filtered only once, to the effect that there was no difference to be observed in the advance of the pepsin. In the gel containing only very little N we could make out in the lowermost cylinder, which had been situated at a few millimeters distance from the pepsin-agar, as much enzyme as in the gel which contained four times that quantity of nitrogen.

That pepsin had no doubt advanced through diffusion. But this movement is very slow.

Whereas after a few days a rather considerable amount of pepsin has penetrated from the reservoir at the lower portion of the tube into the adjoining agar, there is none or hardly any to be made out at a few centimeters distance, anyhow, if the gel has preserved its compactness. If, however, the gel contains protein, the enzyme has proceeded much further in the same space of time.

In my opinion the foregoing warrants the conclusion that the movement of pepsin through a gel which contains protein it is able

to attack, does not entitle us to doubt that the size of the pepsin-molecule is as great as previous observations have assigned to it.

On the other hand it seems to me, that the bearing of protein on the movement of pepsin through a gel, favours the hypothesis that the combination of an enzyme with the "zymotele" is not to be ascribed only to adsorption, but also to a totally different action depending on the structure of the molecules.

On starting this inquiry I purposed to extend it in various directions and over more enzymes, notably invertin and emulsin, which can attack various carbonhydrates of known structure. But I understand that my time for Laboratory work is passed. I must now leave this to younger workers who consider this subject interesting enough to investigate it further in the indicated direction or in their own way.

Physiology. — “*The Myoclonic Reflexes*”. By L. J. J. MUSKENS.
(Communicated by Prof. H. ZWAARDEMAKER).

(Communicated at the meeting of December 23, 1921).

Under the influence of intoxication (camphorum monobromatum, essence of absinth) the myoclonic reflexes may be seen to shorten their normal long refractory stage to a small interval. For the rest the tracing presents the type of the patellar reflex, a rather steep beginning with a protracted termination.

The myoclonic reflexes vary in some respect with the stimulus that elicits them.

Those provoked by tactile- and acoustic-stimuli have a latent period, which is comparatively short; my measurements of this non-reduced reflex-time were 20—60 δ . It appeared that for the tactile reflexes no important changes in the latent period were brought about neither by camphorum monobromatum intoxication (with extension of the reflex-movement over the whole animal), nor by ether-narcosis, nor by removal of a hemisphere.

While with most reflexes a slight decrease of the reflex-time is noticeable with *stronger* stimuli, I found in three experiments with cats, specially carried out for this purpose, (in a definite latitude of intensity), a longer latency with a strong acoustic stimulus than with a weak one.

Latency after acoustic stimulus in $\frac{1}{50}$ sec.

Cat. No.	Light blow	Moderate blow	Heavy blow
205	1.6.	2.5.	2.1
178	1.8. en 1.9.	2.6. en 2.6.	2.1

The acoustic reflexes differ from the tactile reflexes also in other respects. In ether-narcosis a lengthening of the latency of the acoustic reflexes is observed; while the acoustic reflex disappears sooner in the narcosis than the tactile reflexes and also returns later. The latency of the myoclonic reflexes in other animals presents only few divergencies from the values found in cats and monkeys. Tactile stimuli administered to pigeons at the wing gave 2.5 and 3.5 fiftieths of seconds. For ink-fishes (Octopus) I found, after adding some camphorum monobromatum to the seawater, similar latencies; in reptiles in a normal condition four fiftieths (*Trepidonotus natrix*). Just as everywhere in the study of reflexes we find in the myoclonic

reflexes oscillations in latency and in magnitude of the reflex, which, however, are not more considerable than elsewhere.

The reflex-convulsion is in normal conditions restricted not unfrequently to the affected part of the body; if the latter is a limb, the adductors are the first to react. In case of a greater reflectory excitability the reflex involves the whole voluntary muscular system, trunk, and extremities in the process. The propagation of the reflectory effect on the other parts of the body, either through modification of the stimulus, or through increased reflectory excitability, is not gradual but abrupt, in so far as with acoustic stimulation (e. g. clap of the hands) the myoclonic reflex movement is first restricted to the head, then on a slight intensification of the stimulus is transmitted rather abruptly to the fore-limbs, and on a second slight intensification comprises the whole trunk and the extremities. It seems, then, that the centra, which govern the co-operation of the several parts of the body, are not involved in the reflex the one after the other but all together. The rule "all or nothing" seems to hold also here within certain limits. The reflex-convulsion which involves head, legs and trunk, produces an impression as if all the parts of the body are contracted at the same moment. With the aid of separate tambours on the head and the trunk distinct differences are observable, which are evidently connected with the path along which the stimulus proceeds. The subjoined registration of the averages, determined in experimenting with cat 201 after a slight dose of camphorum monobromatum, may serve as an example:

Reflex-time in $\frac{1}{50}$ sec.

Stimulus	Reflex-movement of the head	Movement of the back
Gong.	1.7.	2.2.
Tap on the back.	2.5.	2.6.
Tap on the tail.	3.1.	3.3.

When in such a series of experiments the stimulus is gradually intensified, the reflectory effect will be seen to increase irregularly, until at a given moment a very marked reinforcement of the effect is brought about in the form of an "after-discharge", invariably in the form of a series of convulsions. The extension of the reacting region does not at all take place according to PFLÜGER'S law. In applying the stimulus to the trunk, it is the head that convulses first. Under all circumstances the effect is much stronger when the stimulus is given unexpectedly and without being seen.

Geology. — “On the hot “*Lahav*” (mud flow) of the Valley of Ten Thousand Smokes. (Alaska)”. By B. G. ESCHER. (Communicated by Prof. G. A. F. MOLENGRAAFF).

(Communicated at the meeting of November 26, 1921).

After numerous expeditions to the *Mt. Katmai* volcano and the “Valley of ten thousand smokes” in Alaska, ROBERT F. GRIGGS has amply communicated his observations (lit. 1—6).

Particularly he has viewed the great hot mud flow which occupies an area of 137 sq. Km. in the valley of ten thousand smokes.

As he points out (lit. 5, p. 142)¹⁾ he specially treated this phenomenon so extensively because he felt obliged to give an explanation which would be a novelty in volcanology.

We should be very grateful for his frankness and for the opportunity he has afforded his colleagues to venture on an other explanation of the great hot mud flow.

It is evident that GRIGGS is unaware of the nature of the volcanic explosions of the *Klut* volcano in Java and it seems to me that this volcano gives us the key for the disentanglement of the enigma which was posed before GRIGGS.

We may summarize the observations and explanations of GRIGGS as follows²⁾.

A couple of valleys with an aggregate length of 32 Km. are covered by a hot mud flow, which left practically, everywhere a “high water-(mud-)mark” on the surrounding slopes of the mountains. Stratified ash from the explosion of *Mt. Katmai* in June 1912

¹⁾ In the discussion of this remarkable terrane we have set down numerous considerations which would be quite superfluous if it were located in a district more accessible to geologists, so absolutely clear are its major relations. But, recognizing that under present circumstances it would not be practicable for all geologists who might be skeptical to go and see it for themselves, we have tried to supply the answers to all the questions likely to arise in the minds of such skeptics” (lit. 5 p. 142).

and:

„I would further add that I am not committed to any theory of the origin of this curious terrane, but will be glad to accept any other interpretation that can be suggested, provided only that it is consistent with the facts as found in the field. Certainly any suggestion that would relieve us of the necessity of postulating an entirely new type of volcanic action will be most welcome” (lit. 5, p. 119).

²⁾ For the present I do not take into consideration the most recent version of GRIGGS (lit. 6).

rests directly on the tuff of the mud flow. Moreover this stratified ash covers a more extended area and on the South slope of Mt. Katmai there lies upon this ash a cold mud flow. This cold mud flow is explained by GRIGGS as the result of heavy rains, with which explanation I fully agree. The cold "lahars" from the *Smeru* volcano (Java) which brought about the notorious disaster of *Lumadjan*, are one of the many parallels to this cold mud flow (lit. 11).

GRIGGS seems to be unaware of other mud flows from volcanic material than those caused directly by rainwater or by the thaw water from glaciers¹), but there are sufficient indications in the Katmai region that the glaciers did not melt to any great extent in connection with the explosion of Mt. Katmai. GRIGGS has estimated the cubical capacity of the tuff of the great hot mud flow as one cubic mile (lit. 5 p. 137), or, in other words, as 4096 million cubic metres. To hold this quantity of solid material in suspension he esteems necessary at least as much water, i.e. at least 4096 million cubic metres, and he has not succeeded in finding a source for this enormous quantity of water.

Moreover he has been unable to account for the fact that the great mud flow must be older than the ashfall, although according to his views the ash deposited as subaërial sediment was caused by the explosion of Katmai.

If the strata of ash lay below and the mud flow rested upon it, it is assumed by GRIGGS that the matter is capable for simpler explanation, but this is by no means the case, for the reason that the great mud flow was hot. Since he could not find water coming from above GRIGGS has concluded that the mud which formed the great mud flow welled up from within the valley itself. His view is that the mud welled quietly up without any explosive action through several fissures in the floor of the valley.

GRIGGS is well aware that he has imagined a volcanologic phenomenon wholly unknown to science and declares that he is unable to suggest any hypothesis to account for the mechanism which brought about the great mud flow.

His conclusion he has talked over with some students of volcanism in America, who after the most violent opposition have accepted, as he says, his interpretation as the only one in harmony with the facts.

From this it would appear that the numerous publications on the *Klut* volcano (lit. 7—15) are not well known in America.

The nature of the outbreaks of the *Klut* volcano, which is known

¹) These mud flows are known in Iceland by the name „jökulhlaup” (lit. 18 p. 171).

from numerous explosive eruptions may be summarized as follows.

After each eruption during an average period of rest of 18 years¹⁾ the crater is after about six years filled up with rainwater. Hence the new explosive eruption must take place through the water of the crater lake, so that this is blown out of the crater mixed with hot ash, pumice and volcanic bombs and lapilli all of which flow down the slopes of the volcanic cone as a hot mud flow, which is known as a "*lahar*" (hot lahar) by the Javanese people.

Eruptions of the Klut-volcano are known to have taken place in 1586, 1752, 1771, 1811, October 11—14th 1826, 1835, May 16th 1848, January 4th 1864, May 22th—23th 1901 and May 19th—20th 1919.

In 1875 without any volcanic action the west side of the rim crumbled away, by which the crater lake was partially emptied and cold lahars were formed.

When the eruption lasts longer than the time necessary to blow out all the water from the crater lake, there follows upon the hot lahars an ordinary ash-rain. Still later cold lahars follow in consequence of the abundant tropical rainfall.

The section of deposits which results from the above sequence would comprise in order from above downward:

- III. Tuff from cold lahars in consequence of heavy rainfall. (Transposed material from I and II).
- II. Ash, deposited as subaërial sediment. (Second eruption-sediment).
- I. Tuff from hot lahars. (First eruption-sediment).

It is remarkable how much heat remains in such a lahar after the water has partly drained away and in part evaporated. After the eruption of 1919 KEMMERLING (lit. 14) observed in numerous places pseudo-volcanic phenomena, caused by the water evaporating in the lahar²⁾. VISSERING (lit. 11 p. 73) mentions that a walking-stick which four days after the eruption of 1901 was poked into the lahar, was drawn out in flames. KEMMERLING mentions (lit. 14 p. 811) that some days after the eruption he measured a temperature of 360° C. in a gas-emanation on the lahar. March 25th 1921 I visited the Klut and Mr. G. K. R. HÖJGAARD, topographer to the Netherland East Indian Mining Service (Mijnwezen) told me that the temperature of the lahar of May 1919 still amounted to 178° C. at a depth of 50 cM.

The final account of the Klut eruption of 1919 by the volcano-

¹⁾ This average is computed from the eruption dates since 1811.

²⁾ A splendid photograph of the lahar of 1919 with steam clouds is to be found on pp. 116—117 of the well-known French Weekly „Illustration” of Aug. 9th 1919, No. 3988. This picture was taken on May 22th 1919.

logist to the Netherland East Indian Mining Service Dr. G. L. L. KEMMERLING has not yet appeared. As far as I know the best map of the lahar of 1919 till now appeared in the „Keloet Number” of „Picturesque Netherlands East Indies”, Vol. 1, N^o. 5¹⁾. The scale

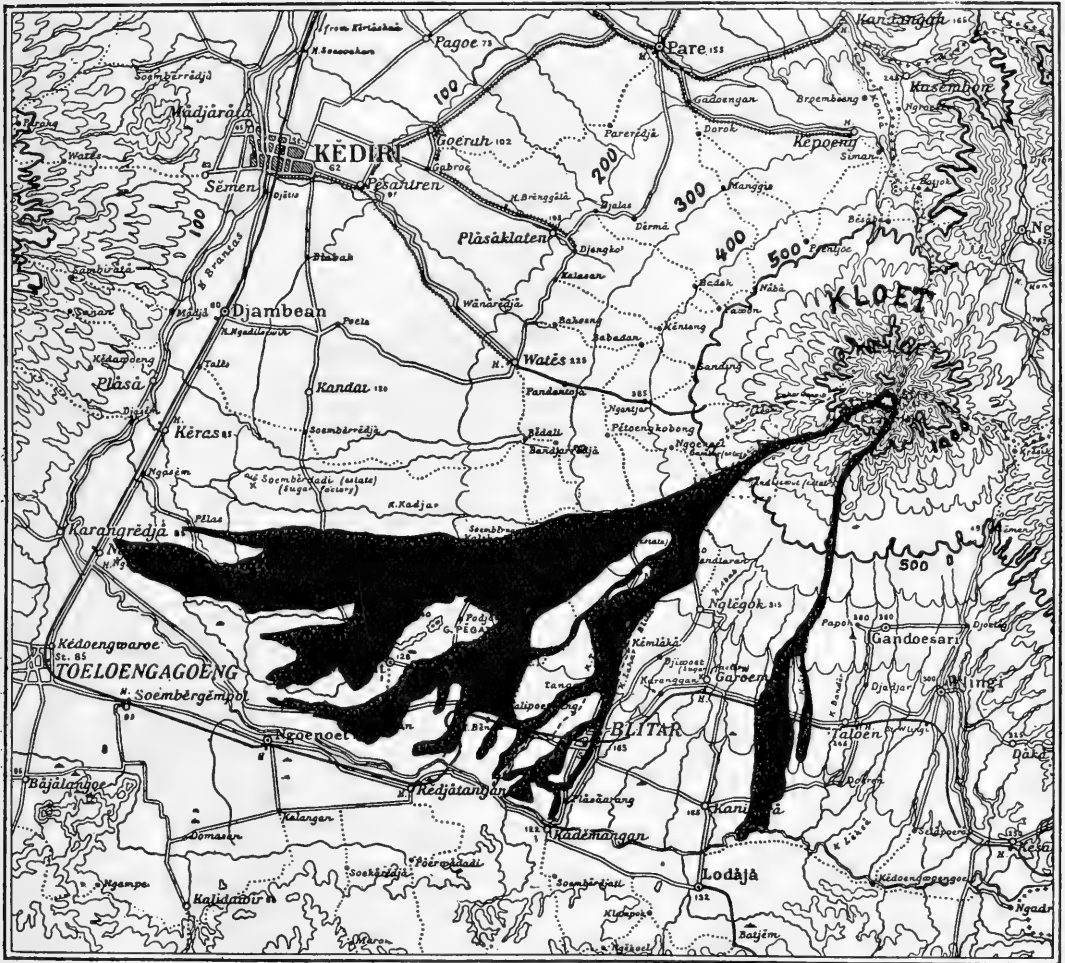

Fig. 1.

The hot lahars of the Kloet volcano, in 1919.

After G. L. L. KEMMERLING.

Scale 1 : 400.000.

of this map is however not 1 : 250.000 as it states but nearly 1 : 400.000. The distribution of the lahar is based on data procured by KEMMERLING (fig. 1). From this map I computed the area occupied by the lahar to be 208 sq. km. (81 sq. miles) or in round numbers 200 sq. km.

¹⁾ Issued by the Official Tourist Bureau Weltevreden, Java, July 1919.

As regards the thickness of the lahar, for the present there are only few data at our disposal. In the upper course in the neighbourhood of the lahar Gupit the thickness is according to my estimate more than 50 m., but here the breadth is only about 200 m. This great thickness is connected with an accumulation behind the Durga-canyon (with a breadth of only 10—15 m.), through which the whole lahar of 1919 had to pass. This upper part of the lahar has now been strongly attacked by erosion, so that its thickness can be measured. More important for an estimate of the cubical capacity of the lahar is the thickness within the plain. KEMMERLING (lit. 14 p. 810) mentions in the town of Blitar a local thickness of 1,55—2,20 m. and observes that in the plain inundated by the mud flow all vegetation is covered under a layer of sand and stones to a depth of 40—60 cm.

If we assume an average thickness of the mudflow of 50 cm., the *cubical capacity of the lahar of 1919* would amount to $0,5 \times 200$ million cubic m. = **100 million cu.m.**; if we assume the average thickness to be 20 cm. only — and to assume a still lower average thickness would be quite absurd — then the cubical capacity would amount to $0,2 \times 200$ million cu.m. = **40 million cu.m.** The material of the lahar consists partly of ash, lapilli and bombs from the eruption of 1919 and in part of old lahar-material, brought up, eroded and swept away by the new mud flow. The cubical capacity of the crater lake amounts to 38 million cubic metres (lit. 14)¹⁾.

The proportion of solid materials (*A*) to water (*W*) in the hot lahar of 1919 consequently would have been as follows:

Supposing an average thickness of the lahar of 50 cm.

$$\frac{A}{W} = \frac{100}{38} = 2,6$$

Supposing an average thickness of the lahar of 20 cm.

$$\frac{A}{W} = \frac{40}{38} = \pm 1.$$

Now let us take up again the *Katmai* region.

It appears that GRIGGS has quite overlooked in his speculations that before the eruption of 1912 the *Katmai* volcano must have possessed a crater lake, just as is now the case according to his section

¹⁾ After the eruption of 1901 the water-mark of the crater lake was lowered artificially so that the cubical capacity was reduced from 44 million cu.m. (lit. 10) to 38 million cu.m. At present there is a tunnel under construction with a view to have the crater lake dry before the next eruption and in future to avoid the formation of hot lahars.

(lit. 2 p. 167), and the water of this crater lake must have acted a similar part as that of the Klut.

Thus the first sediment of the Katmai explosion would not have been as GRIGGS supposes the ash deposited as subaërial sediment but *the hot lahar*, which reduced the trees to charcoal. Afterwards there must have supervened a phase in which all the water of the crater was blown out and the ash was thrown up dry and fell down on an extensive area, and finally (as a phenomenon that is not connected directly with the eruption) the rain caused a cold mud flow on the South slope of Mt. Katmai.

Let us now trace the quantities of solid material and water.

GRIGGS estimates the quantity of solid material of the great mud flow of the Valley of ten thousand smokes at 4096 million cubic metres (lit. 5, p. 137)¹⁾ and the cubical capacity of the crater-hole after the eruption at 4500 million cubic yards = 3442 million cu.m. By the eruption the rim was lowered from 7500 feet (2280 m.) to a maximum of 6970 feet (2120 m.) (lit. 4, p. 167) or a minimum of 5200 feet (1580 m.) (lit. 3, p. 59). According to GRIGGS the crater-hole had before the eruption of 1912 a cubical capacity of 11,000 million cubic yards = 8415 million cu.m.

The content of the crater lake will therefore have amounted to 8415 million cu.m. before the eruption, so that the above mentioned proportion for the Katmai volcano would amount to:

$$\frac{A}{W} = \frac{4096}{8415} = 0,49.$$

If the cubic capacity of the crater lake before the eruption had been smaller and the quantity of solid material in the lahar greater, there would still have been enough water in the Katmai crater to cause the hot mud flow which was observed by GRIGGS in the Valley of ten thousand smokes.

The question whether the distribution of the mud-flow can be brought into harmony with the supposition that the Katmai crater was the source of the hot mud flow has still to be answered. GRIGGS gives on page 132 of his paper of Dec. 1918 (lit. 5), (fig. 2) a map with the distribution of the great hot mud flow. On the West side of Mt. Katmai the hot mud flow attains the contour line of 3000 feet (910 m.), while the lahar running in a northwest direction

¹⁾ In lit. 6, p. 241 GRIGGS computes the total quantity of the sand- (read : mud-flow) „as greater than a cubic mile”.

over a distance of ± 15 miles (24 km.) descends to ± 300 feet (91 m.), (lit. 5, p. 120).

The Valley of ten thousand Smokes.
Het dal der tienduizend rookpluimen.

Simplified after R. F. GRIGGS.

- ← Way of the hot lahar after the author.
 Hot lahar (mud flow) after R. F. GRIGGS.

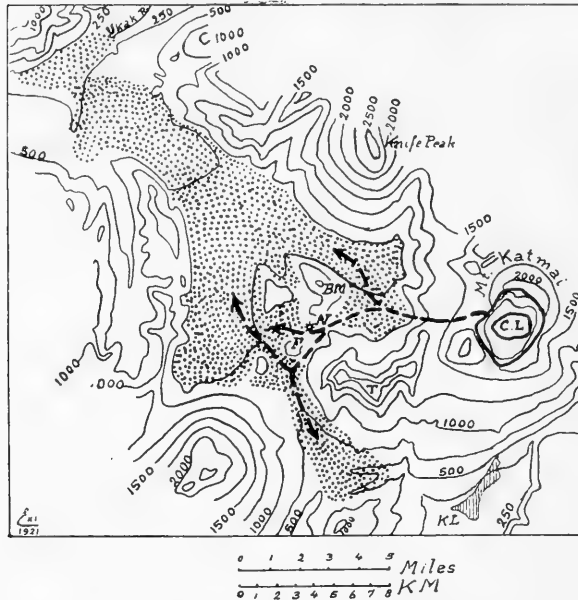

Fig. 2.

Scale 1 : 400.000.

Heights in metres.

- CL = Crater Lake.
 KL = Katmai cold mudflow.
 BM = Broken Mountain.
 N = Novarupta volcano.
 F = Falling Mountain.
 T = Trident volcano.

Between *Broken Hill* and *Trident Volcano* lies the new volcano *Novarupta* which according to the terminology of SCHNEIDER (lit. 16, p. 67) must be classed with the *tholoïdes*¹⁾. The altitude of the pass between Novarupta and Trident Volcano amounts to 2600 feet

¹⁾ Novarupta is composed of a ring of loose efflata and a central lava plug (tholoïde) (lit. 6, photograph p. 230). Just as at the Gunung Galunggung (Java) where in 1918 a tholoïde: Gunung Baru (= New Mountain) originated (lit. 18) in the crater, also at Novarupta the tholoïde is a volcanic structure in a crater, so that F. v. WOLFF (lit. 17, p. 491) seems to be right where he says that tholoïdes ought not to be included among the fundamental forms of volcanic structures. They are secondary forms in existing volcanoes.

(790 m.), while that of the pass between Falling Mountain and Trident Volcano is 2800 feet (850 M.) high.

The course which is taken in my opinion by the hot lahar is drawn on the annexed diagram (fig. 2) by a dashed line. Coming from Katmai crater with great rapidity the lahar descended towards the west, bifurcated the first time near Broken Hill, whereby the main part flowed westwards and a smaller part towards the southwest between Broken Hill and Trident Volcano. A second bifurcation took place near Falling Mt.; one part flowing in a westerly direction and after turning to the north joining the main flow, whereas the other part flowed to the south and southwest over Katmai-pass and descended as far as Mageik Creek to a level of ± 1400 feet (425 m.). This has been derived from GRIGGS' map. He will be able to say whether it agrees with his detailed observations.

What still calls for an explanation is the fact that the mud flow has not been found between the western crater rim (± 6000 feet = 1820 m.) and the contour-line of 3000 feet (910 m.). A similar phenomenon, though less striking¹⁾ is also observed at the Klut. It is due to the fact that the lahar erodes in the shorter and steeper upper part of his course and can lay down deposits only within the much longer and more level lower part. The name Klut signifies: sweeper; at each eruption he entirely cleans away great parts of his slopes and further on sweeps away cultivations and villages.

In connection with the above mentioned phenomena I should like to propose the following nomenclature for mud flows:

I. *Specific volcanic mud flows:*

- | | |
|---|-------------|
| 1. By an eruption through a crater lake: | Type |
| <i>lahar</i> (hot lahar) | Klut (Java) |
| (hot mud flow) | |
| 2. By melting of an ice-cap by an eruption: <i>jökulhlaup</i> | Iceland |

II. *Not specific volcanic mud flows:*

- | | |
|--|--|
| 3. By heavy rains on loose material: <i>Murgang</i> (cold lahar) | |
| (cold mud flow) | |

In the above I have tried to prove that the Katmai eruption of 1912 was an enlarged edition of the Klut eruptions which have been so often observed (fig. 3), and that the hot mud flow of the Valley of Ten Thousand Smokes was a hot lahar.

¹⁾ The narrow Durgá-canyon brakes the lahar which therefore partially remains behind.

On the lahar of the Klut pseudo volcanic phenomena were observed in connection with evaporating rain- and groundwater and the sudden appearance of steam under great pressure. That this pressure can be rather high may be concluded from the temperature of 360° C. which KEMMERLING measured at a gas emanation from the lahar some days after the eruption.

The highest recorded temperature in the Valley of Ten Thousand Smokes was 645° C. (lit. 6 p. 250). I should not dare to assert that the smokes in the latter valley are coming all from the heat which is locked up in the lahar.

It is true that the material of the lahar is an excellent insulator against loss of heat, so that it seems quite possible that the lahar of Mt. Katmai may still retain a part of his own heat after years, but GRIGGS mentions three facts showing that there must be still another source of heat in the valley.

In the first place true solfatares were observed with the sublimation products sulphur and the two sulphides of arsenic (lit. 4 p. 105) which fact in accord with our experience must be brought back to magma the below.

Secondly, GRIGGS succeeded in finding fumaroles not situated on the mud flow but beside it in the Jurassic sandstone, which locally forms the underlying terrane of the valley (lit. 4 p. 111).

Thirdly at one end of the valley lava appeared and formed the lava-plug in Novarupta volcano (lit. 4 p. 111).

These three facts do not agree with the properties of the hot lahars from the Klut volcano and are explained by GRIGGS on the supposition that under the valley the magma lies near the surface.

On the other hand it is certain that the Katmai lahar must form pseudo-volcanic phenomena just as the Klut lahar did; so it will probably be possible to conclude from detailed data whether we must indeed suppose (lit. 4 p. 116) that the area in the vicinity of which the magma reaches nearly to the surface has a length of 32 Km. or that parts of this terrane do not exhibit signs of real volcanic phenomena, but only of pseudo-volcanic lahar phenomena.

Probably this might be settled by help of analyses of the fumarole gases and a map of the distribution of the different kinds of gas.

It seems conceivable for instance that the part of the Katmai lahar which flowed over Katmai-pass towards the southeast does not have real solfatares. In his last paper (lit. 6 p. 248) GRIGGS points to the fact that the intensity of some fumaroles was in 1919 lower than in the preceding years. Some fumaroles had in 1919 a markedly lower temperature, others (about a hundred) did not exist any longer.

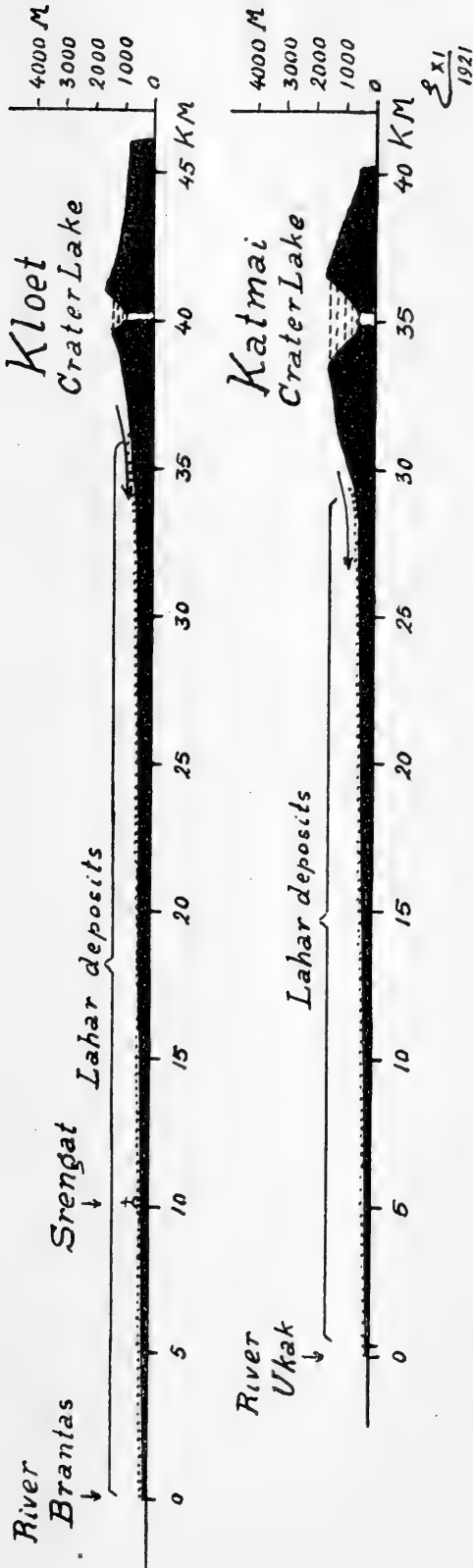

Scale 1 : 250,000.

Fig. 3.

Two hot Lahar's of
Katmai (Alaska) after the eruption of 1912
and *Kloet* (Java) after the eruption of 1919.

It might be possible that these observations have relation to pseudo-fumaroles.

In the discussion of the great mud flow I have till now used only the papers of GRIGGS litt. 1—5. Especially in lit. 5 he gives many detailed observations on the mudflow. It may be noted that he speaks of a "high-water-mark" (lit. 5 p. 121) and in the legend accompanying a photograph (lit. 5 p. 126) of a "high-mud-mark".

In lit. 6 however a "high-sand-mark" (p. 232) is for the first time mentioned and it is evident that GRIGGS interprets the tuff-filling of the valley by the eruption of *dry* ash and sand through hundreds of little volcanoes in the bottom of the valley. He speaks of "the tremendous outflow of incandescent sand" (p. 241) and in the legend to a photograph (p. 228) we find the expression "hot-sand-flow".

The mechanism of this hot sand-flow is for the present insufficiently explained: „The continuity of this „high-sand-mark” shows clearly that the incandescent mass was not poured down one of the adjacent mountain sides into the valley, but must have originated from vents within its confines. This is clearly evidenced by many additional facts which cannot be detailed here. During the whole period of flow the mass was probably kept in a state of constant turmoil by the continued evolution of gas from the substance of its solid components” (lit. 6 p. 232).

In connection with the photograph of Novarupta (lit. 6 p. 230) we find mentioned: “It is probable that a considerable fraction of the incandescent sand came from this vent.”

This new hypothesis of GRIGGS is manifestly invented because on a closer view he no longer found it probable that a hot mud flow welled out of the bottom of the valley.

However this may be, *his detailed observations communicated in lit. 5, have convinced me that the tuff-filling of the „Valley of ten thousand smokes” is brought about by a hot lahar coming from the crater lake of Mt. Katmai.*

We can therefore predict with a great approach to certainty that at the next eruption of Katmai-volcano hot lahars will again occur and principally on that side or those sides where the crater-rim is now lowest.

Nov. 21, 1921.

REFERENCES.

I. MT. KATMAI.

1. ROBERT F. GRIGGS: „*The Valley of ten thousand smokes*”. The National Geographic Magazine. Washington 1917, January pp. 13—68.
2. R. F. GRIGGS: „*The Valley of ten thousand smokes*”. Washington 1918, February pp. 115—169.
3. R. F. GRIGGS: „*The Recovery of Vegetation at Kodiak*”. The Ohio Journal of Science 1918. November pp. 1—57.
4. R. F. GRIGGS: „*Are the ten thousand smokes real volcanoes?*” The Ohio Journal of Science 1918. December pp. 97—116.
5. R. F. GRIGGS: „*The great hot mud flow of the valley of ten thousand smokes*”. The Ohio Journal of Science 1918. December pp. 117—142.
6. R. F. GRIGGS: „*Our greatest national monument*”. The National Geographic Magazine 1921. September p.p. 219—292.

II. KLOET.

7. FR. JUNGHUHN: „*Java*”. Sec. edition 1854. Part III, pp. 668—723.
8. R. D. M. VERBEEK et R. FENNEMA: „*Description géologique de Java et Madoura*”. 1899. Tome I, pp. 177—178.
9. L. HOUWINK: „*Verlag van een onderzoek naar aanleiding van de uitbarsting van den vulkaan Keloet in den nacht van den 22en op den 23en Mei 1901*”. Jaarboek v. h. Mijnwezen in Ned. Oost-Indië. 35e jaarg. 1901, pp. 122—136.
10. H. COOL: „*Eenige mededeelingen en beschouwingen naar aanleiding van een onderzoek aan den kraterwand van den Keloet in Mei 1907*”. Jaarboek v. h. Mijnwezen in Ned. Oost-Indië. 1907, pp. 185—233.
(With a list of older references on the Klut-eruptions).
11. G. VISSERING: „*Geweldige Natuurkrachten*”. Batavia-Amsterdam 1910.
12. B. G. ESCHER: „*De Kloet van een geomorfologisch standpunt beschouwd*”. Natuurkundig Tijdschrift voor Ned. Indië. Vol. LXXIX, pp. 120—127. 1919.
13. B. G. ESCHER: „*De Kloet*”. Waterstaats-Ingenieur. 7e jaargang, pp. 304—309. 1919.
14. G. L. L. KEMMERLING: „*De Kloetramp*”. De Ingenieur. 34e jaargang, pp. 804—813. 1919.

III. MISCELLANEOUS.

16. K. SCHNEIDER: „*Die vulkanischen Erscheinungen der Erde*”.
 17. F. VON WOLFF: „*Der Vulkanismus*”.
 18. TH. THORODDSEN: „*Island*”. Ergänzungshefte zu Petermann's Mitteilungen No. 152—153.
 19. B. G. ESCHER: „*L'éruption du Gounoung Galoungoung en Juillet 1918*”. Natuurkundig Tijdschrift v. Ned. Indië. Vol. LXXX, pp. 260—264. 1920.
-

Physics. — “*On the Equation of State for Arbitrary Temperatures and Volumes. III. On the Law of Force between the Molecules of Mon-atomic Substances*”. By DR. J. J. VAN LAAR. (Communicated by Prof. H. A. LORENTZ).

(Communicated at the meeting of November 26, 1921).

§ 8. General Considerations.

In the two preceding papers ¹⁾ it has been demonstrated that a closer consideration of the problem of the movement of a molecule to and fro between the two adjacent molecules (for the sake of simplicity reduced to a problem of one-dimension) necessarily leads at *low* temperatures to an expression of the form

$$\varepsilon = \Delta + \frac{2\Delta}{e^{\frac{2}{3}\Delta} - 1},$$

in which Δ represents the *zero-point energy*, i.e. the energy of the active forces, which remains when the temperature (determined by the time-average of u^2) has become $= 0$ [loc. cit. p. 1198 (Δ is there represented by E_0) and p. 905].

If it could be proved that in this $\Delta = \frac{3}{2} N h \nu$, the analogy with PLANCK's formula would become identity. But to reach this, we should have to know the accurate law of attraction, i.e. a law which takes into account the *motion in closed orbits* of the negative electrons round the positive nucleus of the atoms. The prevalent laws of attraction have not taken this into account as yet; either because the integrability of the equations of motion required a simple — although still plausible — law of attraction, so that the accurate law had to be purposely set aside for one of a simpler form; or because in the derivation of the required law the influence of the said motion was (consciously or unconsciously) eliminated

¹⁾ These Proc. Vol. XXI, N^o. 9, p. 1184, and These Proc. Vol. XXIII, N^o. 6, p. 887.

by taking averages, as e.g. DEBIJE did in his paper on the VAN DER WAALS' cohesion forces¹⁾.

In our first paper (see p. 1188) we assumed for the attractive force $F = f \times 2x$, in which x represents the distance of the moving molecule from the neutral point; and for the repulsive force on collision $2\varepsilon \times y$, in which y represents the compression of the molecule.

Later on (p. 897) I substituted for the two separate laws of force one single law of the form (cf. the cited paper for the meaning of the different letters)

$$F = f \cdot 2x \left[1 - \frac{(q-s)(\sigma-s)}{(l-s)^2 - x^2} \right],$$

which rendered the solution of the problem raised there still just possible by the aid of elliptical functions.

Though these two laws of attraction by no means represent reality quantitatively accurately, yet at low temperatures we found a relation between E and T , which is analogous with PLANCK'S well-known expression — which certainly proves that the essential part of our considerations (viz. our observance of the *time-average*) rests on solid foundations. The exact form of the law of attraction seems here to a certain extent to be of minor importance, and according to the results of the two papers to have influence only on some numerical coefficients.

¹⁾ Phys. Zeitschr. 21, 178 (1920). In 1908 VAN DER WAALS Jr. already treated a similar problem, but he still considered the atoms (molecules) as electric double points which, like DEBIJE, he besides supposed *far enough* apart to simplify the problem. He found that the force decreased more rapidly than r^{-7} .

Later also KEESOM wrote a paper in connection with the said paper by DEBIJE (These Proc. Vol. XXIII, N^o. 6, p. 939 and 943; also Phys. Zeitschr. 22, 129 (1921) and Mededeelingen Utrecht N^o. 6) on the question of the forces of attraction. There he demonstrates that for H_2 , O_2 and N_2 DEBIJE'S quadrupoles yield a too large value; further that — at least for the said gases — the quadrupole-attraction has considerably more influence on the second virial-coefficient B than the so-called "induced" attraction (unless the temperature is very high), and that the VAN DER WAALS cohesion-forces can chiefly be attributed to forces which the molecules exert on each other in virtue of their quadrupole-momenta.

BURGERS (Dissertatie, Leiden 1918, p. 186) calculated the quadrupole-momentum of the H_2 -molecule according to the model constructed by BOHR and DEBIJE (to which, however, there are several objections), and found a remarkable agreement with the value $2,03 \cdot 10^{-26}$ (electrostatic units $\times cm^2$; uncorrected for the polarisation of the molecules in each others' electric field), derived by KEESOM (Comm. Leiden, Suppl. 39a, p. 15) from the 2nd virial-coefficient, viz. $2,05 \cdot 10^{-26}$.

But, as has been said, a true insight — especially as far as the relation between Δ and $h\nu$ is concerned — cannot be obtained until the law of attraction is accurately known; then the quantities h and ν will also appear automatically in the law of the action between two atoms (molecules).

We shall see in what follows that the real active force is by no means merely an exclusively *attractive* action increasing in intensity, which is only transformed into a *repulsive* force at collision or at a very short distance — but that from the very beginning the action has been **periodically** attractive and repulsive, which only becomes stronger and stronger on approach of the atoms. Several known phenomena can now be explained more easily, not only in the sphere of the solid bodies (and of the liquids), but also in that of the *gases* — particularly as concerns the so-called “*gas-degeneration*” at very low temperatures.

§ 9. Derivation of the Elementary Law of Force.

To simplify the calculations, we shall again place ourselves at the standpoint of the problem of one dimension. In connection with this the circular motion of the electrons round the positive nucleus must be transformed into a motion to and fro rectilinearly, viz. the projection of the circular motion on the direction of the joining line of the two nuclei, so that the electrons always move (fictitiously) to and fro through the nucleus.

Let r be the distance of the two nuclei A and B , a the radius of the orbit of the electrons (thought perfectly circular), so that the deviations x and y of the electrons from the centre are represented by

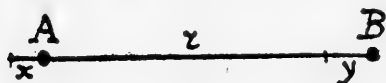

Fig. 1.

$x = a \sin 2\pi \frac{t}{T}$, $y = a \sin 2\pi \frac{t'}{T}$. We then have together for the repulsive and attractive forces (see Fig. 1):

$$F = e^2 \left[-\frac{1}{r^2} - \frac{1}{(r+x-y)^2} + \frac{1}{(r+x)^2} + \frac{1}{(r-y)^2} \right],$$

when for the present we confine ourselves in our considerations to mon-atomic substances, while only *one* electron moves round the nucleus. (H-atoms).

When an atom M moves between two other atoms P and Q , the total action (taken positive when M is drawn to the right (P))

becomes evidently (see fig. 2) — on the supposition that the atoms

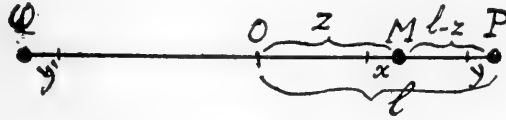

Fig. 2.

P and Q are on an average at rest, and the mutual polarizing action of the atoms may be neglected:

$$\frac{F}{e^2} = \left. \begin{aligned} & -\frac{1}{(l-z)^2} - \frac{1}{(l-z+x-y)^2} + \frac{1}{(l-z+x)^2} + \frac{1}{(l-z-y)^2} \\ & + \frac{1}{(l+z)^2} + \frac{1}{(l+z-x-y')^2} - \frac{1}{(l+z-x)^2} - \frac{1}{(l+z-y')^2} \end{aligned} \right\},$$

when l is the mean distance of the atoms, and z the distance of the moving atom on the right from the mean position of equilibrium (neutral point) O . If therefore F is positive, the force of M is directed towards P .

Now the motion of the electrons round P and Q will exhibit *phase-difference* with that of the electron round M , so that we shall have to calculate the mean value for different values of y and y' , retaining the value of x , that varies periodically with the time in the *considered* molecule M , which we shall, accordingly, *not* eliminate by taking averages. The integral

$$I = \frac{1}{2\pi} \int_0^{2\pi} \frac{d\omega}{((l-z)+x-y)^2} = \frac{1}{2\pi} \int_0^{2\pi} \frac{d\omega}{\left[(l-z) + a \sin 2\pi \frac{t}{T} - a \sin \left(2\pi \frac{t}{T} + \omega \right) \right]^2}$$

has the form

$$I = \frac{1}{2\pi} \int_{\varphi}^{\varphi+2\pi} \frac{d\varphi}{(p-a \sin \varphi)^2},$$

when $2\pi \frac{t}{T} + \omega = \varphi$ is put. (ω is the phase-difference between P and M). With $a = 90 + \varphi$ this becomes:

$$I = \frac{1}{2\pi} \int_{\alpha}^{\alpha+2\pi} \frac{d\alpha}{(p+a \cos \alpha)^2} = \frac{p}{(p^2-a^2)^{3/2}},$$

as is easy to derive. Hence we get, performing the same thing with the integrals in which y' occurs:

$$\frac{F}{e^2} = \left. \begin{aligned} & - \frac{1}{(l-z)^2} - \frac{l-z+x}{((l-z+x)^2-a^2)^{3/2}} + \frac{1}{(l-z+x)^2} + \frac{l-z}{((l-z)^2-a^2)^{3/2}} \\ & + \frac{1}{(l+z)^2} + \frac{l+z-x}{((l+z-x)^2-a^2)^{3/2}} - \frac{1}{(l+z-x)^2} - \frac{l+z}{((l+z)^2-a^2)^{3/2}} \end{aligned} \right\}, \quad (1)$$

and this will be the law of action between M and the two adjacent atoms P and Q . The first four terms refer to P , towards which M e.g. moves; the last four to Q , from which M then moves away.

The expression (1) yields in the equation of motion perfectly unintegrable forms, and we shall try to find for them an approximate expression, when z and x are not too great with respect to l . At any rate it appears at once that F contains the factor x , so that the law of action becomes a **purely periodical** one.

Whenever x becomes $= 0$, i.e. the electron (fictitiously) moves through the nucleus, F will also become $= 0$, and the total force change from *positive* (at x positive), i.e. directed towards the *right*, into *negative* (at x negative), i.e. directed towards the *left*, and vice versa. In reality for $x = 0$ both the first part of the second member of (1) becomes $= 0$, and the second part.

When in his cited article (p. 179 righthand side) DEBIJE states that the potential of a sphere with charge $+e$ in its centre and $-e$ on its circumference is on an *average* $= 0$, he is, of course, right. But in the first place I object to this view of the problem, since it will depend on the mutual position of the electrons in their orbits round the two centres and on their phase-difference, what action will result; which also renders it doubtful whether all orientations of the two electrons on the two sphere-surfaces will, indeed, be equivalent — even on an “average”. And in the second place it seems to me that his method — in order to find still a positive value (i.e. attractive action) for the resulting force — of taking the action into account which one atom exerts on the electric moment of the other, is open to doubt. For according to DEBIJE himself the electric field of this one atom will be on an average $= 0$ (see a few lines lower). How can then this field, which is $= 0$ on an average, exert an appreciable polarizing action¹⁾ on the other atom?

That the attractive action with the periodicity found by us, is

¹⁾ Even apart from the fact that the polarization will certainly always be very small, because in my opinion the exceedingly great velocity of the electrons in their orbits excludes an appreciable deformation. DEBIJE finds finally for the attractive action proportionality as r^{-9} (for so-called dipole gases on the other hand r^{-7} , cf. note 1 on page 183), as against VAN DER WAALS Jr. as $r^{-(7+\delta)}$.

not quite symmetrical with the repulsive action, is clear from formula (1). More-over, also for an estimation of the relative order of magnitude of these forces, we shall give some numerical considerations in the following paragraph.

§ 10. Some Numerical Calculations.

Since the centres of the atoms cannot get nearer to each other than $2a$, a mean distance of $l = 3a$ is, indeed, an extreme value for solid bodies and liquids, sooner too great than too small. For when it is considered that for many liquids $(v-b):v$ is $\approx 1/14$ in the neighbourhood of the point of solidification, then $l = (1 + 1/14)2a$. But as the quantity b in the equation of state will very certainly not be equal to the real volume of the molecules, but larger, in reality l will be $> 2,05a$. Even at the absolute zero-point l will probably not be smaller than $2,1a$. Let us now first put

$$l = 3a.$$

1. $z = 0$. The moving molecule is then exactly in O , halfway between the two others.

We can now write for (1):

$$\frac{F}{e^2} = \left\{ \left[\left\{ \frac{l-z}{((l-z)-a^2)^{3/2}} - \frac{1}{(l-z)^2} \right\} - \left\{ \frac{l-z+x}{(l-z+x)^2-a^2)^{3/2}} - \frac{1}{(l-z+x)^2} \right\} \right] - \right. \\ \left. - [\text{id. with } +z \text{ and } -x] \right\}, \quad (1a)$$

in which we get for the case $z = 0$:

$$\frac{F}{e^2} = \left[\left\{ \frac{l}{(l^2-a^2)^{3/2}} - \frac{1}{l^2} \right\} - \left\{ \frac{l+x}{((l+x)^2-a^2)^{3/2}} - \frac{1}{(l+x)^2} \right\} \right] - \\ - \left[\left\{ \frac{l}{(l^2-a^2)^{3/2}} - \frac{1}{l^2} \right\} - \left\{ \frac{l-x}{(l-x)^2-a^2)^{3/2}} - \frac{1}{(l-x)^2} \right\} \right],$$

in which the first and the third part cancel each other. In order, however, to get to know something of the mutual order of magnitude of the different parts, we have not omitted these terms.

For $x = 0$ all the 4 terms are equal to each other; i.e. $= (3:8^{3/2}-1:9):a^2 = (0,1326-0,1111):a^2 = 0,0215:a^2$, and we have $a^2 F:e^2 = (0,0215-0,0215) - (0,0215-0,0215) = 0-0 = 0$.

For $x = +a$ (extreme deviation of the electron towards the side of Q (see fig. 2) is found with $4:15^{3/2} - (1:16) = 0,0689 - 0,0625 = 0,0064$, and $2:3^{3/2} - 1:4 = 0,3849 - 0,25 = 0,1349$:

$$a^2 F:e^2 = (0,0215-0,0064) - (0,0215-0,1349) = 0,0151 - (-0,1134) = 0,1285.$$

A force, therefore, directed towards the right, chiefly originating from the repulsive action exerted by Q on M .

For $x = -a$ (greatest deviation to the side of P) everything is just the opposite, and we have:

$$\alpha^2 F : e^2 = (-0,1134) - 0,0151 = \underline{-0,1285}.$$

Now the repulsive force predominates, which P exerts on M .

2. $z = \frac{1}{2}a$. This is a mean position of M between O and the perfect contact at $z = a$.

For $x = 0$ we have here, since $2^{1/2} : (5^{1/4})^{3/2} - (1 : 6^{1/4}) = 0,2078 - 0,16 = 0,0478$, and $3^{1/2} : (11^{1/4})^{3/2} - (1 : 12^{1/4}) = 0,09276 - 0,08163 = 0,0111$:

$$\alpha^2 F : e^2 = (0,0478 - 0,0478) - (0,0111 - 0,0111) = 0 - 0 = \underline{0}.$$

For $x = a$ we find:

$$\alpha^2 F : e^2 = (0,0478 - 0,0111) - (0,0111 - 0,0478) = 0,0366 - (-0,0366) = \underline{0,0732}.$$

Here the attractive force of P supports the repulsive force of Q (which happens to have the same value).

Finally $x = -a$ yields with $1^{1/2} : (1^{1/4})^{3/2} - (1 : 2^{1/4}) = 1,0733 - 0,4444 = 0,6289$, and $4^{1/2} : (19^{1/4})^{3/2} - (1 : 20^{1/4}) = 0,0533 - 0,0494 = 0,0039$:

$$\alpha^2 F : e^2 = (0,0478 - 0,6289) - (0,0111 - 0,0039) = (-0,5811) - 0,0072 = \underline{-0,5883}.$$

It will be seen that the action is now quite asymmetric: that towards the right at $x = +a$ is much weaker than that towards the left at $x = -a$. This is, of course, owing to the fact that in this latter position the electron is much nearer P than it is to Q in the case $x = +a$.

3. $z = a$. This is the extreme position of M close to P (distance of the centres = $2a$), in which we shall now find an infinitely great repulsive force at $x = -a$.

In the case $x = 0$ we get:

$$\alpha^2 F : e^2 = (0,1349 - 0,1349) - (0,0064 - 0,0064) = 0 - 0 = \underline{0}.$$

For $x = +a$ we find:

$$\alpha^2 F : e^2 = (0,1349 - 0,0215) - (0,0064 - 0,0215) = 0,1134 - (-0,0151) = \underline{0,1285}.$$

And $x = -a$ yields with $(1 : 0^{3/2}) - (1 : 1) = \infty - 1$, and $(5 : 24^{3/2}) - (1 : 25) = 0,0425 - 0,04 = 0,0025$:

$$\alpha^2 F : e^2 = (0,1349 - \infty) - (0,0064 - 0,0025) = (-\infty) - 0,0039 = \underline{-\infty}.$$

The above can be combined in the following survey (values of $\alpha^2 F : e^2$).

		$z = 0$	$z = \frac{1}{2} a$	$z = a$
	$x = 0$	0	0	0
$(l = 3 a)$	$x = + a$	0,1285	0,0732	0,1285
	$x = - a$	-0,1285	-0,5883	$-\infty$

Let us now repeat these calculations for the case

$$l = 2,1a$$

1. $z = 0$.

For $x = + a$ is found with $3,1 : (8,61)^{3/2} - (1 : 9,61) = 0,12 - 0,10 = 0,02$, and $1,1 : (0,21)^{3/2} - (1 : 1,21) = 11,43 - 0,83 = 10,60$:

$$a^2 F : e^2 = -0,02 + 10,60 = 10,58;$$

while for $x = - a$ of course $-10,58$ will be found.

2. $z = 0,05a$.

With $2,05 : (3,2025)^{3/2} - (1 : 4,2025) = 0,36 - 0,24 = 0,12$; $2,15 : (3,6225)^{3/2} - (1 : 4,6225) = 0,31^2 - 0,21^2 = 0,10$; $3,05 : (8,3025)^{3/2} - (1 : 9,3025) = 0,13 - 0,11 = 0,02$; $1,15 : (0,3225)^{3/2} - (1 : 1,3225) = 6,28 - 0,76 = 5,52$ we get for $x = + a$:

$$a^2 F : e^2 = (0,12 - 0,02) - (0,10 - 5,52) = 5,52,$$

while $x = - a$, with $3,15 : (8,9225)^{3/2} - (1 : 9,9225) = 0,12 - 0,10 = 0,02$; $1,05 : (0,1025)^{3/2} - (1 : 1,1025) = 32,00 - 0,91 = 31,09$, gives:

$$a^2 F : e^2 = (0,12 - 31,09) - (0,10 - 0,02) = -31,05.$$

3. $z = 1,1a$.

With $(2 : 3^{3/2}) - (1 : 4) = 0,38^5 - 0,25 = 0,13^5$; $2,2 : (3,84)^{3/2} - (1 : 4,84) = 0,29^{24} - 0,20^{66} = 0,08^6$; $(3 : 8^{3/2}) - (1 : 9) = 0,13 - 0,11 = 0,02$; $(1,2 : 0,44^{3/2}) - (1 : 1,44) = 4,11 - 0,69 = 3,42$ we get for $x = + a$:

$$a^2 F : e^2 = (0,13^5 - 0,02) - (0,08^6 - 3,42) = 3,45.$$

The value $-\infty$ will again be found for $x = - a$. Hence we have now for $a^2 F : e^2$:

		$z = 0$	$z = 0,05 a$	$z = 0,1 a$
	$x = 0$	0	0	0
$(l = 2,1 a)$	$x = + a$	10,58	5,52	3,45
	$x = - a$	-10,58	-31,05	$-\infty$

In consequence of the so much smaller distance of the molecules, the action has in many cases become as much as 80-times greater.

It appears from the above calculations that at *low* temperatures, in which case l approaches to $2a$, the terms without x can very well be omitted, so that we then might write, putting z everywhere $= 0$:

$$\left(\begin{array}{l} \text{low temp.} \\ l \rightarrow 2a \end{array} \right) \frac{F'}{e^2} = - \left[\frac{l+x}{((l+x)^2 - a^2)^{3/2}} - \frac{1}{(l+x)^2} \right] + \left[\frac{l-x}{((l-x)^2 - a^2)^{3/2}} - \frac{1}{(l+x)^2} \right], \quad (1b)$$

in which the 1st term predominates at $x = -a$, the 2nd at $x = +a$.

Though we may now write:

$$\frac{d^2z}{dt^2} = \frac{e^2}{m} \left[\frac{d}{dx} \left\{ \frac{1}{\sqrt{(l+x)^2 - a^2}} - \frac{1}{l+x} \right\} + \frac{d}{dx} \left\{ \frac{1}{\sqrt{(l-x)^2 - a^2}} - \frac{1}{l-x} \right\} \right] = \frac{e^2}{m} \frac{dL}{dx},$$

the direct integration of this equation is impossible. For, since $x = a \sin \varphi$ (in which φ is in general $= 2\pi \frac{t}{T} + \theta$, because at the beginning of the motion of M through O towards P ($t=0$, when M in O) the electron need not necessarily at the same time be in the position $x=0$), we get:

$$\frac{d^2z}{dt^2} = \frac{e^2}{m} \frac{dL}{dt} \frac{dt}{dx} = \frac{e^2}{m} \frac{dL}{dt} \frac{T : 2\pi}{a \cos(2\pi t/T + \theta)} = \frac{c}{a \cos \varphi} \frac{dL}{dt},$$

and evidently nothing can be done with this differential equation — on account of the complicated form of L , while $\sqrt{a^2 - x^2}$ can be substituted for $a \cos \varphi$.

Hence nothing remains but making the expression (1^b) or (1^a) integrable by expansion into series.

§ 11. Expansion into Series for F.

Instead of e.g. $\frac{l-z}{((l-z)^2 - a^2)^{3/2}} - \frac{1}{(l-z)^2}$ we shall expand

$$\frac{1}{\sqrt{(l-z)^2 - a^2}} - \frac{1}{l-z},$$

and then differentiate the result with respect to z , which is easier. We then get:

$$\frac{1}{(l-z+a)^2 (l-z-a)^{1/2}} - \frac{1}{l-z} = \frac{1}{\sqrt{l^2 - a^2}} \left\{ \left(1 - \frac{z}{l+a}\right)^{-1/2} \left(1 - \frac{z}{l-a}\right)^{-1/2} \right\} - \frac{1}{l} \left(1 - \frac{z}{l}\right)^{-1}.$$

For the expression between {} we may write by joining corresponding terms:

$$\begin{aligned}
 &1 + \frac{1}{2} 2z \frac{l}{l^2 - a^2} + \frac{1.3}{2.4} 2z^2 \frac{l^2 + a^2}{(l^2 - a^2)^2} + \frac{1.3.5}{2.4.6} 2z^3 \frac{l^3 + 3la^2}{(l^2 - a^2)^3} + \\
 &\qquad\qquad\qquad + \frac{1.3.5.7}{2.4.6.8} 2z^4 \frac{l^4 + 6l^2a^2 + a^4}{(l^2 - a^2)^4} + \text{etc.} \\
 &+ \frac{1}{2} \cdot \frac{1}{2} z^2 \frac{1}{l^2 - a^2} + \frac{1}{2} \cdot \frac{1.3}{2.4} 2z^3 \frac{l}{(l^2 - a^2)^2} + \frac{1}{2} \cdot \frac{1.3.5}{2.4.6} 2z^4 \frac{l^2 + a^2}{(l^2 - a^2)^3} + \text{etc.} \\
 &\qquad\qquad\qquad + \frac{1.3}{2.4} \cdot \frac{1.3}{2.4} z^4 \frac{1}{(l^2 - a^2)^2} + \text{etc.,}
 \end{aligned}$$

the structure of which is clear. Hence, after multiplication by $(l^2 - a^2)^{-1/2}$ and expansion of $\left(1 - \frac{z}{l}\right)^{-1}$, the original form becomes:

$$\begin{aligned}
 &\left(\frac{1}{\sqrt{l^2 - a^2}} - \frac{1}{l}\right) + z \left(\frac{\frac{1}{2} 2l}{(l^2 - a^2)^{3/2}} - \frac{1}{l^2}\right) + z^2 \left(\frac{\frac{1.3}{2.4} 2(l^2 + a^2) + \frac{1}{2} \cdot \frac{1}{2} (l^2 - a^2)}{(l^2 - a^2)^{5/2}} - \frac{1}{l^3}\right) + \\
 &\qquad\qquad\qquad + z^3 \left(\frac{\frac{1.3.5}{2.4.6} 2(l^3 + 3la^2) + \frac{1}{2} \cdot \frac{1.3}{2.4} 2l(l^2 - a^2)}{(l^2 - a^2)^{7/2}} - \frac{1}{l^4}\right) + \\
 &+ z^4 \left(\frac{\frac{1.3.5.7}{2.4.6.8} 2(l^4 + 6l^2a^2 + a^4) + \frac{1}{2} \cdot \frac{1.3.5}{2.4.6} 2(l^2 + a^2)(l^2 - a^2) + \frac{1.3}{2.4} \cdot \frac{1.3}{2.4} (l^2 - a^2)^2}{(l^2 - a^2)^{9/2}} - \frac{1}{l^5}\right) + \text{etc.,}
 \end{aligned}$$

i.e.

$$A + P_0 z + P_1 z^2 + P_2 z^3 + P_3 z^4 + \dots,$$

in which A, P_0 , etc. contain only l and a . Through differentiation now arises:

$$\frac{l - z}{((l - z)^2 - a^2)^{3/2}} - \frac{1}{(l - z)^2} = P_0 + 2P_1 z + 3P_2 z^2 + 4P_3 z^3 + \dots,$$

and likewise:

$$\frac{l + z}{((l + z)^2 - a^2)^{3/2}} - \frac{1}{(l + z)^2} = P_0 - 2P_1 z + 3P_2 z^2 + 4P_3 z^3 + \dots,$$

so that the difference of these two expressions (c.f. equation (1a)) is represented by

$$f(z) = 4P_1 z + 8P_2 z^3 + 12P_3 z^5 + \dots$$

After substitution of $z - x$ for z , we have also:

$$f(z - x) = 4P_1 (z - x) + 8P_2 (z - x)^3 + 12P_3 (z - x)^5 + \dots,$$

and finally the following equation is obtained:

$$\begin{aligned}
 \underline{F: e^2 = f(z) - f(z - x) = 4P_1 x + 8P_2 (3z^2 x - 3zx^2 + x^3) +} \\
 \underline{+ 12P_3 (5z^4 x - 10z^2 x^2 + \dots + x^5) + \text{etc.,} \dots} \quad (2)
 \end{aligned}$$

so that F clearly contains the factor x (see § 9).

After calculation of the numerators (to which also P_5 has been added), we have:

$$\left. \begin{aligned} P_1 &= \frac{l^2 + \frac{1}{2}a^2}{(l^2 - a^2)^{3/2}} - \frac{1}{l^3} ; & P_3 &= \frac{l^2 + 3l^2a^2 + \frac{3}{8}a^4}{(l^2 - a^2)^{3/2}} - \frac{1}{l^5} \\ P_5 &= \frac{l^6 + \frac{15}{2}l^4a^2 + \frac{45}{8}l^2a^4 + \frac{5}{16}a^6}{(l^2 - a^2)^{3/2}} - \frac{1}{l^7} ; & \text{etc.} \end{aligned} \right\} \quad (3)$$

For small values of z $F: e^z$ approaches:

$$(z=0) \quad \underline{F: e^z = 4P_1x + 8P_3x^3 + 12P_5x^5 + \text{etc.} ; x = a \left(\sin \frac{2\pi t}{T} + \theta \right)} \quad (4)$$

Remark. That the coefficients of l^2, l^4, l^6 , etc. in the expressions for P_1, P_3, P_5 , etc. become every time $= 1$, is not surprising. For they are resp. $2 \left(\frac{1.3}{2.4} \right) + \left(\frac{1}{2} \right)^2, 2 \left(\frac{1.3.5.7}{2.4.6.8} \right) + 2 \left(\frac{1}{2} \cdot \frac{1.3.5}{2.4.6} \right) + \left(\frac{1.3}{2.4} \right)^2$, etc., being the coefficients of the expansion of $(1-y)^{-1/2} (1-y)^{-1/2}$, i.e. of $(1-y)^{-1}$, which are all $= 1$. The coefficients of a^2, a^4, a^6 etc., viz. $\frac{1}{2}, \frac{3}{8}, \frac{5}{16}$, etc. are evidently those of the expansion ($l=0$) of $\left(1 - \frac{z}{a} \right)^{-1/2} \left(1 + \frac{z}{a} \right)^{-1/2} = \left(1 - \frac{z^2}{a^2} \right)^{-1/2}$, i.e. $\frac{1}{2}, \frac{1.3}{2.4}, \frac{1.3.5}{2.4.6}$, etc. According to what follows, the coefficients of the second terms, viz. $\frac{1}{2}, 3, \frac{15}{2}, 14$, etc. are represented for P_1, P_3, \dots, P_n by $\frac{1}{4} n(n+1)$, i.e. by $\frac{1 \times 2}{4}, \frac{3 \times 4}{4}, \frac{7 \times 8}{4}$, etc. [When we add to this resp. $\frac{5}{2}, \frac{9}{2}$, etc. ($= \frac{1}{4}(2n+3)$) of the exponents in the denominators, we get the coefficients of the limiting values of P_1, P_3 , etc. for $l = \infty$, mentioned farther on viz. $\frac{1}{4}(n+2)(n+3) = \frac{3 \times 4}{4}, \frac{5 \times 6}{4}, \frac{7 \times 8}{4}$, etc.].

Indeed, a somewhat different way of expansion into series of

$$\begin{aligned} & \frac{l-z}{((l-z)^2 - a^2)^{3/2}} - \frac{1}{(l-z)^2} \text{ leads to} \\ & \frac{1}{(l-z)^2} \left[\frac{3}{2} \frac{a^2}{(l-z)^2} + \frac{3.5}{2.4} \frac{a^4}{(l-z)^4} + \dots \right] = \frac{3}{2} \frac{a^2}{(l-z)^4} + \frac{3.5}{2.4} \frac{a^4}{(l-z)^6} + \dots = \\ & = \frac{3}{2} \frac{a^2}{l^4} \left(1 - \frac{4z}{1l} + \frac{4.5z^2}{1.2l^2} + \dots \right) + \frac{3.5}{2.4} \frac{a^4}{l^6} \left(1 + \frac{6z}{1l} + \frac{6.7z^2}{1.3l^2} + \dots \right) + \text{etc.} = \\ & = \left(\frac{3}{2} \frac{a^2}{l^4} + \frac{3.5}{2.4} \frac{a^4}{l^6} + \dots \right) + z \left(\frac{3}{2} \cdot \frac{4}{1} \frac{a^2}{l^5} + \frac{3.5}{2.4} \cdot \frac{6}{1} \frac{a^4}{l^7} + \dots \right) + \\ & \quad + z^2 \left(\frac{3}{2} \cdot \frac{4.5}{1.2} \frac{a^2}{l^6} + \frac{3.5}{2.4} \cdot \frac{6.7}{1.2} \frac{a^4}{l^8} + \dots \right) + \text{etc.} , \end{aligned}$$

so that for the factor of z is found (see above):

$$2P_1 = \frac{a^2}{l^6} \left(\frac{3}{2} \cdot \frac{4}{1} + \frac{3 \cdot 5}{2 \cdot 4} \cdot \frac{6}{1} \frac{a^2}{l^2} + \dots \right); \text{ for that of } z^2 \text{ we have}$$

$$4P_3 = \frac{a^2}{l^7} \left(\frac{3}{2} \cdot \frac{4 \cdot 5 \cdot 6}{1 \cdot 2 \cdot 3} + \frac{3 \cdot 5}{2 \cdot 4} \cdot \frac{6 \cdot 7 \cdot 8}{1 \cdot 2 \cdot 3} \frac{a^2}{l^2} + \dots \right); \text{ we get further}$$

$$6P_5 = \frac{a^2}{l^9} \left(\frac{3}{2} \cdot \frac{4 \cdot 5 \cdot 6 \cdot 7 \cdot 8}{1 \cdot 2 \cdot 3 \cdot 4 \cdot 5} + \frac{3 \cdot 5}{2 \cdot 4} \cdot \frac{6 \cdot 7 \cdot 8 \cdot 9 \cdot 10}{1 \cdot 2 \cdot 3 \cdot 4 \cdot 5} \frac{a^2}{l^2} + \dots \right); \text{ etc., etc.}$$

On the one hand e.g. $6P_5$ approaches for $l = \infty$ to $\frac{3}{2} \cdot \frac{4 \cdot 5 \cdot 6 \cdot 7 \cdot 8}{1 \cdot 2 \cdot 3 \cdot 4 \cdot 5} \frac{a^2}{l^9}$, while on the other hand according to (3) P_5 evidently becomes $= \left(x_5 + \frac{13}{2} \right) \frac{a^2}{l^9}$, if x_5 represents the coefficient of $l^4 a^2$. In P_n we

$$\text{have therefore } x_n = \frac{1}{n+1} \frac{3(n+1)(n+2)(n+3)}{2 \cdot 6} - \frac{2n+3}{2} = \frac{(n+2)(n+3)}{4} - \frac{2n+3}{2} = \frac{n(n+1)}{4}, \text{ by which the above is proved.}$$

According to (4) we can now write for $F: e^z$:

$$(z=0) \frac{F}{e^z} = 2 \frac{a^2}{l^6} \left(\frac{3}{2} \cdot \frac{4}{1} + \frac{3 \cdot 5}{2 \cdot 4} \cdot \frac{6}{1} \frac{a^2}{l^2} \right) x + 2 \frac{a^2}{l^7} \left(\frac{3}{2} \cdot \frac{4 \cdot 5 \cdot 6}{1 \cdot 2 \cdot 3} + \frac{3 \cdot 5}{2 \cdot 4} \cdot \frac{6 \cdot 7 \cdot 8}{1 \cdot 2 \cdot 3} \frac{a^2}{l^2} + \dots \right) x^2 + \\ + 2 \frac{a^2}{l^9} \left(\frac{3}{2} \cdot \frac{4 \cdot 5 \cdot 6 \cdot 7 \cdot 8}{1 \cdot 2 \cdot 3 \cdot 4 \cdot 5} + \frac{3 \cdot 5}{2 \cdot 4} \cdot \frac{6 \cdot 7 \cdot 8 \cdot 9 \cdot 10}{1 \cdot 2 \cdot 3 \cdot 4 \cdot 5} \frac{a^2}{l^2} + \dots \right) x^3 + \text{etc.},$$

or also:

$$(z=0) \frac{F}{e^z} = 12 \frac{a^2}{l^6} x \left[\left\{ 1 + \frac{5}{4} \cdot \frac{6}{4} \frac{a^2}{l^2} + \frac{5 \cdot 7}{4 \cdot 6} \cdot \frac{8}{4} \frac{a^4}{l^4} + \frac{5 \cdot 7 \cdot 9}{4 \cdot 6 \cdot 8} \cdot \frac{10}{4} \frac{a^6}{l^6} + \dots \right\} + \right. \\ \left. + \frac{4 \cdot 5 \cdot 6}{2 \cdot 3 \cdot 4} \frac{x^2}{l^2} \left\{ 1 + \frac{5}{4} \cdot \frac{6 \cdot 7 \cdot 8}{4 \cdot 5 \cdot 6} \frac{a^2}{l^2} + \frac{5 \cdot 7}{4 \cdot 6} \cdot \frac{8 \cdot 9 \cdot 10}{4 \cdot 5 \cdot 6} \frac{a^4}{l^4} + \dots \right\} + \right. \\ \left. + \frac{6 \cdot 7 \cdot 8}{2 \cdot 3 \cdot 4} \frac{x^4}{l^4} \left\{ 1 + \frac{5}{4} \cdot \frac{6 \cdot 7 \cdot 8 \cdot 9 \cdot 10}{4 \cdot 5 \cdot 6 \cdot 7 \cdot 8} \frac{a^2}{l^2} + \frac{5 \cdot 7}{4 \cdot 6} \cdot \frac{8 \cdot 9 \cdot 10 \cdot 11 \cdot 12}{4 \cdot 5 \cdot 6 \cdot 7 \cdot 8} \frac{a^4}{l^4} + \dots \right\} + \text{etc.} \right],$$

i.e.

$$(z=0) \frac{F}{e^z} = 12 \frac{a^2}{l^6} x \left[\left\{ 1 + \frac{15}{8} \frac{a^2}{l^2} + \frac{35}{12} \frac{a^4}{l^4} + \frac{525}{128} \frac{a^6}{l^6} + \dots \right\} + \right. \\ \left. + 5 \frac{x^2}{l^2} \left\{ 1 + \frac{7}{2} \frac{a^2}{l^2} + \frac{35}{4} \frac{a^4}{l^4} + \dots \right\} + 14 \frac{x^4}{l^4} \left\{ 1 + \frac{45}{8} \frac{a^2}{l^2} + \frac{165}{8} \frac{a^4}{l^4} + \dots \right\} + \text{etc.} \right],$$

for which may be written:

$$(z=0) \frac{F}{e^z} = 12 \frac{a^2}{l^6} x \left[\varphi_1 + 5 \frac{x^2}{l^2} \varphi_2 + 14 \frac{x^4}{l^4} \varphi_3 + \text{etc.} \right] \quad (4a)$$

Two limiting cases.

1. If l is *large* with respect to a (gases), (4) or (4a) evidently approaches to

$$\frac{F}{e^2} = 12 \frac{a^2}{l^5} x, \quad (l \text{ large}), \quad \dots \dots \dots (5)$$

and this not only for $z=0$, but also for finite values of z , provided they are not large with respect to l .

This is, therefore, the limiting value of the action, when the moving molecule, with comparatively large distances of the molecules, is between P and Q , if not too close to one of them. The action is in inverse ratio to the **fifth** power of l , and directly proportional to the square of the radius a of the orbit of the electrons. It remains pretty well unchanged at the same value of x , when M moves from O slightly to the left or to the right, but it is on the contrary proportional to the deviation x of the electron in its orbit; hence it is **purely periodical**. For $x=0$ the action is $=0$, but not so for $x = +a$ or $x = -a$, even if M is in the neutral point O .

As regards the action between M and P , resp. Q separately, we have according to (1a) and what was found above:

$$F_1 : e^2 = (P_0 + 2P_1z + 3P_1z^2 + \dots) - (P_0 + 2P_1(z-x) + 3P_2(z-x)^2),$$

i.e.

$$\left. \begin{aligned} F_1 : e^2 &= 2P_1x + 3P_2(2zx - x^2) + 4P_3(3z^2x - 3zx^2 + x^3) + \dots \\ \text{and likewise} \\ F_2 : e^2 &= -2P_1x + 3P_2(2zx - x^2) - 4P_3(3z^2x - 3zx^2 + x^3) + \dots \end{aligned} \right\}$$

so that about half of the total action $(F_1 - F_2) : e^2 = 4P_1x + \text{etc.}$ comes from the atom P ; the other part, as the action of a force in the opposite direction, from the atom Q . If e.g. $x = +a$, the electron is as far as possible in the direction of Q , and M will be attracted by P with a force $=$ about $2P_1ae^2$, and repelled by Q with an almost equal force. (Here $P_1 = 3a^2 : l^5$).

When the gas-molecule M moves towards P , its velocity u will, accordingly, also undergo *periodical* modifications, till it has approached P so closely, that at $l-z =$ about $2a$, the attractive force being still finite at $x = +a$, the repulsive force begins already to approach infinity at $x = -a$. (see § 10); hence the velocity is reduced to 0, after which M moves back (collision).

But with *very small values* of u it may occur that this return already takes place long before P has been reached. We shall revert to this in the next paragraph; it is the well-known case of **gas-degeneration**.

2. If l is *small* with regard to a (*liquids and solid bodies*), then $l \ll 2a$, $z \ll 0$ may be put, and (4) holds therefore again, in which now, however, P_1, P_3 , etc. approach according to (3) to the following values: ¹⁾

$$\left. \begin{aligned} P_1 &= \frac{1}{a^3} \left(\frac{1}{6} \sqrt{3} - \frac{1}{8} \right) = \frac{0,1637}{a^3}, \text{ hence } 4P_1 = \frac{0,6548}{a^3} \\ P_3 &= \frac{1}{a^5} \left(\frac{227}{1944} \sqrt{3} - \frac{1}{23} \right) = \frac{0,1710}{a^5}, \text{ ,, } 8P_3 = \frac{1,3680}{a^5} \\ P_5 &= \frac{1}{a^7} \left(\frac{1103}{11664} \sqrt{3} - \frac{1}{128} \right) = \frac{0,1560}{a^7}, \text{ ,, } 12P_5 = \frac{1,8718}{a^7} \end{aligned} \right\}$$

so that now $F: e^2$ will approach

$$\frac{F}{e^2} = \frac{0,655}{a^3} x \left(1 + 2,089 \frac{x^2}{a^2} + 2,859 \frac{x^4}{a^4} + \dots \right) \dots \dots (6)$$

It is self-evident that this expansion into series is now only valid for *small values of x* with respect to a . For $x = \pm a$ of course F becomes $= \pm \infty$. I will just point out here, that when in $x = a \sin \varphi$ means are taken over all values of φ between 0 and 2π , according to (2) and (4) the total force would become $= 0$ only at $z = 0$. But when z is not $= 0$, hence when M is no longer halfway between P and Q , this is evidently no longer the case (*even powers of x*). And according to the above separate expressions of F_1 and F_2 , they do not become $= 0$ at $z = 0$ even when averaged. The separate forces "averaged" with respect to x , and also the mean total force will always be *repulsive* (excepted at $z = 0$ in the last case), because the terms with even powers of x have all of them the $-$ sign. ²⁾ And this refutes DEBIJE's assertion (see § 8), that without special suppositions (polarisation of the molecules in each other's electric field) the resulting action would always be $= 0$ according to a well-known electric theorem. It is possible to verify by calculation that this is also true for the problem in three-dimensional space.

¹⁾ For the quantities φ_1, φ_2 , etc. in (4a) the values $\varphi_1 = \frac{32}{12} \times 0,6548 = 1,7459$;

$\varphi_2 = \frac{128}{60} \times 1,3680 = 2,9184$; $\varphi_3 = \frac{512}{168} \times 1,8718 = 5,7045$; etc. are easily found.

²⁾ This has of course nothing to do with the question of the *Virial* of attraction and repulsion, as in the calculation of this the *time-average* plays a part. Indeed, in the equation of state for gases $\frac{pv}{RT} = 1 + \frac{b}{v} - \frac{a/v}{RT}$ also the *Virial* of repulsion b/v predominates at high temperatures. This question must afterwards be treated separately.

§ 12. The Equations of Motion. Possibility of Multiple Orbits at Low Temperatures.

Since with small values of z we may write according to (4):

$$F = \gamma_1 x + \gamma_3 x^3 + \gamma_5 x^5 + \dots \quad (x = a \sin \varphi),$$

this may always be reduced to

$$F = \alpha_1 \sin \varphi + \alpha_3 \sin 3\varphi + \alpha_5 \sin 5\varphi + \dots,$$

after which integration is possible. But since the expansion into series is not practicable after all for large values of x , in the neighbourhood of $+a$ or $-a$, it is better to retain only the 1st term in the original equation, or to write:

$$F = \gamma_1 x (1 + \lambda_2 x^2 + \lambda_4 x^4 + \dots),$$

and take the averages with respect to the factor between parentheses. Then we get:

$$F = \gamma_1 x \times \lambda_m = \gamma x,$$

in which γ will be $> 0,655 e^2 : a^2$, when l approaches $2a$. As now

$$\frac{1}{\frac{1}{2}\pi} \int_0^{\frac{1}{2}\pi} \sin^2 \varphi \text{ is } = \frac{1}{2}, \text{ the same with } \sin^4 \varphi \text{ will be } = \frac{1.3}{2.4}, \text{ with } \sin^6 \varphi$$

is $= \frac{1.3.5}{2.4.6}$, etc., F becomes for $l \rightarrow 2a$ according to (6):

$$F = \frac{0,655 e^2}{a^2} x (1 + 1,04 + 1,07 + \dots),$$

hence averaged many times greater than $\gamma_1 x$. Let us now, for the sake of orientation, integrate the simple equation

$$\frac{d^2 z}{dt^2} = \frac{F}{m} = \frac{\gamma}{m} x, \quad \dots \dots \dots (7)$$

in which γ for small values of x will approach γ_1 , when $l \rightarrow 2a$ (solid bodies and liquids), whereas for large values of l (gases) γ approaches $12a^2 e^2 : l^6$ (see above).

Thus we find with $\varphi = 2\pi \frac{t}{T} + \theta$:

$$\frac{dz}{dt} = u = u_0 - \frac{T \gamma}{2\pi m} (a \sin \varphi - a \cos \theta), \quad \dots \dots (8)$$

so that duly u becomes $= u_0$ at $t = 0$ (when M passes through the neutral point O). Repeated integration yields for the path passed over:

$$z = \left(u_0 + \frac{T \gamma}{2\pi m} a \cos \theta \right) t - \left(\frac{T}{2\pi} \right)^2 \frac{\gamma}{m} (a \sin \varphi - a \sin \theta), \quad \dots (9)$$

which yields $\dot{z} = 0$ at $t = 0$. It will now further entirely depend on the value of the phase-difference θ (the difference of time between the fictitious passage of the electron through the nucleus, and of M through O), what type of path of periodic movement will be obtained.

1. If $\theta = 0$ (the electron passes (fictitiously) the nucleus from the *right* towards the *left* exactly when M moves in O towards the right in the direction of P), we get:

$$u = u_0 + \frac{T}{2\pi m} \gamma (a - a \cos \varphi) \quad ; \quad \varphi = 2\pi \frac{t}{T}.$$

The value of u (see fig. 3) will now always be $> u_0$, so that there can only be question of its becoming 0 on collision ($l - z = 2a$).

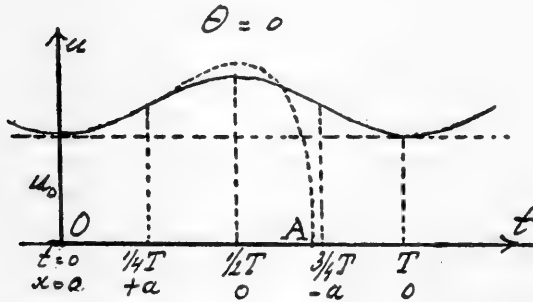

Fig. 3.

The molecule M will then approach P so closely till the electron has assumed the position close to $x = -a$, in consequence of which the repulsive force becomes very great. Then the velocity becomes $= 0$ in an exceedingly short moment, and the molecule is thrown

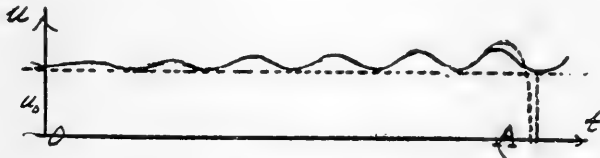

Fig. 3a. (Gases).

back (in A , close to $t = \frac{3}{4}T$). When the molecules are far enough from each other (gases), several periods may pass before this collision at last sets in (Fig. 3a). The increasing values of the amplitudes in Fig. 3a must of course be attributed to the increasing influence of z , through which the action exerted becomes stronger and stronger (cf. also the calculations in § 10). This gives also rise to the deviations of the course, following from (8), close to the collision (repre-

sented by the dotted lines). Indeed, for the sake of simplicity we have so far always neglected the influence of z .

We still point out that the magnitude and the sign of the action exercised are always represented in the figures by the inclination of the tangents to the curve.

2. $\theta = 180^\circ$. Then the electron passes the nucleus (fictitiously) just from the *left* to the *right*, when M goes from O to P , and (8) becomes:

$$u = u_0 - \frac{T}{2\pi m} \gamma (a + a \cos \varphi) \quad ; \quad \varphi = 2\pi \frac{t}{T} + \pi.$$

Now the velocity u always remains below u_0 (see Fig. 4). The case of "collision" has been drawn at two successively possible places, viz. at A and A' .

What distinguishes this case from the preceding one, is the possibility that u becomes $= 0$ before the "collision", and the molecule

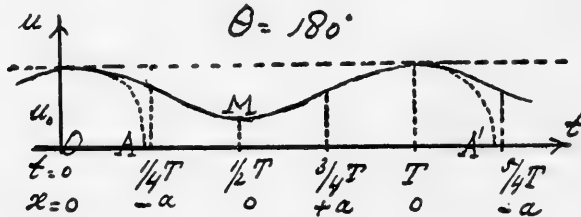

Fig. 4.

accordingly already "returns" before P has been reached. This will evidently take place as soon as u_0 is so small that M lies low enough for the curve to intersect the t -axis ($u = 0$) (Fig. 4a). This takes place e.g. in B . Transformed spatially this means that the molecules will move round the position of equilibrium O in **closed orbits**, as soon as we get below the point where the curve touches the t -axis for the first time (**melting point**)¹⁾. In this case the

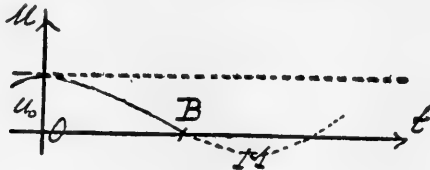

Fig. 4a.

¹⁾ I may be allowed to anticipate on what follows, and state here that the melting-point calculated in this way for H — if it were realisable — will lie at $36^\circ,4$ abs. As this melting-point must lie higher than that of H_2 (because the molecular attraction a that plays a part in it, is greater for H than for H_2), this result is not impossible. (melting-point H_2 lies at 14° abs.).

central force directed towards the centre (O) will always correspond to the resulting repulsion of the surrounding molecules.

Also for *gases* can this take place, but as the distance of the molecules is then greater, hence the oscillations in the value of u much smaller, the limiting value of u_0 (**point of degeneration**) lies much lower than the corresponding value of u_0 (melting-point) for solid bodies. Besides — in accordance with the mutual distance

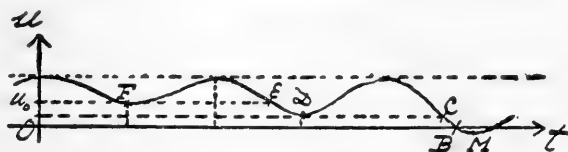

Fig. 4b. (Gases).

of the molecules — this transition may take place at different places, during the 1st period, the 2nd, the 3rd period etc. (Cf. Fig. 4b, where the return takes place at the third period).

To *given* mutual distance of the molecules (gas density) corresponds, therefore, a definite value of u_0 for which the transition already takes place at the 1st period, (*degeneration point proper*), a value where the transition does not occur until the 2nd period, etc. etc. Here too the molecules will, therefore, revolve round the positions of equilibrium in closed, ever narrower orbits — as the temperature descends.

And thus the phenomenon of **gas-generation** has been explained in a natural way.

When at a given gas-density u_0 becomes too great, then u does not become 0 before the molecule comes in contact with P (“collides”), as is drawn at A in Fig. 3 and 4. Hence no longer any closed orbits (solid bodies above the melting-point; gases above the degeneration point).

It is very remarkable in this, that when u_0 (for gases) becomes gradually smaller and smaller (hence the temperature lower and lower), the place where u becomes zero suddenly *skips* from C to D (see Fig. 4b), from E to F , etc. — which corresponds to this that the corresponding *wider* orbit round the position of equilibrium abruptly, hence *discontinuously*, changes into a *narrower* orbit. The latter varies only between D and E , lying *close to each other* (the figure represents time-abscissae, but distance-abscissae of course correspond with them in a corresponding $z-u$ diagram), after which it suddenly skips again to the *still narrower* orbit, corresponding to F . This is then the final orbit, which as u_0 gets still lower, again gradually shrinks. It does not diminish to 0, however, but to a

limiting orbit, which will be discussed later (in connection with the *zero-point energy*)¹⁾.

And thus an *analogue* has been obtained of the possible quantised orbits which a negative electron can describe round the positive nucleus. The points *D* and *E* lie in this latter case *exceedingly close* together, so that the discontinuity in the value of the radii of the possible orbits is almost complete.

But for this the assumption is required that also for electron and nucleus the force acts periodically, e. g. through this that the positive nucleus executes a *pulsating* movement (analogous to the motion studied by BJERKNES)²⁾. It may also be assumed that the nucleus always sucks in "ether" from its surroundings (which is led off to the 4th dimension), the electron expelling ether in the same way. When a rotation is assumed to take place of the electron round an axis coinciding with the direction of the motion, the known equations can be derived of the electro-magnetic field³⁾.

But this cannot yet be fully discussed here. One thing at least is certain, that *if* the electrons revolve round the nucleus in *definite* orbits (in which the quantity *h* plays a part in the determination of radius and velocity), that then necessarily, in consequence of our above considerations, this same quantity *h* must play a part in the movement of the molecules in closed orbits round positions of equilibrium — in consequence of which that quantity will naturally occur in the relation between *E* and *T* which we derived in our previous paper, as analogue of PLANCK's relation; while the quantity *v* will be in connection with the time of revolution of the molecules in their closed orbits, which in its turn will again be in relation with the time of revolution *T* of the electrons round the nucleus — as we saw above.

Clarens, summer 1921.

To be continued.

¹⁾ On decrease of temperature such an abrupt succession of some ever narrower orbits is perhaps also possible for *solid* bodies, and this may possibly be brought in connection with some *allotropic* states, which are met with in many elements and compounds.

²⁾ Very suggestive in this respect is an old Paper, almost entirely forgotten, by VOIGT in the "Journ. f. reine v. angew. Mathematik", Band 89, on "Der leuchtende Punkt." VOIGT chiefly calculated the state of vibration close to this point, when either a periodic translatory movement, or a periodic rotatory movement was supposed. Later on KIRCHHOFF (Ibid 90, p. 34) considerably simplified VOIGT's derivation.

³⁾ The assumption of expulsion of ether from the electron with *the velocity of light* would then also explain that the velocity of the electron can never exceed the velocity of light, and an idea can be obtained of the mechanics of relativity (factor $1 - v^2/c^2$).

Palaeontology. — “*On the Cranial Form of Homo Neandertalensis and of Pithecanthropus Erectus, Determined by Mechanical Factors*”. By Prof. EUG. DUBOIS.

(Communicated at the meeting of Nov. 26, 1921).

All well known fossil men can be ranged around two principal types, differing so much that they must at least be distinguished as *species* of one genus. One type is that of *Homo sapiens*, the modern species of Man. It is true that different races may be recognized also among the fossil representatives of this species. Thus — to mention only the earliest — the eskimo-like race of Chancelade, living in France with a steppe fauna, after the fourth or last Glacial epoch of the Alps (during the dry period, when the trees grew in our country the remains of which we find as the “sand-stubs” under the peat moors); the race of Cro-Magnon, living in France and elsewhere in West Europe during the Reindeer period, that fourth Glacial-epoch (in which the deposition of the upper “Sand-diluvium” took place in the southern part of our country), which race is not to be distinguished from some recent West European and North African tribes. Of somewhat earlier date is the negroid race of Grimaldi, near Mentone on the Mediterranean, almost certainly closely akin to the present-day Bushmen of South-Africa. Probably still older is the australoid Man of Wadjak, Java.

This fact of the differentiation of fossil *Homo sapiens* into still existing forms, which none of them were at a really lower stage of morphological evolution than the corresponding recent races, leads us to assume for the origin of this type a much earlier date than the time of its earliest remains. This follows immediately after the period of the Mammoth, the third Glacial epoch of the Alps (when the northern half of our country lay covered under an ice sheet), in which time *Homo neandertalensis*, the other species of Man, lived. The Heidelberg Man, a neandertaloid form, which is still more sharply distinguished from the sapiens-type than the Neandertalian proper, which latter died out soon after the Mammoth epoch, lived in the second Glacial epoch of the Alps (during which the upper part of the “Fluviatile Gravel-diluvium” was deposited in the soil of the Netherlands) or — which is more probable, judging from the accompanying fauna — in the second Interglacial or Hippopotamus-epoch (the period of our “potclay”),

Hence the two types of man have undoubtedly existed side by side already very early. This is one of the reasons why we cannot consider the Neandertal Man as the ancestor of Modern Man. A more imperative reason is, however, the very particular specialisation of the Neandertal Man.

The discoveries in France and particularly MARCELLIN BOULE's masterly descriptions have furnished us with very full information about this species. We now know that the Neandertal Man was short of stature, shorter than the smallest recent races, but thick-set, strongly built, and very muscular. He had comparatively short legs and a large head, an exceedingly large face, and walked shuffling, with somewhat bent knees, more on the outer borders of the feet than modern Man; the great toe was so mobile that objects could be picked up from the ground even better than by many naturally living men of the present day. As appears from the absence of the neck-curvature of the spinal column (the presence of which is so characteristic of the species *Homo sapiens*), the usual attitude of the head was bent forward. The skull is distinguished from that of modern men by numerous morphological characters. It looks like flattened from above, extended lengthwise and breadthwise, with receding forehead, and flat chignon-shaped projecting occiput. The orbital arches have become enormous prominent supra rounded ridges, the left and the right forming together a torus supraorbitalis, as it is found in most Monkeys and in *Pithecanthropus*. The mastoid processes are very small, from which it appears that the sterno-cleido-mastoid muscles were rather weak as rotators of the head; they could, however, draw the head vigorously back, assisting the dorsal muscles of the neck, particularly through their further attachment. High reliefs and deep depressions of the nuchal plane of the occipital bone show the exceedingly powerful development of those nuchal muscles, which was required to carry the head, which as a rule was hanging heavily forward; for the face was long, and projects almost like a snout, and the jaws are large. The zygomatic arches stick far out, a feature which is accompanied with masticatory muscles which are directed inward, and are more adapted for grinding mastication. The orbits are very large, the consequently large eyes must have been fit for the formation of large images, as in arboreal animals, which must see things accurately close by, and in animals, which need a wide field of view in steppes or deserts. The Neandertal Man found his chiefly vegetable food probably on or in the ground; all investigators have indeed inferred from the premature wear of his teeth that his food was greatly contaminated with earth;

his teeth have very large pulp cavities, were consequently amply provided with blood-vessels and nerves, and therefore very sensitive organs of touch (which are more necessary with vegetarian food than with a carnivorous way of living). The robust lower jaw possesses no chin, or only a rudimentary one; it is strengthened at the place on the inner side (in accordance with the inwardly directed masticatory muscles); the angular part, which is blunted on the edge, is thin and directed inward, like the masticatory muscles, again indicative that the food was rather ground fine than bitten. Nor is the upper dental arcade considerably broader than the lower one, as in *Homo sapiens*, but the two arcades cover each other more or less. It is remarkable that the form of the nasal aperture differs still more from the simian type than that of *Homo sapiens*.

It will appear sufficiently from this short description that *Homo neandertalensis* was specialized to such an extent morphologically and biologically that first, he must be distinguished as a separate species from modern Man — the differences are indeed greater than those by which it is usual to distinguish two species of mammals of one genus —, secondly that the present type of man cannot possibly be derived from him. In many respects modern Man is more primitive, less specialized than the Neandertal Man, just as the African Elephant of these times is more primitive and less specialized than the diluvial *Elephas primigenius*, the Mammoth.

It is true that so many primitive or pithecoïd characters are still very generally ascribed to *Homo neandertalensis* that this type is put at a lower stage of human evolution than modern Man; but when we have got to know them better, not a few of these characters will probably be explained as the direct consequence of particular physiological, mechanical adaptations, as phenomena of convergence. It is not astonishing that one species of *Homo* possesses some primitive or pithecoïd morphological characters which another lacks, and these strike us particularly in *Homo neandertalensis*, because we know those of the other, our own species, better. We are, therefore, easily inclined, and think ourselves justified in considering some characters as primitive, which in reality are not so, and in even supposing other primitive characteristics when the species is concerned that is only known in a fossil, i.e. incomplete state. We may expect that the number of these will be greatly reduced on increase of our knowledge, because it has actually already appeared that we have made a mistake in *Homo neandertalensis* as regards the most important character that distinguishes Man from the Apes, the very great relative brain quantity. Up to

twelve years ago, when only the upper part of the cranium, the calvaria, was accurately known, its shape, which really looks pithecoïd, and corresponding small capacity led to the erroneous conclusion that the capacity of the whole cranium should be estimated as very low. Remarkable enough it was assumed in this estimation that the lacking, or at least less closely known, lower part was built after the common human type, in contrast with the pithecoïd upper part. Thus as late as 1901 SCHWALBE arrived at a much too low estimation of the total cranial capacity, the volume of the brain, which would have come to no more than 1230 cm³, although as early as 1898 it had been shown by me, that in Monkeys the upper part of the cranium constitutes a comparatively smaller, the lower cranium a comparatively greater part of the total cranial capacity than in modern Man. The capacity of the lower part of the cranium up to the plane through the frontal cerebral pole and the transverse boundary lines between the cerebrum and the cerebellum is in modern Man about 40% of the capacity of the upper part of the cranium, in most Apes about 60%, and in the very platycephalic large gibbon species, the Siamang, the two parts are even equal. And it is now a priori probable that to the flattened pithecoïd upper cranial part of the Neandertal-Man belongs a comparatively large lower cranial part, as in the Apes.

The year 1909 brought a total change in our view of the Neandertal Man, when on direct determination of the cranial capacity of the La Chapelle neandertalian by BOULE, VERNEAU, and RIVET 1530 cm³ true capacity (1626 Broca) was found. The capacity of other neandertalian skulls can be calculated from the relative length, breadth, and height. As considerable, or not much smaller amounts are found, taking the comparatively small size of the body into consideration, cranial capacities which certainly are not inferior to those of Europeans of this time, and even exceed them.

In 1914 also SCHWALBE was impressed by the evidence that the Neandertal Man is distinguished from the modern human type by the comparatively much greater height of the lower cranial part, which he bounded by the glabella-inion plane. Thus it becomes comprehensible that the total capacity of the cranium can be great in spite of the flattened pithecoïd upper cranium, which is little voluminous in comparison with the modern human type. Part of the brain volume has simply moved downward with regard to the said plane, so far as the inion has not been displaced upwards.

It would very well be possible that, notwithstanding the large quantity, the quality of the brain was inferior to that of modern

Man. BOULE and ANTHONY have actually thought they saw this on the endocranial cast; but the cerebral convolutions are imprinted too little distinctly through the dura mater membrane, which was probably particularly thick, and besides the imprint is also incompletely preserved, so that even essential features remain uncertain in the configuration of the surface of the brain. Hence great value cannot be assigned to these researches. Nor is it probable that the proportion between the more highly and the lower organized parts of the brain would considerably differ from that of modern Man.

At any rate the very large brain quantity of the Neandertal Man *in comparison with the Apes* remains a significant fact. Like modern Man this diluvial species possessed more than *three* times the brain volume of anthropoid Apes of equal size (weight). If the shape of the Neandertal Man's skull were a really primitive character, its capacity could not differ from that of an ape's skull to that extent. This leads to the supposition that the pithecoïd shape of the skull of the Neandertal Man is no primitive, inherited character, but that it was acquired by convergent development, an adaptation to definite modes of living and due to similar, mechanical causes.

If, therefore, there is no ground to consider the flattening of the upper part of the cranium of *Homo neandertalensis* as a consequence of low, pithecoïd brain-organization, we are naturally led to consider what mechanical factors in Anthropoid Apes can be the cause of, or at least can have influence on the flattening and the formation of the supra-orbital bony ridge, which we also know as the most striking characters of the Neandertal Man.

We then meet with two remarkable facts. First that the skull of the Siamang, the only large gibbon species, is distinguished from all the small species by an equally great flattening and relative decrease of capacity of the upper cranial part together with relative increase of capacity of the lower cranial part¹⁾, as the Neandertal Man from modern Man (Fig. 1 and Fig. 2 of bisected skulls). In this respect the Siamang may be called the Neandertalian among the Gibbons. This large gibbon species is, besides, distinguished from the small species in that the maxillar and actually the whole facial part of the skull, both as regards breadth and length, is disproportionately much larger and heavier. Consequently the nuchal muscles must carry the head, which hangs forward, with the greater strength, and in conjunction with another muscle apparatus which will be discussed later, and an air-brake

¹⁾ This applies both with regard to the internal boundary parts and that of the inion, because this occupies the same place in them.

apparatus much more developed in the Orang utan, break the shocks which, arising in locomotion, might injure the skull and its contents.

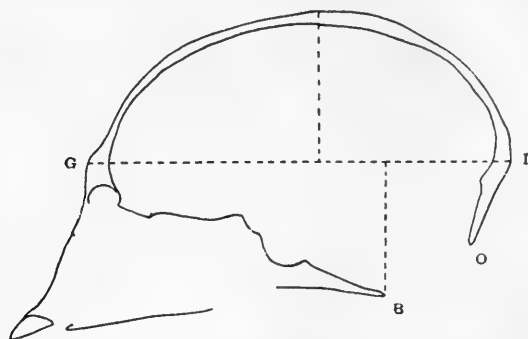

Fig. 1. Median cross-section of the skull of *Hylobates agilis*. $\frac{2}{3}$ of nat. size.

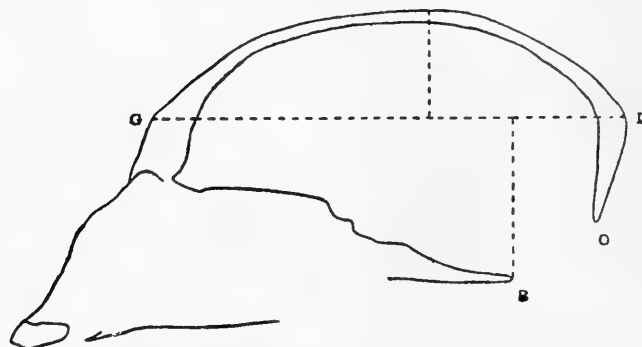

Fig. 2. Median cross-section of the skull of *Hylobates (Symphalangus) syndactylus*. $\frac{2}{3}$ of nat. size.

In connection with these features the foramen magnum in the Siamang lies somewhat more backwards, and its plane stands up somewhat more steeply; also the planum nuchale of the occipital bone is steeper, and the bending of the cranial basis, the basi-cranial axis, is less pronounced than in the small gibbon species.

These are characters of the Siamang which in the comparison of Apes with Man are usually considered as primitive and indicating a lower stage of brain organization, which however, in the comparison with the small gibbon species can decidedly not have such a meaning, but must have geometrical and mechanical causes.

In the calculation of the mean endocranial surface dimensions (the two-third powers of the cranial capacities), and KEITH's palatal areas, it is found that the maxilla of the Siamang is relatively one and a half times as large as that of the small gibbon species, which is undoubtedly in connection with an important difference in the

way of feeding, for the influence on this ratio of the difference in body weight (as 4:3), can be but slight. When the two median-sagittal cross-sections of the skull are divided by straight lines *GB* into an upper (cerebral) and a lower (facial) part, it is found, on determination of the area of these parts that per unit of area of cerebral part *Hylobates syndactylus* has exactly *twice* as much facial part as *Hylobates agilis*. The ratio between the areas of the cerebral and the facial parts of the skull, which is thus changed, must certainly cause the former to extend more in length than in height, directly by geometric adaptation, but at the same time it must modify indirectly the form of cranium as it imposes higher demands on the muscles that support the head.

The second remarkable fact met with when the Anthropoid Apes are compared, is the great difference of the shape of the skull between the Orang utan and the two other large Anthropoids, the Chimpanzee and the Gorilla. The skull of the Orang utan is vaulted more highly, comparatively short and round, with high forehead and round occiput, and without prominent supra-orbital ridges. Now it is also found that in both sexes of the Orang utan the heavy head is supported in front by a huge air throat pouch, or laryngeal sac (Fig. 3), which (like the small laryngeal sacs found in many other Monkeys) can be filled and emptied at will from the larynx, and serve as buffer or shock reducer and air-brake. The Gorilla, the Chimpanzee, and the Siamang — again in both sexes — have only comparatively small laryngeal air sacs; they are entirely absent in the small Gibbon species. The superior parts of the laryngeal sac of the Gorilla are no more than small pouches stretched between the hyoid bone and the larynx towards the right and the left (Fig. 4), while a median continuation, passing before the wind-pipe downwards, forms the channel to the subclavian and axillary pouches as in the Chimpanzee. The Chimpanzee has no pouches worth mentioning above, whereas the air pouch of the Siamang is confined to the space between the body of the mandible and the lower side of the larynx, and a continuation towards the chest is wanting.

The significance of the very large laryngeal sac of the Orang utan cannot be ascribed to strengthening of the sound, for its voice is much seldomer heard and is much less loud than that of its African cousins, which even scare away elephants out of their neighbourhood by their terrible roar. Besides the small gibbon species have, without throat pouches, as loud voices as the Siamang.

The opinion pronounced for the first time by DENIKER and BOULART, that the laryngeal sac of the Orang utan has the significance of an

air-cushion carrying the heavy head, has been accepted by many zoologists. In fact it is very plausible that the inert Orang utan,

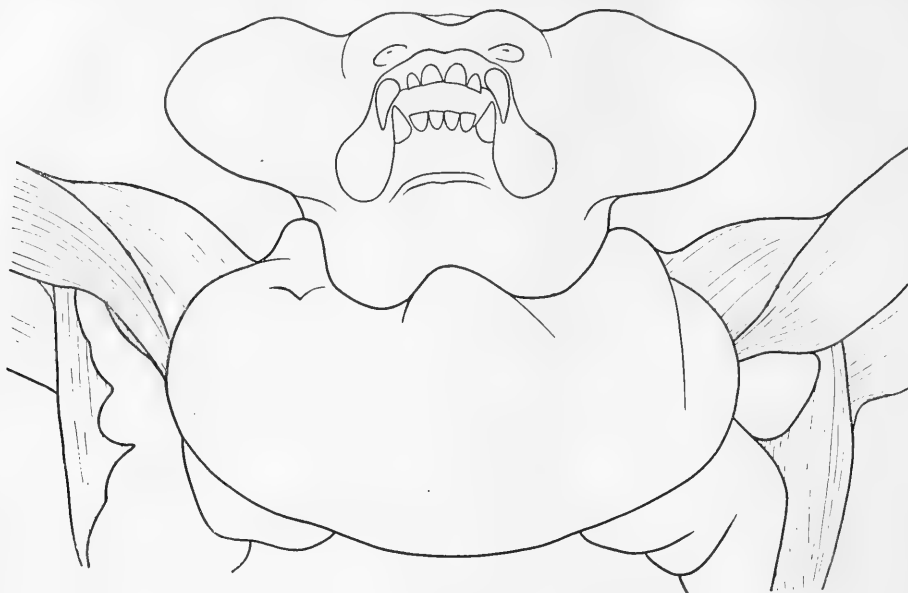

ORANGOETAN

Fig. 3. Laryngeal sac and cheek-lobes of a large male orangutan (reproduced from DENIKER and BOULART). The rather stiff cheek-lobes can prop the head sideways on the air-cushion. Slightly more than $\frac{1}{5}$ of nat. size.

which is much less muscular than the African large Anthropoids, which is particularly provided with weak nuchal muscles according to the two mentioned, French anatomists and which as it were, drops its heavy face on his chest, possesses in the laryngeal sac an apparatus to break as by an air brake the shocks to which his cranium and its contents, which hangs more heavily forward than in the other Anthropoids, but which is less efficiently supported by the neck muscles, would be exposed in locomotion¹).

In the other Anthropoids, which possess a throat pouch, this mechanism is in itself inadequate, so that greater demands are imposed on the cervical muscles with the nuchal ligament to carry the heavy head. But even these, though besides assisted by the air-cushions of the (small) throat-pouches, would be inadequate to protect the cranium and its contents entirely against dangerous shocks without the other above-mentioned muscle apparatus. They are supported in this task by the apparatus of the occipito-frontalis muscle, the *musculus epicranicus*, which is present in all Apes and Man, in

¹) The inion is placed very high, so that the nuchal muscles (and ligament) support the head only when it is lifted up by the laryngeal sac.

different degrees of development. This muscle, which consists of the flat right and left frontal muscles and the right and left occipital

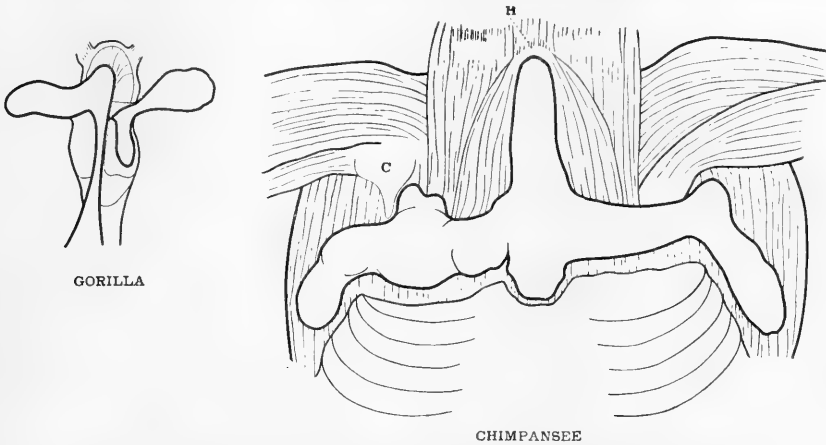

Fig. 4. Upper part of the laryngeal sac of a female gorilla. Laryngeal sac of a female chimpanzee; in this genus the upper part is not developed. (Both reproductions taken from EHLERS). The median air-cushion and the subclavian and axillary cushions protect windpipe and bloodvessels, and also to a certain extent the contents of the cranium against concussions and shocks caused by the heavy head which is thrown forward. *H* hyoid bone, which is placed on a line with that of the Gorilla, *C* coracoid process. $\frac{1}{4}$ of nat. size.

muscles with the epicranial aponeurosis, the galea aponeurotica, as intermediate tendon, is stretched out over the upper surface of the cranium. The epicranial aponeurosis is attached loosely and movably with the skull bone, but firmly bound to the hairy skin of the head, which is thus pressed firmly, but elastically against the bone, in every position of the head, by the whole apparatus, forming a mechanical whole with it, and playing a similar part as paper stuck to glass or the iron rods in reinforced concrete, i.e. increasing the shearing and tensile strength of the cranium, and at the same time deadening the shocks that might injure the contents of the cranium. The action of the frontal muscle in mimicry can certainly not be the only function, nor the principal significance of this muscle apparatus. This follows already from the fact that the frontal muscle in Man, where it arises for the greater part at the skin under the brows, and is generally only little slightly attached to the bone, draws up the brow and *wrinkles the forehead* transversally, expressing in this way attention and astonishment, whereas in monkeys, where it is more attached to the bone of the supra-orbital ridge, *it smoothens the forehead*. In Man just as in the Monkeys, the occipital muscles are

attached to the bone, the external part of the superior curved lines, above the insertion of the neck muscles. Even if this muscle did not exist and the epicranial aponeurosis were at that place directly attached to the bone, this aponeurosis might serve as "punctum fixum" in the mimic contraction of the frontal muscle of Man.

Accordingly the occipital muscle must certainly also serve another purpose; it can hardly be another than the constant application and rendering elastic of the cranial skin cover.

That actually the skull and its contents need protection against the shocks caused by locomotion, is self evident, and appears clearly from the mechanical arrangement of its connection with the trunk. In most Mammals the head is attached to the end of a neck which deviates but little from the horizontal direction, to which it hangs as at an elastic rod sustained chiefly by the elastic ligamentum nuchae. The foramen magnum and the condyles lie on the back side of the skull and the axis of the spine coincides about with the axis of the brain. In the Anthropoid Apes the brain has become much larger; the foramen magnum has been displaced to the basis of the skull, the vertebral column is more oblique with regard to the brain axis, and with a weaker ligament much stronger neck muscles must sustain the skull and secure it and its contents by their strain against concussions. In modern Man the brain has become very voluminous absolutely and in proportion to the face, the foramen magnum and the condyles are brought forwards to near the middle of the base of the skull, with which base the vertebral column forms a right angle, and the skull is balanced in unstable equilibrium on the spinal column. The latter has a double S-shaped curvature, with convex cervical- and lumbar curvature towards the front, and concave dorsal part, through which it possesses a high degree of elasticity and prevents shocks to the contents of the chest and the skull like the spring of a carriage. Notably the neck-curvature, which is characteristic only of the modern human species, makes that part of the spinal column an elastic stem of the head. *The Neandertal Man did not possess this mechanism, as appears from the form of his cervical vertebrae.* Accordingly the head hung forward, somewhat as in Anthropoid Apes. As, besides, the facial part was heavier than that of modern men, and as in this hanging over also the brain, which had greatly increased in weight in comparison with the Anthropoid Apes, had to be upheld by muscular action, very great demands were imposed on the nuchal muscles (and ligament), also to secure the contents of the cranium against shocks, in spite of the supporting transverse axis of the skull, which

lies much more to the front than in Apes. The insertion of these muscles and bands really reached higher at the occiput, with regard to the internal parts of the skull, than in the races of modern Man with small jaws. But this had to be attended with a more powerful epicranial muscular apparatus, and the shape of the upper part of the skull, although not entirely homologous, came to resemble that of the Anthropoid Apes; the skull had namely to be provided with strong supra-orbital ridges, for the attachment of the strong frontal part of the epicranial muscle.

This, apparently, must be the significance of the supraorbital ridges of Neandertal Man. That this torus supra-orbitalis, which is more pronounced in men, would have enhanced masculine charm in the eyes of female neandertalians, or would have contributed to give a fierce and awe-inspiring appearance in fight, or might have served as a protection of the eyes against the glaring light of the steppes, in which the Neandertal Man lived — these are all interpretations that have found little response. We have certainly to think of more mechanical causes for the origin of these strong bony ridges. Many anatomists consider the reinforcement of this part of the frontal bone as being in connection with the masticatory activity of the strong jaws, an interpretation which certainly deserves serious consideration. But the Orang utan has equally strong or stronger jaws than the Chimpanzee, and in contrast with the latter, it has no torus supra-orbitalis. Certainly we have also to think of the circumstance that in the Apes the superior borders of the orbits are more prominent than in modern Man, because the orbits (with their contents, the eye-balls) had to advance under the relatively much smaller brain; the eye-balls of the large Man-like Apes have indeed about the same size as those of Man, the volume of the brain being less than a third of that in Man. In the Orang utan, on account of the existence of the large throat pouch, the brain is greatly displaced frontwards, above the orbits, and the lateral as well as the superior borders, with the roofs and the outer walls of the orbits are not or very little prominent with regard to the forehead. The Neandertal Man, however, possesses enormous supraorbital ridges, but the outer walls of the orbits are not more projecting anteriorly than in the modern species of Man¹⁾. And in the Orang utan we find the epicranial muscle apparatus to be weak, consisting of long thin muscle fascicles with narrow galea, which can partly be brought in relation with the absence of strong bony ridges at the place of the orbital arches. It has, indeed, been shown

¹⁾ This passage on the orbits in the Apes and Man was by mistake omitted in the "Verlag" of this communication.

by AICHEL how muscular strain, acting on the periosteum, causes growth of bony substance, and how pressure counteracts growth of bone. The formation of the torus supraorbitalis in Neandertal Man can then be explained by the strain of a particularly strong epicranial muscle. Strong pressure from above on the cranial vault by this muscle apparatus must, according to AICHEL's view, inhibit the growth on the upper surface (short sagittal suture!) in contrast with the sides of the skull, thus causing flattening from above.

The flattening of the absolutely very large neurocranium can certainly be explained only for a small part by geometric adaptation to the relatively large splanchnocranium. It seems that particularly the mechanical action of the neck muscles and the epicranial apparatus, through strain at the periost, made the cranium extend backwards and frontwards (long squamous suture!) and caused it to be flattened. The result of this was a favourable displacement of the centre of gravity of the head downward.

In this connection the fact is of great importance that in the Neandertal Man, in comparison with modern Man, and in the Siamang, in comparison with the small gibbon species, part of the contents of the cranium has been displaced from above downward. This in an absolute sense, for the external inion at the skull of the Neandertal Man does not lie higher above the internal inion than in many an Australian skull (24 mm. difference — maximum of Neandertalians — in that of La Chapelle —, 23 mm. in the Australian skull (fig. 5), and in all the gibbon species the inion externum occupies an equal place.

In the Frisian skulls of the islet of Marken, artificially flattened according to BÖLK and BARGE by a peculiar kind of tightly fitting children's caps, this downward displacement of the contents of the skull is also to be found. It is of a smaller amount in proportion to the slighter flattening than (vertically only about a third part of) that in the Neandertal Man and the Siamang (in which, in comparison with modern Man and the small gibbon species the contents of the cranium has been displaced downwards in about the same ratio of height — about a seventh of the total height). As was already mentioned above, the mechanical efficiency results here from the displacement of the centre of gravity of the head downwards, nearer to the supporting line lying behind the perpendicular of the centre of gravity, and also from the more favourable direction of the muscular force which pulls at the frontal bone over the cranial vault.

In the Australian aboriginal race the head is, indeed, poised on the vertebral column as in all the races of *Homo sapiens*, but in consequence of the great weight of the jaws the state of equili-

brium is more unstable than in most other living races of man, which requires particularly strong nuchal muscles (and ligament). This is very clearly to be seen by the size, the form, and the external moulding of the lower tabular part of the occipital bone. Calculated in proportion to equal cerebral areas (the two-third powers of the cranial capacities), the Australian human race has about one and a half times larger palatal area than the European (Englishman); in this respect it differs, therefore, almost as much from other living races of Man as the Siamang from the other gibbon species. Among recent Men this race has also the smallest relative height of the calvaria (calvarial height index). In the Neandertal Man it lies between 40 (Gibraltar) and 44.3 (Spy II), and in Australians it reaches (according to BERRY and ROBERTSON) a mean value of 53, however a minimum of 44.9. As a rule at least the median part of the anterior border of the frontal bone, not so very seldom the whole border, is thickened to a bony ridge (torus). But in the last respect the Australians in general distinguish themselves from the Europeans in a higher, in the first respect in a less degree than the Siamang from the small gibbon species. Here the mechanism that has the flattening of the skull and the torus supraorbitalis as morphological consequences, must, again, be different. It seems to me that the great thickness of the skull-bones so characteristic of the Australian race, for a great part takes over the task of the epicranial muscle apparatus, the consequence of which is that the flattening and the torus-formation seldom go so far as in the Neandertal Man, whose cranial bones are accordingly less thick than those of recent Australians, and in whom the mechanism that brought about the flattening, was much more powerful. Though the facial part may not have been much heavier than it is in some Australians, the head of the Neandertal Man, which was not poised on the vertebral column, was carried hanging forward, which renders strong nuchal muscles necessary.

Thus the exceedingly thick-boned Piltdown skull (Eoanthropus) may have been high-vaulted with a comparatively small brain volume, and though accompanied by a large masticatory apparatus.

Towards the middle of November a fossil human skull became known which is exceedingly remarkable, also as regards the subject of this communication. It had been discovered in August of this year in the cavern of Broken Hill in Rhodesia (14° 26' S.L., 28° 37' E. L.), and is at present in the British Museum (Natural History) in London. Through the kind information and photographs sent, in the first place, by Dr. A. SMITH WOODWARD, Keeper of the Geological Department of this Museum, and by Prof. ELLIOT SMITH and

Sir ARTHUR KEITH, I was already soon enabled to test the validity of the above considerations also by means of this new cranial type. Besides with the greatest courtesy Dr. SMITH WOODWARD gave me an opportunity to study the fossil skull itself in London. I feel prompted to express my great indebtedness to him also here.

Through its flattening and very pronounced torus supra-orbitalis, and also through its large jaw, the Rhodesian skull makes at first sight the impression of a neandertalian. But a closer examination and study shows that the fossil skull from Rhodesia deviates in many respects from the neandertal type, and comes closer to that of *Homo sapiens*. Accordingly SMITH WOODWARD¹⁾ considers the fossil African as a new species: *Homo rhodesiensis*, the accurate systematic place of which cannot be defined as yet. He does not think it impossible that this species is the stage of development following after that of the Neandertal Man in the ascending series. KEITH²⁾, on the other hand, sees in the Rhodesian a more primitive type than the Neandertal Man, which approaches the common *ancestor* of the latter and of Modern Man.

In my opinion the resemblance to the neandertalian cranial type is only superficial, and confined to the flattening and the torus formation, which may be explained by physiological, mechanical causes, combined with some characters in subordinate connection with these features. He belongs to the type of *Homo sapiens*, and has particularly much in common with the Australian race.

As an introduction to characterize the skull some of the principal dimensions (compare Fig. 5) may first be given.³⁾ The glabella-inion line (the form of the broken of inion could be reconstructed with great accuracy), at the same time the maximum cranial length, measures 207 mm. (The maximum length of the La Chapelle skull is 208 mm.). The maximum cranial breadth is 145 mm. (in La Chapelle 156 mm.) The minimum frontal breadth is 104 mm. (as against 109 in La Chapelle). On the other hand the breadth of the torus is 139 mm. (as against 124 in La Chapelle). The basi-bregmatic

¹⁾ Nature. Vol. 108. N^o. 2716. November 17th, 1921, p. 371—372.

²⁾ Communicated in a letter.

³⁾ I owe the design of the adjoined norma sagittalis (Fig. 5) taken from the fossil skull, to Mr. W. P. PYCRAFT, M. R. Anthropological Institute. I drew some particulars of the norma lateralis in it according to measures and photos taken from the skull. The other norma sagittalis refers to the Australian skull N^o. 792 of the Anatomical Collection of the Sydney University, described by A. ST. N. BURKITT and J. I. HUNTER. It has been made after the tracing of the median sagittal section of the skull which I was allowed to compare with the fossil Rhodesian skull in London through Dr. HUNTER'S kindness.

EUG. DUBOIS: „On the Cranial Form of Homo Neandertalensis and of Pithecanthropus erectus, Determined by Mechanical Factors.”

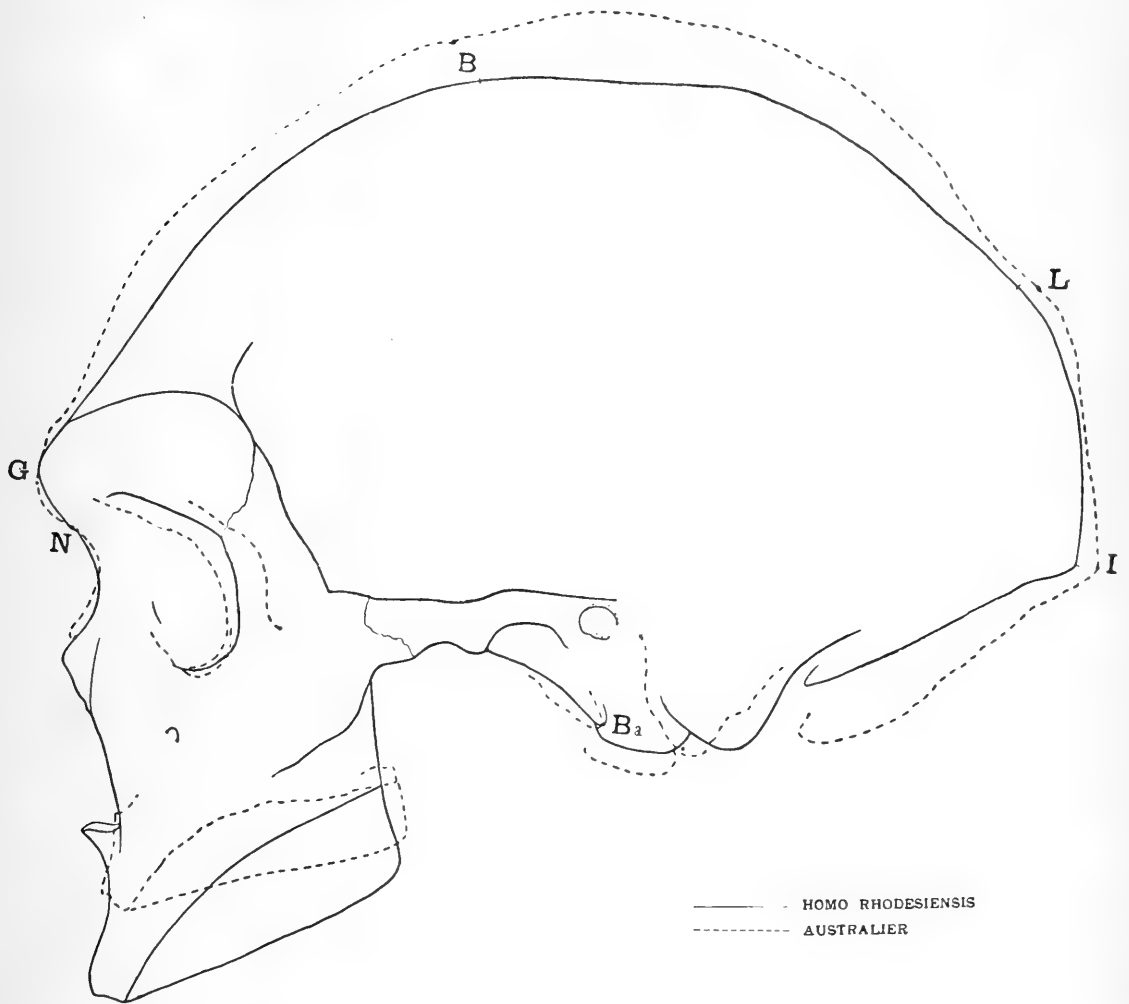

Fig. 5. Norma sagittalis (mediana) and lateralis of *Homo rhodesiensis*, at $\frac{2}{3}$ of nat. size, and Australian N^o. 792 Anat. Coll. Sydney Univ., placed at the nasion-basion line, which is made of equal length. The Australian is, accordingly, proportionately somewhat too large.

Some measures (in mm.) of the Australian skull of Fig. 5 are: Glabella-inion line and maximum cranial length 203. Maximum breadth 132. Breadth index 65. Minimum frontal breadth 90. Basion-bregmatic height 133. Nasion-basion line 105. Prosthion-basion line 100. Basion-inion line 99. Nasion-prosthion line 70. Index of calvarial height 48.2. Bregma-glabella-inion angle 51° . Lambda-inion-glabella angle 73° . Opisthion-inion-glabella angle 33° . Nasion-basion-prosthion angle 38° . Cranial capacity 1211 cm^3 .

height is 130 mm. (in La Chapelle 131). The basi-nasion line is 111 mm. (as against 125 in La Chappelle).

The length-breadth index is, therefore, 70 (equal to that of Spy I, but smaller than that of La Chapelle, 75). The length-height index is 62,8 (equal to that of La Chapelle). The shorter basal line, the deeper post-orbital constriction, together with a broader face, are important differences with the neandertal-type.

By comparison of the endocranial length (mean of left and right hemisphere 171 mm.), breadth (134mm.), and (internal basion-vertex) height (122 mm.) with the corresponding measures of the La Chapelle skull and of the Australian in the adjoined Fig. 5, I calculate, in proportion to the known cranial capacities of the latter (1530 and 1211 cm³), taking the comparative slight difference in form into consideration, about 1400 cm³ in both comparisons for the capacity of the Rhodesian skull, which value, accordingly, will not be far from the truth.

The length of the palate (to the back sides of the third molar teeth) is 59,5 mm., the breadth between the outer sides of the second molars 78 mm. (in Wadjak II 81 mm., in La Ferrassie 71,5). The palate is very high, 19 mm. for *m.* 2. The dental arcade is, therefore, very large (though as with the Wadjak men, the size of the teeth themselves is exceeded by that of many Australians). For the palatal area I find 4000 mm², i.e. 140 mm² less than for Wadjak II, but 500 mm² more than for Wadjak I, 200 mm² more than for La Chapelle, 930 mm² more than for the La Ferrassie neandertalian.

Striking are the differences between the Rhodesian and the Neandertalian skulls in the following points.

Seen in profile the Rhodesian entirely lacks the snout-like form of the facial skull part, which is so characteristic of the Neandertal Man; in this respect he resembles the Australian. The jaw projects less (Flower's alveolar index, basi-alveolar length \times 100:basi-nasal length = 105, against 108 in La Chapelle), but it is higher and broader. The nasi-alveolar line is 92 mm., as against 87 in the La Chapelle skull, 70 in our Australian skull. The line is 72.4% in the Rhodesian, 70% in La Chapelle, 51% in our Australian, 48% in other Australians, of the calvarial height above the basi-nasal line. The nasion-basion-prosthion angle is 46° in the Rhodesian skull, as against about 40° in La Chapelle, and 38° in our Australian and in other Australians. The width of the jaw appears from the distance between the outer sides of the second molars. The occiput is formed after an Australian type (very different from that of the Neandertal-skulls), with large, flat planum nuchale, separated from the upper tabular part of the occipital bone, which at that place

projects most backwards, by very considerable superior curved cristae and a distinct external occipital protuberance. The outer wall of the orbit (external angular process of the frontal bone and frontal process of the malar bone) though drawn out thin in temporal direction, is *much* more massive even than in Australian aborigines (minimum orbito-temporal breadth of the frontal process of the malar bone 13 mm.). This undoubtedly implies that the fascial origin of the anterior part of the temporal muscle, which is chiefly active in biting mastication, was much stronger, hence that part of the muscle itself comparatively more powerful (which is also to be inferred from the deeper post-orbital constriction — smallest frontal width). For the rest the whole malar bone is much more robust (the greatest breadth or height under the orbit is 28 mm.), to which a musculus masseter must have corresponded, which was very powerful, particularly in its outer part (again a feature indicating chiefly biting mastication).

In front view the face is broader. The nasal aperture however, is narrower, of the sapiens type; the face measures across the angular processes of the frontal bone (torus-width), as I stated already, 139 mm. against 124 in the La Chapelle skull. The maximum width across the malar bones is 134 (La Chapelle about 125). Very striking is the roof-like form of the frontal part of the cranial vault, instead of the dome-like form of the neandertalians. Nor is the torus supraorbitalis uniformly round and without any special modelling, as in the neandertal type, but more angular, with some division into pars medialis and lateralis by a very considerable supraorbital notch, by the outer side of which the orbital arch in the middle projects towards the orbit, which latter thus gets a more square form, in contrast with the more rounded form in the neandertalian skulls. The whole torus is of an, as it were strongly exaggerated, Australian type. It is more powerful than that of the neandertalian skulls; its greatest height is 22 mm.!

In the basal view the planum nuchale, large and flat, with foramen magnum lying more towards the middle of the base of the skull, is found perfectly the same as in Australian skulls, and likewise separated from the upper tabular part of the occipital bone by very considerable cristae nuchae superiores and a distinct external protuberance. With the basion-nasion length 111 is the basion-prosthion length 117 mm., and the basion-inion line 99 mm. The differences of these anterior basal lines with that posterior basal line are 12 and 18 mm. The differences between the corresponding lines of the La Chapelle skull of 125, 132, and 84 mm. are 41 and 48 mm.

In our Australian these differences are 6 and 1 mm., in two other Australians 6 and 10, 19 and 20, on an average in these three 10 and 10 mm. As the situation of the basion and of the condyles about determine each other, it may be said that in the mechanism of the skull of the Neandertal Man the frontal lever is long and heavily loaded compared with the occipital lever. Also in this respect the Rhodesian distinguishes himself from *Homo neandertalensis*, and resembles *Homo sapiens*, in particular the Australian race. The direction of the plane of the foramen magnum is also Australian, not neandertaloid. The glenoid fossa and articular eminence for articulation with the lower jaw are of the sapiens type. Very striking is, also seen from below, the greater thickness and more transverse position of the malar bones, whereas the zygomatic arches stick out less laterally. It is noteworthy that the thickness of the wall of the brain-case is less, on the whole, than it is usually found in Australian and even neandertalian skulls.

The relative height of the calvaria (calvarial height index) with regard to the glabella-inion line, is 42.3, as against 40 to 44.3 in the neandertalians, and the minimum 44.9 (according to BERRY and ROBERTSON) in Australians. The degree of flattening is, therefore, about the same as that of the Neandertal Man, and is also almost reached by some Australians. In the comparative lengths of the sagittal suture (chord 114 mm.) and the temporal suture (chord 105 mm.) of the parietal bone the Rhodesian is closer to very platycephalic Australians.

In consequence of the receding forehead the inion-glabella-bregmatic angle is only 46° , against $45\frac{1}{2}^\circ$ in La Chapelle, and 49° as minimum in Australians (BERRY and ROBERTSON). The elevation of the nuchal plane of the occipital bone in the Neandertal Man made the glabella-inion-opisthion angle (lowest inion angle) rise to $44\frac{1}{2}^\circ$ in La Chapelle, even 54° in Spy I; it is only 30° in the Rhodesian, agreeing with modern men. It is 33° in the Australian of Fig. 5, and reaches a minimum in this race of 31° (BERRY and ROBERTSON). The glabella-inion-lambda angle (upper inion angle) is 72° , in our Australian 73° , the minimum in Australians (BERRY and ROBERTSON) is 70° ; this angle is from 66° to 69° in the Neandertal Man. In contrast with the latter the lower inion-angle has, therefore, remained small in the Rhodesian, with a small upper inion angle.

Nor do we find the lower part of the cranium of greater depth, with the flattening of the upper part, to the same extent as in the Neandertal Man. In consequence of the flattening of the Rhodesian skull the depth of the lower part of the cranium, below the glabella-

inion line, is greater than in most modern men, viz. 31,6% of the total height of the basion to the cranial apex. This is considerably less than in the La Chapelle skull (39,3%), and not much more than is usually found in Australian skulls, e.g. in the Australian skull of Fig. 5 it is 27,7%, in the Australoid Wadjak I 28%.

The mastoid process is, indeed, smaller than in most Australians, in my opinion in consequence of the preponderating significance as nuchal muscle which the sterno-cleido-mastoideus obtains in the mechanism of the flattened skull, but considerably larger than in the neandertalians.

The bones of the skeleton found with the skull present the sapiens type — the tibia because of its slenderness, the articular extremities of the femur in that they lack the bulky character of those of the Neandertal Man.

All things considered I cannot doubt that *Homo rhodesiensis* belongs to the type of *Homo sapiens*. He exhibits this type decidedly in the most primitive, in the Australian form; he is still somewhat more platycephalic and the torus is even more pronounced than is found in Australians, who already distinguish themselves in these points from the other living races of Man. With greater justice even than the Australoid Wadjak Man and the Talgai-Australian can the Rhodesian lay claim to the name of proto-Australian. The characteristics mentioned are certainly in relation with the exceeding largeness of the masticatory apparatus and the heaviness of the facial part of the head resulting from it. They may be accounted for by similar mechanical causes as in the Siamang in contradistinction with the small gibbon species, the Chimpanzee in contradistinction with the Orang utan, partially also similar as in the Neandertal Man, and thus corroborate the above considerations.

The primitive character of this Australoid human skull appears from the heaviness of the facial part, the splanchnocranium in comparison with the cerebral part, the neurocranium. Calculated to equal area of the brain (the two-third power of the capacity), the Rhodesian has a sixteenth larger palatal area than KEITH's very large-jawed Tasmanian¹⁾, with 3680 mm.² palatal area and 1350 cm.³ cranial capacity, about a sixth larger than the Australian compared in Fig. 5 (calculated from 3100 mm.² palatal area, derived from the relative length and breadth of the dental arcades), and between a fifth and a fourth larger than Wadjak I. It is very important that here, as in the Wadjak Man and the Neandertal Man (incl. the Heidelberg Man) retrogression of the masticatory apparatus more than increase of the brain indicates the direction in which the genus *Homo* has developed.

¹⁾ Few Australians reach 3600 mm.², certainly also few Tasmanians.

Of the numerous fragments of bones of animals found in the same cave with the remains of the Rhodesian Man some have been identified as belonging to species still living in Rhodesia or to others only slightly different from these. This renders it probable that the time of his occupation of the cave even falls after the Plistocene period. It seems that the bones are not petrified in the ordinary way, but they are impregnated with phosphates of lead and zinc. The Rhodesian Man may all the same be an archaic form; in the same way the living *Ocapia* comes closer to the tertiary *Helladotherium* and *Samotherium* than to the Giraffe.

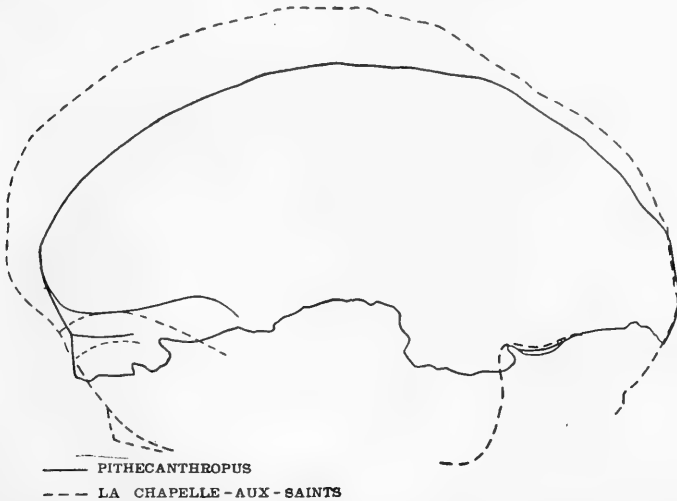

Fig. 6. Right side-views of the endocranial casts of *Pithecanthropus erectus* and the La Chapelle-aux-Saints neandertalian. Both, especially *Pithecanthropus*, somewhat more than $\frac{1}{2}$ of nat. size.

The above considerations are also valid for the fossil Ape Man of Java.

The shape of the calvaria of *Pithecanthropus erectus* is almost entirely the same as that of the small gibbon species; only the parietal region is somewhat more flattened. This resemblance can only be seen by the endocranial cast, as the nuchal tabular part of the occipital bone is defective, also as regards its thickness. This nuchal tabula is almost as steep as in gibbon skulls, quite different from that of the Neandertal Man (Fig. 6); the external profile line of the defective calvaria does not show this. Besides — different from what was inferred by many investigators from the plaster cast — the post-orbital constriction has a pithecoïd situation, as indeed the proportion between the volume of the orbits and the cranial cavity is not human, and the greatest breadth of the skull lies as far towards the occiput as in the Gibbons; — in this post-orbital region the calvaria is defective on the left. Thus from the capacity of the superior part

of the cranium measured accurately (with water) the capacity of the whole cranium can be calculated with pretty great certainty at about 900 cm³. by comparison with that of the small gibbon species. That is: with equal body size (weight), which may be estimated by the femur, double the capacity of the large Anthropoids, and more than two thirds of the cranial capacity of Modern Man (male Australian). The platycephaly, even of Pithecanthropus, which is much more considerable than that of the Neandertal Man, cannot be explained sufficiently as a primitive i. e. merely inherited character. With such a cranial capacity the platycephaly would have to be much less pronounced, if it were not adaptational. The form of the cranium of Pithecanthropus determined by about the same mechanical factors as in the small gibbon species, must also have gone together with an almost perfectly gibbon-like facial skull. Consequently the Ape Man carried his head in almost the same overhanging attitude as the small gibbon species, though the femur shows his completely erect posture and gait. It may, therefore, be assumed that the nuchal muscles were exceedingly powerful, and the stress of the epicranial muscle apparatus very great, because in uniform skulls the areas increase only by squares, the weights — hence the muscular forces proportional to them — by third powers. Therefore the very strong flattening of the parietal region and the development of the torus supraorbitalis which is about the same as in the small gibbon species. The rooflike shape (scaphocephaly), which in Pithecanthropus is confined to the frontal bone, as in *Homo rhodesiensis*, and likewise the scaphocephaly which extends further as far as the parietal bones (lophus of SERGI) of Australians, Tasmanians, Eskimos and others, may be accounted for by the strain exerted as far as the median line on the periosteum by the anterior part of the temporal muscles, which part, active in biting mastication, is then particularly powerful. This strain increases towards above, because the opposed strains of the two muscles meet in the median line. The mechanical efficiency of the roof shape lies in increase of resistance of the cranial vault against the violence of the temporal muscles.

The brain quantity, which is much too great for an Anthropoid of equal bodily size (weight), proves here certainly higher brain-organization. Judging by this relative quantity and the configuration of the cerebral convolutions of the frontal lobe, clearly impressed on the interior surface of the skull-cap, Pithecanthropus presented a closer resemblance to Man than to the Anthropoids. Nevertheless the cranial shape is almost absolutely ape-like; a proof that really even this form was determined partially by *analogous* mechanical factors.

Physics. — “*Double refraction by regular crystals*”. By Prof. H. A. LORENTZ.

(Communicated at the meeting of November 26, 1921).

1. It is well known that crystals of the regular system are anisotropic as to their elastic properties. Their three constants of elasticity are not connected by the same relations as those of isotropic substances. Therefore geometrically equal rods cut from the crystal in different directions are bent or twisted to different degrees.

Substances as rocksalt and fluor-spar on the contrary are single refracting to a first approximation. The FRESNEL ellipsoid from which in crystal optics all phenomena are derived, is a sphere; this is also in accordance with the electromagnetic theory of light on the assumption that the optical properties are defined by the dielectric constant. Crystals with three equivalent mutually perpendicular principal directions can have but one dielectric constant.

More detailed considerations however teach that this optic isotropy can only exist as long as the distance d of the molecules is very small compared with the wavelength λ . When λ becomes of the same order to this distance, we have for each direction of propagation two mutually perpendicular directions of vibration, the “principal directions” to which belong different velocities of propagation.

2. In 1877 I was led to the treatment of this problem¹⁾ by the discussion of the explanation of the chromatic dispersion that was often excepted in those days. The unequal velocities of rays of different wavelength were explained by the assumption that the mutual distances of the molecules may not be neglected compared with the wavelength, which assumption may f.i. still be found in old papers of KELVIN. In the cited paper I explained how this assumption is in contradiction with the fact, that with a few exceptions, the regular crystals are single refracting; when namely the ratio d/λ was so great that it could give rise to the dispersion, this should necessarily be accompanied by a detectable double refraction.

¹⁾ H. A. LORENTZ: Over het verband tusschen de voortplantingssnelheid van het licht en de dichtheid en samenstelling der middenstoffen. Verh. der Akad. van Wetenschappen te Amsterdam, 1878.

The true value of d was then taken from the first estimations of VAN DER WAALS. Nowadays however we know the absolute dimensions of the molecules and also the distance d . Moreover, thanks to the investigations on the interference of the Röntgen rays we can trace the structure of the crystals in detail. This made it desirable to take the problem at hand once more. While the wavelength of the Röntgen rays is comparable with d , the question is, whether already for light rays the molecular discontinuity is of influence, whether there are any indications that d/λ may not be quite neglected.

In my former calculations I made use of the theory of MAXWELL in the form given to it by HELMHOLTZ. I followed this way because I had not yet penetrated deeply enough into the ideas of MAXWELL. In the first place, therefore, the calculations had to be repeated and to be based upon the theory of MAXWELL and the theory of electrons. The new calculations gave the same results as the first ones.

3. It will suffice to consider a cubical arrangement of the molecules. The equations for the light motion were derived on the supposition that equal particles are placed at the points of a cubic lattice. Further it has been assumed that in each molecule an electric force is excited and a corresponding electric moment in the direction of that force.

From considerations on the symmetry of the crystal we may easily deduce that for some definite directions of propagation comparable with the axis of monoaxial crystals we have only one velocity of propagation; these directions are those of the edges of the cubic lattice and of the diagonals of the elementary cube. By the diagonals of the side-faces of this cube however those directions of propagation are given for which we may expect (and this is confirmed by the experiments) the anisotropy in question to be felt most strongly. Further on we shall always assume the direction of propagation to coincide with such a diagonal of a side-face of the cube. Then the principal directions of propagation R_1 and R_2 may be indicated immediately.

The first one is that of the edge of the cube perpendicular to that side-face, the other one that of the second diagonal of that face.

The velocities of propagation belonging to these directions of vibration will be indicated by v_1 and v_2 , while the corresponding values of the refraction index $\frac{c}{v_1}$ and $\frac{c}{v_2}$ (c the velocity in vacuum) will be represented by μ_1 and μ_2 . For the difference between these last

quantities we find by making use of some simplifications that are allowed because of the smallness of this difference:

$$\mu_1 - \mu_2 = 0,11 \frac{n^2 \sigma^2 \mu (\mu^2 - 1)^2}{\pi c^3} (1)$$

Here n is the number of vibrations in the time 2π , σ the distance of the molecules viz. the edge of the cubic lattice and μ one of the refraction indices μ_1 and μ_2 , or rather the mean of both; we may say the observed refraction index.

From (1) we see that the sign of $\mu_1 - \mu_2$ is the same as for a plate of calcite the optical axis of which coincides with the direction R_2 and also the same as for a glass plate that is compressed in the direction R_2 .

During the propagation in the crystal over a distance D a difference of phase arises between the vibrations in the directions R_1 and R_2 . Expressed in periods or wavelengths this difference in phase is determined by

$$\omega = (\mu_1 - \mu_2) \frac{D}{\lambda} = 0,44 \pi \mu (\mu^2 - 1)^2 \frac{D \sigma^2}{\lambda^3} (2)$$

where λ is the wavelength in vacuum.

For rock-salt $\sigma = 2,80 \cdot 10^{-8}$ cm.

With this σ we find for a thickness of 1 cm the following values of ω .

$$\begin{array}{l} \lambda = 5,9 \cdot 10^{-5} \text{ (sodium light); } 5,1 \cdot 10^{-5}; 3,1 \cdot 10^{-5}; 1,8 \cdot 10^{-5} \\ \omega = 0,016 \quad \quad \quad ; 0,025 \quad \quad ; 0,14 \quad \quad ; 2,1. \end{array}$$

Even in the visible spectrum these numbers are great enough to let us expect that under favourable circumstances the effect of the double refraction will be detectable between crossed Nicols.

4. I have sought for the phenomenon in several pieces of rock-salt, in which the faces of the cube were obvious and which were bounded by two side-faces perpendicular to the direction indicated above with L ; the distance between these phases was about one cm. The side-faces could be easily polished, but we met with the difficulty, that they loose their polish even when the crystal is kept in dry air. To avoid this the crystal was put into a tube a little longer than the thickness of the rock-salt and shut on both sides by glass plates from HILGER with neglectable double refraction. The remaining space in the tube was filled with a mixture of carbonic disulphide and benzol, of which for the mean yellow light, the refraction index is equal to that of the rock-salt. Under these circumstances the crystal is beautifully transparent even when the side-faces have not

been polished particularly well. Neither is it now necessary, that these faces are perfectly plane and exactly parallel to each other; it suffices when the glass-plates are rather exactly parallel to each other. We had only to take care that these plates are not exposed to a too high pressure, so that the closeness (with caoutchouc rings between the glass plates and plane metal rims) was not perfectly tight. This however was of no importance.

5. When after having been fixed in this way the crystal was placed between crossed Nicols the light reappears again and when we fix the eye on the crystal we see irregular light spots over its extension (about 1 cm²). These are due to inner structure deviations and tensions and might retain us from further investigation, when not the differences in phase in this "accidental" double refraction proved to be rather small. When anywhere they reached the value of half a wavelength we should see dark spots between parallel Nicols. There is no question of this; a rotation of one of the Nicols over a few degrees from their crossed situation sufficed to obtain a uniform distribution of the light.

The irregular differences in phase being so small, it might be expected that the effect of a regular anisotropy, the same over the whole cross-section of the light beam could be observed when it was superposed on the irregular differences. In fact this was proved to be the case when a thin plate of mica was adjusted before the crystal and rotated in its own plane.

6. Now the experiment was made on the following way. A small round aperture into which the rays of a glow-lamp with opaque bulb are falling is placed in the focus of a collimator lens. After passing this lens the rays fall in a telescope that is focussed for parallel rays.

We then see a sharp image of the lighted aperture, which image is extinguished by two Nicols placed between the collimator lens and the telescope.

When now the crystal is placed between the Nicols and when these are rotated, we see in positions differing 90° minima of the intensity of the light. These minima are not always equally pronounced, but they are always easy to recognize.

That in the mentioned positions the light is not perfectly extinguished, must of course be ascribed to the accidental double refraction, which now however causes a uniform illumination. As we have namely focussed not at the crystal but at the lighted aperture,

we have at every point of the image rays that have crossed the crystal at different points of the section. We may say, that of that double refraction we observe the mean over the whole section.

It may be remarked, that we can also speak of such a mean with respect to the succeeding layers of the crystal and that the great thickness which we use is in a certain respect an advantage. When namely the disturbing double refraction changes irregularly along the ray we may assume the intensity caused by it to be proportional with the thickness, while a regular double refraction gives an intensity proportional with the second power of the thickness as long as the difference in phase is small.

By these disturbing anomalies a sharp focussing at the minimum is impossible. In order to form an estimation of the accuracy of the experiment and therefore of the regularity of the phenomenon we read the positions of the crystal on a divided circle after having focussed at a minimum as accurately as possible. When one of the crystals was rotated continually we obtained the following readings in degrees :

17	107	202	294
14	105	196	293
19	108	196	291

When the numbers of the second column are diminished by 90, those of the third one by 180 and those of the fourth one by 270 and when we then take the mean of the 12 numbers, we find 18, so that the principal positions would be

18	108	198	288
----	-----	-----	-----

With the other crystals we obtained similar results, sometimes a little better, sometimes a little worse.

8. The positions of extinction were always those, for which the directions indicated with R_1 and R_2 coincide with the directions of vibration of the Nicols. As to this, the theoretical expectation is therefore confirmed.

In order to see whether also the sign of the double refraction agrees with (1) we used a glass plate compressed in one direction which was placed in the way of the rays and which was rotated in its plane. It was found then, that for all ten crystals that were investigated and which were cut from different pieces of rock-salt, the effect could be compensated by the glass plate, when the direction of compression coincided with R_2 . Taking into consideration § 4 we come to the conclusion that the sign is opposite to that given by form (1).

Though this contradiction is not satisfactory, our astonishment must not be too great, to my opinion, as in the light of our present knowledge, the theory from which the equation has been derived is so very imperfect. There the assumption has been made that equal molecules were placed at the points of the crystal lattice and that in each of these an electric moment is excited as will be the case when the molecule contains a quasi-elastically and moreover isotropically bound electron. According to the present opinion however the sodium and chlorine nuclei are placed alternately along each edge of the lattice, while round these nuclei and perhaps also round the lines of connection electrons are circulating. When this circulation takes place in planes, the position of these planes may give rise to an anisotropy.

Perhaps the only thing that can make plausible the old theory is, that an anisotropy may be expected which like that determined by (1) is proportional with $\frac{\sigma^2}{\lambda^2}$. I have not tried a calculation based upon the new points of view. First we shall have to be further in the general treatment of light vibrations.

That the old theory is imperfect in several respect may be seen from the following. The difference in phase determined by (2) strongly increases with diminishing wavelength and when working with white light, we should therefore see the field distinctly coloured. This is however not at all the case.

As to the value of the difference in phase, it has hardly been possible to determine it because of the imperfectness of the extinctions.

For the crystals used it could not be measured with the compensator of BABINET. The only thing that could be done was to determine with this means the difference in phase of the compressed glass plate by which the double refraction of the rock-salt was compensated rather satisfactorily. In this way it was found; that the difference in phase was a small fraction, about $\frac{1}{20}$ or $\frac{1}{40}$ of a wavelength.

The idea suggests itself to work also with crystals, the side-faces of which are perpendicular to an edge of the lattice, in which case a double refraction as has been described above cannot exist.

To my astonishment even now we can often distinguish two mutually perpendicular positions in which the intensity is a minimum, so that we get the impression that also for the mean of the accidental double refraction taken over the cross-section of the crystal, we can speak of two principal directions. The phenomena however were doubtlessly less regular than for the crystals with which the

former experiments had been made. The minima were less pronounced and with the exception of a single case we could not focus on them as accurately as in the preceding case. Sometimes the focussing was much more dubious. Besides the positions of extinction were not always the same; sometimes the two edges of the lattice which were now lying in a plane perpendicular to the light beam, nearly coincided with the directions of vibration of the nicols, but sometimes they made with these angles of 30° or 40° . My final impression is however, that the double refraction in question really exists; but I hope that others will have the opportunity to repeat the experiments with better crystals than those that were at my disposal.

CONTENTS.

- ADAPTATION (Light- and dark-) of a plant cell. 17.
- AGAR-AGAR (On the movement of pepsin in a protein-containing or protein-free gel of). 269.
- ALUMINIUM (The electromotive behaviour of). III. 86.
- Anatomy.** J. H. ZALMANN: "Concerning an isolated muscle of the ciliary body of the pigeon's eye, situated near the eye-split." 123.
— CHR. VAN GELDEREN: "On the development of the sternum in reptiles." 221.
- ANTIGEN (On the formation of heterogenetic) by combination of hapten and protein. 237.
- Astronomy.** A. PANNEKOEK: "The local starsystem." 56.
— W. H. VAN DEN BOS: "The orbit of *Bu* 6832 = Σ 1834." 72.
— C. H. HINS: "On a change with the declination in the personal equation in meridian-observations." 168.
- AUTOMATIC movements (Regarding) of the isolated iris. 84.
- AVENA (On anti-phototropic curvatures occurring in the coleoptiles of). 177.
- BABINET'S COMPENSATOR (An extension of the theory of). 102.
— (The optical investigation of surface layers on mercury and a more refined method of observation with). 108.
- BIRDS (Muscle sound in). 78.
- BLAAUW (A. H.) and D. TOLLENAAR. Light- and dark-adaptation of a plant cell. 17.
- BOEKE (J.) presents a paper of Mr. J. H. ZALMANN: "Concerning an isolated muscle of the ciliary body of the pigeon's eye, situated near the eye-split." 123.
- BOER (S. DE). On the action of the novocain on the tonus of the skeletal muscle. 185.
- BÖESEKEN (J.), CHR. VAN LOON, DERX and HERMANS. The condition of motion of the molecules in space. 198.
- BOLK (L.) presents a paper of Mr. CHR. VAN GELDEREN: "On the development of the sternum in reptiles." 221.
- BOS (W. H. VAN DEN). The orbit of *Bu* 6832 = Σ 1834. 72.
- BOSCHMA (H.). On budding and coalescence of buds in fungia fungites and fungia actiniformis. 257.

- Botany.** TH. WEEVERS: "Concerning the influence of light and gravitation on *Pellia epiphylla*." 2.
- D. TOLLENAAR and A. H. BLAAUW: "Light- and dark-adaptation of a plant cell." 17.
- C. E. B. BREMEKAMP: "On anti-phototropic curvatures occurring in the coleoptiles of *Avena*." 177.
- V. J. KONINGSBERGER: "A method of recording growth under various external influences." 209.
- W. E. DE MOL: "On hypotriploid dwarf-hyacinths derived from triploid dutch varieties through somatic variation". 251.
- BREMEKAMP (C. E. B.). On anti-phototropic curvatures occurring in the coleoptiles of *Avena*. 177.
- BRUINS (H. R.) and ERNST COHEN. The use of the ZEISS waterinterferometer (RAYLEIGH-LÖWE) for the analysis of non-aqueous solutions. 114.
- BU 6832 = Σ 1834 (The orbit of). 72.
- BUDS (On budding and coalescence of) in fungia fungites and fungia actiniformis. 257.
- CARBON (On the behaviour of amorphous) and sulphur at high temperatures and on carbon-sulphides. 92.
- CATE (JASPER TEN). Regarding automatic movements of the isolated iris. 84.
- Chemistry.** A. SMITS and C. J. DE GRUIJTER: "The electromotive behaviour of aluminium". III. 86.
- J. P. WIBAUT: "On the behaviour of amorphous carbon and sulphur at high temperatures and on carbon-sulphides". 92.
- ERNST COHEN and H. R. BRUINS: "The use of the ZEISS waterinterferometer (RAYLEIGH-LÖWE) for the analysis of non-aqueous solutions". 114.
- J. BÖESEKEN, CHR. VAN LOON, DERX and HERMANS: "The condition of motion of the molecules in space". 198.
- CILIARY BODY (Concerning an isolated muscle of the) of the pigeon's eye, situated near the eye-split. 123.
- COHEN (ERNST) and H. R. BRUINS. The use of the ZEISS waterinterferometer (RAYLEIGH-LÖWE) for the analysis of non-aqueous solutions. 114.
- COLEOPTILES of *Avena* (On anti-phototropic curvatures occurring in the). 177.
- CONDITION of motion (The) of the molecules in space. 198.
- CONTRACTION (A simple method to obtain a curve of the) of the *M. arrectores pilorum*. 81.
- CORPUT (J. G. VAN DER). On an integral notion of DENJOY. 131.
- CRANIAL-FORM (On the) of homo-neandertalensis and of pithecanthropus erectus, determined by mechanical factors. 313.
- Cryo-Biology.** P. GILBERT RAHM: "Weitere physiologische Versuche mit niederen Temperaturen". 192.

- CRYSTALS (Explanation of some interference-curves of uni-axial and bi-axial) by superposition of elliptic pencils. (Second paper). 195.
— (Double refraction by regular). 333.
- CURVATURE (On) and invariants of deformation of a Vm in Vn. 146.
— (On anti-phototropic) occurring in the coleoptiles of Avena. 177.
- CURVE (A simple method to obtain a) of the contraction of the *M. arrectores pilorum*. 81.
- DARK-ADAPTATION (Light-and) of a plant cell. 17.
- DECLINATION (On a change with the) in the personal equation in meridian-observations. 168.
- DEFORMATION of a Vm in Vn (On curvature and invariants of). 146.
- DENJOY (On an integral notion of). 131.
- DERX, HERMANS, J. BÖESEKEN and CHR. VAN LOON. The condition of motion of the molecules in space. 198.
- DIBBETZ JR. (G. C.) and P. ZEEMAN. An interference phenomenon due to the introduction of sodium vapour into one of the paths of the FIZEAU MICHELSON interferometer-arrangement. 206.
- DUBOIS (EUG.). On the cranial form of homo neandertalensis and of pithecanthropus erectus, determined by mechanical factors. 313.
- DWARF-HYACINTHS (On hypotriploid) derived from triploid dutch varieties through somatic variation. 251.
- ELECTROMOTIVE behaviour (The) of aluminium. III. 86.
- ELLIPTIC PENCILS (Explanation of some interference-curves of uni-axial and bi-axial crystals by superposition of). (Second paper). 195.
- EQUATION OF STATE (On the calculation of the molecular quadrupole-moments from the). 162.
— (On the) for arbitrary temperatures and volumes. III. On the law of force between the molecules of mon-atomic substances. 294.
- ESCHER (B. G.). On the hot lahar (mud flow) of the valley of ten thousand smokes (Alaska). 282.
- EYE-SPLIT (Concerning an isolated muscle of the ciliary body of the pigeon's eye, situated near the). 123.
- FIELD of gravitation (On the path of a ray of light in the) of a single material centre. 187.
- FIZEAU-MICHELSON (An interference phenomenon due to the introduction of sodium vapour into one of the paths of the) interferometer-arrangement. 206.
- FOOTCLONUS (Simple and alternating). 47.
- FUNGIA fungites and fungia actiniformis (On budding and coalescence of buds in). 257.
- GALVANOMETER (A moving coil) of high sensitivity. 239.

- GEL of agar-agar (On the movement of pepsin in a protein-containing or protein-free). 269.
- GELDEREN (CHR. VAN). On the development of the sternum in reptiles. 221.
- Geology.** B. G. ESCHER: "On the hot lahar (mud flow) of the valley of ten thousand smokes. (Alaska)." 282.
- GRAVITATION (Concerning the influence of light and) on *Pellia epiphylla*. 2.
— (On the path of a ray of light in the field of) of a single material centre. 187.
- GRAVITY and pressure of radiation. 64.
- GROOT (H.). Gravity and pressure of radiation. 64.
- GRUYTER (C. J. DE) and A. SMITS. The electromotive behaviour of aluminium. III. 86.
- HAGA (H.) presents a paper of Prof. F. ZERNIKE: "A moving coil galvanometer of high sensitivity." 239.
- HAPTEN and protein (On the formation of heterogenetic antigen by combination of). 237.
- HERMANS, J. BÖESEKEN, CHR. VAN LOON and DERX. The condition of motion of the molecules in space. 198.
- HEUX (J. W. N. LE). Explanation of some interference-curves of uni-axial and bi-axial crystals by superposition of elliptic pencils. (Second paper). 195.
- HINS (C. H.). On a change with the declination in the personal equation in meridian-observations. 168.
- HOLLEMAN (A. F.) presents a paper of Dr. J. P. WIBAUT: "On the behaviour of amorphous carbon and sulphur at high temperatures and on carbon sulphides." 92.
- HOMO-NEANDERTALENSIS (On the cranial form of) and of *Pithecanthropus erectus*, determined by mechanical factors. 313.
- INHIBITION (Psychical). 33.
- INTEGRAL NOTION (On an) of DENJOY. 131.
- INTERFERENCE-CURVES (Explanation of some) of uni-axial and bi-axial crystals by superposition of elliptic pencils. (Second paper). 195.
- INTERFERENCE-PHENOMENON (An) due to the introduction of sodium vapour into one of the paths of the FIZEAU-MICHELSON interferometer-arrangement. 206.
- INTERFEROMETER-arrangement (An interference phenomenon due to the introduction of sodium vapour into one of the paths of the FIZEAU-MICHELSON). 206.
- INVOLUTORIAL-CORRESPONDENCES (2,2) of the first class. 12.
- IRIS (Regarding automatic movements of the isolated). 84.

- ITERSON JR. (G. VÁN) presents a paper of Dr. C. E. B. BREMEKAMP: "On anti-phototropic curvatures occurring in the coleoptiles of *Avena*". 177.
- JULIUS (W. H.) presents a paper of Mr. H. GROOT: "Gravity and pressure of radiation". 64.
- KAISER (Miss L.). Muscle sound in birds. 78.
— A simple method to obtain a curve of the contraction of the *M. arrectores pilorum*. 81.
- KAMERLINGH ONNES (H.). v. ONNES (H. KAMERLINGH).
- KESOM (W. H.). On the calculation of the molecular quadrupole-moments from the equation of state. 162.
- KLUYVER (J. C.) presents a paper of Prof. W. VAN DER WOUDE: "On the path of a ray of light in the field of gravitation of a single material centre." 187.
- KONINGSBERGER (V. J.). A method of recording growth under various external influences. 209.
- KUENEN (J. P.) presents a paper of Mr. P. GILBERT RAHM: "Weitere physiologische Versuche mit niederen Temperaturen." 192.
- LAAR (J. J. VAN). On the equation of state for arbitrary temperatures and volumes. III. On the law of force between the molecules of mon-atomic substances. 294.
- LAHAR (mud flow) (On the hot) of the valley of ten thousand smokes. (Alaska). 282.
- LANDSTEINER (K.). On the formation of heterogenetic antigen by combination of hapten and protein. 237.
- LAW OF FORCE (On the) between the molecules of mon-atomic substances. 294.
- LIGHT (Concerning the influence of) and gravitation on *Pellia epiphylla*. 2.
— and dark-adaptation of a plant cell. 17.
— (On the path of a ray of) in the field of gravitation of a single material centre. 187.
- LOON (CHR. VAN), DEX, HERMANS and J. BÖESEKEN. The condition of motion of the molecules in space. 198.
- LORENTZ (H. A.) presents a paper of Mr. C. A. REESER and Prof. R. SISSINGH: "An extension of the theory of BABINET's compensator." 102.
— presents a paper of Mr. C. A. REESER and Prof. R. SISSINGH: "The optical investigation of surface layers on mercury and a more refined method of observation with BABINET's compensator." 108.
— presents a paper of Dr. J. J. VAN LAAR: "On the equation of state for arbitrary temperatures and volumes. III. On the law of force between the molecules of mon-atomic substances." 294.
— Double refraction by regular crystals. 333.

M. ARRECTORES PILORUM (A simple method to obtain a curve of the contraction of the). 81.

Mathematics. JAN DE VRIES: "Involutorial correspondences (2,2) of the first class". 12.

— J. G. VAN DER CORPUT: "On an integral notion of DENJOY". 131.

— J. A. SCHOUTEN and D. J. STRUIK: "On curvature and invariants of deformation of a V_m in V_n ". 146.

— W. VAN DER WOUDE: "On the path of a ray of light in the field of gravitation of a single material centre". 187.

— J. W. N. LE HEUX: "Explanation of some interference-curves of uni-axial and bi-axial crystals by superposition of elliptic pencils". (Second paper). 195.

Medicine. I. K. A. WERTHEIM SALOMONSON: "Simple and alternating foot-clonus". 47.

MERCURY (The optical investigation of surface layers on) and a more refined method of observation with BABINET'S compensator. 108.

MERIDIAN—OBSERVATIONS (On a change with the declination in the personal equation in). 168.

MOL (W. E. DE). On hypotriploid dwarf-hyacinths derived from triploid Dutch varieties through somatic variation. 251.

MOLECULES (The condition of motion of the) in space. 198.

— (On the law of force between the) of mon-atomic substances. 294.

MOLENGRAAFF (G. A. F.) presents a paper of Dr. B. G. ESCHER: "On the hot lahar (mud flow) of the valley of ten thousand smokes (Alaska)". 282.

MUSCLE sound in birds. 78.

— (Concerning an isolated) of the ciliary body of the pigeon's eye, situated near the eye-split. 123.

— (On the action of the novocain on the tonus of the skeletal). 185.

MUSKENS (L. J. J.). The myoclonic reflexes. 280.

MYOCLONIC reflexes (The). 280.

NOVOCAIN (On the action of the) on the tonus of the skeletal muscle. 185.

ONNES (H. KAMERLINGH) presents a paper of Prof. W. H. KEESOM: "On the calculation of the molecular quadrupole-moments from the equation of state." 162.

OPTICAL INVESTIGATION (The) of surface layers on mercury and a more refined method of observation with BABINET'S compensator. 108.

ORBIT (The) of Bu 6832 = Σ 1834. 72.

Palaeontology. EUG. DUBOIS: "On the cranial form of homo neandertalensis and of pithecanthropus erectus, determined by mechanical factors." 313.

PANNEKOEK (A.). The local starsystem. 56.

PATHS (An interference phenomenon due to the introduction of sodium vapour into one of the) of the FIZEAU-MICHELSON interferometer-arrangement. 206.

PEKELHARING (C. A.). On the movement of pepsin in a protein-containing or protein-free gel of agar-agar. 269.

PELLIA EPIPHYLLA (Concerning the influence of light and gravitation on). 2.

PENCILS (Explanation of some interference-curves of uni-axial and bi-axial crystals by superposition of elliptic). (Second paper). 195.

PEPSIN (On the movement of) in a protein-containing or protein-free gel of agar-agar. 269.

PHOTOTROPIC curvatures (On anti-) occurring in the coleoptiles of *Avena*. 177.

Physics. H. GROOT: "Gravity and pressure of radiation". 64.

— C. A. REESER and R. SISSINGH: "An extension of the theory of BABINET'S compensator". 102.

— C. A. REESER and R. SISSINGH: "The optical investigation of surface layers on mercury and a more refined method of observation with BABINET'S compensator". 108.

— W. H. KEESOM: "On the calculation of the molecular quadrupole-moments from the equation of state". 162.

— G. C. DIBBETZ Jr. and P. ZEEMAN: "An interference phenomenon due to the introduction of sodium vapour into one of the paths of the FIZEAU-MICHELSON interferometer-arrangement". 206.

— F. ZERNIKE: "A moving coil galvanometer of high sensitivity". 239.

— J. J. VAN LAAR: "On the equation of state for arbitrary temperatures and volumes. III. On the law of force between the molecules of monatomic substances". 294.

— H. A. LORENTZ: "Double refraction by regular crystals". 333.

Physiology. Miss L. KAISER: "Muscle sound in birds". 78.

— Miss L. KAISER: "A simple method to obtain a curve of the contraction of the *M. arrectores pilorum*". 81.

— JASPER TEN CATE: "Regarding automatic movements of the isolated iris." 84.

— S. DE BOER: "On the action of the novocain on the tonus of the skeletal muscle." 185.

— K. LANDSTEINER: "On the formation of heterogenetic antigen by combination of haptens and protein." 237.

— H. ZWAARDEMAKER: "On superficial and internal processes." 246.

— C. A. PEKELHARING: "On the movement of pepsin in a protein-containing or protein-free gel of agar-agar." 269.

— L. J. J. MUSKENS: "The myoclonic reflexes." 280.

- PIGEON'S EYE (Concerning an isolated muscle of the ciliary body of the situated near the eye-split. 123.
- PITHECANTHROPUS ERECTUS (On the cranial form of homo-neandertalensis and of) determined by mechanical factors. 313.
- PLANT-CELL (Light- and dark-adaptation of a). 17.
- PRESSURE (Gravity and) of radiation. 64.
- PROCESSES (On superficial and internal). 246.
- PROTEIN (On the formation of heterogenetic antigen by combination of hapten and). 237.
- Psychology (Experimental).** E. D. WIERSMA: "Psychical inhibition." 33.
- QUADRUPOLE-MOMENTS (On the calculation of the molecular) from the equation of state. 162.
- RADIATION (Gravity and pressure of). 64.
- RAHM (P. GILBERT). Weitere physiologische Versuche mit niederen Temperaturen. 192.
- RAY OF LIGHT (On the path of a) in the field of gravitation of a single material centre. 187.
- RECORDING-growth (A method of) under various external influences. 209.
- REESER (C. A.) and R. SISSINGH. An extension of the theory of BABINET'S compensator. 102.
- and R. SISSINGH. The optical investigation of surface layers on mercury and a more refined method of observation with BABINET'S compensator. 108.
- REFLEXES (The myoclonic). 280.
- REFRACTION (Double) by regular crystals. 333.
- REPTILES (On the development of the sternum in). 221.
- RIJNBEEK (G. VAN) presents a paper of Miss L. KAISER: "Muscle sound in birds." 78.
- presents a paper of Miss L. KAISER: "A simple method to obtain a curve of the contraction of the M. arrectores pilorum." 81.
- presents a paper of Mr. JASPER TEN CATE: "Regarding automatic movements of the isolated iris." 84.
- SALOMONSON (I. K. A. WERTHEIM). Simple and alternating foot-clonus. 47.
- presents a paper of Dr. S. DE BOER: "On the action of the novocain on the tonus of the skeletal muscle." 185.
- SCHOUTE (J. C.) presents a paper of Dr. W. E. DE MOL: "On hypotriploid dwarf-hyacinths derived from triploid Dutch varieties through somatic variation." 251.
- SCHOUTEN (J. A.) and D. J. STRUIK. On curvature and invariants of deformation of a V_m in V_n . 146.

- SENSITIVITY (A moving coil galvanometer of high). 239.
- SISSINGH (R.) and C. A. REESER. An extension of the theory of BABINET'S compensator. 102.
- and C. A. REESER. The optical investigation of surface layers on mercury and a more refined method of observation with BABINET'S compensator. 108.
- SITTER (W. DE) presents a paper of Dr. A. PANNEKOEK: "The local starsystem." 56.
- presents a paper of Mr. W. H. VAN DEN BOS: "The orbit of *Bu* 6832 = Σ 1834." 72.
- presents a paper of Mr. C. H. HINS: "On a change with the declination in the personal equation in meridian-observations." 168.
- SKELETAL MUSCLE (On the action of the novocain on the tonus of the). 185.
- SLUITER (C. PH.) presents a paper of Dr. H. BOSCHMA: "On budding and coalescence of buds in fungia fungites and fungia actiniformis." 257.
- SMITS (A.) and C. J. DE GRUYTER. The electromotive behaviour of aluminium. III. 86.
- SMOKES (On the hot lahar (mud flow) of the valley of ten thousand) (Alaska). 282.
- SODIUM-VAPOUR (An interference phenomenon due to the introduction of) into one of the paths of the FIZEAU-MICHELSON interferometer-arrangement. 206.
- SOLUTIONS (The use of the ZEISS waterinterferometer (RAYLEIGH-LÖWE) for the analysis of non-aqueous). 114.
- SOMATIC variation (On hypotriploid dwarf-hyacinths derived from triploid Dutch varieties through). 251.
- SPACE (The condition of motion of the molecules in). 198.
- SPRONCK (C. H. H.) presents a paper of Mr. K. LANDSTEINER: "On the formation of heterogenetic antigen by combination of hapten and protein." 237.
- STARSYSTEM (The local). 56.
- STERNUM (On the development of the) in reptiles. 221.
- STRIJK (D. J.) and J. A. SCHOUTEN. On curvature and invariants of deformation of a V_m in V_n . 146.
- SUBSTANCES (On the law of force between the molecules of mon-atomic). 294.
- SULPHUR (On the behaviour of amorphous carbon and) at high temperatures and on carbon-sulphides. 92.
- SUPERPOSITION (Explanation of some interference-curves of uni-axial and bi-axial crystals by) of elliptic pencils. (Second paper). 195.

- SURFACE LAYERS on mercury (The optical investigation of) and a more refined method of observation with BABINET's compensator. 108.
- TEMPERATUREN (Weitere physiologische Versuche mit niederen). 192.
- TEMPERATURES (On the equation of state for arbitrary) and volumes. III.
On the law of force between the molecules of mon-atomic substances. 294.
- TOLLENAAR (D.) and A. H. BLAAUW. Light- and dark-adaptation of a plant cell. 17.
- TONUS of the skeletal muscle (On the action of the novocain on the). 185.
- VERSUCHE (Weitere physiologische) mit niederen Temperaturen. 192.
- VOLUMES (On the equation of state for arbitrary temperatures and). III. On the law of force between the molecules of mon-atomic substances. 294.
- VRIES (H. K. DE) presents a paper of Dr. J. W. N. LE HEUX: "Explanation of some interference-curves of uni-axial and bi-axial crystals by superposition of elliptic pencils." (Second paper). 195.
- VRIES (JAN DE). Involutorial correspondences (2.2) of the first class. 12.
— presents a paper of Prof. J. A. SCHOUTEN and D. J. STRUIK: "On curvature and invariants of deformation of a V_m in V_n . 146.
- WATERINTERFEROMETER (RAYLEIGH-LÖWE) (The use of the ZEISS) for the analysis of non-aqueous solutions. 114.
- WEEVERS (TH.). Concerning the influence of light and gravitation on *Pellia epiphylla*. 2.
- WENT (F. A. F. C.) presents a paper of Dr. TH. WEEVERS: "Concerning the influence of light and gravitation on *Pellia epiphylla*." 2.
— presents a paper of Mr. V. J. KONINGSBERGER: "A method of recording growth under various external influences." 209.
- WERTHEIM, SALOMONSON (I. K. A.) v. SALOMONSON (I. K. A. WERTHEIM).
- WIBAUT (J. P.). On the behaviour of amorphous carbon and sulphur at high temperatures and on carbon-sulphides. 92.
- WIERSMA (E. D.). Psychological inhibition. 33.
- WOUDE (W. VAN DER). On the path of a ray of light in the field of gravitation of a single material centre. 187.
- ZALMANN (J. H.). Concerning an isolated muscle of the ciliary body of the pigeon's eye, situated near the eye-split. 123.
- ZEEMAN (P.) presents a paper of Prof. A. SMITS and C. J. DE GRUYTER: "The electromotive behaviour of aluminium." III. 86.
— and G. C. DIBBETZ JR. An interference phenomenon due to the introduction of sodium vapour into one of the paths of the FIZEAU-MICHELSON interferometer-arrangement. 206.

- ZEISS WATERINTERFEROMETER (RAYLEIGH-LÖWE) (The use of the) for the analysis of non-aqueous solutions. 114.
- ZERNIKE (F.). A moving coil galvanometer of high sensitivity. 239.
- Zoology.** H. BOSCHMA: "On budding and coalescence of buds in fungia fungites and fungia actiniformis." 257.
- ZWAARDEMAKER (H.). On superficial and internal processes. 246.
- presents a paper of Dr. L. J. J. MUSKENS: "The myoclonic reflexes." 280.
-

KONINKLIJKE AKADEMIE
VAN WETENSCHAPPEN
-:- TE AMSTERDAM -:-

5.00 (+ 4.50) A 5

PROCEEDINGS OF THE
SECTION OF SCIENCES

VOLUME XXIV
— (Nos. 1—7) —

PUBLISHED BY
"KONINKLIJKE AKADEMIE VAN WETENSCHAPPEN", AMSTERDAM
MARCH 1922

(Translated from: „Verslagen van de Gewone Vergaderingen der Wis- en
Natuurkundige Afdeeling” Dl. XXX).

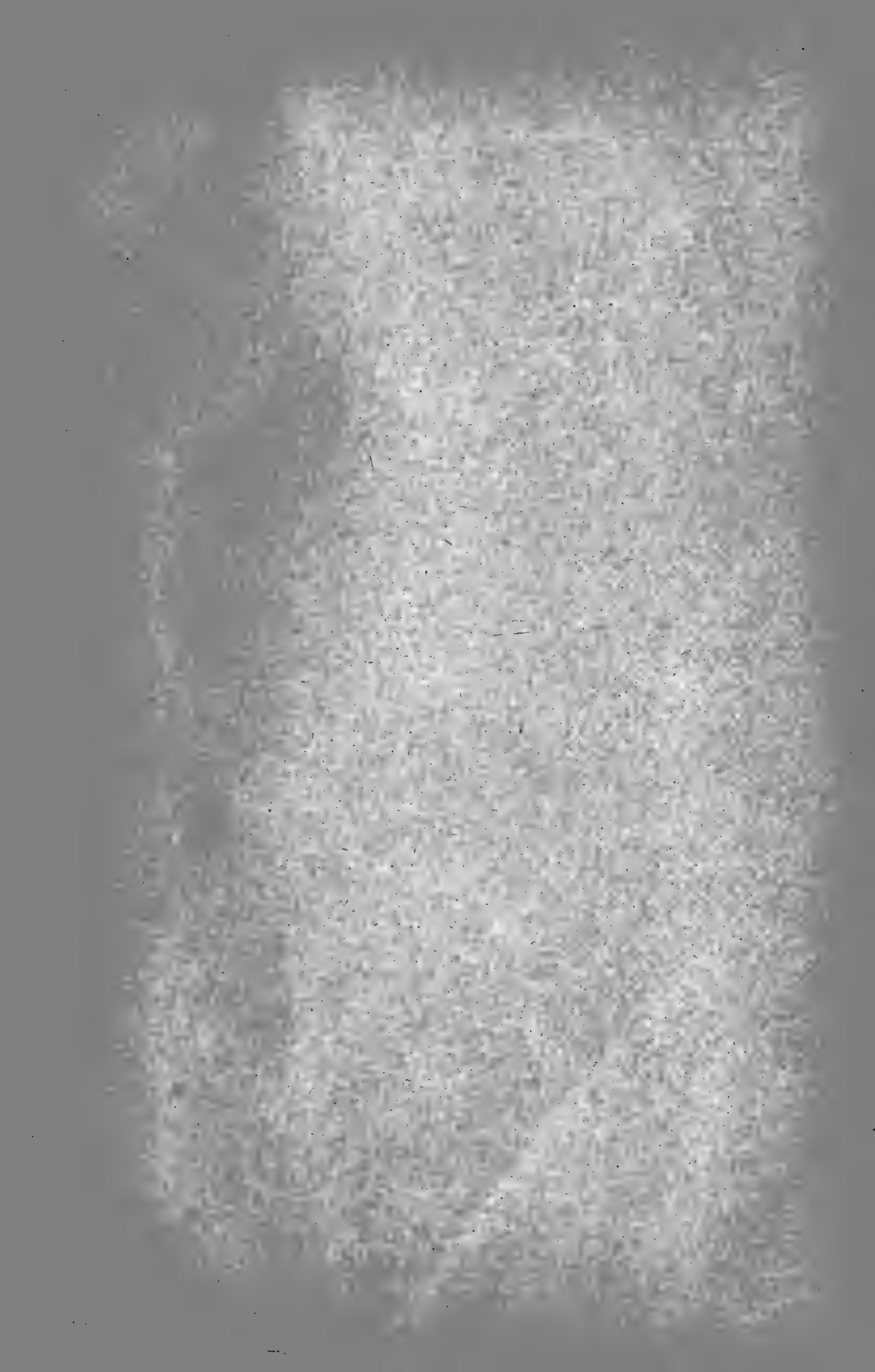

DRUKKERIJ HOLLAND
AMSTERDAM





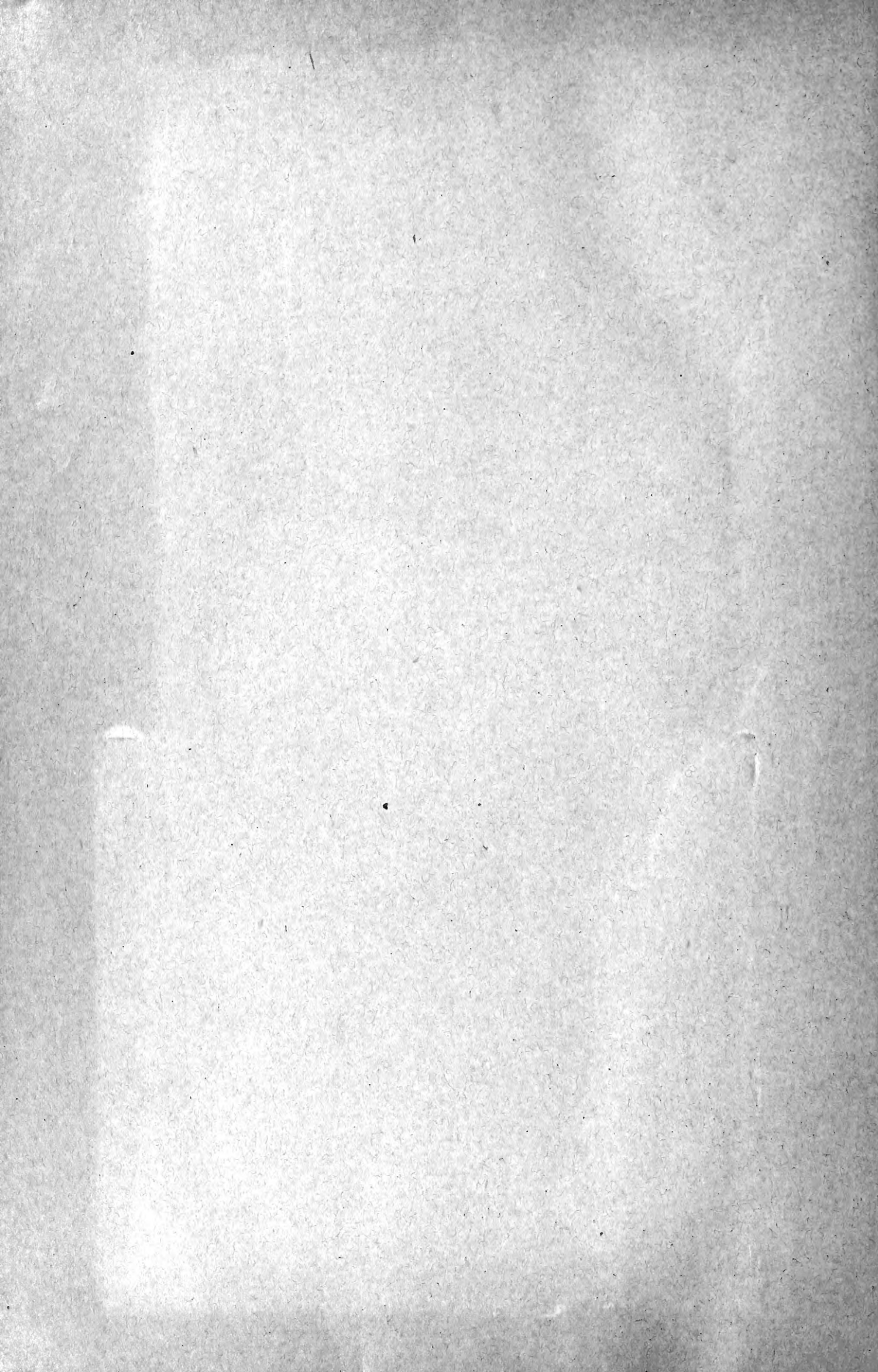

ke Akademie

22. 24-94309

1946

AMNH LIBRARY



100140085