



SMITHSONIAN INSTITUTION
UNITED STATES NATIONAL MUSEUM

PROCEEDINGS

OF THE

UNITED STATES NATIONAL MUSEUM

VOLUME 124
NUMBERS 3624-3650



SMITHSONIAN INSTITUTION PRESS
WASHINGTON : 1968

Publications of the United States National Museum

The scientific publications of the United States National Museum include two series, *Proceedings of the United States National Museum* and *United States National Museum Bulletins*.

In these series are published original articles and monographs dealing with the collections and work of the Museum and setting forth newly acquired facts in the fields of anthropology, biology, geology, history, and technology. Copies of each publication are distributed to libraries and scientific organizations and to specialists and others interested in the various subjects.

The *Proceedings*, begun in 1878, are intended for the publication, in separate form, of shorter papers. These are gathered in volumes, octavo in size, with the publication date of each paper recorded in the table of contents of the volume.

In the *Bulletin* series, the first of which was issued in 1875, appear longer, separate publications consisting of monographs (occasionally in several parts) and volumes in which are collected works on related subjects. *Bulletins* are either octavo or quarto in size, depending on the needs of the presentation. Since 1902, papers relating to the botanical collections of the Museum have been published in the *Bulletin* series under the heading *Contributions from the United States National Herbarium*.

FRANK A. TAYLOR
Director, United States National Museum

CONTENTS

	Number
BRIAN MASON and A. D. MAYNES. The composition of the Allegan, Bur-Gheluai, and Cynthiana meteorites. 12 pages. Published October 6, 1967	3624
JEAN WALKER FOX. Liberian Strepsiptera in the Smithsonian collection with descriptions of seven new Myrmecolicidae. 14 pages, 51 figures. Published December 27, 1967	3625
New species: <i>Myrmecolax blickenstaffi</i> , <i>M. liberiensis</i> , <i>M. mano</i> , <i>M. parva</i> , <i>M. kpelle</i> , <i>Caenocholar bassa</i> , <i>C. harleyi</i> .	
WILLIS W. WIRTH and VERNON H. LEE. New species of <i>Culicoides</i> from high altitudes in the Colombian Andes (Diptera: Ceratopogonidae). 22 pages, 6 figures, 2 plates. Published November 15, 1967	3626
New species: <i>Culicoides andicola</i> , <i>C. orjuelai</i> , <i>C. puracensis</i> , <i>C. popayanensis</i> , <i>C. marinkellei</i> , <i>C. monticola</i> , <i>C. andinus</i> , <i>C. caucaensis</i> , <i>C. tamboensis</i> .	
J. LAURENS BARNARD. <i>Echiniphimedia</i> , an amphipod genus from the Antarctic Ocean. 15 pages, 6 figures. Published December 28, 1967	3627
ARTHUR G. HUMES. Cyclopoid copepods of the genus <i>Paranthesius</i> associated with marine pelecypods in Chile. 18 pages, 43 figures. Published December 28, 1967	3628
New species: <i>Paranthesius protothacae</i> , <i>P. mesodesmatis</i> .	
SOEKARJA SOMADIKARTA. A recharacterization of <i>Collocalia papuensis</i> Rand, the three-toed swiftlet. 8 pages, 2 figures. Published December 28, 1967	3629
RICHARD L. HOFFMAN. Revision of the milliped genus <i>Cleptoria</i> (Polydesmida: Xystodesmidae). 27 pages, 23 figures. Published December 27, 1967	3630
New species: <i>Cleptoria bipraesidens</i> , <i>C. abbotti</i> .	
New subspecies: <i>Cleptoria rileyi alabama</i> .	
New status: <i>Cleptoria rileyi rileyi</i> , <i>C. divergens divergens</i> , <i>C. divergens nigrescens</i> .	
New combination: <i>Cleptoria divergens</i> , <i>C. divergens nigrescens</i> .	
PERRY C. HOLT. Status of genera <i>Branchiobdella</i> and <i>Stephanodrillus</i> in North America with description of a new genus (Clitellata: Branchiobdellida). 10 pages, 4 figures. Published December 28, 1967	3631
New genus: <i>Magnatodrillus</i> .	

- OSCAR L. CARTWRIGHT. Two new species of *Cartwrightia* from Central and South America (Coleoptera: Scarabaeidae: Aphodiinae). 8 pages, 3 plates. Published December 27, 1967 3632
 New species: *Cartwrightia isiasi*, *C. cartwrighti*.
- HERBERT FRIEDMANN. Alloxenia in three sympatric African species of *Cuculus*. 14 pages. Published December 28, 1967 3633
- J. KNOX JONES, JR., and ALBERT SCHWARTZ. Bredin-Archbold-Smithsonian Biological Survey of Dominica, 6: Synopsis of bats of the Antillean genus *Ardops*. 13 pages, 3 figures. Published December 27, 1967 3634
 New subspecies: *Ardops nichollsi koopmani*.
- ALBERT SCHWARTZ and J. KNOX JONES, JR. Bredin-Archbold-Smithsonian Biological Survey of Dominica, 7: Review of bats of the endemic Antillean genus *Monophyllus*. 20 pages, 1 figure. Published December 27, 1967 3635
- LEONARD P. SCHULTZ. Four new fishes of the genus *Parapercis* with notes on other species from the Indo-Pacific area (family Mugiloididae). 16 pages, 4 plates. Published January 24, 1968 3636
 New species: *Parapercis simulata*, *P. somaliensis*, *P. bivittata*, *P. trispilota*.
- JOHN W. ALDRICH. Population characteristics and nomenclature of the hermit thrush. 33 pages, 4 figures. Published January 18, 1968 3637
- MASAHARU KAWAKATSU. North American triclad Turbellaria, 17: Freshwater planarians from Lake Tahoe. 21 pages, 4 figures, 2 plates. Published January 24, 1968 3638
 New species: *Dendrocoelopsis hymanae*.
 New subspecies: *Phagocata nivea takoena*.
- KARL-JOHAN HEDQVIST. Studies in Pteromalidae in the U.S. National Museum (Hymenoptera). 11 pages, 6 figures. Published January 31, 1968 3639
- ROGER B. CLAPP and PAUL W. WOODWARD. New records of birds from the Hawaiian Leeward Islands. 39 pages. Published January 18, 1968 3640
- RAYMOND B. MANNING. Stomatopod Crustacea from Madagascar. 61 pages, 16 figures. Published February 8, 1968 3641
 New species: *Clorida miersi*, *Harpiosquilla melanoura*, *Squilla hesperia*, *Acanthosquilla humesi*, *Gonodactylus bicarinatus*, *G. crosnieri*.

- LEONARD P. SCHULTZ. A new subspecies of parrotfish *Nicholsina ustus collettei* from the eastern Atlantic Ocean. 5 pages, 1 figure, 1 plate. Published January 26, 1968 3642
 New subspecies: *Nicholsina ustus collettei*.
- VICTOR G. SPRINGER and WILLIAM F. SMITH-VANIZ. Systematics and distribution of the monotypic Indo-Pacific blennioid fish genus *Atrosalarias*. 12 pages, 1 figure, 1 plate. Published January 24, 1968 3643
- KARL V. KROMBEIN. Studies in the Tiphidae, X: *Hylomesa*, a new genus of myzinine wasp parasitic on larvae of longicorn beetles. 22 pages, 5 figures, 1 plate. Published January 24, 1968 3644
 New genus: *Hylomesa*.
 New species: *Hylomesa bakeri*.
 New subspecies: *Hylomesa tricolor lieftincki*.
 New combinations: *Hylomesa tricolor tricolor*, *H. shuckardi*, *H. longiceps*, *H. ugandensis*, *H. crassepunctata*, *H. dimidiaticornis*.
- W. STEPHENSON, W. T. WILLIAMS, and G. N. LANCE. Numerical approaches to the relationships of certain American swimming crabs (Crustacea: Portunidae). 25 pages, 4 figures. Published March 28, 1968 3645
- F. E. WOOD. The taxonomic status of *Dineutus serrulatus* and *Dineutus analis* in North America (Gyrinidae: Coleoptera). 9 pages, 11 figures. Published February 13, 1968 3646
 New status: *Dineutus serrulatus analis*.
- WILLIAM A. GOSLINE. The suborders of perciform fishes. 78 pages, 12 figures. Published April 17, 1968 3647
- HERBERT FRIEDMANN. Additional data on brood parasitism in the honey-guides. 8 pages. Published February 8, 1968. 3648
- HILARY A. HACKER. The species of the subgenus *Leptoferonia* Casey (Coleoptera: Carabidae: *Pterostichus*). 61 pages, 41 figures. Published April 23, 1968 3649
 New species: *Pterostichus (Leptoferonia) cochlearis*, *P. (L.) marinensis*, *P. (L.) mattolensis*, *P. (L.) lobatus*, *P. (L.) trinitensis*, *P. (L.) hatchi*, *P. (L.) stapediis*.
 New subspecies: *Pterostichus (Leptoferonia) fenyesi fenderi*, *P. (L.) pumilus willamettensis*, *P. (L.) stapediis yosemitensis*.
- KLAUS RÜTZLER. *Loxosomella* from *Tedania ignis*, the Caribbean fire sponge. 11 pages, 10 figures. Published March 28, 1968 3650
 New species: *Loxosomella bimaculata*, *L. parguerensis*, *L. tedaniac*.

Proceedings of
the United States
National Museum



SMITHSONIAN INSTITUTION • WASHINGTON, D.C.

Volume 124

1967

Number 3624

The Composition of the Allegan,
Bur-Gheluai, and Cynthiana Meteorities¹

By Brian Mason and A. D. Maynes²

The Allegan Meteorite

This meteorite fell on Thomas Hill, in Allegan, Mich., shortly after 8 a.m. on July 10, 1899. Landing within 50 feet of Walter Price, it buried itself to a depth of about 18 inches in sandy ground. It was dug up about 5 minutes later, reportedly too hot to handle, necessitating removal with a shovel. Merrill and Stokes (1900), however, who reported on the fall, remarked that grass welded to the surface of the meteorite by the impact was not charred. In what may well be a record for speed in recovery and display, the meteorite was on exhibit in the shop window of Stern and Company of Allegan some two and a half hours after the fall. The main mass of the stone, weighing 62½ pounds, together with an additional fragment weighing about 1½ pounds, was obtained by the U.S. National Museum from Stern and Company. Numerous fragments had been broken off the stone, and its original weight was probably about 80 pounds.

¹ The authors are indebted to the U.S. Air Force for a contract—AF 19 (628) 5552—and to the National Research Council of Canada for a grant, both of which covered part of the expenses of this research. Their thanks are due also to Prof. C. B. Moore and Mr. C. Lewis of Arizona State University for providing carbon determinations.

² Mason: Curator, Division of Meteorites, Smithsonian; Maynes, Associate Professor, Department of Chemistry, University of Waterloo, Ontario, Canada.

Even allowing for its rapid recovery, the Allegan meteorite has a remarkably fresh appearance. Many chondrites, even fresh falls, soon develop rust stains around the nickel-iron particles. A plausible explanation of this rusty staining is the decomposition of minute amounts of lawrencite originally on the surface of the metal grains. The Allegan specimens have remained perfectly fresh and free from rusting after more than 60 years of exposure to the atmosphere.

In hand specimens the meteorite shows an even granular structure of gray color, with numerous chondrules that average one to two millimeters in diameter, rarely more. Nickel-iron is visible in the form of numerous brilliant metallic particles. The stone is extremely friable, crumbling easily with handling.

The Allegan meteorite was described by Merrill and Stokes (1900), whose chemical analysis, although rated by Urey and Craig (1953) as superior, shows some anomalous features, such as unusually high metal content (23.06 percent nickel-iron), low Na_2O , and high K_2O . Since this meteorite is ideal for research, being very fresh as well as available in comparatively large amounts, we have decided to re-analyze it.

MINERALOGICAL COMPOSITION AND STRUCTURE.—The principal minerals in the Allegan meteorite are olivine and pyroxene. Nickel-iron (kamacite and taenite), troilite, and plagioclase are present in minor amounts. Accessory minerals include chromite and merrillite. Buseck and Keil (1966) recorded trace amounts of rutile, and Prof. P. Ramdohr (pers. comm.) recognized chalcopyrrotite (cubanite), native copper, and mackinawite in polished surfaces. Notes on some of these minerals follow:

Olivine: The refractive indices are $\alpha=1.668$, $\gamma=1.706$, corresponding to a composition of 18 mole percent of the Fe_2SiO_4 component, according to the determinative curve of Poldervaart (1950). Keil and Fredriksson (1964) reported an olivine composition of $\text{Fa}_{17.5}$ from microprobe analyses of this meteorite. By the X-ray method of Yoder and Sahama (1957) the composition was determined as Fa_{19} . The olivine peaks on the diffractometer chart are sharp, symmetrical, and well defined, indicating olivine of uniform composition.

Pyroxene: In an acid-insoluble fraction of this meteorite the pyroxene is a mixture of transparent orthopyroxene and turbid polysynthetically twinned clinopyroxene. The refractive indices of the orthopyroxene are $\alpha=1.672$, $\gamma=1.682$, indicating a content of 16 mole percent of the FeSiO_3 (Fs) component, according to the determinative curve of Kuno (1954). Keil and Fredriksson (1964), by microprobe analysis, determined the composition of the orthopyroxene to be $\text{Fs}_{16.0}$; they reported that the pyroxene contains 0.37 percent Ca. In

terms of the conventional subdivision of meteoritic pyroxene, this falls into the compositional range of bronzite. The refractive indices of the turbid twinned clinopyroxene are similar to those of the orthopyroxene, and it is evidently clinobronzite of similar composition.

The acid-insoluble fraction was scanned optically for the presence of diopside, but none was seen.

Plagioclase: A small amount of this mineral is present. It is fine grained and turbid, and only a mean refractive index, about 1.536, could be measured; this corresponds to a composition of about An_{10} .

Merrillite: Allegan was one of the meteorites in which merrillite originally was recognized by Shannon and Larsen (1925). Fuchs (1962) published an X-ray powder pattern of merrillite from Allegan which showed that this mineral is structurally identical with the terrestrial mineral whitlockite and a spectrographical analysis which indicated a composition corresponding to the formula $(Ca_{2.5}Fe_{0.2}Mg_{0.1}Na_{0.1})(PO_4)_2$. He did not find any chlorapatite in this meteorite, which is consistent with the very low chlorine content reported by Reed and Allen (1966).

Chromite: Snetsinger and Keil (1967) recently reported microprobe analyses of several meteoritic chromites, including that in Allegan. Their results are: Cr_2O_3 55.5, Al_2O_3 6.3, TiO_2 2.08, FeO 32.0, MgO 2.31, MnO 1.05, sum 100.24, i.e., the composition corresponds closely to the ideal formula $FeCr_2O_4$. The presence of over 2 percent TiO_2 is interesting, representing almost a 20-fold concentration of titanium over the amount reported in the bulk analysis of the meteorite; this is present in solid solution, not as exsolved ilmenite or rutile. The rutile in Allegan is disseminated as discrete grains within the silicate matrix, and Buseck and Keil suggest that it is a primary crystallization.

Tassin (1908), from chemical tests, recorded the occurrence of oldhamite, CaS , in the Allegan meteorite; however, he was unable to detect it microscopically, and we have found no trace of this mineral. Perusal of his original paper suggests that the evidence for this identification is unconvincing.

The structure of the Allegan meteorite as seen in thin section under the microscope is highly chondritic, the chondrules ranging from 0.3–2 mm in diameter. Many are perfectly spherical, some are less regular in form, and others appear to have been broken prior to aggregation with the groundmass. A wide variety of chondrule types are present: barred olivine chondrules, the bars consisting alternately of olivine and of dark, turbid, almost opaque material; chondrules consisting of numerous euhedral olivine crystals in a gray turbid matrix, probably devitrified glass; fibrous radiating pyroxene chondrules; and chondrules containing both olivine and pyroxene. The

groundmass in which the chondrules are embedded consists of opaque material and fine-grained olivine and pyroxene, probably with some plagioclase.

The density of a piece of this meteorite was determined by measuring the apparent loss of weight upon suspension in carbon tetrachloride (after evacuation under a bell to remove air). It was found to be 3.75.

CHEMICAL COMPOSITION.—The method of chemical analysis of these meteorites is essentially that outlined by Duke et al (1961). Cobalt was determined colorimetrically in a citrate-phosphate-borate medium with nitrose-R salt, as recommended by Sandell (1959).

TABLE 1.—*Chemical analysis and normative mineral composition of the Allegan meteorite* (analysis: Maynes; norm: Mason)

	<i>Analysis</i>		<i>Norm</i>
Fe	17.23%	Olivine	32.8%
Ni	1.54	Bronzite	27.1
Co	0.09	Diopside	4.0
FeS	5.57	Albite	7.7
SiO ₂	36.65	Anorthite	1.4
TiO ₂	0.13	Orthoclase	0.4
Al ₂ O ₃	2.10	Chromite	0.8
Cr ₂ O ₃	0.51	Apatite	0.7
FeO	9.30	Ilmenite	0.2
MnO	0.30	Troilite	5.6
MgO	23.27	Nickel-iron	18.9
CaO	1.71		
Na ₂ O	0.90		
K ₂ O	0.08		
P ₂ O ₅	0.31		
H ₂ O+	0.24		
H ₂ O=	0.03		
Sum	99.96%		

The chemical analysis of Allegan is given above in the conventional form expressed as metal, troilite, and oxides. This form of presenting meteorite analyses involves certain assumptions; for example, that all S is present as FeS, that Fe in excess of free metal and FeS is present as ferrous iron, that all Ni and Co are present in the metal phase. These assumptions are essentially valid for the Allegan meteorite. The composition shows that it is an olivine-bronzite chondrite in Prior's classification (1920). The total iron content, 28.00 percent, places it in the high-iron (H) group of Urey and Craig (1953).

The normative mineral composition, calculated from the analysis as recommended by Wahl (1951) and expressed as weight percentages, is also given above. The observed mineral composition agrees with that calculated from the analysis. The FeO/FeO+MgO ratio from the analysis is consistent with that deduced from the composition of the

olivine and pyroxene. The normative plagioclase has the composition An_{14} , a little more calcic than indicated by the refractive index, but, because of the fine-grained nature of the feldspar, the latter measurement is not very precise.

Owing to its freshness and availability, the Allegan meteorite has been used for many determinations of minor and trace elements. These elements, in parts per million, are as follows (numbers in parentheses indicate references under "Literature Cited"):

C	160 (1)	Te	0.3 (4)
F	140 (2); 170 (5)	I	0.07 (4)
Na	6700 (3); 5730 (14)	Cs	0.063 (7)
P	1350 (3); 1280 (5)	Ba	4.6 (5)
Cl	9 (4); 57 (5)	La	0.33 (10)
K	660 (3)	Ce	0.54 (10)
Sc	5.0 (5); 8.1 (14)	Pr	0.12 (10)
Ti	533 (5); 780 (3)	Nd	0.65 (10)
V	72 (5)	Sm	0.24 (10)
Cr	2070 (5); 3500 (3); 3640 (14)	Eu	0.087 (10)
Mn	2210 (5); 2300 (3); 2380 (14)	Gd	0.34 (10)
Co	908 (5); 900 (3); 900 (14)	Tb	0.049 (10)
Cu	80 (5); 125 (11); 105 (14)	Dy	0.39 (10)
Zn	43 (5); 48 (11)	Ho	0.082 (10)
Ge	13 (5)	Er	0.22 (10)
Br	0.16 (4)	Tm	0.043 (10)
Rb	2.20 (7)	Yb	0.19 (10)
Sr	10.1 (5)	Lu	0.035 (10)
Zr	8 (6)	Re	0.077 (12)
Ru	0.9 (8)	Os	0.87 (8); 0.89 (12)
Cd	0.015 (9)	Th	0.039 (12)
Sb	0.080 (13)	U	0.011 (12)

Schmitt et al (1965) have compared the abundances of Na, Sc, Cr, Mn, Fe, Co, and Cu in chondrules and in the meteorite as a whole, comparing the abundances by the ratio of the concentration in the chondrules to the concentration in the meteorite as a whole. For the elements Na, Sc, and Mn, this ratio is somewhat greater than unity, indicating that these elements are relatively enriched in the chondrules. For Cr the ratio is 0.7, indicating lower chromium in the chondrules than in the groundmass; for Fe and Cu this ratio is about 0.3, and for Co it is very low, 0.05. This correlates well with the geochemical behavior of these elements and the distribution of minerals within the meteorite. The chondrules are made up almost entirely of silicates, whereas the metal and sulfide phases are practically confined to the groundmass. Thus, the lithophile elements Na, Sc, and Mn are relatively enriched in the chondrules; Cr is present partly in the pyroxene, but also as chromite, and the chromite is mostly in the groundmass; some of the Fe is in the silicates, but most is present

as metal and sulfide in the groundmass; Co is probably entirely in the metal phase and is therefore almost completely absent from the chondrules.

The Bur-Gheluai Meteorite

After detonations and the appearance of a fireball in the sky, many stones fell near Bur-Gheluai in the district of Bur-Hacaba, Somalia, at 8 a.m. on Oct. 16, 1919. This must have been a very large shower; over 120 stones were recovered. The largest weighed 15.4 kg, 5 others weighed between 4 and 8 kg, 8 between 2 and 3 kg, 21 between 1 and 2 kg, 16 between 0.5 and 1 kg, 52 between 0.1 and 0.5 kg, and 18 between 0.01 and 0.1 kg (Neviani, 1921).

Bur-Gheluai does not appear on any maps available to us, but the statement that it is 70 km from Bur-Hacaba and 80 km from Baidoa places it at approximately 3°N, 44°E, or about 200 km northwest of the capital city of Mogadishu.

Since a complete chemical analysis of this meteorite is lacking, we have decided to remedy this, using a piece from a 1.3 kg stone (no. 778) in the collection of the U.S. National Museum.

MINERALOGICAL COMPOSITION AND STRUCTURE.—The principal minerals are olivine, pyroxene, and nickel-iron (kamacite and taenite). The usual amount of troilite is present as well as a small amount of plagioclase. Accessory minerals include chromite and merrillite. Prof. P. Ramdohr (pers. comm.) has examined a polished surface and reports the occurrence of small amounts of native copper and ilmenite, plus a trace of pentlandite.

Olivine: The refractive indices are $\alpha=1.670$, $\gamma=1.708$, indicating a content of 19 mole percent of the Fe_2SiO_4 component, according to the determinative curve of Poldervaart (1950). This was confirmed by the X-ray method of Yoder and Sahama (1957).

Pyroxene: Judging from optical and X-ray examinations, the pyroxene is a mixture of bronzite and clinobronzite in approximately equal amounts. The bronzite grains are transparent and untwinned, and their refractive indices are $\alpha=1.672$, $\gamma=1.682$, indicating a content of 16 mole percent of the FeSiO_3 component, according to the determinative curve of Kuno (1954). The refractive indices of the clinobronzite are approximately the same as those of the orthopyroxene, but the grains are turbid, and optical properties are difficult to measure.

Plagioclase: This mineral is fine grained, and only a mean refractive index, about 1.538, could be measured, which indicates a composition of about An_{12} .

A cut surface of the Bur-Gheluai meteorite is pale gray in color, with numerous silvery-white metal particles. The metal particles are

surrounded by brown limonitic staining, indicative perhaps of the former presence of trace amounts of lawrencite. Chondrules can be distinguished with the aid of a hand lens, but they are not prominent.

In thin section under the microscope the meteorite is seen to be highly chondritic, but the boundaries of the chondrules are frequently ill defined and tend to merge with the groundmass. The grain size of the groundmass is similar to that within the chondrules. Chondrules range from 0.3 to 1.5 mm in diameter and are of diverse types. Commonest are aggregates of euhedral olivine crystals in a dark gray turbid matrix, probably a devitrified glass. Similar chondrules with euhedral crystals of clinobronzite also occur. Other chondrules consist of an aggregate of radiating platy or prismatic crystals of pyroxene. Barred olivine chondrules—the bars being alternately olivine and turbid gray devitrified glass—are not uncommon. The opaque minerals are interstitial to the chondrules.

The density of this meteorite, reported by Neviani (1921), is 3.76.

TABLE 2.—*Chemical analysis and normative mineral composition of the Bur-Gheluai meteorite (analysis: Maynes; norm: Mason)*

	<i>Analysis</i>		<i>Norm</i>
Fe	16.58%	Olivine	33.6%
Ni	1.26	Bronzite	26.9
Co	0.08	Diopside	3.8
FeS	6.04	Albite	7.2
SiO ₂	36.07	Anorthite	1.6
TiO ₂	0.11	Orthoclase	0.6
Al ₂ O ₃	2.10	Chromite	0.8
Cr ₂ O ₃	0.52	Apatite	0.7
FeO	10.35	Ilmenite	0.2
MnO	0.29	Troilite	6.0
MgO	22.81	Nickel-iron	17.9
CaO	1.68		
Na ₂ O	0.85		
K ₂ O	0.09		
P ₂ O ₅	0.30		
H ₂ O+	0.66		
H ₂ O—	0.11		
Sum	99.90%		

CHEMICAL COMPOSITION.—The chemical analysis is given above along with the normative mineralogical composition calculated according to Wahl (1951). The composition is very similar to that of the Allegan meteorite. Bur-Gheluai is an olivine-bronzite chondrite in Prior's classification (1920), and the total iron content, 28.45 percent, places it in the high-iron (H) group of Urey and Craig (1953).

The Cynthiana Meteorite

This meteorite fell about 4 p.m. on Jan. 23, 1877, after a brilliant fireball was seen over a considerable region of southern Indiana and northern Kentucky. The place of fall was in Harrison County, Ky., about 9 miles from the town of Cynthiana. It is remarkable that this was the third meteorite fall in the Middle West within a month's span, the others occurring in Rochester, Ind., on Dec. 21, 1876, and Warrenton, Mo., on Jan. 3, 1877.

A single stone weighing 6 kg was recovered; it was described and analyzed by Smith (1877). He commented on its brecciated appearance and remarked that in this and other characteristics it resembled the Parnallee meteorite. Urey and Craig (1953) rejected Smith's analysis because of the very low Al_2O_3 content shown therein. Because of this, we decided to reanalyze the meteorite, using a piece from the specimen (no. 748) in the U.S. National Museum.

MINERALOGICAL COMPOSITION AND STRUCTURE.—A cut surface of the meteorite is medium gray in color with prominent chondrules, some lighter and some darker than the groundmass. Many of the chondrules show dark rims; occasionally one sees a dark chondrule with a light-colored rim. A moderate amount of metal and troilite is scattered through the groundmass, some of the grains being unusually large, from 2 to 3 mm across. The brecciated structure commented on by Smith is not especially prominent in our hand specimen. The stone is remarkably fresh, the broken surfaces showing no sign of limonitic alteration after nearly a century of exposure to the atmosphere.

The principal minerals are olivine and pyroxene. Troilite and nickel-iron are present in minor amounts. Plagioclase was not certainly identified optically although rare grains with a refractive index of about 1.54 and a low birefringence were seen in an acid-insoluble fraction of the meteorite; a very weak peak corresponding to feldspar was seen in an X-ray diffractogram. Accessory minerals include chromite and a phosphate (apatite or merrillite, or both).

Olivine: The refractive indices are $\alpha = 1.684$, $\gamma = 1.720$, indicating a content of 25 mole percent of the Fe_2SiO_4 component, according to the determinative curve of Poldervaart (1950). This was confirmed by the X-ray method of Yoder and Sahama (1957). The olivine peaks on the diffractometer chart are sharp, symmetrical, and well defined, indicating olivine of uniform composition. Dodd, Van Schmus, and Koffman (1967) made microprobe analyses of the olivine in Cynthiana and report an essentially uniform composition of $\text{Fa}_{25.6}$.

Pyroxene: Optical and X-ray examinations show that the pyroxene is largely clinohypersthene with some hypersthene. The clinohypersthene shows close-spaced polysynthetic twinning, and

the grains are turbid with tiny inclusions, which makes precise refractive index measurements difficult. The hypersthene has $\alpha=1.677$, $\gamma=1.688$, indicating a content of 20 mole percent of the FeSiO_3 (Fs) component, according to the determinative curve of Kuno (1954). Dodd, Van Schmus, and Koffman (1967), by microprobe analysis, reported a mean composition of $\text{Fs}_{20.7}$ for the pyroxene with some variability from grain to grain.

In thin section under the microscope this meteorite is seen to be a close-packed mass of chondrules, from 0.3 to 3 mm. in diameter, with comparatively little interstitial material. A wide variety of chondrules is present. Many consist of numerous euhedral crystals of olivine and/or clinohypersthene in a turbid brown matrix that is probably a devitrified glass. Barred olivine chondrules—the bars being alternately olivine and turbid devitrified glass—are not uncommon. Some chondrules consist of fibrous radiating clinohypersthene, others are made up of intergrown prismatic crystals of olivine and clinohypersthene. The opaque minerals are mostly interstitial to the chondrules or concentrated as rims around individual chondrules.

The density of this meteorite, determined by the method described for Allegan, was found to be 3.47.

TABLE 3.—*Chemical analysis and normative mineral composition of the Cynthiana meteorite (analysis: Maynes; norm: Mason)*

	<i>Analysis</i>		<i>Norm</i>
Fe	3.80%	Olivine	45.4%
Ni	1.01	Hypersthene	25.6
Co	0.03	Diopside	5.2
FeS	6.05	Albite	8.6
SiO_2	41.61	Anorthite	1.6
TiO_2	0.13	Orthoclase	0.6
Al_2O_3	2.36	Chromite	0.9
Cr_2O_3	0.58	Apatite	0.6
FeO	14.89	Ilmenite	0.2
MnO	0.35	Troilite	6.1
MgO	25.74	Nickel-iron	4.8
CaO	1.96		
Na_2O	1.02		
K_2O	0.10		
P_2O_5	0.25		
$\text{H}_2\text{O}+$	0.24		
$\text{H}_2\text{O}-$	0.02		
C	0.11		
Sum	100.25%		

CHEMICAL COMPOSITION.—The chemical analysis and the normative mineral composition calculated from it as recommended by Wahl (1951) are given above. The observed mineral composition is in good

agreement with the calculated norm, except for the presence of 10.8 percent feldspar in the norm. Only a small amount of feldspar actually was observed, and most of this component is evidently in the devitrified glass.

The composition of the Cythiana meteorite shows that it is an olivine-hypersthene chondrite in Prior's classification (1920). The total iron content, 19.2 percent, places it in the low-iron (L) group of Urey and Craig (1953). This iron content is considerably less than the average (22.33 percent) for Urey and Craig's L group, and suggests the assignment of this meteorite to Keil and Fredriksson's (1964) LL subgroup (low iron-low metal). The metal content, however, is not unusually low for an L group chondrite, and the iron content of the olivine is not as high as in those chondrites classified as LL group by Keil and Fredriksson.

Literature Cited

(Superior figures indicate references that appear in tabulation on page 5)

- ⁸ BATE, G. L., and HUIZENGA, J. R.
1963. Abundances of ruthenium, esmium and uranium in some cosmic and terrestrial sources. *Geochim. Cosmochim. Acta*, vol. 27, pp. 345-360.
- BUSECK, P. R., and KEIL, K.
1966. Meteoritic rutile. *American Mineral.*, vol. 51, pp. 1506-1515.
- DODD, R. T.; VAN SCHMUS, W. R.; and KOFFMAN, D. M.
1967. A survey of the unequilibrated ordinary chondrites. *Geochim. Cosmochim. Acta*, vol. 31, in press.
- DUKE, M.; MAYNES, D.; and BROWN, H.
1961. The petrography and chemical composition of the Bruderheim meteorite. *Journ. Geophys. Res.*, vol. 66, pp. 3557-3563.
- ¹¹ GREENLAND, L., and GOLES, G. G.
1965. Copper and zinc abundances in chondritic meteorites. *Geochim. Cosmochim. Acta*, vol. 29, pp. 1285-1292.
- ⁶ GREENLAND, L., and LOVERING, J. F.
1965. Minor and trace element abundances in chondritic meteorites. *Geochim. Cosmochim. Acta*, vol. 29, pp. 821-858.
- FUCHS, L. H.
1962. Occurrence of whitlockite in chondritic meteorites. *Science*, vol. 137, pp. 425-426.
- KEIL, K., and FREDRIKSSON, K.
1964. The iron, magnesium, and calcium distribution in coexisting olivines and rhombic pyroxenes of meteorites. *Journ. Geophys. Res.*, vol. 69, pp. 3487-3517.
- KUNO, H.
1954. Study of orthopyroxenes from volcanic rocks. *American Mineral.*, vol. 39, pp. 30-46.
- MERRILL, G. P., and STOKES, H. N.
1900. A new stony meteorite from Allegan, Michigan. *Proc. Washington Acad. Sci.*, vol. 2, pp. 41-56.
- ¹ MOORE, C. B., and LEWIS, C.
1965. Carbon abundances in chondritic meteorites. *Science*, vol. 149, pp. 317-318.
- ¹² MORGAN, J. W.
1965. The application of activation analysis to some geochemical problems. Unpubl. thesis, Australian National University.
- NEVIANI, A.
1921. Meteorite (aumalite) caduta il 16 ottobre 1919 nel territorio di Bur Hacaba nella Somalia Italiana. *Bull. Soc. Geol. Italiana*, vol. 40, pp. 209-223; vol. 41, pp. 1-16.
- POLDERVAART, A.
1950. Correlation of physical properties and chemical composition in the plagioclase, olivine, and orthopyroxene series. *American Mineral.*, vol. 35, pp. 1067-1079.
- PRIOR, G. T.
1920. The classification of meteorites. *Mineral. Mag.*, vol. 19, pp. 51-63.

- ² REED, G. W.
1964. Fluorine in stone meteorites. *Geochim. Cosmochim. Acta*, vol. 28, pp. 1729-1743.
- ⁴ REED, G. W., and ALLEN, R. O.
1966. Halogens in chondrites. *Geochim. Cosmochim. Acta*, vol. 30, pp. 779-800.
- SANDELL, E. B.
1959. *Colorimetric determination of traces of metals* (third edition). New York: Interscience Publishers Inc.
- ⁶ SCHMITT, R. A.; BINGHAM, E.; and CHODES, A. A.
1964. Zirconium abundances in meteorites and implications to nucleosynthesis. *Geochim. Cosmochim. Acta*, vol. 28, pp. 1961-1979.
- ¹⁴ SCHMITT, R. A.; SMITH, R. H.; and GOLES, G. G.
1965. Abundances of Na, Sc, Cr, Mn, Fe, Co, and Cu in 218 individual meteoritic chondrules via activation analysis. *Journ. Geophys. Res.*, vol. 70, pp. 2419-2444.
- ¹⁰ SCHMITT, R. A.; SMITH, R. H.; LASCH, J. E.; MOSEN, A. W.; OLEHY, D. A.; and VASILEVSKIS, J.
1963. Abundances of fourteen rare-earth elements, scandium and yttrium in meteoritic and terrestrial matter. *Geochim. Cosmochim. Acta*, vol. 27, pp. 577-622.
- ⁹ SCHMITT, R. A.; SMITH, R. H.; and OLEHY, D. A.
1963. Cadmium abundances in meteoritic and terrestrial matter. *Geochim. Cosmochim. Acta*, vol. 27, pp. 1077-1088.
- SHANNON, E. V., and LARSEN, E. S.
1925. Merrillite and chlorapatite from stony meteorites. *American Journ. Sci.*, vol. 9, pp. 250-260.
- SMITH, J. L.
1877. A description of the Rochester, Warrenton, and Cynthiana meteoric stones. *American Journ. Sci.*, vol. 14, pp. 219-229.
- ⁷ SMALES, A. A.; HUGHES, T. C.; MAPPER, D.; MCINNES, C. A. S.; and WEBSTER, R. K.
1964. The determination of rubidium and caesium in stony meteorites by neutron activation analysis and by mass spectrometry. *Geochim. Cosmochim. Acta*, vol. 28, pp. 209-234.
- SNETSINGER, K. G., KEIL, K., and BUNCH, T. E.
1967. Chromite from "equilibrated" chondrites. *American Mineral.*, vol. 52, in press.
- ¹³ TANNER, J. T.
1966. The determination of antimony in natural materials by neutron activation. Unpubl. thesis, University of Kentucky.
- TASSIN, W.
1908. On the occurrence of calcium sulphide (oldhamite) in the Allegan meteorite. *Proc. U.S. Nat. Mus.*, vol. 34, pp. 433-434.
- UREY, H. C., and CRAIG, H.
1953. The composition of the stone meteorites and the origin of the meteorites. *Geochim. Cosmochim. Acta*, vol. 4, pp. 36-82.
- WAHL, W.
1951. Interpretation of meteorite analyses. *Mineral. Mag.*, vol. 29, pp. 416-426.
- YODER, H. S., and SAHAMA, T. G.
1957. Olivine X-ray determinative curve. *American Mineral.*, vol. 42, pp. 475-491.

Proceedings of
the United States
National Museum



SMITHSONIAN INSTITUTION • WASHINGTON, D.C.

Volume 124

1967

Number 3625

Liberian Strepsiptera
in the Smithsonian Collection
with Descriptions of
Seven New Myrmecolicidae¹

By Jean Walker Fox²

The Strepsiptera taken in a light trap by Dr. C. C. Blickenstaff in Suakoko, Liberia, February 1952, were submitted to me at the Carnegie Museum (CM) for identification by Mr. O. L. Cartwright, Curator, Division of Coleoptera, United States National Museum (USNM). I owe him thanks for the opportunity to study this interesting collection. The 29 specimens are all Myrmecolicidae, including 7 new and 1 previously known species.

Since this material had been stored in alcohol in a small vial for about 14 years, it proved somewhat difficult to mount on slides satisfactorily. I take this opportunity to urge those who collect Strepsiptera to add a small amount of glycerin to the alcohol and to avoid putting cotton in the vials. Before being mounted, all the material was examined under magnification ranging from $\times 10$ to $\times 80$. Some of the measurements and characters used in the following descriptions were observed in fluid but did not show up clearly after

¹ Research supported by National Science Foundation Grant G-2928.

² Research Assistant, Section of Insects and Spiders, Carnegie Museum, Pittsburgh, Pa.

mounting. Wing expanse is frequently estimated by doubling the measured width of one wing taken from base of median vein to apex and adding the width of the body between.

Slides were examined with a Wild M20 compound microscope having $\times 10$ oculars and $\times 3$, $\times 10$, and $\times 20$ objectives and a camera lucida attachment, invaluable for accurate drawings.

I wish to acknowledge the patient, professional advice my husband Dr. Richard M. Fox has given me throughout this study as well as his assistance in making some of the slides and drawings. My appreciation also goes to Richard T. Satterwhite, our staff artist, who perfected the drawings for publication, and to Joseph Y. Quil, who typed the final manuscript.

MYRMECOLICIDAE Saunders 1872

Since Bohart's (1951) excellent revision of the Myrmecolicidae, which added 10 new species to the 7 previously known, the family has continued to grow and now comprises 42 species. Of these, Luna de Carvalho (1956, 1959) described 16 from Angola, Oliveira and Kogan (1959) added 4 from Brazil, Kogan and Oliveira (1964) added 3 from New Guinea, Pasteels (1956) added 1 from the Belgian Congo, and Paulian (1959) added 1 from Madagascar. Luna de Carvalho synonymized Bohart's genus *Rhipidcolax* with *Caenocholax* Pierce, which he separated into the *fenyesi* group and the *retrorsus* group. Other recent authors have adopted this classification, recognizing that the detached veins regarded as diagnostic by Bohart actually vary in size, shape, and even visibility with the result that it is difficult to consider them consistent characters.

Myrmecolax blickenstaffi, new species

FIGURES 1-6

Male: Body dark brown, 1.7 mm long; median breadth of hindwing 1.6 mm; wingspread 3.3 mm.

Head: Antenna with segment IV very small and flabellum of III extending about one-third length of segment VII; ratio of VI to VII about 3:5; total length 1.1 mm. Four ocelli seen on inner rim of eye from dorsal view. Mouthparts with slender, lancelike mandibles slightly more than one-half as long as distal segment of maxillary palpus. Palpus and antennal segments III to VII covered with minute hairs and sensoria.

Metathorax: With clearly defined sutures around keystone-shaped prescutum and concave scutellum. Scuti not well defined on inner margins. Postlumbium ovoid with strong anterior rounding. Post-scutellum slightly longer than anterior sclerites of metathorax.

Hindwing: With 6 main veins, seen clearly in fluid inspection, and barely distinguishable detached vein between R and M; M_1 about one-fourth length of M_2 .

Hindleg: Femur not distinguishable, tibia slender, first subsegment of tarsus much shorter than terminal three.

Aedeagus: With thick base narrowing to single apical hook that has a slight projection on dorsal side.

Abdominal segment x: Almost square.

Female, larva, and host unknown.

Holotype male: Suakoko, Liberia, light trap, February 1952, Blickenstaff, USNM type no. 69561.

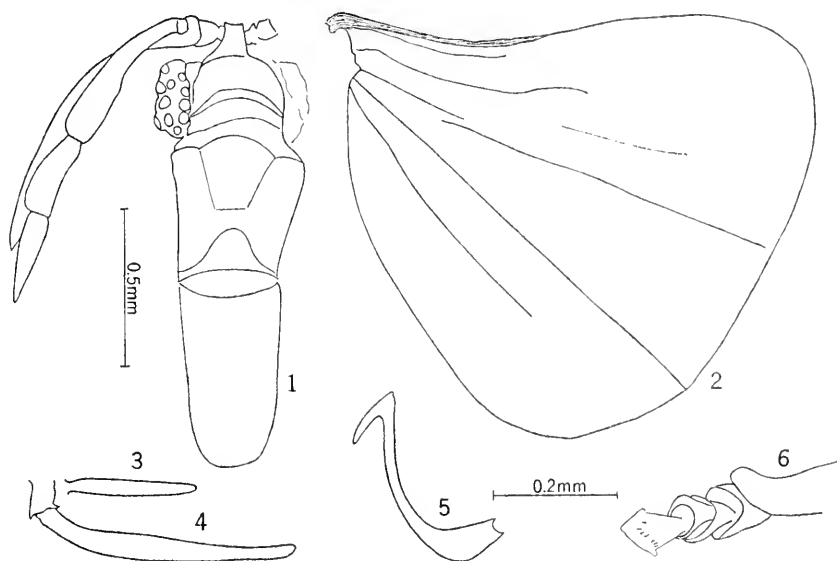

FIGURE 1-6.—*Myrmecolax blickenstaffi*, new species: 1, body and antenna in dorsal aspect; 2, right hindwing; 3, mandible; 4, maxillary palpus; 5, aedeagus, lateral view; 6, hindleg, showing tarsus and part of tibia. (Figs. 3-6 use 0.2 mm scale.)

Discussion: *M. blickenstaffi* can be distinguished easily from other African species of *Myrmecolax* by venation, having only a single, indistinct detached vein instead of two clear ones. In this respect, it is more similar to the species described by Luna de Carvalho under *Caenocholax* Pierce, but the shape of the aedeagus is distinctively different as is that of abdominal segment x.

Myrmecolax liberiensis, new species

FIGURES 7-13

Male: Body dark brown, 1.4 mm long; median breadth of hindwing 1.4 mm; wingspread 3.2 mm.

Head: Antenna with flabellum of segment III reaching about to tip of VI with total length (1.2 mm) almost that of body. Four large ocelli seen on inner rim of eye from dorsal view. Mouthparts with proximal segment of maxillary palpus equal to one-sixth the slender distal one and thin mandibles one-half as long as distal segment of palpus. Palpus and antennal segments III-VII minutely hairy and covered with small sensoria.

Metathorax: With well-defined lateral sutures outlining prescutum, which extends beyond anterior tips of the scuti; semitriangular

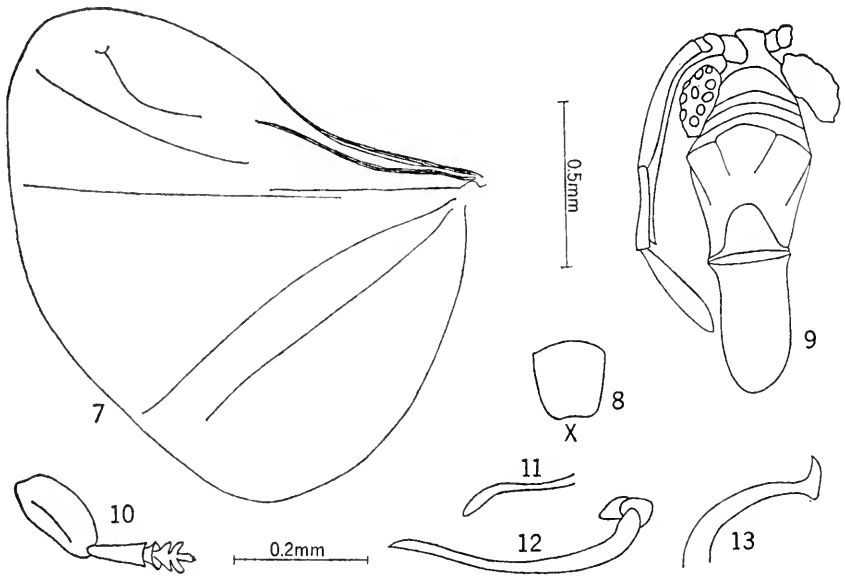

FIGURES 7-13.—*Myrmecolax liberiensis*, new species: 7, left hindwing; 8, abdominal segment x; 9, body and antenna in dorsal aspect; 10, hindleg; 11, mandible; 12, maxillary palpus; 13, aedeagus, lateral view. (Figs. 11-13 use 0.2 mm scale.)

scutellum slightly longer than prescutum; postlumbium thin, ovoid; postscutellum about equal to length of anterior metathoracic sclerites.

Hindwing: With 6 main veins; M_1 about three-fourths length of M_2 ; between R and M, 2 detached veins with slightly defined furca on anterior one.

Hindleg: Very thick femur about as long as tapered tibia. Four tarsal subsegments about equal length.

Aedeagus: Evenly tapered to single apical hook with only slight dorsal projection.

Abdominal segment x: Somewhat tapered but about as broad as long.

Female, larva, and host unknown.

Holotype male: Suakoko, Liberia, light trap, February 1952, Blickenstaff, USNM type no. 69562. One paratype male, same data, at CM.

Discussion: *M. liberiensis* is decidedly smaller than any of the species previously described from Africa except *M. afurcifer* Luna de Carvalho, from which it differs in venation and terminalia of the abdomen. The evenly tapered aedeagus of *M. liberiensis*, with the apical tip rounded rather than strongly produced ventrally, differs distinctly from *M. congoensis* Silvestri, *M. leleupi* Pasteels, *M. lundensis* Luna de Carvalho, and *M. pseudolundensis* Luna de Carvalho. It is further distinct from *M. blickenstaffi* in venation and proportion of antennal segments as well as the formation of metathoracic sclerites.

***Myrmecolax mano*, new species**

FIGURES 14-19

Male: Body brown, 1.4 mm long and 0.3 mm between wings; median breadth of hindwing 1.4 mm; expanse 3.1 mm.

Head: With fairly broad, slightly concave vertex bearing slender antenna 1.0 mm long. Flabellum of segment III reaches almost to tip of VI, which is slightly shorter than VII. Mouthparts with sabre-shaped mandibles one-half as long as distal segment of maxillary palpus.

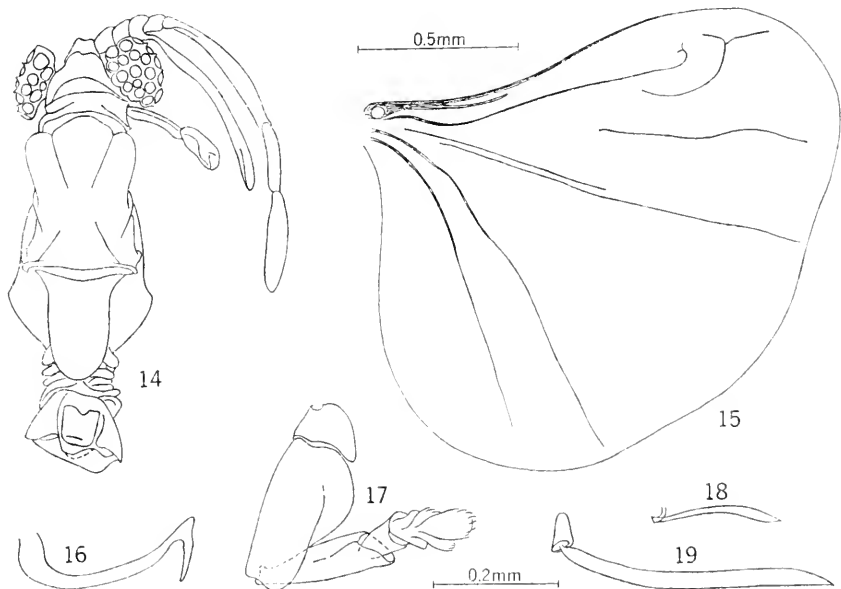

FIGURES 14-19.—*Myrmecolax mano*, new species: 14, body and antenna in dorsal aspect; 15, right hindwing; 16, aedeagus, lateral view; 17, hindleg; 18, mandible; 19, maxillary palpus. (Figs. 16-19 use 0.2 mm scale.)

Distal segment of palpus six times length of proximal. Minute hairs and sensoria on palpus and antennal segments III-VII. Four ocelli visible on inner rim of eye from dorsal view.

Metathorax: With anterior margin of prescutum rounded, about twice width of scutal tips and projecting beyond them; scutellum not well defined, but apparently about equal in length to prescutum; postlumbium an ovoid band; postscutellum tapered to rounded tip and about two-thirds length of anterior metathoracic sclerites.

Hindwing: With 6 main veins; R very strong with slight apical furca; 2 detached veins below R, anterior one with strong furca; M_1 over one-half as long as M_2 ; Cu and single A present.

Hindleg: With robust femur about same length but twice as broad as tapered tibia. Four-segmented tarsus.

Aedeagus: Narrowing to one-half the thickness of base before reaching apical tip, which is sharply hooked on dorsal side and has small crestlike ventral projection. Underside slightly dished.

Abdominal segment x: Practically square.

Female, larva, and host unknown.

Holotype male: Suakoko, Liberia, light trap, February 1952, Blickenstaff, USNM type no. 69563.

Discussion: *M. mano* can be distinguished from *M. liberiensis* by venation, particularly by the strong R with a detectable furca and by the proportion of M_1 to M_2 . The apical hook of the aedeagus is much more acute and the ventral side is dished. The metathoracic divisions also differ.

This species is named for the Liberian tribe that lives just north of Suakoko.

***Myrmecolax parva*, new species**

FIGURES 20-27

Male: Body dark brown, 1.45 mm long and 0.43 mm between wings; median breadth of hindwing 1.4 mm and expanse 3.2 mm. These measurements are an average of the specimens examined, in which body length ranged from 1.35 mm to 1.6 mm.

Head: Antenna with segment IV quite clear; flabellum III reaches slightly beyond tip of VI; length ratio of VI to VII is 7:10. Mouthparts with long, slender mandibles crossing each other in buccal cavity and about one-half as long as distal segment of maxillary palpus; distal segment of palpus thick and four times length of proximal. About 4 ocelli seen on inner rim of eye from dorsal view.

Metathorax: Prescutum with rounded anterior margin, posterior without well-defined suture and scuti not well separated; scutellum basically triangular with rounded apex; postlumbium wide and semi-lunar; postscutellum with rounded posterior tip and about as long as anterior metathoracic sclerites.

Hindwing: With 7 main veins; Sc strong; 2 detached veins below R, anterior one lightly forked; M_1 and M_2 heavy; Cu and 2 anals lighter.

Hindleg: Stout femur slightly shorter than tapered tibia; 4 bell-shaped tarsal subsegments.

Aedeagus: Slender, bearing pointed dorsal process with slight, rounded ventral projection.

Abdominal segment x: With squared posterior margin.

Female, larva, and host unknown.

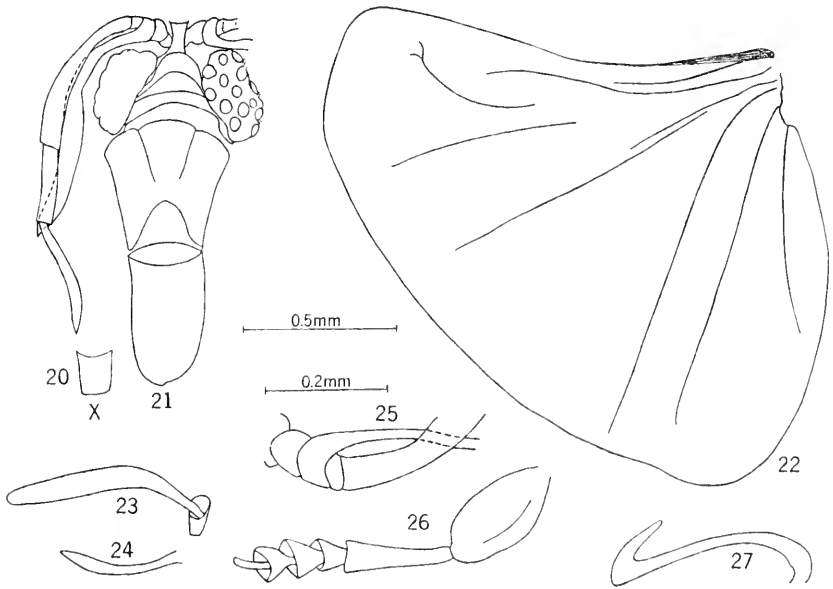

FIGURES 20-27.—*Myrmecolax parva*, new species: 20, abdominal segment x; 21, body and antenna in dorsal aspect; 22, left hindwing; 23, maxillary palpus; 24, mandible; 25, right antenna, enlarged detail showing segment iv; 26, hindleg; 27, aedeagus, lateral view. (Figs. 23-27 use 0.2 mm scale.)

Holotype male: Suakoko, Liberia, light trap, February 1952, Blickenstaff, USNM type no. 69564. Six paratype males, same data, 3 at USNM and 3 at CM. Also 3 fragmentary specimens at USNM probably this species.

Discussion: Since no single one was entirely perfect, this description is necessarily a composite of the specimens seen. *Myrmecolax parva* can be distinguished from the preceding species by having 7 main veins, by the proportions of the maxillary palpus, the proportions of the antennal segments, and the rather squared vertex.

Myrmecolax kpelle, new species

FIGURES 28-34

Male: Body brown, 1.4 mm long and 0.35 mm wide between wings; breadth of hindwing 1.5 mm and wing expanse 3.35 mm; aedeagus 0.24 mm.

Head: Broad frontal region with slightly convex vertex. Flabellum of antennal segment III reaches tip of VI; IV very small; segment VII tapered and almost twice as long as VI. Eye with 4 ocelli on inner rim visible from dorsal view. Mouthparts with slender mandibles two-thirds length of maxillary palpus; robust maxillary palpus with

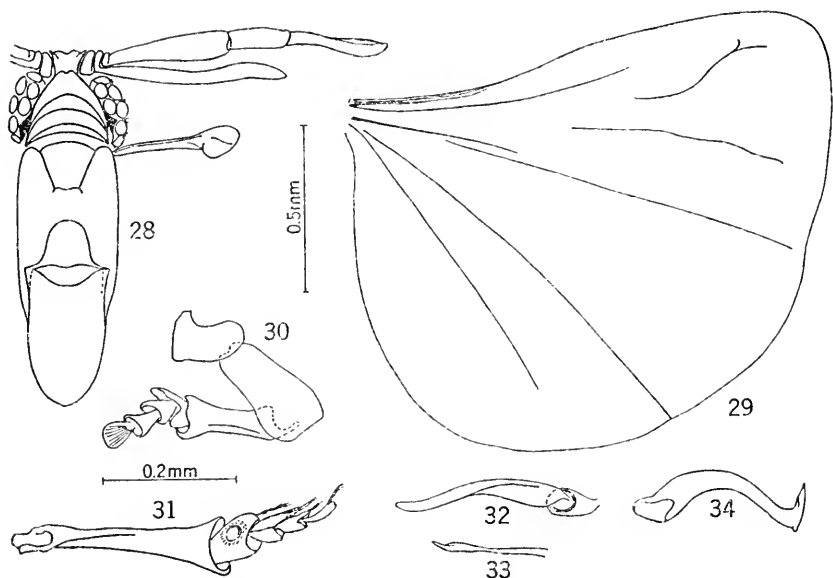

FIGURES 28-34.—*Myrmecolax kpelle*, new species: 28, body and antenna in dorsal aspect; 29, right hindwing; 30, hindleg; 31, middle leg, showing sensorium; 32, maxillary palpus; 33, mandible; 34, aedeagus, lateral view. (Figs. 30-34 use 0.2 mm scale.)

proximal segment one-third as long as distal. Palpus and antennal segments III-VII covered with tiny hairs and sensoria.

Metathorax: Prescutum keystone shaped, well defined, with rounded anterior not projecting quite as far as tips of scuti; dome-shaped scutellum about same length as precutum and separated by some distance from it; postlumbium wide, with slightly sinuate anterior margin; postscutellum equal in length to two-thirds the anterior metathoracic sclerites.

Hindwing: With 6 main veins; 2 detached below R, anterior one being lightly forked. M_1 one-half length of M_2 .

Legs: Middle leg with prominent sensorium on first subsegment of tarsus. Hindleg with stout femur and rather thick tibia that appears slightly shorter. Four tarsal subsegments.

Aedeagus: Evenly tapered from stout base to apical tip that has slight crest on one side and sharply pointed process on the other.

Abdominal segment x: Not clear.

Female, larva, and host unknown.

Holotype male: Suakoko, Liberia, light trap, February 1952, Blickenstaff, USNM type no. 69565.

Discussion: *M. kpelle* differs in venation from the other species already described, particularly in the proportion of M_1 and M_2 . In this respect, it resembles *M. mano* but lacks the strong, slightly forked R. The proximal segment of the maxillary palpus is much larger in proportion to the distal than is true of any of the other species, and the aedeagus remains thick for a greater portion of its length. It is interesting to note that the prominent sensorium on the second leg is similar to that found on the Brazilian *M. incautus* Oliveira and Kogan (1959).

This species is named for the Liberian tribe within whose territory Suakoko is located.

Myrmecolax lunai (Fox and Fox)

FIGURES 35-38

Afrostylops lunai Fox and Fox, 1964, p. 754.

One male. Suakoko, Liberia, light trap, February 1952, Blickenstaff, USNM.

Both Luna de Carvalho and Kogan (pers. comm.) suggested that *Afrostylops lunai* might properly be a *Myrmecolax*. The Suakoko specimen has afforded opportunity for study of additional material and the type and paratype have been critically re-examined. It was

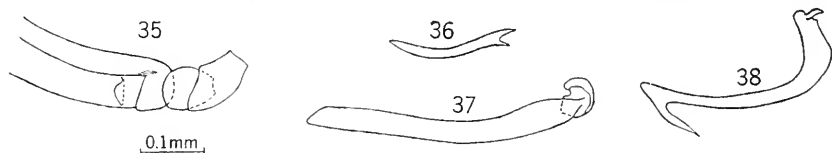

FIGURES 35-38—*Myrmecolax lunai* (Fox and Fox): 35, enlarged detail of antenna, showing segment IV; 36, mandible; 37, maxillary palpus; 38, aedeagus, lateral view.

found that *A. lunai* possesses a short, very ill-defined fourth antennal segment that had been overlooked originally because the antennae of both specimens in the type-series are in unfavorable orientation. Accordingly, *A. lunai* is transferred to *Myrmecolax*.

The Suakoko specimen provides, in addition, a more favorable view of the mouthparts and aedeagus.

Caenocholax bassa, new species

FIGURES 39-44

Male: Body light brown, 1.0 mm long; median breadth of hindwing 1.0 mm and expanse of wings 2.6 mm; width between eyes 0.15 mm; length of aedeagus 0.1 mm. Measurements are averages for 7 specimens studied.

Head: With narrow vertex; slender 7-segmented antenna with segment IV extremely small; flabellum of segment III reaching almost to tip of segment VI; VI two-thirds length of VII. Occipital area with pointed anterior margin extending on either side above eyes. Eye with 5 ocelli on inner row visible from dorsal view. Mouthparts with slender saber-shaped mandibles slightly longer than distal segment of maxillary palpus; maxillary palpus with large proximal segment

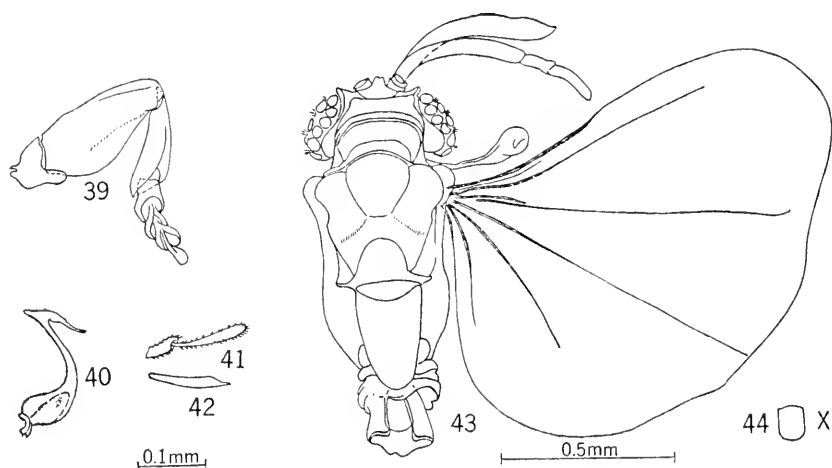

FIGURES 39-44.—*Caenocholax bassa*, new species: 39, hindleg; 40, aedeagus, lateral view; 41, maxillary palpus; 42, mandible; 43, body, showing antenna and wing in dorsal aspect; 44, detail of abdominal segment x. (Figs. 39-42 use 0.1 mm scale.)

equal to about one-half length of broad distal one. Both palpus and antennal segments III-VI covered with minute hairs and sensoria.

Metathorax: Prescutum with rounded anterior margin projecting beyond tips of scuti and well-defined sutures separating it at some distance from rounded tip of scutellum. Scutellum somewhat shorter than prescutum. Postlumbium wide, semilunar in shape. Post-scutellum with rounded tip and slightly shorter than anterior metathoracic sclerites.

Hindwing: With 7 main veins; Sc short but distinct; no inter-medials; M_1 about one-fourth length of M_2 ; 2 anals.

Hindleg: With thick femur slightly longer than more slender, tapered tibia. First subsegment of tarsi much shorter than sum of terminal three.

Aedeagus: Thick for about two-thirds its length, then narrowing abruptly before reaching apical hook; apex slightly rounded on ventral side with acutely pointed dorsal projection.

Abdominal segment x: About as broad as long with rounded posterior.

Female, larva, and host unknown.

Holotype male: Suakoko, Liberia, light trap, February 1952, Blickenstaff, USNM type no. 69566. Six paratype males, same data, 4 at USNM and 2 at CM. Also 3 fragmentary specimens at USNM probably this species.

Discussion: Although this species does not exactly conform in venation to stipulations in Bohart's (1951) revision of the Myrmecolichidae, all the other characters indicate its relationship, and it keys most closely to the *retrorsus* group established by Luna de Carvalho (1959).

Caenocholax bassa is much smaller (1 mm) than any other *Caenocholax*. With the exception of the big *C. goliath* Luna de Carvalho (2.2 mm), the other species in the *retrorsus* group average 1.5 mm. Disregarding size, it most closely resembles *C. horberlandti* (Luna de Carvalho) and *C. boharti* (Luna de Carvalho) but can be distinguished easily from either by the proportion of the antennal segments, particularly of flabellum III, and by the shaping of both the postlumbium and the metathoracic sclerites.

This species is named for one of the largest Liberian tribes, which lives southeast of Suakoko.

Caenocholax harleyi, new species

FIGURES 45-51

Male: Body dark brown, 1.1 mm long; median breadth of hindwing 1.2 mm; wingspread 2.9 mm; length of aedeagus 0.12 mm.

Head: With narrow, slightly convex vertex. Antennal segment IV extremely small and flabellum of segment III reaching middle of VI; segment VII slightly longer than VI. Mouthparts with slender mandibles that cross within buccal cavity and are about one-third longer than thick distal portion of maxillary palpus; proximal segment of maxillary palpus not clear. Palpus and antennal segments III-VII covered with minute hairs and sensoria. Eye with 4 large ocelli visible on inner rim from dorsal view.

Metathorax: With rounded anterior margin of prescutum extending slightly beyond tips of scuti and posterior margin not well defined; scutellum clearly separated, dome shaped; postlumbium broad and

semilunar; postscutellum slightly shorter than anterior metathoracic sclerites.

Hindwing: With 6 main veins and no intermedials; C and Sc basally coalesced; R strong; M_1 about one-fifth length of M_2 ; single anal.

Hindleg: Very stout femur and bell-shaped tibia of about same length; 4 tarsal subsegments with first much shorter than sum of terminal three.

Aedeagus: With bulbous base narrowing abruptly, rather than tapering, to apical tip with sharply pointed dorsal and ventral projections.

Abdominal segment x: Slightly longer than wide, with rounded tip.

Female, larva, and host unknown.

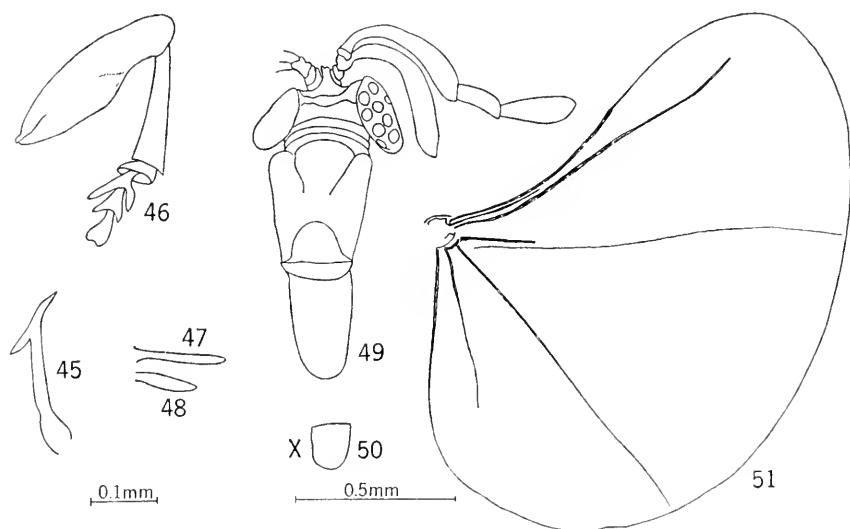

FIGURES 45-51.—*Caenocholax harleyi*, new species: 45, aedeagus, lateral view; 46, hindleg; 47, mandible; 48, distal segment of maxillary palpus; 49, body and antenna in dorsal aspect; 50, abdominal segment x; 51, right hindwing. (Figs. 45-48 use 0.1 mm scale.)

Holotype male: Suakoko, Liberia, light trap, February 1952, Blickenstaff, USNM type no. 69567.

Discussion: This species can be separated quickly from *C. bassa* by the shape of the aedeagus; further, the prescutum and scutellum are not so widely separated, the postlumbium is narrower, and the proportions of the mouthparts and antennal segments differ. Among the *retrorsus* group, *C. harleyi* most closely resembles *C. boharti* (Luna de Carvalho), but, apart from its much smaller size, antennal segments VI and VII are different in proportion, the inner margins of the apical tip of the aedeagus are slanted but not incurved, and the tibia of third leg has a very straight distal margin with one slight projection rather than being rounded.

This species is named in honor of the late Dr. George Harley, who gave over 30 years of dedicated service to Liberia as a medical missionary in Ganta.

Key to Males of Known Liberian Strepsiptera

(Detached vein is used in the same sense as inter-radio-medial vein of some authors)

1. Antenna 7-segmented with 3rd and 4th flabellate; tarsus with 5 segments and post-tarsal claws (Mengeidae). **Triozocera maxi**
Antenna 7-segmented with only 3rd flabellate; tarsus with 4 segments and no claws 2
2. Hindwing without detached veins (*Caenocholar*) 3
Hindwing with 1 or more detached veins (*Myrmecolax*) 4
3. Hindwing with 2 anal veins; aedeagus with prolonged bulbous base and sharp apical dorsal process; mandible sabre shaped. **Caenocholar bassa**
Hindwing with 1 anal vein; aedeagus narrow for most of its length and having acutely pointed dorsal and ventral processes at apex; mandible evenly tapered to tip **C. harleyi**
4. Hindwing with 7 main veins plus 2 detached veins. 5
Hindwing with 6 main veins plus either 1 or 2 detached veins. 6
5. Hindwing with M_1 less than one-half length of $M_2(2:5)$; aedeagus with acutely slanted apex, sharply pointed dorsal process, and slightly angular ventral projection; segment x tapered **Myrmecolax lunai**
Hindwing with M_1 more than one-half length of M_2 ; aedeagus narrow with dorsal apical process not acutely pointed; segment x rectangular. **M. parva**
6. Hindwing with single detached vein; flabellum of antennal segment III reaching one-third length of VII **M. blickenstaffi**
Hindwing with 2 detached veins; flabellum of antennal segment III just reaching tip of VI 7
7. Proximal third of aedeagus wide, distal two-thirds strongly tapered; tip of prescutum not reaching beyond anterior margins of scuti **M. kpelle**
Aedeagus slender, of nearly even width, slightly tapered; tip of prescutum reaching beyond anterior margins of scuti. 8
8. Apical tip of aedeagus with slender dorsal process sharply pointed and curved on inner margin, ventral process short and angular; R with furea. **M. mano**
Apical tip of aedeagus with dorsal process broad but pointed, ventral process rounded; R without furea **M. liberiensis**

References

BOHART, R. M.

1936. Preliminary study of the genus *Stylops* in California, pt. 1. Pan-Pacific Ent., vol. 12, no. 1, pp. 9-18.
1937. A preliminary study of the genus *Stylops* in California, pt. 2. Pan-Pacific Ent., vol. 13, no. 1, pp. 49-67.
1941. Revision of the Strepsiptera with special reference to the species of North America. Univ. California Publ. Ent., vol. 7, pp. 91-160.
1951. The Myrmecolicidae of the Philippines. Wasman Journ. Biol., vol. 9, no. 1, pp. 83-103.

- FOX, R. M., and FOX, J. W.
1964. A new genus and species of Stylopidae (Strepsiptera) from Liberia, West Africa. *Ann. Ent. Soc. America*, vol. 57, pp. 754-756.
- KOGAN, M., and OLIVEIRA, S. J.
1964. New Guinean Mengeidae and Myrmecolicidae (Strepsiptera). *Studia Ent.*, vol. 7, nos. 1-4, pp. 459-470.
- LUNA DE CARVALHO, E.
1956. *Primeria contribuição para o estudo dos Estrepsípteros angolenses.* Pub. Cult. Cia Diamant Angola, Lisbon, vol. 29, pp. 5-54.
1959. *Segunda contribuição para o estudo dos Estrepsípteros angolenses.* Pub. Cult. Cia Diamant Angola, Lisbon, vol. 41, pp. 125-154.
1961. Tabela para a determinação dos generos de Estrepsípteros (Insecta). *In* Garcia de Orta, *Revista d. Junta de Investigações do Ultramar*, vol. 9, no. 4, pp. 691-698.
- OLIVEIRA, S. J. DE, and KOGAN, M.
1959. A contribution to the knowledge of the Brazilian Strepsiptera (Insecta). *Mem. Inst. Oswaldo Cruz*, vol. 57, no. 2, pp. 219-223.
- PASTEELS, J.
1956. Enquêtes sur les Strepsiptères, 5. *Bull. Ann. Soc. Roy. Ent. Belge*, Brussels, vol. 92, pp. 109-119.
- PAULIAN, R.
1959. Recherches sur les insectes d'importance biologique à Madagascar. *Mem. Inst. Sci. Madagascar, Tananarive (E)*, vol. 11, pp. 1-16.
- PIERCE, W. D.
1909. A monographic revision of the twisted winged insects comprising the order Strepsiptera Kirby. *U.S. Nat. Mus. Bull.* 66, 232 pp.
1918. The comparative morphology of the order Strepsiptera together with records and descriptions of insects. *Proc. U.S. Nat. Mus.*, vol. 54, no. 2242, pp. 391-501.
- SAUNDERS, S. S.
1872. *Stylopidarum, ordinem Strepsiptorum Kirbii constituentium, mihi tamen potius Coleoptorum Familiae, Rhipidoridis Meloidisque propinqua*, Monographia. *Trans. Ent. Soc. London*, vol. 20, pp. 1-49.
- SILVESTRI, F.
1939. *Strepsipterorum species nova ex Congo Belgico.* *Bull. Mus. Roy. Hist. Nat. Belgique*, vol. 15, no. 8, pp. 1-4.
- WESTWOOD, J. O.
1858. Notice of the occurrence of a Strepsipterous insect . . . *Trans. Ent. Soc. London*, ser. 2, vol. 5, pp. 418-420.

Proceedings of
the United States
National Museum



SMITHSONIAN INSTITUTION • WASHINGTON, D.C.

Volume 124

1967

Number 3626

New Species of *Culicoides*
from High Altitudes in the Colombian Andes
(Diptera: Ceratopogonidae) ¹

By Willis W. Wirth and Vernon H. Lee ²

No previous accounts of *Culicoides* exist from the Andean highlands of Colombia; furthermore, until the present, only seven species of *Culicoides* have been known from all of Colombia (Forattini, 1957; Wirth and Blanton, 1959). In this paper, we are describing nine new species from that country, all collected in the high, cool elevations of the Andes Mountains. One of these species occurs in such numbers and attacks human beings so severely that it is a serious pest. Affinities of these species are of particular interest and will be noted under the individual species. Generally these species show many more similarities to the *Culicoides* occurring in the North and Central American Temperate Zone than to those known from the tropical lowlands of Colombia. In this connection, it is important to note that the genus is not known to occur in the temperate southern part of South America, and thus it must be concluded that the Andean fauna has been derived from the North American continent.

¹ These observations were made during studies on arboviruses in Colombia with support in part from the Universidad del Valle and the Rockefeller Foundation.

² Wirth: Entomology Research Division, Agricultural Research Service, U.S. Department of Agriculture, Washington, D.C.; Lee: staff member, Rockefeller Foundation, Ibadan, Nigeria.

In 1964 and 1965, the junior author had the opportunity to collect in three distinct sites in the western and central ranges of the Colombian Andes in climates considered temperate to subalpine.

One site was the Finca Carpentaria in the municipality of El Tambo, Department of Cauca, on the eastern slope of the western cordillera at an elevation of 2500 m. In this area, patches of temperate hardwood forest surrounded by grasslands covered the slopes and crests of the mountains. Collections of *Culicoides* were made in one patch of forest with the aid of light traps and a Shannon tent trap.

A second collecting site (pl. 2: top) was located in the central cordillera at Lago Buey (also known locally as Lago San Rafael), 15 km east of the town of Puracé, Department of Cauca, in what is referred to as the Paramo de Puracé. This site was near the edge of a shallow lake at one side of a paramo meadow at 3250 m. Only human bait collections were made in the open, wet, grassy meadow. Also near this site at 3320 m, 18 km east of Puracé, a light trap was operated in a small cluster of trees on the edge of the paramo meadow.

A third site (pl. 2: bottom) was located in the central cordillera near the Paramo de Puracé in an area that has a distinctly different ecology. There, 28.4 km east of Puracé at about 3150 m, an elevation somewhat lower than the paramo meadows, the site was a luxuriant subalpine forest abounding with mosses and epiphytes, including orchids and bromeliads. Collections were made here with human bait and by light traps.

In Chapman's (1917) outline of the life zones of the Colombian Andes, these collecting sites fall within the upper levels of the Subtropical Zone and the lower Temperate Zone. In Espinal's and Montenegro's (1963) outline of the plant formations of Colombia, based on the Holdridge world system of classification, these sites would be classified as "very humid low montane forest," "low montane rain forest," and "montane rain forest." We are much indebted to Sr. Espinal for his kindness in furnishing us an ecological description of the areas in which these collecting sites are located. From this account the following two paragraphs are abstracted.

West of the town of El Tambo, on the route from Popayan to Guapi, Department of Cauca, the terrain is, first, a series of undulating hills at an elevation of 2000 to 2500 m, where the original "very humid low montane forest" has been replaced by grasslands for cattle grazing. The average annual rainfall here is between 2500 and 3000 mm, and the average temperature between 15° and 17° C. Above 2500 m, the Cerro de Munchique of the western cordillera rises abruptly to a very rainy mountain region classified as "low montane rain forest" (average annual rainfall above 4000 mm), where the trees are covered with dense growth of mosses, lichens, and epiphytes.

The road crossing the central cordillera east of Popayan passes through the region known as the Paramo de Puracé. On the steep slopes, natural forest still remains; the trunks and branches, thickly covered with mosses, lichens, bromeliads, aroids, and vines, reflect the very humid conditions (average annual rainfall above 2000 mm and average temperature below 12° C) of the "montane rain forest." Common trees of these mountain slopes are *Weinmannia* (encenillo), *Clusia* (chagualo), and *Orepanax*. Cleared areas are covered with broad and long-leaved grasses such as *Chusquea* (chusque) and *Neurolepis*, mixed with *Blechnum* (bushy ferns) and *Espeletia* (frailejon), and boggy and marshy places are covered with mats and cushions of

TABLE 1.—Mean values of characters of high altitude Colombian Culicoides

Species	wing length (mm)	costal ratio	tibal spines	antennal ratio	antennal sensoria	palpal ratio	mandibular teeth	P/H ratio
Subg. <i>Avaritia</i>								
(Andicola Group)								
<i>andicola</i>	1.51	0.62	5	1.17	3, 11-15	2.7	15	1.00
<i>orjuelai</i>	1.52	0.63	5	1.27	3, 11-15	3.5	25	1.08
<i>puracensis</i>	1.33	0.62	5	1.15	3, 13-15	3.6	17	1.00
Subg. <i>Culicoides</i>								
(Covagarciai Group)								
<i>popayanensis</i>	2.16	0.68	6	0.86	3, 11-15	3.9	19	0.88
Subg. <i>Diphaomyia</i>								
<i>marinkellei</i>	1.61	0.58	4	0.87	3, 8-10	2.9	13	0.83
Subg. <i>Oecacta</i>								
<i>monticola</i>	1.31	0.57	4	0.95	3, 11-14	2.0	15	0.65
<i>andinus</i>	1.35	0.57	4	0.82	3, 13-15	2.3	11	0.60
<i>caucaensis</i>	1.83	0.65	4	0.99	3, 9-14	3.0	20	0.85
<i>tamboensis</i>	1.23	0.61	4	0.85	3, 11-14	2.0	11	0.75

Polytrichum moss and *Sphagnum*. In the meadows are bunches of the grass *Cortaderia* species and shrubby *Hypericum* and *Senecio*; in the ravines are *Gunnera* (hoyas de Pantano), lichens, and mosses.

Our terminology and classification follow essentially that presented by Wirth and Blanton (1959) in their paper on the *Culicoides* of Panama, to which the reader is referred for a fuller discussion. We recognize that the dipterous antenna is 3-segmented and that the "segmentation" of the flagellum is secondary, but, nevertheless, for convenience we prefer to use the term "segment" for all 15 divisions of the *Culicoides* antenna. The antennal ratio (table 1) is obtained by dividing the combined lengths of the distal five elongated segments by the combined lengths of the preceding eight. The palpal ratio is the length-

to-greatest-breadth ratio of the third segment. The P/H ratio is the value obtained by dividing the distance from the interocular seta base to the torva by the distance from the torva to the top of the labrum-epipharynx. Wing length is measured from the basal arculus to the wing tip; costal ratio is the value obtained by dividing the distance from the basal arculus to the end of the costa by the wing length. Measurements are of single specimens unless values are presented as mean value (minimum-maximum, n=number of measurements).

The types of our new species are deposited in the U.S. National Museum in Washington, D.C.; when available, paratypes will be deposited in the British Museum (Natural History) in London, in the Department of Preventive Medicine and Public Health of the Universidad el Valle in Cali, Colombia, in the Department of Parasitology and Tropical Medicine of the Universidad de Los Andes in Bogotá, Colombia, and in the Department of Hygiene and Public Health of the Universidade de São Paulo, Brazil.

Subgenus *Avaritia* Fox

Species of the subgenus *Avaritia* are characterized by a broad wing with short, broad radial cells, the tip of the second radial cell being at least slightly included in the poststigmatic pale spot; wing markings variable, often diffuse at least distally, cell M4 without pale area bordering veins M3+4 and Cu1; wing macrotrichia sparse or absent; third palpal segment usually slender, nearly always with a small, round distal sensory pit, the portion beyond the pit not narrowed; thorax unicolorous dark brown, scutum frequently with a pair of sublateral blackish areas or vittae; eyes contiguous, with or without interfacetal hairs; antennae usually with segments not greatly tapered distally, usually with sensorial pattern of III, IX-XV. Two spermathecae present plus a rudimentary third and a small sclerotized ring on the duct. Male genitalia variable; parameres separate, the bases not knobbed but with stout laterally directed process; aedeagus often with heavier sclerotization across the basal arch and with internal median sclerotized peg distally.

Andicola Group

This new group differs from the two previously known groups of American *Avaritia* as follows: from the Neotropical *Pusillus* Group the species differ in their much larger size, dark legs, broad radial cells, and longer costa, and in their geographical restriction to the temperate higher altitudes; from the Holarctic *Obsoletus* Group they differ in their hairy eyes, stronger radial venation, and darker wing infuscation.

In addition to the three Colombian species described below, this group is known to include an undescribed Costa Rican species that closely resembles *C. puracensis*, new species, in wing pattern, but differs in having the antennal sensorial pattern III, XI-XV, pale rings on each side of the dark knees, and the costa distinctly thickened proximad of the tip of vein R1.

***Culicoides andicola* Wirth and Lee, new species**

FIGURES 1a-c; PLATE 1 (FIG. 1)

FEMALE.—Length of wing 1.51 (1.30-1.58, n=8) mm.

Head: Eyes hairy, contiguous, meeting for a distance equal to the diameter of 2 facets. Antenna (fig. 1a) with lengths of flagellar segments in proportion of 18-13-14-14-15-15-15-16-21-23-25-31-46, antennal ratio 1.17 (1.13-1.23, n=6); XI-XV all stout to apices; distal sensory tufts present on segments III, XI-XV, sometimes also on VII and IX. Palpal segments (fig. 1b) with lengths in proportion of 7-27-26-10-17; third segment slightly swollen distally, 2.69 (2.5-2.9, n=8) times as long as greatest breadth, with a small, round, deep sensory pit. Proboscis moderately long, P/H ratio 1.0; mandible with 15 (14-17, n=14) teeth.

Thorax: Unicolorous dark brown. Legs pale brown, femora darker except distally on midfemur; knee spots dark brown on fore- and hind legs; tibiae paler proximad; hind tibial comb with 5 spines, the one nearest the spur longest.

Wing (pl. 1: fig. 1): Pattern as figured; with large, moderately distinct pale spots; large pale area over basal arculus; large pale area over r-m crossvein broadly extending from costal margin into pale area basally in cell M2; poststigmatic pale spot large and quadrate, covering distal half of second radial cell and touching vein M1; distal pale spot in cell R5 rounded with faint margins and not meeting wing margin or vein M1; small, oval, pale spot in base of cell M1 forming a double spot with distal extension of large pale areas filling cell M2 between medial and mediocubital forks; distal pale spot in cell M1 extending proximad as a sharp point to about middle of cell, the distal side of the spot not meeting wing margin but extending caudad and continuous with the small distal pale spot in cell M2; cell M4 with a large pale spot filling distal half of cell between vein M3+4 and wing margin; anal cell with pale base continuous with pale area over basal arculus, a broad subapical pale band continuous with pale area behind medial fork and extending broadly to posterior wing margin. Macrotrichiae very sparse and confined to distal fourth of wing; costa extending to 0.62 (0.59-0.63, n=8) of distance to wing tip; radial cells of subequal lengths, with distinct lumens, the second much broader. Halter pale.

Abdomen: Dark brown. Spermathecae (fig. 1c) 2 plus rudimentary spermatheca and ring; subequal, each measuring 0.047 x 0.036 mm; deeply sclerotized, ovoid, tapering to short sclerotized necks.

Male.—Unknown.

Types.—Holotype female: Lago Buey, Paramo de Puracé, Cauca, Colombia, 3250 m, Oct. 28, 1964, V. H. Lee, biting man, USNM type no. 69396. Paratypes, 20 females: 9 females, same data as type; 11 females, 28.4 km east of Puracé, 3100 m, Feb. 18, 1965, V. H. Lee, at light.

Remarks.—This is the most brightly marked of the three Andean species of *Avaritia*, and is distinguished easily from the others by the definite pointed distal pale spot in cell M1 and by the proximally pale tibiae. Structurally, *C. andicola* closely resembles *C. orjuelai*, new species, with sensorial pattern III, XI–XV, and wing length 1.51 mm, but differs from that species in its broader third palpal segment, lower antennal ratio, and fewer mandibular teeth.

Culicoides orjuelai Wirth and Lee, new species

FIGURES 1d–g; PLATE 1 (FIG. 2)

FEMALE.—Length of wing 1.52 (1.47–1.58, n=3) mm.

Head: Eyes hairy, contiguous (fig. 1d), meeting for a distance equal to the diameter of 2 facets. Antenna (fig. 1e) with lengths of flagellar segments in proportion of 17–12–12–12–13–13–15–15–22–22–26–29–42, antennal ratio 1.27 (1.25–1.28, n=3); XI–XV all stout to apices; distal sensory tufts present on III, XI–XV. Palpal segments (fig. 1f) with lengths in proportion of 6–29–22–12–13; third segment slightly swollen distally, 3.5 (2.8–4.6, n=3) times as long as greatest breadth, with small, round, shallow, distal sensory pit. Proboscis moderately long, P/H ratio 1.08; mandible with 25 (23–29, n=6) teeth.

Thorax: Unicolorous dark brown. Legs dark brown, tibiae without proximal pale rings; hind tibial comb with 5 spines, the one nearest the spur longest.

Wing (pl. 1: fig. 2): Pattern as figured; pale areas much reduced; a very faint pale area over basal arculus; a small pale spot centered on r-m crossvein, not extending anteriorly past radius; poststigmatic pale spot in cell R5 very small and oblique, transverse, including only distal fourth of second radial cell; a very faint indistinct pale area distally in anal cell. Macrotrichia very sparse and scattered on distal half of wing including some in cell M4; costa extending to 0.63 (0.62–0.65, n=3) of distance to wing tip; radial cells subequal in length, with distinct lumens, the second much broader. Halter pale.

Abdomen: Dark brown. Spermathecae (fig. 1g) 2 plus rudimentary spermatheca and ring; slightly unequal, measuring 0.055 x 0.036 mm

and 0.049 x 0.038 mm; ovoid, tapering to moderately long sclerotized necks.

MALE.—Unknown.

TYPES.—Holotype female: 18 km east of Puracé, 3320 m, Paramo de Puracé, Cauca, Colombia, Oct. 29, 1964, V. H. Lee, at light, USNM type no. 69397. Paratypes, 11 females: 1 female, Lago Buey, 3250 m, Oct. 28, 1964, V. H. Lee, biting man; 10 females, 28.4 km east of Puracé, 3100 m, Feb. 18, 1965, V. H. Lee, at light.

REMARKS.—This species is similar to *C. puracensis*, new species, but can be separated from it by the narrower poststigmatic pale spot,

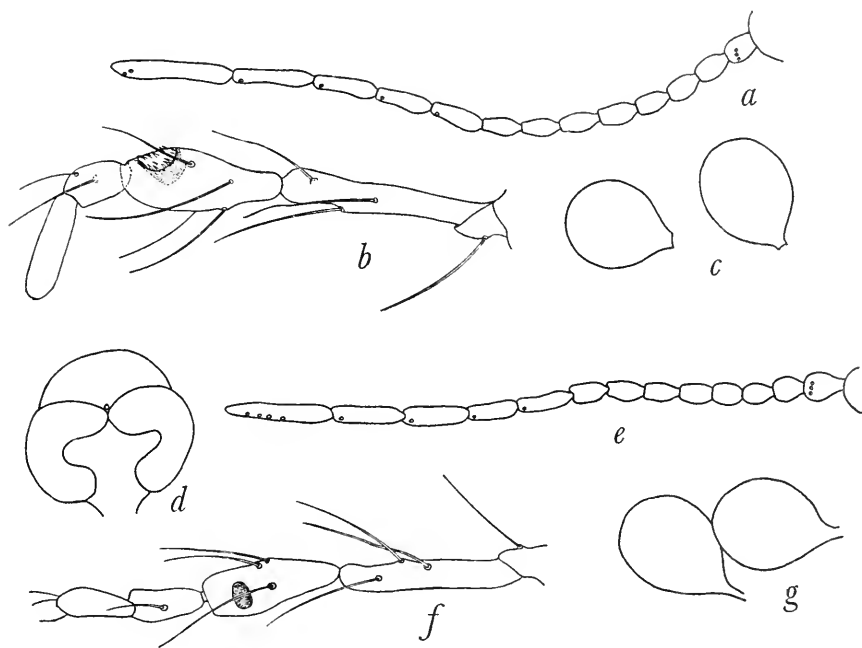

FIGURE 1.—*Culicoides andicicola*, new species, female: *a*, antenna; *b*, palpus; *c*, spermathecae. *Culicoides orjuelai*, new species, female: *d*, eye separation; *e*, antenna; *f*, palpus; *g*, spermathecae.

by the presence of sensoria on antennal segments XI and XII, and by the broader apex of XI.

We take pleasure in naming this species after Sr. Pablo A. Orjuela, in recognition of his many years of devotion to the tasks of field research in Colombia.

Culicoides puracensis Wirth and Lee, new species

FIGURE 2; PLATE 1 (FIG. 3)

FEMALE.—Length of wing 1.33 (1.22–1.40, n=14) mm.

Head: Eyes hairy, contiguous (fig. 2*b*), meeting for a distance equal to the diameter of 2 facets. Antenna (fig. 2*a*) with lengths of flagellar

segments in proportion of 16-11-12-13-13-13-13-14-17-18-22-27-39, antennal ratio 1.15 (1.09-1.19, $n=7$); XI with distinct preapical constriction; distal sensory tufts on segments III, XIII-XV, occasionally also on XII. Palpal segments (fig. 2c) with lengths in proportion of 7-24-26-13-14; third segment very slender, 3.6 (3.2-4.3, $n=16$) times as long as greatest breadth (4.3 in holotype), with a small, round, deep, distal sensory pit. Proboscis moderately long, P/H ratio 1.0; mandible with 17 (16-20, $n=28$) teeth.

Thorax: Unicolorous dark brown. Legs dark brown, tibiae without proximal pale rings; hind tibial comb with 5 spines, the one nearest the spur longest.

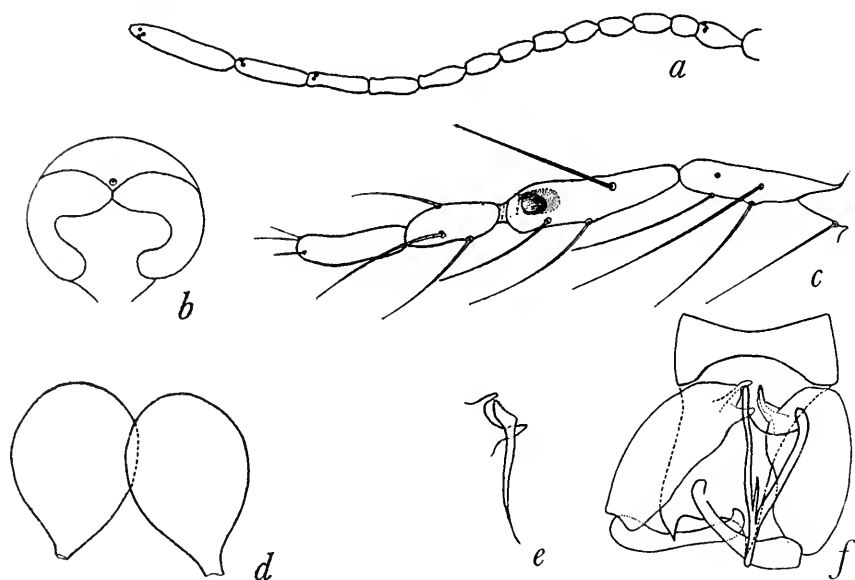

FIGURE 2.—*Culicoides puracensis*, new species, female (except as noted): a, antenna; b, eye separation; c, palpus; d, spermathecae; e, male paramere; f, male genitalia, parameres not shown.

Wing (pl. 1: fig. 3): Pattern as figured; 3 anterior pale spots, variable in size and intensity, a variable one over basal arculus, second over r-m crossvein and meeting costal margin broadly and media slightly (sometimes much reduced as in specimen figured); third or poststigmatic spot covering apex of second radial cell, broad and quadrate and extending caudad three-quarters way to vein M1; an indistinct pale area midway in cell M2 between medial and medio-cubital forks; pale spots absent in distal parts of cells R5 and M2, no pale spots in cell M1; a moderately large, fairly distinct pale spot distally in cell M4 and a slightly smaller pale spot distally in anal cell near mediocubital stem in anterior half of cell. Macrotrichia very

sparse along wing margins in distal portions of cells R5, M1, and M2; costa extending to 0.62 (0.59–0.70, $n=14$) of distance to wing tip, radial cells of subequal lengths, with distinct lumens, the second much broader. Halter pale.

Abdomen: Dark brown. Spermathecae (fig. 2*d*) 2 plus rudimentary spermatheca and ring; slightly unequal, measuring 0.067 x 0.048 mm, and 0.062 x 0.046 mm, deeply sclerotized, ovoid, tapering to short sclerotized necks.

MALE.—As in the female with the usual sexual differences; wing length 1.37 mm; costal ratio 0.62; palpal ratio 2.9. Genitalia as figured (fig. 2*e-f*): Ninth sternum with broad, shallow, caudomedian excavation, the ventral membrane bare; ninth tergum elongate, tapered distally, with short, pointed, apicolateral processes. Aedeagus with very low basal arch, sides nearly straight and tapering to elongate, slender distal stem; internal, subapical, sclerotized point present. Parameres each (fig. 2*e*) with short, stout anterolateral process, midportion slender and nearly straight, tapering to slender, filamentous tip.

TYPES.—Holotype female: Lago Buey, 3250 m, Paramo de Puracé, Cauca, Colombia, Feb. 18, 1965, V. H. Lee, biting man, USNM, type no. 69398. Allotype male: 28.4 km east of Puracé, 3100 m, Feb. 18, 1965, V. H. Lee, at light. Paratypes, 87 females on slides, 500 females in alcohol: 8 females, same data as holotype; 11 females on slides, 250 in alcohol, same data as allotype; 250 females in alcohol, same data as allotype but biting man, Feb. 17, 1965; 68 females, 18 km east of Puracé, 3320 m, Oct. 29, 1964, V. H. Lee, at light.

REMARKS.—This species resembles *C. orjuelai*, new species, in wing markings, but the pale spot over r-m crossvein is variable in size and the poststigmatic pale spot is broader and involves less of the second radial cell, the spermathecae are larger and more unequal, and the antennae differ, having the sensorial pattern III, XIII–XV and the distal constriction of XI. This is by far the commonest of the Paramo species, and the numbers taken in the biting collections attest to its annoyance to human beings.

Subgenus *Culicoides* Latreille

Species of the subgenus *Culicoides* are most numerous in the North Temperate Zone, especially in the colder north latitudes under subarctic conditions. They do occur down the western cordilleras of North America through Central America at higher elevations, i.e., *C. luteovenus* Root and Hoffman and *C. elutus* Macfie. In Central America a characteristic group has evolved, the Covargarciyai Group.

Most species of the subgenus *Culicoides* are large blackish species with prominent wing pattern that includes a pale spot at the tip of the

second radial cell, antennal sensoria usually on segments III, XI-XV, the hind tibial comb with 5-6 spines, and 2 well-developed spermathecae present.

Covagarciai Group

This group consists of large- to medium-sized species with legs yellow or with the knees broadly yellow banded; scutum yellowish to brown, subshining; base of cell M4 dark at the base of the medio-cubital fork, and apices of veins M1, M2, M3+4 and Cu1 always dark; eyes contiguous, bare; male genitalia with basistyles mesally spinose, apicolateral processes of the ninth tergum developed to varying degrees, and variable development of lobes or a cleft on the caudal margin between them. There are five previously described species found in Central America and northern South America.

Culicoides popayanensis Wirth and Lee, new species

FIGURE 3; PLATE 1 (FIG. 4)

FEMALE.—Length of wing 2.16 (1.90-2.43, $n=14$) mm.

Head: Eyes (fig. 3*b*) bare, contiguous for a distance equal at least to the diameter of 3 facets. Antenna (fig. 3*a*) with lengths of flagellar segments in proportion of 32-28-30-31-33-30-28-28-30-34-40-46-68, antennal ratio 0.86 (0.82-0.91, $n=3$); distal sensory tufts present on segments III, XI-XV, 5-7 sensoria on distal half of xv; antenna brownish III-X with extreme bases of segments pale. Palpal segments (fig. 3*c*) with lengths in proportion of 12-32-40-19-19; third segment moderately swollen in midportion 3.9 (3.6-4.5, $n=14$) times as long as greatest breadth, with an open irregular pit subapically. Proboscis moderately long, P/H ratio 0.88; mandible with 19 (16-21, $n=28$) teeth.

Thorax: Brown, scutum with a submedian pair of large yellowish-brown patches on discal area. Legs brown; knees and distal fourth of femora yellow, narrow base of foretibia and approximately basal halves of mid- and hind tibiae yellow, hind tibia with broad apex pale; hind tibial comb (fig. 3*e*) with 6 spines, the second from the spur longest.

Wing (pl. 1: fig. 4): Pattern as figured; pale spots extensive with a yellowish tint; anterior margin with 3 very dark areas; wing base pale for a distance of approximately one-third the length of medial stem; broad yellowish pale spot over r-m crossvein, broadly meeting costal margin and extending narrowly into cell M2; poststigmatic pale spot involving distal two-thirds of second radial cell, extending distally only slightly past it into cell R5, barely touching vein M1 posteriorly, branches of media and cubitus with apices dark at wing margin; a moderately large pale area straddling vein M2 just proximad

of midlength, but the vein itself continuing as a dark line through this spot; cell M1 with 1 distal pale spot, located at about its length from wing margin; cell M2 with a large pale area lying between medial and mediocubital forks, a large rounded distal pale spot attaining wing margin; no pale area in base of mediocubital fork, a large rounded pale spot distally in cell M4, broadly meeting wing margin but not touching vein M3+4; a large transverse, double pale spot distally in anal cell, the posterior portion sometimes very faint. Macrotrichia moderately sparse on distal third of wing and continued proximally in cell M2 and nearly to base of anal cell; costa

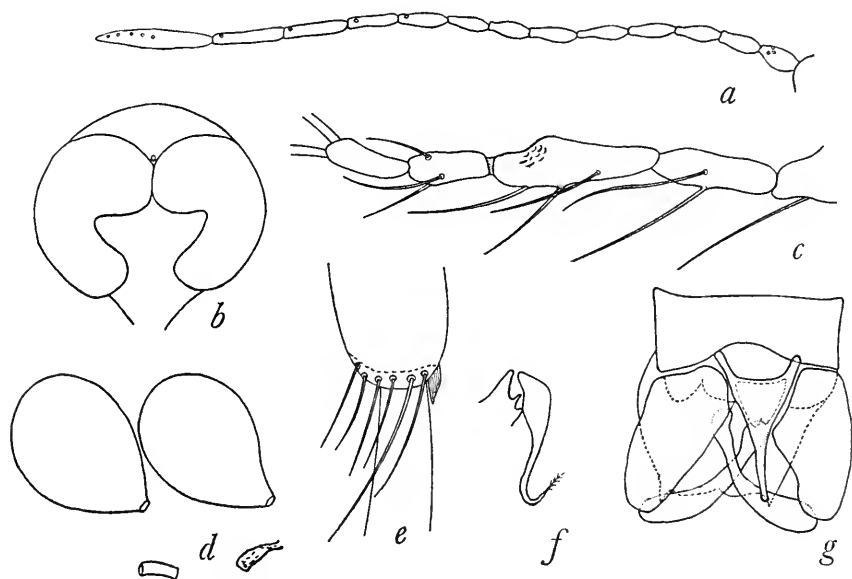

FIGURE 3.—*Culicoides popayanensis*, new species, female (except as noted): *a*, antenna; *b*, eye separation; *c*, palpus; *d*, spermathecae; *e*, hind tibial comb; *f*, male paramere; *g*, male genitalia, parameres not shown.

extending to 0.68 (0.65–0.71, $n=14$) of distance to wing tip; radial cells with distinct lumens, the second broader and about twice as long as first. Halter pale.

Abdomen: Dark brown. Spermathecae (fig. 3*d*) 2 plus a rudimentary third and a long sclerotized ring; subequal, each measuring 0.065 x 0.046 mm, ovoid, tapering gradually to variable, short, sclerotized necks.

MALE.—Similar to the female with the usual sexual differences; wing length 2.07 mm; antennal plume sparse, last 3 antennal segments with lengths in proportion of 75–72–70. Genitalia (figs. 3*f*, *g*)

as figured; ninth tergum rounded caudad, indistinctly bilobed, apico-lateral processes short and moderately prominent, widely separated; ninth sternum with very slight caudomedian excavation, the ventral membrane not spiculate; basistyle moderately stout, mesal margin with numerous small but moderately prominent setae, ventral and dorsal roots short and blunt; dististyle long and curved with a stout rounded tip. Aedeagus with very low basal arch, midportion broad a short distance, then tapered gradually to a long slender distal stem with a small ball-like tip. Parameres separate, each (fig. 3f) with a short, stout anterolateral process, midportion swollen a short distance, tapered distally to a long, slender filament bearing minute hairs distally.

TYPES.—Holotype female, allotype male: 28.4 km east of Puracé, 3100 m, Cauca, Colombia, V. H. Lee, at light, USNM type no. 69399. Paratypes, 2 males, 70 females: same data as types.

REMARKS.—This species belongs to the Covagarciai Group of the subgenus *Culicoides*, with knees broadly yellow banded, and it is most like *C. marshi* Wirth and Blanton. It differs from the latter, however, in its larger size, slenderer legs with 6 tibial spines, more gradually tapering spermathecae, less extensive pale wing spots, with vein M2 forming a dark line through the pale spot straddling vein M2. The genitalia of a male of *C. marshi* (not previously described) from Rio Raposo, Colombia, differ from those of *C. popayanensis* in their well-developed submedian lobes on the ninth tergum similar to those of *C. metagonatus* Wirth and Blanton (figured in Wirth and Blanton, 1959, p. 306).

Subgenus *Diphaomyia* Vargas

Species with the second radial cell dark to tip; wing pattern with small, definite pale spots, the pale spot at r-m crossvein often lying entirely distad of crossvein, vein M1 often with pale spots lying adjacent anteriorly in cell R5, veins M1 and M2 often with pale spots straddling them or lying adjacent to the vein, pale spot in cell M4 usually extending along vein M3+4; 2 spermathecae plus rudimentary third and small sclerotized ring; spermathecae oval in shape with long slender necks; male genitalia with pair of characteristic posterior sclerotized processes on posterolateral "shoulder" of aedeagus; parameres with basal knob and distal portion with lateral fringing barbs.

In Wirth and Blanton (1959), the three previously known Neotropical species, *C. blantoni* Vargas and Wirth, *C. evansi* Wirth and Blanton, and *C. iriartei* Fox, were placed in the Iriartei Group of the subgenus *Oecacta*. These species can be placed conveniently in Vargas' (1960) subgenus *Diphaomyia*, with type species *C. baueri* Hoffman.

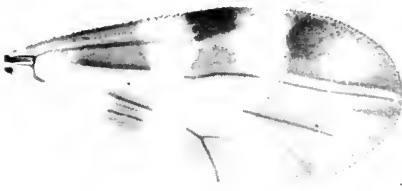

1

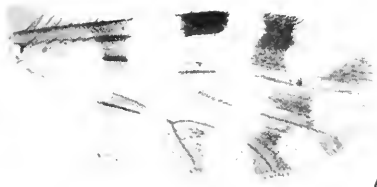

6

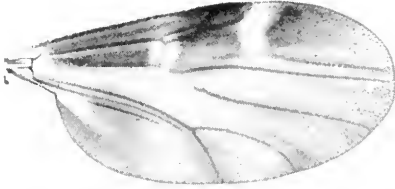

2

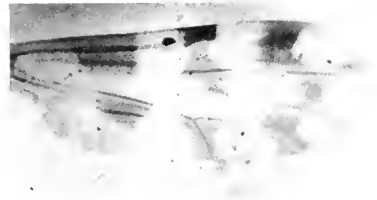

7

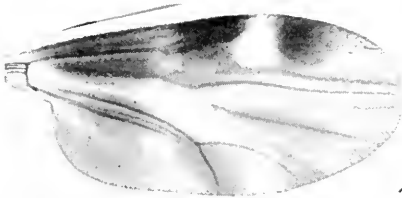

3

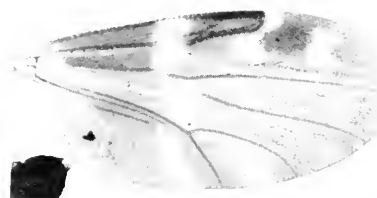

8

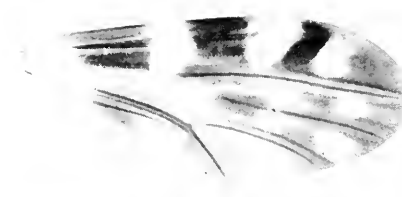

4

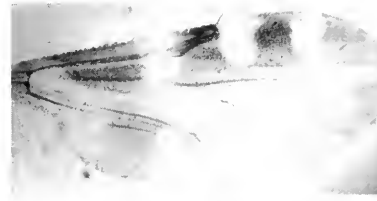

9

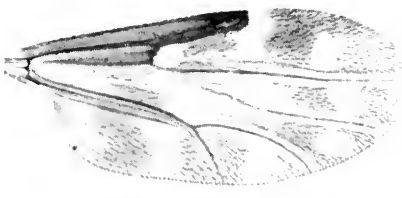

5

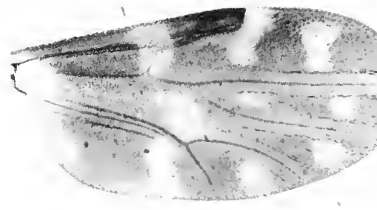

10

FIGURES 1-10.—Wings of *Culicoides*, new species (magnifications not to same scale): 1, *andicola*; 2, *orjuelai*; 3, *puracensis*; 4, *p. payanensis*; 5, *marinkellei*; 6, *monticola*; 7, *andinus*; 8, *caucaensis*; 9, *tamboensis*, male; 10, same, female.



Top: A paramo meadow at Paramo de Puracé, Colombia, sloping gradually to Lago Bucy at 3250 meters elevation (site 2, photo by V. H. Lee). Bottom: Margin of a paramo meadow with frailejon plants (*Espeletia* sp.) prominent in the foreground at about 3000 meters. A slope with a thick forest of low trees and brush is in the right background, the ground covered with a deep litter of branches, vines, mosses, etc. (site 3, photo by M. Kuns).

The species described below is probably more closely allied to the North American *C. haematopodus* Malloch and *C. baueri* Hoffman than to the other three Neotropical species.

Culicoides marinkellei Wirth and Lee, new species

FIGURE 4; PLATE 1 (FIG. 5)

FEMALE.—Length of wing 1.61 (1.55–1.70, $n=13$) mm.

Head: Eyes bare, broadly separated (fig. 4*b*), the interocular space with a long seta. Antenna (fig. 4*a*) with lengths of flagellar segments in proportion of 18–14–16–18–18–17–17–16–18–18–21–23–38, antennal ratio 0.87 (0.82–0.91, $n=7$); distal sensory tufts present on segments

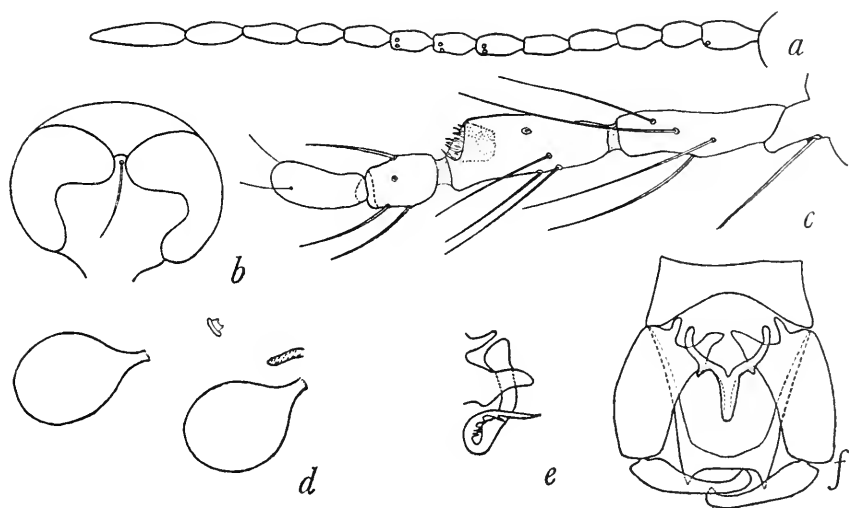

FIGURE 4.—*Culicoides marinkellei*, new species, female (except as noted): *a*, antenna; *b*, eye separation; *c*, palpus; *d*, spermathecae; *e*, male paramere; *f*, male genitalia, parameres not shown.

III, VIII–X, rarely also on VII. Palpal segments (fig. 4*c*) with lengths in proportion of 9–23–25–12–14; third segment slightly swollen distally, 2.9 (2.5–3.2, $n=13$) times as long as greatest breadth, with a small, round, deep, apical sensory pit. Proboscis short, P/H ratio 0.83; mandible with 13 (12–15, $n=25$) teeth.

Thorax: Dark brown; scutal pattern not discernible in slide-mounted specimens. Legs dark brown, knee spots blackish, tibiae with narrow sub-basal pale rings; hind tibial comb with 4 spines, the second from the spur longest.

Wing (pl. 1: fig. 5): Pattern as figured; second radial cell dark to tip; membrane very deeply infuscated and pale spots small and

definite; small pale spot lying just distad of r-m crossvein, the crossvein dark; a small transverse poststigmatic pale spot not attaining vein M1 posteriorly; 1 small transverse pale spot in middle of distal portion of cell R5, not meeting wing margin or vein M1; 2 pale spots in cell M1, the proximal one touching vein M2 posteriorly, the distal one lying far from wing margin; 2 separate pale spots in proximal portion of cell M2, one of which lies behind medial fork, the other just in front of mediocubital fork; only 1 pale spot in distal portion of cell M2, lying near but not meeting wing margin; cell M4 with a round pale spot with an anteroproximal extension a short distance along vein M3+4; anal cell with an indistinct pale spot in anal angle and a large, transverse double pale spot in distal portion. Macrotrichia coarse and numerous distad of r-m crossvein and over all of anal cell; costa extending to 0.58 (0.57–0.59, n=13) of distance to wing tip; radial cells narrow, the first slitlike and longer than the second. Halter infuscated, the flat end of the knob pale.

Abdomen: Dark brown. Spermathecae (fig. 4*d*) 2 plus a rudimentary third and a peculiarly shaped, flangelike, sclerotized ring; moderately sclerotized, subequal, each measuring 0.053 x 0.035 mm, oval with a long, slender, sclerotized neck.

MALE.—Similar to the female, with the usual sexual differences; wing 1.53 mm long; antennal segments with lengths in proportion of 38–14–14–14–14–14–14–14–17–52–42–46; distal sensory tufts on segments III, VIII–XII. Genitalia (figs. 4*e,f*) as figured: Ninth sternum with broad, moderately deep caudomedian excavation, the ventral membrane not spiculate; ninth tergum long and tapering, apicolateral processes short and angular, the caudal between them nearly straight. Basistyle slender, dorsal root foot-shaped with relatively short “toe” and “heel,” ventral root slender; dististyle slightly curved, slender, with bent, pointed tip. Aedeagus with short, broad, rounded, basal arch extending to less than half of total length; “shoulders” each with a short posterior sclerotized process typical of *Diphaomyia*; distal stem parallel sided with bluntly rounded tip. Parameres each (fig. 4*e*) with blackish basal knob, midportion slender and slightly curved with a low ventral lobe distally; distal portion much slenderer, tapering distally to terminal filament and bearing a lateral fringe of 5–6 coarse barbs.

TYPES.—Holotype female: Lago Buey, 3250 m, Paramo de Puracé, Cauca, Colombia, Oct. 28, 1964, V. H. Lee, biting man, USNM type no. 69400. Allotype male: 18 km east of Puracé, 3320 m, Oct. 29, 1964, V. H. Lee, at light. Paratypes, 63 females: 61, same data as holotype; 2, same data as allotype.

REMARKS.—This species is distinguished readily by its wing pattern of definite small pale spots on a very dark ground, with the pale spot

at the r-m crossvein lying entirely distal of the crossvein. Its closest Neotropical relative is *C. iriartei* Fox, a lowland species that has similar male genitalia but within which the wing pattern is much different, with the pale spot centered over the r-m crossvein and a double pale spot distally in cell R5. The North American *C. baueri* Hoffman and *C. haematopotus* Malloch have very similar male genitalia, but these also differ greatly in wing pattern.

We are very pleased to name this species in honor of Dr. C. J. Marinkelle, parasitologist at the Universidad de los Andes in Bogota, Colombia, in recognition of his keen interest in Colombian haematophagous Diptera.

Subgenus *Oeacta* Poey

As it stands, this subgenus is a heterogeneous assemblage of species groups that cannot yet be assigned definitely to the existing subgenera in which the second radial cell is dark to the apex. In the strict sense, this subgenus should be restricted to those species resembling the type species, *C. furens* (Poey), with two well-developed spermathecae, a rudimentary third and a ring; antennal sensoria on segments III, VIII-X, or similar pattern, none on XI-XV; and male genitalia with long apicolateral processes on the ninth tergum, and a strong basal knob and subapical fringing spines on the parameres.

Culicoides monticola Wirth and Lee, new species

FIGURES 5a-d; PLATE 1 (FIG. 6)

FEMALE.—Length of wing 1.31 (1.23–1.39, n=7) mm.

Head: Eyes bare, narrowly separated (fig. 5a), interocular space above with a seta-less tubercle. Antenna (fig. 5b) with lengths of flagellar segments in proportion of 18–15–16–17–17–16–16–16–20–21–25–25–34, antennal ratio 0.95 (0.93–0.98, n=3); distal sensory tufts present on segments III, XI–XIV; III–X prominently bicolored, the narrow apices dark, XI–XV all dark. Palpal segments (fig. 5d) with lengths in proportion of 11–18–24–8–12; third segment distinctly swollen, 2.0 (1.8–2.3, n=8) times as long as greatest breadth, with a moderately large, deep, round sensory pit opening by a smaller pore. Proboscis short, P/H ratio 0.65; mandible with 15 (13–16, n=11) teeth.

Thorax: Brownish, scutum with prominent markings of large yellowish areas. Legs dark brown with very prominent markings; knee spots blackish, all femora with subapical and all tibiae with sub-basal, narrow pale rings, hind tibia with distal half pale; hind tibial comb with 4 spines, the one nearest the spur longest.

Wing (pl. 1: fig. 6): Pattern as figured; with very prominent pattern of large pale spots coalescing transversely to form 5 irregular pale

bands across wing; second radial cell very dark to tip; base of wing pale to level slightly past one-half the distance from basal arculus to r-m crossvein; large spot over crossvein forming a pale band extending to mediocubital fork; poststigmatic pale spot broader than the dark spot distal to it, continued posteriorly as a pale band continuous with pale distal area in cell M4, the portion in cells M1 and M2 slightly displaced distad of anterior and posterior ends; apex of wing with 3 large separate pale spots, the one in cell R5 broadly meeting wing margin anterodistally, the extreme posterodistal corner of cell R5 dark;



FIGURE 5.—*Culicoides monticola*, new species, female: *a*, eye separation; *b*, antenna; *c*, spermathecae; *d*, palpus. *Culicoides andinus*, new species, male: *e*, palpus; *f*, paramere; *g*, genitalia, parameres not shown.

an elongate, oval, pale spot distally in cell M1, not quite meeting wing margin; a rounded pale spot filling apex of cell M2; 2 separate pale spots in distal part of anal cell; no pale spots at apices of veins M1, M2, M3+4, or Cu1. Macrotrichia numerous distad of a line between end of costa and base of mediocubital fork, forming a double row to base of cell M2, and scattered in anal cell; costa extending to 0.57 (0.57–0.58, $n=7$); second radial cell much shorter than the first, with broad lumen, the first slitlike. Halter pale.

Abdomen: Dark brown. Spermathecae (fig. 5*c*) 2 plus a rudimentary third and a sclerotized ring; unequal in size, measuring 0.065 x 0.043

mm and 0.061 x 0.050 mm, slightly ovoid, with long, slender, sclerotized necks.

MALE.—Unknown.

TYPES.—Holotype female: Finca Carpentaria, El Tambo, Cauca, Colombia, 2500 m, July 8, 1964, V. H. Lee, tent trap, USNM type no. 69401. Paratypes, 6 females: 4, same data as type; 2, same data except July 9, 1964, in light trap.

REMARKS.—This species and the next (for their separation see the discussion of *C. andinus*) are closely related to each other, but are not closely related to any other known Neotropical species, probably coming closest to the Limai Group. The wing pattern of large pale spots centered in the cells forming 4 or more less complete transverse pale bands across the wing is similar to that of the North American *C. crepuscularis* Malloch and other species of the subgenus *Beltranmyia* Vargas, which, however, have only 1 spermatheca and differ in many other characters.

Culicoides andinus Wirth and Lee, new species

FIGURES 5e-g; PLATE 1 (FIG. 7)

FEMALE.—Length of wing 1.35 mm.

Head: Eyes bare; nearly contiguous, with a wedge-shaped interocular space bearing a seta-less tubercle above. Antenna with lengths of flagellar segments in proportion of 19-16-17-17-17-16-16-16-18-19-22-22-29, antennal ratio 0.82; distal sensory tufts present on segments III, XIII-XV; segments III-X bicolored but the narrow, dark apices not as prominent as in *C. monticola*. Palpal segments with lengths in proportion of 7-22-23-7-9; third segment short and only moderately swollen, 2.3 times as long as greatest breadth, with a small, round, shallow sensory pit. Proboscis short, P/H ratio 0.60; mandible with 11-12 teeth.

Thorax: Dark brown; scutum without prominent pattern. Legs brownish, knee spots blackish; femora with narrow, subapical pale rings, faint on hind leg; tibiae with narrow, sub-basal pale rings, hind tibia dark distally; hind tibial comb with 4 spines, the 2 nearest the spur longer, subequal in length.

Wing: Pattern nearly as in *C. monticola*; the 2 middle sets of pale spots not coalesced in complete bands; second radial cell dark to tip; pale area over base of wing extending to one-half the distance between basal arculus and r-m crossvein; pale spot over r-m crossvein large and quadrate, extending only slightly into cell M2; poststigmatic pale spot in cell R5 quadrate, not meeting vein M1; distal pale spot in cell R5 large, broadly meeting anterior wing margin, leaving apical corner of cell dark; cell M1 with 2 elongate, oval pale spots, the

proximal one longer; cell M2 with large pale area between medial and mediocubital forks broadly separated from pale basal area of wing continued distally as a narrow streak to level of pale spot in cell M4, a small round pale spot at apex of cell not quite meeting wing margin; cell M4 with large, round pale spot nearly filling distal portion of cell; anal cell with 1 large pale spot in distal portion; apices of veins M1 and M2 faintly pale at wing margin. Macrotrichia numerous on distal portion of wing, continued proximally through anal cell and in a double row to base of cell M2; costa extending to 0.57 of distance to wing tip; radial cells with distinct lumens, the second much broader and slightly shorter than the first. Halter infuscated.

Abdomen: Dark brown. Spermathecae 2 plus a rudimentary third and a ring; subequal, each measuring 0.065 x 0.040 mm, slightly ovoid with long, slender, sclerotized necks.

MALE.—Similar to the female, with the usual sexual differences. Wing length 1.33 mm; costal ratio 0.55; distal 5 antennal segments with lengths in proportion of 13-17-48-37-29; palpal segments (fig. 5e) with lengths in proportion of 6-15-19-8-13; pale wing pattern (pl. 1: fig. 7) more extensive than in female, the pale spots coalescing on disc of wing to form 2 complete middle transverse bands, pale spots at apices of veins M1 and M2 conspicuous. Genitalia (figs. 5f, g): Ninth sternum without caudomedian excavation, the ventral membrane not spiculate; ninth tergum long and tapering, the apicolateral processes long and slender, the caudal margin between them transverse. Basistyle long and slender, ventral root "foot-shaped," dorsal root slender; dististyle slender with distally bent tip. Aedeagus with high basal arch extending to over one-half of total length, the ventral arms nearly straight, forming with the tapering distal stem a V-shaped structure, stem slender distally with a pair of very faintly sclerotized subapical points. Parameres each (fig. 5f) with strong basal knob, midportion slender, slightly sinuate, without ventral lobe, distally narrowed and curved ventrad with a subapical fringe of 3-4 fine barbs.

TYPES.—Holotype female, allotype male: Finca Carpentaria, El Tambo, Cauca, Colombia, 2500 m, July 9, 1964, V. H. Lee, light trap USNM, type no. 69402. Paratypes: 1 female, 18 km east of Puracé, 3320 m, Oct. 29, 1964, V. H. Lee, at light; 1 male, 28.4 km east of Puracé, 3100 m, Feb. 18, 1965, V. H. Lee, at light.

REMARKS.—This species is very closely related to *C. monticola* but can be distinguished readily by its reduced, pale wing markings, with only 1 pale spot distally in anal cell, the palpal pit shallower with pore not narrowed, sensorial pattern III, XIII-XV, dark halter, and dark apices of hind femur and tibia.

Culicoides caucaensis Wirth and Lee, new species

FIGURES 6a-d; PLATE 1 (FIG. 8)

FEMALE.—Length of wing 1.83 (1.69–1.92, n=4) mm.

Head: Eyes with very short interfacetal hairs; very narrowly separated (fig. 6b), interocular space above with a seta-less tubercle.

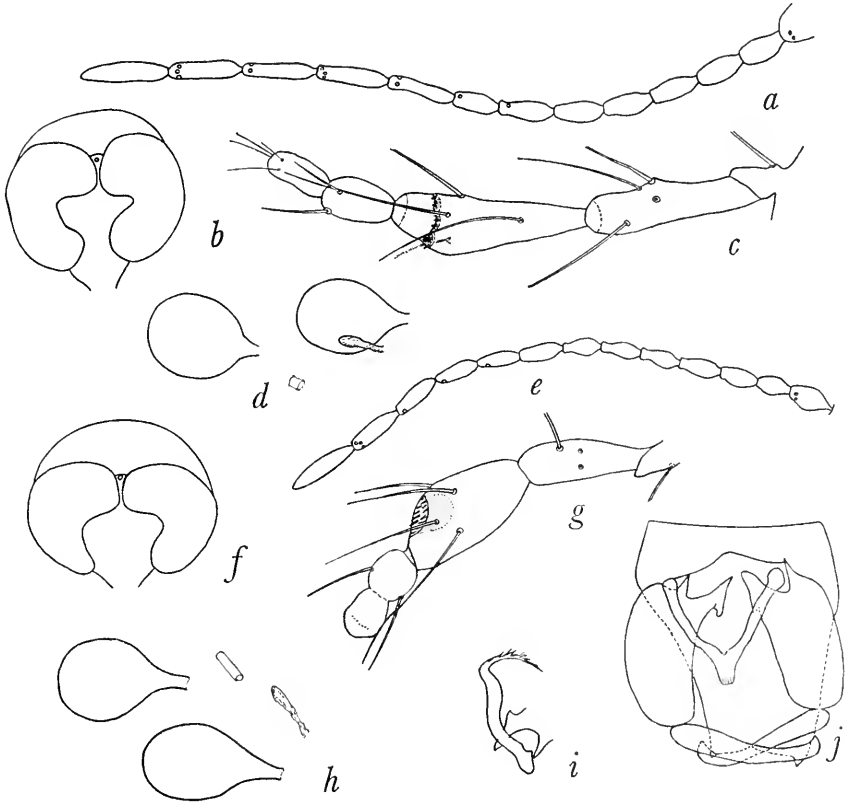

FIGURE 6.—*Culicoides caucaensis*, new species, female: a, antenna; b, eye separation; c, spermathecae; d, palpus. *Culicoides tamboensis*, new species, female (except as noted): e, antenna; f, eye separation; g, palpus; h, spermathecae; i, male paramere; j, male genitalia, parameres not shown.

Antenna (fig. 6a) with lengths of flagellar segments in proportion of 21–17–18–19–19–20–21–18–27–30–30–30–37, antennal ratio 0.99; distal sensory tufts present on segments III, IX–XIV. Palpal segments (fig. 6d) with lengths in proportion of 9–26–29–10–10; third segment moderately swollen distally, 3.0 (2.8–3.2, n=4) times as long as greatest breadth, with a broad, irregular sensory pore distally. Proboscis

moderately long, P/H ratio 0.85; mandible with 20 (18–22, $n=8$) teeth.

Thorax: Brown; scutum without discernible pattern in slide-mounted specimens. Legs brownish, hind tibia with narrow, sub-basal pale ring; hind tibial comb with 4 spines, the one nearest the spur longest.

Wing (pl. 1: fig. 8): Pattern as figured; very deeply brownish infuscated, with only moderately distinct pattern of pale spots: a small one lying just distad of basal arculus; a pale spot lying over r-m crossvein, broadly meeting costal margin and extending caudad to media; cell R5 with 2 small separate poststigmatic pale spots lying obliquely to each other, the one on anterior with margin smaller, the other lying slightly proximad of end of costa; distal pale spot in cell R5 transverse, slightly concave distally, not meeting anterior wing margin or vein M1; 1 very faint pale spot, sometimes absent, in distal portion of cell M1, a very faint one, sometimes absent in distal portion of cell M2, the latter proximally with a double pale spot lying between medial and mediocubital forks; cell M4 with very indistinct pale spot in distal portion; anal cell with 2 very indistinct pale spots in distal portion. Macrotrichia moderately numerous, confined to area distad of a line between end of costa and base of mediocubital fork, plus a few in anal cell; costa extending to 0.65 (0.60–0.67, $n=4$) of distance to wing tip; radial cells subequal in length, with distinct lumens, the second broader. Halter infuscated.

Abdomen: Dark brown. Spermathecae (fig. 6c) 2 plus a rudimentary third and a sclerotized ring; slightly unequal, measuring 0.049 x 0.030 mm and 0.045 x 0.030 mm, oval with moderately long, slender necks.

MALE.—Unknown.

TYPES.—Holotype female: 28.4 km east of Puracé, 3100 m, Cauca, Colombia, Oct. 29, 1964, V. H. Lee, at light, USNM type no. 69403. Paratypes, 5 females: same data except 2 with date "18 Feb. 1965."

REMARKS.—This species resembles species of the Transferrans Group in general features but differs in the possession of 2 spermathecae. Its exact systematic affinities, therefore, remain in doubt. Superficially it is very similar to *C. puracensis* and *C. orjuelai* in the subgenus *Avaritia*, but its palpal structure, eye separation, spermatheca shape, and number of tibial spines readily distinguish it from members of that group.

Culicoides tamboensis Wirth and Lee, new species

FIGURES 6e–j; PLATE 1 (FIG. 9–10)

FEMALE.—Length of wing 1.23 mm.

Head: Eyes hairy, very narrowly separated (fig. 6f), the interocular space with a seta-less tubercle. Antenna (fig. 6e) with lengths of

flagellar segments in proportion of 17-14-16-17-17-17-17-19-19-21-22-31, antennal ratio 0.85; distal sensory tufts present on segments III, XI-XIV, 4 sensoria on XIV. Palpal segments (fig. 6g) with lengths in proportion of 7-19-22-8-6; third segment short and swollen, 2.0 times as long as greatest breadth, with a small, deep sensory pit. Proboscis short, P/H ratio only 0.75; mandible with 11 teeth.

Thorax: Brown; scutum with moderately distinct pattern, which in slide-mounted specimen appears to include many small brown punctures around the seta bases; scutellum yellowish on slides. Legs pale brown; blackish knee spots present on all legs; fore- and midfemora with narrow subapical pale rings, all tibiae with narrow sub-basal pale rings and hind tibia with apex pale; hind tibial comb with 4 spines, the one nearest the spur longest.

Wing (pl. 1: fig. 10): Pattern as figured; second radial cell dark to apex; with moderately distinct pale spots as follows: a moderately large pale area just distad of basal arculus; a somewhat transverse pale spot centered on r-m crossvein and extending from costa to media; a single oblique poststigmatic pale spot extending posteriorly only three-quarters the breadth of cell R5; a transverse subapical pale spot in cell R5 reaching neither anterior nor posterior cell margins; 2 small pale spots in cell M1, the distal one much distant from wing tip; cell M2 with a distinct double pale area lying between medial and mediocubital forks, a distinct, small, round pale spot near wing margin in tip of cell, but no spot between these pale spots; cell M4 with round pale spot near apex; anal cell with single transverse pale spot extending from near mediocubital fork to posterior wing margin. Macrotrichia very sparse on distal half of wing, none extending proximad of level of end of costa; costa extending to 0.61 of distance to wing tip; radial cells with distinct lumens, the second moderately broad. Halter not visible in slide-mounted specimen examined.

Abdomen: Dark brown. Spermathecae (fig. 6h) 2, subequal, moderately large, ovoid with long, slender, sclerotized necks; rudimentary spermatheca and elongate sclerotized ring present.

TYPE.—Holotype female: Finca Carpenteria, El Tambo, Cauca, Colombia, 2500 m, July 9, 1964, V. H. Lee, light trap, USNM type no. 69404.

REMARKS.—A male specimen (from the Paramo de Puracé, 28.4 km east of Puracé, Cauca, Feb. 18, 1965, V. H. Lee, at light) is thought to be the male of *C. tamboensis*, because of the following similarities: Eyes hairy; wing 1.20 mm long, pattern (pl. 1: fig. 9) as figured, very similar to the female but with the poststigmatic pale spot broader and not as oblique, the pale spot lying immediately in front of mediocubital fork not distinct, the distal pale spot in anal cell extending quite broadly to wing margin. The scutum is darker than in the female

and appears to lack the pattern of dark punctures over the hairs; leg banding as in the female, but hind tibia dark to tip. Halter with base of knob dark, the end pale. Third palpal segment very short and broad; antenna with flagellar segments in proportion of 30-24-12-12-12-11-11-10-11-11-40-35-38; distal tufts present on XIII and XIV. Genitalia as figured (figs. 6*i*, *j*): Ninth sternum with very shallow caudomedian excavation, the ventral membrane not spiculate; ninth tergum with short, pointed apicolateral processes. Basistyle with "foot-shaped" ventral root, a distinct "heel" present; dorsal root slender; dististyle long and slender, with bent pointed tip. Aedeagus with broad basal arch extending to two-thirds of total length, the basal arms strongly sclerotized and irregularly convex laterally; distal stem short with bluntly rounded tip. Parameres each (fig. 6*i*) with strong basal knob, main portion slightly sinuate and moderately stout, no ventral lobe present; distal portion gradually narrowed, abruptly twisted to sharp distal point and bearing a lateral subapical fringe of 5-6 fine spines.

This species is very similar to *C. caucaensis*, new species, but is much smaller in size, there is only one poststigmatic pale spot in cell R5, only one distal pale spot in anal cell, and the distal pale spots in cells M1, M2, and M4 are quite distinct; sensoria are not present on antennal segments IX and X, and the palpal pit is small and deep.

References

CHAPMAN, F. M.

1917. The distribution of bird-life in Colombia: A contribution to a biological survey of South America. Bull. American Mus. Nat. Hist., vol. 36, 729 pp.

ESPINAL, L. S., and MONTENEGRO, E.

1963. Formaciones vegetales de Colombia. Bogotá: Dept. Agrológico. Inst. Geogr. Agustín Codazzi, 201 pp.

FORATTINI, O. P.

1957. *Culicoides* da Região Neotropical (Diptera, Ceratopogonidae). Arq. Fac. Hig. Saúde Publ. Univ. São Paulo, vol. 11, pp. 161-526.

VARGAS, L.

1960. The subgenera of *Culicoides* of the Americas (Diptera, Ceratopogonidae). Rev. Biol. Trop., vol. 8, pp. 35-47.

WIRTH, W. W., and BLANTON, F. S.

1959. Biting midges of the genus *Culicoides* from Panama (Diptera: Helicidae). Proc. U.S. Nat. Mus., vol. 109, pp. 237-482.

Proceedings of
the United States
National Museum



SMITHSONIAN INSTITUTION • WASHINGTON, D.C.

Volume 124

1967

Number 3627

Echiniphimedia,
An Amphipod Genus
From the Antarctic Ocean

By J. Laurens Barnard
Associate Curator, Division of Crustacea

Echiniphimedia, a member of the Acanthonotozomatidae, is represented by three known species confined primarily to the sublittoral and upper bathyal depths of antarctic seas. They are the most extraordinarily ornamented members of the family in their departure from the ordinary plan of paired dorsal teeth or low numbers of teeth. Two members of *Echiniphimedia* are virtually covered with medium to long spikelike fixed teeth and are rivalled in the density of their ornamentation only by a member of the Paramphithoidae, *Uschakoviella* Gurjanova, which has dense articulated spines covering the body. The degree of dorsal segmental ornamentation among benthic Amphipoda seems to increase directly with latitude, the tropics having few such species and the polar regions having large numbers of "spiny" amphipods. Ornamentation appears to be highly variable among polar species, differing in extent from youth to senility, from deme to deme, or within demes. The extent of intra-specific variations has scarcely been measured nor has it been identified with ecotypic and racial existence.

The purpose of this paper is to review the known species of the genus, report on variations among their individuals, elucidate a

nomenclatural problem, and determine whether the species have intra-generic affinities.

Materials were collected on the University of Southern California *Eltanin* (ET) Program and were made available through this office as well as that of Miss Patsy A. McLaughlin of the Smithsonian Oceanographic Sorting Center. Dr. Donald F. Squires and Dr. David L. Pawson of the Smithsonian kindly provided specimens from their collections made aboard the icebreaker *Eastwind* (EW). Miss Naomi D. Manowitz of the Smithsonian, on NSF Grant GB-3285, inked my drawings.

Echiniphimedia K. H. Barnard

Echiniphimedia K. H. Barnard, 1930.

TYPE-SPECIES.—*Iphimedia hodgsoni* Walker 1906 (and 1907).

DIAGNOSIS (revised).—Acanthonotozomatid with at least 2 or more coxal pairs obtaining submarginal fixed teeth in adulthood, some or all body segments becoming covered with rows or groups of erect cusps on lateral surfaces, teeth also occurring on dorsal surfaces and posterior margins of segments but not always distinct from ordinary dorsal and marginal cuspidation of other acanthonotozomatids; epistome broad from side to side, upper lip pendant from epistome and rounded or slightly truncate; mandibles of ordinary shape, neither extremely styliform nor bulky, but relatively simple; incisor of medium breadth, serrate or mostly entire; lacinia mobilis vermiform to subvermiform to spatulate, usually entire but occasionally serrate, molar absent; palp of maxilla 1 with 2 articles, reaching or exceeding apex of outer plate; palp of maxilliped 4-articulate, article 4 extremely small but articulate; both pairs of gnathopods minutely chelate (parachelate); telson deeply emarginate or truncate.

REMARKS.—The relative consistency in mouthparts, despite minor variations among the three species and strong differences in ornamentation, suggests that the genus is internally homogeneous. Three other acanthonotozomatid genera (from a total of 21) have close affinities with *Echiniphimedia* and, presumably because of simpler ornamentation, may occur on the line of precursors to *Echiniphimedia*. *Pariphimediella* Schellenberg (1931) seems to be the most primitive of the quartet of genera in that it has a lacinia mobilis in both mandibles. It was distinguished originally from *Iphimediella* Chevreux (1912) in the serrations of the mandibular incisors, but this character varies intraspecifically in *Echiniphimedia* and may be of no value as a generic character. *Iphimediella*, however, also lacks a lacinia mobilis in the left mandible like *Echiniphimedia*. The former differs from the latter in its vestigial mandibular hump (?molar), a slightly stouter mandible, and a thinner and narrower epistomal sclerite. *Pseudiphimediella*

Schellenberg (1931) has a deeply incised upper lip, a tendency toward which may be seen in one species of *Echiniphimedia*. Palp articles 1 and 2 of the maxilliped are broadened in *Pseudiphimediella*. The strong character difference between *Echiniphimedia* and the other three genera remains the acquisition of submarginal coxal teeth in adult *Echiniphimedia* and the acquisition of pereonal and pleonal teeth supernumerary to the basic acanthonotozomatid plan.

Key to the Species of *Echiniphimedia*

1. Pereonites 1-4 covered densely with teeth and cusps 2
Pereonites 1-4 smooth or rarely with vestigial spine teeth **echinata**
2. Head with submarginal tooth on cheek below eye (in addition to teeth of anteroventral cephalic corner); pereonites 2-6 with 2 vertical rows of very slender teeth; coxae 1-3 with 3-7, 4-8, and 5-15 teeth respectively . **hodgsoni**
Cheek below eye lacking tooth (but anteroventral cephalic corner with notch and teeth); pereonites 2-6 with 1 vertical row of stout teeth; coxae 1-3 with 1-2, 2, and 2-3 teeth respectively **scotti**

Echiniphimedia hodgsoni (Walker)

FIGURES 1-3

Iphimedia Hodgsoni Walker, 1906, p. 152.

Iphimedia hodgsoni.—Walker, 1907, p. 30, pl. 11 (fig. 18).

Echiniphimedia hodgsoni.—K. H. Barnard, 1930, pp. 359-360, fig. 31.—Schellenberg, 1931, p. 123.—K. H. Barnard, 1932, p. 125.—Nicholls, 1938, pp. 82-84, figs. 43, 44.

DESCRIPTION.—Female, 38 mm, ET 428: Pereon, coxae, second articles of pereopods 3-5 and pleonites 1-4 covered densely with fixed submarginal, acute teeth, on pereonites and pleonites teeth arranged in crude vertical rows, generally 2 rows per segment or 3 rows on posterior metasomal segments; teeth on coxae arranged in rows to some extent; tubercles rarely occurring on ventrolateral margins of pereonites 2-5 and on dorsolateral margins of pleonites 2-3 (possibly representing scars of broken teeth); pleonite 5 with large dorsolateral tooth on each side with smaller cusp at its base, pleonite 6 with large mediodorsal tooth; pleonal epimeron 1 with slightly convex posterior margin, posteroventral corner with minute tooth extended from lateral ridge, epimera 2 and 3 with much larger posteroventral tooth and lateral ridge, epimeron 3 with large medio-posterior tooth in addition to posteroventral tooth; head with stout rostrum of medium length, lateral planiform base produced laterally into large, hemispherical ocular bulge with pigmented ommatidial tissue, base with supraocular tooth, cheek below eye with 2 teeth, then, ventrally, cheek with deep incision bordered below by large tooth; articles 1 and 2 of antenna 1 extraordinarily palmate, resembling moose antlers, article 3 short and simple, accessory flagellum

small, 1-articulate, bearing 2 distal setules, barrel-like or mammilli-form depending on aspect; antenna 2 basally palmate, article 1 with long ventral cusp appearing as gland cone might from lateral view

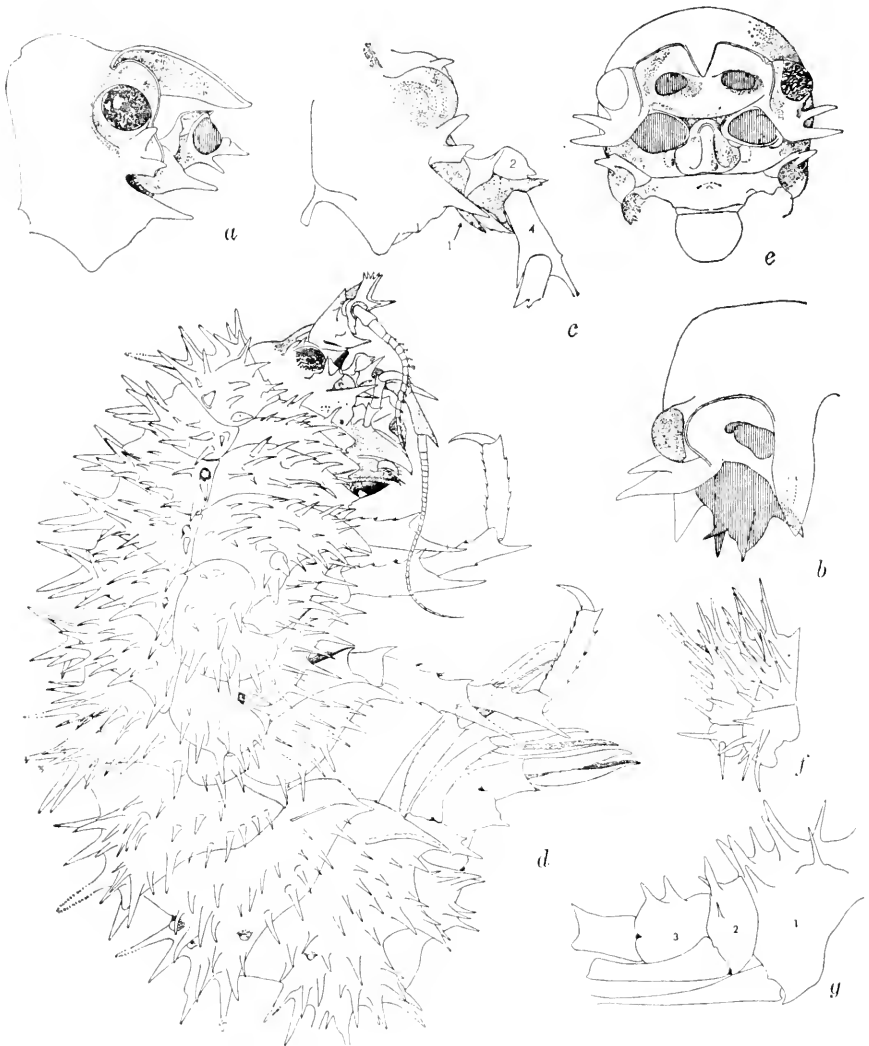

FIGURE 1.—*Echiniphimedia hodgsoni* (Walker), female, 38 mm, EW 66-022: *a*, head, lateral; *b*, half of head, anterodorsal. Female, 38 mm, ET 428: *c*, side of head and base of antenna 2; *d*, lateral view of body. Female, 29 mm, ET 1003: *e*, head, anterior; *f*, perconites 6, 7, right side, right to left; *g*, urosome, right.

and occurring just medial to largest anteroventral cephalic tooth, article 2 with large, complex dorsal keel; epistome with weak anterior process from lateral view, process scarcely discernible from anterior

view, epistome with lateral alae clearly defined and forming ventral articulation sockets for mandible, epistome of this specimen possibly aberrant, having on right side (to left in drawing) a scale of chitin possibly not shed during latest ecdysis; upper lip slightly emarginate; mandibles broad, with flat, apically broad cutting edge, only right mandible with vermiform lacinia mobilis, molar absent; article 1 of mandibular palp with apicomarginal cusp on each extreme, article 3 falciform; outer lobes of lower lip scarcely incised; maxillae shown in figures; maxillipedal palp article 2 with small, poorly projecting mediolateral process scarcely extending along article 3, article 4 minute but distinctly articulate; gnathopod 1 scarcely setose, gnathopod 2 strongly setose, both minutely chelate; gnathopods and pereopods 1 and 2 in preserved condition held under coxae and not visible from lateral view; pereopods 3-5 similar to one another and successively slightly larger (3 broken distally), second articles complexly ornamented with teeth and lateral ridges; uropods without special features or distinctions but shown in figures; telson short, with medium-sized distal emargination, lateral lobes coniform.

Female, 29 mm, ET 1003: This specimen differs from the 38 mm female in many ways; grossly it resembles Walker's (1907) figure more strongly than does the 38 mm female because the segmental teeth are longer and seemingly more closely spaced even though slightly fewer in number than those on the 38 mm female. Possibly in adulthood the teeth do not elongate or thicken proportionally to body growth; however, many of the teeth on the 38 mm female are thicker than those on the 29 mm female. Drawings on two pereopodal segments and the urosome seem sufficient to demonstrate these differences (figs. 1*f*, *g*). Urosomite 3 resembles Walker's drawing in having 2 posterolateral and 2 middorsal teeth. Only the right-sided member of each pair of teeth is shown in the figure herein. Urosomite 3 of the 38 mm female has a single large posterolateral tooth as if the pair of teeth in the smaller female had become amalgamated in the larger female. The 29 mm female lacks the supraorbital tooth seen in both the 38 mm female and the 8 mm juvenile. The second articles of pereopods 3-5 are more slender, and the posteroventral cusps on the corners of the pleonal epimera are longer than in the 38 mm female. Article 2 of the maxillipedal palp of the 29 mm female, like Walker's figure, does not have a distinct distomedial process. The eye is fully developed and almost perfectly circular, with all of its ommatidia clearly delineated, whereas in the 38 mm female, the posterior margin of the eye is clouded, presumably with carbonate deposits.

Female, 37 mm, EW 66-022: This specimen has no supraocular tooth and the dorsolateral cephalic flange is extremely strong. The emargination is especially deep.

Male, 19 mm, EW 66-004: This specimen has essentially no teeth on pleonite 5, no supraocular tooth, the ventrolateral cephalic tooth forming the anterior boundary of the cheek notch is much longer than in other specimens, and the tooth of the posterior boundary is obsolete.

Male, 9 mm, ET 1003: This specimen is somewhat closer to Walker's portrayal of the species than are other specimens. The thin dorsal teeth are densely packed, the supraocular tooth is absent, and the coxae have the following number of teeth: coxa 1=3, 2=4, 3=5, 4=5, 5=8, 6=4 or 5 (left and right) and 7=2. The mandibular incisor is deeply serrate and the lacinia mobilis very broad. Pleonite 5 has one pair of dorsolateral erect cusps and pleonite 6, a small medial pair and a large posterolateral pair.

MATERIAL.—ET 428 (female, 38 mm); 993 (damaged juvenile, 8.0 mm); ET 1003 (female, 29 mm, and male, 9.0 mm). EW 66-004 (male, 19 mm); EW 66-022 (female, 37 mm).

RECORDS.—ET 428, 62°41'S, 57°51'W, 662-1120 m; ET 993, 61°25'S, 56°30'W, 300 m; ET 1003, 62°40'S, 54°45'W, 210-219 m; EW 66-004, 67°49.8'S, 69°10.5'W, 119 m; EW 66-022, 60°26.5'S, 45°53.3'W, 146-168 m. Bransfield Strait; near Elephant Island; off Adelaide Island; South Orkney Islands.

DISTRIBUTION.—Coulman Island, 183 m; McMurdo Sound, 348-547 m; Oates Land, 329-366 m; Cumberland Bay, South Georgia Islands, 250-310 m, and South Georgia Islands, 110-401 m; South Shetland Islands, 200-342 m; Palmer Archipelago, 90-130 m; Commonwealth Bay, 82-730 m; Davis Sea, 200-595 m. Confirmed depth range, 119-662 m.

REMARKS.—This is probably the most strongly ornamented gammaridean amphipod. It is rivalled only by *Ushakoviella echinophora* Gurjanova (1955), on which the ornamental spines are articulate and small, and by *Actinacanthus* Stebbing (1888), on which the processes are fewer in number but so large that they dominate the body completely. The teeth of *Echiniphimedia* have been drawn in the accompanying figures exactly as they appear on the organism except for a few obviously bent or apically broken teeth that have been restored to their presumed original condition; a few large dorsal teeth have not been restored because one cannot determine their extent. The overall appearance of the in toto view of the 38 mm female differs strongly from that published by Walker (1907) mainly because the teeth and cusps are actually smaller than he represented them to be and more of the details of coxae and somites are truly visible. Of course, teeth projecting laterally are foreshortened. The pattern of teeth is not precisely symmetrical on bilateral comparison but is extremely similar from side to side. Surficial chitin between processes

often is marked with faint lines defining shallow basal bulges on the processes, similar to the texture of echinoids; most of these lines have been omitted from the drawings for the sake of clarity.



FIGURE 2.—*Echiniphimedia hodgsoni* (Walker), female, 38 mm, ET 428: *a, b*, gnathopods 1, 2; *c*, left antenna 1; *d*, anterior view of upper lip (*u*), epistome (*E*), and mandible (*M*); *e*, telson; *f*, left lateral view of head, pereonite 1, and base of antenna 1; *g*, base of antenna 2; *h*, right side of head, eye (*E*); *i-k*, uropods 1-3; *l*, accessory flagellum on antenna 1; *m*, end of gnathopod 2. Female, 37 mm, EW 66-022: *n, o*, antenna 1; left and right sides. Male, 19 mm, EW 66-004: *p*, head; *r*, urosome, right side. Juvenile, 8.0 mm, ET 993: *q*, right mandible.

Ocular bulges, projecting strongly, are formed of very clear chitin having a microscopic, almost reticulate, polygonal pattern; ommatidia are extremely small and densely packed.

Walker (1907) wrote that the gnathopods are like those of *Iphimedia obesa* Rathke, but his drawing of gnathopod 1 shows it to be simple; presumably it had twisted in its mount. I therefore assumed Walker's statement was untrue and his figure correct when I erroneously moved *Echiniphimedia echinata* to *Pariphimediella* (see J. L. Barnard, 1964).

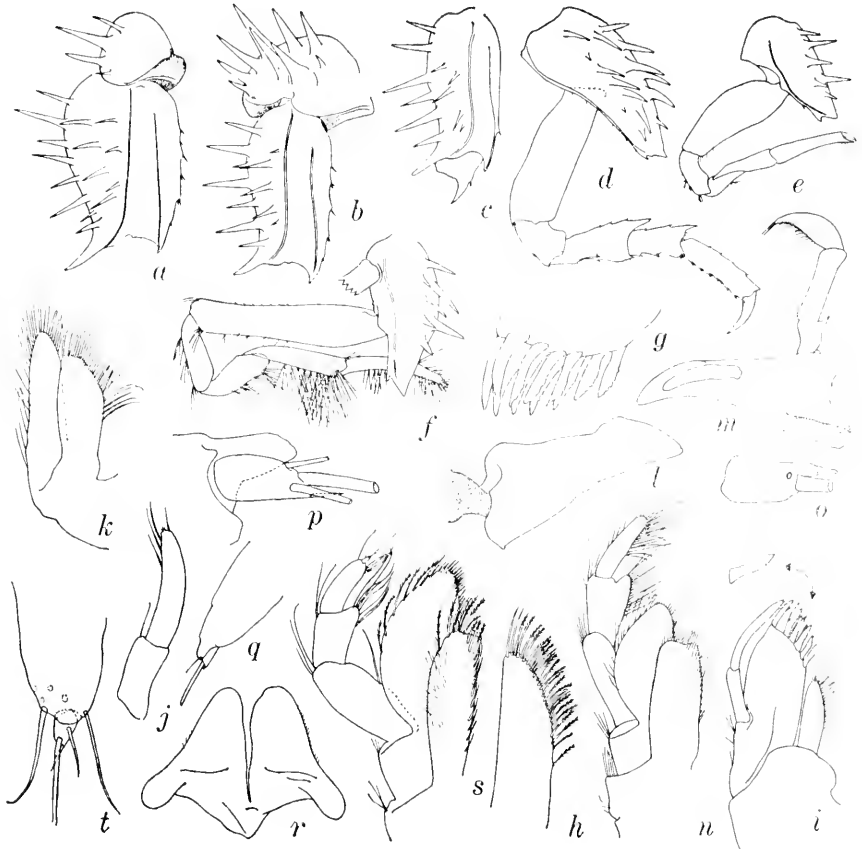

FIGURE 3.—*Echiniphimedia hodgsoni* (Walker), female, 38 mm, ET 428: a-d, pereopods 5, 4, 3, 1; e, f, gnathopods 1, 2; g-j, maxilla 1; k, maxilla 2; l, m, mandibles; n-q, maxillipeds; r, lower lip. Juvenile, 8.0 mm, ET 993: s, t, maxilliped.

A posterodistal tooth on epimeron 2 is not shown in Walker's (1907) figure but all specimens at hand have that tooth.

K. H. Barnard (1930) illustrates a much longer rostrum for *E. echinata* than seen in material at hand or in Nicholls' (1938) drawing. Nicholls' specimens did not have the supraocular tooth. Nicholls has already discussed the differences between his material and that of K. H. Barnard and the difficulty of matching various specimens to

the inadequate description of Walker. A wide variability in characters of *E. echinata* (Walker) is confirmed by Nicholls (1938) and this appears to be true also for *E. hodgsoni*.

Echiniphimedia echinata (Walker)

FIGURES 4, 5

- ?*Iphimedia nodosa* Dana, 1853, p. 928, pl. 63 (figs. 3, a, b).—Bate, 1862, p. 125 pl. 23 (fig. 1).—?Chevreux, 1912, pp. 118–119.
Iphimedia echinata Walker, 1906, p. 150; 1907, pp. 28–29, pl. 10 (fig. 16).—Chevreux, 1912, p. 119.
Echiniphimedia nodosa.—K. H. Barnard, 1930, pp. 361–363, fig. 33.
Echiniphimedia echinata.—K. H. Barnard, 1932, p. 126.—Nicholls, 1938, pp. 80–82, fig. 42.
 Not *Iphimedia nodosa*.—Stebbing, 1906, pp. 216–217.

NOMENCLATURE.—K. H. Barnard (1930) synonymized *Iphimedia echinata* with *I. nodosa* but then reversed his position in 1932 after Schellenberg (1931) refuted the move. Both *I. echinata* and *I. nodosa* bear a strong resemblance to each other in several characters not found as yet in other acanthotozomatids, and K. H. Barnard's conclusion that they were synonymous was probably correct. The absence of teeth on pereonites 1–4 (or 5) but the presence of supernumerary submarginal teeth on pleonites (1) 2–3 are characteristic of both Dana's and Walker's material. Dana apparently did not completely understand the morphology of his species for he failed to account for some important characters such as the giant posterior teeth of pleonal epimeron 3 and the dorsal teeth of the urosome. As his material has long been presumed lost, one can only conjecture on how he failed to illustrate or describe these characters adequately unless an acanthotozomatid fitting his description more closely than does *I. echinata* remains to be rediscovered. Until we can be sure that such does not exist, it is prudent to place Dana's and Walker's species together only in provisional status.

Schellenberg (1931) and K. H. Barnard (1932), in his retraction of the 1930 synonymy, apparently were both misled by Stebbing (1906), who appears to have based his monographic description of Dana's *I. nodosa* on a species only remotely related to Dana's. His interpretation of Dana's work was far too extreme, and we must presume he found in British Museum collections an undescribed acanthotozomatid that seemed close to *I. nodosa*. I have made no attempt to trace that species to a taxon described later, but there is a strong possibility that such exists. It may indeed represent a specimen Schellenberg figured as "*I. nodosa*." The generic assignment is open to question also except that neither fits *Echiniphimedia* as diagnosed herein. K. H. Barnard's (1932) "*Iphimediella nodosa*" is yet another species but not an *Echiniphimedia*.

GROUP DESCRIPTION OF MATERIAL AT HAND.—Pereonites 5-7 or 6-7 only, coxae 3-7 or 5-7 only, second articles of pereopods 3-5 or 4-5 only, and pleonites 1-4 covered sparsely with fixed submarginal and marginal teeth, submarginally mainly on pleon and coxae 5-6, pereonites 1-4 always smooth except for one small posteroventral cusp also found on pereonites 5-7 and forming serially a small lateral carina, teeth of pereopods and pleonites increasing in number with increased size of individual but also varying considerably among equal-sized individuals; thus an individual 22 mm long lacking submarginal teeth on coxae 3-4, whereas an individual 19 mm long having such teeth; small individuals 9 mm or smaller with dorsal midline teeth of pleonites 3-4 anteriorly reverted, becoming vertically erect in larger individuals; pleonite 5 with dorsal hump, 6 with posterolateral wings; pleonal epimeron 1 with slightly convex posterior margin, posteroventral corner lacking tooth, anteroventral corner with one spine, epimeron 2 with small tooth and lateral ridge, epimeron 3 with large posteroventral tooth, a larger posteromedial tooth; rostrum of medium length, weakly developed lateral planiform base of head with large hemispherical ocular bulge enclosing pigmented ommatidial tissue, no extraocular teeth, anteroventral margin of cheek with deep notch, its boundaries forming sharp teeth, anterior tooth essentially forming lateral cephalic lobe; articles 1-2 of antenna 1 moderately palmate, article 3 short and simple, accessory flagellum very small, 1-articulate, bearing several setules, barrel-like; antenna 2 basally palmate to moderate extent, article 1 with long ventral cusp appearing as gland cone; epistome with appearance of fleur-de-lis; upper lip rounded or nearly truncate below; mandibles broad, incisors either smooth or weakly serrate, lacinia mobilis in right mandible subvermiform, distally broadened and flattened and distolaterally serrate minutely and irregularly; article 1 of mandibular palp lacking conspicuous cusp, article 3 falciform; lower lip and maxillae generally as in *E. hodgsoni* but outer lobe of maxilla 2 with 2 distolateral marginal setae; emargination of telson narrower than in *E. hodgsoni*.

MATERIAL.—ET 435 (female, 22 mm, figured); ET 436 (12 specimens, some figured).

RECORDS.—ET 435, 63°14'S, 58°40'W, 73-92 m; ET 436, 63°14'S, 58°45'W, 73 m.

DISTRIBUTION.—Tierra del Fuego; Cape Virgins; Straits of Magellan; south of Graham Land; Commonwealth Bay, 46-732 m; McMurdo Sound, 175-547 m; South Georgia Islands, 122-234 m; Palmer Archipelago, 90-132 m; Marguerite Bay, 200 m; Ile Jenny, 230 m; near King George Island, 73-92 m.

REMARKS.—Dana's *Iphimedia nodosa* would appear to be a younger individual than any in this collection, the smallest at hand being 6.4

mm. A recognizable male is only 7.8 mm long; thus, considerable growth occurs after sexual maturity: the largest individual reported is 45 mm long. The 6.4 mm specimen, however, is better developed in some characters than the largest adults for it has 1 dorsal, 2 lateral,



FIGURE 4.—*Echiniphimedia echinata* (Walker), female, 22 mm, ET 435: *a*, lateral view of body; *b*, left lateral antenna 1; *c*, accessory flagellum; *d*, gnathopod 2, setae removed; *e*, distal end of pereopod 3; *f*, dorsal article 1 of antenna 1; *g*, gnathopod 1; *h*, maxilliped. Juvenile, 6.4 mm, ET 436: *i*, pleonite 4 through pleonite 6, left to right. Male, 7.8 mm, ET 436: *j*, pleonites 1-3, left to right.

and 2 posteroventral teeth on perconite 5, whereas the 22 mm female has only 2 posteroventral and 2 ventral supernumerary teeth on that segment. Considerable phenotypic differences are seen, therefore,

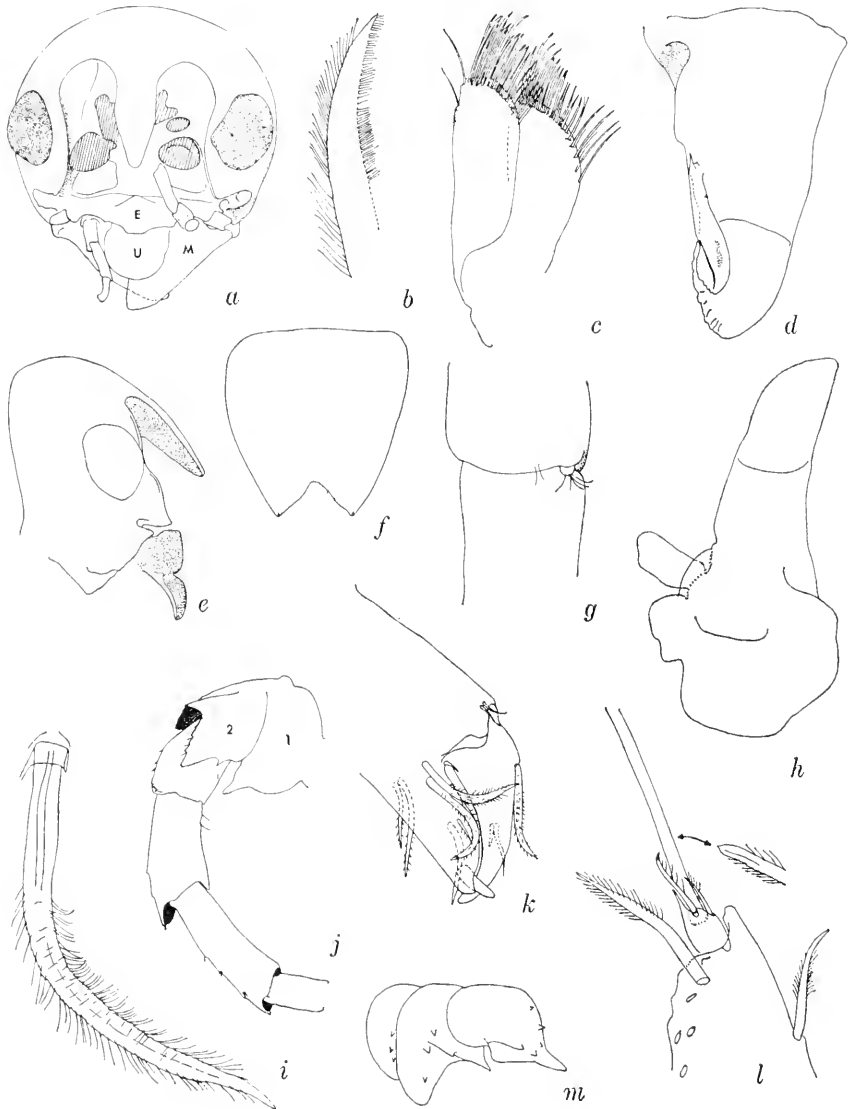

FIGURE 5.—*Echiniphimedia echinata* (Walker), female, 22 mm, ET 435: *a*, head, anterior view (E=epistome, U=upper lip, M=mandible, hatching=antennal socket); *b*, seta of maxilla 2; *c*, maxilla 2; *d*, right mandible; *e*, head and epistomal-labral complex; *f*, telson; *g*, accessory flagellum; *h*, left mandible; *i*, seta of gnathopod 1; *j*, medial antenna 2; *k*, end of gnathopod 1; *l*, apex of maxillipedal palp. Female, 19.5 mm, ET 436: *m*, coxae 3-5, left to right.

and these have been mentioned in detail by K. H. Barnard. Teeth may be added to the pleon but perhaps lost from the pereon with increase in age.

The urosome folds toward the metasome in such a way that the dorsal teeth of pleonite 4 become nearly congruent with those of pleonal epimeron 3. Dana, therefore, with inferior microscopy, may have thought he was seeing the opposite epimeron projecting from behind and thus illustrated the urosome as dorsally smooth.

Nicholls had juvenile and adult specimens with dentations commencing on pereonite 2 instead of pereonites 5 or 6.

Echiniphimedia scotti K. H. Barnard

FIGURE 6

Echiniphimedia scotti K. H. Barnard, 1930, pp. 360-361, fig. 32.

DESCRIPTION.—Male, 22 mm: Pereon, coxae, second articles of pereopods 3-5 and pleonites 1-4 covered with acute or blunt submarginal teeth, teeth especially blunt on anterior pereonites, arranged in crude vertical rows on pereonites and pleonites, generally 2 rows except on pereonites 2-6 with 1 row, teeth on coxae, though sparse, generally arranged in rows; pleonite 5 smooth, pleonite 6 with weak dorsolateral tooth on each side; pleonal epimeron 1 with slightly convex posterior margin, posteroventral corner simple but lateral face with weak ridge, epimeron 2 with small posteroventral tooth, epimeron 3 with large posteroventral tooth, both epimera with strong lateral ridges, epimeron 3 with large medioposterior tooth in addition to posteroventral tooth; stout rostrum of medium length, lateral subplaniform base of head produced laterally into large hemispherical ocular bulge, faintly gray pink in alcohol, without supra- and subocular teeth, cheek below eye with deep incision, its borders asymmetrically cuspidiform; articles 1 and 2 of antenna 1 extraordinarily palmate, resembling moose antlers, article 3 short and simple; accessory flagellum small, 1-articulate, barrel-like or mammilliform depending on aspect; antenna 2 basally palmate like *E. hodgsoni*; epistome weak, upper lip rounded below; mandibles broad, incisors serrate, lacinia mobilis on right mandible slender, thin, short, apex broad but obliquely and weakly serrate, palp article 1 scarcely cuspidate distally, article 3 falciform; outer lobes of lower lip not incised; maxillae and maxillipeds, gnathopods, pereopods and uropods like those of *E. hodgsoni*.

MATERIAL.—ET 1003 (male, 22 mm).

RECORD.—Near Joinville Island, 62°40' S, 54°45' W, 210-219 m.

DISTRIBUTION.—McMurdo Sound, 348-457 m.

REMARKS.—This individual differs from the type-specimen (female, 23 mm) described by K. H. Barnard in the following characters: (1) the asymmetrical boundaries of the subocular notch; (2) the more abundant but shorter anterior pereonal teeth; (3) one more tooth on coxa 1 and one less on coxa 3; (4) pleon segment 3 with only 2 instead of 3 rows of teeth; (5) the unincised, truncate telson.

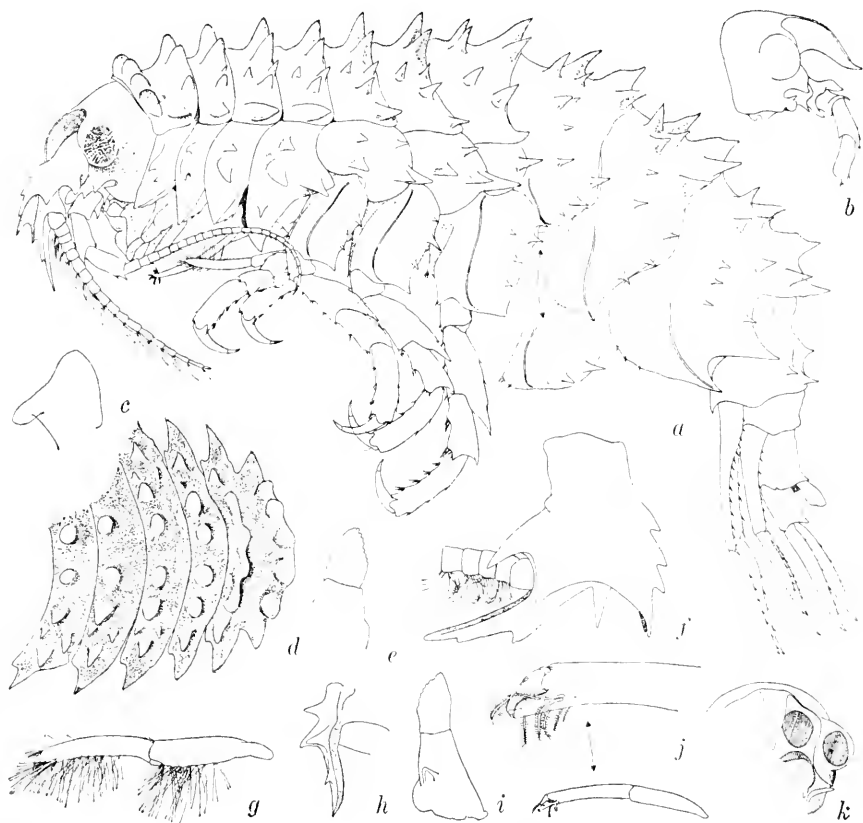

FIGURE 6.—*Echiniphimedia scotti* K. H. Barnard, male, 22 mm, ET 1003: *a*, lateral view of body; *b*, head and peduncle of antenna 2; *c*, half of lower lip; *d*, dorsal view of pereonites 1-5, right to left; *e*, obverse side of right mandible; *f*, right dorsal antenna 1; *g*, left gnathopod 2; *h*, left coxa 4, view from posterior end; *i*, left mandible; *j*, right gnathopod 1; *k*, left side of head, anterior view (hatching=antennal sockets).

Literature Cited

- BARNARD, J. L.
1964. Revision of some families, genera and species of gammaridean Amphipoda. *Crustaceana*, vol. 7, pp. 49-74, 2 tables.
- BARNARD, K. H.
1930. Amphipoda. *In* British Antarctic (*Terra Nova*) Expedition 1910, Natural History Reports, Zoology, vol. 8, pp. 307-454, figs. 1-63.
1932. Amphipoda. *In* Discovery Reports, vol. 5, pp. 1-326, figs. 1-174, pl. 1.
- BATE, C. S.
1862. Catalogue of the specimens of amphipodous Crustacea in the collection of the British Museum, London, iv+399 pp., pls. 1, 1a, 2-58.
- CHEVREUX, E.
1912. Amphipodes. *In* Deuxième Expédition Antarctique Française (1908-1910) comandée par le Dr. Jean Charcot: Sciences naturelles: Documents scientifiques, pp. 79-186, figs. 1-62.
- DANA, J. D.
1853. Crustacea, part II. *In* U.S. Exploring Expedition, vol. 14, pp. 689-1618, atlas of 96 pls.
- GURJANOVA, E.
1955. Novye vidy bokoplavov (Amphipoda, Gammaridea) iz severnoi chasti Tixogo Okeana. *Trudy Zool. Inst., Akad. Nauk SSSR*, vol. 18, pp. 166-218, figs. 1-23. [In Russian.]
- NICHOLLS, G. E.
1938. Amphipoda Gammaridea. Australasian Antarctic Expedition 1911-14, Scientific Report, ser. C (zoology and botany), vol. 2, pt. 4, pp. 1-145, figs. 1-67.
- SCHELLENBERG, A.
1931. Gammariden und Caprelliden des Magellangebictes, Südgeorgiens und der Westantarktis. *In* Further zoological results of the Swedish Antarctic Expedition 1901-1903, vol. 2, no. 6, pp. 1-290, pl. 1, figs. 1-136.
- STEBBING, T. R. R.
1888. Report on the Amphipoda collected by H.M.S. Challenger during the years 1873-76. *In* Great Britain, Report on the scientific results of the voyage of H.M.S. Challenger during the years 1873-76: Zoology, vol. 29, xxiv + 1737 pp., 210 pls. [In 3 vols.]
1906. Amphipoda, 1: Gammaridea. *In* Das Tierreich, vol. 21, pp. 1-806, figs. 1-127.
- WALKER, A. O.
1906. Preliminary description of new species of Amphipoda from the "Discovery" Antarctic Expedition, 1902-1904. *Ann. Mag. Nat. Hist.*, ser. 7, vol. 18, pp. 150-154.
1907. Crustacea, III: Amphipoda. *In* National Antarctic Expedition, British Museum (Natural History), vol. 3, pp. 1-39, pls. 1-13.

Proceedings of
the United States
National Museum



SMITHSONIAN INSTITUTION • WASHINGTON, D.C.

Volume 124

1967

Number 3628

Cyclopoid Copepods of the Genus *Paranthesius*
Associated with Marine Pelecypods in Chile

By Arthur G. Humes¹

Records of the genus *Paranthesius* from the western coast of North and South America are relatively scarce. Thompson (1897, p. 87) in Herdman, Thompson, and A. Scott, described *Pseudolichomolgus columbiae* (= *Paranthesius columbiae* according to Illg, 1949) from a single planktonic specimen in Puget Sound, Washington. Illg (1949) reported five species of *Paranthesius* from various pelecypods in California: *P. columbiae* (Thompson, 1897) from *Schizothaerus nuttalli* (Conrad) and *Protothaca tenerrima* (Carpenter), and four new species, *P. panopeae* from *Panope generosa* Gould, *P. tivelae* from *Tivela stultorum* (Mawe), and *P. saxidomi* and *P. perplexus* from *Saxidomus nuttalli* Conrad.

On Cruise 18 of the R/V *Anton Bruun*, during the Southeastern Pacific Biological Oceanographic Program of the National Science Foundation, the ship visited Valparaiso and Iquique, Chile, where the author collected specimens of the two new copepods described below from pelecypods purchased in the local fish markets. The first of the new species is the second record of *Paranthesius* from the genus *Protothaca* and the second represents the first record from *Mesodesma*.

¹ Department of Biology, Boston University, Boston, Mass.

The discovery of these two new copepods extends the eastern Pacific range of the genus as far south as central Chile.

The study of the specimens has been aided by a grant (GB-5838) from the National Science Foundation.

All figures have been drawn with the aid of a camera lucida. The letter after the explanation of each figure refers to the scale at which it was drawn. The abbreviations used are: A_1 =first antenna, A_2 =second antenna, L=labrum, MD=mandible, P=paragnath, MX_1 =first maxilla, MX_2 =second maxilla, MXP=maxilliped, and P_1 =leg 1.

I thank Prof. José Stuardo of the Universidad de Concepción, Concepción, Chile, for the identifications of the two pelecypod hosts.

Family LICHOMOLGIDAE Kossmann, 1877

Genus *Paranthesius* Claus, 1889

Paranthesius protothacae, new species

FIGURES 1-33

TYPE MATERIAL.—11 ♀♀ and 10 ♂♂ from the mantle cavity of 59 *Protothaca thaca* Molina purchased in the fish market at Iquique, Chile, Aug. 23, 1966. (These pelecypods probably came from Punta Guanillos, 21°15'S, 70°07'W, south of Iquique.) Holotype female, allotype, and 16 paratypes (8 ♀♀, 8 ♂♂) deposited in the United States National Museum, and the remaining paratypes (dissected) in the collection of the author.

FEMALE.—Body (figs. 1, 2) moderately slender, about three times longer than wide, with prosome not greatly thickened dorsoventrally. Length (not including setae on caudal rami) 1.62 mm (1.47–1.78 mm) and greatest width 0.54 mm (0.50–0.61 mm), based on 10 specimens measured in lactic acid. Dorsoventral thickness of prosome about 0.45 mm. Ratio of length to width of prosome 1.9:1. Segment of leg 1 separated from head dorsally and laterally by a distinct furrow. Epimeral areas of metasomal segments as illustrated.

Segment of leg 5 (fig. 3) $91\mu \times 135\mu$. Between this segment and genital segment a weak ventral intersegmental sclerite, its sclerotization more evident laterally (fig. 4). A median prominence in front of segment of leg 5 (figs. 4, 5). Genital segment as long as wide, $216\mu \times 216\mu$, in dorsal view anterior half laterally expanded with rounded margins and posterior half narrower and tapering slightly posteriorly with straight margins. Areas of attachment of egg sacs located dorso-laterally, each area (fig. 6) bearing small seta 13μ long and spiniform process 6μ . Three postgenital segments $78\mu \times 120\mu$, $70\mu \times 109\mu$, and $114\mu \times 99\mu$, from anterior to posterior. Anal segment with postero-ventral margins unornamented.

Caudal ramus (fig. 7) elongated, $135\mu \times 34\mu$ in greatest dimensions, four times longer than wide. Outer lateral seta 52μ , outermost terminal seta 70μ , innermost terminal seta 57μ . Two long median terminal setae 195μ (outer) and 380μ (inner) and inserted slightly dorsally. Dorsal pedicellate seta small, 18μ long. All setae naked. Dorsal surface of ramus without ornamentation.

Dorsal surface of prosome and urosome with a few hairs (as in fig. 1); ventral surface of urosome almost devoid of ornamentation. Ratio of length of prosome to that of urosome 1.4:1.

Egg sac unknown.

Rostrum (figs. 8, 9) a rounded prominence with a rather blunt posteroventral tip.

First antenna (fig. 10) slender (about 358μ in length) and 7-segmented, with a sclerite on third segment (fig. 11) suggesting an intercalary segment. Lengths of segments (measured along posterior nonsetiferous margins) 13μ (50μ along anterior margin), 81μ , 35μ , 60μ , 55μ , 41μ , and 36μ respectively. Formula for armature, as in many other lichomolgids, 4, 13, 6, 3, 4+1 aesthete, 2+1 aesthete, and 7+1 aesthete. All setae naked.

Second antenna (fig. 12) 4-segmented. Armature 1, 1, 3, and I,5. All setae naked. Three long terminal setae on last segment jointed; claw pale brown, 77μ along its axis. Second segment with few short spinules along outer edge.

Labrum (figs. 13, 18) with two widely divergent posteroventral lobes.

Mandible (fig. 14) with a slender elongated blade bearing spinules along each side. Paragnath (fig. 13) a small hairy lobe. First maxilla (fig. 15) with four setae (in one first maxilla of one female only three, seta nearest to two terminal ones being absent). Second maxilla (fig. 16) 2-segmented. First segment unornamented. Second segment having on outer (ventral) margin a small proximal seta, bearing on inner surface a seta with very short barbules and a long seta with spinules along one edge, and terminating in a long lash with long spinules on one margin and few small spinules on opposite side. Maxilliped (fig. 17) 3-segmented. First segment lacking spines or setae. Second segment with two rather unequal setae. Small third segment terminating in a spiniform process (not clearly articulated with segment) with a small seta near base. Postero-outer surface of second segment and postero-outer distal part of first segment with dense covering of fine short hairlike ornamentation.

Postoral area as in figure 18. Median region between mandibles, paragnaths, and first maxillae slightly protuberant. A sclerotized line between bases of maxillipeds.

Legs 1-4 (figs. 19-22) with trimerous rami. Armature as follows (Roman numerals indicating spines, Arabic numerals setae):

P ₁	protopod	0-1	1-0	exp	I-0	I-1	III,I,4
				end	0-1	0-1	I,5
P ₂	protopod	0-1	1-0	exp	I-0	I-1	III,I,5
				end	0-1	0-2	I,II,3
P ₃	protopod	0-1	1-0	exp	I-0	I-1	III,I,5
				end	0-1	0-2	I,II,2
P ₄	protopod	0-1	1-0	exp	I-0	I-1	II,I,5
				end	0-1	0-1	II

Inner margin of basis ornamented with spinules in leg 1, with hairs in legs 2-4. Leg 4 with last segment of exopod most often with the formula II,I,5 (in seven females), but occasionally III,I,5 (in two females) or II,I,5 and III,I,5 (in two females where formula differed on opposite legs). Last segment of endopod in leg 4 measuring 74μ x 28μ in greatest dimensions, with two terminal fringed spines 64μ (outer) and 79μ (inner).

Leg 5 (fig. 23) with its free segment 52μ x 19μ ; ornamented with few minute distal outer spinules and armed with a terminal naked seta 77μ and a subterminal inner lamellate spine 33μ with blunt tip. Seta on body near insertion of free segment 36μ and naked.

Leg 6 probably represented by small seta and spiniform process near attachment of egg sac (see fig. 6).

Color in life in reflected light transparent to slightly amber, eye red.

MALE.—Body (figs. 24, 25) slender as in the female. Length (without setae on the caudal rami) 1.44 mm (1.22-1.54 mm) and greatest width 0.44 mm (0.38-0.50 mm), based on 10 specimens measured in lactic acid. Ratio of length to width of prosome 1.8:1.

Segment of leg 5 (fig. 26) 52μ x 109μ . Between this segment and genital segment no ventral intersegmental sclerite. Genital segment only slightly longer than wide, 255μ x 234μ , with lateral margins gently rounded in dorsal view. Four postgenital segments 52μ x 99μ , 55μ x 94μ , 49μ x 84μ , and 88μ x 81μ , from anterior to posterior.

Caudal ramus resembling that of female, 114μ x 29μ .

Surfaces of body ornamented with few hairs (fig. 24) as in female. Ratio of length of prosome to that of urosome 1.2:1.

Rostrum like that of female.

First antenna (fig. 27) resembling that of female, but with three aesthetes added, so that the formula is 4, 13 + 2 aesthetes, 6, 3 + 1 aesthete, 4 + 1 aesthete, 2 + 1 aesthete, and 7 + 1 aesthete. Second antenna (fig. 28) similar to that of female, but with four elements on third segment and with small spinules along inner edge of second segment.

Labrum, mandible, paragnath, first maxilla, and second maxilla as in female. Maxilliped (fig. 29) slender and 4-segmented, assuming that proximal part of claw represents a fourth segment. First segment unarmed. Second segment bearing two inner setae, innermost with sclerotized basal portions (fig. 30), and row of spinules on posterior surface. Third segment small and unarmed. Recurved claw 172μ along axis, with slight indication of division about midway; terminal lamella very narrow; two unequal setae on proximal part of claw.

Postoral area as in female.

Legs 1-4 as in female, with same spine and setal formula. Last segment of endopod of leg 1 (fig. 31) showing very slight sexual dimorphism, with more numerous terminal spinules and outer fringe on spine more strongly spinulose than in female.

Leg 5 (fig. 32) with free segment $33\mu \times 13\mu$, terminal seta 62μ , and subterminal inner spine 15μ and without lamellae.

Leg 6 (fig. 33) a posteroventral flap on genital segment bearing two naked setae 29μ and 38μ long, with a row of minute spinules near insertion of longer more anterior seta.

Spermatophore not seen.

Color in life like that of female.

ETYMOLOGY.—The specific name *protothacae* is formed from the generic name of the host.

COMPARISON WITH RELATED SPECIES.—Following the views of Illg (1949) and adding information from Bocquet and Stock (1958, 1958a, 1959), Gotto (1961) regarded the genus *Paranthesius* as embracing 21 species. Stock (1964) has, however, removed six of these species to the genus *Scambicornus* Heegaard, 1944. These are *S. prehensilis* (Sars, 1918), *S. robustus* (Thompson and A. Scott, 1903), *S. serendibicus* (Thompson and A. Scott, 1903), *S. propinquus* (Nicholls, 1944), *S. finmarchicus* (T. Scott, 1903), and *S. tenuicaudis* (Sars, 1918). A recently described form, *P. colmani* Reddiah, 1960, must be added to the genus, bringing the number of currently recognized species to 16. For the purpose of the description of *P. protothacae* and the following new species, *Paranthesius* is held to consist of these 16 species, although it is recognized that many problems exist in the determination of the generic limits and that several authors (for example, Monod and Dollfus, 1932; Illg, 1949; Sewell, 1949; Bocquet and Stock, 1957; and Reddiah and Williamson, 1959) have variously interpreted the scope of the genus.

Nine species of *Paranthesius* have a distinct beak on the rostrum and may thus be distinguished readily from *P. protothacae*. These are: *P. columbiae* (Thompson, 1897); *P. panopeae* Illg, 1949; *P. tivelae* Illg, 1949; *P. nasutus* (Edwards, 1891); *P. pectinis* (Pesta,

1909); *P. rostratus* (Canu, 1891); *P. haploceras* Bocquet and Stock, 1959; *P. barneae* (Pelseneer, 1929); and *P. colmani* Reddiah, 1960.

The new species may be separated from the remaining seven species as follows: *P. anemoniae* Claus, 1889, has an elongated segment in leg 5 (about 5:1 in Bocquet and Stock, 1959a, fig. 5d) and the second antenna has three terminal claws; *P. cynthiae* (Brian, 1924) has the caudal ramus equal to the length of the last two postgenital segments and the last segment of the second antenna much longer than the penultimate segment; *P. myxicolae* Bocquet and Stock, 1958, has recurved spines on the first and second segments of the first antenna and three terminal claws on the second antenna; *P. parvus* (Norman and T. Scott, 1905) has jointed setae (no claw) on the last segment of the second antenna in the female; *P. perplexus* Illg, 1949, has an ellipsoid rounded process on each side of the genital segment in the female; *P. saxidomi* Illg, 1949, has a reduced maxilliped in the female (length less than half the basal segment of the second maxilla), the basis of legs 1-3 with stout spinules, the last segment of the endopod of leg 4 with the inner spine nearly 2.5 times the length of the outer spine, the segment of leg 5 in the female with a rounded expansion at the base and the two terminal elements subequal in length, the male maxilliped with a modified seta on the second segment, and the male genital segment with two pairs of rows of spinules; and *P. validus* (Sars, 1918) has a caudal ramus that in the female is only slightly longer than wide.

Paranthesius mesodesmatis, new species

FIGURES 34-43

TYPE MATERIAL.—14 ♀♀ and 16 ♂♂ from the mantle cavity of 39 *Mesodesma donacium* Lamarck purchased in the fish market at Valparaiso, Chile, Aug. 4, 1966. (These pelecypods presumably came from Viña del Mar, near Valparaiso.) Holotype female, allotype, and 24 paratypes (11 ♀♀, 13 ♂♂) deposited in the United States National Museum, and the remaining paratypes (dissected) in the collection of the author.

In the following description those features not mentioned may be assumed to be essentially like those of the previous species.

FEMALE.—Body (figs. 34, 35) with tumid prosome. Length (not including setae on caudal rami) 1.49 mm (1.40-1.63 mm) and greatest width 0.64 mm (0.48-0.77 mm), based on 8 specimens measured in lactic acid. Dorsoventral thickness of prosome about 0.66 mm in a specimen 1.50 x 0.64 mm. (One female less tumid than the others, its dimensions 1.47 x 0.47 mm, with dorsoventral thickness of 0.42 mm.) Ratio of length to width of prosome 1.38:1. Segment of leg 1 very

weakly delimited from head. Epimeral areas of first and second metasomal segments apparently distorted by swelling of prosome (fig. 34).

Segment of leg 5 (fig. 36) $69\mu \times 133\mu$. Genital segment $195\mu \times 190\mu$. Areas of attachment of egg sacs dorsolateral. Three postgenital segments $73\mu \times 104\mu$, $57\mu \times 91\mu$, and $91\mu \times 86\mu$, from anterior to posterior. Caudal ramus $102\mu \times 30\mu$, 3.4 times longer than wide, slightly shorter than in *P. protothacae*.

Ratio of length of prosome to that of urosome 1.5:1.

Egg sac (fig. 34) elongated, 1.25×0.26 mm in one female, 1.73×0.29 mm in another, with many eggs each about 86μ in diameter.

Rostrum (fig. 37) as in previous species.

First antenna segmented and armed as in *P. protothacae*, but shorter, about 285μ long. Lengths of segments (measured along posterior non-setiferous margins) 16μ (42μ along anterior margin), 61μ , 25μ , 51μ , 43μ , 36μ , and 27μ respectively. All setae naked.

Second antenna segmented and armed as in *P. protothacae*. Claw 59μ along axis.

Labrum, mandible, paragnath, first maxilla, and second maxilla as in *P. protothacae*. Maxilliped resembling that of previous species, but the two setae on second segment more nearly equal and fine hairlike ornamentation on first two segments apparently absent.

Postoral area as in previous species.

Legs 1-4 segmented and armed as in *P. protothacae*. Outer edge of first segment of exopod of leg 1 without small spinules. Last segment of exopod of leg 4 with the formula II,I,5 in each of 10 females. Last segment of endopod of leg 4 (fig. 38) shaped as in previous species but shorter, $57\mu \times 24\mu$, its two terminal spines 44μ (outer) and 60μ (inner) in length.

Leg 5 (fig. 39) with the free segment $43\mu \times 16\mu$, ornamented with a small distal outer spinule, terminal seta 50μ , and subterminal spine 18μ with narrow lamellae.

Leg 6 as in *P. protothacae*.

Color in life in reflected light slightly amber, eye pale red, egg sacs whitish opaque.

MALE.—Body form much like that of male of *P. protothacae*, as shown in figures 24, 25. Prosome not tumid. Length (without the ramal setae) 1.38 mm ($1.25-1.50$ mm) and greatest width 0.44 mm ($0.39-0.48$ mm), based on 10 specimens measured in lactic acid.

Genital segment (fig. 40) $260\mu \times 252\mu$. Four postgenital segments $69\mu \times 99\mu$, $69\mu \times 94\mu$, $51\mu \times 81\mu$, and $92\mu \times 79\mu$, from anterior to posterior.

Caudal ramus like that of female, $101\mu \times 30\mu$.

Rostrum similar to that of female. First antenna 297μ long, segmented and armed as in male of *P. protothacae*. Second antenna as

in male of previous species. Labrum, mandible, paragnath, first maxilla, and second maxilla like those of the female. Maxilliped resembling that in *P. protothacae*, but claw 150μ along axis, and sclerotization of innermost seta on the second segment slightly different (fig. 41).

Postoral area as in female.

Legs 1-4 segmented and armed as in female. Last segment of endopod of leg 1 (fig. 42) with terminal spinules slightly coarser than in female.

Leg 5 (fig. 43) with the free segment $32\mu \times 14\mu$, without ornamentation, terminal seta 55μ , and subterminal spine 10μ , slender and setiform, without lamellae.

Leg 6 as in *P. protothacae*, the two setae 31μ and 44μ in length.

Spermatophore not seen.

Color in life in reflected light opaque white, eye pale red.

ETYMOLOGY.—The specific name *mesodesmatis* is formed from the generic name of the host.

COMPARISON WITH RELATED SPECIES.—*P. mesodesmatis* is very close to *P. protothacae*, but differs from it in several features. In *P. mesodesmatis* the prosome of the female is swollen, the ratio of length to width of the caudal ramus is 3.4:1 (instead of 4:1 as in *P. protothacae*), the first antennae are distinctly shorter, and certain other parts are relatively smaller as shown below.

Comparison of certain features of *Paranthessius protothacae* and *P. mesodesmatis* is as follows:

	<i>P. protothacae</i>	<i>P. mesodesmatis</i>
FEMALE		
Body size	1.62 x 0.54 mm	1.49 x 0.64 mm
Ratio of length to width of prosome	1.9:1	1.38:1
Nature of prosome	not tumid	tumid in nearly all specimens
Caudal ramus	$135\mu \times 34\mu$ (4:1)	$102\mu \times 30\mu$ (3.4:1)
Length of first antenna	358μ	285μ
Length of claw on second antenna	77μ	59μ
Formula for last segment of exopod of leg 4	usually II,I,5, but sometimes III,I,5	always II,I,5
Last segment of endopod of leg 4	$74\mu \times 28\mu$	$57\mu \times 24\mu$
Segment of leg 5 and two terminal elements	$52\mu \times 19\mu$, seta 77μ , spine 33μ	$43\mu \times 16\mu$, seta 50μ , spine 18μ
MALE		
Body size	1.44 x 0.44 mm	1.38 x 0.44 mm
Claw of maxilliped	172μ	150μ
Terminal spinules on last segment of endopod of leg 1	slender	coarse
Subterminal element of leg 5	15μ , spiniform	10μ , setiform

The differences observed between these two new species appear to be constant among the specimens studied, without overlap. The swollen prosome in the female of *P. mesodesmatis* occurred in both ovigerous and nonovigerous specimens. Bocquet and Stock (1959) stated that the prosome in *Paranthesius* tends to become larger and more swollen with the age of the females, doubtless because of the pressure exerted by the ovaries. In the preserved specimens of *P. mesodesmatis* it was impossible to separate the females by age since there was no way of being certain that egg sacs in some cases had not accidentally been broken off. The single less tumid mature female mentioned above may represent an individual that had not yet produced egg sacs.

Literature Cited

Bocquet, C., and Stock, J. H.

1957. Copépodes parasites d'invertébrés des côtes de France, iv a-c: Le double parasitisme de *Sipunculus nudus* L. par *Myzomolgus stupendus* nov. gen., nov. sp., et *Catinia plana* nov. gen., nov. sp., copépodes cyclopoïdes très remarquables. Koninkl. Nederlandsch Akad. Wetensch., Amsterdam, Proc., ser. C, vol. 60, no. 3, pp. 410-431.
1958. Copépodes parasites d'invertébrés des côtes de France, vi: Description de *Paranthesius myricolae* nov. sp., copéode semi-parasite du Sabellidae *Myricola infundibulum* (Rénier). Koninkl. Nederlandsch Akad. Wetensch., Amsterdam, Proc., ser. C, vol. 61, no. 2, pp. 243-253.
- 1958a. Copépodes parasites d'invertébrés des côtes de France, viii: Le genre *Ischnurella* Pelseneer, synonyme de *Paranthesius* Claus (Cyclopoida, Lichomolgidae). Koninkl. Nederlandsch Akad. Wetensch., Amsterdam, Proc., ser. C, vol. 61, no. 5, pp. 604-609.
1959. Copépodes parasites d'invertébrés des côtes de France, x: Sur les espèces de *Paranthesius* (Cyclopoida, Lichomolgidae) du groupe des *Herrmannella*, associées à des pélecypodes. Koninkl. Nederlandsch Akad. Wetensch., Amsterdam, Proc., ser. C, vol. 62, no. 3, pp. 238-249.
- 1959a. Copépodes parasites d'invertébrés des côtes de la Manche, vi: Redescription de *Paranthesius anemoniae* Claus (Copepoda Cyclopoida) parasite d'*Anemonia sulcata* (Pennant). Arch. Zool. Exp. Gén., vol. 98, notes et revue, no. 1, pp. 43-53.

BRIAN, A.

1924. Parasitologia Mauritanica: Matériaux pour la faune parasitologique en Mauritanie: Arthropoda (1^{re} partie) Copepoda. Bull. Comité d'Études Hist. Sci. Afrique Occidentale Française, 1924 (July-September) pp. 4-66.

CANU, E.

1891. Les copépodes marins du Boulonnais, v: Les semi-parasites. Bull. Sci. France et Belgique, vol. 23, pp. 467-487.

CLAUS, C.

1889. Über neue oder wenig bekannte halbparasitische Copepoden, insbesondere die Lichomolgiden- und Ascomyzontiden-Gruppe. Arb. Zool. Inst. Univ. Wien, vol. 8, pp. 327-370.

EDWARDS, C. L.

1891. Beschreibung einiger neuen Copepoden und eines neuen copepodenähnlichen Krebses, *Leuckartella paradoxa*. Inaugural dissertation, University of Leipzig, pp. 1-33. Berlin.

GOTTO, R. V.

1961. A new lichomolgid copepod, and the occurrence of two little-known cyclopoids in British waters. Crustaceana, vol. 3, no. 2, pp. 85-92.

HEEGAARD, P.

1944. A new copepod (*Seambicornus hamatus*) parasitic on a Japanese holothurian. Vidensk. Medd. Dansk Naturh. Foren., vol. 107, pp. 359-366.

ILLG, P. L.

1949. A review of the copepod genus *Paranthessius* Claus. Proc. U.S. Nat. Mus., vol. 99, no. 3245, pp. 391-428.

KOSSMANN, R.

1877. Entomostraca (1. Theil: Lichomolgidae). Vol. 4 in Zoologische Ergebnisse . . . Reise in die Küstengebiete des Rothen Meeres, pp. 1-24.

MONOD, T., and DOLLFUS, R.-PH.

1932. Les copépodes parasites de mollusques. Ann. Parasitol. Hum. Comp., vol. 10, pp. 129-204.

NICHOLLS, A. G.

1944. Littoral Copepoda from South Australia (II): Calanoida, Cyclopoida, Notodelphyoida, Monstrilloida and Caligoida. Rec. South Australian Mus., vol. 8, no. 1, pp. 1-62.

NORMAN, A. M., and Scott, T.

1905. Crustacea Copepoda new to science from Devon and Cornwall. Ann. Mag. Nat. Hist., ser. 7, vol. 15, pp. 284-300.

PELSENEER, P.

1929. Copépodes parasites de mollusques. Ann. Soc. Roy. Zool. Belgique, 1928, vol. 59, pp. 33-49.

PESTA, O.

1909. Beiträge zur Kenntnis parasitischer Copepoden. Denkschr. Kais. Akad. Wiss., Wien, Math.-naturwiss. Kl., vol. 84, pp. 257-267.

REDDIAH, K.

1960. A new lichomolgid copepod, *Paranthessius colmani* n. sp., from the *Laevicardium crassum* (Gmelin) Lamellibranchiata-Cardiidae. Ann. Mag. Nat. Hist., 1959, ser. 13, vol. 2, no. 19, pp. 439-443.

REDDIAH, K., and WILLIAMSON, D. I.

1959. On *Modiolicola inermis* Canu and *Modiolicola maxima* (Thompson), lichomolgid copepods associated with pectinid lamellibranchs. Ann. Mag. Nat. Hist., 1958, vol. 13, no. 1, pp. 689-701.

SARS, G. O.

1918. An account of the Crustacea of Norway with short descriptions and figures of all the species, vol. 6: Copepoda Cyclopoida, parts 13 and 14: Lichomolgidae (concluded), Oncaecidae, Corycaecidae, Ergasilidae, Clausiidae, Eunicicolidae, Supplement, pp. 173-225. Bergen: Bergen Museum.

SCOTT, T.

1903. Notes on some Copepoda from the Arctic Seas collected in 1890 by the Rev. Canon A. M. Norman, F.R.S. Ann. Mag. Nat. Hist., ser. 7, vol. 11, no. 61, pp. 4-32.

SEWELL, R. B. S.

1949. The littoral and semi-parasitic Cyclopoida, the Monstrilloida and Notodelphyoida. In John Murray Expedition 1933-34, Scientific Reports, vol. 9, no. 2, pp. 17-199.

STOCK, J. H.

1964. On *Scambicornus* Heegard, 1944, a senior synonym of *Preherrmannella* Seymour Sewell, 1949 (Copepoda, Cyclopoida). Beaufortia, vol. 10, no. 123, pp. 183-192.

THOMPSON, I. C.

1897. Appendix: Note on dredging and tow netting in Puget Sound, Pacific Coast. *In* Herdman, W. A., Thompson, I. C., and Scott, A., On the plankton collected continuously during two traverses of the North Atlantic in the summer of 1897; with descriptions of new species of Copepoda; and an appendix on dredging in Puget Sound. *Trans. Liverpool Biol. Soc.*, vol. 12, pp. 33-90.

THOMPSON, I. C., and SCOTT, A.

1903. Report on the Copepoda collected by Professor Herdman, at Ceylon, in 1902. *In* Herdman, Report to the Government of Ceylon on the Pearl Oyster Fisheries of the Gulf of Manaar, pt. I, Suppl. Rept. no. 7, pp. 227-307.

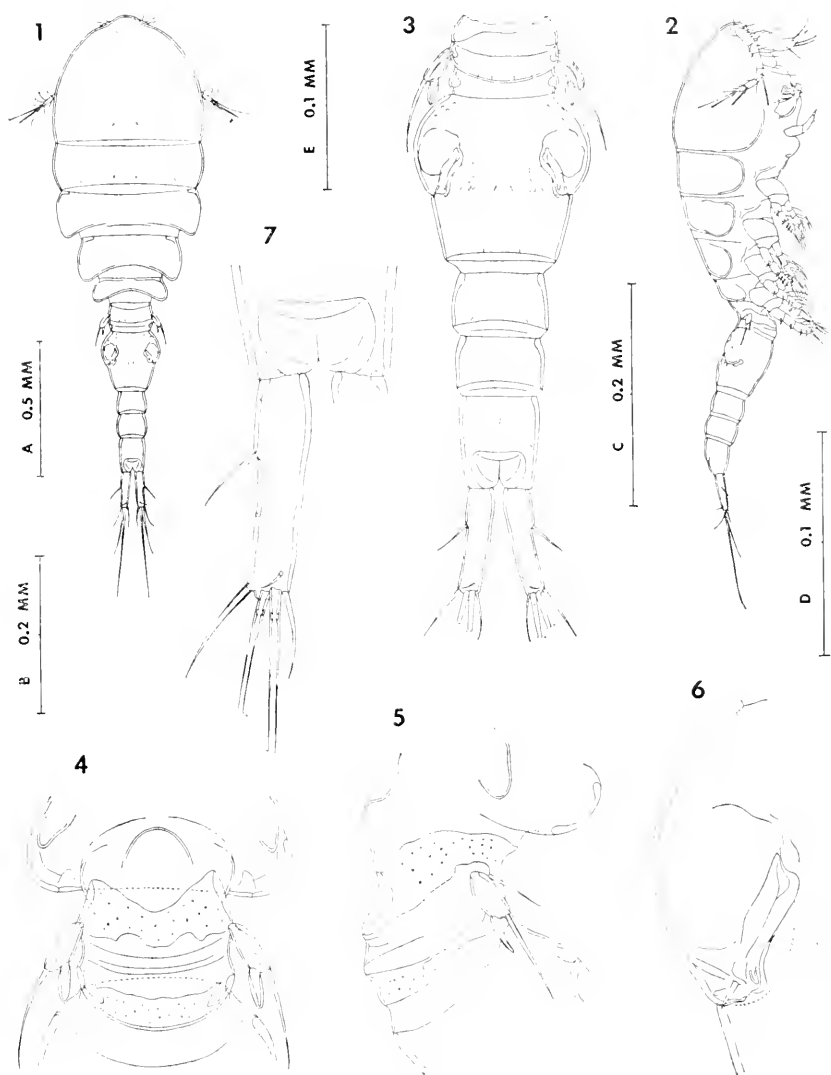

FIGURES 1-7.—*Paranthessius protothacae*, new species, female: 1, body, dorsal (A); 2, body, lateral (A); 3, urosome, dorsal (B); 4, segments of legs 4 and 5, ventral (C); 5, segments of legs 4 and 5, lateral (C); 6, area of attachment of egg sac, dorsal (D); 7, caudal ramus, dorsal (E).

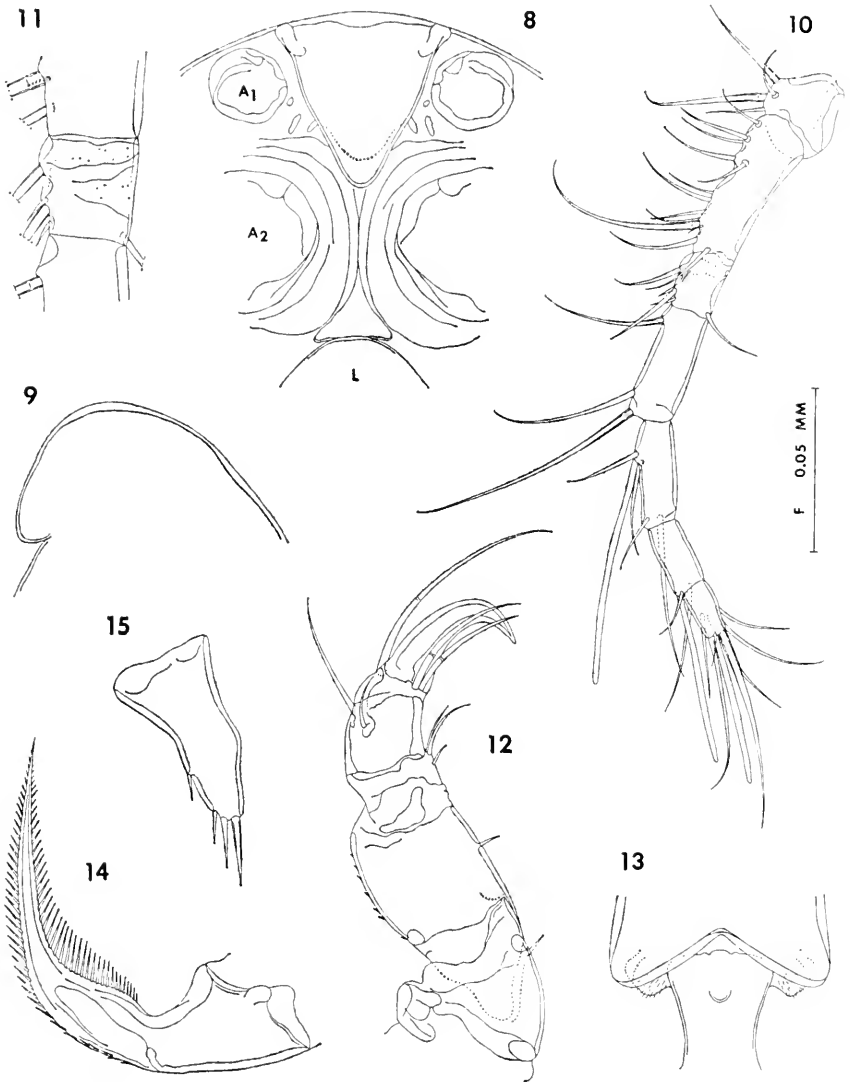

FIGURES 8-15.—*Paranthessius protothacae*, new species, female: 8, rostrum, ventral (E); 9, outline of rostrum, lateral (F); 10, first antenna, dorsal (E); 11, third segment of first antenna, ventral (F); 12, second antenna, posterior (E); 13, edge of labrum, paragnaths, and lingua, ventral (E); 14, mandible, posterior (F); 15, first maxilla, anterior (F).

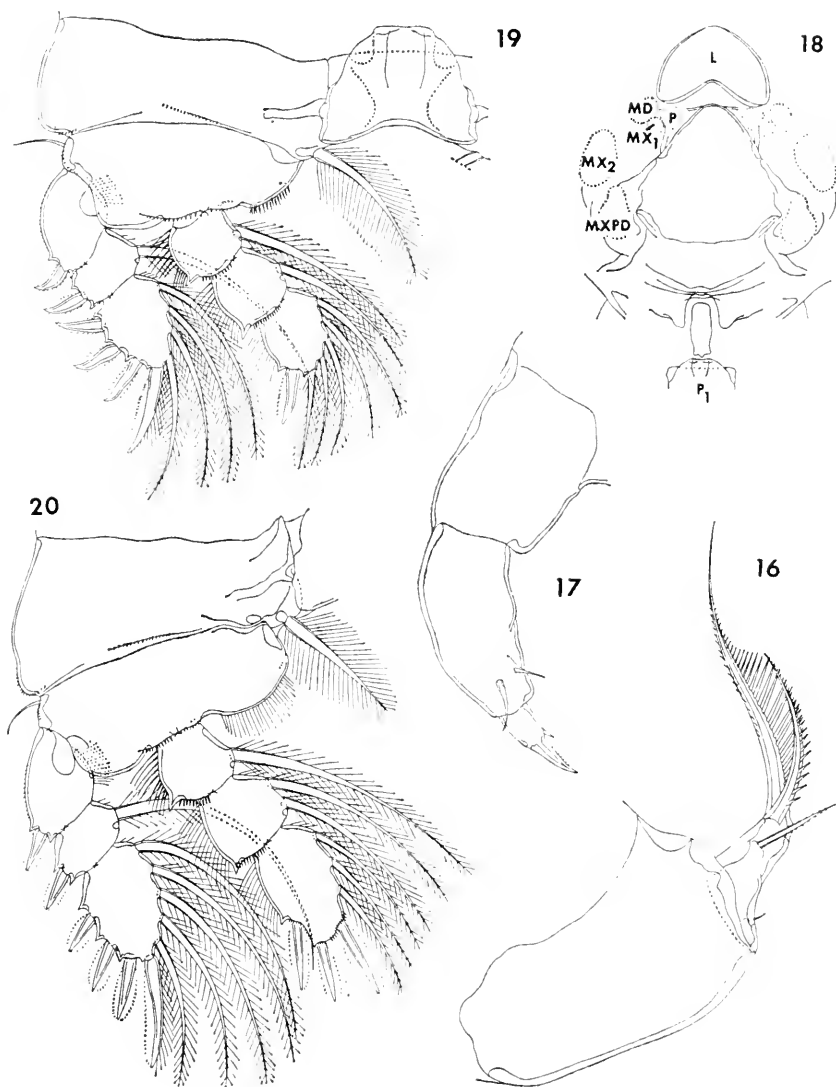

FIGURES 16-20.—*Paranthessius protothacae*, new species, female: 16, second maxilla, inner (F); 17, maxilliped, antero-inner (F); 18, oral and postoral area, ventral (B); 19, leg 1, anterior (E); 20, leg 2, anterior (E).

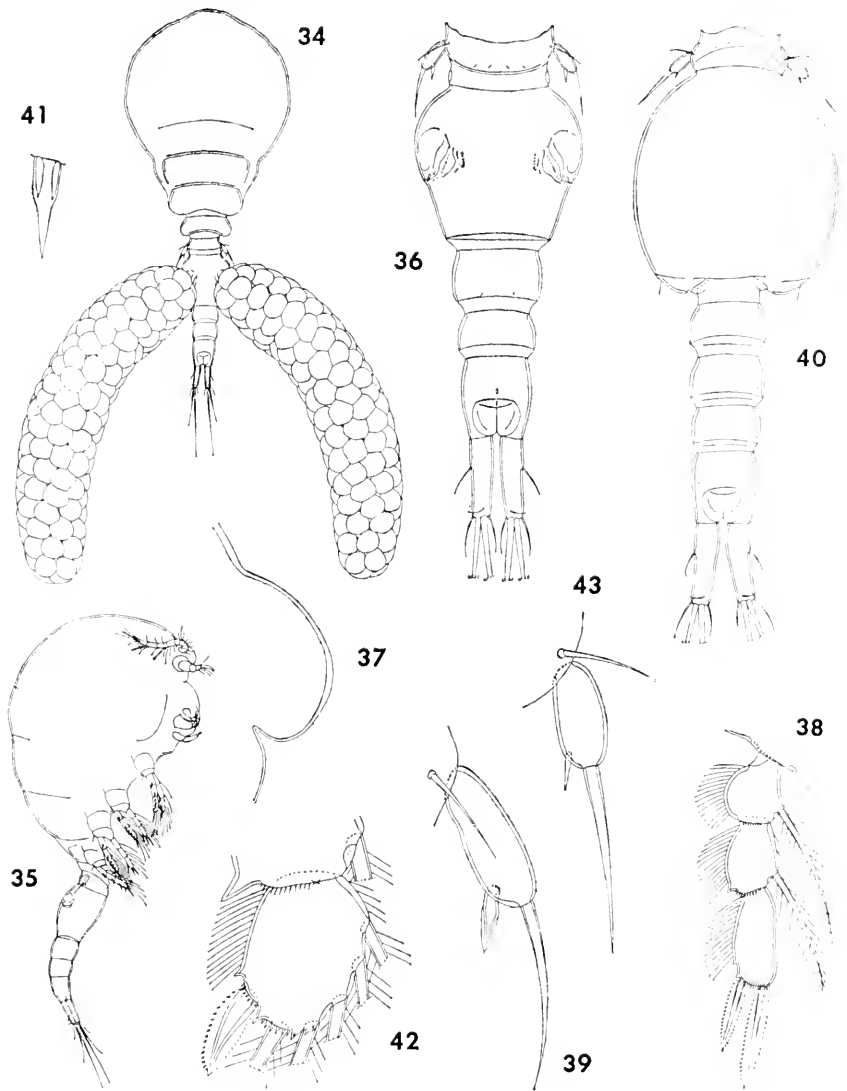

FIGURES 34-43.—*Paranthessius mesodesmatis*, new species, female: 34, body, dorsal (A); 35 body, lateral (A); 36, urosome, dorsal (B); 37, outline of rostrum, lateral (E); 38, endopod of leg 4, anterior (E); 39, leg 5, dorsal (F). Male: 40, urosome, dorsal (B); 41, innermost seta on second segment of maxilliped, inner (G); 42, last segment of endopod of leg 1, anterior (F); 43, leg 5, dorsal (F).

Proceedings of
the United States
National Museum



SMITHSONIAN INSTITUTION • WASHINGTON, D.C.

Volume 124

1967

Number 3629

A Recharacterization
of *Collocalia papuensis* Rand,
the Three-toed Swiftlet

By Soekarja Somadikarta
National Research Council
Visiting Research Associate,
Department of Vertebrate Zoology¹

During a study of the swiftlet genus *Collocalia*, I noticed that the range of the species *C. whiteheadi* as currently understood is discontinuous and that one population, *C. w. papuensis*, generally considered as belonging to this species, differs from all other swiftlets in having only three toes.

Whitehead's swiftlet, characterized by a distinctly forked tail, uniformly dark back and rump, and naked tarsus, was described first from Lepanto, North Luzon, Philippine Islands, by Ogilvie-Grant in 1895 (p. 459), and since then there have been many reports of *C. whiteheadi* from various islands in the Philippines (McGregor, 1909, p. 353; Peters, 1940, vol. 4, p. 221; Delacour and Mayr, 1946, p. 126; and many others). It has also been recorded from New Guinea, Bismarck Archipelago (New Ireland), and Solomon Islands (Guadalcanal) but not from the intervening islands, the Celebes, Lesser Sundas, Moluccas, and western Papuan islands, or from Australia. All localities mentioned in this paper are shown in figure 1.

¹ Permanent address: Museum Zoologicum Bogoriense, National Biological Institute, Bogor, Indonesia.

A larger number of the New Guinea records belongs to the species to be recharacterized in this paper, and I believe the rest belong to what may prove to be another unrecognized species. The unique Guadalcanal specimen belongs to still another species, and the single specimen from New Ireland may be conspecific with it.

I am grateful to Dr. Dean Amadon, American Museum of Natural History (AMNH), and Mr. James D. Macdonald, British Museum (Natural History) (BMNH), for lending the crucial specimens used for this study. I am also indebted to Drs. S. Dillon Ripley and Alexander Wetmore for their advice and comments, to Dr. Richard L. Zusi for preparing the illustrations, and to Mrs. Mary LeCroy for providing the map and information on New Guinea specimens. I particularly wish to thank Drs. Dean Amadon, Paul Slud, George E. Watson, and Richard L. Zusi for their critical reviews aimed at improving the manuscript.

New Guinea Records

Ogilvie-Grant (1912, p. 283) was the first to report the presence of *C. whiteheadi* in New Guinea. This record was based on a single specimen from Parimau, Mimika River, western New Guinea, which he later described (1915, p. 190) as "easily distinguished from *C. lowi*, the only other species of this group approaching it in size, by having the tail distinctly forked and the tarsi entirely devoid of feathers."

Rothschild and Hartert (1913, p. 491) recorded a female *C. whiteheadi* from Mount Goliath (not less than 5000 ft.), Snow Mountains, western New Guinea. Mayr and Rand (1937, p. 76), discussing another female from Baroka, Hall Sound, southeastern New Guinea, stated: "This bird agrees with a female from Mt. Goliath (wing 139) taken at 5000 ft., and both differ from north Luzon birds in the paler, more grayish throat; in the north Luzon birds the throat is more nearly like the abdomen." They regarded *C. whiteheadi* as a subspecies of *C. lowi* (= *C. maxima lowi*, type-locality: Labuan Island, North Borneo; see Deignan, 1955a) without giving any reason. Neither *C. m. maxima* nor *C. m. lowi* has ever been recorded from the Celebes, the Lesser Sunda Islands, the Moluccas, or the western Papuan islands.

Rand (1941, p. 10) described New Guinea *Collocalia* specimens from Hollandia (1 specimen) and the Idenburg River area (12 specimens) from sea level to 1800 meters altitude as a new subspecies, *C. w. papuensis*, including the single specimens from Mount Goliath and from Baroka as paratypes. The characters used by Rand to differentiate *C. w. papuensis* from nominate *whiteheadi* from North Luzon were "throat considerably paler, more silvery gray, contrasting with the brownish abdomen; and the upperparts slightly more iridescent."

He also noted that the "thirteen specimens from north New Guinea all have the tarsus fairly well feathered; the Mount Goliath bird has it unfeathered, as does the Baroka bird."

Mayr (1941, p. 85) listed *C. w. papuensis* with its range as given in the original description. Mayr and Gilliard (1954, p. 342) reported four later specimens of "*C. whiteheadi papuensis*" from the foothills of Mount O'-mar and Mount Orata, Kubor Mountains, east-central New Guinea. Three of these specimens that I was able to examine (2 skins and 1 spirit specimen) in the American Museum of Natural History have the tarsus bare. Another spirit specimen could not be located.

Iredale (1956, pp. 219-220) treated *C. papuensis* as a full species noting that one of its characters was a bare tarsus. He was apparently unaware that *C. w. papuensis* had been described from a composite series of specimens with feathered (including the type) and unfeathered tarsi. He also believed the similarity of *C. w. papuensis* to *C. w. whiteheadi* from Luzon to be only "coincidental, as so many local species are known in this group."

Salomonsen (1963, p. 510) named the bare-legged specimens from Mount Goliath, from Baroka, and from the Kubor Mountains, as a new subspecies, *C. w. nuditarsus*, differing from *C. w. papuensis* "in having a bare tarsus, completely devoid of feathers; also in having the upper-parts dull black, almost without any iridescence, the feathers of nape with blackish grey basis, not—or almost not—contrasting with the black tips; the colour of throat not differing from that of breast and abdomen, but the entire underparts being uniform sooty-brown, darker than in *papuensis*." He further (p. 511) stated: "The difference between *papuensis* and *nuditarsus* in the feathering of the tarsus is very striking. The differences in plumage coloration are constant and easy to be seen in all specimens."

I have examined Salomonsen's parotypic series (5 specimens in AMNH) and Ogilvie-Grant's specimen (1912) from Parimau, Mimika River. The Parimau and Mount Goliath specimens differ slightly from Baroka and the Kubor Mountains specimens in having more blackish brown feathers on the back. All appear closely related, but may represent two different populations of an unrecognized full species. This situation, however, requires further study. Rand and Gilliard, in their recent "Handbook of New Guinea Birds" (1967, p. 277), still consider *C. w. papuensis* to be the only population of *C. whiteheadi* that occurs in New Guinea.

Medway (1966, pp. 162-164), in a review of field characters in the genus *Collocalia*, mentioned neither *C. w. papuensis* nor *C. w. nuditarsus*. He treated *C. whiteheadi* not as a distinct species but as a race of *C. brevirostris* (type-locality: Assam; Horsfield, 1839; see also

McClelland, 1839, and Deignan, 1955b), as had Stresemann (1926) because of the "intermediate [systematic] position" of *C. inopina* (type-locality: Ma-fu-ling, Hupeh, China; Thayer and Bangs, 1909) and the similarities in nest structure.

All authors who have discussed *C. w. papuensis*, however, have overlooked one very important character. The type and paratypes (examined in the American Museum of Natural History and the Bogor Museum) from Hollandia and the Idenburg River area have three toes instead of four.

I believe the three-toed birds represent a full species, which is characterized thus below.

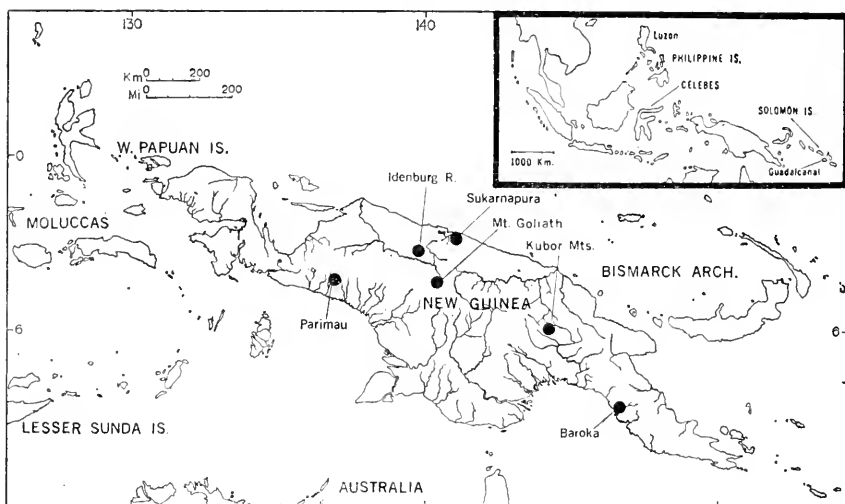

FIGURE 1.—Localities in New Guinea from which *Collocalia papuensis* and "*C. whiteheadi*" have been secured.

Collocalia papuensis Rand

THREE-TOED SWIFTLET

Collocalia whiteheadi papuensis Rand, 1941, American Mus. Novit., no. 1102, p. 10.

HOLOTYPE.—AMNH 305670, ♂ ad., 1800 m altitude, 15 km southwest of Bernhard Camp on Idenburg River, Netherlands New Guinea (now West Irian); Jan. 20, 1939; collected by Richard Archbold, A. L. Rand, and W. B. Richardson (original no. 9049).

SPECIMENS EXAMINED.—13. Hollandia: 1 ♀, July 11, 1938; Bernhard Camp, 50 m: 7 ♂♂ and 2 ♀♀, Mar. 23–May 3, 1939; Bernhard Camp, 850 m: 1 ♂, Apr. 9, 1939; 15 km southwest of Bernhard Camp, 1800 m: 1 ♂ and 1 ♀, Jan. 20, 1939. This is the same paratype series that was available to Rand.

SPECIFIC CHARACTERS.—Three toes (hallux lost) instead of four; a character unique in the genus. Tarsus densely feathered; upper parts dark fuscous brown, slightly iridescent; crown and back with white concealed barbs; feathers around the neck paler than back and crown; bases of feathers forming supraloral spot, light brownish grey contrasting with their black shafts and tips; throat silvery grey, abdomen grayish brown; dark shafts pronounced on feathers of abdomen and undertail coverts, tenth primary shorter than eighth.

MEASUREMENTS (mm).—Wing (chord): 9 ♂♂, 119.5–136.5 (129.5); 4 ♀♀, 125.0–136.0 (131.6); type, 126.0. Central tail feathers: 9 ♂♂, 45.5–51.0 (48.2); 3 ♀♀, 48.5–50.5 (49.6), type, 48.0. Outermost tail feathers: 9 ♂♂, 48.5–56.5 (52.4); 4 ♀♀, 49.0–53.0 (51.7); type, 52.0. Tail furcation (difference between longest and shortest rectrix): 9 ♂♂, 3.0–5.5 (4.2); 3 ♀♀, 2.5–3.5 (3.0); type, 4.0.

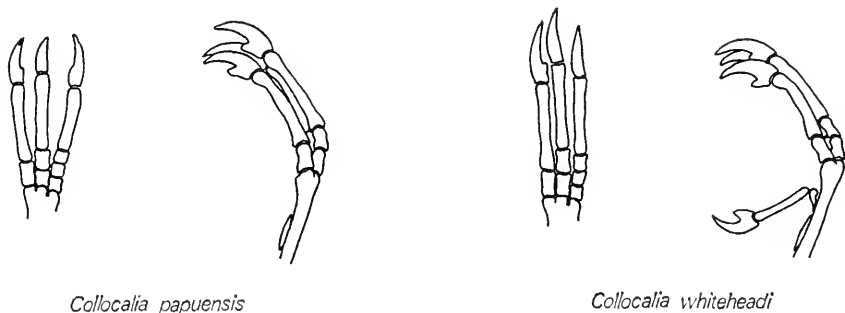

FIGURE 2.—Front and side views of bones of the foot in *Collocalia papuensis* and *C. whiteheadi* drawn from X-rays. Splint of bone along tarsus of both species is a sesamoid of the flexor tendons.

RANGE AND HABITAT.—Known from Sukarnapura (Hollandia) and the Idenburg River area between sea level and 1800 meters in the western part of New Guinea (now West Irian).

According to Rand (1942, p. 459), *C. w. papuensis* was common at Bernhard Camp, where it fed in parties of 20 to 30 birds. The flocks were usually too high to permit collecting, but occasionally they came low over the marshes; *Chaetura novaguineae* often and *Collocalia vanikorensis* sometimes fed with them (see also Rand and Gilliard, 1967, p. 278).

REMARKS.—The primaries of the birds from the Idenburg River area are in molt (primary scores 35 to 100; see Newton, 1966, p. 43) in descending mode from the first (inner) primary (see Stresemann and Stresemann, 1966, pp. 407, 410); the primaries of the Hollandia specimen are fresh (July 11), but its central tail feathers are in molt.

The second toe on both feet of one male specimen from Idenburg River (AMNH 339915) is abnormal. It has only two phalanges and lacks the claw. An X-ray shows that the tip of the second phalanx is rounded and spongy.

Forbes (1882), Mayr (1945a, p. 106), Delacour (1951), Bock (1958), and Bock and Miller (1959) gave examples of related species of birds with three and four toes. I agree with the opinion that the mere loss of one toe is not in itself sufficient reason for separating generically two species that differ only slightly in other characters. The three-toed swiftlet is such a case. It agrees with the other species of *Collocalia* in all other characters including phalanx formulae (3, 4, 5; see fig. 2) of its remaining toes and in having seven secondaries.

Other "*C. whiteheadi*" Records

There remains to be discussed the *C. whiteheadi* records from the Bismarck Archipelago and the Solomon Islands. Mayr (1935, p. 3) described a single specimen from Guadalcanal as *C. lowi orientalis* differing from "*C. lowi whiteheadi*" in being "much darker and with a pale rump; tarsus with a few feathers. . . ." He later (1945b, p. 238) included *C. l. orientalis* as a race of the species *C. whiteheadi* (see Peters, 1940, vol. 4, p. 222). I prefer, for the present, to consider *C. orientalis* as a separate species because it differs from *C. papuensis*, *C. nuditarisus*, and *C. whiteheadi* (North Luzon) in having a pale rump, the fourth toe and tarsus thinly feathered, and a less curved bill.

Salomonsen (1963, p. 511) regarded *C. w. orientalis* as a race of *C. whiteheadi* along with *C. w. nuditarisus*. In the same paper he described the unique specimen from New Ireland as *C. w. leletensis*, diagnosed as follows: "Tarsus unfeathered as in *nuditarisus*, and the colour of the under-parts is also exactly similar to that in *nuditarisus*. *C. w. leletensis* differs, however, strikingly from *nuditarisus* in having a grey, contrasting band across the rump and, also, in having a much stronger and darker bluish gloss on the upper-parts." He also pointed out that *C. w. orientalis* differs from *C. w. leletensis* "in having much broader (double as broad) and slightly paler grey rump band; colour of upper-parts exactly as in *nuditarisus*, without the dark, bluish gloss of *leletensis*; colour of under-parts as in two preceding forms [*nuditarisus* and *leletensis*]; tarsus thinly feathered."

Although I have not examined the type, I believe that the pale rump indicates the specific affinities of *C. w. leletensis* better than tarsal feathering and that it is best treated as conspecific with *C. orientalis*.

Literature Cited

- BOCK, W. J.
1958. A generic review of the plovers (Charadriinae, Aves). Bull. Mus. Comp. Zool., vol. 118, pp. 27-97.
- BOCK, W. J., and MILLER, W. DEW.
1959. The scansorial foot of the woodpeckers, with comments on the evolution of perching and climbing feet in birds. American Mus. Novit., no. 1931, pp. 1-45.
- DEIGNAN, H. G.
1955a. The identity of *Collocalia maxima* Hume. Bull. British Orn. Club, vol. 75, pp. 82-83.
1955b. The races of the swiftlet *Collocalia brevirostris* (McClelland). Bull. British Orn. Club, vol. 75, pp. 116-118.
- DELACOUR, J.
1951. The significance of the number of toes in some woodpeckers and kingfishers. Auk, vol. 68, pp. 49-51.
- DELACOUR, J., and MAYR, E.
1946. Birds of the Philippines, xv+309 pp., with line drawings. New York: MacMillan & Co.
- FORBES, W. A.
1882. Exhibition of, and remarks upon, some preparations showing the rudimentary hallux of several birds commonly described as three-toed. Proc. Zool. Soc. London, pp. 548-549.
- HORSFIELD, T.
1839. Communication to the Society of Mr. McClelland's List of Mammalia and birds collected in Assam. Proc. Zool. Soc. London, pp. 146-167.
- IREDALE, T.
1956. Birds of New Guinea, etc., vol. 1, xv+230 pp., col. pls., figs. Melbourne: Georgian House.
- MAYR, E.
1935. Birds collected during the Whitney South Sea Expedition, xxx: Descriptions of twenty-five new species and subspecies. American Mus. Novit., no. 820, pp. 1-6.
1941. List of New Guinea birds: A systematic and faunal list of the birds of New Guinea and adjacent islands, xi+260 pp., map. New York: American Museum of Natural History.
1945a. In Delacour and Mayr, Notes on the taxonomy of the birds of the Philippines. Zoologica, vol. 30, pp. 105-117.
1945b. Birds of the southwest Pacific: A field guide to the birds of the area between Samoa, New Caledonia, and Micronesia, xix+316 pp., col. pls., line drawings. New York: The MacMillan Company.
- MAYR, E., and GILLIARD, E. T.
1954. Birds of central New Guinea: Results of The American Museum of Natural History Expedition to New Guinea in 1950 and 1952. Bull. American Mus. Nat. Hist., vol. 103, pp. 311-374.
- MAYR, E., and RAND A. L.
1937. Results of the Archbold Expeditions, no. 14: The birds of the 1933-1934 Papuan Expedition. Bull. American Mus. Nat. Hist., vol. 73, pp. 1-248, pl. 1, figs. 1-3.

McClelland, J.

1839. List of Mammalia and birds collected in Assam. Proc. Zool. Soc. London, pp. 146-167.

McGregor, R. C.

1909. A manual of Philippine birds, pt. 1: Galliformes to Eurylaemiformes, x + 412 pp. Manila: Bureau of Printing.

Medway, Lord

1966. Field characters as a guide to the specific relations of swiftlets. Proc. Linn. Soc. London, vol. 177, pp. 151-172, 2 pls., 2 text-figs.

Newton, I.

1966. The moult of the bullfinch *Pyrrhula pyrrhula*. Ibis, vol. 108, pp. 41-67.

Ogilvie-Grant, W. R.

1895. On the birds of the Philippine Islands, pt. 5: The highlands of the Province of Lepanto, North Luzon; With field-notes by John Whitehead. Ibis, pp. 433-472, pls.

1912. Notes on the birds collected by the B.O.U. Expedition to Dutch New Guinea: Appendix A, p. 263-302. In Wollaston, Pygmies and Papuans: The stone age to-day in Dutch New Guinea, xxiv+352 pp., illustr., map. New York: Sturgis & Walton Company. [Reprinted in Ibis, 1913.]

1915. Report on the birds collected by the British Ornithologists' Union Expedition and the Wollaston Expedition in Dutch New Guinea. Ibis, Jub. Suppl., no. 2, xx+329 pp., maps, pls., text-figs.

Peters, J. L.

1940. Check-list of birds of the world, vol. 4, xii+291 pp. Cambridge: Harvard University Press.

Rand, A. L.

1941. Results of the Archbold Expeditions, no. 32: New and interesting birds from New Guinea. American Mus. Novit., no. 1102, pp. 1-15.

1942. Results of the Archbold Expeditions, no. 43: Birds of the 1938-1939 New Guinea Expedition. Bull. American Mus. Nat. Hist., vol. 79, pp. 425-516.

Rand, A. L., and Gilliard, E. T.

1967. Handbook of New Guineabirds, x+612 pp., map, illustr. London: Weidenfeld and Nicolson.

Rothschild, W., and Hartert, E.

1913. List of the collections of birds made by Albert S. Meek in the lower ranges of the Snow Mountains, on the Eilanden River, and on Mount Goliath, during the years 1910 and 1911. Novit. Zool., vol. 20, pp. 473-527.

Salomonson, F.

1963. Whitehead's swiftlet (*Collocalia whiteheadi* Ogilvie-Grant) in New Guinea and Melanesia. Vidensk. Medd. Dansk. Naturh. Foren., København, vol. 125, pp. 509-512.

Stresemann, E.

1926. Beiträge zur Ornithologie der indo-australischen Region, II: Bruchstücke einer Revision der Salanganen (*Collocalia*). Mitt. Zool. Mus. Berlin, vol. 12, pp. 347-353.

Stresemann, E., and Stresemann, V.

1966. Die Mauser der Vögel. Journ. Orn., vol. 107, spec. no., viii+445 pp.

Proceedings of
the United States
National Museum



SMITHSONIAN INSTITUTION • WASHINGTON, D.C.

Volume 124

1967

Number 3630

Revision of the Milliped Genus *Cleptoria*
(Polydesmida: Xystodesmidae)

By Richard L. Hoffman¹

The present paper is concerned with a small group of xystodesmids occurring in Georgia, South Carolina, and Alabama. There is no doubt that these forms are closely related and comprise a homogeneous entity. There is, however, a very real problem concerning the formulation of an opinion about their relative taxonomic status. As will be subsequently pointed out, it is becoming increasingly difficult to draw suitable definitions for several nominal genera set up for American xystodesmids in recent years, genera that were initially distinct only because they happened to be monotypic or contained only a few species.

In the present instance, some students of Diplopoda will surely contend that the species here treated as the genus *Cleptoria* cannot be set off precisely from other groups of southeastern xystodesmids and should at most be given the status of a "species-group." While I admit that this contention is probably a valid one, it seems in the present state of our knowledge that the designation of such groups by a generic name makes it slightly easier to categorize them for convenience in classification. Later, when the fauna has been thoroughly developed and all of the species accounted for, it will

¹ Department of Biology, Radford College, Radford, Va.

be appropriate to re-evaluate these groups and adjust their status in the hierarchy accordingly. In the meantime, we must go ahead with the procedure that is more expedient in accomplishing the initial goals.

The preliminary work upon which the following synopsis is based was done more than a decade ago and forms the basis for the arrangement of the genus in the "Checklist of the Millipeds of North America," in which three valid species were recognized. Present departure from this arrangement lies in the addition of two new species and a new subspecies, the transfer into *Cleptoria* of a form originally described in *Signoria*, and the transfer out of *Cleptoria* of one species into a new genus as yet unpublished. Surprisingly few specimens have been available for study despite the extensive field work done by Leslie Hubricht in the southeastern States.

The first species referable to the genus *Cleptoria* as currently conceived was described by C. H. Bollman in 1889, under the name *Fontaria rileyi*, on the basis of a single male taken at Macon, Ga., by L. M. Underwood. The male gonopods were not illustrated, but the descriptive phrase "terminal end subsimilar to a bird's head" made it possible for Dr. R. V. Chamberlin to associate *F. rileyi*, in the original proposal of *Cleptoria* (1939), with his type-species *C. macra*. In 1943, *C. macra* was synonymized under *C. rileyi* by H. F. Loomis, who had seen Bollman's type-specimen and had felt that the two nominal species were identical; in the following year (1944) Loomis described *C. shelfordi*. Since then, no further published references pertaining to the genus have appeared other than the "Checklist" (1958), in which *C. macra* is reinstated as a valid species without comment. In the same paper, however, in which *Cleptoria* was proposed, Chamberlin also described a species under the name *Signoria divergens*; more recently, I (1950) added an additional form, *S. nigrescens*, that has an obvious affinity to *S. divergens*. A restudy of both of these forms indicates that the relationship between them is subspecific at best and that *S. divergens* should be transferred to *Cleptoria*.

I have been fortunate in being able to restudy the type-specimens of all of the species mentioned above. Dr. R. V. Chamberlin (RVC) very kindly lent the types of *C. macra* from his personal collection in 1948 and facilitated their re-examination in 1963. Dr. P. J. Darlington kindly allowed access to the type of *C. shelfordi* at the Museum of Comparative Zoology during a visit of mine in 1949. The collection of the U.S. National Museum, under the care of Dr. Ralph E. Crabill, contains not only the type of *Fontaria rileyi*, but specimens of a related form from Alabama that had been recognized as new and so labeled by O. F. Cook over 60 years ago.

I have been able to secure only one member of the genus through personal collection, and all of the new material at hand springs from the unflagging diligence of Leslie Hubricht, who has generously sent me material of all of the species here considered valid, including the two undescribed forms. It would not be incorrect to state that our expanding knowledge of American diplopods is due in large measure to Mr. Hubricht's skill as a collector and his willingness to devote time and effort to the collection of specimens outside of his own special area of interest.

My own field experience with *Cleptoria divergens* has been implemented by grants administered by the Highlands Biological Station. The synthesis was commenced at the U.S. National Museum in 1959 and completed at Radford College in 1963 with the support of grants (G-9805 and G-21519) from the National Science Foundation.

Taxonomic Characters

GONOPODS.—As usual, the gonopods offer specific characters of primary importance in the recognition of species. Attention may be called to one feature that is somewhat more variable and significant than in other related xystodesmid genera: the course of the seminal groove on the distal half of the telopodite.

Basically, the telopodite in *Cleptoria* is rather short and massive, and usually bent nearly at a right angle or strongly curved (in *C. divergens*), as shown in figures 7, 9, 14, and 18. The prefemoral area is small and either mutic or with only a small spur on the lateral side. The abruptly narrowed and compressed femoral region, where the angulation occurs, usually has a rather distinct flange-like lateral edge, most distinctive in *C. macra* (fig. 6), where it comes to a prominent angular termination. The distal third of the telopodite has a characteristic appearance ("shaped like a bird's head . . ." in the opinion of Bollman) in that the apex is strongly recurved proximad, usually with a prominent rounded enlargement on the outer surface. This distal change in direction is strongly reflected by the course of the seminal groove, which runs out on the inner side of the femoral flange and then turns proximad at about a right angle. In several species, such as *C. rileyi*, *C. abbotti*, and *C. divergens*, the extreme end of the distal area is convex and striate on the lateral side, forming a kind of short, heavy solenomerite. This area is flat and smooth in *C. bipraesidens* and *C. macra*. In *C. macra* also, the seminal groove runs along the outer edge of the basal postfemoral region instead of its approximately medial location in the other species.

In *C. abbotti* the prefemoral region is unusually enlarged and the postfemoral elements considerably reduced in size; the telopodite in this species accordingly is about the most massive in form that I

have seen in the family. The subterminal outer postfemoral lobe not only is enlarged but also is reflexed somewhat proximad toward the seminal groove and is overhung partially in that area.

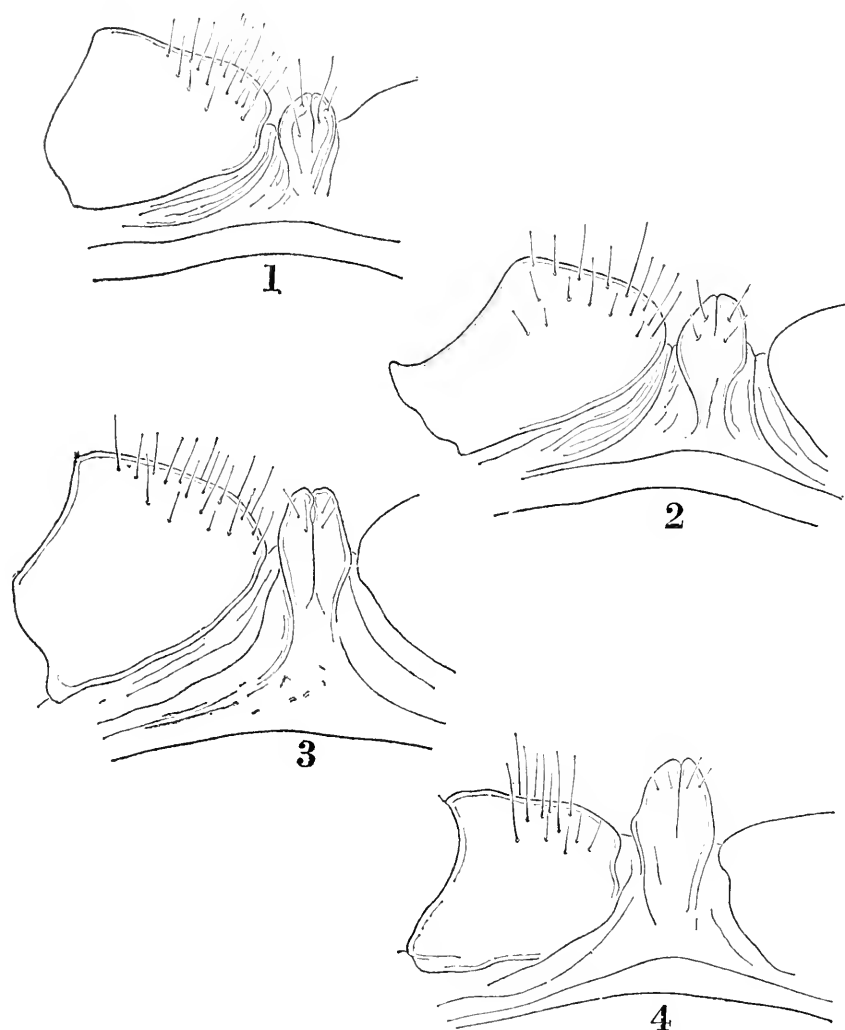

FIGURE 1-4.—Median sternal process of third segment, caudal aspect, in four species of *Cleptoria*: 1, *C. divergens*; 2, *C. rileyi*; 3, *C. macra*; 4, *C. abbotti*.

STERNA.—The sternum of the third segment in the male is modified by being produced distally into two elongate midventral lobes that are coalesced except for the extreme apices. As shown in figures 1-4, these sternal knobs extend ventrad almost as far as the ventral

surface of the coxae; they are longest in *C. macra* and shortest in *C. divergens*, in the latter of which they are of a size about normal for the family. These lobes are actually not sufficiently different in appearance to be useful in species diagnosis, but they do afford a secondary measure of specialization in the genus. Apparently their size is correlated with divergence in gonopod characters.

COLORATION.—The distribution of metatergal pigmentation is not yet well known enough to be discussed in any detail. The characteristic coloration for most of the species is that of a very dark brown dorsum with deep reddish paranotal spots and red legs. The holotype of *C. macra*, however, was recorded as having yellow spots. Whether this is a normal phenotypic variation is uncertain. In *C. bipraesidens* the paranotal red spots are linked by broad red crossbands on each metatergite. *C. divergens* and its nominal subspecies show an unusual pigmentation of intense bluish-purple or violet paranotal spots and crossbands, a coloration so far known only in two other species of xystodesmids.

Genus *Cleptoria* Chamberlin

Cleptoria Chamberlin, 1939, p. 9.—Chamberlin and Hoffman, 1958, p. 28.

TYPE-SPECIES.—*Cleptoria macra* Chamberlin, 1939, by original designation.

DIAGNOSIS.—A genus of large robust xystodesmids with the following characteristics:

Body composed of head and 20 segments in both sexes; relatively large and compact in form, W/L ratio varying from 23 to 26 percent. Head of normal appearance, smooth, polished, genae not or but moderately impressed, interantennal isthmus rather broad (up to one-fourth antennal length); facial setae reduced, epicranial, interantennal, and frontal setae absent. Epicranial suture distinct, not ventrally bifid. Antennae extending caudad to posterior edge of third metatergite; distally with four sensory cones, no other sensory structures.

Terga of body segments generally smooth middorsally, becoming coriaceous laterally toward and on paranota; latter broad, depressed, continuing slope of dorsum, peritremata broad, flattened, and elevated above adjoining discal surface; ozopores large and distinct, in normal sequence, opening dorsolaterally. Prozonites and metazonites of about same diameter, separated by fine, slightly elevated suture line at front side of stricture, latter shallow middorsally, becoming most sharply defined laterally at level of stigmata.

Posterior segments of typical appearance for family; hypoproct broadly rounded to transversely oval, with (usually) or without distinct median projection.

Sterna gradually but distinctly elevated, beginning flush with caudal edge of stricture, to form thin, overhanging transverse shelf between coxae of posterior pair of legs of each segment, this shelf usually flattened or depressed medially and produced into prominent subcoxal lobes ("bilobed sterna" of my 1965 classification). Each metasternum usually with a field of 6 to 10 setae adjacent to base of each posterior coxa and short transverse row of setae at base of each anterior coxa.

Legs moderately long and slender; coxae distally produced into small acute spines; prefemora with longer, slightly curved distal spines. Pretarsi (tarsal claws) slender, bisinuately curved, distinctly compressed, and with prominent carinae on dorsal side. Sides of segments nearly smooth, caudal edge of metazonite set off by fine elevated marginal ridge preceded by depression in most species. Stigmata large, pyriform-oval, subauriculate.

Anterior legs shorter and heavier in males but not otherwise modified. Sternum of third segment produced into prominent, bilobed process between third pair of legs; sternum of segment 5 with two pairs of small lobes or elevated areas between legs.

Gonopods unusually large and robust, projecting forward between legs of sixth segment, telopodites overlapping or interlocked. Coxae massive, subglobose, without dorsal apophysis, connected by membrane only, no sternal remnant evident. Prefemora small, with or without small subtriangular process on dorsal side, femora abruptly more slender, setose on lateral side, postfemoral element without evident differentiation, usually prominently enlarged and flattened, often with broad flange on medial side, apex recurved or bent proximad at angle, usually a smaller and more sharply defined apical projection carrying the seminal groove to the end.

Cyphopods massive, subquadrate in general outline (figs. 15, 16), receptacle forming at least a right angle and thus enclosing valves on at least two sides; valves large, distally excavate, and transversely striate; operculum small and displaced strongly proximad.

RANGE.—Piedmont physiographic province of southeastern United States, from west-central South Carolina, south into Georgia, west as far as extreme eastern Alabama (fig. 12).

SPECIES.—Five species, two of them having two subspecies each, are recognized as valid. One species, *C. shelfordi* Loomis (1944, p. 172), is removed herewith from *Cleptoria* pending relocation in another generic group so far unpublished. The members of *Cleptoria* appear to be localized, and several additional species are to be anticipated with further field work in Georgia.

Key to Species of *Cleptoria*

1. Telopodite of gonopod elongate, sigmoidally curved, the gonopods in situ usually interlocked distally; dorsum black with purple or violet paranota and crossbands **divergens** Chamberlin, p. 21

- Telopodite of gonopod short, massive, at most somewhat twisted, the gonopods in situ occasionally overlapping each other but never distinctly interlocked; dorsum blackish with markings of red or yellow 2
2. Gonopod with an acute, distinct prefemoral process 3
Gonopod without trace of prefemoral process 4
3. Prefemur exceptionally robust and massive in form; seminal groove running along middle of telopodite distally, terminating on a prominent convex retrorse solenomerite (fig. 14), subterminal lobe of telopodite prominent, rounded, abruptly reflexed toward the flexure of the seminal groove.
abbotti, new species, p. 18
- Prefemur of normal dimension; seminal groove running along the outer edge of the telopodite arc for a short distance, terminating on a small, flat, scarcely distinguishable solenomerite (fig. 6); subterminal lobe of telopodite distinct but not reflexed. **macra** Chamberlin, p. 7
4. Solenomerite short, broad, distinctly convex, the seminal groove paralleled by numerous fine but distinct striations **rileyi** Bollman, p. 11
Solenomerite elongate, relatively slender, flat and laminate.
bipraesidens, new species, p. 17

Cleptoria macra Chamberlin

FIGURES 3, 5, 6, 12

Cleptoria macra Chamberlin, 1939, p. 9, figs. 36, 37.—Chamberlin and Hoffman, 1958, p. 28.

Cleptoria rileyi Loomis, 1943, p. 393.

TYPE-SPECIMENS.—Male holotype and female paratype, RVC, from Taylors, Greenville County, S.C., collected by R. V. Chamberlin, Aug. 5, 1910.

DIAGNOSIS.—A relatively small member of the genus, paranotal spots reddish-pink (yellow), gonopod slender without prominent flange on medial face, seminal groove forming two right-angle turns, solenomerite small, short, not convexly elevated.

DESCRIPTION OF HOLOTYPE.—Body large, robust; length 50 mm, greatest width 12.0 mm; W/L ratio 24 percent; sides of body subparallel, segments 5–15 of approximately full width. Dorsum arched, paranota broad and interrupting slope of middorsum.

Head smooth and polished, slightly convex, facial surface nearly flat, epicranial suture distinct; genae convex, not margined, with only very faint median impressions; labral setae about 18, clypeal setae about 22, series extended onto lower end of genal margin. Vertigial, interantennal, and frontal setae not detected and presumably absent. Interantennal isthmus rather broad (25 percent of antennal length).

Antennae fairly long (7.5 mm) and slender, extending caudad to posterior edge of third segment. Article 1 subglobose with a few long setae on dorsal side, articles 2–6 subequal in size and shape, article 7 short, subconical, with four terminal sensory cones.

Collum large and broad, extending about 0.5 mm beyond ends of following tergite on each side, its surface smooth and polished, anterior

marginal ridge distinct. Anterior and posterior edges symmetrically tapering laterad to the rounded ends.

Paranota of segments 2-4 generally similar, paranota directed slightly cephalolaterad, anterior and posterior corners broadly rounded, lateral marginal swelling only slightly developed. Segments 5-15 similar, paranota more or less directly transverse, with peritremata larger and more strongly defined; anterior corners rounded, posterior corners subrectangular, becoming somewhat more acute on more caudal segments. Paranota depressed, moderately interrupting slope of dorsum, scapulae entirely marginal, dorsal surface with distinct coriaceous sculpture, each paranotum with distinct low ovoid swelling within scapular arc.

Peritremata distinct, broad, flattened, elevated above adjoining surface of paranota; pores large and distinct, set near middle of peritreme, opening dorsolaterad. Metatergites medially smooth, becoming coriaceous towards paranotal bases; prozonites smooth, slightly elevated above level of metatergites at middorsal region, but the two subsegments meeting at a common level further laterad and ventral. Posterior edges of paranota not margined.

Tergites of segments 16-19 becoming narrower, with paranota increasingly produced into acute angles, those of segment 19 forming short bluntly rounded lobes about 0.9 mm in length; width of segment 19 between paranotal bases 2.3 mm.

Epiproct of usual subtriangular outline, dorsally convex and wrinkled transversely; ventrally concave; with usual two transverse whorls of setae and four apical setae. Paraprocts slightly convex, smooth except for few oblique grooves on outer basal quadrant, mesial margins smooth and strongly elevated, setiferous discal tubercle small and located close to midlength of mesial margin. Hypoproct broadly rounded, paramedian setiferous, tubercles small and inconspicuous, median terminal projection not strongly developed.

Sides of metazonites mostly smooth except for distinctive oblique grooves extending caudoventrad toward legs from anterior end of paranota. Caudal edge of metazonite set off by fine but distinct elevated marginal ridge, preceded by a groove. Vertical low ridge above posterior legs of each segment, sometimes provided with few vaguely defined tubercles. Stricture broad, distinct, and well-defined down sides, its surface finely granular in contrast to smooth glossy surface of prozonite; structure narrowing to mere suture across sternal region, but with prozonite definitely elevated and slightly overhanging suture line.

Sternal surface of metazonites distinctly but gradually elevated behind stricture, forming thin, overhanging transverse ridge between coxae of posterior pair of legs, usually medianly flattened or depressed;

subcoxal lobes are distinct, but not precisely acute or spiniform; a small field of 6 to 10 setae adjacent to base of each posterior coxa, and a short transverse row of 4 or 5 setae running in from base of each anterior coxa.

Legs fairly long and slender, distal end of femora visible beyond paranota when extended laterad and viewed from above; coxae subtrapezoidal, slightly compressed, 1.25 mm in length and height, with small spine at ventodistal end; prefemora rather short, also compressed, 1.5 mm in length and 1.1 mm in height, ventrodistal spine conical, acute, about 0.75 mm long, curved slightly caudad; femora elongated, cylindrical, increasing in diameter from a narrow base, 2.75 mm in length, 0.37 mm in basal diameter, distal diameter 0.62 mm; postfemur, tibia, and tarsus each 0.40 mm in diameter and 1.0, 1.0, and 1.12 mm in length, respectively. Pretarsus slender, somewhat sinuately curved, distinctly compressed, with a large median and two smaller paramedian dorsal carinae, length about 0.37 mm. Length relationship of podomeres: $3 > 2 > 1 > 6 > 5 = 4$.

Anterior legs shorter and heavier than those at midbody, basal joints with dense long vestiture on ventral side. Sternum between third pair of legs produced into a median process of moderate size for the genus (fig. 3); sternum of segment 5 produced into two small digitiform lobes between fourth pair of legs, and into two broad, flat, elevated areas between fifth pair.

Gonopod aperture large and broadly oval, 4.5 mm wide and about 2.5 mm in length at median line, anterior margin distinctly indented across most of its width, prozonite reduced to narrow transverse strip in front of aperture.

Gonopods (figs. 5, 6) large, massive, compressed, extending forward between legs of segment 6, the ends slightly overlapping. Coxae attached by strip of membrane only, no distinct sclerotized sternal remnant. Coxa massive, subglobose, about as long as telopodital arc, without trace of coxal apophysis, with two macrosetae on dorsal side. Prefemur small, with usual basal enlargement set with long fine setae, a small but distinct, acutely conical prefemoral process originates on dorsal side. Femur (tentatively understood to include telopodite blade as far as setae occur) slender and flattened, strongly bent at middle by torsion of telopodite, which bends distal half both proximally and laterally, so that ventral lateral edge of outer femur is brought into a mesial position. Seminal groove running along middle of femur at base, but changing to lateral edge of telopodite and forming two nearly right-angle turns before running out onto slightly developed short solenomerite.

Color in life said to be blackish dorsally, with yellow paranotal spots.

VARIATION.—Second male, from Newberry County, S.C., is similar in all respects except that the dorsal surface is more distinctly coriaceous, the hypoproct is produced into a distinct median lobe, and the subcoxal spines are more definitely formed. The gonopods of this specimen are slightly more elongate than those of the type-specimen



FIGURES 5, 6.—*Cleptoria macra* Chamberlin, left gonopod of male holotype: 5, medial aspect; 6, dorsal aspect.

but do not differ in proportion or general appearance otherwise. This specimen in life had reddish paranotal spots as normal for the genus.

Newberry County is about 50 miles southeast of the type-locality of *C. macra*. It is possible that additional material will show that specimens from the two places differ consistently enough to receive subspecific recognition, but such action can certainly not be made or even predicted on the basis of only two specimens.

DISTRIBUTION.—*Cleptoria macra* so far is known from only two localities in central and western South Carolina; however, it almost certainly occurs also in adjacent parts of western North Carolina. Specimens have been examined as follows:

SOUTH CAROLINA: GREENVILLE COUNTY: Taylors, ♂ holotype, ♀ paratype, collected by R.V. Chamberlin, Aug. 5, 1910, RVC. NEWBERRY COUNTY: upland mixed woods, 5.5 miles north of Chappelle, 1♂, collected by Leslie Hubricht, May 21, 1960, RLH.

Cleptoria rileyi (Bollman)

This species originally was described (Bollman, 1888) in a very few lines that indicate little more than family characters, but because of the reference to the end of the male gonopod ("subsimilar to a bird's head") (p. 345) it was possible for Dr. Chamberlin to correctly suspect that *C. rileyi* was congeneric with his own *C. macra* when that name was proposed in 1939. It could not be known with certainty, however, that specific differences existed, and Chamberlin was able to contrast the two only by recourse to supposed differences in size and coloration. H. F. Loomis, who subsequently examined the type of *C. rileyi*, considered the two names to be synonymous, as the gonopods are indeed similar when seen under low magnification in situ. Having had the opportunity to study the types of both names, I can confirm their distinctness, which I think will be revealed by inspection of the gonopod drawings.

Specimens from eastern Alabama are obviously conspecific with typical *C. rileyi* but differ in details of the gonopod structure and, in my opinion, probably represent a recognizable terminal geographic race. O. F. Cook, who had studied one of the Alabama millipeds, had in fact even designated it as a full species by the manuscript name *Fontaria alabama*.

Cleptoria rileyi as a species differs from other members of the genus chiefly in gonopod characters as set forth in the foregoing key. The telopodite lacks all traces of a prefemoral process, the apical part of the postfemur is broadly lobate on the outer margin with the extreme distal end directed proximad toward the coxa, the solenomerite is convex and striate, and the seminal groove is bent at an acute angle.

The two presumptive subspecies of *C. rileyi* are best separated by small details of the telopodite form, as seen in medial aspect (cf. figs. 7 and 9):

- Postfemur with at most a very moderate marginal flange along the inner side; retrorse part of the apex relatively narrow and tapering (north-central and northeastern Georgia) **rileyi rileyi** (Bollman)
 Postfemur with a very prominent broad flange on the inner surface (fig. 9, pff); reflexed apical part of telopodite relatively much broader (east-central Alabama).
rileyi alabama, new subspecies

***Cleptoria rileyi rileyi* (Bollman), new status**

FIGURES 2, 7, 8, 12

Fontaria rileyi Bollman, 1889, p. 345.

Cleptoria rileyi.—Chamberlin, 1939, p. 9.—Chamberlin and Hoffman, 1958, p. 28.

TYPE-SPECIMEN.—Adult male holotype, USNM 2742, from Macon, Bibb County, Ga., collected by Lucien M. Underwood, August 1887.

DIAGNOSIS.—*Cleptoria rileyi* has been distinguished from its congeners under the species heading; the nominate subspecies contrasted with *C. r. alabama* by the characters cited in the above key couplet.

DESCRIPTION OF HOLOTYPE.—Length of body 40 mm (slightly contracted); width of sixth segment 11.0 mm, of twelfth segment 10.5 mm; of sixteenth segment 10.0 mm. W/L ratio 27 percent (probably closer to 25 percent); W/D ratio at segment 12 62 percent.

Head smooth and polished, slightly convex, facial surface nearly flat; genae not margined, with distinct median impressions; labral setae about 18, clypeal setae about 14, series extended onto lower parts of genal margins. Vertigial, interantennal, and frontal setae not detected. Interantennal isthmus broad (1.5 mm) and flat, 20 percent of antennal length.

Antennae fairly long (7.5 mm) and slender, extending caudad to posterior edge of third tergite. Article 1 subglobose with few setae on dorsal side, articles 2–6 subequal in size and shape (1.4 mm in length), article 7 very short, subconical, with 4 terminal sensory cones.

Collum broad, extending about 0.5 mm beyond ends of following tergite on each side, its surface smooth and polished, anterolateral marginal ridge distinct. Anterior and posterior edges symmetrically tapering laterad to ends.

Body segments from second caudad with paranota transverse, none swept forward, anterior corners broadly rounded, posterior either rectangular or with peritremata slightly projecting beyond caudal margin. Paranota depressed, only slightly interrupting slope of middorsum, scapulae strictly marginal, dorsal surface smooth or very minutely coriaceous, each paranotum with distinct ovoid swelling

within scapular arc. Peritremata distinct and elevated above adjoining surface of paranota even on second and third segments. Pores large and distinct, set near middle of peritreme, opening dorsolaterad. Metatergites medially smooth but becoming slightly coriaceous near base of paranota; prozonites smooth, slightly elevated above level of metatergites at middorsal region but the two subsegments meeting at a common level further laterad and ventrad. Posterior edges of paranota not margined.

Paranota of segments 16-18 distinctly acute triangular in shape, somewhat more coriaceous and with peritremata relatively more elevated than on preceding segments. Paranota of segment 19 in the form of small oblong-ovoid lobes.

Epiproct of usual subtriangular outline, dorsally convex and transversely wrinkled, ventrally concave; with usual two transverse whorls of setae and four terminal setae. Paraprocts nearly flat, smooth except for few oblique grooves on outer basal quadrants, mesial margins very distinct and strongly elevated. Hypoproct broad, semicircular in outline, paramedian setal sockets not set on raised tubercles and slightly removed from margins, no median projection formed.

Pleural surfaces mostly smooth except for distinctive oblique grooves extending caudoventrad toward legs from anterior end of paranota. Caudal edge of metazonite set off by a fine but distinct elevated marginal ridge, this becoming more distinct dorsally. Vertical low ridge above second legpair of each segment, sometimes with a few vaguely defined tubercles. Stricture broad, distinct, and well defined down sides, its surface very finely granular in contrast to smooth glossy texture of prozonite; furrow narrows down to broad suture across sternal region but with prozonite definitely elevated and slightly overhanging suture line.

Sternal surfaces distinctly but gradually elevated caudad behind stricture, almost horizontal between legs or even shallowly depressed, glabrous except for small field of setae near base of each coxa. No trace of production into subcoxal spurs or angles.

Legs fairly long (7.5 mm) and slender, distal end of femora visible beyond paranota when extended and viewed from above; coxae posterior to gonopods with very small ventral spines, these increasing in size caudally; prefemora with short acute spines. Podomeres becoming increasingly setose from nearly glabrous femur, tarsus with numerous ordinary setae and terminal group of larger and longer setae around base of pretarsus. Latter of normal size and shape for family, somewhat bisinuate and distinctly compressed, with large median and two smaller paramedian dorsal carinae. Lengths of podomeres in decreasing order: 3-6-2-5-4-1.

Anterior legs shorter and heavier than those at midbody, basal joints with dense long vestiture on ventral side. Sternum between third legpair produced into usual narrow apically bilobed process; sternum between fourth legpair with two small erect digitiform lobes; sternum between fifth legpair with two broad flat elevated areas.

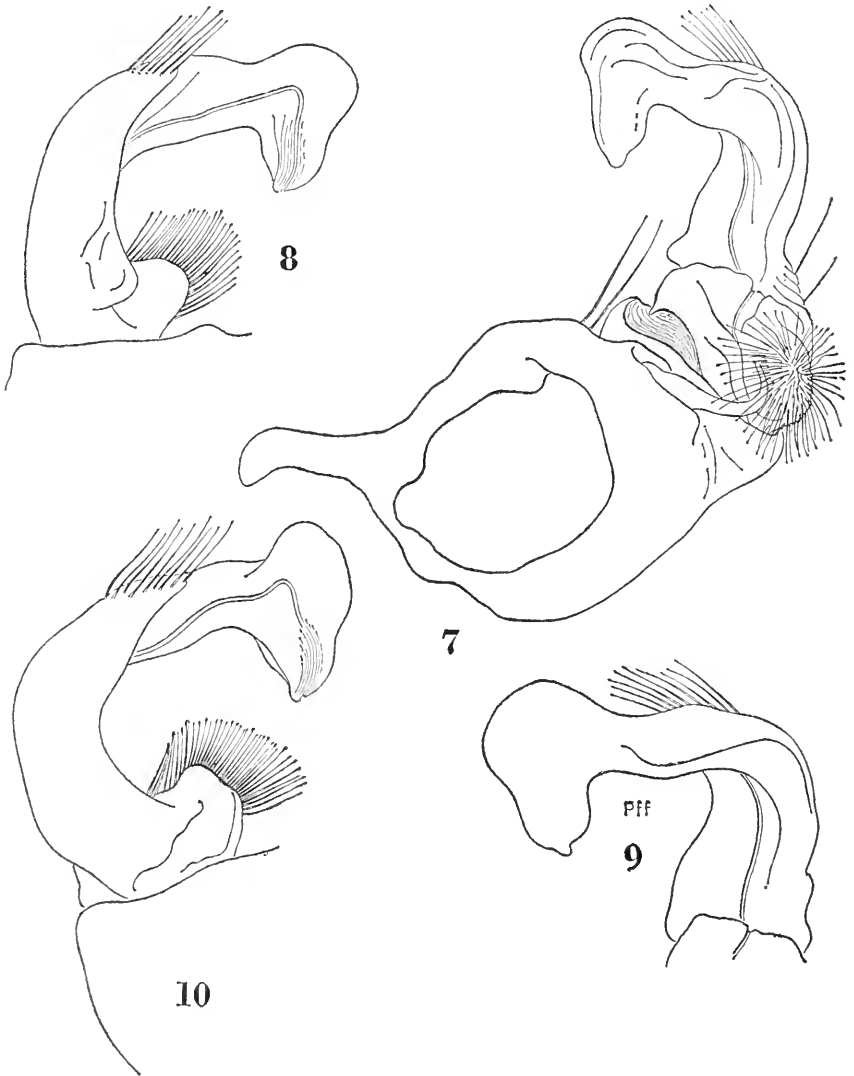

FIGURES 7-10.—*Cleptoria rileyi* (Bollman), male gonopods: 7, *C. r. rileyi*, medial aspect; 8, *C. r. rileyi*, dorsal aspect; 9, *C. r. alabama*, new subspecies, left gonopod, medial aspect; 10, *C. r. alabama*, left gonopod, dorsal aspect.

Gonopod aperture broadly oval, its lateral ends broadly rounded and extending laterad beyond both coxal sockets and stigmata. Lateral edges with rounded margins, anterior and posterior edges about level with adjoining segmental surface. Prozonite reduced to narrow transverse strip in front of aperture.

Gonopods large and massive, telopodites extending cephalomesad with apical halves usually overlapping. Each coxa subglobose, distally slightly produced into short subcylindrical portion at coxotelopodital joint; length of coxae, exclusive of sternal apodeme, about equal to length of telopodite. No coxal apophyses formed, upper side with two or three subterminal macrosetae in usual position. Prefemur globosely enlarged, about equally bisected by seminal groove into convex glabrous elevation on coxal side, and densely setose region on adcoxal side. No indication of prefemoral process evident. Femoral division of telopodite broad, compressed, with distinct projecting marginal lobe on coxal side; femur rather strongly curved at about midlength, bringing distal half of gonopod mesially over base, dorsal margin produced into wide thin flange. Femoral division terminated by distinct obliquely transverse constriction that is subtended by field of large setae, texture of postfemoral surfaces much smoother and more shiny. Postfemur apically bent proximad at more than right angle, outer edge of arc produced into large rounded lobe adjacent to bisecting axis of angle formed by seminal groove (fig. 7); distal half of postfemur strongly convex, forming elevated, striate ridge carrying seminal groove out to bluntly acuminate tip of gonopod. Mesal side of postfemur with small but distinct submarginal flange.

According to Bollman, the type-specimen shortly after preservation was dorsally brownish with red paranota, the antennae, legs, and underparts yellow. The several specimens in my collection, however, appear to have had yellow paranotal spots and yellow legs prior to preservation. Obviously, additional field observations are desirable to confirm this apparent polymorphism in coloration.

DISTRIBUTION—Central to northeastern Georgia, in the Piedmont region. There is so far a lacuna of nearly 100 miles between Macon, Ga., and Auburn, Ala. (where the species is represented by a geographic variant); certainly specimens eventually will be discovered in west-central Georgia also. The following material has been examined:

GEORGIA: BIBB COUNTY: Macon, ♂ holotype, collected by L. M. Underwood, August 1887, USNM. CLARKE COUNTY: wooded hillside, 9 miles west of Athens, 1 ♂, collected by Hubricht, May 6, 1961. PUTNAM COUNTY: upland oak woods, 6 miles northeast of Eatonton, 1 ♂, collected by Hubricht, May 7, 1960, RLH. LINCOLN COUNTY: 4.2 miles south of Lincolnton, 1 ♀, collected by Hubricht, May 1, 1960, RLH [agrees structurally with males of *C. rileyi* and is in the right geographic area to be this species].

Cleptoria rileyi alabama, new subspecies

FIGURES 9, 10, 12

HOLOTYPE.—Male, USNM 3245, also six male and female topoparatypes, from Auburn, Lee County, Ala., collected by O. F. Cook, July 1896.

DIAGNOSIS.—Similar to *C. r. rileyi* in most respects but differing in more strongly produced sternal areas and in details of gonopod structure, particularly appreciably larger flange of femoral portion as seen in mesal aspect (cf. figs. 9 and 10).

DESCRIPTION OF HOLOTYPE.—Length, ca. 44 mm, width of sixth segment 12 mm, of twelfth segment 12.8 mm, of sixteenth segment 11.0 mm; W/D ratio at twelfth segment 61 percent.

Agrees in details with description of *C. r. rileyi* but with following exceptions:

Collum not distinctly broader than following tergite.

Hypoproct with distinct median projection.

Podosterna more strongly modified, produced into subacute conical lobes between bases of posterior legs of each segment, but most distinctly developed on segments 8–14. Many of these segments also have sterna produced into low but distinct transverse ridge running mesally from base of coxa of each of anterior legs, these ridges carrying transverse row of setae noted for other subspecies. Interzonal furrow very pronounced down sides and deepest just in front of large, auriculate stigmata, edge of prozonite here emphasized as suberect, acute-edged flange.

Caudal edge of sides of segments set off by conspicuous elevated marginal ridge running from paranota down to upper end of coxal openings, becoming higher and more distinct ventrally, this ridge preceded by well-defined submarginal furrow similar to that of *Deltotaria brimleii*. Lower sides with short ridge just above coxae, variously denticulate and much more prominent than in two related subspecies.

Sterna between third legs produced strongly distad into medially sutured, apically somewhat divergent process, sternum between fourth legs with two processes as described for *C. rileyi* but these about twice as long, attaining level of ventral surface of adjacent coxae.

Gonopods generally similar to those of *C. r. rileyi* but somewhat more abruptly curved in femoral division and with adcoxal femoral flange larger and better defined; in mesal aspect tibiotarsal part of gonopod is distinctly more massive than corresponding area in *C. rileyi*.

DISTRIBUTION.—Known so far only from east-central Alabama. The following material, all topotypical, has been examined:

ALABAMA: LEE COUNTY: Auburn, ♂♂ ♀♀, types, collected by O. F. Cook, July 1896, USNM; 4.5 miles southwest of Auburn, 1 ♂, paratype, collected by L. Hubricht, Apr. 4, 1960, RLH.

Cleptoria bipraesidens, new species

FIGURE 11

HOLOTYPE.—Adult male, USMN 3246, from Jefferson, Jackson County, Ga., collected by Leslie Hubricht, Apr. 4, 1953.

DIAGNOSIS.—A species of Rileyi Group characterized by distal end of gonopod, which is slender and elongate and without striations parallel to seminal groove, and by color pattern of transverse red crossbands.

DESCRIPTION OF HOLOTYPE.—Length ca. 45.0 mm, width of sixth segment 11.0 mm, width of twelfth segment 11.0 mm, width of sixteenth segment 10.0 mm. L/W ratio 24 percent; W/D ratio at segment 12 59 percent.

Structural details in general as described for *C. rileyi* but with following exceptions:

Antennae slightly longer in proportion, 8.0 mm in length; inter-antennal isthmus wider, 1.7 mm, 21 percent of antennal length.

Collum not broader than following tergite.

Peritremata less distinctly elevated, somewhat broader and flatter than in *C. rileyi*, their lateral edges slightly sinuous on poriferous segments. Dorsal surface of paranota less coriaceous, nearly as smooth as middorsal area.

Paraprocts smooth but mesial margins elevated abruptly only along ventral half. Above level of marginal setae, margins only slightly elevated and merging gradually into discal paraproctal surface. Hypoproct broadly triangular in outline with distinct median projection.

Sterna produced into low but distinct subconical lobes at bases of posterior pair of legs, these lobes most distinctive on segments 8–14. Row of 3–6 large setae extending mesad from coxal base of each leg of anterior pair; sternal lobes between posterior legs of each segment carrying rounded field of about 12–18 setae, this arrangement constant for most segments.

Posterior edge of gonopod aperture distinctly elevated into high flange above intercoxal surface of segment 7. Gonopods similar to *C. rileyi* except that recurved distal part of telopodite is flat instead of strongly convex, distinctly more slender and elongated, and seminal grooved not paralleled by numerous striations.

Color in life black dorsally, with posterior corners of paranota, broad transverse band on caudal edges of metatergites, and circumference of collum red; underparts grayish white, legs pink basally, becoming reddish distally.

REMARKS.—This species so far is known only from the holotype, with the result that details of cyphopod structure, seasonal occurrence, and geographic range must await future discoveries for elaboration. There can be no doubt that *C. bipraesidens* is closely related to *C. rileyi*, but sufficient differences between the two insure specific separation.

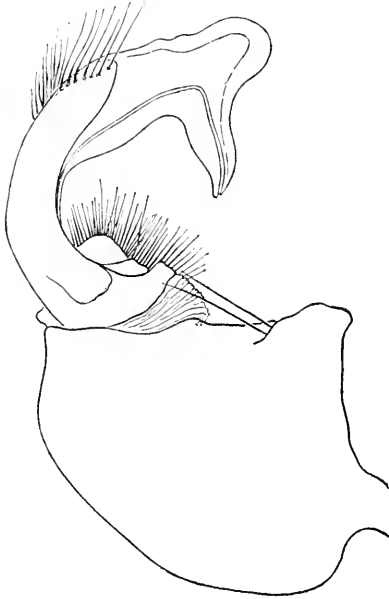

FIGURE 11.—*Cleptoria bipraesidens*, new species, left gonopod of male holotype, dorsal aspect.

***Cleptoria abbotti*, new species**

FIGURES 4, 12-16

TYPE-SPECIMENS.—Male holotype and female paratype, USNM 3103 (D-729), three male and three female paratypes (RLH), from 5 miles southwest of Waynesboro, Burke County, Ga., collected by Leslie Hubricht, May 22, 1960.

DIAGNOSIS.—Large member of genus with exceptionally short and massive gonopods, subapical rounded lobe of telopodite partly reflexed laterodorsad, apical lobe strongly convex and striated; sternal process between third pair of legs extending well beyond lower surface of adjoining coxae.

DESCRIPTION OF HOLOTYPE.—Adult male, length of body 49.5 mm (somewhat contracted), width of sixth segment 12.2 mm, of twelfth segment 12.8 mm, of sixteenth segment 11.3 mm. W/L ratio 26 percent; W/D ratio at segment 12 57 percent.

Structurally quite similar to *C. rileyi* with following exceptions: genae evenly convex without median impressions; antennae relatively shorter 8.4 mm, 65 percent of maximum body width as opposed to 71 percent in *C. rileyi*; interantennal isthmus relatively broader in proportion to antennal length, 24 vs. 20 percent in *C. rileyi*.

Dorsal surface of paranota essentially flat, lacking the median discal convexity of *C. rileyi* and other species. Ozopores opening dorsally on peritremata instead of somewhat dorsolaterally.

Hyproct with small but distinct median projection between setiferous tubercles.

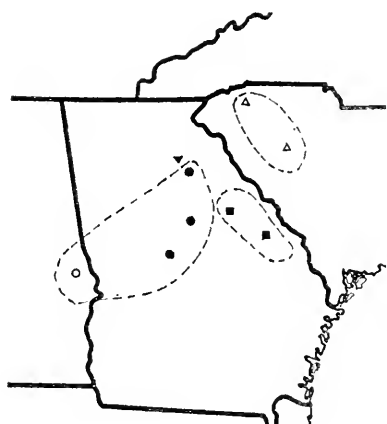

FIGURE 12.—Distribution of four species of *Cleptoria* in Georgia and adjoining areas of Alabama and South Carolina.

- | | |
|------------------------|--------------------------|
| △ <i>C. macra</i> | ▼ <i>C. bipraesidens</i> |
| ■ <i>C. abbotti</i> | ● <i>C. r. rileyi</i> |
| ○ <i>C. r. alabama</i> | |

Sternum between third pair of legs produced into unusually long, anteriorly curved, apically notched process (fig. 4).

Posterior edge of gonopod aperture forming compressed elevated rim distinctly higher than sternal surface behind it. Gonopods massive and robust, telopodite shorter than usual for genus, of the form shown in figures 13 and 14. Prefemur with erect subconical process; subapical rounded lobe reflexed somewhat proximad toward angle of seminal groove, solenomerite strongly convex and striated parallel to seminal groove; medial face of postfemur without a flange.

Specimens discolored by preservation but apparently dark brown dorsally in life, with paranotal spots and distal podomeres dark reddish pink.

PARATYPE.—Adult female, length about 46.3 mm, width of segment 6 11.9 mm, of segment 12 12.8 mm, of segment 16 11.5 mm; W/L ratio about 28 percent. Structurally similar to male except for usual sexual differences: shorter and more slender antennae, relatively broader sterna, and more slender legs.

Cyphopods rather massive, receptacle largest on median or posterior side, strongly ridged vertically, curving around in front of valves and slightly around to anterior or lateral side of latter (fig. 15). Valves

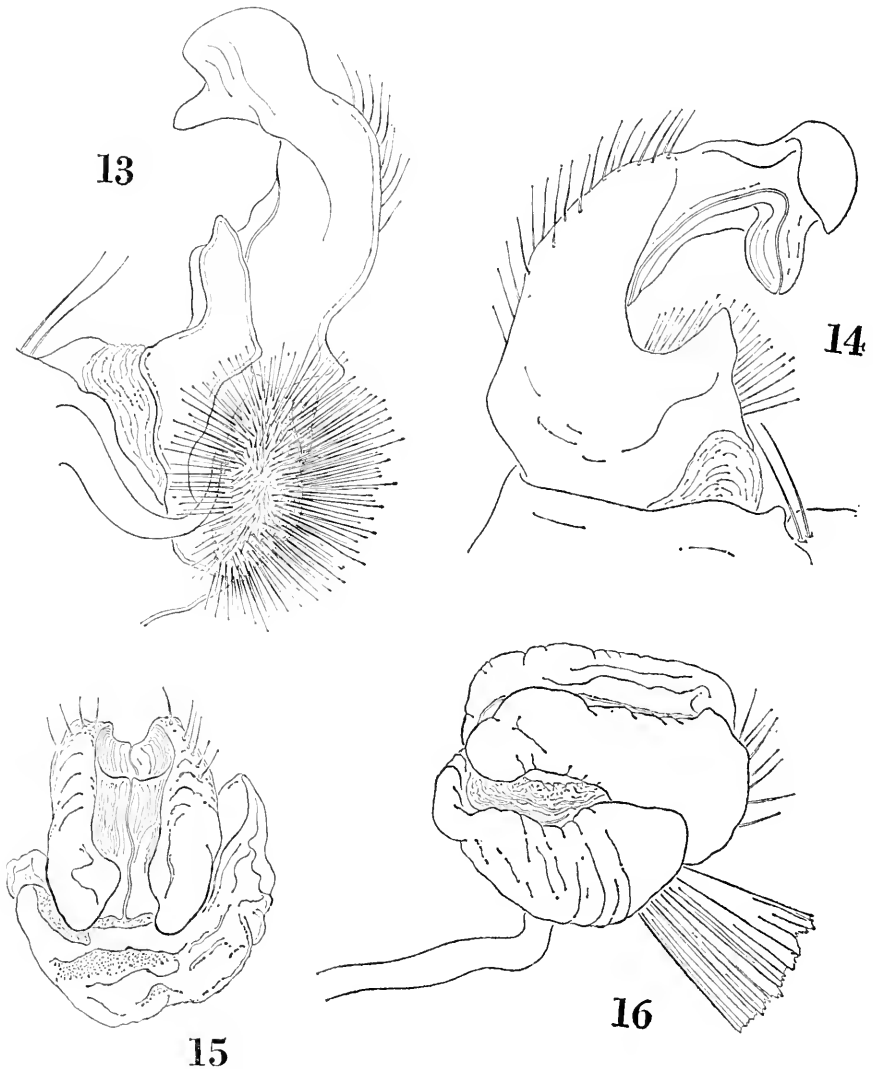

FIGURES 13-16.—*Cleptoria abbotti*, new species: 13, left gonopod of holotype, medial aspect; 14, same, dorsal aspect; 15, left cyphopod of female paratype, caudoventral aspect; 16, same, medial aspect.

essentially similar in size and appearance, largest basally, attenuated toward free ends, distally concave to enclose flat impressed surface traversed by median suture. Operculum small, concealed in dorsal and medial aspects, under convex basal ends of valves.

REMARKS.—In addition to the eight specimens from the type-locality, *Cleptoria abbotti* is known from a single male taken 2.8 miles north of Cadley, Warren County, Ga. (collected by L. Hubricht, May 30, 1960). Both of the localities are in the drainage system of Briar Creek, a tributary of the Savannah River. This area was for many years the residence of the early American amateur arachnologist John Abbott, and it seems entirely appropriate to associate Abbott's name with a species of milliped apparently endemic to the region in which he carried on his work.

Cleptoria divergens (Chamberlin), new combination

This moderate sized, somewhat disjunct species was described originally in *Sigmoria*, and, in fact, the male gonopod corresponds well to the diagnosis given for that genus: "Includes large, robust species which are characterized by the sigmoidally curved blade of the telopodite." By actual comparison, however, with typical sigmorias such as *S. munda*, *S. aberrans*, *S. mariona*, and *S. conclusa*, the gonopod of *S. divergens* assumes a quite different appearance. The termination of the telopodite, when seen from the correct perspective, is broadened considerably and provided with a large rounded subapical lobe quite reminiscent of that so characteristic of *C. rileyi* and *C. abbotti*. It seems preferable to me to reassign *S. divergens* to the genus *Cleptoria* although it is almost as "divergent" there as in *Sigmoria* and the species is unquestionably a credit to its name.

There is striking geographic variation in the color pattern of this relatively localized form. Chamberlin's types were black with red dorsal markings and legs; in going southwest along the Blue Ridge, the red pigment changes to an intense dark bluish purple that merges with the black ground color. As there is a small but distinctive geographic range occupied by these two variants, I think they may be distinguished by subspecific names as shown in the following key:

Metatergites nearly black with caudal margins and paranotal spots red; basal podomeres yellow, distal four reddish . . . *divergens divergens* (Chamberlin)
 Metatergites nearly black, with caudal margins and paranotal spots deep violet purple; legs whitish, reticulated with black . . . *divergens nigrescens* (Hoffman)

Cleptoria divergens divergens (Chamberlin), new status

FIGURES 1, 17-19, 21

Sigmoria divergens Chamberlin, 1939, p. 8, figs. 19-21.—Hoffman, 1950, p. 28.—Chamberlin and Hoffman, 1958, p. 49.

TYPE-SPECIMENS.—Male holotype and numerous topoparatypes, RVC, from Landrum, Spartanburg County, S.C., collected by R. V. Chamberlin, Aug. 4, 1910.

DIAGNOSIS.—With characters of the species, distinguished from *C. d. nigrescens* by presence of normal red pigmentation of metatergites and legs.

DESCRIPTION (male from Greenville Co., S.C.).—Length 43.7 mm, width of segment 6 10.0 mm, of segment 12 9.9 mm, of segment 16 9.8 mm. W/L ratio 23 percent; W/D ratio at midbody 65 percent.

Structural features essentially as in *C. rileyi* with following exceptions: interantennal isthmus slightly broader, 24 percent of antenna length instead of 20 percent; antennae about 7.5 mm long.

Paranota essentially transverse from segments 2 through 14; their dorsal surface nearly flat. Peritremata weakly set off from adjoining surface, continuous with caudal edge of paranota on segments 2 through 4. Paranota of segment 19 in form of subtriangular lobes.

Caudal sides of metazonites smooth and unmodified, lacking distinct marginal ridge, preceded by groove. No low ridge above posterior pair of legs of segments.

Sterna of metazonites with fairly distinct subcoxal acute lobes between legs of posterior pair. Coxae of legs posterior to gonopods with very prominent ventral spines; prefemora with moderately long acute distal spines.

Posterior edge of gonopod aperture forming distinctly elevated flange. Gonopods large, directed cephalad, telopodites interlocked in situ. Coxa without peculiarities, usual two macrosetae on dorsal side. Prefemur somewhat more elongated than in other species, with small acutely laminate process on dorsal side. Gonopod beyond prefemur forming sigmoidally curved acropodite without subdivisions evident; curvature first ventromedial, thence abruptly expanded with prominent lobation on the outer side, seminal groove running out onto small short "solenomerite" as seen in dorsolateral aspect (fig. 19), this terminal area corresponding closely in shape to telopodite ending in other species of genus with shorter and more massive gonopods.

Sternal processes of third segment somewhat shorter than in other species of *Cleptoria* (fig. 1).

Dorsum blackish, with caudolateral halves of paranota and transverse marginal band on each metatergite reddish; sides of segments whitish with vertical red stripe; basal podomeres yellowish, distal four segments pink.

DISTRIBUTION.—Foothills and eastern escarpment of Blue Ridge along western edge of Greenville County, S.C. Almost certainly it will be found in the adjoining North Carolina counties of Henderson and Rutherford; probably the valley of the French Broad River forms the northwestern boundary of the range (see fig. 21).

Specimens from the vicinity of Caesar's Head, S.C., appear to be intermediate both in gonopod form and color pattern with the nominal subspecies *C. n. nigrescens*; the locality is indicated on the map by an X. Specimens have been examined from the following localities:

SOUTH CAROLINA: SPARTANBURG COUNTY: Landrum, ♂♂ ♀♀, types, collected by R. V. Chamberlin, Aug. 4, 1910, RVC. GREENVILLE COUNTY: 1.5 miles east of North Carolina state line on U.S. Hy. 25, 1♂, 2♀, collected by L. Hubricht, June 24, 1950, RLH. PICKENS COUNTY: 1 mile west of Caesar's Head on U.S. Hy. 276, 4♂, collected by Hubricht, June 24, 1950, RLH [intergrades with *C. d. nigrescens*].

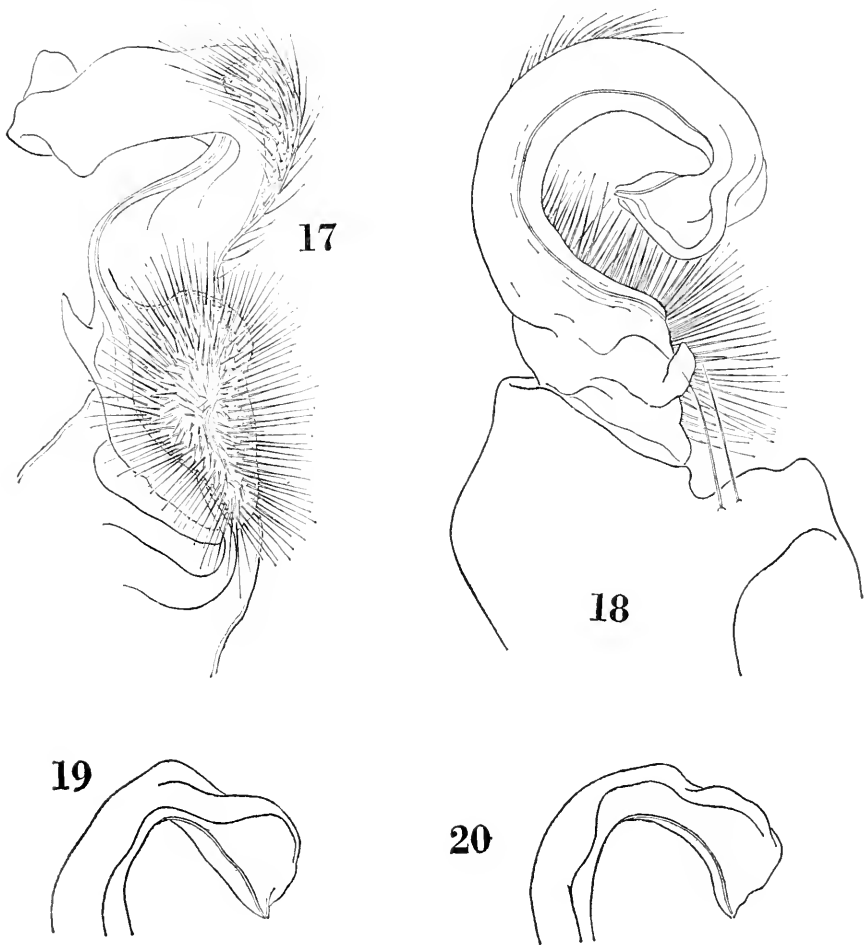

FIGURES 17-20.—*Cleptoria divergens* (Chamberlin): 17, *C. d. divergens*, left gonopod, medial aspect; 18, same, dorsal aspect; 19, same, apex of telopodite, caudolateral aspect; 20, *C. d. nigrescens* (Hoffman), caudolateral aspect of apex of telopodite.

Cleptoria divergens nigrescens (Hoffman), new combination, new status

FIGURE 20

Sigmoria nigrescens Hoffman, 1950, p. 28, figs. 28-32.—Chamberlin and Hoffman, 1958, p. 51.

TYPE-SPECIMENS.—Male holotype and female paratype, USNM 1880 (D-193); male paratype, RLH, from Sassafras Mountain on

U.S. Hy. 178, 1 mile north of intersection with S.C. Rt. 228, ca. 4 miles south of Rocky Bottom, Pickens County, S.C.; collected by R. L. Hoffman, July 15, 1949.

DIAGNOSIS.—Similar to nominate subspecies in structural details except for slight difference in termination of gonopod (cf. figs. 19 and 20), and for color pattern, in which red pigmentation is replaced by dark bluish purple, almost concolorous with dorsal color.

DISTRIBUTION.—This form is known to occur on the Blue Ridge in the strict sense as well as on Pisgah Ridge, and presumably these two

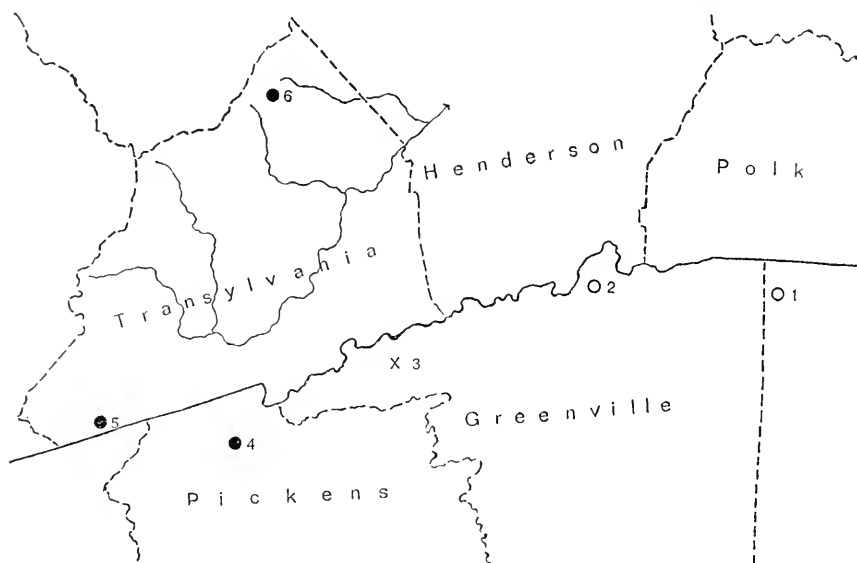

FIGURE 21.—Distribution of *Cleptoria divergens* in western South Carolina and adjoining counties in North Carolina.

- | | | |
|--------------------------|---------------------------|----------------------------|
| ———state line | | -----county lines |
| ○ <i>C. d. divergens</i> | ● <i>C. d. nigrescens</i> | X intermediate population |
| 1=Landrum | 3=Caesar's Head | 5=Horsepasture River Gorge |
| 2=U.S. Highway 25 | 4=Sassafras Mountain | 6=Pink Beds |

populations are connected by others in the intermediate high country west of Brevard, N.C., around the headwaters of the French Broad River (see fig. 21). The following specimens have been examined:

SOUTH CAROLINA: PICKENS COUNTY: south slope of Sassafras Mountain, 1 mile west of intersection with S.C. Hy. 288, on U.S. Hy. 178, 2 ♂♂, 1 ♀, types collected by R. L. Hoffman, July 15, 1949, USNM, RLH.

NORTH CAROLINA: TRANSYLVANIA COUNTY: Field station of Highlands Biological Station in Horsepasture River Gorge, ca. 4 miles south of Lake Toxaway, 4 ♂, 4 ♀, collected by W. H. Adams and J. R. Paul, July 16, 1961; Chubb Gap Trail, Pink Beds Recreation Area, ca. 8 miles north-northwest of Brevard, 1 ♀, collected by R. L. and Marian S. Hoffman, July 30, 1958; 2 ♂, 1 ♀, July 13, 1962.

REMARKS.—The type-specimens from South Carolina were uniformly blackish dorsally; the material from the Pink Beds area according to field notes, were nearly black with the paranota a delicate pinkish violet.

From what little is known so far, *C.d. nigrescens* at least shows a strong partiality for moist woods with rhododendron thickets. Individuals are apparently nocturnal, as many man-hours of collecting at Pink Beds have turned up only four specimens, in contrast to literally hundreds of *Cherokia georgiana*! One hour spent in the Horsepasture Gorge was fruitless although during the evening of the same day Adams and Paul picked up a small series and saw others in exactly the same place in which I had collected.

It will be of interest to establish additional localities in the western half of Transylvania County as this form almost certainly makes a swing around the headwaters of the French Broad River. Probably, also, future work will reveal it further to the southwest in the gorges of the Whitewater and Chatooga Rivers.

Relationships

There is no doubt that *Cleptoria* is related most closely to several genera, notably *Sigmoria* and *Brachoria*, occurring in the southeastern part of the United States. Beyond this general statement, it is difficult to present detailed comparisons for several reasons. First, the distinctions between these genera (or species groups) are based on subjective evaluation of gonopod patterns and are thus liable to personal bias

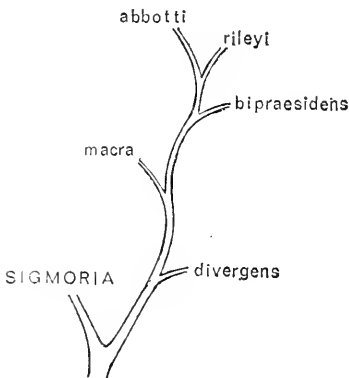

FIGURE 22—Schematic diagram of possible phylogeny in *Cleptoria*, the most primitive species on the right, the more specialized toward the left.

in interpretation. Secondly, *Sigmoria* as presently known appears to be somewhat heterogeneous and perhaps divisible into two or more groups. Finally, quite a number of species, some of them possibly annectant in their characters, remain to be discovered and published.

With the exception of *C. divergens*, however, the species here referred to *Cleptoria* share such a distinctive basic gonopod configuration

that identification of a male specimen as a *Cleptoria* can be made with the unaided eye. As implied by its name, *C. divergens* has a somewhat less characteristic gonopod and rather approximates a structure one might consider as fairly typical of *Sigmoria*. Perhaps this species represents a level of evolution just beyond that of the dichotomy separating the stocks ancestral to present members of these two genera. Certain species of *Cleptoria* appear to be closely related in the gonopod structure as indicated by the very provisional

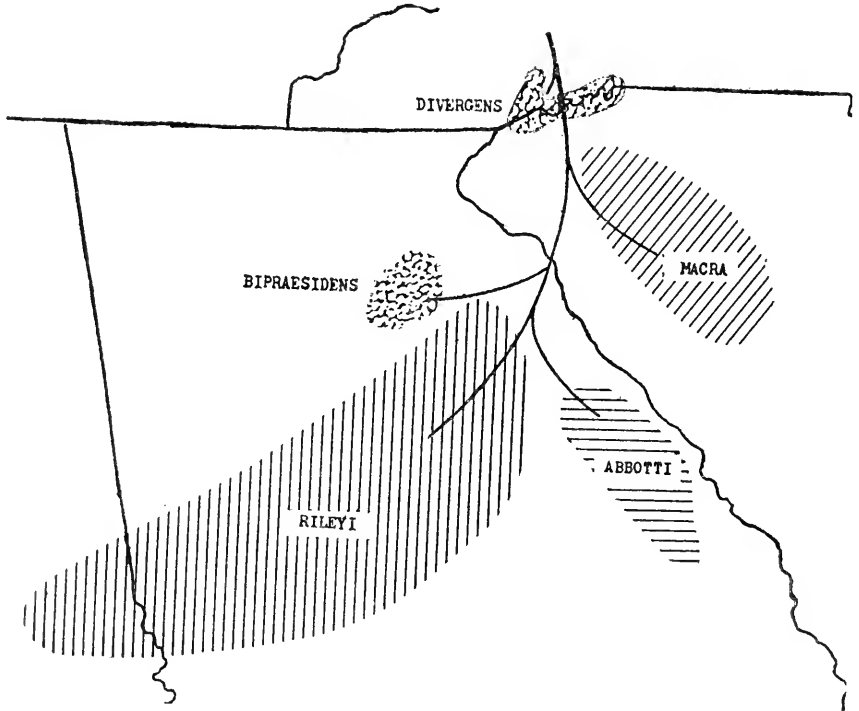

FIGURE 23.—Superposition of phylogenetic dendrogram from figure 22 upon the known distribution of species of *Cleptoria*.

diagram in figure 22. The overall appearance of the appendage is judged in guessing at affinities and not single "key-characters" that, although obvious, probably have little significance in phylogenesis. The presence or absence of a prefemoral process, for instance, constitutes such a character.

By the assumption that the gonopod of *C. divergens* represents a relatively unspecialized form, it is possible to arrange the species of *Cleptoria* in a tentative evolutionary sequence with *C. abbotti* representing the extreme development: its gonopod is especially shortened

and robust, with a massive and convex solenomerite, and the sternal processes of the third segment are the most prominent in the genus. Obvious affinity is seen with *C. rileyi*, which has a somewhat more slender telopodite, and with *C. bipraesidens*, in which the solenomerite is longer and not notably thickened. These three species might be considered as making up a single group. *Cleptoria macra* is intermediate between the members of this group and *C. divergens*. On the diagram (fig. 22), the presumed sequence of specialization runs from right to left.

A second diagram (fig. 23) shows the remarkably good "fit" that obtains when the foregoing derivation is superimposed on the present distribution of the various species. Although species of *Sigmoria* now occur widely in the South Carolina Piedmont and may be sympatric with *C. macra* at the present, the majority of species of that genus occur in the Southern Appalachians. It seems reasonable to suspect that the ancestral lineage of *Cleptoria* developed in that area and subsequently migrated south and west through the Piedmont of Georgia. There is some indication that speciation may have occurred in a sort of straight-line (perhaps "leap-frog") sequence rather than by in situ speciation from a single widespread ancestral form.

Literature Cited

BOLLMAN, CHARLES H.

1888. Descriptions of fourteen new species of North American myriapods. Proc. U.S. Nat. Mus., vol. 10, pp. 617-627.

CHAMBERLIN, RALPH V.

1939. On some diplopods of the family Fontariidae. Bull. Univ. Utah, Biol. Ser., vol. 5, no. 3, pp. 1-19, figs. 1-37.

CHAMBERLIN, RALPH V., and HOFFMAN, RICHARD L.

1958. Checklist of the millipeds of North America. U.S. Nat. Mus. Bull. 212, 236 pp.

HOFFMAN, RICHARD L.

1950. Records and descriptions of diplopods from the southern Appalachians. Journ. Elisha Mitchell Sci. Soc., vol. 66, pp. 11-33, figs. 1-32.

LOOMIS, H. F.

1943. New cave and epigean millipeds of the United States, with notes on some established species. Bull. Mus. Comp. Zool., vol. 92, no. 7, pp. 371-410, figs. 1-18.

1944. Millipeds principally collected by Professor V. E. Shelford in the eastern and southeastern United States. Psyche, vol. 51, pp. 166-177, figs. 1-6.

Proceedings of
the United States
National Museum



SMITHSONIAN INSTITUTION • WASHINGTON, D.C.

Volume 124

1967

Number 3631

Status of Genera *Branchiobdella* and *Stephanodrilus*
in North America with Description of a New Genus
(Clitellata: Branchiobdellida) ¹

By Perry C. Holt ²

Visiting Research Associate, Department of Invertebrate Zoology

In a previous paper (Holt, 1960), the status of one North American species of the branchiobdellid worms that had been assigned by an earlier worker to a non-American genus was clarified. An attempt is made here to establish the generic affinities of the remaining North American branchiobdellids that have been placed in Asiatic or European genera. There are three of these: *Branchiobdella tetradonta* Pierantoni, 1906; *Branchiobdellida americana* Pierantoni, 1912; *Stephanodrilus obscurus* Goodnight, 1940. Since one of the areas of intrinsic interest in the study of the branchiobdellids is a consideration of their zoogeography, it is important to determine if these species are assigned correctly and, hence, if there are defensible cases of multicontinental generic ranges among them.

A brief reference has been made to this problem before and attention has been directed to the general relationships of the branchiobdellid fauna of North America to those of Asia and Europe (Holt, 1964). It is not beyond credibility that representatives of the same genus might occur in eastern Asia and in eastern North America as is reputed to be the case for one of the species I am considering herein: my studies

¹ Supported by grant GB 372 from the National Science Foundation.

² Department of Biology, Virginia Polytechnic Institute, Blacksburg, Va.

indicate that this does not occur and that the distributional patterns of the branchiobdellids do not conform to those of their astacid hosts.

The origin of the taxonomic problems I am involved with go back to the early days when the casual students of the branchiobdellids held such broad generic concepts that there was a tendency to assign any species not quite obviously distinguished by peculiarities of body form and ornamentation to the European genus *Branchiobdella*. Pierantoni (1912, p. 8), in the first monograph of the order, listed five genera, mostly separated by such characters of body form, though he was aware of the distinctive difference (one testicular segment as opposed to two) between the genus *Branchiobdella* and the other genera. In addition, he and perhaps others worked with material recovered from the bottoms of museum jars in which crayfish collections were stored. Such material almost invariably is in such a poor state of preservation that specific diagnoses or even generic assignments are difficult, doubtful, and often futile.

Moore (1894) in his work on branchiobdellids during the time when many workers considered them leeches placed Leidy's species *Astacobdella philadelphica* (Leidy, 1851) in the European genus *Branchiobdella* and described as new members of this genus *B. illuminata*, *B. pulcherrima*, and *B. instabilia*. He quickly reassigned *B. illuminata*, establishing the new genus *Bdellodrilus* for it in his excellent treatment of its anatomy (Moore, 1895). Pierantoni (1912, pp. 21-22), who realized that these species have two testicular segments, placed *Branchiobdella pulcherrima* and *B. instabilia* in Moore's genus *Bdellodrilus*. It remained for Ellis (1919, pp. 243-253) to establish the genera *Xironogiton*, in which he placed *Bdellodrilus instabilia*, and *Xironodrilus*, which includes *B. pulcherrima*. Ellis, however, did not have material that would allow him to deal with *Branchiobdella tetradonta* (Pierantoni, 1906, p. 3) and *B. americana* (Pierantoni, 1912, p. 14). The next important paper in which these species were considered was written by Clarence J. Goodnight (1940), who retained Pierantoni's generic assignments for them. Though he had not seen anything he could identify as *B. tetradonta*, he did consider animals from Cleveland, N.Y., taken from *Cambarus bartonii robustus* (Goodnight, 1940, pp. 28-29) as representative of *B. americana*. In the same paper (p. 55) he described the third species I am dealing with here as *Stephanodrilus obscurus*. *Stephanodrilus* is a junior synonym of *Cirrodrilus* Pierantoni (Yamaguchi, 1934, pp. 191-192), and Yamaguchi's error in ignoring the law of priority by using *Stephanodrilus* as the name of the Asiatic species, all of which he considered to be congeneric, was corrected by Goodnight (1940, pp. 55, 63) by reverting to the use of both of the Pierantonian names (*Cirrodrilus* and *Stephanodrilus*). For the present, basing the position on Yamaguchi's descriptions, figures, and some Japanese material that he very kindly gave me a few years ago, I accept his decision

as to the generic unity of his Japanese worms. The correct name of the genus, then, must be *Cirrodrilus* Pierantoni, 1905, and not *Stephanodrilus* Pierantoni, 1906. If Goodnight was correct in placing his species from Fall River, Calif., in the Asiatic genus, its name must become *Cirrodrilus obscurus* (Goodnight). One of the conclusions of the present paper, however, is that he was not correct and that *S. obscurus* must become the type of a new genus.

Magmatodrilus, new genus³

Stephanodrilus.—Goodnight, 1940, p. 55. [In part.]

TYPE-SPECIES.—*Magmatodrilus obscurus* (Goodnight, 1940), here designated by monotypy.

DIAGNOSIS.—Medium sized, stout branchiobdellid worms with two pairs of testes; unpaired nephridiopore on the dorsum of segment III; body terete; spermiducal gland with vasa deferentia entering entally; prostate absent; ejaculatory duct present; bursa large, enclosing protrusible penis entally; spermatheca present, not bifid, with ectal duct and bulb invested with thick muscular covering.

DISTRIBUTION AND AFFINITIES.—*Magmatodrilus* at this time stands as a monotypic genus known only from the type-locality of *M. obscurus*.

Goodnight's (1940, p. 55) assignment of *S. obscurus* to *Stephanodrilus* (= *Cirrodrilus*) appears to rest upon the absence of a prostate and a mistaken belief that the anterior nephridia open by separate pores on the dorsum of segment III. In addition to *Cirrodrilus*, the genera *Xironodrilus*, *Xironogiton*, *Ankyrodrilus*, and *Branchiobdella* have paired nephridiopores, lack a prostate and, with the exception of *Xironodrilus*, the vasa deferentia enter the spermiducal gland along its midlength rather than entally. Most genera that have a common anterior nephridiopore also have a prostate gland. The closest relatives of *Magmatodrilus*, then, should be among those genera in which a prostate is absent and the anterior nephridia open by a common pore on the dorsum of segment III. There are three (possibly four) such genera, including an unnamed one represented by species from the southeastern United States and Mexico: *Bdellodrilus*, *Caridinophila*, and the Mexican genus. The prostate of *Ceratodrilus* (the fourth possible relative of *Magmatodrilus*) is a minute lobe or region of differentiated epithelial cells on the side of the spermiducal gland (Holt, 1960, pp. 57, 63). Leaving this question for the moment, *Bdellodrilus illuminatus* (the genus is monotypic) differs from *Magmatodrilus* in the possession of an eversible penis, in the entrance of the vasa deferentia along the midlength of the

³ From *magma* (Greek, =lava) + *drilos* (Greek, =worm), masculine, "lava-worm" for the locality, springs in the lava beds of Shasta County, Calif., from which topotypes were taken.

spermiducal gland, and in the primitive bifid character of the spermatheca. *Caridinophila unidens* (another monotypic genus) from Yunnan Province, China, lacks a spermatheca, has a peculiar almost spherical spermiducal gland (Liang, 1963, pp. 564, 569), and cannot be considered in any way close to *Magmatodrilus*. The unnamed group of species from Mexico, Georgia, and South Carolina resembles *Magmatodrilus* in the absence of a prostate, in the entrance of the vasa deferentia at the ental end of the spermiducal gland, and in the large size of the copulatory bursa, but differs in the facies (size and shape) of the jaws and most importantly in the presence of an eversible penis instead of the protrusible one of *M. obscurus*. The latter point requires further comment: the penes of *Bdellodrilus illuminatus*, *Ceratodrilus*, *Oedipodrilus*, *Branchiobdella*, and perhaps those of *Cirrodrilus* and *Ankyrodrilus* are eversible, i.e., the penis itself is turned inside out in copulation; those of other genera are protrusible, i.e., the bursal atrium everts and carries to the outside a cone-shaped muscular penis papilla that does not itself evert. Material in museum collections, however, rarely contains animals with everted or protruded penes, and conclusions as to the functioning of the organ frequently, as in the case of *Magmatodrilus*, rest on inferences from the structure of the uneverted or unprotruded penis. In brief, *Magmatodrilus* also is related to *Ceratodrilus* but differs in the lack of body ornamentation (peristomial and body tentacles or projections), in the presence of a rudimentary or vestigial prostate in *Ceratodrilus*, and in the presence of a protrusible instead of an eversible penis in *Magmatodrilus*. Further study may unite the species of the unnamed southeastern genus with *Magmatodrilus*, but following the criteria previously used (e.g., Holt, 1953, 1960, 1965; Hoffman, 1963; Liang, 1963), *Magmatodrilus* must be considered a separate genus.

Magmatodrilus obscurus (Goodnight)

FIGURES 1-4

Stephanodrilus obscurus Goodnight, 1940, p. 55.

DIAGNOSIS.—Jaws subrectangular in en face view, dental formula 6/5; prosomites of segments I-IV, VIII raised (supernumerary muscles present); spermiducal gland with large anterior deferent lobe, shorter posterior one, gland long and looped at ental end of bursa; bursa large, extending to dorsal margin of segment VI; spermathecal bulb clavate or bulbous, without ental process, wrinkled and often appearing in sections to be diverticulate. Average size of 10 measured animals 2.8 mm in length.

TYPE-LOCALITY.—Fall River, Shasta County, Calif. (Goodnight, 1940, p. 55). Additional topotypical material: Thousand Springs

(head of Fall River) on Thousand Springs Ranch,⁴ Fall River Mills, Shasta County, Calif.; collectors, Perry C. and Virgie F. Holt.

DISPOSITION OF MATERIAL.—Holotype, USNM 20568; 2 topotypes, USNM 45696; 11 topotypes, PCH 1818, in my collection at the Virginia Polytechnic Institute.

Cambarincola philadelphica (Leidy)

Cambarincola philadelphica (Leidy), 1851, p. 209.

Branchiobdella americana Pierantoni, 1912, p. 14.—Hall, 1914, p. 190.—Goodnight, 1940, pp. 28–29.

Pierantoni (1912, p. 14) described *Branchiobdella americana* on the basis of material in the possession of the Hamburg Museum. In the summer of 1966, Professor Richard L. Hoffman of Radford College visited the Zoologische Staatsinstitut und Zoologische Museum at Hamburg and inquired as to the existence of this material. Through Dr. Hoffman's good offices, Dr. M. Dzwillo lent me this material, consisting of the syntypes. I am grateful to both of these scholars. The material itself, upon which Pierantoni based his diagnosis of *B. americana*, is macerated badly and must have been so when he examined the material and described *B. americana* as follows:

Prostomio intero, poco slargato a ventosa, capo ben distinto dal corpo; corocina di papille circumboccali presente; superficie ventrale del corpo non appiatta, corpo non rigonfia nella regione mediana, quasi cilindrico.

Ventosa terminale poco prominente.

Clitello poco visibile.

Lunghezza mm. 5 circa.

Mascella disugali; la dorsale (Fig. 6B nel testo e 7A della tavola) provvoluta di un grosso dente mediano e di due paia di dentelli laterali rivolti in basso; la ventrale di due grossi denti (Fig. 6C nel testo e 7B della tavola) con mediani alquanto divaricati e sol paio di dentelli laterali. Questo due mascelle nella disposizione dei denti si corrisponde in modo che i dente della mascelle ventrale ingranano negli spazii che intercedo fra i denti e dentelli consecutivi nella dorsale, il che avviene di frequente nella specie a mascelle disugali.

La spermateca in questa specie non è molto sviluppata e si presente in forma di ampolla o fiasco collo corto, senza processo terminale.

L'atrio è poco rigonfia.

Nel complesso dei caratteri questa specie si avvicina alla *Br. pentodonta* . . .

Habitat: Su varie specie di *Cambarus*.

Nota.—Esemplari riferibili a questa specie ho riconosciuto sovente nel materiale del Museo di Amburgo, e tutti provenienti dell'America del Nord; di questi esemplari alcuni erano registrati come viventi su *Cambarus viridis* Hay., altri su *Cambarus latimanus* Fabr., altri *Cambarus Hayi* Fosc. (Texas), altri su *Cambarus rusticus* Gir., altri su *Cambarus immunis* Hay., e su *Cambarus sp.* (Raleigh, N. Car.). È quindi da ritenere che sia una specie frequente nel Nord America.

⁴ I am indebted to Mrs. Vincent Meyer, wife of the owner of Thousand Springs Ranch, for her hospitality and permission to collect on the ranch house grounds.

This description of *B. americana* could apply to several species of the branchiobdellids. The range, all provinces of North America ("e tutti provienti dall'America del Nord"), can apply to no species that I know. The one clue as to the identity of the species in Pierantoni's description is in the description and illustrations of the jaws, and this could apply to several species of the genus *Cambarincola*, including the widespread *C. philadelphica*.

Among the syntypes, the only recognizable specimen belongs to *C. philadelphica* (Leidy, 1851, p. 209), conforming in all diagnostic characters to the topotypical material (Hoffman, 1963, p. 342) that is in my collection (PCH 695). *Branchiobdella americana* Pierantoni is reduced hereby to synonymy as *Cambarincola philadelphica* (Leidy) and Pierantoni's specimen "V 2914" has been labeled as the lectotype of *B. americana* and returned to the Hamburg Museum.

***Branchiobdella tetradonta* Pierantoni**

Branchiobdella tetradonta Pierantoni 1906, p. 3; 1912, p. 12.—Ellis 1912, p. 190.—Goodnight 1940, p. 28.

Pierantoni (1906, p. 3) treats this species as follows:

Questa nuova specie è molto affine alla *Br. pentadonta* di Whitman, di cui mi sono estesamente occupato nel mio citato lavoro. . . . Gli esemplari studiati furono rinvenuti su *Astacus klamathensis* (del fiume Klamath) di California, faciente parte delle collezioni del Museo di Vienna.

Caratteri esterni.—Ha forma sottile ed allungata, quasi cilindrica, con capo ovoidale, provvisto di due labbra, l'uno dorsale, l'altro ventrale.

È anche questa una piccola specie, non oltrepassando i 2 mm. di lunghezza e avendo una grossezza di non oltre 1/5 di mm. La ventosa posterior non è molto slargata, ed ha la forma di una piccola coppa. I pori genitali sono poco visibili. Il clitello occupa il 7° segmento dopo il capo.

Caratteri interni.—Le due mascelle (Fig. 8) sono provviste ciascuna di quattro dentelli uguali, e sono esattamente simili fra loro.

La spermateca è fatta ad ampolla, con breve condotto di uscita.

Lo spermateco è molto evidente; l'atrio è slargato sacciforme; il pene provvisto di rigonfiamento a forma di bulbo, e sprovvisto, come in tutte le piccole specie, di uncinetti e di guaina chitinoso.

Gli ovari sono bene sviluppati, e grosse le uova che ricolmano la cavità del 7° segmento postcefalico.

Diagnosi riassuntiva.—Corpo allungato, capo poco rigonfio, bocca provvista di due labbra. Mascelle simili e provviste di quattro dentelli uguali ciascuna. Spermateca in forma di ampolla, atrio sacciforme.

Dimensioni: Lunghezza 2 mm. grossezza 1/5 mm.

Habitat: *Astacus klamathensis*: fiume Klamath (California).

This is all that has been recorded concerning *B. tetradonta*. Pierantoni (1912, p. 12), Ellis (1912, p. 190), and Goodnight (1940, p. 28) do no more than cite the original description with no indication that any additional material other than that on which Pierantoni based his description had been seen.

Dr. Robert P. Higgins of Wake Forest College unsuccessfully attempted to locate the types of *B. tetradonta* in the Naturhistorisches Museum, Vienna, for me. They apparently are lost and, without them, it is impossible to identify this species. I am grateful to Dr. Higgins. In the summer of 1964, my wife and I took two collections (PCH 1815, 1816; USNM 35698, 35699) from the Klamath River, one about four miles east of the village of Klamath River and the other at Burbell Resort about 10 miles north of Yreka, and a third (PCH 1817; USNM 35697) from the Shasta River about eight miles north of Yreka, all in Shasta County, Calif. Previous attempts in 1960 to collect branchiobdellids near the mouth of the Klamath in California and from just below and around the shores of Klamath Lake in Oregon were unsuccessful. All of the hundreds of specimens obtained near Yreka and the village of Klamath River belong to *Xironogiton oregonensis* Ellis, 1919; moreover, Pierantoni's (1906) illustration of the jaws of *B. tetradonta* (his fig. 8) could be one of the jaws of *X. oregonensis*. Uncertainty is introduced, however, by his statements about size (*X. oregonensis* normally exceeds 2 mm in length), shape (the species of *Xironogiton* are flattened), and the penis with hooks and a chitinous sheath. In addition, his not-too-clear drawing (his fig. 7) shows male reproductive organs more like those of *Cambarincola*, which does not have a chitinous sheath (I know of no branchiobdellid that does) nor penial hooks (which are present in at least one as yet undescribed species of the recently established genus *Oedipodrilus* Holt, 1967, and in some European species of *Branchiobdella*). It is possible that Pierantoni was dealing with small, extended, and macerated specimens of *Xironogiton oregonensis*; it is also possible that he was working with a collection containing specimens of *Cambarincola* or *Oedipodrilus*: species of both genera occur in the Coastal Range of Oregon, but not, as far as I know, in the Klamath River in California. There is grave doubt as to the type-locality. The Klamath River is a large stream of some length in Oregon and California, and it is now well known that not all parts of the same stream contain the same branchiobdellids (Hobbs, Holt, and Walton, 1967). Before I was aware of the existence of the very small village of Klamath River, I first read "fiume Klamath" to mean simply the river. This is still the reasonable interpretation, but it is possible that translation of the original locality data made the name of the fishing camp into that of the river. It is, finally, possible that Pierantoni's material was labelled incorrectly. Unless the original material is found (an unlikely event), restudied, and a lectotype designated, the status of *Branchiobdella tetradonta* must remain forever uncertain and the name regarded as a nomen inquirendum. I regard it as such.

To summarize: *Stephanodrilus obscurus* Goodnight, 1940, is designated the type of a new genus, *Magmatodrilus*; *Branchiobdella tetradonta* Pierantoni, 1906, unidentifiable and the types unavailable is hence regarded as a nomen inquirendum; *Branchiobdella americana* Pierantoni, 1912, is reduced to synonymy with *Cambarincola philadelphica* (Leidy, 1851). Many thousands of specimens of branchiobdellids from all parts of North America have been examined, none belong to the genus *Branchiobdella*, and the conclusion is reached that no species of this genus is endemic to North America. There are, then, no known cases of intercontinental generic ranges among the branchiobdellids.

Literature Cited

ELLIS, MAX M.

1912. A new discodrilid from Colorado. Proc. U.S. Nat. Mus., vol. 42, no. 1912, pp. 481-486, text figs. 1-5.
 1919. The branchiobdellid worms in the collections of the United States National Museum, with descriptions of new genera and new species. Proc. U.S. Nat. Mus., vol. 55, no. 2267, pp. 241-265, pls. 10-13.

GOODNIGHT, CLARENCE J.

1940. The Branchiobdellidae (Oligochaeta) of North American crayfishes. Illinois Biol. Monogr., vol. 17, no. 3, pp. 1-75, pls. 1-111.

HALL, MAURICE C.

1914. Descriptions of a new genus and species of the discodrilid worms. Proc. U.S. Nat. Mus., vol. 48, no. 2071, pp. 187-193, text figs. 1-3.

HOBBS, HORTON H., JR.; HOLT, PERRY C.; AND WALTON, MARGARET

1967. The crayfishes and their epizoötic branchiobdellid and ostracod associates of the Mountain Lake, Virginia, region. Proc. U.S. Nat. Mus., vol. 123, no. 3602, 84 pp., 22 figs.

HOFFMAN, RICHARD L.

1963. A revision of the North American annelid worms of the genus *Cambarincola* (Oligochaeta: Branchiobdellidae). Proc. U.S. Nat. Mus., vol. 114, no. 3470, pp. 271-371, text figs. 1-79.

HOLT, PERRY C.

1953. Characters of systematic importance in the family Branchiobdellidae (Oligochaeta). Virginia Journ. Sci., vol. 4, no. 2, pp. 57-61.
 1960. The genus *Ceratodrilus* Hall (Branchiobdellidae, Oligochaeta) with the description of a new species. Virginia Journ. Sci., vol. 11, no. 2, pp. 53-77, pls. I-IV (figs. 1-16).
 1964. The distribution of the branchiobdellids: Some zoogeographical problems. American Zool., vol. 4, no. 4, abstr. 260.
 1965. On *Ankyrodrilus*, a new genus of branchiobdellid worms (Annelida). Virginia Journ. Sci., vol. 16, no. 1, pp. 9-21, figs. 1-14.
 1967. *Oedipodrilus oedipus*, new genus and species (Annelida, Clitellata: Branchiobdellida). Trans. American Microsc. Soc., vol. 86, no. 1, pp. 58-60.

LEIDY, JOSEPH

1851. Contributions to helminthology. Proc. Acad. Nat. Sci. Philadelphia, vol. 5, p. 209.

LIANG YAN-LIN

1963. Studies on the aquatic Oligochaeta of China, 1: Descriptions of new naids and branchiobdellids. Acta Zool. Sinica, vol. 15, no. 4, pp. 560-570, text figs. 1-4.

MOORE, J. PERCY

1894. On some leech-like parasites of American crayfish. Proc. Acad. Nat. Sci. Philadelphia (for 1893), pp. 419-428.
1895. The anatomy of *Bdellodrilus illuminatus*. Journ. Morph., vol. 10, no. 2, pp. 497-540, pls. xxviii-xxxii.

PIERANTONI, UMBERTO

1906. Nuovi discodrilidi de Giappone e della California. Ann. Mus. Zool. R. Univ. Napoli, vol. 2, pp. 1-9, pl. 5.
1912. Monografia dei Discodrilidae. Ann. Mus. Zool. R. Univ. Napoli, vol. 3, pp. 1-28, text figs. 1-20, pl. 5.

YAMAGUCHI, HIDEJI

1934. Studies on Japanese Branchiobdellidae with some revisions on the classification. Journ. Fac. Sci., Hokkaido Imp. Univ., ser. 6, vol. 3, no. 3, pp. 177-219, text figs. 1-17, pls. xii-xiii.



Fig. 1



Fig. 2

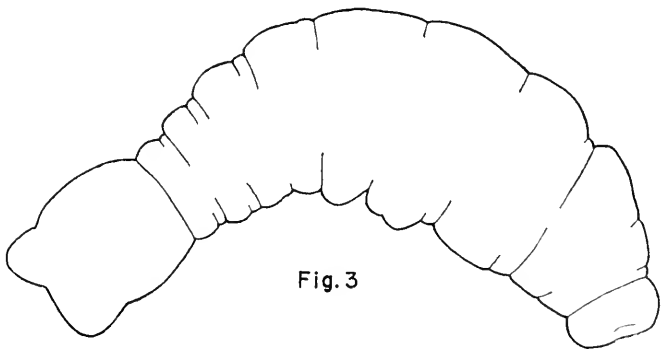

Fig. 3

FIGURES 1-3.—*Magmatodrilus obscurus*: 1, upper jaw; 2, lower jaw; 3, body in lateral aspect.

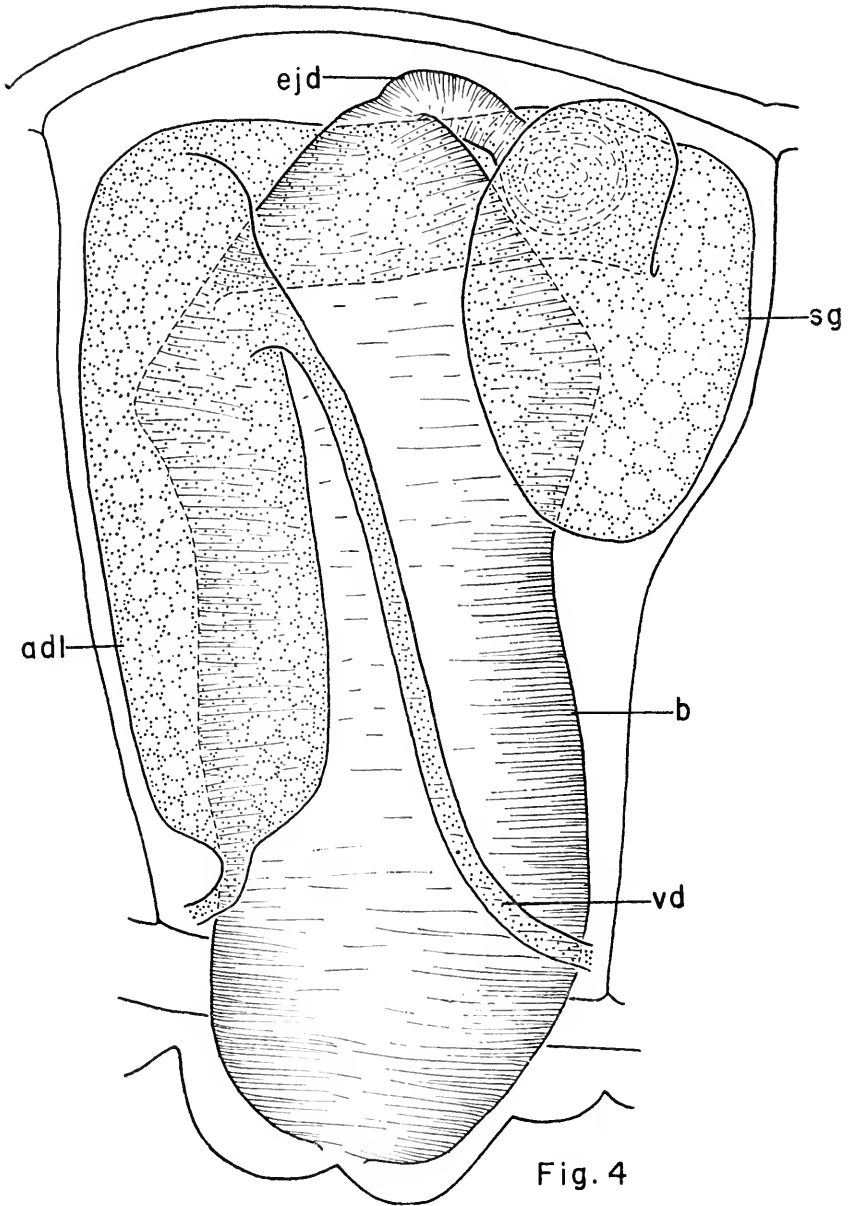

Fig. 4

FIGURE 4.—*Magmatodrilus obscurus*, lateral view of male reproductive system (adl=anterior deferent lobe, b=bursa, ejd=ejaculatory duct, sg=spermiducal gland, vd=vas deferens).

Proceedings of
the United States
National Museum



SMITHSONIAN INSTITUTION • WASHINGTON, D.C.

Volume 124

1967

Number 3632

Two New Species of *Cartwrightia*
from Central and South America
(Coleoptera: Scarabaeidae: Aphodiinae)

By Oscar L. Cartwright
Curator, Division of Coleoptera

The genus *Cartwrightia*, described by Federico Islas S. in 1958 for a single Mexican species, superficially appears most closely allied to *Rhyparus* in the tribe Rhyparina but actually will fall in the tribe Eupariina as now defined. The species are myrmecophilous as are those of *Euparia*, *Euparixia*, *Myrmecaphodius*, and some others of the Eupariina. One of the two new species described below was collected in a detritus cavity six to eight feet deep in the nest of a leaf-cutting ant, *Atta cephalotes* (L.). *Euparixia* have been taken as deep as 12 feet below the surface in *Atta* nests.

The species of *Cartwrightia* (so beautifully shown in the plates by Mrs. Elsie Froeschner, our staff artist) have a very distinctive habitus not duplicated in any other genus. The depressions of the pronotum and the two large bulbous formations at the apices of the elytra are unique.

The first Mexican species is redescribed for the benefit of non-Spanish readers and because a few additional characters may help in its determination. The original description was in Spanish.

Key to Species

1. Pronotal ridges widely bare, shining and noticeably punctate (see pl. 1);
Mexico, El Salvador, Guatemala *C. islasi*, new species
Pronotal ridges not widely bare, shining or noticeably punctate 2
2. Anterior longitudinal pronotal ridges narrow, sharply carinate; Bolivia.
C. cartwrighti, new speciesAll pronotal ridges low, rounded; Mexico *C. intertribalis* Islas

Cartwrightia islasi, new species

PLATE 1

HOLOTYPE MALE.—Length 3.45 mm, width 1.5 mm. Elongate, subparallel, generally dark reddish brown with areas of grayish golden-brown argillaceous coating showing on head, pronotum, tips of elytra and underside. Clypeus with double anterior edge, upper and lower margins separated by fine narrow furrow extending from gena to gena, lower margin with median triangular tooth directed downward; upper margin very narrowly recurved, moderately deeply emarginate between low triangular teeth, laterally nearly straight to genal suture; gena arcuate downward with sharp posterior angle; clypeal-frontal suture distinct from gena to base; discal area convex, slightly concave each side, surface shining brown, minutely alutaceous, without argillaceous coating, punctures shallow, fine to moderate, separated by about their diameter, group of slightly coarser punctures on each side near frontal suture; posterior margin of clypeus elevated above frontal-basal area and downward on each side to gena; fine carina-like margin following curvature of eye with furrow in front of it; basal area behind clypeus dull, minutely alutaceous.

Pronotum wider in front, anterior edge narrowly membranous, surface generally shining, dark brown, with five depressed areas and posterior margin showing argillaceous coating, five areas separated and surrounded by low rounded ridges; two large anterior areas separated by longitudinal median ridge, replaced suddenly by narrow median depressed area of equal width over posterior half to base; two sinuate lateral depressed areas extending diagonally backward from anterior angles to middle of median basal area (pl. 1); median basal area with deep, sharply incised median line and diagonal areas with similar sinuate incised line; deep line also visible from side along posterior angle. Shiny ridges quite closely finely punctate, slightly finer and closer along anterior pronotal margin; two anterior depressions with row of close coarse punctures in front and group of very close, coarse punctures posteriorly. Base of pronotum very weakly angulate at middle.

Scutellum elongate, parallel, three times as long as wide. Elytra length 2.3 mm, width 1.5 mm. Humeri distinctly dentate. Each

elytron with sutural, four discal, and marginal costa separated by wide shiny intervals; costae, without argillaceous coating in holotype, high, cariniform, about half as wide as discal intervals, which have lateral rows of punctures except over apical declivity, where they disappear. First discal costa widened apically into large argillaceous bulbous end as wide as first two intervals and first two discal costae combined; large bulbous end narrowly separated from sutural costa and from second and third discal costae with slightly enlarged argillaceous ends. Sutural costae not appreciably widened at apex.

Prosternum with large, wide, triangular posterior intercoxal process. Mesosternum flattened, slightly concave, sides flaring and partly covering anterior three-fifths of middle coxae; meso-metasternal suture as wide as length of middle trochanter. Metasternum with long, deeply incised midline in slightly concave discal area, minutely alutaceous, finely punctate, a slightly roughened triangular depression in front of hind coxa, otherwise very finely alutaceous outward to sides.

Five visible abdominal segments, narrower at middle than at sides, terminal segment about three times as long as penultimate, all except terminal narrowly edged posteriorly with argillaceous coating, anteriorly indistinctly crenate, surface otherwise finely alutaceous and with scattered very fine punctures, terminal with fine shallow punctures generally separated by one diameter or less. Pygidium with scabrous-argillaceous coating and low median, longitudinal carina.

Anterior femora with perimarginal groove, six or seven long setae along outer margin and row of shorter setae along posterior margin, surface finely alutaceous with evenly distributed, shallow, moderate, setigerous punctures separated by two or three diameters, setae short, semi-appressed about as long as diameter of punctures; tibia with three teeth, two terminal one on inside, one outside, and one lateral at apical fourth; apical spur slender, acuminate, slightly hooked. Middle and posterior femora slender, shining, setigerously punctate as forefemora, complete posterior marginal line; tibia slender, parallel sided, tarsi longer than tibia, long spur half as long as first tarsal segment, latter subequal in length to remaining four segments combined; claws very fine.

ALLOTYPE FEMALE.—Length 4 mm, width 1.6 mm. Head outlined with fine cream-colored argillaceous line close to finely reflexed anterior margin of clypeus, curving up around eyes and across base; large similarly colored comma-shaped argillaceous area curving down around each side of median convexity, small median frontal spot behind elevated posterior margin of clypeus. Elytral costae with very fine line of argillaceous coating on each side of sharp shining top.

Spur of anterior tibiae heavier and straight. Femora less shining than in male, covered with thin argillaceous coating. Terminal and penultimate abdominal segments of equal length, with cream-colored argillaceous coating covering half their length along their common margin.

TYPES.—Holotype: collected at light, El Salvador, San Salvador, May 1, 1957, by P. A. Berry, USNM 69609. Allotype: Mexico, Sinaloa, 27 miles east of Villa Union, July 7, 1964, H. F. Howden (Canadian National Collection). Paratypes, 6 females: 3, El Salvador, San Salvador, May 1, 1957, P. A. Berry, at light; 1, Mexico, Veracruz, Cuitlahuac, Aug. 10–12, 1964, Paul J. Spangler; 1, Mexico, Veracruz, 18 miles north of San Andres, June 1954, D. G. Kissinger; 1, Guatemala, Suchitepequez, Cuyotenango, Olimpo, Finca San Rafael, Jan. 21, 1956, J. M. Campbell, ex large detritus cavity of *Atta cephalotes* (L.), 6–8 feet deep (Canadian National Collection).

REMARKS.—This species usually shows no argillaceous coating on the elytral costae; however, the allotype does show a very fine line of this coating along each side of the costae—one of the reasons the specimen was chosen as allotype. It was also the best of the female specimens available.

The species is named in honor of Dr. Federico Islas S. of Mexico City, who described the genus and first species of this interesting and unusual group of myrmecophilous scarabs.

Cartwrightia cartwrighti, new species

PLATE 2

HOLOTYPE MALE.—Length 3.0 mm, width 1.25 mm. Elongate, subparallel; except for smooth black elytral intervals, completely covered, including legs and underside, with grayish-brown argillaceous coating. Clypeus with double anterior edge, upper and lower margins separated by fine narrow furrow extending from gena to gena, lower margin with median triangular tooth directed downward; upper margin anteriorly narrowly shining brown, very narrowly recurved, shallowly emarginate between two low, widely spaced angles, straight laterally to genal angles; genae at middle notched or angulate inward, leaving sharp angle posteriorly; posterior margin of clypeus sharply elevated above frontal-basal area of head and down laterally to genae; fine furrow ending in pit anteriorly behind gena, furrow just in front of fine carinaform margin following curvature of eye; clypeus with strong median longitudinal swelling over middle third, surface argillaceous with some masked, close moderate punctures on each side of median swelling separated by one diameter or less, elsewhere with fine indistinct punctures.

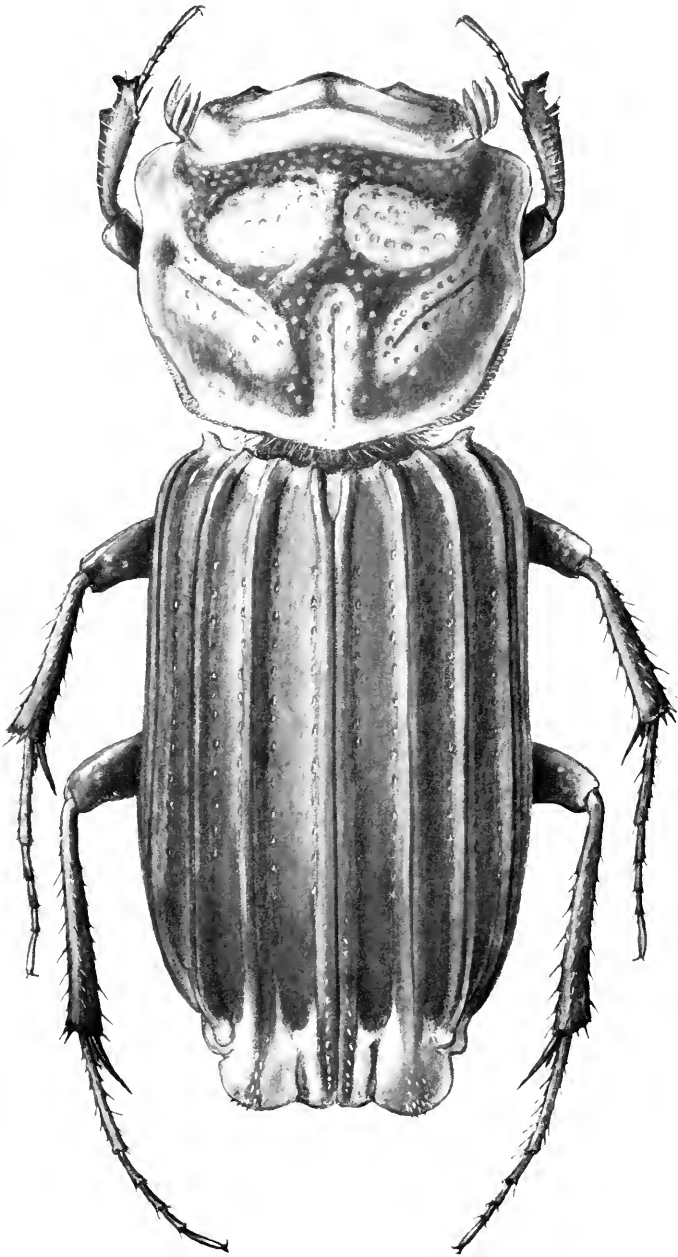

Cartwrightia islasi, new species.

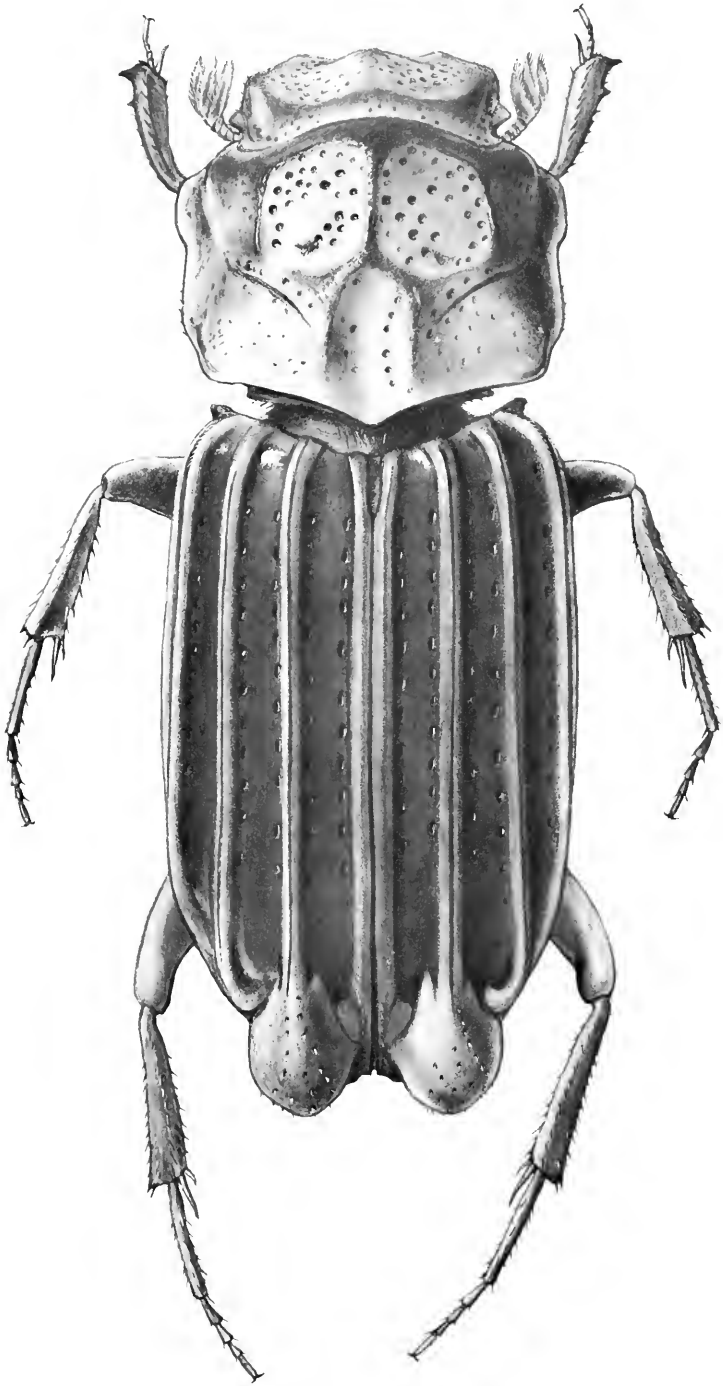

Cartwrightia cartwrighti, new species.

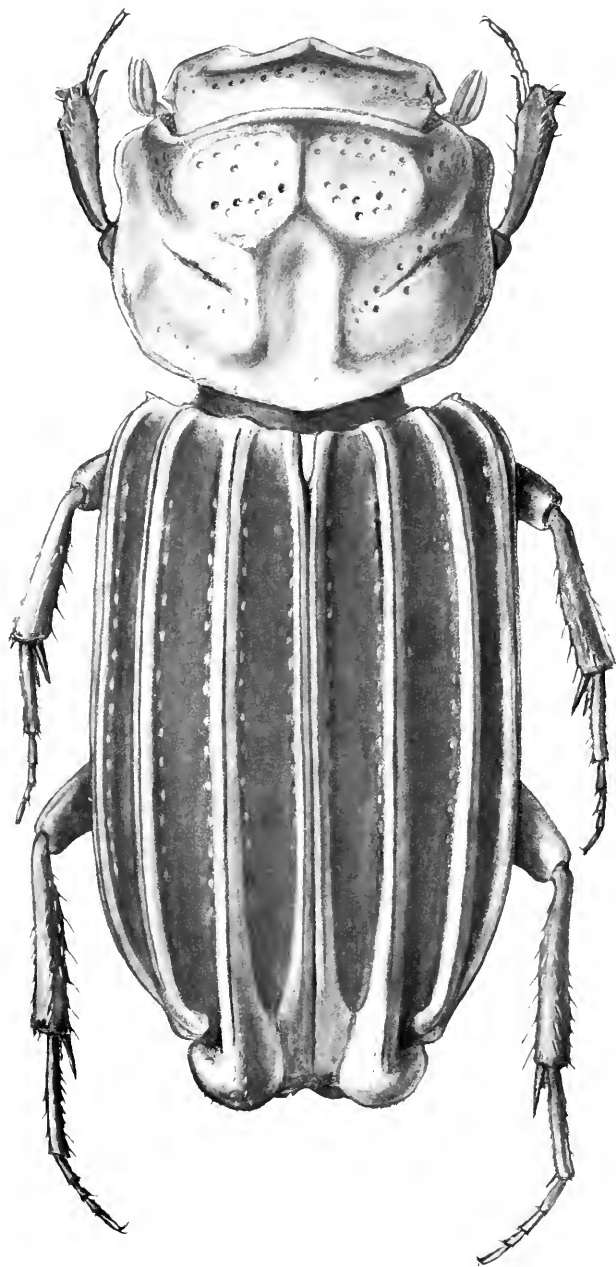

Cartwrightia intertribalis Islas.

Pronotum quadrate, anteriorly with narrow membranous edge, slightly wider anteriorly, lateral margins shallowly doubly sinuate, narrowly explanate, angles obtusely rounded, base angulate at midline; surface with five depressed areas, large area on each side of median ridge anteriorly, median, longitudinal, wide area over basal half, and depressed area with long, deep, sharply incised, sinuate line from anterior angles diagonally back to basal fourth (pl. 2); two anterior depressed areas bordered anteriorly by wide rounded edge, on each side and in middle by rather narrow carinae, surface with numerous deep, coarse punctures running together slightly posteriorly; middle anterior carina divided like inverted tuning fork to enclose median basal area, surface of which with few deep moderate punctures toward sides; diagonal lateral depressions also with few similar punctures as well as deep incised lines; latter areas open to anterior depressions without intervening ridge; surface generally with indistinct very fine punctures.

Elytral length 2.0 mm, width 1.25 mm, with sutural and four high, sharply carinate, argillaceous, discal costae on each elytron and flat feebly shining minutely alutaceous intervals in between, intervals bordered on each side by row of very moderate punctures separated by three or four diameters except over posterior fourth, where they disappear and leave a very shiny smooth area; elytral costae with very fine smooth midline under moderate magnification, straight and parallel except at posterior ends, where first enlarged into large bulbous argillaceous mass and next three converge to mass, their ends enlarged very slightly with argillaceous coating but remaining very narrowly separated from large mass of first; diameter of enlarged end of first about equal to width between sutural and second costa, first well separated from elytral margin and covered with fine setigerous punctures separated by one to two diameters, setae fine, short, and inconspicuous.

Entire underside covered by thin argillaceous coating with alutaceous surface sculpture masking surface features. Prosternum with large wide triangular posterior intercoxal piece. Mesosternum shallowly concave with thin margin expanding to partly cover edge of middle coxae along anterior three-fifths; coxae diverging and almost meeting elytra anteriorly; middle coxae separated by width of middle femur. Metasternum with long, deep, moderately wide midline, disc with scattered, shallow, indistinct, moderate setigerous punctures, generally separated by two or more times their diameters, smooth and impunctate outward to sides; large, rough, depressed, triangular area in front of posterior coxae.

Abdominal segments alutaceous and thinly argillaceous, the last five times wider than penultimate; other segments normal. Pygidium

medially weakly ridged longitudinally, alutaceous-argillaceous with few scattered, shallow indistinct punctures.

Anterior femur surprisingly flat with weak indistinct perimarginal groove, everywhere alutaceous-argillaceous; tibia with two sharp, triangular external teeth, posterior tooth at apical fourth, inner margin ending in tooth bent downward, spur long, slender, bent inward, underside alutaceous outside a longitudinal carina to posterior tooth, smooth and shining along inside; first, last, and middle three antennal segments combined, approximately equal in length; claws short, hair-like. Middle femora and tibiae alutaceous-argillaceous with fine setigerous punctures separated generally by two or more diameters, postfemoral line complete, tibial short spur short, sharp, curved, half as long as long spur; long spur long, narrow, acuminate, half length of first tarsal segment, latter longer than remaining four combined; tarsus slightly longer than tibia in length. Posterior femur, tibia, and tarsus as in preceding.

ALLOTYPE FEMALE.—Length 3.5 mm, width 1.4 mm. Seemingly identical with male except for straight, slightly downwardly curved anterior spur of anterior tibia, and for penultimate abdominal segment, which is normal and slightly shorter than preceding segment.

TYPES.—Holotype: collected in 15-watt black light trap, Saavedra Exper. Sta., 60 miles north of Santa Cruz, Dept. Santa Cruz, Bolivia, Jan. 4, 1960, by Robert B. Cumming, USNM 69610. (The station is on the fringe of the Amazon basin, intermediate between Chaco and rainforest.) Allotype: same locality, Jan. 3, 1960. Paratype, 1 female: same data, Jan. 2, 1960, collection of Div. Plant Industry, Florida Dept. Agric., Gainesville, Fla.

REMARKS.—*Cartwrightia cartwrighti* is named after my brother Raymond Kenneth Cartwright, who, though not an entomologist, accompanied me and served as guide on many pleasant and productive field trips.

Cartwrightia intertribalis Islas

PLATE 3

Cartwrightia intertribalis Islas, 1958, p. 345.

Male.—Eight specimens: Length 3.31 mm, width 1.35 mm. Elongate, subparallel, head, pronotum, and elytral costae covered with argillaceous covering, intervals of elytra shining, dark castaneous. Clypeus with double anterior edge, upper and lower margin separated by fine narrow furrow extending from gena to gena, lower margin with median triangular tooth directed downward; upper margin angularly rounded on each side of wide shallow emargination, laterally straight to genal angles, entire anterior edge narrowly shining brown, finely recurved; genae small, margin emarginate, to sharp posterior angle;

yellowish-brown argillaceous surface of clypeus with distinct coarse punctures over large area on each side of median convexity; posterior margin of clypeus sharply elevated above frontal-basal area of head and laterally down to genae, deep pit behind gena.

Pronotum generally with argillaceous coating, more or less quadrate, anteriorly with narrow membranous edge, anterior angles broadly rounded, lateral margin sinuate to broadly rounded posterior angles, base slightly angulate posteriorly at middle; surface with five depressed areas, large area on each side of median ridge anteriorly; over basal half a median, wide, depressed longitudinal area; depressed area with deep, sharply incised line from anterior angles diagonally back to basal fourth (see pl. 3); five depressed areas separated by rounded, faintly shining ridges showing very fine punctures and alutaceous sculpture; anterior depressed areas with deep coarse punctures in argillaceous coating; most of them grouped rather closely in posterior half of depression; some coarse punctures in diagonal depressions also; none noticeable in median basal depression; sharp, deep, narrow depression just inside posterior angles visible in lateral view.

Scutellum long, narrow, parallel, three times as long as wide. Elytra 2.15 mm long, 1.35 mm wide. Each elytron with strong sutural, lateral, and discal costae, four discal costae with fine, shining, median carina bordered on each side with narrow argillaceous line; first discal costa ending posteriorly in large, swollen, argillaceous mass, hooked laterally toward ends of other costae, second and third with very slight swelling, hooked inward toward first but not quite uniting with it, end of fourth with practically no swelling; sutural costae flattened and widened posteriorly toward bulbous ends of first but remaining separated by narrow furrow; intervals flat, smooth, shining, with row of small distinct punctures on each side close to bordering costae, punctures gradually disappearing over apical declivity.

Pronotum with large, wide, triangular posterior intercoxal process. Mesosternum flattened, slightly concave, sides flaring and partly covering anterior three-fifths of middle coxae; middle coxae separated by length of middle trochanter. Metasternal midline long and deep but somewhat masked by argillaceous coating of elongate concave discal area, this area with mixed, scattered fine and moderate indistinct punctures, surface everywhere finely alutaceous; triangular depression in front of posterior coxae moderately deep and slightly scabrous.

Five visible abdominal segments narrower at middle than at sides, penultimate segment very narrow at middle, only about one-sixth length of terminal segment at middle, segments bordered anteriorly with row of indistinct close moderate punctures. Pygidium concave on each side of low, wide indistinct carina. Entire undersurface, includ-

ing legs, with thin to moderate argillaceous coating with alutaceous surface sculpture.

Anterior femora with rather heavy argillaceous coating and scattered indistinct punctures bearing short, fine, inconspicuous yellow hairlike setae; foretibiae with two terminal teeth and one lateral close by; anterior spur hooked. Middle and hind femora with thin argillaceous coating and fine hair bearing indistinct punctures as on profemur; tibiae very weakly arcuate; first tarsal segment twice as long as long spur, slightly longer than remaining four segments combined.

FEMALE.—Six specimens: Length 3.33 mm, width 1.39 mm. The only noticeable differences from the male are the straight spur of the anterior tibia and the much wider, normal penultimate abdominal segment.

SPECIMENS.—Specimens on hand were all collected by H. F. Howden 21 to 28 miles east of Villa Union, Sinaloa, Mexico, July 7, 25, 26, 1964. Specimens are in Canadian National Collection, U.S. National Museum, and the private collection of H. F. Howden.

Literature Cited

ISLAS S., FEDERICO

1958. Un genero y especie nuevos de la subfamilia Aphodiinae en Mexico (Col. Scarabaeidae). *Anal. Inst. Biol.*, vol. 29, nos. 1 and 2, pp. 343-348, 1 fig.

Proceedings of
the United States
National Museum



SMITHSONIAN INSTITUTION • WASHINGTON, D.C.

Volume 124

1967

Number 3633

Alloxenia in Three Sympatric
African Species of *Cuculus*

By Herbert Friedmann¹

Research Associate, Department of Vertebrate Zoology

In a recent note (1967) I have proposed the term "alloxenia" to describe the situation wherein two or more related species of parasites tend to use different species of hosts. Opposed to this is the term "homoxenia," signifying the use of the same hosts by different species of parasites. Just as geographical or ecological allopatry is of obvious significance in the economy of related species with fairly similar habits, so too the avoidance of needless or of difficulty-inducing competition for brood hosts that is brought about by alloxenia confers definite advantages on parasites with fairly similar needs. Given sufficient time for development, alloxenia is, indeed, a situation that one might expect to develop under the influence of natural selection. The actual existence of alloxenia cannot be assumed, however, until a considerable body of observational data is available for its elucidation.

The object of the present paper is to demonstrate that we have now reached this point in our knowledge of the three largely sympatric species of *Cuculus* in Africa. As a matter of fact, I had anticipated this situation in my book on all the African parasitic cuckoos (1949a, p. 190) when I wrote that they appear "to divide up both

¹ Director, Los Angeles County Museum of Natural History, Los Angeles, Calif.

the African landscape and the African avifauna in such a way as to avoid undue host competition among themselves" In the present paper I am concerned with three of these cuckoos, all of which occur together in many parts of the continent and on which we have much more information than was available 20 years ago.

In the prolonged task of amassing egg record data, I have been helped by several collectors and observers who have generously sent me unpublished data. Due thanks for their contributions are here given to R. I. G. Attwell, G. Duve, B. V. Neuby-Varty, G. Symons, V. G. L. van Someren, and C. Vernon.

The red-chested cuckoo, *Cuculus solitarius*, is by far the best known of all the African species of its genus. The black cuckoo, *C. clamosus*, is becoming more adequately understood although its suggestive and yet puzzling plumages (the so-called *mabirae*, *jacksoni*, and *gabonensis* entities) are still awaiting satisfactory clarification. The third member of the genus, *C. canorus gularis*, the yellow-billed cuckoo, is the least often observed and, hence, the least fully documented. Enough is now known of the egg morphism and of the host selection of each of these species, however, to be able to make some meaningful comparisons.

For the first species, there are now available to me data on 134 instances of its parasitism involving some 39 species of hosts (or 45 kinds of birds if we list subspecies as well). These data give a good picture of the range and of the frequency of host choice by the red-chested cuckoo. Of the 39 species of hosts, 20, or 51.3 percent, are thrushes, but the percentage of the total number of records of parasitism that involve thrushes as hosts is even higher—69 percent, or 93 out of the total 134 records.

For *Cuculus clamosus*, we now have information on 39 cases of its parasitism involving 16 species of hosts (or 21 if we include subspecies). Of these, 26 instances, or 66.6 percent of the total, involve seven species of shrikes. On the other hand, only three species of thrushes have been noted as victims of the black cuckoo, and for two of these there is as yet but a single record—and only two records for the third species.

The data for *Cuculus canorus gularis* are much less adequate: 14 definite and 3 indefinite records, involving 7 definite and 3 indefinite host species. Of the definite records, 8, or 57 percent, involve three species of shrikes; 3 involve one species of drongo; 1 each involve single species of bulbuls, starlings, thrushes, and weaver finches; while the 3 indefinite instances involve one shrike and two kinds of thrushes.

In the present paper I list the currently known hosts of each of these cuckoos and also describe their egg morphism in order to determine what, if any, host egg adaptations may have evolved. In con-

sidering each of these host catalogs, the reader should keep in mind that these lists will grow steadily as additional field data become available and that we may well find it necessary to reappraise the apparent preferences of the third and least known species.

Red-chested Cuckoo: *Cuculus solitarius*

The hosts recorded so far for this species are as follows:

	Rec- ords		Rec- ords
<i>Motacilla c. capensis</i> Linnaeus	8	<i>Pogonocichla swynnertoni</i> (Shelley)	1
<i>M. c. wellsii</i> Ogilvie-Grant	2	<i>Cossypha humeralis</i> (Smith)	2
<i>M. alba vidua</i> Sundevall	8	<i>C. n. natalensis</i> Smith	2
<i>Anthus novaeselandiae cinnamo-</i> <i>mea</i> Rüppell	1	<i>C. n. intensa</i> Mearns	1
<i>A. leucophrys zenkeri</i> Neumann	2	<i>C. c. caffra</i> (Linnaeus)	34
<i>Prionops plumata poliocephala</i> (Stanley)	1	<i>C. c. iolaema</i> Reichenow	1
<i>Tchagra</i> species	1	<i>C. cyanocompter bartteloti</i> Shelley	1
<i>Pycnonotus barbatus tricolor</i> (Hart-	4	<i>C. semirufa intercedens</i> (Cabanis)	7
laub)		<i>C. h. heuglini</i> Hartlaub	9
<i>F. b. layardi</i> Gurney	2	<i>C. h. subrufescens</i> Bocage	2
<i>Andropadus v. virens</i> Cassin	1	<i>C. dichroa</i> (Gmelin)	2
<i>Baeopogon indicator</i> (Verreaux)	1	<i>C. niveicapilla melanonota</i> (Ca-	1
<i>Chlorocichla flaviventris centralis</i> Reichenow	1	banis)	
<i>C. flavicollis pallidigula</i> (Sharpe)	1	<i>Neocossyphus poensis praepecto-</i> <i>ralis</i> (Jackson)	1
<i>Saxicola t. torquata</i> (Linnaeus)	3	<i>Stizorhina f. fraseri</i> (Strickland)	1
<i>S. t. axillaris</i> (Shelley)	5	<i>Turdus libyanus tropicalis</i>	3
<i>Cercomela familiaris hellmayri</i> (Reichenow)	1	Peters	
<i>Monticola rupestris</i> (Vieillot)	6	<i>Muscicapa a. adusta</i> (Boie)	2
<i>Pinarornis plumosus</i> Sharpe	4	<i>M. c. caerulescens</i> (Hartlaub)	1
<i>Cercotrichas coryphaeus</i> (Linnaeus) subspecies	1	<i>Terpsiphone rufiventer tricolor</i> (Fraser)	1
<i>C. leucophrys brunneiceps</i> (Reich-	2	<i>T. viridis</i> (Müller)	1
enow)		<i>Remiz m. minutus</i> (Shaw and	1
<i>C. barbata</i> (Finsch and Hartlaub)	1	Nodder)	
<i>Alethe a. archeri</i> (Sharpe)	1	<i>Nectarinia f. famosa</i> (Linnaeus)	1
		<i>Passer m. melanurus</i> (Müller)	1
		<i>Serinus c. canicollis</i> (Swainson)	1

As noted earlier, 93, or more than two-thirds of all these records, involve thrushes, and 62 of these involve eight species of a single genus of fosterers, *Cossypha*, the robin chats. The only other thrushes for which there are numerous records are *Saxicola torquata* (two races) with eight cases, *Monticola rupestris* with six instances, and *Pinarornis plumosus* with four cases; all the other thrushes have only one or two records apiece.

Next in frequency of choice as hosts are the wagtails and pipits (family Motacillidae) with 21 records involving four species. Here it should be observed that the pipits (*Anthus*) are not very important

as hosts (two species, one with a single record, the other with two) but the wagtails (*Motacilla*) are among the regular fosterers of the parasite (with 10 records for one species and 8 for the other). Of bulbuls (family Pycnonotidae) five species have been found to be parasitized 10 times; but only one of these, the common *Pycnonotus barbatus*, is known to be a frequent host (six records).

The other groups of hosts apparently are seldom bothered by the red-chested cuckoo, and it seems safe to conclude that these hosts play no important role in the cuckoo's economy and that, conversely, its effect on them is very slight. These groups include the flycatchers, tits, sunbirds, weavers, shrikes, and finches.

If we attempt to estimate the relative frequency of host selection by the red-chested cuckoo, our present data reveals the following sequence: By far the most frequently imposed upon host is *Cossypha caffra* with 35 records, followed by *C. heuglini* with 11, *Motacilla capensis* with 10, *M. alba* and *Saxicola torquata* with 8 each, *C. semirufa* with 7, *Monticola rupestris* and *Pycnonotus barbatus* with 6 each, while all the other hosts are known as yet only from single or, at most, two instances apiece.

It seems evident that unusually small hosts, such as *Remiz minutus* and *Nectarinia famosa*, are probably unusual reports in the same sense as the "freak" host records for the cuckoo (*C. canorus*) in Europe or the brown-headed cowbird (*Molothrus ater*) in North America. There are but single records for *R. minutus* and *N. famosa*, and it may be recalled that the record for the former is an old Levaillant one, unsupported by more recent evidence, that is open to doubt as I pointed out in an earlier publication (1949a, p. 77). The lone instance involving the malachite sunbird, however, is clearly acceptable as it was recorded by a very careful and reliable observer in Natal, Godfrey Symons.

All the known hosts are passerine birds and all are birds that make open nests. These cuckoos "have been said to show interest" in some of the domed or globular nests of weavers, but I know of no records of their depositing eggs in them. The absence of babblers from the list is of interest as it leaves these birds to the attention of the crested cuckoos, *Clamator*, with which the red-chested cuckoo does not seem to conflict seriously.

Not only do we now have a fairly good picture of the range of host selection of this cuckoo, but also we now have to revise our earlier conclusions about its egg morphism. When I first wrote of this matter (1949a, pp. 68-69), I could only state that the eggs showed very little variation when compared with those of the well-known common cuckoo of Europe. The majority of all the then-known eggs of the red-chested cuckoo were plain, unmarked chocolate brown to olive

brown, and the few eggs of other coloration were regarded as unusual. One of the latter, unmarked blue, is now to be considered as probably misidentified *Clamator jacobinus* eggs. To the other types then described may now be added still others, all suggesting a wide range of coloration indeed although it is still apparent that the plain brown egg outnumbers all the others many times over.

The range of color variation may be seen in the following egg types:

1. Plain chocolate brown to olive brown (the commonest type).
2. Similar to no. 1 but paler, more pinkish, less chocolate, and slightly smaller (Zululand, ex nest of *Cossypha humeralis*).
3. Pale greenish white, thickly spotted with browns of several shades (Congo, oviduct egg).
4. Pale bluish green with an indistinct band of obscure brownish spots at the larger end (Kenya, ex nest of *Cercotrichas leucophrys*, according to Nehrkorn 1910, and ex nest of *Saxicola torquata*, both according to Schönwetter, 1964, p. 545). Pitman (1964, pp. 140-141) has described additional similar eggs: one, from a *Tchagra* nest in Southern Rhodesia, was pale green with a few rusty-brown spots, some very pale and small; another, from a *Motacilla capensis* nest in South Africa, was pale greenish, heavily marked with shades of brown ". . . and may link the previously described spotted or freckled egg with the well-known normal type which is so profusely and finely marked as to appear almost immaculate."
5. Similar to no. 4 but olive green, flecked with strong reddish brown, especially at the larger end (ex nest of *Cossypha caffra*, no locality given, according to Schönwetter, 1964, p. 545).
6. Fawn brown with intense dark reddish-brown flecks (Schönwetter, 1964, p. 545).
7. Very pale green with very delicate pale-brown and grayish-violet flecks (ex nest of *Cercotrichas ruficauda* [= *C. leucophrys brunneiceps* of our list], according to Schönwetter, 1964, p. 545).
8. Almost uniform grayish white, tinged with pale pink, with barely visible scrawls (ex nest of *Cossypha caffra*, according to Schönwetter, 1964, p. 545).

It should be mentioned that Schönwetter (1964, p. 545) writes that eggs of *Cuculus solitarius* are confused easily with those of *Cossypha*. This cannot be correct, however, in nests of *Cossypha caffra*, the most heavily parasitized species, whose eggs are whitish, freckled, especially at the larger pole, with pale brown. There is much closer agreement with the eggs of *Cossypha natalensis* and *C. dichroa*, an observation first mentioned by Roberts (1940, pp. 139-140). As may be inferred from the foregoing, there is less evidence than might have been expected for host egg mimicry in this cuckoo. The species of robin chats to whose eggs the cuckoo's own are most similar are seldom used by the parasite, whereas with no eggs of its frequent hosts do the cuckoos' eggs bear such close resemblance as to be regarded as highly evolved mimics in the same sense that some of the gentes of the European cuckoo have become. Moreau (1949) thought there was some slight adaptation in egg size by the red-chested cuckoo to the eggs of its hosts, but this is not noticeable.

Black Cuckoo: *Cuculus clamosus*

The following birds have been found to be parasitized by this species (all races combined):

	records		records
<i>Pinarornis plumosus</i> Sharpe	2	<i>L. leucorhynchus</i> (Hartlaub)	1
<i>Prionops plumata poliocephala</i> (Stanley)	1	<i>L. lühderi</i> (Reichenow)	1
<i>Dryoscopus cubla hamatus</i> Hartlaub	1	<i>Malaconotus o. olivaceus</i> (Shaw)	1
<i>Laniarius ferrugineus pondoensis</i> Roberts	6	<i>Oriolus auratus notatus</i> Peters	2
<i>L. f. natalensis</i> Roberts	3	<i>Pycnonotus barbatus layardi</i> Gurney	2
<i>L. f. limpopoensis</i> Roberts	3	<i>Cossypha n. natalensis</i> Smith	2
<i>L. f. transvaalensis</i> Roberts	2	<i>C. c. caffra</i> (Linnaeus)	1
<i>L. f. tongensis</i> Roberts	1	<i>C. h. heuglini</i> Hartlaub	1
<i>L. f. aethiopicus</i> (Gmelin)	2	<i>Melaenornis pammelaina</i> (Stanley)	1
<i>L. barbarus atrococcineus</i> (Burchell)	4	<i>Prinia m. maculosa</i> (Boddaert)	1
		<i>P. subflava melanorhyncha</i> (Jardine and Fraser)	1

Of the 16 species of hosts, 6 also are known to be parasitized by the red-chested cuckoo, but 3 of these are included herein on the basis of single records, and 3 on the basis of two records each. Furthermore, one of these, *Prionops plumata*, is known as a host of the red-chested cuckoo only on the basis of its having been seen with a recently fledged young of that parasite and not on the basis of an actual nest record. The likelihood of this being a valid instance of parasitism must be accepted with some reservation since a fledgling cuckoo might attract the attention of birds other than those that actually reared it.

Not only are shrikes the chief hosts of the black cuckoo, but also the involved species of this group are not the same as those parasitized by the jacobin cuckoo, *Clamator jacobinus*. That bird parasitizes the fiscal shrike, *Lanius collaris*, very frequently. The black cuckoo has not yet been found to use this wide-ranging, common bird as a host, but the yellow-billed cuckoo does use it. The only overlapping host is the boubou, *Laniarius ferrugineus*, and for this species there is only a single record of parasitism by the jacobin cuckoo, whereas it is the commonest fosterer of the black cuckoo.

As in the case of the red-chested cuckoo, all the hosts of the black cuckoo are open-nesting passerine birds, but within this wide range of potential victims there is relatively little overlap in the host preferences of the two parasites. The instances of homoxenia between the black and the red-chested cuckoos involve 37 percent of the hosts but only 25 percent of the total records of the former species.

The eggs of the black cuckoo are variable, but so far as I know, at least in southern and eastern Africa (typical *clamosus*), they do not resemble and, hence, are not apt to be mistaken by their observers for

the plain chocolate or olive-brown, unmarked eggs of the red-chested cuckoo, *C. solitarius*, the commonest egg morph of that species. There is, however, enough similarity among other types, especially the greenish type, of the eggs of both *C. solitarius* and *C. clamosus*, to cause confusion and at times to raise some doubts as to their identification.

The eggs of *C. clamosus* may be said to be of three types: one with a whitish ground color, one with pale brownish, and one with a pale greenish ground, all variously speckled with shades of brown and gray. These types are not isolated geographically and, hence, are not typical of different populations or subspecies of the cuckoo since two or more occur in the same area.

Thus, in Cameroon, Bates (1911, pl. 9, fig. 4) found an egg of the race *gabonensis* that was pale brownish, everywhere flecked with dark umber, the speckles most heavily concentrated at one pole. Later (1927, pl. 2), he took another egg from a freshly shot hen, which had a whitish ground color, speckled all over with reddish brown and gray. From Gabon, another oviduct egg reported by Schönwetter (1964, p. 545) was pale green, abundantly flecked with burnt sienna and gray. Still another oviduct egg from Cameroon was described by Searle (1965, p. 71) as having a cream-colored ground, profusely blotched and spotted with reddish-brown and with claret-brown primary and ashy-purple secondary markings, all of these markings coalescing near the large pole to form a ring.

A somewhat similar greenish egg with flecks of olive brown and gray was taken in Mozambique (typical *clamosus*), but in the same area other eggs of this cuckoo were dirty white, sharply flecked with pale brown and pale gray. Whitish eggs similar to these also were taken in Natal and in the eastern Cape Province, South Africa (Chubb, 1914, p. 62; Skead, 1951a, pp. 163-173; Roberts 1963, p. 182). A fairly similar egg, but less heavily flecked, taken in northwestern Ethiopia by Cheesman (1935, p. 311), was described as being dull white with a few reddish-brown flecks.

As in the red-chested cuckoo, it is not possible to detect the evolution of adaptive egg mimicry in the black cuckoo, but it should be noted that Searle (1965, p. 71) thought that an oviduct egg of the race *gabonensis* showed some resemblance to "certain shrike and bulbul eggs." Both species of cuckoos have a considerable range of color variation in their egg shells, and to that degree both have the possibility of developing egg adaptive genetes. The evidence available clearly shows preponderant host preferences but fails to reveal proportional egg morph specialization. Hoesch (1940) wrote that the eggs of the black cuckoo tend to match those of the boubou shrike in markings but not in color. Moreau (1949) considered that the eggs might be looked upon as showing some color resemblance to those of

two of the hosts but not to those of the commonest one. Even this seems somewhat doubtful.

Yellow-billed Cuckoo: *Cuculus canorus gularis*

The hosts of the African yellow-billed cuckoo, as stated earlier are less well known than are those of its congeners. To date, so far as I have been able to learn, the only fosterers for which there are more than single records are the drongo, *Dicrurus adsimilis*; the bou-bou, *Laniarius ferrugineus*; and the fiscal shrike, *Lanius collaris*. Two of the following list, the bush shrike (*Malaconotus zeylonus*) and the robin chat (*Cossypha caffra*), were listed as hosts by Levaillant over 150 years ago and have not been so reported by anyone since then. They may be considered, therefore, as indefinite, especially since they were not documented in detail by their reporter. The absence of more recent records would be cause for scepticism in the case of a better known species of cuckoo; in this case there are so very few observations, one can hardly claim that the old pioneer of African cuckoo studies has or has not been contradicted.

The recorded or reputed hosts are as follows:

	records		records
<i>Dicrurus a. adsimilis</i> (Bechstein)	3	<i>Lanius collaris</i> Linnaeus	4
<i>Pycnonotus barbatus tricolor</i> (Hartlaub)	1	<i>Cercotrichas p. paena</i> (Smith)	1
<i>Lamprotornis</i> species	1	<i>C. leucophrys pactoralis</i> (Smith)	1
<i>Laniarius ferrugineus</i>	3	<i>Cossypha caffra</i> (Linnaeus)	1
<i>Malaconotus z. zeylonus</i> (Linnaeus)	1	<i>Passer griseus diffusus</i> (Smith)	1

It is of interest to note that, unlike its two African congeners, this cuckoo does make some use of nests in holes in trees, as shown by the instances of the glossy starling and the gray-headed sparrow. It may be recalled that Haydock (1950, pp. 149-150) in Northern Rhodesia saw a pair of an unidentified species of *Lamprotornis* feeding a recently fledged red-chested cuckoo. Because it is known that adult birds of many species often react with food to the clamorous importuning of fledgling birds that they have not reared themselves, this record is not included in our list of hosts of *Cuculus solitarius*. The fact that the yellow-billed cuckoo has been found to lay in a nest of a glossy starling may lend probability to the nature of Haydock's record, but it still remains uncertain. In its use of shrikes' and of drongos' nests as repositories for its eggs, the yellow-billed cuckoo does compete with the jacobin cuckoo, but the latter parasitizes drongos very seldom.

Eggs of three types have been described for the yellow-billed cuckoo: pale greenish blue with pale mauve and brown spots; light bluish gray

with blotches of slate and dark greenish olive brown, more numerous at the large pole, but present elsewhere as well; and very pale pink with spots of mauve and russet, the spots slightly more concentrated at the blunt end of the egg than elsewhere (Pitman, 1957, p. 139). The first two of these were taken in the same area in Southern Rhodesia by Neuby-Varty (1948, 1950), a fact that shows the nongeographical nature of the variability. An uncertainly identified egg found in a scrub robin's nest (*Cercotrichas*) in Northern Rhodesia and attributed to this cuckoo by Lees (1938, p. 18) was said to have a coffee-colored ground, darkening at the wide end. The identification of the two eggs taken by Neuby-Varty is completely acceptable; the one reported by Lees was identified "by elimination," i.e., it was thought to be *C. gularis* because it did not fit either *C. solitarius* or *C. clamosus*. This record cannot be looked upon as more than a guess.

In light of the limited data on the yellow-billed cuckoo, it is premature to generalize, but what little we know does not suggest any marked development of host egg mimicry. The fact that eggs with a pinkish-ground color, described above, were all found in nests of drongos, whose own eggs have a pinkish ground, may suggest some incipient tendency in this direction, but the number of cases is still too small to show a real trend.

The absence of marked adaptive host egg resemblance in the eggs of the three species of largely sympatric African *Cuculus*, all of which show considerable variation in coloration, makes one wonder if alloxenia may have the effect of reducing the need for such a development and if this differential host selection, therefore, may be reflected in the fact that little or no adaptive egg evolution has taken place. It seems hardly likely that this in itself could have had that result although natural selection is by no means restricted to items of large value: small changes, provided they are advantageous, are equally apt to be acted upon by natural selection over a sufficient period of time. If the three species of *Cuculus* were homoxenic, adaptive host egg resemblance might be more critically important because of the competition for the same hosts by the several parasites. Even in a state of relatively good, if not total, alloxenia, such adaptations would seem to be of sufficient value to have occasioned more evolutionary change than appears to have transpired. This is what has happened with the completely allopatric European cuckoo and has resulted in that case in the formation of host-specific gentes with well-marked egg mimicry. The situation in the European cuckoo's African congeners is, therefore, puzzling, but it has the features outlined in this paper. The gentes in the European cuckoo differ from each other only in their egg shell coloration and in their host choice. It is only in their egg shells that the gentes show any change

comparable to the slight morphological characters of the "host races" described in some groups of insects and nematodes specific on diverse plant hosts. As Mayr (1963, p. 458) has pointed out, these organisms may concentrate upon specific hosts in one area but are able to establish themselves equally well on others elsewhere. This is equally true of the European cuckoo in areas that have experienced ecological disturbances owing to agriculture or to other inroads of human influence.

An important point should be stressed. In the European cuckoo we have good evidence of individual host specificity; in the African species of *Cuculus* we have none. We only assume, with some reason but not with any real evidence, that probably each hen lays all its eggs in nests of a single species of host. If anything, the actuality of alloxenia in these sympatric parasites argues for such individual host constancy.

Appendix: Source Data on Host Records

Additional data on host records of the three African species are appended herein for the benefit of readers of this paper who may otherwise wonder where the records came from. Instances that are merely additional and repetitive cases are not considered necessary to describe but have been included in the enumeration given for each host earlier in the paper. (See also: Bouet, 1961; Rorke, 1947; Skead, 1951b.)

Cuculus solitarius

In the list of known hosts of the red-chested cuckoo given earlier in this paper, some 14 kinds of birds are added to my earlier (1949a, 1949b, 1956) compilations of the fosters of this parasite. The data for these additions as well as new records for little known but previously recorded hosts are as follows:

Tchagra species: Nest with a red-chested cuckoo egg found at Baragoi, Samburu district, Kenya, by Pitman (1964, pp. 140-141).

Andropadus virens virens: Listed as a host in Fernando Poo by Basilio (1963).

Chlorocichla flaviventris centralis: Found to be parasitized in the Ngong region, Kenya, by van Someren (1956, p. 154).

Pinarornis plumosus: A parasitized nest reported from Northern Rhodesia by Benson and Pitman (1956, pp. 37-38). Refers also to a second instance, from Southern Rhodesia, collected by Plowes. Since then R. K. Brooke has sent me two more Rhodesian records, one observed at Plumtree, Mar. 6, 1961, by C. J. Vernon, and one by A. W. Wragg at the same place on Dec. 16, 1962.

Cercotrichas barbata: One overlooked record from the Zimbiti district, Mozambique, reported by Sheppard (1914, p. 3). If the subspecies *rovumae* should be reinstated this host record would refer to that race.

Alethe archeri: van Someren (in litt., May 14, 1961) informed me that his chief collector Yokana found a young fledged red-chested cuckoo cared for by this thrush in the Humia valley, west Ruwenzori, in 1946.

Pogonocichla swynnertoni: One record, a nest containing a red-chested cuckoo egg, found at Stapleford, near Umtali, Southern Rhodesia, Jan. 8, 1963, by A. Williams and reported to me by R. K. Brooke.

Cossypha semirufa intercedens: In the Ngong area, Kenya, van Someren (1956, p. 306) reported this as the chief victim of the red-chested cuckoo, writing that the "three pairs of cossyphas that nest near my stream are regularly victimized; they seldom raise a brood of their own . . ."

Cossypha cyanocampter bartteloti: van Someren (in litt., May 14, 1961) reported a female of this thrush caring for a young red-chested cuckoo in the Kyetume area, Uganda, in 1912.

Cossypha niveicapilla melanonota: van Someren (in litt., May 14, 1961) wrote me that in 1913 he found several nests of this robin chat, each with an egg of the red-chested cuckoo, in the Mabira Forest, Uganda. It is not possible at this late date to check this statement, but it should be noted that the black cuckoo, *C. clamosus jacksoni*, also occurs in the Mabira Forest.

Neocossyphus poensis praepectoralis: Listed as a host in Fernando Poo by Basilio (1963).

Stizorhina fraseri fraseri: Said to be victimized in the island of Fernando Poo (Basilio, 1963).

Turdus libyanus tropicalis: Pitman (1961, pp. 48-49) lists three instances of parasitism on this thrush by the red-chested cuckoo, all in Southern Rhodesia.

Muscicapa adusta adusta: One additional record for this seldom-used host has come to my attention from R. I. G. Attwell (in litt., Apr. 10, 1963), who found a pair of these flycatchers with a fledgling red-chested cuckoo at Knysna, Cape Province, Dec. 28, 1962.

Terpsiphone rufiventer tricolor: Listed as a host in Fernando Poo by Basilio (1963).

Terpsiphone viridis viridis: Jessop (1960, p. 179) reported a nest of this paradise flycatcher with a red-chested cuckoo's egg near the Sir Lowry's Pass River, Cape Province, on November 4, 1956.

Cuculus clamosus

The list of hosts of the black cuckoo presented in this paper includes a few on which further data should be presented:

Pinarornis plumosus: One record is known of this babbler as a host of the black cuckoo. McLean (1957) found a parasitized nest at Que Que Reserve, Southern Rhodesia, November 26. He saw the cuckoo fly out of the nest, which, on inspection, was found to contain one egg of the parasite and two of the host.

Laniarius barbarus atrococcineus: The known instances of parasitism on this shrike recently have been doubled. Rowan, Skead, and Winterbottom (1964, p. 235) noted that a pair of these shrikes was seen caring for a fledgling black cuckoo at Hoffnung, Damaraland, February 11. In the Wankie Game Reserve, Southern Rhodesia, Vernon (in litt., 1961) made a similar observation in January 1958.

Oriolus auratus: To the single instance mentioned in my earlier (1949a) list may be added a second one. Benson and Pitman (1956, p. 25) found a nest at Kasana, Zambia, November 14, containing two newly hatched young, one of which turned out to be a black cuckoo and became the sole occupant of the nest five days later.

Cossypha natalensis: Oatley (1959, p. 431) recorded this robin chat as a victim of both the black and the red-chested cuckoo. Previously only a single record of its serving as a host to the black cuckoo was known to me.

Cossypha heuglini: Heuglin's robin was added to the known hosts of the black cuckoo by McLean (1957), who found it to be parasitized in the Que Que Reserve, Southern Rhodesia, November 28.

Cuculus canorus gularis

To the still limited information on the hosts of the African yellow-billed cuckoo the following should be added:

Laniarius ferrugineus: G. Duve (in litt., 1962) informed me that he has in his collection three parasitized sets of eggs of the boubou, each with one egg of this cuckoo, all taken near Johannesburg, Transvaal, October 2 to January 12.

Lanius collaris: In the Transvaal, G. Duve (in litt., 1962) found three instances of the black cuckoo parasitizing the fiscal shrike.

Literature Cited

- BASILIO, AURELIO
1963. Aves de la Isla de Fernando Poo, 202 pp. Madrid: Editorial Coculsa.
- BATES, G. L.
1911. Further notes on the birds of southern Cameroon, pt. I. *Ibis*, ser. 9, vol. 5, pp. 479-545, 3 pls.
1927. Notes on some birds of Cameroon and the Lake Chad region: Their status and breeding times. *Ibis*, ser. 12, vol. 3, pp. 1-64.
- BENSON, C. W., and PITMAN, C. R. S.
1956. Some breeding records from Northern Rhodesia, pt. III. *Oologists' Rec.*, vol. 30, pp. 21-27, 37-43.
- BOUET, G.
1961. Oiseaux de l'Afrique Tropicale, pt. 2. *Faune Trop.*, vol. 17, pp. 421-798, 140 figs.
- CHEESMAN, R. E., and SCLATER, W. L.
1935. On a collection of birds from north-western Abyssinia, pt. III. *Ibis*, ser. 13, vol. 5, pp. 297-329.
- CHUBB, E. C.
1914. A descriptive list of the Millar collection of South African birds' eggs. *Ann. Durban Mus.*, vol. 1, pp. 29-106.
- FRIEDMANN, H.
1949a. The parasitic cuckoos of Africa. *Washington Acad. Sci. Monogr.*, no. 1, 204 pp.
1949b. Additional data on African parasitic cuckoos. *Ibis*, vol. 91, pp. 514-519.
1956. Further data on African parasitic cuckoos. *Proc. U.S. Nat. Mus.*, vol. 106, pp. 377-408.
1967. Evolutionary terms for parasitic species. *Syst. Zool.*, vol. 16, p. 175.
- HAYDOCK, E. L.
1950. Supplementary notes on African cuckoos. *Ibis*, vol. 92, pp. 149-150.
- HOESCH, W., and NIETHAMMER, G.
1940. Die Vogelwelt Deutsch-Sudwestafrikas. *Journ. Ornith.*, vol. 88, spec. issue, 404 pp., 1 pl.
- JESSOP, J. P.
1960. Red-cheded cuckoo egg in Cape paradise flycatcher nest. *Ostrich*, vol. 31, p. 179.
- LEES, R. H.
1938. Further bird notes from Northern Rhodesia. *Ostrich*, vol. 9, pp. 13-26.
- MAYR, E.
1963. *Animal species and evolution*, 797 pp. Harvard University: Belknap Press.
- MCLEAN, F.
1957. Black cuckoo, *Cuculus cafer*, laying its egg in Heuglin's robin nest and sooty babbler's nest. *Ostrich*, vol. 28, pp. 175-176.
- MOREAU, R. E.
1949. Friedmann on African cuckoos. *Ibis*, vol. 91, pp. 529-537.

NEHRKORN, A.

1910. Katalog der Eiersammlung, nebst Beschreibungen der aussereuropäischen Eier, ed. 2, 499 pp.

NEUBY-VARTY, B. M.

1948. Some nests and eggs. *Ostrich*, vol. 19, pp. 158-160.
1950. Some oological notes. *Ostrich*, vol. 21, pp. 37-38.

OATLEY, T.

1959. Notes on the genus *Cossypha* with particular reference to *C. natalensis* Smith and *C. dichroa* (Gmelin). In Proceedings of the First Pan-African Ornithological Congress. *Ostrich*, suppl. 3, pp. 426-434.

PITMAN, C. R. S.

1957. On the egg of the African cuckoo, *Cuculus canorus gularis* Stephens. *Bull. British Ornith. Club*, vol. 77, pp. 138-139.
1961. The Kurrichane thrush, *Turdus libonyanus tropicalis* Peters: A host of the red-chested cuckoo *Cuculus solitarius* Stephens in Southern Rhodesia. *Bull. British Ornith. Club*, vol. 81, pp. 48-49.
1964. A further note on the egg of the red-chested cuckoo, *Cuculus solitarius* Stephens. *Bull. British Ornith. Club*, vol. 84, pp. 140-141.

ROBERTS, A.

1940. The birds of South Africa, 463 pp., 41 pls. London: Witherby.
1963. Birds of South Africa, 542 pp., 56 col. pls. Rev. ed. by McLachlan and Liversidge. Cape Town.

ROWAN, M. K.; SKEAD, C. J.; and WINTERBOTTOM, J. M.

1964. Notes on some Damaraland birds, chiefly around Windhoek. *Ostrich*, vol. 35, pp. 234-235.

RORKE, T.

1947. Breeding habits of Heuglin's robin. *Ostrich*, vol. 18, p. 107.

SCHÖNWETTER, M.

1964. Handbuch der Oologie, pts., 9 and 10, pp. 513-640. [Ed. by W. Meise.]

SEARLE, W.

1965. A third contribution to the ornithology of the British Cameroons. *Ibis*, vol. 107, pp. 60-94.

SHEPPARD, P. A.

1914. Additional list of, and notes on, birds collected and observed in Zimbiti district, 22 miles from Beira, P.E.A. *Journ. South African Ornith. Union*, vol. 10, pp. 1-4.

SKEAD, C. J.

- 1951a. Cuckoo studies on a South African farm. *Ostrich*, vol. 22, pp. 163-175.
1951b. Recent records of interest. *Ostrich*, vol. 22, p. 197.

VAN SOMEREN, V. G. L.

1956. Days with birds: Studies of habits of some east African species. *Fieldiana, Zool.*, vol. 38, 520 pp.

VAN SOMEREN, V. G. L., and VAN SOMEREN, G. R. C.

1949. The birds of Bwamba. *Uganda Journ.*, vol. 13, spec. suppl., 111 pp.

Proceedings of
the United States
National Museum



SMITHSONIAN INSTITUTION • WASHINGTON, D.C.

Volume 124

1967

Number 3634

BREDIN-ARCHBOLD-SMITHSONIAN
BIOLOGICAL SURVEY OF DOMINICA¹

6. Synopsis of Bats of the Antillean Genus *Ardops*

By J. KNOX JONES, JR., and ALBERT SCHWARTZ²

The stenodermine bat genus *Ardops*, endemic to the Lesser Antilles, was named and described by Miller (1906, p. 84), based on *Stenoderma nicholli* Thomas (type-species) from Dominica, *S. montserratensis* Thomas from Montserrat, and *S. luciae* Miller from St. Lucia. Subsequently, Miller (1913, p. 33) named a fourth species, *Ardops annectens*, from Guadeloupe. The four named taxa, of which a total of 15 specimens have been reported in the literature, have stood until now as distinct species. Recently acquired material, collected primarily under the aegis of the Bredin-Archbold-Smithsonian Biological Survey of Dominica, has made possible a meaningful reassessment of variation in the genus and has resulted in the systematic arrangement herein proposed.

Ardops is related to three other endemic Antillean genera, *Ariteus* of Jamaica, *Phyllops* of Cuba and Hispaniola, and *Stenoderma* of

¹ See list at end of paper.

² Jones: Museum of Natural History, University of Kansas, Lawrence 66044; Schwartz: Department of Biology, Miami-Dade Junior College, Miami, Florida 33167.

Puerto Rico and the Virgin Islands. Of these, *Ardops* may be related most closely to *Ariteus*, from which it differs principally in having a broader rostrum, narrower mesopterygoid fossa, distinctive sphenoid-basioccipital region, a small, peglike M3 (lacking in *Ariteus*), and the absence of any trace of a metaconule on the first lower molar. *Ardops* presently is known from Dominica, Martinique, St. Lucia, and St. Vincent in the Windward Islands, and from Guadeloupe, Montserrat, and St. Eustatius in the Leeward chain. Bats of this genus probably occur also on Nevis and St. Christopher [St. Kitts], and possibly elsewhere in the Lesser Antilles, but doubtfully in the Greater Antilles, where they are replaced by the genera mentioned above.

Other workers have commented on the slight differences ascribed to the four nominal species of *Ardops*. G. M. Allen (1942, p. 19), for example, noted that the "slightly differing" species were of "similar appearance." Hall and Kelson (1959, p. 142) wrote: "The currently recognized species are separated from each other seemingly on little more than slight differences in size and should possibly be regarded as actually constituting but one species." After study of the available material, taking into account individual and secondary sexual variation (females average larger than males—strikingly so in some populations), we recommend arranging the named kinds as subspecies of a single species, *Ardops nichollsi*, because (1) the differences between them are slight and quantitative in nature, (2) overall variation does not exceed that described as occurring in a number of other polytypic species of stenodermine genera, and (3) such a classification best reflects the similarities and obviously close affinities of the included taxa.

Among the subspecies, *A. n. nichollsi* of Dominica is the smallest (possibly excepting the population on St. Vincent, known to us by a single battered specimen in spirits from which the fragmentary skull has been removed). In order of increasing size, the other recognized races are distributed on St. Lucia (*A. n. luciae*), Guadeloupe (*A. n. annectens*), Martinique (subspecies newly named herein), and on Montserrat and St. Eustatius (*A. n. montserratensis*). A continuum in size can be demonstrated among the five subspecies but the continuum is not clinal, suggesting that the various insular populations have adapted independently to conditions prevailing on individual islands. Some size relationships are illustrated in figures 1 and 2 and in table 1.

Among 29 skulls with complete maxillae and mandibles, we find only two that do not possess the full complement of teeth (2/2, 1/1, 2/2, 3/3=32) typical of *Ardops*. Both of these, a female from St. Eustatius and a female from St. Lucia, lack the peglike M3 on the

left side. Additionally, we note a considerable range of variation in size in the third molars of both upper and lower jaws. In males of *A. n. nichollsi*, for example, the M3 varies from .55 mm wide by .40 mm long up to .70 by .50 mm; in females of that subspecies the tooth varies from .70 by .45 mm up to .90 by .50 mm. Otherwise, only minor variations in tooth structure were observed among the specimens studied.

It has not been possible for us to assess accurately infraspecific variation in color because, save for one skin from Guadeloupe (a female that may have been initially preserved in spirits), the only

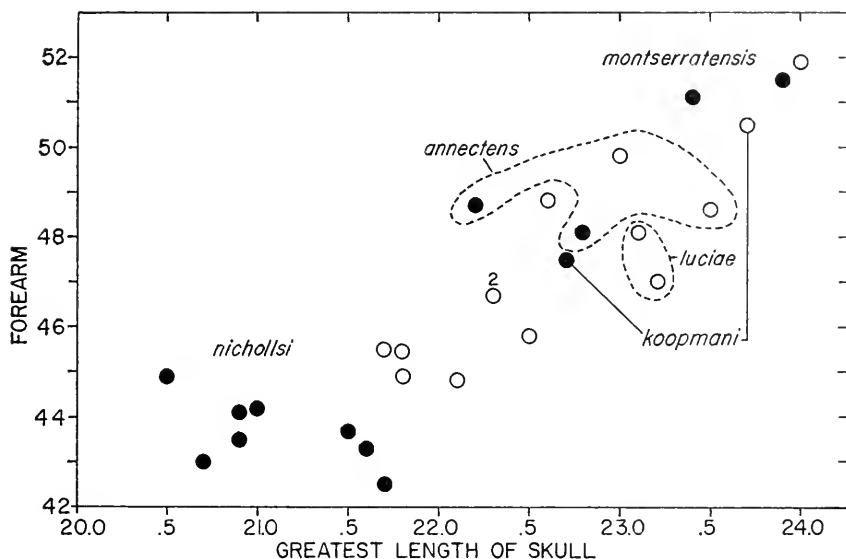

FIGURE 1.—Scatter diagram: length of forearm plotted against greatest length of skull (in mm) for specimens of five subspecies of *Ardops nichollsi* (solid=males, open=females).

museum study skins available are from Dominica. Nevertheless, comparison of specimens stored in alcohol of all named subspecies with the skins from Dominica suggests that geographic variation is slight. The dorsal pelage varies in overall color from near Prout's Brown (capitalized color terms from Ridgway, 1912) or Bister through various paler shades to near Buffy Brown (in one noticeably pale individual), and it is dense and relatively long (measuring 9–11 mm middorsally) in all specimens studied; usually there is a faint grayish-brown patch over the shoulders. The individual dorsal hairs are dark brownish basally, pale buffy in the midregion, and mostly tipped with brown, imparting a distinctly tricolored appearance to the pelage when it is parted. A white spot is present at the junction of

the wing with the body in all specimens that we examined (but see account of *A. n. montserratensis*) and is somewhat better developed in females than in most males. The ears are brownish in museum skins and contrast little with the color of the dorsum. The tragus and basal parts of the ear, tinged with greenish yellow in life, are yellowish or yellowish brown in dried skins. The membranes are dark brownish, contrasting to a greater or lesser degree with the color of the dorsum. Ventrally, the pelage usually is a rich brownish, tinged with grayish white; the hairs of the venter lack the tricolored appearance of those on the dorsum. Some photoelectric reflection readings of pelage colors are given in the account of *A. n. nichollsi*.

Bats of the genus *Ardops* evidently roost exclusively in trees and other types of arborescent vegetation although little precise informa-

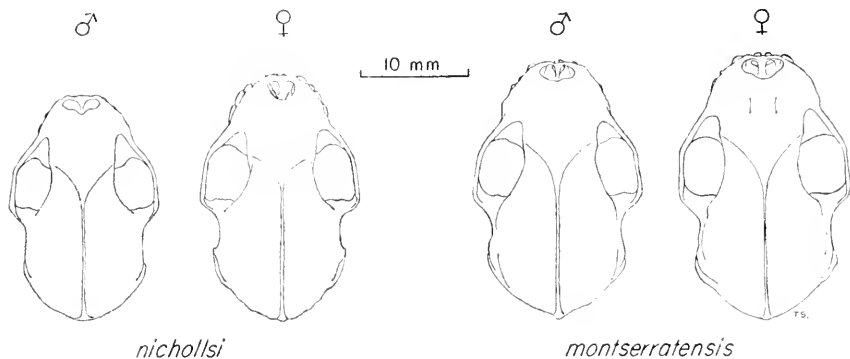

FIGURE 2.—Dorsal view of crania illustrating extent of secondary sexual variation: *Ardops nichollsi nichollsi* (one of smallest males examined, AS 5342; one of largest females, KU 104807); *A. n. montserratensis* (male, C. E. Ray 7926; female, CER 7927). Overall infraspecific variation in cranial size also is illustrated by fact that *A. n. nichollsi* is smallest subspecies of species and *A. n. montserratensis* is largest.

tion currently is available concerning their natural history. Those few observations that have been made are mentioned in the accounts of the several subspecies, particularly under *A. n. nichollsi* of Dominica. Much remains to be learned, too, of distribution and variation in *Ardops*, and we hope this synopsis will provide a useful basis for future work.

All measurements cited in text are in millimeters and all weights are given in grams. For the loan of specimens or for allowing us to study material housed in the institutions mentioned (abbreviations used to identify specimens in text are in parentheses), we are indebted to the following: Charles O. Handley, Jr., and Gary L. Ranck, U.S. National Museum (USNM); Karl F. Koopman, American Museum of Natural History (AMNH); Barbara Lawrence, Museum of

Comparative Zoology, Harvard (MCZ); Joseph C. Moore, Field Museum of Natural History (FM). Specimens in the Museum of Natural History of The University of Kansas (KU) and the collection of Albert Schwartz (AS) also were used. J. E. Hill of the British Museum (Natural History) (BMNH) kindly provided measurements of the holotypes of *Ardops nichollsi* and *A. montserratensis*. We are grateful also to Horton H. Hobbs, Jr., and other officials of the Smithsonian Institution for allowing one of us (Jones) to participate in March and April of 1966 in the Bredin-Archbold-Smithsonian Biological Survey of Dominica.

Ardops nichollsi nichollsi (Thomas)

Stenoderma nichollsi Thomas, 1891, p. 529.

Ardops nichollsi.—Miller, 1906, p. 84.

HOLOTYPE.—Adult female in spirits, skull removed, BMNH 91.5.14.4, from unknown locality on Dominica, Lesser Antilles.

DISTRIBUTION.—Known only from Dominica (see fig. 3).

MEASUREMENTS.—Average and extreme external measurements of six males, followed by those of seven females, are: total length 63.8 (60–67), 67.1 (62–73); length of hind foot 15.5 (15–16), 15.1 (13–16); length of ear 17.4 (16–18), 17.7 (17–18); length of forearm (eight males averaged) 43.6 (42.5–44.9), 46.2 (44.9–48.8). The forearm of the female holotype measures 45.7. Weight of five males averaged 16.9 (15.1–18.5); two nonpregnant females weighed 18.3 and 18.7 (lactating), and four pregnant females averaged 22.8 (17.8–25.2). See table 1 for cranial measurements.

REMARKS.—Representatives of *A. n. nichollsi* are the smallest of the species, save for one bat from St. Vincent that tentatively is referred to the subspecies *A. n. luciae*. The remarkable sexual dimorphism in size seen in specimens from Dominica—no overlap, for example, when length of forearm is plotted against length of skull (see fig. 1)—evidently is shared at least with the population occurring on Martinique, but dimorphism may not be so marked in other races of the species.

Color, as described earlier, seems not to vary with sex but varies individually in specimens at hand from dark brown to yellowish brown, the palest specimen, a female, being notably paler than any of the others and possibly in worn pelage prior to the onset of molt. At any rate, using a Photovolt 610 Photoelectric Reflection Meter, the reflected values of red, green, and blue on dorsum and venter, respectively, of 13 skins of *A. n. nichollsi* are: red 15.3 (11–22), 18.6 (15–24.5); green 6.3 (4–11), 10.0 (7–15); blue 5.6 (4.5–8), 8.8 (6.5–13). The upper limits for each value are measurements of the unusually pale female. Reflectance readings for the only other museum skin

examined, a female from Guadeloupe that may at one time have been immersed in spirits, fall near the average for the Dominican series except in green and blue values of the ventral pelage, which are at the lower (darker) end of the observed variation.

The female holotype (Thomas, 1891, pp. 529-530) and a male listed by Miller (1902, pp. 407-408) are the only two specimens of the sub-

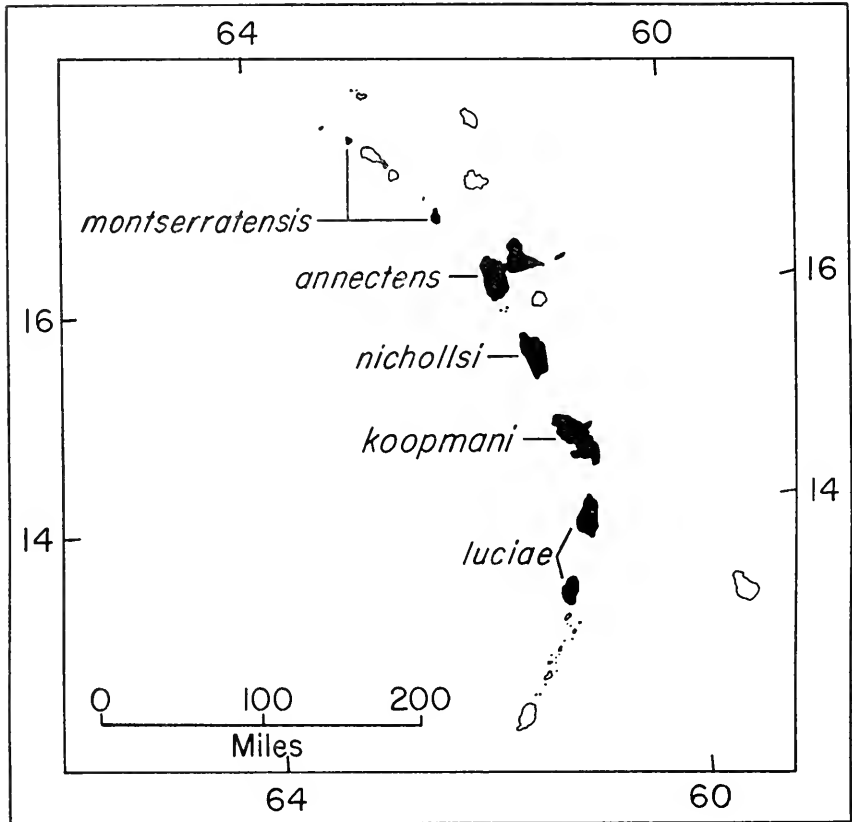

FIGURE 3.—Distribution of subspecies of *Ardoops nicholli* in the Lesser Antilles (north to south): *A.n. montserratensis* (St. Eustatius and Montserrat); *A.n. annectens* (Guadeloupe); *A.n. nicholli* (Dominica); *A.n. koopmani* (Martinique); *A.n. luciae* (St. Lucia and St. Vincent).

species *A. n. nicholli* reported previously. Of the remaining 14 individuals examined, we have information concerning the circumstances of capture of 13, all of which were taken in mist nets—one in 1962, one in 1964, and 11 in 1966. At Clarke Hall Estate one bat was trapped in a net (in which *Artibeus*, *Monophyllus*, and *Myotis* also were taken) stretched over a trail bordered by trees and a cacao

grove, and eight were netted in company with *Artibeus*, *Brachyphylla*, *Monophyllus*, and *Sturnira* over a rock-strewn gravel bar between the edge of the Layou River and lush vegetation that lined the bar. A female from 1 mile northwest of Portsmouth was taken in a net stretched across a trail on the side of a hill overlooking the Caribbean in dry, relatively scrubby forest; another female captured near the same place in 1964 was netted near the ruins ("Cabrit") on Prince Rupert Bluff. A male from 6 miles northeast of Roseau was netted in 1962 over a stream in rain forest, whereas a female from Roseau was trapped along with several *Artibeus jamaicensis* in a net placed adjacent to a pond in the Botanic Garden.

Each of six females collected in the spring of 1966 was reproductively active. One taken on April 19 was lactating. The others each carried a single embryo on the following dates (crown-rump length of embryos in parentheses): March 27 (11); March 28 (21); March 29 (31); April 2 (18); April 14 (29). Testes of March- and April-taken males varied in length from 4.5 to 6.0. Wing mites (Spinturnicidae) and hair mites (Lästrophoridae) were obtained from several individuals, but no other kinds of ectoparasites were found.

SPECIMENS EXAMINED.—16. DOMINICA: "Cabrit" [northwest of Portsmouth], 1 (USNM); 1 mile northwest of Portsmouth, 100 ft, 1 (KU); Clarke Hall Estate, 100 ft, 9 (KU); 6 miles northeast of Roseau, 1 (AS); Roseau, 1 (USNM); Botanic Garden, Roseau, 50 ft, 1 (KU); no specific locality, 2 (1 MCZ, 1 BMNH—examined for us by J. E. Hill).

Ardops nicholli montserratensis (Thomas)

Stenoderma montserratense [sic] Thomas, 1894, p. 133.

[*Ardops*]. *montserratensis*.—Miller, 1906, p. 84.

HOLOTYPE.—Adult male in spirits, skull removed, BMNH 94.1.9.1, from unknown locality on Montserrat, Lesser Antilles.

DISTRIBUTION.—Known from Montserrat and St. Eustatius (see fig. 3).

MEASUREMENTS.—External measurements taken from a male and female preserved in alcohol from St. Eustatius are, respectively: total length 69, 72; length of hind foot 18, 17; length of ear 18, 18; length of forearm 51.1, 51.9. The male holotype, also in alcohol, was recorded in the original description as measuring: head and body [total length] 69; length of ear 16.5; length of forearm 51.5. See table 1 for cranial measurements.

REMARKS.—*Ardops nicholli montserratensis* is so much larger than the holotype of *A. n. nicholli* that it is easy to understand why Thomas (1894, p. 133) named it as a full species. The subsequently described subspecies on Guadeloupe, Martinique, and St. Lucia

bridge the gap in size between *A. n. montserratensis* and *A. n. nichollsi*. Although we have not personally compared them with the holotype, the two specimens from St. Eustatius resemble it in size to such a marked degree that we unhesitatingly refer them to *A. n. montserratensis*, which also may occur on the intervening islands of Nevis and St. Christopher. Thomas (loc. cit.) described *A. n. montserratensis* as lacking a white spot at the base of the wing. This spot is

TABLE 1.—Cranial measurements of five subspecies of *Ardops nichollsi*

Number of specimens averaged, or catalogue number, and sex	Greatest length of skull	Zygomastic breadth	Postorbital constriction	Mastoid breadth	Breadth across upper molars	Length of maxillary tooththrow	Length of mandibular tooththrow (c-m3)
<i>Ardops nichollsi nichollsi</i> : Dominica							
Average 8 ♂	21.1	13.7	5.5	11.5	8.9	6.6	6.6
Minimum	20.5	13.4	5.3	11.2	8.7	6.2	6.3
Maximum	21.7	14.2	5.9	11.9	9.2	7.0	6.9
BM 91.5.14.4 ♀ ¹	21.8	—	5.6	—	9.5 ²	6.8	7.0
Average 7 ♀	22.2	14.5	5.6	12.0	9.6	7.3	7.3
Minimum	21.7	14.2	5.3	11.8	9.3	7.0	7.0
Maximum	22.6	14.8	5.9	12.1	9.7	7.5	7.5
<i>Ardops nichollsi montserratensis</i> : Montserrat							
BM 94.1.9.1 ♂ ¹	23.9	15.8	6.0	12.6	10.2	7.5	7.6
St. Eustatius							
C. Ray 7926 ♂ ³	23.4	15.5	6.1	12.6	10.1	7.7	7.6
C. Ray 7927 ♀ ³	24.0	15.8	6.4	13.0	10.9	8.4	8.1
<i>Ardops nichollsi luciae</i> : St. Lucia							
USNM 110918 ♀	23.1	14.9	5.9	11.8	10.3	7.9	8.0
USNM 110921 ♀ ¹	23.2	14.8	5.7	12.0	10.3	7.8	7.8
<i>Ardops nichollsi annectens</i> : Guadeloupe							
USNM 113498 ♂	22.2	14.4	5.6	11.3	9.6	7.1	7.0
USNM 113501 ♂	22.8	14.7	6.0	12.1	9.7	7.3	—
USNM 113499 ♀	23.0	—	5.9	12.5	—	7.8	7.9
USNM 113502 ♀ ¹	23.5	15.7	5.9	13.2	10.3	7.8	8.0
MCZ 15927 ♀	—	15.7	5.8	—	10.6	7.7	7.9
<i>Ardops nichollsi koopmani</i> : Martinique							
AMNH 213954 ♂	22.7	14.5	5.7	11.6	9.5	7.2	7.1
AMNH 213951 ♀ ¹	23.7	16.0	5.9	12.6	10.5	8.1	8.0

¹ Holotypes (measurements of *A. n. nichollsi* and *A. n. montserratensis* taken by J. E. Hill).

² Measurement after Thomas (1891, p. 530).

³ 7926 in AMNH and 7927 in University of Florida collection.

present in both specimens from St. Eustatius although it is much less distinct in the male than the female. Possibly Thomas overlooked a similarly faint spot on the male from Montserrat.

In the original description, Thomas alluded to the habits of *Ardops* on Montserrat as follows: "This Bat is said to hang all day under the branches of trees, and not to take refuge in holes and crannies as most other species do." He also noted that it was thought to do "much damage to the cacao plantations," which we doubt. The two specimens from St. Eustatius were collected by Clayton E. Ray and Robert R. Allen on Mar. 9, 1963, at a steep-sided volcanic crater called "The Quill." One was taken in a mist net placed across a path at the rim of the crater; this net also captured *Artibeus* and *Brachyphylla*. The other was netted in a small banana patch on the floor of the crater (C. E. Ray, pers. comm.). The female carried a single embryo that measured 15 in crown-rump length.

SPECIMENS EXAMINED.—3. MONTSERRAT: no specific locality, 1 (BMNH—examined for us by J. E. Hill). ST. EUSTATIUS: rim of crater of The Quill, 1 (AMNH); floor of crater of The Quill, 1 (AMNH—to be deposited in University of Florida collection).

Ardops nichollsi luciae (Miller)

Stenoderma luciae Miller, 1902, p. 407.

A[rdops]. luciae.—Miller, 1906, p. 84.

HOLOTYPE.—Adult female in spirits, skull removed, USNM 110,921, from unknown locality on St. Lucia, Lesser Antilles.

DISTRIBUTION.—Known from St. Lucia and tentatively recorded also from St. Vincent (see fig. 3).

MEASUREMENTS.—Some external measurements of the female holotype, preserved in alcohol, were reported in the original description as: head and body [total length] 65; length of hind foot 12.6; length of ear 18. Length of the forearm of a male and four females from St. Lucia are, respectively: 47.0, 45.1, 48.1, approximately 45, 47.0. See table 1 for cranial measurements.

REMARKS.—*Ardops nichollsi luciae* is of medium size and most closely resembles *A. n. annectens* of Guadeloupe among named subspecies. *Ardops n. luciae* averages smaller than *A. n. annectens* in length of forearm. Judging from the limited material available for study, the skulls of the two races are essentially of the same overall size, but skulls of *A. n. annectens* are broader (especially in zygomatic breadth and mastoid breadth) when specimens of the same sex are compared.

Miller (1902, p. 407) described the color of *A. n. luciae* as follows: After a year's immersion in alcohol the color of the fur is a uniform clay color, that of the back, limbs and membranes strongly washed with wood-brown, that

of the under parts somewhat lightened by faintly paler hair-tips. A small but very distinct whitish spot on shoulder at point where membrane joins body. Ears and noseleaf light-brown. Membranes dark-brown throughout, except that the antibrachium has a distinct pale border extending from base of thumb halfway to shoulder. Bones of fingers and distal half of forearm much lighter than membrane.

The skull was described as "distinctly larger than that of . . . *nichollsi*, but of essentially the same form throughout." The several dental characters mentioned by Miller as distinctive in *A. n. luciae* in comparison with *A. n. nichollsi* (bifid upper incisors, for example) have been found individually variable in the sample of the latter now available.

A male from St. Vincent (FM 47718), the first member of the genus to be reported from that island, is preserved in alcohol and the fragmentary skull has been removed. The specimen is in poor condition, but all observable characters indicate that it is referable to the genus *Ardops*. Fragments of the skull, including part of the upper toothrow, are similar in size to corresponding parts of skulls of *A. n. nichollsi* of Dominica. Both forearms are broken, but the right can be reconstructed for an approximate measurement, which is 39. Judged by this one specimen, bats on St. Vincent may be smaller than those of any described race of *A. nichollsi*, and we have tentatively referred FM 47718 to *A. n. luciae* on geographic grounds pending the acquisition of additional material from the island.

SPECIMENS EXAMINED.—6. ST. LUCIA: no specific locality, 5 (USNM). ST. VINCENT: no specific locality, 1 (FM).

Ardops nichollsi annectens Miller

Ardops annectens Miller, 1913, p. 33.

HOLOTYPE.—Adult female in spirits, skull removed, USNM 113, 502, from unknown locality on Guadeloupe, Lesser Antilles.

DISTRIBUTION.—Known only from Guadeloupe (see fig. 3).

MEASUREMENTS.—Some external measurements of an adult male and the holotype (female), respectively, both in alcohol, were recorded in the original description as follows: head and body [total length] 61, 68; length of hind foot 12.6, 14.6; length of ear 17, 18. The forearms of three males measured 48.1, 48.1, 48.7; those of four females measured 48.4, 48.6, 48.7, and 49.8. See table 1 for cranial measurements.

REMARKS.—All eight specimens of *A. n. annectens* here recorded as examined have been reported previously (Miller, 1913, p.33; G. M. Allen, 1942, p. 20). Differences between *A. n. annectens* and *A. n. luciae* are discussed in the account of the latter subspecies; comparisons between *A. n. annectens* and the subspecies occurring on Martinique are made in the following account.

No information seems to be available concerning the means of

collection of the five specimens listed by Miller (loc. cit.) in the original description save that they were obtained by H. Selwyn Branch between Jan. 25 and Feb. 1, 1902. Of the other three specimens, Allen (loc. cit.) wrote as follows: "Dr. G. K. Noble, who secured an adult female and well-grown young in Guadeloupe in 1914, writes me that he found these hanging [in a tree?] together directly over a path he was following through the woods near Sainte Rose. Later his guide caught another . . ." The young bat mentioned was approximately half grown (forearm 34.4); the exact date of its capture in 1914, however, is not recorded on the specimen label.

SPECIMENS EXAMINED.—8. GUADELOUPE: Sainte-Rose, 2 (MCZ); no specific locality, 6 (1 MCZ, 5 USNM).

Ardops nichollsi koopmani, new subspecies

HOLOTYPE.—Adult female in spirits, skull removed, AMNH 213,951, from near Balata, Martinique, Lesser Antilles; obtained by Harry Beatty and Peter Martin on Mar. 18, 1967, original no. 656.

DISTRIBUTION.—Known only from Martinique (see fig. 3).

DIAGNOSIS.—A medium- to large-sized subspecies of *Ardops nichollsi* having a large though relatively narrow skull, well-developed sagittal crest, narrow molariform teeth, and marked sexual dimorphism; color generally as in *A. n. nichollsi*, white spot at junction of wing with body prominent in both sexes.

MEASUREMENTS.—External measurements of the holotype, another adult female, and two adult males (all taken from specimens preserved for several months in alcohol) are, respectively: total length 70, 68, 67, 65; length of hindfoot 17, 17, 16, 16; length of ear 18.5, 18, 18, 17; length of forearm 50.5, 47.3, 47.5, 46.0. See table 1 for some cranial measurements of the holotype and the first-listed male; additional measurements of these two skulls are condylobasal length 21.0 and 19.2, and breadth across upper canines 6.2 and 5.1.

REMARKS.—*Ardops nichollsi koopmani* differs from populations of the species on adjacent islands (*A. n. nichollsi* to the north on Dominica and *A. n. luciae* to the south on St. Lucia) in being considerably larger. Judging from the skulls of the male and female available for study, secondary sexual dimorphism is marked in *A. n. koopmani* in that the cranium of the male is about the size of that of the largest female of the subspecies *A. n. nichollsi* examined, whereas the cranium of the female holotype is the largest we have studied save for those referred to *A. n. montserratensis*. Both the male and female of *A. n. koopmani* have well-developed sagittal crests, reminiscent of some individuals of *A. n. nichollsi*. Members of the new subspecies are notably smaller and somewhat narrower of skull than specimens of the northerly *A. n. montserratensis*.

Among named subspecies, *A. n. koopmani* most closely resembles *A. n. annectens* of Guadeloupe. Cranially, the one male examined is comparable in overall size with two males of *A. n. annectens* studied, but it is narrower relative to length of the skull and has a better developed sagittal crest. The female holotype has a longer forearm and longer, relatively narrower skull (excepting zygomatic breadth) than any of the females of *A. n. annectens* examined and, in direct comparison with a large female *A. n. annectens* (MCZ 15927), has narrower molars and a better developed sagittal crest. The two subspecies are separated geographically by the much smaller race *A. n. nicholli* of Dominica, and we assume, therefore, that the general resemblance in size has evolved independently.

Ardops was unknown from Martinique until five specimens were collected there in March of 1967 for the American Museum of Natural History by Harry Beatty and Peter Martin, supported by a grant from the Explorers Club. All the bats were captured near Balata "in mist nets set over streams in second-growth (about 40 years old) montane rain forest" (Karl F. Koopman, pers. comm., May 25, 1967). We take pleasure in according patronymic recognition to Dr. Koopman for his generosity in making the specimens from Martinique available to us for study and also for his contributions to chiropteran biology in the Caribbean region.

SPECIMENS EXAMINED.—4. MARTINIQUE: Balata, 4 (AMNH).

Literature Cited

- ALLEN, G. M.
 1942. Extinct and vanishing mammals of the Western Hemisphere. American Comm. Internat. Wild Life Protect., Spec. Publ. 11, xvi + 620 pp., illustr.
- HALL, E. R., and KELSON, K. R.
 1959. The mammals of North America, vol. 1, xxx + 546 + 79 pp., illustr. New York: Ronald Press Co. March 31.
- MILLER, G. S., JR.
 1902. Twenty new American bats. Proc. Acad. Nat. Sci. Philadelphia, vol. 54, pp. 389-412. September 12.
 1906. Twelve new genera of bats. Proc. Biol. Soc. Washington, vol. 19, pp. 83-86. June 4.
 1913. Five new mammals from tropical America. Proc. Biol. Soc. Washington, vol. 26, pp. 31-34. February 8.
- RIDGWAY, R.
 1912. Color standards and color nomenclature, iii + 43 pp., illustr. Washington, D.C.: Privately printed.
- THOMAS, O.
 1891. Descriptions of new bats in the British Museum collection. Ann. Mag. Nat. Hist., ser. 6, vol. 7, pp. 527-530. June.
 1894. Description of a new bat of the genus *Stenoderma* from Montserrat. Proc. Zool. Soc. London, pp. 132-133. June.

Dominica Survey in the *Proceedings*

paper	author	subject	year	volume	number
1	Kier	Echinoids	1966	121	3577
2	Stone	Diptera: Anisopodidae, Bibionidae	1966	121	3578
3	Kirsteuer	Marine archannelids	1967	123	3610
4	Allen	Hymenoptera: Tiphiidae	1967	123	3617
5	James	Diptera: Stratiomyidae	1967	123	3622

Proceedings of
the United States
National Museum



SMITHSONIAN INSTITUTION • WASHINGTON, D.C.

Volume 124

1967

Number 3635

BREDIN-ARCHBOLD-SMITHSONIAN
BIOLOGICAL SURVEY OF DOMINICA¹

7. Review of Bats of the Endemic Antillean Genus *Monophyllus*

By ALBERT SCHWARTZ and J. KNOX JONES, JR.²

As recently as 1959, Hall and Kelson (p. 116) commented on the status of the bats comprising the seven species of the phyllostomatid genus *Monophyllus*, endemic to the Antillean region: "Some of the species of *Monophyllus* are known from only one specimen and none is really well represented in collections. Therefore the extent and nature of individual variation is only poorly known. Further, the characters employed to distinguish each of the several species from others are minor differences in proportion that are best appreciated only by direct comparison." Consequently, Hall and Kelson's key to the named species of *Monophyllus* is based primarily on provenance of the known kinds rather than on morphological characteristics; such a course could hardly have been avoided since nowhere are there definitive statements concerning the variation of all the species involved. Miller, the first and only reviser (1900) of *Monophyllus*, had at that time eight specimens. From

¹ See list at end of paper.

² Schwartz: Department of Biology, Miami-Dade Junior College, Miami, Florida 33167; Jones: Museum of Natural History, University of Kansas, Lawrence 66044.

this suite of material he named three new species, one of which was from an unknown locality. Between 1900 and the present, additional material has accumulated, but, aside from occasional large series from specific localities, the accretion has been gradual; material from the Lesser Antilles has been especially slow in reaching collections.

The field work of the senior author has taken him to all islands whence *Monophyllus* has been reported although he has not in every case secured specimens. In his Antillean endeavors, Schwartz has had the assistance of Ronald F. Klinikowski, David C. Leber, and Richard Thomas; all have made collections of *Monophyllus* that have interest and value. The junior author spent six weeks on Dominica in 1966 under the auspices of the Bredin-Archbold-Smithsonian Biological Survey of Dominica and secured the first recent series of *Monophyllus* from any of the Lesser Antillean islands.

Eight names are currently associated with the genus *Monophyllus* Leach, as follows: *M. redmani* Leach, 1821 (type-species); *M. portoricensis* Miller, 1900; *M. plethodon* Miller, 1900; *M. clinedaphus* Miller, 1900; *M. cubanus* Miller, 1902; *M. luciae* Miller, 1902; *M. frater* Anthony, 1917; *M. ferreus* Miller, 1918. Of these, all but *M. c. cubanus* and *M. c. ferreus* are regarded as full species; *M. frater* is known only from fossil fragments and *M. clinedaphus* is known from a single specimen of unknown provenance. The ranges of the species, as presently understood, are: *M. redmani*, Jamaica; *M. portoricensis*, Puerto Rico; *M. plethodon*, Barbados; *M. cubanus cubanus*, Cuba; *M. c. ferreus*, Hispaniola; *M. luciae*, St. Lucia; *M. frater*, Puerto Rico, fossil; *M. clinedaphus*, unknown.

Both of us have collected specimens of *Monophyllus* on the Lesser Antillean island of Dominica. In borrowing specimens from various collections, we have inadvertently discovered unreported *Monophyllus* from several other Lesser Antillean islands. Although it was not our intent to examine all specimens of *Monophyllus* presently available, we have been able to study a total of 139 specimens from throughout the West Indies. Abbreviations used in the present paper to denote collections in which *Monophyllus* are housed are: AMNH (American Museum of Natural History); AS (Albert Schwartz collection); BMNH (British Museum, Natural History, London); KU (Museum of Natural History, University of Kansas); MCZ (Museum of Comparative Zoology, Harvard University); RMNH (Rijksmuseum van Natuurlijke Historie, Leiden); USNM (United States National Museum). For the loan of material we are grateful to Karl F. Koopman, John E. Hill, Miss Barbara Lawrence, A. M. Husson, and Charles O. Handley, Jr. The senior author also wishes to acknowledge the gift of specimens of Cuban *Monophyllus* from Gilberto Silva Taboada.

Gary L. Ranck has supplied us with invaluable data on two of the holotypes in the United States National Museum.

All external measurements and weights, except for length of forearm, are those recorded by the collectors on original labels. Skull measurements and length of forearm were taken with vernier calipers; all are standard and expressed in millimeters. Length of maxillary tooththrow is the alveolar length and greatest length of skull includes upper incisors. All weights are given in grams.

Systematic Treatment

Six nominal forms of *Monophyllus* (excluding for the moment *M. frater* and *M. clinedaphus* from consideration) vary in total length from a low mean of 61 (Hispaniola) to a high mean of 78 (Dominica), with the Jamaican population almost as large (mean 76) as the Dominican specimens, and the Cuban and Puerto Rican material almost as small (means 66 and 65) as the Hispaniolan bats. In general, other external measurements follow this same trend; means for length of forearm range from 36.9 on Puerto Rico to 42.1 on Dominica and St. Lucia. Cranial measurements likewise show the same tendencies; greatest length of skull varies from 19.0 (Puerto Rico) to 24.2 (Dominica), with means from 19.9 (Puerto Rico) to 23.4 (Dominica). Length of maxillary tooththrow ranges from 6.8 (Puerto Rico) to 8.9 (Jamaica), with means from 7.1 (Puerto Rico) to 8.5 (Jamaica). Cranial measurements generally form a continuum (with Puerto Rican bats having the smallest skulls and Lesser Antillean or Jamaican bats having the largest) and are useful primarily at the subspecific level. Several cranial features, however, suggest that we are dealing with two species rather than one as would otherwise seem to be the case.

One of the characters that was presumed to separate the Barbadian *M. plethodon* from its relatives was the fact that the two upper premolars (PM 2 and PM 3 in formal terminology) were so crowded that the customary diastema between these two teeth was obliterated. Comparison of a skull of *M. plethodon* with those of *Monophyllus* from the Leeward and Windward Islands shows that this feature is common to all Lesser Antillean specimens in that the space between the upper premolars is narrow, much less than half the length of the first tooth. On the other hand, this space in Greater Antillean *Monophyllus* is long, being at least as long as half the length of the first premolar, and often longer. We have been unable to determine any other wholly consistent cranial or dental details and have placed emphasis on this relatively trivial feature as a basis for distinguishing two species (rather than six) among the living *Monophyllus*. We are deterred from considering all *Monophyllus* as conspecific by the

knowledge that at one time *M. portoricensis* and *M. frater* were contemporaneous on Puerto Rico. *Monophyllus portoricensis* has a long diastema (like other Greater Antillean forms) and *M. frater* has a short one (like the Lesser Antillean assemblage). Thus, Puerto Rico is interpreted as once having been inhabited by two stocks of *Monophyllus*, one Greater Antillean and the other Lesser Antillean, of which the latter is presumed presently to be extinct.

Once this dichotomy is recognized, the two species can be shown to differ in some average cranial measurements. Greatest length of skull in Greater Antillean bats varies from 19.0 to 23.9, for example, whereas that of Lesser Antillean bats ranges from 21.4 to 24.2. Post-orbital constriction shows almost no overlap, with Greater Antillean *Monophyllus* having measurements of 3.8 to 4.6 and Lesser Antillean specimens having measurements of 4.5 to 5.0. Less trenchant differences include length of forearm (35.5 to 42.8 in Greater Antilles, 38.8 to 45.7 in Lesser Antilles). Although facial adornments have been gainfully employed to distinguish between congeneric species of other genera of phyllostomatids, the noseleaves and chin details in all *Monophyllus* appear identical. It is possible that we are over-emphasizing the single dental character between the two species and that they are indeed preferably considered as conspecific, but such an action tends to obscure the one major difference between the two geographic segments of *Monophyllus*. It also poses the problem of the relationships of *M. frater*, which would then have to be regarded as a local derivative of *M. portoricensis* on Puerto Rico—a derivative oddly like its Lesser Antillean congeners—or else double invasion of the island by widely different stocks of the same species would need to be postulated. We feel that our arrangement is defensible zoogeographically as well as morphologically and provides a more meaningful systematic arrangement than that currently in use.

Monophyllus Leach

Monophyllus Leach, 1821, p. 75. [Generotype: *Monophyllus redmani* Leach.]

Monophyllus redmani Leach

DEFINITION.—A species of *Monophyllus* characterized by a combination of small to large size (total length 58–80), small hind foot (9–14), small ear (ear from notch 9–14), short forearm (35.5–42.8), small skull (greatest length 19.0–23.9), narrow postorbital constriction (3.8–4.6), and the upper premolars separated by a diastema one-half or more the length of the first premolar. The pelage is some shade of brown, tending generally toward paler shades.

Key to Living Species and Subspecies of Genus *Monophyllus*

1. Upper premolars separated by diastema equal to one-half or more of length of first premolar 2
Upper premolars crowded, separated by small diastema less than half length of first premolar 4
2. Maxillary tooththrow more than 7.5 mm 3
Maxillary tooththrow less than 7.4 mm *M. r. portoricensis*
3. Greatest length of skull 22.8 mm or more *M. r. redmani*
Greatest length of skull 22.4 mm or less *M. r. clinedaphus*
4. Forearm shorter (38.8–41.0 mm); maxillary tooththrow shorter (7.2–7.8 mm).
M. p. plethodon
Forearm longer (40.1–45.7 mm); maxillary tooththrow longer (7.8–8.5 mm).
M. p. luciae

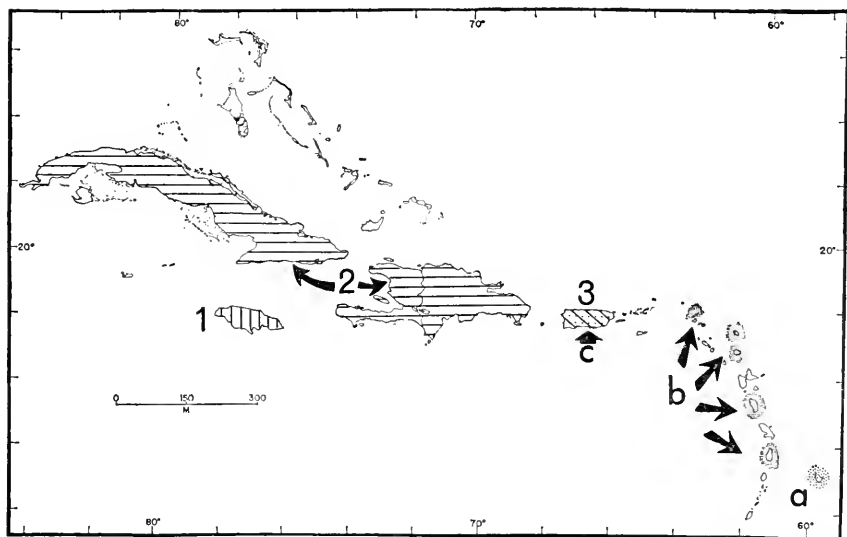

FIGURE 1.—Distribution of *Monophyllus* in the West Indies (*M. redmani*=lines; *M. plethodon*=stippling): 1, *M. r. redmani* (vertical lines); 2, *M. r. clinedaphus* (horizontal); 3, *M. r. portoricensis* (diagonal); a, *M. p. plethodon* (heavy stippling); b, *M. p. luciae* (medium); c, *M. p. frater* (open).

***Monophyllus redmani redmani* Leach**

Monophyllus redmani Leach, 1821, p. 76. [Type-locality: Jamaica.]

DISTRIBUTION.—Known only from Jamaica (see fig. 1).

DEFINITION.—A subspecies of *M. redmani* characterized by large body size (total length 73–80, mean 76.1) but relatively short forearm (37.6–41.0, mean 40.2), large skull (greatest length 22.8–23.9, mean 23.3) with broad postorbital and mastoid regions and zygomata, and long tooththrow. The color varies from dark brown to pale brown; there is no obvious dichromatism.

REMARKS.—*Monophyllus r. redmani* is the largest subspecies of the species and is readily separable from other subspecies by the

greatest length of skull (lower extreme in *M. r. redmani* 22.8, high extreme in all other subspecies 22.4). Other skull measurements (condylobasal length, postorbital constriction, mastoidal breadth) show some degree of overlap but length of maxillary tooththrow (8.3–8.9 in *M. r. redmani*, 6.8–8.3 in other races) is almost as effective as greatest length of skull in distinguishing the nominate subspecies. Of external measurements, the total length of *M. r. redmani* is greater (73–80) than that of the other two subspecies (59–71), and measurements of ear from notch lie at the upper extreme for the species. Mensural data are given in tables 1 and 2.

The senior author took four specimens of *M. r. redmani* from a large cave at Windsor, Jamaica, where the bats were observed clinging to and flying just below the high ceiling of the moist cave, well back from the entrance. Koopman and Williams (1951, p. 20) recorded *Monophyllus* in surface and subsurface deposits in Jamaican caves, but not as fossils: these authors regarded *M. redmani* as common in Jamaica today (p. 23). Williams (1952) reported *Monophyllus* from the "bat layers" of a single cave at Portland. No information has been published on weights or dates of parturition.

SPECIMENS EXAMINED.—JAMAICA: St. Elizabeth Parish: Oxford Cave, Balaclava, 2 ♂, 3 ♀ (AMNH 45233, 45236–39). Trelawny Parish: Windsor, 3 ♂, 2 ♀ (AMNH 45241–42, 45244–46); Windsor Cave, 3 ♂, 1 ♀ (AS 5248–51); no specific locality, other than Jamaica, 1 ♂ (MCZ 45778).

Monophyllus redmani clinedaphus Miller

Monophyllus clinedaphus Miller, 1900, p. 36. [Type-locality: unknown, herein restricted to the vicinity of Baracoa, Oriente Province, Cuba.]

Monophyllus cubanus Miller, 1902, p. 410. [Type-locality: Baracoa, Oriente Province, Cuba.]

Monophyllus cubanus ferreus Miller, 1918, p. 40. [Type-locality: cave eight miles west-southwest of Jérémie, Département du Sud, Haiti.]

DISTRIBUTION.—Cuba and Hispaniola; on the latter island apparently as yet unknown in the Dominican Republic (see fig. 1).

DEFINITION.—A subspecies of *M. redmani* characterized by small body size (total length 59–70, mean 65.5 for six Cuban specimens and 60.7 for three Hispaniolan specimens), relatively long forearm (37.6–42.5, mean 40.1 for 32 Cuban specimens and 39.8 for 24 Hispaniolan specimens), skull of moderate size (greatest length 21.0–22.1, mean 21.9 for nine Cuban specimens and also for four Hispaniolan specimens) with broad postorbital region, moderately broad mastoid region, and narrow zygomata, and moderately long tooththrows. The color is brownish, generally paler than in *M. r. redmani*.

REMARKS.—*Monophyllus clinedaphus* was described by Miller (1900, p. 36) on the basis of a single male in alcohol with skull re-

moved. The major difference between *M. clinedaphus* and the other "species" recognized in the same paper—*M. redmani*, *M. portoricensis*, *M. plethodon*—was that the "plane of the basioccipital and basisphenoid, instead of sloping forward at a faint angle as in the other species of the genus, pitches abruptly forward and downward at an angle of 32°." It may be recalled also that Miller had no material at that time from Cuba or Hispaniola and, thus, was unaware of the size and general characters of populations from those islands.

Gary L. Ranck (pers. comm., Feb. 8, 1966) has taken measurements for us of the skull and skin of the holotype (USNM 5210/37405) of *M. clinedaphus*. Pertinent measurements are: forearm 39.6; greatest length of skull 21.7, condylobasal length 19.6, postorbital constriction 4.1, maxillary tooththrow 7.8. Ranck also confirmed the peculiarity of the basioccipital-presphenoid angle on which Miller placed so much emphasis, but Ranck suggested (as had C. O. Handley previously) that it may well be due to the fact that the skull was removed from a specimen in spirits and that preparation and subsequent drying possibly resulted in distortion of the skull. Later, the junior author examined the skull of *M. clinedaphus* and reached a similar conclusion, i.e., that it somehow had been distorted after collection. The base of the braincase, just above the basioccipital-presphenoid angle, clearly indicates that the skull has been bent, probably while wet and, therefore, possibly prior to the time it was extracted for study. Additionally, the palate is damaged, having been laterally compressed so that the toothrows are closer together than usual and nearly parallel. In any event, in all measurements except condylobasal length the holotype of *M. clinedaphus* agrees with *Monophyllus* examined from Cuba (the condylobasal length in the holotype is 19.6, whereas the lowest measurement in nine Cuban bats is 19.7). In the maxillary tooththrow, the first two premolars are separated by a diastema slightly more than half the length of the first tooth, indicating that the holotype presumably originated in the Greater Antilles. We have seen no other specimen, however, with the peculiar basioccipital-presphenoid configuration of *M. clinedaphus* and conclude that this unique condition is indeed due to distortion. Therefore, we consider *M. clinedaphus* as the prior name for those bats that up to now have been known as *Monophyllus cubanus* Miller, 1902.

Mensural data for the two segments of *M. r. clinedaphus* are presented in tables 1 and 2. Of the three subspecies of *M. redmani*, the Cuban and Hispaniolan *M. r. clinedaphus* is intermediate in size between *M. r. redmani* of Jamaica and *M. r. portoricensis* of Puerto Rico. This is demonstrated most clearly by cranial measurements. Forearms of *M. r. redmani* and *M. r. clinedaphus* are comparable in size; thus, the forearms are relatively longer in *M. r. clinedaphus* than in

M. r. redmani since the former is otherwise a larger bat than the latter. *Monophyllus r. clinedaphus* can be separated completely from *M. r. redmani* on the basis of greatest length of skull; the two races are also virtually separable by length of maxillary tooththrow. Other cranial measurements (condylobasal length, postorbital constriction, mastoidal breadth) show only slight overlap. Measurements of ear from notch also show little overlap, with *M. r. redmani* being the larger.

Monophyllus cubanus ferreus was based upon a series of 24 specimens from the type-locality in extreme southwestern Haiti. Of the type and paratypes, only two were skins, the balance being preserved in spirits. Skins and skulls of *Monophyllus* from Hispaniola are still uncommon in collections, but we have been able to examine one paratype, two freshly taken topotypes, and another individual from central Haiti. The characters of *M. c. ferreus* (in contrast to those of specimens from Cuba) were stated (Miller, 1918, p. 40) to be "color of upperparts clear hair-brown with a slight metallic gloss and with no obvious trace of the buffy-brown or fawn-color characteristic of the Cuban race. Measurements as well as cranial and dental characters apparently identical with those of true *M. cubanus*." Our freshly taken Haitian specimens do not differ appreciably in dorsal color from older (1917-1928) material, but all Hispaniolan specimens are darker (more blackish) than older (1902) specimens from Cuba. A single Cuban *M. r. clinedaphus* collected in 1956 is comparable to older Cuban specimens. The differences in color between bats from

TABLE 1.—*Mensural data for eight populations of Monophyllus showing extremes and means (in millimeters) for five external measurements (bracketed figures= number of specimens included in each calculation if different from N)*

	N	Total length	Tail	Hindfoot	Ear from notch	Forearm
<i>redmani</i> (Jamaica)	9 ♀	76.1 (73-80)[14]	9.7 (8-11)[14]	13.0 (11-14)[14]	13.8 (13-14)[4]	40.2 (37.6-41.0)
	6 ♂					
<i>clinedaphus</i> (Cuba)	17 ♀	65.5 (63-70)[6]	9.5 (8-11)[6]	10.5 (9-11)[6]	11.2 (9-13)[6]	40.1 (38.5-42.8)
	14 ♀					
	1 ♂					
<i>clinedaphus</i> (Hispaniola)	13 ♂	60.7 (59-60)[3]	10.5 (10-11)[2]	13.0 (11-14)[3]	10.7 (10-11)[3]	39.8 (37.6-42.5)[24]
	12 ♀					
<i>portoricensis</i> (Puerto Rico)	10 ♂	65.0 (60-71)	8.3 (7-10)	11.7 (10-13)	11.5 (10-12)[12]	36.9 (35.5-38.5)
	12 ♀					
<i>luciae</i> (Anguilla, Barbuda, Antigua)	4 ♂	73[1]	12[1]	13[1]	-	41.6 (40.1-43.3)
	2 ♀					
<i>luciae</i> (Dominica)	10 ♂	78.1 (69-84)[18]	13.6 (8-16)[18]	14.6 (12-15)[18]	15.7 (15-16)[16]	42.1 (40.6-45.7)
	11 ♀					
<i>luciae</i> (St. Lucia)	2 ♂		-	-	-	42.1 (40.5-43.7)
	11 ♀					
<i>plethodon</i> (Barbados)	2 ♂	67	9	12	14	39.9 (38.8-41.0)

TABLE 2.—Cranial data for eight populations of *Monophyllus* showing extremes and means (in millimeters) for six measurements (size of samples as in table 1; bracketed figures = number of specimens used in each calculation if different from N in table 1)

	Greatest length	Condylobasal length	Zygomatic breadth	Postorbital constriction	Mastoidal breadth	Maxillary toothrow
<i>redmani</i>	23.3 (22.8-23.9)	22.0 (21.4-22.6)[14]	9.9 (9.1-10.4)[14]	4.3 (4.2-4.6)	9.7 (9.4-10.0)	8.5 (8.3-8.9)
<i>clinedaphus</i> (Cuba)	21.9 (21.0-22.4)[9]	20.6 (19.7-21.9)[9]	9.2 (8.7-9.8)[9]	4.2 (3.9-4.4)[9]	9.0 (8.9-9.3)[9]	8.0 (7.8-8.3)[9]
<i>clinedaphus</i> (Hispaniola)	21.9 (21.6-22.1)[4]	20.6 (20.2-20.7)[4]	9.3 (8.9-9.7)[3]	4.3 (4.2-4.4)[4]	9.1 (8.6-9.6)[4]	7.8 (7.5-8.0)[3]
<i>portoricensis</i>	19.9 (19.0-20.4)	18.5 (17.9-18.9)	8.5 (8.2-8.8)[16]	4.0 (3.8-4.2)	8.4 (8.2-8.8)	7.1 (6.8-7.3)
<i>luciae</i> (Anguilla, Barbuda, Antigua)	23.4 (22.8-24.0)[5]	22.1 (21.5-22.6)[5]	10.4 (9.8-11.0)[5]	4.8 (4.5-5.0)	9.6 (9.5-10.5)	8.2 (7.8-8.5)
<i>luciae</i> (Dominica)	23.4 (22.8-24.2)[18]	21.9 (21.0-22.5)[18]	10.1 (9.4-10.8)[18]	4.7 (4.5-4.9)[18]	9.8 (9.4-10.5)[18]	8.0 (7.8-8.4)[17]
<i>luciae</i> (St. Lucia)	23.1 (22.1-23.6)[8]	21.5 (20.6-22.0)[8]	9.9 (9.5-10.2)[8]	4.8 (4.6-4.9)[8]	9.8 (9.5-10.0)[8]	8.0 (7.8-8.2)[8]
<i>plethodon</i> (Barbados)	22.3 (21.4-23.2)	20.5 (19.5-21.4)	10.4[1]	4.8 (4.6-5.0)	10.1[1]	7.5 (7.2-7.8)

Cuba and Hispaniola are so slight and depend so much on original treatment and later storage of specimens that we cannot justify the retention of *M.c. ferreus* as a valid subspecies on this basis.

As Miller noted, the Cuban and Haitian populations do not differ in mensural characters. We have available external measurements for only three Haitian specimens and cranial measurements for only four. Although total length indicates a complete dichotomy between Cuban and Hispaniolan specimens (63–70 in Cuba, 59 and 60 in Hispaniola), these data are unreliable because of the small Haitian sample. Extremes of length of forearm for 24 Hispaniolan specimens (37.6–42.5) bracket those of 32 Cuban specimens (38.5–41.8). Cranial measurements of the two populations show identical or similar means, the greatest discrepancy being in length of maxillary toothrow (mean 7.8 in Hispaniola, 8.0 in Cuba). In the latter instance, there are data for only nine Cuban and three Hispaniolan specimens. It is possible that when additional Hispaniolan material becomes available, *M. c. ferreus* can be shown to be a recognizable subspecies, but at this time it appears neither identifiable nor nameworthy.

The recently collected Haitian specimens were taken in a large wet cave in a mesic situation in the Monts Cartaches massif; this cave may well be the same place whence W. L. Abbott secured the holotype and paratypes of *M. c. ferreus* in 1917. Miller (1904, p. 344) reported that William Palmer found this bat abundant on Cuba at the type-locality of *M. cubanus*, a damp cave; Palmer took not only *Monophyllus* but also *Natalus micropus*, *Mormoops blainvillei*, *Pteronotus parnellii*, *Pteronotus macleayi*, and *Phyllonycteris poeyi* at the entrance of this same cave. Allen (1911, p. 231) cited Gundlach's records of *Monophyllus* at Rangel in the Sierra del Rosario in Pinar del Río Province and at Guisa in eastern Cuba. Koopman and Ruibal (1955, p. 3) reported fossil *Monophyllus* from a cave in the Sierra de Cubitas in Camagüey Province, Cuba, and Anthony (1919, p. 637) took a single *Monophyllus* in a cave at Jarahueca, near Sabanilla, in Oriente Province. In Haiti, Miller (1929, p. 8) recorded taking a skull from owl pellet material at Diquini, Département de l'Ouest, and Koopman (1955, p. 110) reported a single fragmentary skull from a cave at Nan Café, Ile de la Gonâve. Presumably this latter specimen is referable to *M. r. clinedaphus* although at least one chiropteran species (*Pteronotus parnellii*) has an endemic subspecies on Gonâve (*P. p. gonavensis*) that differs from its mainland Hispaniolan relative (*P. p. pusillus*). All the above records refer either to fossil or subfossil finds in caves or to cave-taken living bats. Like *M. r. redmani*, *M. r. clinedaphus* is a confirmed cave dweller. We have no data on weights or parturition for *M. r. clinedaphus*.

SPECIMENS EXAMINED.—CUBA: Habana Province: Cueva de Cotilla, 9 km southwest of San José de las Lajas, 3 ♂, 2 ♀ (AS 4776–80); Cueva de la Numancia, Aguacate, 1? (AMNH 176156). Oriente Province: Baracoa, 4 ♂, 2 ♀ (USNM 113668, 113671–73, 113675–76); Cueva de la Majana, Baracoa, 10 ♂, 10 ♀ (MCZ 11658, 16663–65, 16667–69, 16671–73, 16675, 16681, 16684, 16688–89, 16694–95, 16697–98, 16700). HAITI: Département du Sud: Grotte la Forêt, 9 km west-southwest of Jérémie, 6 ♂, 2 ♀ (AS 5599–606); 8 miles west-southwest of Jérémie, 7 ♂, 9 ♀ (USNM 219152–58, 219160–63, 219165, 219167–68, 219171, 219174). Département de l'Artibonite: St. Michel de l'Atalaye, 1 (USNM 253646).

Monophyllus redmani portoricensis Miller

Monophyllus portoricensis Miller, 1900, p. 34. [Type-locality: cave near Bayamón, Puerto Rico.]

DISTRIBUTION.—Known only from Puerto Rico (see fig. 1).

DEFINITION.—A subspecies of *M. redmani* characterized by small size (total length 60–71, mean 65.0), short forearm (35.5–38.5, mean 36.9), small skull (greatest length 19.0–20.4, mean 19.9) with narrow postorbital and mastoid regions, and narrow zygomata, and short tooththrows. The color is medium brown.

REMARKS.—The subspecies *M. r. portoricensis*, although of about the same body size as *M. r. clinedaphus*, has a distinctly shorter forearm and smaller skull. Greatest length of skull will separate *M. r. portoricensis* (19.0–20.4) from the other subspecies of *M. redmani* (21.0–23.9). Nonoverlap of cranial measurements occurs also in condylobasal length and length of maxillary tooththrow; other skull measurements average smaller, but there is some overlap in these dimensions, the greatest being between *M. r. portoricensis* (high extreme 8.8) and Hispaniolan *M. r. clinedaphus* (low extreme 8.6) in mastoidal breadth. The forearm of *M. r. portoricensis* is distinctly shorter than those of the subspecies *M. r. redmani* and *M. r. clinedaphus*, both of which, despite a discrepancy of body size, have forearms of comparable lengths. Mensural data for 22 specimens of *M. r. portoricensis* are given in tables 1 and 2.

Freshly collected *M. r. portoricensis* seem intermediate in depth of dorsal pigmentation between the darker *M. r. redmani* and the paler *M. r. clinedaphus*. Such color differences are very difficult to assess, owing to the age of the skins involved. The color differences among all subspecies of *M. redmani* are slight at best; verification of supposed differences in pelage among the races must await the availability of fresh specimens from throughout the range of the species.

Anthony (1918, p. 349) commented that *M. r. portoricensis* was uncommon in Cueva de Fari near Bayamón but was the most abun-

dant bat at Cueva de Trujillo Alto. He reported a single fragmentary fossil skull of this subspecies from Cueva Catedral near Morovis, and we have examined a second skull from fossil or subfossil deposits in Cueva de Clara in the same area.

Schwartz and Thomas captured *M. r. portoricensis* in mist nets. Those from near Utuado were collected in a net set in a "cafetal" near the edge of the northern escarpment of the Cordillera Central at an elevation of 1100 feet (336 meters); this area is mesic and heavily forested. At a slightly higher elevation (1300 feet=397 meters) *Monophyllus* was collected near Cidra; here the net was set in a wooded ravine. In the southwestern portion of Puerto Rico, *M. r. portoricensis* was taken from mist nets set in a ravine and across an unused road, both in xeric woods and scrub near sea level. Since the Utuado and Guánica areas represent the two climatic extremes in Puerto Rico, *M. r. portoricensis* seems to tolerate a wide variety of habitats.

We have no data on weights or parturition in *M. r. portoricensis*.

SPECIMENS EXAMINED.—PUERTO RICO: 7.5 km east of Guánica, 1 ♂, 3 ♀ (AS 5526–29); 17.7 km northeast of Utuado, 1 ♂, 1 ♀ (AS 5538–39); Cueva de Trujillo Alto, Trujillo Alto, 3 ♂, 4 ♀ (AMNH 39433–35, 39444–47); Cueva de Fari, Pueblo Viejo, 3 ♂ (AMNH 39430–32); ca. 1 km northeast of Cidra, 1300 ft, 4 ♂, 4 ♀ (AS 5509–12, 5669–70); Cueva de Clara, near Morovis, 1 (KU uncataloged, fossil).

Monophyllus plethodon Miller

Monophyllus plethodon Miller, 1900, p. 35.

DEFINITION.—A species of *Monophyllus* characterized by a combination of large size (total length 67–84), large hind foot (12–15), long forearm (38.8–45.7), large skull (greatest length 21.4–24.2), broad postorbital region (4.5–5.0), and the first and second premolars separated by a diastema much less than half the length of the first premolar. The pelage usually is brown, but a few specimens are pale buffy tan.

Monophyllus plethodon plethodon Miller

Monophyllus plethodon Miller, 1900, p. 35. [Type-locality: St. Michael's Parish, Barbados.]

DISTRIBUTION.—Known only from Barbados (see fig. 1).

DEFINITION.—A subspecies of *M. plethodon* characterized by small body size (total length 67 and 68 in two known specimens), short forearm (38.8–41.0), small skull (greatest length 21.4–23.2), and short tooththrows (maxillary tooththrow 7.2–7.8).

REMARKS.—We are somewhat reluctant to regard the Lesser Antillean *Monophyllus* as comprising two subspecies. It is particularly unfortunate that Barbados is the type-locality of *M. plethodon* since, other than the holotype, we have examined only one specimen from

that island. Measurements of the male holotype of *M. plethodon*, taken for us by Gary L. Ranck, plus those given by Miller (1900, p. 38), show that it is somewhat smaller than the other individual, which was collected in 1961. It is purely on the basis of the holotype that we recognize *M. p. plethodon* as distinct from other Lesser Antillean populations; the second specimen (also a male) has measurements that fall within the parameters established by other Lesser Antillean *Monophyllus*; those of the holotype do not. It is possible that *Monophyllus* from Barbados average slightly smaller than their relatives elsewhere in the Lesser Antilles and, for this reason, we accept *M. p. plethodon* as a distinctive Barbadian subspecies with full cognizance that additional material from Barbados may well demonstrate the incorrectness of this conclusion.

On the basis of the single fresh male examined, there seem to be no differences in color between *M. p. plethodon* and the subspecies *M. p. luciae* that occurs on other Lesser Antillean islands. The recently collected specimen was taken in a mist net set between the buttresses of the road bridge at Jack-in-the-box Gully. The gully is a steep-sided and wooded ravine in an area otherwise devoted to cultivation of sugarcane. *Artibeus jamaicensis* was the only other bat taken in the gully.

SPECIMEN EXAMINED.—BARBADOS: St. Thomas Parish: Jack-in-the-box Gully, 1 ♂ (AS 5302).

Monophyllus plethodon luciae Miller

Monophyllus luciae Miller, 1902, p. 111. [Type-locality: St. Lucia.]

DEFINITION.—A subspecies of *M. plethodon* characterized by a combination of large size (total length 69–84), long forearm (40.1–45.7), large skulli (greatest length 22.1–24.2), and long toothrows (maxillary toothrow 7.8–8.5).

DISTRIBUTION.—KNOWN presently from the Lesser Antillean islands of Anguilla, Barbuda, Antigua, Dominica, and St. Lucia (see fig. 1).

REMARKS.—At the time of its description, *M. plethodon* was compared only with the then-named kinds of *Monophyllus*—*M. redmani*, *M. portoricensis*, and *M. clinedaphus*. The dental peculiarities (primarily the crowding of the upper premolars) used to distinguish *M. plethodon* from these other taxa do indeed distinguish it from these Greater Antillean bats. When *M. luciae* was named (on the basis of 16 specimens), it was compared with *M. plethodon* and was said to differ from the latter in being larger (which apparently it is) and in having less crowded teeth. The teeth of our Barbadian specimen, although crowded as typical of the species, are no more closely appressed than in specimens from St. Lucia, Dominica, or other Lesser Antillean islands. Since there are no skins available from St. Lucia,

we do not know if there are color differences between topotypical *M. p. luciae* and *M. p. plethodon*, but we are inclined to doubt that such occur.

Mensural data for three samples of *M. p. luciae* are presented in tables 1 and 2. External measurements are available only from our large series from Dominica, but comparison with those of isolated bats from other islands indicates no difference in size. Means and extremes of cranial measurements for the three different populations of *M. p. luciae* are quite comparable; some measurements (condylobasal length, zygomatic breadth, maxillary tooththrow) intimate the existence of a cline, with larger bats in the north, but others (greatest length of skull, postorbital constriction, mastoidal breadth) do not demonstrate this phenomenon clearly, if at all. There is no evidence in bats from the northern part of the range of *M. p. luciae* of a trend in size toward the much smaller, geographically adjacent *Monophyllus redmani portoricensis*.

Two specimens of *M. p. luciae* (KU 104779, gravid ♀; USNM 361897, ♀) from Dominica are distinctly paler dorsally than other bats from that island. Instead of being the medium to dark brown of all other *M. p. luciae*, these two bats are pale buffy tan above and only slightly darker (more grayish) below. No other sample of *M. redmani* or *M. plethodon* shows such variation. The mentioned differences in color could be due to dichromatism in the population on Dominica or to change in color of the pelage relating to wear and fading.

Monophyllus has not been reported previously from the islands of Antigua and Barbuda. The specimen from Barbuda was collected by P. W. Hummelinck, and his notes state that the bat was found dead near the entrance of Dark Cave. Dark Cave is situated at the bottom of a wooded sinkhole and is about 170 meters long and has three water-filled basins. No other bats of any species were observed in the cave. The four Antiguan *M. p. luciae* were collected in Bat Cave near English Harbour. Both the caves on Antigua and Barbuda are located in xeric regions.

Howes (1930, pp. 102-103) reported taking *Monophyllus* in a cave at Dleau Manioc near the Layou River on Dominica; the cave entrance lay about 200 feet (61 meters) up on the face of cliffs bordering the river. Howes' report of this bat from Dominica has been overlooked by other workers. Of 16 *M. p. luciae* collected by the junior author on Dominica, six were netted in banana groves, four were taken in nets across a trail that separated woodlands from a *Theobroma* grove, and others in a net stretched across part of the Layou River. One individual was netted in a banana grove at Marigot. A male was found dead adjacent to a small cave a few yards from the ocean near

Mahaut. The single specimen taken by the senior author was captured in a mist net stretched across a montane stream in dense rain-forest. Elevations of known occurrence of *M. p. luciae* range from sea level up to approximately 1800 feet (550 meters); these extremes are from Dominica material.

Bats taken in nets that also contained *M. p. luciae* on Dominica include *Artibeus jamaicensis*, *Brachyphylla cavernarum*, *Sturnira angeli*, *Myotis nigricans*, and *Ardops nicholli*. There are no data on associated species from situations wherein *Monophyllus* has been collected on other Lesser Antillean islands.

Females collected on Dominica by the junior author between Mar. 24 and Apr. 22, 1966, were gravid; fetuses varied in length from 17 to 24, with larger fetuses occurring on the later dates. Males during the same period had testes 4 to 4.5 in length. Only one young is born to a female. Weights of males ranged from 13.8 to 17.2; those of females from 12.5 to 17.0, with the single nongravid female weighing the least.

SPECIMENS EXAMINED.—ANGUILLA: Small Fountain Cave, Little Bay, 1 ♀ (AMNH 72367). BARBUDA: Dark Cave, 1 ♀ (RMNH 17854). ANTIGUA: Parish of St. Paul: Bat Cave, 4 ♂ (BMNH 18.4.1.7-9, MCZ 17468). DOMINICA: St. Joseph Parish: Clarke Hall Estate, 100 ft, 7 ♂, 10 ♀ (KU 104766-79, USNM 361896, 391225, 391275); St. Paul Parish: Sylvania, 1 ♀ (USNM 361897); 1½ miles northwest of Mahaut, sea level, 1 ♂ (KU 104780); 6 miles northeast of Roseau, 1100 ft, 1 ♀ (AS 5357); St. Andrew Parish: Marigot, 100 ft, 1 ♀ (KU 104765); St. Lucia: no specific locality, 2 ♂, 11 ♀ (USNM 106090-94, 106098-100, 110901-05).

Monophyllus plethodon frater Anthony

Monophyllus frater Anthony, 1917, p. 565. [Type-locality: cave (Cueva Catedral) near Morovis, Puerto Rico.]

DISTRIBUTION.—Known only as fossil from Puerto Rico (see fig. 1).

REMARKS.—*Monophyllus plethodon frater* was described from five fragmentary skulls; the species was differentiated from *M. r. portoricensis* by its larger size. Anthony (1918, p. 350) commented:

This large species of *Monophyllus* was apparently contemporaneous with *M. portoricensis* . . . since a typical skull of the smaller *portoricensis* was found in the same deposit with the skulls of *frater*. It is partly for this reason that *frater* has been accorded full specific rank instead of being placed in the line of direct ancestry of *portoricensis* The relationship with *portoricensis* is very close however and the differences appear to be in size rather than detail. Were the two forms from adjacent islands rather than from the same island doubtless they would best be considered subspecifically related *M. frater* is probably even more closely related to the larger *M. luciae* from the Island of St. Lucia, Lesser Antilles, than to the small *portoricensis* Compared with *M. luciae*

the fossil *Monophyllus* may be distinguished by its rather longer rostrum and noticeably longer toothrow.

We have examined three fragments of *M. frater*, including two rostra and one palate. As in other representatives of *M. plethodon*, the diastema between the upper premolars is narrow; the first upper premolar is lacking in the three fragments, but its alveolus and either the alveolus of the second premolar or the tooth itself clearly demonstrate that the two upper premolars were appressed as in the Lesser Antillean *M. plethodon*. There is no question that *M. frater* is related to *M. plethodon* rather than to the Greater Antillean *M. redmani*.

We use a trinomial to show the close affiliations of *M. frater* with *M. plethodon*. There are those who feel that such usage is inappropriate for nonsynchronous taxa. We do so here for three reasons: (1) Although no large *Monophyllus* has been taken in the flesh on Puerto Rico, there is a good possibility that *M. p. frater* may be so encountered. Several other Antillean mammals (*Brachyphylla nana* and *Capromys nana* in Cuba, and *Brachyphylla pumila* on the island of Hispaniola) were named originally from fragmentary cave material and were later secured in the flesh. (2) *Monophyllus r. portoricensis* and *M. p. frater* were apparently at least partially contemporaneous in Puerto Rico, suggesting that the latter species is a relatively recent inhabitant of the island rather than an ancient arrival. Anthony (1918, p. 338), writing specifically about the Cueva Catedral fossils, concluded that "the fossil bats of Cueva Catedral have been fossil for no lengthy period" and that, considering the Puerto Rican fossil fauna as a whole, a "conservative estimate would place the island mammalia as living at the end of the late Pleistocene and there is little doubt that this age may be extended into the Recent." (3) Use of a trinomial clearly shows the close relationship of *M. frater* with the other subspecies of *M. plethodon*. Maintaining two distinct species obscures their obvious affinities.

Anthony's (1918, p. 350) brief comparison of *M. frater* with *M. luciae* (that the former differs from the latter in having a "rather longer rostrum and noticeably longer tooth row") seems to be affirmed by recently acquired specimens of *M. p. luciae* although, considering the total variation in *luciae*, the differences are far from striking. Anthony's measurements (1918, p. 350) of "interorbital breadth" (4.6-4.9 in three *M. frater*) fall within the known variation of our measurements of postorbital breadth in *M. luciae* (4.5-5.0) and above those of *M. redmani* (3.8-4.6 in all subspecies, with *M. r. redmani* most closely approaching the measurements of *M. p. frater*). The alveolar length of the upper molariform series of two *M. p. frater* measures 6.8 and 7.1, quite comparable to similar measurements in other *M. plethodon*. It is even possible that *M. p. frater* is not

worthy of recognition as an entity distinct from *M. p. luciae*. We are deterred from so considering *M. p. frater* by the fact that all skulls are incomplete, usually grossly so, and by the lack of specimens on which pelage characters and external measurements can be ascertained. We therefore retain *M. p. frater* with full knowledge that it may prove later to be synonymous with *M. p. luciae*. Retention of the name at this time permits its convenient use in dealing with the larger of the two species of *Monophyllus* from Puerto Rico.

SPECIMENS EXAMINED.—PUERTO RICO: Cueva Catedral, Morovis, Arecibo, 3 (AMNH 40942-44).

Discussion

The genus *Monophyllus* is composed of two species, each with three subspecies, which, except for the sympatric occurrence of representatives of each species on Puerto Rico, are allopatric. One species (*M. redmani*) is Greater Antillean in distribution and the other (*M. plethodon*) is Lesser Antillean, except for the occurrence (only in the past?) of a population on the island of Puerto Rico. Such a picture suggests that there have been two independent centers of differentiation of *Monophyllus* in the West Indies with the resultant evolution of two practically allopatric species. The Lesser Antillean *M. plethodon*, however, succeeded in crossing the Anegada Passage and reached Puerto Rico at a time when that island was occupied also by *M. redmani*. Clear evidence of immigration from the Lesser Antilles to the Greater Antilles (in contrast to the reverse situation) is quite rare in the terrestrial vertebrate biota of the Antillean islands, and *M. plethodon* stands out as an invader of the Greater Antilles from the south.

The degree of differentiation of the subspecies of *M. redmani* (in contrast to those of *M. plethodon*) is striking. The races of *M. redmani* (*M. r. redmani*, *M. r. clinedaphus*, *M. r. portoricensis*) all are distinctly different, the primary difference being in overall size and concomitantly in size of skull. Although perhaps interpretable as grossly clinal, with the largest subspecies in the west (*M. r. redmani*) and the smallest in the east (*M. r. portoricensis*), the size difference is not quite so diagrammatically demonstrated as one might assume from first glance. The subspecies *M. r. redmani* and *M. r. clinedaphus*, for instance, have comparably long forearms despite a distinct dichotomy in overall size; secondly, the occurrence of *M. r. clinedaphus* on two islands (Cuba and Hispaniola), rather than each island having its own subspecies, suggests also that we are not dealing with variation of a typically clinal nature.

In contrast to the subspecific differentiation in *M. redmani*, the races of *M. plethodon* are much less distinctly defined. In fact, were

it not for the small holotype of *M. p. plethodon* and temporal considerations of *M. p. frater*, we would be prone to consider *M. plethodon* as monotypic. The limited material of topotypic *M. p. plethodon* and *M. p. frater*, plus the fact that the latter is known only from fragmentary skulls, make assessment of the status of the Barbadian and Puerto Rican subspecies extremely difficult. The geographic isolation of Barbados from the balance of the Lesser Antillean chain and the presence of an apparently isolated segment of *M. p. plethodon* in Puerto Rico have been decisive factors in our retention of these two populations as distinct from the main body of Lesser Antillean *M. p. luciae*. Lack of presently demonstrable differences between the populations of *M. p. plethodon* on the Lesser Antillean islands of St. Lucia, Dominica, Antigua, Barbuda, and Anguilla suggests that the species is relatively stable genetically (a suggestion somewhat confirmed by the small differences among the subspecies *M. p. plethodon*, *M. p. luciae*, and *M. p. frater*), or that there is intercourse between populations of *M. p. plethodon* on the various Lesser Antillean islands (although as yet *Monophyllus* remains unknown from any two adjacent islands except Barbuda and Antigua on the same bank), or that *M. p. plethodon* is a relatively recent arrival on at least some of the Lesser Antillean islands, which it now occupies without sufficient elapsed time for local subspecific differentiation. The latter seems to us to be the most acceptable interpretation. Doubtless, additional collecting will reveal the presence of *M. plethodon* on at least those Lesser Antillean islands (Martinique, Guadeloupe, and the islands of the Anguilla Bank) that lie either between known stations of occurrence of the species or on the same bank as islands from which *M. plethodon* is known.³ The French islands in particular are poorly explored mammalogically.

The complete dichotomy of *M. plethodon* and *M. redmani* in the one character that distinguishes them—the diastema between the upper premolars—makes any analysis of relationships, history, and loci of origin extremely difficult. The general concordance in size of *M. plethodon* and *M. r. redmani* suggests that the latter is the subspecies of *M. redmani* most closely related to *M. plethodon*. This indeed may be the case, but *M. r. redmani* occupies that island (Jamaica) in the range of the species that is farthest removed from the present distribution of *M. plethodon*. Perhaps *M. r. redmani* was an early fortuitous arrival in Jamaica from the Lesser Antilles. Data presented by Koopman and Williams (1951), however, suggest that *M. redmani* arrived relatively recently on Jamaica although Williams (1952)

³ After this paper was submitted for publication, a specimen of *M. plethodon* was collected on St. Vincent by a field party from the Museum of Natural History, University of Kansas.

reported finding *Monophyllus* as a fossil on the island. Absence of *Monophyllus* from earlier Jamaican fossiliferous deposits may be due merely to the chance nature of such deposits themselves.

Once established on Jamaica, *M. redmani* could thus have extended its distribution to Hispaniola (*M. r. clinedaphus*) and still further to Puerto Rico (*M. r. portoricensis*). Since Hispaniola and Cuba both are inhabited by *M. r. clinedaphus*, we suggest that Cuba was the last island of the Greater Antilles to be invaded by *Monophyllus*, that these invaders came from Hispaniola to the east rather than from Jamaica to the south, and that there has been little or no subsequent divergence of the Cuban populations of *M. r. clinedaphus* from their Hispaniolan forebearers.

Meanwhile, in the Lesser Antilles, *M. plethodon* became established on some of the Windward Islands from a center of origin there. Any of the mountainous inner chain of islands would seem a suitable locus for the origin and center of dispersal of *M. plethodon*: Dominica or Guadeloupe, both near the central portion of the Lesser Antillean arc, might have been the region whence *M. plethodon* colonized the balance of these islands. From this Lesser Antillean center, *Monophyllus* reached Barbados (*M. p. plethodon*) on one hand and Puerto Rico (*M. p. frater*) on the other, while the parent populations (*M. p. luciae*) remained in situ on the Windward and Leeward Islands. Although this suggested history may bear little resemblance to the sequence of events as they really occurred, it offers at least a tentative explanation that appears to do little violence to the relationships and distribution as currently understood.

Literature Cited

ALLEN, GLOVER M.

1911. Mammals of the West Indies. Bull. Mus. Comp. Zool., vol. 54, no. 6, pp. 175-263.

ANTHONY, H. E.

1917. Two new fossil bats from Porto Rico. Bull. American Mus. Nat. Hist., vol. 37, pp. 565-568, 1 pl.

1918. The indigenous land mammals of Porto Rico, living and extinct. Mem. American Mus. Nat. Hist., n. s., vol. 2, no. 2, pp. 333-435, 55 figs., 20 pls.

1919. Mammals collected in eastern Cuba in 1917, with descriptions of two new species. Bull. American Mus. Nat. Hist., vol. 41, pp. 625-643.

HALL, E. RAYMOND, and KELSON, KEITH R.

1959. The mammals of North America, vol. 1, xxx, + 546 pp., 312 figs., 320 maps. New York: Ronald Press.

HOWES, PAUL G.

1930. Wild life in Dominica. Nat. Hist., vol. 30, pp. 90-103.

KOOPMAN, KARL F.

1955. A new subspecies of *Chilonycteris* from the West Indies and a discussion of the mammals of La Gonave. Journ. Mamm., vol. 36, no. 1, pp. 109-113, 1 pl.

- KOOPMAN, KARL F., and RUIBAL, RODOLFO
 1955. Cave-fossil vertebrates from Camaguey, Cuba. *Breviora*, Mus. Comp. Zool., vol. 46, pp. 1-8.
- KOOPMAN, KARL F., and WILLIAMS, ERNEST E.
 1951. Fossil Chiroptera collected by H. E. Anthony in Jamaica, 1919-20. *American Mus. Nov.*, vol. 1519, pp. 1-29, 6 figs.
- LEACH, WILLIAM E.
 1821. The characters of seven genera of bats with foliaceous appendages to the nose. *Trans. Linn. Soc. London*, vol. 13, pp. 73-82.
- MILLER, GERRIT S., JR.
 1900. The bats of the genus *Monophyllus*. *Proc. Washington Acad. Sci.*, vol. 2, pp. 31-38.
 1902. Twenty new American bats. *Proc. Acad. Nat. Sci. Philadelphia*, vol. 54, pp. 389-412.
 1904. Notes on the bats collected by William Palmer in Cuba. *Proc. U.S. Nat. Mus.*, vol. 27, pp. 337-348, 1 pl.
 1918. Three new bats from Haiti and Santo Domingo. *Proc. Biol. Soc. Washington*, vol. 31, pp. 39-40.
 1929. A second collection of mammals from caves near St. Michel, Haiti. *Smithsonian Misc. Coll.*, vol. 81, no. 9, pp. 1-30, 1 pl.
- WILLIAMS, ERNEST E.
 1952. Additional notes on fossil and subfossil bats from Jamaica. *Journ. Mamm.*, vol. 33, pp. 171-179, 1 fig.

Dominica Survey in the *Proceedings*

<i>paper</i>	<i>author</i>	<i>subject</i>	<i>year</i>	<i>volume</i>	<i>number</i>
1	Kier	Echinoids	1966	121	3577
2	Stone	Diptera: Anisopodidae, Bibionidae	1966	121	3578
3	Kirsteuer	Marine archiannelids	1967	123	3610
4	Allen	Hymenoptera: Tiphidae	1967	123	3617
5	James	Diptera: Stratiomyidae	1967	123	3622
6	Jones and Schwartz	Bats of genus <i>Ardops</i>	1967	124	3634

Proceedings of
the United States
National Museum



SMITHSONIAN INSTITUTION • WASHINGTON, D.C.

Volume 124

1968

Number 3636

Four New Fishes of the Genus *Parapercis*
with Notes on Other Species
from the Indo-Pacific Area
(Family Mugiloididae)

By Leonard P. Schultz

Senior Zoologist, Department of Vertebrate Zoology

Mugiloidid fishes of the genus *Parapercis* from the International Indian Ocean Expeditions (IIOE), 1964, the Te Vega Expeditions (TVE), 1963 and 1965, and the Smithsonian Institution Pacific Ocean Biological Survey (SIPOBS), 1964, together with other specimens in the United States National Museum form the basis of this paper. Among this material four new species were discovered and are described herein.

Dr. George E. Cantwell (1964), who revised the genus *Parapercis*, recognized 26 species. Not included in Cantwell's analysis of species are *P. okamurai* Kamohara (1960) and *P. kamoharai* Schultz (1966).

Dr. Chuichi Aranga (Seto Marine Biological Laboratory, Japan), who collected the types of *P. kamoharai*, informed me through correspondence that the type-locality was incorrect as published. He writes that he collected the types on the "Southwest Coast of Kii Peninsula, Wakayama Prefecture, south of Osaka Prefecture. This species inhabits the coastal waters, but it has never been collected from the inner part of any bay."

Parapercis okamurai Kamohara is very close to *P. aurantiaca*, both having palatine teeth, whereas all the new species described herein lack palatine teeth.

Since the recently discovered new species were unknown when Cantwell made his revision (loc. cit), I have extensively expanded and modified his "Key to the Species of *Parapercis*." Differences in counts between the two keys result from new counts by me, the correction of a few errors in the Cantwell key, and additional color descriptions. The following key distinguishes 32 species.

Key to the Species of *Parapercis*

- 1a. Palatine teeth present.
- 2a. 10 teeth in outer row of lower jaw.
- 3a. Total anal rays 19; soft dorsal fin rays 22; no dark spot at tip of chin; front of premaxillary plain brownish but lighter just laterally; side of upper lip with 2 small brown spots (southern and western Australia).
haackei (Steindachner)
- 3b. Total anal rays 18; soft dorsal fin rays 21, rarely 22; dark spot at tip of chin; front of premaxillary with 3 brown-edged light cross bars; side of upper lip plain brown (Great Barrier Reef, Queensland, Australia, northward to Ryukyu Islands; Marshall and Fiji Islands). **cylindrica** (Bloch)
- 2b. 6 or 8 teeth in outer row of lower jaw.
- 4a. 6 teeth in outer row of lower jaw.
- 5a. 7-13 dark bars on upper side.
- 6a. Midbase of caudal fin with dark spot; brown-edged light bar across nape, interrupted at middorsal line by narrow brown isthmus; 10 narrow dark bars on upper side, one below spiny dorsal and 8 below base of soft dorsal (Japan, Korea, Formosa, and Hawaiian Islands).
multifasciata Steindachner and Döderlein
- 6b. Midbase of caudal fin without dark spot; no light bar across nape.
- 7a. 13 narrow dark bars on upper side, 2 under spiny dorsal and 9 under base of soft dorsal fin (New South Wales, Australia) . . . **binivirgata** (Waite)
- 7b. 7 broad dusky bars on upper side, sometimes absent after long preservation, with 5 of the bars under base of spiny and soft dorsal fins (Japan to Formosa) **aurantica** Steindachner and Döderlein
- 5b. No dark bars on upper side or on back, coloration plain light yellowish; black spot at dorsal base of caudal fin; few small black spots above base of pectoral fin, pectoral axil blackish; few small black specks along anterior part of lateral line (Japan) **okamurai** Kamohara
- 4b. 8 teeth in outer row of lower jaw.
- 8a. Dorsal fin spines longest posteriorly.
- 9a. Total pectoral rays 16 or 17; scales in zigzag row around caudal peduncle 30-34; 5 V-shaped dark bars on upper side; dorsal base of caudal fin with large black spot (Japan, Korea, Formosa to South China Sea).
sexfasciata (Temminck and Schlegel)
- 9b. Total pectoral rays 19; scales in a zigzag row around caudal peduncle 27; no V-shaped dark bars on upper side; base of caudal fin without distinct large black spot; upper side tessellated in color pattern (Japan).
mimaseana (Kamohara)
- 8b. Dorsal fin spines longest at middle of fin.

- 10a. Last dorsal fin spine connected by membrane to base of first soft dorsal ray; 5 dark V-shaped bars on upper side, 1 under spiny dorsal, 4 under soft dorsal; pectoral fin base with a black spot (Korea; Japan to Formosa).
snyderi Jordan and Starks
- 10b. Last dorsal fin spine connected by membrane to first soft dorsal fin ray opposite tip of last dorsal spine.
- 11a. Dorsal fin rays IV,24; total pectoral fin rays 16; oblique scale rows 60-64; scales above lateral line 4 (New South Wales and South Australia).
ramsayi Steindachner
- 11b. Dorsal fin rays V,23; total pectoral fin rays 20; oblique scale rows 50-54; scales above lateral line 6 (Japan and Formosa) . . . **muronis** (Tanaka)
- 1b. Palatine teeth absent.
- 12a. 6 teeth in outer row of lower jaw.
- 13a. Last dorsal fin spine connected by membrane to base of first soft dorsal ray.
- 14a. Dorsal fin rays V,21 rarely 22; total anal rays 18, rarely 19; upper and lower caudal fin rays greatly elongated, with brownish coloration (Hawaiiian and Seychelles Islands) **schauinslandi** (Steindachner)
- 14b. Dorsal fin rays V,22; total anal rays 19; no caudal fin ray greatly elongated.
- 15a. Oblique rows of scales above lateral line 56-62; scales above lateral line to first soft dorsal ray 4 or 5 with 13-15 below to anus; zigzag row of scales around caudal peduncle 24-30.
- 16a. Total pectoral rays 16; zigzag row of scales around caudal peduncle 26-30; total gill rakers 9-12; anterior rays of soft dorsal fin greatly elongated (Singapore and Hainan) **filamentosa** (Steindachner)
- 16b. Total pectoral rays 17-19; zigzag row of scales around caudal peduncle 24-26; no soft ray of dorsal elongated.
- 17a. Total pectoral fin rays 18 or 19; gill rakers 6 or 7 + 12-16 = 19-23 (Arabian Sea, Bay of Bengal, Andaman Sea, Misool Island [2°S 130°E], Philippines, and China Sea) **alboguttata** (Günther)
- 17b. Total pectoral fin rays 17; gill rakers 4 or 5 + 9 or 10 = 14 or 15 (Somali coast and Red Sea) **simulata**, new species
- 15b. Oblique rows of scales above lateral line 70-83; scales above lateral line to base of first soft dorsal ray 8-10, and below lateral line to anus 20-24; zigzag row of scales around caudal peduncle 35-44.
- 18a. Total gill rakers 17-20; oblique scale rows above lateral line 70-77; 3 dark stripes across interorbital space; 5 V-shaped dark bars below dorsal fins, but no broad, light, lengthwise streak with dark edge along middle of side, interrupting the dark bars (Bustard Head, Queensland to Dampier Archipelago, Western Australia) **emeryana** (Richardson)
- 18b. Total gill rakers 11-17; oblique scale rows above lateral line 77-87; no dark stripe in interorbital space; dark bars somewhat V-shaped below dorsal fins, interrupted along middle of side by dark-edged, broad, light streak (Durban, Natal, Persian Gulf, Madagascar, off Somali, Reunion, West Australia, Queensland, and New South Wales).
nebulosa (Quoy and Gaimard)
- 13b. Last dorsal fin spine connected by membrane to first soft dorsal ray opposite tip of last dorsal spine.
- 19a. 4 dorsal fin spines.
- 20a. Small intense black spot in each of 9 vertical bars on side along lengthwise line just below midside; black ocellate spot just above opercle; midcaudal fin rays occasionally with white area in basal half; snout in front of eyes notably brown spotted; anal fin distally with single series

- of small dark spots (Philippines, Marshalls, Gilberts, East Indies, Samoa, Fiji Islands, Carolines) **clathrata** Ogilby
- 20b. No small black spots in dark vertical bars on side of body as in *clathrata*; no black above opercle; middle caudal fin rays with white blotch in distal half of fin; snout without brown spots; no row of brown spots distally on anal fin (Philippines, Marianas, Marshalls, Gilberts, Fiji Islands, Ceylon, Ryukyu Islands, East Indies, Carolines, Mauritius, and off Thailand). **cephalopunctata** (Seale)
- 19b. 5 dorsal fin spines.
- 21a. Zigzag row of scales around caudal peduncle 26-32.
- 22a. Oblique scale rows 55-64.
- 23a. Large dark ocellate spot above operculum and above lateral line; exposed distal part of each soft anal ray dusky; dark vertical bars on sides meeting at midventral line of body (Japan to East Indies, Samoa, Fiji Islands, Bay of Bengal, Cocos Islands) **tetracantha** (Lacépède)
- 23b. No dark ocellate spot as in *tetracantha*; exposed distal tips of soft anal rays unpigmented; dark vertical bars on sides not continuing to midventral line of body (Japan to Queensland, Fiji Islands, Zanzibar, Madagascar). **xanthozona** (Bleeker)
- 22b. Oblique scale rows 66-72; checks and rear of head with conspicuous light and dark cross-bars; side of body with 7 light bars ending in 7 black ocellate spots on lower side, leaving belly plain light tan; 7 scales from base of first soft dorsal ray to lateral line (Japan) **kamoharai** Schultz
- 21b. Zigzag row of scales around caudal peduncle number 24-26.
- 24a. Oblique scale rows 51-55, with 4 scales above lateral line to base of first soft dorsal ray and 12-13 below lateral line to anus; gill rakers 5 or 6+9 or 10 on first arch (off coast of Somali) **somaliensis**, new species
- 24b. Oblique scale rows 56-62, with 5 scales above and 13 or 14 below lateral line; gill rakers 6+9 or 10 on first arch.
- 25a. 2 dark bars across belly between bases of pelvic fins and anus; no dark spot on side of body below depressed pectoral fin (Seychelles Islands). **bivittata**, new species
- 25b. No dark bars across belly; 3 dark ocellate spots in row on side in area between depressed pectoral fins and that of pelvic fins (Seychelles Islands). **trispilota**, new species
- 12b. 8 teeth in outer row of lower jaw.
- 26a. Dorsal fin spines longest posteriorly; caudal vertebrae 18.
- 27a. Dorsal rays V (rarely VI), 20; total anal rays 17, occasionally 18; scales above lateral line 10-12; total gill rakers on first arch 21-26; brownish pigment at base of pectoral fin (New Zealand, Chatham, and Alderman Islands) **colias** (Bloch)
- 27b. Dorsal rays V, 21; total anal rays 18; scales above lateral line 4-7; total gill rakers on first arch 15-20; base of pectoral fin without brown coloration.
- 28a. Oblique scale rows 60-65; zigzag scales in row around caudal peduncle 25-29; scales in row from lateral line to anus 16 or 17, and above lateral line 4 or 5 (New South Wales, South Australia, Tasmania). **allporti** (Günther)
- 28b. Oblique scale rows 65-69; zigzag scales in row around caudal peduncle 30-34; scales in row from lateral line to anus 18 or 19, and above lateral line 6 or 7 (New Zealand) **gilliesi** (Hutton)
- 26b. Dorsal spines longest at middle of fin; caudal vertebrae 19.
- 29a. Membrane from last dorsal fin spine connects at base of first soft dorsal ray; no large black blotch on middle rays of caudal fin.

- 30a. Dorsal fin rays V,21, occasionally 22; total anal rays 18, occasionally 19; total pectoral rays 16 or 17; scales from lateral line to anus 14-17, and above lateral line 4-6; no black spot on caudal fin base (Japan to China Sea, Comores, east coast of Africa to Durban, Zanzibar).
pulchella (Temminck and Schlegel)
- 30b. Dorsal fin rays V,22; total anal rays 19, rarely 20; total pectoral rays 14 or 15, rarely 16; scales from lateral line to anus 10-13 and above lateral line 3, rarely 4; black spot at base of upper lobe of caudal fin (Korea, Japan to Formosa, Hong Kong) **ommatura** Jordan and Snyder
- 29b. Membrane of spinous dorsal connects with first soft dorsal ray opposite tip of last dorsal spine; large black blotch on middle rays of caudal fin.
- 31a. 2 or 3 lengthwise rows of brown spots on cheek; 5-7 dark ocellate spots in a row along ventral side of body (Okinawa; Philippines; Rennell Islands; Ryukyu Islands; New Caledonia; east coast Africa; Zanzibar; Red Sea).
polyophthalma (Cuvier and Valenciennes)
- 31b. 4-8 oblique dark lines across cheek; 3-5 dark ocellate spots in a row along ventral side of body (North China and Ryukyu Islands south to Northern Australia, east to Fiji Islands, westward to Red Sea, and south to Durban).
hexophthalma (Cuvier and Valenciennes)

Paraperkis simulata, new species

PLATE 1

HOLOTYPE.—USNM 200760, Somali Coast, lat. 11°4'N, long. 51°15'E, Dec. 17, 1964, IIOE, *Anton Bruun* Cruise 9, Sta. 451, depth 76-80 meters, standard length 150 mm.

PARATYPES.—USNM 200761, same data as holotype, 11 spec., 121-146 mm. USNM 200759, Somali Coast, 11°11'N 51°14'E, Dec. 17, 1964, IIOE, *Anton Bruun* Cruise 9, Sta. 453, depth 47-49 meters, 2 spec., 118 and 126 mm. USNM 250258-F19, Red Sea, Safaga, Egypt, Feb. 9-10, 1964, otter trawl, collector C. J. D. Brown, 1 spec., 143 mm.

DESCRIPTION.—Measurements made on the holotype and 7 paratypes are recorded in table 1. Counts for the holotype and paratypes are recorded in tables 2 to 4.

Teeth present on vomer, absent on palatines; 6 hooked canine teeth (3 on each side) at tip of lower jaw; spinous dorsal fin connected by membrane at base of first soft ray; pectoral rays 9 to 11 (counted from dorsal edge) longest; fourth soft pelvic ray longest; upper caudal fin rays longest and sometimes projecting as a free ray as much as diameter of pupil; scales in a zigzag row around caudal peduncle 24-26.

COLOR IN ALCOHOL.—General background of head and body straw colored, with edges of scales dusky on sides giving a netlike appearance; on lower side dark pigmentation on scale edges intensified to form 5 evenly spaced dusky bars; sometimes there is intensification of pigment on edges of about two vertical scale rows in each area between the 5 larger dusky blotches; belly plain light straw colored;

dusky bar from eye to snout tip; 2 dusky bars from eye across pre-orbital and maxillary, another dark bar with light center from lower rear of eye downward to corner of mouth, and a dusky pale centered bar across preopercle; all bars separated by light areas; inner rays of pelvic fins blackish; dorsal three-fourths of base of axil of pectoral fin dusky; dark spot near base of middle rays of upper lobe of caudal fin, and sometimes a less intense dark spot in lower lobe in a similar position; caudal fin and posterior soft dorsal rays lightly marked with dusky bars; pectoral and anal fin rays unmarked.

TABLE 1.—Measurements made on two species of *Parapercis* expressed in thousandths of standard length

Characters	<i>P. alboguttata</i>						<i>P. simulata</i> , new species									
	USNM 200693			USNM 200697			Holo- type USNM 200760	Paratypes USNM 200761								
Standard length (in mm)	165	136.5	121.5	167	145	119	118.5	117	150	153	153	138	133	130	125	121
Length of head	306	298	317	344	331	322	331	316	287	289	307	290	297	277	297	294
Length of snout	108	98	101	121	114	101	110	94	109	110	108	95	105	100	107	94
Diameter of eye	81	75	82	74	70	79	76	76	69	63	62	77	69	73	73	70
Postorbital length of head	127	131	135	156	161	151	154	149	137	127	130	135	132	123	126	137
Width fleshy interorbital space	42	48	41	69	60	67	49	51	43	56	60	47	43	42	44	41
Snout tip to rear edge maxillary	128	117	123	144	137	124	132	122	120	124	132	111	120	118	116	116
Width of preorbital	50	43	45	63	58	44	53	43	51	50	55	47	50	48	48	41
Least depth of body	63	67	75	62	64	60	63	58	79	75	80	76	79	78	78	75
Greatest depth of body	155	150	165	174	159	162	180	144	177	170	173	174	173	177	174	174
Length fourth dorsal spine		81	77	94	86	91	93	75	87	86	90	85	83	82	90	92
Longest pectoral ray	158	160	173	158	159	166	164	165	157	154	168	167	177	180	160	163
Longest pelvic ray	173	183	189	177	200	181	207	190	191	196	189	203	198	213	200	202
Longest caudal ray	162	161	165	201	204	193	211	172	185	186	202	191	184	206	195	196
Length base of dorsal fin	642	655	626	623	586	621	595	560	646	612	638	674	648	646	684	634
Length base of anal fin	482	458	465	473	469	454	451	418	494	488	483	467	478	485	468	496

DISCUSSION.—This new species was collected at depths between 47 and 80 meters and at an unknown depth in the Red Sea. It is closely related to *P. alboguttata* Günther, type-locality of which is Misoöl Island, about lat. 2°S and long. 130°E, off the western tip of New Guinea. Cantwell (1960, p. 258) reports it from Museat, Monja Island, China Sea. *Neopercis tesselata* Herre from Manilla Bay, without palatine teeth, was placed in the synonymy of *P. alboguttata* by Cantwell, with which opinion I agree on the basis of a radiograph showing i,17 pectoral rays instead of i,16 as found in *P. simulata*, new species.

Fortunately, the IIOE collected a fine series of specimens of *P. alboguttata* from the Arabian Sea and the Bay of Bengal. A comparison of *P. alboguttata* with *P. simulata* reveals that although the color patterns of the two species are nearly identical, they differ in regard to the following characters: In table 2, it can be observed that *P. alboguttata* almost always has i,17 and i,18 pectoral rays while, in table 3, the gill rakers number 6-9 + 12-15 = 19-23, whereas *P. simulata* has i,16 pectoral and 4 or 5 + 9 or 10 = 13-15 gill rakers respectively. In the genus *Parapercis*, a difference in total number of gill rakers from 13 to 15 compared with 19 to 23 with no overlap in the range is highly significant and indicates in my opinion two distinct species.

An examination of the measurements recorded in table 1 indicates that *P. alboguttata* is a more slender species (least depth of caudal peduncle 58-75, average 64, thousandths; greatest depths 144-180, average 161) than *P. simulata*, (75-80, average 77.5, and 170-177, average 174). In addition, *P. simulata* has a shorter head (277-307, average 292 thousandths of length), smaller eye (62-73, average 69.5), and shorter mouth (snout tip to rear of maxillary 111-132, average 120), whereas in *P. alboguttata* these figures are, respectively, 298-344, average 321; 70-82, average 77; and 117-144, average 128.

In table 5, a comparison of certain body proportions was made and the data in this table shows that the least depth of body into head length is 3.5-4.0 for *P. simulata* and 4.1-5.6 for *P. alboguttata*, and, respectively, for least depth of body into eye, 0.8-1.0 and 1.1-1.3.

Since *P. alboguttata* is known now to range from the China Sea to Museat in the northern Arabian Sea, it may be thought that *P. simulata* may represent a subspecies of *P. alboguttata*. There was no variability, however, in counts or measurements for *P. alboguttata* that indicated a morphocline or any other data that might be correlated with range.

Other distinct species of fish have identical or nearly identical color patterns: *Paramia quinquelineata* (Cuvier and Valenciennes) and

TABLE 2.—Frequency distribution of number of soft fin rays recorded for certain closely related species of Parapercis (x=range of counts from Cantwell, 1964)

Species	Dorsal		Anal				Pectoral				
	21	22	15	16	17	18	1,14	1,15	1,16	1,17	1,18
<i>trispilota</i>	12				12			3	20	1	
<i>bivittata</i>	3	1			3			2	5	1	
<i>schaunislandi</i>											
Hawaii	4				4			7	1		
Seychelles	3				3		2	4			
<i>somaliensis</i>	3				3				6		
<i>alboguttata</i>		20				20			2	69	37
<i>simulata</i>		14				14			25	3	
<i>xanthozona</i>	x				x			x	x		
<i>kamoharai</i>	2		1		1				3	1	

TABLE 3.—Frequency distribution of number of gill rakers recorded for certain closely related species of Parapercis (x=range of counts from Cantwell, 1964)

Species	Upper Arch					Lower Arch										Total											
	4	5	6	7	8	9	7	8	9	10	11	12	13	14	15	13	14	15	16	17	18	19	20	21	22	23	
<i>trispilota</i>			7						3	4									2	5							
<i>bivittata</i>		2	1						3										2	1							
<i>schaunislandi</i>																											
Hawaii				3	1				3	1									3	1							
Seychelles		2					1	1	1							1	1										
<i>somaliensis</i>		2	1						1	2									1	1	1						
<i>alboguttata</i>			6	10	3	1						4	6	7	3								6	5	4	3	2
<i>simulata</i>	3	10							4	14						1	5	7									
<i>xanthozona</i>			x	x							x	x	x	x						x	x	x	x				
<i>kamoharai</i>			2						1	1									1	1							

TABLE 4.—Frequency distribution of number of scales recorded for certain closely related species of Parapercis (x=range of counts from Cantwell, 1964)

Species	Oblique rows																					
	51	52	53	54	55	56	57	58	59	60	61	62	63	64	65	66	67	68	69	70	71	72
<i>trispilota</i>						1	2	3	4	2												
<i>bivittata</i>								3	1													
<i>schaunislandi</i>																						
Hawaii									2	1	1											
Seychelles									1	1	1											
<i>somaliensis</i>	1	1			1																	
<i>alboguttata</i>										1	3	4										
<i>simulata</i>								1	3	4	2	1										
<i>xanthozona</i>					x	x	x	x	x	x	x	x	x									
<i>kamoharai</i>																	1					1

Species	Above lateral line					Below lateral line to anus					
	4	5	6	7	8	12	13	14	15	16	17
<i>trispilota</i>				12				5	7		
<i>bivittata</i>				4			1		3		
<i>schaunislandi</i>											
Hawaii						4			3	1	
Seychelles					3				1	2	
<i>somaliensis</i>		3					2	1			
<i>alboguttata</i>		7	1					5	3		
<i>simulata</i>		4						7	3		
<i>xanthozona</i>						x		x	x	x	x
<i>kamoharai</i>								2		1	1

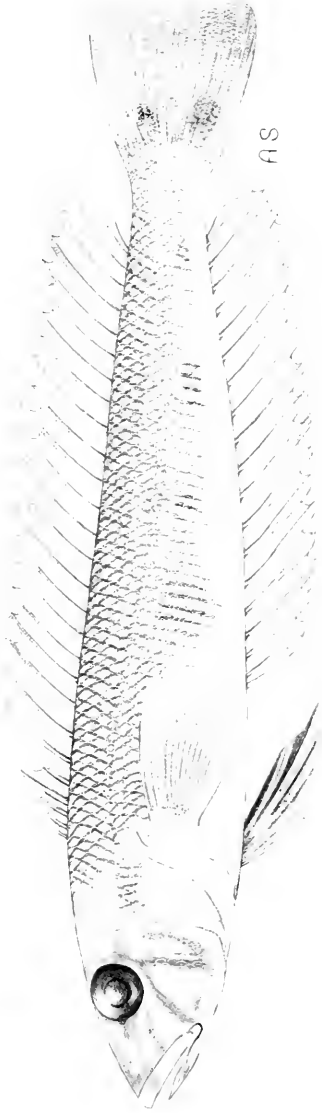

Paraperis simulata, new species: holotype, USNM 200760 (drawn by Ann Schreitz).



Parapericis somaliensis, new species: holotype, USNM 200751 (drawn by Ann Schreitz).



Paraperca bivittata, new species: holotype, USNM 200752 (drawn by Ann Schreitz).



Paraperca trispilota, new species: holotype, USNM 200721 (drawn by Ann Schreitz).

Cheilodipterops isostigma Schultz; also *Apogon nigrofasciatus* Lachner and *Apogon aroubiensis* Hombron and Jocquinot, among others.

The name "*simulata*" indicates that its color pattern is similar to that of its closest relative, *P. alboguttata*.

Parapercis alboguttata Günther

The following specimens, which were used for a comparison with *P. simulata*, new species, were collected by the International Indian Ocean Expedition during 1963 and 1964: USNM 200684, Nov. 17, 1963, Cruise 4B, Sta. 215A, 21°21'N 68°25'E, depth 123 meters, 1 spec., standard length 116 mm. USNM 200685, Dec. 17, 1964, Cruise 9, Sta. 9-456, off Somali Coast, 11°14'N 51°08'E, 1 spec., 138 mm. USNM 200686, Nov. 18, 1963, Cruise 4B, Sta. 219A, 21°52'N 68°6'E, 115 meters, 3 spec., 103-116 mm. USNM 200687, Nov. 15, 1963, Cruise 4B, Sta. 206A, 20°23'N 70°0'E, depth 71 meters, 6 spec., 103-136 mm. USNM 200688, Mar. 24, 1963, Cruise I, Sta. 22, 10°37'N 97°34'E, depth 96 meters, 1 spec., 125 mm. USNM 200689, Nov. 14, 1963, Cruise 4B, Sta. 202C, 18°27'N 71°13'E, 84 meters, 3 spec., 71-104 mm. USNM 200690, Mar. 30, 1963, Cruise I, Sta. 38, 14°7'N 97°5'E, 11 spec., 77-117 mm. USNM 200691, Mar. 30, 1963, Cruise 1, Sta. 37, 13°28'N 97°19'E, 1 spec., 118 mm. USNM 200692, Mar. 30, 1963, Cruise 1, Sta. 36A, 13°0'N 97°41'E, 3 spec., 110-121 mm. Photo of 121 mm specimen, USNM 200693, Mar. 24, 1963, Cruise 1, Sta.

TABLE 5.—Comparison of frequency distributions of certain body proportions for *Parapercis simulata* and *P. alboguttata*

Species	Least depth of body into head length											Least depth into eye						
	3.5	3.7	3.9	4.1	4.3	4.5	4.7	4.9	5.1	5.3	5.5	0.8	0.9	1.0	1.1	1.2	1.3	
<i>alboguttata</i>	3.6	3.8	4.0	4.2	4.4	4.6	4.8	5.0	5.2	5.4	5.6							
<i>simulata</i>	2	4	2	1	1	1		2	2	1	2	5	1	3	2	3		
<i>alboguttata</i>	Greatest depth into length of upper jaw						Diameter of eye into longest pelvic ray											
	.60	.65	.70	.75	.80	.85	2.1	2.2	2.3	2.4	2.5	2.6	2.7	2.8	2.9	3.0	3.1	
	.64	.69	.74	.79	.84	.89												
<i>simulata</i>	1	5	1	1	2	2	1		2	2	1		1		1			
												1	1	1	3	1	1	
<i>alboguttata</i>	Head into standard length																	
	2.9	3.0	3.1	3.2	3.3	3.4	3.5	3.6										
	1	2	1	2	2													
<i>simulata</i>					1	5	1	1										

Hydro. 21, 9°54'N 97°42'E, 5 spec., 117–163 mm. USNM 200694, Mar. 27, 1963, Cruise 1, Sta. 28A, 11°52'N 92°49'E, 1 spec., 89 mm. USNM 200695, Dec. 3, 1963, Cruise 4B, Sta. 269A, 23°43'N 58°23'E, depth 49 meters, 1 spec., 142 mm. USNM 200696, Dec. 3, 1963, Cruise 4B, Sta. 269B, 23°33'N 58°23'E, depth 106 meters, 2 spec., 131 and 184 mm (photographed). USNM 200697, Nov. 14, 1963, Cruise 4B, Sta. 202B, 17°41'N 71°33'E, depth 90 meters, 29 spec., 94–167 mm.

Parapercis somaliensis, new species

PLATE 2

HOLOTYPE.—USNM 200751, off coast of Somali, depth 50–70 meters, Dec. 18, 1964, IIOE, Sta. 468, 11°52'N 51°14'E, standard length 105 mm.

PARATYPES.—USNM 200750, off coast of Somali, depth 67–72 meters, Dec. 18, 1964, IIOE, Sta. 465, 11°37'N 51°27'E, 2 spec., 81 and 120 mm.

DESCRIPTION.—Counts are recorded in tables 2–4 and measurements made on the holotype and paratypes are expressed in thousandths of the standard length in table 6.

Vomer with teeth, none on palatines; 6 canine teeth (3 on each side) near tip of lower jaw; spinous dorsal fin connected by membrane to first soft dorsal ray opposite tip of fifth dorsal spine; ninth branched pectoral ray from dorsal edge longest; upper caudal fin rays elongate, projecting as much as diameter of eye behind rear edge of that fin; scales in a zigzag row around caudal peduncle 24–26.

COLOR IN ALCOHOL.—Body with straw-colored background; dorsal half of body marked with 8 bars, and an additional bar crossing in front of dorsal fin; the checkered nature of these bars ends at a light streak along middle of the side, below which they continue as faintly pigmented bars not reaching base of anal fin; a pair of large brown spots near occiput; preorbital and snout brown, but not continuing on the premaxillary; a wedge-shaped brown bar below eye extending obliquely backward; preopercle light straw colored, except the posterior edge is brown; opercle brownish with about 4 dark brown spots; base of pectoral fin brownish posteriorly and anteriorly; pectoral, pelvic, and anal fins unmarked; dorsal fin rays with brown bases opposite the brown bars on upper sides; caudal fin with several light dusky cross bars.

DISCUSSION.—This new species traces down through Cantwell's (1964, p. 248) key to *P. xanthozona* but differs by having 5 or 6+9 or 10=14–16 gill rakers instead of 6 or 7+11–14=17–20 gill rakers as in *P. xanthozona*. *Parapercis somaliensis* has only 4 scales from lateral line to base of first ray of soft dorsal whereas *P. xanthozona* has 6–8.

Parapercis xanthozona has 6 small brown spots in a row across top of head behind eyes with a pair of small brown spots in front of the row behind interorbital space, whereas *P. somaliensis* has 6 large spots in a row across top of head behind eyes with the 2 spots at middorsal line greatly enlarged and no spots in front of the enlarged ones; the large dark spot just above the opercle in *P. xanthozona* is lacking in *P. somaliensis* or confined to a very intense and small black spot surrounding 2 pores. The series of dark spots on middle rays of caudal fin with a light unpigmented streak separating the spots in *P. xanthozona* are lacking in *P. somaliensis*. *Parapercis somaliensis* has a shorter snout and larger eye than *P. xanthozona* so that the preorbital is contained in the eye of *P. somaliensis* 1.8 to 2.1 instead of 1.1 to 1.4 in *P. xanthozona*; the preorbital into the postorbital is 1.5 to 1.8 instead of 1.9 to 2.2; the snout in head is 3.1 to 3.2 instead of 2.6 to 2.8, respectively.

The name "*somaliensis*" refers to the Republic of Somali off the shores of which this new species was collected.

Parapercis bivittata, new species

PLATE 3

HOLOTYPE.—USNM 200752, Seychelles Islands, south of Round Island, depth 12–15 meters, Feb. 22, 1964, IIOE Sta. F-61, standard length 114 mm.

PARATYPES.—USNM 200754, Seychelles Islands, Amirantes Islands, off north end Eagle Island, depth 6–9 meters, Mar. 4, 1964, IIOE Sta. F-85, 90 mm. USNM 200753, Seychelles Islands, Amirantes Islands, D'Arros Island, off east side, depth 29–34 meters, Mar. 9, 1964, IIOE Sta. F-105, 80.3 mm. USNM 200762, Seychelles Islands, Amirante Islands, near St. Joseph Island, southwest of Ressource Island, off small boat entrance to lagoon, depth 15–27 meters, Mar. 10, 1964, IIOE Sta. F-110, 91 mm.

DESCRIPTION.—Counts are recorded in table 2, and measurements made on the holotype and paratypes are expressed in thousandths of the standard length in table 6.

Vomer with teeth, none on palatines; 6 canine teeth (3 on each side), near tip of lower jaw; spinous dorsal fin connected by membrane to first soft dorsal ray opposite tip of fifth dorsal spine; ninth or tenth branched pectoral ray from dorsal edge longest; upper caudal fin ray elongate and slightly projecting; scales around caudal peduncle in a zigzag row 26.

COLOR IN ALCOHOL.—Body light tan ventrally, light brown dorsally with 3 irregular rows of brown spots on upper sides becoming 2, then 1, on the peduncle; the brown background coloration of the upper side forms 7 light brown bars, separated by light straw coloration,

the bars not extending below the lower row of spots associated with the brown background bars; middle of side with broad light band, speckled with tiny brown spots irregularly spaced and not in a row; lower side of body behind pectoral base with 8 dark bars, the first is composed of 2 or 3 dark spots in a narrow dark streak that meets or almost meets its fellow about midway between anus and pelvic base; the next 7 bars are composed of large dark spots dorsally, thence becoming paler and narrower as they extend ventrally, but not reaching anal fin base; axis of pectoral base with a narrow black bar that extends ventrally and meets its fellow across belly just behind pelvic fin bases; all of the body bars are in line with black spots in the median fins; base of caudal fin with a pair of small dark spots; front of base of pectoral with 2 to 4 small black spots; lower edge of pectoral fin with a small black spot basally; 6 dark spots in a row across top of head behind orbits and a pair of dark spots of same size in front of the row of spots at rear of interorbital space; a few other dark spots in interorbital space; side of head with dark spots and 2 oblique dark bars from below eye extending posteroventrally; caudal fin with tiny dark spots, irregularly scattered; anal fin with 2 rows of dark spots, the basal row composed of larger spots; dorsal

TABLE 6.—Measurements made on three new species of *Parapercis* expressed in thousandths of standard length

Characters	<i>P. bivittata</i>				<i>P. somaliensis</i>			<i>P. trispilota</i>			
	Holo- type USNM	Paratypes USNM			Holo- type USNM	Paratypes USNM		Holo- type USNM	Paratypes USNM		
	200752	200754	200753	200762	200751	200750		200721	200722	200725	200723
Standard length (in mm)	114	90	80.3	91	105	120	81	69	98	74.5	47
Length of head	273	300	299	288	312	308	316	283	281	304	298
Length of snout	97	92	101	92	97	103	91	116	85	99	81
Diameter of eye	61	72	61	66	82	83	94	77	66	74	87
Width fleshy interorbital space	40	42	40	38	51	48	33	35	40	40	32
Snout tip to rear edge of maxillary	111	121	105	115	133	132	123	103	107	113	114
Least depth of body	90	91	87	88	93	93	90	90	92	86	89
Greatest depth of body	171	178	162	185	200	196	210	175	179	174	168
Length of fourth dorsal spine	74	87	87	80	86	87	90	87	80	84	94
Longest pectoral fin ray	174	202	192	179	181	183	185	178	199	201	213
Longest pelvic fin ray	200	228	235	230	210	196	222	234	225	245	277
Longest caudal fin ray	175	211	204	209	257	238	200	184	177	188	213
Length of base of dorsal fin	615	644	632	631	633	621	605	634	651	625	617
Length of base of anal fin	420	444	452	444	449	439	420	435	434	423	448

fin with 3 lengthwise rows of dark spots, the distal row represented by tiny spots as in the anal fin, whereas the two rows, medially and basally, composed of larger dark spots.

DISCUSSION.—This new species traces through Cantwell's key (1964, p. 248) to section 17b and is related to a group of species centering around *P. xanthozona*, *P. kamoharai*, *P. somaliensis*, new species, and *P. trispilota*, new species, described below. *Parapercis kamoharai* has 30–32 scales in a zigzag row around caudal peduncle, 66–72 oblique scale rows, distinct dark cross bars on head, whereas, *P. bivittata* has 26 scales around the caudal peduncle, 58 or 59 oblique scale rows along upper side, and a color pattern completely unlike that of *P. kamoharai*. *Parapercis bivittata* differs from *P. xanthozona* in having only 5 scales above lateral line instead of 6–8; also *P. bivittata* has fewer gill rakers (see table 3) than *P. xanthozona* and a different color pattern.

Parapercis bivittata, new species, differs from *P. trispilota*, new species, chiefly in regard to color pattern, as follows:

Characters	<i>trispilota</i>	<i>bivittata</i>
number of dark bars across belly between pelvic fin bases and anus	none	2
number of dark spots in the area between depressed pectoral and pelvic fins	3	none
small black specks or spots in light broad band lengthwise along middle of sides	none	numerous
ventral basal edge of pectoral with a black spot	absent	present
axil of pectoral base with a black bar	absent	present
interior side of pectoral base with black spots	none	2–4
number of dark spots on check in addition to one below eye	none	4 or 5
dark spots along posterior edge of preopercle	1 or 2	3 or 4
dark spots on branchiostegal membranes	1 large or 2 small ones	3–5 small ones

The name "*bivittata*" refers to the 2 black streaks across the belly.

Parapercis trispilota, new species

PLATE 4

HOLOTYPE.—USNM 200721, Seychelles Islands, Curieuse Island, just southeast of point forming south end of Laraie Bay, depth about 9 meters, Feb. 23, 1964, IIOE Sta. F-64, standard length 69 mm.

PARATYPES.—USNM 200719, Seychelles Islands, Mahé Island off north tip north of North Island, depth about 27 meters, Feb. 15, 1964, IIOE Sta. F-52, 66 mm. USNM 200722, Seychelles Islands, Mahé, North Islet, west side, depth 8–18 meters, Mar. 16, 1964, IIOE Sta. F-115, 3 specimens, 63–98 mm. USNM 200723, Seychelles Islands, Amirante Islands, D'Arros Island, off east side, depth 24 meters, Mar. 8, 1964, IIOE Sta. F-103, 47 mm. USNM 200724,

Seychelles Islands, Amirantes Islands, D'Arros Island, off east side, depth 29–110 meters, Mar. 9, 1964, IIOE Sta. F-105, 80.3 mm. USNM 200725, Seychelles Islands, Amirantes Islands, near St. Joseph Island, southwest of Ressource Island, depth 27–31 meters, Mar. 7, 1964, IIOE Sta. F-95, 74.5 mm. USNM 200726, Seychelles Islands, near Praslin, south of Round Island, depth 12–15 meters, Feb. 22, 1964, IIOE Sta. F-61, 76.5 mm. USNM 200727, Seychelles Islands, Amirantes Islands, Eagle Islands off north end, depth 6–9 meters, Mar. 4, 1964, IIOE Sta. F-85, 49 mm.

DESCRIPTION.—Counts are recorded in table 2, and measurements made on the holotype and paratypes are expressed in thousandths of the standard length in table 6.

Vomer with teeth, none on palatines; 6 canine teeth (3 on each side) near tip of lower jaw; spinous dorsal fin connected by membrane to first soft dorsal ray nearly opposite tip fifth dorsal spine; ninth branched pectoral ray longest; none of the caudal fin rays elongated and projecting; scales in zigzag row around caudal peduncle 25.

COLOR IN ALCOHOL.—Body light tan, upper sides and back with 9 dusky cross bars, one in front of spiny dorsal, 7 along base of dorsal and one on caudal peduncle; 3 lengthwise rows of small dark spots across dark cross bars becoming 2, then 1, row on caudal peduncle; a broad light band along midside without spots; along middle of lower side 7 or 8 dark spots, each at the dorsal end of a light brown bar that fades ventrally and not reaching anal fin base; pair of small dark spots at base of caudal fin; caudal fin minutely spotted distally; 6 brown spots in a row across head behind eyes with a few dark spots or a pair of dark spots posteriorly in interorbital space. The most characteristic black spots are the 3 in a row beginning between bases of pectoral and pelvic fins and continuing evenly spaced to a vertical line through the middle of a light interspace between the first 2 dark bars at base of dorsal fin; spiny dorsal fin blackish; 2 rows of dark spots lengthwise along anal and 3 in soft dorsal, the distal row in each fin composed of very tiny dark spots.

DISCUSSION.—*Parapercis trispilota* differs from *P. xanthozona*, *P. kamoharai*, and *P. somaliensis* in the same ways that *P. bivittata* differs from them, except in color pattern. *Parapercis trispilota* and *P. bivittata* are distinguished adequately under "Discussion" in *P. bivittata*.

The name "*trispilota*" refers to the 3 dark spots on the area below the depressed pectoral fin.

Additional Species

In addition to the four new species, four other species of *Parapercis* were collected by the three expeditions: *P. hexophthalma* (Cuvier and

Valenciennes), *P. clathrata* Ogilby, *P. cephalopunctata* (Seale), *P. pulchella* (Temminck and Schlegel). In addition, the range for the following three species was extended.

Parapercis nebulosa (Quoy and Gaimard)

The following two collections represent an extension of the range farther into the southern and farther into the northern parts of the Indian Ocean than previously reported: USNM 200718, Dec. 17, 1964, IIOE, Cruise 9, Sta. 462, off Somali Coast, 11°21'N 51°9'E, hand line, 1 spec., 177 mm. USNM 200720, Sept. 25, 1964, IIOE, Cruise 8, Sta. 394B, 29°27'S 31°31'E, shrimp trawl, 1 spec., 195 mm.

Parapercis schauinslandi (Steindachner)

USNM 200763, Mar. 9, 1964, IIOE, Sta. F-105, Seychelles Islands, Amirante Islands, D'Arros Island off east side, depth 27-34 meters, 1 spec., 57 mm. USNM 200764, Mar. 10, 1964, IIOE, Sta. F-110, Seychelles Islands, Amirante Islands, near St. Joseph Island, southwest of Ressource Island, off small boat entrance to lagoon, depth 15-27 meters, 2 spec., 49-65 mm.

The three specimens listed above represent the first known occurrence of this species outside the Hawaiian Islands and the first record for the Seychelles Islands. Usually a reef-inhabiting species found such a great distance apart without occupying the intervening seas is likely to show at least subspecific differences when the populations are compared. In this case, the only possible difference observed was the probability of about one more gill raker on the first arch of the Seychelle specimens. With only three specimens, however, the variability cannot be determined and undoubtedly the range of counts would overlap when more specimens are studied. Tentatively, I refer these Seychelles specimens to *P. schauinslandi*.

Parapercis polyophthalma (Cuvier and Valenciennes)

The following specimens represent the first record of this species from the Seychelles Islands: USNM 200698, Feb. 14, 1964, IIOE, Field No. JR-72, East Aurbariobi-Nossi Be, Madagascar, 13°26'10''S 48°22'54''E, 3 spec., 101-161 mm. USNM 200699, Mar. 10, 1964, IIOE, Sta. F-110, Amirantes Islands, St. Joseph Island, depth 15-27 meters, 4 spec., 113-126 mm. USNM 200700, Mar. 7, 1964, IIOE, Sta. F-95, Amirantes Islands, near St. Joseph Island, depth 25-30 meters 2 spec., 119-133 mm. USNM 200701, Feb. 10, 1964, IIOE, Sta. F-37, Mahé vicinity, Seychelles Islands, depth to 3 meters, 1 spec., 53 mm. USNM 200702, Feb. 4, 1964, IIOE, Sta. F-23, Near Mahé, Seychelles Islands, 1 spec., 59 mm. USNM 200703,

Feb. 2, 1964, IIOE, Sta. F-17, Mahé, Seychelles Islands, depth to 3 meters, 3 spec., 43-71 mm. USNM 200742, Jan. 27, 1964, IIOE, Sta. F-7, Beacon Island, Seychelles Islands, depth 11-15 meters, 1 spec., 30 mm. USNM 200743, Dec. 8, 1964, IIOE, Cruise 9, Sta. HA-19, Indian Ocean, Amirante Islands, St. Joseph Island, Ressourcee Island, 5°24'50''S 53°19'43''E, 2 spec., 107-112 mm. USNM 200744, Jan. 24, 1964, IIOE, Sta. F-4, Faon Island, Seychelles Islands, depth 13 meters, 1 spec., 61 mm. USNM 200745, Jan. 29, 1964, IIOE, Sta. F-11, Faon Island, Seychelles Islands, depth 11-12 meters, 4 spec., 48-58 mm. USNM 200746, Mar. 6, 1964, IIOE, Sta. F-90, Amirantes Islands, D'Arros Island, depth 6-9 meters, 1 spec., 117 mm. USNM 200747, Jan. 28, 1964, IIOE, Sta. F-10, Faon Island, Seychelles Islands, depth 12-15 meters, 6 spec., 46-119 mm.

Literature Cited

CANTWELL, GEORGE E.

1964. A revision of the genus *Parapercis*, family Mugiloididae. Pacific Sci., vol. 18, no. 3, pp. 239-280, figs. 1-9.

KAMOYARA, TOSHIJI

1960. A review of the fishes of the family Parapercidae found in the waters of Japan. Rep. Usa Mar. Biol. Sta., vol. 7, no. 2, pp. 1-13, pls. 1-2.

SCHULTZ, LEONARD P.

1966. *Parapercis kamoharai* (family Mugiloididae), a new fish from Japan with notes on other species of the genus. Smithsonian Misc. Coll., vol. 151, no. 4, pp. 1-4, pl. 1.

Proceedings of
the United States
National Museum



SMITHSONIAN INSTITUTION • WASHINGTON, D.C.

Volume 124

1968

Number 3637

Population Characteristics and Nomenclature
of the Hermit Thrush

By John W. Aldrich ¹

Research Associate, Department of Vertebrate Zoology

My interest in the geographical variation in the hermit thrush, *Catharus* (= *Hylocichla*) *guttatus*, was aroused while investigating marked differences among populations of the Pacific Northwest (Jewett, Taylor, Shaw, and Aldrich, 1953). Since that time I have examined specimens from the entire range of the species that seem to give a somewhat different picture of the subspecific relationships from that of my previous arrangement as well as from that of the most recent previous revision (Phillips, 1962) and such recent standard manuals as "American Ornithologists' Union" (1957) and Ripley (1964).

Many of the specimens utilized in the study are in the U.S. National Museum, but a considerable number were borrowed from other institutions. For the loan of critical material I am indebted to the curators of the following collections: Museum of Comparative Zoology, Harvard University; National Museum of Canada; Cleveland Museum of Natural History; British Columbia Provincial Museum; Museum of Vertebrate Zoology, University of California; Field Museum of Natural History, H. H. Bailey Collection; Ira N. Gabrielson Collection; San Diego Natural History Museum; Charles R. Conner Museum, Washington State University; Museum of Zoology, University of Utah; Museum of Zoology, University of Michigan; University of Alaska; American Museum of Natural History; Washington State Museum, University of Washington; Collection of Alex Walker; and Denver Museum of Natural History.

¹Research Staff Specialist, Bureau of Sport Fisheries and Wildlife, U.S. Department of Interior, Washington, D.C.

Statistical reliability of the measurement differences recognized in this paper was determined by Robert Heath, Bio-statistician of the Bureau of Sport Fisheries and Wildlife.

Geographical and Ecological Distribution

The hermit thrush is one of the most widely distributed migratory birds in North America. Its breeding range is extensive, including most of the boreal and mountainous coniferous forest areas of the continent north of Mexico. There is no good evidence that the species breeds south of the United States-Mexican border. Summer specimens collected in the Sierra de la Laguna, Baja California, were regarded by Brewster (1902) and Grinnell (1928) as indicating breeding, but McCabe and McCabe (1932) and Banks (1967) seem to be justified in considering them migrants or at most nonbreeding birds. In migration, hermit thrushes move southward and spread out to winter over most of the southern portion of the United States and through Mexico to Guatemala.

The hermit thrush breeds in all or part of seven major ecological climax zones or "Life Areas" delineated by Aldrich (1963, p. 532). These include all of the region characterized by the transcontinental "Closed Boreal" forest from Newfoundland to northern British Columbia and central Alaska, the more southern "Northern Hardwood-Conifer" area from Nova Scotia to Minnesota and southeastern Manitoba, southward in the Appalachian Mountains to West Virginia, and the "Aspen Parkland" from central Manitoba and northwestern Minnesota west to central and central-southern Alberta. The small breeding populations on Long Island, N.Y., and Cape Cod, Mass., in the pine barrens section of the "Eastern Deciduous" Life Area are probably relicts of a former more favorable ecological situation. The hermit thrush breeds also, at least locally, in the more northern, transcontinental "Open Boreal" forest area that extends from Labrador to western Alaska. In the western part of the continent it nests in high mountain forest zones with climax vegetation of a coniferous or mixed coniferous-deciduous life form, particularly the "Closed Boreal" (subalpine) and "Montane Woodland-Brush," from interior British Columbia south to southern California, Arizona, New Mexico, and extreme western Texas. Along the Pacific coast it breeds in the lowland and coastal mountain "Pacific Rain Forest" zone from California northward to the coast of southern Alaska and westward to the base of the Alaska Peninsula and Kodiak Island. Westward on the Alaska Peninsula it nests in alders beyond the limit of large trees in the "Arctic-Alpine" area (Murie, 1959).

Within these geographically extensive "Life Areas," each characterized by a single ecological climax type, the hermit thrush nests

in a variety of habitats ranging from dense coniferous forest to low deciduous shrubs. It is primarily, however, a bird of somewhat open situations in a generally forested area such as brushy thickets along roadsides or forest borders, partly open bogs, and young mixed coniferous-deciduous growth that has sprung up after a forest has been cut or burned.

In winter the habitat is usually a dense cover of woody growth such as pine forests with brushy undergrowth or brushy swamps in the southeastern United States and chaparral and streamside thickets in the Southwest.

Trends in Morphological Variation

Morphological variation of the hermit thrush was determined by comparison of 2039 study specimens. Of these, 524 were adults collected during the breeding season in virtually all sections of the breeding range of the species. The other 1515 specimens were adults taken during migration and wintering seasons or were juveniles collected on the breeding grounds.

The adult plumages of the hermit thrush are derived from a single basic plumage grown after a postjuvinal or postnuptial (prebasic) molt that takes place in the late summer. The fall plumage, therefore, consists of freshly grown feathers while the nuptial plumage of late spring and early summer is derived gradually by wear from these same feathers.

For the study of geographic variation in size and color, I have relied entirely on adult specimens taken during the breeding season. Identification of specimens in fresh autumn plumage was made by using the same relative differences in color determined from more or less worn breeding specimens. I realize that discrimination of both color and length of wing and tail would be more exact if based entirely on specimens in fresh postnuptial or postjuvinal plumage. In my opinion, however, individuals that have molted into fresh plumage, particularly young of the year, cannot safely be assumed to be on their breeding grounds. Evidence of postbreeding wandering by many species is coming to light more and more often. A good example has been documented in the white-crowned sparrow (DeWolfe, 1967). A number of apparent cases were noted during the present hermit thrush study. T. D. Burleigh (in litt.) informs me that he has recorded fall migrant hermit thrushes at Moscow, Idaho, as early as September 4. Phillips et al. (1964) record *C. g. sequoiensis* at San Francisco Peaks, Ariz., on September 1. They also found a specimen of *C. g. auduboni* away from the breeding grounds at Flagstaff, Ariz., in August and interpreted its presence as representing postfledgling dispersal of young.

The specimen study showed the hermit thrush to be quite variable in size and color. Within any given breeding population, male hermit thrushes average larger, and in most cases significantly larger, than females in wing length (fig. 1). On the other hand, the bills of females tend to be equal to or longer than those of males (fig. 2). When shown as a ratio, the relatively longer bills of females in proportion to wing

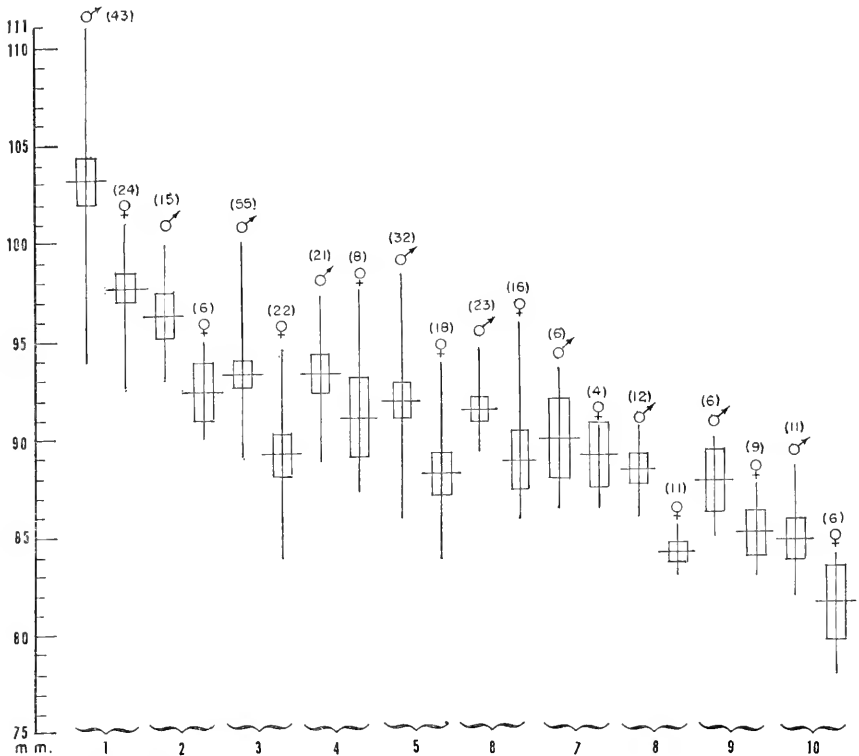

FIGURE 1.—Wing lengths of subspecies of *Catharus guttatus*, showing ranges (vertical lines), means (horizontal), and two standard errors on either side of the means (rectangles). (Numbers in parens=sample sizes. Numbers at bottom=1, *auduboni*; 2, *sequoiensis*; 3, *faxoni*; 4, *euborinus*; 5, *crymophilus*; 6, *oromelus*; 7, *vaccinius*; 8, *guttatus*; 9, *nanus*; 10, *slevini*.)

length becomes more apparent (table 1). In nine out of 10 populations, female specimens have proportionately longer bills on the average than males. Within any given breeding population, no differences in color correlated with sex were detected. There are two slightly differentiated color phases (rufescent and grayish) that may appear in any population (Oberholser, 1932). In the present study these phases, noted in all populations, seemed to be most distinct among eastern birds. The speckled dorsal plumage of juveniles is quite dif-

ferent from the uniformly colored upper parts of adults. Some of the speckled juvenal feathers among the upper wing coverts are carried over after the postjuvenal molt, even into the following breeding season, making possible the recognition of first-year birds up to the time of the first postnuptial molt. This subadult plumage (with the scattered juvenal feathers among the wing coverts) is very slightly more rufescent and paler on the average than the fully adult plumage when equivalent color phases of each are compared in series. Wear of

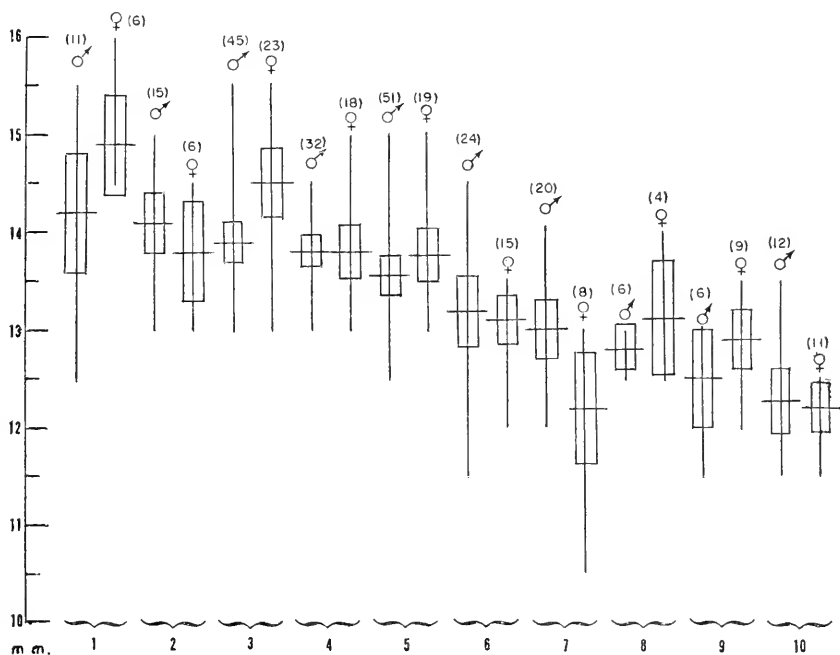

FIGURE 2.—Bill lengths of subspecies of *Catharus guttatus*, showing ranges (vertical lines), means (horizontal), and two standard errors on either side of the means (rectangles). (Numbers in parens = sample sizes. Numbers at bottom = 1, *slevini*; 2, *sequoiensis*; 3, *auduboni*; 4, *crymophilus*; 5, *faxonii*; 6, *oromelus*; 7, *cuporius*; 8, *vaccinius*; 9, *nanus*; 10, *guttatus*.)

feathers causes color to be duller, more grayish, and sometimes paler in the breeding season than in fresh autumn plumage.

Although McCabe and McCabe (1932) minimized the reliability of color characters in distinguishing populations of hermit thrushes, specimens taken at the same season of the year reveal marked geographical differences in color (shade and hue) that are far greater than the differences due to age or color phase. East of the Rocky Mountains, color of breeding birds is relatively uniform over a vast area, but west of the Rockies, particularly along the coast, much geographical variation occurs in a relatively limited area, and changes

between extremes are quite sharp. Trends in geographical variation of the hermit thrush indicated by Ridgway's (1907) detailed descriptions of subspecies recognized at that time agree in general with findings of the present study.

If we assume that wing length is an indicator of overall size of hermit thrushes—and studies by McCabe and McCabe (1932) indicate that it is—the smallest birds breed in the immediate vicinity of the Pacific Coast. On the other hand, the bill lengths of birds in this area, correlated with distribution from north to south, range from the smallest to the largest found in the species (averages of males 12.2–15.6 mm). There is a trend of decreasing tarsal length from north to south. Based on wing measurements, there is a rather abrupt increase in size of hermit thrushes in passing from Pacific coastal populations to those of interior mountain ranges. Examples from the Cascade range are slightly but significantly larger than California coastal birds and those from the Sierra Nevada considerably larger. Those from the Great Basin mountains and middle and southern Rockies are still larger, reaching the largest extreme for the species in the latter area. Eastern hermit thrushes are uniform sized with wings of medium length and relatively long legs (fig. 3).

TABLE 1.—*Comparison of ratios of bill to wing length (culmen: wing) in males and females among subspecies of Catharus guttatus*

Subspecies	Male	Female
auduboni	14.0	14.4
	$\frac{101.6}{14.0} = .1377$	$\frac{97.2}{14.4} = .1481$
guttatus	12.3	12.2
	$\frac{88.5}{12.3} = .1389$	$\frac{84.2}{12.2} = .1418$
cuborius	13.0	12.2
	$\frac{93.4}{13.0} = .1391$	$\frac{91.2}{12.2} = .1337$
vaccinius	12.8	13.1
	$\frac{90.0}{12.8} = .1422$	$\frac{89.4}{13.1} = .1465$
nanus	12.5	12.9
	$\frac{87.9}{12.5} = .1425$	$\frac{85.1}{12.9} = .1515$
oromelus	13.2	13.1
	$\frac{91.6}{13.2} = .1441$	$\frac{88.9}{13.1} = .1473$
faxoni	13.6	13.8
	$\frac{93.5}{13.6} = .1454$	$\frac{89.2}{13.8} = .1547$
sequoiensis	14.1	13.8
	$\frac{96.4}{14.1} = .1462$	$\frac{92.5}{13.8} = .1491$
crymophilus	13.8	13.8
	$\frac{92.1}{13.8} = .1498$	$\frac{88.3}{13.8} = .1562$
slevini	14.2	14.9
	$\frac{84.8}{14.2} = .1674$	$\frac{81.7}{14.9} = .1823$

In color the greatest variation occurs in the Pacific Northwest. The most darkly colored birds appear on Vancouver and the Queen Charlotte Islands off the coast of British Columbia and the palest in the interior of that province as well as the vicinity of the California coast. The extreme in grayness is reached by populations in northern Idaho and central southern British Columbia, and one of the most reddish occurs on the Queen Charlotte Islands. All of these extremes in color are found in the smaller winged group of hermit thrushes (fig. 4).

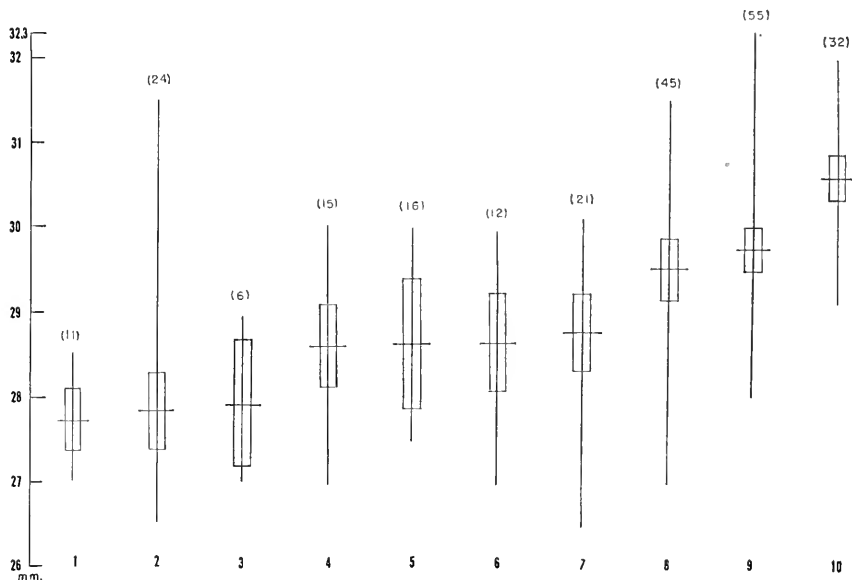

FIGURE 3.—Male tarsus lengths of subspecies of *Catharus guttatus*, showing ranges (vertical lines), means (horizontal), and two standard errors on either side of the means (rectangles). (Numbers in parens=sample sizes. Numbers at bottom=1, *slevini*; 2, *oromelus*; 3, *vac-cinius*; 4, *sequoiensis*; 5, *nanus*; 6, *gut-ta'us*; 7, *euborius*; 8, *auduboni*; 9, *faxonii*; 10, *crym-philus*.)

In the north, the transition from the small-winged Pacific coastal populations to the medium-sized eastern birds occurs almost immediately after leaving the coast. Examples from interior Alaska, Yukon, and interior northern British Columbia are larger and paler than the coastal birds. From there eastward there is a change to darker coloration with more rufescent upper parts and flanks, and to relatively long legs. Transition in these characters occurs in western Alberta. Birds from south-central Mackenzie (Great Slave Lake), northeastern Alberta, and Saskatchewan east to the Atlantic seaboard are relatively uniformly colored on upper parts and flanks. The only distinct geographical trend in coloration of this thrush in

the eastern parts of its range is a darkening of the pigmentation of the upper parts in the northeast.

In the south, transition from the very small birds of the California coast to the large type of the Great Basin and southern Rockies is quite abrupt through intermediate populations of the Sierra Nevada and Cascades. Color change is a relatively slight darkening above and an increase in both number and darkness of ventral spots progressing from west to east in this area.

Morphological Variation and Environment

References to apparent correlation of color intensity of birds with environmental moisture and of size with temperature are too numerous to mention although experimental evidence of the exact environmental factors responsible for the variations is rare.

Bowers (1960), in a significant pioneering study, found a relationship between environmental moisture and background color of wren-tit (*Chamaea fasciata*) habitat that, in turn, was correlated with the color of the birds' plumage. The fact that wren-tit plumage color and habitat background color varied together, in a gradient passing from moist to drier environments away from the coast in California, indicated a definite relationship. Natural selection for protective coloration by predation, as shown experimentally for deer mice by Dice (1947) and for moths by Kettlewell (1955, 1956), seems to be the likely explanation of this phenomenon. It is probable that the evidently indirect effect of environmental moisture on color is brought about by natural selection through predation in many species of animals, including the hermit thrush to some degree. It is assumed that cryptic coloration, if it exists in hermit thrushes, should be judged on the basis of general resemblance to the forest floor or very low vegetation since this species nests and spends most of its time on or near the ground (Bent, 1949). Thus, general tone of leaf and twig litter on the forest floor would be significant. Moisture would affect the shade of the litter and humus, and density of the understory would control the amount and quality of light reaching the ground; therefore, as Bowers (1960) suggests, the general background tone in vegetated environments is darker in moist climates and paler in arid regions. Other important observations on the correlation of bird plumage coloration with habitat backgrounds include: Moreau (1930), Behr (1942), Davis (1951), Meinertzhagen (1950), and Selander (1954).

McCabe and McCabe (1932) and Munro and Cowan (1947) have commented on the general correlation of variation in hermit thrushes with environment in the Northwest. Certainly both the morphology

of the birds and environmental conditions vary more markedly there than anywhere else within the breeding range of this species.

In the redwood section of the "Pacific Rain Forest" belt along the coast of California and southwestern Oregon, as delineated by Schantz and Zon (1924) and K uchler (1964), occurs a very small, pale hermit thrush with a large bill. This is sharply distinct from larger, relatively small-billed and darker populations from the adjoining mountain forests of the Cascades and the very much larger, although similarly colored, birds of the adjoining mountain forests of the Sierra Nevada. Thrushes from varying types of the "Pacific Rain Forest" (Halliday, 1937; Rowe, 1959; K uchler, 1964) further north are slightly larger in wing and tarsus than those from the California coast, have smaller bills, and break down into several color variants, all quite distinct from the California coastal birds. Thus, there is no uniform color type—conforming to Gloger's rule—characterizing the very moist "Pacific Rain Forest" as a whole, as delineated by Aldrich (1963). Rather, the hermit thrushes of this zone, relatively uniform ecologically, exhibit the extremes in color variation found in the species—from almost the most reddish to the most grayish and from the darkest to the palest.

Specimens from the Pacific coastal belt also exhibit the extremes in bill size. The only characters they seem to possess in common are small measurements of structures other than bill. These birds are correlated with a milder coastal climate and, if indicative of body mass as McCabe and McCabe (1932) found to be the case in wings of hermit thrushes, they are in accordance with Bergmann's rule. Pitelka (1951) found a similar situation in the variation of scrub jays. An exception to Bergmann's rule would seem to be the small size of hermit thrushes in the high interior mountains of southern British Columbia and northern Idaho.

The relatively large bill of the more southern Pacific coastal population is in conformance with Allen's rule although the length of legs does not follow this rule. The longest legs are found in eastern populations but, contrary to Allen's rule, the northernmost ones have longer legs than those from farther south. This is also the trend on the Pacific Coast.

Except for the coastal population from California north to Washington, there appears to be a correlation in the dark color tone of the plumage of hermit thrushes from the humid coastal area as compared with the paler shade found in those from more interior mountains. Thus, the grayish trend exhibited by birds of southern British Columbia has its darkest expression in the rain forests of Vancouver Island, while the more rufescent birds of northern British Columbia and Alaska reach the peak of darkness on the extremely

wet offshore islands of northern British Columbia and southeastern Alaska. In the opposite direction, the grayish populations of the relatively moist cedar-hemlock-pine "Columbian Forest," a disjunct of the "Pacific Rain Forest," on the west side of the Rockies in southern British Columbia and northern Idaho, become paler in the relatively dry mountain coniferous forests to the north, east, and south.

Progressing eastward from the relatively dry Rocky Mountain forests through the moister and fairly uniform boreal forests of eastern Canada, the color of hermit thrushes becomes more rufescent and slightly darker immediately upon departure from the Rocky Mountains. Further darkening occurs when we reach the eastern part of the "Closed Boreal" forest east of James Bay in Quebec and Newfoundland. The darker pigmentation in this northeastern part of the species' range is correlated to some extent with the "Closed Boreal" forest as distinguished from the "Northern-Hardwood-Conifer" area that comprises the southeastern part of its range. This correlation, however, is far from complete because west of James Bay and Lake Mistassini, Quebec, the morphological differences correlated with these two ecological zones disappear. It is possible that habitat background values vary from one association to another within the boreal forest belt to supply the basis for selection. The darker coloration is correlated roughly with sections of the "Closed Boreal" area that Halliday (1937) called the "Northeastern Coniferous Section," the "Gaspé Section," the "East James Bay Section," and the "Hamilton-Ungava Valleys Section." These sections agree in having relatively deep, well-drained soils and are characterized by upland forests of a relatively luxuriant growth of large trees, chiefly black spruce and balsam fir. Forest sections to the west, starting with the "Central Laurentian Section" and the "Northern Clay Section" of Halliday (1937), have either sandy or poorly drained soils that support forests of more stunted or open type, chiefly of black spruce, jack pine, aspen, balsam-poplar, and white birch. These differences in forest growth type conceivably could produce color and light differences of the substratum that would be the basis for differential selection in darker and lighter colored hermit thrushes. However this may be, the reason why the birds of the "Northern Hardwood-Conifer" area are closer to the western "Closed Boreal" forest sections than to the eastern is not evident. As far as is known, the winter environments of the two differing eastern populations are similar.

Although there are a few apparent discrepancies, there appear to be certain correlations between climax forest type of breeding areas and colors of plumages in the western part of the continent. There, all the darkest types are in the moist areas of the Pacific Northwest.

All of the pale types (with the exception of the California to Washington coastal population) are from the relatively dry interior mountain forests. All of the small types are along the humid Pacific Coast or almost equally moist coastal mountains and west slopes of the Rockies in southern British Columbia and northern Idaho. On the other hand, the largest types are from the higher and drier mountain forest of the interior.

The large interior birds, although individually quite variable, show surprisingly little average variation either in size or color over vast areas despite the extremely discontinuous distribution of their mountain coniferous summer home. Suitable breeding habitat frequently is broken up into many "islands" sometimes separated by wide expanses of desert. Such disruptions of populations might be expected to offer much more of an obstacle to gene flow than the contiguous areas of different ecological climax type that support quite different appearing populations in the vicinity of the Pacific Coast. Evidence seems to support a greater importance of adaptation to environmental conditions than of physiographic or ecological barriers to gene flow in the development of present morphological differences in hermit thrushes. On the other hand, isolation on Vancouver and Queen Charlotte Islands may have reinforced the trend toward dark pigmentation of birds adapted to moist forest conditions along the northwest coast.

Another fact, indicated by Grinnell (1901), that may bear on the seeming greater effect of moist habitat on the color of the Vancouver and Queen Charlotte Islands birds is that they are less migratory than other populations and winter chiefly along the Pacific Coast in habitats similar to those in which they breed. Thus, they are exposed to habitat conditions associated with a humid climate throughout the entire year. On the other hand, the paler populations of the Pacific Coast south of the Canadian border and those of the interior mountains are less restricted in migration and winter to a large extent in relatively arid environments of the southwestern United States and Mexico. Thus, there is an opportunity for an entirely different set of selection factors to operate on these populations in winter, and these may be more critical to survival of paler individuals than factors encountered on the breeding grounds, as suggested by Salomonsen (1955) for certain other species.

It would seem that the hermit thrush, which breeds in a variety of habitats located in at least seven "Life Areas," each characterized by different climatic climax types, is a racially variable species. This variation might be expected since the hermit thrush has become adapted to many different environments, a response that Miller (1956) has pointed out is conducive to intraspecific variability. In some

instances the variable characters are in agreement with obvious environmental conditions on the breeding grounds and in accordance with the classical Gloger's, Bergmann's, and Allen's rules.

The numerous exceptions probably are accounted for by adaptation to critical environmental conditions encountered by these populations while in migration or on their wintering grounds. Such exceptions have been documented frequently for intensively studied species such as the juncos (Miller, 1941b), vireos (Hamilton, 1958), and white-crowned sparrows (Banks, 1964).

Characteristics and Nomenclature of Populations

The generally accepted name for the hermit thrush has been *Hylocichla guttata* (Pallas) (type-locality: Kodiak Island, Alaska) since the American Ornithologists' Union (1902) decided that the previously accepted name, *Hylocichla aonalaschkae* (Gmelin), was based on an unidentifiable description.

Inclusion of the hermit thrush in the genus *Catharus* is based on evidence presented by Ripley (1952) and Dilger (1956). There are rather marked morphological differences between most of the Neotropical members of the group originally separated in the genus *Catharus* and the North American species that previously have been included in the genus *Hylocichla*. These differences include relatively long leg bones, short rounded wing with relatively long tenth primary, small sternum, brightly colored eye ring and bill in the tropical group. These differences, however, are not as pronounced in some of the more northern members of the tropical group. As Dilger (1956) has pointed out, all members of the genus *Hylocichla*, except *H. mustelina*, are more like *Catharus*, while the wood thrush is more like *Turdus*. The relationships of *H. mustelina* to *Turdus* noted by Dilger were in aggressive display, nest construction, and serological resemblance. In addition, I have noted that certain skull characters, particularly a deep groove above the auditory bulla for the attachment of the aductor mandibulae muscle, are present in typical members of genus *Turdus* and to a lesser extent in *H. mustelina* but which are quite indistinct in other species of *Hylocichla* and *Catharus*. Everything considered, there appear to be sufficient resemblances and overlap of characters to warrant placing all species that have been grouped in the genus *Hylocichla*, except *H. mustelina*, in the genus *Catharus*, and equally good reasons for not including *H. mustelina* in this genus. Since the wood thrush is the type-species of *Hylocichla*, this probably should be maintained as a monotypic genus, as Dilger (1956) has suggested, until such time as its relationships are better understood.

In previous sections of this paper it has been noted that color and size were associated during the breeding season with particular geographical areas and, to a large extent, with particular sets of ecological conditions. The differences in certain groupings of characters appear to be sufficiently distinct morphologically, ecologically, and geographically to permit recognition of the populations possessing them as different subspecies (fig. 4).

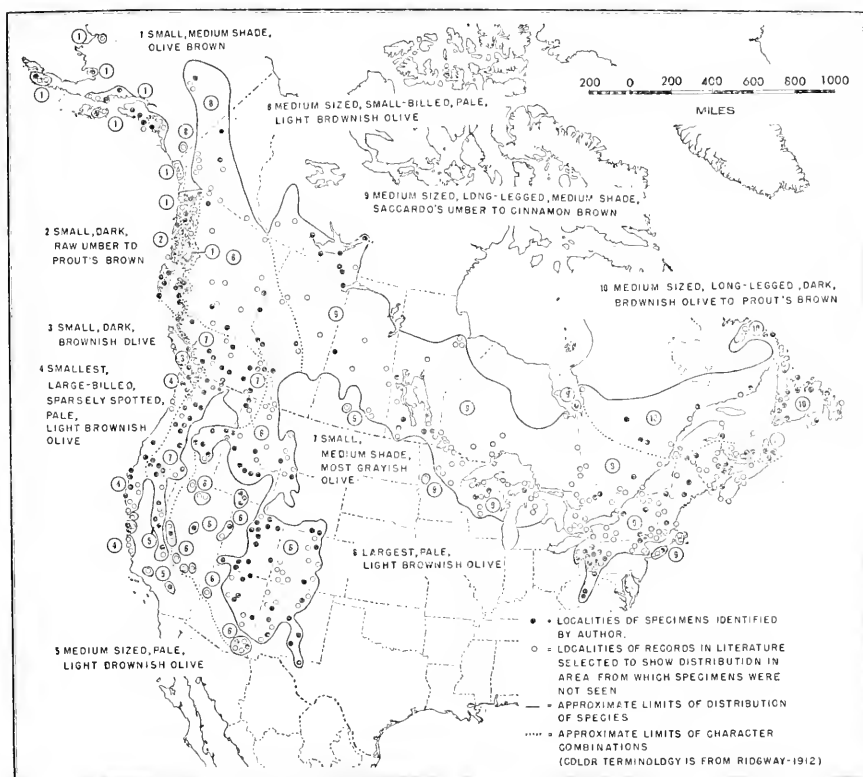

FIGURE 4.—Breeding distribution and morphological variation in subspecies of *Catharus guttatus* (1=*guttatus*; 2=*nanus*; 3=*vaccinius*; 4=*slevini*; 5=*sequoiensis*; 6=*audubonis*; 7=*oromelus*; 8=*euborius*; 9=*faxonii*; 10=*crymophilus*).

All of these populations have previously supplied names based on adequate descriptions. These are characterized under the oldest names available for them in the following descriptions. Unless otherwise specified, color designations are for the back, wings, and crown (not upper tail coverts and tail). Capitalized color terms are those of Ridgway (1912). Numbers preceding the name refer to the position of the populations' distribution on the map (fig. 4). Measurements (extremes and means) are in millimeters. They include the wing

(chord of unflattened wing), tail (from insertion of two central tail feathers), culmen (exposed portion), tarsus, and middle toe (without claw). Comparisons of means of wing, culmen and tarsus measurements are given in tables 2 to 7 and their ranges, means, and two standard errors are shown in figures 1 to 3. Gradation of races by wing, tail, bill, and tarsus length and by shade and hue of color is shown in table 8. Breeding, migration, and winter distribution is based almost entirely on determination of specimens examined in the present study.

1. ALASKA HERMIT THRUSH: *Catharus guttatus guttatus* (Pallas).—Medium shade. Olive Brown. Small: ♂ (12 specimens), wing 86–90.5 (88.5), tail 61–68.5 (65), culmen 11.5–13.5 (12.3), tarsus 27–30 (28.7), midtoe 16–17.5 (16.5); ♀ (11 specimens) wing 83–85.5 (84.2), tail 59.5–65.6 (63.2), culmen 11.5–12.5 (12.2), tarsus 27–29 (28.3), midtoe 15.5–16.5 (16.2).

Paler and less rufescent than *nanus*; more rufescent, shorter winged and longer legged than *oromelus*; paler than *vaccinius*; smaller winged and darker than *euborius*.

Breeds on the southern Alaskan and northern British Columbian coasts, excluding the outer islands of southeastern Alaska and the Queen Charlotte Islands.

Winters on Pacific Coast and in interior from Washington (Port Angeles) south to Baja California (Casa Pintada and Ensenada) and Jalisco (October record at Jonila), east to Idaho (Moscow), Texas (San Antonio, Langtry, Brewster County, Fort Clark, mouth of Pecos River), occasionally to North Carolina (Asheville), Georgia (De Kalb County), and northeastern Mexico (Monterrey and Rodriguez, Nuevo Leon).

Exceptions to the general color trend in coastal Alaska were noted in one June and two July specimens from Yakutat that were darker and more grayish above than the general mode. They were quite similar in color to breeding specimens from the Cascade Mountains, being only slightly darker. A specimen taken May 11 on Chichagof Island, Hoonah Sound, and one taken May 2 on Lemesurier Island, Icy Strait, Alaska, look like the dark gray Yakutat Bay population and possibly are migrants. Breeding specimens from Chichagof Island look like other medium olive-brown breeding birds from coastal Alaska.

There is general agreement in the literature, including Ridgway (1907), Hellmayr (1934), and the American Ornithologists' Union (1957), that the name *guttatus*, originally applied to the birds of Kodiak Island, Alaska, is applicable to the population of Alaska in general and southward in a rather indefinite pattern into British Columbia, or even as far as northwestern United States (Miller et al., 1957; Phillips, 1962), excluding the coastal islands of southeastern Alaska

TABLE 2.—Comparisons of male mean wing lengths among subspecies of *Catharus guttatus* (X=means are different at the five percent level of significance or less)

Subspecies	Average wing length (mm)	Number of birds										
			slevini	nanus	guttatus	vaccinius	oromelus	erymophilus	euborius	faxoni	sequoiensis	auduboni
slevini	84.8	11		X	X	X	X	X	X	X	X	X
nanus	87.9	6	X				X	X	X	X	X	X
guttatus	88.5	12	X				X	X	X	X	X	X
vaccinius	90.0	6	X						X	X	X	X
oromelus	91.6	23	X	X	X				X	X	X	X
erymophilus	92.1	32	X	X	X				X	X	X	X
euborius	93.4	21	X	X	X	X	X	X			X	X
faxoni	93.5	55	X	X	X	X	X	X			X	X
sequoiensis	96.4	15	X	X	X	X	X	X	X	X		X
auduboni	101.6	43	X	X	X	X	X	X	X	X		X

TABLE 3.—Comparisons of female mean wing lengths among subspecies of *Catharus guttatus* (X=means are different at the five percent level of significance or less)

Subspecies	Average wing length (mm)	Number of birds										
			slevini	guttatus	nanus	erymophilus	oromelus	faxoni	vaccinius	euborius	sequoiensis	auduboni
slevini	81.7	6		X	X	X	X	X	X	X	X	X
guttatus	84.2	11	X			X	X	X	X	X	X	X
nanus	85.1	9	X			X	X	X	X	X	X	X
erymophilus	88.3	18	X	X	X				X	X	X	
oromelus	88.9	15	X	X	X					X	X	
faxoni	89.2	21	X	X	X					X	X	
vaccinius	89.4	4	X	X	X							X
euborius	91.2	8	X	X	X	X						X
sequoiensis	92.5	6	X	X	X	X	X	X				X
auduboni	97.2	24	X	X	X	X	X	X	X	X		

TABLE 4.—Comparisons of male mean culmen lengths among subspecies of *Catharus guttatus* (X=means are different at the five percent level of significance or less)

Subspecies	Average culmen length (mm)	Number of birds										
			guttatus	nanus	vaccinius	euborius	oromelus	faxoni	erymophilus	auduboni	sequoiensis	slevini
guttatus	12.3	12				X	X	X	X	X	X	X
nanus	12.5	6				X	X	X	X	X	X	X
vaccinius	12.8	6				X	X	X	X	X	X	X
euborius	13.0	20	X				X	X	X	X	X	X
oromelus	13.2	24	X				X	X	X	X	X	X
faxoni	13.6	51	X	X	X	X	X			X	X	
erymophilus	13.8	32	X	X	X	X	X					
auduboni	14.0	45	X	X	X	X	X					
sequoiensis	14.1	15	X	X	X	X	X	X				
slevini	14.2	11	X	X	X	X	X	X				

TABLE 7.—Comparisons of female mean tarsus lengths among subspecies of *Catharus guttatus* (X=means are different at the five percent level of significance or less)

Subspecies	Average tarsus length (mm)	Number of birds	slevini	oromelus	euborius	nanus	guttatus	vaccinius	sequoiensis	auduboni	faxoni	crymophilus
slevini	26.9	6				X	X	X	X	X	X	X
oromelus	27.1	16				X	X	X	X	X	X	X
euborius	27.8	8						X	X	X	X	X
nanus	28.3	9	X	X							X	X
guttatus	28.3	11	X	X							X	X
vaccinius	28.4	4	X	X							X	X
sequoiensis	28.7	6	X	X	X						X	X
auduboni	28.7	24	X	X	X						X	X
faxoni	29.3	22	X	X	X	X	X	X	X	X		X
crymophilus	30.4	17	X	X	X	X	X	X	X	X	X	

TABLE 8.—Gradation of *Catharus guttatus* subspecies by size and color (reading from top or bottom)

<i>longest wing</i>	<i>longest bill</i>	<i>longest tarsus</i>
auduboni	slevini	crymophilus
sequoiensis	sequoiensis	faxoni
faxoni	auduboni	auduboni
euborius	crymophilus	euborius
crymophilus	faxoni	guttatus
oromelus	oromelus	nanus
vaccinius	euborius	sequoiensis
guttatus	vaccinius	vaccinius
nanus	nanus	oromelus
slevini	guttatus	slevini
<i>shortest wing</i>	<i>shortest bill</i>	<i>shortest tarsus</i>
<i>longest tail</i>	<i>darkest</i>	<i>most rufescent</i>
auduboni	vaccinius	faxoni
sequoiensis	nanus	crymophilus
euborius	crymophilus	nanus
crymophilus	guttatus	euborius
faxoni	oromelus	slevini
oromelus	faxoni	sequoiensis
vaccinius	auduboni	auduboni
nanus	sequoiensis	guttatus
guttatus	slevini	vaccinius
slevini	euborius	oromelus
<i>shortest tail</i>	<i>palest</i>	<i>most grayish</i>

and British Columbia. The present study indicates a more restricted distribution of this population, to which the name *guttatus* applies, to the vicinity of the coast in Alaska and southward, excluding the outer islands, to middle coastal British Columbia. The southern limit of *guttatus* in that area is indicated by specimens of this race from Yale Lake, Swanson Bay, head of Kukshua Pass, Calvert Island, Canoona River near Graham Reach, Princess Royal Island, and Aristazabal Island.

2. DWARF HERMIT THRUSH: *Catharus guttatus nanus* (Audubon).—Dark, Raw Umber to Prout's Brown. Small: ♂ (6 specimens), wing 85–90 (87.9), tail 62–70 (66.3), culmen 11.5–13 (12.5), tarsus 27.5–30 (28.7), midtoe 15.5–17.5 (16.8); ♀ (9 specimens), wing 83–87.5 (85.1), tail 61–65.5 (63.2), culmen 12–13.5 (12.9), tarsus 27–30 (28.3), midtoe 15–18 (16.7).

Darker and more rufescent than *guttatus*; more rufescent than *vaccinius*; smaller and flanks more grayish than *crymophilus*; more rufescent and shorter wing and tarsus than *oromelus*; much darker, shorter bill, and longer wing than *slevini*.

Breeds on the outer islands of the Alexander Archipelago in southeastern Alaska and the Queen Charlotte Islands of British Columbia.

Winters on the Pacific Coast from southwestern British Columbia (Victoria) south to California (Humboldt Bay).

Osgood (1901) accurately described the hermit thrush population of the Queen Charlotte Islands, distinguishing it from that of the coast of southern Alaska, and named these dark, rufescent birds "*Hylocichla guttata verecunda*." In so doing he disposed of the name *nanus* Audubon (1839) by referring it to the eastern population. He did this chiefly on the grounds that Audubon's (1838) folio plate, on which the original description of *nanus* was based, showed a bird with "brown sides," a characteristic considered by Osgood to be restricted entirely to eastern birds. This view has been supported by Phillips (1962).

In the course of the present study, I have compared both fresh and worn plumaged hermit thrush specimens representing different recognizable populations with Fig. 1, Plate 419, of Audubon's (1838) folio edition, which depicts the "Little Tawny Thrush, *Turdus minor*, Gmelin" that Audubon (1839) later said represented his newly described "*Turdus Nanus*." The plate I used, which is in the set of Audubon's folio in the library of the Smithsonian Institution, shows a relatively dark brown-backed hermit thrush with fairly dark gray flanks tinged with buff, not the light grayish buffy characteristic of eastern populations. Of the specimens used in the comparison, it matches most closely in color those from the Queen Charlotte

Islands. In fresh plumage these have a distinct buffy wash on the relatively dark gray flanks. The small size, particularly the bill, which was stressed by Audubon (1839) in his description of *nanus*, also would seem to eliminate all except the small western races, and of these the only one with a buffy tinge to the flanks is the Queen Charlotte Island population. Audubon said that the haunts of his newly described *nanus* were the valleys of the Columbia River whence he had obtained it through Dr. Townsend. This further indicates the probability that the description of *nanus* was based on a western specimen. Audubon mentioned a few very small specimens from eastern localities that he referred to *nanus*. These were probably also representatives of far western populations, although not necessarily the Queen Charlotte Island one, which seems to stick more closely to the Pacific Coast than some of the other small hermit thrushes such as *guttatus* and *oromelus*. Specimens of both these races from the Atlantic seaboard have been seen in connection with the present study, but neither has any buffy tinge to the flanks and so could not have been the basis for Audubon's plate.

Since there is some question (see Phillips, 1962) about the authenticity of the presumed type-specimen of *nanus* designated by Brewster (1902) and located in the Museum of Comparative Zoology at Harvard, it seems prudent to rely most heavily on Audubon's original description and the illustration that was mentioned in it. On the basis of these, I believe the correct course is that set by Ridgway (1907), Hellmayr (1934), and many others in assigning the name *nanus* to the Queen Charlotte Island population on the basis of Audubon's description of a migrant specimen taken near the lower Columbia River.

Ridgway (1907) seems to have correctly distinguished the distribution of *nanus* from that of *guttatus* in Alaska, with the former restricted to the Queen Charlotte Islands and the outer islands of the Alexander Archipelago. Specimens examined in the present study, however, indicate that his postulated extension of the range of *nanus* southward to include the coast of British Columbia and Washington is without basis.

Munro and Cowan (1947) noted that the population of the Queen Charlotte Islands is typical *nanus* and, although extending its range south to the mountains of the Vancouver region, noted that the population of that area exhibits characters of the inland race, *oromelus*. This accords with findings in the present study but, unlike Munro and Cowan, I consider the populations of southwestern British Columbia too different from the Queen Charlotte birds to include under the name *nanus*, and I have included them under *vaccinius*.

3. VANCOUVER HERMIT THRUSH: *Catharus guttatus vaccinius* (Cumming).—Dark, Brownish Olive. Small: ♂ (6 specimens), wing 86.5–93.5 (90), tail 64–69.5 (66.9), culmen 12.5–13 (12.8), tarsus 27–29 (27.9), midtoe 15–16.5 (15.7); ♀ (4 specimens), wing 86.5–90.5 (89.4), tail 66–68.5 (67.3), culmen 12.5–14 (13.1), tarsus 27–30 (28.4), midtoe 16–17 (16.3).

Darker and longer tarsus than *oromelus*; longer wing, shorter bill, and darker than *slevini*; more grayish than *nanus*; darker than *guttatus*.

Breeds on Vancouver Island, British Columbia, and in a very limited area on the mainland near Vancouver.

Winters on Pacific Coast from southwestern British Columbia (Victoria) south to California (Pasadena). Eastward in migration to Idaho (Moscow) and New Mexico (Mogollon Mountains).

Swarth (1912) first suggested the distinctness of a dark Vancouver Island population on the basis of six juvenile specimens, and Cumming (1933) accurately described it as a separate subspecies giving it the name "*vaccinia*." There is no indication in either the original description of *vaccinius* or in the present study of a smaller size among breeding specimens from Vancouver Island as compared with the breeding examples from coastal areas farther north mentioned by McCabe and McCabe (1932). If anything, Vancouver Island specimens are larger than more northern coastal birds. Since the original description, most investigators seem to have overlooked the distinctive characters of this race and have usually incorporated the Vancouver Island population under *nanus* (= *verecundus*). Munro and Cowan (1947), the American Ornithologists' Union (1957), Phillips (1962), and Ripley (1964) followed this course. The main character distinguishing *vaccinius* from *nanus* is the more grayish or sooty (less reddish) brown coloration of the upperparts. Munro and Cowan (1947) described specimens from the "mainland coast adjacent to Vancouver" as appearing to share the characters of both *nanus* and *oromelus*, but included the specimens under the former name. The present writer, in Jewett et al. (1953), recognized the distinctness of the dark relatively grayish Vancouver Island race but made the error of incorporating northern Washington State and adjoining portions of British Columbia within its range. It appears from the present study that the very dark characters of *vaccinius* do not apply extensively to mainland populations although birds occupying a mountain habitat adjacent to Vancouver are included herein in the range of *vaccinius* on the basis of characters noted by Munro and Cowan (1947).

4. MONTEREY HERMIT THRUSH: *Catharus guttatus slevini* (Grinnell).—Pale, Light Brownish Olive, sparsely spotted below. Shortest wing, long bill: ♂ (11 specimens), wing 82–88.5 (84.8), tail

59-67 (64.1), culmen 12.5-15.5 (14.2), tarsus 27-28.5 (27.7), midtoe 14.5-16 (15.1); ♀ (6 specimens), wing 78-84 (81.7), tail 57-63.5 (60.4), culmen 14.5-16 (14.9), tarsus 26-28 (26.9), midtoe 15.5-16 (15.6).

Shorter wing, longer bill, paler above and more sparsely spotted below than *oromelus*, *vaccinius*, *nannus*, and *guttatus*; much smaller wing and tarsus than *sequoiensis*, but color and bill length similar; smaller wing and tarsus and longer bill than *euborius*.

Breeds locally in coastal areas of California, Oregon, and Washington State.

Winters in Baja California (Mt. Miraflores, El Sauz, Laguna, and Cape San Lucas); probably also in other portions of southwestern United States and northwestern Mexico (Phillips et al., 1964). Eastward in migration to Texas (Leon Springs, El Paso, and San Antonio).

Grinnell's (1901) original description accurately portrays the characters of this very small, pale coastal subspecies although the distribution he gave is more limited than is actually the case. McCabe and McCabe (1933, map, p. 123) seem to have been the first to suggest the northward extension of the range of *slevini* from California along the Pacific coastal mountains of Oregon and Washington. Examination of specimens in the present study shows this to be correct. The birds with characters of *slevini*, although not in typical form, range northward to the west of the Cascade Mountains as far as the Olympic Peninsula of northwestern Washington, but the breeding distribution appears to be interrupted considerably in Oregon and Washington. Specimens from the west slopes of the Cascades in this general area are intermediate between *slevini* and *oromelus*. They are lighter and more rufescent above than typical *oromelus* of the eastern slopes of the Cascades, northern Idaho, and southern British Columbia, and in this respect are like *slevini*. The specimens are intermediate in size and ventral spotting between these two races.

The abrupt transition from the pale, Light Brownish Olive *slevini*-type of coloration found on the Olympic Peninsula of Washington to the dark, Brownish Olive *vaccinius* on Vancouver Island across the Straits of Juan de Fuca is rather surprising and, together with the very disrupted range in coastal areas of Oregon and Washington, suggests a relatively recent occupation of the Olympic Peninsula by extension of the range from the south.

The hermit thrush population of the Olympic Peninsula has been described as a distinct subspecies (*jewetti*) by Phillips (1962) on the basis of darker and more reddish brown coloration above and heavier spotting below than *slevini* of California. The present study has verified the difference from both *slevini* and *oromelus* of specimens

from the Olympic Peninsula noted by Phillips, as well as of similarly colored specimens from the west slopes of the Cascades. These differences, however, seem to be better treated as indicating populations intermediate in both size and color between the races *slevini* and *oromelus*, with those closer to the coast being nearer *slevini* and those closer to the Cascade divide nearer to *oromelus*.

5. SIERRA HERMIT THRUSH: *Catharus guttatus sequoiensis* (Belding).—Pale, Light Brownish Olive. Medium sized: ♂ (15 specimens), wing 93–100 (96.4), tail 67–75 (70.8), culmen 13–15 (14.1), tarsus 27–30 (28.6), midtoe 15–18.5 (16.8); ♀ (6 specimens), wing 90–95 (92.5), tail 64–73 (68.8), culmen 13–14.5 (13.8), tarsus 28–30 (28.7), midtoe 15–17.5 (16.4).

Shorter wing and tarsus than *auduboni*; longer wing than *slevini*, *nanus*, and *guttatus*; larger, paler, and more rufescent than *oromelus* and *vaccinius*; longer bill than *euborius*; more grayish and shorter tarsus than *faxoni* and *crymophilus*.

Breeds in the Sierra Nevada, Mount Pinos, and San Bernardino Mountains of California.

Winters in Mexico (Baja California and Monterrey, Nuevo Leon) south to Guatemala (Hacienda Chancol, also May 1 at Chemal).

McCabe and McCabe (1933) and the American Ornithologists' Union (1957) have correctly limited the northward extension of the population to which the name *sequoiensis* applies to the Sierra Nevada of California. Other populations to the north of California, even as far as the Yukon River in Northwest Territory, have been referred to *sequoiensis* by Ridgway (1907), Brooks and Swarth (1925), Gabrielson and Jewett (1940), Rand (1948), and Phillips (1962). These populations, however, appear to be referable to other races or are intermediate between these (see accounts under *auduboni* and *euborius*).

6. AUDUBON'S HERMIT THRUSH: *Catharus guttatus auduboni* (Baird).—Pale, Light Brownish Olive. Largest: ♂ (45 specimens), wing 94–111 (101.6), tail 66.5–79 (73.5), culmen 13–15.5 (14.0), tarsus 27–31.5 (29.4), midtoe 15.5–19.5 (17.3); ♀ (24 specimens), wing 92.5–101 (97.2), tail 66–74 (70.0), culmen 13–15.5 (14.4), tarsus 26.5–30.5 (28.7), midtoe 15.5–19 (17.0).

Longer wing and tarsus but similar in color to *sequoiensis* and *euborius*; larger and more grayish than *crymophilus* and *faxoni*; much larger and more rufescent than *oromelus* and *vaccinius*; much larger than *guttatus* and *nanus*.

Breeds in the mountains of the Great Basin and Rocky Mountains from southeastern Washington, middle Idaho, southeastern British Columbia, and southwestern Alberta south almost to the Mexican border.

Winters in Mexico (Sonora, Chihuahua, Guerero, Michoacan, Morelos, Vera Cruz), south to Guatemala (Hacienda Chancel).

Populations breeding in northwestern Montana, extreme southeastern British Columbia, and southwestern Alberta that have been referred to *sequoiensis* by various authors, including Ridgway (1907), Rand (1948), and Phillips (1962), probably are better considered as intermediates between the large *auduboni*, to which race it is assigned, and smaller races to the west, north, and east. Migrant specimens from this region very likely are responsible for some of the more eastern literature records of "*sequoiensis*," which race they resemble superficially.

As McCabe and McCabe (1932) pointed out, there is a tendency for specimens with largest measurements to be from the southern and middle Rocky Mountain area. For that reason, these authors, as well as other investigators, recognized the distinctness of a Great Basin race named "*polionota*" by Grinnell (1918) on the basis of breeding birds taken in the White Mountains in central eastern California. In the present study, I was unable with any degree of certainty to sort out specimens on the basis of either size or color as belonging to either a Great Basin or a Rocky Mountain race. Larger and smaller as well as more grayish and more rufescent specimens seemed completely intermingled even at the type-locality of *polionota* in the White Mountains. If segregation into discrete breeding populations with different combinations of morphological characters exists, it must be quite local and possibly correlated with local ecological differences of the sort reported for hermit thrushes in Colorado by Packard (1945) or as postulated for nighthawks by Selander (1954). Such segregation was not apparent in the information furnished by specimens examined in the present study; therefore, I am taking the course followed by Phillips (1962) and considering *polionota* a synonym of *auduboni* and applying that name to the entire Rocky Mountain-Great Basin complex of large, pale hermit thrushes.

7. CASCADE HERMIT THRUSH: *Catharus guttatus oromelus* (Oberholser).—Medium shade, most grayish, Olive. Small: ♂ (24 specimens), wing 89.5–94.5 (91.6), tail 58–73 (68.0), culmen 11.5–14.5 (13.2), tarsus 26.5–31.5 (27.8), midtoe 15–18 (16.8); ♀ (16 specimens), wing 86–96 (88.9), tail 62–74 (66.5), culmen 12–13.5 (13.1), tarsus 25.5–29 (27.1), midtoe 15.5–18 (16.8).

Longer wing and shorter bill, darker and more grayish than *slevini*; longer wing and bill, shorter tarsus, and more grayish than *guttatus*; shorter tarsus, paler and more grayish than *nanus*; paler than *vacinius*; shorter wing, darker and more grayish than *sequoiensis* and *euborius*.

Breeds on the mainland of southern British Columbia south to northern Idaho and northern Washington, and in the Cascade Mountains south to extreme northern California.

Winters on Pacific Coast of southern California (Los Angeles County), east to Texas (Langtry and Frijole), and occasionally to North Carolina (Asheville), south to northeastern Mexico (Monterrey, Nuevo Leon, and Victoria, Tamaulipas).

McCabe and McCabe (1932) apparently were the first to point out the distinctive characters of the small, grayish hermit thrushes breeding in southern British Columbia, northern Washington, and northern Idaho but did not assign a name to them. They did not at that time have material to show the extension of the characters southward in the Cascades to northern California. Oberholser (1932) described the distinct characteristics of the birds from the Warner Mountains of southern Oregon and the Cascades and noted that these characteristics were shared by birds from central-southern British Columbia. He named this subspecies "*oromela*." With additional material, McCabe and McCabe (1933, map) completed the picture of distribution of races of hermit thrushes in the northwestern United States and assigned the Cascades and northern Idaho, along with southern British Columbia, to the race *oromelus*. This arrangement agrees with findings in the present study. Later, Bishop (1933) described the small gray population occupying part of the range of *oromelus* in northern Idaho, naming it "*dwrighti*." Although Ripley (1964) includes this in the synonymy of *auduboni*, the present study indicates that it is a synonym of *oromelus*.

Munro and Cowan (1947) further confirm the distinctness of *oromelus* in southern British Columbia and define its distribution there more precisely. Their findings agree with those of the present study, except that they apparently lacked specimens at the time which showed the westward extension of *oromelus* characters to the vicinity of the Pacific Coast north of Vancouver Island.

Doubt has been cast on the applicability of the name *oromelus* to the population in question because of the selection of the type-specimen from the Warner Mountains of central-southern Oregon, a locality at the extreme southern end of the range of this subspecies. McCabe and McCabe (1933) and Miller (1941a) pointed out the intermediacy of the Warner Mountains birds between those from farther north in the Cascades and *slevini* of the California coast; and, although they had not seen the type-specimen of *oromelus*, they questioned the use of this name for the more northern population. Ripley (1964) considers *oromelus* a synonym of *slevini*. Both Phillips (1962) and the present writer, after correspondence with Robert Storer and the late Josselyn Van Tyne of the Museum of

Zoology at the University of Michigan, are convinced that the type-specimen of *oromelus*, which is in that museum, is in fact a representative of the Cascade race. Van Tyne (in litt., 1955) reported that he had compared the type, an immature male, with two breeding male specimens I had sent him, one typical of the Cascade race and the other typical *slevini*, and found that it was closer in color to the former. The measurements of the type of *oromelus* (wing 93 mm, tail 72, exposed clumen 13, tarsus 29.5, and midtoe 15) are typical of the Cascade and southern British Columbia population and quite unlike those of *slevini*. For indication of intergradation between *oromelus* and *slevini* in western Oregon and Washington, see the account under *slevini* (no. 4).

8. YUKON HERMIT THRUSH: *Catharus guttatus euborius* (Oberholser).—Pale, Light Brownish Olive. Medium sized, small billed: ♂ (21 specimens), wing 89–97.5 (93.4), tail 65–73.5 (69.2), culmen 12–14 (13.0), tarsus 26.5–30 (28.8), midtoe 16.5–18.5 (17.3); ♀ (8 specimens), wing 87.5–97.5 (91.2), tail 65–75 (68.9), culmen 10.5–13 (12.2), tarsus 25.5–30 (27.8), midtoe 14.5–18.5 (16.2).

Longer wing, paler and more rufescent than *guttatus* and *vaccinius*; longer wing and tarsus, paler and more rufescent than *oromelus*; shorter tarsus and more grayish than *faxoni* and *crymophilus*; shorter wing and bill than *sequoiensis* and *auduboni*.

Breeds from central Alaska southeastward through southern Yukon to central British Columbia and southwestern and south-central Alberta.

Winters from Arizona (Santa Rita Mountains) and western Texas (Brewster County and mouth of Pecos River) south to northeastern Mexico (Rodriguez and Monterrey, Nuevo Leon). In migration east to Illinois (Glenwood), Mississippi (Saucier), and Georgia (Jeffersonville).

The original description of *euborius* (Oberholser, 1956) fits the characteristics of this population very well. The original range given also falls entirely within the more extensive area in which the characters were found to occur in the present study.

This population has been included by earlier authors, such as Ridgway (1907), Gabrielson and Jewett (1940), and Rand (1948), within the range of *sequoiensis*. More recently, however, most authors have considered the birds of this area referable to *guttatus* (Munro and Cowan, 1947; Brooks and Swarth, 1925; the American Ornithologists' Union, 1957; and Ripley, 1964).

Phillips (1962), after rejecting the name *euborius* because he considered the type-specimen too worn for certain identification but probably referable to the eastern hermit thrush "*nanus*" (= *faxoni*), proceeded to describe as a distinct subspecies the breeding birds of the central and northern interior of British Columbia and named the

subspecies "*munroi*." Ripley (1964) has considered this name a synonym of *nanus* but, according to the present study, both the type-locality of *munroi* (Nulki Lake in central British Columbia) and that of *euborius* (Lewes River in south-central Yukon) are in the range of hermit thrushes having similar morphological characters quite different from coastal birds. Also, since the original description of *munroi* and a specimen taken at Nulki Lake on May 18, examined in the present study, fit well with the characters of this population, it appears that *munroi* must be considered a synonym of *euborius*, the older name.

Two specimens taken on May 20 and one in May without specific date at Fairbanks, Alaska, have characters that fit *euborius*. Although these specimens probably were not breeding at that time, on the probability that they would nest in that general area, the range of *euborius* is considered to extend northwestward to that point on the Tanana River in central Alaska.

Breeding specimens from Tupper Creek and Charlie Lake in north-eastern British Columbia, also Banff, Jasper Park, and Grimshaw in southern Alberta, are somewhat intermediate toward *faxoni*, but are closer to *euborius* in pale coloration and grayishness of flanks. Other investigators, including Munro and Cowan (1947) and Rand (1948), have assigned specimens from these same areas to *faxoni*. These facts indicate that the area of intergradation between *euborius* and *faxoni* is a broad one in those regions.

9. EASTERN HERMIT THRUSH: *Catharus guttatus faxoni* (Bangs and Penard).—Medium shade, Saccardo's Umber to Cinnamon Brown. Medium size, long tarsus; ♂ (55 specimens), wing 89–100 (93.5), tail 64–79 (68.5), culmen 12.5–15 (13.6), tarsus 28–32.3 (29.7), midtoe 15–18.5 (17.2); ♀ (22 specimens), wing 84–94.5 (89.2), tail 60–70 (65.0), culmen 13–15 (13.8), tarsus 27.5–31 (29.3), midtoe 15–19 (16.9).

Longer bill and tarsus, darker and more rufescent than *euborius*; shorter wing, longer tarsus, and more rufescent than *auduboni* and *sequoiensis*; paler than *crymophilus*; larger and more rufescent than *oromelus*, *vaccinius*, and *guttatus*; larger, paler and more rufescent than *nanus*.

Breeds from south-central Mackenzie, extreme northeastern British Columbia (?), and central-eastern Alberta east to central-western Quebec, Nova Scotia, southeastern New York, and the northern Appalachian Mountains.

Winters in eastern and central-southern United States from New York State (Highland Falls) south to Florida (Jacksonville and Enterprise) and west to Oklahoma (Tulsa) and Texas (San Antonio, Hidalgo, Navasota, and Fort Clark).

Bangs and Penard (1921), after considering the confusion in the literature relating to the name of the eastern hermit thrushes, concluded that no name that had been proposed could with certainty be considered as referring to that population. They therefore described and named it "*faxoni*" on the basis of an adult breeding specimen from Shelburne, N.H. Most authorities, including the American Ornithologists' Union (1957), have used this name ever since. Phillips (1962), as noted above, has renewed the old controversy over the applicability to the eastern hermit thrush population of Audubon's *nanus*. The evidence, however, seems to support the conclusion that Audubon (1839) used the name *nanus* to refer to a small far-western form. Under the circumstances I prefer to follow well-established current usage and apply the name *faxoni* to the eastern population, which embraces the New Hampshire birds from which the type-specimen was selected. This includes all breeding hermit thrushes, with virtually no geographical variation, from the vicinity of Great Slave Lake southeastward to Nova Scotia and Long Island, N.Y. Breeding birds from the latter locality apparently were examined for the first time in the present study. Specimens from western Mackenzie (Hay River, Fort Providence, and Fort Resolution) are somewhat intermediate toward *euborius* in possessing more grayish flanks and slightly paler and more grayish coloration above than breeding birds from the Appalachian Mountains and New England, but in both respects they are closer to the eastern specimens.

10. NEWFOUNDLAND HERMIT THRUSH: *Catharus guttatus crymophilus* (Burleigh and Peters).—Dark Brownish Olive to Prout's Brown. Medium size, long tarsus: ♂ (33 specimens), wing 87–98.5 (92.1), tail 65–75.5 (69.2), culmen 13–14.5 (13.8), tarsus 29.1–32 (30.6), midtoe 15.5–19.5 (17.6); ♀ (18 specimens), wing 84–94 (88.3), tail 62–71.5 (66.5), culmen 13–15 (13.8), tarsus 28.6–32.5 (30.4), midtoe 15.5–19.5 (17.3).

Darker than *faxoni*; larger and more rufescent on flanks than *nanus*; longer tarsus, shorter wing, darker and more rufescent than *auduboni*, *sequoiensis*, and *euborius*; longer tarsus, darker and more rufescent than *guttatus*, *vaccinius*, and *oromelus*.

Breeds from James Bay in central-western Quebec east to southern Labrador, Newfoundland, and Cape Breton Island, Nova Scotia.

Winters in southeastern, central and central-southern United States from Maryland (Elliot Island, Shadyside, Leonardstown, Port Tobacco, and Powellville), south to Florida (Kissimmee) and west occasionally to central Colorado (one record, west Denver) and central-southern Texas (San Antonio, Sinton, and Harlingen).

The original description of *C. g. crymophilus* by Burleigh and Peters (1948), depicting it as darker above than *faxoni* of the eastern

United States, also accurately describes breeding populations of a considerably greater area of eastern Canada northeast of the range of *faxonii*.

All eastern populations of the hermit thrush have distinct color phases—rufescent and grayish—and it is important to sort specimens into their respective phase groups before comparisons for identification are attempted. Compared with each other, phase with phase, plumage of the upper parts of breeding specimens from southern Quebec, New England, and the Appalachian Mountains shows a paler shade than that of birds from farther north in Quebec and Newfoundland. Specimens from the mainland of Labrador and Quebec are somewhat more greenish, less brownish than Newfoundland birds, but are closer to them than to *faxonii*.

Breeding specimens from northern Maine, eastern New Brunswick, and Prince Edward Island are intermediate between *faxonii* and *crymophilus* but closer to the former, while those from Cape Breton Island of extreme northeastern Nova Scotia are referable to *crymophilus*.

Summary

The hermit thrush, *Catharus guttatus*, is distributed widely on the North American continent, breeding in seven different ecological climax zones or "Life Areas," and wintering mostly south of these areas in the southern United States, Mexico, and Guatemala.

Females are smaller in wing but proportionately larger in bill measurements than males; there are no color differences correlated with sex.

Young birds may carry a few recognizable juvenal wing coverts until their first postnuptial molt.

There are two slightly differentiated color phases.

There are marked geographical differences in color, size, and proportion among hermit thrushes.

The greatest geographically correlated variation occurs west of the Rocky Mountains.

The smallest birds, except for bill, breed in the vicinity of the Pacific Coast; the largest in the middle and southern Rockies.

The population with the longest bill and the shortest wing breeds near the California coast.

Eastern populations are medium sized but have the longest legs.

Relatively rufescent coloration is associated with more northern and eastern distribution; relatively grayish coloration with more southern coastal and interior mountain areas of the west. Darkest tones are associated with the northern Pacific coastal islands and

extreme northeast, palest with more southern Pacific Coast and interior mountains.

Color variation seems to be correlated at least in part with environmental moisture of the breeding areas (Gloger's law), but there are a few exceptions.

Body mass, as indicated by wing length, and length of appendages are correlated with temperature in accordance with Bergmann's and Allen's laws, respectively, in some breeding areas but not in others.

Failure of certain populations to conform to these laws of geographical variation with respect to breeding distribution may be explained in some cases by adaptation to environments in wintering areas.

Adaptation to environmental conditions appears to be more important in producing morphological variation in populations than physiological or ecological barriers to gene flow.

Regional trends toward dark pigmentation associated with moist climate may be enhanced by physical isolation on offshore islands.

The hermit thrush and others recently included in the genus *Hyllocichla*, excepting the woodthrush, are better classified on the basis of morphology and behavior in the genus *Catharus*.

Populations of hermit thrushes grouped by morphological, ecological, and geographic characteristics break up into 10 recognizable groups that may be considered as distinct races or subspecies; all of these have previously supplied names.

Each named subspecies is characterized as to color, size, breeding distribution, and winter distribution; and the history of its characterization and nomenclature are discussed.

Literature Cited

- ALDRICH, J. W.
1963. Geographic orientation of American Tetraonidae. *Journ. Wildl. Mgmt.*, vol. 27, pp. 528-545.
- AMERICAN ORNITHOLOGISTS' UNION
1902. Eleventh supplement to the American Ornithologists' Union Check-list of North American Birds, pp. 315-342.
1957. Check-list of North American Birds, 5th ed., 691 pp. Baltimore, Md.: The Lord Baltimore Press, Inc.
- AUDUBON, J. J.
1838. *Birds of America*, 4 vols., 435 pls. Elephant folio. London.
1839. *Ornithological biography*, vol. 5, 664 pp. Edinburgh.
- BANGS, O., and PENARD, T. E.
1921. The name of the eastern hermit thrush. *Auk*, vol. 38, pp. 432-434.
- BANKS, R. C.
1964. Geographic variation in the white-crowned sparrow, *Zonotrichia leucophrys*. *Univ. California Publ. Zool.*, vol. 70, pp. 1-123.
1967. Birds and mammals of La Laguna, Baja California. *Trans. San Diego Soc. Nat. Hist.*, vol. 14, pp. 205-232.
- BEHLE, W. H.
1942. Distribution and variation of the horned larks (*Otocoris alpestris*) of western North America. *Univ. California Publ. Zool.*, vol. 46, pp. 205-316.
- BENT, A. C.
1949. Life histories of North American thrushes, kinglets and their allies. *United States Nat. Mus. Bull.* 196, pp. 1-454.
- BISHOP, L. B.
1933. Two apparently unrecognized races of North American birds. *Proc. Biol. Soc. Washington*, vol. 46, pp. 201-203.
- BOWERS, D. E.
1960. Correlation of variation in the wren tit with environmental gradients. *Condor*, vol. 62, pp. 91-120.
- BREWSTER, W.
1902. Birds of the Cape Region of Lower California. *Bull. Mus. Comp. Zool.*, vol. 41, pp. 1-241.
- BROOKS, A., and SWARTH, H. S.
1925. A distributional list of the birds of British Columbia. *Pacific Coast Avif.*, vol. 17, pp. 1-129.
- BURLEIGH, T. D., and PETERS, H. S.
1948. Geographic variation in Newfoundland birds. *Proc. Biol. Soc. Washington*, vol. 61, pp. 111-126.
- CUMMING, R. A.
1933. Descriptions of a proposed new race of song sparrow and of a hermit thrush. *Murrelet*, vol. 14, pp. 78-79.
- DAVIS, J.
1951. Distribution and variation of the brown towhees. *Univ. California Publ. Zool.*, vol. 52, pp. 1-120.

- DEWOLFE, B. B.
1967. Biology of white-crowned sparrows in late summer at College, Alaska. *Condor*, vol. 69, pp. 110-132.
- DICE, L. R.
1947. Effectiveness of selection by owls of deer mice (*Peromyscus maniculatus*) which contrast in color with their background. *Contr. Lab. Vert. Biol. Univ. Michigan*, vol. 34, pp. 1-20.
- DILGER, W. C.
1956. Relationships of the thrush genera *Catharus* and *Hylocichla*. *Syst. Zool.*, vol. 5, pp. 174-182.
- GABRIELSON, I. N., and JEWETT, S. G.
1940. Birds of Oregon, 1-650 pp. Corvallis: Oregon State College.
- GRINNELL, J.
1901. The Monterey hermit thrush. *Auk*, vol. 18, pp. 258-260.
1918. Seven new or noteworthy birds from east-central California. *Condor*, vol. 20, pp. 86-90.
1928. A distributional summation of the ornithology of Lower California. *Univ. California Publ. Zool.*, vol. 32, pp. 1-300.
- HALLIDAY, W. E. D.
1937. A forest classification for Canada. Canada Dept. Mines Res., Forest Serv. Bull. 89, 50 pp. + sep. map.
- HAMILTON, T. H.
1958. Adaptive variation in the genus *Vireo*. *Wilson Bull.*, vol. 70, pp. 307-346.
- HELLMAYR, C. E.
1934. Catalogue of birds of the Americas. *Field Mus. Nat. Hist. Zool. Ser.*, vol. 13, pt. 7, 531 pp.
- JEWETT, S. G.; TAYLOR, W. P.; SHAW, W. T.; and ALDRICH, J. W.
1953. Birds of Washington State, xxiv + 768 pp. Seattle: University of Washington Press.
- KETTLEWELL, H. B. D.
1955. Selection experiments on industrial melanism in the Lepidoptera. *Heredity*, vol. 9, pp. 323-342.
1956. Further selection experiments on industrial melanism in the Lepidoptera. *Heredity*, vol. 10, pp. 287-301.
- KÜCHLER, A. W.
1964. Potential natural vegetation of the conterminous United States. *American Geogr. Soc. Spec. Publ.*, no. 36, 116 pp., 1 map.
- MCCABE, T. C., and MCCABE, E. B.
1932. Preliminary studies of western hermit thrushes. *Condor*, vol. 34, pp. 26-40.
1933. Hermit thrushes of the Northwestern States. *Condor*, vol. 35, pp. 122-123, 1 map.
- MEINERTZHAGEN, R.
1950. Some problems connected with Arabian birds. *Ibis*, vol. 92, pp. 336-340.
- MILLER, A. H.
1941a. A review of centers of differentiation for birds in the western Great Basin region. *Condor*, vol. 43, pp. 257-269.
1941b. Speciation in the avian genus *Junco*. *Univ. California Publ. Zool.*, vol. 44, pp. 173-434.
1956. Ecologic factors that accelerate formation of races and species of terrestrial vertebrates. *Evolution*, vol. 10, pp. 262-277.

- MILLER, A. H.; FRIEDMANN, H.; GRISCOM, L.; and MOORE, R. T.
1957. Distributional check-list of the birds of Mexico, pt. 2. Pacific Coast Avif., no. 33, 436 pp.
- MOREAU, R. E.
1930. On the age of some races of birds. Ibis, ser. 12, vol. 6, pp. 229-239.
- MUNRO, J. A., and COWAN, I. McT.
1947. A review of the bird fauna of British Columbia. British Columbia Prov. Mus. Spec. Publ. No. 2, 285 pp.
- MURIE, O.
1959. Fauna of the Aleutian Islands and Alaska Peninsula. North American Fauna, vol. 61, pp. 1-406.
- OBERHOLSER, H. C.
1932. Descriptions of new birds from Oregon, chiefly from the Warner Valley Region. Sci. Publ. Cleveland Mus. Nat. Hist., vol. 4, pp. 1-12.
1956. A new hermit thrush from Canada. Proc. Biol. Soc. Washington, vol. 69, no. 12, pp. 69-70.
- OSGOOD, W. W.
1901. New subspecies of North American birds. Auk, vol. 18, pp. 179-185.
- PACKARD, F. M.
1945. On *Hylocichla guttata oromela*. Auk, vol. 62, p. 345.
- PHILLIPS, A. R.
1962. Notas sistematicas sobre aves Mexicanas, I. Sobret. Anal. Inst. Biol., vol. 32, nos. 1 and 2, pp. 333-387.
- PHILLIPS, A., MARSHALL, J., and MONSON, G.
1964. The birds of Arizona, 212 pp. Tucson: University of Arizona Press.
- PITELKA, F. A.
1951. Speciation and ecologic distribution in American jays of the genus *Aphelocoma*. Univ. California Publ. Zool., vol. 50, pp. 195-464.
- RAND, A. L.
1948. Birds of Southern Alberta. Nat. Mus. Canada Bull. 3, pp. 1-105
- RIDGWAY, R.
1907. Birds of North and Middle America, pt. 4. U.S. Nat. Mus. Bull. 50, pp. 39-51.
1912. Color standards and color nomenclature. Washington, D.C.: published by author.
- RIPLEY, S. D.
1952. The thrushes. Postilla, Yale Peabody Mus. Nat. Hist., vol. 13, pp. 1-48.
1964. Family Muscicapidae, Subfamily Turdinae. In Deignan, Paynter, and Ripley, vol. 10 (ix+502 pp.), in Checklist of birds of the world. Cambridge, Mass.: Museum of Comparative Zoology.
- ROWE, J. S.
1959. Forest regions of Canada. Canada Dept. Northern Affairs Nat. Res., Bull. 123, 71 pp. + sep. map.
- SALOMONSEN, F.
1955. Evolution and bird migration. Acta XI Congr. Intern. Ornith. 1954, pp. 337-339.
- SCHANTZ, H. L., and ZON, R.
1924. The natural vegetation of the United States, pp. 1-29. Atlas of American Agriculture. Washington, D.C.: U.S. Department of Agriculture.

SELANDER, R. K.

1954. A systematic review of the booming nighthawks of western North America. *Condor*, vol. 56, pp. 57-82.

SWARTH, H. S.

1912. Report on a collection of mammals and birds from Vancouver Island. *Univ. California Publ. Zool.*, vol. 10, pp. 1-116.

Proceedings of
the United States
National Museum



SMITHSONIAN INSTITUTION • WASHINGTON, D.C.

Volume 124

1968

Number 3638

North American Triclad Turbellaria, 17:
Freshwater Planarians From Lake Tahoe¹

By Masaharu Kawakatsu²

The present paper is concerned with the taxonomy and chorology of two freshwater planarians that occur in Lake Tahoe in the Sierra Nevada Mountains of California and Nevada. Bottom samples of planarians were collected in 1962 and 1963 during the California-Nevada Tahoe Fisheries Study made by the staffs of the California Fish and Game Department and the Nevada Fish and Game Commission.

According to communications from Mr. Ted C. Frantz, Lake Tahoe Fisheries Manager, planarians were taken with a 6-inch Ekman dredge in depths of less than 500 feet and with a 9-inch modified Ekman dredge from 600 to 1640 feet. Planarians collected were first relaxed in epsom salts, then fixed on the spot in 99 percent isopropyl alcohol. Forty vials of specimens were obtained (22 vials of the 1962 material and 18 vials of the 1963 material). The collection consists of about 250 specimens and includes two species. Examination with a binocular microscope shows that a considerable number of the planarians were in a sexually mature state.

The first pigmented planariid species in the material is a new subspecies of *Phagocata nivea* Kenk, 1953, a species hitherto known only

¹ Continuation of a series by L. H. Hyman (see "References").

² Biological Laboratory, Fuji Women's College, Sapporo (Hokkaidô), Japan.

from Alaska. The second species, of which only two specimens are available, one sexual and the other asexual, is a dendrocoelid. A series of sections of these animals showed that this is an undescribed species of the genus *Dendrocoelopsis* Kenk, 1930.

The 1962 material of the Lake Tahoe planarians was sent first by the collector for identification to Dr. L. H. Hyman of the American Museum of Natural History. It was, however, returned to me by Dr. Hyman herself, who told me that her declining health did not permit her to continue taxonomic work. The 1963 material was presented to me by Mr. Frantz upon my request. He also provided me with the detailed data of collections of the Lake Tahoe bottom samples, some notes on living material, and several publications about the lake.

I wish to express my hearty thanks to Dr. Libbie H. Hyman not only for giving me the rare opportunity of studying these valuable materials but also for kindly permitting me to continue her excellent serial work "North American Triclad Turbellaria" (see "References"). She also gave me much valuable criticism. I am indebted to Mr. Ted C. Frantz and his co-workers (Messrs. A. J. Cordone, D. Weidlein, S. Davis, R. Wickwire, S. Nicola, J. Curran, N. Saake, R. Hauswald, V. Keefer, M. Arnold, and B. Zorko) for the gift of the present collections. I owe much to Dr. Roman Kenk and to Professor Atsuhiko Ichikawa for their interest in the work and to Dr. Marie M. Jenkins for some pertinent literature and for correction of my English manuscript.

This paper is affectionately dedicated to Dr. Libbie Henrietta Hyman, an old specialist of turbellarians.

ABBREVIATIONS USED IN FIGURES.—bc=bulbar cavity; bs=bursa stalk; cb=copulatory bursa; ca=common antrum; cg=cement glands; cod=common ovovitelline duct; e=eye; ed=ejaculatory duct; gp=genital pore; i=intestine; ia=intestinal anastomosis; m=mouth; ma=male antrum; o=ovary; od=ovovitelline duct; pb=penis bulb; pg=penis glands; ph=pharynx; pp=penis papilla; sd=sperm duct; sv=spermiducal vesicle; t=testis; v=vagina; yg=yolk gland.

LIST OF LOCALITIES.—The original vial numbers were rearranged according to the division of counties and states of the localities (see fig. 1). Stations 1-24 are located in California in the western two-thirds of the lake area; 25-40 are located in Nevada in the eastern third of the lake area. The number following each station number indicates the specimen lot number as it was registered in my fixing notebook. The information following this number is the data found on the labels of the vials, together with my own notes made from examination of the specimens. Four lots of specimens (nos. 5, 23, 30, 32) that I received from Dr. Hyman were already dry.

No. 1. Specimen Lot No. 477. South Tahoe, Eldorado County, California. Depth, 15 to 16 feet. Oct. 17, 1963. Six asexual specimens of *Phagocata*. Coll. Frantz.

No. 2. Lot No. 475. South Tahoe, Eldorado County, California. Depth, 85 to 99 feet. Aug. 14, 1963. One sexual (No. 475a; slides) and 1 asexual specimen and 2 fragments of *Phagocata*. Coll. Frantz and Saake.

No. 3. Lot No. 453. South Tahoe Shelf, Eldorado County, California. Depth, 21 to 405 feet. Aug. 20, 1962. Eight asexual specimens and 3 fragments of *Phagocata*. Coll. Frantz, Curran, and Saake.

No. 4. Lot No. 460. South Tahoe Shelf, Eldorado County, California. Depth, 248 to 448 feet. Dec. 9, 1962. One sexual specimen with cocoon (No. 460a: whole mount) and about 20 fragments of *Phagocata*. Coll. Frantz, Curran, and Saake.

No. 5. Lot No. 446. Emerald Bay, Eldorado County, California. Depth, 116 to 198 feet. July 11, 1962. One asexual specimen (No. 446a: slides) of *Phagocata*. Coll. Frantz, Curran, and Saake.

No. 6. Lot No. 484. Emerald Bay, Eldorado County, California. Depth, 190 to 203 feet. Dec. 22, 1963. Four asexual specimens of *Phagocata*. Coll. Frantz.

No. 7. Lot No. 449. Sugar Pine Point, Eldorado County, California. Depth, 19 to 229 feet. July 18, 1962. Two asexual specimens and 2 fragments of *Phagocata*. Coll. Frantz, Curran, and Saake.

No. 8. Lot No. 464. Tahoma, Placer County, California. Depth, 213 feet. Dec. 21, 1962. Two sexual but not fully mature (No. 464 b, c: slides) and 23 asexual (No. 464a, d: slides) specimens and 2 fragments of *Phagocata*. Coll. Frantz and Curran.

No. 9. Lot No. 463. Tahoma, Placer County, California. Depth, 439 to 460 feet. Dec. 21, 1962. One sexual but not fully mature (No. 463a: slides) and 1 asexual (No. 463b) specimen of *Phagocata*. Coll. Frantz and Curran.

No. 10. Lot No. 472. McKinney Bay, Placer County, California. Depth, 17 to 20 feet. June 12, 1963. One sexual specimen and 1 fragment of *Phagocata*. Coll. Frantz and Saake.

No. 11. Lot No. 481. McKinney Bay, Placer County, California. Depth, 218 to 285 feet. Dec. 18, 1963. Fourteen asexual specimens and 1 fragment of *Phagocata*. Coll. Frantz and Saake.

No. 12. Lot No. 478. McKinney Bay, Placer County, California. Depth, 408 to 432 feet. Oct. 24, 1963. One sexual and 8 asexual specimens of *Phagocata*. Coll. Frantz and Keefer.

No. 13. Lot No. 470. McKinney Bay, Placer County, California. Depth, 415 to 423 feet. Feb. 19, 1963. Four asexual specimens and 2 fragments of *Phagocata*. Coll. Frantz and Wickwire.

No. 14. Lot No. 479. McKinney Bay and Sand Point, Placer County, California. Depth, 810 to 835 feet. Oct. 28, 1963. One sexual but not fully mature (No. 479a: slides) and 10 asexual specimens of *Phagocata*. Coll. Frantz and Arnold.

No. 15. Lot No. 454. Out from McKinney Bay, Placer County, California. Depth, 820 to 840 feet. Sept. 24, 1962. Three sexual (No. 454 b, c, d: slides) and 5 asexual (No. 454a: slides) specimens of *Phagocata*. Coll. Cordone and Frantz.

No. 16. Lot No. 469. Out from McKinney Bay, Placer County, California. Depth, 900 feet. Feb. 25, 1963. Two asexual specimens of *Phagocata*. Coll. Frantz and Davis.

No. 17. Lot No. 455. Out from McKinney Bay, Placer County, California. Depth, 1255 feet. Sept. 24, 1962. One sexual specimen (No. 455a: slides) of *Phagocata*. Coll. Cordone and Frantz.

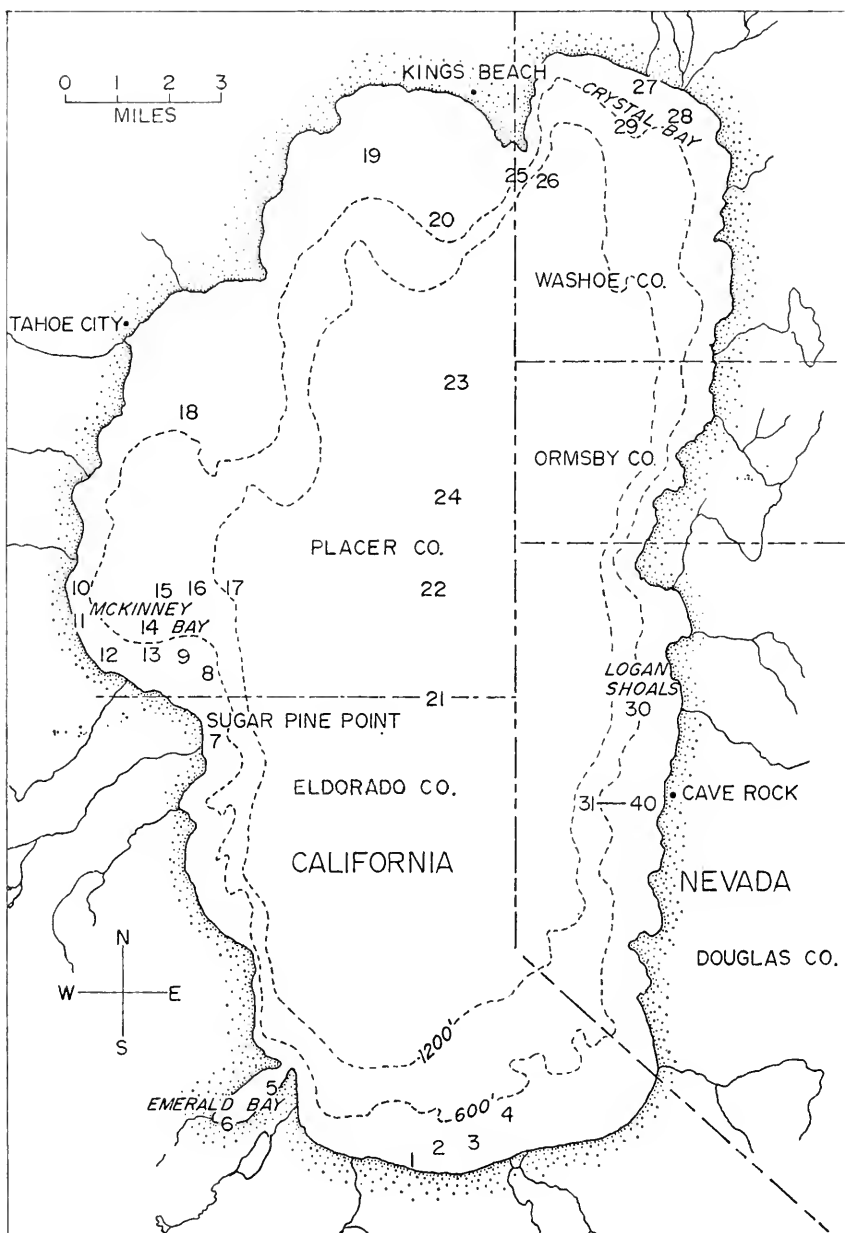

FIGURE 1.—Lake Tahoe, showing stations where planarians were collected (see “List of Localities”).

No. 18. Lot No. 450. Tahoe City area, Placer County, California. Depth, 45 to 257 feet. July 24, 1962. Two asexual specimens and 2 fragments of *Phagocata*. Coll. Frantz, Curran, and Saake.

No. 19. Lot No. 458. Off Tahoe Vista, Placer County, California. Depth, 270 to 330 feet. Nov. 7, 1962. One sexual (No. 458a: slides—holotype) and 3 asexual (No. 458b, c: slides) specimens of *Phagocata*. Coll. Weidlein.

No. 20. Lot No. 459. Off King's Beach, Placer County, California. Depth, 474 feet. Five sexual (No. 459a, b, d, e: slides; No. 459f: whole mount—unfortunately broken through the atrial complex in transit) and 11 asexual (No. 459c: slides) specimens of *Phagocata*. Coll. Weidlein.

No. 21. Lot No. 483. Off Cave Rock and Secret Harbor (center of lake), Eldorado and Placer Counties, California. Depth, 1460 to 1582 feet. Dec. 4, 1963. Six sexual (No. 483a, b, c, d, e, f: slides) and 14 asexual specimens of *Phagocata*. Coll. Frantz and Davis.

No. 22. Lot No. 486. Off Logan Shoals and Secret Harbor (center of lake), Placer County, California. Depth, 1529 to 1583 feet. Oct. 28, 1963. Three sexual (No. 486a: slides) and 5 asexual specimens and 1 fragment of *Phagocata*. Coll. Frantz and Arnold.

No. 23. Lot No. 467. Between Skunk Harbor and Tahoe City (center of lake), Placer County, California. Depth, 1554 to 1623 feet. Dec. 14, 1962. Thirty-six asexual specimens (No. 467a, b, c: slides) and about 30 fragments of *Phagocata*. Coll. Frantz, Nicola, and Wickwire.

No. 23'. Lot No. 468. One sexual (No. 468a: slides—holotype) and 1 asexual (No. 468b, posterior piece: slides; No. 468b, broken head piece: whole mount) specimen of *Dendrocoelopsis*. (Same locality as No. 23.)

No. 24. Lot No. 485. Off Logan Shoals and Secret Harbor (center of lake), Placer County, California. Depth, 1566 to 1632. Aug. 27, 1963. Three sexual (No. 485a: slides) specimens and 2 fragments of *Phagocata*. Coll. Frantz and Davis.

No. 25. Lot No. 465. Crystal Bay, Washoe County, Nevada. Depth, 65 feet. Dec. 13, 1962. One fragment of *Phagocata*. Coll. Frantz.

No. 26. Lot No. 466. Crystal Bay, Washoe County, Nevada. Depth, 250 to 444 feet. Dec. 20, 1962. One asexual specimen and 3 fragments of *Phagocata*. Coll. Frantz, Curran, and Saake.

No. 27. Lot No. 452. Crystal Bay, Washoe County, Nevada. Depth, 19 feet. Aug. 13, 1962. One asexual specimen of *Phagocata*. Coll. Frantz, Curran, and Saake.

No. 28. Lot No. 473. Crystal Bay, Washoe County, Nevada. Depth, 253 to 288 feet. June 26, 1963. Three sexual specimens and 1 fragment of *Phagocata*. Coll. Frantz and Saake.

No. 29. Lot No. 474. Crystal Bay, Washoe County, Nevada. Depth, 428 to 438 feet. June 26, 1963. Six asexual specimens and 1 fragment of *Phagocata*. Coll. Frantz and Zorko.

No. 30. Lot No. 451. Logan Shoals, Douglas County, Nevada. Depth, 618 to 630 feet. Aug. 16, 1962. One asexual specimen and 1 fragment of *Phagocata*. Coll. Frantz and Cordone.

No. 31. Lot No. 462. Cave Rock, Douglas County, Nevada. Depth, 24 to 70 feet. Dec. 19, 1962. Six asexual specimens (No. 462a: slides) and 2 fragments of *Phagocata*. Coll. Frantz, Curran, and Saake.

No. 32. Lot No. 447. Cave Rock, Douglas County, Nevada. Depth, 61 feet. July 16, 1962. One asexual specimen of *Phagocata*. Coll. Frantz, Curran, and Saake.

No. 33. Lot No. 480. Cave Rock, Douglas County, Nevada. Depth, 110 to 159 feet. Dec. 21, 1963. Ten asexual specimens of *Phagocata*. Coll. Frantz and Saake.

No. 34. Lot No. 457. Cave Rock, Douglas County, Nevada. Depth, 245 feet. Oct. 28, 1962. Three asexual specimens and 3 fragments of *Phagocata*. Coll. Frantz, Curran, and Saake.

No. 35. Lot No. 448. Cave Rock, Douglas County, Nevada. Depth, 290 to 325 feet. July 17, 1962. One, probably not fully mature, specimen of *Phagocata*. Coll. Frantz, Curran, and Saake.

No. 36. Lot No. 461. Cave Rock, Douglas County, Nevada. Depth, 299 to 415 feet. Dec. 19, 1962. Two asexual specimens and 2 fragments of *Phagocata*. Coll. Frantz, Curran, and Saake.

No. 37. Lot No. 482. Cave Rock, Douglas County, Nevada. Depth, 342 to 348 feet. Dec. 21, 1963. One sexual (No. 482a: whole mount) and 12 asexual specimens of *Phagocata*. Coll. Frantz and Saake.

No. 38. Lot No. 456. Cave Rock, Douglas County, Nevada. Depth, 422 feet. Oct. 28, 1962. Three asexual specimens of *Phagocata*. Coll. Frantz, Curran, and Saake.

No. 39. Lot No. 471. Cave Rock (Skyland), Douglas County, Nevada. Depth, 438 feet. May 13, 1963. One sexual (No. 471a: whole mount) and 3 asexual specimens of *Phagocata*. Coll. Frantz and Hauswald.

No. 40. Lot No. 476. Cave Rock, Douglas County, Nevada. Depth, 443 to 449 feet. Aug. 20, 1963. Two sexual (476a: slides) and 4 asexual specimens of *Phagocata*. Coll. Frantz and Zorko.

Family PLANARIIDAE

Genus *Phagocata* Leidy, 1847

Phagocata nivea tahoena, new subspecies

FIGURES 2, 3; PLATE 1

A large number of specimens of this planarian was collected from many stations of Lake Tahoe (see "List of Localities").

DESCRIPTION.—The appearance of this subspecies is shown in plate 1A-F. This is a slender, rather small pigmented species.³ Sexually mature worms in a preserved condition are usually 5 to 8 mm long and 0.7 to 1.0 mm wide (largest specimens measured up to 12 mm in length), with the typical appearance of the genus *Phagocata*, i.e., with a truncate head without conspicuous auricles. There is no distinct narrowing behind the head. The body then gradually widens, reaching its greatest width at the level of the pharynx and copulatory apparatus. Behind the genital pore the body tapers to the moderately rounded posterior end.

³ Regarding the color and size of the living specimens of the Lake Tahoe planarians, Mr. Ted C. Frantz informed me (in litt.) that "color varied from dark brown to translucent pink. The 'pink' were few in number and inhabited the bottom depth of the lake. They were also the largest of the planarians and approximately one-half inch or so in length." I consider his "dark brown" specimens to be *Phagocata nivea tahoena* and the "large translucent pink" specimens to be *Dendrocoelopsis hymanae*, described as a new species later in this paper.

The color of the dorsal side of the preserved specimens is usually a uniform grayish brown, that of the ventral side a light grayish brown. The situation of the pharynx and the copulatory apparatus may be marked by lighter pigmentation (pl. 1A-F). There are two eyes, situated close together (pl. 1G-I), each enclosed in a small, reniform clear space (pl. 1G). There is a pair of slightly visible auricular sense organs in the usual position (pl. 1G).

In mature worms the pharynx is situated behind the middle of the body and measures in length almost one-sixth the length of the body. In histological sections, it was observed that the internal muscle zone of the pharynx consists of two layers, circular fibres, and longitudinal fibres (characteristic of the family Planariidae). The anterior trunk of the intestine bears five to eight lateral branches; each posterior trunk has 10 to 12 lateral branches and many short medial branches in both the pharyngeal and postpharyngeal regions.⁴ In many large worms, one to two pairs of medial branches situated at the level of the genital pore are united and form intestinal anastomoses that are located dorsally. Their cavities are lined with the same epithelium as that of the usual intestine.

The arrangement of the parts of the reproductive system was seen translucently from the whole mount (fig. 2). The numerous small testes extend in lateral regions from the level of the ovaries almost to the posterior end of the body. Their position is predominantly ventral, below the intestinal branches. Behind the genital pore, they are also found between the two intestinal trunks. In the central cavity of each testis a tangled mass of spermatozoa is found. The two sperm ducts are first noticeable as thin-walled tubular expansions (sperimidical vesicles) packed with sperm and lying on each side of the pharynx. They are found in a ventral position from the level of the posterior two-thirds of the pharynx to the penis bulb (pl. 1B).

The two ovaries are of moderate size and typical, each situated behind the first pair of lateral branches of the anterior intestinal trunk. Numerous mature ova occur in the ovaries of the mature specimens. Occasionally, a ball of sperm was seen in a small chamber or ampulla of the ovovitelline duct next to each ovary (i.e., in the seminal receptacle). The two ovovitelline ducts proceed posteriorly in a ventral position and form a common ovovitelline duct at the level of the genital pore. The greater part of the ovovitelline ducts receives the ducts of numerous yolk glands (or vitellaria), the bodies of which are scattered in the surrounding parenchyma.

⁴ According to the original description of *Phagocata nivea* from Alaska, the species possesses 10 or 11 pairs of the branches in the anterior intestinal trunk and 21 to 27 lateral branches in each posterior intestinal trunk (Kenk, 1953, p. 165).

The copulatory apparatus is shown in sagittal view in figure 3. The general anatomy of the copulatory apparatus of the present new subspecies bears a great resemblance to that of the Alaskan subspecies, *Phagocata nivea nivea* (cf. my fig. 3 and Kenk, 1953, p. 167, fig. 21).

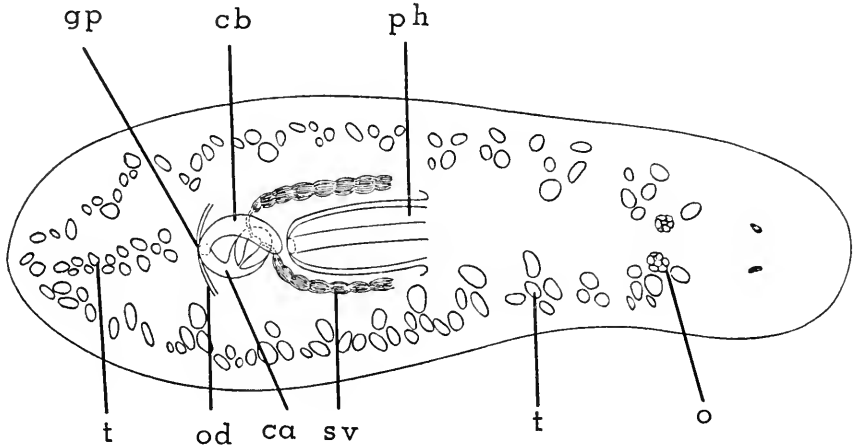

FIGURE 2.—General view of mature specimen of *Phagocata nivea tahoenae* from whole mount: No. 459f.

The genital pore, situated in about the middle of the postpharyngeal region, leads immediately into a small cavity, the common antrum. This cavity leads to the left and dorsally into the canal of the copulatory bursa or the well-developed vagina, and to the right and anteriorly into the male antrum. The male antrum is wide anteriorly, tapering toward the genital pore, and its outer wall is lined with a rather tall, glandular epithelium. Below the epithelium there are two muscle layers, one circular and the other longitudinal. The narrow posterior part of the male antrum receives into its dorsal wall the common ovovitelline duct. Terminal portions of the ovovitelline ducts and the common ovovitelline duct are equipped with numerous eosinophilic cement glands.

The penis consists of two parts, a moderately large spherical bulb embedded in the parenchyma and a free, well-developed papilla projecting into the male antrum; the penis bulb is muscular. It contains a single bulbar cavity (seminal vesicle) from which a wide canal continues to the tip of the penis papilla. Typically, the penis lumen appears to be wider in the bulb than it is in the papilla, but no distinct ejaculatory duct is differentiated. The penis lumen is lined with an epithelium of glandular structure, tapering in thickness posteriorly. The penis bulb is pierced by numerous ducts of the penis glands, the

secretions of which pass into the bulbar cavity. Often the penis lumen and the male antrum are packed closely with this heavily eosinophilic granular secretion. The two sperm ducts enter the bulbar cavity from the anterolateral sides of the penis bulb separately.

The penis papilla has a symmetric conical shape when well extended but varies according to the degree of contraction. The outer wall of the penis papilla is lined with a flat epithelium, under which there are two muscle layers, a layer of circular fibres below the epithelium, and a layer of longitudinal fibres.

A slight morphological difference was noted in comparing the present new subspecies and *Phagocata n. nivea*. The new subspecies has a symmetric conical papilla with the opening of the penis lumen on its tip (fig. 3). The penis lumen of *Phagocata n. nivea*, however, opens ventrally at the tip of the papilla (Kenk, 1953, pp. 164-168, fig. 21). Kenk also notes that in "*Phagocata nivea* the penis lumen opens usually below the tip of the papilla" (p. 168).

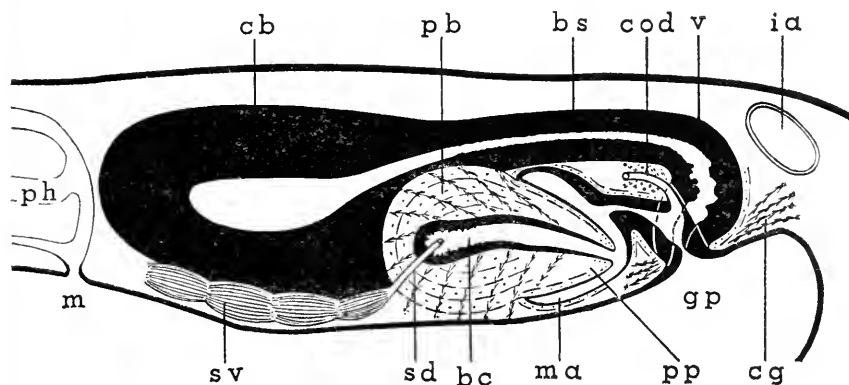

FIGURE 3.—Sagittal view of copulatory apparatus of *Phagocata nivea tahoena*.

The copulatory bursa, which is situated in the usual position, is a large sac with somewhat irregular outline (fig. 3). The cavity of the bursa is lined with a very tall and thick glandular epithelium. In the lumen of this organ, in several worms examined, a mass of sperm was found enveloped in a coagulum of the secretion. The bursa stalk, a wide duct surrounded with a strong muscular coat consisting of intermingled circular and longitudinal fibres, runs posteriorly to the left of the midline, and curves ventrally to open to the common antrum (fig. 3). The posterior terminal part of the bursal canal becomes wide and forms the well-developed vagina. Numerous eosinophilic glands open into the common antrum near the genital pore.

In the lumen of the genital antrum in one of the worms examined (No. 460j), an undeposited cocoon was found. It was ovoid (0.8 x 0.5 mm) and a semitranslucent brown (pl. 1j).⁵

REMARKS.—The taxonomy of the genus *Phagocata* Leidy, 1847 (= *Fonticola* Komárek, 1926) has been discussed heatedly by several taxonomists such as de Beauchamp (1961), Dahm (1958), Darlington (1959), Hyman (1937a,b; 1951a,b), Ichikawa and Kawakatsu (1962a, b,c; 1963), Kenk (1930, 1935, 1944, 1953) and Kawakatsu (1965a). The genus as presently defined has representatives in Europe, Asia, and North America.

The indubitable North American *Phagocata* species are as follows:

Phagocata gracilis gracilis (Haldeman, 1840) from Pennsylvania and Virginia westward to Missouri; *P. g. woodworthi* (Hyman, 1937a) from New England westward to the Delaware River (transitional forms between *gracilis* and *woodworthi* occur in New Jersey; see Hyman 1945, 1951b); *P. g. monopharyngea* Hyman (1945) from Iowa; *P. velata* (Stringer, 1909) from the Mississippi Valley, Michigan, and Ontario westward to Nebraska (probably also Colorado and southward into Missouri); *P. vernalis* Kenk (1944) from Michigan (midcentral states); *P. morgani* (Stevens and Boring, 1906) from the Appalachian region, Wisconsin, Michigan, and also Canada; *P. morgani polycelis* Kenk (1935) from Virginia; *P. bursaperforata* Darlington (1959) from Georgia; *P. oregonensis* Hyman (1963) from Oregon; *P. nivea* Kenk (1953) from Alaska; *P. subterranea* Hyman (1937b) from Donaldson's Cave and Mayfield's Cave of Indiana; *P. cavernicola* Hyman (1954) from Evac Cave of Pennsylvania. In these species (8 species and 4 subspecies) only *P. subterranea* and *P. cavernicola* are cave-dwelling planarians and are known from the subterranean waters in caves. The other species occur in epigean waters.

Externally, *Phagocata nivea tahoena* is readily distinguishable from all other North American *Phagocata* species except three, *P. velata*, *P. vernalis*, and *P. gracilis monopharyngea*, by the following points: size and form of the body, pigmentation on the dorsal side of the body, number of eyes, and number of pharynges. Anatomically, the arrangement and number of the testes and the structure of the copulatory apparatus of *P. n. tahoena* are distinctive.

Phagocata nivea tahoena differs from the other members of the genus in the following characters: small, up to 12 mm in the preserved state; head truncate without auricles; eyes two; colored; testes small, numerous, extending to the posterior end, lying ventrally; spermiducal

⁵ After being photographed, the cocoon was mounted on a slide but unfortunately shrank into ridges. The head piece (the posterior part of the body had disintegrated) also was mounted on the same slide (No. 460j).

vesicles sacciform; sperm ducts entering bulbar cavity separately; penis bulb moderate in size and muscular; penis papilla conical; copulatory bursa large; bursal canal widened; common ovovitelline duct entering roof of posterior part of male antrum; one to two anastomoses of posterior intestinal trunks present; capsule oval.

HOLOTYPE.—One set of serial sagittal sections (No. 458a: 3 slides) will be deposited in the Division of Worms, Museum of Natural History, Smithsonian Institution, with four whole mounts (Nos. 459f, 471a, 482a, 460a: head piece and one cocoon) and 34 sets of serial sections (Nos. 446a, 454a-d, 455a, 458b,c, 459a-e, 462a, 463a,b, 464a-d, 467a-c, 475a-c, 476a, 479a, 483a-f, 485a, 486a). Some of these whole mounts and sections selected from the author's collection also will be deposited in that museum.

LOCALITY.—Lake Tahoe, Station No. 19 (holotype) and other stations at depths from 15 to 1632 feet.

Family DENDROCOELIDAE

Genus *Dendrocoelopsis* Kenk, 1930

Dendrocoelopsis hymanae, new species

FIGURE 4; PLATE 2

Only two specimens of this planarian, one mature and one immature, are available for this description. These were collected from the center of the lake (Station 23, depth 1554 to 1623 feet). As seen in plate 2A, B, a small part of the left side edge in the prepharyngeal region of the mature planarian was broken off; the immature specimen was broken in half near the pharyngeal base in transit (pl. 2C, D). These specimens were fixed but dried when received and were run up into a fluid of glycerin-alcohol for about two weeks. After taking photographs, I made serial sagittal sections of the mature specimen and the posterior piece of the immature specimen. The head piece of the immature specimen has been mounted on a slide and has broken into two fragments.

DESCRIPTION.—This is an unpigmented, eyeless species and measures up to 14 mm in length and about 2 mm in width in a preserved condition. The external appearance of both the mature and immature specimens is shown in plate 2A-D. The body form, however, especially the shape of the head, of a living worm is unknown.

The pharynx is situated behind the middle of the body. It is structurally typical of the family Dendrocoelidae: its internal muscular zone consists of intermingled circular and longitudinal fibres. The copulatory apparatus, which could be seen vaguely from the ventral side, occupies more than half the postpharyngeal region.

Externally the adhesive (or grasping) organ in fixed specimens (pl. 2B, D, E) is a well-developed concave ventral depression. On the basis of comparative observations on *Dendrocoelopsis ezensis* from Hokkaidô in northern Japan, the adhesive organ of *D. hymanae* is less developed than that of *D. ezensis*. The histological construction of the adhesive organ is illustrated in plate 2F. The subepidermal adhesive surface is covered with an epithelium devoid of rhabdites and pierced by numerous long gland ducts filled with a granular, eosinophilic secretion. The cell bodies of the glands are most numerous dorsally but also occur throughout the mesenchyme of the head region. The muscular system of this organ, which could not be analyzed in detail because of the poor histological condition of my slides and the density of the glandular structures, has fibres attached to the entire adhesive surface. This structure of the adhesive organ of the present species is very similar to that of the adhesive organ of *Dendrocoelopsis garmieri* (de Beauchamp, 1950, p. 69, fig. 2). Its muscular system is more weakly developed than in *Dendrocoelopsis spinosipenis* (Kenk, 1925, p. 133, fig. 2; Dahm, 1960, p. 16, fig. 9), or in *Dendrocoelopsis ezensis* (Ichikawa and Okugawa, 1958, p. 13, figs. 3, 4, pl. figs. 43-68) but more than in *Dendrocoelopsis vaginatus* (Hyman, 1935, p. 340, pl. 51: figs. 1, 2) and *Dendrocoelopsis vandeli* (de Beauchamp, 1932, p. 257, fig. 43).

The longitudinal strip of coarsely eosinophilic gland cells in each lateral margin is found in the present species; this character is common in many *Dendrocoelopsis* species (Ichikawa and Okugawa, 1958; Hyman, 1935; Kenk, 1925, 1953). It occurs both in the prepharyngeal region and in the posterior terminal part of the body (some sections of the body margin were lost) in the new species.

The anterior trunk of the intestine bears eight or nine pairs of lateral branches. Each posterior trunk has 13 or more pairs of lateral branches. The paired, rather large ovaries, situated behind the second pair of lateral branches of the anterior intestinal trunk, show no histological peculiarities. The ovovitelline ducts proceed backward and finally unite to form a short common ovovitelline duct at the anterior level of the genital pore and open into the male antrum close to the genital pore. The yolk glands or vitellaria, clusters of large and darkly stained cells, occur throughout the body length between the diverticula of the intestine.

The testes are moderate in size, numerous, and ventral in position. They are arranged in two zones on both sides of the midline, extending from the level of the ovaries to the base of the pharynx. In the central cavity of each testis occurs a tangled mass of sperm. The two sperm ducts form the usual sinuous tubes packed with sperm (the spermiducal vesicles) and are found from the level of about the middle of the

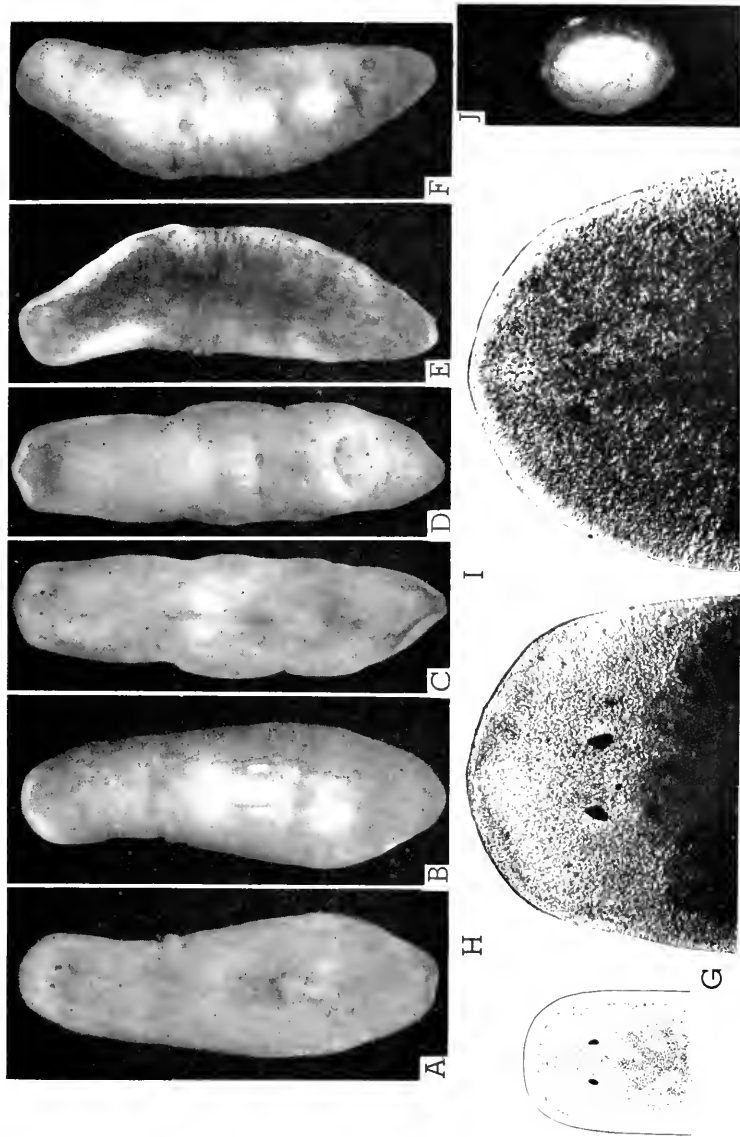

Phagocata nireu taboena, new subspecies (actual length 10–12 mm): A and B, no. 459f; C and D, no. 459a; E and F, no. 483a (a pair of normal eyes were found in the sections). Sketch of head of a preserved specimen: G, no. 454 group. Photographs of head of preserved specimens from whole mounts: H, no. 459f; I, no. 460a. Cocoon: J, no. 460a (actual size 0.8 x 0.5 mm).

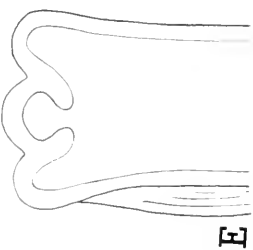

F

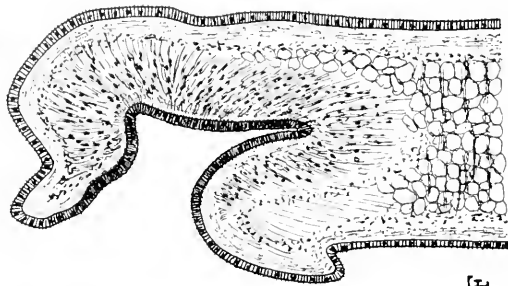

F



C

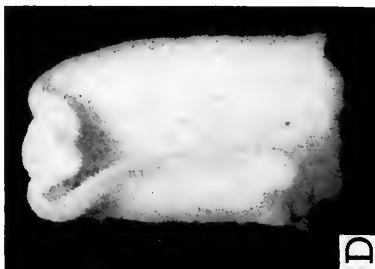

D

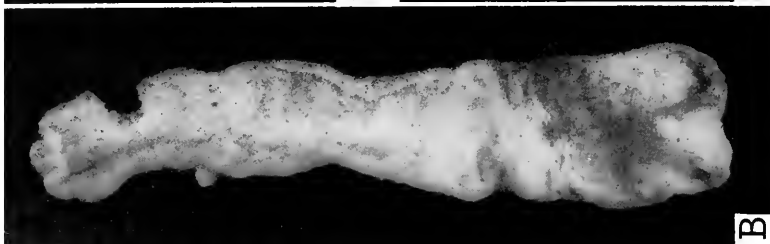

B

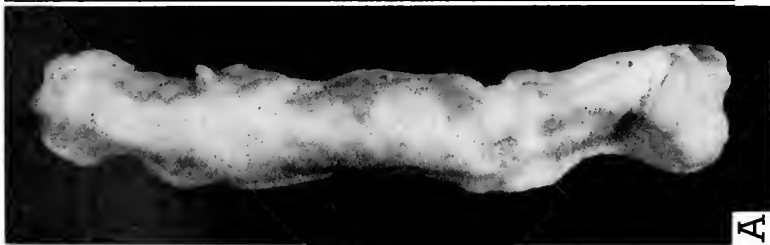

A

Dendrocoelopsis tymanax, new species, preserved but dried specimens: A and B, sexually mature, no. 468a, holotype; C and D, sexually immature, no. 468b. Sketch of ventral side of prepharyngeal region: E, no. 468b. Median sagittal section through adhesive organ: F, no. 468a.

pharynx to that of the penis bulb. A sagittal view of the copulatory apparatus is shown in figure 4.

The genital pore opens immediately into two cavities, i.e., anteriorly into the male antrum containing the penis papilla and posterodorsally into the duct of the copulatory bursa. There is no division of the genital antrum into a common antrum and a male antrum (fig. 4). The opening of the common ovovitelline duct is situated in the roof of the terminal part of the male antrum. Terminal portions of the ovovitelline ducts and the common ovovitelline duct receive numerous glands, the secretion of which becomes a deep red when stained with eosin. The wall of the male antrum is lined with a cuboidal epithelium; the epithelium of the male antrum on the dorsal side is taller and more glandular than on the ventral. Under the epithelium there are two muscle layers, one circular and the other thick and longitudinal.

The penis consists of a large spherical bulb and a moderately large conical papilla; the bulb is very muscular. It consists of the usual mesh of muscle fibres taking a curved course paralleling the contours of the bulb. The penis bulb is pierced by numerous eosinophilic gland ducts that open into the bulbar cavity; these are seen easily in sections stained with Delafield's haematoxylin and eosin. The distinguishing feature of this species is the division of the bulbar cavity (seminal vesicle) into a pair of moderately wide, oval-shaped cavities in the penis bulb (fig. 4). The two continue to a narrow ejaculatory duct in the penis papilla.⁶ Both the bulbar cavity and the ejaculatory duct are lined with a glandular epithelium of very tall cells, tapering in thickness toward the tip of the penis papilla. The two sperm ducts penetrate the penis bulb from the anterolateral sides and each opens into a cavity of the seminal vesicle.

The penis papilla has a slender and symmetric conical shape (fig. 4). It is covered with a tall epithelium similar to that lining the male antrum, under which there are two muscle layers, tapering in thickness toward the tip of the papilla: a layer of circular fibres containing a dense fibrous material next to the epithelium and a second layer of longitudinal fibres. The ejaculatory duct opens at the tip of the papilla.

The copulatory bursa is a large sac closely fitted into the space between the posterior wall of the pharyngeal chamber and the penis bulb (fig. 4). It has a narrow lumen and the internal wall is lined by a tall glandular epithelium. The bursa stalk runs posteriorly above

⁶ In sagittal sections of the copulatory apparatus, the two parts of the separated bulbar cavity appear as if they are situated above and below the penis bulb rather than on either side of the midline of the body. This condition, however, seems to be the result of a postmortem muscular contraction, with a consequent listing to the side of the dorsoventral axis, through which the material was sagittally sectioned.

the penis, then curves ventrally and opens into the roof of the genital antrum. Its lumen enlarges distally; the epithelial lining of the lumen is thrown into villus-like folds. The muscle coat of the bursa stalk is well developed and consists of intermingled longitudinal and circular fibres. The walls of the distal part of the bursa stalk and the genital antrum near the genital pore are supplied with eosinophilous glands.

The egg-capsule or the cocoon of this species is not known.

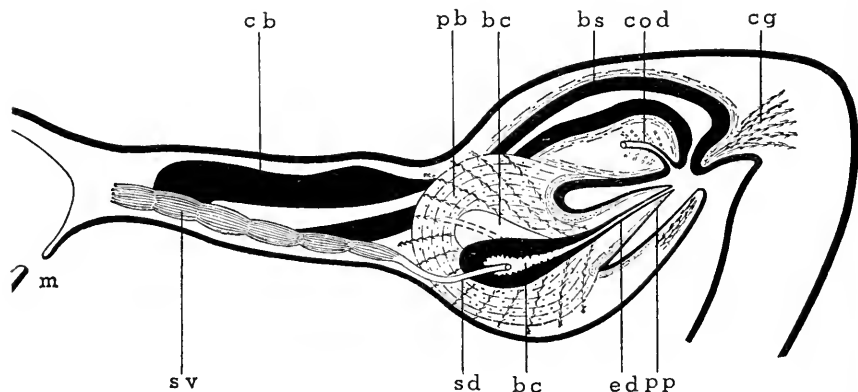

FIGURE 4.—Sagittal view of copulatory apparatus of *Dendrocoelopsis hymanae*: no. 468a.

REMARKS.—The genus *Dendrocoelopsis* was described originally by Kenk (1930). Afterward, Kenk (1953) modified the original definition of the genus by omitting the presence of a sucker as a generic character in order to include the species described under *Amyadenium* de Beauchamp. The taxonomy of *Dendrocoelopsis*, thus defined, was discussed by Hyman (1935), by Kenk (1953), by Ichikawa and Okugawa (1958), and recently by Dahm (1960). I am in complete accord with their opinions.

The species described under the genus *Dendrocoelopsis* (including *Amyadenium*) are as follows: *Dendrocoelopsis spinosipennis* (Kenk, 1925; possibly including *Digonoporus macroposthia* An Der Lan, 1941) from Yugoslavia, Sweden, and Denmark; *Dendrocoelopsis vandeli* (de Beauchamp, 1931), *D. brementi* (de Beauchamp, 1919) and *D. chattoni* (de Beauchamp, 1949) from the Pyrenees; *D. garmieri* (de Beauchamp, 1950) from central France; *D. brementi oculatum* (Porfirjeva, 1958) from the Caucasus; *D. lacteus* Ichikawa and Okugawa (1958) and *D. ezensis* Ichikawa and Okugawa (1958) from North Japan; *D. piriformis* Kenk (1953) and *D. alaskensis* Kenk (1953) from Alaska; *D. vaginatus* Hyman (1935) from Montana and Oregon in North America (Hyman, 1963).

Of the four known North American species of the genus (*D. piriformis*, *D. alaskensis*, *D. vaginatus*, and *D. hymanae*), only *D. piriformis* is a pigmented form, with two eyes and a well-developed adhesive organ. The Montana specimens of *D. vaginatus* are white and the Oregon (vicinity of Portland) specimens of the same species are dark, but microscopic examination shows that the dark color is caused by dark points in the cells of the entoderm (Hyman, 1963). This species has two eyes and an adhesive organ. *Dendrocoelopsis alaskensis* is also a nonpigmented form but without an adhesive organ. This species has two pairs of principal eyes.

Dendrocoelopsis hymanae differs from the other members of the genus in the following characters: moderate size, 14 mm in length (preserved), white, and eyes wanting; adhesive organ more developed than in *D. vaginatus*; testes prepharyngeal and ventral; penis bulb well developed; the seminal vesicle separated into two cavities (their positions are somewhat asymmetrical in my specimen) and sperm ducts entering separately; penis papilla conical, pointed, with single ejaculatory duct; copulatory bursa large; bursal canal thickened but less developed than in *D. vaginatus*; common ovovitelline duct entering the roof of the male antrum.

HOLOTYPE.—One set of serial sagittal sections (No. 468a: 11 slides) will be deposited in the Division of Worms, Museum of Natural History, Smithsonian Institution; also one whole mount of the head piece (No. 468b) and one set of sagittal sections of the posterior piece of the same specimen (No. 468b: 2 slides).

LOCALITY.—Lake Tahoe, Station No. 23', at depths from 1554 to 1623 feet.

Ecological Notes

Lake Tahoe (fig. 1) is located in the Sierra Nevada Mountains at an elevation of 2097 m. It is 35.4 km long, 19.3 km wide, has a 114-km shoreline, a maximum depth of 548 m, and is the tenth deepest lake in the world. Water temperature of the lake is—offshore surface: maximum 20°C, minimum 5.5°C; at 67 m in depth: maximum 8°C, minimum 5°C.

Phagocata nivea tahoena and *Dendrocoelopsis hymanae* are the first recorded true lake-dwelling planarians in the United States. The former seems very common in the lake. Mr. Ted C. Frantz of the Nevada Fish and Game Commission informed me (in litt.) that "when we started our work on Tahoe we were surprised to find fairly large concentrations of planarians at various locations. Particularly so, when you consider Tahoe is relatively infertile. There has been some speculation as to their feeding habits on lake trout eggs." I was also much surprised to learn from the collector that a large number

of planarians that I had received were collected by the Ekman dredge method. According to my experience, *Bdellocephala annandalei* Ijima and Kaburaki, which inhabits Lake Biwa-ko in Middle Japan and is one of the largest freshwater planarians of the world, was taken easily with a dragnet used for *Chaenogobius annularis urotaenia* and *Gnathopogon elongatus*, but collection of this planarian hardly can be expected with the Ekman dredge (Kawakatsu, 1964). The chief food of *B. annandalei* is *Tubifex* worms inhabiting the muddy bottom of the lake (Gose, 1964).

Phagocata nivea from Alaska is an unpigmented epigeal species with two eyes. It is a very interesting fact that a pigmented 2-eyed subspecies of *P. nivea* occurs in the bottom fauna of Lake Tahoe. In the North American freshwater planarian fauna, however, most of the *Phagocata* species are white, and so the absence of pigment in this genus cannot be regarded as adaptive (Hyman, 1954). *Phagocata bursaperforata*, which may be related to *P. morgani* and inhabits granite outcrops in Georgia, and *P. subterranea* from Indiana caves, which probably loses its eyes when adult, are the only white species without eyes in the genus. On the other hand, in the planarian fauna of the Japanese Islands, every subterranean *Phagocata* species known up to the present is white or translucent with two small eyes (*P. albata* Ichikawa and Kawakatsu, *P. tenella* Ichikawa and Kawakatsu, *P. papillifera* (Ijima and Kaburaki), *Phagocata* species Ichikawa and Kawakatsu of Tsushima Island), or translucent without eyes (*Phagocata?* species Ichikawa of Asahigawa, and several other undescribed forms). The Japanese epigeal *Phagocata* species always are pigmented—*P. vivida* (Ijima and Kaburaki), *P. kawakatsui* Okugawa, *P. teshirogii* Ichikawa and Kawakatsu, *P. iwamai* Ichikawa and Kawakatsu (Kawakatsu 1960, 1965a, b).

A study of the present geographical distribution of planarian species of the world suggests that *Phagocata*, *Polycelis*, and *Dendrocoelopsis* are primarily Eurasian genera (Kawakatsu, 1965a). The chorology of species belonging to these genera has been discussed extensively: *Phagocata* species by Kenk (1943, 1953) and Kawakatsu (1965a), *Polycelis* species by Kenk (1952, 1953) and Kawakatsu (1965a), and *Dendrocoelopsis* species by Dahm (1960) and Kawakatsu (1965a). The occurrence of *Phagocata nivea tahoena* and *Dendrocoelopsis hymanae* in the Sierra Nevada Mountains may suggest that Alaska and the western area of the United States were populated by the proto-species migrating to these areas from Asia across the old land bridge on the Bering Strait (Kawakatsu, 1965a, fig. 10).

In the central and eastern states of North America, many species of the family Kenkiidae (consisting of the three genera: *Kenkia* Hyman, *Sphalloplana* de Beauchamp, and *Speophila* Hyman) have been

recorded from many caves. They are all white, eyeless cave-dwellers with an adhesive organ in the center of the anterior margin. The copulatory apparatus follows the plan of the genus *Phagocata*, from which the Kenkiidae presumably derive (Hyman, 1951b). In the Japanese Islands no specialized forms of planarians have been recorded from caves (Kawakatsu, 1960). The Japanese Islands are the continental islands of the Asiatic Continent and consist of younger strata than those of the North American Continent. Moreover, in the Neogene, the greater part of the Old Japanese Islands had sunk beneath the waves; this may have had a fatal effect upon the old Japanese flora and fauna (Kawakatsu, 1965a). On the other hand, a number of undescribed species belonging to the family Kenkiidae (probably *Speophila*) has been recorded from the subterranean waters in Middle Japan (Kawakatsu 1965a, b, c).⁷ Knowledge is scanty concerning the Japanese subterranean water fauna although some troglobionts of the ancient type or preglacial relics—*Bathynella*, *Parabathynella*, *Allobathynella*, *Phreatodytes*, and *Morimotoa*—have been found in subterranean waters in the Japanese Islands (M. Uéno, 1960; S.-I. Uéno, 1957).

One of the speculations about the speciation of the genus *Phagocata* is that the members of the North American cave-dwelling Kenkiidae are the old immigrants to the New World, and at the same time a group more adapted to the cave habitat than those of the present North American *Phagocata* species. The speciation of the Japanese *Phagocata* species, which apparently originated from the Eurasian Continent, may not be so differentiated as the North American cave inhabitants except for a number of the above-mentioned true subterranean forms. More light could be thrown on this question by a more thorough study of the turbellarian fauna of the North Pacific areas of the Far East.

⁷ Dr. Hyman kindly examined my photomicrographs of one of the forms that occurs in a well in Himeji City, near Ōsaka, Middle Japan (coll. Mr. Y. Morimoto).

References

AN DER LAN, HANNES

1941. *Digonoporus macroposthia* nov. gen., nov. sp., eine neuer paludicoler Tricladentypus. Zool. Anz., vol. 136, pp. 18-24.
1960. *Dendrocoelopsis spinosipenis* (Kenk) aus Jugoslavien und Schweden sowie *Digonoporus macroposthia* An Der Lan (Turbellaria Tricladida Paludicola). Zool. Anz., vol. 165, pp. 403-406.

BEAUCHAMP, PAUL DE

1919. Diagnoses préliminaires de triclades obscuricoles. Bull. Soc. Zool. France, vol. 64, pp. 243-251.
1920. Biospeologica, XLIII: Turbellariés et hirudinées, sér. 1. Arch. Zool. Expér. Gén., vol. 50, pp. 177-219 + pls. v-vi.
- 1931a. Nouvelles diagnoses de triclades obscuricoles: 1° Essai d'une classification des Dendrocoelidae. Bull. Soc. Zool. France, vol. 55, pp. 155-163.
- 1931b. Biospeologica, LVI: 2, Turbellariés triclades. In Campagne spéologique de C. Bolivar et R. Jeannel dans l'Amérique du Nord (1928). Arch. Zool. Expér. Gén., vol. 71, pp. 317-331.
1932. Biospeologica, LXVIII: Turbellariés, hirudinées, branchiobdellidés, sér. 2. Arch. Zool. Expér. Gén., vol. 73, pp. 113-380 + pls. vi-viii.
1949. Biospeologica, LXIX: Turbellariés, sér. 3. Arch. Zool. Expér. Gén., vol. 86, pp. 50-65.
1950. Nouvelles diagnoses de triclades obscuricoles. Bull. Soc. Zool. France, vol. 75, pp. 65-70.
1961. Classe des turbellariés. In Masson and Cie, Traité de zoologie, vol. iv, pp. 35-132, 199-212, 887-890. Paris.

DAHM, ANDERS G.

1958. Taxonomy and ecology of five species groups in the Family Planariidae, 241 pp. Malmö, Sweden: Nya Litografen.
1960. *Dendrocoelopsis spinosipenis* (Kenk) from Yugoslavia and Sweden, and *Digonoporus macroposthia* An Der Lan (Turbellaria Tricladida Paludicola). Lunds Univ. Årsskr., n. s., 2, vol. 56, no. 8, pp. 1-39.

DARLINGTON, JULIAN

1959. The Turbellaria of two granite outcrops in Georgia. American Midl. Nat., vol. 61, pp. 257-294.

FRANTZ, TED C., and CORDONE, ALMO J.

1966. A preliminary checklist of invertebrates collected from Lake Tahoe, 1961-1964. Biol. Soc. Nevada Occas. Pap., no. 8, pp. 1-12.

GOSE, KYÛEMON

1964. The food of *Bdellocephala annandalei*. Proc. 29th Ann. Meet. Japanese Soc. Limnol., p. 5. [In Japanese.]
1966. Food habit of *Bdellocephala annandalei* of Lake Biwa. Japanese Journ. Ecol., vol. 16, pp. 78-79. [In Japanese.]

HYMAN, LIBBIE H.

1935. Studies on the morphology, taxonomy, and distribution of North American triclad Turbellaria, vi: A new dendrocoelid from Montana, *Dendrocoelopsis vaginatus* n. sp. Trans. American Micros. Soc., vol. 54, pp. 338-345.

- 1937a. Studies, etc., VII: The two species confused under the name *Phagocata gracilis*, the validity of the generic name *Phagocata* Leidy 1847, and its priority over *Fonticola* Komárek 1926. Trans. American Micros. Soc., vol. 56, pp. 298-310.
- 1937b. Studies, etc., VIII: Some cave planarians of the United States. Trans. American Micros. Soc., vol. 56, pp. 457-477.
1939. North American triclads Turbellaria, X: Additional species of cave planarians. Trans. American Micros. Soc., vol. 58, pp. 276-284.
1945. North American triclads Turbellaria, XI: New, chiefly cavernicolous, planarians. American Midl. Nat., vol. 34, pp. 475-484.
- 1951a. The invertebrates, vol. II, 550 pp. New York: McGraw-Hill Book Co.
- 1951b. North American triclads Turbellaria, XII: Synopsis of the known species of fresh-water planarians of North America. Trans. American Micros. Soc., vol. 70, pp. 154-167.
1954. North American Triclad Turbellaria, XIII: Three new cave planarians. Proc. U.S. Nat. Mus., vol. 103, no. 3333, pp. 563-573.
1963. North American triclads Turbellaria, XVI: Fresh-water planarians from the vicinity of Portland, Oregon. American Mus. Novit., no. 2123, pp. 1-5.
- ICHIKAWA, ATSUIHIKO, and KAWAKATSU, MASAHARU
- 1962a. *Phagocata albata*, a new probably subterranean freshwater planarian, from Hokkaidô. Annot. Zool. Japon., vol. 35, pp. 29-37.
- 1962b. *Phagocata iwamai*, a new freshwater planarian, from Hokkaidô. Annot. Zool. Japon., vol. 35, pp. 38-46.
- 1962c. *Phagocata teshirogii*, a new freshwater planarian, from Tôhoku Region in Honshû. Annot. Zool. Japon., vol. 35, pp. 112-120.
1963. *Phagocata tenella*, a new freshwater planarian, from Hokkaidô. Annot. Zool. Japon., vol. 36, pp. 102-106.
1967. Records of two planarians species of the family Kenkiidae from the Japanese subterranean waters. Arch. Hydrobiol., vol. 63, pp. 512-519.
- ICHIKAWA, ATSUIHIKO, and OKUGAWA, KAZUNOSUKE I.
1958. Studies on the probursalian (fresh-water triclads) of Hokkaidô, I: On two new species of the genus *Dendrocoelopsis* Kenk, *D. lacteus* and *D. ezensis*. Bull. Kyoto Gakugei Univ., ser. B, no. 12, pp. 9-18 + pls. 1-5.
- IJIMA, ISAO, and KABURAKI, TOKIÖ
1916. Preliminary descriptions of some Japanese Triclads. Annot. Zool. Japon., vol. 9, pp. 153-171
- KABURAKI, TOKIÖ
1922. On some Japanese freshwater triclads; with a note on the parallelism in their distribution in Europe and Japan. Journ. Coll. Imp. Univ. Tokyo, vol. 44, art. 2, pp. 1-71 + pl. I.
- KAWAKATSU, MASAHARU
1960. Notes on the freshwater planarians found in the subterranean waters of the Akiyoshi district. Japanese Journ. Zool., vol. 12, pp. 609-620.
1964. Notes on freshwater planaria of Lake Biwa-ko. The Heredity (Tokyo), vol. 18, no. 9, pp. 32-35. [In Japanese.]
- 1965a. On the ecology and distribution of freshwater planarians in the Japanese Islands, with special reference to their vertical distribution. Hydrobiologia, vol. 26, pp. 349-408.

- 1965b. Report on the ecological survey of freshwater planarians in the Hidaka district, Hokkaidô. Japanese Journ. Ecol., vol. 15, pp. 173-183. [In Japanese with English summary.]
- 1965c. The outline of the investigations of ecology, taxonomy, and chorology made on freshwater planarians in Japan. Shinoda Osamu Sensei Taikankinen Ronbun-shû (Seikatsu Bunka Kenkyû, no. 13), pp. 53-68. [In Japanese.]
- 1965d. Some ecological notes on the freshwater planarians of Lake Tahoe in the Sierra Nevada Mountains in North America and Lake Biwa-ko in Middle Japan. Japanese Journ. Limnol., vol. 26, pp. 106-112. [In Japanese with English summary.]
- 1966a. On the distribution of freshwater planarians in the North Pacific area. Japanese Soc. Syst. Zool. Circ., no. 34, pp. 3-7. [In Japanese.]
- 1966b. Synopsis of the known species of freshwater planarians in Japan. Bull. Biogeogr. Soc. Japan, vol. 24, pp. 9-28. [In Japanese.]
- 1966c. Japanese freshwater planarians. The Heredity (Tokyo), vol. 20, no. 4, pp. 54-57. [In Japanese.]
- KAWAKATSU, MASAHARU, and HORIKOSHI, ISAO
1966. On the re-discovery of *Phagocata papillifera* (Ijima and Kaburaki). The Heredity (Tokyo), vol. 20, no. 10, pp. 13-16. [In Japanese.]
- KAWAKATSU, MASAHARU, and IWAKI, SUMIE
1967. Studies on the morphology, taxonomy and ecology of the Japanese freshwater planarian, *Phagocata kawakatsui* Okugawa, with remarks on distribution. Japanese Journ. Ecol., vol. 17.
- KAWAKATSU, MASAHARU, and KIM, WUN-JAI
1967. Results of the Speleological Survey in South Korea 1966, VI: Freshwater planarians from limestone caves in South Korea. Bull. Nat. Sci. Mus. Tokyo, vol. 10.
- KENK, ROMAN
1925. Zur Anatomie von *Dendrocoelum spinosipenis* Kenk (Turbellaria Tricladida). Zool. Anz., vol. 63, pp. 131-146.
1930. Beiträge zum System der Probursalier (Tricladida Paludicola), I-III. Zool. Anz., vol. 89, pp. 145-162, 289-302.
1935. Studies on Virginia triclads. Journ. Elisha Mitchell Sci. Soc., vol. 51, pp. 79-125+pl. 45.
1943. Notes on the planarian fauna of Canada. Canadian Field Nat., vol. 57, pp. 5-6.
1944. The freshwater triclads of Michigan. Misc. Publ. Mus. Zool. Univ. Michigan, no. 60, pp. 1-44+pls. I-VII.
1952. Freshwater triclads (Turbellaria) of the Rocky Mountain National Park region, Colorado. Journ. Washington Acad. Sci., vol. 42, pp. 193-198.
1953. The freshwater triclads (Turbellaria) of Alaska. Proc. U.S. Nat. Mus., vol. 103, no. 3322, pp. 163-186, pls. 6-8.
- KOMÁREK, JULIUS
1926. Doplněk ku Vejdovského revisi českých Triclad. Věstník české Spol. Nauk, 1925, art. 7, pp. 1-32+pl. I. [In Czechoslovakian with English summary.]
- NEVADA FISH AND GAME COMMISSION
No date. Angler's guide to Lake Tahoe, 15 pp. Carson City, Nev.: State Printing Office.

OKUGAWA, KAZUNOSUKE I.

1956. A new fresh-water planaria *Phagocata kawakatsui* sp. nov. from Kyoto Prefecture. Bull. Kyoto Gakugei Univ., ser. B, no. 8, pp. 19-22, photo pl. 1.

PORFIRJEVA, ANNA N.

1958. Planarii Srednei Azii [Freshwater planarians from Central Asia]. Trudy Obshch. Estestvoisp., 62 (Uchenye Zap. Kazan. Gosud. Univ., vol. 118, no. 1), pp. 39-88. [In Russian with German summary.]

STEVENS, NETTIE M., and BORING, ALICE M.

1906. *Planaria morgani* n. sp. Proc. Acad. Nat. Sci. Philadelphia, vol. 58, pp. 7-9.

STRINGER, CAROLINE M.

1909. Notes on Nebraska Turbellaria with descriptions of two new species. Zool. Anz., vol. 34, pp. 257-262.

UÉNO, MASUZÔ

1960. Freshwater biology, 162 pp. Tokyô: Hokuryû-kan Co. Ltd. [In Japanese.]

UÉNO, SHUN-ICHI

1957. Blind aquatic beetles of Japan, with some accounts of the fauna of Japanese subterranean waters. Arch. Hydrobiol., vol. 53, pp. 250-296.

Proceedings of
the United States
National Museum



SMITHSONIAN INSTITUTION • WASHINGTON, D.C.

Volume 124

1968

Number 3639

Studies in Pteromalidae
in the U.S. National Museum
(Hymenoptera)

By Karl-Johan Hedqvist¹

Genus *Epistenia* Westwood

Species of the genus *Epistenia* Westwood are comparatively large, stout chalcid flies characterized as follows: Coarsely punctured. Head large, broader than thorax, with deep antennal grooves that converge and meet in front of median ocellus. Eyes large, hairy. Antennae inserted near base of clypeus, with 11 segments (formula, 11171), the type-species, *E. coeruleata* Westwood, has first fourth funicle segments longer than wide. Clava and seventh funicle segment with micropilosity (in *E. coeruleata* also apex of sixth). Clypeus slightly sinuated. Labrum free. Each mandible with three teeth. Ocelli in isosceles triangle. Pronotum produced anteriorly into a short neck, the neck with a median carina. Mesonotum with notaulices complete. Scutellum large, convex, and prolonged slightly over metathorax and propodeum. Apex of scutellum nipple-like. Prepectus large, punctate. Propodeum short with a median carina and an incomplete plica. Spiracles large. Gaster longer than head plus thorax, sessile, first segment smooth, second segment not visible dorsally. Apex of gaster more or less tubelike, elongated, with a delicate median carina. Legs stout, all femora swollen, anterior one stoutest, with a tooth distally on the ventral side. Hind tibia with two spurs (in one species, *E. odyneri* Ashmead, also with long bristles on the hind tibia.) Fore-

¹ Royal College of Entomology, Stockholm 50, Sweden.

wing without any speculum, costal cell with many hairs along margin. Postmarginal vein longer than marginal vein. Stigmal vein short, about one-third length of marginal vein.

In the Nearctic region there are five known species. I describe two new species in the present paper.

The species of *Epistenia* are primary parasites of solitary nesting aculeate Hymenoptera. Rau (1922) reared *E. osmiae* Ashmead (now considered a synonym of *E. coeruleata*) from an elder twig that had been tunneled by *Ceratina* species or *Ectemnius* (*Hypocrabro*) species. Parker and Bohart (1966) reared *E. coeruleata* from *Isodontia elegans* (Smith) and *Trypargilum tridentatum tridentatum* (Packard) nesting in borings in *Sambucus* stems. *Epistenia regalis* Cockerell (1934) (a probable synonym of *E. coeruleata*) was described originally from a specimen reared from the nest of an odynerid wasp. The original hosts of *E. osmiae* and *E. odyneri* Ashmead are obvious from their names; the first was described from a specimen reared from an *Osmia* species in a catalpa twig, and the second emerged from burrowings of *Odynerus* (now *Leptochilus*) *rufobasilaris* Ashmead in twigs of *Nama*. There are in the USNM collection specimens of *E. coeruleata* that were reared by J. C. Bridwell from *Trypargilum collinum rubrocinctum* (Packard) and by K. V. Krombein from *Leptochilus republicanus zendaloides* (Robertson). The latter rearing was from a sumac stem boring.²

Key to Nearctic Species of *Epistenia*

1. Hind tibiae with long bristles, 2-3 times breadth of tibia . . . **odyneri** Ashmead
Hind tibiae with short spines, shorter than breadth of tibia 2
2. Malar space as long as half breadth of an eye. Distance between upper edges of antennal scrobes twice diameter of an ocellus **burksi**, new species
Malar space as long as or nearly as long as breadth of an eye. Distance between upper edge of antennal scrobe and front edge of median ocellus only equal to or less than diameter of ocellus 3
3. Wings distinctly smoky **polita** (Say)
Wings hyaline, without darker clouds 4
4. Last tergite of gaster short, about one and one-half times as long as its basal breadth **media**, new species
Last tergite of gaster long, more than twice as long as its basal breadth 5
5. Tegulae black **regalis** Cockerell
Tegulae yellowish brown **coeruleata** Westwood

Epistenia odyneri Ashmead

Epistenia odyneri Ashmead.—Davidson, 1896, p. 336.

This species differs from the other species from the Nearctic region in having long bristles on the hind tibia (fig. 5*d*). Originally described from California. The author has seen a male specimen from Arizona (Grand Canyon, Bright Angel Trail, May 15, 1952, E. B. Haydon, Jr.).

² Paragraph added by B. D. Burks.

Epistenia burksi, new species

FEMALE.—Length 4.0–4.5 mm.

Bluish black with blue and green spots on head, prothorax, and

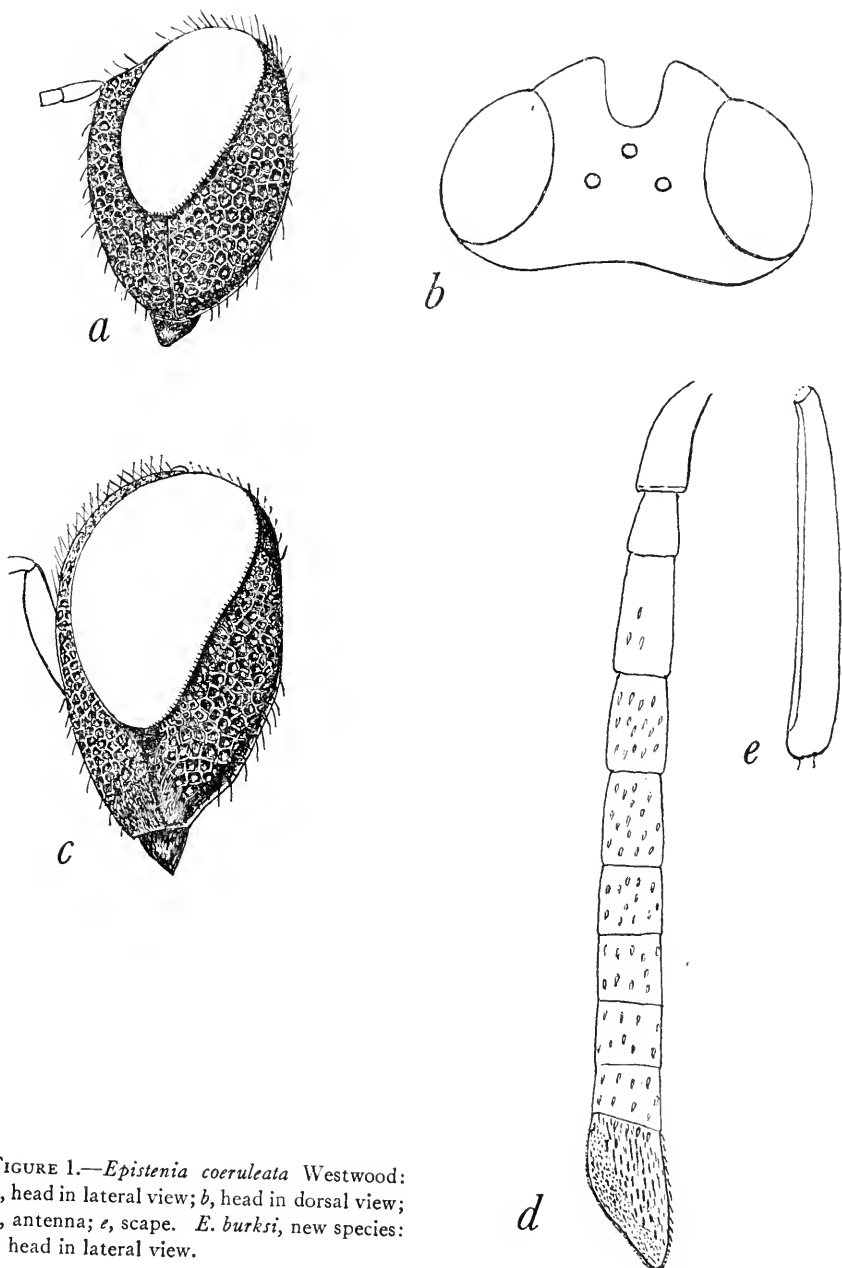

FIGURE 1.—*Epistenia coeruleata* Westwood: *a*, head in lateral view; *b*, head in dorsal view; *d*, antenna; *e*, scape. *E. burksi*, new species: *c*, head in lateral view.

mesothorax. Wide band of green and purple over anterior part of scapulae and median part of mesonotum. Lateral part of metathorax and propodeum green and blue. First tergite of gaster golden green. Antenna with bluish-green reflection on scape and pedicel, flagellum dark brown. Legs honey yellow. Ocelli and eyes grayish white. Legs and body clothed with white pubescence. Wing veins brown.

Head (fig. 1c) large with very large eyes. Funicle with first-third segments longer than wide. Diameter of median ocellus about twice distance between upper edge of antennal scrobe and front edge of median ocellus. Malar space half breadth of an eye. Scutellum posteriorly conical, apex nipple-like. Propodeum (fig. 3c) with median carina and small spiracles. Callus with tuft of hairs. Gaster slightly longer than thorax and head together. Last tergite one and one-half times as long as basal breadth (figs. 4c, 5c).

MALE.—Length 2.2 mm. Similar to female, but color not as strong. Antenna and gaster brown.

HOLOTYPE.—Female, in collection of USNM, no. 69556.

TYPE-LOCALITY.—Linton, Ind., 1956, summer, apple orchard.

ALLOTYPE.—Male, in same collection, Austin, Tex., Carl Hartmann.

PARATYPE.—1 ♀ in author's collection, Austin, Tex., Carl Hartmann.

Epistenia polita (Say)

Spalangius politus Say, 1828, p. 79

Epistenia polita (Say).—Gahan, 1951, p. 174.

The type is lost and Gahan (1951) has selected a neotype. This specimen was taken at Washington, D.C., Sept. 15, 1944. The lost type specimen was said to have been collected on Senipuxent Island, Va.

Epistenia polita (Say) is characterized especially by smoky wings with the basal part of wings hyaline. It is a stout species and similar to *E. coeruleata* Westwood. From *E. coeruleata* it differs in having, except for the above mentioned color of the wings, a more rugose propodeum with large spiracles. The last segments of the gaster are also punctated in a stronger way than in *E. coeruleata* (see key and figs. 3b, 4b, 5b).

Male similar to female, but color more greenish.

SPECIMENS EXAMINED.—1 ♀, Alachua County, Fla., Apr. 16, 1947, Warner. 1 ♀, Lake Annie, Highlands County, Fla., Apr. 14–24, 1963, K. V. Krombein. 1 ♀, Archbold Biol. Sta., Highlands County, Fla., Apr. 14–24, 1963, K. V. Krombein. 1 ♀, Duval County, Fla., October 10, Brinkley (Florida Fruit Fly Trap Survey). 1 ♂, Kill Devil Hills, Dare County, N. C., July 30, 1958, K. V. Krombein.

Epistenia media, new species

FEMALE.—Dark blue with tint of violet (mixed with green) on face, collar, scapulae, scutellum, propodeum, and coxae. Occiput with tint of green, also anterior part of mesoscutum and below antennal sockets glistening with green. Legs except coxae dark yellowish brown. Funicle of antenna and wing veins dark brown. Apex of gaster black.

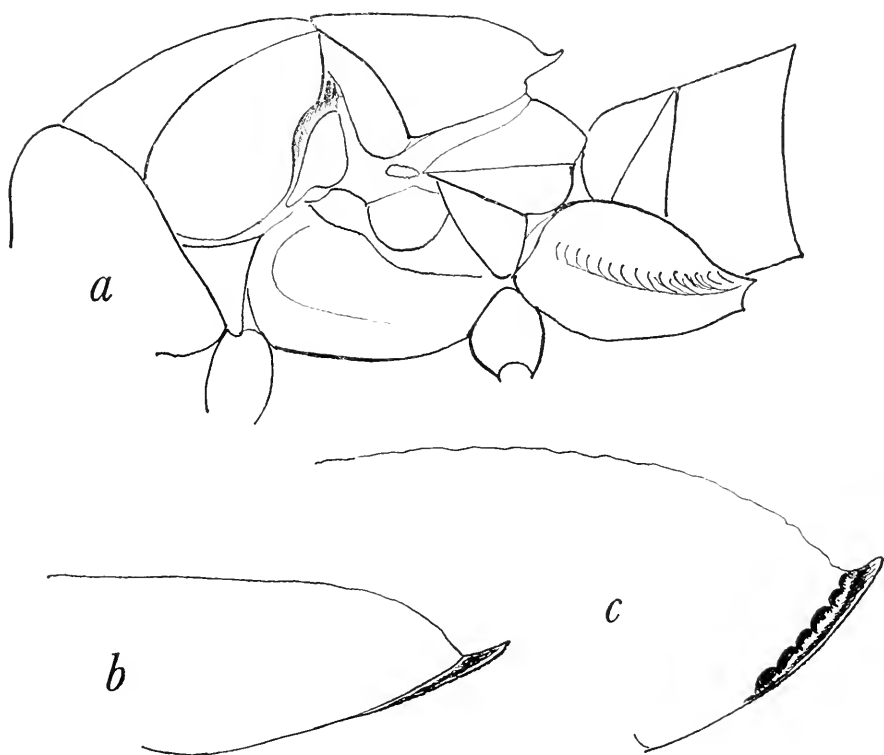

FIGURE 2.—*Epistenia coeruleata* Westwood: *a*, thorax in lateral view; *b*, scutellum in lateral view. *E. media*, new species: *c*, scutellum in lateral view.

Gaster short, only as long as head and thorax combined. First tergite of gaster as long as third (second not visible in dorsal view). Median ocellus with clava as long as funicle joints 5-7; funicle joints with few rhinariae. Distance from ocellus to antennal scrobe half diameter of an ocellus. Last tergite of gaster nearly as long as wide at base.

MALE.—Similar to female.

HOLOTYPE.—Female, in collection of USNM, no. 69557.

TYPE-LOCALITY.—Verdi, Washoe County, Nev., F. D. Parker.

ALLOTYPE.—Male, in same collection as holotype. Verdi, Washoe County, Nev., F. D. Parker.

PARATYPES.—1 ♀, Verdi, Washoe County, Nev., F. D. Parker. 1 ♀, 1 ♂, Verdi, Washoe County, Nev., Dec. 16, 1960, reared from elderberry stems, F. D. Parker. 1 ♀, same data, but Jan. 28, 1961.

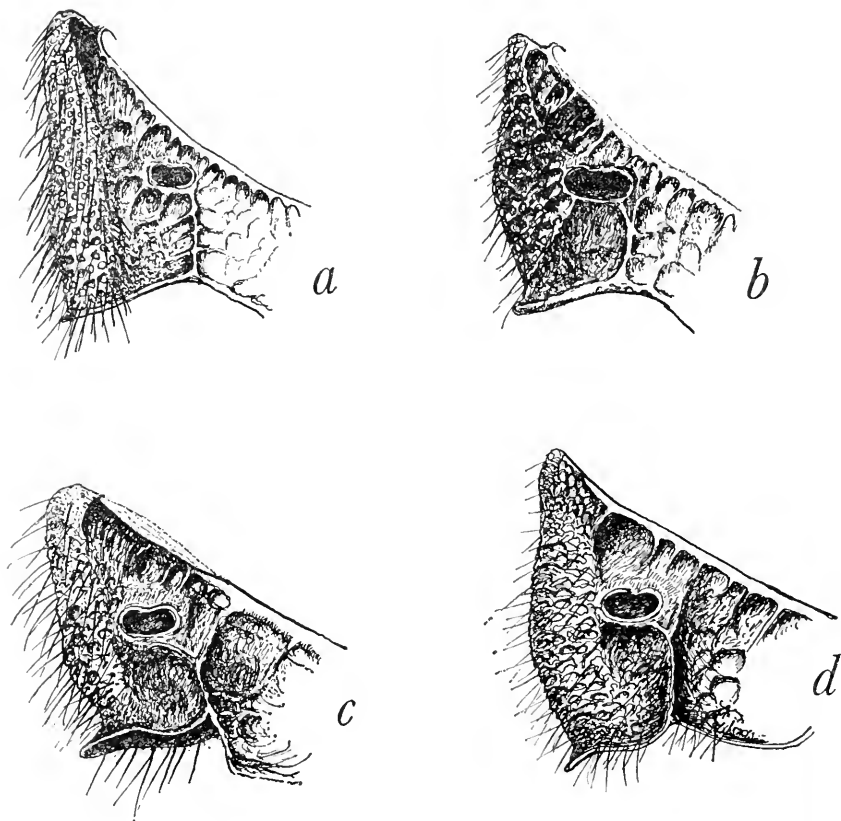

FIGURE 3.—Left part of propodeum, dorsal view: *a*, *Epistenia coeruleata* Westwood; *b*, *E. polita* (Say); *c*, *E. burksi*, new species; *d*, *E. media*, new species.

1 ♀, Putah Canyon, Yolo County, Calif., Nov. 20, 1960, reared from elderberry stems, F. D. Parker. 2 ♂, Putah Canyon, Yolo County, Calif., F. D. Parker, 1 ♂, Texas, Belfrage. 1 ♂, 1 ♀, Rochester, N. Y., K. W. C. Cooper. 1 ♀, Verdi, Washoe County, Nev., F. D. Parker. 1 ♀, Verdi, Washoe County, Nev., Jan. 28, 1961, reared from elderberry stems, F. D. Parker. 1 ♂, Putah Canyon, Yolo County, Calif.,

F. D. Parker. 1 ♂, Santa Cruz Mountains, Calif., 4 ♀, 5 ♂ paratypes in USNM collection.

REMARKS.—*Epistenia media* is very similar to *E. coeruleata* but differs in having the last tergite of the gaster shorter (see key and fig. 4*d*) and the propodeum is different. Funicle segments in *E. media* have fewer rhinariae than in *E. coeruleata*. Scutellum in lateral view (fig. 2*c*) has a different profile in *E. media* than in *E. coeruleata* or in *E. polita*.

It is difficult to separate the males of *E. media*, *E. polita*, and *E. coeruleata*. One can find small differences in the shape of the propodeum (fig. 3*d*), the profile of the scutellum (fig. 2*c*) and in the punctuation (see key and species descriptions).

Epistenia regalis Cockerell

Epistenia regalis Cockerell, 1934, pp. 228–229.

I have not seen any specimen of this species. According to the description, *E. regalis* has tegulae small and black. This is a character one may not find in the other species of *Epistenia*. *Epistenia regalis* has been included in the key in regard to this character. Dr. B. D. Burks has examined the type of this species, and his notes indicate that *E. regalis* is probably a synonym of *E. coeruleata*.

Epistenia coeruleata Westwood

Epistenia coeruleata Westwood.—Griffith, 1832, p. 432.

Dasyglenes osmia Ashmead, 1888, p. 174. [New synonymy.]

Dr. M. W. de V. Graham, Oxford, who has kindly compared specimens with the type of *E. coeruleata* Westwood at the British Museum (Natural History), has furnished the information that has aided me in understanding *E. coeruleata* Westwood.

It is a stout species with the last segment of the gaster long (figs. 4*a*, 5*a*), and the distance between the upper edge of the antennal scrobe and the front edge of the median ocellus is only about half the diameter of the ocellus. This latter character is variable, and among all the specimens I have studied there are few with the distance between the upper edge of the antennal scrobe and the front edge of the median ocellus nearly as long as the diameter of the ocellus. The head (figs. 1*a*, *b*) is nearly globular and the eye is elongate. For the differences between *E. coeruleata*, *E. polita*, and *E. media*, see the key and the discussion under *E. media* (see also figs. 1*d*, *e*, 2*a*, *b*, 3*a*).

I have failed to find a real character that separates *E. osmia* (Ashmead) from *E. coeruleata*, and for that reason I have made the former a synonym of the latter.

SPECIMENS EXAMINED.—1 ♀, Kill Devil Hills, N.C., Apr. 22, 1954, Karl V. Krombein. 2 ♀, Davis Mountains, Tex., July 2, 1940, D. J.

and J. N. Knull. 1 ♀, Verdi, Washoe County, Nev., F. D. Parker. 15 ♀, Verdi, Washoe County, Nev., F. D. Parker. 1 ♀, Verdi, Washoe County, Nev., reared from elderberry stems, Jan. 28, 1961, F. D. Parker. 2 ♀, Verdi, Washoe County, Nev., reared from elderberry stems, Jan. 25, 27, 1961, F. D. Parker. 1 ♀, Verdi, Washoe County, Nev., reared from elderberry stems, Dec. 16, 1960, F. D. Parker. 6 ♂, Verdi, Washoe County, Nev., reared from elderberry stems, Dec. 16, 1960, F. D. Parker. 1 ♀, Brownsville, Tex., May 22, 1935, J. N. Knull.

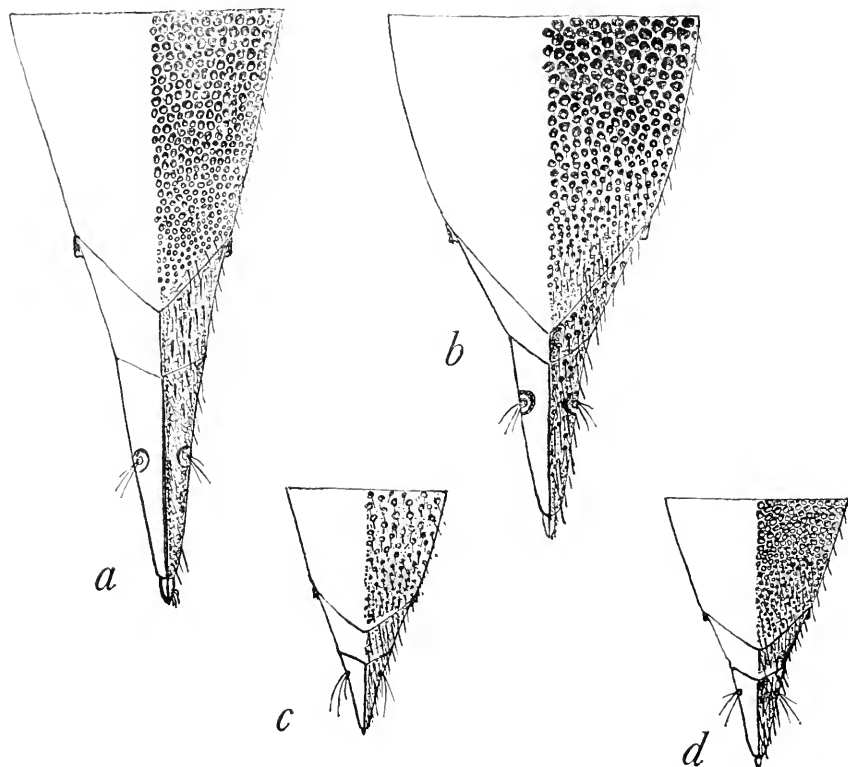

FIGURE 4.—Posterior part of gaster, dorsal view: *a*, *Epistenia coeruleata* Westwood; *b*, *E. polita* (Say); *c*, *E. burksi*, new species; *d*, *E. media*, new species.

1 ♀, Atlanta, Ga., July 22, 1942, P. W. Fattig. 1 ♀, Santa Cruz Mountains, Calif. 1 ♀, St. Louis, Mo., P. Rau. 1 ♀, Rochester, N.Y., K. W. Cooper. 1 ♂, S. Hampton, Mo., Mar. 30, 1922, P. Rau.

Genus *Macromesus* Walker

From Dr. B. D. Burks, U.S. National Museum, Washington, I have received specimens of a new species of *Macromesus* Walker for description.

Macromesus javensis, new species

FEMALE.—Length 2.0–2.5 mm. Head dark blue with tint of violet. Face below toruli testaceous with metallic tint of blue. Scape, pedicel, and first funicle segment yellowish brown. Thorax yellowish brown, along notaulices dark brown. Legs stramineous. Gaster blue with tint of violet. Wing veins pale yellowish brown.

Head (fig. 6*b*) semiglobular, eyes large. Antennae inserted just above level of ventral margin of eyes. Scape short, enlarged, not reaching median ocellus. All funicle segments elongate, much longer than wide. Punctuation of head consists of fine reticulation. Mesonotum with well-defined notaulices. Pro- and mesonotum, scutellum, and metanotum dorsally with equal reticulation. Propodeum medially shorter than length of metanotum, with six longitudinal carinae. Both head and thorax with few scattered black setae. Gaster longer than head plus thorax and with a stylet-shaped posterior part. Forewing (fig. 6*a*) with marginal vein longer than postmarginal vein.

MALE.—Length 1.9–2.2 mm. Similar to female, but gaster with more yellowish brown at anterior part of gaster. Propodeum with plicae; antennae with more setae on funicle segments.

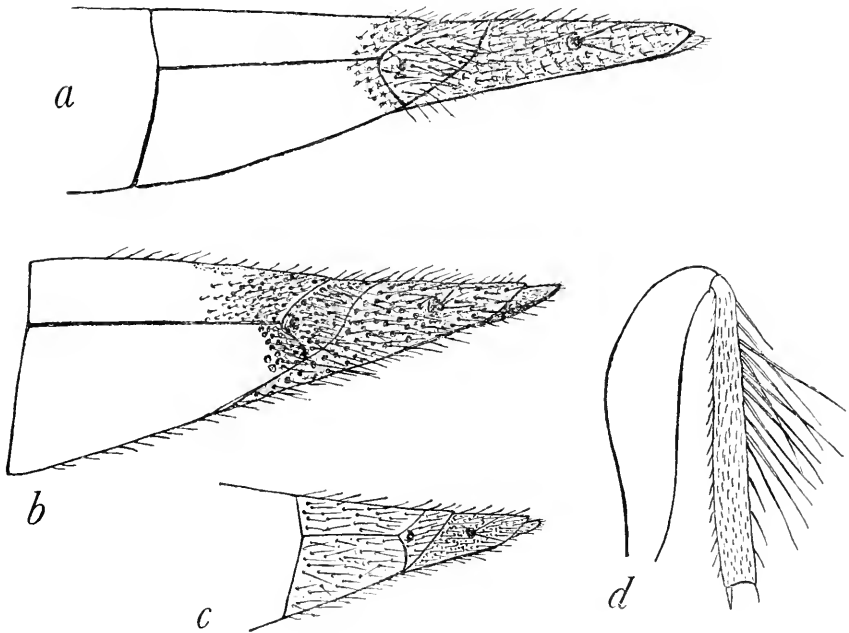

FIGURE 5.—Posterior part of gaster, lateral view: *a*, *Epistenia coeruleata* Westwood; *b*, *E. polita* (Say); *c*, *E. burksi*, new species. Hind femur and tibia: *d*, *E. odyneri* Ashmead.

HOLOTYPE.—Female, in collection of USNM, no. 69558, Bogor, Java, August 1964, *ex* scolytid-infested wood, N. L. H. Krauss.

ALLOTYPE.—Male, same data.

PARATYPES.—Six specimens (3 ♀ and 3 ♂) in collections of USNM and author. All paratypes from same locality as holotype.

REMARKS.—*Macromesus javensis* is related to *M. amphiretus* Walker but differs by having a shorter propodeum and different wing veins; the color of the two species also is quite different.

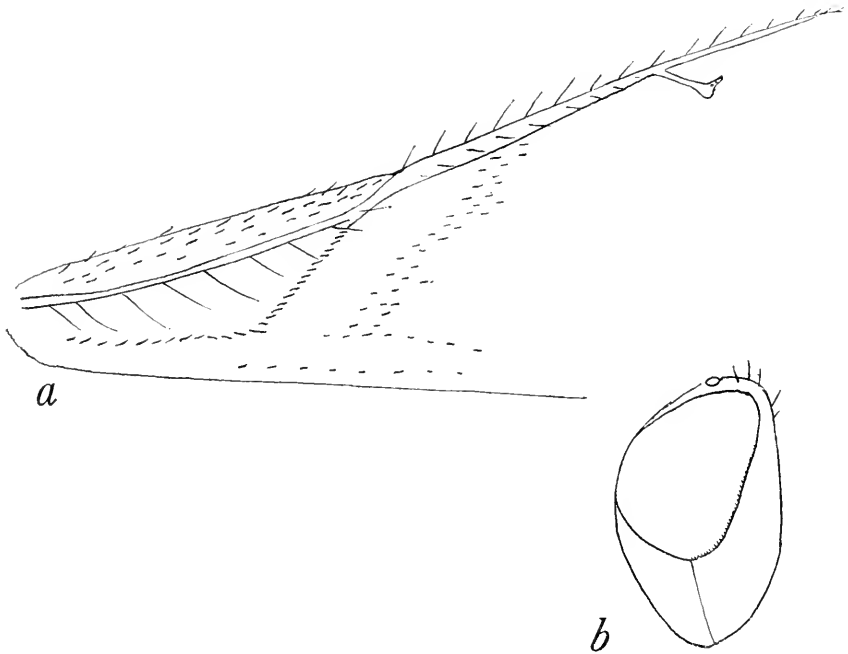

FIGURE 6.—*Macromesus javensis*, new species: *a*, forewing; *b*, head in lateral view.

The genus *Macromesus* now comprises five species distributed as follows: *M. amphiretus* Walker (Europe), *M. africanus* Ghesquière (Africa), *M. filicornis* (Delucchi) (Africa), and *M. americanus* Hedqvist (USA). *Macromesus javensis*, new species, is the first representative from the Indo-Malayan region. All species are known as parasites of woodboring beetles, especially of the family Scolytidae. The position of *Macromesus* in the Chalcidoidea is difficult to assess. I think it is best to place it provisionally in the Pteromalidae tribe Macromesini (see Graham, 1959; Ghesquière, 1963; and Szczepanski, 1959) and await the discovery of more species.

Literature Cited

- ASHMEAD, W. H.
1888. On the chalcidous tribe Chiropachides. Canadian Ent., vol. 20, pp. 172-176.
- COCKERELL, T. D. A.
1934. A species of *Epistenia* (Hymenoptera, Chalcidoidea) from Colorado. Psyche, vol. 41, pp. 228-229.
- DAVIDSON, M. D.
1896. Habits and parasites of a new California wasp. Psyche, vol. 7, pp. 335-336.
- GAHAN, A. B.
1951. Some synonymy and new combinations in Chalcidoidea (Hymenoptera). Canadian Ent., vol. 83, pp. 170-176.
- Ghesquière, J.
1963. Le genre *Macromesus* Walker nouveau pour la faune africaine. Rev. Zool. Bot. Africaine, vol. 67, pp. 1-2, 81-90.
- GRAHAM, M. W. R. DE V.
1959. Rediscovery of *Macromesus amphiretus* Walk. (Hym. Chalcidoidea, Pteromalidae) in Britain, with a discussion of its systematic position. Ent. Monthl. Mag., vol. 95, pp. 73-78.
- GRIFFITH, E.
1832. Insecta, vol. 2. Vol. 15 in The animal kingdom arranged in conformity with its organisation by the Baron Cuvier, pp. 1-570.
- HEDQVIST, K.-J.
1960. Notes on *Macromesus* Walk. (Hym. Chalcidoidea, Pteromalidae) and description of a new species. Ent. Tidskr., vol. 81, pp. 140-143.
- PARKER, F. D., and BOHART, R. M.
1966. Host-parasite associations in some twig-nesting Hymenoptera from western North America. Pan-Pacific Ent., vol. 42, pp. 91-98.
- RAU, P.
1922. Ecological and behavior notes on Missouri insects. Trans. Acad. Sci. St. Louis, vol. 24, no. 7, pp. 1-171.
- SAY, T.
1828. Descriptions of new species of *Hymenoptera* of the United States. Contr. Maclurian Lyc. Philadelphia, vol. 1, pp. 67-83.
- SZCZEPANSKI, H.
1959. przyczynek do systematyki i Biologi *Macromesus amphiretus* Walk. (Hym. Pteromalidae). Zeszy. Nauk. SGGW, Lesnictwo, vol.3, pp. 97-104.

Proceedings of
the United States
National Museum



SMITHSONIAN INSTITUTION • WASHINGTON, D.C.

Volume 124

1968

Number 3640

New Records of Birds
from the Hawaiian Leeward Islands ¹

By Roger B. Clapp and Paul W. Woodward ²

In the spring of 1963 the Pacific Ocean Biological Survey Program (POBSP) of the Smithsonian Institution began periodic surveys of the islands of the Central Pacific between latitudes 30° N and 10° S and between longitudes 150° and 180° W. The surveys were designed to amass varied and detailed data on the biota of the area in order that a much more complete understanding of its nature might be developed than was previously possible. One of the Program goals was simply to discover what birds occurred on the different islands and to determine more precisely their exact status on each island. (For a more thorough discussion of POBSP aims and objectives, see Humphrey, 1965.)

From February 1963 through March 1967 POBSP field workers or research teams participated in 18 expeditions to one or more of the Hawaiian Leeward Islands and made biological surveys of them for periods of from one to six days. For much of the entire period a permanent field station was operated on Kure Atoll, and three more extended surveys, each of slightly more than a month's duration, were made on French Frigate Shoals.

As one result of these surveys, a great many new distributional records were obtained. This paper presents new and unusual records of

¹ Paper No. 19, Pacific Ocean Biological Survey Program.

² Clapp, Research Curator; Woodward, Research Assistant: POBSP, Department of Vertebrate Zoology.

birds from the Hawaiian Leeward Islands of Nihoa, Necker, French Frigate Shoals, Gardner Pinnacles, Laysan, Lisianski, Pearl and Hermes Reef, Midway, and Kure. The records here presented are primarily of specimens collected from February 1963 through March 1967 by members of the Pacific Ocean Biological Survey Program although we include some well-documented sight records as well. In addition, Dr. Alexander Wetmore, who visited the Hawaiian Leewards in 1923 (see Wetmore, 1925), has kindly permitted us to report several previously unreported specimens obtained by him during his trip.

Common and scientific names are taken from the "American Ornithological Union Checklist" (AOU, 1957), Vaurie (1959, 1965), and King (1967). Procellariiformes, gulls, and terns are from King, and all other species are from the "A. O. U. Checklist" or, when not in that list, from Vaurie. Major alternatives of the common names are listed in parentheses.

Order of the species accounts follows Peter's "Checklist" (1931-1967) and Mayr and Greenway (1956), with the exception of the Procellariiformes, which conform to the recent recommendations of W. B. Alexander, et al. (1965).

Whenever possible, the age of vagrant birds was determined to discover whether their occurrence might be restricted to a particular age-class. Many of the vagrants, however, were found as long-dead, very partial remains; consequently, no such determinations could be made.

A number of the shorebirds collected during the fall could be aged by the shape of the tibio-tarsus. In young of the year this bone becomes gradually thicker from the distal to the proximal end, whereas, in adults, the sides of the legs are almost parallel for most of their length and then flare out abruptly at the proximal end (R. Zusi, pers. comm.). This character is not reliable during the spring and is considerably more difficult to determine in the smaller species of shorebirds. We thus include here ages for only those birds for which we believe that our age-determinations are completely reliable.

Gulls and ducks were aged by plumage characters when possible. Kortright (1942) and the "British Handbook" (Witherby, 1939) were used as sources of age characters for ducks; the latter work (Witherby, 1941) and Dwight (1901) were used for gulls. Molt terminology in these sources and in this paper conforms to Dwight (1900, 1901).

Many of the plumages observed in the specimens of gulls and ducks are aberrant in that molt in some feather tracts was considerably retarded, presumably in response to abnormal environmental or physiological conditions.

Table 1, at the end of the species accounts, summarizes the new distributional records of birds from the Hawaiian Leeward Islands.

ACKNOWLEDGMENTS.—The authors gratefully acknowledge those members of the Pacific Ocean Biological Survey Program who made the collections and observations upon which this paper is based. These people are referred to by last name only in the species accounts: A. Binion Amerson, Jr., Alan H. Anderson, David A. Bratley, Richard S. Crossin, Paul G. Dumont, Robert R. Fleet, C. Douglas Hackman, Brian A. Harrington, Lawrence N. Huber, J. Vincent Hoeman, Cameron B. Kepler, Warren B. King, T. James Lewis, James P. Ludwig, Robert W. McFarlane, Ralph W. Schreiber, Fred C. Sibley, Dennis L. Stadel, Robert S. Standen, Max C. Thompson, Jeffrey P. Tordoff, William O. Wirtz, II, and George S. Wislocki.

We also express our appreciation to Dr. Richard L. Zusi, Dr. Charles A. Ely, Dr. Robert L. Pyle, A. Binion Amerson, Jr., and David Bridge, all of whom criticized the manuscript. Dr. Alexander Wetmore, Dr. Clayton M. White, Dr. Lester L. Short, Jr., Dr. George E. Watson, Dr. Charles A. Ely, Mrs. Roxie C. Laybourne, David Bridge, Patrick J. Gould, Robert A. Sundell, and Max C. Thompson helped us with specific and subspecific determinations. Mrs. Laybourne was also especially helpful in aging gulls and ducks. We should especially like to thank Dr. George E. Watson for his encouragement and advice in the preparation of the manuscript.

DISCUSSION.—One hundred new distributional records of 68 species of birds are reported herein, including 16 records of species previously unrecorded from either the main Hawaiian Islands or the Hawaiian Leeward Islands. In addition, specimen verification is given for eight species whose presence in the Hawaiian or Leeward Islands heretofore has been based solely on sight records.

Eighty of the 100 new records are from but four islands: Gardner Pinnacles, Pearl and Hermes, Kure, and Midway. This preponderance of records from the first three of these islands is in part an indication of the relative frequency with which these islands had been visited by observers in the past but reflects to only a slightly lesser degree differences in habitat from island to island.

Kure, Pearl and Hermes, and Gardner Pinnacles have been surveyed very infrequently prior to POBSP visits and few of these visits were reported subsequently. Midway, at the other extreme, has been surveyed and reported upon more frequently than any other Leeward Island. Nonetheless, continued observation by the POBSP on this island has resulted in more new records than for any other islands but Kure and Pearl and Hermes.

The presence of certain habitats on Midway, those presumably most attractive to the kinds of migrants and vagrants (e.g., ducks,

shorebirds, gulls) of most frequent occurrence in the Leewards, certainly accounts in large part for the increment of new records. Near the overrun area of the main airstrip is a series of small ponds that probably attract wandering ducks and gulls. These ponds almost always have muddy margins that are particularly attractive to shorebirds. Adjacent to these ponds is a several-hundred-yard-long strip of low ground, often marshy during rainy periods, that, at times, has ducks and large numbers of shorebirds foraging on and around it. The ponds and the area nearby, from which most new records for Midway have been taken, are referred to as the "overrun ponds" and "overrun area" in the species accounts.

The new and unusual records obtained by the POBSP fall into two categories. One group of records is of species that regularly occur in the Hawaiian chain but which represent new records for individual islands. These records of migrants and winter residents or breeding birds scarcely can be considered unusual, but it is worthwhile to document their occurrence where heretofore unrecorded. Some of these constitute not only new distributional records but also breeding locality records: Christmas shearwater (*Puffinus nativitatus*), Bulwer's petrel (*Bulweria bulwerii*), sooty storm petrel (*Oceanodroma tristrami*), red-tailed tropicbird (*Phaethon rubricauda*), brown booby (*Sula leucogaster*), gray-backed tern (*Sterna lunata*), brown noddy (*Anous stolidus*), and black noddy (*Anous tenuirostris*).

The other group of records is of species of uncommon or seldom documented occurrence in the Hawaiian Leeward Islands. These records consist of petrels, ducks, shorebirds, gulls, and a heterogenous group of accidentals, composed mainly of vagrant passeriforms but including wandering birds of prey, an alcid, and a coot. A large number of these forms are Palearctic in origin.

Some of the procellariiforms were birds that normally occur at sea in the vicinity of the Leewards and that washed up on the beach—northern fulmar (*Fulmarus glacialis*), sooty shearwater (*Puffinus griseus*), and Leach's petrel (*Oceanodroma leucorhoa*). Others had straggled far from their known range—little shearwater (*Puffinus assimilis*), Kermadec petrel (*Pterodroma neglecta*), and Murphy's petrel (*Pterodroma ultima*).

Of the migrant ducks, some records are of species that occur frequently in the main Hawaiian Islands in winter—American widgeon (*Mareca americana*) and shoveler (*Spatula clypeata* [see Medeiros, 1958]). These birds may have come from North America although the shovelers could have wandered eastward from the Old World. Other records involve species only known to breed in the Old World—garganey teal (*Anas querquedula*), European widgeon (*Anas penelope*), and tufted duck (*Aythya fuligula*), whereas the common teal (*Anas*

crecca) may have been either of North American or Asiatic derivation since specimen material was inadequate for subspecific determination.

Judging from their moderate to very heavy fat deposits, some of these ducks were strong and healthy—two common teal and a European widgeon. Most of the ducks, however, had little or no fat, were emaciated, or were found as beach-worn remains. This suggests that a majority of ducks reaching the islands fail to survive the winter. Tufted ducks, in particular, fared very badly. Only two of the eight specimens obtained were strong enough to fly. Three of the others were so weak that they were captured by hand and the remaining three were found dead.

Records of wandering and migrant shorebirds are comprised, in part, of species that, although on the "Hawaiian Check List" (Bryan, 1958) or its supplement (Udvardy, 1961b), are not verified by Hawaiian specimen records—greater yellowlegs (*Totanus melanoleucus*), lesser yellowlegs (*Totanus flavipes*), knot (*Calidris canutus*), and long-billed dowitcher (*Limnodromus scolopaceus*). Other shorebird records are of species previously unreported in the Hawaiian and Leeward Islands—dotterel (*Eudromias morinellus*), pintail snipe (*Capella stenura*), Polynesian tattler (*Heteroscelus brevipes*), short-billed dowitcher (*Limnodromus griseus*), marbled godwit (*Limosa fedoa*), ruff (*Philomachus pugnax*), and one species whose basis for inclusion in the Hawaiian fauna (AOU, 1957) we have not been able to discover: wood sandpiper (*Tringa glareola*). Five of these seven species breed primarily in the Old World. Since many of the sight records of shorebird species reported from the main Hawaiian Islands by Bryan and Udvardy and in the recent issues of "Elepaio," are North American species that may be confused easily with Old World species (e.g., *Charadrius semipalmatus* with *C. hiaticula*, *Erolia minutilla* with *E. temmincki*, "common snipe" with several Old World *Capella* species), it is important that such records be substantiated by specimens.

Gulls, particularly immatures, are frequent wanderers to the Hawaiian and Leeward Islands. Of the seven species of gulls collected in the Hawaiian Leeward Islands by the POBSP, only one, the slaty-backed gull (*Larus schistisagus*), is previously unknown from the area. In this group of birds, as in the shorebirds and ducks, both Old and New World species are present. Two species, Franklin's gull (*L. pipixcan*) and ring-billed gull (*L. delawarensis*), are North American; two forms, herring gull (*L. argentatus vegae*) and slaty-backed gull (*L. schistisagus*), are Palearctic; and three, glaucous-winged gull (*L. glaucescens*), glaucous gull (*L. hyperboreus*), and black-legged kittiwake (*Rissa tridactyla*), are Holarctic.

Twelve of the 39 gull specimens were found dead, either recently dead or as partial remains, indicating that many (if not most) of the

gulls die on the islands to which they have wandered. The larger gulls (herring, glaucous, glaucous-winged, slaty-backed) apparently survive longer on the Leeward Islands than do the smaller species (ring-billed, Franklin's, and black-legged kittiwake). Of the 31 specimens of larger gulls, only six were found dead (two glaucous gulls and four glaucous-winged gulls). On the other hand, two of the eight smaller gulls (a ring-billed gull and a black-legged kittiwake) were alive when collected, and one of these, the kittiwake, was injured.

Thirty-four of the 39 gull specimens were subadult birds. Six of these 34 specimens were in too poor condition to allow accurate aging. Of the remaining 28, 10 were in first winter plumage, 13 were in first nuptial plumage, one was molting into second winter plumage, and four were in second winter plumage.

Frings (1965a, 1965b), Amadon (1965), and more recently, Sibley and McFarlane (in press) have discussed reasons why gulls have not become established on tropical oceanic islands. Frings has suggested that both nonadaptability to local food sources and inefficient production of fresh water by salt gland secretion may in part account for the absence of gulls on most oceanic islands. Amadon suggested that unavailability of food is the more probable cause of their absence. Sibley and McFarlane have discussed the problem at length, pointing out reasons why neither hypothesis is likely to be a wholly sufficient answer.

Of the remaining records, some species evidently wandered from the main Hawaiian Islands, where they have breeding populations—black-crowned night heron (*Nycticorax nycticorax*), American coot (*Fulica americana*), mockingbird (*Mimus polyglottos*), and house sparrow (*Passer domesticus*). One hawk (*Circus cyaneus hudsonius*) was of North American derivation but another (*Falco peregrinus pealei?*) was a North Pacific form. The alcid (horned puffin, *Fratercula corniculata*) may have come from either North America or Asia. The barn swallow (*Hirundo rustica gutturalis*), red-throated pipit (*Anthus cervinus*), water pipit (*Anthus spinoletta japonicus*), and skylark (*Alauda arvensis pekinensis*) are Palearctic forms, whereas the snow bunting (*Plectrophenax nivalis townsendi*) is represented by the Pribilof-Aleutian form.

Species Accounts

Northern Fulmar (Fulmar)

Fulmarus glacialis rogersii

POBSP personnel have obtained four fulmar specimens that washed up on the beach on Green Island, Kure Atoll, in early 1964. The first specimen (USNM 492919), collected Jan. 16, 1964, was the only one

fresh enough to skin. It was referred to the race *F. g. rodgersii* by Sundell. The other three specimens (USNM 498110, February 26; USNM 498111, March 28; and USNM 498112, March 30) were skeletonized.

On Sand Island, Midway Atoll, Bratley collected two partially decomposed fulmars that he found 100 feet apart on the north beach Aug. 15, 1964. Both birds were preserved subsequently as skeletons (USNM 498113, 498114).

The earliest record from the Hawaiian area, however, is a hitherto unreported beach-dried mummy (USNM 489327) found on the beach of Tern Island, French Frigate Shoals, and collected by Wetmore, June 25, 1923.

Fulmars have been reported previously from Oahu (King, 1959a) and from Midway Atoll (Fisher, 1965), but none have been reported previously from either Kure Atoll or French Frigate Shoals.

Fulmarus g. rodgersii breeds from Siberia to the Pribilof and Aleutian Islands (AOU, 1957).

Murphy's Petrel

Pterodroma ultima

A female (USNM 492988) collected by Ludwig, Oct. 7, 1963, on Green Island, Kure Atoll, and another female (USNM 497224) collected by Harrington as it flew over Tern Island, French Frigate Shoals, on Sept. 9, 1966, are being reported by Gould and King (in press). There are no previous records of this petrel from any of the islands of the main Hawaiian or Hawaiian Leeward groups.

This little-known petrel breeds only on some of the islands of the Austral and Tuamotu groups in the Central Pacific (Murphy, 1952).

Kermadec Petrel

Pterodroma neglecta

A male (USNM 300679) collected on Green Island, Kure Atoll, Apr. 30, 1923, by Wetmore is being reported by Gould and King (in press). The present specimen constitutes the first specimen record from any of the islands of the Hawaiian area.

This species nests on islands in the South Pacific from the Juan Fernandez Islands in the east to Lord Howe Island in the west and recently has been seen frequently at sea in the Central Pacific (Gould and King, *ibid.*).

Bulwer's Petrel

Bulweria bulwerii

Sibley and Amerson estimated that an adult population of 25 Bulwer's petrels was present on Gardner Pinnacles June 16, 1963. Ten nests were found and all contained eggs.

POBSP personnel have found Bulwer's petrels on Southeast Island, Pearl and Hermes Reef, on three separate occasions. Fifteen adults and three nests with eggs were found June 18-22, 1963; five adults were seen Aug. 16-19, 1964; and one large young was found Sept. 25-27, 1966.

This species previously has been reported breeding on Nihoa, Necker, Laysan, Midway, and French Frigate Shoals in the Hawaiian Leewards (Bailey, 1956; Richardson, 1957), but it has not been reported previously from either Gardner Pinnacles or Pearl and Hermes Reef.

Sooty Shearwater

Puffinus griseus

Bratley found a sooty shearwater carcass (USNM 496201) washed up on the beach May 18, 1965, on Green Island, Kure Atoll. Six more specimens were taken at the same locality by Woodward in the spring of 1966 (USNM 496557, Apr. 23, 1966; USNM 498253, 498254, May 4, 1966; USNM 496558, May 19, 1966; USNM 496559, 496560, May 28, 1966). Five of these specimens were dead birds that washed up on the beach. One specimen (USNM 496558) was captured alive as it swam in the lagoon.

This species breeds in Tasmania, on the islands in the New Zealand area, and on islands near Cape Horn (AOU, 1957). Sooty shearwaters are regular migrants through the Central Pacific and have been reported previously from Oahu, in the main Hawaiian Islands (Woodside and Walker, 1964), and from Midway Atoll (Kenyon and Rice, 1957; Fisher, 1965), and Laysan Island (Bailey, 1956) in the Hawaiian Leeward Islands. They have not been recorded previously from Kure Atoll.

Christmas Shearwater

Puffinus nativitatus

The POBSP collected specimens of Christmas shearwaters from one island of the Leeward Islands from which they had not been recorded before. These specimens (USNM 492965, Mar. 7, 1963; USNM 492966, Feb. 26, 1963) were collected on Southeast Island, Pearl and Hermes Reef.

Since there are no previous records for this island and since Robbins (1966) gave no details of his observations of breeding birds on Green Island, Kure Atoll, we include here a short summary of POBSP breeding data from these islands for the period 1964-1966 as follows:

Kure Atoll, Green Island: Christmas shearwaters are present on Kure Atoll from March to October, reaching their peak numbers (about 100 adults) during the peak of the nesting season, which occurs from May through August. Nests with eggs have been found in the

months of April, May, and June; downy chicks were present in June and July; and nearly fledged birds were present in September and October. The breeding cycle as indicated by our data is quite similar to that reported for other islands in the Leeward chain.

Pearl and Hermes Reef, Southeast Island: Far fewer Christmas shearwaters occur on Pearl and Hermes Reef than on Kure Atoll. The largest number of adults present was about 20 birds Sept. 25-27, 1966, with smaller numbers having been recorded in the months of March, June, and August. Nests have been found on two occasions (a nest containing an egg June 18-22, 1963, and three nests with young Sept. 25-27, 1966).

This species previously has been reported breeding on Nihoa, French Frigate Shoals, Laysan, Lisianski, Midway, and Kure in the Hawaiian Leeward Chain (Richardson, 1957; Robbins, 1966).

Little Shearwater

Puffinus assimilis (*assimilis*?)

On Feb. 18, 1963, Amerson collected a male little shearwater (USNM 492974) in a colony of Bonin petrels (*Pterodroma hypoleuca*) near the Chief Petty Officers' Club on Sand Island, Midway Atoll. The testes of the specimen were 4 mm long, indicating that the bird was not breeding. This specimen constitutes not only the first record for any of the Hawaiian Islands, but it is also the first record for the North Pacific Ocean.

Dr. Alexander Wetmore, who compared the specimen with material at the American Museum of Natural History, informed us that in most regards the present specimen matches those of the race *P. a. assimilis* but that it has more white on the under-tail coverts than is typical of *P. a. assimilis*. *Puffinus assimilis* breeds on the Norfolk and Lord Howe Islands in the southwestern Pacific (Murphy, 1927).

Leach's Storm Petrel

Oceanodroma leucorhoa leucorhoa

(Leach's Petrel)

On May 10, 1964, Wislocki found a Leach's storm petrel (USNM 494243) washed up on the beach of Green Island, Kure Atoll. The specimen was identified subsequently as *O. l. leucorhoa* by Gould. A second Leach's storm petrel that washed up on the beach was collected at the same locality Dec. 21, 1964, and was preserved subsequently as an alcoholic (USNM 503371). No Leach's storm petrels have been reported hitherto from Kure Atoll or any of the other Hawaiian Leeward Islands.

Bryan (1965) reported another specimen that washed up on the beach on Oahu and that was collected Oct. 26, 1964. Still another specimen that washed up on the beach at Oahu was collected Jan. 5, 1967 (Throp, 1967).

These specimens and others taken at sea near the main Hawaiian Islands (POBSP, unpubl. data) suggest that some earlier sight records attributed to the very similar Harcourt's storm petrel (*Oceanodroma castro*) may in fact have been records of Leach's storm petrel (e.g., records by Munro at sea near Necker Island and Gardner Pinnacles and by Palmer between Kauai and Niihau [Munro, 1944]).

The subspecies *O. l. leucorhoa* breeds on the coast of Japan and in the Kurile, Komandorskie, and Aleutian Islands (AOU, 1957). It winters south to at least the equator in the Central Pacific (P. J. Gould, pers. comm.) and even further south in the eastern Pacific (G. E. Watson, pers. comm.).

Sooty Storm Petrel
(Tristram's Petrel)

Oceanodroma tristrami

POBSP personnel have collected five sooty storm petrel specimens on Green Island, Kure Atoll. The first specimen (USNM 493026, Jan. 1, 1964), a male with enlarged gonads, was one of two birds that were observed digging at the base of a clump of grass (*Lepturus*). Two other specimens collected, a female (USNM 494358, Mar. 1, 1965), and a male (USNM 496223, Dec. 12, 1965) had decidedly enlarged gonads. A female (USNM 497297) collected Jan. 3, 1967, had only slightly enlarged gonads.

Other sooty storm petrels were seen occasionally from 1963 to 1967 in the months from November through January, but no nests have been found. Two sooty storm petrels were seen excavating a burrow on Apr. 2, 1964. One bird examined in the field during the period from Dec. 30, 1966 through Jan. 5, 1967 had a completely bare brood patch and another had a partially bare brood patch. It seems very likely that one or more pairs may have nested on Kure Atoll in the last four years.

On Mar. 14, 1967, Hackman found two sooty storm petrel chicks, one downy and very small, the other about three-quarters grown, on Whale-Skate Island, French Frigate Shoals. Both chicks were found in shallow burrows under the grass.

In the Hawaiian Leeward Chain this species has been reported breeding on Laysan, Pearl and Hermes, Midway, and perhaps Necker (Richardson, 1957) and has been reported from Nihoa as well (Bryan and Greenway, 1944). None have been reported previously from either Kure Atoll or French Frigate Shoals.

Red-billed Tropicbird

Phaethon aethereus mesonauta

On June 15, 1923, Wetmore collected an immature female red-billed tropicbird (USNM 300977) as it flew over Nihoa Island. The only other record from the vicinity of the Hawaiian Islands is Moynihan's

(1957) sight record of two red-billed tropicbirds on Sand Island, Johnston Atoll, in early April 1957.

In the Pacific this species breeds from the Gulf of California and the Revilla Gigedo Islands to the Galapagos and islands near the coast of Ecuador (AOU, 1957).

Red-tailed Tropicbird

Phaethon rubricauda

Munro (1942) reported that he had seen "tropicbirds" flying over Pearl and Hermes Reef in July 1891. We have found no other literature records pertaining to the occurrence of this species on Pearl and Hermes Reef. Red-tailed tropicbirds have been reported previously from all the rest of the Hawaiian Leeward Islands (Bryan and Greenway, 1944; Richardson, 1957; Kenyon and Rice, 1958). A summary of POBSP observations of red-tailed tropicbirds on Pearl and Hermes Reef is given for each island as follows:

Southeast Island: An estimated 15 adults present Feb. 28–Mar. 8, 1963; about 80 adults, five nestlings, and 24 eggs June 18–22, 1963; six adults and two eggs Mar. 13, 1964; 15 adults, three nestlings, and three eggs Aug. 16–19, 1964; 15 adults and three nestlings Sept. 16–17, 1964; 15 adults and three nestlings Mar. 15–17, 1965; 10–15 adults and four eggs Sept. 7, 1966.

North Island: About 60 adults, four nestlings, and 15 eggs June 23–24, 1963; about 40 adults, 15 nestlings, and one egg Aug. 19–20, 1964; 10 adults and one nestling Sept. 17, 1964; 5–10 adults and two eggs Mar. 17–18, 1965; about 10 adults and two eggs Mar. 21–23, 1967.

Seal Island: Twenty adults and six eggs June 26, 1963; 15 adults and two nestlings Aug. 18, 1964.

Grass Island: Five adults and two eggs June 26–27, 1963; eight adults and one nestling Aug. 18, 1964; one seen over island Mar. 22, 1967.

White-tailed Tropicbird

Phaethon lepturus

Kepler observed a white-tailed tropicbird as it flew low over the east beach of Green Island, Kure Atoll, Feb. 6, 1965. This species breeds in the Hawaiian Islands (AOU, 1957), has been reported breeding on Midway Atoll (Bailey, 1956), but has not been reported previously from Kure Atoll.

Red-footed Booby

Sula sula

Sibley and Amerson observed an immature or subadult red-footed booby roosting on Gardner Pinnacles, June 16, 1963. The red-footed booby, a species of pantropical distribution in the world's oceans,

breeds commonly on most of the islands of the Hawaiian Leeward Chain (Richardson, 1957), but its occurrence on Gardner Pinnacles has not been reported previously.

Brown Booby

Sula leucogaster

Sibley and Amerson found a brown booby incubating two eggs on Gardner Pinnacles, June 16, 1963. The occurrence and breeding of this species on Gardner Pinnacles has not been reported previously. The brown booby, a widespread inhabitant of tropical oceans, has been reported breeding on most of the other islands of the Hawaiian Leeward Chain (Richardson, 1957).

Black-crowned Night Heron

Nycticorax nycticorax (hoaetli?)

Woodward found the partially decomposed remains (USNM 496776) of a black-crowned night heron in *Scaevola* bushes on Green Island, Kure Atoll, June 3, 1966. The specimen, an adult, has the following measurements: wing (chord) 295 mm, culmen 77 mm, and tarsus 80 mm. These measurements are well within the range given for female *Nycticorax n. hoaetli* by Peters (1930) and are larger than those given for either sex of *N. n. nycticorax*. The race *N. n. hoaetli* breeds in the main Hawaiian Islands and has wandered previously to Midway Atoll, 57 miles to the east of Kure (Bryan and Greenway, 1944).

Garganey Teal

Anas querquedula

On Sept. 17, 1963, Ludwig collected two juvenile garganey teal, a male and a female, from an overrun pond on Sand Island, Midway Atoll (USNM 493451, 493452). These birds constitute the first specimen records from any of the islands of the Hawaiian area although this teal has been seen on two other occasions. Walker (1961) reported seeing one at a pond near Hilo, Hawaii, Mar. 20, 1961, and Gauthey (1967) reported a drake seen at Kahuku, Oahu, Mar. 21, 1967.

This species breeds across northern Eurasia and winters from northern Africa and the Philippines south to equatorial Africa, the Seychelles, southern Asia, and casually to Australia (Vaurie, 1965).

Common Teal

Anas crecca

(Green-winged Teal)

In 1963 Ludwig collected four teal from the overrun ponds on Sand Island, Midway Atoll, two, a male and a female, on November 13 (USNM 493479, 493480) and two moderately fat females on December 4 (USNM 493455, 493456). At least five more teal were present.

Since the specimens are all juveniles molting into their first winter plumage, no subspecific identifications can be made.

In years past specimens have been collected on Laysan, Maui, and Molokai (Bryan and Greenway, 1944). At least 15 sight records of teal on Oahu, Maui, and Hawaii have appeared in the "Elepaio" since 1940, indicating that these teal are probably regular visitors to the main Hawaiian Islands.

Teal, either *A. c. crecca* or *A. c. carolinensis*, previously have been reported only from Laysan and Midway in the Hawaiian Leeward Islands. Rothschild (1893-1900) reported that Schauinsland had collected a female on Laysan, Oct. 27, 1896. Fisher (1965) reported that small groups of three to eight birds are not uncommon on the brackish pond at Sand Island, Midway Atoll.

This species breeds across Eurasia and North America (AOU, 1957).

European Widgeon

Mareca penelope

Clapp collected a female, an adult molting into winter plumage, on Sand Island, Midway Atoll, Jan. 12, 1965 (USNM 493458). On Green Island, Kure Atoll, an emaciated second winter female was captured by Coast Guard personnel Nov. 10, 1964 (USNM 494359), and Lewis shot a first winter female there on Nov. 14, 1965 (USNM 496208). These specimens are not only the first records for Kure and Midway Atolls, but also they are the first specimens collected on any of the islands of the Hawaiian area.

This Eurasian species is a regular visitor to both coasts of North America (Vaurie, 1965) and has been seen on Oahu and Hawaii (Udvardy, 1961b).

American Widgeon

Mareca americana

Ludwig found the remains of an American widgeon at an overrun pond on Sand Island, Midway Atoll, Dec. 4, 1963 (USNM 496202). On Jan. 12, 1964, Clapp saw four more American widgeons in the same area and collected a very fat adult male (USNM 493457) that was molting into winter plumage.

These specimens are the first that have been collected on Midway, but Kenyon and Rice (1957) saw at least two birds of this species on Eastern Island, Midway Atoll, during the winter of 1956-57. Two more were seen by Fisher (1965) on Sand Island, Nov. 30, 1963. Laysan Island is the only other island in the Hawaiian Leewards on which an American widgeon specimen has been taken (Bryan and Greenway, 1944).

This duck breeds primarily in northwestern North America from Alaska to Wisconsin south to Colorado and northeastern California

(AOU, 1957) and is a regular winter visitor in small numbers in the main Hawaiian Islands (Udvardy, 1961a).

Shoveler

Spatula clypeata

Ludwig saw two shovelers Dec. 4, 1963, on Sand Island, Midway Atoll. During the rest of the winter shovelers were seen there at least six times by POBSP personnel and yet another was seen there in mid-January 1966. On Apr. 30, 1964, Wislocki collected a male and a female (USNM 493584, 493585) both thin, second winter birds. These birds constitute the first specimen records from Midway Atoll.

The only other island in the Hawaiian Leewards from which shovelers are known is Laysan, where several sight records and one specimen have been obtained (Bailey, 1956). To these records we add a POBSP sight record of three shovelers that were seen on the small pond north of the lagoon Oct. 22, 1966.

This species breeds mainly in northern North America, northern Europe, and northern Asia, and is of casual occurrence in the main Hawaiian Islands (AOU, 1957).

Tufted Duck

Aythya fuligula

On Oct. 29, 1963, Wirtz caught an emaciated female tufted duck by hand at Green Island, Kure Atoll (USNM 493448). During the fall and winter of 1963, Clapp and Ludwig collected four of at least seven seen on the overrun ponds of Sand Island, Midway Atoll: November 13, ♀, USNM 493828; December 2, ♀, USNM 493450; and December 4, ♂, ?USNM 493449, 498077. These birds were either sick and emaciated or found dead.

The following fall Wirtz collected two more tufted ducks in the same area. One was shot Oct. 30, 1964 (?USNM 494360) and the other was found dead Nov. 1, 1964 (?USNM 498125).

Kepler saw another in the overrun ponds Oct. 25, 1965, and on Jan. 7, 1967, Huber found a dried carcass of yet another tufted duck (?USNM 497500) near the reservoir between the runways.

Those specimens that were preserved as skins (493448-493450, 493828, 494360) are all juveniles, many of which exhibit a considerably retarded molt.

The only other records from the Hawaiian Leewards are those of Fisher (1960, 1965). He shot an emaciated male on Dec. 5, 1959, at Sand Island, Midway Atoll, and saw five others there in December 1963, some of which are probably the same birds as those reported above.

The tufted duck breeds from Iceland and the Scandinavian Peninsula across northern Asia south to central Europe and central Asia.

It has been recorded as a vagrant in the Aleutian and Pribilof Islands (AOU, 1957).

Marsh Hawk
(Hen Harrier)

Circus cyaneus hudsonius

On Oct. 30, 1964, Wirtz was told by military personnel on Midway Atoll that two hawks with rusty underparts, white rumps, and unbarred tails, had been seen recently on the atoll. The following day, he collected an immature female marsh hawk (USNM 494360) as it quartered low over *Scaevola* on Eastern Island, Midway Atoll. This subspecies is found from Alaska south to northern Baja California and in other parts of North America (AOU, 1957).

Henshaw (1902) reported that several specimens had been taken in Oahu but gave no further details. The present specimen apparently is the first seen or collected in the Hawaiian area since the late 19th century.

Peregrine Falcon

Falco peregrinus (pealei?)

Standen collected a female peregrine falcon (USNM 494363) Mar. 7, 1965, as it flew over the beach and over *Scaevola* bushes at the western end of Green Island, Kure Atoll. The specimen, which was badly worn, had very dark underparts and a wing measurement of 377 mm. Dr. Clayton M. White (in litt.) informed us that he identified the specimen as *F. p. pealei* on the basis of the extremely heavily marked flanks and thighs but that "in every other regard the specimen is a match for darker examples of *F. p. japonensis*." *Falco p. japonensis* is a migratory race that breeds from northeastern Siberia to Kamchatka, the Kuriles, and northern Japan (Vaurie, 1965) while *F. p. pealei* is believed to be a more sedentary form that breeds in the Commander and Aleutian Islands and on islands off the coast of southern Alaska (Vaurie, 1965).

Another falcon, identified as a peregrine by POBSP personnel, was seen offshore of Lisianski Island Mar. 12, 1965, and over the island on March 13 and 14. On the 13th, a roost that the falcon evidently had been using was found in a *Casuarina* tree. The remains of many birds, at least three gray-backed terns (*Sterna lunata*), one black noddy (*Anous tenuirostris*), 47 ruddy turnstones (*Arenaria interpres*), and 20 golden plovers (*Pluvialis dominica*), found beneath the roost indicated that the falcon probably had been present on the island for at least a week or more before the arrival of the POBSP field party.

On Mar. 24, 1967, Hackman saw still another peregrine falcon, an adult, flying over the thickly inhabited section of Sand Island, Midway Atoll, accompanied by a large flock of white terns (*Gygis alba*). The

falcon had been present on the island since at least the preceding January (Hackman, pers. comm.).

Sight records of peregrine falcons have been reported from Hawaii by Dunmire (1961) and from Oahu by Ord (1966), anonymously (1966), and by Donaghho (1967). None have been reported previously from any of the Hawaiian Leeward Islands and no specimens have been reported from any of the Hawaiian Islands.

American Coot

Fulica americana

Amerson found a dead coot (USNM 503194) Aug. 11, 1965, on Tern Island, French Frigate Shoals. The bird was found in low *Messerschmidia* over 100 feet from the beach, suggesting that it had not been washed up on the beach. Coots breed on the main Hawaiian Islands but have not been recorded previously from French Frigate Shoals.

Black-bellied Plover (Grey Plover)

Squatarola squatarola

Clapp collected two black-bellied plovers, a male and a female (USNM 494120, 494121), Mar. 13, 1965, on the rocky east beach of Lisianski Island. A third specimen from Lisianski (USNM 496779), a female, was collected by Crossin June 18, 1966, as it fed along the shoreline. Single black-bellied plovers were seen by POBSP personnel on Green Island, Kure Atoll, in late October 1963 and in late May 1964.

This species breeds from north-central Russia to northern Alaska and southwestern Baffin Island and migrates along the Pacific coasts of both the Old and New Worlds (AOU, 1957). In the Leeward Hawaiian chain black-bellied plovers have been observed previously on Midway Atoll (Donaghho, 1953-1954) and have been collected previously on Laysan Island (Bailey, 1956). They have not been recorded previously from either Kure Atoll or Lisianski Island.

American Golden Plover

Pluvialis dominica

Fleet saw three American golden plovers on Necker Island Sept. 25, 1964, and Hackman saw two there Mar. 10, 1967. POBSP personnel have observed these plovers on the various islets of Pearl and Hermes Reef as follows:

Southeast Island: An estimated 40 present Feb. 26-Mar. 8, 1963; five seen June 18-22, 1963; three seen Mar. 13, 1964; one seen Aug. 16-19, 1964; about 150 present Sept. 16-17, 1964; "a few" seen Mar. 15-17, 1965; nine counted Mar. 21-22, 1965; about 175 present Sept. 27, 1966; 15-20 seen Mar. 21-23, 1967.

North Island: Three seen June 23–24, 1963; one seen Sept. 18, 1964; "a few" seen Mar. 17–18, 1965.

Seal Island: A "few" seen Mar. 18, 1965; two seen Mar. 22, 1967.

Kittery Island: A "few" seen Mar. 18, 1965; one seen Mar. 22, 1967.

Grass Island: A "few" seen Mar. 19, 1965; two seen Mar. 22, 1967.

This species is a regular winter visitor in the Hawaiian Leeward Islands (Bryan and Greenway, 1944), but it has not been reported previously from either Necker or Pearl and Hermes Reef.

Dotterel

Eudromias morinellus

Dumont captured an immature female dotterel (USNM 494299) in a mist net Sept. 9, 1964, on Green Island, Kure Atoll. The dotterel had been seen flying with flocks of golden plovers for several days before it was collected. No specimens or sight records of dotterels have been reported previously from any of the islands of the Hawaiian Leeward Islands nor from any of the main Hawaiian group. This species breeds in Siberia and has been reported previously as a straggler to Alaska and the northwestern United States. It has been recorded once breeding in Alaska (AOU, 1957).

Bar-tailed Godwit

Limosa lapponica baueri

Wislocki shot a female (USNM 493478) Mar. 11, 1964, on Lisianski Island. On May 9, 1966, Woodward saw two bar-tailed godwits on the southeast beach of Green Island, Kure Atoll. He subsequently collected one of them (USNM 496599), a male molting into nuptial plumage. These godwits have been seen thrice on Laysan by POBSP personnel. One was seen on the west shore of the lagoon Sept. 19, 1964; two were seen foraging together on the east and south beaches during the period Mar. 6–11, 1965; and another was observed Oct. 21, 1966.

Specimens of *L. l. baueri* have been reported previously from Laysan (Rothchild, 1893) and Midway (Fisher, 1960) in the Hawaiian Leewards, but none have been reported previously from either Kure or Lisianski. The race *L. l. baueri* breeds in Siberia and northern Alaska (Vaurie, 1965) and winters irregularly in small numbers in central Polynesia.

Marbled Godwit

Limosa fedoa

On Oct. 21, 1966, POBSP personnel saw two marbled godwits feeding in the lagoon at Laysan Island. One of them (USNM 496790) was then collected by Lewis and proved to be an immature male with heavy fat deposits. No sight records of specimens of marbled godwits

have been reported previously from any of the islands of the Hawaiian area.

This species breeds from central Alaska and southern Manitoba south to central North Dakota and west-central Minnesota. It migrates along the California coast and through the western interior of North America (AOU, 1957).

Lesser Yellowlegs

Totanus flavipes

On Green Island, Kure Atoll, Aug. 30, 1964, Dumont captured an immature female lesser yellowlegs (USNM 494297) in a colony of sooty terns (*Sterna fuscata*). The bird was lying on the ground and was very emaciated.

Another lesser yellowlegs was seen by POBSP personnel on Laysan Island Oct. 21, 1966. This bird was feeding with wandering tattlers and two greater yellowlegs with which it was compared closely.

Sightings of lesser yellowlegs have been reported from the main Hawaiian or Leeward Islands on six previous occasions: once from Midway (Donaghho, 1953-1954), once from Maui (Bryan, 1962), and four times from Oahu (Hatch, 1953; anonymous, 1964; anonymous, 1967; Gauthey, 1967).

The specimen collected on Kure is the first reported from any of the islands of the Hawaiian area and also constitutes the first record from Kure Atoll. The sight record from Laysan is the first record of the lesser yellowleg's occurrence there.

This species breeds from north-central Alaska east to northern Ontario and northwestern Quebec and migrates south to the southern United States, Central America, Chile, and Argentina (AOU, 1957).

Greater Yellowlegs

Totanus melanoleucus

On Oct. 21, 1966, Harrington collected one (USNM 496780) of two greater yellowlegs from the lagoon at Laysan Island. The specimen, a very fat immature female, had been feeding with wandering tattlers (*Heteroscelus incanum*) when it was first seen.

Sight records of greater yellowlegs have been reported on seven previous occasions from the main Hawaiian Islands (see Udvardy, 1961b; anonymous, 1962; Ord, 1962) and once from Midway Atoll in the Hawaiian chain (Donaghho, 1953-1954). The bird taken on Laysan constitutes the first specimen record from either the main Hawaiian or Hawaiian Leeward Islands. Greater yellowlegs breed across northern North America from southern Alaska to Newfoundland and migrate south through the interior and coastal regions of the United States (AOU, 1957).

Wood Sandpiper*Tringa glareola*

Ludwig shot a male wood sandpiper (USNM 493333) that had very little fat on Dec. 11, 1963, in the overrun area on Sand Island, Midway Atoll. Another specimen (USNM 496777) of unknown sex and with no fat deposits was collected by Bratley on Green Island, Kure Atoll, May 22, 1965.

Wood sandpipers are reported as "accidental in Hawaii" (AOU, 1957), but we have been unable to discover the source of this statement. The present specimens confirm the occurrence of wood sandpipers in the Hawaiian Islands and, so far as we can determine, constitute the first distributional records from Kure and Midway Atolls.

**Polynesian Tattler
(Gray-rumped Sandpiper)***Heteroscelus brevipes*

Wirtz collected a moderately fat, immature male (USNM 494300) on Eastern Island, Midway Atoll, Oct. 30, 1964. This specimen constitutes the first record of the occurrence of the Polynesian tattler in either the main Hawaiian or Hawaiian Leeward Islands. This species probably breeds in eastern Siberia and migrates south along the coasts of Japan, China, and Indochina. It winters in the Philippine and Caroline Islands south to New Guinea and Australia and has been recorded from the Pribilof Islands (AOU, 1957).

Wandering Tattler*Heteroscelus incanum*

Sibley and Amerson saw one wandering tattler on Gardner Pinnacles June 16, 1963. Wandering tattlers have been seen 15 times on the islets of Pearl and Hermes Reef. These observations are given by islet as follows:

Southeast Island: Three seen Feb. 26–Mar. 8, 1963; one seen June 18–22, 1963; one seen Mar. 13, 1964; one or two seen Aug. 16–19, 1964; five seen Sept. 16, 1964; one seen Mar. 21–22, 1965; four seen Sept. 25–27, 1966; two seen Mar. 21–23, 1967.

North Island: One seen June 23–24, 1963; one or two seen Aug. 19–20, 1964.

Grass Island: One seen June 26–27, 1963.

Seal Island: One seen Mar. 14, 1964; one seen Mar. 18, 1965; one seen Mar. 22, 1967.

Humphrey Island: One seen Aug. 18, 1964.

Kittery Island: One seen Mar. 22, 1967.

Even though wandering tattlers are regular winter residents on the Hawaiian Leeward Islands (Bryan and Greenway, 1944), their occur-

rence on Pearl and Hermes Reef and Gardner Pinnacles has not been documented previously.

Ruddy Turnstone
(Turnstone)

Arenaria interpres

Ruddy turnstones have been recorded on all POBSP visits to Pearl and Hermes Reef. A short summary of the number observed on each island is as follows:

Southeast Island: About 200 present Feb. 26–Mar. 8, 1963; 15–20 seen June 18–22, 1963; 178 counted Mar. 13, 1964; about 75 present Aug. 16–19, 1964; an estimated 500 present Sept. 16–17, 1964; “a few” seen Mar. 15–17, 1965; 86 counted Mar. 21–22, 1965; about 350 present Sept. 27, 1966; about 100 present Mar. 21–23, 1967.

North Island: 12 to 15 present June 23–24, 1963; about 75 present Sept. 17, 1964; 75–100 present Mar. 17–18, 1965.

Grass Island: One seen June 26–27, 1963; about 20 present Mar. 14, 1964; about 80 seen in one flock Mar. 22, 1967.

Humphrey Island: Fifteen present Sept. 17, 1964; “a few” seen Mar. 17, 1965.

Kittery Island: A “few” seen Mar. 17, 1965; one seen Mar. 22, 1965; 15 seen Mar. 22, 1967.

Planetree Island: One seen Mar. 22, 1965.

Sand Island: Four seen Mar. 22, 1965.

Seal Island: Twelve seen Mar. 22, 1965; 45 seen in one flock Mar. 22, 1967.

The one specimen (USNM 494155) collected by the POBSP on Pearl and Hermes Reef was taken on Southeast Island Aug. 17, 1964. Although ruddy turnstones are regular winter visitors to the islands of the Hawaiian Leeward Chain (Bryan and Greenway, 1944), their occurrence on Pearl and Hermes Reef has not been reported heretofore.

Long-billed Dowitcher

Limnodromus scolopaceus

On Oct. 3, 1963, a moderately fat, immature male (USNM 493854) was collected by Ludwig on Green Island, Kure Atoll. Several other dowitchers of unknown species were seen on Green Island during the same month but were not collected. No long-billed dowitchers have been collected previously in either the main Hawaiian or Hawaiian Leeward Islands, and none have been reported previously from Kure Atoll.

From 1945 through May 1967, 15 sight records of dowitchers or long-billed dowitchers were published in the “Elepaio.” Since none were confirmed by specimens, it is not possible to establish which of

the two sibling dowitcher species the records actually comprised although the long-billed dowitcher is included in the "Hawaiian Checklist" (Bryan, 1958).

This species breeds from northeastern Siberia and northwestern Alaska to MacKenzie and migrates primarily through the western United States to Mexico and Guatemala (AOU, 1957).

Short-billed Dowitcher

Limnodromus griseus caurinus

Wirtz collected an immature female (USNM 496057), one of two dowitchers seen, Oct. 30, 1964, on Sand Island, Midway Atoll. The specimen, identified as *L. g. caurinus* by Laybourne, constitutes the first record of the occurrence of the short-billed dowitcher in the Hawaiian area. *Limnodromus g. caurinus* breeds in southern Alaska (Pitelka, 1950) and migrates south along the Pacific coast of North America to at least Baja California (AOU, 1957).

Pintail Snipe

Capella stenura

On Jan. 13, 1964, King collected a male (USNM 493341) in an open grassy area on Green Island, Kure Atoll. No pintail snipes have been reported previously from any of the islands of the Hawaiian area. This species breeds from Siberia to northwestern Manchuria and winters south to Malaya (Vaurie, 1965).

Common Snipe

Capella gallinago delicata

Schreiber collected an immature male (USNM 496778), later identified as *C. g. delicata* by Thompson, from an open field on Green Island, Kure Atoll, Sept. 25, 1966. A snipe, probably this bird, had been seen daily for the preceding five days.

This subspecies of the common snipe breeds from northwestern Alaska east to central Labrador and south to California, northern West Virginia, and Connecticut. It winters south to Central America, Venezuela, and southern Brazil (AOU, 1957) and has been reported several times from the main Hawaiian Islands (Munro, 1944). In the Leeward Chain, it has been reported previously from Laysan (Bryan and Greenway, 1944) but this record is erroneous (Bailey, 1956).

Knot

Calidris canutus

Clapp collected a very fat adult female (USNM 494130), Mar. 15, 1965, on Southeast Island, Pearl and Hermes Reef. Another knot was seen on Sand Island, Midway Atoll, Aug. 28, 1965, by three POBSP members. The latter bird was in breeding plumage and the lengthy

description in the observers' field notes adequately confirms the identification. The specimen from Pearl and Hermes constitutes the first specimen record from either the main Hawaiian or Hawaiian Leeward Islands. The sight record of the knot from Midway constitutes the first record of this species' occurrence there. The only other record from the entire Hawaiian area is a knot seen on Oahu Oct. 29, 1961 (Ord, 1962).

Knots breed in arctic North America east to Greenland, the New Siberian Islands, and Wrangel Island, and migrate south principally along the coasts of the Old World (AOU, 1957).

Sanderling

Crocethia alba

Although a regular winter resident in the Hawaiian area (Bryan and Greenway, 1944), sanderlings nonetheless are unrecorded from several of the atolls and islands in the Hawaiian Leeward Chain. Specimens have been taken on Laysan Island and French Frigate Shoals (Bailey, 1956), and sight records have been reported from Midway Atoll (Donaghho, 1953-54; Kenyon and Rice, 1957) and Kure Atoll (Robbins, 1966).

To these records we add specimen records from Green Island, Kure Atoll (USNM 496975, Jan. 16, 1966), and Sand Island, Midway Atoll (USNM 493259, Sept. 14, 1963; USNM 493250, 493252, Nov. 13, 1963; USNM 493251, Jan. 12, 1964). New sight records made by the POBSP include the following:

Lisianski Island: An estimated 20 sanderlings seen Mar. 12-13, 1963, and Mar. 11-12, 1964; two seen Sept. 18, 1964; five seen Mar. 13, 1965; eight seen Mar. 20, 1967.

Pearl and Hermes Reef, Southeast Island: One sanderling seen Feb. 26, 1963; two seen Mar. 13, 1964; one seen Mar. 21, 1965; two seen Mar. 21-23, 1967. Seal Island: A "few" seen Mar. 5, 1963; one seen Mar. 22, 1967. Grass Island: One seen Feb. 5, 1963; three seen Mar. 14, 1964; two seen Aug. 18, 1964; three seen Mar. 19, 1965. Sand Island: One seen Mar. 14, 1964. Humphrey Island: One seen Aug. 18, 1964. North Island: One seen Aug. 19, 1964.

Western Sandpiper

Ereunetes mauri

Huber collected a moderately fat, male western sandpiper (USNM 497298) Dec. 30, 1966, on a sandy beach at Green Island, Kure Atoll. Three sight records of western sandpipers have been reported previously from Oahu in the main Hawaiian Islands (Udvardy, 1961b; Rockafellow, 1964), but no specimens have been collected previously in that area and none have been reported from the Hawaiian Leeward Islands.

Western sandpipers breed along the coasts of western and northern Alaska and winter from the coast of California, the coasts of the Gulf of Mexico and North Carolina south on both coasts of Mexico to northern South America (AOU, 1957).

Pectoral Sandpiper

Erolia melanotos

In the last six years (1961–1966) at least 12 sight records of pectoral sandpipers have been reported from the main Hawaiian Islands in "Elepaio," and several sight records have been reported previously from Midway Atoll (see Bailey, 1956, and Udvardy, 1961b, for a summary of these records). None of these records have been verified by the collection of specimens.

Four specimens have been collected in the main Hawaiian Islands, two from Hawaii (Henshaw, 1902), and two from Oahu (Bryan, 1905; and a previously unreported POBSP specimen, USNM 493229, collected Oct. 4, 1963, at Pearl Harbor, Oahu). No specimens have been reported previously from the Leeward Chain.

Specimens of pectoral sandpipers collected by POBSP personnel from the Hawaiian Leeward Islands are listed by each island as follows:

Kure Atoll, Green Island: USNM 493227, Oct. 14, 1963; USNM 494322, 494323, 494324, Sept. 25, 1964; USNM 497221, 497222, Sept. 21, 1966.

Midway Atoll, Sand Island: USNM 493226, Sept. 17, 1963; USNM 494325, Oct. 31, 1964; USNM 497218, 497219, 497220, Sept. 29, 1966.

Pectoral sandpipers breed from the Arctic coast of eastern Siberia across northern North America to Southampton Island and winter primarily in South America. They have been recorded casually from Samoa, Australia, and New Zealand (AOU, 1957).

Sharp-tailed Sandpiper

Erolia acuminata

Although there are many sight records of sharp-tailed sandpipers from the main Hawaiian Islands (Udvardy, 1961b; see also miscellaneous field notes in the "Elepaio" for the years 1961–1967) and although at least six specimens have been collected there (Munro, 1944; Rothschild, 1893), few records have been reported from the Hawaiian Leeward Chain.

The POBSP has many sight records of both this species and the similar appearing pectoral sandpiper (*Erolia melanotos*) from the Hawaiian Leeward Islands, but on several occasions a shorebird identified in the field as a sharp-tailed sandpiper has proven to be a pectoral sandpiper in the hand. We thus include here only the verified POBSP specimen records as follows:

Kure Atoll, Green Island: USNM 493231, Oct. 7, 1963; USNM 493232, Oct. 29, 1963.

Midway Atoll, Sand Island: USNM 493475, Nov. 13, 1963; USNM 493248, Dec. 17, 1963; USNM 495889, Oct. 31, 1964.

Laysan Island: USNM 496697, Oct. 21, 1966.

Pearl and Hermes Reef, Southeast Island: USNM 497216, 497217, Sept. 27, 1966.

One specimen has been reported previously from Laysan (Rothschild, 1893) and two specimens and several sight records have been reported from Midway Atoll (Bailey, 1956; Fisher, 1965). No sharp-tailed sandpipers have been reported previously from either Kure Atoll or Pearl and Hermes Reef.

This species breeds in northern Siberia and winters from New Guinea, New Caledonia, and the Tonga Islands south to Australia and Tasmania (AOU, 1957).

Dunlin

Erolia alpina sakhalina

A male dunlin (USNM 494127) was collected Mar. 15, 1965, by Clapp while the bird was feeding in a small *Sesuvium*-bordered pool on Southeast Island, Pearl and Hermes Reef. Two other dunlins, a male and a female (USNM 493477, Jan. 12, 1964; USNM 496781, Mar. 28, 1965), were collected on Sand Island, Midway Atoll. Lewis collected a fourth specimen (USNM 496782), a female, Nov. 15, 1965, on Green Island, Kure Atoll. The three specimens for which fat data is available (494127, 496781, 496782) were all very fat. All specimens were subsequently referred to the race *E. a. sakhalina* by Laybourne.

Sight records of dunlins have been reported previously from Sand Island, Midway Atoll (Kenyon and Rice, 1957), and Laysan Island (Rothschild, 1893-1900) in the Hawaiian Leeward Islands, and a specimen has been taken on Laysan (Bailey, 1956). The POBSP specimens from Pearl and Hermes and Kure constitute the first distributional records from those atolls and the birds collected on Midway are the first specimens reported from there.

The subspecies *E. a. sakhalina* breeds in northern Siberia and winters south through Japan to India (Vaurie, 1965).

Ruff

Philomachus pugnax

On Green Island, Kure Atoll, Dec. 11, 1963, Clapp saw a ruff feeding at a rainwater puddle in association with golden plovers and ruddy turnstones. A male (USNM 493332), collected on the beach the same day, had heavy fat deposits and was in winter rather than prenuptial plumage (see Kozlova, 1956).

This species breeds in the Old World from northern Norway to southern Siberia and is casual or accidental on St. Lawrence Island and

in the Pribilof Islands (AOU, 1957). None have been reported previously from any of the Central Pacific islands.

Northern Phalarope
(Red-necked Phalarope)

Lobipes lobatus

Two very fat northern phalaropes in winter plumage, a male (USNM 494118) and a female (USNM 494119), were collected on Laysan Island, Mar. 7, 1965, by Clapp. Both were feeding actively near large flocks of golden plovers, ruddy turnstones, and wandering tattlers on the south shore of the lagoon. The only known specimen reported previously from the main Hawaiian or Hawaiian Leeward Islands was shot on Kauai during the winter of 1892-93 (Henshaw, 1902).

This species is a circumpolar breeder that in the Pacific migrates south to the west coast of South America and south to the Ryukyu Islands, Sundas, and New Guinea (Vaurie, 1965).

Red Phalarope
(Grey Phalarope)

Phalaropus fulicarius

Sibley saw two red phalaropes in the lagoon on Laysan, Feb. 11, 1963. On Mar. 1, 1964, Fleet found a moderately fat male in winter plumage (USNM 494298) with an injured wing on the beach of Green Island, Kure Atoll. Hackman obtained the carcass of another (USNM 497293) found in the interior of Southeast Island, Pearl and Hermes Reef, Mar. 22, 1967.

This species is the most abundant phalarope in the Hawaiian area and has been recorded from most of the main Hawaiian Islands and from Laysan (Bryan and Greenway, 1944; Bailey, 1956) although very few specimens have been collected. Red phalaropes have not been reported previously from either Kure Atoll or Pearl and Hermes Reef.

These phalaropes breed circumpolarly in the Northern Hemisphere and migrate southward throughout the oceans of both the Eastern and Western Hemispheres (AOU, 1957).

Ring-billed Gull

Larus delawarensis

POBSP personnel have obtained specimens of ring-billed gulls from two of the Hawaiian Leeward Islands, from which they had not been recorded heretofore. A female in first nuptial plumage (USNM 493343), found dead on Green Island, Kure Atoll, Feb. 22, 1963, was obtained from Coast Guard personnel by Sibley. Sibley also shot an unsexed ring-billed gull in second winter plumage (USNM 493342) on Humphrey Island, Pearl and Hermes Reef, Mar. 5, 1963.

Munro (1944) reported a specimen from Molokai and another, probably from Maui, in the St. Louis College Collection, Honolulu.

Ring-billed gulls breed throughout much of northern North America and migrate south throughout the interior of the United States. In winter they are found as far south as southern Mexico along the Pacific coast and southern Florida along the Atlantic coast (AOU, 1957).

Herring Gull

Larus argentatus vegae

Twelve specimens of herring gulls have been collected in the Leeward Islands by POBSP personnel. All were identified subsequently as *L. a. vegae* by Laybourne, Short, or Thompson. These specimens are as follows:

Kure Atoll: USNM 493348, 493349, 493350, Mar. 10, 1963; USNM 494375, Nov. 10, 1964; USNM 494367, Jan. 20, 1965; USNM 494371, Mar. 8, 1965; USNM 494374, Apr. 1, 1965.

Midway Atoll: USNM 493351, Feb. 25, 1963.

Laysan Island: USNM 493352, Feb. 12, 1963.

Lisianski Island: USNM 493353, Feb. 14, 1963.

Pearl and Hermes Reef, Southeast Island: USNM 493346, Feb. 27, 1963. Kittery Island: USNM 493347, Mar. 5, 1963.

These specimens were all young birds that had not yet attained adult plumage. Six of the gulls (493346, 493348, 493349, 493350, 493351, 494371) were in first winter plumage; four (493347, 493352, 493353, 494374) were in first nuptial plumage; and two (494367, 494375) were in second winter plumage (Dwight, 1901).

Specimens of herring gull have been recorded from Laysan (Bailey, 1956), Oahu (King, 1959a), and Midway (Bryan, 1962b). None have been reported previously from Kure, Lisianski, or Pearl and Hermes Reef.

The subspecies *L. a. vegae* breeds in Siberia and winters as far south on the Asiatic coast as central China and Formosa. It wanders casually to western Alaska, the Aleutians, and British Columbia (AOU, 1957).

Slaty-backed Gull

Larus schistisagus

Fleet and Standen collected an adult male in winter plumage Mar. 9, 1965, on Green Island, Kure Atoll (USNM 494373). No slaty-backed gulls have been reported previously from any of the islands of the main Hawaiian or Hawaiian Leeward groups. This species breeds in Northeastern Siberia, south to the northern part of Japan, and winters as far south as the coast of China. It has been recorded in the Aleutians, Pribilof, and on the coast of Alaska (AOU, 1957).

Glaucous-winged Gull*Larus glaucescens*

Twelve specimens of glaucous-winged gulls have been collected in the Hawaiian Leeward Islands by POBSP personnel. These are listed by each island as follows:

Kure Atoll, Green Island: USNM 493344, Mar. 10, 1963; USNM 494365, Dec. 24, 1964; USNM 494368, Feb. 1, 1965; USNM 494369, Mar. 1, 1965; USNM 494370, Mar. 7, 1965; USNM 494372, Mar. 9, 1965; USNM 497295, 497223, Dec. 31, 1966.

Pearl and Hermes Reef, Southeast Island: USNM 493345, Feb. 26, 1963. Humphrey Island: USNM 494131, 494132, Mar. 18, 1965.

Lisianski Island: USNM 494133, Mar. 12, 1965.

These specimens were all immature birds. Two (494132, 497223) were in first winter plumage; eight (493344, 493345, 494131, 494133, 494368-494370, 497295) were in first nuptial plumage; one (494372) was molting into second winter plumage; and one (494365) was in second winter plumage (Dwight, 1901).

Three other hitherto unreported glaucous-winged gulls were collected as beach-dried remains in 1923 by Wetmore. One, an adult (USNM 489330), was collected on Seal Island, Pearl and Hermes Reef, Apr. 27, 1923. Two others, immature specimens in too poor condition for accurate age assessment, were obtained on Kure Atoll (USNM 489328, Apr. 18, 1923) and Necker Island (USNM 489329, June 18, 1923).

Specimens have been reported from Hawaii and Laysan (Henshaw, 1900, 1902). An adult was seen at French Frigate Shoals on Mar. 19-20, 1954 (Richardson, 1954), and two were seen at Kure Atoll Feb. 3-7, 1963 (Robbins, 1966). A single glaucous-winged gull was found dead at Midway Atoll Mar. 7, 1957 (Kenyon and Rice, 1957). No glaucous-winged gulls have been reported previously from Pearl and Hermes Reef, Lisianski, or Necker.

This species breeds from the Komandorskie, Pribilof, and Aleutian Islands through Alaska to northwestern Washington and winters south to northwestern Mexico and Japan (AOU, 1957).

Glaucous Gull*Larus hyperboreus*

During January 1965, POBSP personnel saw two gulls, both presumably this species, on Green Island, Kure Atoll. One, a male in first winter plumage (USNM 494366), collected on January 17, was identified as a glaucous gull. An earlier (and not previously reported) record from Kure Atoll is a beach-dried mummy (USNM 489331)

that Wetmore collected Apr. 18, 1923. The specimen is in too poor condition to be aged accurately, but it was in an immature plumage.

On Mar. 31, 1967, Hackman collected a wing (USNM 497294) from a badly decayed carcass of an adult glaucous gull found near the end of the overrun runway on Sand Island, Midway Atoll.

Specimens have been collected previously on Kauai and Maui (Henshaw, 1902), Laysan (Bailey, 1956), and Lanai (Munro, 1944), and sight records have been reported from Midway (Kenyon and Rice, 1957). No glaucous gulls have been reported previously from Kure. The specimen from Midway listed above is the first reported from that island.

The glaucous gull is a circumpolar breeder that winters as far south in the Pacific as California, Japan, and northern China (AOU, 1957).

Franklin's Gull

Larus pipixcan

Amerson found the remains of a Franklin's gull near the runway on Tern Island, French Frigate Shoals, Aug. 4, 1965 (USNM 496203). Judging from the markings on the primaries and from the coloration and condition of the other wing feathers, the gull had been molting into adult plumage when it died.

The only other records from the Hawaiian area are a specimen from Maui, two sight records from Oahu, and an adult taken two miles off Kauai (King, 1959b).

This species breeds in northwestern North America from southeastern Alberta to South Dakota, Minnesota, and Iowa. It winters along the Pacific coast of Central and South America and along the coast of the Gulf of Mexico (AOU, 1957).

Black-legged Kittiwake

Rissa tridactyla

On Dec. 24, 1964, two adults and one immature were seen at Green Island, Kure Atoll. The immature, a female in first winter plumage (USNM 494296), was found injured on the beach Dec. 30, 1964, and was collected by Stadel and Kepler. On Mar. 29, 1967, another specimen (USNM 497296), the remains of a mummified carcass of an adult bird, was collected on Green Island by Hackman. Hackman had seen another adult black-legged kittiwake flying over the island the previous day.

In March 1965 the remains of three black-legged kittiwakes were found on Pearl and Hermes Reef. Two, an adult in winter plumage (USNM 496205) and the wing of an immature bird (USNM 497375), were found on Southeast Island on March 15. The remains of the third kittiwake, an immature (USNM 496206), were found on Grass Island on March 19. Neither of the remains of the two immature

birds are complete enough for accurate aging, but the markings on the wings indicate that both birds were less than two years old.

Bryan and Greenway (1944) list this species from Laysan Island on the basis of a fragmentary specimen in the Bernice P. Bishop Museum. No observations or specimens of black-legged kittiwakes have been reported previously from either Kure Atoll or Pearl and Hermes Reef.

Black-legged kittiwakes are circumpolar breeders that winter south to Japan and northwestern Baja California in the Pacific (AOU, 1957).

Gray-backed Tern
(Spectacled Tern)

Sterna lunata

POBSP personnel have recorded many observations of gray-backed terns on various islets of Pearl and Hermes Reef, from whence the species has not been reported previously. These observations are briefly summarized below:

Southeast Island: Two hundred adults seen Feb. 26–Mar. 8, 1963; 1000 adults, 40 nestlings, and many eggs seen June 18–22, 1963; 30 adults seen Mar. 13, 1964; 350 adults, 250 nestlings, and one egg seen Aug. 16–19, 1964; 30 adults and 10 immatures seen Sept. 16–17, 1964; 500–600 adults seen Mar. 15–17, 1965; 40 adults and seven nestlings seen Sept. 25–27, 1966; about 75 courting adults Mar. 21–23, 1967.

Seal Island: One hundred adults and 40 nestlings seen June 26, 1963; 4–5 adults seen Mar. 14, 1964; 15 adults seen Aug. 18, 1964; 200–300 adults and 50 eggs seen Mar. 18, 1965; 25 adults seen Mar. 22, 1967.

Kittery Island: One seen Aug. 18, 1964.

North Island: Two seen June 23–24, 1963; six seen Aug. 19–20, 1964.

Bird Island: One seen Aug. 18, 1964.

Gray-backed terns are common residents on most of the islands of the Hawaiian Leeward Islands (Bryan and Greenway, 1944).

Blue-gray Noddy

Procelsterna cerulea

Sibley and Amerson saw from eight to 10 blue-gray noddies on Gardner Pinnacles June 16, 1963. In the Hawaiian Leeward Islands, blue-gray noddies have been reported breeding on Nihoa, Necker, La Perouse Pinnacle at French Frigate Shoals, and Kaula (Richardson, 1957; Bryan and Greenway, 1944). None have been reported previously from Gardner Pinnacles.

Brown Noddy
(Common Noddy)
(Noddy Tern)

Anous stolidus

On June 16, 1963, Sibley and Amerson estimated that 5400 brown noddies (including 400 nestlings) were present on Gardner Pinnacles. Several hundred of these noddies were seen flying around the island by Hackman from offshore Mar. 15, 1967. Brown noddies are common breeding birds in the Hawaiian Leeward Chain (Richardson, 1957) but have not been reported heretofore from Gardner Pinnacles.

Black Noddy
(White-capped Noddy)
(Hawaiian Noddy)

Anous tenuirostris

Sibley and Amerson found one nestling and 15 adult white-capped noddies on Gardner Pinnacles June 16, 1963. White-capped noddies occur on many Pacific islands and have been recorded breeding on most of the islands of the Leeward group (Richardson, 1957). Their occurrence and breeding on Gardner Pinnacles have not been reported previously.

Horned Puffin

Fratercula corniculata

During the months of January, February, and March 1963, POBSP personnel found 16 specimens of horned puffins on the Hawaiian Leeward Islands. Only two of these were returned to the U.S. National Museum. One of these specimens (USNM 493357) was an adult in winter plumage that was found dead on the beach, Feb. 20, 1963, on Green Island, Kure Atoll. The other specimen (USNM 497918), a skeleton taken on Laysan Island, Feb. 12, 1963, constitutes the first record of the occurrence of horned puffins on that island. From January 26 through February 25, 12 puffins were found on Sand and Eastern Islands, Midway Atoll. Eleven were dead, the twelfth, captured January 26, was banded and released. Another dead puffin was found on Grass Island, Pearl and Hermes Reef, on March 5, and another was found on North Island, Pearl and Hermes Reef, the following day. These observations of puffins on Pearl and Hermes Reef constitute the first records of their occurrence there.

Fisher (1965) reported that in January 1963 seven dead horned puffins had been found on Midway Atoll and that one live horned puffin had been found on the beach at Kure Atoll. Robbins (1966) reported finding five carcasses on Kure Atoll in the period Feb. 3-7, 1963. It seems likely that some of the puffins reported by these authors may have been the same birds as some of those found by POBSP personnel.

Horned puffins breed from northeastern Siberia and the Komandorskies Islands east to the islands of the Bering Sea, the Aleutians, and the Alaska Peninsula. They winter in the breeding range and south to Oregon and have been recorded in Japan and California (AOU, 1957).

Short-eared Owl

Asio flammeus (flammeus?)

A short-eared owl (or owls) was recorded frequently on Green Island, Kure Atoll, during POBSP studies there. One was seen in the months of October and November 1963, February, March, and December 1964, and January, February, and March 1965. Two owls were seen on Dec. 24, 1964.

An injured bird (USNM 494362), the first specimen from Kure Atoll, was collected by Fleet on Feb. 12, 1964. One might expect that this owl had wandered to Kure from the endemic population (*A. f. sandwichensis*) in the main Hawaiian Islands or possibly from the population (*A. f. ponapensis*) in the Caroline Islands.

Both these insular populations are smaller than the Holarctic form, *A. f. flammeus*. Wing measurements of two *A. f. ponapensis* given by Mayr (1945) are 295 and 307 mm, and wing measurements of two additional specimens from the Caroline Islands in the U.S. National Museum are 286 and 278 mm. Wings of six specimens of *A. f. sandwichensis* in the U.S. National Museum, four reported by Bryan (1901), and two recorded in the "Catalogue of Birds in the British Museum" (Sharpe, 1875) range from 282 to 305 mm and average 295 mm.

The wing of the present specimen, however, measures 315 mm and agrees well with the range and mean (300–326 mm, 312 mm) given by Ridgway (1914) for 16 females of the typical race, *A. f. flammeus*.

The tail measurement of the Kure bird (151 mm) also agrees better with measurements of *A. f. flammeus* than it does with *A. f. sandwichensis*. Ridgway (1914) gives a range and mean for 16 female *A. f. flammeus* as 142–158.5 mm and 152 mm. The range and mean of 12 *A. f. sandwichensis* (those referred to above) is 134–158 mm and 142 mm. On the basis of these measurements we tentatively assign the present specimen to the form *A. f. flammeus*.

Short-eared owls have been reported present on Kure by two other observers. Fisher (1965) visited Kure in December 1963 and saw an owl at that time. Robbins (1966) saw two of these owls on Kure in the period Feb. 2–4, 1962, and believed that they might be breeding there. POBSP observers, however, have made no observations that would support this conjecture.

The form *A. f. flammeus* breeds in the Old World from Iceland east to Sakhalin and breeds in North America from northern Alaska east

to Labrador and south to southern California, southern Illinois, and tidewater areas of Virginia. In Asia it winters south to northern India and southeastern China and on the Pacific coast of North America winters as far south as Baja California and Oaxaca (AOU, 1957).

Skylark

Alauda arvensis pekinensis

Two small dark birds with white outer tail feathers were seen on Green Island, Kure Atoll, for over a week before a specimen (USNM 493504) was finally collected Oct. 7, 1963. The bird, a female, flushed with a group of golden plovers from a hard-surfaced roadway.

The specimen was subsequently referred to Dr. George E. Watson for subspecific determination. He informed us (pers. comm.) that

the Skylark introduced on the Hawaiian Islands is usually listed as "probably *Alauda a. arvensis*," the European population, which is dark brown above and rich rufous buff below. The specimen from Kure, however, has the black central portions of the back feathers far more extensive than in any European specimens and in this character resembles specimens from western China. Wing length (114 mm in ♀) and its pointed shape (fourth primary from outside 8 mm shorter than third) agree with the population *pekinensis* which breeds in northeastern Siberia, Kamchatka, and the Kuriles.

Skylarks (presumably *Alauda a. arvensis*) were introduced to the main Hawaiian Islands from England and New Zealand in the late 19th and early 20th centuries. A number of birds thought to be *A. a. japonica* also were introduced to these islands in 1934 but did not become established (Bryan, 1958).

Barn Swallow
(Swallow)

Hirundo rustica gutturalis

Three POBSP personnel saw two barn swallows on Green Island, Kure Atoll, Sept. 25, 1964. Both were subsequently shot, but the specimens fell into dense vegetation and could not be found. On Mar. 27, 1965, Wirtz collected a barn swallow (USNM 495966, an unsexed specimen) that Wetmore later identified as *H. r. gutturalis*. Still another barn swallow was seen on Eastern Island, Midway Atoll, Feb. 13, 1965 (Anderson), and possibly on Mar. 1, 1963 (Kepler). No barn swallows have been seen or collected previously in either the main Hawaiian or Hawaiian Leeward Islands.

The race *H. r. gutturalis* is found on migration in Japan and the Ryukyu, Bonin, Volcano, and Caroline Islands (Vaurie, 1959), suggesting that Wirtz's specimen may have been a straggler from the northwest.

Water Pipit*Anthus spinoletta japonicus*

Ludwig collected a very fat water pipit (USNM 493506) Oct. 25, 1963, on Green Island, Kure Atoll, as the bird ran on the north beach along the edge of a stand of *Scaevola*. The specimen, a female in winter plumage, was identified as *A. s. japonicus* by Laybourne.

This subspecies breeds in Siberia and migrates through Mongolia, Japan, and the Ryukyus (Vaurie, 1959). No water pipits have been seen or collected previously on any of the islands of the main Hawaiian or Hawaiian Leeward groups.

Red-throated Pipit*Anthus cervinus*

Ludwig shot a winter-plumaged female pipit (USNM 493505) as it flew over *Scaevola* on Green Island, Kure Atoll, Sept. 26, 1963. Red-throated pipits have not been reported previously from any of the main Hawaiian or Hawaiian Leeward Islands.

This species is found in northeastern Siberia and has been recorded as an accidental in the Aleutians (Vaurie, 1959), California, and Baja California (McCaskie, 1966). There is one breeding record for Alaska as well (Bailey, 1932).

Mockingbird*Mimus polyglottos*

On Aug. 4, 1965, Amerson saw two mockingbirds in vegetation along the runway on Tern Island, French Frigate Shoals. On Aug. 18, 1965, Huber collected a male in juvenal plumage with fully grown flight feathers (USNM 495887). Mockingbirds, which were introduced into the main Hawaiian Islands in 1928 (Munro, 1944), were first seen on Tern Island, Oct. 19, 1960, when Woodside (1960, unpubl.) observed two birds in vegetation south of the runway.

House Sparrow*Passer domesticus*

Woodward observed a male house sparrow on three different occasions June 18-20, 1966, on Green Island, Kure Atoll. Possibly the sparrow had arrived on the island on a cargo plane that had arrived from Oahu, June 15, 1966.

This widespread species was introduced to Hawaii before 1870 (Munro, 1944) and is now common on all the main islands of the Hawaiian group. None have been reported previously from Kure Atoll.

Snow Bunting*Plectrophenax nivalis townsendi*

Sibley shot a female snow bunting Mar. 10, 1963, on Green Island, Kure Atoll. The snow bunting (USNM 493358), subsequently identi-

fied as *P. n. townsendi* by Bridge, was in winter plumage. The specimen constitutes the first distributional record of the occurrence of this species on any of the islands of the Hawaiian area.

Another snow bunting, probably this species, was seen by POBSP personnel on Midway Atoll during the winter of 1964-65.

Plectrophenax n. townsendi breeds from the Pribilof and Aleutian Islands to the Alaskan Peninsula and the Alaskan range. It winters in part in the breeding area but is found also in southeastern Alaska and the northwestern United States (Gabrielson and Lincoln, 1959).

TABLE 1.—Summary of new records of birds from the Hawaiian Leeward Islands (r=first sight record from an island; sr=first specimen record from an island; SR=first specimen confirmation of a species previously known only from sight records for both the main Hawaiian and Hawaiian Leeward Islands chain; SR=specimen record is for a species which has not been heretofore reported from any of the main Hawaiian Islands or Leeward Hawaiian Islands chain)

	Kure	Midway	Pearl and Hermes Reef	Lisianski	Lay- san	Gardner Pinnacles	French Frigate Shoals	Necker	Nihoa
Northern fulmar		sr					sr		
Murphy's petrel		SR					sr		
Kermadec petrel		SR							
Bulwer's petrel			r			r			
Sooty shearwater		sr							
Christmas shearwater			sr						
Little shearwater		SR							
Leach's storm petrel		sr							
Sooty storm petrel		sr					r		
Red-billed tropicbird									SR
Red-tailed tropicbird			r						
White-tailed tropicbird		r							
Red-footed booby						r			
Brown booby						r			
Black-crowned night heron		sr							
Garganey teal		SR							
Common teal		sr							
European widgeon		sr	SR						
American widgeon			sr						
Shoveler			sr						
Tufted duck		sr							
Marsh hawk		sr							
Peregrine falcon	SR	r		r					
American coot							sr		
Black-bellied plover	r			sr					
American golden plover			r					r	
Dotterel		SR							
Bar-tailed godwit		sr		sr					
Marbled godwit					SR				
Lesser yellowlegs		SR			r				
Greater yellowlegs					SR				
Wood sandpiper	sr	SR?							
Polynesian tattler		SR							
Wandering tattler			r			r			
Ruddy turnstone			sr						
Long-billed dowitcher	SR								
Short-billed dowitcher		SR							
Pintail snipe		SR							

Literature Cited

- ALEXANDER, W. B., et al.
1965. The families and genera of the petrels and their names. *Ibis*, vol. 107, pp. 401-405.
- AMADON, D.
1965. Distribution of gulls—some further considerations. *Elepaio*, vol. 25, pp. 95-96.
- ANONYMOUS
1940. Records and notes. *Elepaio*, vol. 1, p. 2.
1962. Honolulu Christmas count, December 31, 1961. *Elepaio*, vol. 22, pp. 58-59.
1964. Field notes. *Elepaio*, vol. 25, p. 36.
1966. Field trip to Ulupau Head, April 10, 1966. *Elepaio*, vol. 26, pp. 112-113.
1967. Excerpts from the minutes of the general meeting of the Hawaiian Audubon Society, January 16, 1967. *Elepaio*, vol. 27, p. 97.
- AMERICAN ORNITHOLOGISTS' UNION
1957. Check-list of North American birds, 5th ed., xii + 691 pp. Baltimore, Md.: Lord Baltimore Press.
- BAILEY, A. M.
1932. Additional records from Cape Prince of Wales, Alaska. *Condor*, vol. 34, p. 47.
1956. Birds of Midway and Laysan Islands. *Denver Mus. Nat. Hist., Mus. Pict.*, no. 12, 130 pp.
- BRYAN, E. H., JR.
1958. Check list and summary of Hawaiian birds, 28 pp. Honolulu: Books about Hawaii.
1962a. Observations on the "Yellow-legs" on Maui. *Elepaio*, vol. 22, pp. 81-82.
1962b. *Larus argentatus vegae* collected on Midway Island. *Elepaio*, vol. 23, p. 28.
1965. Leach's storm petrel in Hawaii. *Elepaio*, vol. 25, p. 79.
- BRYAN, E. H., JR., and GREENWAY, J. C., JR.
1944. Contributions to the ornithology of the Hawaiian Islands. *Bull. Mus. Comp. Zool., Harvard*, vol. 94, pp. 79-142.
- BRYAN, W. A.
1901. A key to the birds of the Hawaiian group. *Mem. Bernice P. Bishop Mus.*, vol. 1, pp. 259-332.
1905. Notes on the American birds collected in the Hawaiian Islands by Mr. Gerrit Wilder. *Bernice P. Bishop Mus., Occas. Pap.*, vol. 2, pp. 53-56.
- DONNAGHNO, W. R.
1953-1954. Ornithological notes. *Elepaio*, vol. 14, pp. 9-11, 18-21, 30-33, 41-43, 46-49, 57-59.
- DUNMIRE, W. W.
1961. Peregrine falcon in Hawaii National Park. *Elepaio*, vol. 21, p. 80.

DWIGHT, J., JR.

1900. The sequence of plumages and moults of the passerine birds of New York. *Ann. N.Y. Acad. Sci.*, vol. 13, pp. 73-360.
1901. The sequence of moults and plumages of the Laridae (gulls and terns). *Auk*, vol. 18, pp. 49-63.

FISHER, H. I.

1960. Records of the bar-tailed godwit and tufted duck on Midway Atoll. *Condor*, vol. 62, p. 480.
1965. Bird records from Midway Atoll, Pacific Ocean. *Condor*, vol. 67, pp. 355-357.

FRINGS, H.

- 1965a. Absence of gulls on Pacific islands—some speculations. *Elepaio*, vol. 25, pp. 51-54.
1965b. Distribution of gulls—still further considerations. *Elepaio*, vol. 25, pp. 96-98.

GABRIELSON, I. N., and LINCOLN, F. D.

1959. The birds of Alaska, 922 pp. Washington, D.C.: Wildlife Management Institute.

GAUTHEY, J. R.

1967. Field trip to Waipio Peninsula and Kahuku to study shore birds, March 12, 1967. *Elepaio*, vol. 27, p. 106.

GOULD, P. J., and KING, W. B.

- In press. Records of four species of *Pterodroma* from the Central Pacific Ocean. *Auk*.

HATCH, G.

1953. Field notes. *Elepaio*, vol. 14, p. 35.

HENSHAW, H. W.

1900. Occurrence of *Larus glaucescens* and other American birds in Hawaii. *Auk*, vol. 17, pp. 201-206.
1902. Birds of the Hawaiian Islands, being a complete list of the birds of the Hawaiian possessions with notes on their habits, 146 pp. Honolulu: Thos. G. Thrum.

HUMPHREY, P. S.

1965. An ecological survey of the Central Pacific. Pp. 24-30 in *Smithsonian Year, 1965: Annual Report of the Smithsonian Institution for the year ended June 30, 1965 . . .* Washington, D.C.: Smithsonian Institution.

KENYON, K. W., and RICE, D. W.

1957. Bird observations at Midway Atoll. *Elepaio*, vol. 18, pp. 2-4.
1958. Birds of Kure Atoll, Hawaii. *Condor*, vol. 60, pp. 188-190.

KING, J. E.

- 1959a. Three unusual records from Hawaii. *Elepaio*, vol. 19, p. 61.
1959b. Franklin gull in the Central Pacific. *Condor*, vol. 61, p. 226.

KING, W. B.

1967. Preliminary Smithsonian identification manual: Seabirds of the Tropical Pacific Ocean, xxxii+126 pp. Washington, D.C.: Smithsonian Institution Press.

KORTRIGHT, F. H.

1942. The ducks, geese and swans of North America, viii+476 pp. Washington, D.C.: The American Wildlife Institute.

KOZLOVA, E. V.

1956. [On the evolution of seasonal plumage in the ruff.] *Zool. Zh.*, vol. 35, pp. 1908-1910. [In Russian.]

- MAYR, E.
1933. Two new birds from Micronesia: Birds collected during the Whitney South Sea Expedition, XXIII. American Mus. Novit., no. 609, pp. 1-4.
- MAYR, E., and GREENWAY, J. C.
1956. Sequence of passerine families. Breviora, no. 58, pp. 1-11.
- McCASKIE, R. G.
1966. The occurrence of red-throated pipits in California. Auk, vol. 83, pp. 135-136.
- MEDEIROS, J. S.
1958. Present status of migratory waterfowl in Hawaii. Journ. Wildl. Mgmt., vol. 22, pp. 109-117.
- MOYNIHAN, M.
1957. Notes on the sea-birds of Sand Island of the Johnston Island group. Elepaio, vol. 18, pp. 35-37.
- MUNRO, G. C.
1942. Birds of Hawaii . . . An ocean cruise, no. 10. Elepaio, vol. 3, pp. 12-13, 15-16.
1944. Birds of Hawaii, 189 pp. Honolulu: Tongg Publ. Co.
- MURPHY, R. C.
1927. On certain forms of *Puffinus assimilis* and its allies. American Mus. Novit., no. 276, pp. 1-15.
1952. Larger petrels of the genus *Pterodroma*. American Mus. Novit., no. 1580, pp. 1-41.
- ORD, W. M.
1962. Field notes. Elepaio, vol. 22, pp. 53-55.
1966. Field notes. Elepaio, vol. 26, p. 63.
- PETERS, J. L.
1930. Notes on some night herons. Proc. Boston Soc. Nat. Hist., vol. 39, pp. 263-277.
1931-1964. Check list of birds of the world, vols. 1-7, 9-10, 15. Cambridge: Harvard University. [Volumes subsequent to 7 produced by other editors.]
- PITELKA, F. A.
1950. Geographic variation and the species problem in the shore bird genus *Limnodromus*. Univ. California Publ. Zool., vol. 50, pp. 1-108.
- RICHARDSON, F.
1954. Notes on the birds of French Frigate Shoals. Elepaio, vol. 14, pp. 61-63; vol. 14, pp. 73-75.
1957. The breeding cycles of Hawaiian sea birds. Bernice P. Bishop Mus. Bull. 218, 41 pp.
- RIDGWAY, R.
1914. The birds of North and Middle America. U. S. Nat. Mus. Bull. 50, pt. vi, xx+882 pp.
- ROBBINS, C. S.
1966. Birds and aircraft on Midway Island, 1959-63 investigations. U.S. Fish Wildl. Serv. Spec. Sci. Rep., Wildlife, no. 85, vi+63 pp. Washington, D.C.
- ROCKAFELLOW, R. R.
1964. Field trip to study shore birds, October 11, 1964. Elepaio, vol. 25, pp. 48-49

ROTHSCHILD, W.

- 1893-1900. The avifauna of Laysan and the neighboring islands . . . 320 pp. London: R. H. Porter.

SHARPE, R. B.

1875. Catalogue of the striges or nocturnal birds of prey, in the collection of the British Museum, xi+325 pp. London.

SIBLEY, F. C., and McFARLANE, R. W.

- In press. Gulls in the Central Pacific. Pacific Science.

THROP, J. L.

1967. White-throated storm petrels. *Elepaio*, vol. 27, p. 83.

UDVARDY, M. D. F.

- 1961a. Continental migrants and shore birds on Oahu, during 1958-1959. *Elepaio*, vol. 21, pp. 47-50.

- 1961b. Additions to the check list of Hawaiian Birds. *Elepaio*, vol. 21, pp. 83-90.

VAURIE, C.

1959. The birds of the Palearctic fauna: Order Passeriformes, xii+762 pp. London: H. F. and G. Witherby Ltd.

1965. The birds of the Palearctic fauna: Non-Passeriformes, xx+763 pp. London: H. F. and G. Witherby Ltd.

WETMORE, A.

1925. Bird life among lava rock and coral sand. *Nat. Geogr. Mag.*, vol. 48, pp. 77-108.

WITHERBY, H. F., ed.

1939. The handbook of British Birds, vol. III, x+387 pp. London: H. F. and G. Witherby Ltd.

1941. The handbook of British Birds, vol. V, xii+356 pp. London: H. F. and G. Witherby Ltd.

WALKER, R. L.

1961. Field notes from the Island of Hawaii. *Elepaio*, vol. 22, p. 7.

WOODSIDE, D. H.

1960. Report on a brief visit to Tern Island, French Frigate Shoals, on October 19, 1960. U.S. Fish and Wildlife Service. [Unpublished.]

WOODSIDE, D. H., and WALKER, R. L.

1964. Sooty shearwater in Hawaii. *Elepaio*, vol. 21, pp. 83-90.

Proceedings of
the United States
National Museum



SMITHSONIAN INSTITUTION • WASHINGTON, D.C.

Volume 124

1968

Number 3641

Stomatopod Crustacea from Madagascar

By Raymond B. Manning

Chairman, Department of Invertebrate Zoology

This report is based on four different collections of stomatopods from the island of Madagascar (Malagasy Republic) and adjacent islands, including the Comoro Islands (Comores) and Ile Europa. Two of the collections were made available for study by M. Michel Pichon, Centre d'Océanographie et des Pêches, Nosy Bé, Madagascar, and by A. G. Humes, Boston University, at that time the field chief on Madagascar for the International Indian Ocean Expedition. The third collection was made by several individuals under the auspices of the U.S. Program in Biology, International Indian Ocean Expedition; most of this series of specimens was collected by J. Rudloe while at Madagascar on assignment from the Smithsonian Institution Oceanographic Sorting Center. The fourth and most important collection was assembled by Alain Crosnier, now at the Centre d'Océanographie et des Pêches, Pointe-Noire, Republic of the Congo, over a period of several years while working at the Centre d'Océanographie et des Pêches (O.R.S.T.O.M.) in Nosy Bé, Madagascar.

Together, all of these materials indicate the richness of the stomatopod fauna of Madagascar. The collections reported herein include 28 species, approximately one-half of the stomatopods known from the western Indian Ocean, of which six species are described as new. All 10 species previously recorded from Madagascar are represented in the collections reported in this paper.

LITERATURE REVIEW.—Few species of stomatopods have been recorded from the island of Madagascar. Hoffmann (1874, 1874a), in papers on the crustaceans of Madagascar and neighboring islands, recorded the occurrence of four species from Mauritius and Reunion Islands but included no records from Madagascar. Lenz and Richters (1881) recorded two species, *L. maculata* (Fabricius) and *G. chiragra* (Fabricius), from Madagascar. Miers (1880), in the first review of the stomatopods, listed *Odontodactylus scyllarus* (Linnaeus) from Madagascar, and, in 1884, in a table of the distribution of species taken by the *Alert*, included Madagascar as a locality for *G. chiragra* (Fabricius) but mentioned no specimens from that locality in the text. Lenz (1910) reported three species from Madagascar: *Squilla nepa* Latreille, *Pseudosquilla ciliata* (Fabricius), and *Gonodactylus platysoma* Wood-Mason (as *G. chiragra* var. *acutus*).

Kemp (1913), in his survey of the Indo-West Pacific stomatopods, included no material from Madagascar, but he did include earlier references to material from there. Gravier (1920) included records for *S. nepa* and *G. chiragra* and in 1935 included records for *P. ciliata*, *G. chiragra*, and *G. demanii*. Also in his paper (1935) he erroneously noted that Lenz (1910) reported *G. fimbriatus* from Madagascar; Lenz only recorded that species from Zanzibar.

In an account of the stomatopods of West Africa, Monod (1925) figured the rostral plate of a specimen of *L. maculata* from Madagascar.

In 1938 Dollfus recorded Madagascar in his paragraph on the distribution of *Gonodactylus spinosus* Bigelow (as *G. De Mani* var. *spinosus*, p. 215), but no authenticated references to the occurrence of *G. spinosus* in Madagascar have come to my attention. A closely related species, *G. lanchesteri*, is recorded from Madagascar proper for the first time in the present report.

In 1941 Holthuis (p. 287) reidentified Hoffmann's specimens of *G. chiragra* from Reunion as *G. falcatus* (Forskål); in his section on material Holthuis recorded these specimens from Reunion but mentioned Madagascar in the text. Hoffmann mentioned only Reunion in his account.

Fourmanoir (1952, 1953) recorded *G. chiragra* from Madagascar and, in the second paper, gave observations on larval stages of that species and *S. nepa*. Poisson (1949), in a paper on the fauna of the *Cymodocea* biotope in Madagascar, noted the occurrence of *G. chiragra* there.

Humes (1965) recorded the occurrence of an *Acanthosquilla* from Nosy Bé that was a host for a new cyclopid copepod, *Hemicyclops acanthosquillae*. The species of *Acanthosquilla* is described herein as *A. humesi*, new species.

Crosnier (1965) listed *Squilla nepa* and *S. raphidea* as occurring among catches of penaeid shrimps off Madagascar; the latter species is probably *Harpiosquilla harpax*.

In a review of the genus *Odontodactylus*, Manning (1967a) recorded the occurrence of two species, *O. japonicus* (de Haan) and *O. scyllarus* (Linnaeus); those records were based on three specimens reported below.

Manning (1967b) reported *Gonodactylus lanchesteri* Manning from the Comoro Islands; none of the seven species of *Gonodactylus* included in that study were from Madagascar proper.

EXPLANATIONS AND ACKNOWLEDGMENTS.—In general, synonymies are shortened, including only major references and some recent pertinent references; original citations, if made by Kemp (1913), are not repeated here. Where applicable, reference is made to Kemp's 1913 monograph of the Indo-West Pacific stomatopods.

In the section "Previous Records," earlier records of the occurrence of each species on Madagascar are summarized. For the species not illustrated herein, a figure to aid identification of the species is cited under the paragraph entitled "Illustration."

Measurements are given in millimeters (mm). In the material examined, the numerals following the number of specimens denote total length (TL), unless carapace length (CL) is specified; the latter is given only for damaged specimens. Total length is measured along the midline from the apex of the rostral plate to the apices of the submedian teeth of the telson. Carapace length is measured along the midline and does not include the rostral plate.

An abdominal spine formula of "submedian, 5-6; intermediate, 2-6; lateral, (1) 2-6; marginal, 1-5" indicates that the submedian carinae of the abdomen terminate in spines on the fifth and sixth somites, the intermediate carinae terminate in spines on the second to sixth somites, inclusive, the lateral carinae always terminate in spines on the second to somites, but these carinae occasionally are armed on the first somite, and all five marginal carinae terminate in spines. A parenthesis is used to indicate that a carina on a certain somite may be unarmed. A telson denticle formula of "5, 7-10, 1" indicates that on the telson margin, on each side of the midline, there are five submedian denticles, seven to 10 intermediate denticles, and one lateral denticle. The count of teeth on the dactylus of the claw always includes the terminal teeth.

The corneal index (CI) is calculated as carapace length/cornea width $\times 100$.

Most specimens, including all holotypes, have been deposited in the Division of Crustacea, Smithsonian Institution (USNM); an identi-

fied set of specimens also has been deposited in the Muséum National d'Histoire Naturelle, Paris (MNHN). The abbreviation IIOE identifies material obtained through the International Indian Ocean Expedition.

I thank Michel Pichon, Arthur G. Humes, and Alain Crosnier for making collections available for study; this report would not have been so complete without the large collection received from Crosnier. L. B. Holthuis, Rijksmuseum van Natuurlijke Historie, Leiden, loaned a syntype of *Squilla harpax* de Haan, and Claude Michel, Mauritius Institute, allowed me to borrow the type of *Squilla juxtaortoria* Ward.

The illustrations were made by my wife Lilly with the support of the Smithsonian Institution through its Research Awards program.

Clorida Eydoux and Souleyet, 1842

With the recent description of two species from India (Chhapgar and Sane, 1967) and a new species from Madagascar described herein, the genus *Clorida* now comprises 16 species, all of which occur in the Indo-West Pacific region. In view of the large number of species now placed in the genus, it is felt that the key to species presented below will be of some aid to other students of the group.

The key does not include *Squilla gibba* Nobili, 1903, a species aligned with *Clorida latreillei* Eydoux and Souleyet and its allies by previous workers. I have transferred Nobili's species to another genus in a paper now in press (Manning, 1967c).

Five species have been recorded from the Western Indian Ocean, including records given herein. *Clorida latreillei* has been recorded from southern Moçambique by Barnard (1926, 1950), and *C. microphthalma* (H. Milne-Edwards) has been recorded from Zanzibar by Jurich (1904) and Stephenson (1962). Either of these two species could occur off Madagascar.

Key to Species of *Clorida*

1. Mandibular palp absent 2
Mandibular palp present 6
2. One rounded lobe present between spines of basal prolongation of uropod. 3
Two rounded lobes present between spines of basal prolongation of uropod 5
3. Cornea broader than stalk; rostral plate with median carina.
C. incerta (Hansen, 1926)Cornea not as broad as stalk; rostral plate lacking median carina 4
4. Lateral margins of intermediate teeth of telson with prominent denticles; inner margin of basal prolongation of uropod with 3-4 spines.
C. denticauda (Chhapgar and Sane, 1967)

- Lateral margins of intermediate teeth of telson not denticulate; inner margin of basal prolongation of uropod with 6-9 spines.
C. granti (Stephenson, 1953)
5. Sixth abdominal somite with supplementary spinules on posterior margin in addition to spines of dorsal carinae . . . *C. mauiana* (Bigelow, 1931)
 Sixth abdominal somite armed at most with spines of dorsal carinae.
C. fallax (Bouvier, 1914)
6. First 5 abdominal somites lacking submedian carinae 7
 Submedian carinae present on one or more of the first 5 abdominal somites 12
7. Carapace lacking anterolateral spines . . . *C. rotundicauda* (Miers, 1880)
 Carapace with anterolateral spines 8
8. Postanal carina absent 9
 Postanal carina present 10
9. Marginal carinae of abdomen unarmed . . . *C. choprai* (Tweedie, 1935)
 Marginal carinae of at least second through fifth abdominal somites with posterior spines *C. depressa* (Miers, 1880)
10. Cornea broader than stalk *C. miersi*, new species
 Cornea not as broad as stalk 11
11. Width of cornea about one-third eye length; lateral margin of carapace, posterior to anterolateral spine, straight or convex; rostral plate longer than broad *C. microphthalmia* (H. Milne-Edwards, 1837)
 Width of cornea about one-half eye length; lateral margin of carapace, posterior to anterolateral spine, concave; rostral plate broader than long.
C. chlorida (Brooks, 1886)
12. No submedian carinae on first through third abdominal somites 13
 All 6 abdominal somites with submedian carinae 14
13. Fifth and sixth abdominal somites with submedian carinae.
C. merguiensis (Tiwari and Biswas, 1952)
 Fourth, fifth, and sixth abdominal somites with submedian carinae.
C. verrucosa (Hansen, 1926)
14. Lateral processes of sixth and seventh thoracic somites with posterolateral spine *C. bombayensis* (Chhapgar and Sane, 1967)
 Lateral processes of sixth and seventh thoracic somites unarmed 15
15. Ventral surface of telson smooth on either side of postanal carina.
C. latreillei Eydoux and Souleyet, 1842
 Ventral surface of telson tuberculate and carinate on either side of postanal carina *C. decorata* Wood-Mason, 1875

Clorida chlorida (Brooks, 1886)

FIGURE 1

Squilla chlorida Brooks, 1886, p. 40, pl. 2 (figs. 1-5).—Bigelow, 1894, p. 510 [key].—Kemp, 1913, p. 33.—Serène, 1952, fig. 12.

PREVIOUS RECORDS.—None.

MATERIAL.—1 juv., 12.1; Large Baie de Moramba, northwestern coast of Madagascar; dredge; 30 m; muddy sand; 1 March 1958; USNM. 1 ♂, 15.5; 1 ♀, 16.5; Banc de Pracel, western coast of Madagascar; dredge; 40 m; muddy sand; A. Crosnier; June 1959; USNM. 2 ♂, 19.5-32.0; 1 broken ♀, CL 9.6; same; dredge; 65 m; sand; A.

Crosnier; June 1959; MNHNP. 1 ♂, 38.2; Iles Mitsio, northwestern coast of Madagascar; trawl; 64 m; muddy sand; 28 July 1958; USNM.

DESCRIPTION.—Eye small, extending slightly beyond middle of first segment of antennular peduncle; stalk inflated, almost twice as long as broad; cornea small, bilobed, less than half as long as stalk; ocular scales rounded, fused along midline.

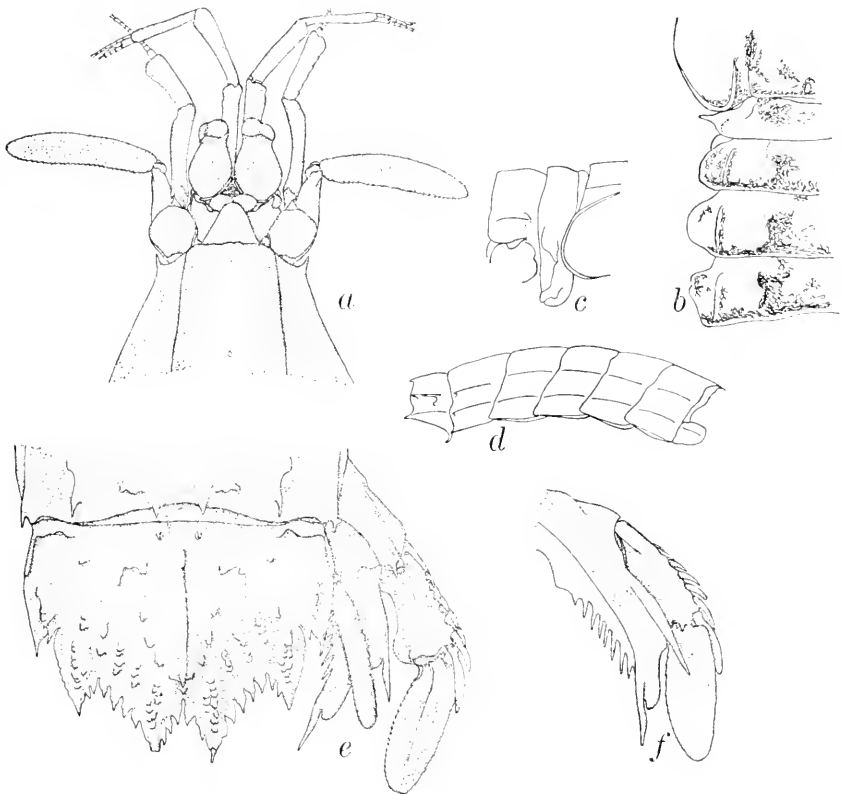

FIGURE 1.—*Clorida chlorida* (Brooks), male, TL 38.2, Iles Mitsio: *a*, anterior portion of body; *b*, lateral processes of exposed thoracic somites; *c*, outline of lateral processes of fifth and sixth thoracic somites, lateral view; *d*, outline of abdomen, lateral view; *e*, last abdominal somite, telson, and uropod; *f*, uropod, ventral view. (Setae omitted).

Antennular peduncle elongate, as long as carapace or nearly so; dorsal processes of antennular somite visible lateral to rostral plate as broad, sharp, anteriorly directed spines.

Antennal peduncle elongate, first segment extending well beyond eye; antennal scale slender, curved, over half as long as carapace.

Rostral plate broader than long, triangular, rounded anteriorly, without carinae.

Carapace strongly narrowed anteriorly, lateral margin concave, completely lacking median and intermediate carinae; posterior fourth of carapace usually with reflected marginal carinae only, traces of lateral carinae present or absent; posterior margin straight; anterolateral margins slope posterolaterally to strong anterolateral spines, which do not extend to base of rostral plate.

Raptorial claw stout; dactylus with 5 teeth, outer margin of dactylus flattened; dorsal ridge of carpus with single, low, blunt spine.

Mandibular palp and 4 epipods present.

Exposed thoracic somites without submedian carinae, last 3 somites with well-formed, unarmed intermediate carinae; lateral process of fifth somite a short sharp spine, directed laterally; fifth somite with blunt, tubercular, triangular or spiniform ventral projection on each side; lateral processes of next two somites not bilobed, rounded anterolaterally and posterolaterally, process of sixth somite more triangular than that of seventh; ventral keel of eighth somite a low, inconspicuous projection.

Abdomen broad, depressed, lacking submedian carinae on first 5 somites; abdominal carinae spined as follows: submedian, 6; intermediate, 5-6; lateral, (4) 5-6; marginal, (4) 5; sixth somite with sharp spine on each side in front of articulation of uropod.

Telson broader than long, with 3 pairs of sharp marginal teeth, submedians with movable apices; prelateral lobes formed dorsally, not noticeably projecting laterally; carinae of marginal teeth short, tuberculate dorsally; dorsal surface with short, U-shaped carinae, open posteriorly, at anterior end of line of 4 tubercles converging under posterior apex of median carina; 4 rows of tuberculate carinae present between submedian and intermediate teeth, outer row anterior to carina of intermediate tooth; single denticle present on surface anterior to outer row, at level of U-shaped carina; small spined tubercle present under spine of median carina; denticles sharp, spiniform, 3, 6-7, 1; ventral surface of telson with low postanal keel.

Outer margin of proximal segment of uropodal exopod with 7 slender, movable spines, last extending to midlength of distal segment; proximal segment of uropodal exopod with long dorsal carina; endopod slender, tapered, curved; basal prolongation with 6-8 slender spines on inner margin and broad, rounded lobe on outer margin of longer inner spine.

COLOR.—Carapace with 2 broad bands of dark pigment, gastric grooves dark; dorsal surface of merus dark; posterior margin of carapace, last 3 thoracic, and all abdominal somites dark; last 3 thoracic somites with some dark pigment on lateral processes; last 3 thoracic and first 5 abdominal somites with dorsal rectangular dark patch; pattern on telson faded, but with median triangle, apex at apical spine

of median carina, outlined in dark pigment; uropod with dark color on distal half of proximal segment, inner half of distal segment of exopod, and most of endopod.

SIZE.—Males, TL 15.5–38.2; females, TL 16.5 (largest specimen broken); juvenile, TL 12.1. Other measurements of male, TL 38.2; carapace length 7.7; cornea width 1.1; stalk width 1.3; eye length 2.2; rostral plate length 1.3, width 1.6; fifth abdominal somite width 10.3; telson length 6.2, width 8.4.

DISCUSSION.—It is with some hesitation that I assign these specimens to Brooks's species, one of the poorest known in the genus. The specimens agree in all respects with his account except that the lateral process of the fifth thoracic somite is inclined slightly forward and there are more spines on the inner margin of the basal prolongation of the uropod. Although Brooks indicated that the ventral surface of the telson of the type was smooth, examination of that specimen revealed a low postanal carina that is present in the Madagascar specimens as well.

Clorida chlorida most closely resembles *C. microphthalmia* (H. Milne-Edwards), but the latter has longer, slender eyes, a more elongate rostral plate, a broader carapace, with the lateral margins convex or straight, and a shorter lateral process on the fifth thoracic somite. The differences in shape of the lateral margin of the carapace were noted by R. P. Bigelow in his unpublished work on the Philippine stomatopods; it seems to be a useful character to distinguish these two similar species.

The young specimens are assigned to this species on the basis of their inflated eyes, the same number of teeth on the claw (5), their short rostral plate, and, in the cases of the two larger specimens, a color pattern identical to that of all adults examined.

Kemp (1913) has discounted Lanchester's (1901) record of the species from the Malay Peninsula, which was based on a specimen with submedian carinae on the abdomen.

DISTRIBUTION.—Indo-West Pacific, from Amboina (Brooks, 1886) and off Madagascar, in depths between 27 and 64 m.

Clorida fallax (Bouvier, 1914)

FIGURE 2

Squilla fallax Bouvier, 1914, p. 699; 1915, p. 308, figs. 39–42.—Barnard, 1950, p. 841 [footnote and key only].—Serène, 1954, p. 6.—Stephenson and McNeill, 1955, p. 241.

Squilla ambigua Hansen, 1926, p. 6, pl. 1 (figs. 2 a–c).

PREVIOUS RECORDS.—None.

MATERIAL.—1 broken ♀, CL 5.6; Lagon de Mayotte, Comoro Islands; MYT 192 bis; A. Crosnier; August 1959; USNM.

DESCRIPTION.—Eye small, extending beyond end of first segment of antennular peduncle; stalk not markedly dilated, 1.8 times as long as broad; cornea broad, bilobed, broader than stalk and set transversely on it; ocular scales fused and sinuate along midline, acute laterally.

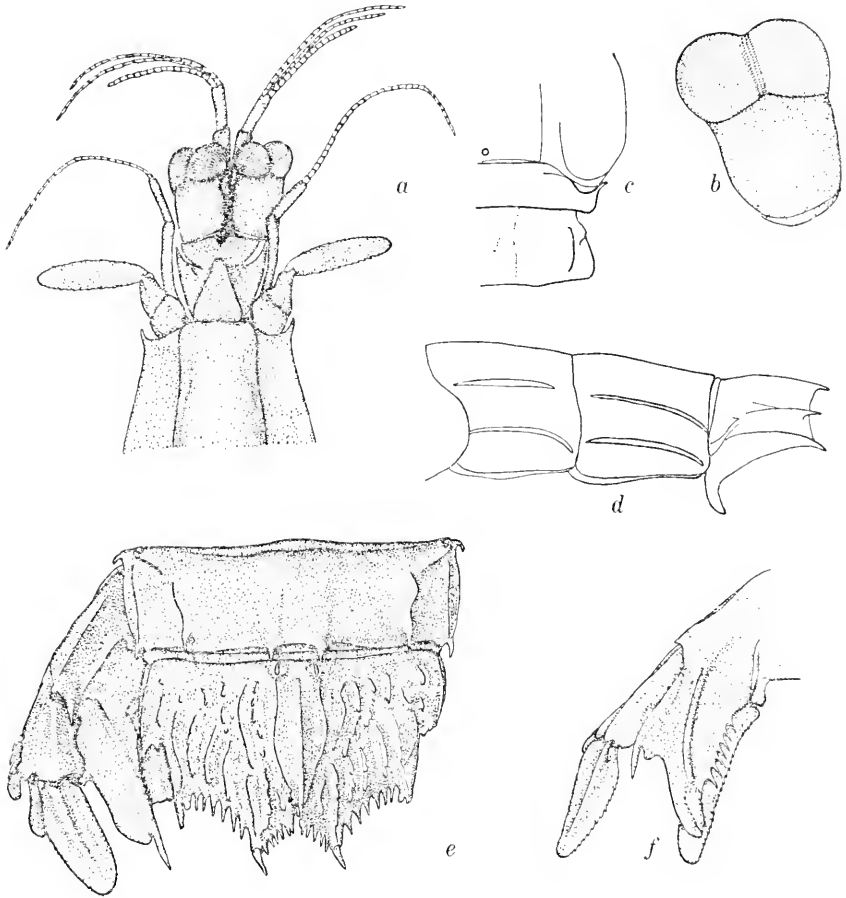

FIGURE 2.—*Clorida fallax* (Bouvier), female, CL 5.6, Comoro Ids.: *a*, anterior portion of body; *b*, eye; *c*, outline of lateral processes of fifth and sixth thoracic somites; *d*, outline of last three abdominal somites, lateral view; *e*, last abdominal somite, telson, and uropod; *f*, uropod, ventral view (outer spine broken). (Setae omitted).

Antennular peduncle short, more than half as long as carapace; dorsal processes of antennular somite visible lateral to rostral plate as slender, anteriorly directed spines.

Antennal peduncle extending to cornea; antennal scale curved, short, less than half as long as carapace.

Rostral plate longer than broad, triangular, apex rounded but acute, median carina absent.

Carapace narrowed anteriorly, completely lacking median and intermediate carinae; reflected marginal carinae present on posterior fourth of carapace; posterior margin straight; anterolateral margins sloping laterally to short anterolateral spines.

Raptorial claw slender; dactylus with 4 teeth, outer margin straight, with 2 proximal lobes, distal larger, separated by a shallow emargination; dorsal ridge of carpus terminating in rounded lobe.

Mandibular palp absent; 4 epipods present.

Exposed thoracic somites lacking submedian carinae; last 3 thoracic somites with low, unarmed intermediate carinae; lateral process of fifth somite a short, slender spine, directed anterolaterally; a pair of long, slender ventral spines also present on fifth somite; lateral processes of next 2 somites subtriangular, not bilobed, rounded or angled, but unarmed posterolaterally; ventral keel of eighth somite a low, obtuse tubercle.

Abdomen broad, depressed, lacking submedian carinae on first 5 somites; only carinae of sixth somite armed with posterior spines; area between submedian and intermediate carinae on sixth somite irregular; sixth somite with ventrolateral spine on each side in front of articulation of uropod.

Telson broader than long, with 3 pairs of sharp marginal teeth, submedians with movable apices; prelateral lobes absent; marginal carinae and carinae of intermediate and lateral teeth smooth, carinae of submedian teeth denticulate dorsally; entire dorsal surface of telson covered with carinae of varying length; dorsal submedian carinae interrupted posteriorly, posterior portions fusing with posterior end of median carina; dorsal surface with 1 short carina present inside carina of submedian tooth and 4 long curved carinae, terminating in tubercles, present between submedian and intermediate teeth; anterior surface of telson with several other carinae of varying length, as shown in figure 2; median carina with distal spine overhanging smaller median spinule; denticles 5-6, 7, 1, most sharp, outer intermediate and lateral denticles rounded; ventral surface with postanal keel flanked laterally by 1 short and 1 long carina and about 14 shorter, longitudinal carinae.

Outer margin of proximal segment of uropodal exopod with 5 movable spines, proximal 3 sharp, distal 2 spatulate, last extending about to midlength of distal segment; proximal segment of exopod with dorsal carina; endopod slender, curved; ventral surface of protopod with carina extending anteriorly from articulation of endopod; inner margin of basal prolongation with 5 slender spines; inner spine of basal prolongation longer; 2 rounded lobes present

between spines of basal prolongation, inner larger, apex deflected dorsally.

COLOR.—Posterolateral angles of carapace and lateral portions of body black; telson with lateral black patches; uropodal exopod with dark spot at articulation of distal segment.

SIZE.—Only specimen examined, a female, broken. Measurements: carapace length 5.6; cornea width 1.3; eye length 1.8; stalk width 1.0; rostral plate length 1.2, width 0.8; fifth abdominal somite width 6.5; telson length 3.8, width 5.4.

DISCUSSION.—The present broken specimen agrees very well with the limited accounts of *S. fallax* given by Bouvier (1914, 1915) and the detailed account of *S. ambigua* given by Hansen (1926). Their accounts differ only in the extent of carination of the telson and the armature of the marginal carinae of the abdomen. Bouvier's figure (1915) indicates that most of the dorsal carinae of the telson are broken, whereas the carinae on the telson of Hansen's specimen are mostly entire. In the broken specimen from the Comoro Islands they are divided proximally, entire distally. On another specimen in the U.S. National Museum, from the Solomon Islands, the carinae of the telson are broken mostly into tubercles. In view of the normal variation in telson ornamentation in this genus, the extremes exhibited by Hansen's specimen and Bouvier's as well must be considered within the expected range of variation.

Although the specimen from the Comoro Islands lacks marginal spines on the fifth abdominal somite, as in *S. fallax*, the larger specimen from the Solomon Islands has this spine, which was also present in Hansen's type.

Finally, the dark lateral portions of the body, mentioned by both Hansen and Bouvier, are present in the specimens from both the Indian Ocean and Pacific Ocean.

DISTRIBUTION.—Indo-West Pacific, from Mauritius (Bouvier, 1914, 1915), Madagascar, Dangan Besaar, Indo-Malaya (Hansen, 1926), Viet Nam (Serène 1954), New South Wales, Australia (Stephenson and McNeill, 1955), and the Solomon Islands.

Clorida miersi, new species

FIGURE 3

HOLOTYPE.—1 ♂, 32.8; Banc de Pracel, western coast of Madagascar; 65 m; sand; A. Crosnier; June 1959; USNM 124091.

DESCRIPTION.—Eye small, extending to end of first segment of antennular peduncle; stalk slightly inflated, not as broad as cornea; cornea small, bilobed, breadth about two-thirds length of eye; ocular scales rounded, fused along midline.

Antennular peduncle elongate, over half as long as carapace; dorsal processes of antennular somite visible lateral to rostral plate as slender, sharp, anteriorly directed spines.

Antennal peduncle not extending beyond eye; antennal scale slender, curved, less than half as long as carapace.

Rostral plate longer than broad, margins proximally subparallel, distally convergent on rounded apex; median carina absent.

Carapace strongly narrowed anteriorly, completely lacking median and intermediate carinae; posterior fourth of carapace with reflected marginal carinae only; posterior margin straight; anterior margins slope posterolaterally to strong anterolateral spines, which do not extend to base of rostral plate.

Raptorial claw slender: dactylus with 5 teeth, outer margin flattened, with proximal notch flanked distally by rounded lobe; dorsal ridge of carpus terminating in low, rounded tubercle.

Mandibular palp and 4 epipods present.

Exposed thoracic somites lacking submedian carinae, least 3 somites with well-formed, unarmed intermediate carinae; lateral process of fifth somite a short, sharp, slender, anterolaterally directed spine; fifth somite with ventral tubercle under each lateral spine; lateral processes of sixth and seventh somites not bilobed, obliquely truncate, rounded anterolaterally and posterolaterally; ventral keel of eighth somite prominent, rounded, projecting ventrally.

Abdomen broad, depressed, first 5 somites lacking submedian carinae; abdominal carinae spined as follows: submedian, 6; intermediate, 5-6; lateral, 6; marginal, 5; sixth somite with ventrolateral spine in front of articulation of each uropod.

Telson broader than long, with 3 pairs of sharp marginal teeth, submedians with movable apices; prelateral lobes absent; carinae of submedian and intermediate teeth nodulose, marginal carinae smooth; telson ornamented dorsally with a series of anterior tubercles, a submedian line of tubercles on each side of median carina converging under its apex, and 6-7 short, curved lines of tubercles; median carina with slender spine and ventral tubercle under spine; denticles sharp, 2-3, 7-8, 1; ventral surface of telson with postanal keel.

Outer margin of proximal segment of uropodal exopod with 6 slender, curved spines, last extending about to midlength of distal segment; proximal segment of exopod with longitudinal dorsal carina; endopod slender, curved; basal prolongation with 7 slender spines on inner margin and broad rounded lobe on outer margin of longer inner spine.

COLOR.—Almost completely faded; some dark chromatophores present on anterior appendages, arranged in lines on propodus of claw;

uropod with traces of dark pigment on inner half of exopod and distal half of endopod.

SIZE.—Male holotype, only specimen examined, TL 32.8. Other measurements: carapace length 5.2; cornea width 1.3; eye length 1.8;

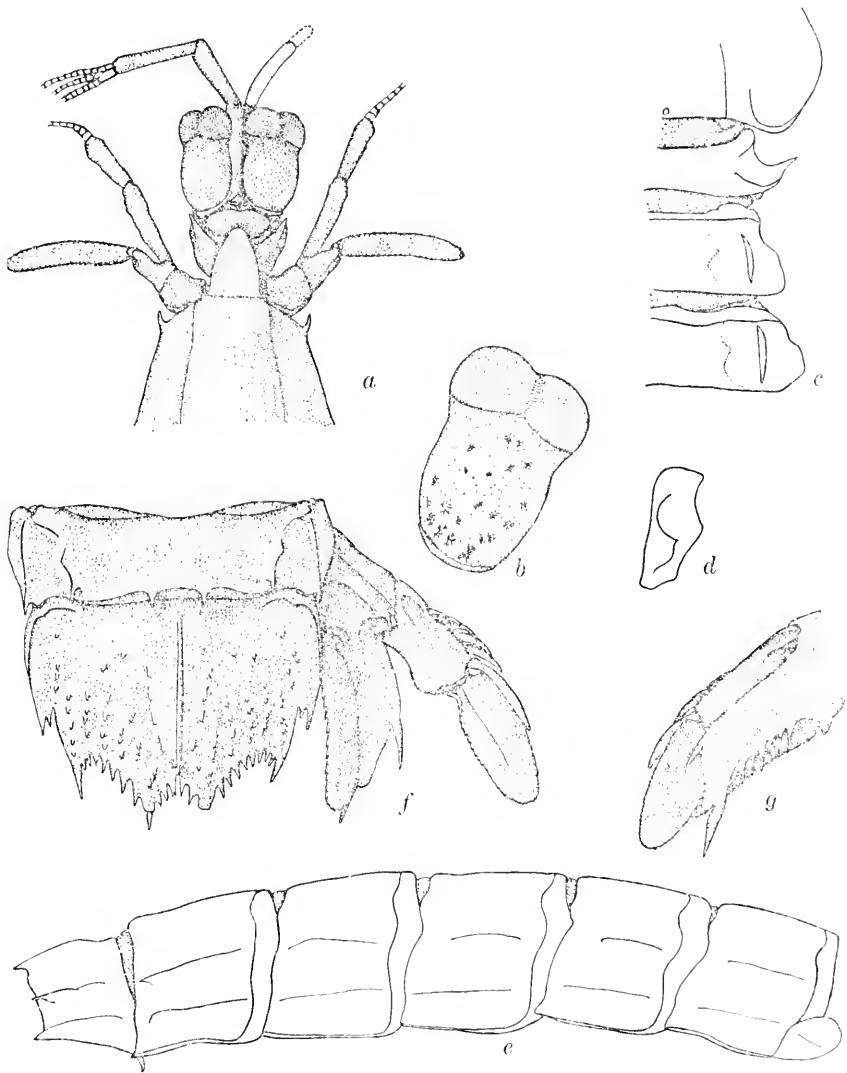

FIGURE 3.—*Clorida miersi*, new species, male holotype, TL 32.8, Banc de Pracecl: *a*, anterior portion of body; *b*, eye; *c*, outline of lateral processes of fifth, sixth, and seventh thoracic somites; *d*, outline of fifth thoracic somite, lateral view; *e*, outline of abdomen, lateral view; *f*, last abdominal somite, telson, and uropod; *g*, basal prolongation of uropod, ventral view. (Setae omitted).

stalk width 1.1; rostral plate length 1.4, width 0.9; fifth abdominal somite width 7.3; telson length 3.9, width 5.3.

DISCUSSION.—*Clorida miersi* closely resembles *C. verrucosa* (Hansen) in most features but shows several important differences, as follows: (a) the eyes are of different shape, the stalk is not as long and is less expanded laterally, and the broader cornea is set transversely on the stalk; (b) there are no submedian carinae on the first five abdominal somites, but they are present on the fourth and fifth somites in *C. verrucosa*; (c) fewer abdominal carinae are armed (in *C. verrucosa* the abdominal carinae of the fourth, fifth, and sixth somites are all provided with spines); and (d) the anterior lobe of the lateral process of the fifth thoracic somite is spiniform in *C. verrucosa*, rounded in *C. miersi*.

The large eyes and elongate rostral plate will immediately distinguish this species from the others known from the western Indian Ocean, *C. clorida* (Brooks), *C. fallax* (Bouvier), *C. latreillei* Eydoux and Souleyet, and *C. microphthalmia* (H. Milne-Edwards).

ETYMOLOGY.—The species is named for E. J. Miers, the British carcinologist who made valuable early contributions to our knowledge of the stomatopods.

DISTRIBUTION.—Known only from the type-locality, off the west coast of Madagascar.

Harpiosquilla Holthuis, 1964

Four species, all from the Indo-West Pacific region, have been assigned to this genus; all four occur in the western Indian Ocean. Balss (1910) reported *H. raphidea* from off East Africa and Chopra (1939) recorded *H. annandalei* from the Gulf of Oman. Two species, *H. harpax* and one described as new, are reported herein. The following key will serve to distinguish all of the species.

Key to Species of *Harpiosquilla*

1. Fifth thoracic somite with a lateral spine 2
 Fifth thoracic somite rounded laterally 3
2. Submedian carinae of fifth abdominal somite armed posteriorly; distal segment of uropodal exopod black with a white midrib. **H. annandalei** (Kemp, 1911)
 Submedian carinae of fifth abdominal somite unarmed; distal segment of uropodal exopod with inner half only dark, not black. **H. raphidea** (Fabricius, 1798)
3. Carapace with median carina; first 5 abdominal somites with submedian carinae **H. harpax** (de Haan, 1844)
 Carapace lacking median carina; first 5 abdominal somites lacking submedian carinae **H. melanoura**, new species

Harpiosquilla harpax (de Haan, 1834)

FIGURE 4

Squilla harpax de Haan, 1844, pl. 51 (fig. 1).—Tiwari and Biswas, 1952, p. 358, figs. 3b, d, f.—Barnard, 1955, p. 49.—Ingle, 1963, p. 18, figs. 9, 59.—Holthuis, 1964, p. 140 [description of *Harpiosquilla*].

Squilla raphidea.—Crosnier, 1965, p. 61 [listed].

Not *Harpiosquilla harpax*.—Manning, 1966, p. 87, fig. 1 [an undescribed species].

Harpiosquilla harpax.—Manning, 1967, p. 103.

PREVIOUS RECORDS.—Crosnier, 1965.

MATERIAL.—1 ♀, 118.2; Ambaro Bay, Nosy Bé; trawl; 2–5 m; M. Pichon; 8 September 1964; USNM. 1 ♂, 171.0; Baie de Narendry, northwestern coast of Madagascar; trawl; 6 m; mud; A. Crosnier; February 1958; USNM. 1 ♀, 141.5; same; MNHNP.

DESCRIPTION.—Eye large, T-shaped, cornea bilobed, set almost transversely on stalk; eyes not extending past end of first segment of antennular peduncle; ocular scales truncate, situated laterally; anterior margin of ophthalmic somite rounded; corneal indices 269–358.

Antennular peduncle slender, as long as or slightly shorter than carapace; dorsal processes of antennular somite slender, tapered, directed anterolaterally.

Rostral plate triangular, longer than broad, without carinae; lateral margins sinuous, convex posteriorly, convex anteriorly, converging on short, blunt apex that extends just beyond edge of antennular somite.

Carapace narrowed anteriorly, anterior width less than one-half median length; anterolateral spines strong but not extending to base of rostral plate; median carina present, not bifurcate at either end; intermediate carinae not extending to anterior margin.

Mandibular palp and 5 epipods present.

Raptorial claw large, propodus almost half again as long as carapace; dactylus with outer margin evenly curved in female, with proximal obtuse angle in male, inner margin with 8 teeth; propodus with erect spines and tubercles on margin opposing dactylus; dorsal ridge of carpus undivided.

Exposed thoracic somites with, at most, vestiges of submedian carinae, last three somites with prominent unarmed intermediate carinae; lateral process of fifth somite rounded, obscure, a ventral spine, with convex posterior lobe, present on each side; lateral process of sixth somite bilobed, anterior lobe low, rounded, posterior triangular, with spiniform apex; lateral process of seventh somite with irregular margin, at most an anterior tubercle present, postero-laterally spiniform; ventral keel on eighth somite rounded, inclined posteriorly.

Abdomen with submedian carinae of first 5 somites low, poorly developed, but present; remainder of abdominal carinae well-formed, spined as follows: submedian, 6; intermediate, 2-6; lateral, 1-6; marginal, 1-5; sixth somite with sharp spine in front of articulation of each uropod and with median ventral carina.

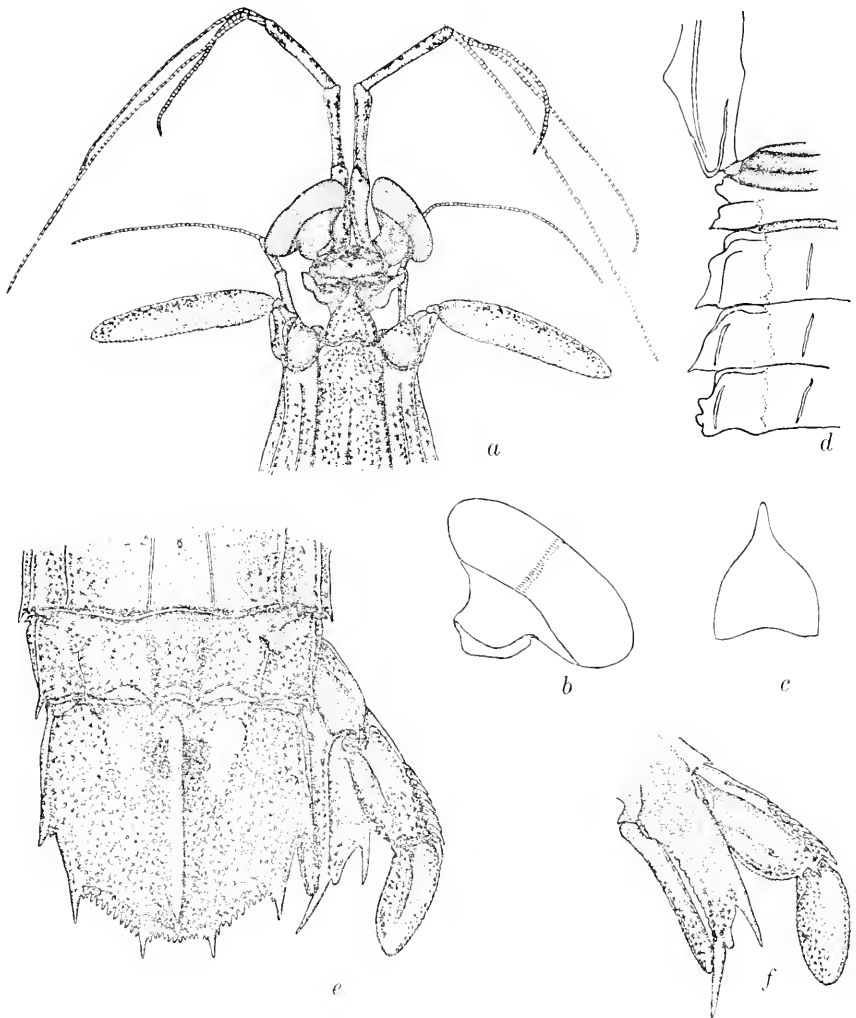

FIGURE 4.—*Harpiosquilla harpax* (de Haan), female, TL 118.2, Ambaro Bay: *a*, anterior portion of body; *b*, outline of eye; *c*, outline of rostral plate; *d*, outline of lateral processes of exposed thoracic somites; *e*, last two abdominal somites, telson, and uropod; *f*, basal prolongation of uropod, ventral view. (Setae omitted).

Telson as broad as long, appearing elongate; carinae of marginal teeth short, rounded, slightly nodulose dorsally; 3 pairs of marginal teeth present, prelateral lobe formed dorsally but not projecting laterally; marginal carina over twice as long as carina of lateral tooth; denticles subequal, sharp, 4-7, 10-12, 1; ventral surface with postanal keel extending about halfway between anus and posterior margin.

Uropod with 9 movable teeth on outer margin of proximal segment of exopod, last short; lobe on outer margin of inner spine of basal prolongation prominent, rounded, margin concave.

COLOR.—Anterior edge of antennal scale dark; carinae, grooves, and posterior margin of carapace dark; thoracic and abdominal somites with anterior and posterior dark, transverse lines, posterior broader and darker, and intermediate and marginal carinae outlined with dark pigment; telson with pair of anterior, submedian, round black spots; carinae and margins of uropod with dark chromatophores, particularly inner margin of exopod; endopod with dark pigment lining both edges of distal half, central portion clear.

SIZE.—Male, TL 171.0; females, TL 118.2-141.5. Other measurements of male, TL 171.0: carapace length 32.2; cornea width 10.4; rostral plate length 5.6, width 5.1; fifth abdominal somite width 32.8; telson length 30.4, width 30.4.

DISCUSSION.—The presence of a median carina on the carapace, submedian carinae on the abdomen, and the lighter colored uropods distinguish this species from *H. melanoura*, new species, described below. Other differences are discussed under the account of the new species.

Harpiosquilla harpax lacks the lateral spine on the fifth thoracic somite, which is characteristic of *H. raphidea* (Fabricius), and lacks the armed intermediate carinae of the thoracic somites, which characterize *H. annandalei* (Kemp) and which may occur also in very large specimens of *H. raphidea*. In their account separating *H. harpax* from *H. raphidea*, Tiwari and Biswas (1952) also pointed out other differences between the two species.

The specimen from Australia assigned to this species by Manning (1966) belongs to an undescribed species, an account of which is in preparation.

Through the kindness of L. B. Holthuis, Rijksmuseum van Natuurlijke Historie, Leiden, I was able to study one of the syntypes of *Squilla harpax* de Haan and compare it directly with the specimens of *H. harpax* and *H. melanoura*, new species, reported here. The specimen, a male, TL 152.5, from Japan, RMNH 2SH, is here selected as the lectotype of *Squilla harpax*. It agrees in all details with the specimens of *H. harpax* from Madagascar.

The corneal indices of the two females of *H. harpax* reported here, CL 21.0 and 28.5, are 269 and 320; in the two males (including the lectotype), CL 29.1–32.2, they are 316 and 358, respectively. Tiwari and Biswas (1952) reported a range of 2.7–3.2 (270–320) in their material. Not enough material is available to determine if there are any sexual or geographic differences in the corneal indices of this species.

The eyes of *H. melanoura*, new species, appear to be larger, and the range of corneal indices, 229–252, indicates that the cornea is appreciably broader in that species.

The corneal index of the specimen reported from Australia by Manning (1966), a female, CL 30.6, was 336, which falls within the range observed for *H. harpax*. In the Australian specimen, however, the eye appears to be more inflated than in *H. harpax*.

DISTRIBUTION.—Indo-West Pacific, from the Red Sea and East Africa to Japan.

Harpiosquilla melanoura, new species

FIGURE 5

HOLOTYPE.—1 ♂, 128.6; Banc de Pracel, western coast of Madagascar; 55 m; sand; A. Crosnier; July 1959; USNM 124092.

PARATYPES.—1 ♀, 135.6; Banc de Pracel, western coast of Madagascar; 55 m; muddy sand; A. Crosnier; June 1959; USNM 124093. 1 ♂, 101.6; 1 ♀, 126.1; same; MNHN.

DESCRIPTION.—Eye large, T-shaped, cornea bilobed, set almost transversely on stalk; eyes extending anteriorly almost to end of first segment of antennular peduncle; ocular scales obliquely truncate or rounded, situated laterally; anterior margin of ophthalmic somite rounded; corneal indices 229–252.

Antennular peduncle slender, slightly longer than carapace; dorsal processes of antennular somite broad, each tapered to an acute apex, directed anterolaterally.

Antennal scale slender, curved, two-thirds as long as carapace.

Rostral plate triangular, longer than broad, without carinae; lateral margins sinuous, convex posteriorly, concave anteriorly, converging on slender, blunt apex; plate extending just beyond dorsal margin of antennular somite.

Carapace narrowed anteriorly, anterior width less than one-half median length; anterolateral spines strong but not extending to base of rostral plate; median carina completely absent; intermediate carinae not extending to anterior margin.

Mandibular palp and 5 epipods present.

Raptorial claw large, propodus slightly less than half again as long as carapace; dactylus with 8 teeth, outer margin of dactylus evenly

curved in female, with proximal, obtuse, angular prominence in male; propodus with series of upright spines on upper margin; dorsal ridge of carpus undivided.

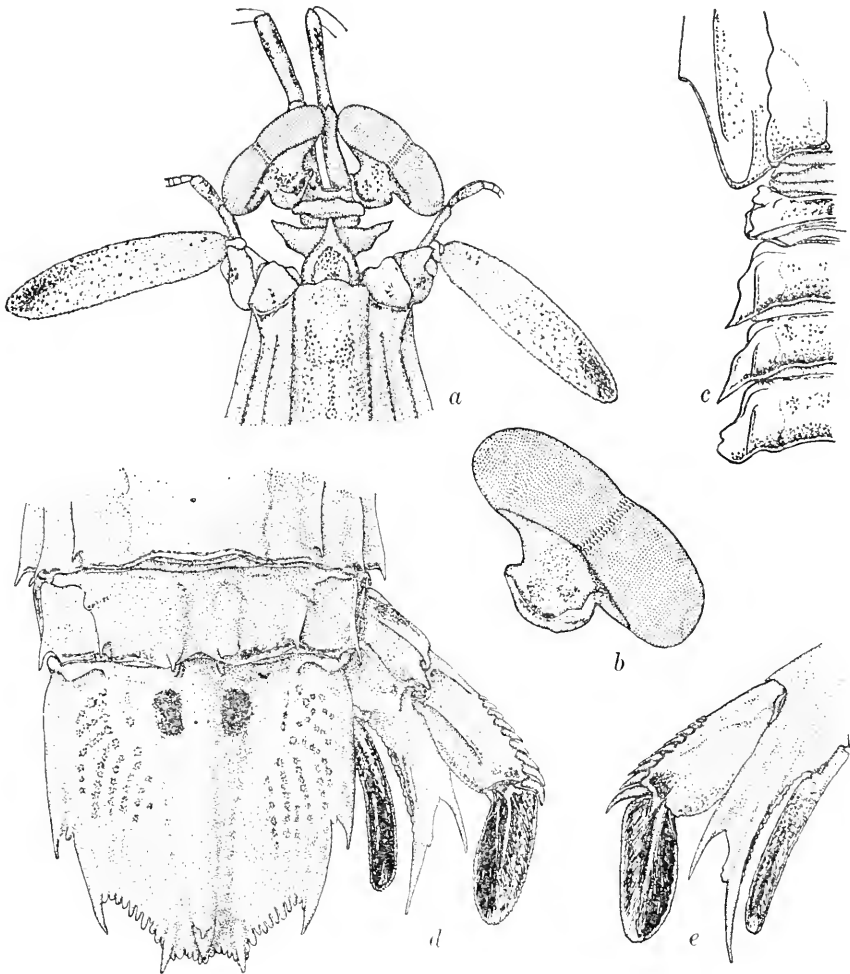

FIGURE 5.—*Harpiosquilla melanoura*, new species, male holotype, TL 128.6, Banc de Pracel: a, anterior portion of body; b, eye; c, lateral processes of exposed thoracic somites; d, last two abdominal somites, telson, and uropod; e, basal prolongation of uropod, ventral view. (Setae omitted).

Exposed thoracic somites lacking submedian carinae, last 3 somites with short, unarmed intermediate carinae; lateral process of fifth thoracic somite obscure, unarmed; fifth somite with slender ventral spine on each side, margins sinuous, apex very sharp; lateral process

of sixth somite bilobed, anterior lobe obtusely rounded, posterior triangular, apex spiniform; lateral process of seventh somite not conspicuously bilobed, margin sinuous, triangular posterolateral apex spiniform; ventral keel of eighth somite inclined posteriorly, rounded anteriorly, angled or rounded posteriorly.

Abdomen lacking submedian carinae on first 5 somites; remainder of abdominal carinae well-formed, spined as follows: submedian, 6; intermediate, 2-6; lateral, 1-6; marginal, 1-5; sixth somite with sharp posterolateral spine in front of articulation of uropod and short, median, ventral keel.

Telson noticeably longer than broad, median carina thick, terminating in slender posterior spine; carinae of marginal teeth short, rounded, slightly irregular dorsally; 3 pairs of marginal teeth present, prelateral lobes formed dorsally but not projecting laterally; marginal carina almost 3 times as long as carina of lateral tooth; denticles subequal, angular but not sharp, 5, 9-10, 1; ventral surface with short postanal keel, not extending halfway from anus to posterior margin.

Uropod with 9 graded, movable spines on outer margin of proximal segment of exopod, last short; lobe on outer margin of inner spine of basal prolongation prominent, rounded, inner margin concave.

COLOR.—Anterolateral angle of antennal scale black; carapace with U-shaped median dark patch, open anteriorly, anterior to cervical groove; posterior margin of carapace, last 3 thoracic somites, and first 5 abdominal somites black; telson with pair of proximal, submedian black squares, convergent rows of pits on surface black; distal segment of uropodal exopod black, with small, clear posterolateral area; distal two-thirds of uropodal endopod black.

SIZE.—Males, TL 101.6-128.6; females, TL 126.1-135.6. Other measurements of male holotype: carapace length 24.4; cornea width 10.2; rostral plate length 4.6, width 4.1; fifth abdominal somite width 24.6; telson length 24.5, width 21.7.

DISCUSSION.—*H. melanoura* most closely resembles *H. harpax* (de Haan), but it differs in several important features, as follows: (a) the eyes are noticeably larger; (b) the median carina of the carapace is absent; (c) submedian carinae are absent on the first five abdominal somites; (d) the telson is slenderer and longer; (e) the postanal keel is shorter, less than half the distance between the anus and the posterior margin of the telson; and (f) the distal portions of the uropod are black. Specimens of the two species can be separated immediately by the differences in color of the uropod alone.

Harpiosquilla raphidea (Fabricius) is a larger species, in which the lateral process of the fifth thoracic somite is spined; it is unarmed in *H. melanoura*. The only other known species of *Harpiosquilla*, *H.*

annandalei (Kemp), differs from *H. melanoura* in having the intermediate carinae of the last three thoracic somites armed with a posterior spine.

The four specimens of *H. melanoura* described here have been compared with the lectotype of *H. harpax* (de Haan).

ETYMOLOGY.—The name is derived from the Greek, "melanos," meaning "dark," and from "oura," meaning "tail," referring to the dark uropods of the species.

DISTRIBUTION.—Known only from the type-locality, Banc de Pracel, off the west coast of Madagascar; all specimens were taken at 55 m.

Squilla Fabricius, 1737

Ten species of *Squilla* have been recorded in the western Indian Ocean from localities between the Red Sea and southern Mozambique, and five of these occur off Madagascar. The five species not now recorded from Madagascar are: *Squilla investigatoris* Lloyd, 1907, from the Gulf of Aden (Chopra, 1939; Ingle, 1963); *S. mikado* Kemp and Chopra, 1921, from Zanzibar and Mozambique (Chopra, 1939; Barnard, 1950; Manning, 1965); *S. massavensis* Kossmann, 1880, from the Red Sea and Zanzibar(?) (Ingle, 1963); *S. minor* Jurich, 1904, from Zanzibar; and *S. woodmasoni* Kemp, 1911, from Zanzibar(?) and Mozambique (Kemp, 1913; Barnard, 1962). With the exception of *S. massavensis*, which may not occur south of the Red Sea (see discussion below), any of these species could occur off Madagascar.

Squilla carinata Serène, 1950

FIGURE 6

Squilla multica rinata.—Dollfus, 1938, p. 196, fig. 1.—Gravier, 1938, p. 174, fig. 4 [not *S. multica rinata* White].

Squilla carinata Serène, 1950, p. 571; 1954, pp. 6, 8.—Ingle, 1963, p. 17, figs. 6-8, 10-12, 67.

PREVIOUS RECORDS.—None.

MATERIAL.—1 ♀, 65.1; Banc de Pracel, western coast of Madagascar; 55 m; muddy sand; A. Crosnier; June 1959; MNHNP. 1 ♂, 88.4; Baie d'Ambaro, Madagascar; 26 m; shelly sand; A. Crosnier; June 1959; USNM.

DESCRIPTION.—Body covered with short, longitudinal carinae; antennular peduncle longer than carapace and rostral plate combined; eye of moderate size, cornea set obliquely on stalk, stalk with several irregularly placed dorsal carinae; ocular scales bifurcate, apices rounded or acute; rostral plate appearing elongate, with long median carina and carinate lateral margins; carapace narrowed anteriorly, covered with longitudinal carinae, median carina with anterior

bifurcation, posterior margin produced into median point; antero-lateral spines of carapace strong but not extending to base of rostral plate; mandibular palp and 4 epipods present; raptorial claw slender, dactylus with 6 teeth, outer margin of dactylus flattened but not conspicuously sinuate; dorsal ridge of carpus undivided; fifth thoracic somite irregularly carinate, with longitudinal and transverse carinae; anterior portion of lateral process of fifth somite directed antero-laterally, apex blunt; posterior lobe slender, apex rounded; submedian carinae of last 3 thoracic somites armed posteriorly, at least 4 of carinae between submedians also armed; lateral process of sixth somite bilobed, anterior lobe large, apex obliquely truncate, posterior lobe triangular,

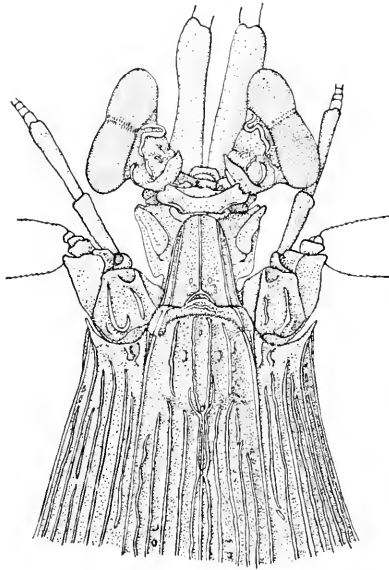

FIGURE 6.—*Squilla carinata* Serène, male TL 88.4, Ambaro Bay: anterior portion of body.

slenderer; lateral process of seventh thoracic somite bilobed, both lobes triangular, anterior lobe smaller; ventral keel on eighth thoracic somite low, triangular; each abdominal somite with numerous longitudinal carinae, last somite with fewest; abdomen with submedian, intermediate, and lateral carinae spined posteriorly on all 6 somites, marginals of first 5 somites also armed; on first 5 somites median and up to 4 other carinae between submedians also armed; on fifth somite only, 1-2 carinae on each side between intermediate and lateral carinae spined; remainder of abdominal carinae unarmed; telson slender, longer than broad, with 4 pairs of sharp marginal teeth and 12 or more carinae of varying length on either side of median carina;

denticles rounded, 4-5, 8-9, 1; ventral surface of telson with postanal keel flanked by numerous longitudinal carinae; uropod slender, elongate, all segments longitudinally carinate; penultimate segment of exopod with 11 graded, movable spines, last not extending to mid-length of distal segment; basal prolongation of uropod with series of short spines on inner margin, lobe on outer margin of inner spine small, acute.

COLOR.—Posterior margin of carapace, last 3 thoracic and first 5 abdominal somites lined with black; body carinae with faint traces of longitudinal lines of dark pigment; telson with bases of intermediate, lateral, and marginal teeth dark, dark pigment on telson terminating anteriorly at a line across level of posterior spine of median carina; uropodal exopod with distal fourth of proximal segment and most of distal segment black, apex clear; distal third of uropodal endopod black.

SIZE.—Male, TL 88.4; female, TL 65.1. Other measurements of male: carapace length 19.8; cornea width 4.4; rostral plate length 3.0, width 2.6; telson length 17.2, width 14.8.

DISCUSSION.—The description given above is based on the two specimens reported herein. Judging from other accounts in the literature, this species exhibits some variation in ornamentation and sinuation of the body carinae. Dollfus (1938, fig. 7) showed that in one specimen from the Gulf of Suez several of the body carinae, other than those reported here, terminated in spines.

The present material agrees with Serène's account in having carinae on the eyestalks, bifurcate ocular scales, and a mandibular palp. Serène did not go into any detail on the other features of his material but did mention that the first two of these characters would differentiate this species from others. The Madagascar specimens agree well with the accounts of the species given by Gravier (1938), Dollfus (1938), and Ingle (1963).

DISTRIBUTION.—Indo-West Pacific, from the Gulf of Suez, Madagascar, and Viet Nam; the species has not been recorded previously from Madagascar.

Squilla gonypetes Kemp, 1911

FIGURE 7

Squilla gonypetes.—Kemp, 1913, p. 54, pl. 4 (figs. 42-44).—Ingle, 1963, p. 15, figs. 1, 5, 14.—Manning, 1965, p. 250, pl. XI (fig. b) [older references].

PREVIOUS RECORDS.—None.

MATERIAL.—1 ♂, 53.1; 1 ♀, 45.2; Banc de Pracel, western coast of Madagascar; 55 m; muddy sand; A. Crosnier; June 1959; USNM. 1 ♂, 51.4; 1 ♀, 38.8; same; MNHNP. 1 ♂ postlarva, 14.8; Large Baie

Moramba, northwestern coast of Madagascar; dredge; 30 m; muddy sand; A. Crosnier; 1 March 1958; USNM.

DIAGNOSIS.—Eye small, cornea set obliquely on stalk; rostral plate without median carina; anterior bifurcation of median carina of carapace obscure, interrupted in some specimens; dactylus of raptorial claw with 5 teeth; dorsal ridge of carpus of claw undivided; inferodistal

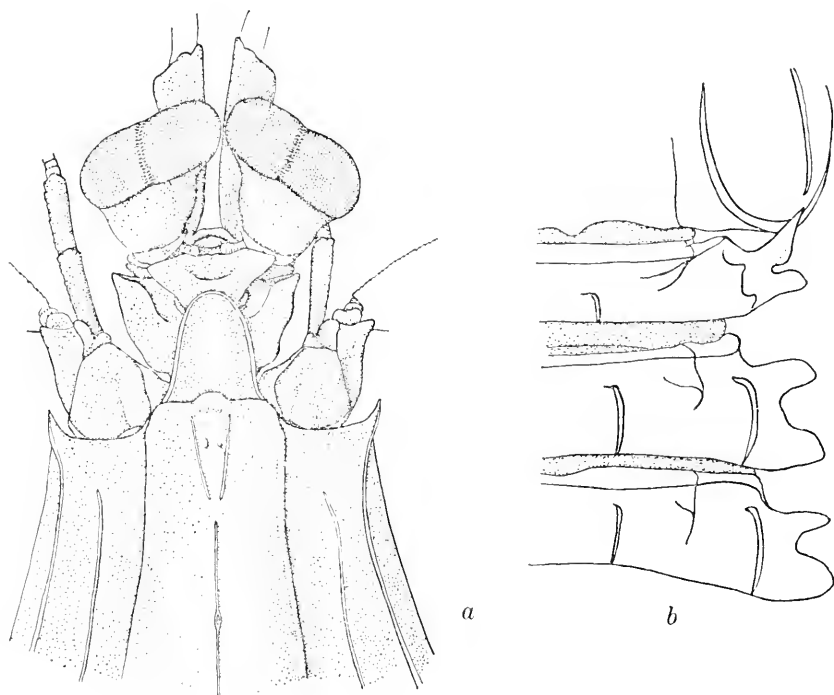

FIGURE 7.—*Squilla gonypetes* Kemp, male, TL 53.1, Banc de Pracel: *a*, anterior portion of body; *b*, outline of lateral processes of fifth, sixth and seventh thoracic somites.

angle of merus of claw unarmed; mandibular palp and 4 epipods present; lateral processes of fifth to seventh thoracic somites bilobed, anterior lobe of process of seventh somite well developed; abdominal carinae spined as follows: submedian, 5–6; intermediate, 4–6; lateral, 3–6; marginal, 1–5; telson with 4, 7, 1 denticles, outer submedian and outer intermediate larger than remainder; ventral surface of telson with short postanal keel.

COLOR.—Thoracic and abdominal somites with dark, irregular posterior line; second abdominal somite with dark transverse patch, fifth somite with pair of dark, triangular submedian patches; sixth abdominal somite black posterolaterally; telson with rectangular anterior and triangular posterior dark patches along median carina;

uropodal exopod with distal portion of proximal segment and inner half of distal segment with scattered dark chromatophores; distal half of endopod dark.

DISCUSSION.—These specimens agree in most details with Kemp's (1913) account of the species, but differ in the following features: (a) the rostral plate appears to be more elongate; (b) the branches of the anterior bifurcation of the median carina of the carapace are present although obscure; (c) the dactylus of the claw is curved more strongly; (d) the posterior lobe of the lateral process of the seventh thoracic somite is not acute but rounded; (e) the intermediate carinae of the third abdominal somite and the lateral carinae of the second somite are unarmed; and (f) the submedian dark squares of the fifth abdominal somite are represented in these specimens by triangles. Kemp noted that one specimen from Madras differed in these respects from other material available to him. This species still is known too poorly to determine whether or not these differences reflect normal variation, or whether or not two or more species are present.

DISTRIBUTION.—Indo-West Pacific, from scattered localities between the Red Sea and Japan.

Squilla hesperia, new species

FIGURE 8

?*Squilla nepa*.—Miers, 1880, p. 25 [part; specimen from Zanzibar].

?*Squilla woodmasoni*.—Kemp, 1913, p. 74 [part; specimens from Zanzibar reported by Miers (1880), reidentified].

?*Squilla massavensis*.—Ingle, 1963, p. 15 [part; specimens from Zanzibar reported by Miers (1880) and Kemp (1913), reidentified].

HOLOTYPE.—1 ♀, 116.6; Baie de Tsimipaika, northwestern coast of Madagascar; trawl; 15 m; muddy sand; A. Crosnier; March 1959; USNM 124094.

DESCRIPTION.—Eye large, cornea bilobed, set very obliquely on stalk; prominent lateral projection present on each stalk; eyes extending to end of first segment of antennular peduncle; anterior margin of ophthalmic somite obtusely rounded; corneal index 364.

Antennular peduncle slightly shorter than carapace; dorsal processes of antennular somite visible lateral to rostral plate as slender, acute projections, directed anterolaterally.

Antennal scale slender, curved, over one-half as long as carapace.

Rostral plate subquadrate, as long as broad, margins sloping to rounded apex; neither median carina nor median tubercle present; lateral margins carinate.

Carapace broad, anterior width more than one-half median length, excluding rostral plate; anterolateral spines of carapace not extending to base of rostral plate; anterior portion of median carina of carapace

lacking bifurcation, posterior portion bifurcate anteriorly; posterior margin of carapace with angular median prominence; intermediate carinae of carapace not extending to anterior margin; posterolateral margins not angled anteriorly.

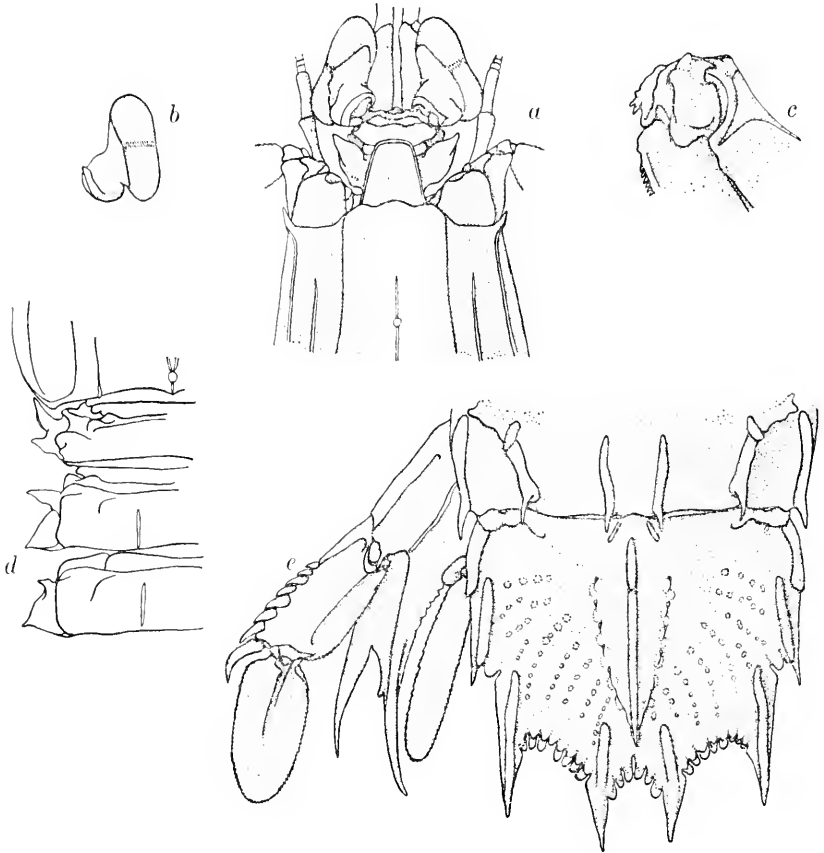

FIGURE 8.—*Squilla hesperia*, new species, female holotype, TL 116.6, Baie de Tsimipaika: a, anterior portion of body; b, eye; c, outline of carpus of raptorial claw; d, outline of lateral processes of fifth, sixth, and seventh thoracic somites; e, last abdominal somite, telson, and uropod (setae omitted).

Daetylus of raptorial claw with 6 teeth, outer margin of daetylus sinuate; dorsal ridge of carpus with 3 tubereles; inferodistal angle of merus at most angled, not strongly spined.

Mandibular palp and 4 epipods present.

Last 3 thoracic somites with submedian and intermediate carinae, none armed; lateral process of fifth somite bilobed, anterior lobe produced into a blunt, anteriorly directed spine, posterior lobe short,

slender, triangular, directed laterally; lateral process of sixth somite bilobed, both lobes triangular, anterior lobe shorter and much slenderer than posterior; lateral process of seventh somite bilobed, anterior lobe obtuse, smaller than that of sixth somite, posterior lobe as long as but broader than posterior lobe of sixth somite; ventral keel of eighth somite low, rounded.

Abdomen with 8 carinae on first 5 somites, 6 on last, submedians subparallel on each somite; second to fifth somites with anterior pair of tubercles lateral to intermediate carinae; abdominal carinae spined as follows: submedian, 4-6; intermediate, 3-6; lateral, 1-6; marginal, 1-5; sixth somite with sharp ventral spine on each side in front of articulation of uropod.

Telson slightly longer than broad, with 6 sharp marginal teeth, each with short dorsal carina; prelateral lobe present; anterior portion of median carina flanked by 2 short, oblique carinae at level of submedian carinae of sixth somite; median carina interrupted anteriorly, terminating posteriorly in slender spine overhanging 2 tubercles; convergent line of pits lateral to median carina marked by mesial tubercles at middle of telson, mesial carina distally; remainder of dorsal surface of telson smooth, convergent rows of pits neither in well-marked grooves nor separated by carinae or low ridges; denticles rounded, subequal, 3, 8, 1, each with proximal dorsal swelling; ventral surface of telson with postanal keel.

Proximal segment of uropodal exopod with 7-8 graded, movable spines, last short, not extending to midlength of distal segment; lobe on outer margin of inner spine of basal prolongation rounded, projecting slightly, margin concave.

COLOR.—Antennal scale outlined in dark pigment; carinae of body dark; last 3 thoracic and first 5 abdominal somites with dark posterior line; telson with dark bar across surface, distal portion of median carina and marginal carinae dark; distal half of proximal segment and inner half of distal segment of uropodal exopod black; distal half of uropodal endopod black.

The color pattern is very similar to that found in *S. massavensis* Kossmann.

SIZE.—Female holotype, only specimen examined, TL 116.6. Other measurements: carapace length 23.3; cornea width 6.4; rostral plate length 4.0, width 4.0; telson length 21.1, width 20.2.

DISCUSSION.—*Squilla hesperia* closely resembles *S. massavensis* Kossmann, from the Red Sea but differs in having the rostral plate shorter and broader, in having the submedian carinae of the abdomen divergent on each somite rather than subparallel, and in having many less dorsal tubercles on the telson. *Squilla massavensis* has two submedian rows of tubercles converging distally on the median carinae of

the telson and has one or more tubercles lateral to these rows. In addition, adults of *S. massavensis* may have the dorsal surface of the telson ornamented with curved rows of carinae between the curved rows of pits; most of the dorsal surface of the telson in *S. hesperia* is smooth.

In the holotype of *S. hesperia* the anterior lobe of the lateral process of the sixth thoracic somite is slenderer than that found in any of the specimens of *S. massavensis* examined.

Judging from the accounts of Kemp (1913) and Serène (1954), specimens identified as *S. massavensis* from outside of the Red Sea do not belong to that species. I have seen small specimens of a *Squilla* from the Persian Gulf in which the submedian carinae of the fourth abdominal somite are unarmed and which also differ from *S. massavensis* in having dark dorsal patches on the second and fifth abdominal somites. It seems likely that specimens reported in the literature as *S. massavensis* from localities outside of the Red Sea belong to *S. hesperia* or to one or more undescribed species.

The records of Miers (1880), Kemp (1913), and Ingle (1963), all based on the same two specimens from Zanzibar, are included tentatively in the synonymy of *S. hesperia*; these two specimens must be reexamined.

ETYMOLOGY.—The name is derived from the Latin, "hesperius," meaning "western."

DISTRIBUTION.—Known only from the type-locality.

Squilla mauritiana Kemp, 1913

FIGURE 9

Squilla mauritiana Kemp, 1913, p. 68.

Squilla jurtaoratoria Ward, 1942, p. 55.

PREVIOUS RECORDS.—None.

MATERIAL.—1 ♀, 102.0; Ile Europa, off Madagascar; P. Fourmanoir; USNM.

DESCRIPTION.—Eye of moderate size, cornea bilobed, set obliquely on stalk; eyes not extending to end of first segment of antennular peduncle; anterior margin of ophthalmic somite rounded, faintly emarginate along midline; ocular scales obliquely truncate; corneal index 397.

Antennular peduncle shorter than carapace; dorsal processes of antennular somite triangular, apices acute, directed anterolaterally.

Antennal scale slender, curved, about three-fifths as long as carapace.

Rostral plate slightly broader than long, appearing elongate, with upturned lateral margins; apex rounded; median tubercle present on dorsal surface.

Carapace narrowed anteriorly, anterior width less than one-half median length; median carina low, entire, not as sharp as remainder of carinae, with well-marked anterior bifurcation; distance from dorsal pit to bifurcation less than distance from bifurcation to anterior margin; portion of median carina posterior to cervical groove also bifurcate anteriorly; posterior margin projecting along midline;

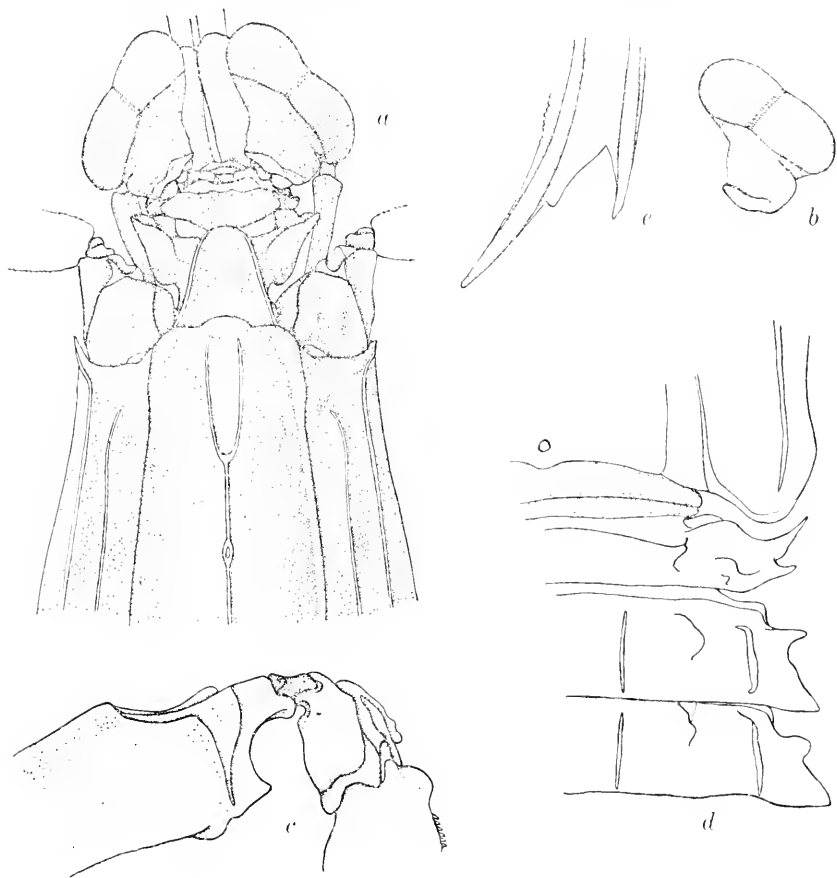

FIGURE 9.—*Squilla mauritiana* Kemp, female, TL 102.0, Ile Europa: *a*, anterior portion of body; *b*, eye; *c*, carpus of raptorial claw; *d*, outline of lateral processes of fifth, sixth, and seventh thoracic somites; *e*, basal prolongation of uropod, ventral view.

anterolateral spines strong but not extending to base of rostral plate; intermediate carinae not extending to anterior margin; posterolateral portion of margin lacking anterior angle.

Dactylus of raptorial claw with 6 teeth, outer margin sinuate; dorsal ridge of carpus with 2 tubercles; inferodistal angle of merus with blunt spine.

Mandibular palp and 4 epipods present.

Last 3 thoracic somites with unarmed submedian and intermediate carinae; lateral process of fifth somite bilobed, anterior lobe a slender, anteriorly curved spine, posterior lobe slender, short, directed laterally; lateral process of sixth somite bilobed, both portions triangular, acute, anterior much slenderer and shorter than posterior; lateral process of seventh somite bilobed, anterior lobe small, obtuse, posterior lobe much larger, triangular; ventral keel of eighth somite rounded, inclined posteriorly.

Abdomen with 8 carinae on first 5 somites, 6 on last, submedians slightly divergent on each somite; abdominal carinae spined as follows: submedian, 4-6; intermediate, 2-6; lateral, 1-6; marginal, 1-5; sixth somite with spine on each side in front of articulation of uropod.

Telson longer than broad, with 6 sharp marginal teeth, each with short dorsal carina; prelateral lobe present; denticles rounded, 4-5, 7-8, 1; ventral surface with postanal keel.

Proximal segment of uropodal exopod with 9 graded, movable spines, last short, not extending to midlength of distal segment; lobe on outer margin of inner spine of basal prolongation prominent, rounded, margin concave.

COLOR.—Largely faded in specimen from Madagascar except for dark pigment on uropods; proximal segment of exopod with distal half dark, distal segment with dark patch on proximal half of inner side; distal half of endopod dark.

SIZE.—Only specimen examined, female, TL 102.0; other measurements of female: carapace length 23.0; cornea width 5.8; rostral plate length 3.5, width 3.8; telson length 21.4, width 18.9.

DISCUSSION.—In his account of the variation in *Squilla oratoria*, Kemp (1913, p. 68) noted that two specimens from Mauritius differed from typical *S. oratoria* in having (a) a longer rostral plate, (b) the anterior portion of the lateral process of the sixth thoracic somite shorter than the posterior, and (c) the submedian carinae of the fourth and the lateral carinae of the first and second abdominal somites spined posteriorly. It was in this account that the name, "*S. mauritiana*," a manuscript name of Wood-Mason, was introduced. The specimens reported here differs from *S. oratoria* in these three features.

In 1942 Ward described *Squilla juxtaoratoria* from Mauritius. Although he gave some differences between his species and *S. oratoria*, his account was too brief to permit recognition of the species. Through the kindness of M. Claude Michel of the Mauritius Institute, I was able to examine Ward's type and confirm that it is conspecific with the specimen reported here. A more complete account of the type is in preparation in a review of the species of the "*oratoria* group."

Kemp (1913, p. 68) also noted that his specimens from Mauritius resembled material from Hawaii, which shared the distinctive features mentioned above. The form from Hawaii is another distinct species the description of which is in preparation.

Squilla mauritiana agrees with *S. oratoria* in having the median carina of the carapace uninterrupted; that character will distinguish both species from *S. fabricii* Holthuis, *S. inornata* Tate, *S. interrupta* Kemp, and *S. perpensa* Kemp. *Squilla woodmasoni*, *S. hesperia*, and *S. massavensis*, other species of the "oratoria complex" that occur in the western Indian Ocean, lack the anterior bifurcation on the median carina of the carapace; *S. woodmasoni* has a much broader carapace and smoother telson than either *S. hesperia* or *S. massavensis*. Manning (1966) outlined the diagnostic features of several of the species in the "oratoria complex."

DISTRIBUTION.—Indian Ocean, from Mauritius, and Madagascar.

Squilla nepa Latreille, 1825

FIGURE 10

Squilla nepa.—Lenz, 1910, p. 571.—Kemp, 1913, p. 60, pl. 4 (fig. 49) [older references].—Gravier, 1920, p. 377.—Holthuis, 1941, p. 245.—Barnard, 1950, p. 847, figs. 1b, 2a.—Fourmanoir, 1953, p. 153.—Kurian, 1954, p. 85.—Serène, 1954, pp. 6, 8.—Stephenson and McNeill, 1955, p. 243.—Crosnier, 1965, p. 61 [listed].

PREVIOUS RECORDS.—Tamatave (Lenz, 1910); Diego Suarez (Gravier, 1920); several localities (Fourmanoir, 1953); no specific locality (Crosnier, 1965).

MATERIAL.—2 ♀, 122.6–127.0; Baie Narendry, northwestern coast; trawl; 6–7 m; soft mud; A. Crosnier; February 1958; MNHNP. 2 ♀, 85.8–128.6; same; USNM. 5 ♂, 89.6–132.2; 4 ♀, 100.7–135.8; Ambaro Bay, Nosy Bé; trawl; 2–5 m; M. Pichon; 8 September 1964; USNM. 12 ♂, 89.2–126.7; 24 ♀, 70.0–146.0 (in 5 lots); from localities around Nosy Bé; J. Rudloe, col.; IIOE; January–February 1964; USNM.

DIAGNOSIS.—Eye very small, cornea set transversely on stalk; corneal indices 514–690; rostral plate quadrangular or subtriangular; anterolateral spines of carapace strong; median carina of carapace with anterior bifurcation open for half or more of its length; dactylus of raptorial claw with 6 teeth, outer margin of dactylus sinuate; dorsal ridge of carpus with 2–3 tubercles; inferodistal angle of merus of claw armed; mandibular palp and 4 epipods present; lateral processes of fifth to seventh thoracic somites bilobed; abdominal carinae spined as follows: submedian, (3) 4–6; intermediate, (2–3) 4–6; lateral, 1–6; marginal, 1–5; denticles, 1–3, 7–9, 1, rounded; ventral surface of telson with postanal keel.

COLOR.—Entire body dusky, appearing mottled; carinae green in preservative; some specimens with transverse patch of dark pigment on second abdominal somite; distal portions of uropod dark, except for distal segment of exopod, which is light with dark edges.

DISCUSSION.—The present specimens agree well with accounts of the species in the literature. In shape of rostral plate and spination of the abdomen they show an unusual amount of variation. The

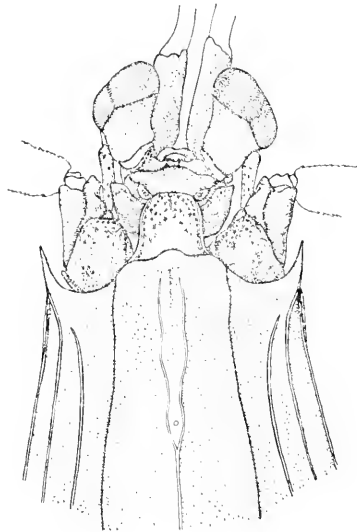

FIGURE 10.—*Squilla nepa* Latreille, female, TL 85.8, Baie Narendry: anterior portion of body.

rostral plate may be triangular or subquadrate, with the apex transverse or rounded. In one specimen the plate is very short and broadly rounded. The submedian carinae of the third abdominal somite are armed in about half the specimens; the spines may be present on large or small specimens. The intermediate carinae of the second and third somites may be armed.

DISTRIBUTION.—Western portion of Indo-West Pacific region, from the western Indian Ocean and South Africa to Hong Kong.

Acanthosquilla Manning, 1963

Four species of *Acanthosquilla* have been recorded from the Indo-West Pacific region and one new species is described herein. The following key will distinguish the five species, of which all but one, *A. tigrina* (Nobili), occurs in the western Indian Ocean.

Key to Indo-West Pacific Species of *Acanthosquilla*

1. Telson with 4 pairs of fixed marginal teeth 2
Telson with 2 pairs of fixed marginal teeth 4
2. Ventral margin of sixth abdominal somite with posterior spines.
A. *tigrina* (Nobili, 1903)
Ventral margin of sixth abdominal somite unarmed 3
3. Rostral plate trispinous; dactylus of claw with 10–11 teeth; submedian denticles arranged in semicircle A. *vicina* (Nobili, 1904)
Rostral plate angled anterolaterally, with median spine; dactylus of claw with 7 teeth; submedian denticles in transverse row A. *humesi*, new species
4. Lobes on outer margin of dactylus subequal; submedian denticles in transverse row; first and third intermediate denticles larger than second and fourth A. *acanthocarpus* (Miers, 1880)
Distal lobe on outer margin of dactylus much larger than proximal; submedian denticles in oblique row; second and fourth intermediate denticles larger than first and third A. *multifasciata* (Wood-Mason, 1895)

Acanthosquilla humesi, new species

FIGURE 11

Acanthosquilla Humes, 1965, p. 184.

HOLOTYPE.—1 ♀, 62.5; Ambatozavary, Nosy Bé, Madagascar; E. Cutler; 16 July 1964; USNM 124095.

PARATYPES.—1 ♂, 63.2; 1 ♀, 64.5; Antsakoabe, northwestern shore of Nosy Bé, Madagascar; dug from 30 cm intertidal sand; A. G. Humes; host no. 889; 12 July 1964; USNM 124096.

DESCRIPTION.—Eye small, not extending to end of antennular peduncle; cornea subglobular, slightly larger than and set obliquely on stalk; ocular scales small, erect, bases fused, apices divergent.

Antennular peduncle short, less than half as long as carapace; dorsal processes of antennular somite visible on either side of rostral plate as a slender, anteriorly directed spine.

Antennal peduncle with 1 mesial and 1 ventral papilla; antennal scale short, less than half as long as carapace.

Rostral plate trapezoidal, narrowed anteriorly, angled anterolaterally, with slender median spine; anterior portion of median spine resting in apex of V formed by ocular scales.

Carapace narrowed anteriorly, rounded anterolaterally and posteriorly, lacking spines, carinae, or cervical groove.

Raptorial claw stout, dactylus with 7 teeth, penultimate shorter than antepenultimate; base of dactylus with proximal angled projection and distal obtuse projection separated by a shallow concavity; propodus with 4 proximal movable spines and normal pectination; dorsal ridge of carpus terminating in slender spine; merus much longer than ischium.

Propodi of third and fourth thoracic appendages broader than long, with ventral ribbing; propodus of fifth appendages as broad as long, with inferior brush of setae.

Mandibular palp and 5 epipods present.

Exposed thoracic somites smooth, lateral margins rounded or subtruncate; basal segment of each walking leg unarmed; endopods of

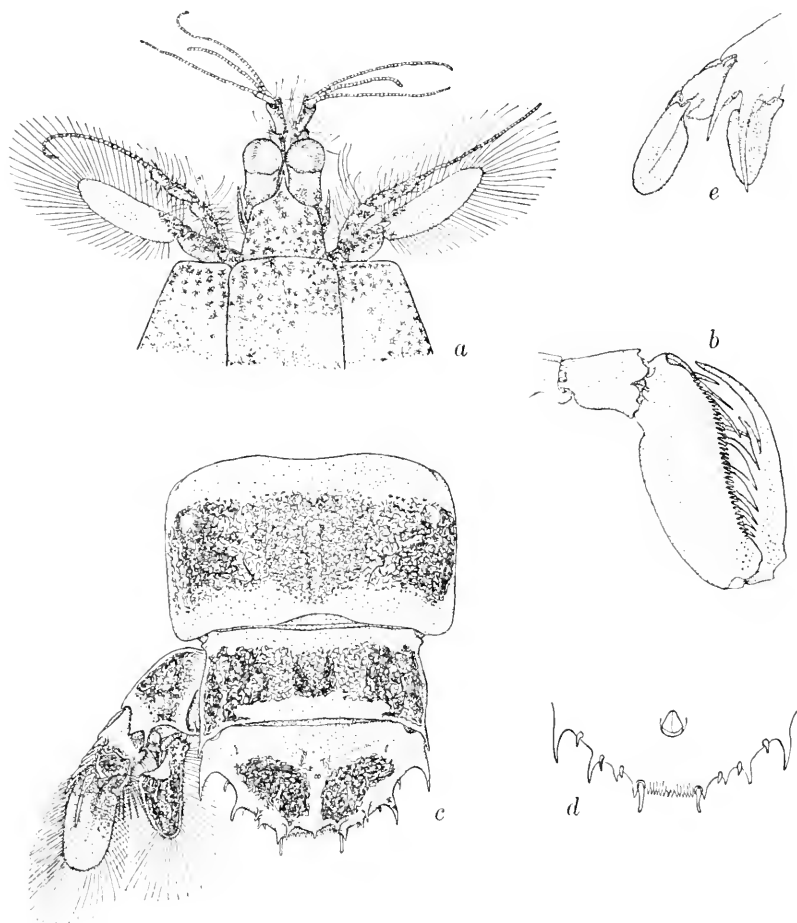

FIGURE 11.—*Acanthosquilla humesi*, new species, female holotype, TL 62.5, Nosy Bé: *a*, anterior portion of body; *b*, raptorial claw; *c*, last two abdominal somites, telson, and uropod; *d*, telson, ventral view; *e*, uropod, ventral view (setae omitted).

walking legs 2-segmented, subcircular on first 2 legs, ovate on last; eighth somite without noticeable ventral keel.

Abdomen depressed, somites broad, smooth, unarmed except for slender posterolateral spines on sixth; sixth somite with prominent

ventral projections overhanging articulation of uropod, each armed with accessory spinule; ventral surface of sixth abdominal somite unarmed.

Telson broader than long, with normal dorsal fan of 5 teeth; marginal armature consisting of, on either side of the midline, 1 movable submedian tooth and 4 fixed teeth, inner overhanging movable submedians; 6-7 submedian denticles present, with 1 denticle present between each of the other marginal teeth.

Uropod with 7 slender movable spines present on outer margin of proximal segment of exopod, last extending to midlength of distal segment; 9-13 stiff setae present on inner distal lobe of proximal segment of exopod; endopod triangular, with prominent fold on inner, proximal margin; spines of basal prolongation trefoil in cross section, inner longer than outer.

COLOR.—Rostral plate, eyestalks, anterior appendages, and dorsal surface of claws with scattered dark spots; carapace with 3 transverse black bands plus dark crescent at each posterolateral angle; last 3 thoracic and all 6 abdominal somites with broad, transverse black band; telson with 4 oval dark patches, interrupted at midline and between second and third dorsal teeth on each side; uropodal exopod with black spot at articulation of distal segment, inner angle of distal segment dark; endopod black.

SIZE.—Only male known, TL 63.2; females, TL 62.5-64.5. Other measurements of female paratype: carapace length 10.6; cornea width 1.6; rostral plate length 3.1, width 3.4; fifth abdominal somite width 11.1; telson length 5.0, width 8.8.

DISCUSSION.—*A. canthosquilla humesi* can be distinguished from both *A. acanthocarpus* (Miers) and *A. multifasciata* (Wood-Mason) by the presence of four fixed marginal teeth on the telson; the latter two species both have but two fixed spines. *Acanthosquilla humesi* agrees with *A. tigrina* (Nobili) and *A. vicina* (Nobili) in having four pairs of fixed marginal teeth on the telson but may be readily distinguished from both of those species. It lacks the posterior ventral spines on the sixth abdominal somite that are characteristic of *A. tigrina*, and it differs from *A. vicina* in having a single median spine on the rostral plate, fewer spines on the claw (seven instead of 10-11), and in having the submedian denticles of the telson arranged in a transverse row rather than in a semicircle.

These specimens were the hosts of a cyclopoid copepod, *Hemicyclops acanthosquillae* Humes, collected and described by Arthur G. Humes (1965). This, I believe, is the first recorded occurrence of a copepod-stomatopod association.

Humes (1965, p. 184) noted that the stomatopods appeared in the water seeping into a hole 30 cm deep that had been dug in clear sand.

ETYMOLOGY.—The species is named for the collector, Arthur G. Humes.

DISTRIBUTION.—Known only from Nosy Bé, Madagascar.

Lysiosquilla Dana, 1852

Only two species of *Lysiosquilla* have been recognized from the Indo-West Pacific region in recent years, *L. capensis* Hansen, 1895, and *L. maculata* (Fabricius, 1793). Two varietal forms of the latter species, *L. m.* var. *sulcirostris* Kemp, 1913 and *L. m.* var. *tredecimdentata* Holthuis, 1941, also have been recognized. All four of these forms are distinct species that may be distinguished by means of the key below.

A redescription of *L. capensis* Hansen is in preparation.

Two species of *Lysiosquilla*, *maculata* and *tredecimdentata*, occur off Madagascar.

Key to Indo-West Pacific Species of *Lysiosquilla*

1. Rostral plate triangular, greatest width at base; median carina of plate flanked by longitudinal grooves; dactylus of claw with 8 teeth.

L. sulcirostris Kemp, 1913

Rostral plate cordiform, greatest width in advance of base; median carina of plate, when present, not flanked by longitudinal grooves; dactylus of claw with more than 8 teeth 2
2. Antennal scale oval, less than twice as long as broad; anterior margin of antennal protopod lacking projection; ventral keel of eighth thoracic somite rounded ***L. maculata*** (Fabricius, 1793)
- Antennal scale slender, elongate, more than twice as long as broad; anterior margin of antennal protopod with projection; ventral keel of eighth thoracic somite acute, sharp, posteriorly 3
3. Rostral plate lacking median carina; ventral surface of uropodal protopod with slender spine at articulation of endopod . . . ***L. capensis*** Hansen, 1895
- Rostral plate with median carina; ventral surface of uropodal protopod lacking spine at articulation of endopod . . . ***L. tredecimdentata*** Holthuis, 1941

Lysiosquilla maculata (Fabricius, 1793)

FIGURE 12

Lysiosquilla (*Miers*) *maculata*.—Lenz and Richters, 1881, p. 428.

Lysiosquilla maculata.—Kemp, 1913, p. 111, pl. 8 (fig. 89-91) [older references].—Monod, 1925, pl. XXI (fig. D).—Holthuis, 1941, p. 269, fig. 5.—Barnard, 1950, p. 855, figs. 3d, 4c-d.—Serène, 1954, pp. 6, 8, 11, 13, 64, 66, fig. 12, pl. 5 (figs. 1-2), pl. 6 (figs. 1-2).—Kurian, 1954, p. 86.—Stephenson and McNeil, 1955, p. 246.—Manning, 1962, p. 2; 1967, p. 103.

Lysiosquilla maculata maculata.—Ingle, 1963, p. 23, figs. 23, 45, 61, 72 [part; not specimen from Gulf of Aden].

PREVIOUS RECORDS.—Lenz and Richters, 1881; Monod, 1925.

MATERIAL.—1 ♀, 146.0; Nosy Bé, Madagascar; intertidal zone; A. Crosnier; May 1960; USNM.

DESCRIPTION.—Eye large, cornea bilobed, set almost transversely on stalk; eyes not extending beyond end of second segment of antennular peduncle; ocular scales triangular, apices acute, curved anteriorly; corneal index 362.

Antennular peduncle short, about half as long as carapace; dorsal processes of antennular somite visible lateral to rostral plate as anteriorly directed spines.

Antennal scale broad, ovate, more than twice as long as broad; antennal peduncle extending to or slightly beyond eye; basal portion of antenna with anterior margin straight, not produced into an anterior triangular projection or spine, and with 3 papillae, 1 mesial, 2 ventral.

Rostral plate cordiform, broader than long, apex deflexed; median carina present on anterior half.

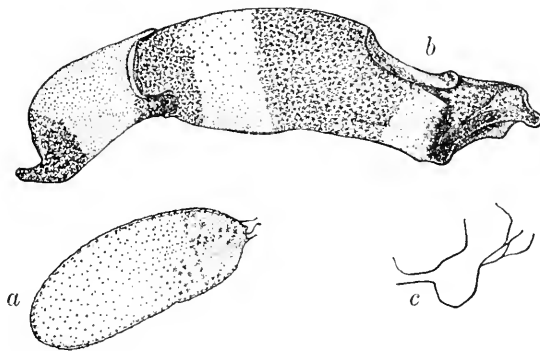

FIGURE 12.—*Lysiosquilla maculata* (Fabricius), female, TL 146.0, Nosy Bé: *a*, antennal scale (setae omitted); *b*, color pattern of ischium and merus of raptorial claw; *c*, outline of ventral keel of eighth thoracic somite.

Dactylus of raptorial claw with 9–11 teeth (10 in present specimen), outer margin of dactylus sinuate; propodus with few hairs proximally; dorsal ridge of carpus terminating in single spine, apex not deflexed.

Mandibular palp and 5 epipods present.

Ventral keel of eighth thoracic somite low, rounded, unarmed.

Abdomen smooth, unarmed; sixth somite with irregular submedian area separated from smooth lateral boss by a longitudinal sulcus; sixth somite with slender, triangular projection in front of articulation of each uropod.

Telson much broader than long, pitted dorsally, with low, raised triangular median boss and 2 lower, oval, submedian bosses on dorsal surface; posterior margin with 4 pairs of projections, outer 2 best developed.

Basal segment of uropod with dorsal spine; proximal segment of exopod with 8 slender, movable spines, last not extending to midlength of distal segment; distal segment of exopod longer than proximal; endopod broad, triangular, twice as long as broad; basal prolongation consisting of 2 spines, trefoil in cross section, inner longer; ventral surface of uropodal protopod unarmed at articulation of endopod.

COLOR.—Body with dark bands, pattern variable (see illustration in Kemp, 1913); carapace with 3 dark bands, body with dark band at articulation of each somite; antennal scale with 1–2 dark patches, not outlined with dark pigment; claw conspicuously banded with dark pigment; basal portion of first walking leg light, of last 2 dark; sixth abdominal somite light dorsally; telson with median and 2 submedian dark patches, connected anteriorly; basal segment of uropod dark proximally; distal half of distal segment clear; most of distal portion of endopod dark.

SIZE.—Only specimen examined, female, TL 146.0. Other measurements: carapace length 26.4; cornea width 7.3; rostral plate length 5.3, width 5.9; antennal scale length 16.5, width 7.1; fifth abdominal somite width 30.5; telson length 20.2, width 28.6.

DISCUSSION.—The unarmed antennal and uropodal protopods, broad rostral plate, broad antennal scale, and characteristically barred claw will distinguish this species from others in the genus.

DISTRIBUTION.—Widely distributed in the Indo-West Pacific, from numerous localities between the western Indian Ocean and Hawaii.

Lysiosquilla tredecimdentata Holthuis, 1941

FIGURE 13

?*Lysiosquilla maculata*.—Chopra, 1939, p. 16.

Lysiosquilla maculata var. *tredecimdentata* Holthuis, 1941, p. 273, fig. 6.

Lysiosquilla maculata tredecimdentata.—Manning, 1963, p. 317 [listed].

?*Lysiosquilla maculata maculata*.—Ingle, 1963, p. 23 [part; reference to specimen from Gulf of Aden only].

PREVIOUS RECORDS.—None.

MATERIAL.—1 ♂, 161.7; Estuaire du Mangoky, western coast of Madagascar; trawl; 9 m; grey mud, sand; A. Crosnier; June 1959; USNM.

DESCRIPTION.—Eye large, cornea bilobed, set almost transversely on stalk; eye not extending beyond end of second segment of antennular peduncle; ocular scales subtriangular, flattened dorsally, apices acute, directed anteriorly; corneal index 354.

Antennular peduncle short but more than half as long as carapace; dorsal processes of antennular somite visible lateral to rostral plate as anteriorly directed spines.

Antennal scale slender, curved, more than 3 times as long as broad; antennal peduncle not extending beyond eye; basal portion of antenna with anterior triangular projection, directed anterolaterally, and with 3 papillae, 1 mesial, 2 ventral.

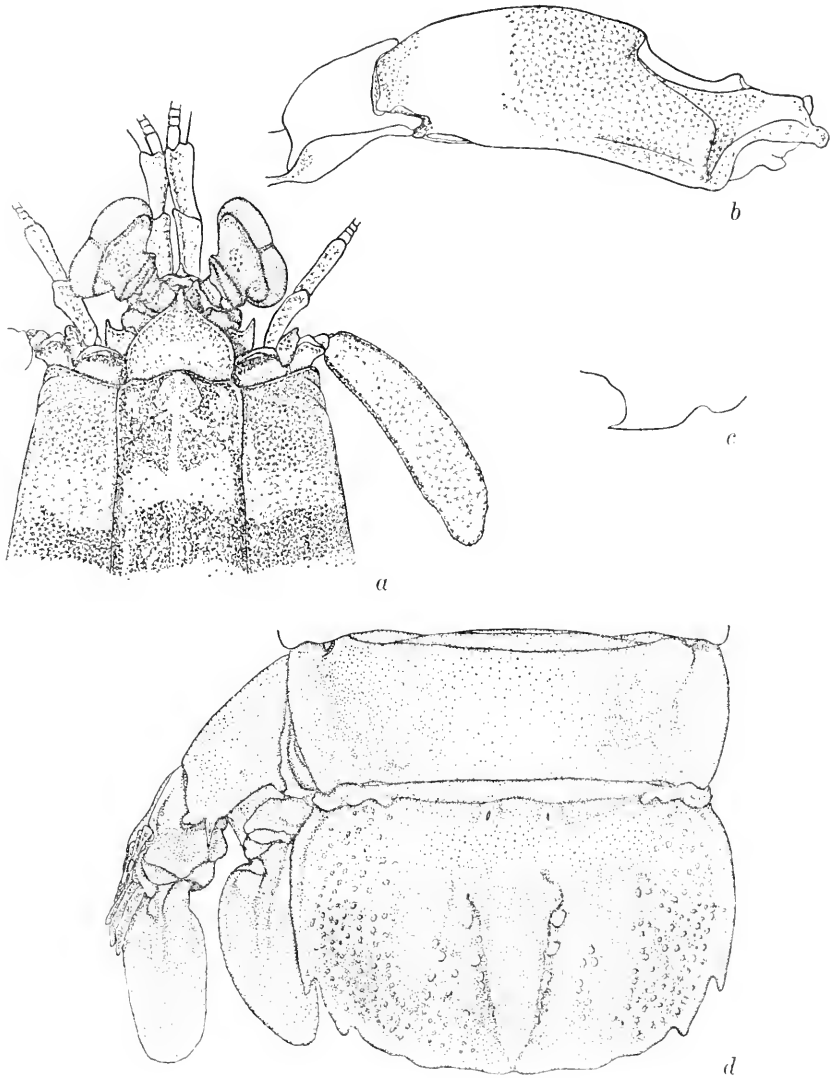

FIGURE 13.—*Lysiosquilla tredecimdentata* Holthuis, male, TL 161.7, Mangoky estuary: *a*, anterior portion of body; *b*, color pattern of ischium and merus of raptorial claw; *c*, outline of ventral keel of eighth thoracic somite; *d*, last abdominal somite, telson, and uropod. (Setae omitted).

Rostral plate cordiform, broader than long, apex deflexed; median carina present on anterior half.

Raptorial claw with 10 teeth (12-13 on other specimens), outer margin of dactylus sinuate; propodus with some proximal hairs, as in female *L. maculata*; dorsal ridge of carpus terminating in a single spine, deflexed mesioventrally.

Mandibular palp and 5 epipods present.

Ventral keel of eighth thoracic somite produced into a posteriorly directed spine.

Abdomen smooth, unarmed; sixth somite with irregular submedian area separated from longitudinal lateral boss by a longitudinal sulcus; sixth somite with blunt triangular projection in front of articulation of each uropod.

Telson much broader than long, pitted dorsally, with low, raised triangular median boss and 2 lower oval submedian bosses on dorsal surface; posterior margin with 4 pairs of projections, outer 2 best developed.

Basal segment of uropod with dorsal spine; proximal segment of exopod with 9 slender, movable spines on outer margin, last not extending to midlength of distal segment; distal segment of exopod longer than proximal; endopod broad, triangular, over twice as long as wide; basal prolongation consisting of 2 spines, trefoil in cross section, inner longer; ventral surface of uropodal protopod unarmed at articulation of endopod.

COLOR.—Body with dark bands, as in *L. maculata*; carapace with 3 dark bands and body with broad, dark band at articulation of each somite; claw lacking prominent dark bars, distal half of merus and proximal half of propodus with dark flush; basal fourth of all walking legs dark; sixth abdominal somite dark; telson with broad, transverse dark patch, most of distal margin lighter; basal segment of uropod dark; distal half of proximal segment and proximal half of distal segment of uropodal exopod dark, distal half of distal segment light; most of distal portion of uropodal endopod dark.

SIZE.—Single male examined, TL 161.7. Other measurements: carapace length 28.3; cornea width 8.0; rostral plate length 6.4, width 7.4; antennal scale length 17.2, width 5.4; fifth abdominal somite width 35.2; telson length 21.8, width 32.0.

DISCUSSION.—The slender antennal scale, outlined in dark pigment, the anterior projection on the basal portion of the antenna, the lack of dark bands on the claw, the deflexed spine on the carpus of the claw, the triangular keel on the eighth thoracic somite, and the unarmed ventral surface of the uropodal protopod will distinguish this species from all others in the genus.

Lysiosquilla tredecimdentata has not been recorded previously from outside the Gulf of Aden. I have compared this specimen, a male, with three females taken at Aden Harbor during the International Indian Ocean Expedition. It differs in having a larger eye, which is broader than the rostral plate, and in having fewer teeth, 10 instead of 12, on the dactylus of the claw. I have assumed that these are sexual differences, for in all other respects the four specimens are almost identical, even to overall color pattern.

Chopra (1939) noted that his specimen of *L. maculata* from the Gulf of Aden had 12 teeth on the dactylus of the claw, an unusually high number for *L. maculata*. All the specimens of *L. tredecimdentata* from the Gulf of Aden examined by me had 12 teeth on the claw. It seems likely that Chopra was dealing with *L. tredecimdentata* not *L. maculata*. Ingle (1963) also listed the occurrence of the same specimen previously recorded by Chopra.

The single male specimen from Madagascar shows some trace of the hairs on the propodus of the raptorial claw characteristic of adult females of *L. maculata*. There is no apparent reduction in size of the claw or in size and number of teeth.

DISTRIBUTION.—Western Indian Ocean, from Aden (?Chopra, 1939; Holthuis, 1941; ?Ingle, 1963) and from Madagascar.

***Odontodactylus* Bigelow, 1893**

Three species of this genus are known to occur in the Indian Ocean, and two of these are recorded below from Madagascar. *Odontodactylus brevirostris* (Miers), which is not represented in the present collection, has been reported from the Seychelle Islands and from Providence Island (Miers, 1884; Borradaile, 1907; Manning, 1967a) and could be expected off Madagascar.

The three specimens reported below were included by me in a review of the genus *Odontodactylus*, which contained complete accounts for each of the five known species.

***Odontodactylus japonicus* (de Haan, 1844)**

Odontodactylus japonicus.—Kemp, 1913, p. 139.—Manning, 1967a, p. 7, fig. 2 [other references].

ILLUSTRATION.—Manning, 1967a, fig. 2.

PREVIOUS RECORDS.—Ambovombe (Manning, 1967a).

MATERIAL.—1 ♀, 117.0; Ambovombe, southern coast of Madagascar; 60 m; shelly sand; A. Crosnier; 8 October 1958; USNM.

REMARKS.—This specimen was recorded by Manning (1967a).

DISTRIBUTION.—Indo-West Pacific, from two localities in the Indian Ocean, Seychelles (Borradaile, 1907) and Madagascar (Mann-

ing, 1967a), and from locations around China and Japan. In moderate depths, to 200 m.

Odontodactylus scyllarus (Linnaeus, 1758)

Gonodactylus scyllarus.—Miers, 1880, p. 115.—Richters, 1880, p. 167.

Odontodactylus scyllarus.—Kemp, 1913, p. 135.—Manning, 1967a, p. 10, fig. 3 [other references].

ILLUSTRATION.—Manning, 1967a, fig. 3.

PREVIOUS RECORDS.—Miers, 1880; Richters, 1880; Manning, 1967a.

MATERIAL.—1 ♀, 131.0; Nosy Bé, Madagascar; P. Fourmanoir; MNHNP. 1 broken ♂, CL 36.0; same; A. Crosnier; USNM.

REMARKS.—These specimens were reported by Manning (1967a).

DISTRIBUTION.—Indo-West Pacific, from the western Indian Ocean to Japan. Shallow water.

Pseudosquilla Dana, 1852

Pseudosquilla ciliata (Fabricius, 1787)

Pseudosquilla ciliata.—Lenz, 1910, p. 571.—Kemp, 1913, p. 96 [older references].—Holthuis, 1941, p. 261 [older references].—Barnard, 1950, p. 852, fig. 3a.—Serène, 1951, p. 11, figs 1-6, 8-1; 1954, pp. 6, 10.—Stephenson and McNeill, 1955, p. 245.—Manning, 1962, p. 2.—Ingle, 1963, p. 21, figs. 18, 39, 52, 68.

ILLUSTRATION.—Serène, 1951, figs. 1-6, 8-1.

PREVIOUS RECORDS.—Sainte Marie (Lenz, 1910); Fort Dauphin (Gravier, 1935).

MATERIAL.—1 ♀, 36.8; Nosy Bé, Madagascar; intertidal zone; A. Crosnier; September 1958; USNM. 1 ♂, 37.7; Nosy lava (?); A. Crosnier; MNHNP. 1 ♂, 37.8; 1 ♀, 24.2; Banc de Pracel, western coast of Madagascar; 55 m; muddy sand; June 1959; USNM. 1 ♀, 80.3; Anjouan Id., Comoro Ids.; A. Crosnier; USNM. 1 ♀, 63.8; Anjouan Id., Comoro Ids.; from stomach of *Caranx*; A. Crosnier; MNHNP. 1 postlarva, 17.9; Mayotte Id., Comoro Ids.; 47 m; sand; A. Crosnier; August 1959; MNHNP. 1 ♀, 20.0; same; 51 m; coarse sand; A. Crosnier; 1 October 1959; MNHNP.

REMARKS.—All specimens correspond to the "forme claire" discussed by Serène (1951).

DISTRIBUTION.—Widely distributed in the Atlantic and Indo-West Pacific Oceans.

Gonodactylus Berthold, 1827

The Indo-West Pacific species of *Gonodactylus* fall into three distinct groups or sections, one centered around *G. chiragra* (Fabricius), one around *G. falcatus* (Forskål), and one around *G. demanii* Henderson.

The "*chiragra* section" includes large species with broad ocular scales and with three large carinae on the median dorsal surface of the

telson. Species in this section include the three species reported below, *G. chiragra* (Fabricius), *G. platysoma* Wood-Mason, and *G. smithii* Pocock. It is suggested below that *G. acutirostris* de Man is based on an aberrant specimen, and that de Man's species is conspecific with *G. smithii*.

The "falcatus section" includes only two species, *G. falcatus* (Forskål) and *G. graphurus* Miers; these species have small ocular scales and five carinae on the median area of the telson. Manning (1966) and others have pointed out that the latter species does not occur west of Indo-Malaya and that earlier records to it in the literature from the western Indian Ocean are referable to *G. falcatus*.

The "demanii section" includes 10 small species, mature at TL 50 mm or less, seven of which were reported by Manning (1967b). Three additional species are reported below from Madagascar, including one species revived from the synonymy of *G. chiragra* and two described as new.

Gonodactylus chiragra (Fabricius, 1781)

Gonodactylus chiragra.—Lenz and Richters, 1881, p. 428.—Kemp, 1913, p. 155, fig. 2 on p. 161, pl. 9 (fig. 107).—Gravier, 1920, p. 377; 1935, p. 358.—Holthuis, 1941, p. 277, fig. 7 [older references].—Poisson, 1949, p. 23.—Barnard, 1950, p. 861.—Fourmanoir, 1952, p. 171; 1953, p. 157.—Serène, 1954, pp. 6, 10, 11, 27, 42, 74, 84, figs. 9-10, 13-1, 13-2, 15, pl. 7.—Stephenson and McNeill, 1955, p. 250.—Manning, 1965, p. 2; 1966, p. 113; 1967, p. 102. Not *Gonodactylus chiragra chiragra*.—Ingle, 1963, p. 27, figs. 27, 47, 63. [= *G. smithii* Pocock?]

ILLUSTRATION.—De Man, 1898, pl. 38 (fig. 77); Kemp, 1913, fig. 1 on p. 161.

PREVIOUS RECORDS.—Fort Dauphin (Gravier, 1935); Ile Europa (Fourmanoir, 1952); no specific locality (Lenz and Richters, 1881; Gravier, 1920; Poisson, 1949; Fourmanoir, 1953).

MATERIAL.—1 broken ♀, CL 13.9; Mayotte Island, Comoro Islands; reef flat; L. S. Kornicker, Sta. LK-39; *Anton Bruun* Cruise 9, IIOE; 24 November 1964; USNM. 1 ♀, 48.3; Nosy Bé, Madagascar; A. Crosnier; 10 December 1958; MNHNP. 1 ♂, 83.5; Nosy Bé; under dead coral debris; Mme. Chavane; 18 September 1958; MNHNP. 1 ♂, 70.9; 2 ♀, 48.4-68.9; Nosy Bé; in sandstone; 20 May 1958; MNHNP. 4 ♂, 31.8-55.7; 5 ♀, 22.8-72.1; Nosy Bé; sandstone; A. Crosnier; November 1961; USNM. 1 ♂, 70.5; Ambatoloaka, Nosy Bé; Mme. Chavane; 25 September 1964; USNM. 8 ♂, 22.4-88.4; 3 ♀, 41.9-67.3; Pt. Fièvre, Nosy Bé; 13°24'21" S, 48°18'33" E; J. Rudloe, field no. Jr-13; IIOE; 26 December 1963; USNM. 2 ♂, 50.3-51.2; Ambatomboka (?) Crater Point, Nosy Bé; 13°24'17" S, 48°13'31" E; taken from base of volcanic rocks; J. Rudloe, Field no. JR-23; IIOE; 3 January 1964; USNM. 1 ♂, 44.1; 1 ♀, 51.6; 50 yds.

right of Centre d'Océanographie pier, Pt. Fièvre, Nosy Bé; 13°24.4' S, 48°17.8' E; intertidal mud flat, mud, rock; J. Rudloe, field no. 24A; IIOE; 4 January 1964; USNM. 1 ♂, 105.5; mud flats of Ambatozavavy, Nosy Bé; 13°22'10" S, 48°19'52" E; J. Rudloe, field no. JR-52; IIOE; 29 January 1964; USNM. 1 ♂, 42.7; Tani Keli (Tany Kely), Nosy Bé; 13°26'36" S, 48°14'48" E; J. Rudloe, field no. JR-62; IIOE; USNM. 1 ♂, 21.3; 3 ♀, 68.5-73.2; Nosy Bé; J. Rudloe, field no. JR-63-1; IIOE; 17 December 1963; USNM. 1 ♂, 51.3; 2 ♀, 67.4-69.2; Nosy Bé; J. Rudloe, field no. JR-63-2; IIOE; USNM.

DISTRIBUTION.—Widely distributed in the Indo-West Pacific region, from the western Indian Ocean through Oceania.

***Gonodactylus platysoma* Wood-Mason, 1895**

Gonodactylus chiragra var. *acutus* Lanchester, 1903, p. 447, pl. 23 (figs. 2, 3, 3a).—Lenz, 1910, p. 571.

Gonodactylus chiragra var. *tumidus* Lanchester, 1903, p. 447, pl. 23 (figs. 1, 1a).—Lenz, 1910, p. 571.

Gonodactylus chiragra var. *platysoma*.—Kemp, 1913, p. 162, fig. 1 on p. 161.—Bigelow, 1931, p. 117, pl. 1 (fig. 2), pl. 2 (fig. 2).—Holthuis, 1941, p. 281.

Gonodactylus platysoma.—Serène, 1954, pp. 10, 74, fig. 13-4.—Manning, 1962, p. 3; 1966, p. 110; 1967, p. 103.

Gonodactylus chiragra platysoma.—Ingle, 1963, p. 25 [key].

ILLUSTRATION.—Bigelow, 1931, pl. 1 (fig. 2), pl. 2 (fig. 2).

PREVIOUS RECORDS.—Tamatave, Sainte Marie, Angontil (Lenz, 1910).

MATERIAL.—1 ♂, 72.8; Mayotte Id., Comoro Islands; intertidal zone; A. Crosnier; September 1959; MNHNP. 1 ♂, 59.7; Anjouan Id., Comoro Islands; intertidal zone; A. Crosnier; November 1961; USNM.

REMARKS.—The specimen from Anjouan Island has two commensal gastropods attached to the pleopods. Holthuis (1951) has commented on the occurrence of a gastropod, *Caledoniella montrouzieri* Souverbie, on specimens of *Gonodactylus chiragra*. As far as I can determine, no commensals have been reported for *G. platysoma*.

DISTRIBUTION.—Indo-West Pacific, from scattered localities between the western Indian Ocean and Oceania.

***Gonodactylus smithii* Pocock, 1893**

Gonodactylus smithii Pocock, 1893, p. 475, pl. 20B (fig. 1).—Serène, 1954, pp. 6, 7, 10, 74, 76, fig. 13-5, pl. 8.—Manning, 1966, p. 112.

Gonodactylus chiragra var. *acutirostris* de Man, 1898, p. 695, pl. 38 (figs. 77b, c).—Lanchester, 1903, p. 454.—Gravier, 1937, p. 204, fig. 20.

Gonodactylus chiragra var. *smithii*.—Borradaile, 1898, p. 33, 35.—Lanchester, 1903, p. 447, pl. 23 (figs. 4-5).—Lenz, 1905, p. 387.—Tattersall, 1906, p. 167.—Borradaile, 1907, p. 211 [key], p. 212.—Lenz, 1910, p. 571.—Rathbun, 1914, p. 664.

- Gonodactylus chiragra* var. *c* (*acutirostris*).—Borradaile, 1899, pp. 400, 401, 402.
Gonodactylus chiragra var. *d* (*smithii*).—Borradaile, 1899, p. 402.
Gonodactylus chiragra.—Lanchester, 1901, p. 555.—Nobili, 1906, p. 157 [part].
 Tattersall, 1921, p. 359 [*smithii* in discussion].
Gonodactylus acutirostris.—Borradaile, 1907, p. 210 [key].—Kemp, 1913, p. 163.—
 Serène, 1947, p. 382, fig. 1, pl. 1.—Dawydoff, 1952, p. 145.—Serène, 1953,
 pp. 506, 507.
Gonodactylus chiragra var. *intermedia* de Man, 1929, p. 25, pl. 3 (figs. 9–9b);
 1929a, p. 3.
 ?*Gonodactylus chiragra chiragra*.—Ingle, 1963, p. 27, figs. 27, 47, 63 [part?].

ILLUSTRATION.—Serène, 1947, fig. 1, pl. 1.

PREVIOUS RECORDS.—None.

MATERIAL.—1 ♂, 38.9; Mayotte Id., Comoro Islands; reef flat; L. S. Kornicker, Sta. LK-39; *Anton Bruun* Cruise 9, IIOE; 24 November 1964; USNM. 1 ♀, 29.4; Anjouan Id., Comoro Islands; intertidal zone; A. Crosnier; November 1961; USNM. 1 ♀, 41.0; Nosy Bé, Madagascar; in sandstone; 20 May 1958; MNHNP. 1 ♀, 30.2; Banc de l'Etoile, Madagascar; dredge; 20–80 m; A. Crosnier; May 1960; MNHNP. 1 ♂, 34.7; 1 ♀, 41.7; Tulear, Madagascar; A. Crosnier; October 1958; USNM. 1 ♂, 50.0; 2 ♀, 44.4–48.2; Tulear; from offshore reef; K. J. Boss; *Anton Bruun* Cruise 7, IIOE; 9 August 1964; USNM.

DISCUSSION.—I believe Lanchester (1903) was correct in suggesting that *G. acutirostris* de Man was based on a specimen with a damaged telson, with the deformity affecting the posterior end of the median carina and the anterior ends of the carinae of the submedian teeth. In other respects, including the sharpness of carinae on the telson and the acute anterolateral angles of the rostral plate, it agrees with *G. smithii* Pocock. There is little doubt in my mind that *G. chiragra* var. *intermedia* de Man, from Pulau Berhala, is conspecific with *G. smithii*; it agrees with the latter species in all respects.

Odhner (1923) pointed out that Kemp (1913), in his account of *G. acutirostris*, misunderstood de Man's original description in stating that *G. acutirostris* lacked the anterior tubercles on the telson; Odhner pointed out that these tubercles were present, but that the type lacked the flukes of the anchor. In my account of *G. smithii* (1966) from Australia, I made the same error in pointing out differences between my specimens and *G. acutirostris*. De Man (1929) noted that in the type of *G. acutirostris* the anterior tubercles were present.

Specimens of *G. smithii* from Australia differ from those reported here in having a broader endopod on the uropod, on which the inner margin is convex. In the specimens from Madagascar the inner margin of the uropodal endopod is sinuous, convex proximally, concave distally.

One of the male specimens from Tulear has two gastropod molluscs attached to the body, a large one on the pleopods and a smaller one on the ventral surface of the eighth thoracic segment. As noted under *G. platysoma*, commensal gastropods have been reported only for *G. chiragra*.

DISTRIBUTION.—Indo-West Pacific, from the western Indian Ocean to Viet Nam and Australia. Shallow water to 50 fms.

Gonodactylus falcatus (Forskål, 1775)

Gonodactylus glabrous.—Kemp, 1913, pp. 167, 197, fig. 2 on p. 170, pl. 9 (fig. 113) [older references].—Barnard, 1950, p. 863, fig. 3f.

Gonodactylus falcatus.—Holthuis, 1941, p. 284, fig. 9a.—Serène, 1954, pp. 6, 7, 10, 11, 42, 77, figs. 8, 13-6, pl. 9.—Stephenson and McNeill, 1955, p. 249.—Manning, 1962, p. 4.—Ingle, 1963, p. 29, figs. 28, 57.—Manning, 1965, p. 260; 1966, p. 109; 1967, p. 102.

ILLUSTRATION.—Brooks, 1886, pl. 14 (fig. 5).

PREVIOUS RECORDS.—None.

MATERIAL.—1 ♀, 21.1; Mayotte Id., Comoro Islands, reef flat; L. S. Kornicker, Sta LK-39; *Anton Bruun* Cruise 9, IIOE; 24 November 1964; USNM. 1 ♂, 35.9; 1 ♀, 22.8; Ile Europa, off Madagascar; A. Crosnier; MNHNP. 1 ♂, 63.3; Iles Mitsio, northwestern coast of Madagascar; trawl; 26 m; sand; A. Crosnier; June 1959; MNHNP. 2 ♂, 33.8-54.5; 11 ♀, 37.7-71.6; Sud Mitsio, northwestern coast of Madagascar; trawl; 26 m; sand; A. Crosnier; June 1959; USNM. 1 ♂, 20.3; Banc de Pracel, western coast of Madagascar; 50 m; muddy sand; A. Crosnier; June 1959; MNHNP.

DISTRIBUTION.—Indo-West Pacific region, from Red Sea and South Africa to Japan.

Gonodactylus bicarinatus, new species

FIGURE 14

HOLOTYPE.—1 ♀, 26.7; Nosy Bé, Madagascar; intertidal zone; A. Crosnier; October 1959; USNM 124097.

DESCRIPTION.—Anterior margins of rostral plate straight, anterolateral angles rounded.

Ocular scales small, erect.

Mandibular palp and 5 epipods present.

Lateral processes of sixth and seventh thoracic somites subtruncate, rounded laterally, subequal.

Carinae of sixth abdominal somite not markedly inflated, each with apical spine.

Telson broader than long, with 3 pairs of slender, sharp marginal teeth, laterals well developed; dorsal surface of telson with numerous spinules and tubercles, smaller and more abundant on anterior carinae than on carinae of marginal teeth; median carina oval, very inflated,

with 1-2 irregular marginal rows of tubercles, apical spine largest, median surface smooth; anterior submedian carinae with 1-2 dorsal spinules, 1 distal spine, and distolateral patch of spinules; knob with 3 spinules; anterior surface of telson with rounded lobe, each tuberculate, at level of intermediate carinae of sixth somite; carinae of submedian and intermediate marginal teeth each ornamented with numerous large spines; numerous small submedian and 2 sharp intermediate denticles present; outer intermediate denticle recessed ante-

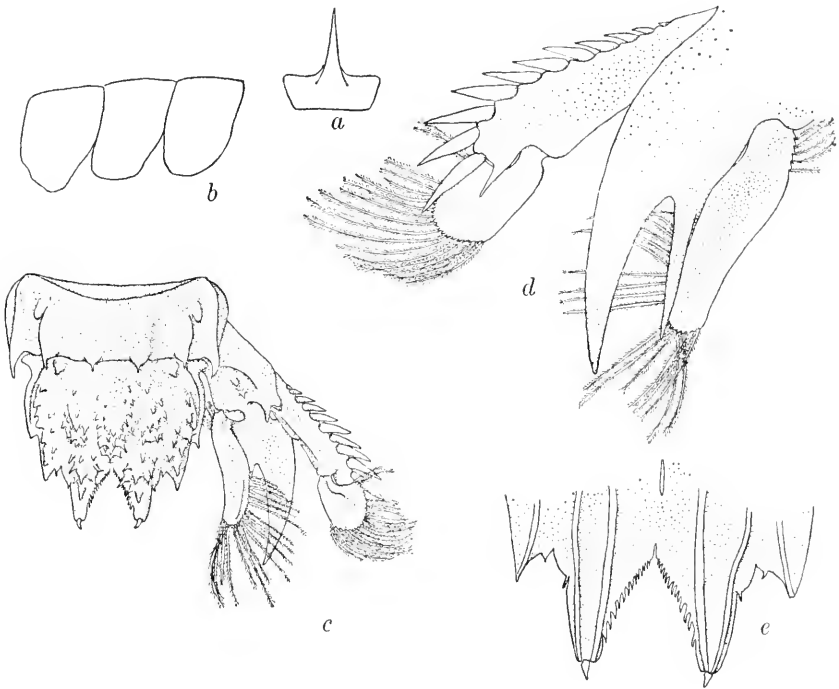

FIGURE 14.—*Gonodactylus bicarinatus*, new species, female holotype, TL 26.7, Nosy Bè: *a*, outline of rostral plate; *b*, outline of lateral processes of sixth, seventh, and eighth thoracic somites, right side; *c*, last abdominal somite, telson, and uropod; *d*, uropod, ventral view, enlarged; *e*, submedian teeth of telson, ventral view, enlarged.

riorly, inner denticle appressed to margin of submedian tooth, apex at level of intermediate tooth; ventral surface of telson with longitudinal carinae, including a short postanal keel, 2 sharp, long carinae on each submedian tooth, and 1 shorter, less distinct carina on each intermediate tooth.

Proximal segment of uropod with 2 sharp, dorsal tubercles mesial to dorsal carina; uropod setation reduced; most of inner margin of proximal segment of exopod smooth, a few small proximal setae present; proximal segment of exopod with fixed ventrodistal spinule

overhanging articulation of distal segment; distal segment of exopod smooth mesially, distolateral setae present; endopod slender, sinuous, most of inner margin smooth, lacking setae, 4-5 small, proximal setae present; distolateral margins of endopod with normal complement of setae; inner spine of basal prolongation slenderer and shorter than outer.

COLOR.—Traces of dark chromatophores present across posterior third of carapace, sixth thoracic somite, and first, third, fourth, and fifth abdominal somites, pattern most visible on first abdominal somite; telson with dark spots along anterior margin.

SIZE.—Female, TL 26.7. Other measurements: carapace length 5.2; fifth abdominal somite width 4.5; telson length 3.1, width 3.5.

DISCUSSION.—*G. bicarinatus* closely resembles *G. demanii* Henderson and *G. hendersoni* Manning in the reduction of setae on the inner portions of the uropod but differs from both of these and other species of the genus in having two ventral carinae on each submedian tooth as well as a short, median postanal keel. As in *G. demanii*, a few proximal setae are present on the inner margin of the endopod in the new species. The carinate submedian teeth of the telson and the slender uropodal endopod will distinguish this species from the following new species, *G. crosnieri*.

ETYMOLOGY.—The name is from the Latin, "bi", meaning "two," and "carina", meaning "keel," referring to the bicarinate ventral surface of the submedian teeth of the telson.

DISTRIBUTION.—Known only from the type-locality, Nosy Bé, Madagascar.

Gonodactylus crosnieri, new species

FIGURE 15

HOLOTYPE.—1 ♀, 17.8; Banc de Pracel, western coast of Madagascar; 50 m; muddy sand; A. Crosnier; June 1959; USNM 124098.

PARATYPES.—1 ♀, 19.3; Lagon de Mayotte Id., Comoro Islands; 50 m; A. Crosnier; August 1959; USNM 124099. 1 ♀, 13.5; same; MNHNP.

DESCRIPTION.—Anterior margins of rostral plate straight or with slight posterolateral slope; anterolateral angles acute but rounded.

Ocular scales small, erect.

Mandibular palp and 5 epipods present.

Lateral processes of sixth and seventh thoracic somites subtruncate, subequal in size or that of sixth somite slightly larger.

Carinae of sixth abdominal somite not markedly inflated, each with apical spinule.

Telson as long as broad, appearing elongate, with 2 pairs of slender, sharp, marginal teeth; lateral teeth not developed, lateral carina fusing with margin of intermediate tooth; dorsal surface of telson

with numerous spinules and tubercles; median carina flask shaped, tapering distally, with apical spine and subapical tubercles; 1-2 rows of spinules flank median carina, converging posteriorly; anterior submedian carinae with distal tubercle or spinule, flanked laterally and distally by spinules; anterior surface of telson with sharp tubercle on each side at level of intermediate carinae of sixth somite; carinae of marginal teeth each ornamented dorsally with spinules; numerous small submedian denticles and 2 sharp intermediate denticles, latter recessed anteriorly, present; ventral surface lacking distinct longitudinal carinae.

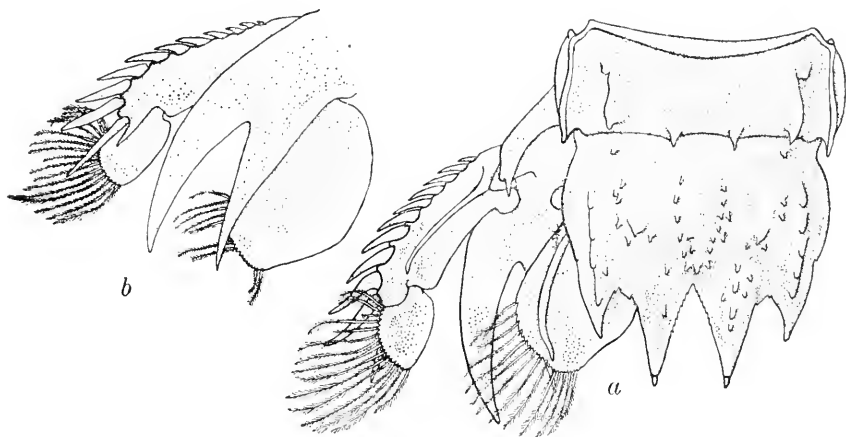

FIGURE 15.—*Gonodactylus crosnieri*, new species, female holotype, TL 17.8, Banc de Pracel: a, last abdominal somite, telson and uropod; b, uropod, ventral view.

Uropod abnormal in shape and setation; inner margin of exopod smooth, lacking setae, apex and outer margin of exopod setose; proximal segment of exopod with fixed ventrodistal spinule overhanging articulation of distal segment; endopod very broad, almost half or more than half as broad as telson, inner and outer margins convex, lacking setae, distolateral setae present; endopod with long, dorsal carina; spines of basal prolongation subequal in length.

COLOR.—Faded.

SIZE.—Females only known, TL 13.5-19.3. Other measurements of female holotype, TL 17.8: carapace length 3.6; fifth abdominal somite width 2.8; telson length 2.4, width 2.5.

DISCUSSION.—*G. crosnieri*, new species, resembles *G. demanii* Henderson, *G. hendersoni* Manning, and *G. bicarinatus*, new species, in dorsal armature of the telson but can be distinguished from these species by the absence of lateral teeth on the telson and by the broad uropodal endopod, which is half or more than half as broad as the telson

and which has smooth lateral margins and a distolateral fringe of setae. In the other three species the outer margin of the narrow endopod is fringed completely with setae. The new species lacks the longitudinal ventral carinae of the telson and the acute anterolateral angles of the rostral plate that are characteristic of *G. hendersoni*.

The broad uropodal endopod of this species will separate it from all other species in the genus.

ETYMOLOGY.—The species is named for Alain Crosnier, who collected the species and made available for study most of the other material reported herein.

DISTRIBUTION.—Known only from Madagascar and the Comoro Islands, in 50 m.

Gonodactylus demanii Henderson, 1933

Gonodactylus demani.—Gravier, 1935, p. 360, fig. 3.

Gonodactylus De Mani.—Dollfus, 1938, p. 213 [part].

Gonodactylus demanii.—Manning, 1967b, p. 8, fig. 3 [older references].

ILLUSTRATION.—Manning, 1967b, fig. 3.

PREVIOUS RECORDS.—Fort Dauphin (Gravier, 1935); Maromandia (Dollfus, 1938).

MATERIAL.—1 broken ♂, CL 2.5; Tulear, Madagascar; from off-shore reef; K. Boss; *Anton Bruun* Cruise 7, IIOE; USNM.

DIAGNOSIS.—Anterolateral angles of rostral plate rounded or angled; ocular scales small; telson with 3 pairs of well-developed marginal teeth, submedians with movable apices; dorsal surface of telson with numerous spinules and tubercles; inner margin of uropodal exopod smooth, lacking setae; most of inner margin of uropodal endopod smooth, 1–5 proximal setae present; submedian teeth of telson each with 1 ventral carina.

COLOR.—Faded.

DISCUSSION.—As shown by Manning (1967b), *G. demanii* is the western Indian Ocean counterpart of *G. hendersoni* Manning; it differs from the latter in having more rounded anterolateral angles on the rostral plate, 1–5 proximal setae on the uropodal endopod, and in lacking sharp ventral carinae on both the submedian and intermediate marginal teeth of the telson. *Gonodactylus crosnieri*, described above, differs from both *G. demanii* and *G. hendersoni* in having a broad, inflated uropodal endopod, with most of the inner and outer margins lacking setae but a few distal setae present.

DISTRIBUTION.—Western Indian Ocean, from scattered localities between southern India, the Red Sea, and northern Moçambique (Manning, 1967b).

Gonodactylus lanchesteri Manning, 1967

?*Gonodactylus De Mani* var. *spinosus*.—Dollfus, 1938, p. 215, fig. 17.

Gonodactylus lanchesteri Manning, 1967b, p. 11, fig. 4 [older references].

ILLUSTRATION.—Manning, 1967b, fig. 4.

PREVIOUS RECORDS.—Comoro Islands (Manning, 1967b); ?Madagascar (Dollfus, 1938).

MATERIAL.—1 ♂, 25.6; Mayotte Id., Comoro Islands; intertidal zone; A. Crosnier; September 1959; USNM. 1 ♂, 27.8; 1 ♀, 29.9; Nosy Bé, Madagascar; in sandstone; A. Crosnier; 20 May 1958; USNM. 1 ♀, 15.5; same; A. Crosnier; 10 December 1958; MNHNP. 1 ♀, 24.0; same; intertidal zone; A. Crosnier; February 1962; MNHNP. 1 ♀, 25.4; same; from hard coral; A. G. Humes; 10 September 1964; USNM. 1 ♂, 27.3; Ambatoloka, Nosy Bé, Madagascar; Mme. Chavane; July 1958; USNM.

DIAGNOSIS.—Rostral plate rounded anterolaterally; ocular scales small; telson with 3 pairs of marginal teeth, submedians with movable apices; dorsal surface of telson with numerous spinules and tubercles; uropod with normal setation, margins of endopod, inner portion of proximal segment, and distal segment of exopod fringed with setae.

COLOR.—Faded in most specimens; in the male from the Comoro Islands there are median and lateral dark patches on the sixth thoracic somites, a dark patch on the first abdominal somite, traces of a dark band on each abdominal somite, and the ventral surface of the thorax and the copulatory tubes are dark.

DISCUSSION.—The uropod provided with a normal fringe of setae will immediately distinguish this species and *G. spinosus* Bigelow from *G. demanii* Henderson, *G. hendersoni* Manning, and *G. crosnieri* Manning. *Gonodactylus hendersoni* differs from *G. spinosus* in having the lateral teeth of the telson well developed, projecting, and in having the intermediate denticles recessed anteriorly.

All of the specimens reported herein have few, large tubercles on the telson.

DISTRIBUTION.—Western Indian Ocean from the Red Sea southward to South Africa (Manning, 1967b).

Gonodactylus segregatus Lanchester, 1903

FIGURE 16

Gonodactylus chiragra var. *segregatus* a+b Lanchester, 1903, p. 448, pl. 23 (figs. 6, 7, 7a).

PREVIOUS RECORDS.—None.

MATERIAL.—1 ♀, 22.9; Banc Vert, Madagascar; 14 m; A. Crosnier; January 1959; USNM. 1 ♀, 17.8; Mayotte Id., Comoro Islands; intertidal zone; A. Crosnier; September 1959; MNHNP.

DESCRIPTION.—Rostral plate with anterior margins transverse; anterolateral angles acute but not spiniform.

Ocular scales small, erect.

Mandibular palp and 5 epipods present.

Lateral process of sixth thoracic somite more truncate and larger than that of seventh somite.

Carinae of sixth abdominal somite almost tubular, not greatly inflated, each with apical spinule.

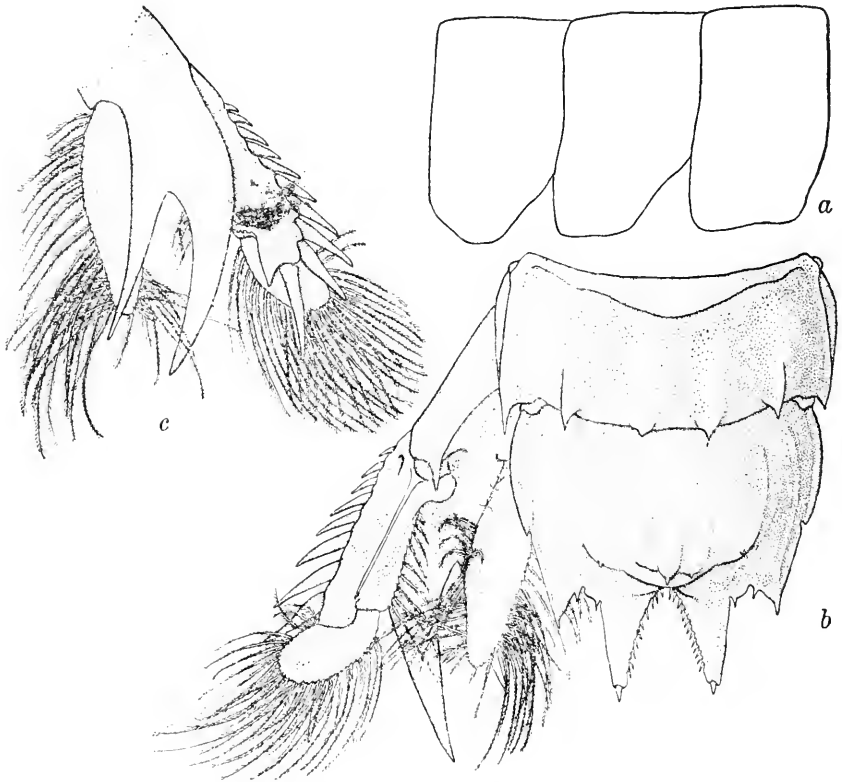

FIGURE 16.—*Gonodactylus segregatus* Lanchester, female, TL 22.9, Banc Vert: *a*, outline of lateral processes of sixth, seventh, and eighth thoracic somites, right side; *b*, last abdominal somite, telson, and uropod; *c*, uropod, ventral view.

Telson as broad as or broader than long, with 2 pairs of sharp marginal teeth, laterals distinct but not well developed, submedians with movable apices; dorsal surface of telson lacking tubercles and spinules except for apical armature of dorsal carinae; median carina tapering distally, with posterior spinule; accessory medians short, well developed, with posterior spinule, subapical tubercle present or

absent; accessory medians not fusing with median to form anchor; anterior submedians slender, with apical tubercle; an irregular U-shaped ridge, open anteriorly, extends posteriorly from midlength of telson between anterior submedian and intermediate carinae, across central carinae, to equivalent point on other side of telson; carinae of marginal teeth sharp, submedians divergent anteriorly; numerous small submedian denticles present; 2 intermediate denticles present, each sharp, anteriorly recessed; ventral surface of telson lacking sharp longitudinal carinae.

Endopod and exopod of uropod with normal complement of setae, some distal setae of endopod erect; endopod slender, tapered distally, with long dorsal carinae; proximal segment of exopod with slender, ventrodistal spine at articulation of distal segment; inner spine of basal prolongation shorter than outer.

COLOR.—Body light, with traces of darker pigment on dorsum; carapace, sixth thoracic somite, and first abdominal somite each with dark dorsal patch; sixth thoracic somite dark laterally; merus of claw with dark, dorsal patch.

SIZE.—Females only examined, TL 17.8–22.9. Lanchester's specimens were all small, TL 7.5–17.5. Other measurements of female, TL 22.9: carapace length 4.4; fifth abdominal somite width 3.1; telson length 2.8, width 2.8.

DISCUSSION.—These two specimens correspond very closely with the account of the species given by Lanchester (1903); the telson ornamentation most closely resembles that recorded by Lanchester as "*segregatus* b."

Borradaile (1907) considers this species to be identical with *G. affinis* de Man, 1902, from Ternate, a form described by de Man as a variety of *G. chiragra*. Identification of *G. segregatus* with *G. affinis* must await direct comparison of type material or adequate redescription of both species based on type material.

The specimens recorded herein are similar to *G. choprai* Manning, 1967b, described from specimens taken in the northwestern Indian Ocean. *Gonodactylus choprai*, however, differs from all other species in the genus in lacking a fixed distoventral spine on the proximal segment of the uropodal exopod.

DISTRIBUTION.—Central and western Indian Ocean, from the Comoro Islands, Madagascar, and from several localities in the Maldive Islands (Lanchester, 1903); shallow water to 35 fms.

Protosquilla Brooks, 1886

The genus *Protosquilla* includes the species assigned by Kemp (1913) to *Gonodactylus* Group III. Seréne (1952, 1954) commented on

the affinities of some of the species and listed the species known at that time.

Three species occur off Madagascar.

Protosquilla lenzi (Holthuis, 1941)

Gonodactylus glaber.—Kemp, 1913, p. 182, pl. 10 (fig. 121).—Serène, 1947, p. 385, fig. 1, pl. 2.

Gonodactylus lenzi Holthuis, 1941, p. 288 [new name for *G. glaber*; older references].—Tiwari and Biswas, 1952, p. 362.—Serène, 1954, pp. 6, 7, 10, 34, 52, 73, figs. 5-7, 11A-C, 13-12.—Manning, 1962, p. 11.—Ingle, 1963, p. 31, fig. 31.

ILLUSTRATION.—Serène, 1947, fig. 1, pl. 2.

PREVIOUS RECORD.—None.

MATERIAL.—1 ♀, 25.5; Nosy Bé; intertidal zone; Macnae; December 1958; USNM. 5 ♀, 25.8-30.0; same; sandstone; A. Crosnier; November 1961; MNHNP. 1 ♂, 25.9; Point Fièvre, Nosy Bé; 13°24'21" S, 48°18'33" E; J. Rudloe field no. Jr. 13; IIOE; 26 December 1963; USNM. 1 ♀, 32.3; same; 13°24.4' S, 48°17.8' E; intertidal mud flat, 50 yds. right of Centre d'Océanographie pier; J. Rudloe field no. 24A; IIOE; 4 January 1964; USNM. 1 ♀, 26.5; Ambatomboka Crater Point, Nosy Bé; 13°24'17" S, 48°13'31" E; from base of volcanic rocks; J. Rudloe field no. JR-23; IIOE; 3 January 1964; USNM.

REMARKS.—These specimens agree well with Kemp's account of the species. There is some variation in the amount of pitting on the dorsal bosses of the telson; Serène (1947) also commented on this variation.

The body is covered with light brown chromatophores aggregated in bands; darker bands or spots are present on the anterior and posterior third of the carapace and on the sixth and seventh thoracic and first abdominal somites. There is a characteristic dark spot laterally on the sixth thoracic somite.

DISTRIBUTION.—Indo-West Pacific, from scattered localities between the eastern Indian Ocean and the Philippines. Shallow water.

Protosquilla pulchella (Miers, 1880)

Gonodactylus pulchellus.—Kemp, 1913, p. 177, pl. 10 (figs. 117-118).—Holthuis, 1941, p. 288, fig. 9b [older references].—Serène, 1954, p. 52 [listed].—Stephenson and McNeill, 1955, p. 252.—Ingle, 1963, p. 30, figs. 29, 49.

ILLUSTRATION.—Kemp, 1913, pl. 10 (figs. 117, 118).

PREVIOUS RECORD.—None.

MATERIAL.—2 ♂, 18.6-30.0; 1 ♀, 28.0; Nosy Bé; in sandstone; A. Crosnier; 20 May 1958; USNM. 1 ♂, 14.6; same; intertidal zone; A. Crosnier; September 1958; MNHNP. 1 ♂, 29.5; same; R. Legendre;

July 1959; USNM. 1 ♀, 30.4; same; A. Crosnier; January 1962; USNM. 1 ♀, 31.4; same; February 1962; MNHNP.

REMARKS.—These specimens agree well with Kemp's (1913) account of the species. All specimens have small posterolateral spines on the carinae or bosses of the sixth abdominal somite. The dark patches on the sixth thoracic somites may be well marked on the males but not on the females.

DISTRIBUTION.—Indo-West Pacific, from scattered localities between East Africa, the Red Sea, and Australia. Shallow water.

Protosquilla spinosissima (Pfeffer, 1838)

Gonodactylus spinosissimus.—Kemp, 1913, p. 191, pl. 10 (figs. 124–125).—Holthuis, 1941, p. 292, fig. 9c [with synonymy].—Serène, 1953, p. 507; 1954, pp. 6, 52 [listed].—Ingle, 1963, p. 31, fig. 30.

ILLUSTRATION.—Kemp, 1913, pl. 10 (figs. 124–125).

PREVIOUS RECORD.—None.

MATERIAL.—1 ♀, 12.8; Nosy Bé; intertidal zone; December 1958; MacNae; USNM.

DESCRIPTION.—Cornea flattened, faintly bilobed, set obliquely on stalk; ocular scales acute laterally; rostral plate trispinous, median spine longer than anterolaterals, extending to cornea, anterolateral spines extending just past base of eyestalk; anterior margin of carapace lateral to rostral plate slightly concave, angled anterolaterally; dactylus of claw with basal notch on outer margin; mandibular palp 2-segmented; first 4 abdominal somites smooth, margin of fourth angled posterolaterally; fifth somite smooth dorsally, with 3–4 longitudinal lateral carinae, posterolateral margin spined; sixth somite with anterior row of spinules, dorsal surface with 6 irregular groups of erect spines, each situated on low dorsal bosses indistinctly separated by shallow furrows; telson longer than broad, completely fused with sixth somite, ornamented dorsally with 3 bosses, median round, situated anteriorly, submedians oval, situated at and posterior to apex of median cleft; surface of telson covered with erect, slender spines, arising primarily from dorsal bosses and lateral margins; lateral spines arranged in 3 rows, outermost directed laterally, with 9–11 spines; posterior margin of telson with deep median cleft, lined with spines, and shallower submedian clefts; basal segment of uropod with 1–2 proximal dorsal spines; outer spines of basal prolongation of uropod longer than inner.

COLOR.—Body mottled brown; carapace and merus of claw with lighter transverse band; telson and uropods lighter than body, lacking definite pattern in preservative.

DISCUSSION.—This small specimen agrees in all details with the excellent account of the species given by Kemp (1913).

Protosquilla guerinii (White) is the only other species of *Protosquilla* known from the western Indian Ocean in which the telson is ornamented with long dorsal spines. That species, however, differs in having the fifth abdominal somite armed with 3-5 transverse rows of spinules, a row of spinules on the uropodal endopod, and the dorsal spines of the telson arranged in an entirely different pattern. The central spines on the telson of *P. guerinii* form a corona; the three fissures of the telson margin are almost equally deep and are lined with spinules. In addition, the dorsal spines on the telson of *P. guerinii* may be provided with fleshy tips that are absent in *P. spinosissima*.

DISTRIBUTION.—Indo-West Pacific, from scattered localities between the western Indian Ocean and Japan. It has not been recorded previously from Madagascar. It usually is recorded from shallow water, on reefs, but Tattersall (1906) reported material from 45-50 fms off Ceylon.

Literature Cited

BALSS, H.

1910. Ostasiatische Stomatopoden. Abh. Math.-phys. Klasse Bayer Akad. Wiss. München, suppl. 2, trans. 2, pp. 1-11, figs. 1-2.

BARNARD, K. H.

1926. Report on a collection of Crustacea from Portugese East Africa. Trans. Roy. Soc. South Africa, vol. 13, pt. 2, pp. 119-129, pl. 10.
1950. Descriptive list of South African stomatopod Crustacea (mantis shrimps). Ann. South African Mus., vol. 38, pp. 838-864, figs. 1-4.
1955. Additions to the fauna-list of South African Crustacea and Pyenogonida. Ann. South African Mus., vol. 43, pp. 1-107, figs. 1-53.
1962. New records of marine Crustacea from the East Africa region. Crustaceana, vol. 3, no. 3, pp. 239-245, figs. 1-3.

BIGELOW, R. P.

1894. Report on the Crustacea of the Order Stomatopoda collected by the steamer "Albatross" between 1885 and 1891 and on other specimens in the U.S. National Museum. Proc. U.S. Nat. Mus., vol. 17, pp. 489-550, figs. 1-28, pls. 20-22.
1931. Stomatopoda of the southern and eastern Pacific Ocean and the Hawaiian Islands. Bull. Mus. Comp. Zool. Harvard, vol. 72, no. 4, pp. 105-191, figs. 1-10, pls. 1-2.

BORRADAILE, L. A.

1898. On some crustaceans from the South Pacific: Stomatopoda, pt. 1. Proc. Zool. Soc. London, 1898, pp. 32-38, pls. 5-6.
1899. On the Stomatopoda and Macrura brought by Dr. Willey from the South Seas. In Willey, Zoological results based on material from New Britain, New Guinea, Loyalty Islands and elsewhere, collected during the years 1895, 1896, and 1897, vol. 4, pp. 395-428, pls. 36-39.
1907. Stomatopoda from the western Indian Ocean. In The Percy Sladen Trust Expedition to the Indian Ocean in 1905, under the leadership of Mr. J. Stanley Gardiner. Trans. Linn. Soc. London, ser. 2, vol. 12, pp. 209-216, pl. 22.

BOUVIER, E. L.

1914. Sur la faune carcinologique de l'île Maurice. C. R. Acad. Sci., vol. 159, pp. 698-704.

1915. Décapodes marcheurs et stomatopodes recueillis à l'île Maurice par M. Paul Carrié. Bull. Sci. France et Belge, ser. 7, vol. 48, no. 3, pp. 178-318, figs. 1-42.

BROOKS, W. K.

1886. Report on the Stomatopoda collected by H. M. S. "Challenger" during the years 1873-76. In Reports on the scientific research of the "Challenger," Zoology, vol. 16, pp. 1-116, pls. 1-16.

CHHAPGAR, B. F., and SANE, S. R.

1967. Two new species of *Squilla* (Stomatopoda) from Bombay. Crustaceana, vol. 12, pt. 1, pp. 1-8, figs. 1-2.

CHOPRA, B.

1939. Stomatopoda. In The John Murray Expedition, Scientific Reports, vol. 6, no. 3, pp. 137-181, figs. 1-13.

CROSNIER, A.

1965. Les crevettes penaeides du plateau continental Malgache. Cahiers O.R.S.T.O.M., Océanographie, vol. 3, no. 3, suppl., pp. 1-158, figs. 1-14, maps.

DAWYDOFF, C.

1952. Contribution a l'étude des invertébrés de la faune marine benthique de l'Indochine. Biol. Bull. France Belgique, suppl. 37, pp. 1-158.

DOLLFUS, R. PH.

1938. Stomatopoda, II: Catalogue synonymique des espèces jusqu'à présent récoltées dans la Mer Rouge, y compris la partie sud du Canal de Suez et le Golfe d'Aden. In Mission Robert Ph. Dollfus en Egypte, x. Mem. Inst. Egypte, vol. 37, pp. 185-236, figs. 1-8, 10-11, 13-23.

FOURMANOIR, P.

1952. Observations sur la faune marine et le peche à l'île Europa. Mem. Inst. Sci. Madagascar, ser. A, vol. 7, no. 2, pp. 167-188, 1 fig., pls. 9-13.

1953. Note sur le developpement postembryonnaire de deux squilles (stomatopodes) de Madagascar. Nat. Malgache, vol. 5, no. 2, pp. 153-158, figs. 1-13.

GRAVIER, C.

1920. Sur une collection de crustacés recueillis a Madagascar par M. le lieutenant DeCary. Bull. Mus. Hist. Nat. Paris, vol. 26, pp. 376-383.

1935. Crustacés stomatopodes recueillis par M. R. Decary, a Fort-Dauphin (Madagascar). Arch. Mus. Hist. Nat. Paris, ser. 6, vol. 12, pp. 357-361, figs. 1-3.

1937. Stomatopodes de cotes d'Indo-Chine. Ann. Inst. Océanogr., vol. 17, fasc. 3, pp. 175-211, figs. 1-23.

1938. Stomatopoda, I. In Mission Robert Ph. Dollfus en Egypte, ix. Mem. Inst. Egypte, vol. 37, pp. 163-183, figs. A-D, 1-5.

HAAN, W. DE

1833-1850. Crustacea. In de Siebold, Fauna Japonica sive descriptio animalium, quae in itinere per Japoniam, jusse et auspiciis superiorum, qui summum in India Batavia Imperium tenent, suscepto, annis 1823-1830 collegit, notis observationibus et adumbrationibus illustravit, pp. i-xvi, i-xxxi, vii-xvii, 1-243, pls. A-Q, 1-55, circ. 2.

HANSEN, H. J.

1926. The Stomatopoda of the Siboga Expedition. *In* Siboga Expedition, Monogr. 35, pp. 1-48, pls. 1-2.

HOFFMANN, C. K.

1874. Crustacés et échinodermes de Madagascar et de l'île de la Réunion, pp. 1-36, pls. 1-10. *In* Pollen and van Dam, Recherches sur la faune de Madagascar et des ses dependances, vol. 5, pt. 2, pp. 1-58, pls. 1-10.

- 1874a. Enumeration des crustacés trouvés a Madagascar et les Mascareignes, pp. 37-44. *In* Pollen and van Dam, Recherches sur la faune de Madagascar et des ses dependances, vol. 5, pt. 2, pp. 1-58, pls. 1-10.

HOLTHUIS, L. B.

1941. The Stomatopoda of the "Snellius" Expedition. No. XII *in* Biological results of the "Snellius" Expedition. Temminckia, vol. 6, pp. 241-294, figs. 1-9.

1951. Note on *Caledoniella montrouzieri* Souverbie, a gastropod mollusc living commensally on stomatopod Crustacea. Basteria, vol. 15, nos. 3-4, pp. 69-71.

1964. Preliminary note on two new genera of Stomatopoda. Crustaceana, vol. 7, no. 2, pp. 140-141.

HUMES, A. G.

1965. New species of *Hemicycllops* (Copepoda, Cyclopoida) from Madagascar. Bull. Mus. Comp. Zool. Harvard, vol. 134, no. 6, pp. 159-259, pls. 1-36.

INGLE, R. W.

1963. Crustacea Stomatopoda from the Red Sea and the Gulf of Aden. No. 26 *in* Contributions to the knowledge of the Red Sea. Bull. Sea Fish. Res. Sta., Haifa, no. 33, pp. 1-69, figs. 1-73.

JURICH, B.

1904. Die Stomatopoden der deutschen Tiefsee-Expedition. *In* Wissenschaftliche Ergebnisse Deutschen Tiefsee-Expedition, "Valdivia," vol. 7, pp. 361-408, pls. 25-30.

KEMP, S.

1913. An account of the Crustacea Stomatopoda of the Indo-Pacific region, based on the collection in the Indian Museum. Mem. Indian Mus., vol. 4, pp. 1-217, 10 text-figs., pls. 1-10.

KURIAN, C. V.

1954. Contributions to the study of the crustacean fauna of Travancore. Bull. Centr. Res. Inst., Univ. Travancore, Trivandrum, ser. c, vol. 3, no. 1, pp. 69-91, 3 figs.

LANCHESTER, W. F.

1901. On the Crustacea collected during the "Skeat Expedition" to the Malay peninsula, together with a note on the genus *Actaeopsis*. Proc. Zool. Soc. London, 1901, pp. 534-574, pls. 33-34.

1903. Marine crustaceans, VIII: Stomatopoda, with an account of the varieties of *Gonodactylus chiragra*. *In* Gardiner, The fauna and geography of the Maldive and Laccadive Archipelagoes: Being an account of the work carried on and of the collections made by an expedition during the years 1899 and 1900, vol. 1, pp. 444-459, pl. 23.

LENZ, H.

1905. Ostafrikanische Dekapoden und Stomatopoden gesammelt von Herrn Prof. Dr. A. Voeltzkow. Vol. III in Voeltzkow, Wissenschaftliche Ergebnisse der Reisen in Madagaskar und Ostafrika in den Jahren 1889-95. Abhandl. Senckenb. Naturf. Ges., vol. 27, pp. 341-392, pls. 47-48.
1910. Crustaceen von Madagaskar, Ostafrika und Ceylon. In Voeltzkow, Reise in Ostafrika in den Jahren 1903-1905 mit Mitteln der Herman und Elise geb. Heckmann Wentzel-Stiftung ausgeführt, vol. 2, pp. 539-576.

LENZ, H., and RICHTERS, F.

1881. Beitrag zur Krustaceenfauna von Madagascar. Abhandl. Senck. Naturf. Ges. Frankfurt, vol. 12, pp. 421-428.

MAN, J. G., DE

1898. Bericht über die von Herrn Schiffscapitän Storm zu Atjeh, an den westlichen Küsten von Malakka, Borneo und Celebes sowie in der Java-See gesammelten Decapoden und Stomatopoden. Sechster (Schluss-) Theil. Zool. Jahrb. Syst., vol. 10, pp. 677-708, pls. 28-38.
1929. On a collection of decapod and stomatopod Crustacea from Pulau Berhala, an islet situated in the Straits of Malacca. Bijdr. Dierk., vol. 26, pp. 1-26, pls. 1-3.
- 1929a. Decapoda and Stomatopoda from Pulau Berhala. Misc. Zool. Sumatrana, no. 36, pp. 1-3.

MANNING, RAYMOND B.

1962. Stomatopod Crustacea collected by the Yale Seychelles Expedition, 1957-1958. Postilla, no. 68, pp. 1-15, figs. 1-2.
1965. Stomatopoda from the collection of His Majesty The Emperor of Japan. Crustaceana, vol. 9, pt. 3, pp. 249-262, figs. 1-2, pls. 11-12.
1966. Notes on some Australian and New Zealand stomatopod Crustacea, with an account of the species collected by the Fisheries Investigation Ship *Endeavour*. Rec. Australian Mus., vol. 27, no. 4, pp. 79-137, figs. 1-10.
1967. Stomatopoda in the Vanderbilt Marine Museum. Crustaceana, vol. 12, pt. 1, pp. 102-106.
- 1967a. A review of the genus *Odontodactylus* (Crustacea: Stomatopoda). Proc. U.S. Nat. Mus., vol. 123, no. 3606, pp. 1-35, figs. 1-8, pl. 1.
- 1967b. Notes on the *demanii* section of genus *Gonodactylus* Berthold with descriptions of three new species (Crustacea, Stomatopoda). Proc. U.S. Nat. Mus., vol. 123, no. 3618, pp. 1-27, figs. 1-8.
- 1967c. A revision of the family Squillidae (Crustacea, Stomatopoda), with the description of eight new genera. Bull. Mar. Sci., in press.

MIERS, E. J.

1880. On the Squillidae. Ann. Mag. Nat. Hist., ser. 5, vol. 5, pp. 1-30, 108-127, pls. 1-3.
1884. Crustacea. In Report of the zoological collections made in the Indo-Pacific Ocean during the voyage of H.M.S. "Alert," 1881-82, pp. 178-322, 513-575, pls. 18-35, 46-52.

MONOD, TH.

1925. Sur les stomatopodes de la cote occidentale d'Afrique. Bull. Soc. Sci. Nat. Maroc, vol. 5, no. 3, pp. 86-93, pls. xx-xxi.

NOBILI, G.

1906. Crustacés décapodes et stomatopodes. *In* Mission J. Bonnier et Ch. Pérez (Golfe Persique, 1901). Bull. Sci. France Belge, vol. 40, pp. 13-159, figs. 1-3, pls. 2-7.

ODHNER, T.

1923. Indopazifische Stomatopoden. Göteborg Vetensk. Samh. Handl., ser. 4, vol. 27, pt. 4, pp. 1-16, figs. 1-10.

POCOCK, R. I.

1893. Report upon the stomatopod crustaceans obtained by P. W. Bassett-Smith, Esq., surgeon, R. N., during the cruise, in the Australian and China seas, of H.M.S. "Penguin," Commander W. U. Moore. Ann. Mag. Nat. Hist., ser. 6, vol. 11, pp. 473-479, pl. 20B.

POISSON, H.

1949. Le biotope a cymodocées a Madagascar. Nat. Malgache, vol. 1, no. 1, pp. 11-25, 1 fig., pls. 2-3.

RATHBUN, M. J.

1914. Stalk-eyed crustaceans collected at the Monte Bello Islands. Proc. Zool. Soc. London, vol. 3, pp. 653-654.

RICHTERS, F.

1880. Decapoda. *In* Möbius, Beiträge zur Meeresfauna der Insel Mauritius und der Seychellen, pp. 139-178, pls. 15-18.

SERÈNE, R.

1947. Sur des stomatopodes rares trouvés en Indo-chines et n'existant pas dans les collections du Muséum. Bull. Mus. Hist. Nat. Paris, vol. 19, no. 5, pp. 381-389, figs. 1-2, pls. 1-4.
1950. Deux nouvelles espèces Indo Pacifiques de Stomatopodes. *Ibid.*, vol. 22, no. 5, pp. 571-572.
1951. Observations sur deux *Pseudosquilla* d'Indochine. *Treubia*, vol. 21, no. 1, pp. 11-25, figs. 1-8.
1952. Etude d'une collection de stomatopodes de l'Australian Museum de Sydney. *Rec. Australian Mus.*, vol. 23, no. 1, pp. 1-24, figs. 1-33, pls. 1-3.
1953. Sur la collection des stomatopodes de l'Institut Oceanographique de l'Indochine. *Proc. 7th Pacific Sci. Congr.*, 1949, vol. 4, pp. 506-508.
1954. Observations biologiques sur les stomatopodes. *Mém. Inst. Océanogr. Nhatrang*, no. 8, pp. 1-93, figs. 1-15, pls. 1-10.

STEPHENSON, W.

1962. Some interesting Stomatopoda—mostly from Western Australia. *Journ. Roy. Soc. Western Australia*, vol. 45, pt. 2, pp. 33-43, figs. 1-2, pl. 1.

STEPHENSON, W., and McNEILL, F.

1955. The Australian Stomatopoda (Crustacea) in the collections of the Australian Museum. *Rec. Australian Mus.*, vol. 23, no. 5, pp. 239-265, fig. 1.

TATTERSALL, W. M.

1906. Report on the Leptostraca, Schizopoda, and Stomatopoda collected by Professor Herdman, at Ceylon, in 1902. *In* Herdman, Report to the Government of Ceylon on the Pearl Oyster Fisheries of the Gulf of Manaar, vol. 5, pp. 157-188, pls. 1-3.
1921. Report on the Stomatopoda and macrurous Decapoda collected by Mr. Cyril Crossland in the Sudanese Red Sea. *Journ. Linn. Soc. London, Zool.*, vol. 34, pp. 345-398, pls. 27-28.

TIWARI, K. K., and BISWAS, S.

1952. On two new species of the genus *Squilla* Fabr., with notes on other stomatopods in the collections of the Zoological Survey of India. Rec. Indian Mus., vol. 49, nos. 3-4, pp. 349-363, figs. 1-5.

WARD, M.

1942. Notes on the Crustacea of the Desjardins Museum, Mauritius Institute, with descriptions of new genera and species. Bull. Mauritius Inst., vol. 2, no. 2, pp. 49-108, pls. 5-6.

Proceedings of
the United States
National Museum



SMITHSONIAN INSTITUTION • WASHINGTON, D.C.

Volume 124

1968

Number 3642

A New Subspecies of Parrotfish
Nicholsina ustus collettei
from the Eastern Atlantic Ocean

By Leonard P. Schultz
Senior Zoologist, Department of Vertebrate Zoology

At the time of my review (1958, U.S. Nat. Mus. Bull. 214, p. 128) of the parrotfishes (family Scaridae), the genus *Nicholsina* Fowler had not been reported from the eastern tropical Atlantic Ocean; however, among the fishes collected during November and December 1963 by Dr. Bruce B. Collette from the Guinean trawling survey ship *La Rafale*, there is a fine series of a new subspecies of *Nicholsina ustus* (Cuvier and Valenciennes) taken off Guinea, the west coast of Africa, from 8°52'N to 9°53'N latitude and 13°48'W to 15°56'W longitude at depths from 20 to 50 meters. The genus *Nicholsina*, thus, is now known from the eastern and western coastal waters of the Atlantic Ocean and the eastern coastal waters of the Pacific Ocean.

The specimens collected by Dr. Collette represent an extension of the range of the genus *Nicholsina* from the western Atlantic into the eastern Atlantic Ocean. This new subspecies is another example of species and subspecies differentiation between the two sides of the Atlantic Ocean, especially for reef-inhabiting and shallow water bottom-dwelling kinds of fishes.

The genus *Nicholsina* may be distinguished from other genera of scarid fishes by the following combination of characters: dorsal fin

IX,10, anal III,9, pectoral ii,11, rarely ii,12, median predorsal scales 4, the single row of scales below eye on cheek total 4, gill rakers 3 or 4+6 to 10 totalling 9 to 13; the branchiostegal membranes are attached to the isthmus with a narrow free fold across the isthmus; anterior nostril with a short free dermal flap not quite reaching the posterior nasal opening; dorsal and anal spines flexible, nonpungent.

The species and subspecies of *Nicholsina* are distinguished in the following key:

- 1a. Base of pectoral fin same color as body, not blackish; none of the spiny dorsal rays ending distally in a filament; distal edge of caudal fin not white edged; least width of preorbital notably very wide, contained about .6 to .7 in interorbital space; distance from tip of snout to rictus 1.6 to 1.7 in length of snout; diameter of eye contained about 2 times in the width of the preorbital.
- 2a. Total number of gill rakers on first gill arch 9 to 12 (rarely 12), average 10.53; number of teeth in outer posterior row of dentary 9 to 20, increasing in number with increase in length of fish (western Atlantic).
ustus ustus (Cuvier and Valenciennes)
- 2b. Total number of gill rakers on first gill arch 11 to 13, average 11.93; number of teeth in outer posterior row of dentary 9 to 14, rarely 14, and not increasing in number with increase of length (eastern Atlantic) **ustus collettei**, new subspecies
- 1b. Pectoral fin base black; spiny dorsal fin rays, at least posteriorly, ending distally in a short filament; distal edge of caudal fin broadly white edged in the young; least width of preorbital narrow, contained about 1.2 to 1.3 times in interorbital space; distance from tip of snout to rictus contained 1.0 to 1.2 times in length of snout; diameter of eye contained 1.0 to 1.2 times in preorbital width (Gulf of California to Peru).
denticulatus (Evermann and Radcliffe)

Nicholsina ustus collettei, new subspecies

PLATE 1

HOLOTYPE.—USNM 201582, off Guinea, west Africa, at 9°53'N, 15°56'W, collected by Dr. Bruce B. Collette on the vessel *La Rafale*, Guinean Trawling Survey I, Transect 5, Station 3, depth 40 meters, Dec. 1, 1963, field number BBC-954, standard length 194 mm.

PARATYPES.—All obtained off Guinea, west Africa, by *La Rafale* in Guinean Trawling Survey I in 1963, collector Dr. Bruce B. Collette, as follows:

USNM 201446, same data as holotype, 4 spec., 146-181 mm.

USNM 201444, Trans. 7, Sta. 2, Nov. 26, 1963, field no. BBC-932, depth 30 m, lat. 9°27'N, long. 14°22'W, 2 spec., 133-164 mm.

USNM 201450, Trans. 8, Sta. 2, Nov. 24, 1963, field no. BBC-924, depth 30 m, lat. 8°52'N, long. 13°52'W, 6 spec., 125-157 mm.

USNM 201445, Trans. 8, Sta 1, Nov. 24, 1963, field no. BBC-923, depth 20 m, lat. 8°59'N, long. 13°48'W, 2 spec., 103-130 mm.

USNM 201447, Trans. 7, Sta. 1, Nov. 25, 1963, field no. BBC-931, depth 20 m, lat. 9°36'N, long. 14°13'W, 11 spec., 91-146 mm.

USNM 201449, Trans. 6, Sta. 3, Nov. 29, 1963, field no. BBC-947, depth 40 m, lat. 9°35'N, long. 15°18'W, 1 spec., 129 mm.

USNM 201448, Trans. 7, Sta. 3, Nov. 28, 1963, field no. BBC-933, depth 40-45 m, lat. 9°13'N, long. 14°38'W, 2 spec., 157-165 mm.

USNM, 201443, Trans. 6, Sta. 4, Nov. 29, 1963, field no. BBC-946, depth 50 m, lat. 9°24'N, long. 15°26'W, 1 spec., 140 mm.

DESCRIPTION.—Measurements were made on the holotype and six paratypes of *Nicholsina ustus collettei* and recorded in table 1 in thousandths of standard length, along with similar data for seven speci-

TABLE 1.—Measurements on specimens of two closely related species of *Nicholsina* expressed in thousandths of standard length

Characters	<i>N. ustus collettei</i> , new subspecies							<i>N. ustus ustus</i>						
	Holo-type	Paratypes						USNM 53314	USNM 26554	USNM 163440	USNM 118990	USNM 38674	USNM 38674	USNM 53313
Standard length (in mm)	191	185	185	161	152	148	130	178	162	157	143	137	131	98
Length of head	356	382	346	335	349	358	331	337	333	344	329	336	321	327
Greatest depth of body	356	378	346	367	355	371	392	356	340	350	370	343	351	347
Length of snout	175	178	168	149	145	155	131	163	154	165	154	153	137	123
Diameter of eye	59	59	54	56	59	61	62	56	55	57	52	62	61	71
Least preorbital width	110	111	108	106	92	101	85	101	102	108	98	88	76	71
Least width fleshy interorbital	81	84	78	71	86	74	69	73	71	70	82	69	61	77
Postorbital length of head	167	178	173	162	181	183	169	163	167	163	157	161	153	188
Least depth caudal peduncle	141	143	141	140	138	142	146	163	148	140	161	142	149	143
Length of caudal peduncle	126	124	130	124	138	142	115	139	134	108	133	131	134	143
Length of longest fin ray														
spiny dorsal	115	124	151	130	145	148	100	146	154	147	154	146	156	138
soft dorsal	152	143	146	155	145	155	146	157	173	179	168	175	168	153
spine of anal	100	108	151	99	99	135	115	101	148	121	119	106	114	102
soft anal	141	141	141	137	132	135	123	157	130	134	133	139	126	117
pectoral	178	178	184	205	184	203	161	197	178	191	182	212	183	173
pelvic	147	173	151	162	165	169	154	174	161	172	175	190	168	158
caudal	194	243	227	230	230	243	231	253	272	280	245	256	252	255

mens of *N. u. ustus* from the vicinity of Florida. All counts except those of the gill rakers (table 2) are the same as those listed for the genus *Nicholsina*. I have found no variation in number of median fin rays and scales.

The lips almost cover the white teeth; along the margin of the upper jaw occur several canines that project outward from the premaxillary, the number of such canines increases with the increase in length, often numbering three or more on each side; the incisor-like teeth at front of both jaws are somewhat imbricated; inside of mouth the pre-

maxillary may have from one to several short canines on the largest specimens, but absent on those from 100 to 140 mm in length; the posteriormost row of teeth at side of dentary number from nine to 14 and the teeth apparently do not increase in number with increase in length as found for *N. u. ustus* (see table 2). The profile of snout forms an angle of 65° to 80° with that of lower jaw; distal margin of caudal fin slightly rounded; middle spines of dorsal longest and the sixth to eighth soft dorsal rays longest; the most dorsally located branched ray of pectoral longest and notably longer than any pelvic fin ray.

The appearance in alcohol is shown in plate 1.

REMARKS.—*Nicholsina ustus ustus* occurs abundantly in the western Atlantic Ocean from off New Jersey southward through Florida, Yucatan, Venezuela to Brazil eastward to Bermuda and Cuba.

Nicholsina denticulatus lives in the eastern Pacific Ocean and was recorded from the Gulf of California and at Lobos de Afuera, Peru (Schultz, op. cit., p. 129); additional Peruvian localities are: Lobos de Tierra (USNM 128106, 128107, 128108, 128109, 128110), North Chincha Island (USNM 128111), and Don Martin Island (USNM 128112).

This new subspecies from the eastern Atlantic is close to *N. u. ustus* of the western Atlantic. The color pattern of specimens preserved in alcohol has faded so much that a comparison of the differences, if any,

TABLE 2.—Number of gill rakers on first gill arch of *Nicholsina ustus*

Subspecies	upper		lower					total					average
	3	4	6	7	8	9	10	9	10	11	12	13	
<i>ustus ustus</i>	17	—	2	5	9	1	—	2	5	9	1	—	10.53
<i>ustus collettei</i>	25	2	—	—	8	15	4	—	—	6	17	4	11.93

between the two subspecies is not now possible. Perhaps a comparison of the color patterns of the two subspecies of living specimens might reveal significant differences; however, no color photographs are available.

Two characters distinguish *N. u. collettei* from *N. u. ustus* at the subspecies level. The number of gill rakers on the first gill arch of *ustus* vary from 9 to 12, rarely 12 (average 10.53) (see table 2), whereas those of *collettei* are 11 to 13 (average 11.93). There is an 84 percent degree of separation if lines are drawn between 11 and 12 gill rakers (table 2). The other main difference observed between *ustus* and *collettei* is in the number of incisor-like teeth in the posterior row of the dentary. In *ustus* the teeth are smaller anteriorly and the number

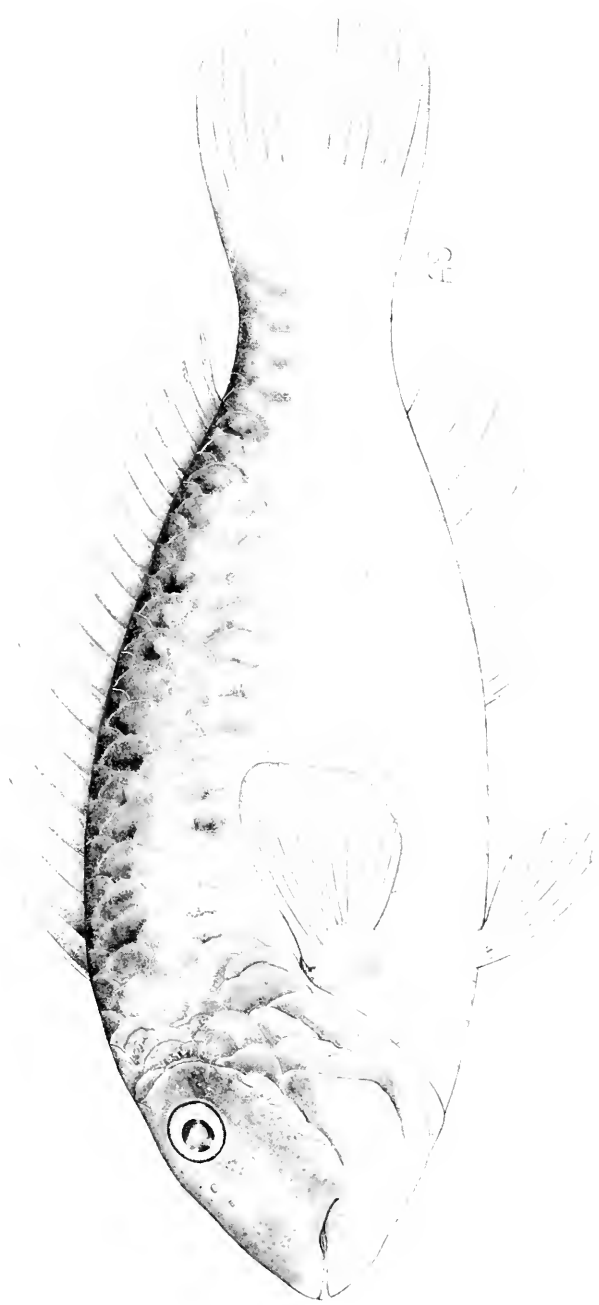

Holotype of *Aichaulina testis callitrici*, new subspecies USNM 201582 (drawn by Miss Ann Schreitz)

increases with increase in length, whereas in *collettei* the teeth do not make such a change in number with length of specimen (fig. 1). Dr. Collette kindly ran the number of teeth correlated with standard length through the automatic data processing equipment at the Smithsonian Institution and determined the correlation coefficient for *ustus* to be .65 (significant at .001 level with 42 degrees of freedom) and

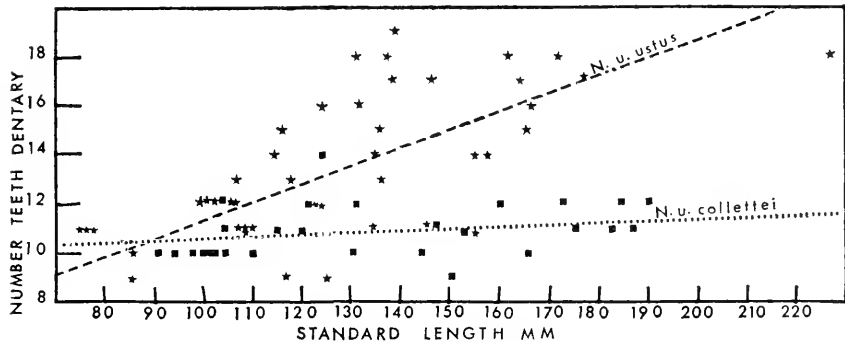

FIGURE 1.—Number of denticles plotted against standard length for specimens of *Nicholsina ustus ustus* (broken line and stars) and *N. u. collettei*, new subspecies (dotted line and squares) (coefficient of correlation: *ustus* = .65; *collettei* = .26).

for *collettei* to be .26 (not significant at the .1 level with 22 degrees of freedom).

This new subspecies is named "*collettei*" in honor of Dr. Bruce B. Collette, my ichthyological colleague at the Smithsonian Institution, who collected these parrotfishes in the eastern Atlantic Ocean.

Proceedings of
the United States
National Museum



SMITHSONIAN INSTITUTION • WASHINGTON, D.C.

Volume 124

1968

Number 3643

Systematics and Distribution of the Monotypic
Indo-Pacific Blenniid Fish Genus *Atrosalarias*

By Victor G. Springer and William F. Smith-Vaniz

Division of Fishes

Our attention was first called to the possibility that a systematic problem might exist within the monotypic blenniid genus *Atrosalarias* because Chapman (1951) had reported that the dorsal fin had 10 spines and Smith (1959) had reported that it had 11 spines. Our purposes here are to redefine *Atrosalarias* and to discuss the meristic variation and geographic distribution of the genus. We have attempted to examine all extant material and to give a complete synonymy at least through 1964 (three references, each marked with an asterisk, were not seen). The synonymy is not given separately for each of the two subspecies that we recognize under *A. fuscus* because several authors refer to material that comprise both subspecies or because it was impossible to determine which of the two subspecies the authors were considering. Of the five nominal species referable to *Atrosalarias*, four are *A. fuscus fuscus*. *Salarias holomelas* is considered a subspecies, *A. fuscus holomelas*.

We wish to thank the following institutions and personnel for making available to us the facilities of their collections (abbreviations are those used in the material list): Academy of Natural Sciences of Philadelphia (ANSP), J. E. Böhlke; Australian Museum, Sydney

(AMS), F. H. Talbot and S. Beresford; California Academy of Sciences (CAS), W. I. Follett and W. N. Eschmeyer; British Museum (Natural History) (BMNH), P. H. Greenwood and A. C. Wheeler; Field Museum of Natural History (FMNH), L. P. Woods and P. Sonoda; Hebrew University, Israel (HUI), H. Steinitz; Institut Royal des Sciences Naturelles de Belgique (IRSN), J. P. Gosse; Los Angeles County Museum (LACM), D. K. Caldwell and R. J. Lavenberg; Museo Civico de Storia Naturale (MCSN), E. Tortonese; Naturhistorisches Museum, Wien (NMW), P. Kähnsbauer; Queensland Museum, Brisbane (QMB), B. Campbell; Rijksmuseum van Natuurlijke Historie, Leiden (RNH), M. Boeseman; Natur-Museum und Forschungs-Institut Senckenberg (SMF), W. Klausewitz; Division of Systematic Biology, Stanford University (SU), W. C. Frehofer and G. S. Myers; University of Hawaii (UH), W. A. Gosline and R. H. Snider; University of Michigan, Museum of Zoology (UMMZ), R. M. Bailey; United States National Museum (USNM); University of Washington (UW), R. Van Cleave; Western Australian Museum (WAM), R. McKay; Zoologisches Staatsinstitut und Zoologisches Museum, Hamburg (ZSZM), K. Kosswig and W. Ladiges.

For assistance in the field we are much indebted to J. H. Choat of the University of Queensland, P. Woodhead of the Heron Island Marine Laboratory, and several members of the staff of the Australian Museum. Fanny L. Phillips of the U.S. National Museum executed the illustration. Our colleagues, B. B. Collette and R. H. Gibbs, Jr., critically read the manuscript and offered valuable suggestions for its improvement. Field work for this study was supported by a grant from the Tropical Fish Hobbyist Fund. Other aspects of the research were supported by a grant from the Smithsonian Research Foundation.

Atrosalarias Whitley

Atrosalarias Whitley, 1933, Rec. Australian Mus., vol. 19, p. 93 [type-species: *Salarias phaiosoma* Bleeker, by original designation].—Norman, 1944, Draft synopsis of the orders, families and genera of recent fishes and fish-like vertebrates, p. 451 [synonym of *Salarias*].—Schultz and Chapman, 1960, U.S. Nat. Mus. Bull. 202, pt. 2, p. 304 [in key].—Springer, 1966, Copeia, no. 1, p. 59 [nature of interopercle].

Atrosalarias fuscus (Rüppell)

PLATE 1

Salarias fuscus Rüppell, 1835, Neue Wirbel. Faun. Abyssin., Fische Roth. Meer., vol. 1, pt. 4, p. 135 [Massaua; original description; figured].—Günther, 1861, Catalogue Acanthopterygian fishes, vol. 3, p. 245 [synonymy; description; distribution].—Bleeker, 1865a, Ned. Tijdschr. Dierk., vol. 2, p. 191 [Piru; Waihai; *S. phaiosoma* Bleeker a synonym]; 1865b, *ibid.*, p. 293 [Amboina].—Day, 1870, Proc. Zool. Soc. London, p. 695 [Nicobars].—Klunzinger, 1871,

Verh. Zool.-Bot. Ges. Wien, vol. 21, p. 489 [Red Sea; description].—Günther, 1877, Journ. Mus. Godeffroy, vol. 13, p. 202 [Pelew; Vavau; distribution; synonymy; description; figured].—Day, 1878, Fishes of India, vol. 2, p. 330 [Kurrachee, India; description; distribution; figured]; 1888, *ibid.*, suppl., p. 797 [synonymy]; 1889, Fauna of British India, vol. 2, p. 311, 313, 314 [key; description; distribution].—Pellegrin, 1904, Bull. Mus. Hist. Nat. Paris, vol. 10, no. 8, p. 543 [Djibouti].—Borsieri, 1904, Ann. Mus. Civ. Stor. Nat. Genova, ser. 3, vol. 1, no. 41, p. 209 [Massaua; Daalac].—Weber, 1913, Fische Siboga Expedition, p. 530, 632 [Beo; synonymy; distribution; reefs].—McCulloch and McNeill, 1918, Rec. Australian Mus., vol. 12, no. 2, p. 12 [Murray Is.; Masthead Is.; Sind, India; Friendly Is.; New Hebrides; synonymy; description].—Fowler, 1918, Copeia, no. 58, p. 65 [Philippines]; 1927, Proc. Acad. Nat. Sci. Philadelphia, vol. 79, p. 295 [misidentification in part; Philippines]; 1928, Mem. Bernice P. Bishop Mus., vol. 10, p. 435 [synonymy; description; distribution].—McCulloch, 1929, Mem. Australian Mus., no. 5, p. 343 [distribution].—Fowler, 1931, Mem. Bernice P. Bishop Mus., vol. 11, no. 5, p. 363 [Oceania]; 1932, Occas. Pap. Bishop Mus., vol. 9, no. 20, p. 12 [Suva, Fiji]; 1934, Mem. Bernice P. Bishop Mus., vol. 11, no. 6, p. 445 [Friendly Is.].—Herre, 1935, Journ. Pan-Pacific Res. Inst., vol. 10, no. 2, p. 166 [Pelew Is.].—Abe, 1939, Japan Soc. Promot. Sci. Res., p. 574 [Koror; distribution].—Herre, 1939a, Philippine Journ. Sci., vol. 70, no. 4, pp. 348-349 [Jolo; Sibutu; Sitankai; synonymy; description]; 1939b, Rec. Indian Mus., vol. 41, no. 4, pl. 361 [synonymy; description; distribution].—Fowler, 1940, Proc. American Philos. Soc., vol. 85, no. 5, p. 796 [Fiji].—Aoyagi, 1941, Sci. South Seas, vol. 4, no. 1, p. 61 [in Japanese; Palau Is.].—Herre, 1942, Proc. Biol. Soc. Washington, vol. 55, no. 1, p. 3 [Philippines].—Norman, 1943, Ann. Mag. Nat. Hist., ser. 11, vol. 10, p. 811 [listed].—Fowler, 1944, Proc. Acad. Nat. Sci. Philadelphia, vol. 96, p. 198 [New Hebrides].—Smith, 1949, Sea fishes of southern Africa, p. 348 [description; Natal record possible error].—Aoyagi, 1954, Zool. Mag. Tokyo, vol. 63, p. 280 [Okinawa; Honto; Niyako Is.; Ishagaki Is.; Irimote Is.; figured].—Munro, 1958, Papua New Guinea Agric. Journ., vol. 10, no. 4, p. 250 [listed].—Fowler, 1959, Fishes of Fiji, p. 520 [distribution; description; figured].—Marshall, 1964, Fishes Great Barrier Reef, p. 389 [Queensland].

Salarias ruficaudus Ehrenberg in Cuvier and Valenciennes, 1836, Hist. Nat. Poissons, vol. 11, p. 328 [Massaua; original description].

Erpichthys ruficauda—Swainson, 1839, Natural history of fishes, amphibians and reptiles, vol. 2, p. 275 [listed]

Salarias phaiosoma Bleeker, 1855 Nat. Tijdschr. Ned. Indië, vol. 8, p. 317 [Archipelago Batu; original description]; 1856-57a, Nat. Tijdschr. Ned. Indië, vol. 12, p. 215 [Nias]; 1856-57b, *ibid.*, p. 233 [Batoe]; 1857c, *ibid.*, vol. 13, p. 372 [Sangi]; 1858-59, *ibid.*, vol. 16, p. 337 [Priaman]; 1860, Act. Soc. Sci. Indo-Niederlandische, vol. 8, p. 43 [Benkulen; Priaman]; 1863a, Ned. Tijdschr. Dierk., vol. 1, p. 236 [Ternate]; 1863b, *ibid.*, pp. 249, 252 [Flores]; 1865, *ibid.*, vol. 2, p. 149 [Bouro].—Fowler, 1949, Mem. Bernice P. Bishop Mus., vol. 12, no. 2, p. 149 [Oceania; synonymy].

Salarias holomelas Günther, 1872, Ann. Mag. Nat. Hist., ser. 4, vol. 10, p. 399 [Cebu; original description].—Schmeltz, 1877*, Cat. Mus. Godeffroy, vol. 6, p. 15 [Pelew Is.]; 1879*, Cat. Mus. Godeffroy, vol. 7, p. 49 [Pelew Is.].—Pöhl, 1884*, Cat. Mus. Godeffroy, vol. 9, p. 34 [Pelew Is.].—Meyer, 1885, Ann. Soc. España Hist. Nat., Madrid, vol. 14, pp. 6, 13 [Cebu].—Jordan and Seale, 1906, U.S. Bur. Fish. Bull., no. 25, p. 431 [synonymy].—Herre, 1934, Fishes of the Herre Philippine expedition 1931, p. 97 (Jolo; Sitankai).

- Salarias niger* Kossmann and Räuber in Kossmann, 1877, Zool. Ergebn. Auftr. König. Acad. Wiss. Berlin ausgefuh. Reise Küsten. Rothen Meeres. Pisces. p. 21 [Massaua; original description; figured].
- Atrosalarias phaisoma*.—Whitley, 1933, Rec. Australian Mus., vol. 19, p. 93 [*S. phaisoma* designated type-species of *Atrosalarias* Whitley; distribution].
- Atrosalarias fuscus*.—Catala, 1950, Bull. Biol. Paris, pp. 274, 302 [New Caledonia; habitat].—Chapman, 1951, in Beaufort, Fishes Indo-Australian Archipelago, vol. 9, pp. 255–257 [synonymy; description; distribution; figured].—Herre, 1953, U.S. Dept. Interior, Fish and Wildl. Serv. Res. Rep., no. 20, pp. 809–810 [synonymy].—Fowler, 1958, Quart. Journ. Taiwan Mus., vol. 11, nos. 3 and 4, pp. 176–177 [synonymy; description; distribution].—Inger, 1957, Fieldiana, Zool., vol. 36, no. 3, p. 399 [Pulo Bakkungaan Kechil, Borneo].—Okada, 1959, An annotated list of animals of Okinawa Islands, p. 80 [in Japanese; listed].—Smith, 1959, Rhodes Univ., Ichthyol. Bull., no. 14, p. 239 [Ibo, Mozambique; description; figured].—Whitley, 1961, Proc. Zool. Soc. New South Wales, 1958–59, p. 64 [New Caledonia].—Woodland and Slack-Smith, 1963, Univ. Queensland Pap., Dept. Zool., vol. 2, no. 2, p. 47 [Heron Is.; habitat].—Whitley, 1964, Rec. Australian Mus., vol. 26, no. 5, p. 150 [Swains Reefs].—Tortonese, 1964, Ann. Mus. Civ. Stor. Nat. Genova, vol. 75, p. 65 [Baia di Geelwink, New Guinea].

DESCRIPTION.—Dorsal fin rays IX to XI, 18 to 22, total elements 28 to 32, subposterior rays longest, posteriormost ray shortest, fin membrane behind last ray attached over caudal procurent rays; anal fin rays II, 18 to 21 (one specimen of 224 had 16 rays), terminal ray not divided to base, subposterior rays longest, posteriormost ray shortest, fin membrane behind last ray attached at caudal base; pectoral rays 15 to 18 (usually 16 or 17) on each side, total pectoral rays 30 to 36; pelvic rays I, 2; segmented caudal rays 10 to 14 (usually 12 or 13), rays all simple, uppermost and lowermost rays much reduced and frequently bearing only one or two segments, all rays unbranched, ray tips becoming free in large individuals; pseudo-branchial filaments 7 to 12 (usually 8 to 11); gill-rakers on first arch 22 to 35 (usually 26 to 31); vertebrae 10 + 22 to 26 = 32 to 36 (usually 34 or 35); total premaxillary comblike teeth 135 to 226; total dentary comblike teeth 82 to 147, one very small canine on each side posterior to comblike teeth; no teeth on vomer.

Short, simple cirri on each side of nape (nape cirri rarely forked at tip), above each eye, and on posterior rim of each anterior nostril; upper lip irregularly crenulate; circumorbital, preoperculomandibular, prenasal, and lateral line pores in simple series; one pore in midline before dorsal fin; lateral line a continuous tube ending above pectoral fin; isolated porelike depressions sometimes present along midside of body.

OSTEOLOGY (based primarily on one specimen of each subspecies).—Last dorsal ray supported by distal and proximal pterygiophores; last anal ray supported by proximal pterygiophore, with or without distal pterygiophore; dorsal procurent caudal rays 5 or 6, ventral procurent

rays 5; 2 epurals present, no minimal hypural (=posteriormost epural of Springer, 1966; hypural 5 of Nybelin, 1963); one pectoral radial attached to scapula, one in part to scapula and coracoid, and two to coracoid; two well-developed postcleithra on each side; lateral line tube passing through supracleithrum; post-temporal forked, ventral limb attached by ligament to pterotic (no attachment to intercalar); lateral extrascapular present on each side; 5 weak circumorbitals (including lachrymal and dermosphenotic) on each side; no subocular shelf; ascending wings of parasphenoid meet descending wings of frontals to exclude pterosphenoids and prootics from orbital region; belophragm and meningost portions of basisphenoid present (basisphenoid complete; for discussion of the composition of the basisphenoid, see Chabanaud, 1936); 13 to 15 epipleurals on each side; one pleural attached to parapophysis on each side of third through tenth or eleventh vertebrae; no neural spine on first vertebra; low neural spine on second vertebra; well-developed neural spines on all other vertebrae; conspicuous neural arch processes on third and fourth vertebrae only (processes attach by strong ligaments to third and fourth pair of epipleurals); parapophysial stays (haemal arches without spines) on eighth through tenth vertebrae; first haemal spine on eleventh vertebra.

PRESERVED COLORATION (ethyl alcohol).—Body, head, and fins, except pectorals and caudal, mostly brown to black; dorsal fin most intensely black basally over anterior three spines; pectorals clear to light dusky with dark spot at base of upper rays; caudal clear to dark dusky; occasional variants exhibit up to five irregular dark bands on body separated by paler interspaces.

The caudal fin has been described in the literature as ranging from clear to dark. Most specimens exhibit a dark dusky caudal, but occasional specimens with pale (immaculate) caudals are found in collections of specimens where dusky caudals predominate. Specimens from the Great Barrier Reef usually have immaculate caudals.

LIFE COLORATION (based on specimens from One Tree Island, Great Barrier Reef).—Caudal fin bright yellow orange, pectorals yellow; deep amber submarginal stripe in spinous dorsal; color otherwise black.

SIZE.—Specimens examined ranged in size from 16.8 to 105 mm SL. No ophioblennius larvae were represented in our collections. Some males were noted to have the skin over the anal spines and anterior two or three anal rays rugose. It is presumed, as for *Entomacrodus* (see Springer, 1967), that these were mature specimens. In females, as is typical of blenniids, the first anal spine is not visible externally.

MERISTIC VARIATION (table 1).—Specimens with 11 dorsal spines are restricted predominantly to Indian Ocean localities, where all specimens except the one from western Australia (9 spines) had that number. The 9-spined specimen from western Australia probably indicates that the population from that area is more closely related to Pacific Ocean populations, where specimens with 9 or 10 spines predominate. Only 4 of 176 non-Indian Ocean specimens had 11 spines. It is on the basis of dorsal spine count associated with distribution that we recognize two subspecies of *A. fuscus*. Springer (1967) noted a similar distribution pattern for *Entomacrodus decussatus* (Bleeker), found in western Australia but otherwise distributed only in the Pacific Ocean and adjacent inland seas, with a cognate species found only in the Indian Ocean, exclusive of western Australia.

Specimens with 11 dorsal spines had about the same total number of dorsal elements as those with 9 or 10 spines, indicating that the decrease in spine numbers probably is effected by conversion of spines to rays rather than by increasing the number of rays. Such a conversion probably is not a simple matter, as there is a relatively complex relationship between the posteriormost spine and anteriormost ray. Each dorsal element except these two is associated with its own proximal pterygiophore; the two elements in question are associated with a single, common, proximal pterygiophore. It is of interest here, however, that one Australian specimen exhibited a somewhat malformed, segmented element in the position where a normal spine should have occurred. The segmented portion occurred distal to a point where the element apparently had been injured. This element exhibited a normal spinelike attachment (no distal pterygiophore) to its proximal pterygiophore (all rays, and no spines, normally have distal pterygiophores) and was counted as a spine.

Fin elements and vertebral numbers are generally highest in the northern Australian (Gulf of Carpentaria) population. This population showed higher total pectoral ray counts than the other populations. No other blenniid so far has been demonstrated to have a population varying from all others in pectoral ray count. It is important to note that, while the eastern Australian specimens had the typical number of pectoral and anal rays for the species, they and the northern Australian population shared the highest average vertebral counts, indicating that pectoral ray and anal ray counts are independent of vertebral count.

Upper and lower jaw tooth counts were made on 20 specimens, 16.8 to 105 mm standard length. The upper teeth ranged from 135 to 226, and the lower teeth ranged from 82 to 147, excluding the canines. The correlation coefficient for both the number of upper jaw teeth,

TABLE 1.—Frequency distributions for certain meristic characters in subspecies of *Atrosalarias fuscus*

	Dorsal spines			Dorsal rays				Total dorsal elements				Anal rays				Total pectoral rays				Vertebrae						
	9	10	11	18	19	20	21	22	28	29	30	21	32	16	17	18	19	20	21	30	31	32	33	34	35	36
<i>A. f. fuscus</i>																										
Red Sea	-	-	16	7	7	2	-	-	-	7	7	2	-	-	6	8	2	-	-	1	2	12	1	-	-	-
India	-	-	1	-	1	-	-	-	-	1	-	-	-	-	-	1	-	-	-	1	-	-	-	-	-	-
Zanzibar	-	-	1	1	-	-	-	-	-	1	-	-	-	-	-	-	1	-	-	-	-	1	-	-	-	-
Indonesia	-	-	7	-	7	-	-	-	-	7	-	-	-	-	-	-	7	-	-	-	-	7	-	-	-	-
<i>A. f. holomelas</i>																										
S. China Sea	1	-	-	-	1	-	-	-	-	1	-	-	-	-	-	1	-	-	-	-	1	-	-	-	-	-
N. Borneo	-	18	2	-	10	10	-	-	-	8	12	-	-	-	-	6	13	-	-	-	-	15	3	2	-	-
Cebu	1	-	-	-	-	1	-	-	-	-	1	-	-	-	-	1	-	-	-	-	1	-	-	-	-	-
Palau Is.	-	15	-	-	4	11	-	-	-	4	11	-	-	-	-	1	12	2	-	-	1	12	1	1	-	-
Timor	1	-	-	1	-	-	-	-	-	1	-	-	-	-	-	1	-	-	-	-	1	-	-	-	-	-
Banda Sea	-	15	1	-	8	8	-	-	-	7	9	-	-	-	-	3	10	-	-	-	9	1	4	-	-	-
New Guinea	1	-	-	-	-	1	-	-	-	-	1	-	-	-	-	-	-	1	-	-	-	-	1	-	-	-
New Britain	1	1	-	1	1	-	-	-	-	2	-	-	-	-	-	2	-	-	-	-	2	-	-	-	-	-
Solomon Is.	-	12	-	1	6	4	-	-	-	1	6	4	-	-	-	6	4	-	-	1	1	10	-	-	-	-
N. Australia	-	27	-	-	1	11	14	1	-	-	1	9	16	1	-	-	2	3	2	-	-	6	2	17	1	1
W. Australia	1	-	-	-	-	1	-	-	-	-	1	-	-	-	-	1	-	-	-	-	-	1	-	-	-	-
E. Australia	5	74	-	1	4	52	18	4	-	1	4	56	17	1	-	11	54	13	-	1	12	60	5	1	-	
New Hebrides	-	13	-	1	8	3	-	-	-	1	8	3	-	-	-	6	6	-	-	1	1	11	-	-	-	-
New Caledonia	1	-	-	-	1	-	-	-	-	1	-	-	-	-	-	1	-	-	-	-	1	-	-	-	-	-
Fiji Is.	-	10	-	-	-	8	2	-	-	-	8	2	-	-	-	5	5	-	-	1	2	7	-	-	-	-
Tonga Is.	-	3	-	-	-	-	3	-	-	-	-	3	-	-	-	-	-	3	-	-	3	-	-	-	-	-
Tabiti	1	-	-	-	-	1	-	-	-	-	1	-	-	-	-	-	1	-	-	-	-	1	-	-	-	-
Marshall Is.	-	2	-	-	-	-	2	-	-	-	-	2	-	-	-	-	-	1	1	-	-	2	-	-	-	-

0.677, and the number of lower jaw teeth, 0.686, and standard length were significant above the 99.5 percent level. The regression equation for the upper jaw was $Y=0.62769 X+152.491$, and for the lower, $Y=0.43656 X+95.149$, indicating thus that number of teeth does increase with increase in standard length.

DISTRIBUTION.—The known distribution of *A. fuscus* is given in figure 1. Literature records were included only if we were reasonably certain of the author's identification. The overall distribution, East Africa to Tahiti, is not an uncommon one for marine shorefishes of the Indo-West Pacific. Apparent absences of *A. f. fuscus* from Indian Ocean island groups such as the Seychelles are unexpected but may well be real. (J. E. Böhlke, et al., recently spent several months collecting fishes in the Seychelles Islands and failed to obtain specimens in habitats that would be expected to harbor *A. fuscus*). In the Pacific, *A. f. holomelas* appears to be restricted primarily to the southern island chain. The northern island chain (Marianas, Marshall, Phoenix, and Line Islands) have been collected frequently in recent years, and one would expect *A. f. holomelas* to have been collected there if present. (*A. fuscus* was reported from Saipan by Fowler, 1945, but this report was based on a misidentification.) Inasmuch as *A. f. holomelas* has not been collected otherwise from the northern island chain in recent years, we have some doubts as to the validity of the locality record for the two specimens from Boston Island, Marshall Islands. These are old specimens that were originally in the Museum Godeffroy collections. Perhaps support for our doubts is to be found in the high total dorsal element counts of the two specimens, outside the range for Solomon Islands and New Hebrides specimens (nearest localities to Boston Island for which there are records). It is also possible, however, that the Boston Island specimens represent a newly established or relict population (if the species were more widely distributed in the past) that has tended to diverge as a result of isolation.

Much of the Pacific distribution of *A. f. holomelas* is peripheral in the sense discussed by Springer (1967).

HABITAT.—Springer collected *Atrosalarias* abundantly at One Tree Island, Great Barrier Reef. At that locality the species occurs at depths of less than a meter up to about three meters. It inhabits living or dead coral, most abundantly on the leeward side of the island. Relatively few specimens were taken on the windward side of that island. During the day at least, *A. f. holomelas* remained well hidden within the interstices of the coral, occasionally darting out and moving short distances to other positions in the coral. That the species is almost entirely black may indicate it is primarily a noctur-

nal form. One may collect specimens by removing and breaking up large chunks of "pie-crust" coral. Since the species also is collected easily with fish poisons, one would expect it to be taken readily in other localities.

RELATIONSHIPS.—*Atrosalarias* belongs to the subfamily Salariae as defined by Norman (1943). Within that subfamily it appears to be most closely related to the genera *Salarias* Cuvier and *Negoscartes* Whitley. These genera are distinct from other Blenniidae in having some or all species with two epurals and no minimal hypural in the caudal fin and in having only two segmented rays in each pelvic fin. *Atrosalarias* differs from the other two genera in having fewer dorsal fin spines, more pectoral rays, and no branched rays in the caudal fin.

Superficially *A. fuscus* bears a close resemblance to *Ecsenius lividinalis* Chapman and Schultz (Fowler, 1927, reported on four specimens of *A. fuscus* from the Philippines, one of which is *E. lividinalis*). Aside from many osteological differences between *Atrosalarias* and *Ecsenius*, *E. lividinalis* can be distinguished from *A. fuscus* by its three segmented pelvic rays (one of these rays may not be visible externally), 12 dorsal spines, fewer than 15 segmented dorsal or anal rays, and a conspicuous black spot surrounding the anus.

NOMENCLATURE.—*Salarias ruficaudus* Ehrenberg was described from Massaua, Red Sea, same type-locality as for *A. fuscus*, without comparison with other species. No type material was designated, and none was found in the Paris Museum, where it would be expected. The description could apply to *A. fuscus* but might apply to some other species. We know of no other Red Sea blenny, however, that would fit the description as well.

Salarias niger Kossman and Räuber also was described from Massaua without comparison with either *A. fuscus* or *A. ruficaudus*. The author's figure clearly indicates *A. fuscus*. If type material is available, it is probably in the East Berlin museum.

Salarias phaiosoma Bleeker was described with mention of the possibility that it was a synonym of *S. fuscus*. Bleeker (1865) later recognized that his species was indeed a synonym of *S. fuscus*. The holotype apparently is lost.

MATERIAL (asterisks denote material not included in table 1 because of insufficient locality data).—

Atrosalarias fuscus fuscus.—RED SEA: HUI E60/120/II (1); Gulf of Aqaba: Eliat: HUI E60/96,14 (1), E60/93,3 (1); Strait of Jubal: USNM 200540 (1); Sarso: NMW 71362 (1); Kamaran Is.: BMNH 1937.4.26.14 (1); Massaua: BMNH 1871.4.13.48 (1), MCSN 12389 (1), SMF 1832 (2 syntypes); Noera: HUI E62/1248 (1); Um Aabak: HUI E60/3660 F (5). INDIA: Sind: AMS B7994 (1). EAST AFRICA: Zanzibar: USNM 197639 (1). INDONESIA: RNH* 4782 (3); Sumatra: Pulo Bai, Batu Group: USNM 199482 (2); Mentawai Is.: USNM 199484 (3); Java: Djakarta Bay: UMMZ 144755 (2).

Astrosalarias fuscus holomelas.—SOUTH CHINA SEA: Amboyna Cay: BMNH 1858.4.21.421. PHILIPPINE IS.: ANSP* 48648-50 (3); Sitankai: Seila Prov.: UMMZ 100295 (2); Sulu Is., BMNH 1933.3.11.709-710 (2), FMNH 47007 (1); Siluag Is.: UW 10276 (1), 10274 (9); Cebu: BMNH 1872.10.18.108 (holotype). BORNEO: Pulo Bakkungan Kechil: FMNH 51794 (2); Darvel Bay: USNM 200537 (2); USNM 201102 (1). PALAU Is. [Pelew Is.]: BMNH 1874.11.19.71 (2), NMW 71366-67 (4), UW 9265 (1), ZSZM 2210 (1), 14043 (1); Kayangel Atoll, off Ngajangel Is.: SU 62084 (1); Anenptegel Is.: SU 62083 (4), 62085 (1). TIMOR: Kupang Bay: RNH 20300 (1). BANDA SEA: NMW* 71361 (2); Banda Neira, Goenoeng Api: IRSN 2714 (10); Elpapoetih Bay: RNH 20251 (4). NEW GUINEA: Geelvick Bay: MCSN 27208 (1); Netherlands Indies: USNM* 195721 (4). NEW BRITAIN: Keraward Is.: USNM 200539. SOLOMON IS.: Russell Is.: AMS IB.6715-16 (2), IB.6720-22 (3); Vanikoro Is.: USNM 200538 (4); New Georgia: USNM 144290 (1); Tautsina Is.: USNM 200542 (2). AUSTRALIA: Northern Territory, Gulf of Carpentaria, Yirrkalla: USNM 174329 (27); Western Australia, Abrolhos Is., Houtmans: WAM P4662 (1); Queensland (eastern Australia): USNM 176950 (1); Torres Strait, Murray Is.: AMS I.11794 (1), QMB I.4825 (1); Green Is.: USNM 177145 (1); Swain Reef: AMS IB.6201 (1); Northwest Is.: BMNH 1933.1.25.173-4 (2); Masthead Is.: AMS I.1424 (3); One Tree Is.: USNM 201251-6 (63); Heron Is.: LACM 8979-1 (6). NEW HEBRIDES: AMS I.14250-3 (8), ANSP 91588 (2); Vila Sandwich Is.: AMS I.6325 (1); Aneityum: ANSP 102190 (2). NEW CALEDONIA: Noumea: AMS IB.2259 (1). FIJI Is.: ANSP 87035 (1), FMNH 47767 (2), NMW 71363-5 (6), UH (uncataloged) R. H. Snider station no. F-1 (1). TONGA Is.: Tonga: AMS IA.5189 (1); Vavau: BMNH 1874.11.19.47 (1), 1876.5.1.31 (1). TAHITI: CAS 24044 (1). MARSHALL IS.: Boston Is. [Ebon Atoll]: ZSZM 766 (1), 2135 (1).

Literature Cited

- BLEEKER, P.
1865. Enumération des espèces de poissons actuellement connues de l'île de Céram. Ned. Tijdschr. Dierk., vol. 2, pp. 182-193.
- CHABANAUD, P.
1936. Le neurocrane osseux des téléostéens dyssymétriques. Ann. Inst. Oceanogr., n.s., vol. 16, pt. 3, pp. 223-297.
- CHAPMAN, W. M.
1951. Family Blenniidae (in part). In de Beaufort, The fishes of the Indo-Australian Archipelago, vol. 11, xi + 484 pp.
- FOWLER, H. W.
1927. Notes on the Philippine fishes in the collection of the Academy. Proc. Acad. Nat. Sci. Philadelphia, vol. 79, pp. 255-297.
1945. Fishes from Saipan Island, Micronesia. Proc. Acad. Nat. Sci. Philadelphia, vol. 97, pp. 59-74.
- NORMAN, J. R.
1943. Notes on the blennioid fishes, 1: A provisional synopsis of the genera of the family Blenniidae. Ann. Mag. Nat. Hist., vol. 11, no. 10, pp. 793-812.
- NYBELIN, O.
1963. Zur Morphologie und Terminologie des Schwanzskelettes der Actinopterygier. Ark. Zool., vol. 15, pp. 485-516.
- SMITH, J. L. B.
1959. Fishes of the families Blenniidae and Salariaidae of the western Indian Ocean. Rhodes Univ. Ichthyol. Bull. 14, pp. 229-252.

SPRINGER, V. G.

1966. *Medusablennius chani*, a new genus and species of blennioid fish from the Tuamotu Archipelago: Its implication on blennioid classification. *Copeia*, 1966, no. 1, pp. 56-60.
1967. Revision of the circumtropical shorefish genus *Entomacrodus* (Blenniidae: Salariae). *Proc. U.S. Nat. Mus.*, vol. 122, no. 3582, pp. 1-150.

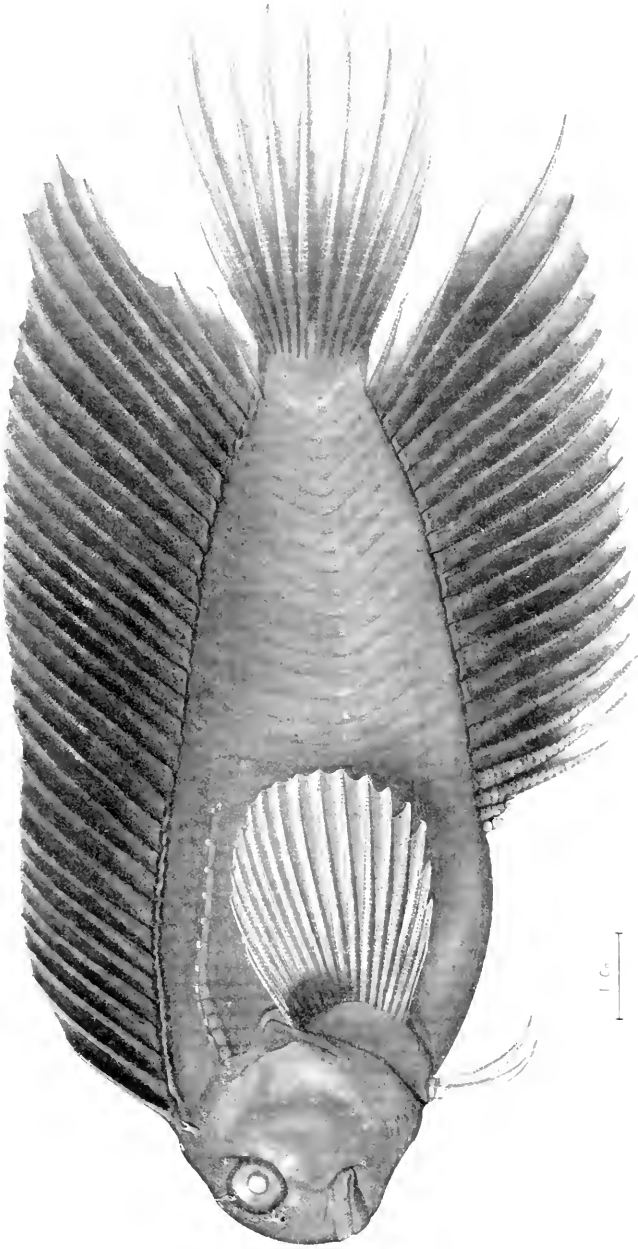

Arosadaria fuscus holomelas, USNM 174329, adult male 105 mm standard length, from Yirrkalla Gulf of Carpentaria, Northern Territory, Australia.

Proceedings of
the United States
National Museum



SMITHSONIAN INSTITUTION • WASHINGTON, D.C.

Volume 124

1968

Number 3644

Studies in the TIPHIIDAE, X ¹
Hylomesa, a New Genus of Myziniine Wasp
Parasitic on Larvae of Longicorn Beetles
(Hymenoptera)

By Karl V. Krombein
Chairman, Department of Entomology

Hylomesa differs from its closest relative, *Mesa* Saussure, in a number of characters of generic significance, the most important of which reflect a change in prey preferences from soil-inhabiting scarabaeid larvae to wood-boring cerambycid larvae. The porrect, quadrate head and generally more slender body of the female are obvious adaptations for traversing the narrow tunnels of wood-boring beetle larvae; one is reminded of similar head and body shape in such bethylid genera as *Scleroderma* and *Nesepyris*, which also parasitize wood-boring beetle larvae. The stout, slightly curved mandibles of *Hylomesa* with an inner subapical tooth are adapted for chewing through wood

¹ Previous parts of this same series are: I, Krombein, 1937, Ann. Ent. Soc. America, vol. 30, pp. 26-30; II, Krombein, 1938, Trans. American Ent. Soc., vol. 64, pp. 227-292; III, Krombein, 1938, Ann. Ent. Soc. America, vol. 31, pp. 59-60; IV, Krombein, 1940, Trans. American Ent. Soc., vol. 65, pp. 415-465; V, Krombein, 1942, Rev. Ent., vol. 13, pp. 308-353; VI, Mickel and Krombein, 1942, American Midl. Nat., vol. 28, pp. 648-679; VII, Krombein, 1949, Proc. Ent. Soc. Washington, vol. 51, pp. 45-73; VIII, Allen and Krombein, 1961, Trans. American Ent. Soc., vol. 87, pp. 57-66; IX, Allen and Krombein, 1964, Trans. American Ent. Soc., vol. 89, pp. 211-275.

to get to its prey; these contrast markedly with the broad but thin, sickle-shaped mandibles without subapical tooth of *Mesa* that are adapted for tunneling through soil. Likewise, the legs of *Hylomesa* are much less spinose than in *Mesa*, a reflection of the different kind of substrate through which the latter has to tunnel to reach its prey.

The presence of transverse ridges anteriorly on the pronotal disk and the disk of the first abdominal tergum also serve to distinguish both sexes of most species of *Hylomesa* from *Mesa*; these modifications serve no apparent functional purpose. Other distinguishing characters of *Hylomesa* are: the lack of a closely striate pygidial area in the female, the shorter male antennae, the lack of an apical notch on the last abdominal tergum of the male, and the carinate hind coxa of the male.

Mesa, with its numerous species, has a relatively broad distribution in the Ethiopian and Oriental Regions, occasionally penetrating the southern Palaearctic Region. *Hylomesa* has a much more restricted distribution; its few species occur in Gabun, Uganda, Ceylon, India, Assam, Malaysia, Borneo, Java, Sumbawa, and the Philippines. The few detailed label data suggest that *Hylomesa* is restricted to tropical forested areas at moderate altitudes, whereas *Mesa* is primarily a genus of open lands, both tropical and temperate.

Twenty-five years ago I set aside the National Museum specimens as a genus discrete from any Myzininae treated in my earlier publication on the genera of this subfamily (Krombein, 1937). I delayed erecting a new genus, however, because of uncertainty as to the status of *Poecilotiphia* Cameron and also because of the desirability of studying the primary types of all of the taxa referable to this supposed new genus.

Poecilotiphia was based on the Indian species *albomaculata* Cameron, known originally only from a male. Cameron's generic and specific descriptions did not agree well with any species in my supposed new genus. His descriptive work, however, is so notoriously poor that uncertainty still existed particularly because of some of Turner's remarks. The latter author (1908b, p. 131) suggested that *Methocha rugosa* Cameron and *Myzine dimidiaticornis* Bingham, both based on males, were allied closely to *Poecilotiphia*. Later, Turner (1909, p. 480) sank *Poecilotiphia* as a synonym of *Myzine* Latreille, but he associated female *apimacula* Cameron as the opposite sex of *albomaculata*. He stated further that *apimacula* differed from most *Plesia* in the feebly sculptured last abdominal tergum, agreeing in this detail with the peculiar female, *Myzine tricolor* Smith, which I assigned to my supposed new genus.

I was able to resolve the application of names satisfactorily when I studied types in the collections of the British Museum and Oxford

University during the summer of 1965. *Poecilotiphia albomaculata* Cameron belongs to the Myziniinae, but it is either a synonym of *Meria* Illiger or a good genus closely allied to *Meria*. *Myzine apimacula* Cameron is a species of *Mesa* and certainly cannot be the opposite sex of *albomaculata*. *Methocha rugosa* Cameron from Ceylon is colored similarly to the species I assign to *Hylomesa*, but it is definitely a member of the Methochinae, not of the Myziniinae as suggested by Turner. The only previously described taxa referable to what I describe here as *Hylomesa* are: *Myzine tricolor* Smith (1858), *Myzine dimidiaticornis* Bingham (1896), *Elis (Mesa) crassepunctata* Turner (1914), *Elis (Mesa) ugandensis* Turner (1918), *Elis (Mesa) tricolor longiceps* Turner (1918), and *Elis (Mesa) tricolor shuckardi* Turner (1918).

For the loan of material discussed in the following pages or for other assistance, I am indebted to: Dr. Clare Baltazar, Philippine Bureau of Plant Industry, Manila (PBPI); Dr. Delfa Guiglia, Museo Civico di Storia Naturale, Genoa (MCSN); Dr. Fred Keiser, Naturhistorisches Museum, Basel (NMB); Dr. M. A. Lieftinck, Rijksmuseum van Natuurlijke Historie, Leiden (RNH); Dr. Laszlo Moczar, Természettudományi Múzeum Állattára, Budapest (TMA); Dr. J. F. Perkins, British Museum (Natural History), London (BMNH); Dr. H. K. Townes, Ann Arbor, Mich. (HKT); Mr. C. R. Vardy, British Museum (Natural History), London; Dr. G. C. Varley, Hope Museum, Oxford University (HMOU); Dr. I. H. H. Yarrow, British Museum (Natural History), London; Dr. C. M. Yoshimoto, Bernice P. Bishop Museum, Honolulu, Hawaii (BPBM).

Mrs. Elsie H. Froeschner made the habitus illustrations that accompany this article, and Mr. André Pizzini made the genitalia figures.

Hylomesa, new genus

Type-species: *Myzine tricolor* Smith, 1858.

FEMALE.—Head porrect, more or less quadrate as viewed from above; eye comparatively smaller than in *Mesa*, touching base of mandible, inner margin shallowly and broadly emarginate; mandible stout, slightly curved, with a stout subapical tooth on inner margin that is smaller than the apical tooth, groove parallel to outer margin bearing a series of long, stiff hairs and a short median groove bearing shorter hairs, no groove parallel to inner margin; antennae arising from beneath frontal lobes, pedicel concealed in recessed apex of scape, thus antennae apparently 11-segmented; ocelli small, three in number; clypeus broad and narrow, median keel weak to strongly produced, the apical margin with a small rounded lobe on each side, the median lobe broadly rounded and usually with a pair of small,

close teeth; occipital carina complete dorsally; maxillary palpus 6-segmented, labial palpus 4-segmented.

Thorax narrower than in *Mesa*, considerably longer than broad; pronotum comparatively longer than in *Mesa*, the anterior portion abruptly declivous and separated from posterior horizontal disk by a ridge, the posterior margin arcuate; scutum slightly shorter than pronotal disk, with notauli and parapsidal furrows present on posterior three-fourths; scutellum slightly longer than scutum; post-scutellum a narrow curved sclerite; mesopleuron bulging; metapleuron flat, reduced; propodeum with distinctly differentiated dorsal, posterior, and lateral surfaces, dorsum with a narrow, elongate, median cuneate impression, lateral surface with close, weak, oblique ridges.

Abdomen relatively broad, flattened, 6-segmented; disk of first tergum ridged anteriorly; pygidial area shagreened or polished at apex, not closely longitudinally striate as in *Mesa*.

Wings extending to about apex of fourth abdominal tergum; marginal cell with outer half of anterior margin removed from wing edge, the apex acute, not narrowly rounded as in *Mesa*, three submarginal cells, the second and third each receiving a recurrent nervure; in hind wing cubitus arises beyond transverse median nervure.

Legs relatively short and stout, much less spinose than in *Mesa*; outer surface of mid- and hind tibiae with weaker, more separated, prickle-like spines than in *Mesa*; longer spur of hind tibia with posterior margin rounded, not toothed; tarsal claws cleft; foretarsal rake weaker than in *Mesa*.

Color black, abdomen usually with strong blue reflections; head red; wings strongly infumated.

MALE.—Head not porrect as in female, but much better developed behind eyes than in *Mesa*; eye comparatively smaller than but shaped as in *Mesa*, less strongly reniform than in *Myzinum*, touching base of mandible; the latter similar to that of female but weaker, not strongly curved as in *Mesa*; antennae arising from beneath frontal lobes, apparently 12-segmented, pedicel mostly concealed in recessed apex of scape, much shorter than in *Mesa*, most segments less than twice as long as broad; ocelli three in number, small; clypeus much as in female but median keel weaker and never strongly produced; maxillary palpus 6-segmented, labial palpus 4-segmented.

Thorax longer than broad; pronotal disk about as long as broad, the sides slightly converging anteriorly, a strong ridge between disk and abruptly declivous anterior portion of pronotum; scutum shorter than pronotal disk, notauli and parapsidal furrows well-developed on posterior three-fourths; scutellum as long as scutum; mesopleuron not so strongly bulging as in female, without an anterior ridge and not produced anteriorly in middle; propodeum with ridge between dorsal

and posterior surfaces, lateral surface pitted as are the dorsal and posterior.

Abdomen slender, 7-segmented; disk of first tergum ridged anteriorly; last dorsal segment convex, without differentiated pygidial area, its apex not notched for reception of the recurved hypopygial aculeus as in *Mesa*.

Genitalia very similar in conformation to those of *Mesa* except that the lamina volsellaris is much better developed, extending to or almost to apex of cuspis volsellaris.

Wings reaching nearly to apex of abdomen; anterior margin of marginal cell confluent anteriorly with costal margin of wing, narrowly rounded apically; three submarginal cells, the second and third each receiving a recurrent nervure; cubitus in hind wing arising before transverse median nervure.

Legs rather short, mid- and hind tibiae lacking the scattered spines found in *Mesa*; hind coxa carinate along inner margin above; tarsal claws cleft.

Color as in female, but basal flagellar segments of antenna usually red, and wings frequently less infumated.

Key to Species and Subspecies of *Hylomesa*

(The males are unknown in *t. tricolor* and *ugandensis*; females are unknown in *crassepunctata* and *dimidiaticornis*.)

1. Females; abdomen with six visible segments, antenna apparently only 11-segmented because of the nearly entirely recessed pedicel 2
Males; abdomen with seven visible segments, antenna apparently only 12-segmented because of the recessed pedicel 7
2. Apex of hind tibia on inner surface with four stout, short, flattened setae; distance between hypostomal and occipital carinae only half the length of hypostoma 3
Apex of hind tibia without such setae; distance between hypostomal and occipital carinae subequal to length of hypostoma 5
3. Posterolateral angle of head angulate beneath; clypeal keel very strongly produced, nasiform as viewed from side; inferior margin of hind femur obtusely angulate at middle; Borneo, Sumbawa, Burma.
shuckardi (Turner)
Posterolateral angle of head rounded beneath; clypeal keel distinct but not so produced; inferior margin of hind femur rounded . . . **tricolor** (Smith) . 4
4. Clypeal keel rather weak, present only on basal two-thirds; median teeth on clypeal margin weaker; pronotal ridge weaker, the disk with more dispersed punctures; anterior ridge on first tergum weaker; Borneo.
tricolor tricolor (Smith)
Clypeal keel stronger, complete, terminating on apical third in an inverted U-shaped carina the arms of which extend to the strong marginal teeth; pronotal ridge stronger, the punctures more crowded on anterior half of disk; anterior ridge on first tergum stronger; Java.

tricolor lieftincki, new subspecies

5. Inferior margin of hind femur sharply right-angled at middle; apical fourth of sixth tergum polished and impunctate; mesopleural disk only slightly or not at all produced in middle; comparatively more sparsely punctate species, most of pronotal disk with punctures small and separated by one or more times the diameter of a puncture; anterior ocellus closer to occiput than to apices of antennal tubercles; ocellocular distance 0.50-0.58 times the ocelloccipital distance 6

Inferior margin of hind femur obtusely angulate in middle; apical fourth of sixth tergum shagreened and impunctate; mesopleural disk produced anteriorly in middle so that it overhangs the concave anterior face; comparatively a more densely punctate species, most of punctures on anterior half of pronotal disk coarse, subcontiguous and separated by less than the diameter of a puncture; ocellocular distance 0.42-0.44 times the ocelloccipital distance; anterior ocellus closer to apices of antennal tubercles than to occiput; Ceylon, India, Burma, Malaysia, and Philippines.

longiceps (Turner)

6. Anterior margin of pronotum not ridged; first tergum not transversely ridged anteriorly; mesopleural disk slightly produced anteriorly in middle; distance from apex of antennal insertions to occiput 0.83-0.93 times the width across eyes; Uganda and Gabon **ugandensis** (Turner)

Pronotal disk and disk of first abdominal tergum each with a strong transverse ridge anteriorly; mesopleural disk not produced anteriorly; distance from apex of antennal insertions to occiput 0.94-1.0 times the width across eyes; Philippines **bakeri**, new species

7. Intermediate flagellar segments with length and width subequal; ocellocular and ocelloccipital distances subequal; pronotal disk anteriorly with one weak, transverse ridge; head and pronotum red; South India.

crassepunctata (Turner)

Intermediate flagellar segments with length 1.2-1.5 times the width; ocellocular distance 0.6-0.7 times the ocelloccipital distance; pronotal disk anteriorly either with a single strong ridge or with three weak ridges; head usually red, pronotum always black 8

8. Sterna 5-6 each with the posterior area clothed with dense, short, velvety vestiture; pronotal disk anteriorly with three weak transverse ridges; ocellocular distance 1.5 times the postocellar distance; metapleuron above with close coarse ridges; genitalia with inner surface of squama and cuspis volsellaris densely setose, cuspis volsellaris digitate at apex; India, Burma.

dimidiaticornis (Bingham)

None of sterna with velvety vestiture; pronotal disk anteriorly with a single strong transverse ridge 9

9. Small (11 mm long), quite sparsely punctate species; pronotal disk with almost all of punctures separated by one or more times the diameter of a puncture; sterna 3-5 with very sparse, scattered hairs; ocellocular distance 1.6 times the postocellar distance; genitalia with inner surface of squama and cuspis volsellaris not densely setose, apex of cuspis volsellaris digitate; Philippines **bakeri**, new species

Larger (12-17 mm long), more closely punctate species; pronotal disk with many of punctures contiguous or separated by less than the diameter of a puncture; sterna 3-5 each with short, erect, moderately dense vestiture on apical half; ocellocular distance 1.9-2.8 times the postocellar distance.

10

10. Clypeal keel complete, terminating on apical third in an inverted U-shaped carina the arms of which extend to the very strong marginal teeth; meta-

- pleuron strongly and closely ridged on upper half; genitalia with inner surface of squama and cuspis volsellaris densely setose, cuspis volsellaris digitate at apex; Java **tricolor lieftincki**, new subspecies
- Clypeal keel simple, present only on basal three-fourths, the marginal clypeal teeth absent or weaker; metapleuron on upper half smooth or with fine, close ridges only 11
11. Distance between hypostomal and occipital carinae about half the hypostomal length; clypeal teeth lacking, the apical margin rounded out in middle; flagellum entirely black; genitalia with inner surface of squama and cuspis volsellaris not densely setose, cuspis volsellaris very slender and curved, lamina volsellaris on ventral margin with three long, stout setae, paramere with a small blunt tubercle on inner ventral surface halfway to apex; Borneo, Sumbawa, Borneo **shuckardi** (Turner)
- Distance between hypostomal and occipital carinae subequal to hypostomal length; median clypeal teeth moderately developed, the apical margin shallowly emarginate between teeth; two or more of basal flagellar segments red; genitalia with inner surface of squama and cuspis volsellaris densely setose, cuspis volsellaris broad and truncate at apex, lamina volsellaris with fine setae only, paramere without tubercle; Ceylon, India, Burma, Malasia, and Philippines, but apparently not Borneo . . . **longiceps** (Turner)

***Hylomesa tricolor tricolor* (Smith), new combination**

PLATE 1 (FIGS. 3, 7)

Myzine tricolor Smith, 1858, p. 91.—Dalla Torre, 1897, p. 128.

Smith described *tricolor* from a unique female from "Borneo (Sarawak)" that I have examined in the collection of the Hope Museum at Oxford University. Most of the subsequently published references to *tricolor* actually are referable to *shuckardi* (Turner) except for that cited above from Dalla Torre's catalog. The misidentifications were based on a female of *shuckardi* from Borneo in the British Museum collection misidentified as *tricolor* and considered erroneously to be the type of Smith's species.

Hylomesa tricolor and *H. shuckardi* are the only Oriental species in which the females have the hind tibia armed apically on the inner surface with four short, flattened setae. Also, they are the only known *Hylomesa* from Borneo. The rounded posterolateral angles of the head beneath, the lack of a median clypeal process, and the rounded median angle of the posterior margin of the hind femur readily distinguish *tricolor* from *shuckardi*. The genitalic characters separating the males are the densely setose inner surfaces of the squama and cuspis volsellaris of *tricolor lieftincki* as contrasted to the very sparsely setose condition of these parts in *shuckardi*, and the different conformation of the parts.

There are two races of *tricolor*, the typical one from Borneo, and *H. t. lieftincki*, new subspecies, from Java. In the Bornean race the median teeth on the apical border of the clypeus are weaker as is

the median carina that terminates about two-thirds of the distance to the apical margin.

FEMALE.—Length 16–22, forewing 10–13 mm. Head red except tip of mandible, antenna, and hypostomal area; thorax, legs, and abdomen black, the latter with blue reflections; wings moderately infumated, more strongly so on outer two-thirds of forewing, and with violaceous reflections.

Head from above with length (apex of antennal insertions to occiput) about five-sixths (0.83–0.84) the width across eyes; clypeal keel weak, present only on upper two-thirds, the median teeth on apical margin also weak; median sulcus on front extending halfway to anterior ocellus; lower half of front with coarse, contiguous punctures arranged in longitudinal rows, the upper half with scattered coarse punctures; vertex punctured about as upper half of front; ocellular distance 2.78–2.88 times the postocellar distance and 0.55–0.67 times the ocellocipital distance; anterior ocellus about as close to apices of antennal tubercles as to occiput; head beneath with posterolateral angles rounded; distance between occipital and hypostomal carinae about half the length of hypostomal area.

Anterior margin of pronotal disk with a strong ridge, anterior half of disk with coarse, subconfluent punctures arranged in longitudinal rows, the posterior half with more scattered smaller punctures; scutum with moderately large, subconfluent punctures except posteriorly in middle, where they are confluent; scutellum with punctures more evenly distributed; mesopleural disk produced anteriorly in middle beyond concave anterior face of sclerite, the punctures mostly coarse and mostly separated by less than the diameter of a puncture, slightly sparser than in *shuckardi*; punctures adjacent to cuneate space on dorsum of propodeum small, more closely grouped there than on anterior two-thirds of disk, and with larger, subconfluent pits posteriorly and posterolaterally; posterior propodeal surface with coarse pits that are confluent in irregular, transverse rows, and with the rows separated from each other by about twice the diameter of a pit.

Disk of first tergum weakly ridged anteriorly; last tergum shagreened at extreme apex.

Inferior margin of hind femur rounded at middle; hind tibia at apex on inner surface with four short, flattened setae.

MALE.—Unknown.

SPECIMENS EXAMINED.—1 ♀, Sar. [Sarawak] (HMOU, the holotype). 2 ♀, Sandakan, Borneo (USNM, Baker Collection).

Hylomesa tricolor lieftincki, new subspecies

FIGURE 4; PLATE 1 (FIG. 4)

Females of this Javan race differ from those of typical *tricolor* in having stronger clypeal teeth, in the stronger clypeal keel terminating below in an inverted U-shaped carina, and in being comparatively more strongly punctate or sculptured in certain features as detailed in the description below.

The male associated here with *tricolor lieftincki* females was also taken on Java, though in a different locality. The sex association is believed to be correct because the male also has a strongly developed clypeal keel terminating below in an inverted U-shaped carina; in this feature it differs from any other *Hylomesa* males known to me.

FEMALE.—Length 21.5, forewing 14 mm. Color as in typical *tricolor* except blue reflections on abdomen evanescent.

Head from above with length (apex of antennal insertions to occiput) 0.85 times the width across eyes; clypeal keel stronger than in typical *tricolor*, terminating below in an inverted U-shaped carina, the arms of which extend to the pair of strong median teeth on the apical margin; punctation as in typical *tricolor*; ocellocular distance 2.64 times the postocellar distance and 0.52 times the ocelloccipital distance.

Pronotal ridge somewhat stronger than in typical *tricolor*, and punctures more crowded on anterior half of disk; punctures also more crowded on posterior surface of propodeum.

Ridge on first tergum stronger than in typical *tricolor*.

MALE.—Length 15, forewing 11 mm. Color as in female except abdomen with strong blue reflections and forewing less strongly infumated.

Clypeal keel strong, terminating below in a high, inverted U-shaped carina whose arms form a sharp tooth as viewed from side; distance from apex of frontal platform to occiput 0.88 times the head width across eyes; front with coarse, subcontiguous punctures, the median furrow obsolete; ocellocular distance 2.63 times the postocellar distance and 0.70 times the ocelloccipital distance; occipital carina very weak dorsally; median flagellar segments 1.25 times as long as wide.

Pronotal disk with a strong ridge anteriorly, immediately behind which on anterior third are several rows of punctures subcontiguous in irregular transverse rows, elsewhere on disk the punctures very sparse and small; scutum with coarse pits on most of disk, slightly separated except posteriorly in middle, where they are contiguous; scutellum with coarse, very crowded, larger pits; mesopleural disk

with coarse, subcontiguous pits on upper two-thirds; metapleuron with close parallel ridges above; dorsal propodeal surface with a narrow, median channel, laterad of this a strip of small contiguous pits, and further laterad with scattered pits; lateral propodeal surface with moderate-sized, crowded pits; posterior surface ridged above and with mostly contiguous pits.

First tergum moderately ridged anteriorly, behind which is a row of confluent punctures, sparsely punctate elsewhere; terga each with an apical row of stronger setae than in other species except *shuckardi*; sterna 3-6 with short, erect, moderately dense vestiture.

Genitalia with inner surface of squama and cuspis volsellaris densely setose, cuspis volsellaris digitate at apex; lamina volsellaris with relatively fine setae only; paramere without tubercle on inner ventral surface halfway to apex.

HOLOTYPE.—♀, Mt. Semeroe, R. Daroengan, southeast Java, 800 meters elev., 6-13 June 1941, M. A. Lieftinck (RNH).

ALLOTYPE.—♂, K. O. Blawan, Idjen Plateau, Java, 900-1500 meters elev., 25 April 1936, H. Lucht (RNH).

PARATYPES.—4 ♀, same data as type (RNH, USNM). 1 ♀, Java, Muller (RNH).

Female paratypes are 18-21 mm long and are very similar to the type in all essential details; the ocellocular distance is 2.3-3.0 times the postocellar distance and 0.54-0.62 times the ocelloccipital distance. One paratype bears a label stating that eight examples were taken on flowers of Araliaceae in a dense forest; only five of these are before me.

Hylomesa shuckardi (Turner), new combination

FIGURE 5; PLATE 1 (FIGS. 2, 6)

Myzine tricolor Smith.—Bingham, 1897, in part, p. 66 [the specimen from Borneo].

Elis (Mesa) tricolor (Smith).—Turner, 1912, in part, p. 720 [the specimen from Borneo].

Elis (Mesa) tricolor tricolor (Smith).—Turner, 1918, pp. 87-88 [the specimen from Borneo].

Elis (Mesa) tricolor shuckardi Turner, 1918, pp. 87-88.

Mesa tricolor (Smith).—Guiglia, 1965, p. 316.

Turner's interpretation of this species is exceptionally misleading. He stated that in *tricolor shuckardi* the clypeus was "depressed in the middle" and not carinate, failing to note that part of the clypeus, including the median process, had been broken off when someone extended the mandible. The flattened exposed labrum beneath thus gives the clypeus the superficial appearance of being depressed and unarmed.

Actually the female of *shuckardi* is the most easily distinguished of the several species of *Hylomesa*. In other species the clypeus has

a median keel that is not raised into a process; in *shuckardi* the keel is produced into a process that is nasiform as viewed in profile. Also, *shuckardi* has the lateroventral part of the head angulate beneath, whereas this area is rounded in the other species.

Turner stated that his unique type in the British Museum was from "India (probably the South or West), ex coll. Shuckard." The locality label, however, a round disk, bears only "Ind." on one side and "63/81" on the other. J. F. Perkins of the British Museum staff advised me that the registry entry for 63/81 is "18 Myzine—Africa, India and Brazil. Purchased of E. W. Janson. From the collection of E. W. Shuckard." The more explicit label data on the other specimens of *shuckardi* before me suggest that "Ind." actually may stand for Indies rather than India.

FEMALE.—Length 14–20, forewing 10–13 mm. Black, the head red except tip of mandible, hypostomal area, and antenna, the abdomen with bluish reflections; forewing moderately infumated except basal third very lightly so, the darkened portion with violaceous reflections.

Head from above with length (apex of antennal insertions to occiput) about four-fifths (0.78–0.82) the width across eyes; clypeal keel produced into a nasiform process as viewed laterally; median lobe of clypeus broadly rounded, with a pair of separated median teeth, weak except in the specimen from Marang; front with a median sulcus extending from antennal insertions halfway to anterior ocellus, and with moderately large punctures confluent in vertical rows from insertions two-thirds of distance to anterior ocellus; remainder of front with smaller, scattered, shallow punctures; vertex with more scattered punctures except behind eye, where they are denser; ocellular distance 2.33–2.70 times the postocellar distance and 0.52–0.61 times the ocellocipital distance; anterior ocellus closer to apices of antennal tubercles than to occiput; head beneath angulate posterolaterally; distance between occipital and hypostomal carinae about half the length of hypostomal area.

Anterior margin of pronotal disk with a strong ridge, behind which are coarse punctures more or less confluent in longitudinal rows on anterior half, the posterior half with more scattered and smaller punctures; side of pronotum with coarse, more or less confluent punctures; scutum with moderately large, subconfluent punctures except posteriorly in middle, where they are confluent; scutellum with punctures of same size, confluent in a row laterally and in several rows medianly; mesopleural disk produced anteriorly in middle beyond concave anterior part of sclerite, the discal punctures coarse and mostly separated by less than the diameter of a puncture; upper surface of propodeum with small confluent punctures adjacent to median cuneate impression, larger pits posteriorly, and scattered

punctures elsewhere; posterior surface with coarse, close pits laterally becoming smaller and more separated toward midline; lateral surface with close oblique rugae.

Disk of first tergum weakly ridged anteriorly; last tergum shagreened at apex, somewhat shining.

Inferior margin of hind femur obtusely angulate at middle; hind tibia at apex on inner surface with four short, flattened setae.

MALE (hitherto unrecognized).—Length 13, forewing 9 mm. Color as in female.

Clypeal keel stronger than in other *Hylomesa* except *tricolor lieftincki*, not protruding in middle into a nasiform process as in female; clypeal teeth lacking; distance from apex of frontal platform to occiput 0.89 times the head width across eyes; front with coarse, contiguous punctures, median furrow strongly impressed on basal half; ocellular distance 2.1 times the postocellar distance and 0.65 times the ocell-occipital distance; occipital carina indistinct above in middle; distance between hypostomal and occipital carinae about half the hypostomal length; median flagellar segments 1.2 times as long as wide.

Pronotal disk with a strong anterior ridge, behind this on anterior third with moderately coarse and subcontiguous punctures that form irregular transverse rows; scutum with coarse pits on most of disk, slightly separated except posteriorly in middle, where they are contiguous; scutellum with coarse, very crowded larger pits; mesopleural disk with coarse, subcontiguous pits on upper two-thirds; metapleuron above with very fine, close ridges; propodeal dorsum with a narrow median channel, laterad of which are coarse, contiguous pits; lateral and posterior surfaces similarly pitted.

First tergum slightly more strongly ridged anteriorly than in *tricolor lieftincki*; sterna 3–6 with short, erect moderately dense vestiture.

Genitalia with inner surface of squama and cuspis volsellaris not densely setose; cuspis volsellaris very slender and curved; lamina volsellaris on ventral margin with three long, stout setae; paramere with a small blunt tubercle on inner ventral surface halfway to apex.

SPECIMENS EXAMINED.—1 ♀, Ind, 63/81 (BMNH, the holotype). 1 ♀, Borneo (BMNH, determined as *Myzine tricolor* and thought erroneously to be the holotype of *tricolor* Smith. 1 ♀, Borneo, 1909, C. J. Brooks (BMNH). 1 ♀, Midden, O-Borneo, 28 August 1925, H. C. Siebers (RNH). 1 ♂, Bandjermas, Borneo (MCSN, Gribodo Collection). 1 ♀, Marang, Burma (MCSN, Gribodo Collection). 1 ♀, Sumbawa Island (MCSN, Gribodo Collection).

***Hylomesa longiceps* (Turner), new combination**

FIGURE 1; PLATE 1 (FIG. 1)

Plesia tricolor (Smith).—Magretti, 1892, in part, pp. 258–259.—Turner 1909, in part, p. 480 [the specimen from Assam].

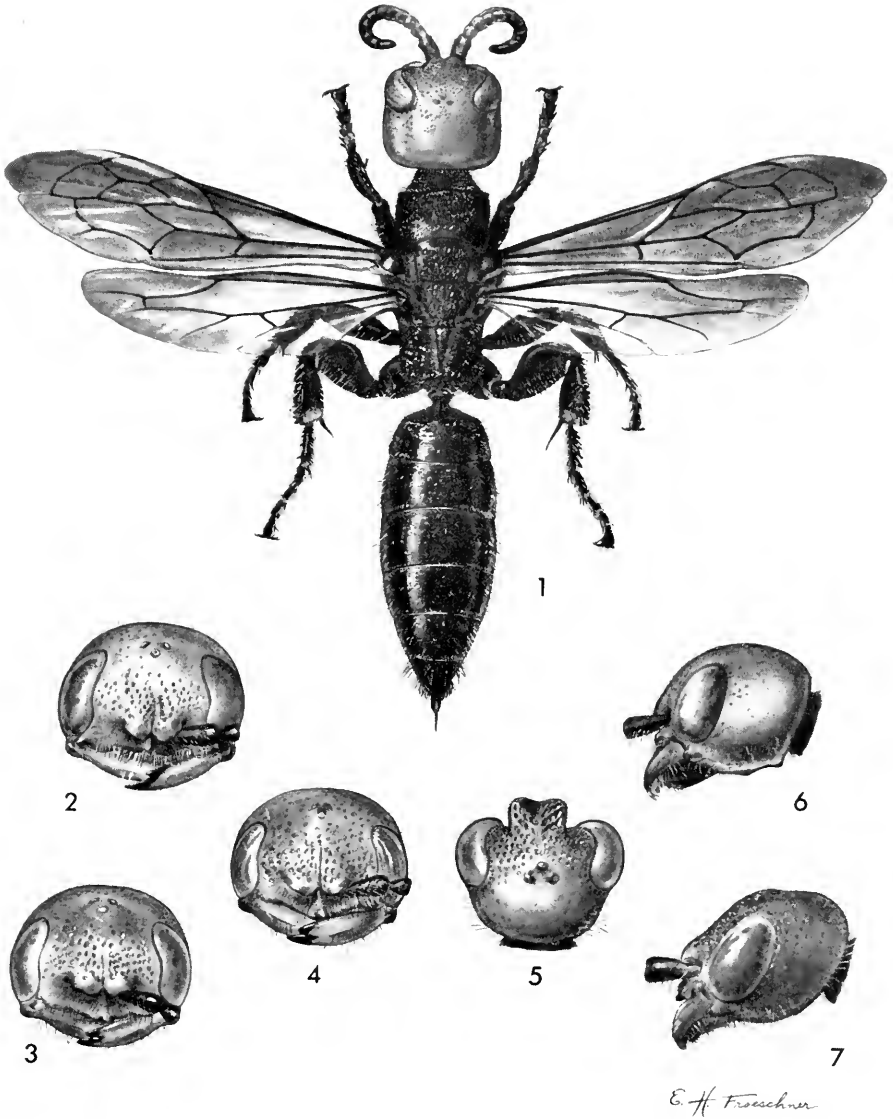

FIGURES 1-7.—1, *Hylomesa longiceps* (Turner), dorsal view, female, Anshi, India, $\times 3.6$. 2, *H. shuckardi* (Turner), frontal view, female head, Marang, Burma, $\times 6.9$. 3, *H. tricolor tricolor* (Smith), frontal view, female head, Sandakan, Borneo, $\times 6.2$. 4, *H. tricolor lieftincki* Krombein, holotype, frontal view, female head, Mt. Semeroe, Java, $\times 5.3$. 5, *H. dimidiaticornis* (Bingham), dorsal view, male head, Yakorubi, India, $\times 9.7$. 6, *H. shuckardi*, lateral view, female head, Marang, $\times 6.9$. 7, *H. tricolor tricolor*, lateral view, female head, Sandakan, $\times 6.2$.

Myzine tricolor Smith.—Bingham, 1897, in part, p. 66 [the specimen from Assam].

Elis (Mesa) tricolor (Smith).—Turner, 1912, in part, p. 720 [the specimens from Assam and W. India].

Elis (Mesa) tricolor longiceps Turner, 1918, p. 87.—Rohwer, 1921, p. 90.

Mesa tricolor longiceps (Turner).—Guiglia, 1965, p. 315.—Baltazar, 1966, p. 207.

For many years specimens of *longiceps* were confused with *tricolor* even by Turner. The latter author eventually recognized *longiceps* as a discrete taxon at the subspecific level; however, it must certainly rank as a good species, and it is, in fact, one of the most easily recognized species of *Hylomesa*. The more elongate head of the female separates that sex immediately from females of other species except *bakeri*. The shagreened pygidium, the obtusely angulate posterior margin of the hind femur, and the much greater ocelloccipital:ocellular ratio separate *longiceps* from *bakeri* females. The male genitalia are also quite distinctive; this sex also may be identified readily by having somewhat more elongate intermediate flagellar segments and in having the hypostomal length subequal to the distance between the hypostomal and occipital carinae.

Hylomesa longiceps is also noteworthy in that it is the most widely distributed species of the genus with definite records of capture in Ceylon, India, Assam, Burma, Malaysia, and the Philippines.

It is also the only *Hylomesa* for which we have any information on host preferences. Turner (1912) stated that T. R. Bell "informed me that he bred this species from the larva of a longicorn beetle." This statement is at variance with the label data on the only female *longiceps* bearing a Bell label: "in dead wood with longicorn larvae 14-1-07."

FEMALE.—Length 15-23, forewing 10-16 mm. Black, the head except apex of mandible and hypostomal area and occasionally the ocellar triangle, varying from light to dark red; scape, pedicel, and from one to four of basal flagellar segments also red; abdomen occasionally with metallic blue reflections; forewing entirely infumated or with basal area lighter in some specimens, the darkened area with violaceous reflections.

Head more elongate than in other species, from above with length (apex of antennal insertions to occiput) subequal (0.94-1.0) to width across eyes; in larger specimens the sides of head are somewhat rounded out behind eyes so that eyes are not so protuberant as in smaller specimens; clypeal keel weak, present only on basal half or two-thirds; clypeal margin with the median teeth weak, slightly more separated than in *shuckardi*; median frontal sulcus extending halfway to anterior ocellus; front with punctures moderate in size and contiguous or almost so; vertex with more scattered punctures on anterior third and almost impunctate on posterior two-thirds; ocellular distance 2.17-2.43 times the postocellar distance, and 0.42-0.44 times

the ocelloccipital distance; anterior ocellus closer to apices of antennal tubercles than to occiput; head beneath with rounded posterolateral angles; distance between occipital and hypostomal carinae subequal to length of hypostomal area.

Anterior margin of pronotal disk strongly ridged, the anterior half with coarse, confluent to subconfluent punctures, arranged in longitudinal rows; scutum with subconfluent, coarse punctures except posteriorly somewhat more crowded; scutellum with punctures slightly more separated; mesopleural disk produced anteriorly in middle beyond concave anterior face of sclerite, the punctures about as in *shuckardi*; punctures small on areas adjacent to cuneate space on propodeum, the disk posteriorly and laterally with larger, subconfluent pits; posterior surface of propodeum with mostly confluent or subconfluent pits.

Disk of first tergum strongly ridged anteriorly; last tergum shagreened at apex.

Inferior margin of hind femur obtusely angulate at middle; apex of hind tibia on inner surface without heavy, flattened, short setae.

MALE.—Length 12–17, forewing 7–12 mm. Color as in female except that venter of head occasionally is all black and as many as six flagellar segments may be red.

Clypeal keel strong, present on basal two-thirds or three-fourths; median lobe of clypeus with a shallow emargination separating the two well-developed teeth; distance from apex of frontal platform to occiput 0.85–0.87 times the width across eyes; front with mostly contiguous to subcontiguous pits; vertex with smaller, more scattered punctures; ocellocular distance 1.9–2.8 times the postocellar distance, and 0.59–0.71 times the ocelloccipital distance; occipital carina weak or evanescent dorsally; median flagellar segments 1.4–1.5 times as long as wide.

Pronotal disk anteriorly with a strong ridge, behind that with weak to strong punctures, sometimes rather scattered, sometimes arranged almost contiguously in a few transverse rows; scutum and scutellum with coarse, shallow, contiguous to subcontiguous pits; mesopleural disk with very coarse, contiguous to scattered pits; metapleuron usually without ridges above, but occasionally with a few weak ridges; propodeal dorsum irregularly rugulose, the narrow median channel with a few transverse rugae, the posterior margin strongly ridged; lateral surface with a few strong rugae anteriorly, the rest of surface with coarse contiguous pits or irregularly rugulose; posterior surface varying from contiguously pitted to irregularly rugulose.

First tergum with strong transverse ridge anteriorly, the disk with scattered large punctures; sterna 3–5 with short, erect vestiture, a

bit denser than in *tricolor* but not velvety as in *dimidiaticornis* on sterna 5 and 6.

Genitalia with inner surface of squama and cuspis volsellaris densely setose; cuspis volsellaris broad and truncate at apex; lamina volsellaris with fine setae only; paramere without tubercle on inner ventral surface halfway to apex.

SPECIMENS EXAMINED.—1 ♀, Kandy, Central Prov., Ceylon, 20 November 1953, F. Keiser (NMB). 1 ♂, Inginiyagata, Uva Prov., Ceylon, 31 August 1953, F. Keiser (NMB). 1 ♀, Ceylon (TMA). 1 ♀, Anshi near Karwar, Mysore Prov., India, 14 January 1907, T. R. Bell, in dead wood with longicorn larvae (BMNH). 1 ♀, Dibrughur, Assam, August 1891, Bingham (BMNH, type of *longiceps*). 7 ♂, Schwego Myo, Burma, October 1885, L. Fea (MCSN). 8 ♀, 5 ♂, Penang, Baker (USNM). 1 ♀, Zamboanga, Mindanao, Baker (USNM). 1 ♀, Butuan, Mindanao, Baker (USNM). 2 ♀, Mt. Canalaon, 3600 ft. alt., Negros Or., 29 April and 8 May 1953, H., M., and D. Townes (HKT). 2 ♂, Cuernos Mts., Negros, Baker (USNM). 2 ♀, 1 ♂, Sibuyan, Baker (USNM). 1 ♀, 2 ♂, Samar, Baker (USNM). 3 ♀, Mt. Makiling, Luzon, Baker (USNM). 1 ♂, Baguio, Benguet, Luzon, Baker (USNM). 1 ♂, Baguio, June 1917, F. X. Williams (BPBM). 1 ♂, Baguio (USNM).

***Hylomesa ugandensis* (Turner), new combination**

Elis (*Mesa*) *ugandensis* Turner, 1918, pp. 86-87.

This species, known at present only from the female, is distinguished from all *Hylomesa* except *bakeri* by the much sparser punctation and by the more sharply (right-angled) inferior margin of the hind femur. The lack of anterior transverse ridges on the pronotum and first tergum immediately separate *ugandensis* from *bakeri*. This species is the only known *Hylomesa* from Africa.

FEMALE.—Length 17, forewing 11 mm. Head and appendages red except tip of mandible, ventral surface of head in type (hypostoma only in Gabun specimen), ocellar triangle, and last three flagellar segments dark brown to black (type only); thorax black, tegula and legs dark castaneous except foreleg with apex of femur, all of tibia and tarsus light red in type; in Gabun specimen antenna and legs are entirely red as well as pronotum, scutum, scutellum, most of mesopleural disk, and part of lateral propodeal surface; wings entirely and strongly infumated, with bronzy reflections; abdomen black, the first two terga with bluish reflections.

Head from above with length (apex of antennal insertions to occiput) five-sixths (0.83) the greatest width (across eyes); clypeus with a moderately strong median keel, gently rounded as seen in profile, terminating just before anterior margin, the latter with a shallow

median emargination on either side of which the margin goes laterad at a right angle to a sinus just before the rounded anterolateral termination; front with a median sulcus extending half the distance to anterior ocellus and with moderately large punctures confluent to subconfluent in vertical rows from antennal insertions two-thirds of distance to anterior ocellus; remainder of front with smaller, scattered, shallow punctures; vertex more sparsely punctate than upper front; ocellocular distance 2.5–3.0 times the postocellar distance and 0.53 times the ocelloccipital distance; anterior ocellus slightly closer to occiput than to apices of antennal tubercles; head beneath rounded posterolaterally.

Pronotum with anterior margin not ridged, the disk with shallow, scattered punctures, separated by two or more times the diameter of a puncture; laterally the punctures somewhat closer except in lower posterior area, where they are confluent; scutum with somewhat larger and closer punctures, some of which are confluent in rows posteriorly in the middle; scutellum slightly longer than scutum, the punctures slightly larger and more scattered, and with a shallow, narrow median sulcus on anterior third; postscutellum with smaller contiguous punctures in middle; mesopleural disk slightly produced anteriorly beyond the concave anterior part of the sclerite, the discal punctures quite scattered except posteriorly along upper margin; metapleuron with minute, close punctures; propodeum dorsally with a shallow, median depressed area tapering gradually toward the posterior margin, laterad of this with scattered shallow punctures; posterior surface of propodeum rather densely punctate; lateral surface of propodeum with oblique rugae; hind tibia at apex on internal surface without flattened setae; inferior margin of hind femur right angled at middle.

Disk of first tergum not ridged anteriorly, with scattered small punctures as on succeeding terga; last tergum polished and with somewhat closer punctures except apical fourth impunctate.

MALE.—Unknown.

SPECIMENS EXAMINED.—1 ♀, Tero Forest, Uganda, July 1912, C. G. Gowdey (BMNH, the type). 1 ♀, Gabun, 1892 (TMA).

Hylomesa bakeri, new species

FIGURE 3

The small size and sparser punctation of both sexes readily distinguish *bakeri* from other species in the genus. In addition, the female differs from most other *Hylomesa* in the entirely polished pygidium, more sharply angled inferior margin of hind femur, and the simpler mesopleural disk, which is not extended anteriorly beyond the anterior surface of the mesopleuron. The male has the sterna with very

sparse vestiture, and the clypeal margin is rounded out in the middle, not dentate.

FEMALE.—Length 13.5, forewing 8 mm. Black, the head red except apex of mandible, hypostomal area, and flagellum, the abdomen with weak blue reflections; wings moderately infumated on outer two-thirds, the darker part with bronzy and violaceous reflections.

Head from above with length (apex of antennal insertions to occiput) subequal (0.93) to the width across eyes; clypeal keel relatively weak, present on basal half only; median lobe of anterior clypeal margin narrowly rounded, the paired teeth obsolescent; lower half of front with a weak median groove, and scattered, contiguous to subcontiguous, moderate-sized punctures; remainder of front and vertex with a few scattered, minute punctures; ocellocular distance only 1.33 times the postocellar distance, and 0.50 times the ocelloccipital distance; anterior ocellus slightly closer to occiput than to apices of antennal tubercles; head beneath with posterolateral angles rounded; distance between occiput and hypostomal carinae subequal to length of hypostomal area.

Pronotal disk strongly ridged anteriorly, immediately behind the ridge with a row of subcontiguous, moderately large punctures, elsewhere with very scattered, small punctures; scutum with 18–20 shallow pits of varying size on posterior two-thirds; scutellum similarly sculptured with about a dozen pits; mesopleural disk not produced anteriorly, its surface with the pits more scattered than in other species; dorsal propodeal surface rather densely punctate laterad of narrow cuneate space, the punctures small except posteriorly; posterior surface weakly ridged above, with moderate, subcontiguous pits.

Disk of first tergum strongly ridged anteriorly, behind the ridge a row of subcontiguous pits; last tergum polished, the apical fourth impunctate.

Inferior margin of hind femur right-angled at middle; hind tibia at apex without short, flattened setae.

MALE.—Length 11, forewing 7.5 mm. Color as in female except antenna entirely black, and wings more strongly infumated and with violaceous reflections.

Clypeal keel strong, present on basal three-fourths; clypeus with median lobe of apical margin narrowly rounded, teeth indistinct; distance from apex of frontal platform to occiput 0.92 times the width across eyes; front with contiguous and subcontiguous punctures on lower two-thirds and scattered punctures above; vertex with a few small punctures; ocellocular distance 1.57 times the postocellar distance, and 0.61 times the ocelloccipital distance; occipital

carina indistinct dorsally; median flagellar segments 1.25 times as long as wide.

Pronotal disk moderately ridged anteriorly, with scattered, medium-sized punctures; scutum and scutellum with large pits arranged as in female; mesopleural disk with pits of variable size except in center; metapleuron smooth above; median channel on dorsal propodeal surface with transverse ridges, laterad of this with pits of variable size; posterior surface ridged above, and with shallow contiguous pits.

First tergum moderately ridged anteriorly, behind the ridge with a row of confluent punctures; vestiture of sterna very sparse.

Genitalia with inner surface of squama and cuspis volsellaris not densely setose; apex of cuspis volsellaris digitate; lamina volsellaris with fine setae on ventral margin; paramere without tubercle on inner ventral surface halfway to apex.

HOLOTYPE.—♀, Mt. Maquiling, Luzon, Philippines, 50 meters elev., 7 October 1950, L. B. Uichanco (USNM Type No. 69649).

ALLOTYPE.—♂, Los Baños, Luzon, Philippines, 1917, F. X. Williams (BPBM).

PARATYPE.—♀, Mt. Maquiling, 19 January 1954, F. R. Candelaria (PBPI).

The female paratype is 11.5 mm long, its forewing 7.5 mm; the ocellocular distance is 1.83 times the postocellar distance and 0.58 times the ocelloccipital distance.

Hylomesa crassepunctata (Turner), new combination

Elis (*Mesa*) *crassepunctata* Turner, 1914, pp. 246–247.

The only specimen available for my study was the unique type in the British Museum. It was collected 8 July 1912 in Coimbatore, South India.

MALE.—Length 11, forewing 7 mm. Black, head red except ocellar triangle and nine apical flagellar segments; pronotum, tegula, and foreleg except coxa and trochanter also red; abdomen with weak blue reflections; apical half of forewing and apical third of hind wing strongly infumated and with bronze to blue reflections.

Clypeus with apical margin slightly thickened, the median teeth weaker than in *dimidiaticornis*, the frontal keel weak and present on basal two-thirds; distance from apex of frontal platform to occiput 0.89 times the head width including eyes; front with coarse, contiguous punctures and a weak median furrow extending half the distance from median ocellus to frontal platform; ocellocular distance 1.75 times the postocellar distance and subequal to ocelloccipital distance; occipital carina lacking dorsally; median flagellar segments about as broad as long; head shorter behind eyes than in *dimidiaticornis*.

Pronotal disk margined anteriorly by a weak ridge, the anterior half with punctures arranged contiguously in irregular transverse rows; scutum and scutellum with coarse, shallow, contiguous pits; mesopleural disk with very large, shallow, contiguous pits; metapleuron with only faint traces of ridges above; dorsal surface of propodeum with a narrow median channel crossed by a few, very weak rugae, laterad of this with coarse pits, the posterior margin with a strong transverse ridge anterior to which are some elongate pits; lateral surface with a few strong rugae, posteriorly with close, contiguous pits; posterior surface with smaller, shallow, contiguous pits.

First tergum with a strong transverse ridge anteriorly, behind which is a series of large, confluent punctures; none of sterna with patches of fine dense hair.

Genitalia not examined.

FEMALE.—Unknown.

***Hylomesa dimidiaticornis* (Bingham), new combination**

FIGURE 2; PLATE 1 (FIG. 5)

Myzine dimidiaticornis Bingham, 1896, p. 423; 1897, p. 68, fig. 11.—Turner, 1908a, p. 501; 1908b, p. 131; 1909, p. 480.

Plesia tricolor (Smith).—Margretti, 1892, in part, pp. 258-259.

Elis (Mesa) dimidiaticornis (Bingham).—Turner, 1912, pp. 720-721, pl. 81 (fig. 15); 1914, p. 247.

This species, known only from the male, is recognized easily because of the patches of velvety vestiture at the apices of the fifth and sixth sterna and because of the three transverse ridges on the pronotal disk anteriorly. There is some variation in color, the type from Kumaon, North India, having the head black except for ferruginous on the clypeus and parts of the front and antenna, whereas males from Mysore and Burma have the head almost entirely red.

MALE (redescription of type).—Length 13, forewing 10 mm. Head, thorax, and abdomen black, the latter with faint bluish reflections on terga; the following dull red: palpi, mandible, clypeus, small area laterad of antennal insertions, the frontal platform immediately above antennae, scape, pedicel, first four flagellar segments, and fifth segment beneath; wings clear on basal half to cross veins, forewing infumated on apical half with weak violaceous reflections, hind wing infumated on apical third.

Clypeus with apical margin slightly thickened and with two small, close teeth in middle, the median keel weak, present on basal two-thirds; distance from apex of frontal platform to occiput 0.91 times the head width across eyes; front with coarse contiguous punctures, confluent in irregular vertical rows, median furrow lacking; ocelloc-

ular distance 1.5 times the postocellar distance and about 0.6 times the ocellocipital distance; occipital carina lacking on dorsum; median flagellar segments with length about 1.4 times the width.

Pronotum with sparse, rather small punctures, disk anteriorly with three weak, transverse rugae, the interspaces with coarser, subcontiguous punctures; scutum and scutellum with very coarse, shallow, contiguous pits; mesopleural disk with very large, shallow, contiguous to subcontiguous pits; metapleuron above with close, fine ridges that become coarser on anterior part of lateral propodeal surface; dorsal propodeal surface with a narrow, elongate cuneate depression along midline somewhat irregularly wrinkled, laterad of this with some scattered to contiguous large pits, posteriorly with a strong transverse ridge; posterior part of lateral surface with large, subcontiguous pits, posterior surface similarly sculptured.

First tergum with strong transverse ridge anteriorly, behind which is a series of large confluent pits; fifth sternum with a narrow transverse patch of fine, short velvety hair at apex; sixth sternum with a denser and larger patch of similar hair across posterior half of sclerite.

Genitalia with inner surface of squama and cuspis volsellaris densely setose; cuspis volsellaris digitate at apex; lamina volsellaris with fine setae only on ventral margin; paramere without tubercle on inner ventral surface halfway to apex.

SPECIMENS EXAMINED.—1 ♂; Kumaon, northern India, April 1891, Bingham (BMNH, the type). 3 ♂, Yakorubi near Karwar, Mysore Province, India, 28 April 1910, T. R. Bell, variously labeled "at dead tree" and "flying over dead tree" (BMNH, USNM). 2 ♂; Schwego Myo, Birmania, October 1885, Fea (MCSN, USNM; misdetermined as *tricolor* by Magretti).

The Yakorubi specimens are 13–14 mm long and agree with the type in all essential details except that all of the head is red except tip of mandible, hypostomal area, ocellar triangle, and last six flagellar segments. The Burma specimens are 10 mm long and have the head colored as in the series from Yakorubi except that the last eight flagellar segments are black; also, the pronotal ridges are weaker. All five specimens have stronger blue reflections on the abdomen than does the type; the head length is 0.85–0.88 times the width and the ocellocular distance is 1.5–1.7 times the postocellar and 0.6–0.7 times the ocellocipital distance.

Literature Cited

- BALTAZAR, C. R.
1966. A catalogue of Philippine Hymenoptera (with a bibliography, 1758-1963). Pacific Ins., Monogr. 8, 488 pp.
- BINGHAM, C. T.
1896. On some exotic fossorial Hymenoptera in the collection of the British Museum, with descriptions of new species and of a new genus of the Pompilidae. Journ. Linn. Soc. Zool., vol. 25, pp. 422-445, 1 pl.
1897. The fauna of British India, including Ceylon and Burma: Hymenoptera, vol. 1, 579 pp., 4 pls.
- DALLA TORRE, K. W. VON
1897. Catalogus Hymenopterorum, 749 pp.
- GUIGLIA, D.
1965. Hymenoptera Scoliidea. In Risultati scientifici della spedizione del Dr. Fred Keiser all'Isola di Ceylon. Verhandl. Naturf. Ges. Basel, vol. 76, pp. 315-324.
- KROMBEIN, K. V.
1937. Studies in the Tiphidae (Hymenoptera Aculeata), I: A review of the genera of Myzininae. Ann. Ent. Soc. America, vol. 30, pp. 26-30.
- MAGRETTI, P.
1892. Viaggio di Leonardo Fea in Birmania e regioni vicine, XLIII: Imenotteri, Parte prima, Mutillidei, Scoliidei, Tifidei, Tinnidei colla descrizione di parecchie nuove specie. Ann. Mus. Civ. Stor. Nat. Genova, ser. 2, vol. 12, pp. 197-266, 1 pl.
- ROHWER, S. A.
1921. The Philippine wasps of the subfamilies Scoliinae and Elidinae. Philippine Journ. Sci., vol. 19, pp. 75-90.
- SMITH, F.
1858. Catalogue of the hymenopterous insects collected at Sarawak, Borneo; Mount Ophir, Malacca; and at Singapore. Journ. Proc. Linn. Soc. Zool., vol. 2, pp. 42-130, 2 pls.
- TURNER, R. E.
1908a. Additions to the hymenopterous genera *Myzine* and *Plesia*. Ann. Mag. Nat. Hist., ser. 8, vol. 1, pp. 497-514.
1908b. Remarks on the hymenopterous genus *Tiphia*. Ann. Mag. Nat. Hist., ser. 8, vol. 2, pp. 116-131.
1909. Remarks on some genera of the Scoliidae, with descriptions of new species. Ann. Mag. Nat. Hist., ser. 8, vol. 3, pp. 476-486.
1912. Studies in the fossorial wasps of the family Scoliidae, subfamilies Elidinae and Anthoboscinae. Proc. Zool. Soc. 1912, pp. 696-754, 3 pls.
1914. Notes on fossorial Hymenoptera, XII. Ann. Mag. Nat. Hist., ser. 8, vol. 14, pp. 245-257.
1918. Notes on fossorial Hymenoptera, XXXII: On new species in the British Museum. Ann. Mag. Nat. Hist., ser. 9, vol. 1, pp. 86-96.

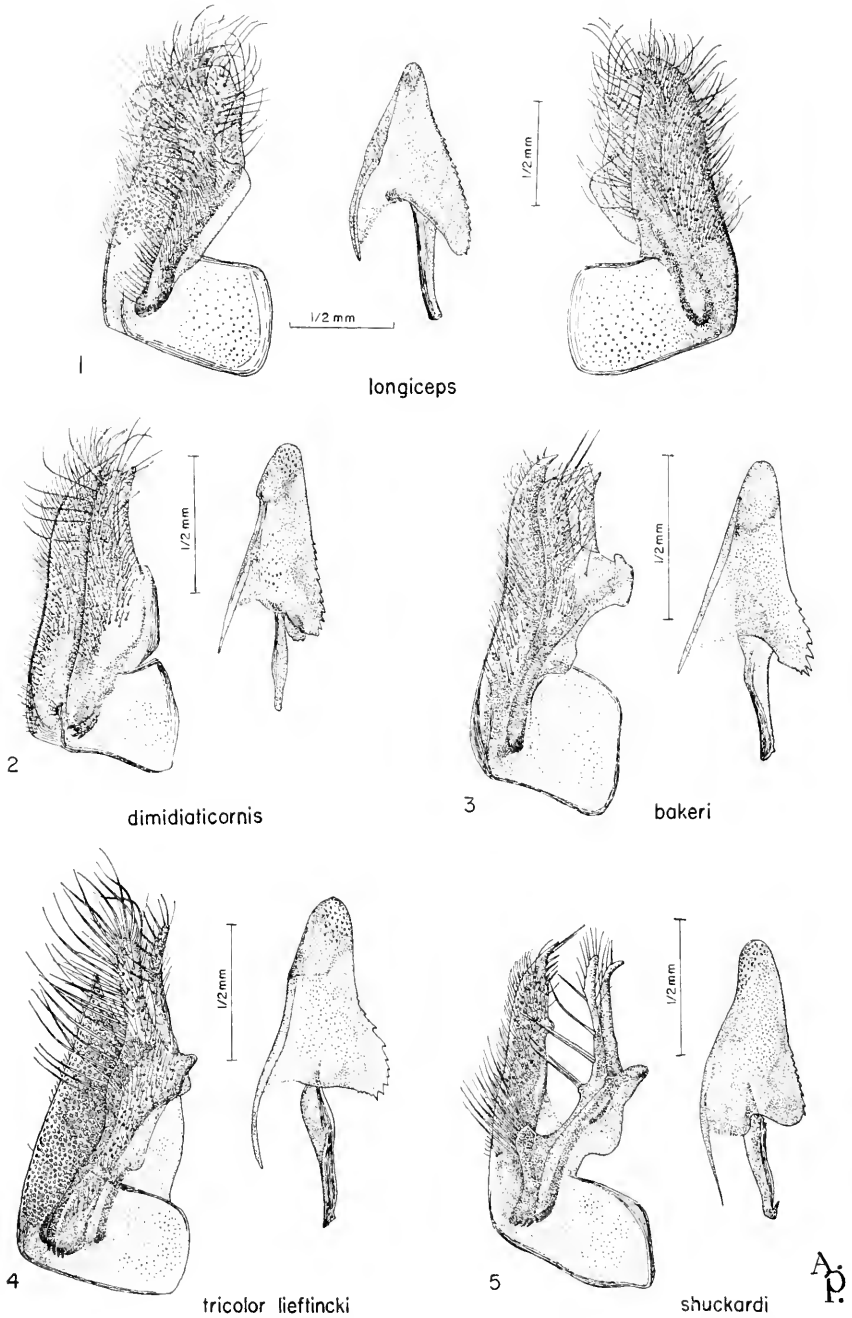

FIGURES 1-5.—Male genitalia, cardo omitted, *Hylomesa*: 1, internal aspect at left, exterior aspect at right, lateral aspect of aedeagus in center; 2-5, internal aspect at left, lateral aspect of aedeagus at right.

Proceedings of
the United States
National Museum



SMITHSONIAN INSTITUTION • WASHINGTON, D.C.

Volume 124

1968

Number 3645

Numerical Approaches to the Relationships
of Certain American Swimming Crabs
(Crustacea: Portunidae)

By W. Stephenson, W. T. Williams,
and G. N. Lance¹

Research for this paper was financed partially by the National Science Foundation, which enabled one of us (W. S.) to examine material in the United States National Museum, Smithsonian Institution, and partly by the University of Queensland Research Grants Committee for completion of the analysis. We wish to thank the directors and curators of Crustacea of the following museums for allowing access to their material: Allan Hancock Foundation, University of Southern California, Los Angeles, Calif.; U.S. National Museum, Smithsonian Institution, Washington, D.C.; and Scripps Institute of Oceanography, La Jolla, Calif. We also wish to thank Miss May Rees, Department of Zoology, University of Queensland, Brisbane, for valuable assistance in certain computations, in compilation of references, and in model construction.

This paper attempts an assessment of the status and interrelationships of various taxa of American portunids within the genera *Portunus*

¹Stephenson: Department of Zoology, University of Queensland, Brisbane; Williams and Lance: Computing Research Section, Commonwealth Scientific and Industrial Research Organization, Canberra, Australia.

Weber 1795, *Callinectes* Stimpson 1860, and *Arenaeus* Dana 1851 by other than the classical techniques of descriptive systematics.

The work began by detailed comparisons between pairs of species in each of the genera. Rathbun (1930) has listed eight pairs of analogous species (or twin species, or geminate species) in which one of each pair is a western American species and one an eastern. Most of these are not clearly detectable by a classical approach (Garth and Stephenson, 1966), which instead has suggested "confused" relationships between groups of western and groups of eastern species. Nine of the ten western "species" (including one subspecies; authors and dates of species are given in table 1) of *Portunus* appear closely related. Several different dichotomous keys can be devised for their separation, but none has obvious precedence for convenience or indications of relationships. (The key to the western species that eventually was adopted employed an initial pentachotomy.) It seemed that all characters had equivalent hierarchial significance. The problems of establishing a hierarchy are emphasised by the fact that Rathbun (1930) had used two subgenera, *Portunus* and *Achelous* de Haan 1833, that are linked by continuous variation within one species, *P. xantusii*.

To some extent the present work was a trial of numerical techniques and initially involved a small number of species, the nine western species of *Portunus*. When the eastern species of the genus were added, the increased complexity of information gave added convenience to the numerical methods.

As the work progressed, it was widened to include the relationships among *Callinectes*, *Arenaeus* (which is very close to it; see Garth and Stephenson, 1966, p. 52), and *Portunus*. *Callinectes* is a particularly interesting case. Stephenson and Campbell (1959, p. 88) questioned whether *Callinectes* differs sufficiently from the general span of the genus *Portunus* for it "to have more than the status of a subgenus if such are to be recognised."

When *Callinectes* species are compared with western American *Portunus* species, there are numerous differences. Garth and Stephenson (1966), partly influenced by preliminary results of the present work, retained *Callinectes* as a genus. It is diagnosed by three features only (Garth and Stephenson, 1966, p. 42): (1) male abdomen \perp -shaped, which is shared with certain Indo-West Pacific species of *Portunus* and with *Arenaeus*; (2) anteroexternal angle of merus of third maxilliped strongly produced outward, which is shared with many species of *Portunus*; (3) wrist of cheliped without an inner spine, which is the only unique feature.

When eastern American *Portunus* species are considered, the morphological gap to *Callinectes* becomes partly bridged. If the

type-species of the genus *Portunus*, *P. pelagicus*, is considered, a general classical impression is gained that *Callinectes* species are closer to *P. pelagicus* than are the bulk of the American species of *Portunus*. Inclusion of *P. pelagicus* suggested to us that additional Indo-West Pacific species should be considered, involving several species close to *P. pelagicus*, *P. macrophthalmus* for comparison with *P. tuberculatus*, and *Scylla serrata* exemplifying another related genus.

The number of species eventually compared (44) is sufficiently large to give convenience to numerical techniques but not too large for the conclusions from each technique to be checked against the "common sense" of the classical background. With such comparison possible, we found it not surprising that the overall outlook on the group has not been changed materially. The important conclusions, therefore, are in the field of methodology. It was hoped that a method would be developed that could be applied to the very numerous Indo-West Pacific species of *Portunus*, whose complex interrelationships are difficult to determine by the traditional approach.

Numerical Methods

FORM OF DATA.—Basic taxonomic data normally are mixed: they may, for example, comprise attributes that are qualitative ("yes" or "no", "present" or "absent"), multistate (A, B, or C), ordered multistate or ranked ("absent", "rare", "common"), and numerical (measured). Few numerical models capable of accommodating all these approaches are known; and, although computer programs using such models exist, they are relatively inflexible and allow little or no choice of alternative approaches in an exploratory situation. There are, therefore, advantages in using simpler types of data if this is practicable within the problem under study. When very closely-related organisms are concerned—for example, in intra-specific comparisons—the investigation normally involves measured characters, and these alone may suffice. Interspecific comparisons usually involve qualitative differences, and it may be advantageous to reduce all the data to the qualitative form. The advantages are: first, data can be tabulated in an extremely economical form, which permits rapid intuitive assessment of taxonomic similarities; and second, numerical systems for processing qualitative data are powerful, fast, and flexible, and their properties are well understood.

Certain problems, nevertheless, remain to be resolved: (1) decision must be taken as to whether double-negative matches are to count as evidence of similarity (past experience of numerical classifications suggests that they should do so, and the programs at our disposal all make this assumption). (2) Provision must be

made for missing or inapplicable attributes (the latter arise if, as is commonly the case, the applicability of later questions depends on the answer to earlier ones). (3) The dichotomizing of a single multi-state attribute always generates a set (at least two) of qualitative attributes, and these are linked logically in the sense that certain combinations of states will be redundant (experience suggests that this will not disturb the analysis, provided the number of originally multistate attributes is small; Watson, Williams, and Lance, 1966). (4) In a completely qualitative system no provision can be made for "doubtful" entries (in the present case these comprised less than 2 percent of the total). (5) A character may be capable of subdivision; for example, carapace ornamentation can be reduced to the single character "mostly ridges present rather than raised granular areas," or (as in the present case) the ridges can be listed separately; this decision necessarily involves the concept of "weighting" and must be resolved on taxonomic grounds, not numerical grounds.

As the investigation proceeded, 44 species eventually were compared by reference to 57 features (selected features are listed in table 1, species in table 2, and data in table 3).² Selected features were those believed likely to give good overall discrimination. Had particular comparison been an issue, other characters might well have been more appropriate. The wording of the features was designed to give positive answers to our specific questions for most of the western American *Portunus* species.

During tabulation of data, the inadequacy of many past descriptions of the species became apparent. Such descriptions have concentrated upon specific recognition and distinctions from nearly related species but have omitted similarities to more distant species.

NUMERICAL MODEL.—Any study of inter-relationships requires the definition of a measure of likeness to serve as the basic numerical model of the system. Such measures—the so-called "similarity coefficients"—have been proposed in great variety; the best known are summarized and defined in Goodman and Kruskal (1954, 1959), Dagnelie (1960), and Sokal and Sneath (1963). The simplest measure of difference between two qualitatively specified individuals is the "number of features of difference" (the NFD value) wherein one individual scores + and the other -. In the conventional "*a, b, c, d*" symbolism of a 2×2 contingency table, this is the quantity "*b+c*." Moreover, if we regard the attributes as defining a set of orthogonal axes in Euclidean space and regard the coordinate along a given axis as "1" (if the feature is possessed) and "0" (if it is lacking), "*b+c*" then represents the square of the Euclidean distance between the two

²Tables at end of paper.

individuals concerned. Alternatively, the square root of this quantity (i.e., the Euclidean distance itself) may be used as a measure of "taxonomic distance" (TD). Preliminary investigations using other measures—the correlation coefficient, the nonmetric coefficient, and Euclidean distance standardized to zero mean and unit variance—suggested that these offered no advantages over the NFD and TD values. The latter, therefore, have been used throughout this study.

STRATEGY.—In the present problem we were concerned not only with the overall configuration of inter-relationships but also with the possible light that this might throw on certain specified problems. We used three approaches:

(1) Direct comparison of intergroup NFD and TD values: Since the original values relate only to distances between individuals, a further definition of individual/group or group/group distance is required. The distance between group centroids commonly is used for this purpose, but this is troublesome to calculate from the inter-individual NFD or TD values and requires manipulation of the original data. We, therefore, have preferred to use the "group-average" measure of Sokal and Michener (1958), whereby the distance between two groups is defined as the average of all interindividual between-group NFD or TD values.

(2) Classification: General accounts of classificatory methods are given in Sokal and Sneath (1963), MacNaughton-Smith (1965), and Williams and Dale (1965). Four methods were used: (a) nearest and farthest neighbor sorting of the NFD values; (b) centroid sorting using the original data; (c) the nonmetric coefficient; and (d) information analysis (Williams, Lambert, and Lance, 1966). The results were disappointing: groups were not clear-cut, and the configurations obtained by various methods differed considerably. Although it would now be possible to increase the clarity of the picture by the greater power of "flexible" sorting (Lance and Williams, 1967), the process is not to be recommended in the current situation. The variability of the results suggests that at least part of the system is more or less continuous, with the result that ordination, rather than classification, is likely to represent the most fruitful approach. The classificatory approach, therefore, was abandoned, and the results are not presented in this paper.

(3) The efficient representation of a multidimensional system in fewer dimensions normally would be undertaken by principal component analysis. In our case, however, several attributes are missing from one of the individuals, a fact that would complicate the calculation. It is desirable, therefore, to ordinate the interindividual matrix of mean NFD values. This problem is discussed in Sokal and Sneath (1963), but the methods given therein are empirical, since at that

time no general solution to the problem was known. The transformation established by Gower (1966) now provides a simple and elegant solution. We write d_{ij} for the average NFD value between individuals i and j ; we form a matrix (a_{ij}) such that $a_{ii}=a_{jj}=0$ and $a_{ij}=-\frac{1}{2}(d_{ij})^2$. Let the row-means of this matrix be the vector $(a_{i.})$, the column means $(a_{.j})$, and the grand mean $a_{..}$; we then form the matrix (b_{ij}) , where $b_{ij}=a_{ij}-a_{i.}-a_{.j}+a_{..}$. The eigenvalues and eigenvectors of this matrix are extracted and standardized so that the length of each vector is equal to the value of its corresponding root. Gower demonstrates that these vectors define a Euclidean space in such a way that the distance between two individuals is equal to its original d_{ij} value, and in such a way that the space has been reduced as efficiently as is possible with a linear transformation. (The space is not everywhere real, but this is of no importance in practice.) In our case, three axes were found to suffice for the general configuration, but any substantial deviations in the next three axes were noted.

It is possible to simplify the configuration further by moving overtly into the techniques of factor analysis. Given that three axes are all that is required, the requirement is to reduce the values of the principal diagonal of the "b_{ij}" matrix so that the least possible information remains in the matrix after the extraction of three positive roots. The method is explained in standard books on factor analysis (e.g., Cattell, 1952; Thomson, 1951); it is iterative and somewhat time-consuming in computation. Automatic programs exist on the Control Data Corporation 3600 computer at Canberra for the basic ordination (program GOWER) and the factor-analysis version (NEWGOWER). These two programs accept the upper triangle of the original (d_{ij}) matrix as a string of coefficients and carry out all subsequent adjustments and calculations automatically.

Material Examined

All known American species of *Portunus*, *Callinectes*,³ and *Arenaeus* were examined. Also examined were: (1) certain Indo-West Pacific species of *Portunus*, comprising *P. pelagicus*, *P. sanguinolentus*, *P. pubescens*, *P. convexus*, and *P. cf. trituberculatus*; (2) the known non-American species of *Callinectes*; and (3) *Scylla serrata* for comparison with the distinctness of other genera.

The species examined are listed in table 2. Extensive series of western American forms were examined, as recorded in Garth and Stephenson (1966), but fewer specimens of Atlantic species were seen, and there were no critical examinations of difficult groups. Atlantic species were

³ Since this paper has been completed, Williams (1966) has described a new species of *Callinectes*, *C. similis*, which is commented upon later (p. 18)

identified from type-material or from specimens identified by Rathbun. Most Indo-West Pacific species were known from previous investigations (Stephenson and Campbell, 1959; 1960) or from types; however, one was based upon a recently collected Australian specimen related, but not identical with, *P. trituberculatus*. (Further study showed this to be an unusual specimen of *P. pelagicus*, which differs in only a single tabulated feature from *P. trituberculatus*: it lacks the tubercles on the carapace: feature 13 in table 1). Another Indo-West Pacific species, *P. convexus*, was based upon the literature, mostly from Crosnier (1962).

To simplify later treatment, all species and subspecies are referred to in the text below as "species." Throughout the text, ringed numbers that accompany specific names are those listed in table 2.

Results

Our investigation considered, first, certain specific questions relevant to the taxonomic problem and, second, the larger scale inter-relationships and the evidence they provide for parallel evolution. Conclusions were based, first, on inspection of the NFD and TD values obtained from the tabular data of table 3, and, second, on the 3-dimensional ordination of the numerical models. Since 2-dimensional sections proved somewhat unrevealing, 3-dimensional models were constructed. Figures 1 and 2 have been drawn from oblique photographs of the model obtained from the basic GOWER ordination. Several of the plotted points in this model may be regarded as spuriously close together since substantial deviations in the fourth, fifth, and sixth axes are suppressed. Each instance of a deviation greater than 100 scale units is shown by a black spot in the figures; a considerable number of such discrepancies is evident. Figures 3 and 4 have been derived from similar photographs of the model obtained from the NEWGOWER ordination, which had been reduced by iteration to three factor axes.

Specific Questions

ANALOGOUS SPECIES.—Consideration of both tabular data and the models indicated that none of the following pairs of species of *Portunus* listed as analogous by Rathbun (1930) can be considered analogous (pairs are listed with western species first): *P. xantusii* xantusii ⑧/*P. gibbesii* ⑮; *P. brevimanus* ④/*P. spinimanus* ⑳; *P. angustus* ②/*P. ordwayi* ⑯; and *P. iridescens* ⑥/*P. spinicarpus* ⑳.

While the general conclusions from the two methods are identical, the models distort some of the detailed relationships of the above species to other species; for example, in the models, *P. iridescens* ⑥

appears closer to *P. stanfordi* ① and *P. acuminatus* ① than to *P. spinicarpus* ⑳ and *P. guaymasensis* ⑤, which are its nearest neighbors on both tabular and classical grounds.

Neither of the following pairs of species of *Callinectes* can be con-

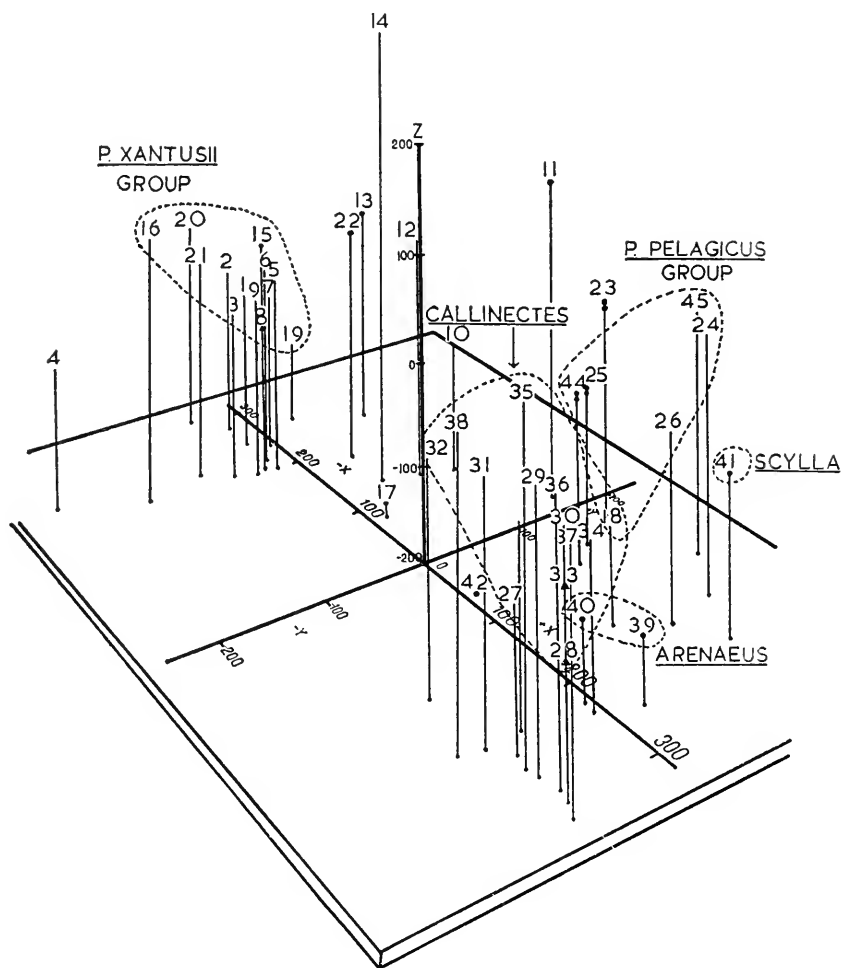

FIGURE 1.—Model from basic GOWER ordination based on an oblique photograph taken from the “southeast” (black spots=deviations greater than 100 scale units in the fourth, fifth, and sixth axes; dotted lines=species groups).

sidered analogous from tabular data or from model inspection: *C. bellicosus* ⑳/*C. sapidus acutidens* ⑳ and *C. toxotes* ⑳/*C. boucourti* ⑳. From consideration of tabular data, *C. arcuatus* ⑳ and *C. danae* ⑳ are an analogous pair (NFD 3). This is not apparent from the model

first figured (figs. 1 and 2) but it is indicated in the second (figs. 3 and 4).

Arenaeus mexicanus ⑩/*A. cribrarius* ③⑨ as the only two species in the genus presumably must be analogous although there are numerous

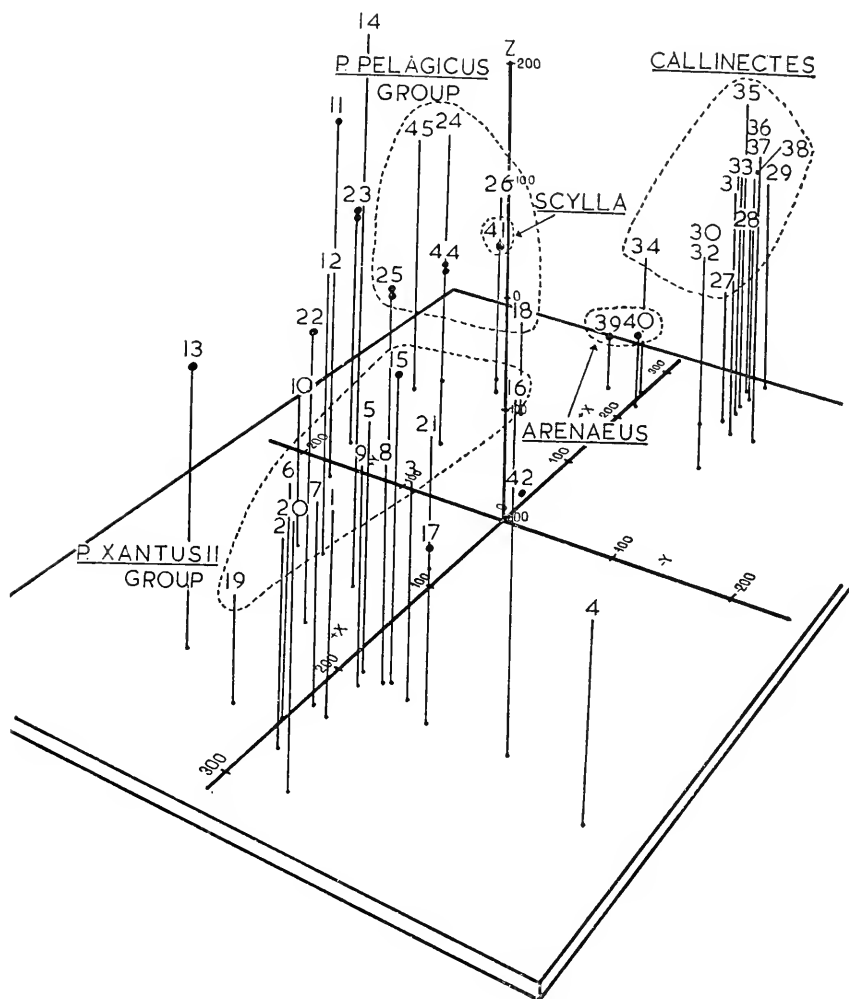

FIGURE 2.—Model from basic GOWER ordination based on an oblique photograph taken from the "southwest" (black spots = deviations greater than 100 scale units in the fourth, fifth, and sixth axes; dotted lines = species groups).

differences in tabular data (NFD 7) and they are some distance apart on the models.

Evidently, at most, one of the postulated pairs of analogous species has clear claims to such a status. We believe it is desirable that

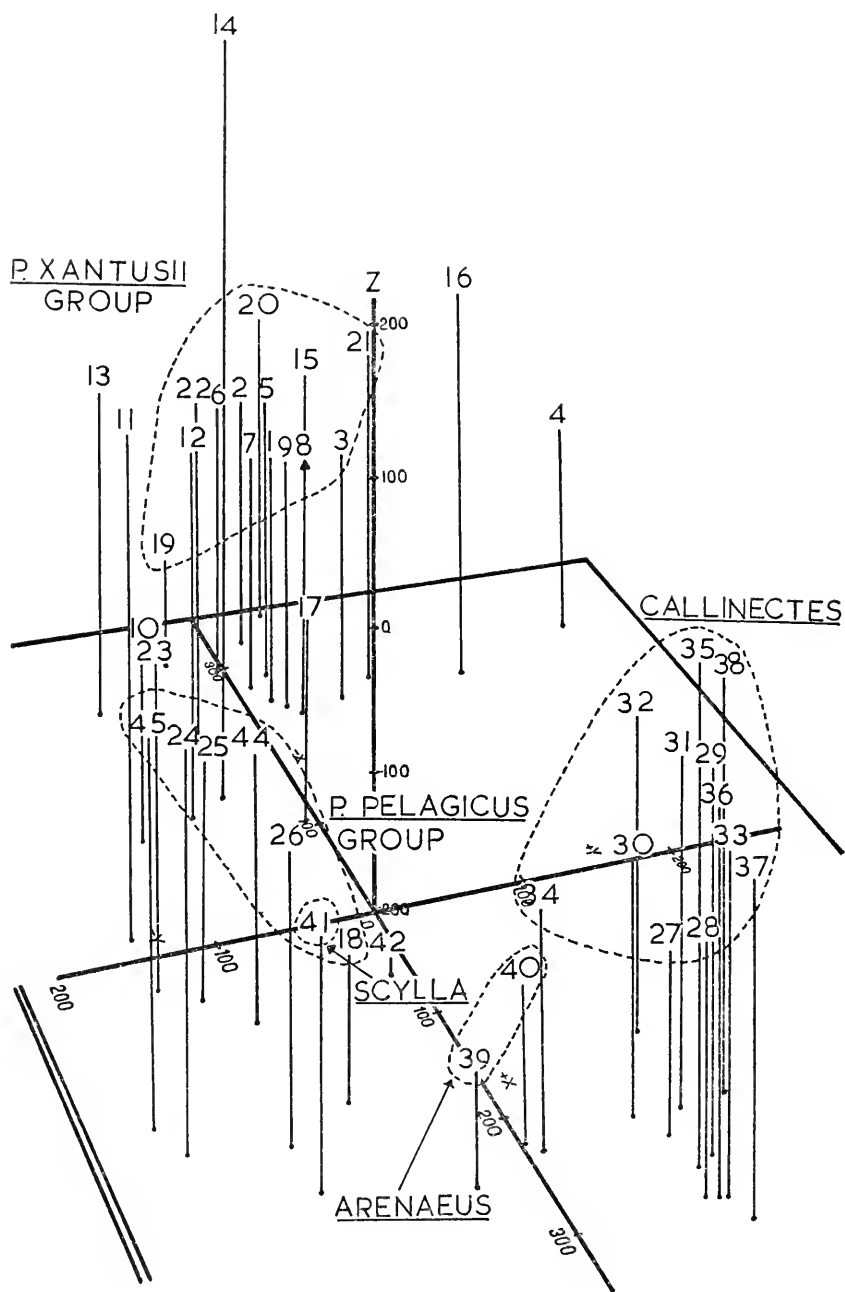

FIGURE 3.—Model from NEWGOWER ordination based on an oblique photograph taken from the "southeast" (dotted lines=species groups).

examples of analogous pairs in other crustacean groups should be re-investigated.

RELATIONSHIPS AMONG WESTERN AMERICAN GROUPS OF *PORTUNUS*.—These comprise species ①–⑩, inclusive, of table 2. Consideration of NFD or TD values or inspection of the models shows that *P. tuberculatus* ⑩ is distant from the remainder, as known already from the classical studies.

Tabular data: The remaining nine species give mean values (of each species considered in relation to the remainder) as follows:

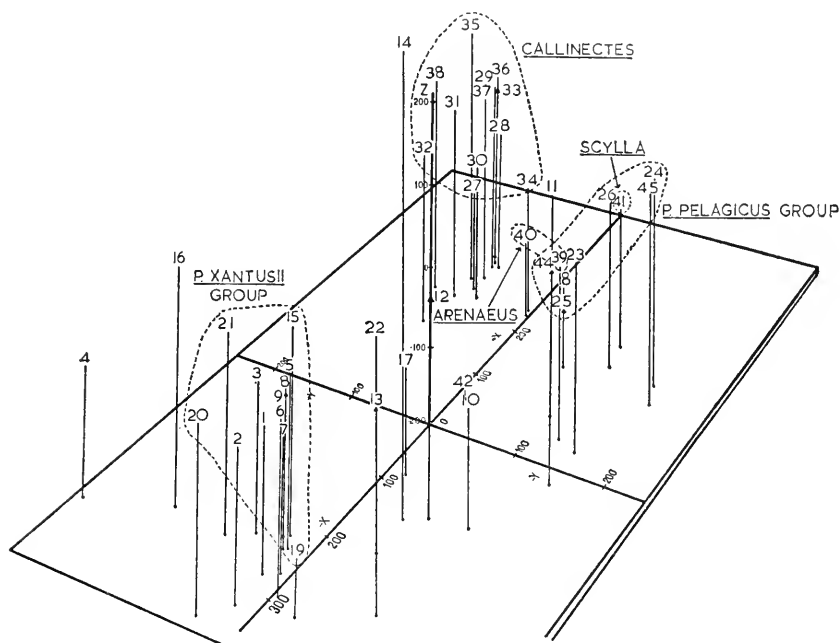

FIGURE 4.—Model from NEWGOWER ordination based on an oblique photograph taken from the “southwest” (dotted lines=species groups).

P. acuminatus ①, NFD 6.3, TD 2.3; *P. angustus* ②, NFD 7.6, TD 2.7; *P. asper* ③, NFD 6.1, TD 2.4; *P. brevismanus* ④, NFD 11.0, TD 3.3; *P. guaymasensis* ⑤, NFD 8.0, TD 2.8; *P. iridescens* ⑥, NFD 8.8, TD 2.8; *P. stanfordi* ⑦, NFD 7.3, TD 2.7; *P. xantusii xantusii* ⑧, NFD 5.4, TD 2.2; and *P. xantusii affinis* ⑨, NFD 5.6, TD 2.3.

These data suggest that *P. xantusii* with its two subspecies ⑧ and ⑨ and also *P. acuminatus* ① are close to the “morphological center” of the western American species of *Portunus*.

Inspection of the models: These show that the above nine species are grouped closely with the possible exception of *P. brevismanus* ④.

The models also show an "incenter" of the above species approximately midway between *P. xantusii xantusii* (8) and *P. acuminatus* (1).

RELATIONSHIPS OF THE REMAINING AMERICAN SPECIES OF *PORTUNUS* TO THE WESTERN GROUP OF NINE.—These comprise species (10)–(22) and also (42) of table 2.

Tabular data: Mean values of eastern species to both *P. xantusii xantusii* (8) and *P. xantusii affinis* (9) were computed and are as follows:

P. anceps (11), NFD 20, TD 4.5; *P. bahamensis* (12), NFD 16, TD 4.1; *P. depressifrons* (13), NFD 16, TD 3.7; *P. floridanus* (14), NFD 17, TD 4.2; *P. gibbesii* (15), NFD 10, TD 3.0; *P. ordwayi* (16), NFD 7, TD 2.8; *P. rufiremus* (17), NFD 17, TD 4.0; *P. sayi* (18), NFD 24, TD 4.8; *P. sebae* (19), NFD 9, TD 3.0; *P. spinicarpus* (20), NFD 10, TD 3.2; *P. spinimanus* (21), NFD 6, TD 2.6; and *P. ventralis* (22), NFD 10, TD 3.0.

If NFD values of 10 or less or, alternatively, TD values of 3.3 or less are taken as an arbitrary limit of "close relationship," then the following six species are part of the western American group "centered" near *P. xantusii*: *P. gibbesii* (15), *P. ordwayi* (16), *P. sebae* (19), *P. spinicarpus* (20), *P. spinimanus* (21), and *P. ventralis* (22). Mean values mutually between species of this now enlarged group of 15 species are NFD 9.6, TD 3.0. These relatively low values indicate a reasonably homogeneous group.

The remaining American species comprise five species distantly related to the 15-species *P. xantusii* group: (1) *P. bahamensis* (12) and *P. depressifrons* (13), which form a related pair (NFD 7) and are closer to the *P. xantusii* group than to the remainder. (2) *P. anceps* (11) and *P. floridanus* (14) are a more distantly related pair (NFD 12), also more distant from the *P. xantusii* group; they are moderately close to the *P. bahamensis* (12)/*P. depressifrons* (13) pair (mean NFD 16.3, mean TD 4.0). (3) *P. rufiremus* (17) is in an isolated position, being distant from the other four species above; it is closest to *P. acuminatus* (1) (NFD 13). (4) The western American *P. tuberculatus* (10) is related to the Indo-West Pacific species in the *P. longispinosus* group (see Garth and Stephenson, 1966; Stephenson and Rees, 1967); because of synonymy problems within this group, *P. tuberculatus* (10) was compared with the only "fixed point" available, the holotype of *P. macrophthalmus* (23); it is closer to this species (NFD 11) than to the nearest member of of the 15-species group (NFD 13 to *P. x. xantusii* (8)); it is probably closer to other species in the *P. longispinosus* group, and shows a distant relationship to *P. vocans* (42) (see following). (5) The eastern *P. vocans* (42) is so similar to *P. nipponensis* (Sakai) 1938 from Japan that numerical techniques are unnecessary; it probably is related distantly to *P. tuberculatus* (10), *P. macrophthalmus* (23), and other members of the *P. longispinosus* group, but since only a female was

available for study, full tabular data could not be obtained; *P. vocans* (42) is not restricted to American waters, occurring also at Ascension Island in the South Atlantic (Rathbun, 1930). (6) The eastern *P. sayi* (18) is a member of the *P. pelagicus* group (see p. 15).

Inspection of the models: From the models, the same eastern species are part of the *P. xantusii* group: *P. gibbesii* (15), *P. ordwayi* (16), *P. sebae* (19), *P. spinicarpus* (20), *P. spinimanus* (21), and *P. ventralis* (22); however, *P. ventralis* (22), which was a borderline case from the tabular data, now becomes an even more doubtful member of the group.

Again from the models, the incenter of the 15-species *P. xantusii* group is approximately equidistant from *P. acuminatus* (1), *P. asper* (3), *P. xantusii xantusii* (8), and *P. xantusii affinis* (9). While the term "*P. xantusii* group" implies an oversimplification, it is considered significant that all four of the above "central" species occur in the Pacific. It seems probable that the group originated from a western American ancestor.

The remaining American species (apart from *P. sayi* (18)) appear in the models to be scattered between the *P. xantusii* group and the *P. pelagicus* group (see p. 15), apart from *P. depressifrons* (13), which is somewhat "to one side." While the general arrangement follows that derived from the tabular data, no pairing of species is evident.

RELATIONSHIPS AMONG SPECIES OF *CALLINECTES*.—Tabular data: Consideration of the species of *Callinectes*, each mutually in relation to the remainder, gives mean values as follows:

C. arcuatus (27), NFD 6.8, TD 2.6; *C. bellicosus* (28), NFD 9.0, TD 3.0; *C. boucourti* (29), NFD 5.5, TD 2.3; *C. danae* (30), NFD 5.8, TD 2.5; *C. exasperatus* (31), NFD 6.8, TD 2.6; *C. gladiator* (32), NFD 7.4, TD 2.7; *C. latimanus* (33), NFD 4.9, TD 2.1; *C. marginatus* (34), NFD 8.9, TD 3.0; *C. ornatus* (35), NFD 6.0, TD 2.4; *C. sapidus* (36), NFD 5.4, TD 2.3; *C. sapidus acutidens* (37), NFD 5.5, TD 2.2; *C. toxotes* (38), NFD 5.2, TD 2.2. The mean overall values of NFD 7.2 and TD 2.5 indicate that the genus is very homogeneous.

The west African species *C. latimanus* (33) is closest to the "morphological center" in this predominantly Atlantic genus. The three western American species differ appreciably from each other, with *C. toxotes* (38) closest to the bulk of the remaining species and particularly close to five Atlantic species (*C. boucourti* (29), *C. ornatus* (35), *C. sapidus acutidens* (37), and *C. latimanus* (33), all NFD 3; and *C. exasperatus* (31), NFD 4). On structural and distributional grounds any of the first three could have given rise to *C. toxotes* (38) as a result of a Pacific isolate. The second Pacific species, *C. bellicosus* (28), forms an analogous pair with *C. danae* (30), and presumably they had a common origin.

Inspection of the models: The models show the genus as a close-packed group. In the first figured model (figs. 1 and 2) *C. gladiator* ③② and *C. marginatus* ③④ are the most peripheral species. This differs somewhat from the results of the tabular data, in which *C. bellicosus* ②⑧ and *C. marginatus* ③④ were the most peripheral species. The second figured model gives a closer approximation to the tabular data, with *C. marginatus* ③④ as a peripheral species. The "incenter" in the first figured model lies approximately equidistant from *C. boucourti* ②⑨, *C. danae* ③⑩, and *C. ornatus* ③⑤; in the second model, the "incenter" lies approximately midway between *C. arcuatus* ②⑦, *C. bellicosus* ②⑧, and *C. boucourti* ②⑨. These results differ from the tabular consideration, in which *C. latimanus* ③③ was the "focal" species. It is considered significant that most of the postulated "central" species occur in the Atlantic, and it is conceivable that the group originated from an eastern American ancestor. It seems virtually certain that the western American forms arose from eastern American ancestors.

PORTUNUS PELAGICUS ②④ AND RELATED SPECIES OF *PORTUNUS*.—Five species are known on classical grounds to be related closely, forming a *P. pelagicus* "group": *P. pelagicus* ②④, *P. sanguinolentus* ②⑥, *P. pubescens* ②⑤, *P. convexus* ④④, and *P. trituberculatus* ④⑤.

Neptunus madagascariensis Hoffman, 1874, has not been included in this group in spite of its obvious resemblance to *P. sanguinolentus* ②⑥, which has been commented upon by both Hoffman (1874, p. 8) and Crosnier (1962, p. 47). Crosnier put the species in the genus *Portunus*. Hoffman, however, stated in his description that it differed from *Neptunus diacanthus* Latreille, 1825, only in "l'absence de l'épine sur le bord posterieur du bras. Cette différence est tellement minime que cette espèce ne forme peut-etre qu'une variété de *Neptunus diacanthus*." The varieties of *N. diacanthus* of Hoffman's time are now species of *Callinectes*, and Miers (1886) has suggested already that *N. madagascariensis* belongs to *Callinectes*. It possesses the following diagnostic features of that genus: anteroexternal angle of merus of third maxillipeds expanded and wrist of cheliped without inner spine. The absence of a spine on the posterior border of the arm is shared with *C. exasperatus* ③① although the species keys out from Rathbun (1930) as *C. danae* ③⑩. It is unfortunate that this most interesting species is known only from the holotype female, whose present location is unknown.

Stephenson (1968, in press) recently has obtained evidence of the existence of an undescribed subspecies of *P. sanguinolentus* ②⑥. This has been omitted from present consideration because it is identical with normal *P. sanguinolentus* ②⑥ on the basis of the list of features that are used herein.

Consideration of the results in table 3 and of the models showed that *P. sayi* (18) clearly belongs to the *P. pelagicus* group; thus, six species in the group were considered.

Tabular data: Mean values of each species considered separately against the remainder are as follows:

P. sayi (18), NFD 13.0, TD 3.6; *P. pelagicus* (24), NFD 9.2, TD 3.0; *P. pubescens* (25), NFD 12.8, TD 3.5; *sanguinolentus* (26), NFD 11.6, TD 3.4; *P. convexus* (44), NFD 11.0, TD 3.3; and *P. cf. trituberculatus* (45), NFD 11.1, TD 3.2. The overall means of NFD 11.5 and TD 3.3 indicate a less homogeneous group than either the *P. xantusii* group or the genus *Callinectes*. No individual species is close to the "morphological center."

Inspection of the models: Identical conclusions were obtained.

General Considerations

INTERGROUP AND INTERGENERIC RELATIONSHIPS.—The critical group is probably the six species in the *P. pelagicus* group, and this has been considered in relation to the remainder.

Tabular data: Mean values to other groups are as follows:

(1) *P. xantusii* group (15 species), NFD 26.6, TD 5.2. The species in the *P. pelagicus* group closest to the *P. xantusii* group is *P. convexus* (44), NFD 23.9, TD 4.9. The species in the *P. xantusii* group closest to the *P. pelagicus* group is *P. ventralis* (22), NFD 22.8, TD 4.8, closely followed by *P. xantusii xantusii* (8), NFD 23.7, TD 4.9.

(2) *Callinectes* species (12), NFD 17.4, TD 4.2. The species in the *P. pelagicus* group closest to *Callinectes* species is *P. sanguinolentus* (26), NFD 14.5, TD 3.8. The species of *Callinectes* closest to the *P. pelagicus* group is *C. marginatus* (34), NFD 15.2, TD 3.9.

(3) *Arenaeus* species (2), NFD 17.0, TD 4.1. The species of *Arenaeus* closest to the *P. pelagicus* group is *A. cribrarius* (39), NFD 16.3, TD 4.0. The species of the *P. pelagicus* group closest to *Arenaeus* species is *P. sayi* (18), NFD 11.5, TD 3.4.

(4) *Scylla* species (1), NFD 20.3, TD 4.5. The species of the *P. pelagicus* group closest to *Scylla* is again *P. sayi* (18), NFD 16, TD 4.

These values show: (1) The *P. pelagicus* group is much further from the bulk of the American species of *Portunus* (the *P. xantusii* group) than it is from *Callinectes*, *Arenaeus*, or *Scylla*. (2) The degree of separation of *Arenaeus*, plus *Callinectes*, from the *P. pelagicus* group is greater than the average separations between the members of this group; hence, the genus *Portunus* stands apart from these two genera. (3) *Scylla* is even more distant from the *P. pelagicus* group. (4) The most doubtful of the classical separations is that between *Arenaeus* and *Callinectes*. While *Callinectes* species form a homogeneous entity

(mean NFD 7.2, TD 2.5), the two species of *Arenaeus* scarcely can be excluded from this assemblage; thus, *A. cribrarius* ⑳ is closer to *C. bellicosus* ㉘ (NFD 11) than this species is to *C. exasperatus* ㉙, *C. gladiator* ㉚, and *C. marginatus* ㉛. It would seem desirable to re-examine these genera in the first instance by a detailed classical approach. (5) The genus *Portunus* covers a wide range of morphological diversity. If only the *P. pelagicus* group and the *P. xantusii* group are considered, clearly these should belong to different genera.

Inspection of the models: On the one hand, this confirmed visually the main conclusions (1), (2), (4), and (5) above; on the other hand, the validity of separating *Scylla* from the *P. pelagicus* group appears very doubtful. In addition, the detailed relationships of individual species are altered; for example, *P. sayi* ㉜ becomes the closest species of the *P. pelagicus* group to *Callinectes*; also the closest approach of *Arenaeus* and *Callinectes* species are *A. mexicanus* ㉝ and *C. marginatus* ㉛.

EVIDENCES OF PARALLEL EVOLUTION WITHIN THE GENUS *PORTUNUS*.—The following main groups have been recognized in the above discussion: (1) 15 species group centered on *P. xantusii*; (2) *P. pelagicus* group; (3) *P. longispinosus* group, represented in America by *P. tuberculatus* ㉞; (4) *P. vocans* group, containing a second species from the Indo-West Pacific; (5) an indistinct *P. bahamensis* group, containing *P. bahamensis* ㉟, *P. depressifrons* ㊱, *P. anceps* ㊲, and *P. floridanus* ㊳.

In many cases a given taxonomic feature occurs in species belonging to two or more of the above groups. In a few cases it occurs in only some of the species of the groups, in which case presumably parallel evolution has occurred. Excluding secondary sexual characters of the males, the features showing parallel evolution are as follows (feature numbers are from table 1, unnecessary negatives having been eliminated):

- 2 Median frontal lobes forming pointed teeth.
- 6 Inner supraorbital sinus open.
- 7 Third maxilliped not conspicuously hairy.
- 11 Carapace not hairy.
- 12 Carapace broad.
- 14 Postlateral junction of carapace spinous.
- 16 Mesogastric area of carapace with broad granular ridge.
- 26 First anterolateral tooth more slender than second.
- 28 Last anterolateral tooth distinctly long.
- 29 Chelae attenuated.
- 30 Chelae robust.
- 31 Undersurface of chelae with squamiform markings.
- 33 Posterior border of arm without spines.
- 37 Hand of chelae swollen.
- 39 Upper surface of hand with single spine.
- 40 Posterodistal border of merus of fifth leg spinulose.
- 57 Iridescence present somewhere on body.

An additional feature is the presence of large red spots on the posterior portion of the carapace.

Many of these are without great evolutionary significance and do not appear early in keys. Others do (e.g., 14, 29, and 33) and even have been used for subgeneric distinctions (e.g., 14). Knowledge of the characters of a wide range of Indo-West Pacific species (Stephenson and Campbell, 1959; Stephenson and Rees, 1967) suggests that many additional features result from parallel evolution (e.g., expansion of the antero-external angle of the merus of the third maxilliped).

The problems of recognising subgenera of *Portunus* by classical criteria have been detailed (Stephenson and Campbell, 1959). The present study, by showing gradations in affinities among several groups or complexes and by adding to the list of features showing parallel evolution, does not make this recognition any easier.

General Conclusions

With the work carried out against a background of classical knowledge of the group, we found it not surprising that most of the detailed conclusions do not greatly distort the accepted patterns. The most significant of these conclusions appear to be as follows:

(1) Analogous pairs of species of portunids with Pacific and Atlantic forms are far from recognisable in most cases.

(2) There are about 15 closely related American species, herein called the *P. xantusii* group, which comprise nine Pacific and six Atlantic species. This group appears to have originated from Pacific ancestors.

(3) The genus *Callinectes* appears to have had an Atlantic origin.

(4) One primarily Atlantic species, *P. sayi* (18), belongs to the predominantly Indo-West Pacific *P. pelagicus* group. *P. sayi* is possibly the species in the group most closely related to the genera *Arenaeus* and *Callinectes*.

(5) There are grave doubts over the validity of separating *Arenaeus* from *Callinectes*; these genera merit monographic treatment.

Possibly the most important conclusions concern methodology. In working on the American forms of *Portunus*, *Callinectes*, and *Arenaeus* we hoped to develop techniques that could be applied to the very numerous Indo-West Pacific species of *Portunus*, whose complex interrelationships are difficult to clarify by the traditional approach.

The results have shown that (1) for the recognition of groups, the method embodied in the 3-dimensional models is entirely acceptable; of these models, the second (based on three axes only) appears slightly preferable; (2) for the detailed consideration of affinities within the groups, the tabular method is adequate and gives less distortions;

hence, if future investigations are attempted, the methods will be used in the reverse order from that given above.

POSTSCRIPT.—Williams (1966) recently has described a new species, *Callinectes similis*, from eastern America that had been confused previously with *C. ornatus* and *C. danae*. Using the features listed in table 1, we find that the species appears, from the description, to resemble *C. danae* rather than *C. ornatus* in three features and to resemble *C. ornatus* rather than *C. danae* in two. The new species also differs from the other two in one listed feature, viz. 55. The existence of another species further increases the "cohesion" of the genus and supports its claim for continued generic status.

References

Specific and generic authors have been omitted for those American species dealt with in Rathbun (1930) or in Garth and Stephenson (1966), and for the Indo-West Pacific species dealt with in Stephenson, Hudson, and Campbell (1957) or in Stephenson and Campbell (1959, 1960).

- CATTELL, R. B.
1952. Factor analysis. New York: Harper.
- CROSNIER, A.
1962. Crustacés décapodes Portunidae. *In* Faune de Madagascar, vol. 16, pp. 1-154, 13 pls.
- DAGNELIE, P.
1960. Contribution à l'étude des communautés végétales par l'analyse factorielle. *Bull. Serv. Carte Phytogéogr., sers. B, vol. 5, pp. 7-71, 93-195.*
- GARTH, J. S., and STEPHENSON, W.
1966. Brachyura of the Pacific Coast of America. Brachyrhyncha: Portunidae. Allan Hancock Monogr. Mar. Biol., no. 1, pp. 1-154, 12 pls.
- GOODMAN, L. A., and KRUSKAL, W. H.
1954. Measures of association for cross-classification. *Journ. American Statist. Assoc., vol. 49, pp. 732-764.*
1959. Measures of association for cross-classification, II. *Journ. American Statist. Assoc., vol. 54, pp. 123-163.*
- GOWER, J. C.
1966. The distance properties of latent root and vector methods used in multivariate analysis. *Biometrika, vol. 53, pp. 325-338.*
- HOFFMAN, C. K.
1874. Crustacés et échinodermes de Madagascar et de l'île de La Réunion. *In* Recherches sur la faune de Madagascar, pt. 4, pp. 1-58, 10 pls.
- LANCE, G. N., and WILLIAMS, W. T.
1967. A general theory of classificatory sorting strategies, 1: Hierarchical systems. *Comput. Journ., vol. 9, pp. 373-380.*
- MACNAUGHTON-SMITH, P.
1965. Some statistical and other numerical techniques for classifying individuals. *In* Home Office: Studies in the causes of delinquency and treatment of offenders, vol. 6, pp. i-v, 1-33. London: Her Majesty's Stationery Office.
- MIERS, E. J.
1886. Report on the Brachyura collected by H.M.S. *Challenger* during the years 1873-1876. *In* The *Challenger* Reports (Zoology), vol. 17, no. 4, 1 + 362 pp., 29 pls.
- RATHBUN, MARY J.
1930. The caneroid crabs of America of the Families Euryalidae, Portunidae, Ateacyclidae, Cancridae and Xanthidae. *Bull. U.S. Nat. Mus, vol. 152, pp. i-xvi, 1-609, 230 pls.*
- SOKAL, R. R., and MICHENER, C. D.
1958. A statistical method for evaluating systematic relationships. *Univ. Kansas Sci. Bull., vol. 38, pp. 1409-1438.*

SOKAL, R. R., and SNEATH, P. H. A.

1963. Principles of numerical taxonomy, xvi + 359 pp. San Francisco: Freeman.

STEPHENSON, W.

1968. Studies on *Portunus pelagicus* (Linnaeus) and *P. sanguinolentus* (Herbst). Occas. Pap. B.P. Bishop Mus., Honolulu [in press].

STEPHENSON, W., and CAMPBELL, B.

1959. The Australian portunids (Crustacea: Portunidae), III: The genus *Portunus*. Australian Journ. Mar. Freshw. Res., vol. 10, no. 1, pp. 84-124, 5 pls.

1960. The Australian portunids (Crustacea: Portunidae), IV: Remaining genera. Australian Journ. Mar. Freshw. Res., vol. 11, no. 1, pp. 73-122, 6 pls.

STEPHENSON, W., and REES, MAY

1967. Portunid crabs from the Indian and Pacific Oceans in the collections of the Smithsonian Institution. Proc. U.S. Nat. Mus., vol. 120, no. 3556, pp. 1-114, 9 pls.

THOMSON, G. H.

1951. The factorial analysis of human ability. Boston: Houghton Mifflin; Cambridge: Riverside.

WATSON, L.; WILLIAMS, W. T.; and LANCE, G. N.

1966. Angiosperm taxonomy: A comparative study of some novel numerical techniques. Journ. Linn. Soc., vol. 59, pp. 491-501.

WILLIAMS, A. B.

1966. The western Atlantic swimming crabs *Callinectes ornatus*, *C. danae*, and a new, related species (Decapoda, Portunidae). Tulane Stud. Zool., vol. 13, no. 3, pp. 83-93.

WILLIAMS, W. T., and DALE, M. B.

1965. Fundamental problems in numerical taxonomy. Adv. Bot. Res., vol. 2, pp. 35-68.

WILLIAMS, W. T.; LAMBERT, J. M.; and LANCE, G. N.

1966. Multivariate methods in plant ecology, V: Similarity analyses and information-analysis. Journ. Ecol., vol. 54, pp. 427-445.

TABLE 1.—*Features used in distinguishing species* (designed to give positive or negative answers; initially intended to cover the western American species of *Portunus*; the list has been expanded to cover the species of *Callinectes*)

<i>Body region</i>	<i>Morphological features</i>	<i>Their arbitrary numbers</i>
Front and orbital region	Four frontal lobes or teeth	1
	Frontal processes rounded lobes, not pointed teeth	2
	Median frontal lobes more protruding than lateral	3
	Inner supraorbital angle subdivided (or almost) into two	4
	Inner supraorbital angle not acute	5
	Inner supraorbital sinus open	6
	Outer supraorbital sinus open	7
	Suborbital sinus open	8
Third maxilliped	Anteroexternal angle of merus not expanded	9
	Generally hairy	10
	Normally covered with pile of hairs	11
	Narrow	12
	Without tubercular elevations	13
	Postlateral junctions not spinous	14
Carapace	Protogastric areas with granular patches	15
	Mesogastric with broad granular ridge	16
	Central gastric patch joining meso- and metagastriacs	17
	Metagastriacs a pair of short ridges	18
	Epibranchial ridges well developed	19
	Anterolateral granular patches present	20
	Anterior mesobranchial area bearing "almost a ridge"	21
	Posterior mesobranchial ridge present	22
	Cardiac area with narrow, prominent, separate ridges	23
	Lateral postcardiac areas with granular patches	24
	Median postcardiac area with granular patches (often inconspicuous)	25
	Anterolateral teeth	First stouter than second
With a hint of being alternately large and small		27
Last tooth distinctly long		28
Chelae	Not attenuated	29
	Robust, not slender	30
	Undersurface not smooth, tending to squamiform markings	31
	Posterior border of arm not with two spines	32
	Posterior border of arm not without spines	33
	Spine on inner surface wrist not particularly long	34
	Spine on inner surface wrist not reduced to tubercle	35
	Upper plus outer surface wrist with only one spine	36
	Hand not swollen	37
	Inner surface hand with carina	38
	Upper surface hand with one spine only	39
	Upper surface hand with spine on inside only	40
Fifth leg	Fingers strongly carinated	41
	Upper margin moveable finger not fringed with hairs	42
	Posterodistal border merus bearing spine or spines	43
	Border bearing spinules	44

TABLE 1.—Continued

Body region	Morphological features	Their arbitrary numbers
Male abdomen	Overall a moderately elongate triangle	45
	Penultimate segment with slightly sinuous sides	46
	Penultimate segment broad (1/b 1—1½)	47
	Ultimate segment lanceolate, not triangular with rounded tip	48
	Ultimate segment narrow (1/b > 1)	49
First male pleopod	Smoothly curving, not sinuous	50
	Curving evenly throughout, distal portion not straight	51
	Not robust	52
	Not attenuated	53
	Without stout erect spines	54
	Outer surface subterminally with recurved spinules	55
	Inner surface subterminally with minute hairs or their follicles	56
General	No iridescence on body	57

TABLE 2.—Data on material examined (AHF=Allan Hancock Foundation, University of Southern California; SIO=Scripps Institute of Oceanography; USNM=United States National Museum; UQ=University of Queensland, Department of Zoology; entire collection examined unless indicated otherwise)

Species	Number	Distribution	Specimens examined
<i>Portunus acuminatus</i> (Stimpson) 1871	①	western America	AHF (including neotype)
<i>P. angustus</i> Rathbun 1898	②	Galapagos Islands	AHF, USNM (part, including holotype)
<i>P. asper</i> (A. Milne Edwards) 1861	③	western America	AHF, USNM (part)
<i>P. brevipennis</i> (Faxon) 1895	④	islands off western America	AHF, USNM (part, including holotype)
<i>P. guaymasensis</i> Garth and Stephenson 1966	⑤	Gulf of California	Holotype (unique)
<i>P. iridescens</i> (Rathbun) 1893	⑥	western America	AHF, USNM (part, including holotype)
<i>P. stanfordi</i> Rathbun 1898	⑦	Galapagos Islands	AHF, USNM (part, including holotype)
<i>P. x. xantusii</i> (Stimpson) 1860	⑧	western America	AHF, USNM (part)
<i>P. x. affinis</i> (Faxon) 1893	⑨	western America	AHF, USNM (part)
<i>P. tuberculatus</i> (Stimpson) 1860	⑩	western America	AHF, USNM (part, including cotype)
<i>P. anceps</i> (Saussure) 1858	⑪	eastern America	AHF (part) and USNM (part)
<i>P. bahamensis</i> Rathbun 1930	⑫	eastern America	USNM (part, including types)
<i>P. depressifrons</i> (Stimpson) 1859	⑬	eastern America	AHF (part), USNM (part)
<i>P. floridanus</i> Rathbun 1930	⑭	eastern America	AHF (part), USNM (types)
<i>P. gibbesii</i> (Stimpson) 1859	⑮	eastern America	USNM (part)
<i>P. ordwayi</i> (Stimpson) 1860	⑯	eastern America	AHF, USNM (part)

TABLE 2.—Continued

<i>Species</i>	<i>Number</i>	<i>Distribution</i>	<i>Specimens examined</i>
<i>P. rufiremus</i> Holthuis 1959	⑴	eastern America	USNM (paratypes)
<i>P. sayi</i> (Gibbes) 1850	⑵	eastern America, southern Indian Ocean	USNM (part)
<i>P. sebae</i> (H. Milne Edwards) 1834	⑶	eastern America	USNM (part)
<i>P. spinicarpus</i> (Stimpson) 1871	⑷	eastern America	USNM (part)
<i>P. spinimanus</i> Latreille 1819	⑸	eastern America	USNM (part)
<i>P. ventralis</i> (A. Milne Edwards) 1879	⑹	eastern America	USNM (part)
<i>P. vocans</i> (A. Milne Edwards) 1878	⑺	eastern America, western Africa	USNM (?part)
<i>P. macrophthalmus</i> Rathbun 1906	⑽	Indo-West Pacific	USNM (holotype)
<i>P. pelagicus</i> (Linnaeus) 1766	⑾	Indo-West Pa- cific, Mediter- ranean	USNM (part), SIO, UQ (part)
<i>P. pubescens</i> (Dana) 1852	⑿	Indo-West Pacific	USNM (part)
<i>P. sanguinolentus</i> (Herbst) 1796	⑿	Indo-West Pa- cific, Mediter- ranean	UQ (part)
<i>P. convexus</i> de Haan 1833	⑿	Indian Ocean	(literature only)
<i>P. cf. trituberculatus</i> (Miers) 1876	⑿	Indo-West Pacific	UQ (single specimen)
<i>Callinectes arcuatus</i> Ordway 1863	⑿	western America	AHF, USNM (part)
<i>C. bellicosus</i> (Stimpson) 1859	⑿	western America	AHF, USNM (part)
<i>C. boucourti</i> A. Milne Edwards 1879	⑿	eastern America	USNM (part)
<i>C. danae</i> Smith 1869	⑿	eastern America	USNM (part)
<i>C. exasperatus</i> (Gerstaecker) 1856	⑿	eastern America	USNM (part)
<i>C. gladiator</i> Benedict 1893	⑿	western Africa	USNM (part)
<i>C. latimanus</i> Rathbun 1897	⑿	western Africa	USNM (part, includ- ing type)
<i>C. marginatus</i> (A. Milne Edwards) 1861	⑿	eastern America, western Africa	USNM (part)
<i>C. ornatus</i> Ordway 1863	⑿	eastern America	USNM (part)
<i>C. sapidus</i> Rathbun 1895	⑿	eastern America	USNM (part)
<i>C. s. acutidens</i> Rathbun 1895	⑿	eastern America	USNM (part, includ- ing cotype)
<i>C. toxotes</i> Ordway 1863	⑿	western America	AHF, USNM
<i>Arenaeus cribrarius</i> (Lamarek) 1818	⑿	eastern America	AHF, USNM (part)
<i>A. mexicanus</i> (Gerstaecker) 1856	⑿	western America	AHF, USNM (part)
<i>Scylla serrata</i> (Forskål) 1753	⑿	Indo-West Pacific	USNM (part), SIO, UQ (part)

Proceedings of
the United States
National Museum



SMITHSONIAN INSTITUTION • WASHINGTON, D.C.

Volume 124

1968

Number 3646

The Taxonomic Status of
Dineutus serrulatus and *Dineutus analis*
in North America
(Gyrinidae: Coleoptera)¹

By F. E. Wood²

The genus *Dineutus* in North America is represented by a number of common species that, since the study by Roberts (1895), have been recognized fairly easily. Roberts' taxonomic work is reflected in nearly every species, and his concepts have been accepted so widely that a few errors in his work have not been apparent.

An example of this is *Dineutus serrulatus* LeConte (1868), a well-known lotic species described from one male and one female from the middle and southern states respectively. This form was recognized by its broadly oval shape, which is slightly narrowed in front, the strong, sharp tooth on the front femur of the male, and the serrulate apices of the elytra. It was characterized further by Roberts (1895) as having, among other things, the "surface polished black" and the "under surface chestnut-brown." A key and complete description by Roberts, accompanied by good illustrations of the male genitalia and the male and female elytral apices, established *D. serrulatus* as an easily recognized species from Florida.

¹ Scientific Article No. A1341, Contribution No. 3901, Maryland Agricultural Experiment Station.

² Department of Entomology, University of Maryland, College Park.

The species *Dineutus analis* described by Régimbart (1882) from Texas was not defined so clearly. It was characterized as follows: oval, slightly narrowed anteriorly; bronzed above; reddish black below, sides of the next to last abdominal segment and the last segment entirely rufous; male anterior femur unidentate. Régimbart compared the four specimens (two males and two females) from which he described the species with *D. americanus* (Say) (= *D. assimilis* Kirby) and *D. emarginatus* (Say).

Roberts (1895) redescribed *D. analis* from 20 specimens, from "Hab.-Texas," and called attention to the serrulate elytral apices that Régimbart did not include. Roberts also compared *D. analis* with *D. serrulatus* LeConte, separating the two by stating that *D. analis* was less convex, more bronzed above, with a different outline of the elytral apices, a weaker femoral tooth, finer serration of the elytra, and with undersurface dark brown. Roberts' key separated *D. serrulatus* and *D. analis* essentially by the difference in color of the venter.

Since the papers by Régimbart (1882, 1884, 1892, 1902, 1907) and Roberts (1895), only Hatch (1930) and Young (1954) have compared the two species. The portion of the 1930 paper by Hatch concerning these species is principally a key. Young discussed the species of *Dineutus* in Florida and stated (pp. 148-150) that he did not recognize *D. analis* among his Floridian specimens. He further stated that he might have mixed *D. analis* with *D. serrulatus* and that some specimens identified as *D. analis* were to him indistinguishable from *D. serrulatus*.

Régimbart in his 1882 description of *D. analis* overlooked the elytral serration in this form as he did also in the case of *D. carolinus* LeConte, when he synonymized that species with *D. emarginatus* (Say). Roberts, in redescribing the species, cleared up these oversights and the concepts of Roberts became those of Régimbart in his later papers (1902, 1907). At the same time, Roberts' interpretation of *D. serrulatus* delimited that species as being the form with reddish-brown venter and toothed male profemur found in Florida. In deciding this, Roberts used specimens only from Florida for the latter form and specimens only from Texas for *D. analis*.

Recently, specimens from drainage ditches in southeastern Missouri were found to run to *D. analis* in the keys of Roberts and Hatch, but the male and female genitalia were those of *D. serrulatus* (figs. 1, 2). Further study of the species of *Dineutus* in North America revealed that this population extended from eastern Texas north to southeastern Missouri and south to western Florida, where it intergraded with *D. serrulatus*.

In my analysis of these populations, it appears that Roberts' concept of *D. analis* is represented by the dark ventered form of *Dineutus* ranging from Texas to western Florida. This was confirmed by comparison of these specimens with a female paratype of *D. analis* from the collection of Régimbart. Also confirmed was the suspicion that the illustration of the male genitalia of *D. analis* in Roberts' 1895 paper (his Plate VI-10b), drawn for him by Professor John B. Smith (Roberts' p. 281) was incorrect and in fact did not apply, as drawn, to any species of American *Dineutus*. The female genitalia, although not as distinct as the male, nevertheless offer good diagnostic characters, and the female genital lobes of Régimbart's paratype are the same as those of Roberts' (and later authors') concept of *D. serrulatus* from Florida. This, with other morphological characters, indicates that the two forms are conspecific and necessitates the following changes in nomenclature.

Dineutus serrulatus LeConte

Dineutus serrulatus serrulatus LeConte

Dineutus serrulatus LeConte, 1868, pp. 366, 367.—Hatch, 1925, p. 106.

Dineutus (Cyclinus) serrulatus.—Ochs, 1926, p. 121.—Hatch, 1930, pp. 18, 20-22.—Young, 1954, pp. 143, 145, 148-150.

Dineutes serrulatus.—Schwarz, 1878, p. 438.—Régimbart, 1882, p. 415; 1884, p. 469.—Severin, 1889, p. 154.—Régimbart, 1892, p. 739.—Roberts, 1895, pp. 279-282, 286.—Régimbart, 1902, p. 4; 1907, p. 145.—Ahlwarth, 1910, p. 7.—Leng and Mutchler, 1918, pp. 95, 96.—Blatchley, 1919, p. 316.—Leng, 1920, p. 82.—Brimley, 1938, p. 132.

Length 9-12 mm; broadly oval, more or less narrowed anteriorly; dorsal surface shining, black, striae faint; exterior apical angle of elytra moderately sinuate, more so in the female, elytral apices slightly dehiscent at suture, sutural angles obtuse, slightly sinuate, not produced, serrulate; undersurface shining, uniformly castaneous; hypomera orange; anterior leg castaneous; anterior tibia narrow at basal one-fourth to one-third, then broadened and subparallel to apex, apex truncate, exterior apical angle rounded, female less so than male; anterior femora of male always with a distinct, acute tooth.

Because lectotypes have not been specified for LeConte's two specimens, I hereby designate the following:

Holotype: a male in the Museum of Comparative Zoology, the pin bearing a pink disc with a red label designating "Type 6094" and a white paper label on which is written "*D. serrulatus*" in ink. The pink disc, LeConte's indication of "middle states" on the holotype, is unexplainable since this subspecies is found only in Alabama, Florida, and Georgia, and its boundaries are well limited. "*D. serrulatus*" is written in cursory writing and in LeConte's hand (Horn and Kahle, 1936).

Allolectotype: a female in the Museum of Comparative Zoology with a pin bearing an orange disc and a white paper label on which is written "*serrulatus* 2," which does not appear to have been written by LeConte.

Dineutus serrulatus analis Régimbart, new status

Dineutes analis Régimbart, 1882, p. 416; 1884, p. 469.—Severin, 1889, p. 151.—Régimbart, 1882, p. 739.—Roberts, 1895, pp. 286, 287.—Régimbart, 1902, p. 4; 1907, p. 146.—Ahlwarth, 1910, p. 4.—Leng and Mutchler, 1918, p. 95.—Leng, 1920, p. 82.

Dineutus (Cyclinus) analis.—Ochs, 1926, pp. 121, 137.—Hatch, 1930, pp. 18, 20–22.—Young, 1954, pp. 143, 145, 148–150.

Same as the nominate subspecies except dorsal surface bronzed; sutural angles of the elytra produced; undersurface shining; thoracic sterna dark castaneous to piceous; abdominal venter piceous, caudal three segments laterally rufotestaceous, the last almost entirely; anterior leg dark castaneous; anterior male femur toothed.

Range and Variation of the Two Subspecies

Dineutus serrulatus is a coastal plains species and apparently occupies small streams below 500 feet elevation from South Carolina to Texas. It consists of two subspecies, one eastern and one western (fig. 11).

The western subspecies *D. s. analis* inhabits the wider of the two subspecific ranges. In the west, it is found in eastern Texas from Kenedy County on the Gulf Coast inland to Brazos County and from there northeastward to Hempstead County, Ark. A large series of specimens from Hope, Ark., in Hempstead County collected from July 1 to July 19, 1925, by L. Knobel contained 16 specimens (collected on July 3) apparently from a locale different than that of the other specimens. The venter, underside of legs, and external genitalia of these individuals are strikingly, uniformly black. This color combination was not observed elsewhere. From southwestern Arkansas the apparent western boundary proceeds north to Stoddard County, Mo. In Missouri, specimens were collected from large drainage ditches and streams that drain into the St. Francis and Mississippi Rivers. From the Missouri "bootheel" area *D. s. analis* follows the Ohio River valley to the northernmost point of the known range, Orange County, Ind. Three large specimens, one male and two females, collected by T. S. Acker at West Baden, Ind., Sept. 27, 1961, are 12 mm in length and perhaps were collected at an elevation higher than 500 feet. From Orange County, Ind., the northern boundary descends south and east to Bullitt County, Ky., and then westward to Christian County, Ky., along the southern boundary of the valley.

The range then drops south along the Tennessee River and into Colbert County, Ala., where the Tennessee River Valley is a finger projecting eastward into northern Alabama. In southern Alabama and western Florida the range is narrowed to a width of about 125 miles by the Appalachian Mountains. Here, in this restricted area, occur intermediates in which the color of the venter changes from dark to light. Half of the specimens in series from Santa Rosa County, Fla., and from Houston County, Ala., have characteristic piceous venters (fig. 5). Along the Chattahoochee River in Alabama, specimens with light castaneous venters appear, but west of that area, in the same county (Houston), specimens are taken with piceous venters. In the finger of the Chattahoochee projecting north along the Alabama-Georgia border, specimens from Lee County, Ala., have light castaneous abdominal sterna.

Specimens from Houston County, Ala., collected by Mr. George Folkerts of Auburn University, suggest distribution patterns worthy of special note. These specimens are from two localities in Houston County. One site is the Chattahoochee State Park in the very southeastern corner of the county, where *D. s. serrulatus* was collected. The other is Bazemore Grocery, the location of a small spring from which *D. s. analis* was taken. This location is only 10-12 miles west of Chattahoochee State Park in the south-central part of the county.

The Bazemore Grocery spring flows into Cowarts Creek, a small tributary of the Chipola River, which merges with the Apalachicola River in Florida. Small streams in the Chattahoochee State Park from which *D. s. serrulatus* was collected drain into the Chattahoochee River, which in turn meets the Apalachicola River at the southwestern corner of Georgia.

During the Pleistocene, the Chipola River formed a distinct, separate drainage that flowed into the Gulf of Mexico. This situation precluded any fresh water connection with the Apalachicola River (Folkerts, 1966, in litt.) and may well have produced isolation that resulted in subspeciation. Young (1954, pp. 25-27) has discussed this area, its various plant refuges, and other instances of isolation.

Two collections of *D. serrulatus* lie outside the projected range of this species—one female of *D. s. analis* from El Paso, Tex. "AMNH Acc. 4858," and two males of *D. s. serrulatus* from Medora, Reno County, Kans. The latter most likely are mislabeled.

The boundary of *D. s. serrulatus* extends from Santa Rosa County, Fla., and Houston County, Ala., north to Lee County, Ala., eastward to Bibb County, Ga., and northeast to Baldwin County, Ga., where forms with slightly darker venters occur. The northern limit of the range of *D. s. serrulatus* is Richmond County, Ga. It then extends

southeastward along the Savannah River to Chatham County on the Atlantic Coast. Collecting in South Carolina may extend the range into that state.

Specimens of *D. s. serrulatus* from the southwestern limit of its range—Santa Rosa, Walton, and Calhoun Counties, Fla.—present a dark, smokey, castaneous venter that becomes reddish or castaneous in Franklin County, throughout the remainder of Florida, and throughout most of Georgia. The western border of the range of *D. s. serrulatus* then appears to be the eastern margin of the Piedmont Plateau.

Dineutus serrulatus analis is somewhat more variable over its large range than is *D. s. serrulatus*. The elytral apices of *D. s. analis* may be obtuse at the sutural angle (fig. 6), but they usually are produced (fig. 7). Both conditions can occur in a single series. The male profemoral tooth usually is prominent (fig. 3), but in a single series it may be either apparent or merely the truncation of a femoral carina (fig. 4). The external apical angles of the protibiae are rounded (fig. 10). This character is more apparent in the male than in the female, and in some female specimens the angle may even be distinct, but never produced. Bronzing of the dorsum is the most common condition, but specimens with a black dorsal surface are not uncommon.

Dineutus serrulatus serrulatus appears to be more constant in its characters than does the western subspecies. The elytral apices are not produced (fig. 8), but occasionally a tendency toward that condition may be seen in a few specimens with a more sinuous elytral apex than usual (fig. 9); in fact, this is the case with both of the type-specimens. The profemoral tooth of the male is always distinct and acute. The shining castaneous venter varies somewhat. In western Florida it appears uniformly darker, rather less reddish and slightly more brown, but never approaching piceous.

The differences in ventral coloration in species of *Dineutus* having a light venter appear to be associated closely with the tissue underlying the integument. The integument tends to be more or less transparent in these forms, and the color is largely dictated by underlying fat, muscle tissue, and internal organs that are darkened slightly by various brown or reddish pigments in the integument. Heating the specimens in water to relax them for genitalia extraction often detaches the underlying tissues from the integument, causing a darkening in color. Preserving methods and materials also can alter color, and, where the tissues are separated from the integument, the space separating them can be observed with correct lighting and magnification. Other factors affecting ventral color are the pygidial sacs of the repugnatory organ (see Brinck, 1955, for discussion of internal anatomy) and the exudations of these organs and musculature of the genitalia.

The two pygidial sacs lie laterally between the caudal abdominal segments and release a white liquid when the live insects are disturbed. The effect of alcohol or drying on this exudate are unknown but the pygidial sacs turn white. This color may be altered or masked outwardly by pigment in the body fluids; nevertheless, it shows through unpigmented or lightly pigmented integument. Where the integument is very darkly pigmented, like the piceous portion of the abdomen of *D. s. analis*, internal tissues are masked completely; but where pigmentation is light or lacking (e.g., portions of the last three ventral abdominal segments), tissues show through, presenting a light color. In the uniformly dark specimens from Hope, Ark., there is no absence of pigment in the caudal ventral segments, and all the ventral sterna are pigmented equally. The head, pronotum and elytra, and terga of the last three abdominal segments are pigmented heavily and darkly, but the thoracic sterna are pigmented like the abdominal sterna. The heavy and broadly attached thoracic muscles do not separate easily from the ventral integument; furthermore, they fill the thoracic cavity so completely that there is little change in ventral thoracic coloration regardless of treatment. The actual piceous pigmentation of most of the venter of *D. s. analis*, therefore, allows for little change in ventral coloration, except caudally, while the more lightly pigmented venter of *D. s. serrulatus* permits variation in color, depending on how the specimen has been treated.

The protibiae of *D. s. serrulatus* are rounded at the exterior apical angle. This character, as with the western subspecies, is more evident in the male but is constant in both sexes. The dorsum of the eastern taxon is usually black with an occasional bronze form occurring within a series. All specimens in both subspecies that are black dorsally show very faint bronzing under magnification, especially when viewed laterally and more especially on the lateral aspects of the pronotum and the head. The specimens studied (over 900) ranged from 9 to 12 mm in length (measured from the anterior margin of the clypeus to the elytral apices).

Literature Cited

AHLWARTH, K.

1910. Gyrinidae. *In* Coleopterorum catalogus, pt. 21, pp. 1-42. Berlin: W. Junk.

BLATCHLEY, W. S.

1919. Insects of Florida, Va: Supplementary notes on the water beetles. *Bull. American Mus. Nat. Hist.*, vol. 41, art. 4, pp. 305-322.

BRIMLEY, C. S.

1938. Insects of North Carolina, 560 pp.

HATCH, M. H.

1925. An outline of ecology of Gyrinidae. *Bull. Brooklyn Ent. Soc.*, vol. 20, no. 3, pp. 101-114.

1930. Records and new species of Coleoptera from Oklahoma and western Arkansas, with subsidiary studies. Publ. Univ. Oklahoma Biol. Surv., vol. 21, no. 1, pp. 15-26, 1 fig.
- HORN, W., and KAHLE, I.
1936. Über Entomologische Sammlungen. Ent. Beih. Berlin-Dahlem, vol. 3, pp. 161-296.
- LECONTE, J. L.
1868. The Gyrinidae of America north of Mexico. Proc. Acad. Nat. Sci. Philadelphia, vol. 20, pp. 365-373.
- LENG, C. W.
1920. Catalogue of the Coleoptera of America north of Mexico, 470 pp. Mount Vernon, N. Y.: John D. Sherman, Jr.
- LENG, C. W., and MUTCHLER, A. J.
1918. Insects of Florida, V: The water beetles. Bull. American Mus. Nat. Hist., vol. 38, art. 3, pp. 73-116, 2 figs.
- OCHS, G. H. A.
1926. Die Dineutini. Ent. Zeits. (Frankfurt A. M.), vol. 40, no. 5, pp. 112-126; no. 6, pp. 129-140.
1927. Über die Gyriniden von Linné und Fabricius. Koleopt. Rundschau vol. 13, pp. 34-42.
- RÉGIMBART, A.
1882. Essai monographique de la famille des Gyrinidae. Ann. Soc. Ent. France, ser. 6, vol. 2, pp. 379-468, 3 pls.
1884. Essai monographique de la famille des Gyrinidae. Ann. Soc. Ent. France, ser. 6, vol. 3, pp. 381-482, 4 pls.
1892. Essai monographique de la famille des Gyrinidae. Ann. Soc. Ent. France, vol. 60, pp. 665-752, 2 pls.
1902. Gyrinidae. In Genera insectorum, fasc. 1, pp. 1-12, 1 pl.
1907. Essai monographique de la famille des Gyrinidae. Ann. Soc. Ent. France, suppl. 3, vol. 76, pp. 137-245.
- ROBERTS, C. H.
1895. The species of *Dineutes* of America north of Mexico. Trans. American Ent. Soc., vol. 22, pp. 279-288, 2 pls.
- SCHWARZ, E. A.
1878. The Coleoptera of Florida. Proc. American Philos. Soc., vol. 17, pp. 353-372.
- SEVERIN, G.
1889. Catalogue des coleopteres de la famille des gyrinides. Ann. Soc. Ent. Belgique, vol. 33, pp. 149-179.
- YOUNG, F. N.
1954. The water beetles of Florida. Univ. Florida Stud., Biol. Sci. Ser., vol. 5, no. 1, 238 pp., 31 figs.

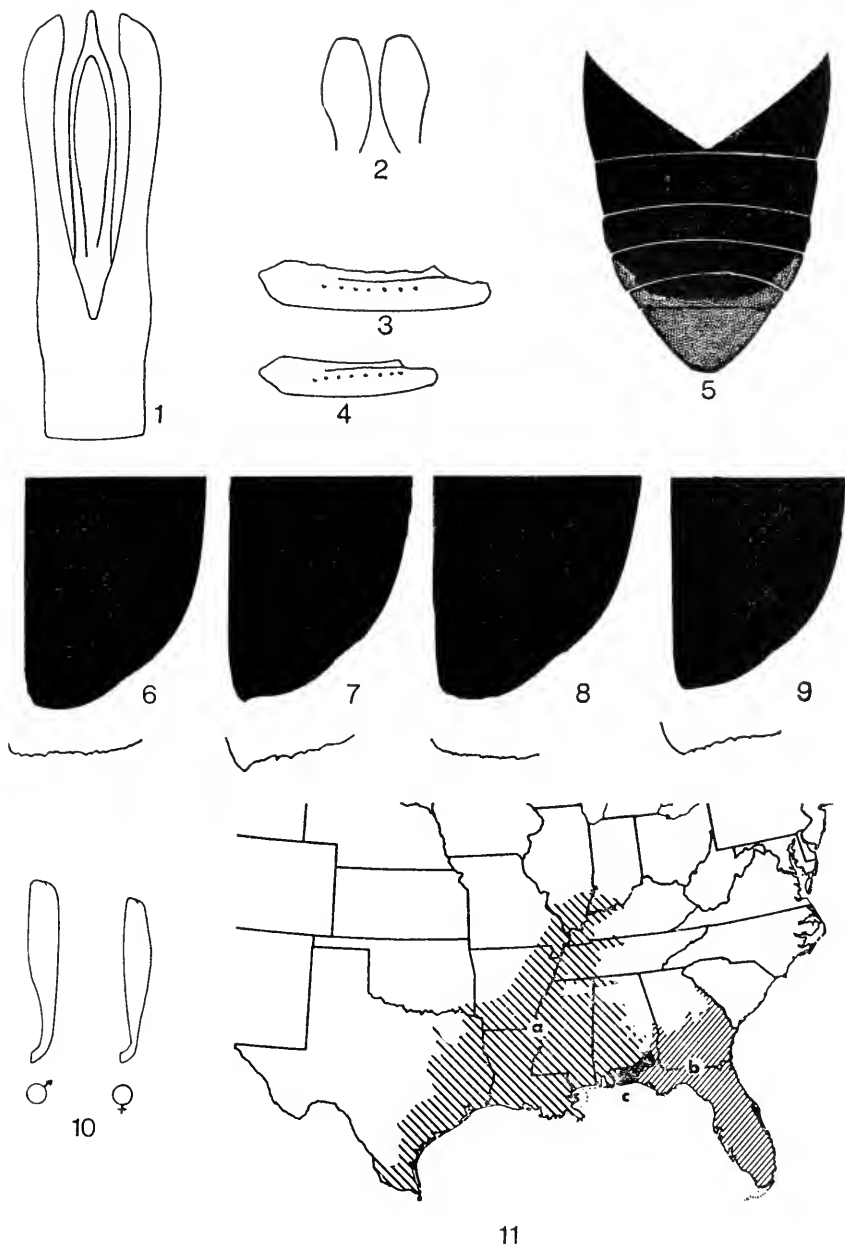

FIGURES 1-11.—*Dineutus serrulatus*: 1, male aedeagus; 2, female lateral lobes; 3, 4, male profemora, showing variation of profemoral tooth. *D. s. analis*: 5, venter; 6, 7, apical half of right elytron with serrulation of sutural angle enlarged. *D. s. serrulatus*: 8, 9, apical half of right elytron with serrulation of sutural angle enlarged; 10, male and female protibiae. Range: 11 (a=*D. s. analis*; b=*D. s. serrulatus*; c=area of overlap between subspecies).

Proceedings of
the United States
National Museum



SMITHSONIAN INSTITUTION • WASHINGTON, D.C.

Volume 124

1968

Number 3647

The Suborders of Perciform Fishes

By William A. Gosline¹

Senior Post-Doctoral Fellow, Division of Fishes

Introduction

The basic concept and limits of the order Perciformes (Percomorphi) as defined by Regan (in various papers but especially 1929) seem to me to be the best yet proposed. Patterson (1964) has presented the view that the Perciformes are polyphyletic. In the same broad sense that mammals are polyphyletic (cf. Simpson, 1959) this may well be, but the particular lines of polyphyletic perciform derivation drawn by Patterson (1964) seem highly unconvincing (Gosline, 1966b). Still more recently, Greenwood, et al. (1966), have removed some of the forms here included in the perciform fishes to the separate superorders Atherinomorpha and Paracanthopterygii. This action, which seems to me to involve a confusion between convergence and inheritance, is in my opinion untenable (see below). Various people, including Regan (1936) and the present author (1962), have tinkered with the boundary lines established by Regan (1929) for the Perciformes. Of such authors, Berg (1940) made the most drastic changes. The question of whether to include certain groups in or exclude them from the Perciformes is certainly moot. Here, aside from the exclusion of the callionymoid fishes, I follow the old perciform boundaries of Regan (1929).

¹ Department of Zoology, University of Hawaii, Honolulu 96822.

The present paper is addressed to the problem of how best to arrange and classify the fishes that make up the order Perciformes. Attention has been focused on the subordinal and superfamilial levels. Families have been considered only insofar as they have been misplaced or indicate what fishes are included in a suborder or superfamily. Such formal family classifications as have been included are not original, and the sources from which they have been adopted are stated.

It has, of course, been possible to examine only a small proportion of the thousands of species included in the Perciformes. Selection of material for investigation has been made on two bases. The greatest amount of time has been spent on the most controversial groups, notably the Blennioidei. Within a group the morphologically generalized members have been investigated.

Names used throughout this paper are conventional. In no instance has an effort been made to solve nomenclatorial problems with regard either to bone or fish names.

ACKNOWLEDGMENTS.—Almost all of the work on which this paper is based has been done during tenure of a Smithsonian Research Associate-ship. For space and facilities in the Fish Division of the U.S. National Museum during the year 1965–1966, I am greatly obligated to the staff of that Division, especially to its Curator, Dr. E. A. Lachner. The majority of the material investigated is in the U.S. National Museum. I would like also to thank Drs. D. M. Cohen and D. W. Strasburg of the U.S. Fish and Wildlife Service and Drs. J. Böhlke and J. C. Tyler of the Academy of Natural Sciences of Philadelphia (ANSP) for the loan of specimens. Though I have benefited greatly from discussion with all of the ichthyologists in the U.S. National Museum, I would like specifically to acknowledge the help of Dr. D. M. Cohen with the ophidioids, of Drs. B. B. Collette and R. H. Gibbs with the scombroids, and of Dr. V. M. Springer with the blennioids, all of whom have been kind enough to read one draft or another of the section on the groups mentioned.

The original manuscript of this paper, submitted in December 1966, was revised and brought up to date in August 1967. Both drafts have been typed by my wife, whose assistance gratefully is acknowledged.

Material Examined

Unless otherwise noted, all material investigated forms part of the U.S. National Museum fish collections. Specimens that were examined merely for superficial characters will not be listed. Other material falls into four categories: a very few of the specimens were cleared and stained by the trypsin method developed at the USNM by Dr. W. R. Taylor; a number of forms were X-rayed through the courtesy of the USNM Fish Division; some of the skeletons in the skeleton collection

of the Fish Division were utilized; and the majority of the material listed consists of single preserved specimens, one side of which has been dissected more or less completely with or without alizarin staining. Aside from a few specimens that disintegrated during staining, the specimens, along with their dissected parts, are now back in the bottles from which they came.

Names of species are those on the USNM bottles, except in one or two instances wherein the generic name obviously was incorrect.

ANABANTOIDEI.—Specimens of *Ophicephalus* species (148517), *Anabas testudineus* (102556), and *Osphronemus goramy* (12876).

Specimens of *Nandus marmoratus* (44785) and *Pristolepis fasciatus* (107835) were stained and dissected.

One specimen of *Luciocephalus pulcher* (35737) was X-rayed.

Among comparative material, one stained and cleared (17428) and one stained and dissected (8568) specimen of *Centrogenys marmoratus* and one partially dissected *Toxotes jaculatrix* (174913) were examined.

ACANTHUROIDEI.—Partially dissected specimens of *Teuthis oramin* (195521), *Zanclus canescens* (82945), and *Prionurus sculprum* (3882).

SCOMBROIDEI.—The stained and partially dissected specimen, about four inches long, upon which the account of *Scombrolabrax* is based was loaned to me by Dr. D. W. Strasburg. The original description was checked subsequently against a series of *S. heterolepis* (USNM 187651), one of which was stained.

A whole series of tuna and mackerel skeletons in the collections of the USNM and the University of Hawaii was examined for the pineal organ.

OPHIDIOIDEI.—One X-rayed specimen of *Gadopsis marmoratus* (ANSP 81566) kindly loaned by the Philadelphia Academy of Natural Sciences. One stained and partly dissected specimen of the same species (48813).

Two stained and partially dissected specimens of *Neobythites gilli* (200553) and one of *Dicrolene intronigra* (200554).

One partly dissected specimen of *Brotula barbata* (131279). One stained and partly dissected *Lepophidium negropinna* (197144).

Among comparative material, one stained and partly dissected *Phycis regius* (190434) and one "Macruridae" (158664) were examined.

BLENNIOIDEI.—Parapercidae: one partly dissected *Prolatilus jugularis* (176470) and an X-ray of the same species (77365); X-rays of *Mugiloides chilensis* (114930), *Pinguipes brasiliensis* (83241), and *Parapercis allporti* (179797); partly dissected *P. cephalopunctata* (1430785).

Trichonotidae (sensu lato): one partly dissected *Hemerocoetes* species? (177085); one skeleton (26335) and one stained and partly dissected specimen of *Bembrops gobioides* (158132).

Cheimarrichthyidae: one stained and partly dissected *Cheimarrichthys fosteri* (198510).

Bovictidae: one partly dissected *Cottoperca gobio* (114925).

Nototheniidae: one stained and partly dissected *Trematomus pennellii* (179676) and one partly dissected *Eleginops maclovina* (77319).

Harpagiferidae: one stained and partly dissected *Harpagifer bispinis* (77282).

Trachinidae: partly dissected *Trachinus draco* (31064), *T. vipera* (39473), and *T. radiatus* (2213).

Uranoscopidae: one partly dissected *Uranoscopus japonicus* (122508)

Dactyloscopidae: one slightly dissected *Dactyloscopus crossotus* (114411).

Leptoscopidae: one slightly dissected *Leptoscopus angusticeps* (39684).

Congrogadidae: one stained and partly dissected *Congrogadus subducens* (173805).

Notograptidae: one stained and partly dissected *Notograptus guttatus* (173798).

Tripterygiidae: one stained and partly dissected *Enneapterygius theostoma* (71528).

Clinidae: one stained and partly dissected *Labrisomus nuchipinnis* (uncataloged); one partly dissected specimen of *Clinus superciliosus* (93637).

Blenniidae: one partly dissected *Blennius cristatus* (185376); one stained and partly dissected specimen of *Runula tapeinosoma* (195704).

Bathymasteridae: one skeleton (26230) and one partly dissected *Bathymaster signatus* (111994); one partly dissected *Ronquilus jordani* (103689).

Anarhichadidae: a partial skeleton of *Anarhichas lupus* (110814).

Cryptacanthodidae: one skeleton of *Cryptacanthodes maculatus* (26512).

Zoarcidae: one stained and partly dissected *Lycodes* species? (177654); one partly dissected *Zoarces viviparus* (10065); a partial skeleton of *Z. anguillarum* (26498).

A good deal of additional material, not included in the Blennioidei, was used in delimiting it.

The Basis of Perciform Classification

The Perciformes are the largest order of modern fishes. The classification, like that of fishes in general, has evolved piecemeal over the years; nevertheless, out of the efforts of such ichthyologists as Jordan and Regan, the classification of the Perciformes (and of the higher teleostean fish orders) has developed a largely unstated but nonethe-

less real structural coherence. This basic structure is accepted here, and such changes in subordinal status as are suggested have been made with the idea of strengthening rather than altering it. A brief account of the basis of perciform classification may help to explain this.

The basal percoid fishes represent the greatest focal point of fish evolution that exists today. Some 50 families of these with thousands of species generally are recognized, and they dominate all of the richer marine fish faunas. The families are differentiated on relatively slight bases but to require any other would result in one tremendous, taxonomically meaningless, and unmanageable family. As it is, the Serranidae (*sensu lato*) has been tending in that direction (Gosline, 1966a).

It is assumed that from the basal percoids an adaptive radiation has taken place. Some of the lines of development have differentiated very little, in which case they are still included with the basic stock; others, considered separate superfamilies, somewhat more; separate suborders, more still; and derivative orders, most of all. The question which fish belongs in which taxon and why constitutes the subject of perciform classification. Some of the theoretical and practical problems will be discussed briefly here.

The basic difficulty is the old one of vertical vs. horizontal classifications. Stated briefly: if, in figure 1a, the lineages, represented by

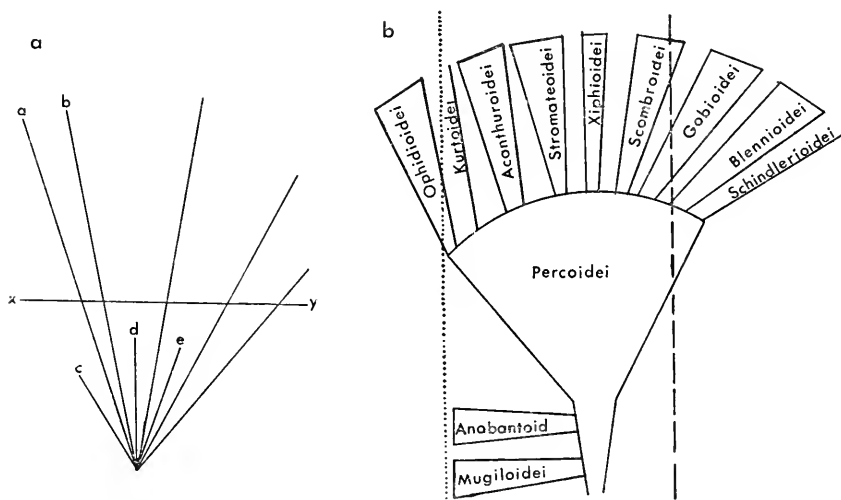

FIGURE 1.—Diagrammatic representation of perciform radiation: *a*, hypothetical (see p. 6 for lettering); *b*, with actual suborders included. (At right of broken line in *b* are those forms with dorsal and anal soft rays showing exact 1:1 correspondence with vertebrae; to left of dotted line forms have about 2+ dorsal and anal rays per vertebra; between dotted and broken lines normal ratio of 1+ ray per vertebra is maintained.)

the radiating lines, are traced back to their bases, in this case into the basal mass of percoid families, then how does one distinguish them? Contrariwise, if a line XY , representing some theoretical stage of structural development, is drawn across the radiating lines and everything below XY is called a suborder Percoidae, then how does one classify the parts of the radiating lines above XY ?

Omitting from present consideration the mugiloids and anabantoids, Regan (1913), followed herein, places all of the Perciformes below a theoretical line XY in the suborder Percoidae. Matsubara (1955, 1963), following the lead of Jordan and others, adopts what is probably a more consistent approach and divides the areas both above and below XY into separate divisions; e.g., the Percina, Chaetodontina, Carangina. As far as I can determine, there are no concrete morphological criteria for the separation of the more basal groups, and a decision as to which of the basal percoid families should be assigned to which section has to be made on a largely intuitive or authoritarian basis. Furthermore, I feel no intuitive assurance that such a group as the Chaetodontina is not an assemblage of similar-looking but unrelated fishes. It may well be that when other and sharper tools are devised for investigating the relationships of percoid families (see, e.g., Freyhof, 1963) elimination of the line XY and the basal suborder Percoidae will prove feasible. For the moment, however, recognition of a central group Percoidae seems preferable.

Such a recognition, as already noted, causes difficulties in the treatment of the percoid-derivative taxa. If all of the radiating lines below XY (for example c , d , and e) are considered to belong to the single suborder Percoidae, then should all the individual lines above XY , however close (for example a and b), be considered separate suborders? Regan (1929) seems to have adopted essentially this course in recognizing the Siganoidea (Teuthidoidea) as distinct from the related Acanthuroidea, the Scombroidea distinct from the Trichiuroidea, etc. In this, I do not follow him. In the first place, I can see no compelling logic in the procedure. In the second, it has the practical result of creating a tremendous basal suborder Percoidae with numerous splinter offshoot suborders. Here, the concept of a derivative percoid suborder is that it should contain fishes more closely related to one another than to any other fishes outside the boundary of the suborder Percoidae. This concept admits the possibility that a derivative suborder may have been polyphyletic at the time it crossed the line XY . In practice (fig. 1*b*) it has the effect of combining certain of Regan's (1929) suborders.

Another problem of perciform classification is that of determining which lineages should be recognized as derivative suborders rather than as full orders. Many factors have a bearing on this question.

One is logical consistency. The callionymoids are a case in point. I believe that the callionymoids, like the gobiesocids, are notothenioid derivatives. Thus, unlike the other suborders recognized herein, the callionymoids would seem to be derivatives of derivatives of the percoids. To be consistent, therefore, they should not be placed in parallel with the other suborders recognized here but either should be included in the notothenioids or be removed from the Perciformes entirely. Of these alternatives, I prefer the latter. From the point of view of classification, the callionymoids then would have a position analogous to that of the Tetraodontiformes (which seem to have arisen from the percoid suborder Acanthuroidei).

In general, recognition of a group as a separate superfamily, suborder, or order is based on degree of morphological differentiation, precedent, and the size of the group under consideration. As to the last factor, the generally accepted dictum "that the size of the gap [between units] be in inverse relation to the size of the unit" (Mayr, 1943, p. 139) has been adopted. Thus, the large group Scorpaeniformes is considered herein a separate order from the Perciformes, though the known differences between the two units are not great (cf. Berg, 1940; Matsubara, 1953). Conversely, though the above dictum militates against small units, the complete elimination of certain small perciform suborders does not appear feasible at the present time. Thus, to combine the Kurtoidei, containing but a single genus, with any other perciform suborder would seem to abrogate phylogenetic principles. The same is true of the Schindlerioidei. Again, I have come to the somewhat reluctant conclusion that the Istiophoridae, Xiphiidae, and Luvaridae bear no real relationship to the scombrid fishes and must, at least provisionally, be placed in a separate suborder by themselves (see p. 28).

Finally, there arises the question of how to draw the line *XY* in figure 1*a*. One could draw such a line with a view to creating a definable basal suborder Percoidei. This would leave bits and pieces of radiating lineages outside the line *XY* to be tucked away in one suborder or another as decorously as possible. In practice, the line *XY* has been drawn with an eye to creating coherent derivative suborders. In figure 1*a*, therefore, *XY* should have been drawn as a zigzag line, dipping more or less deeply into the basal Percoidei at different points. In practice, then, the Percoidei contains all those perciform fishes that do not belong to some other suborder. The Percoidei presumably contain related fishes, but defining it morphologically in positive terms is difficult.

With regard to the derivative suborders, as knowledge increases, more and more structurally transitional forms between these and the basal Percoidei become known. Thus, to a greater or lesser extent,

Scombrolabrax (see p. 33) closes the structural gap between the percoids and the scombroids, *Gadopsis* (see p. 26) that between the percoids and the ophidioids, and a new family for which only a provisional notice has so far been given (Haedrich, 1967b) is stated to be intermediate between the percoids and the stromateoids. With such gaps being filled in, the separation of perciform suborders into neat, precisely definable pigeon holes becomes increasingly impossible.

The classification of the Perciformes to suborder adopted here is as follows:

- Order Perciformes
 - Suborder Mugiloidei
 - " Anabantoidei
 - " Percoidei
 - " Kurtoidei
 - " Acanthuroidei
 - " Ophidioidei
 - " Stromateoidi
 - " Xiphioidei
 - " Scombroidei
 - " Gobioidi
 - " Blennioidei
 - " Schindlerioidei

"Protopercoid" Suborders

Though the great majority of modern perciform fishes belong to the basal suborder Percoidei and its derivatives, there are two groups that at least may have developed from a "protopercoid" stock, namely the Mugiloidei and Anabantoidei.

The main, and only significant reason for considering this possibility is that the Mugiloidei always and the Anabantoidei often lack a direct articulation between the pelvic bones and the cleithra. This condition suggests the subabdominal pelvic position of prepercoid orders. Various interpretations are possible, however, and I am not sure which one is correct. First, as already suggested, the Mugiloidei and/or Anabantoidei may have evolved from a protopercoid stock in which a direct connection between the pelvics and cleithra had not yet developed. A variant of this hypothesis, again postulating a protopercoid ancestry for the Mugiloidei and/or Anabantoidei, would be that in the protopercoids, as in the berycoids, the pelvic-cleithral relationship remained variable, a more or less fixed articulation between the two elements only becoming established at the percoid stage of development. Under this thesis, the Mugiloidei would represent the nonarticulated aspect of protopercoid inheritance, whereas in the Anabantoidei the whole gamut of protopercoid pelvic variation still would be represented. Conversely, it may be, as Dollo (1909) has suggested, that the lack of a pelvic-cleithral articulation in the

Mugiloidei and in some of the Anabantoidei represents a secondary loss; certainly such a loss has occurred in such other percoid derivatives as the Stromateidae, Tetragonuridae, Gempylidae, and Trichiuridae (Regan, 1909a).

Because of the possibility that the Mugiloidei and Anabantoidei diverged from a protopercoid stock somewhat ahead of the other existing Perciformes, they will be dealt with first. Whether these two suborders, however, are considered as "protopercoid" (fig. 1*b*) or percoid derivatives is of no great moment for overall Perciformes classification.

Suborder MUGILOIDEI

The suborder Mugiloidei, as understood herein, contains the Polynemidae, Mugilidae, Sphyrænidae, Atherinidae, and phallostethoid families. Rosen (1964; and *in* Greenwood, et al., 1966) recently has removed the Atherinidae and phallostethoid families to a separate order Atheriniformes of the superorder Atherinomorpha. This order and superorder I believe to comprise three unrelated groups—the exocoetoids, the cyprinodontoids, and the atherinoids—all of which are adapted basically to living at or very close to the water surface and, consequently, have developed numerous features in common. The question of an atherinid-cyprinodontoid relationship has been discussed widely in recent years (e.g., Hubbs, 1944; Rosen, 1964; Greenwood, et al., 1966; and Foster, 1967). I have nothing to add to or subtract from what I have said already on the subject (1961*b*, 1962, 1963). Alexander (1967) recently has discussed the jaw structure of the two groups.

In an earlier paper (Gosline, 1962), I advocated the exclusion of the Mugiloidei from the Perciformes as a separate order, largely because of the consistent lack of a direct articulation between the pelvic girdle and the cleithra. At that time, I was unaware of the whole range of variation in this characteristic that occurs in the Anabantoidei. Because of the doubt thrown on the character of the pelvic-pectoral articulation by the anabantoids, as well as on other grounds (Freihofer, 1963), it seems advisable to return the mugiloid fishes to the Order Perciformes.

Suborder ANABANTOIDEI

The suborder Anabantoidei, as recognized herein contains the Ophicephaliformes and Anabantoidei of Berg (1940) and Liem (1963), and the Luciocephalidae (Liem, 1967). The morphological divergence among these three groups is not contested. It seems to me, however as it did to Regan (1909*b*), that they are related more closely to one another than to any other fishes. They hold in common three morphological features that are highly peculiar among acanthopteran fishes:

a suprabranchial air-breathing organ, a gas bladder that extends posteriorly well behind the body cavity, and teeth usually present on the parasphenoid. With regard to the last feature, Liem (1967, p. 108) describes the parasphenoid of *Luciocephalus* as toothless, but according to Regan (1909b, p. 768) there are "two or three minute teeth on the parasphenoid." It may be that in the Luciocephalidae the presence of parasphenoid teeth is a variable feature, as indeed it is among the ophiocephalids and anabantids (*sensu lato*). Additional suggestions of a relationship among the three groups are their freshwater, Old World distribution, centering in southeast Asia, and their nest-building and/or oral-incubating proclivities. It seems most unlikely that all these features are the result of convergent evolution from independent origins.

As already noted, the pelvic girdle of some of the Anabantoidei is remote from the cleithra (*Ophicephalus*=*Channa*, *Anabas*); in others, it articulates directly with the cleithra in typical percoid fashion (*Betta*, *Colisa*, *Trichogaster*). Furthermore, in *Ophicephalus* the pelvic fin consists of six segmented rays. If the outermost pelvic rays of *Ophicephalus* represent the usual percoid pelvic spines transformed back into soft rays, such a secondary regression is only represented elsewhere, to my knowledge, among the Pleuronectiformes (Hubbs, 1945).

Among the anabantoids are found two seemingly atavistic characteristics. One, discussed at length by Liem (1967), is the presence of a mental ossification that closely resembles the gular plate of elopoid and earlier fishes. My own belief is that the mental ossification of *Luciocephalus* is not a true gular plate. The other characteristic is the parasphenoid teeth already mentioned. Aside from two other percoid families (see below), teeth on the parasphenoid are not found in the Teleostei above the elopoids. Why they should reappear in the anabantoids and two other percoid families I do not know, but again it seems to me that a postulate of reappearance is preferable to one of inheritance.

In searching for possible anabantoid relatives, one is led naturally to the two percoid families that also have parasphenoid teeth: the Nandidae and Pristolepidae. The "bite" provided by the parasphenoid dentition of *Pristolepis* is quite different from that of *Nandus* (which resembles that of *Ophicephalus*), just as that of *Ophicephalus* differs from the parasphenoid apparatus of the anabantids (*sensu lato*). Aside from the parasphenoid dentition, *Nandus* and *Pristolepis* appear to be rather normal percoids, lacking such specialized anabantoid features as the accessory air-breathing organ and the backwardly extended gas bladder. They do bear certain features, however, suggesting an anabantoid relationship. First, all of these fishes have an expanded auditory bulla on the cranium. Second, *Ophicephalus* (fig. 2a),

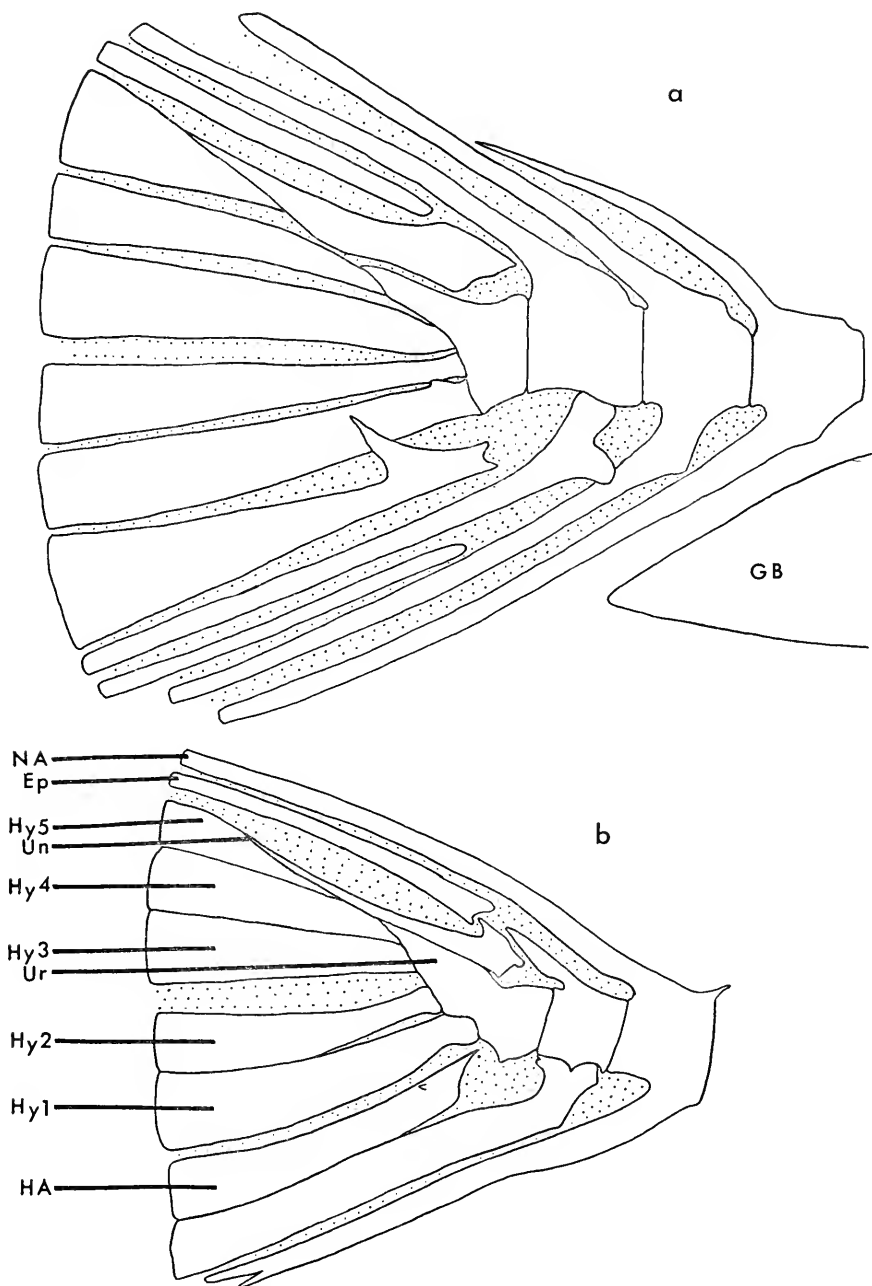

FIGURE 2.—Caudal skeletons: *a*, *Ophicephalus* species; *b*, *Pristolepis fasciatus*. (Ep=epural, Gb=gas bladder, Ha=hemal arch, Hy=hypural, Na=neural arch, Un=uroneural, Ur=urostyle.)

Anabas, and *Pristolepis* (fig. 2b) hold in common certain peculiarities of the caudal skeleton. In all three, there is the full percoid complement of five hypurals (using Nybelin's [1963] system of counting); these are all subequal in width and splayed out like the spokes of a fan. There is only one epural, and the last hemal arch is not in contact with the urostyle. (Judging from X-ray photographs [e.g., Liem, 1967, fig. 9], *Luciocephalus* seems to have a specialized version of the same basic type of caudal structure.) Finally, there is the fact that the Nandidae and Pristolepidae, like the Anabantoidei, are freshwater fishes with a distribution center in southeast Asia.

The PERCOIDEI and Derivative Suborders

The suborder Percoidei comprises the central mass of the perciform fishes; its members dominate the richer marine fish faunas today, notably those of coral reefs.

An ecological peculiarity that is at least worth noting is that many of the percoid families that, on morphological grounds, seem to stand at the base of the suborder contain or comprise euryhaline and/or freshwater forms; e.g., the Centropomidae, Percichthyidae, Kuhliidae, Centrarchidae, Percidae, Nandidae. The same is true of the "prepercoid" families Mugilidae, Atherinidae, Phallos-tethidae, Ophicephalidae, Anabantidae, and Luciocephalidae.

As compared with the presumably ancestral Beryciformes, the percoids seem to differ in no one important character (Gosline, 1966b); rather, judging by living forms, they appear to have integrated a number of minor features in what amounts to an advance over the Beryciformes in general adaptiveness. Again judging from the observation of living forms, the most satisfactory answer to the question of wherein this advance lies seems to be in an increase in swimming abilities in the percoids.

On the other hand, if the suborders and orders derived from the percoids are compared with the Percoidei, it becomes clear that each of these derived taxa has adopted some specialized mode of life; thus, of derivative percoid suborders, the xiphioids, scombroids, and schindlerioids have taken up an existence in the open sea, the gobioids and blennioids have adopted a life in direct contact with the bottom, the acanthuroids and stromateoids have developed specialized food habits, etc. But, again, most of these specializations have involved further changes in methods of swimming and maneuvering. Indeed, this aspect of existence runs so continuously through the evolution of the percoids and their derivatives that it seems well to take it up by way of an introduction to these groups.

The adult percoids are mostly maneuverers living close enough to the bottom to use it for protection but not maintaining direct physical

contact with the bottom (at least during the day). Though the defensive armature of percoids is less extensive than that of most living berycoids, the percoids seem to have provided the pelvic spines with a firmer base in the development of a direct pelvic-cleithral attachment. In bringing the pelvics forward under the pectorals, the percoids also seem to have increased their ability to maneuver. Harris (1938) showed that acanthopteran pectorals are so constructed as to give an upward thrust to the front of the fish when erected for the purpose of turning or stopping and that erection of the pelvics at the same time offsets this. In this respect, the pelvics seem to counteract the pectorals more efficiently if they are directly below the pectorals rather than behind them, as they are in lower fishes and still, to some extent, in most Beryciformes.

For the paired fins to be effective in stopping or turning, a forward speed ("headway") must have been generated previously. This is usually developed by the vertical fins and the body. Among the lower percoids, the forked caudal fin, a basal teleostean feature, plays a large role. Gero (1952) has shown that, for a swimming fish, a forked tail shape is the most efficient. From this basal type, found in such a lower percoid as *Roccus* (= *Morone*), two divergent lines of development have occurred. One is carried to its extreme in the Scombridae. Here, the widely forked fin has a short, high, relatively stiff blade firmly attached to the caudal skeleton at the end of a slender caudal peduncle. This type provides great power and speed, but it has its limitations. Harris (1953, pp. 26, 27) stated: "Tails of this type are found in fishes which are fast *continuous* swimmers (scombroids); if a sudden burst of speed from a standing start is required, the angle of attack of this type of tail would be too high and the tail would 'stall'." At the opposite extreme is the rounded caudal that has been developed again and again in percoids and their derivatives. Such a caudal shape not only provides a better "getaway" mechanism but seems to be a more efficient (or perhaps accurate) propulsive force at slow speeds and in enclosed areas.

Aside from caudal shape, there are other factors that affect the forward locomotion of the percoids and their derivatives (fig. 3). Thus, when a fish becomes either very deep-bodied or very elongate, the potentiality for rapid locomotion seems to be lost. At both extremes, the importance of the caudal fin as a source of forward thrust diminishes. Such a deep-bodied form as *Chaetodon* has a relatively long posterior border to the body, covered by the soft dorsal and anal fins, and a short, brushlike tail. In moving forward, it flaps the whole rear portion of the body, of which the tail is only an insignificant part. The end point in such a line of development is of course the tetraodontiform *Mola*, which has no caudal fin at all.

Elongate perciform fishes usually move forward by undulation, but this may be by two very distinct methods. In one, the fish holds its body more or less rigid and undulates the dorsal and anal fins only. In these forms, the dorsal and anal soft fins tend to be long and the fin rays to be closely spaced (i.e., two or more per vertebra), inserted basally on a sort of ball and socket axis, and with well-developed musculature. Locomotion by means of fin undulation seems to provide precision of movement rather than speed and enables the fish to move backward or forward with almost equal ease. Such a method of locomotion has been developed frequently among the lower teleosts; e.g., gymnarchids, gymnotids, probably halosaurids and macrourids, and the Syngnathiformes. It occurs, however, only in the ophidioids among the Perciformes (fig. 1*b*), and in the Tetraodontiformes.

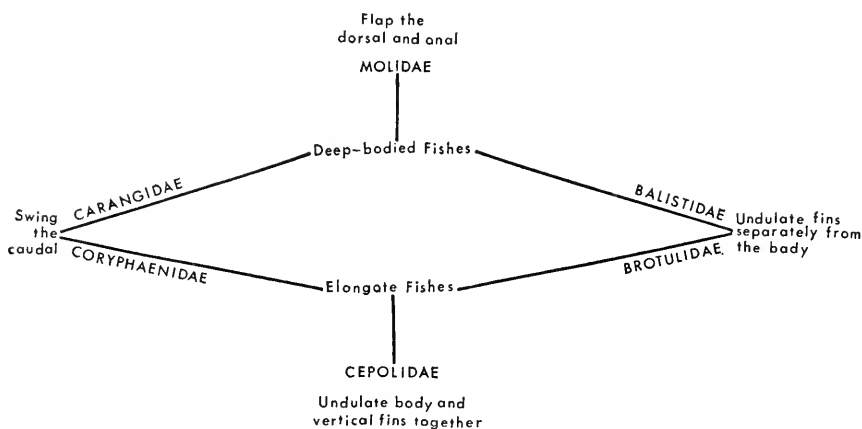

FIGURE 3.—Diagram of certain types of forward motion in the perciform fishes and their derivatives.

The other, more usual method of locomotion among elongate perciform fishes and their derivatives is for the fish to undulate its body and fins together. Here, the vertical fins tend to coordinate their structure as well as movement with that of the body, the relationship between soft dorsal and anal fin rays and vertebrae becoming 1:1. Generally, also, the number of vertebrae in such fishes is increased over the basal percoid number of 24 or 25. This development of a 1:1 ratio between soft fin rays and vertebrae in elongate perciform fishes occurs again and again (fig. 1*b*). Sometimes it occurs in free-swimming forms like the Cepolidae or Schindleriidae, but more frequently it develops in bottom-resting forms.

Whereas the great majority of the lower percoids and, for that matter, of lower teleosts, live constantly in midwater, i.e., off the bottom, a great many adult percoid derivatives have taken up a life in direct contact with the bottom, making only short dashes to obtain food or to avoid enemies. Some of the various percoid derivatives that have adopted this habit are the Blennioidei, Gobioidi, Scorpaeniformes, Pleuronectiformes, Gobiesociformes, and many Lophiiformes. The fin requirements of such forms are in many respects almost opposite to those of a swimming fish. An account of them can be deferred best to the section on the suborder Blennioidei (see p. 48).

Of the suborders among the Percoidei and their presumed derivatives, there are some for which I can add little or nothing to existing knowledge. It seems well to deal with these first, leaving until last those suborders to which the major portion of the present investigation has been devoted.

Suborder PERCOIDEI

For purposes of the present paper, the superfamily (division) classification of Regan (1913, p. 112) will be accepted, except that his Gadopsiformes, Nototheniiformes, Callionymiformes, and most of his Trachiniformes have been removed and, following Norman (1929), the Chiasmodontoidae have been added. Here, Regan's Gadopsiformes are included in the Ophidioidi; the Nototheniiformes and most of the Trachiniformes have been placed in the Blennioidei; and the Callionymiformes have been taken out of the order Perciformes. The only family of Trachiniformes retained in the suborder Percoidei is the Opistognathidae, and this seems to belong in the superfamily Percoidae, close to the Acanthoclinidae. The Trachiniformes of Regan, thus, is abolished.

Suborder KURTOIDEI

This suborder consists of a single genus. The anatomy of this peculiar fish has been described by de Beaufort (1914). I can add only that, in six specimens of *Kurtus indicus* examined, five had 15 and one had 14 branched caudal rays; de Beaufort and Chapman's (1951, p. 82) statement that the suborder has the "Caudal with 17 divided rays" seems to be in error.

Suborder SCHINDLERIOIDEI

This is another perciform suborder based upon a single isolated genus. The fish is neotenic, but its peculiar caudal supporting structure seems to be unique among fishes of any stage of ontogenetic development (Gosline, 1959). The most recent of the varied suggestions concerning the relationships of *Schindleria* is that it might have evolved from something near the ammodytoid *Hypoptichus* (Gosline, 1963).

Suborder STROMATEOIDEI

No examination has been made of any stromateoid by the present author. A recent review of the group, however, has been provided by Haedrich (1967a).

Suborder GOBIOIDEI

Certain of the families formerly placed in the blennioids have been moved to the Gobioidae by me (Gosline, 1955), but I have nothing to add to that paper.

Suborder ACANTHUROIDEI

The zancrids, acanthurids, and siganids (teuthidids) herein are considered members of a single suborder. The relationships among the three groups, to my knowledge, have not been disputed. The question merely is whether the siganids represent a sufficiently aberrant offshoot of the acanthurid stock to warrant a separate suborder. Starks (1907) was in doubt about the matter. From the overall view of perciform fishes taken in this paper it seems preferable to consider the siganids as one of the two superfamilies in the suborder Acanthuroidei.

The primary specialization of these fishes seems to be the development of a nipping type of jaw structure. Gregory's (1933, pp. 279-283) analysis of this structural complex and the relationships of these fishes appears to me to be entirely correct. He raises what seems to be the only important taxonomic question regarding the group; namely, whether or not it should be removed entirely to the Tetraodontiformes, which it foreshadows.

In this connection, the "prepalatine" bone (Starks, 1907, 1926) of the Siganidae (Teuthididae) warrants brief mention. In the siganids, as in the Tetraodontiformes, the upper jaw, instead of being protrusile as in most percoids, rocks in and out on the tip of the palatine as a fixed point. In the Tetraodontiformes, the whole palatine may become attached rigidly to the cranium and remain free from the rest of the suspensorium. In the siganids, a somewhat different system has been developed to accomplish the same end. The palatine bone has become divided into two parts, with the rear portion attached to the rest of the suspensorium as usual. The front portion, i.e., the "prepalatine" bone, however, has developed as a separate element from the rest of the palatine and has developed a firm attachment to the inner surface of the expanded nasal bone above and of the lacrimal below. The nasal in turn has a rigid, sutured attachment on the front of the cranium.

Suborder OPHIDIOIDEI

The suborder Ophidioidei (treated as an order by Mead, Bertelsen, and Cohen [1964, p. 580] without comment), as generally understood, contains the fishes included in the families Brotulidae, Aphyonidae, Ophidiidae, Pyramodontidae, and Carapidae. To these I add the family Gadopsidae for reasons dealt with below.

The suborder may be defined as follows: pelvics, when present, of one or two filamentous rays on each side, originating ahead of the pectoral fins; dorsal and anal long, without spines except in *Gadopsis*, the rays more numerous than the vertebrae between them; one or more of the first few ribs usually expanded.

To the end of the last century, the ophidioids, along with the gadoids, blennioids, and other fishes with anterior pelvics, generally were placed in an assemblage known as "Jugulares." In 1903b, Regan concluded (p. 460) "that the Blennioid fishes [in which Regan at that time included the ophidioids] are modified Acanthopterygii, but that the Gadoids have originated from some less specialized stock, and that the absence of non-articulated fin-rays, the large number of rays in the ventrals, and the lack of direct attachment of the pelvic bones to the clavicles, taken together must be regarded as primitive characters." Between 1903 and 1966 (Greenwood, et al., 1966) this separation of the gadoids from the blennioids and ophidioids generally has been accepted.

In 1903b, as noted, and again in 1912d, Regan included the ophidioids in his perciform suborder Blennioidea. In 1929, however, he segregated them as a separate perciform suborder "Ophidioidea." The later allocation appears to me to be correct.

The clarity of the distinction between the percoids and the ophidioids, however, is obscured considerably by the Australian genus *Gadopsis*, a morphological intermediate usually placed among the percoids but herein assigned to the ophidioids.

In my opinion, the basic specializations of the ophidioid fishes lie along two probably interrelated lines. One involves locomotion and the other sensory systems. The presumed nature of these will be discussed before dealing with general characters.

In the basal percoids (see p. 5), there are somewhat more fin rays than vertebrae, but the relationship is indeterminate (François, 1959). *Gadopsis* shows a fairly typical condition, with 28 soft dorsal rays whose pterygiophores extend downward over 25 neural spines and with 18 soft anal rays under 14 hemal spines (in the X-rayed ANSP specimen). The other ophidioids, instead of going the usual way of elongate percoid derivatives in developing an exact 1:1 relationship between soft dorsal and anal rays and vertebrae, have

developed an approximately 2 : 1 ratio between rays and vertebrae (fig. 1*b*).

Specimens of *Brotula multibarbata* in the Honolulu aquarium, though they remained with the body curved and in contact with the substrate during the period I was able to observe them, continually passed undulations along the free portions of the dorsal and anal fins. Suggestions of similar fin undulations are found in the observations of living brotulids by Whitley (1935) and Dawson (1966). This is not to say that all brotulid locomotion is carried on by fin undulation alone, for all brotulids can doubtless undulate the body in coordination with the fins and probably do when greater speed is needed. Certainly such coordination occurs in ophidiids (Herald, 1953; and Briggs and Caldwell, 1955) and carapids (Arnold, 1956).

Phylogenetically, the argument regarding ophidioids herein advanced is not that they all swim in a manner very different from, say, the zoarcids (which have a 1 : 1 fin ray to vertebra relationship), but that their capability for independent fin undulation has led toward a morphological endpoint contrary in direction to that at which the basal percoids (with about 1.1 or 1.2 fin rays per vertebra) almost have arrived, and in a direction that has been followed by relatively few other percoid derivatives. Consequently, this development (of an approximately 2:1 fin-ray-to-vertebra ratio) in ophidioids appears to be systematically significant.

With regard to the sensory peculiarities of the ophidioid fishes, it seems to me that these are basic and that most, if not all, of the other ophidioid specializations are secondary to and related to them. Because of this, certain structural complexes that are not in themselves strictly sensory will be included in the discussion here.

Morphologically, one of the peculiarities common to all brotulids, ophidiids, *Gadopsis*, and certain gadids, e.g., *Urophycis*, is the development of the pelvic fin into one or two well-developed filaments originating more or less far forward. Functionally, the pelvics of brotulids and ophidiids have not been studied beyond the few preliminary observations of Herald (1953) and Briggs and Caldwell (1955). The function of the *Urophycis* pelvics, however, has been the subject of an excellent recent investigation by Bardach and Case (1965).

With regard to behavior, Bardach and Case (1965, p. 198) wrote in part:

Fishes swimming along the bottom ordinarily direct their [pelvic] fins forward, with the branches spread apart to an angle of up to 45°, the entire fin sweeping from slightly forward of the snout back toward the flank (Fig. 5) [their figure]. Each fin encompasses an arc of approximately 120° ahead and to the side of the fish. Upon touching a morsel of food with a fin tip, the fish often has to back up to veer down and ingest what it found.

Although, as just mentioned, observations on living brotulids and ophidiids are only preliminary, there are two pieces of circumstantial evidence beyond gross pelvic morphology that suggest these fishes use their pelvics as *Urophycis* does. One piece of evidence is that the ophidiids, at the expense of considerable elongation of the cleithra, have brought their pelvics forward under the chin and, hence, nearer the mouth. The other is that the brotulids and ophidiids, like *Urophycis* and gadoids in general, have developed a direct route of innervation for taste perception in the pelvic fins. As Freihofer (1963, p. 141) has noted, in these fishes, the pelvic branch of the ramus lateralis accessorius "passes anterior to the base of the pectoral fin and lateral to the cleithrum and the pectoral actinosts." This does not occur in *Gadopsis*, which retains the inherited and, for fishes with anterior pelvics, circuitous nerve "route of passing down the postcleithra and then turning and coursing anteriorly en route to the distant pelvic fin" (loc. cit.).

There is, I believe, a close relationship between the method of locating food by means of pelvic filaments, as noted by Bardach and Case, and the jaw structure of brotulids, ophidiids, *Urophycis*, and, for that matter, polynemids (which presumably locate food by means of pectoral filaments). In all of these fishes, the food items are detected under the fish rather than ahead of it, and, in all, the mouth is inferior. In all also, such premaxillary protrusion as occurs extends the upper jaw vertically downward or even downward and slightly backward (rather than forward as in most percoids); the premaxillary pedicel is short and vertical, or it even extends up and somewhat forward. Finally, there is a peculiar development of a muscle to the maxillary that Rosen (1964; and in Greenwood, et al., 1966) called a levator maxillae superioris.

In *Merluccius*, which differs from most gadoids in having a prognathous lower jaw, I can find no "levator maxillae superioris." That some fishes with prognathous lower jaws, however, do have a muscle of this sort is clear from the batrachoid fishes (see Rosen, in Greenwood, et al., 1966). For a further account of this muscle in the cod, see Holmquist (1910) and van Dobben (1935).

With regard to senses other than that of taste in the ophidioids, morphological data suggest that the acustico-lateralis system is developed highly, olfaction is normal, and the eyes are degenerate.

In *Gadopsis*, as in other ophidioids, the lateralis system of the head lies in enlarged canals that, in the pterotic (fig. 4) and circumorbital bones, are partially or completely open, bony troughs. There is also a large median opening (mucous or sensory pit) without a bony roof on the middorsal line between the two halves of the interorbital commissure.

In one respect, the lateralis system of *Gadopsis* is specialized considerably less than that of the ophidioids. In *Gadopsis*, as in most percoids, the epaxial body musculature extends forward over the dorsal surface of the skull and attaches in part to a low supraoccipital crest. The supratemporal commissure, as in most percoids and in the gadoids, is incomplete; it extends upward on each side of the head through the lateral extrascapular and then ends blindly over the epaxial musculature noted above. In the other ophidioids, the epaxial body musculature does not extend in over the skull; there is no supraoccipital crest rising above the cranial surface; and the supratemporal commissure is complete. There appears to be, as in the northern and many tropical blennies, a medial (as well as a lateral) extrascapular that has become fused completely with the parietal bones.

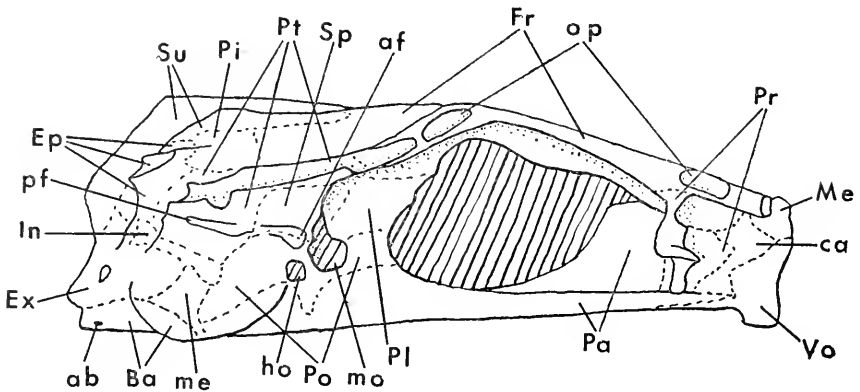

FIGURE 4.—Cranium of *Gadopsis marmoratus* (ab=attachment surface for Baudelot's ligament, af=anterior facet for hyomandibular articulation, Ba=basioccipital, ca=cartilage, Ep=epiotic, Ex=exoccipital, Fr=frontal, ho=hyomandibular opening of trigemino-facialis chamber, In=intercalar, me=membrane, Me=mesethmoid, mo=main opening of trigemino-facialis chamber, op=opening of supraorbital sensory canal, Pa=parasphenoid, pf=posterior facet for hyomandibular articulation, Pi=parietal, Pl=pleurosphenoid, Po=prootic, Pr=lateral ethmoid, Pt=pteroptic, Sp=sphenotic, Su=supraoccipital, Vo=vomer).

In *Gadopsis*, as in other ophidioids, the eyes are relatively small or completely absent. In all, the eyeball seems to be capable of slight rotation or none. The eye muscles are weak and usually flabby in the preserved specimens, and there are no eye muscle canals (myodomes). The eyeball is covered by a heavy membrane. In the ophidioids this is taut over the eyeball, but in *Gadopsis* it appears to be infolded around the eyeball, perhaps permitting greater eye rotation.

The relatively small eye and weak eyeball musculature are contained in a small eye socket. This I think is associated with certain features of the skull in the interorbital region and of the brain and olfactory

nerve location. In this connection, I propose the working hypothesis that degeneration of the eye and its musculature is followed in time by the loss of the myodome and the basisphenoid and that a longitudinal trough bounded by membrane or bone and containing the anterior portion of the brain eventually will extend forward between the orbits. Extreme examples of this sort of development are found particularly in such small-eyed, broad-headed fishes as the salmonoid *Galaxias*, the gadoid *Lota* (Svetovidov, 1948), the zoarceoid *Cryptacanthodes* (Makushok, 1961a), and the ophidioid "*Dinematichthys*" (Gosline, 1953).

In *Gadopsis*, as in ophidioids and numerous other fishes, the basisphenoid is absent. The interorbital space has been encroached upon from both the posterior and elsewhere. In *Gadopsis* the anterior portion of the interorbital space is filled medianly in large part by a crest rising from the parasphenoid (fig. 4). Above and behind this crest is a V-shaped trough comprising a pair of membranes leading upward and outward from the parasphenoid crest to attachments on the lower surfaces of the frontals. At the posterior end of the orbital cavities in *Gadopsis*, the internal orbital bony walls are extended anteromedially well beyond the trigemino-facialis opening (fig. 4).

In ophidioids, as in the gadoids and other fishes, the anteromedial extension of the bony orbital rims is developed further. In *Brotula*, for example, lateral flanges from the parasphenoid meet the frontals ahead of the pleurosphenoid ("alisphenoid" of Regan, 1903b, p. 461, fig. 1A). The latter bone, now completely surrounded by other ossifications, seems to disappear completely in some brotulids.

The olfactory organ of *Gadopsis* and ophidioids seems to be developed normally. In the forms examined, the two well-separated nostrils on each side lead in over an elongate-oval rosette. In *Gadopsis*, the olfactory nerve to each rosette passes back through the lateral ethmoid and, for a short distance, through the anterior end of the orbital cavity and alongside the parasphenoid crest. About one-third of the way back in the orbits, the olfactory nerves of each side pass into the membranous trough described above. They extend posteriorly into this trough to the olfactory lobes of the brain, which project forward into the trough. (Unlike many gadoids, the olfactory bulbs of *Gadopsis* and ophidioids are at the front of the olfactory lobes of the brain; see Svetovidov, 1948, pp. 13-17.)

In the otic system of *Gadopsis* and ophidioids, there is always a more or less enlarged auditory bulla. In the juvenile *Gadopsis* dissected (106 mm SL), the wall of the central portion of this enlarged bulla is membranous (fig. 4), and the intercalar (opisthotic) has only a minute extension on it. In *Brotula*, the expansion of the bulla is

relatively slight and almost entirely comprises the exoccipital and prootic. In *Microbrotula*, the expansion is greater but comprising the same two bones. In another brotulid, "*Dinematichthys*" (see Gosline, 1953), in *Benthocometes robustus* (see Bougis and Ruivo, 1954, fig. 17), and apparently in the carapid "*Fierasfer acus*" (see Emery, 1880), the intercalar forms a part of the bulla wall.

One seems to be on fairly firm ground in associating auditory bulla expansion with some specialization in hearing though, to my knowledge, the exact nature of the association remains unknown. It is probably more controversial to attempt to relate the gas bladder peculiarities of ophidioids with hearing; however, I agree with Marshall (1965, p. 314) that there is such a relationship. In the ophidioids except *Gadopsis*, there always appears to be ligamentous tissue extending between the anterior end of the gas bladder and the anterior ribs, one or more pairs of which are modified considerably (Regan, 1903b; Arnold, 1956). In the ophidiids (Rose, 1961) and oviparous brotulids (Marshall, 1965, p. 314 quoting Courtenay, in litt.), it has been suggested that the ligaments to the forward end of the gas bladder are used in sound production.

Something should be said at this point about the Carapidae and Pyramodontidae. These families, most if not all the members of which live as inquilines in the cavities of invertebrates, generally are agreed to be related to the brotulids and ophidiids. Among the numerous features probably associated with their mode of life, however, are the loss of the pelvic fins and the development of a more or less terminal mouth, often with enlarged teeth. The other systems dealt with above seem to be essentially the same as those in the brotulids and ophidiids.

To summarize briefly the sensory systems and related structures in the ophidioids, these fishes seem to have become modified extensively in association with the development of filamentous pelvics that are used presumably as probes for finding food. Though various fishes have developed similar probes from other structures, the gadoids, ophidioids, some anabantoids, and pegasids are, to my knowledge, the only fishes that have developed filamentous pelvics of this type. By contrast, the hypertrophy of the acustico-lateralis system and the degeneration of the eyes have occurred repeatedly, especially among deep-sea forms. (Whether these features are brotulid preadaptations to or have been developed in association with a deep-sea existence has no bearing on the present argument.) The unique feature, presumably associated with the acustico-lateralis system, that the ophidioids seem to have developed is the gas bladder-rib relationship.

In the following paragraphs no attempt will be made to give any complete structural account of *Gadopsis* or other ophidioids. Regard-

ing *Gadopsis*, only those features not previously considered, in which it differs from the ophidioids, will be mentioned. In addition, in view of the recent reassignment of the ophidioids and zoarcids to the Gadiformes by Greenwood, et al. (1966), it seems necessary to discuss once again some of those features that provide the basis for believing that the similarities among these three groups are due to convergence and not to genetic inheritance.

JAW STRUCTURE.—In addition to characters already discussed, two other aspects of ophidioid jaw structure will be noted herein. First, most, if not all, of the brotulids and ophidiids retain a supramaxillary. In this minor feature, *Gadopsis* has advanced farther from the basal percoid condition, for it has no supramaxillary. Second, *Gadopsis* and the ophidioids, like most percoids, have the premaxillary subequal to the maxillary in length. In this they differ from such groups as the zoarcids, uranoscopids, and batrachoids, which often have very short premaxillaries and the much longer maxillaries to some extent included in the gape.

SUSPENSORIUM AND ASSOCIATED STRUCTURES.—The major peculiarity of the suspensorium of *Gadopsis* and the ophidioids is a trend toward the fusion of the mesopterygoid and ectopterygoid. This fusion, which seems to be a constant feature of ophidiids, pyramodontids, and carapids (see Regan, 1912d, and Gosline, 1960) occurs in *Gadopsis*. Here again, *Gadopsis* is somewhat more advanced than brotulids, in which, so far as known, the ectopterygoid and mesopterygoid are separate.

The suspensorium of the gadiform fishes and its innervation is very different from anything found in *Gadopsis*, the ophidiids, or, for that matter, in the percoid fishes. Regan (1903b, p. 464) has commented on some of the gadiform peculiarities as follows:

Certain features of the suspensory apparatus seem to be constant throughout the suborder, and may prove to be of some importance. The head of the hyomandibular articulates with a single socket, to the formation of which the squamosal and postfrontal contribute. The entopterygoid is well developed, attached to the ectopterygoid below and in front by a vertical suture to the palatine. The palatine is attached anteriorly only to the praefrontal, and has a long maxillary process.

By contrast, *Gadopsis* and other ophidioids have two more or less separate articular heads on the hyomandibular, and the mesopterygoid (entopterygoid) is attached to and forms a continuous surface with the metapterygoid and sometimes posteriorly with the hyomandibular.

The most peculiar feature of the Gadiformes is the course of the hyomandibular branch of the facial nerve. In most teleosts that have been investigated (Patterson, 1964, p. 435), as in *Gadopsis* and ophidioids, the hyomandibular branch and the main trunk of the facialis nerve exit from the cranium by separate openings, that of the hyoman-

dibular branch being posterior and more or less internal to the hyomandibular bone (fig. 4: ho). After exiting from the skull, the hyomandibular branch enters the medial face of the hyomandibular bone and passes downward within it. In the gadoids (Stannius, 1849, p. 33), the hyomandibular branch has the same cranial exit as the main facialis trunk, after which it swings backward and penetrates the front of the hyomandibular bone.

BRANCHIOSTEGAL RAYS.—The ophidioids are said to have six to eight branchiostegal rays (Regan, 1912d, p. 277); in *Gadopsis* there are seven. This is a rather high number for percoid derivatives. In the stichaeoid blennies (Makushok, 1958, p. 21), these are rarely seven, generally fewer.

PELVIC FINS AND PELVIC GIRDL.—The filamentous fins and their presumed function in *Gadopsis*, the ophidiids, brotulids, and certain gadids already have been discussed. (Zoarcids never have filamentous pelvics.) Despite the general similarity between the pelvic fins of the Ophidioidei and certain of the Gadiformes, there are minor differences, some of which suggest different ancestries for the two groups. Thus, even when, as in the gadoid *Laemonema*, the pelvics become reduced to two main filamentous rays, there are rudimentary rays medial to these; in the ophidioids, when there is a rudimentary structure in addition to the filaments, it is a small ossicle lateral to the main rays and presumably represents a reduced spine (as in the Blenniidae and Zoarcidae). At the other extreme, however, the maximum number of soft pelvic rays in gadoids is twelve, but the ophidioids never have more than two. The pelvic fins of the Gadiformes, when present, are wide set and articulate with pelvic bones that are never attached directly to the cleithra; the pelvic fins of ophidioids, when present, are close set and articulate with pelvic bones that are usually, though not always (D. M. Cohen, pers. comm.), attached directly to the cleithra.

Freihofer (1963, p. 141) recently has noted the similarity of the ramus lateralis accessorius pattern in the gadoids, ophidioids, zoarcids, and (in litt.) nototheniids. In all of these, the pelvic branch of the ramus lateralis accessorius extends downward across the base of the pectorals instead of downward along the postcleithrum behind the pectorals and thence forward to the pelvics. But all four groups of fishes mentioned have the pelvics far forward, where the normal percoid nerve course would be highly circuitous. Furthermore, all four are groups living near the bottom, which may or do (*Phycis*, see above) use their pelvic fins to locate food. That the shorter and presumably more efficient course of the ramus lateralis to the pelvics developed independently in these groups is suggested by the fact that *Gadopsis*, herein considered to be at the base of the ophidioids, and the Bathymasteridae, at the base of the zoarcids, have a perfectly normal percoid

ramus lateralis pattern (Freihofer, 1963, p. 136). In this instance, then, I would view the similarities in nerve course as an adaptive trait that has been elicited more than once by similar circumstances.

PECTORAL.—In *Gadopsis* and ophidioids, there are four actinosts. In the Gadiformes, the number varies from three to 13. The scapular foramen of Gadiformes is usually between the scapula and coracoid; in *Gadopsis* and ophidioids, it is contained in the scapula.

DORSAL AND ANAL FINS.—It is in the structure of the vertical fins that the percoid affinities of *Gadopsis* are most plainly manifest. In that fish, there is a single dorsal fin with 10 pungent spines anteriorly, followed by 27 or 28 soft rays. Anterior to the dorsal fin, there are two well-developed predorsal bones, the anterior interdigitating between the second and third neural spines and the posterior between the third and fourth. The anal fin has three sharp, graduated spines at the front of the fin and 18 or 19 soft rays. The pterygiophores of these spines are separate, but the second is considerably enlarged and extends up in front of the first hemal arch. (One peculiarity of the dorsal and anal fins of *Gadopsis* is that its last dorsal and anal rays are not divided to the base.)

RIBS.—In *Gadopsis*, Baudelot's ligament originates on the basioccipital. There are epipleurals from the first vertebra and pleural ribs from the third. The anterior pleural ribs are enlarged only slightly, if at all. The gas bladder is large, firm walled, simple, and without special ligaments to either the ribs or skull. In all these respects, *Gadopsis* is typically percoid.

The ribs of ophidioids are modified in various ways as already noted. In one of the less-marked modifications, *Brotula* has epipleural ribs from the first vertebra and pleural ribs from the third (Regan, 1912d, p. 278). Baudelot's ligament is attached to the basioccipital; however, in *Brotula*, the first two pleural ribs are expanded, and there is a sheath of ligamentous tissue extending up and forward from the gas bladder over the anterior ribs. In no known ophidioid is the first vertebra fused to the skull.

The gadoids differ in the above features in several respects. There are never any epipleural or pleural ribs on the first two vertebrae. In most macrourids, the first vertebra is free from the skull and Baudelot's ligament, so far as known, is attached to the first vertebra. In the gadids, by contrast, the neural arch of the first vertebra is attached firmly to and its centrum completely fused into the cranium; here, Baudelot's ligament originates on the rear of the skull. Unlike ophidioids, there may be a direct connection between the gas bladder and inner ear in gadoids (in Moridae; Svetovidov, 1948), and when the gadoids have "drumming muscles," these usually are not attached to the ribs or skull (Marshall, 1965, pp. 312-313).

CAUDAL FIN AND SKELETON.—Aside from the rounded shape, the caudal fin of *Gadopsis* and its supporting structure (fig. 5a) seem to be of a fairly normal percoid type. There are five hypurals (counting as in Nybelin's 1963 system), one uroneural, and two epurals—all autogenous—and 15 branched caudal fin rays.

Among the brotulids, at least one member (Gosline, 1953) has 15 branched caudal rays, but there are more or less fusion and/or reduction in the caudal skeletons of all. In carapids, the caudal skeleton and fin are absent.

The caudal fin of the gadids has been the subject of much discussion. The caudal skeleton at least seems to represent a modification from a perfectly normal teleostean type (see, e.g., Barrington, 1936, and Gosline, 1964) but so reduced as to be morphologically similar to that of some brotulids.

SUMMARY.—To summarize *Gadopsis*, this fish seems in many respects to present a mosaic of characters, some percoid and others ophidioid. In the sense organs and associated structures, *Gadopsis* seems to have developed most of the basic peculiarities of the ophidioids: it has the anteriorly located, filamentous pelvics, the subterminal mouth and jaw structure, the at least partially reduced eyes, the expanded auditory bullae, and the troughlike sensory canals of the head. In the following features, however, *Gadopsis* retains the percoid condition rather than the more advanced ophidioid type: the ramus lateralis innervation of the pelvics, the incomplete supratemporal commissure, and the simple gas bladder without special relationships to the anterior ribs.

In fin structure, aside from the pelvics, *Gadopsis* shows a generalized percoid rather than the ophidioid condition. There are pungent spines at the front of the dorsal and anal, three in the anal, with the pterygiophore of the second extending in front of the first interhemal. There are two predorsal bones. The caudal fin has 15 branched rays and five autogenous hypurals. Finally, the dorsal and anal soft ray relationship to vertebrae is percoid and does not show the crowding of the rays found in ophidioids.

In a few minor characters, *Gadopsis* is more specialized than at least the more generalized ophidioids. It has no supramaxillary, and the entopterygoid and ectopterygoid are fused. Perhaps into this category should be added the fact that *Gadopsis* is a freshwater fish.

The question arises as to whether or not *Gadopsis* should be retained among the percoids or placed among the ophidioids. Zoologically, I cannot see any clearcut basis for decision. From the viewpoint of indicating the type of fish from which the ophidioids arose, *Gadopsis* and the Gadopsidae perhaps can be allocated best to the ophidioids, where the spiny-rayed *Gadopsis* would hold a position somewhat

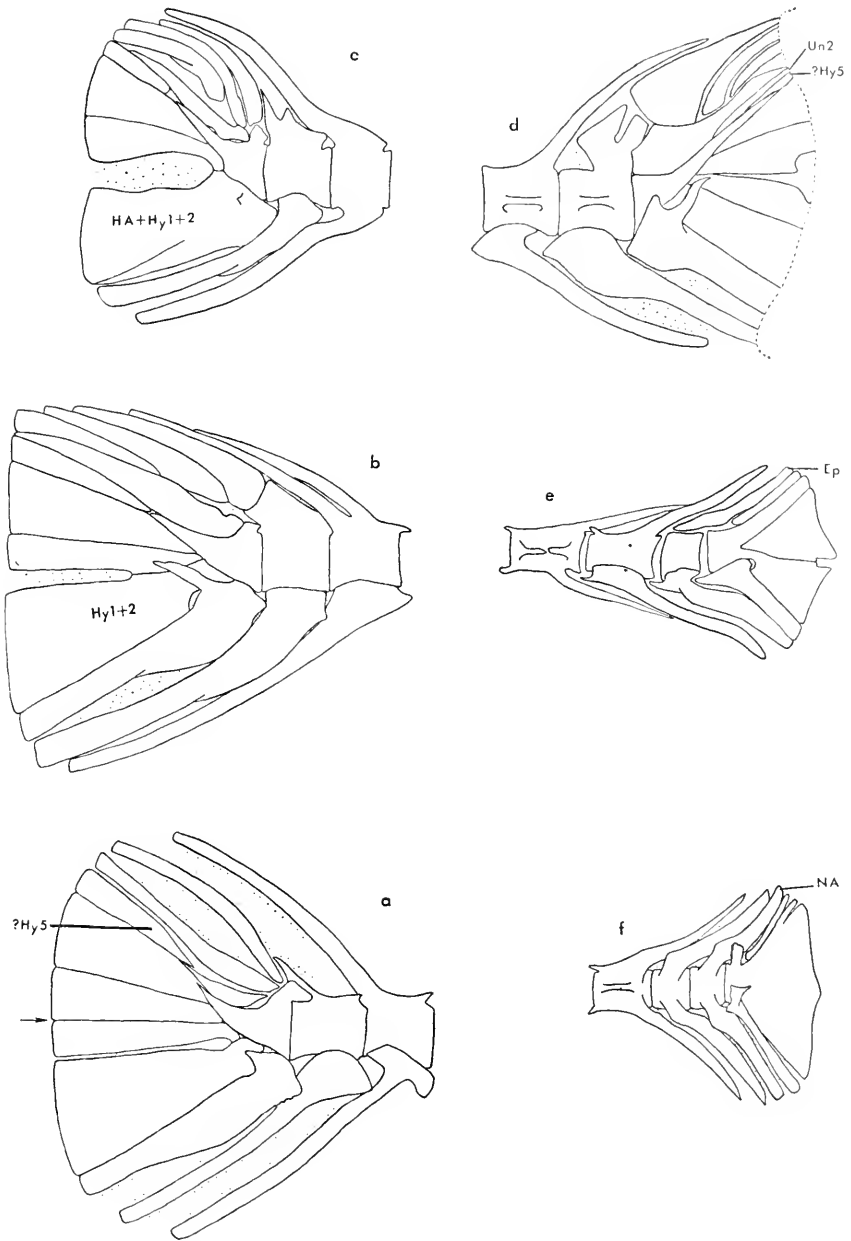

FIGURE 5.—Caudal skeletons: *a*, *Gadopsis marmoratus*; *b*, *Trachinus draco*; *c*, *Bathymaster signatus*; *d*, *Scombrolabrax heterolepis*; *e*, *Scomber japonicus*; *f*, *Thunnus albacares*. (*a*, *b*, *d* drawn from preserved material; *c*, *e*, *f* from dried skeletons; Ep=epural, HA=hemal arch, Hy=hypural, and NA=nural arch; broken line in fig. *d*=basal limits of caudal rays.)

analogous to that of *Psettodes* among the Pleuronectiformes (Norman, 1934).

As noted above, Greenwood, et al. (1966, p. 397), have added the ophidioids and zoarcids to the order Gadiformes. In the present paper the more generally held view that the ophidioids and zoarcids (see below) have no close relationship to the gadoid fishes or to one another is supported. In agreement with Makushok (1958 and elsewhere), the zoarcids are assigned herein to the Blennioidei, close to the stichaeid families. The ophidioids differ from these and all blennioids in having, among other things, the dorsal and anal fin rays more numerous than the vertebrae between them and, except in the Carapidae, which lack pelvics, in the one or two rayed filamentous pelvic fins. That the similarity between the zoarcids and ophidioids in ramus lateralis accessorius nerve pattern (Freihofer, 1963) may be the result of convergent evolution has been suggested above.

Regarding the fin-ray-to-vertebra relationship and the filamentous pelvic fins, some of the gadoids are similar to the ophidioids. Furthermore, there seems to be no one well investigated character by which all of the gadoids can be separated from all ophidioids; for example, no pelvic differences can be used to differentiate the two groups because the carapids among the ophidioids and the gadiform genus *Macruroides* completely lack pelvics. Again, Svetovidov (1948) placed considerable emphasis on the penetration of the intercalary by the glossopharyngeal nerve in gadoids, but this did not occur in the macrurids that Pfüller (1914, p. 76) investigated.

Despite the lack of criteria that will separate all gadoids from all ophidioids, I follow Regan (1903b), Svetovidov (1948), and others in separating these two groups widely. If, as I have tried to show, the ophidioids can be traced back through a fish very much like *Gadopsis*, then the percoid derivation of the ophidioids seems assured; by contrast, no one in recent years has suggested a percoid derivation for the gadoids (see, e.g., Rosen, 1964; Gosline, 1964). Leaving aside presumed ancestries, however, many of the central tendencies in the two groups are very different. Regan (1903b) noted a number of these tendencies long ago, and more have been added by subsequent authors.

Suborder XIPHIOIDEI

The suborder Xiphioidae, as herein understood, comprises the families Istiophoridae, Xiphiidae, and, provisionally, the Luvaridae.

The Istiophoridae and Xiphiidae usually have been considered "a highly specialized end-stage of the scombriform series" (Gregory and Conrad, 1937, p. 23). The Luvaridae, containing only *Luvarus*

imperialis, has been allocated variously; Regan (1903a, p. 372) considered it "a most abnormal and specialized Scombroid."

A principal reason why Regan (1903a; 1909a) placed *Luvarus* among the scombroids seems to have been that in it, as in the Scombridae and Xiphiidae, "the deeply forked bases of the rays of the caudal fin are inserted nearly vertically and extend over the hypural so as to almost entirely conceal that bone, those of the upper and lower series nearly meeting in the middle line on each side" (1903a, p. 372). Additionally, in *Luvarus*, "the ossified sclerotic and broad opercular bones are typically Scombroid features" (1903a, p. 374).

In the Xiphiidae and Istiophoridae, along with the peculiar caudal ray bases noted above, the rostral structure has been considered a morphological extrapolation of the type found in the scombrids in general, most notably in *Acanthocybium* (cf. fig. in Regan, 1909a).

To the present author, it seems that all of the morphological features mentioned above may well be merely adjustments of large, powerfully swimming fishes to the requirements of hydrodynamic efficiency. (Hertel, 1966, e.g., p. 255, stresses the difference in what constitutes hydrodynamic efficiency in large, powerfully swimming animals and in small, weak swimmers.) With increase of body size and swimming speed, the role of hydrodynamic forces in the existence of the animal becomes, of course, increasingly important. It is probably significant that among the members of the percoid family Carangidae, which also contains large, powerful swimmers, almost all of the morphological characters discussed above have been duplicated. Another, at least curious, parallel in the Carangidae is that, in those forms with a high, blunt head, the premaxillary remains protrusile, as in *Luvarus*; however, in the pointed-headed Chorineminae (Suzuki, 1962, p. 147), the premaxillaries are rigid and form a beaklike structure similar to that of *Scomber*.

If, however, one excludes from consideration those features that may be related to hydrodynamic efficiency, there seems to be slight resemblance between the Istiophoridae, Xiphiidae, and Luvaridae on the one hand, and the Scombridae, on the other. In the former group, the vertebrae number from 23 to 26 (a typically percoid condition); in the Scombridae, the vertebrae are 30 or more. In *Xiphias* and *Tetrapterus* (Gregory and Conrad, 1937, fig. 5), the caudal skeleton is only about as specialized as that of *Scomber*, certainly far less modified than the caudal skeleton of the tunas. In *Luvarus*, with the fusion of the last two vertebrae, the caudal skeleton (Gregory and Conrad, 1943, fig. 7) has become modified in a different fashion than that of the Scombridae.

Probably of greater importance, the istiophorids *Xiphias* and *Luvarus* seem to guide their forward trajectory in a somewhat different

way than do the Scombridae. In the Scombridae, the route of forward trajectory seems to be controlled, at least in part, in usual percoid fashion by a combination of well-developed 6-rayed pelvics directly below the highly placed pectoral fins (Harris, 1938). In the istiophorids, xiphiids, and *Luvarus*, the pelvic fins have a reduced number of rays or none. The pectorals are low on the body and have become fixed in extended position in the adults of *Xiphias* and of the istiophorid *Istiompax indicus* (thus secondarily resembling the shark condition). In this regard, it should be noted that, in the trichiurids and in many gempylids, the pectorals are low and the pelvics reduced or absent, but such forms are relatively small, weakly swimming fishes.

Finally, the dorsal fin of the Scombridae commences well behind the head. That of the Istiophoridae and Xiphiidae originates over the back of the head. The first interneurals of *Xiphias* are shown by Gregory and Conrad (1937, fig. 3) to extend downward into the region of the skull-vertebrae articulation. In the juvenile *Luvarus* (Gregory and Conrad, 1943, fig. 38), the dorsal fin again originates far forward, but, with growth, moves back, leaving, however, a pair of large interneurals that interdigitate between the cranium and the first vertebra (Gregory and Conrad, 1943, fig. 8).

In certain respects, e.g., the 23-26 vertebrae, the Istiophoridae, Xiphiidae, and Luvaridae are more generalized than the Scombridae. That they are specialized scombrid offshoots seems an impossible conclusion, and that they are even related to the Scombridae, an improbable one.

A more difficult problem is to determine what the Xiphioidei is related to and/or derived from. Before this matter can be profitably discussed, the question arises as to whether or not the Istiophoridae, Xiphiidae, and Luvaridae are interrelated. Regan (1909a), Gregory and Conrad (1937), and others have postulated that the Xiphiidae and Istiophoridae extend back separately into Eocene times. That the two families are related more closely to one another than to any other modern family has not, to my knowledge, been questioned.

Whether or not the Luvaridae are related to the Istiophoridae and Xiphiidae is more doubtful. Certainly *Luvarus* has many features that separate it widely from all other living fishes. In mouth and snout structure, *Luvarus* differs widely from the istiophorids and xiphiids. It may be that these features provide good indications of phylogenetic relationships, but the alternative possibility at least is suggested here that the anterior profiles of *Luvurus*, on the one hand, and of the istiophorids and xiphiids, on the other, represent alternative attainments of hydrodynamic efficiency in large, strongly swimming fishes and, hence, are not necessarily of great phylogenetic significance. In any event, the Luvaridae herein are included pro-

visionally in the Xiphioidei. What appear to me to be the more important unifying elements of the Xiphioidei, as understood herein, are the following:

Vertebrae 23–26. Pelvic fins, if present, with not more than three rays. Pectorals inserted low on sides. Dorsal and anal fin rays at least somewhat more numerous than the vertebrae. Anterior interneurals interdigitating between the skull and the vertebral column. Frontal bones without a median crest (though the supra-occipital extends forward over the frontals in *Luvarus*). Nasal bones forming a rigid portion of the head skeleton (or possibly absent in *Luvarus*: see Gregory and Conrad, 1943, p. 254).

The Xiphioidei seem to have originated among the basal percoid stock, though no modern percoid group suggests any obvious relationship with the xiphioids. That the group is an old one, extending back at least to the Eocene, is well attested to by fossil evidence (though the usual attribution of the Palaeorhynchidae, with 50–60 vertebrae, to the xiphioids seems dubious).

Suborder SCOMBROIDEI

The fishes herein included in the suborder Scombroidei are the Scombridae as defined by Regan (1909a), Fraser-Brunner (1950), Collette and Gibbs (1963) and the trichiroid fishes, i.e., the families Gempylidae (cf. Matsubara and Iwai, 1958), the Trichiuridae (cf. Tucker, 1956), and the Scombrolabracidae (Roule, 1922). The Istiophoridae, Xiphiidae, and Luvaridae, usually included in the Scombroidei (e.g., Regan, 1909a; Gregory and Conrad, 1937, 1943), herein have been removed to a separate suborder, Xiphioidei, for reasons given in the previous section.

Among the trichiroid families, the relationship between the Gempylidae and the Trichiuridae has never, to my knowledge, been questioned. *Scombrolabrax*, discussed below, has been placed near the Gempylidae since its discovery in 1922.

Again, a postulate of relationship between the Scombridae and the trichiroid families, particularly the Gempylidae, generally has been accepted. The only question has been whether or not the two groups should be placed together in a single suborder (e.g., Regan, 1909a) or allocated to separate suborders (e.g., Regan, 1929). It is true that the principal evolutionary trends in the two groups have been very different. That of the trichiroids has been toward large-fanged, ribbon-shaped forms, whereas the scombrids have developed into the bulky, powerfully swimming tunas. Nevertheless, in many of what would appear to be basic structures, the trichiroids and scombrids overlap. Indeed, the presumed gempylid *Lepidocybium* shows so many

scombrid characters (Matsubara and Iwai, 1958) that its transfer to the family Scombridae has been advocated. Conversely, the scombrid *Grammatorecynus* has a number of gempylid characters (Matsubara and Iwai, 1958). Finally, it seems that, except in a few characters, the genus *Scombrolabrax* (fig. 6), could serve morphologically as an ancestral form for the trichiroids and, in most respects, for the Scombridae as well.

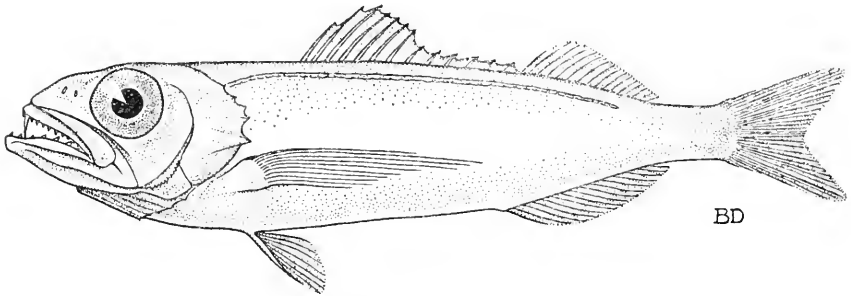

FIGURE 6.—*Scombrolabrax heterolepis*: sketch to show external appearance, based on specimen 5½ inches SL (USNM 197651) taken off Mississippi delta by the "Oregon" (drawn by Barbara Downs).

Regarding scombrid phylogeny, Kishinouye (1923) considered certain of the tunas to be so specialized as to warrant a separate order, Plecostei. This classification, though adopted by Berg (1940), was shown long ago to be based on inadequate grounds (Takahasi, 1926).

At the base of the scombrid series, Fraser-Brunner (1950) placed *Gasterochisma*. It appears to me, however, that *Gasterochisma*, which I have examined only superficially, bears at least as much resemblance to the Bramidae as to the Scombridae; if *Gasterochisma* is a scombrid at all, it is at best a highly aberrant one.

Starks (1910) seems to have been correct in considering *Scomber* as the least specialized living scombrid. Among the percoid-like characters retained by *Scomber* but lost by most or all of the rest of the Scombridae are the following:

Mesethmoid with a low median crest anterodorsally (see Allis, 1903, pl. 4: fig. 5). Intercalar not expanded on the posterodorsal face of the skull, not separating the exoccipital from the pterotic; lower limb of the posttemporal articulating with an intercalar projection that extends downward and backward from the ventral cranial surface. Premaxillaries with separate articular and ascending processes, the latter not greatly expanded (ibid., pl. 5: fig. 16). Circumorbital series of bones complete (ibid., pl. 3: fig. 4). Operculum without a smoothly rounded free border but rather with a moderately deep indentation above (ibid., pl. 3: fig. 4). An anal spine present (Matsui,

1967). In the caudal skeleton of *Scomber* (fig. 5e), the upper and the lower hypural plates remain separate with a notch between them, and the preurostylar vertebra has no attached neural arch; by contrast, in such an advanced scombrid as *Thunnus* (fig. 5f), the upper and lower hypurals have fused into a single plate without a median notch and the preurostylar vertebra seems to have a well developed neural arch (fig. 5f: NA), though this may represent a fusion between the anterior epural of *Scomber* (fig. 5e) and the preurostylar centrum (cf. Gregory and Conrad, 1943, fig. 5d).

Among the trichiuroid fishes, increasing degrees of morphological specialization are shown by the series Scombrolabracidae—Gempylidae—Trichiuridae. Since no account of the osteology of the basal member of the series, namely *Scombrolabrax* (fig. 6), has ever been given, one is presented below.

The Osteology of *Scombrolabrax*

FIGURES 5d, 6

TEETH.—The jaw teeth are all well separated from one another, and all point more or less backward. They are in single rows except for one to three inner teeth near the midline of each jaw; these inner teeth of the upper jaw are needle-like fangs and are by far the largest in the mouth, but the inner teeth of the lower jaw are small. The outer row in each jaw is made up of well separated, sharp, distally-proximally flattened teeth; those along the sides of the lower jaw are much the larger. There is a single row of small teeth on each palatine and a V-shaped row on the vomer. Mesopterygoid toothless.

There are three patches of needle-like teeth on the upper pharyngeals of each side; the separate lower pharyngeals have similar teeth.

On the first arch are five lathlike gill rakers that, however, have spines projecting from their posterior border. The other gill rakers are in the form of low, spinulose platelets. On the rear face of the anterior arch and on succeeding arches are numerous rakers consisting of single, upright, needle-like spines (cf. Matsubara and Iwai, 1952).

There are no teeth on the hypobranchials, basibranchials, or tongue.

SENSORY CANALS OF HEAD AND ASSOCIATED BONES.—The infraorbital canal is complete and joins the supraorbital canal between the frontal and pterotic as usual. The lacrimal is a long bone that does not overlap the maxillary except far forward. It has no serrations but has the usual three canal exits along the lower surface. The first circumorbital is essentially a continuation of the lacrimal. The second circumorbital bears a very large subocular shelf that extends somewhat forward as well as somewhat back of its canal-bearing portion. Above the second circumorbital are 11 bony half rings (the medial halves) that carry

the infraorbital canal up to its junction with the supraorbital canal (three of these are slightly larger than the others and may represent the usual percoid circumorbital bones).

The supraorbital canal starts in a tubular nasal bone that is attached movably to the frontal behind it. The canal then passes back through the frontals, giving off two major lateral exits and one median. The median exit apparently represents the interorbital commissure; on each side, it passes in through a low frontal rise and opens out onto the surface of the skull on the interior slope of this rise; the opening is covered with a membrane, and there is no sign of any connection between canals of the two sides of the head.

The temporal canal extends the full length of the pterotic in a trough, open externally. The preopercular canal joins the temporal canal via a membranous tube.

JAWS.—The upper jaw is distinctly protrusile. The usual ethmoid-maxillary and palatine-premaxillary ligaments are present.

The maxillary has a long, subtriangular supramaxillary.

The premaxillary is not beaklike. Its ascending process is nearly vertical, with the usual deep groove between it and its well-developed if low articular process over which the maxillary head rides.

SUSPENSORIUM.—The top of the interopercle and the lower portions of the subopercle and preopercle have weak serrations. There are two weak points on the opercle separated by a deep indentation; above the upper of these, the opercular edge is more or less ragged edged.

There is no metapterygoid lamina (cf. Katayama, 1959).

HYOID APPARATUS.—There are seven branchiostegals on each side, not six as reported by Roule (1922).

There is a groove along the epihyal continued forward into the ceratohyal, also one anteriorly on the ceratohyal; the grooves at the two ends of the ceratohyal are connected by a completely enclosed tunnel.

The usual gill arch bones are present.

There is a well-developed pseudobranch.

CRANIUM.—The inner face of the maxillary head rides on the side of the vomerine portion of the ethmovomerine keel. The ethmoid contributes to the keel but also has a broad, flat upper portion under and between the frontals.

Posteriorly, the frontals become slightly raised medially. Appressed against a portion of the lower surface of this rise is the "pineal organ" (Rivas, 1953). Laterally, there are two low ridges over the supraorbital canal. The whole top of the skull looks like that shown by Matsubara and Iwai (1958, fig. 5) for *Ruvettus*.

The parasphenoid is slightly arched. There is no posterior opening to the myodome.

The pleurospenoids do not meet on the midline.

A basisphenoid is present.

The auditory bulla is swollen somewhat, with a peculiar, lateral, puffed-out area in the exoccipital. There are no soft areas on the bullae walls.

The round facets for vertebral articulation on the exoccipitals seem to be separate from each other and from the round area on the basioccipital.

PAIRED FINS AND GIRDLES.—There are four actinosts. In the wet specimen, the bottom one articulates with the cartilage over and between the scapula and the coracoid. The very long pectoral fin has 18 rays, the uppermost of which inserts below the level of the main (lowermost) opercular projecting point.

The upper, laminar postcleithrum is attached entirely to the cleithrum above. To its anterior edge is attached the lower, long sword-like postcleithrum, which runs down in back of, and has a ligament extending to, the pelvis.

The pelvis extends between and is attached tightly to the cleithra in normal percoid fashion. The pelvic bones are long and somewhat separate on the midline. They have relatively long posterior processes.

The pelvic fin has a well-developed spine and five soft rays.

AXIAL SKELETON.—Vertebrae 13+17. The first vertebra with a well-developed hemal spine is the fourteenth. Vertebrae five through 13 have parapophyses, the anterior more or less laterally directed, changing to vertically posteriorly. Pleural ribs articulate with notches in and behind the tips of the parapophyses.

In the caudal skeleton (fig. 5*d*), the urostyle extends back between the fourth and fifth hypurals (counting as in Nybelin's 1963 system), leaving the uppermost hypural alongside the two autogenous uroneurals. (The possibility that *Scombrolabrax* has only four hypurals and three uroneurals was investigated and dismissed because the lowermost of the three bones immediately above the urostyle [fig. 5: ?Hy5] ends posteriorly in a cartilaginous plate that forms a continuous edge with that of the hypurals below, whereas the upper two bones of the series, i.e., the uroneurals, do not.) There are three separate epurals and three autogenous hemal arches. The caudal rays only slightly overlap the hypurals (about as shown by Matsubara and Iwai, 1958, fig. 9).

The first dorsal pterygiophore interdigitates between neural arches two and three. There are no predorsal bones.

In the anal fin there are three close-set, graduated anal spines. The first two anal spines articulate with one pterygiophore, the third with a separate one.

INTERNAL ORGANS.—The peritoneum is black. The stomach is straight, elongate, and thick walled. There are six finger-like pyloric caeca. The gas bladder extends nearly the full length of the abdominal cavity and is rounded at both ends.

Discussion

Roule (1922, 1929) and Grey (1960) agreed that *Scombrolabrax* is related to the gempylid fishes. Both authors have noted the similarity in general appearance between *Scombrolabrax* and the gempylid genus *Epinnula*. Grey demonstrated in some detail the similarities between the peculiar lateral-line scales of gempylids and those of *Scombrolabrax*. The upper jaw structure with its long supramaxillary and its fang duplicates that of the Gempylidae as illustrated by Matsubara and Iwai (1958, fig. 3). The skull roof, as previously noted, seems to be that of the gempylid *Ruvettus*. The spinulose gill rakers again are like those of gempylids. Indeed, there seems nothing about *Scombrolabrax* that would militate against a *Scombrolabrax*-gempylid relationship.

In most instances wherein *Scombrolabrax* differs from the gempylids, it differs in the direction of the percoids. Thus, in *Scombrolabrax*, the upper jaw is protrusile, some of the opercular bones are spinous or serrate, the pelvic girdle is relatively strong and firmly attached to the cleithra, the parts of the caudal skeleton are not fused, the lateral line is simple, the lateral-line scales bear a groove rather than a completely bone-enclosed tunnel (Grey, 1960), the number of vertebrae is relatively low, etc.

If *Scombrolabrax* is included in the trichiuroid fishes and if the trichiuroids and Scombridae are combined in a single suborder, the difficulties of defining the suborder become considerably greater. The best that I can do in this regard is as follows.

The suborder Scombroidei are perciform fishes with nonprotrusile upper jaws (except *Scombrolabrax*), the postorbital members of the circumorbital ring of bones represented either by numerous small pieces or absent, the interorbital commissure of the supraorbital canals widely incomplete or lacking, the predorsal bones (Smith and Bailey, 1961) lacking, and the vertebrae numbering 30 or more.

Regarding the origins of the Scombroidei and more especially the Scombridae, these frequently have been postulated to lie in the area of the percoid family Carangidae (e.g., Starks, 1911). My own work has led to the conviction that Regan (1909a) was correct in separating the Scombridae widely from the Carangidae and that the rather numerous morphological features held in common by members of the two families (Starks, 1911) are the result of convergence. The reasons for this conclusion are as follows:

(1) In the Carangidae (see Suzuki, 1962), the supraoccipital crest always is carried forward on the frontals to the ethmoid region and

provides a source of attachment for the body musculature, which extends anteriorly along either side of it. The interorbital commissure of the lateralis canals is always complete and has a median opening between the frontals on the top of the crest.

In the scombroid fishes (including the trichiroids), the supraoccipital crest and the body musculature do not extend forward over the head medially beyond the supraoccipital, except, to my knowledge, in *Gasterochisma*, *Scomberomorus*, and *Acanthocybium*. Other than in these genera, there is either a median open space between the frontals posteriorly or a transparent area in the frontals directly under which is an expanded "pineal organ" (Rivas, 1953). The interorbital commissure of the lateralis system is never complete (it was not located in the large skull of *Gasterochisma* examined). Except in *Scomberomorus* and presumably *Acanthocybium*, the two lateral portions of the commissure are widely incomplete on the midline; in *Scomberomorus* and presumably *Acanthocybium*, the two halves of the commissure extend up the outside surfaces of the halves of the frontal crest and open by separate exits on either side of its rim. If Rivas (1953) is correct in postulating the pineal body as a light receptor in scombroids, then the scombroids, except *Scomberomorus* and *Acanthocybium*, have a rather different system of sensory perception on the top of the head than the carangids, and the two exceptional genera would represent an incomplete return toward the carangid system.

(2) In the Carangidae, the usual five suborbital bones are present (see Suzuki, 1962), forming a typical complete circumorbital ring.

In the scombroids, the suborbital bones behind the eye are variously modified or absent. In *Scomber* and *Rastrelliger* (Allis, 1903, pl. 3; fig. 4; Starks, 1910), they form a series of flat, somewhat expanded plates that appear to be variable in number. In *Scombrolobraz*, they occur as rather numerous small ringlike ossicles (see above). In most of the other scombroids, the posterior suborbitals, along with the postorbital section of the infraorbital canal, are absent or represented by scalelike ossifications.

(3) In the Carangidae, the vertebrae are almost always 24 and never exceed 26 (Suzuki, 1962).

In the Scombridae, the vertebrae are 30 or more.

To me, a more promising area of scombroid origin among the percoid fishes is that represented today by the Pomatomidae, especially *Scombrops*. It is not so much that the pomatomids positively foreshadow the scombroids as that they appear to be more generalized percoids, lacking the rather numerous nonscombroid specializations found in the Carangidae; e.g., the median frontal crest bearing the interorbital lateral-line commissure. The Pomatomidae have the

anterior portion of the cranial roof flat or with a low arch, the inter-orbital commissure of the lateralis system is broadly incomplete, and the vertebrae number 26.

Suborder BLENNIOIDEI

The fishes united here under the Blennioidei form one of the most unsatisfactory suborders of the Perciformes. The blennioids are percoid derivatives that basically have taken up a mode of life in contact with the bottom. This mode of life, however, has been adopted repeatedly by percoid derivatives; indeed, it is the most successful of postpercoid developments among fishes. All of the various fishes that live in contact with the bottom have developed certain specializations in common. For one thing, all of the sense organs in which perception depends on ambient water tend to move toward the upper surface of the head and body. More important are the changes associated with locomotion. Insofar as the basal percoid must maintain at least equilibrium in a fluid environment, it is always "swimming" or at least "treading water." By contrast, a fish maintaining contact with the bottom is basically sedentary (unless it is a continuous "grazer") and swims only in short dashes from a standing start. These differences in swimming requirements are reflected in fin structure.

The problem with the bottom-living percoid derivatives is to distinguish the convergent characters associated with a life in contact with the substrate from the indicators of similar genetic inheritance. Beyond that lies the difficulty of defining groups and of separating them from the basal Percoidei.

From Linnaeus (1758) to the present, the position of the pelvic fins has formed a major basis for fish classification. The majority of the percoids and their derivatives have the pelvics more or less under the pectorals. Most or all of the derivative forms with pelvics ahead of the pectorals usually have been allocated to the Jugulares. Such a division assumes that the pelvics, once they have moved forward of the pectorals, do not return. To my knowledge, this assumption is correct. The question of how many different times the pelvics have moved forward is more difficult. The refinements in the Jugulares proposed by Boulenger (1901, 1904) and Jordan (1923) have consisted primarily in excluding from the Jugulares polyphyletic elements in which anterior pelvics had been developed independently. Jordan's (1923) concept of the Jugulares is closest to the suborder Blennioidei, as accepted here, of any classification previously proposed (see table 1).

Since the Jugulares of Jordan and Boulenger are percoid derivatives, one difficulty is to determine where the percoids end and the Jugulares start. In many percoids, e.g., the Serranidae, Cepolidae, Chiasmodontidae, and the whole series of families around the Pseudochromidae-

Plesiopidae, the pelvics are sometimes behind and sometimes in front of the pectorals. Under the circumstances, it seems impossible to adopt pelvic position alone as a basis for distinction. As an additional character, Regan (1912d) used reduction in the pelvic to four or fewer rays to separate out a group (table 1), which he called the Suborder Blennioidea. Various aspects of the artificiality of Regan's Blennioidea, however, have been pointed out by Starks (1923), Regan himself (1929), Hubbs (1952), Smith (1952), Gosline (1955), and Makushok (1958). In this paper, a different supplementary character to define the Jugulares will be adopted, namely, the presence of an exact 1:1 ratio between the vertebrae and the dorsal and posterior anal soft rays.

One result of adopting this additional criterion is to exclude from the Jugulares a number of fishes with anterior pelvics such as serranids and serranid-like families and the Opistognathidae. It also excludes from the Jugulares some almost certainly extraneous elements such as the Mastacembeliformes and Gadopsidae and three "Series" included by Jordan (1923), namely, the Brotuliformes, Ophidiiformes, and Carapiformes. If this supplementary criterion clarifies the limits of the Jugulares, it adds certain phylogenetic complications that will be noted below.

Even if the Jugulares are defined as acanthopteran fishes with the pelvics ahead of the pectorals and an exact correspondence between the dorsal and anal rays and the vertebrae, certain groups would be included that do not seem to belong there. These are the champsodontoids, the ammodytoids, the schindleroids, certain gobioids, the Pleuronectiformes, and possibly the Symbranchiformes. Of these, the Symbranchiformes can be at least technically excluded because they have no dorsal and anal rays at all. The flatfishes are set aside easily on the basis of asymmetry. The schindleroids have no pelvics, but neither do a number of specialized Jugulares. Under the circumstances, it is easiest to exclude *Schindleria* on the basis of its fused caudal vertebrae. Among the gobioids, certain burrowing forms, e.g., *Trypauchen*, *Microdesmus*, *Kraemeria*, have anterior pelvics; these may be removed on the basis of their lack of parietals.

The champsodontoids and ammodytoids provide more serious problems. In the first place, it is not absolutely certain, in my opinion, that they should be excluded from the Jugulares. On the assumption followed here that they should be, the best means of doing so would seem to be their forked caudal fin preceded by a long, constricted caudal peduncle supported by bladelike neural and hemal arches.

The only remaining problem in defining the Jugulares is that of certain specialized groups that may well have been derived from them. Such groups are the batrachoids and lophioids, the Callionymidae, Draconettidae, and Gobiesocidae. What the batrachoids and lophioids

evolved from is not clear to me. They are, in any event, much more highly specialized than the Jugulares in a number of respects (Regan, 1912b), and perhaps they are excluded most easily because of their rigid attachment of the post-temporal to the cranium. The Callionymidae, Draconettidae, and Gobiesocidae appear to have been derived from one of the Jugulares groups (see fig. 12). Once again, however, they are specialized sufficiently to warrant separation. They may be removed most easily by the absence of a metapterygoid.

The net effect of the restrictions outlined above is to eliminate a number of groups from Jordan's (1923) Jugulares. Such excluded groups are: the suborder Haplodoci, the series Callionymiformes, Ammodytiformes, Brotuliformes, Ophidiiformes, and Carapiformes, and the families Chiasmodontidae, Opistognathidae, Owstoniidae, Champsodontidae, and Cerdalidae. (In the families Chiasmodontidae [Norman, 1929] and Owstoniidae [Kamohara, 1935], the position of the pelvis, judging from illustrations, is somewhat variable but hardly warrants their inclusion in Jordan's Jugulares. These two families will not be mentioned further here.) The fishes in the remaining families of Jordan's (1923) Jugulares are those comprising the group to be dealt with here. These fishes may be defined as follows:

Symmetrical acanthopteran fishes with the pelvic fins, when present, inserted ahead of the pectorals. Dorsal and posterior soft anal rays exactly equal in number to the vertebrae between them. Caudal fin usually rounded; when forked, it is not preceded by a constricted peduncle supported by several fused vertebrae or by blade like neural and hemal spines. Metapterygoid and parietal bones present. Post-temporal movably attached to cranium.

Though the group herein dealt with is closest to the Jugulares of Jordan (1923), as noted above, it will be called, henceforth, the suborder Blennioidei, to bring the subordinal nomenclature into line with that usually used in fishes.

Morphological Characters

GENERAL FEATURES.—As compared with the percoids, the Blennioidei (for the families included in this suborder as herein understood see table 3) have less deep, compressed bodies. The abdominal region of the Blennioidei frequently is rather short, with the anus relatively far forward and with the caudal portion of the body always more or less attenuated. Dorsal and anal fins are low and long, usually ending posteriorly close to the outer caudal rays, and frequently extending farther forward than is usual in percoids. The caudal and pectoral fins usually are rounded. The gas bladder is generally absent in the adult.

Members of the Blennioidei that I have seen in life, primarily tropical blennies, move forward by undulation of the body and fins; even when at rest on the bottom, they maintain a sinuous body configuration.

NASAL ORGANS.—The Blennioidei are somewhat unusual in that the two nostrils have become reduced to one in two different groups. All of the cold-water blennies (Zoarceoidae) have only a single nostril on each side. The same is true of the Bovictidae, Nototheniidae, Harpagiferidae, Bathydraconidae, and Channichthyidae, though other members of the notothenioid stock, e.g., the parapercids, trichonotids and cheimarrichthyids, have two on each side. Attempts to relate nostril number to gross olfactory rosette structure have been unsuccessful. There does, however, seem to be a correlation between nostril number and geography—perhaps 90 percent of all frigid-water fishes, including Blennioidei, have one nostril on each side, whereas some 90 percent of all tropical fishes, including Blennioidei, have two.

CIRCUMORBITAL BONES (fig. 7).—The circumorbital bones have been used extensively in the classification of certain groups of Blennioidei (e.g., Regan, 1912d; Stephens, 1963; and Springer, 1964). Nevertheless, for distinguishing major groups, they must be utilized with considerable circumspection. The basal percoid pattern comprises a lacrimal and five circumorbitals, the uppermost (dermophenotic) movably attached to the cranium. The second circumorbital normally bears a subocular shelf in marine forms (Smith and Bailey, 1962). The sensory canal of the lacrimal contains several neuromast organs; that of the second circumorbital, two; the other circumorbitals have a single neuromast. Among the Blennioidei, the percoid pattern just described breaks down in many ways, though the basic trends are only two.

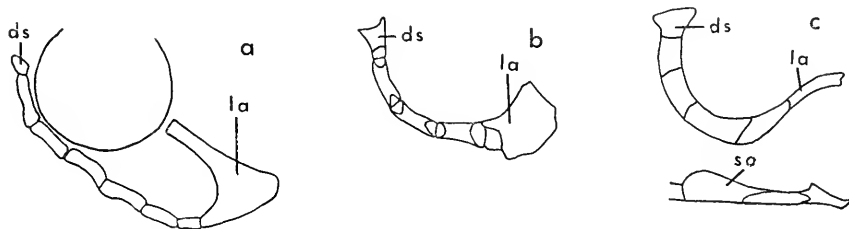

FIGURE 7.—Right circumorbital bones: *a*, *Cheimarrichthys fosteri*; *b*, *Harpagifer bispinis*; *c*, *Trachinus draco*. Lateral views, except that in *c* a top view of the anterior end of the series is shown below. (ds=Dermosphenotic, la=lacrimal, so=subocular shelf.)

The first trend, occurring in most of the notothenioid and zoarceoid series, is toward a disintegration of the circumorbital system. The first stage in such a trend is shown by the notothenioid *Parapercis* (Gosline, 1963, fig. 2a). There, the subocular shelf is missing

and six circumorbital bones are present; undoubtedly, this increase has occurred by the breaking up of the percoid second suborbital into two components, each with a single neuromast. Further change in the system may take place in three fashions. First, disintegration may come to involve the lacrimal, as apparently occurs in the zoarceoid *Lycodes*, in which the lacrimal is divided into two almost separate portions. Second, in fat-cheeked forms, the lower circumorbitals may leave the orbital border, as occurs in the notothenioid *Cheimarrichthys* (fig. 7a) and again in the zoarceoid *Lycodes*. Finally, the central portion of the circumorbital system may drop out entirely, as occurs in the notothenioid *Bembrops* or the zoarceoids *Lumpenus* and *Ptilichthys* (Makushok 1961b, p. 235, fig. 4).

In addition to the various stages and types of circumorbital disintegration occurring in the notothenioids and zoarceoids, there are frequent instances of a complete reversal of the trend itself. Thus, among zoarceoids, the anarhichadids have a strongly constructed, nearly rigid circumorbital chain of bones (Barsukov, 1959, pls. 7-16). Among the notothenioids, the circumorbital series forms a more or less rigid ring of bones in *Hemerocoetes* and *Harpagifer* (fig. 7b), and in *Crystallodytes*, this ring is made up of only three bones (Gosline, 1963).

As contrasted with the notothenioids and zoarceoids, the general trend of circumorbital bones in the tropical blennies, trachinoids, and congrogadoids is toward a strengthening of the ring and a consolidation of its elements. Again, various processes are involved. Some of these are well indicated within the single genus *Trachinus*. In *T. draco* (fig. 7c), which approaches the percoid condition more closely than any other member of the Blennioidei, there are a lacrimal and five circumorbitals, with a well developed subocular shelf on the second. In *T. radiatus*, the whole chain forms a rigidly interlocked series of bones; the lacrimal and what was the first circumorbital of *T. draco* are united rigidly; there is a subocular ledge running all the way around the bottom of the orbit; and the first circumorbitals have also expanded downward over the cheek, foreshadowing the condition in the "urano-scorpoid families."

At the posterodorsal end of the circumorbital series, two different things may happen. One appears to be a simple loss of elements. Thus, in *T. vipera*, I can find only two circumorbital bones above that which bears the subocular shelf, instead of the three of *T. draco*. Again, among the congrogadoids, there are two circumorbital bones above that bearing the subocular shelf of *Congrogadus*, but in the related *Notograptus*, there is only one.

A different development of the uppermost circumorbital bone occurs in the topical blennies. In *Enneapterygius* and to some extent in *Clinus*,

the uppermost circumorbital retains its usual superficial position behind the orbit. But in *Labrisomus* and *Blennius*, this uppermost element becomes largely buried in the flesh and forms what appears to be a cranial bone rather than a member of the circumorbital series (Springer, 1966).

Once again, however, it must be noted that consolidation of the circumorbital series is not a universal feature in the tropical blennies, congrogadoids, and trachinoids. Indeed, in the clinid blenny *Exerpes asper*, the circumorbital chain is widely incomplete, being represented anteriorly only by an isolated lacrimal (Springer, 1955).

JAW APPARATUS.—There is no supramaxillary in the Blennioidei.

In forms with relatively long premaxillary pedicels, there seems to be two kinds of jaw protrusion. In one, represented by *Congrogadus*, the pedicels are stout and affixed firmly to the toothed portions. In such fishes, protrusion of the upper jaw may be great, but there is little possibility of expanding the gape laterally. A different system occurs in most trichonotids and in certain of the tropical blennies. Here, the premaxillary pedicel is hinged at its base with the result that the distal ends of the premaxillaries can expand outward at the same time the whole bone is protruded forward.

In the zoarceoids especially but also in the unrelated gobiesocid and batrachiform fishes, the toothed portion of the premaxillary is relatively short, with the maxillary extending well out behind it. Indeed, in such a zoarceoid as *Anarhichas*, it cannot be said that the maxillary is excluded from the gape.

OPERCULAR AND HYOID APPARATUS.—Opercular armature is uncommon in the Blennioidei.

As in other bottom fishes, water tends to be expelled from the upper portion of the gill cavity. Among many of the Blennioidei there is a special valve for this purpose (Makushok, 1958, pp. 20, 21, fig. 8). By contrast, the gill openings usually are restricted more or less below, with the gill membranes attached to one another across the isthmus or broadly attached to the isthmus. The trachinoids and the notothenioid families Trichonotidae (sensu lato) and Bovietidae are exceptional in having the gill openings extending far forward. The trachinoid fishes (Gill, 1907) and at least some trichonotids bury themselves up to the eyes in sand or mud. Baglioni (1908) has shown that *Trachinus* and *Uranoscopus*, at least, pump water over the gills by sliding the branchiostegal membranes up and down over the cleithral region. Inasmuch as the branchiostegals of these fishes and of such trichonotids as *Crystallodytes* (Gosline, 1963) are largely covered by the operculi, this method of breathing must cause a minimum of disturbance in the surrounding sand or mud.

Lycodapus, generally placed among the zoarceoids, is another fish with the gill openings extending far forward, but the relationships of this fish seem open to question.

Another feature that may be associated with wide gill openings is the branchiostegal ray number. Thus, in most Blennioidei, there are six branchiostegal rays, but in the Bovictidae and frequently in the Trichonotidae, there are seven. Among the zoarceoids, however, the Anarchichadidae, with the gill membranes broadly joined to the isthmus, also have seven. Makushok (1958, p. 21) considers the condition in anarchichadids to represent a secondary increase.

SUSPENSORIUM (fig. 8).—The suspensorium develops various modifications among the Blennioidei, but it is difficult to evaluate these phylogenetically.

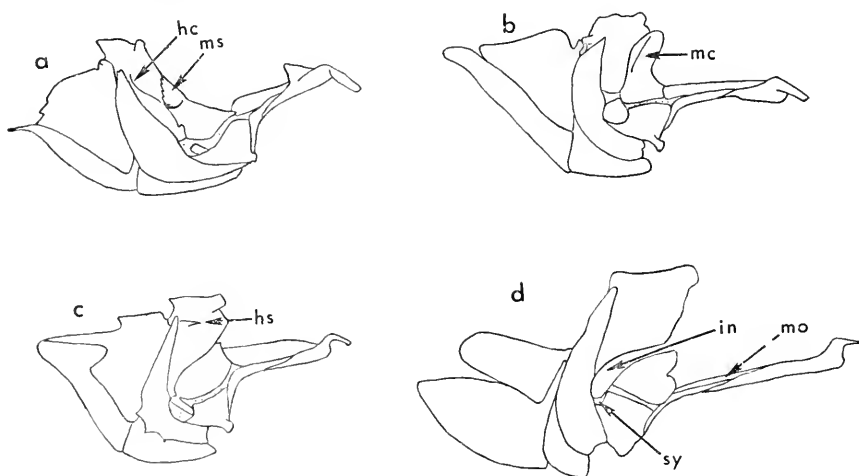

FIGURE 8.—Right suspensoria and opercular bones: *a*, *Prolatilus jugularis*; *b*, *Bathymaster signatus*; *c*, *Trachinus draco*; *d*, *Notograptus guttatus*. (hc=Hyomandibular crest, hs=hyomandibular spine, in=interspace between upper and lower portions of suspensorium, mc=metapterygoid crest, mo=mesopterygoid, ms=metapterygoid strut, sy=symplectic.)

The parapercid genus *Prolatilus* (fig. 8a) seems to be the only member of the Blennioidei to retain the rather typical percoid metapterygoid strut (Katayama, 1958).

Across the surface of the back of the suspensorium, various crests develop for muscular attachment. Among the parapercids, such a ridge runs anteroventrally across the hyomandibular. In zoarcids (fig. 8b), it is usually on the metapterygoid. In *Trachinus* and uranoscopids, the hyomandibular sends forward a hooklike process (fig. 8c).

Various members of the Blennioidei lose a firm attachment between the anterior and posterior portions of the suspensorium. Among such

fishes are the trichonotid *Crystallodytes*, notograptids (fig. 8d), congrogadids, and possibly the zoarceoid *Ptilichthys* (Makushok, 1958, p. 66, fig. 38b).

The mesopterygoid is developed variously. In *Trachinus*, it is broad and in *T. draco*, it bears teeth. Another family in which, so far as known, it is consistently broad is the Trichonotidae. On the other hand, the mesopterygoid appears to be narrow throughout the zoarceoids.

GILL ARCH SYSTEM.—The gill arch system of the Blennioidei is basically percoid, with the lower pharyngeals always separate. Only two modifications in the Blennioidei will be noted. The first, occurring in the congrogadoid *Notograptus*, is that the posterior basibranchials have dropped out. The second, which recurs repeatedly, is that the three upper pharyngeal tooth patches become reduced to two or, in blenniids, to one.

DORSAL PORTION OF THE HEAD (fig. 9).—The frontals usually are paired in the Blennioidei; however, in at least the tropical blenny *Runula*, the frontals of the two sides seem to have fused.

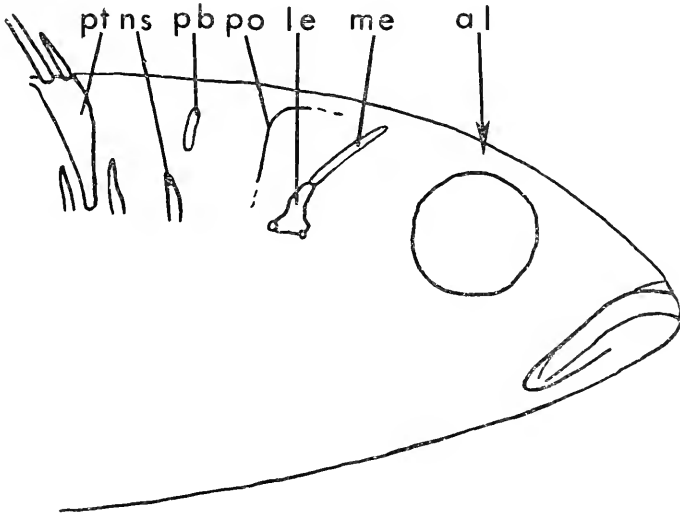

FIGURE 9.—Diagram of certain structures in *Prolatilus jugularis* (al= anterior level reached by the body musculature extending over the cranium, le=lateral extrascapular, ns= upper end of neural spine, pb=predorsal bone, po=posterior rim of supraoccipital, pt= pterygiophore of first two dorsal spines).

On the dorsal surface of the cranium posteriorly, the Blennioidei in general differ from the typical percoid in that the body musculature does not extend forward over the skull, and the supraoccipital and frontal-parietal crests, which, in part, form surfaces of attachment

for such musculature, usually are missing; however, in *Prolatilus* (fig. 9), a very generalized genus of the notothenioid family Paraperidae, the usual percoid condition is retained; furthermore, as in the percoids, the supratemporal commissure is incomplete, ending blindly over the musculature.

Generally, in the Blennioidei, the supratemporal commissure is complete. In such fishes as most notothenioids, all congrogadoids, trachinids, and certain tropical blennies of the families Tripterygiidae (Rosenblatt, 1957, unpubl. Ph.D. dissertation) and Clinidae, the supratemporal canal runs up on each side through the lateral and medial extrascapulars and then crosses the midline in a membranous tube; however, in the "uranoscopoid families," in most tropical blennies, and in all the zoarceoids, the medial extrascapular appears to have fused with the parietal.

Certain tropical blennies and zoarceoids have secondarily developed crests on the skull; e.g., a median crest along the frontals. Such crests, however, are for the attachment of jaw musculature, not body musculature (Makushok, 1958, p. 51).

Even though a supraoccipital crest rarely occurs on the dorsal surface of the skull in the Blennioidei, a small crest may be retained on the posterior surface. In the zoarceoids, with the single exception (known to me) of *Cryptacanthodes* (Makushok, 1961a, fig. 3), even this section of the crest is lost.

SPHENOID REGION OF THE CRANIUM (fig. 10).—So far as the differentiation of lineages among the Blennioidei is concerned, the sphenoid region of the cranium seems to be one of the most diagnostic parts of the whole fish. The features of importance here are the basisphenoid and the postorbital bar.

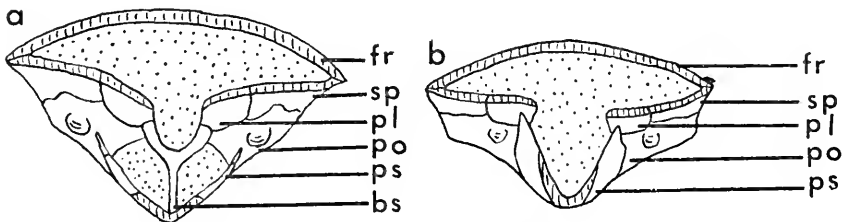

FIGURE 10.—Diagrammatic cross-section of cranium, looking toward rear, at level of front of basisphenoid: *a*, *Prolatilus jugularis*; *b*, *Bathymaster signatus*. (Vertical hatching=cut areas, stippling=cranial cavity, bs=basisphenoid, fr=frontal, pl=pleurosphenoid, po=prootic, ps=parasphenoid, sp=sphenotic.)

The basisphenoid is a bone that has been lost repeatedly in fishes. In general, this loss seems to be associated with the development of a broad, depressed cranium (see p. 21). Thus, among the noto-

thenioids, the basisphenoid, though generally present, is lacking in the flat-headed *Bembrops* and is said to be absent (Regan, 1913, p. 141) in the Hemerocoetidae. Among the tropical blennies and their relatives, it is apparently always present. In the zoarceoids, there is no basisphenoid.

In the zoarceoid *Bathymaster*, the brain cavity is separated from the posterior myodome only by membrane anteriorly (fig. 10*b*), though posteriorly there appears to be the usual horizontal prootic ledge separating the two cavities. In such a fish as the parapercid *Prolatilus* (fig. 10*a*), by contrast, the myodome is separated almost completely from the cranial cavity by the wings of the basisphenoid anteriorly and by a well-developed prootic ledge posteriorly. This is the usual percoid condition. (For an account of variations of the posterior myodome in scorpaeniform fishes, see Quast, 1965, pp. 574, 584.)

In the basal percoids, the ascending wing of the parasphenoid is low (as in fig. 4) and does not extend up to a junction with the pleurosphenoid in front of the prootic. But again and again in the percoid derivatives—and, for that matter, in lower teleosts (see, e.g., figs. in Svetovidov, 1948)—the ascending wing of the parasphenoid becomes prolonged upward in front of the prootic to the pleurosphenoid and, in extreme instances, meets a descending wing of the frontal ahead of both the prootic and pleurosphenoid. Starks (1923, pp. 261–263), Makushok (1958, pp. 41, 42), and Quast (1965, pp. 572–574) discuss variations in this character.

Among the Blennioidei, the parasphenoid always extends up to the pleurosphenoid or frontal ahead of the prootic in the Zoarceoidae and Trachinoideae; it does not do this in the Notohenioideae. In the tropical blennies, it is variable (Starks, 1923, p. 263, and Springer, 1966). Among congrogadoids, a long sliver of prootic extends forward to the orbital border between the pleurosphenoid and parasphenoid in *Congrogadus*, but in *Notograptus* the parasphenoid and pleurosphenoid meet.

FIN STRUCTURE.—With a few exceptions, the differentiation between spines and soft rays is not as clear in the Blennioidei as it is in most percoids. On the one hand, pungent spines and their large pterygiophores tend to be reduced or lost. The tropical blennies are the only group that consistently has dorsal fin spines. On the other hand, the branching of the soft rays usually is reduced; where it does occur in the vertical fins, the posterior half of each branch rebranches sooner than the anterior half. In many blennioid genera, e.g., *Medusablennius* (Springer, 1966), there are no branched fin rays at all.

PAIRED FINS AND THEIR GIRDLES.—As noted above, the function and structure of the paired fins in the Blennioidei are different from

what they are in the percoids. In the percoids, the pectorals may be used to govern the vertical plane of forward movement, for stopping, turning, "treading water," and even in some—e.g., the labrids—for forward locomotion. One of the structural features that permits all of these activities is the ability to rotate the pectoral base around the upper ray as an axis. In the percoids, the uppermost pectoral ray articulates with the scapula (as in fig. 11a), but the lower rays articulate with progressively longer and independently movable actinosts. (If the outer ends of these actinosts are swung outward and downward, the pectoral fin base is brought into a plane vertical to the water; if they are swung up and back, the fin base moves toward a horizontal plane.) Among all but the most generalized of the Blennioidei (fig. 11a), both the function and structure of the pectoral change consider-

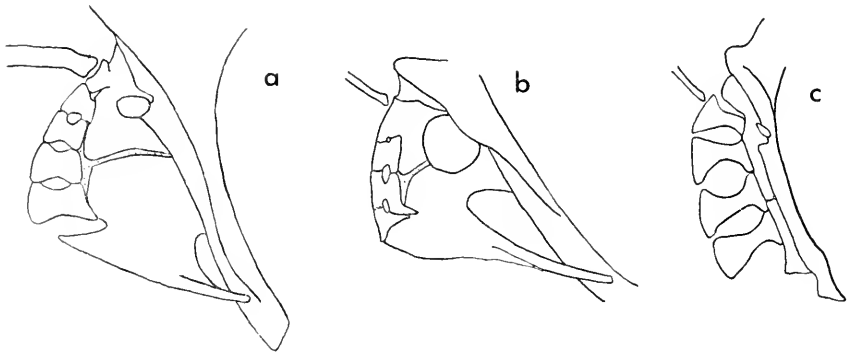

FIGURE 11.—Primary pectoral girdle, right side: a, *Prolatilus jugularis*; b, *Hemerocoetes* species; c, *Labrisomus nuchipinnis*. (In each figure, position of base of uppermost pectoral ray is shown.)

ably. These fins (except in tropical blennies), instead of being used in maneuvering, may act as props against the bottom and, by being brought back sharply against the body from a somewhat erect position, may provide a fast standing start from the normal stationary position. Structurally, the pectorals of the Blennioidei, except where secondarily reduced as in the Congrogadidae, almost always are rounded and broad based. The pectoral girdle tends to have broad actinosts rigidly attached to the scapula and coracoid and to one another in order to form a rather rigid, platelike surface of attachment for the pectoral rays. In one group of the Blennioidei, the Notothenioidae, the platelike nature of the primary girdle frequently has been increased further by the fusion of the uppermost actinost with the scapula, reducing the autogenous actinosts to three. This has occurred in the Bovictidae, Nototheniidae, Harpagiferidae, Bathydraconidae, Chanichthyidae, and the trichonotid (sensu lato) *Hemerocoetes* (fig. 11b).

Regan (1913, p. 141) states that the trichonotid (*sensu lato*) *Bembrops* also has three actinosts, but I find four in two specimens identified as *B. gobioides*.

Inasmuch as the possibility for pectoral rotation has been largely lost in most of the Blennioidei, the differentiation between the uppermost ray articulation and that of the lower rays diminishes. Indeed, several of the upper pectoral rays usually move up to an articulation on the scapula along with the uppermost.

The tropical blennies, with the batrachoids and lophioids (Starks, 1930), are unique among teleosts in that they have developed secondarily an ability to rotate the fins—but not on the uppermost ray articulating with the scapula as an axis. Except in the Tripterygiidae, the pectoral rays all articulate with separately movable actinosts (fig. 11*c*). (The axis for maximum rotation for such a fin theoretically would lie between the two middle actinosts.)

The pelvic fins in the Blennioidei, when present, are always in advance of the pectoral bases, though in a few of the generalized forms, like the parapercid *Prolatilus*, not much so.

Among the Blennioidei, three things happen to the pelvic fins. One, which seems to have no phylogenetic significance, is that, in elongate fishes, the pelvics tend to dwindle in size and disappear completely. A sequence of this sort can be followed in the notothenioid family Trichonotidae (*Apocreeedia*), in the congrogadoids, and in the zoarceoids (Makushok, 1958).

Those Blennioidei in which the pelvics are not minute or absent seem to have put them to two rather different uses. In one, represented by the Dactyloscopidae, almost all the Blennioidae, and to some extent the Trachinidae, the two or three outer soft rays are simple, somewhat strengthened, and recurved at their tips, which extend well beyond the membrane between them. Usually such fins are held more or less erect under the body.

In the other type of development, the pelvic fins are held back flat against the abdomen, but all five rays are retained, none are strengthened, and the inner are at least somewhat the longest. In this type of development, which occurs in almost all of the the Notothenioidae and in the Leptoscopidae, the pelvics frequently become separated widely from one another. Such fishes must rest with their thoracic areas between the pelvics in direct contact with the substrate.

The pelvic girdles of the Blennioidei are very varied. The only taxonomically meaningful structural peculiarity that I could find is that mentioned under the Trachinoidae (see p. 59).

VERTICAL FINS.—The basic dorsal fin arrangement that runs through many of the Blennioidei is a short, anterior spinous dorsal followed by a long, low fin of soft rays. Especially in the eel-shaped forms,

the separate anterior spinous dorsal is lost, and there is a single long dorsal fin that may be made up entirely of soft rays (*Congrogadus*), almost entirely of spines (*Notograptus*), or partly of each (Blenniidae). The anteriormost dorsal ray is almost always far forward, and generally there are no predorsal bones (Smith and Bailey, 1961); however, the notothenioid genus *Cheimarrichthys* does have the basal percoid number of three predorsals, and *Congrogadus* has two.

The anal fin of the Blennioidei rarely contains pungent spines (see, however, Makushok, 1958, p. 34), though one or two unsegmented anterior rays frequently are present. Among the percoids there is usually a more or less constant relationship between the anterior anal pterygiophores and the first hemal spine. Among percoids with large, pungent anal spines, the two or three first anal pterygiophores frequently are fused; however, in forms with smaller anal spines, such as *Acanthoclinus* or the opisthognathid *Gnathypops*, they remain separate. In *Acanthoclinus*, the first anal pterygiophore extends up behind the first hemal spine; in *Gnathypops*, the first pterygiophore is short, and the second extends up behind the anteriormost hemal spine. This more or less constant relationship between the anterior anal pterygiophores and the first hemal spine is maintained in the members of the family Tripterygiidae, Clinidae, and Blenniidae that I have examined; however, it is lost in the other groups of Blennioidei. Most frequently, e.g., in the Parapercidae, Trachinidae, and Bathymasteridae, the first few anal pterygiophores are short and well forward of the first hemal spine. The great variation that may occur even within a group has been demonstrated by Makushok (1958, p. 29) for zoarceoid families.

Posteriorly, the dorsal and anal usually approach and sometimes are connected membranously with the caudal fin. Only in some of the clinine clinids is there a lengthy, constricted caudal peduncle behind the dorsal and anal. Where it does occur, it is supported, as elsewhere, by expanded, bladelike neural and hemal arches—e.g., among the ammodytoids (Gosline, 1963).

CAUDAL FIN AND CAUDAL SKELETON.—In the Blennioidei, the fin is generally rounded or it is brushlike. Exceptions may be divided into two categories. One contains certain of the secondarily pelagic forms that have a somewhat lunate caudal fin, e.g., the tropical blenny *Runula*. The other is made up of certain basal notothenioids with bilobed tails. Certain species of *Parapercis* (Cantwell, 1964) and possibly *Cheimarrichthys* fall into this category.

As so often happens among fishes with rounded caudal fins, the number of branched rays becomes variable (Makushok, 1958). In the Blennioidei, the notothenioid Parapercidae is the only family that

maintains the usual percoid number of 15 branched rays, all other families having a reduced number.

In the caudal skeleton, the amount of fusion and/or loss varies all the way from an almost basal percoid condition (Gosline, 1961b) to a single bone (Makushok, 1958). The whole gamut is covered in the notothenioid group and to a lesser extent in the others. At the very base is *Parapercis* (Gosline, 1963, p. 95, fig. 6) with five hypurals (counting as in Nybelin's 1963 system), one uroneural, three epurals, and three hemal arches—all of these elements autogenous, i.e., separate. In *Trachinus* (fig. 5b), at the base of the trachinoid-blennioid-congrogadoid series, there are only 11 branched rays in the caudal fin, and the two hypurals to the lower portion of the caudal fin have become fused, but the other elements are as in *Parapercis*. In *Bathymaster*, at the base of the zoarceoids, there are 14 branched rays; the last hemal arch has fused to the lower hypurals to form a single element supporting the bottom half of the caudal fin, but there are still three separate upper hypurals, a uroneural, and three separate epurals (fig. 5c). All of the above fishes show less fusion in the caudal skeleton than such percoids as *Acanthoclinus* and *Opistognathus*.

The pathways of fusion seem to be about the same in the various groups of Blennioidei. Thus, a general first stage seems to be a fusion of the lower hypurals (*Trachinus*, fig. 5b) followed by an ankylosis of these with the last hemal arch (*Bathymaster*, fig. 5c). This single element fused to the lower part of the caudal fin remains separate from the last centrum until after all of the upper hypurals and the uroneural have fused to the urostyle.

VERTEBRAL COLUMN AND RIBS.—The basal percoids tend to have a rather standardized vertebral column with 24 or 25 vertebrae, 10 abdominal and 14 or 15 caudal. This basal number always is exceeded among the Blennioidei. The increase in the vertebral number occurs first in the caudal section of the column; in the abdominal section, members of the Parapercidae (Cantwell, 1964), Tripterygiidae (Gosline, 1963), and Leptoscopidae (Regan, 1913) all are recorded with 10 abdominal vertebrae.

Ribs may be quite variable among the Blennioidei. Among the flatter forms, pleural ribs may be lacking completely, as in *Bembrops* and the leptoscopids. Pleural ribs also are lacking in the elongate Pholidae (Makushok, 1958, p. 28). In the Uranoscopidae, pleural and epipleural ribs both are attached to independent bony struts that Starks (1923, p. 279) has called basipleurals. More frequently, however, the usual percoid configuration of epipleural ribs from the first, pleural ribs from the third vertebra, is present. From structure, it is sometimes difficult (e.g., among congrogadoids) to distinguish pleural from epipleural elements.

Relationships of the Blennioidei

In the first part of this section, the Blennioidei have been delimited.

Within the group, there is a whole series of what might be called central tendencies that will distinguish the group from its ancestral percoid type. Thus, in the Blennioidei, the body musculature (except *Prolatilus*) does not extend forward over the top of the head, and supraoccipital and frontal-parietal crests for its attachment are lacking. The supratemporal commissure usually is complete, extending across the supraoccipital. There are always more than 25 vertebrae. Predorsal bones usually are absent. The anal fin rarely has pungent spines, though there may be one of two unsegmented rays anteriorly; the anterior interhemals are not enlarged and do not abut against the first hemal arch. The pelvic fins either have fewer than five soft rays or the inner rays are the longer. Pectoral and caudal fins usually are rounded. In the caudal (except Paraperceidae), there are fewer than 15 branched rays. The gas bladder usually is absent in the adult.

Most or all of the above characters are associated with the basal mode of life of the Blennioidei noted previously; however, some members show secondary modifications. These cause some of the principal difficulties in distinguishing the lineages within the suborder (fig. 12) and, for that matter, in defining the Blennioidei. Thus, certain members of the Blennioidei of various ancestries have developed secondarily a more or less pelagic existence, e.g., the petrosclirtines among tropical blennies and *Zaprora* among zoarceoids. When this happens, the tail may be more or less lunate, as in *Runula*, instead of having the rounded form typical of the Blennioidei. Furthermore, the pelvic rays of the petrosclirtines tend to become filiform and weak (completely lacking in *Plagiotremus*) rather than sturdy, as in other tropical blennies.

Some forms of the Notothenioidae and Blennioidae and all of the Trachinoideae apparently bury themselves at least up to the eyes in sand. This obviously creates several problems in breathing and probably is associated with the wide gill openings of the notothenioid family Trichonotidae and the superfamily Trachinoideae (see previous section), as contrasted with the usual ventral restriction of the gill slits in the Blennioidei.

Certain members of the notothenioid family Trichonotidae have become sand divers. Here, as elsewhere when this habit occurs—e.g., in the Ammodytidae and Kraemeriidae—certain morphological features seem to develop. Thus, unlike the rest of the notothenioids, the pelvics of sand-diving trichonotids are close together and may be reduced or disappear completely, as in, e.g., *Apocreedia*.

Among eel-shaped forms, there is the usual tendency for the pelvics to dwindle away and disappear first, followed by the pectorals. These

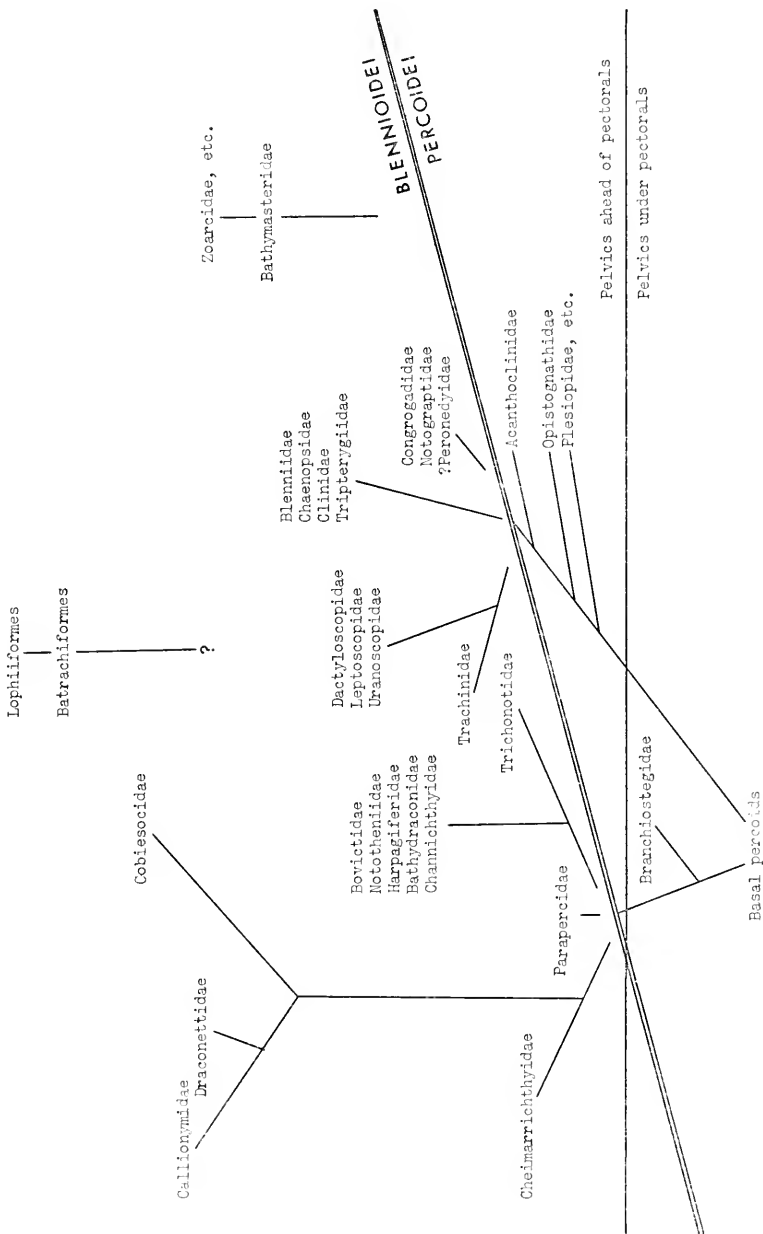

FIGURE 12.—Diagram of blennioid relationships (groups above diagonal double line have exact 1:1 ratio between dorsal and anal rays and vertebrae; groups below double line have slightly more than 1 fin ray per vertebra).

trends are encountered not only in the more elongate zoarceoids, but also in the congrogadoids.

In regard to what would seem to be primary phylogenetic differences (fig. 12), the Blennioidei appear to be divisible into three main groups: a notothenioid, a zoarceoid, and a trachinoid-blennioid-congrogadoid series. These three groups (see fig. 12) are contrasted in table 2.

In many respects, evolution within the three groups has progressed along parallel lines; for example, in the progressive fusion of elements of the caudal skeleton. On the other hand, the same trend of development may occur in all three, but apparently has progressed at different rates. Thus, among the notothenioids, the medial extrascapular remains free of the parietal in all of the forms I have examined except *Harpagifer*; in the trachinoid-blennioid-congrogadoid series, it frequently fuses with the parietal; and in the zoarceoids there is no trace of a free medial extrascapular. Finally, there are indications of secondary convergence of characters in the three series, as among the pelagic and the burrowing forms already noted.

But for all these difficulties, the three do show certain primary differences in evolutionary development. Thus, the notothenioids have tended to flatten the head and anterior portion of the body. Probably associated with this are peculiarities of paired fin structure. With the exception of certain sand-diving trichonotids, the pelvics are well separated and maintain a full complement of five soft rays, with the inner usually the longest; these pelvics normally are held back flat against the body. In the pectoral girdle, the actinosts are always broad and platelike, and the uppermost frequently fuses with the scapula. In the above features, the notothenioids have developed along lines that are not duplicated elsewhere in the Blennioidei. Conversely, the notothenioids retain certain percoid features that most of the other members have lost. Of these, the independent medial extrascapular already has been mentioned. More important, the parasphenoid in notothenioids (fig. 10a) has no wing extending in front of the prootic in such a way as to exclude the prootic from the internal orbital border.

The notothenioids have, morphologically speaking, the longest lineage in the Blennioidei. They extend from the Paraperceidae, the most percoid-like family of the Blennioidei, out to the Callionymidae and Gobiesocidae. The latter groups show quite clearly all the trends of notothenioid development listed above (except that the Gobiesocida have only four pelvic rays), and the specializations that seem to warrant their exclusion from the Perciformes altogether lie along other lines.

The other two main series of the Blennioidei rarely are flattened anteriorly, generally tend (for very different reasons) to reduce the number of pelvic rays, and, with the exception of the Leptoscopidae, never have the pelvics widely separated.

Of these two series, the Zoarceoidae, so far as known (but see below), are structurally the most homogeneous. There is among the zoarceoids a general trend toward elongation, and concurrently (as noted) for the pelvic fins, followed by the pectorals, to diminish and disappear. In skull characters, the zoarceoids are all specialized: there is no separate, medial extrascapular; the prootic always is excluded from the orbital border by the parasphenoid (fig. 10*b*); and there is no basisphenoid. In this last feature, the zoarceoids differ from all but a few of the other Blennioidei. The single nostril on each side of the head will distinguish immediately the zoarceoids from all tropical Blennioidei.

The trachinoid-blennioid-congrogadoid series is internally diverse. It is defined more easily in terms of lack of peculiarities that the notothenioid and zoarceoid lines have developed than in terms of its own specializations; nevertheless, there are two weak trends of development that may be noted for the trachinoid-blennioid-congrogadoid series. The first trend is toward a consolidation of the bones of the circumorbital ring. *Trachinus* (fig. 7*c*) and the congrogadoids are the only members of the Blennioidei with a well developed percoid-type subocular shelf, and from here there is usually a further fusion of circumorbital elements, rather than a disintegration of the circumorbital ring that tends to occur in the zoarceoids and notothenioids. This differentiation in circumorbitals, however, is not constant (see above). The second trend seems to be a tendency in the Trachinidae, Uranoscopidae, Dactyloscopidae, and tropical blennies to erect the close-set pelvics and use them as props under the body. This trend, however, does not extend to the Leptoscopidae, Congrogadidae, and Notograptidae.

If the specializations held in common by the trachinoid-blennioid-congrogadoid series are unimpressive, those that differentiate the three components of the series are well marked. In the first place, the three groups making up the series appear to have very different modes of life. The trachinoids, made up of the Trachinidae, Uranoscopidae, Leptoscopidae, and Dactyloscopidae, partially bury themselves in sand or mud (Gill, 1907) and apparently wait for or positively attract passing prey. Of the various morphological characteristics related to this habit, only one associated with respiration need be noted here. The gill covers extend down over the branchiostegal membranes, which are completely free from each other and from the isthmus (see p. 43). In the tropical blennies and congrogadoids, by

contrast, the gill covers are more or less broadly attached to one another or to the isthmus or both, and a different method of respiration must be used.

The tropical blennies (Blennioidea), though some members secondarily have taken up a different mode of life, are fishes that basically prop themselves off a hard bottom by means of one or more strengthened pelvic rays. Though the number of pelvic rays always is reduced from the five usually found in the trachinids and others, the pelvics, except in secondarily pelagic forms, are never rudimentary as they are in the congrogadoid group. Another feature found in all but the most generalized tropical blennies, i.e., the Tripterygiidae, is that the uppermost pectoral ray articulates with an actinost rather than the scapula. In this character, unique, to my knowledge, among the Blennioidei, the tropical blennies approach the batrachoid fishes (Starks, 1930). Also, the Blennioidea are the only superfamily in the suborder in which a large anterior portion of the dorsal fin (or fins) is made up usually of spines.

The congrogadids, with their allies the notographtids and possibly the peronediyids, are enigmatic eel-like forms. In these, the front and back of the suspensorium are associated loosely. They hold with the Trachinidae, alone among the Blennioidei, a subocular shelf, but this is a trait inherited from the percoids.

An attempt to establish the most generalized, i.e., percoid-like, families among the Blennioidei leads down to the Parapercidae (notothenioids), on the one hand, and the Trachinidae (trachinoid-blennioid-congrogadoid series), on the other (fig. 12). Yet the percoid characteristics that these two families retain are rather different. In the parapercid genus *Prolatilus*, there is a percoid supraoccipital crest and incomplete supratemporal commissure, no strut from the parasphenoid extending up in front of the prootic, 10 abdominal vertebrae in *Parapercis*, five separate hypurals (counting as in Nybelin's 1963 system), and 15 branched caudal rays. The generalized features of *Trachinus*, on the other hand, are the broad subocular shelf and the toothed mesopterygoid of *T. draco*. Though the parapercids and trachinids already have evolved in somewhat different directions, a basal percoid family such as the Branchiostegidae could, so far as morphology is concerned, stand at the base of both. Indeed, the superficial similarities are such that it is sometimes difficult to separate the members of the Branchiostegidae from the Parapercidae (however, see p. 43). As for the trachinids, it is not necessary to go so deeply into the percoid stock to find a fish that would provide a morphologically ancestral type. Except for certain specializations, e.g., fusion of elements in the caudal skeleton, *Opistognathus* or *Acanthoclinus* seem to serve fairly well. These genera already have the

erectile pelvic fins well ahead of the pectorals and other typical (if not universal) trachinoid features; however, as already suggested, there is no morphological reason why the opistognathids and acanthoclinids, as well as the trachinoids, should not have been derived from some basal percoid near the Branchiostegidae.

In the section that follows, the Blennioidei, essentially the Jugulares of Jordan (1923), will be considered a suborder of the Perciformes. The reasons for this are as follows: First, the members of the Blennioidei form a recognizable, definable group of fishes. Second, though I am as dubious about a strictly monophyletic origin for the Blennioidei (within the limits of that suborder as herein defined) as those who have investigated the group before me—e.g., Regan (1913, p. 138) and Starks (1923, p. 264, ftn. 1)—it seems possible that the ancestors of the various groups of Blennioidei lie deep in the basal percoids not too distant from one another. Finally, those who insist on strictly monophyletic groups would be forced, I think, into the alternative of recognizing at least three and probably five separate suborders among the Blennioidei. This possibility has been considered and rejected.

Classification of the Blennioidei

In the present section, for the sake of completeness, the classification of the suborder Blennioidei (= order Jugulares of Jordan, 1923 in part) is carried down to family. For the contents and a definition of this suborder as understood here, see p. 40.

SUPERFAMILY NOTOTHENIOIDAE (= Superfamily Notothenioidae + Trachinoidae, in part, of Berg, Regan, and Norman).—Head and anterior part of body usually more or less flattened. One nostril on each side in the nototheniid fishes (*sensu lato*), two on each side in the rest. Gill openings extending far forward in the Bovictidae and Trichonotidae (*sensu lato*), the gill membranes attached to one another or broadly attached to the isthmus in the rest. Branchiostegal rays seven in the Bovictidae and most Trichonotidae (*sensu lato*), six in the rest. Circumorbital series of bones usually movably connected, sometimes incomplete, without a subocular shelf on the second. Front and rear portions of suspensorium firmly attached except in some Trichonotidae (*sensu lato*). Prootic forming a part of the internal orbital border. Basiphonoid usually present.

Pectoral actinosts platelike, three or four in number, the upper pectoral ray or rays articulating with the scapula. Pelvic fins, except in some Trichonotidae (*sensu lato*), with a spine and five branched soft rays, the interspace between pectoral bases usually broader than the distance across one pelvic base.

The Notothenioidae are the only superfamily of the Blennioidei represented in both tropical and cold waters. Around the Antarctic

continent, this is the dominant group of fishes. The Notothenioidae also are the only superfamily to contain freshwater members (*Cheimarrichthys* and *Pseudaphritis*).

Aside from the Gobiocidae, Draconettidae, and Callionymidae, which herein are removed from the Perciformes entirely, the members of the notothenioid lineage (fig. 12) seem to fall into three or four groups:

At the base of the whole lineage are the two families Paraperidae and Cheimarrichthyidae. These retain predorsal bones and a number of other percoid features that have been lost by the rest of the notothenioids and, for that matter, the other members of the Blennioidei. (*Cheimarrichthys* does not, however, have an orbitosphenoid as stated by Lane, 1965).

A second group is made up of the notothenioids (*sensu stricto*), namely the Bovictidae, Nototheniidae, Harpagiferidae, Bathyracidae, and Channichthyidae (Norman, 1957). This group is characterized by the three pectoral actinosts, by a single nostril on each side of the head, and by its primarily Antarctic distribution; however, the distinction between this and other groups is not as clear-cut as it appears from the literature. The presence of only three actinosts occurs in the notothenioid (*sensu lato*) derivative Callionymidae and in the "trichonotid" *Hemerocoetes*, which, with other "trichonotids," has two nostrils on each side of the head, although the first may be very small; but the derivative Callionymidae and also *Melanostigma* (see under Zoarceidae) have only one.

The third group is made up of the Trichonotidae (*sensu lato*) (Schultz, 1960, pp. 273-277; except *Cheimarrichthys*, among the genera I have seen). This group contains a wide spectrum of morphological variation; however, the members I have been able to examine have the following features in common: The gill openings extend far forward under the throat, as in the Bovictidae among notothenioid (*sensu stricto*) families. The branchiostegal rays are seven, except *Hemerocoetes*, which has six. The ascending process of the premaxillary is attached movably to the toothed portion. At least in *Crystallodytes*, *Bembrops*, and *Hemerocoetes*, the mesopterygoid forms a broad shelf, free posteriorly, but attached to the palatine anteriorly; the palatine, in turn, is attached movably to the pterygoid. Though these characters are quite distinctive, *Hemerocoetes* with three actinosts may be intermediate between the Trichonotidae and the Bovictidae among notothenioid families.

A possible fourth group is represented by *Melanostigma*, which (see p. 63) may prove to be merely a pelagic notothenioid (*sensu stricto*).

SUPERFAMILY TRACHINOIDAE (=Trachinidae, Uranoscopidae, Leptoscopidae and Dactyloscopidae).—Head compressed or rounded. Two external nostrils on each side. Gill openings extending far forward. Circumorbital bones firmly connected, more or less expanded onto the cheek, sometimes with a subocular shelf on the second. Medial tabular firmly attached, but not fused to parietal. Front and rear of the suspensorium firmly connected. Prootic not forming a part of the internal border of the orbit. Basisphenoid present.

Pectoral actinosts four, broad or columnar, the upper pectoral ray articulating with the scapula. Pelvic fins with a spine and five soft rays (except Dactyloscopidae), the interspace between them less than the distance across one pelvic base (except Leptoscopidae).

The trachinoids possess two additional characters in which, to my knowledge, they are unique among the suborder Blennioidei. In the pelvic girdle, the ridge on which the pelvic spine rides extends forward into a point. This point may lie adjacent to its fellow on the opposite side of the midline, as in *Trachinus*, *Leptoscopus*, and *Dactyloscopus*, or form a more laterally located projection from the flesh, as in the Uranoscopidae. The second peculiarity is that at least *Trachinus* and *Uranoscopus* have a bony point extending forward from the outer surface of the posterior rim of the hyomandibular (fig. 8c). Further similarities are as follows: In all four families, the scapular foramen is very large and, except in the Leptoscopidae (Starks, 1930, p. 226), extends to the cleithrum. All four families have a low number of abdominal vertebrae (10–12) for the Blennioidei. Certain other tendencies among the trachinoids may be associated with their habit of living in the sand or mud. One is the development, in some trachinids and uranoscopids, of a continuity between adjacent scale edges to form ridges extending down and back across the body. Another is for the mouth to have a fringed border. Finally, the circumorbital bones are more or less expanded down over the cheek; armature is usually developed; and the top of the head is frequently rugose.

The Trachinoidea is made up of tropical and temperate marine fishes occurring on soft bottoms in which they bury themselves up to the eyes (Gill, 1907).

On the basis of the reduction in pelvic ray number in the Dactyloscopidae, Regan (1912d) placed this family in a different suborder from the Uranoscopidae and Leptoscopidae. Starks (1923) pointed out the artificiality of this procedure. On the other hand, Starks denied any relationship between the Trachinidae and the "uranoscopoid" families. To me, the evidence to the contrary given above seems wholly convincing.

SUPERFAMILY CONGROGADOIDAE (=Congrogadidae, Notograptidae, and provisionally the Peronedyidae).—Head compressed or rounded.

Two nostrils on each side. Gill openings somewhat restricted below. Circumorbital series of bones firmly connected, complete, with a subocular shelf from the second. Medial extrascapular not fused to the parietal. Front and rear of the suspensorium loosely connected. Prootic forming a part of the internal orbital border or not. Basisphenoid present.

Pectoral actinosts columnar, four in number, the upper pectoral ray articulating with the scapula. Pelvic fins minute or absent; if present, the interspace between them less than the distance across one pelvic base.

The suborder is entirely inshore, tropical Indo-West Pacific in distribution.

The families included here in the Congrogadoidae are the Congrogadidae, Notograptidae, and very provisionally the Peronedyiidae. In 1952 Smith divided the Congrogadidae of Regan (1912d) into two families, the Congrogadidae and Haliophidae. This seems, however, an unnecessary proliferation of families among obviously related fishes. Besides, the type of *Congrogadus heirichthys* and, for that matter, juveniles of *C. subducens* fall between the two families as Smith defines them.

So far as the congrogadids and notograptids are concerned, a relationship between the two families needs demonstration. This is by no means easy, despite the general eel-like form in both; however, both have a subocular shelf on the second suborbital bone, a feature held in common with *Trachinus* and many percoids. Second, though the mechanism is different in the two families, both have a suspensorium in which the anterior half is connected only weakly with the posterior portion. Third, the soft dorsal and anal rays show a type of branching that does not extend to the base but in which the posterior, but not the anterior branch, redivides. (The Peronedyiidae are based on a single Australian species I have not seen, the affinities of which are doubtful. It will not be discussed here.)

Granting a relationship between notograptids and congrogadids, the question then arises as to what the two families are in turn related to. Smith (1952, p. 87) suggests that the congrogadids may be aberrant percoids. This is a distinct possibility, but Smith's further suggestion of "Spariform relations" seems most improbable. The anterior pelvic position of *Notograptus* and certain congrogadid genera and the 1:1 relationship between dorsal and anal rays and vertebrae suggest the Blennioidei, and there seems to be no reason to deny them such an allocation.

An effort to locate possible relatives of the Congrogadoidae has led to an investigation of certain other eel-shaped fishes. The results, though negative, may be noted briefly.

In *Mastacembelus liberiensis* (USNM 118751), there are no pelvic fins. The dorsal and anal rays are somewhat more numerous than the vertebrae. The structure of the trunklike snout seems to be unique in fishes. The nasal bone (Regan, 1912a, fig.) forms a long lid over the nasal cavity. It is attached tightly by ligament to the ethmoid medially and along its outer surface to the lacrimal. In the cavity below the nasal bone, there is a long nasal organ of the same gross shape as that of *Anguilla*; however, the nasal organ of *Mastacembelus* is folded over on itself with the fold hinge medial. The nasal epithelium extends down from the top fold and up from the bottom one as a series of transverse leaves, and the water apparently passes between the two folds. The posterior nostril is just ahead of the eye, but the anterior is at the end of a tube at the front of the trunk. Just above the anterior nostril on each side is the opening to another long, membranous tube that connects posteriorly with the supra-orbital sensory canal at the front of the nasal bone. The upper jaw is suspended far forward, below the rostral "trunk," from a membranous extension of the mesethmoid. The maxillary has no connection whatsoever with the palatines, and neither the premaxillary nor the maxillary have the usual articular surfaces or pedicels.

A fish that possibly is related more closely to the Congrogadoidae than *Mastacembelus* is *Alabes*. In *Alabes*, the premaxillary pedicels extend up under the nasal bones, as in *Congrogadus*, and the anterior and posterior portions of the suspensorium are disconnected. *Alabes*, however, is so specialized (degenerate) as to have obscured any real evidence of relationship; *Alabes* has no supratemporal canal, no dorsal or anal fin rays, and no primary pectoral girdle. Under the circumstances, it seems best to leave *Alabes*, at least provisionally, in the Symbranchiformes, where it usually is placed (Regan, 1912c).

SUPERFAMILY BLENNIOIDAE (= Tripterygiidae, Clinidae, Chaenopsidae and Blenniidae).—Head compressed or rounded. Two nostrils on each side. Gill openings more or less restricted below, the gill membranes attached to one another or to the isthmus. Circum-orbital bones usually firmly connected, without a subocular shelf from the second. Medial tabular usually fused to the parietal. Front and rear of suspensorium firmly connected. Prootic usually excluded from the internal orbital border. Basisphenoid present.

Pectoral actinosts columnar, longer than the scapula and coracoid are broad (fig. 11c), the upper pectoral ray articulating with an actinost (except Tripterygiidae). Pelvic fins with two to four soft rays of which the outer are strengthened and the membrane between the rays deeply incised (except such secondarily pelagic forms as *Aspidontus*, *Runula*, *Xiphasia*). Dorsal and anal soft rays usually unbranched.

An additional feature that seems to separate the Blennioidea from all other members of the suborder is that the members I have examined, at least, retain a constant relationship between the anterior-most anal pterygiophores and the first hemal spine.

Members of this superfamily are abundant inhabitants of all tropical inshore areas, and some extend their ranges well into temperate waters.

The relationship of the tropical blennies to any other fish group is by no means clear.

SUPERFAMILY ZOARCEOIDAE (=Zoarceoidae+Stichaeoidae+Cryptacanthodidae of Makushok+Bathymasteridae+Zaproridae+?Derepodichthyidae+?Scytalinidae).—As Norman (1957, p. 477) indicates, *Zoarcaeus* Nilsson, 1832, appears to be the first Latinized version of Cuvier's (1829, p. 400) "Les Zoarcés." But *Zoarcaeus* is an objective synonym of *Enchelyopus* Gronow, an invalid name that, depending upon interpretation, may have been validated nomenclatorially by Scopoli (1777). Though the proper generic name to be used herein is by no means clear, the family group names Zoarceoidae and Zoarcidae are available whether or not the generic name on which they are based is a synonym ("International Code of Zoological Nomenclature," 1964, p. 11).

Head compressed or rounded. The body is long and more or less tapering posteriorly, with a short, usually poorly demarcated caudal peduncle. A single nostril on each side of head. Gill openings rarely (*Derepodichthys*) extending far forward below the head. Medial extrascapular of the usually well developed lateral line (seismosensory of Makushok) system fused to the parietals. Front and rear of the suspensorium usually firmly connected (apparently weakly connected in *Ptilichthys*; see Makushok 1958, p. 66, fig. 38b). Prootic excluded from the interior orbital rim. Basisphenoid absent.

Pectoral actinosts broad, usually four in number (said to be three sometimes in *Cebedichthys* [Starks, 1930, p. 83] and altogether absent in *Azygopsis* [Makushok, 1958, p. 106, fig. 72]), the uppermost pectoral ray articulating with the scapula. Pelvic fins with fewer than five soft rays (except Bathymasteridae), frequently absent; if present, none of the soft pelvic rays are strengthened or the interradiial membranes between them deeply incised. Interspace between pelvic fins less than the distance across one pelvic base.

In addition to the above features, there are others common to most or all zoarceoids that will separate them from many of the other Blennioidei. First, the maxillary is much longer than the premaxillary, sometimes more than twice as long in such extreme instances as *Anarrhichas*. Second, the dorsal fin is always continuous (except for *Ptilichthys*, which has separate spines anteriorly). Third, the entop-

terygoid is never, to my knowledge, more than a narrow strut, and the metapterygoid frequently has a vertical crest along the posterior border of its outer face (fig. 8b).

The zoarceoids are one of the major marine, cold-water groups. They are found in both hemispheres but are primarily and basically northern. In depth, they range from the intertidal region to the deep sea. They are generally demersal but at least *Zaprora* and *Lycodapus* have developed secondarily a pelagic habit. "*Zoarces*" *viviparus* is unusual in being a viviparous form that frequently occurs in water of reduced salinity (Schmidt, 1917).

The foregoing account has been based largely on inshore forms that are more readily available and that have been investigated much more thoroughly (e.g., Makushok, 1958, 1961a, 1961b). These give an impression of homogeneity that may be belied when the more peculiar of the deep-water and pelagic "zoarceoids" have been studied more intensively. Of those that have been reported on, *Zaprora* (Chapman and Townsend, 1938) is, as McAllister and Krejsa (1961) pointed out, a not too abnormal stichaeid-like form; however, the so-called zoarceid *Melanostigma*, judging from Yarberry's (1965) description, gives every indication of being a modified notothenioid and not a zoarceoid at all. Thus, a basisphenoid, unknown in zoarceoids, is present in *Melanostigma*. Its parasphenoid wings are low and do not extend up to the pleurosphenoids in front of the prootic (Yarberry, 1965, p. 445, fig. 2). There are only three pectoral actionosts. Finally, *Melanostigma* has seven branchiostegal rays, a number found throughout the Bovictidae and in most of the Trichonotidae, but only among the Anarhichadidae of the zoarceoids (see p. 44).

Even the inshore zoarceoids, however, despite their morphological homogeneity and peculiarity, have caused what would seem to be an unnecessary amount of taxonomic confusion. Regan (1912d, 1913), for example, placed the Bathymasteridae in the suborder Percoidei and then mixed the remaining zoarceoid families in with the tropical blennies. Hubbs (1952) and Makushok (1958) rectified the latter error. As already noted, the two groups differ significantly in skull (see fig. 10) and fin structure and even in the number of nostrils.

The Bathymasteridae seem to be a perfectly good zoarceoid family in both skeleton and soft anatomy. In two features it stands on the percoid side of the Zoarceoidae and, hence, may be considered the most generalized family in the group. First, the pelvic fin contains a spine and five soft rays; in all other zoarceoids, the pelvic fin is reduced. Second, the ramus lateralis accessorius (Freihofer, 1963, p. 136) has a percoid-type pattern, rather than one which is of the ophidiid-brotulid type (in Zoarcidae), or reduced (in Pholidae or Stichaeidae). Rosen (*in* Greenwood, et al., 1966, pp. 389, 397), primarily on the

basis of Freihofers data, has assigned the Zoarcidae to the order Gadiformes of the superorder Paracanthopterygii. Since, however, in other respects the Zoarcidae are very similar to the Bathymasteridae, with a typical percoid accessorius nerve pattern, I prefer to view the peculiar accessorius configuration in the Zoarcidae as a specialization within that group (as in the Brotulidae and Ophidiidae; see p. 24) rather than as an indication of relationship with the codfishes.

Table 3 will serve as a summary of the classification of the suborder Blennioidei adopted here.

Summary

The higher classification of the Order Perciformes adopted here can be summarized in synoptic form as follows.

To attempt a definition of this order that would exclude the Beryciformes and Zeiformes on the one hand and the various orders presumably derived from the Perciformes on the other is almost impossible (see Norman, 1957, pp. 58, 59); in any event, it would require more detail than seems warranted here.

SUBORDER PERCOIDEI.—(For reasons dealt with at the beginning of this paper, the Percoidei can be defined only in terms of central perciform tendencies, or negatively by lacking the combination of peculiarities that characterize the other perciform suborders.) Pelvic bones extending between and attached by a direct articulation to the cleithra; pelvic fins usually inserted about below the pectoral bases, normally with a spine and five, but sometimes fewer, soft rays, rarely altogether absent; dorsal and anal soft rays generally somewhat more numerous than the vertebrae between them. Basal counts in the Percoidei (and Perciformes) are as follows: vertebrae 24 or 25, frequently more, rarely fewer; anal spines three, predorsal bones three, and branched caudal rays 15, all frequently fewer, rarely more; and branchiostegal rays six, ranging from four to nine. (Compiled.)

Superfamilies (mainly following Regan, 1913, and Norman, 1957, but modified from the preceding account): Percoidae, Cirrhitoidae, Embiotocoidae, Pomacentroidae, Labroidae, Trichodontoidae, Amodytoideae, Champsodontoidae, and Chiasmodontoidae.

SUBORDER MUGILOIDEI.—Pelvic bones without a cleithral articulation. (1) The pectoral fins are divided into two separate parts (Polynemoidar); or (2) the pelvic fins have been modified into a specialized clasping organ in the males (Phallostethoidae); or (3) the spinous dorsal is represented by a short fin well separated from the soft portion. (Compiled.)

Superfamilies (following Myers, 1935): Polynemoidae, Mugiloidae, and Phallostethoidae.

SUBORDER ANABANTOIDEI.—An epibranchial air-breathing organ; gas bladder extending posteriorly well beyond the body cavity; teeth usually present on the parasphenoid. (Compiled.)

Superfamilies: Anabantoidae, Ophicephaloidae, and Luciocephaloidae.

SUBORDER KURTOIDEI.—Ribs much expanded, enclosing the anterior portion of the gas bladder partially, the posterior portion completely; males with an occipital hook, formed by the supraoccipital, used for carrying eggs. (From de Beaufort and Chapman, 1951.)

This suborder contains the single genus *Kurtus*.

SUBORDER ACANTHUROIDEI.—High-headed, compressed fishes with more or less lunate caudal fins, the gill openings restricted below, and small mouths; nasal bones elongate, more or less rigidly attached to the cranium; teeth specialized, setiform in the Zancidae, bicuspid to multicuspid in the rest; cleithra expanded below; additional armature present in the form of (1) a spine at the corner of the mouth in juvenile zancids, (2) one or more spines on the caudal peduncle of acanthurids, or (3) a second pelvic spine in teuthids. (Compiled.)

Superfamilies: Acanthuroidae and Teuthidoidea (=Siganoidea).

SUBORDER OPHIDIOIDEI.—Pelvics, when present, consisting of one or two filamentous rays inserted ahead of the pectoral fins; dorsal and anal fins long and low, spineless except in *Gadopsis*, the rays considerably more numerous than the vertebrae between them; one or more of the first few ribs usually expanded. (Reworded from preceding account.)

The Ophidioidei generally have not been divided into separate superfamilies.

SUBORDER STROMATEOIDEI.—“Perciform fishes with toothed sacular outgrowths in the gullet immediately behind the last gill arch” (Haedrich, 1967a, but see also Haedrich, 1967b).

Haedrich (1967a) recognizes only a single superfamily (including the Tetragonuridae).

SUBORDER XIPHIOIDEI.—Large oceanic fishes with 23–26 vertebrae and the anteriormost interneurals interdigitating between the cranium and the first vertebra; pelvic fins absent or reduced to three or fewer rays; pectorals inserted low on the sides; mouth inferior except in *Luvarus*. (Compiled.)

Superfamilies: Xiphioidae and Luvaroidae.

SUBORDER SCOMBROIDEI.—Vertebrae 30 or more; predorsal bones lacking; postorbital members of the circumorbital series of bones either fragmented or absent; upper jaw fixed except in *Scombrolabrax*. (Reworded from preceding account.)

Superfamilies: Scombroidae and Trichiuroidae.

SUBORDER GOBIOIDEI.—“Parietals lacking. Branchiostegals (4) 5 or 6, the first one or two well separated from the others. Mesopterygoid narrow or absent. Preopercle and symplectic widely divergent above, with an interspace between them. Hypurals with a splint-like bone above and below” (Gosline, 1955, p. 166).

The Gobioidi generally have not been divided into separate superfamilies.

SUBORDER BLENNIOIDEI.—Pelvic fins, when present, inserted ahead of the pectorals; dorsal and posterior soft anal rays exactly equal in number to the vertebrae between them; caudal fin usually rounded. (Reworded from the preceding account.)

Superfamilies: Notothenioidae, Trachinoidae, Congrogadoidae, Blennioidae, and Zoarceoidae.

SUBORDER SCHINDLERIOIDAE.—Minute, transparent, neotenic, oceanic fishes with the last few vertebrae and the hypural fan fused into a single plate. (Compiled.)

This suborder contains only the genus *Schindleria*.

References

- ALEXANDER, R. McN.
1967. Mechanisms of the jaws of some atheriniform fishes. *Journ. Zool.*, London, vol. 151, pp. 233-255, 10 figs.
- ALLIS, E. P., JR.
1903. The skull, and the cranial and first spinal muscles and nerves in Scomber scomber. *Journ. Morph.*, vol. 18, pp. 45-328, pls. 3-12.
- ARNOLD, D. C.
1956. A systematic revision of the fishes of the teleost family Carapidae (Percomorphi, Blennioidea), with descriptions of two new species. *Bull. British Mus. (Nat. Hist.), Zool.*, vol. 4, no. 6, pp. 247-307, 20 figs.
- BAGLIONI, S.
1908. Der Atmungsmechanismus der Fische. *Zeitschr. Allgemeine Phys.*, vol. 7, pp. 177-282.
- BARDACH, J. E., and CASE, J.
1965. Sensory capabilities of the modified fins of squirrel hake (*Urophycis chuss*) and searobins (*Prionotus carolinus* and *P. evolans*). *Copeia*, 1965, pp. 194-206, 10 figs.
- BARRINGTON, E. J. W.
1937. The structure and development of the tail in the plaice (*Pleuronectes platessa*) and the cod (*Gadus morrhua*). *Quart. Journ. Microsc. Sci.*, new ser., vol. 79, pp. 447-469, 25 figs.
- BAR SUKOV, V. V.
1959. Family Anarhichadidae. *Fauna SSSR, Ryby*, vol. 5, pt. 5, 173 pp., 22 pls., 42 figs.
- DE BEAUFORT, L. F.
1914. Die Anatomie und systematische Stellung des Genus *Kurtus* Bloch. *Morph. Jahrb.*, vol. 48, pp. 391-410, pl. 12, 3 text figs.
- DE BEAUFORT, L. F., and CHAPMAN, W. M.
1951. The fishes of the Indo-Australian Archipelago, vol. IX, xi+484 pp., 88 figs. *Lciden: E. J. Brill.*
- BERG, L. S.
1940. Classification of fishes, both recent and fossil. *Trav. Inst. Zool. Acad. Sci. URSS*, vol. 5, pt. 2, pp. 87-517, 190 figs.
- BOUGIS, P., and RUIVO, M.
1954. Recherches sur le poisson de profondeur *Benthocometes robustus* (Goode et Bean) (= *Pteridium armatum*, Doederlein) (Brotulidae). *Vie et Milieu*, suppl. no. 3, pp. 155-209, 33 figs.
- BOULENGER, G. A.
1901. On the Trachinidae and their allies. *Ann. Mag. Nat. Hist.*, ser. 7, vol. 8, pp. 261-271.
1904. Fishes (Systematic account of the Teleostei). *In* The Cambridge natural history, vol. 7, pp. 541-727, figs. 325-440.

- BRIGGS, J. C., and CALDWELL, D. K.
1955. The characteristics and distribution of the spotted cusk eel *Otophidium onostigmum* (Jordan and Gilbert). *Quart. Journ. Florida Acad. Sci.*, vol. 18, no. 4, pp. 285-291.
- CANTWELL, G. E.
1964. A revision of the genus *Parapercis*, family Mugiloididae. *Pacific Sci.*, vol. 18, pp. 239-280, 9 figs.
- CHAPMAN, W. M., and TOWNSEND, L. D.
1938. The osteology of *Zaprora silenus*, with notes on its distribution and early life history. *Ann. Mag. Nat. Hist.*, ser. 11, vol. 2, pp. 89-117, 10 figs.
- COLLETTE, B. B., and GIBBS, R. H., JR.
1963. A preliminary review of the fishes of the family Scombridae. *FAO Fish. Rep.*, no. 6, vol. 1, pp. 23-32.
- CUVIER, G. L. C. F. D.
1829. *Le regne animal . . .*, ed. 2, 5 vols. Paris.
- DAWSON, C. E.
1966. *Gunterichthys longipennis*, a new genus and species of ophidioid fish from the northern Gulf of Mexico. *Proc. Biol. Soc. Washington*, vol. 79, pp. 205-214, 3 figs.
- VAN DOBBEN, W. H.
1935. Über den Kiefermechanismus der Knochenfische. *Arch. Neerlandais Zool.*, vol. 2, pt. 1, pp. 1-72, 50 figs.
- DOLLO, L.
1909. Les téléostéens à ventrales abdominales secondaires. *Verh. Zool.-Bot. Ges. Wien*, vol. 59, pp. 135-140.
- EMERY, C.
1880. Le specie del genere *Fierasfer* del Golfo di Napoli e regione limitrofe. *Fauna und Flora Golfes Neapel*, monogr. no. 2, 76 pp., 9 pls.
- FOSTER, N. R.
1967. The utility of egg and larval characters in the classification of atheriniform fishes. *American Soc. Ichth. Herp.*, Forty-seventh Ann. Meeting, Abstr.: Ichthy., p. 10.
- FRANÇOIS, Y.
1959. La nageoire dorsale—anatomie comparée et evolution. *Ann. Biol.* ser. 3, vol. 35, pp. 81-113, 18 text figs.
- FRASER-BRUNNER, A.
1950. The fishes of the family Scombridae. *Ann. Mag. Nat. Hist.*, ser. 12, vol. 3, pp. 131-163, 35 figs.
- FREIHOFER, W. C.
1963. Patterns of the ramus lateralis accessorius and their systematic significance in teleostean fishes. *Stanford Ichth. Bull.*, vol. 8, no. 2, pp. 80-189, 29 figs.
- GERO, D. R.
1952. The hydrodynamic aspects of fish propulsion. *American Mus. Novit.*, no. 1601, 22 pp., 21 figs.
- GILL, T.
1863. On a remarkable new type of fishes allied to Nemophis. *Ann. Lyc. Nat. Hist.*, New York, vol. 8, pp. 138-141, 1 pl.
1907. Life histories of toadfishes (batrachoidids) compared with those of weevers (trachinids) and stargazers (uranoscopids). *Smithsonian Misc. Coll.*, vol. 48, pt. 4, pp. 388-427, figs. 106-123.

GOSLINE, W. A.

1953. Hawaiian shallow-water fishes of the family Brotulidae, with the description of a new genus and notes on brotulid anatomy. *Copeia*, 1953, no. 4, pp. 215-225, 5 figs.
1955. The osteology and relationships of certain gobioid fishes, with particular reference to the genera *Kraemeria* and *Microdesmus*. *Pacific Sci.*, vol. 9, pp. 158-170, 7 figs.
1959. Four new species, a new genus, and a new suborder of Hawaiian fishes. *Pacific Sci.*, vol. 13, pp. 67-77, 6 figs.
1960. Hawaiian lava-flow fishes, pt. IV: *Snyderidia canina* Gilbert, with notes on the osteology of ophidioid families. *Pacific Sci.*, vol. 14, no. 4, pp. 373-381, 4 figs.
- 1961a. Some osteological features of modern lower teleostean fishes. *Smithsonian Misc. Coll.*, vol. 43, no. 3, 42 pp., 8 figs.
- 1961b. The perciform caudal skeleton. *Copeia*, 1961, pp. 265-270, 3 figs.
1962. Systematic position and relationships of the percesocine fishes. *Pacific Sci.*, vol. 16, no. 2, pp. 207-217, 3 figs.
1963. Notes on the osteology and systematic position of *Hypoptychus dybowskii* Steindachner and other elongate perciform fishes. *Pacific Sci.*, vol. 17, pp. 90-101, 8 figs.
1964. Considerations regarding the relationships of the pereopsiform, cyprinodontiform, and gadiform fishes. *Occas. Pap. Mus. Zool., Univ. Michigan*, no. 629, 38 pp.
- 1966a. The limits of the fish family Serranidae, with notes on other lower percoids. *Proc. California Acad. Sci.*, ser. 4, vol. 33, no. 6, pp. 91-112, 10 figs.
- 1966b. Comments on the classification of the percoid fishes. *Pacific Sci.*, vol. 20, pp. 409-418, 2 figs.

GREENWOOD, P. H.; ROSEN, D. E.; WEITZMAN, S. H.; and MYERS, G. S.

1966. Phyletic studies of teleostean fishes, with a provisional classification of living forms. *Bull. American Mus. Nat. Hist.*, vol. 13, art. 4, pp. 341-455, pls. 21-23, 32 charts, 9 text figs.

GREGORY, W. K.

1933. Fish skulls: A study of the evolution of natural mechanisms. *Trans. American Phil. Soc.*, vol. 23, pt. 2, pp. vii + 75-481, 302 figs.

GREGORY, W. K., and CONRAD, G. M.

1937. The comparative osteology of the swordfish (*Xiphias*) and the sailfish (*Istiophorus*). *American Mus. Novit.*, no. 952, 25 pp., 12 figs.
1943. The osteology of *Luarus imperialis*, a scombroid fish: A study in adaptive evolution. *Bull. American Mus. Nat. Hist.*, vol. 81, pp. 225-283, 38 figs.

GREY, M.

1960. Description of a western Atlantic specimen of *Scombrolabrax heterolepis* Roule and notes on fishes of the family Gempylidae. *Copeia*, 1960, pp. 210-215, 3 figs.

HÆDRICH, R. L.

- 1967a. The stromateoid fishes: Systematics and a classification. *Bull. Mus. Comp. Zool.*, vol. 135, pp. 31-139, 56 figs.
- 1967b. A new family of aberrant stromateoid fishes from the equatorial Pacific. *American Soc. Ichth. Herp., Forty-seventh Ann. Meeting, Abstr.: Ichth.*, p. 12.

HARRIS, J. E.

1938. The role of the fins in the equilibrium of the swimming fish, II: The role of the pelvic fins. *Journ. Experi. Biol.*, vol. 15, no. 1, pp. 32-47, 8 figs.
1953. Fin patterns and mode of life in fishes. *In Essays in marine biology*, pp. 17-28, 4 figs.

HERALD E. S.

1953. Spotted cusk-eel, the strange fish that stands on its tail. *California Fish and Game*, vol. 39, pp. 381-384, 3 figs.

HERTEL, H.

1966. Structure, form and movement, 251 pp., 297 figs. New York: Reinhold Publ. Corp.

HOLMQVIST, O.

1910. Der Musculus protractor hyoidei (Geniohyoideus auct.) und der Senkungsmechanismus des Unterkiefers bei den Knochenfischen. *Lund Universitetets Årsskrift, new ser.*, vol. 2, no. 6, 24 pp., 1 pl.

HUBBS, C. L.

1944. Fin structure and relationships of the phallostethid fishes. *Copeia*, 1944, pp. 69-79.
1945. Phylogenetic position of the Citharidae, a family of flatfishes. *Misc. Publ. Mus. Zool. Univ. Michigan*, no. 63, 38 pp., 1 fig.

HUBBS, CLARK

1952. A contribution to the classification of the blennioid fishes of the family Clinidae, with a partial revision of the eastern Pacific forms. *Stanford Ichth. Bull.*, vol. 4, no. 2, pp. 41-165, 64 figs.

JORDAN, D. S.

1923. A classification of fishes, including families and genera as far as known. *Stanford Univ. Publ., Univ. Ser., Biol. Sci.*, vol. 3, no. 2, pp. 79-243.

JORDAN, D. S., and EVERMANN, B. W.

1898. Fishes of North and Middle America, vol. 3. *Bull. United States Nat. Mus.*, no. 47, pp. xxiv+2183-3136.

KAMOYARA, T.

1935. On the Owstoniidae of Japan. *Annot. Zool. Japonensis*, vol. 15, pp. 130-138, 4 figs.

KATAYAMA, M.

1959. Studies on the serranid fishes of Japan, 1. *Bull. Fac. Educ., Yamaguchi Univ.*, vol. 8, pp. 103-180, 39 figs.

KISHINOUE, K.

1923. Contributions to the comparative study of the so-called seombroid fishes. *Journ. Coll. Agric., Univ. Tokyo*, vol. 8, pp. 293-475, pls. 13-34, text figs.

LANE, E. D.

1965. The osteology of *Cheimarrichthys fosteri* Haast (Pisces, Percomorphi). *Trans. Roy. Soc. New Zealand, Zool.*, vol. 6, pp. 207-213, 10 figs.

LIEM, K. F.

1963. The comparative osteology and phylogeny of the Anabantoidi (Teleostei, Pisces). *Illinois Biol. Monogr. No. 30*, 149 pp., 104 figs.
1967. A morphological study of *Luciocephalus pulcher*, with notes on gular elements in other recent teleosts. *Journ. Morph.*, vol. 121, pp. 103-133, 23 figs.

LINNAEUS, C.

1758. *Systema naturae*, ed. X, vol. 1, 824 pp., Holmiae.

MAKUSHOK, V. M.

1958. The morphology and classification of the northern blennioid fishes (Stichaeoidea, Blennioidei, Pisces). *Trudy Zool. Inst. Akad. Nauk SSSR*, vol. 25, pp. 3-129, 83 figs. [In Russian, English translation mimeographed, 1959.]

1961a. Some additional data on morphology of the wrymouths (Cryptacanthodidae, Blennioidei, Pisces). *Trudy Inst. Okean., Akad. Nauk SSSR*, vol. 43, pp. 184-197, 4 figs.

1961b. Some peculiarities in the structure of the seismosensory system of the northern blenniids (Stichaeoidea). *Trudy Inst. Okean., Akad. Nauk SSSR*, vol. 43, pp. 225-269, 9 figs.

MARSHALL, N. B.

1965. Systematic and biological studies of the macrourid fishes (Anacanthini—Teleostei). *Deep-Sea Res.*, vol. 12, no. 3, pp. 299-322, 9 figs.

MATSUBARA, K.

1943. Studies of the scorpaenoid fishes of Japan, I. *Trans. Sigenkagaku Kenkyusyo*, no. 1, 170 pp., 66 figs.

1955. Fish morphology and hierarchy, pt. I, xi+789 pp., 289 figs. Tokyo: Ishizaki-shoten. [In Japanese.]

1963. Fishes. *In* Animal systematic taxonomy, vol. 9, pt. 2, Vertebrata (Ib), pp. 197-531, figs. 195-657. Tokyo. [In Japanese.]

MATSUBARA, K., and IWAI, T.

1952. Studies on some Japanese fishes of the family Gempylidae. *Pacific Sci.*, vol. 6, pp. 193-212, 12 figs.

1958. Anatomy and relationships of the Japanese fishes of the family Gempylidae. *Mem. Coll. Agric., Kyoto Univ., Fish. Ser., Spec. No.*, pp. 23-54, 14 figs.

MATSUI, T.

1967. Review of the mackerel genera *Scomber* and *Rastrelliger* with description of a new species of *Rastrelliger*. *Copeia*, 1967, pp. 71-83, 7 figs.

MAYR, E.

1943. Criteria of subspecies, species, and genera in ornithology. *Ann. New York Acad. Sci.*, vol. 44, pp. 133-139.

MCALLISTER, D. E., and KREJSA, R. J.

1961. Placement of the prowlfishes, Zaproridae, in the Superfamily Stichaeoidea. *Nat. Hist. Pap., Nat. Mus. Canada*, no. 11, 4 pp.

MEAD, G. W.; BERTELSEN, E.; and COHEN, D. M.

1964. Reproduction among deep-sea fishes. *Deep-Sea Res.*, vol. 11, pp. 569-596.

MYERS, G. S.

1935. A new phallostethid fish from Palawan. *Proc. Biol. Soc. Washington*, vol. 48, pp. 5, 6.

NILSSON, S.

1832. *Prodromus ichthyologiae Scandinavicae*, iv+124 pp. Lund.

NORMAN, J. R.

1929. The teleostean fishes of the family Chiasmodontidae. *Ann. Mag. Nat. Hist.*, ser. 10, vol. 3, pp. 529-544, 11 figs.

1934. A systematic monograph of the flatfishes (Heterosomata), vol. 1, viii+459 pp., 317 figs. London: British Museum.

1957. A draft synopsis of the orders, families and genera of recent fishes and fish-like vertebrates, 649 pp. British Museum (Natural History). [Photoduplicated.]
- NYBELIN, O.
1963. Zur Morphologie und Terminologie des Schwanzskelettes der Actinopterygier. *Ark. Zool.*, ser. 2, vol. 15, pp. 485-516, 22 figs.
- PATTERSON, C.
1964. A review of Mesozoic acanthopterygian fishes, with special reference to the English Chalk. *Phil. Trans. Roy. Soc. London*, ser. B, vol. 247, pp. 313-482, pls. 2-5, 103 text figs.
- PFÜLLER, A.
1914. Beiträge zur Kenntnis der Seitensinnesorgane und Kopfanatomie der Macruriden. *Jenaische Zeitschr. Naturw.*, vol. 52, pp. 1-134, 2 pls.
- QUAST, J. C.
1965. Osteological characteristics and affinities of the hexagrammid fishes, with a synopsis. *Proc. California Acad. Sci.*, ser. 4, vol. 31, pp. 563-600, 3 figs.
- REGAN, C. T.
1903a. On the skeleton and systematic position of *Luvarus imperialis*. *Ann. Mag. Nat. Hist.*, ser. 7, vol. 11, pp. 372-374, 1 fig.
1903b. On the systematic position and classification of the gadoid or anacanthine fishes. *Ann. Mag. Nat. Hist.*, ser. 7, vol. 11, pp. 459-466, 2 figs.
1909a. On the anatomy and classification of the scombroid fishes. *Ann. Mag. Nat. Hist.*, ser. 8, vol. 3, pp. 66-75, 1 fig.
1909b. The Asiatic fishes of the family Anabantidae. *Proc. Zool. Soc. London*, pp. 767-787.
1912a. The osteology of the teleostean fishes of the order Opisthomi. *Ann. Mag. Nat. Hist.*, ser. 8, vol. 9, pp. 217-219, 1 fig.
1912b. The classification of the teleostean fishes of the order Pediculati. *Ann. Mag. Nat. Hist.*, ser. 8, vol. 9, pp. 278-289, 6 figs.
1912c. The anatomy and classification of the symbbranchoid eels. *Ann. Mag. Nat. Hist.*, ser. 8, vol. 9, pp. 387-390, pl. 9.
1912d. The classification of the blennioid fishes. *Ann. Mag. Nat. Hist.*, ser. 8, vol. 10, pp. 265-280, 4 figs.
1913. The classification of the percoid fishes. *Ann. Mag. Nat. Hist.*, ser. 8, vol. 12, pp. 111-145.
1929. Fishes. *In Encyclopaedia Britannica*, ed. 14, vol. 9, pp. 305-329.
1936. Natural history, 896 pp., illustr. London: Ward, Lock & Co.
- RIVAS, L. R.
1953. The pineal apparatus of tunas and relative scombrid fishes as a possible light receptor controlling phototactic movements. *Bull. Mar. Sci. Gulf and Caribbean*, vol. 3, pp. 168-180, 5 figs.
- ROSE, J. A.
1961. Anatomy and sexual dimorphism of the swim bladder and vertebral column in *Ophidion holbrooki* (Pisces: Ophidiidae). *Bull. Mar. Sci. Gulf and Caribbean*, vol. 11, no. 2, pp. 280-308, 13 figs.
- ROSEN, D. E.
1964. The relationships and taxonomic position of the halfbeaks, killifishes, silversides, and their relatives. *Bull. American Mus. Nat. Hist.*, vol. 127, art. 5, pp. 217-268.

ROULE, L.

1922. Description de *Scombrolabrax heterolepis* nov. gen. nov. sp., poisson abyssal nouveau de l'Île de Madère. Bull. Inst. Océanogr. Monaco, no. 408, 8 pp., 4 figs.
1929. Considerations sur la nature teratologique probable de quelques formes de poissons abyssaux. Proc. 10th Intern. Zool. Congr., Budapest, 1927, vol. 1, pp. 795-798.

SCHAEFFER, B., and ROSEN, D. E.

1961. Major adaptive levels in the evolution of the actinopterygian feeding mechanism. American Zool., vol. 1, pp. 187-204, 7 figs.

SCHMIDT, J.

1917. Racial investigations, no. 1: *Zoarcetes viviparus* and local races of same. Compt. Rend. Lab. Carlsberg, vol. 13, pp. 279-396.

SCHULTZ, L. P., et al.

1960. Fishes of the Marshall and Marianas Islands, vol. 2. United States Nat. Mus. Bull. 202, ix + 438 pp., pls. 75-123, text figs. 91-132.

SCOPOLI, J. A.

1777. Introductio ad historiam naturalem, x + 506 pp. Prague.

SIMPSON, G. G.

1959. Mesozoic mammals and the polyphyletic origin of mammals. Evolution, vol. 13, pp. 405-414.

SMITH, C. L., and BAILEY, R. M.

1961. Evolution of the dorsal-fin supports of percoid fishes. Pap. Michigan Acad. Sci., Arts, Letters, vol. 46, pp. 345-362, 1 pl., 1 text fig.
1962. The subocular shelf of fishes. Journ. Morph., vol. 110, pp. 1-18, 3 pls.

SMITH, J. L. B.

1952. The fishes of the family Haliophidae. Ann. Mag. Nat. Hist., ser. 12, vol. 5, pp. 85-101, pl. 6, 2 text figs.

SPRINGER, V. G.

1955. The taxonomic status of the fishes of the genus *Statmonotus*, including a review of the Atlantic species. Bull. Mar. Sci. Gulf and Caribbean, vol. 5, no. 1, pp. 67-80, 2 figs.
1964. Review of "A revised classification of the blennioid fishes of the family Chaenopsidae" by J. S. Stephens, Jr. Copeia, 1964, pp. 591-593.
1966. *Medusablennius chani*, a new genus and species of blennioid fish from the Tuamotu Archipelago: Its implication on blennioid classification. Copeia, 1966, no. 1, pp. 56-60, 3 figs.

STANNIUS, H.

1849. Das peripherische Nervensystem der Fische, 156 pp., 5 pls. Rostock.

STARKS, E. C.

1907. On the relationships of the fishes of the family Siganidae. Biol. Bull., vol. 13, no. 4, pp. 211-218, 1 fig.
1910. The osteology and mutual relationships of the fishes belonging to the family Scombridae. Journ. Morph., vol. 21, pp. 77-99, 2 pls., 2 text figs.
1911. Osteology of certain scombroid fishes. Leland Stanford Junior Univ. Publ., Univ. Ser., no. 5, 49 pp., 2 pls., 1 text fig.
1923. The osteology and relationships of the uranoseopoid fishes. Stanford Univ. Publ., Univ. Ser., Biol. Sci., vol. 3, no. 3, pp. 259-290, 5 pls.
1930. The primary shoulder girdle of bony fishes. Stanford Univ. Publ., Univ. Ser., Biol. Sci., vol. 6, no. 2, pp. 149-239, 38 figs.

STEPHENS, J. S., JR.

1963. A revised classification of the blennioid fishes of the American family Chaenopsidae. Univ. California Publ. Zool., vol. 68, pp. iv+133, 15 pls., 11 figs.

SUZUKI, K.

1962. Anatomical and taxonomical studies of the carangid fishes of Japan. Rep. Fac. Fish., Pref. Univ. Mie, vol. 4, pp. 43-232, 61 figs.

SVETOVIDOV, A. N.

1948. Gadiformes. In Fauna of the U.S.S.R., Fishes, vol. IX, no. 4. Zool. Inst. Akad. Nauk, 221 pp., 72 pls., 39 text figs. [In Russian; English translation, 1962.]

TAKAHASHI, N.

1926. On the Plecostei, an order of Teleostomi, established by Prof. Kishinouye. Journ. Coll. Agric., Univ. Tokyo, vol. 7, no. 4, pp. 83-98.

TUCKER, D. W.

1956. Studies on the trichiurid fishes, 3: A preliminary revision of the family Trichiuridae. Bull. British Mus. (Nat. Hist.), Zool., vol. 3, pp. 73-130, pl. 10, 23 text figs.

WHITLEY, G. P.

1935. Studies in ichthyology, no. 9. Rec. Australian Mus., vol. 19, pp. 217-250, pl. 18, text figs.

YARBERRY, E. L.

1965. Osteology of a zoarcid fish *Melanostigma pammelas*. Copeia, 1965, pp. 442-462, 9 figs.

TABLE 1.—*Families included under various classifications*

Jordan (1923) Order JUGULARES	Regan (1912d) Suborder BLENNIOIDEA	Fishes that will be included in the Blennioidei here
Series Trachiniformes		x
Family Trachinidae		
Series Nototheniiformes		x
Family Nototheniidae		x
" Bathydraconidae		x
" Channichthyidae		x
" Bovichidae		x
" Harpagiferidae		x
Series Callionymiformes		
Family Draconettidae		
" Callionymidae		
Series Percophidiformes		
Family Percophidae		x
" Mugiloididae		x
" Parapercidae		x
" Pteropsaridae		x
" Hemerocoetidae		x
" Chimarrichthyidae		x
" Creediidae		x
" Linnichthyidae		x
" Trichonotidae		x
" Oxudercidae		x
Series Ammodytiformes		
Family Ammodytidae		
" Blekeriidae		
" Hypoptychidae		
Series Bathymasteriformes		
Family Bathymasteridae		x
" Zaproridae		x
Series Uranoscopiformes		
Family Chiasmodontidae		
" Opisthognathidae		
" Owstoniidae		
" Champsodontidae		
" Uranoscopidae		x
" Leptoscopidae		x
" Dactyloscopidae	x	x

TABLE 1.—*Families included under various classifications—Continued*

Jordan (1923) Order JUGULARES	Regan (1912d) Suborder BLENNIOIDEA	Fishes that will be included in the Blennioidel here
Series Blenniiformes		
Family Clinidae	x	x
" Notograptidae	x	x
" Peronedyiidae		?x
" Ophioclinidae	x	x
" Blenniidae	x	x
" Emblemariidae	x	x
" Runulidae	x	x
" Atopoclinidae	x	x
" Chaenopsidae	x	x
" Cebedichthyidae	x	x
" Pholidae	x	x
" Xiphisteridae	x	x
" Stichacidae	x	x
" Lumpenidae	x	x
" Ptilichthyidae	x	x
" Cryptacanthodidae	x	x
" Anarhichadidae	x	x
" Anarrhichthyidae	x	x
" Xiphasiidae	x	x
" Xenocephalidae	?	?
Series Zoareiformes		
Family Congrogadidae	x	x
" Cerdalidae	x	
" Seytalinidae	x	?
" Zoarcidae	x	x
" Lycodapodidae	x	?x
" Derepodichthyidae		?x
Series Brotuliformes		
Family Brotulidae	x	
Series Ophidiiformes		
Family Rhodichthyidae	x	
" Ophidiidae	x	
Series Carapiformes		
Family Carapidae	x	
Suborder Haplodoeci		
Family Batrachoididae		

TABLE 2.—*Basal characteristics*

ZOARCEOIDAE	NOTOTHENIOIDAE	Trachinoid-Blennioid-Congrogadoid Series
Tendency toward elongation	Tendency toward flattening of the head	Various, but the head usually not flattened
Tendency toward pelvic reduction	Tendency toward spread of pelvics with retention of 5 soft rays	Tendency to use the pelvics as props under the body with a strengthening of the outer rays and incision of the membrane between them
Tendency toward disintegration of circumorbital chain of bones	Tendency toward disintegration of circumorbital chain of bones	Tendency toward consolidation of circumorbital bones
Parasphenoid and frontals always form a stay excluding the prootic from the orbital border	Parasphenoid and frontals never form a stay excluding the prootic from the orbital border	Parasphenoid and frontals usually exclude the prootic from the orbital border
Basisphenoid never present	Basisphenoid usually present	Basisphenoid usually present
Medial extrascapular always fused with cranium	Medial extrascapular rarely fused with cranium	Medial extrascapular usually fused with cranium
Pectoral actinosts usually 4, broad	Pectoral radials 3 or 4, broad	Pectoral radials 4, variously shaped
<i>All cold water forms</i>	<i>Cold water forms</i> <i>Tropical forms</i>	<i>All tropical forms</i>
One nostril on each side	One nostril Two nostrils	Two nostrils

TABLE 3.—*Suborder Blennioidei*

Superfamily Notothenioidae

Family Parapercidae (= Mugiloididae) (Cantwell, 1964)

- “ Trichonotidae (sensu lato) (Schultz, 1960, except Cheimarrichthyidae)
- “ Cheimarrichthyidae (Regan, 1913)
- “ Bovictidae (Norman, 1957)
- “ Nototheniidae (Norman, 1957)
- “ Harpagiferidae (Norman, 1957)
- “ Bathydraconidae (Norman, 1957)
- “ Channichthyidae (Norman, 1957)

Superfamily Trachinoidea

Family Trachinidae (Regan, 1913)

- “ Uranoscopidae (Starks, 1923)
- “ Leptoscopidae (Starks, 1923)
- “ Dactyloscopidae (Starks, 1923)

Superfamily Congrogadoidae

Family Congrogadidae (Regan, 1912d)

“ Notograptidae (Regan, 1912d)

? “ Peronediyidae (Norman, 1957)

Superfamily Blennioidea

Family Tripterygiidae (Hubbs, 1952)

- “ Clinidae (Hubbs, 1952)
- “ Chaenopsidae (Stephens, 1963)
- “ Blenniidae (Hubbs, 1952)

Superfamily Zoarceoidea

Family Bathymasteridae (Regan, 1913)

- “ Stichaeidae (Makushok, 1958)
- “ Pholidae (Makushok, 1958)
- “ Anarhichadidae (Makushok, 1958; Barsukov, 1959)
- “ Ptilichthyidae (Makushok, 1958)
- “ Zapruidae (McAllister and Krejsa, 1961)
- “ Cryptacanthodidae (Makushok, 1961a)
- “ Zoarcidae (= Lycodidae) (Norman, 1957, in part)
- ? “ Derepodichthyidae (Jordan and Evermann, 1898)
- ? “ Scytalinidae (Jordan and Evermann, 1898)
- ? “ Lycodapodidae (Jordan and Evermann, 1898)

Proceedings of
the United States
National Museum



SMITHSONIAN INSTITUTION • WASHINGTON, D.C.

Volume 124

1968

Number 3648

Additional Data on Brood Parasitism
in the Honey-guides

By Herbert Friedmann¹

Ornithologist Emeritus, Division of Birds

Additions to our knowledge of the reproductive parasitism of three African species of honey-guides are presented herein and correlated with earlier information. The birds are *Indicator indicator*, *I. minor*, and *Prodotiscus regulus*. Information recorded in this paper for the latter species, while meager in quantity, is relatively important because so very little was known at the time of my previous reports in 1955 and 1958. The data on the two *Indicator* species, on the other hand, are far more extensive but of a kind that lends itself to brief and easy reporting.

The new data for *Indicator* stem from a total of 73 additional instances of parasitism, 49 for *I. indicator* and 24 for *I. minor*. The majority of these cases occurred with previously known host species, and they support very well the earlier estimates of the relative frequency of choice of the common hosts. They also bear out the fact that usually only a single egg is deposited by the parasite in any one nest of a host. In the present paper, I discuss solely those hosts

¹ Director, Los Angeles County Museum of Natural History, 900 Exposition Boulevard, Los Angeles, California 90007.

of each of the honey-guides for which the recent data involve previously unreported hosts, hosts reported for the first time in scattered journals since my last paper, or hosts that offer information requiring significant alterations or extensions of earlier summary statements. There is no need to tabulate more and more instances of a repetitive nature unless they are accompanied by biological observations.

Besides accumulating such records from the recent literature, I have been able to include much unpublished information kindly supplied to me by various friends in Africa and Europe. Among these should be mentioned R. K. Brooke in Rhodesia, G. Duve in the Transvaal, R. Kreuger in Finland (data *ex* egg collections), H. M. Miles in Rhodesia, and G. Symons, in Natal. To each of these gentlemen I herewith acknowledge my indebtedness and convey my thanks.

Greater Honey-guide: *Indicator indicator*

In my 1955 and 1958 reports on the greater honey-guide, I was able to present data on 106 cases of parasitism on 32 species of birds, or, counting races, on 38 species and subspecies of hosts. The data accumulated since then bring the total to 155 instances, involving, in all, some 35 species or 42 species and subspecies of victims. The additional cases support the earlier conclusions that bee-eaters, hoopoes, wood hoopoes, barbets, woodpeckers, and starlings are the main hosts of the greater honey-guide. As might have been anticipated, all the new records are of hole-nesting birds, the "new" hosts comprising two kinds of kingfishers, a roller, and a barbet. The most frequently reported host species are the little bee-eater, *Merops pusillus*, with 30 records; the pied starling, *Spreo bicolor*, with 20; the hoopoe, *Upupa epops africana*, with 19; the golden-tailed woodpecker, *Campethera abingoni*, with 8; the red-billed wood hoopoe, *Phoeniculus purpureus*, and the crested barbet, *Trachyphonus vailantii*, with 7 each. These are the birds that are the mainstay of the greater honey-guide; all the others, with from six to one records apiece, are the less usual fosterers, some of which, however, are regularly, but less frequently, parasitized. Among these are several kinds of bee-eaters, kingfishers, and barbets. Other hosts, for which only single instances have been reported, can only be looked upon as unusual.

It is, of course, to be expected that when further data become available from some portions of the African continent that still are entirely unrepresented in our total body of information, some local host species, possibly not yet in our lists, may turn out to be locally important and frequently used hosts in their respective areas.

Pygmy kingfisher*Ceyx picta* (Boddaert)

The southern race, *C. p. natalensis*, of this diminutive kingfisher was added to the list of known hosts of the greater honey-guide by Benson and Pitman (1966, pp. 26-27), on the basis of a nest containing one egg of the parasite and three of the host found at Livingstone, Zambia, October 21. The disparity in size between the two species makes one wonder if the pygmy kingfisher could rear a young greater honey-guide successfully.

Striped kingfisher*Halcyon chelicuti* (Stanley)

The recent reporting of a fourth instance of this kingfisher as a honey-guide host in Southern Rhodesia (Benson, Brooke, and Vernon, 1964, p. 67) demonstrates that this kingfisher is a regular victim, at least in that area. All the records refer to the nominate race of the host. The fact that this kingfisher is largely a fish eater and not an insect eater may subject a young honey-guide to a diet quite different from what it receives in nests of other hosts.

Brown-hooded kingfisher*Halcyon albiventris* (Scopoli)

Two races of this insectivorous kingfisher, *albiventris* and *orientalis*, are known to be victims of *Indicator indicator*. In my earlier account (1955, p. 140) I listed two South African records for the nominate race, whereas, more recently, Brooke (1965, pp. 6, 9) reported one case for *orientalis*, from the Lingove River, Furancungo district, northern Tete province, Mozambique, Oct. 20, 1928, a record that had remained unpublished for several decades.

Boehm's bee-eater*Merops boehmi* Reichenow

Benson, Brooke, and Vernon (1964, p. 67) list this bee-eater as a host of *I. indicator* in Zambia. While they give no further details, the record appears to be definite. Previously there was a single, not completely certain record from Chikwawa, Malawi.

White-fronted bee-eater*Merops bulocki* Vieillot

This bee-eater is known as a host of the greater honey-guide in Southern Rhodesia and in Kenya. With six records now available, it seems obvious that it will be found to be one of the "usual," regularly chosen fosterers. This host has been found rearing the young parasite in addition to merely having the parasite's eggs laid in its nest. All the records refer to the host race *bullockoides*.

Swallow-tailed bee-eater*Merops hirundineus* Lichtenstein

Previously recorded as a host near Elisabethville, Congo, and at Dedza, Malawi, this bee-eater recently has been found to be victimized in Zambia as well (Benson, Brooke, and Vernon, 1964, p. 67). The nominate race of the host is the one involved in both instances.

Abyssinian roller

Coracias abyssinica Hermann

This roller, one of the largest birds known to be used as a host by the greater honey-guide, only recently has been added to the host catalog by Parker (1966, p. 81), who reported a set of eggs in the British Museum, containing one *Indicator* and three *Coracias*, collected by Schuel at Zaria, Nigeria, Apr. 13, 1964.

African hoopoe

Upupa epops Linnaeus

The hoopoe, subspecies *africana*, for which earlier (1955, pp. 143-144) I had compiled nine records, is clearly one of the birds most frequently selected as a fosterer. I know at present of 10 additional records, and it now appears that little is to be gained from further accumulations of such cases. So far, I have not heard of the lesser honey-guide, *I. minor*, affecting the hoopoe.

Red-billed hoopoe

Phoeniculus purpureus (Miller)

Increasing information indicates that this species is a fairly regular host of the greater honey-guide. I have now learned of seven instances, involving four races of the red-billed hoopoe: *purpureus*, *marwitzi*, *angolensis*, and *guineensis*. Jubb (1966) has found that this bird is a real fosterer, not just a victim. He noted a young greater honey-guide reared successfully by a pair of red-billed hoopoes. The latter continued to feed it regularly for at least 12 days after it had left the nest fully feathered, and they were observed feeding it even as late as 22 days after it had fledged. The following (twenty-third) day the young parasite was attacked and driven off by its foster parents.

Yellow-headed barbet

Buccanodon whytii (Shelley)

This barbet was added to the list of known victims of the greater honey-guide in Southern Rhodesia, by Benson, Brooke, and Vernon (1964, p. 67) on the basis of a single observation. The record refers to the race *B. w. sowerbyi* (Sharpe).

Crested barbet

Trachyphonus vaillantii Ranzani

This is another host for which enough records now have been amassed to show that it is one of the greater honey-guide's regular victims, especially in Southern Rhodesia, where four of the seven cases known to me have been found.

Golden-tailed woodpecker

Campethera abingoni (Smith)

This small woodpecker now has been found to be parasitized by the greater honey-guide in South Africa, Malawi, Southern Rhodesia, and Kenya. A total of eight records, involving four races of the host (*abingoni*, *suahelica*, *mombassica*, and *smithii*), demonstrate that this is a frequently used host.

Banded sand martin

Riparia cincta (Boddaert)

Previously (1958, p. 312), I have known of only one instance of this swallow as a victim; the identity of the parasitic egg as that of *I. indicator* was not wholly certain. Since then, an observation of a fledged young greater honey-guide fed by a pair of banded sand martins near Salisbury, Southern Rhodesia, in January 1966, has been reported by Hosken (1966a, pp. 234-235). Both records refer to the nominate race of the host.

Cape anteater-chat

Myrmecocichla formicivora (Vieillot)

To the two records listed previously by me (1955, p. 151) three others should be added, all from Natal, information on which was kindly sent me by Mr. Godfrey Symons, who found the nests near Estcourt.

Red-shouldered glossy starling

Lamprocolius nitens (Linnaeus)

At Estcourt, Natal, on Nov. 29, 1932, Godfrey Symons (in litt., 1963) found a nest of this starling with one egg of a greater honey-guide and two eggs of the starling. Previously I had known of two instances of parasitism on this bird. It probably will be found to be a fairly regular host in Natal.

Lesser Honey-guide: *Indicator minor*

Information on the hosts of the lesser honey-guide also has increased by observations of nearly half as many new instances as were available to me for my 1955 and 1958 statements. The black-collared barbet, *Lybius torquatus*, is clearly the most frequently used host, with some 43 records (an increase of 13 since 1958); and the pied barbet, *Tricholaema leucomelan*, is probably the next most heavily parasitized, with nine more records since 1958. As in the case of the greater honey-guide, all the recent host records are of hole-nesting birds. Only three of these merit special mention at this time, the others being merely repeats.

Little bee-eater

Merops pusillus (Muller)

Mr. R. Kreuger (in litt.) informs me that he has in his collection a set of five eggs of this little bee-eater with one of the lesser honey-guide, taken at "Mile 100," Accra-Lane Road, Ghana, in March 1943 by F. C. Holman. This is the first record for any host for the race *I. m. alexanderi* of the parasite. It refers to the nominate race of the host, the southern race of which, *meridionalis*, is known to be victimized regularly by *I. m. minor* in Rhodesia. The honey-guide egg measured 22.8 x 15.4 mm.

Bennett's woodpecker

Campethera bennetti (Smith)

This woodpecker was added to the hosts of the lesser honey-guide by Benson, Brooke, and Vernon (1964, p. 67) on the basis of a single record from Rhodesia. There was a single, earlier, very indefinite record from Malawi.

Golden-tailed woodpecker

Campethera abingoni (Smith)

To the previous two records involving the nominate race of this woodpecker as a host should be added one for the subspecies *C. a. smithii* (Malherbe) in Rhodesia (Benson, Brooke, and Vernon, 1964, p. 67).

Sharp-billed Honey-guide: *Prodotiscus regulus*

The breeding biology of the sharp-billed honey-guide previously was almost unknown as the few observational records were marred by indefiniteness. The situation now may be improved by the following data.

Hosken (1966b, p. 235) noted during a short period of observation a recently fledged young sharp-billed honey-guide that was fed several times by a pair of grass warblers, *Cisticola lais*, at Inyanga, Rhodesia, Jan. 25, 1966. The young honey-guide paid no attention to other birds feeding nearby on termites and acted as though the *Cisticola* were its parents. The grass warbler in the Inyanga area would be the subspecies *C. l. mashana* Lynes. It is an addition to the known hosts of this parasite.

Duve (in litt., 1967) informs me that he has in his collection two sets of eggs of the swallow, *Hirundo abyssinica unitatis*, each with an egg of *Prodotiscus regulus*, one taken at Lalapanzi, northern Transvaal, Dec. 29, 1958, and the other at Estcourt, Natal, Jan. 25, 1946. The honey-guide egg from the first set measured 18 x 13.4 mm, and it was white with a little gloss and a slight gray trend. Mr. Duve further informs me that an oviduct egg of *Prodotiscus regulus*, also in his collection, is slightly less glossy and it too has a slight grayish tone.

Finally, it should be noted that Clancey (1964, p. 282) reported that one of these honey-guides was seen emerging from a swallow's nest tenanted by white-rumped swifts, *Apus cafer cafer*.

None of these species had been recorded before as hosts of *Prodotiscus regulus*. The only previous records, inconclusive at best, referred to the yellow-throated sparrow, *Petronia superciliosus*, and to the larger stripe-breasted swallow, *Hirundo cucullata* (Friedmann, 1955, p. 260).

The *Cisticola* record is surprising as it adds a host that is not a hole-nester. In our present state of knowledge, we only can accept

Hosken's observations and hope for additional instances to give us a truer picture of the host choices of the sharp-billed honey-guide.

An Uncertain but Suggestive Record

While it is obvious that an unidentified parasitic egg record has little usefulness as a potential increment to knowledge, I may mention one such case, chiefly as a suggestion for further field work. Mr. Godfrey Symons, of Estcourt, Natal, informs me (in litt.) that he has in his collection a set of two eggs of the little tinker-bird, *Pogoniulus pusillus affinis*, with one egg of a small honey-guide, which he considers to be *Prodotiscus insignis*, taken at Wajier, Northern Frontier District, Kenya, Feb. 3, 1941. The honey-guide egg is plain white with a dull texture and measures 15.6 x 12 mm. These dimensions agree with those given by Mackworth-Praed and Grant (1952, p.748) for an oviduct egg of the slender-billed honey-guide, a fact that thus seems to confirm the identification. All of the previous records of the parasitism of this species, however, have been with small passerine birds that are not hole-nesters, birds such as a flycatcher (*Platysteira*), a warbler (*Apalis*), and two white-eyes (*Zosterops*). Mr. Symons informs me that actually he did not see the honey-guide in the field, and that, therefore, his identification is not to be taken as final.

Further, it should be noted that no one has ever found *Prodotiscus insignis* at Wajier. I am informed by John G. Williams (pers. comm.), who is familiar with the area, that it is an unsuitable habitat for this species. This leaves two parasitic possibilities: *Indicator meliphilus* and *I. narokensis*. Nothing is known of the eggs or of the hosts of either of these, but a small barbet such as *Pogoniulus* certainly would seem a likely host for either, and also it would seem that their eggs would be similar in size to those of *Prodotiscus insignis*.

Literature Cited

- BENSON, C. W.; BROOKE, R. K.; and VERNON, C. J.
1964. Bird breeding data for the Rhodesias and Nyasaland. Occas. Pap. Nat. Mus. Southern Rhodesia, no. 27B, pp. 30-105.
- BENSON, C. W., and PITMAN, C. R. S.
1966. Further breeding records from Zambia. Bull. British Ornith. Club, vol. 86, pp. 21-33.
- BROOKE, R. K.
1965. Ornithological notes on the Furancungo district of Mozambique. Arnoldia, vol. 2, no. 10, pp. 1-13.
- CLANCEY, P. A.
1964. The birds of Natal and Zululand, 511 pp.

FRIEDMANN, H.

1955. The honey-guides. United States Nat. Mus. Bull. 208, 292 pp.

1958. Advances in our knowledge of the honey-guides. Proc. U.S. Nat. Mus., vol. 108, no. 3404, pp. 309-320.

HOSKEN, J. H.

1966a. Juvenile greater honeyguide, *Indicator indicator* (Sparman), soliciting food from a pair of banded sand martins, *Riparia cincta* Linnaeus. Ostrich, vol. 37, pp. 234-235.

1966b. Sharp-billed honeyguide, *Prodotiscus regulus*, being fed by a pair of *Cisticolas*. Ostrich, vol. 37, p. 235.

JUBB, R. A.

1966. Red-billed hoopoe and a greater honey-guide. Bokmakierie, vol. 18, pp. 66-67.

MACKWORTH-PRAED, C. W., and GRANT, C. H.B.

1952. Birds of eastern and north eastern Africa, vol. 1, 836 pp.

PARKER, S. A.

1966. *Coracias abyssinica*: An unrecorded host of *Indicator indicator*. Bull. British Ornith. Club, vol. 86, p. 81.

Proceedings of
the United States
National Museum



SMITHSONIAN INSTITUTION • WASHINGTON, D.C.

Volume 124

1968

Number 3649

The Species of the Subgenus *Leptoferonia* Casey
(Coleoptera: Carabidae: *Pterostichus*)

By Hilary A. Hacker¹

The purpose of this paper is to facilitate identification of the species in the subgenus *Leptoferonia* Casey of the genus *Pterostichus* Bonelli. As currently defined, the subgenus may be an artificial grouping of species. After the subgenus *Hypherpes* Chaudoir has been revised, it may be possible to clarify the relationships between the two subgenera and between the species within *Leptoferonia*. The subgenus *Leptoferonia* is composed of 21 species that occur from British Columbia south through California and east to Montana. Seven new species and three new subspecies are described.

I am very grateful for assistance from a number of people. G. E. Ball, O. L. Cartwright, the K. M. Fenders, and R. L. Hacker reviewed the manuscript and offered many valuable suggestions. O. L. Cartwright and P. J. Spangler examined the types in the United States National Museum. P. J. Darlington, Jr., lent the types of *Pterostichus linearis* LeConte and *P. longicollis* LeConte from the LeConte collection in the Museum of Comparative Zoology. K. M. Fender, F. Hasbrouck at Oregon State University, M. H. Hatch at the University of Washington, H. B. Leech at the California Academy of Sciences, J. Shuh, and W. C. Stehr at Ohio University also lent specimens.

¹ 235 Randall Street, San Francisco, California 94131.

Material and Methods

MATERIAL.—This study is based upon approximately 2400 preserved specimens of the subgenus *Leptoferonia*. Most of the Oregon and California material was collected by the author between 1959 and 1965. Specimens were collected by hand from under branches and logs in forested areas. An effort was made to collect as many specimens as possible from areas where subspecies or species meet or overlap. This was often impossible since so much forest had been cut down. All specimens of subgenus *Leptoferonia* known to me, except for some specimens of *P. inanis* Horn from Oregon, are included in this study. Approximately 300 specimens from related subgenera also were examined.

TAXONOMIC TREATMENT.—Two similar forms were regarded as distinct species if their geographical ranges overlapped and there was no evidence of intergradation in morphological characteristics. In many cases, the ranges of two similar forms are not known to overlap, perhaps because of insufficient collecting. In these cases, the forms were considered to be separate species if the differences between them were indicated by more than two characteristics and not just a matter of degree. Two forms were regarded as conspecific if there were morphologically intermediate specimens in their relatively narrow area of contact. They also were regarded as conspecific if no intermediates were known, no specimens were collected from intermediate areas, and the differences between the two were a matter of degree only. The forms or geographical populations of species exhibiting broad clinal variation were discussed but not named. The forms in insufficiently studied species, such as *P. inanis* Horn, were not named; later they may prove to merit the rank of subspecies.

METHODS.—Examinations and measurements, except body length, were made at $\times 60$. A $10 \times \frac{1}{100}$ ocular micrometer was used in making measurements. Drawings were made using an ocular grid. The external morphology of the aedeagus was examined in all males. The aedeagus can be teased out of relaxed specimens with a pin without much danger of breakage. The internal sac of the median lobe of the aedeagus was examined in relatively few specimens. The drawings in figures 1–26 of the everted sac are rough sketches and do not indicate the exact shape or location of the lobes, microtrichiate areas, etc. The aedeagi were treated with warm 10 percent potassium hydroxide prior to everting the sac. The autopsy sign (!) indicates that the holotype, excluding the internal sac of the aedeagus, was examined. Those types not seen by me in person were examined for me according to a list of characteristics and compared to specimens from my collection. All new holotypes and allotypes have been de-

posited in the United States National Museum in Washington, D.C. (USNM). Paratypes are in the collections of the California Academy of Sciences, San Francisco (CAS); of the Fenders, McMinnville, Oreg.; of the Museum of Comparative Zoology, Cambridge, Mass. (MCZ); of the USNM; of the University of Washington, Seattle (UW); and of the author.

MEASUREMENTS (tables 1-4).—Width of head: Maximum width through eyes or through genae in those with very small eyes.

Width of pronotum between anterior angles: Distance between tips of angles.

Width of base of pronotum: Distance between tips of angles except in *inopinus* Casey, *infernalis* Hatch, *pumilus* Casey, *fenyesi* Csiki, and *cochlearis*, new species. In these species it is the distance through the posterior pair of setiferous punctures.

Width of pronotum: Maximum width.

Length of pronotum: Length along midline, not necessarily the maximum length.

Width of elytral humeri: Distance between humeral dentations.

Width of elytra: Maximum width across both elytra together.

Length of body: Distance from tips of mandibles to elytral apices, to the nearest 0.5 mm, viewed dorsally without magnification.

Characteristics of Taxonomic Importance in *Leptoferonia*

COLOR.—Piceous is used to mean dark brown. Rufous means a light reddish brown. I do not consider any of the *Leptoferonia* to be a true black color. Some specimens that I consider to be dark piceous have been called black by other authors.

MICROSCULPTURE.—The term microreticulate refers to fine lines forming a honeycomb or scalelike pattern. Microstrigulose refers to nonanastomosing lines, which are usually transverse. Micropunctures, or fine punctures, are invisible at magnifications lower than about $\times 60$. Specimens often must be cleaned by being brushed with carbon tetrachloride in order to observe the microsculpture.

HEAD.—In some species, such as *inopinus*, the eyes are large and protruding as is usual in the subgenus *Hypherpes*. They do not cover the entire genae in either subgenus. In several species the eyes are smaller and flattened. The frontal impressions are long and sharply impressed in most species. In a few, such as *sphodrinus* LeConte, they are shallow and short. The term "forming an angle of 45° " means that lines drawn through the two impressions would intersect at an angle of 45° .

PRONOTUM.—There are usually two pairs of lateral setiferous punctures; the anterior pair is before the middle, and the posterior

pair is normally at the hind angles. In the *inopinus* and *fenyesi* groups, the posterior pair is forward, and the hind angles often are rounded. This condition also occurs in *sphodrinus*, which otherwise seems unrelated to the five species in those two groups. In *termitiformis* Van Dyke the posterior pair of setae has been lost.

PLEURAL AND STERNAL SCLERITES OF THE THORAX.—The presence of a margin around the posterior part of the prosternum was used as a diagnostic characteristic by earlier authors. It seems to be a variable character in many species. Many *Leptoferonia* have coarse punctures on the concave area of the mesepisternum. In some there are also punctures on the rest of the mesepisternum and on adjacent sclerites.

ELYTRON.—The humeral dentation was viewed dorsally from above the elytral apices. From this angle at $\times 60$ the humerus appears dentate in some species that previous authors reported to have edentate humeri. The term scutellar puncture refers to the puncture on the disc near the scutellum, on the scutellar or second stria. The setiferous punctures on the eight stria can be divided into three series in *Leptoferonia*. In subgenus *Hypherpes* there are usually more punctures, and they tend to be more evenly spaced. In *Leptoferonia* the anterior series consists of six punctures; the sixth is sometimes detached from the others. Some species have a single intermediate puncture bearing a short seta located about halfway between the anterior and posterior series. The posterior series consists of up to eight punctures (except nine in *sphodrinus*). There are one or two setiferous punctures at the posterior end of the seventh stria (except three in *sphodrinus*). The setae are of three lengths (see figs. 27–31) and very fragile. The elytral apices are slightly more blunt in females of all species than in males.

LEGS.—In most species the legs are fairly stout, and the hind trochanter is about half the length of the hind femur. In *beyeri* Van Dyke, *falli* Van Dyke, and *termitiformis* Van Dyke, the legs are relatively slender. In the latter two, the hind trochanter is smaller, being only about one-third the length of the hind femur. Specimens of *P. (Hypherpes) gracilior* LeConte also have slender legs and short hind trochanters. The hind trochanter is pointed in several species. In some male specimens of *inanis* the hind trochanter is also very attenuate. The legs of females are somewhat less robust than those of males. The inner margin of the tibia of the middle leg has raised areas in the males. These are well developed in *angustus* Dejean, giving the margin a saw-toothed appearance. In females these areas are much reduced or absent. There are four setae on the outer side of the femur of the middle leg. Some species have setae, generally three pairs, along the ventrolateral margins of the last article of all

tarsi. In others these setae are absent on all tarsi. One pair of long dorsal setae is always present on the last article (*termitiformis* has three pairs). There are probably other differences among species in the setae on the legs, but these have not been investigated. The tarsi of the front legs are expanded in the males and narrow in females.

SIXTH ABDOMINAL STERNUM OF MALE.—In the traditional system the last visible sternum, which bears the anal setae, is designated as the sixth sternum. In *Leptoferonia* all males have a single pair of anal setae, and females have two pairs. In the males of some species, the apical portion of the sternum is thickened. The thickening usually gives rise to a transverse lobe or carina on the ventral surface of the sternum either before the apical marginal impression or at the edge. An unnamed species, which may belong in the subgenus *Anilloferonia* Van Dyke, has a similar modification of its sixth sternum. In most other subgenera of *Pterostichus*, carinae, when present, are longitudinal rather than transverse and do not reach the apical edge.

MALE GENITALIA.—The descriptions of the right paramere refer to the distal portion which is not surrounded by membranes. In subgenus *Hypherpes* a short, small, right paramere seems to be the rule; the exact shape varies. In some *Leptoferonia* and in some other subgenera of *Pterostichus* the right paramere is elongate. In *Hypherpes* there is frequently a ridge or lobe on the right side of the ventral surface of the median lobe. This lobe occurs in many *Leptoferonia*. In some it extends diagonally across the ventral surface. In *pumilus* the isolated tooth in the middle of the ventral surface appears to be derived from this lobe. In *Hypherpes* the central area of the distal third of the ventral surface generally is less heavily sclerotized than the adjacent areas. Sometimes the boundary between the left side and tip and the lightly sclerotized area is sharp and there is a clear break between the tip and the shaft on the right side. In some *Leptoferonia* the lightly sclerotized area is demarcated clearly and forms a diagonal membranous strip separating the tip and left side from the remainder of the shaft. This condition also occurs in the subgenus *Pseudoferonina* Ball (1965, p. 107). It can be seen clearly only in material that has been cleared in potassium hydroxide and that is immersed in liquid. Sometimes the tooth in the internal sac of the median lobe is a prominent, dark plate that is curved and tapers to a point at one end, resembling a canine tooth. Sometimes the tooth is small, lightly sclerotized, and obscured by the lips of the gonopore. Sometimes it is absent or replaced by a lobed structure. In the *Hypherpes* known to me, a large and heavily sclerotized tooth is always present.

Subgenus *Leptoferonia* Casey

Leptoferonia Casey, 1918, pp. 321, 336-338.—Leng, 1920, p. 56.

Pterostichus (Leptoferonia) Casey.—Van Dyke, 1925, pp. 72-75.—Csiki, 1930, p. 582.—Hatch, 1936, pp. 702-706; 1953, pp. 105, 111-113.—Ball, 1960, pp. 77, 124.—Lindroth, 1966, pp. 469-472.

TYPE-SPECIES OF SUBGENUS.—*Feronia angusta* Dejean, designated by Casey, 1918.

DIAGNOSTIC CHARACTERISTICS OF *Leptoferonia*.—Members of the subgenus *Leptoferonia* have the characteristics of the tribe Pterostichini and the genus *Pterostichus* as listed by Ball (1960, pp. 63, 77; 1966, p. 13). The species of subgenus *Leptoferonia* share the following characteristics with the subgenera *Anilloferonia* and *Hypherpes*: elytra sealed together; no setiferous punctures on the third or fifth stria of the elytra; metepisternum with anterior margin as long as lateral margin; first and second segments of middle and hind tarsi with a longitudinal ridge on outer side. Specimens of *Leptoferonia* differ from those of *Anilloferonia* in having pigmented and at least somewhat larger eyes. There has never been a satisfactory characteristic for separating *Leptoferonia* from *Hypherpes*. The species of *Leptoferonia* usually are smaller and often paler in color. The maximum length in *Leptoferonia* is about 12.5 mm, and the minimum length in *Hypherpes* is about 8 mm. Specimens of *Leptoferonia* are sometimes more cylindrical or more ventricose and six species lack the elytral scutellar puncture. With the exception of *sphodrinus*, the species of *Leptoferonia* have a maximum of 17 setiferous punctures on the margin of the elytron; in *Hypherpes* there are frequently more. Usually *Leptoferonia* are either 9 mm or less in length, or, if between 9 and 12.5 mm, then the head is unusually large or the body form cylindrical or ventricose. *Hypherpes* do not have large heads and those with lengths less than 12 mm generally are not cylindrical or ventricose. I have used the subgeneric name *Leptoferonia* in the sense of previous authors, except that I have excluded *horni* LeConte. *Pterostichus horni* LeConte (1873, p. 313) probably should be placed in the subgenus *Hypherpes* and may be the same as *P. gracilior* LeConte. *Pterostichus arizonicus* Schaeffer is a member of the subgenus *Ithytolus* (fide Darlington, 1936) and not a *Leptoferonia*, as some authors have supposed.

NOTES ON ECOLOGY.—Most *Leptoferonia* are members of the Vancouverian fauna (see Hatch, 1953, pp. 20-24 and Van Dyke, 1919). In Oregon, at least, adults can be found the year around, even under permanent winter snow. Frequently they are the most common ground beetles in coniferous forests. I am unfamiliar with the larval and pupal stages. Adults can be found under branches and logs on the forest floor. Sometimes they are inside rotten logs

or in the duff. In drier areas they are more abundant near streams than on the dry slopes. Teneral specimens have been collected from May through October. Copulation is known to occur in the fall. The lighter color and small eyes of some species probably are a result of burrowing habits. This is analogous to the loss of pigmentation and eyes in cave-dwelling animals.

RELATIONSHIPS TO OTHER SUBGENERA.—The subgenus *Leptoferonia* shares similarities with the subgenera *Hypherpes* and *Anilloferonia*. The meaning of these similarities is not clear because the three groups have not been accurately defined, and accurate definition depends, above all, on a careful revision of *Hypherpes*. The numerous similarities shared by these subgenera, however, are best interpreted as an indication of close relationship.

It is tempting to say that *Leptoferonia* occupies a position intermediate to *Hypherpes* and *Anilloferonia*. The species are generally intermediate in size, color, and number of elytral setae. At present it is best not to interpret the sequence *Hypherpes-Leptoferonia-Anilloferonia* as a phyletic one because the similarities between the latter two may be a result of convergent evolution, and some of the apparent similarities between *Hypherpes* and *Leptoferonia* may be the result of incorrect classifications. All specimens of *Hypherpes* known to me have a short right paramere. If the elongate right paramere of some *Leptoferonia* and some of the other pterostichines is a holdover from the ancestral type, then those species of *Leptoferonia* probably are not derived from *Hypherpes*.

SPECIES GROUPS.—Thirteen of the species can be arranged into four groups of from two to six species each. These groups consist of species that share several morphological characters and appear to be closely related. They are the *inopinus*, *fenyesi*, *fuchsi*, and *hatchi* groups, which are characterized in their appropriate places in the text.

I have relied heavily upon the structure of the aedeagus in separating populations as species or subspecies. Its structure seems to be stable within each taxon described herein. The aedeagi of all 24 species and subspecies are illustrated in figures 1–26. In the key I have used only male characteristics in some of the couplets when other characteristics are difficult to treat objectively. Reference to the distribution maps should help an investigator if he has only females from a given locality.

Key to Species and Subspecies of *Leptoferonia* Casey

1. Pronotum with posterior pair of setiferous punctures 2
 Pronotum without posterior pair of setiferous punctures.
 24. *termitiformis* Van Dyke
- 2(1). Elytron with scutellar setiferous puncture 3
 Elytron without scutellar setiferous puncture 18

- 3(2). Pronotum with posterior setiferous puncture far forward from posterior angle (fig. 27) 4
 Pronotum with posterior setiferous puncture at posterior angle (figs. 29, 30, 31) 11
- 4(3). Head with frontal impressions sharply impressed; eight or fewer setiferous punctures in posterior series on eighth stria of elytron 5
 Head with frontal impressions shallow; nine setiferous punctures in posterior series on eighth stria of elytron . . . 21. **sphodrinus** LeConte
- 5(4). Head with frontal impressions diverging posteriorly; if entire dorsum microreticulate, right paramere short 6
 Head with frontal impressions recurved posteriorly; entire dorsum strongly microreticulate; right paramere elongate. 1. **inopinus** Casey
- 6(5). Pronotum with hind angles obsolete; sides of pronotum entirely arcuate 7
 Pronotum with hind angles distinct 9
- 7(6). Male with sixth abdominal sternum weakly lobed; median lobe of aedeagus narrower, tip more prominent (figs. 5, 6) 8
 Male with sixth abdominal sternum more strongly lobed; median lobe broader and tip rounded (fig. 7) 7. **cochlearis**, new species
- 8(7). Male with median lobe with tip blunter (fig. 5).
 5. **fenyesi fenyesi** sensu stricto Csiki
 Male with median lobe with tip narrower (fig. 6).
 6. **fenyesi fenderi**, new subspecies
- 9(6). Mesepisternum with numerous distinct punctures 10
 Mesepisternum without punctures, or at most with a few shallow punctures on concave portion 4. **infernalis** Hatch
- 10(9). Pronotum with sides before hind angles strongly sinuate.
 2. **pumilus pumilus** sensu stricto Casey
 Pronotum with sides before angles from slightly sinuate to slightly arcuate 3. **pumilus willamettensis**, new subspecies
- 11(3). Hind trochanter long, about half the length of hind femur; body length less than 9 mm 12
 Hind trochanter short, about a third the length of hind femur; body length greater than 9 mm 20. **falli** Van Dyke
- 12(11). Hind trochanter blunt at tip; pronotum without outer pair of longitudinal impressions 13
 Hind trochanter slightly pointed at tip; pronotum usually with outer pair of longitudinal impressions present . . . 14. **angustus** Dejean
- 13(12). Tarsus with last article with setae on ventrolateral margins 14
 Tarsus with last article without setae on ventrolateral margins . . . 15
- 14(13). Male with sixth abdominal sternum with tubercles relatively small and sharp; inhabits Marin County, Calif. . . 9. **marinensis**, new species
 Male with sixth sternum with tubercles relatively large and blunt; inhabits southern Humboldt and northwestern Mendocino Counties, Calif. 11. **mattolensis**, new species
- 15(13). Male with sixth abdominal sternum without prominent lobe at apical margin 16
 Male with sixth sternum with long, narrow, truncate lobe at apical margin (fig. 10); frontal impressions forming angle of less than 80° 10. **lobatus**, new species
- 16(15). Head with frontal impressions not recurved, forming an angle of less than 80° 17

- Head with frontal impressions recurved posteriorly, forming an angle of about 80° 8. *fuchsi* Casey
- 17(16). Male with right paramere not sharply angulate in lateral view, narrowed laterally in about middle (fig. 12) 12. *trinitensis*, new species
Male with right paramere sharply angulate in lateral view, not abruptly narrowed laterally (fig. 13) 13. *humilis* Casey
- 18(2). Hind trochanter blunt at tip 19
Hind trochanter pointed at tip; body form subparallel 23
- 19(18). Head not unusually large, ratio of head width to pronotum width less than 0.75 20
Head unusually large, ratio of head width to pronotum width greater than 0.75 19. *beyeri* Van Dyke
- 20(19). Tarsus with last article without setae on ventrolateral margins; frontal impression forming angle of about 45° 21
Tarsus with last article with setae on ventrolateral margins; head with frontal impressions forming angle of more than 45° 22. *idahoae* Csiki
- 21(20). Male with median lobe of aedeagus not concave on ventral surface, tip very long and spatulate (figs. 16, 17) 22
Male with median lobe deeply concave on ventral surface, tip short (fig. 15) 15. *hatchi*, new species
- 22(21). Male with right paramere of aedeagus long and crescent shaped (fig. 16) 16. *stapedius*, new species
Male with right paramere shorter, not crescent shaped (fig. 17). 17. *stapedius yosemitensis*, new subspecies
- 23(18). Eyes not especially small, head not unusually large, ratio of head width to pronotal width less than 0.80 24
Eyes very small; head unusually large, ratio of head width to pronotal width greater than 0.80 (fig. 29) 18. *caligans* Horn
- 24(23). Hind trochanter slightly pointed and never attenuate; inhabits California coastal ranges 14. *angustus* Dejean
Hind trochanter strongly pointed and often attenuate; inhabits Sierra Nevada and Cascade ranges 23. *inanis* Horn

The *inopinus* Group

FIGURE 40

This group includes *inopinus*, *pumilus*, and *infernalis*. They have a ventricose body form and inhabit adjacent and slightly overlapping areas. They share the following characteristics.

COLOR OF BODY.—Piceous.

HEAD.—Eyes normally large and prominent.

PRONOTUM.—Sides arcuate in middle, from arcuate to sinuate and diverging in basal third; posterior pair of setiferous punctures forward from hind angles; outer pair of longitudinal impressions absent; base weakly bisinuate.

ELYTRON.—Humerus somewhat rounded; humeral dentation small or absent; scutellar stria and puncture present.

LEGS.—Hind trochanter blunt and about half the length of hind femur; setae present on ventrolateral margins of last article of tarsus.

SIXTH ABDOMINAL STERNUM OF MALE.—Apical edge thickened; lobe on ventral surface at edge; one or two impressions on face.

AEDEAGUS.—Right paramere elongate; lobe present, beneath and parallel to long distal portion. Median lobe narrowed distally; tip short; lightly sclerotized strip across distal portion. Internal sac with two adjacent, sclerotized, flexible lobes, one surrounding gonopore, other more or less mushroom shaped.

LENGTH OF BODY.—7 to 10 mm.

1. *Pterostichus (Leptoferonia) inopinus* (Casey)

FIGURES 1, 32, 40

Leptoferonia inopina Casey, 1918, p. 338.—Leng, 1920, p. 56.

Pterostichus inopinus (Casey).—Van Dyke, 1925, p. 75.—Csiki, 1930, p. 582.—Hatch, 1953, p. 112.

Pterostichus (Leptoferonia) fenyesi.—Hatch, 1936, p. 704 [in part; not Csiki, 1930, p. 582]. [New synonymy.]

SPECIES DESCRIPTION.—Same as description of *inopinus* group plus the following.

HEAD.—Frontal impressions forming an angle greater than 45°, converging posteriorly; area on inner side of impressions distinctly flattened; microreticulate.

PRONOTUM.—Sides from slightly arcuate to slightly sinuate in vicinity of posterior setiferous punctures, in former case hind angles less distinct; transverse basal impression complete in about 25 specimens, reaching only to longitudinal basal impressions in about 25 specimens, intermediate in 210; single pair of longitudinal impressions not deep, usually not reaching basal margin; disc microreticulate.

ELYTRON.—Humeral dentation small, sometimes acute; setiferous punctures on eighth stria consisting of six in anterior series, sixth frequently detached, none intermediate, seven in posterior series; two setae at posterior end of seventh stria; microreticulate.

VENTRAL SURFACE.—Coarse punctures confined to mesepisternum; prosternal tip completely margined in only about 60 specimens.

SIXTH ABDOMINAL STERNUM OF MALE (fig. 1).—Large, truncate, ventrally curved lobe at edge; face with two impressions separated by curved carina, right impression larger than left.

AEDEAGUS (fig. 1).—Right paramere with lobe beneath distal portion small, evenly arcuate; nearly cylindrical distal portion very long, with 90° bend near tip. Median lobe with tip shallow and blunt; lobe on right side large, its highest part a ridge down inner side.

LENGTH OF BODY.—7.0 to 8.5 mm.

VARIATION.—Specimens from south of about the middle of Douglas County, Oreg., have a variable second bend in the right paramere of the aedeagus. Specimens from the coast are uniformly small; the minimum length of noncoastal specimens is 7.5 mm.

HOLOTYPE.—Male, USNM!

TYPE-LOCALITY.—Golden, Josephine County, Oreg. (T. 33 S, R. 5 W, Willamette meridian, elevation approximately 1600 feet).

SPECIMENS EXAMINED.—266.

DISTRIBUTION. (fig. 32).—This species occurs in the central and southern parts of western Oregon and extreme northwestern California. It occurs from elevations of sea level to 4500 feet in the north and probably higher in the south. Two specimens in the University of Washington collection are labelled "Toppenish [Yakima County], Wash.," which is probably an error.

REMARKS.—Hatch's (1936) description of "*fenyesei*" consists, at least in part, of specimens of *inopinus*. The holotype of *ovicollis* Schaeffer is not conspecific with the holotype of *inopinus* Casey. The species *inopinus* can be distinguished from the other members of the *inopinus* group on the basis of the aedeagus, or the divergent and recurved frontal impressions on the head, or the entirely microreticulate dorsum. Externally *inopinus* and the two species of the *fenyesei* group are similar. In *inopinus* the hind angles of the pronotum are usually more prominent, the posterior setiferous punctures on the pronotum not quite so far forward, and the elytral humeri less rounded.

Pterostichus (Leptoferonia) pumilus Casey

FIGURE 40

This species comprises a group of populations classified herein as two subspecies: the more northern *pumilus pumilus* Casey, and *pumilus willamettensis*, new subspecies. Those characteristics common to all specimens of *pumilus* are listed below.

SPECIES DESCRIPTION.—Characters of the *inopinus* group plus the following.

HEAD.—Frontal impression sharp, curved, forming an angle of about 45°, divergent posteriorly; small triangular depressed area on front between impressions; microstrigulose.

PRONOTUM.—Sides arcuate in anterior two-thirds, from strongly sinuate to slightly arcuate in vicinity of posterior setiferous punctures; single pair of longitudinal impressions deepest in middle, weakly reaching to complete basal transverse impression; area between longitudinal impression and side margin tumid except in area immediately adjacent to angle; midline sharp, not reaching either edge; disc microstrigulose or partly microreticulate.

ELYTRON.—Humeral dentation small; setiferous punctures on eighth stria consisting of six in anterior series, one intermediate, eight in posterior series; two setae at posterior end of seventh stria; microreticulate.

SIXTH ABDOMINAL STERNUM OF MALE (figs. 2, 3).—Face of sternum with one large impression to right of center.

2. *Pterostichus (Leptoferonia) pumilus pumilus* Casey

FIGURES 2, 33

- Pterostichus longicollis* LeConte, 1852, p. 239 [not Duftschmid, 1812, p. 180; not Motschulsky, 1859, p. 147; not Casey, 1924, p. 75]; 1857, p. 8; 1863b, p. 10; 1869, p. 370; 1873, p. 313.—Schaupp, 1882, p. 41.—Casey, 1913, p. 129.—Van Dyke, 1925, p. 75 [fide synonymy of *pumilus*].—Leech, 1935, p. 121.—Hatch, 1936, p. 703.
- Leptoferonia longicollis* (LeConte).—Casey, 1918, p. 337.—Leng, 1920, p. 56.
- Pterostichus pumilis* Casey, 1913, p. 127.—Csiki, 1930, p. 582.—Van Dyke, 1925, p. 75.—Hatch, 1953, p. 112.
- Pterostichus pumilus*.—Casey, 1914, p. 356.—Lindroth, 1966, p. 471.
- Leptoferonia pumilus* (Casey).—Casey, 1918, p. 337.—Leng, 1920, p. 56.
- Micromaeseus longicollis*.—Casey, 1924, p. 75 [not LeConte, 1852, p. 239].—Leng and Mutchler, 1927, p. 10.—Hatch, 1953, p. 112 [fide synonymy of *pumilus*].
- Feroniens oregona* Chaudoir, 1868, p. 335 [fide LeConte, 1873, p. 304].
- Pterostichus oregonus* (Chaudoir).—Csiki, 1930, p. 712 [not LeConte, 1861, p. 339].—Lindroth, 1966, p. 471.
- Pterostichus (Leptoferonia) oregonis*.—Csiki, 1930, p. 582 [new name for *longicollis* LeConte].—Leng and Mutchler, 1933, p. 12.—Hatch, 1936, p. 703; 1953, p. 112.

The characteristics below are found in *pumilus pumilus* sensu stricto in addition to the characteristics listed above that are common to all specimens of *pumilus*.

PRONOTUM.—Sides sinuate in vicinity of posterior setiferous punctures, then diverging; hind angles acute.

ELYTRON.—Humeral dentation often acute.

AEDEAGUS (fig. 2).—Right paramere with lobe beneath and parallel to elongate distal portion not evenly rounded, notched in middle. Median lobe with a weak swelling or small tubercle in about middle of ventral surface; impression on right side at about middle; no lobe on right side.

LENGTH OF BODY.—7.0 to 9.0 mm.

VARIATION.—The above description of the reduced tooth on the median lobe of the aedeagus applies to specimens from the Cascade Mountains of Oregon and southern Washington. The holotype of *pumilus* has only a weak swelling. Figure 2 shows the tooth typical of the other Washington and British Columbia specimens examined, viz., long, narrow, and trough shaped. Specimens from the northern part of the Willamette Valley have a shorter and thicker tooth. Specimens from the Oregon Coast Range have teeth ranging from the northern Willamette Valley form to a weak swelling. Six males in the Fender collection, all labelled "Tillamook," show the complete range.

HOLOTYPE.—*Pterostichus pumilus* Casey, male, USNM!; *P. longicollis* LeConte, female, MCZ!; *Micromaesus longicollis* Casey, male, not seen; *Feroniens oregona* Chaudoir, female, apparently lost (fide Lindroth, 1966, p. 471).

TYPE-LOCALITIES.—*Pterostichus pumilus*, Clackamas County, Oreg.; *P. longicollis* LeConte, "Oregon," which includes the present states of Oregon and Washington; *Micromaesus longicollis* Casey, Seattle, Wash.; *Feroniens oregona* Chaudoir, presumably Oregon.

SPECIMENS EXAMINED.—397.

DISTRIBUTION (fig. 33 for part).—The typical subspecies, *pumilus pumilus* sensu stricto, occurs at least as far north as the city of Vancouver and southwestern Vancouver Island in British Columbia. It has been collected as far south as Green Peter Mountain, Linn County, in the Oregon Cascades, and Buell, Polk County, in the Oregon Coast Range. It occurs from sea level to 4000 feet elevation.

REMARKS.—Casey intentionally changed the spelling of *pumilis* to *pumilus*. He described the type of *pumilus* as having an unusually small labrum. This is probably because it is pushed back beneath the clypeus. Specimens I have seen differ from his description on several other points, such as: color piceous, not "deep black"; humeral denticle not "wholly obsolete"; elytral striae not "punctate." The female in MCZ assumed to be the holotype of LeConte's *longicollis* has many distinct punctures on the mesepisternum. This is the most reliable characteristic I know to distinguish females of *pumilus pumilus* from those of the southern form of *infernalis*. The microsculpture of *pumilus* is slightly stronger than in *infernalis* and weaker than in *inopinus*. The frontal impressions of *pumilus* form an angle of about 45° rather than the wider angle found in *inopinus*, *fenyesi*, and *cochlearis*.

3. *Pterostichus (Leptoferonia) pumilus willamettensis*, new subspecies

FIGURES 3, 27, 33, 40

HOLOTYPE MALE.—Same as description of *pumilus* plus the following.

PRONOTUM.—Sides only slightly sinuate near posterior setiferous punctures, then oblique and converging before subrectangular hind angles; posterior pair of setiferous punctures somewhat farther forward than in typical subspecies.

ELYTRON.—Humeral tooth small, not acute.

VENTRAL SURFACE.—Punctures on mesepisternum less numerous than in *pumilus pumilus* sensu stricto.

AEDEAGUS (fig. 3).—Right paramere with basal lobe evenly rounded; distal portion longer and narrower in middle than in typical subspecies. Median lobe with tooth on ventral surface broad, thick, blunt, subtruncate; small lobe present on right side near tooth.

LENGTH OF BODY.—9.0 mm.

ALLOTYPE FEMALE.—Same as holotype except for usual female characteristics; length of body 8.5 mm.

VARIATION.—Other specimens range in length from 8 to 10 mm. In some, the sinuation before the hind angles is absent and the sides are entirely, though weakly, arcuate; in others it is very distinct and the sides are subparallel before the angles.

TYPE.—USNM 69599.

TYPE-LOCALITY.—Five miles north of Mabel, Linn County, Oreg.

SPECIMENS EXAMINED.—181.

DISTRIBUTION (fig. 33).—Holotype male, allotype female, hills east of the Willamette Valley 5 miles north of Mabel, T. 15 S, R. 1 W, sec. 4, Willamette meridian, elev. 700 ft., Linn County, Oreg., Jan. 29, 1960, H. A. Hacker. Also the following paratypes: 13 males, 5 females, same data as holotype; 2 males, 3 females, 2 miles north of Mabel, T. 15 S, R. 1 W, sec. 28, elev. 900 ft.; 1 male, 4 females, 3 miles southeast of Crawfordville, T. 14 S, R. 1 W, sec. 29, elev. 600 ft.; 6 males, 5 females, 2 miles south of Coberg, T. 17 S, R. 3 W, sec. 9, elev. 400 ft.

A few colonies of *pumilus willamettensis* still occur in the Willamette Valley itself, but the subspecies is more common in the surrounding foothills. It occurs in woods of *Pseudotsuga menziesii* (Mirb.) Franco with some *Quercus garryana* Douglas or *Tsuga heterophylla* (Ref.) Sargent and to an elevation of 900 feet.

REMARKS.—This subspecies has been confused with specimens of *inopinus* and the northern form of *infernalis* in some collections. It can be distinguished from the former by the frontal impressions and from the latter by the punctate mesepisternum. Intermediates between *pumilus pumilus* sensu stricto and *pumilus willamettensis* have been collected from McMinnville, Yamhill County, in six localities in and near the Eola Hills, Polk County, and two miles northwest of Tangent, Linn County. These 43 specimens differ from *pumilus willamettensis* in the following: sides of the pronotum more definitely sinuate; tooth on median lobe longer and lobe reduced or absent on right side; right paramere broader; elytral humeri more strongly dentate.

4. *Pterostichus (Leptoferonia) infernalis* Hatch

FIGURES 4, 34, 40

Pterostichus (Leptoferonia) infernalis Hatch, 1936, p. 704, 706; 1953, p. 112.

SPECIES DESCRIPTION.—Same as description of *inopinus* group plus the following.

HEAD.—Frontal impressions sharply impressed, curved, forming an angle of about 45°, divergent posteriorly; usually a faint triangular depressed area on front; microstrigulose or microreticulate.

PRONOTUM.—Sides from sinuate to slightly arcuate in vicinity of posterior setiferous punctures; hind angles from acute to subrectangular; base usually weakly bisinuate, sometimes arcuate with hind angles more prominent; basal transverse margin always complete; single pair of curving longitudinal impressoins sharply impressed; faintly microstrigulose.

ELYTRON.—Humerus from edentate to weakly dentate; setiferous punctures on eighth stria consisting of six in anterior, one intermediate, and eight in posterior series; two setae at posterior end of seventh stria; faintly microstrigulose.

VENTRAL SURFACE.—No coarse punctures, or rarely with a few faint sparse punctures or rugosity on mesepisternum.

SIXTH ABDOMINAL STERNUM OF MALE (fig. 4).—Lobe on apical margin "rolled back" forward, giving an emarginate appearance when viewed ventrally; small impression on face on right side.

AEDEAGUS (fig. 4).—Right paramere with large inward-directed lobe on basal portion; long lobe beneath distal portion; sinuate distal portion cylindrical except at tip; median lobe with lobe present on right side.

LENGTH OF BODY.—7.0 to 9.0 mm.

VARIATION.—There are two characteristics that show clinal variation. Specimens of the northern form, from north of about Waldport, Lincoln County, Oreg., have the sides of the pronotum slightly arcuate or oblique before the hind angles and the elytral humeri are edentate. In specimens of the southern form, from south of about Coos Bay, Coos County, the sides of the pronotum are distinctly sinuate toward the posterior pair of setiferous punctures, then subparallel or diverging to the more prominent hind angles. The elytral humerus is distinctly, though not strongly, dentate. In the area between Coos Bay and Waldport, specimens are intermediate in these two characteristics. Since the changes in the two characteristics are gradual, these three categories are arbitrary. There does not appear to be geographical variation in any other character; the structure of the aedeagus, including internal sac, appears to be constant.

HOLOTYPE.—Male, UW!

TYPE-LOCALITY.—Devil's Lake, Lincoln County, Oreg.

SPECIMENS EXAMINED.—432.

DISTRIBUTION (fig. 34).—This species has been collected from Netarts, Tillamook County, Oreg., south to two miles south of Smith River, Del Norte County, Calif. In the north it occurs as far east as the eastern slopes of the Coast Range. In the south it is restricted probably to areas nearer the coast. It is often abundant and has been found to the elevation of 3700 feet.

REMARKS.—*Pterostichus inopinus* and *P. pumilus willamettensis* have been confused with northern specimens of *infernalis*. Externally they can be distinguished readily by their dentate humeri and punctate mesepisterna. Southern form specimens of *infernalis* externally are nearly identical with *pumilus pumilus*; females can be identified on the basis of the punctures on the mesepisternum.

The *fenyesi* Group

This group includes two species, *fenyesi* Csiki and *cochlearis*, new species. The *fenyesi* and *inopinus* groups are similar except for some of the aedeagal characteristics. They occupy adjacent and slightly overlapping areas. The following characteristics are shared by both species of the *fenyesi* group.

COLOR OF BODY.—Piceous.

HEAD.—Eyes normally large and prominent; sharp frontal impressions forming an angle greater than 45° , diverging posteriorly; microreticulate.

PRONOTUM.—Sides entirely arcuate; hind angles obsolete; posterior pair of setiferous punctures far forward, about even with middle of longitudinal impressions; outer pair of longitudinal impressions absent; base weakly bisinuate; basal transverse impression complete; area between sharply impressed longitudinal impressions and lateral gutter tumid; disc microstrigulose and partly microreticulate.

ELYTRON.—Humerus very rounded; humeral dentation small, at most, subrectangular; scutellar stria present though sometimes short; scutellar puncture present; eighth stria with six anterior setiferous punctures, one intermediate, usually seven in posterior series; two setae at posterior end of seventh stria; microreticulate.

VENTRAL SURFACE.—Coarse punctures confined to mesepisternum; tip of prosternum usually completely margined.

LEGS.—Hind trochanter blunt and about half the length of hind femur; setae present on ventrolateral margins of last article of tarsus.

SIXTH ABDOMINAL STERNUM OF MALE.—Apical edge thickened; lobe small or obsolete.

AEDEAGUS.—Right paramere not elongate, somewhat enlarged. Median lobe with raised area where left paramere rests. Internal sac with small, lightly sclerotized tooth and adjacent lobe.

LENGTH OF BODY.—6.0 to 8.5 mm.

REMARKS.—The two species in this group are related closely. The primary differences between the two are found in the aedeagi although there are also small differences in the shape and midline of the pronotum and in the lobe on the male sixth abdominal sternum. *Pterostichus fenyesi* can be divided into two forms on the basis of aedeagal and pronotal characteristics. I have named them subspecies. Unfor-

tunately, the holotype of *P. ovicollis* Schaeffer, renamed *P. fenyesi* by Csiki, is a female from "California." The ratio of its pronotal length to width is 0.93, and its pronotal midline is incised sharply, with the result that it probably is not the same as the population described as *P. cochlearis*. It is more likely that it belongs to the northern subspecies of *P. fenyesi*; hence, that subspecies has been designated as *P. fenyesi fenyesi* sensu stricto.

***Pterostichus (Leptoferonia) fenyesi* Csiki**

SPECIES DESCRIPTION.—Same as the *fenyesi* group description plus the following.

PRONOTUM.—Midline sharply incised, area adjacent to midline relatively flat.

SIXTH ABDOMINAL STERNUM OF MALE.—Lobe very small or obsolete.

AEDEAGUS.—Right paramere not bulbous. Median lobe noticeably twisted, not as broad as in *cochlearis*; tip narrower and more definitely directed to left; ventral surface and right side meeting abruptly, forming a low ridge.

5. *Pterostichus (Leptoferonia) fenyesi fenyesi* Csiki

FIGURES 5, 35

Pterostichus ovicollis Schaeffer, 1910, p. 393 [not Motschulsky, 1865, p. 265; not Reitter, 1884, p. 40].—Casey, 1913, p. 129.—Van Dyke, 1925, p. 75.—Leng and Mutchler, 1933, p. 12.—Hatch, 1936, p. 70.

Leptoferonia ovicollis (Schaeffer).—Casey, 1918, p. 337.—Leng, 1920, p. 56.

Pterostichus (Leptoferonia) fenyesi Csiki, 1930, p. 582 [new name for *ovicollis* Schaeffer].—Leng and Mutchler, 1933, p. 12.—Hatch, 1936, p. 704; 1953, p. 112.

SUBSPECIES DESCRIPTION.—The characteristics below are found in *fenyesi fenyesi* sensu stricto in addition to the characters listed above for *P. fenyesi* and the *fenyesi* group.

PRONOTUM.—Ratio of pronotal length to width 0.93–1.00, median 0.97, in males; ratio 0.92–0.98, median 0.94, in females.

SIXTH ABDOMINAL STERNUM OF MALE (fig. 5).—Lobe small but evident.

AEDEAGUS (fig. 5).—Right paramere cone shaped. Median lobe with tip rounded and directed to left; ventral surface concave, then convex just before tip; ventral surface and right side meeting rather sharply.

HOLOTYPE.—*Pterostichus ovicollis* Schaeffer, female, USNM!

TYPE-LOCALITY.—California, probably from Humboldt County and possibly from north or east of the Eel River.

SPECIMENS EXAMINED.—36.

DISTRIBUTION (fig. 35).—This subspecies has been collected from Child's Hill Prairie, T. 9 N, R. 2 E, Humboldt meridian, south to

nine miles northwest of Blocksburg, Humboldt County, Calif., and to the elevation of 2200 feet.

REMARKS.—Hatch's (1936) description of "*fenyesi*" is a composite drawn from specimens of *inopinus* and *cochlearis*. The name *fenyesi* is not a synonym of the name *infernalis*.

6. *Pterostichus (Leptoferonia) fenyesi fenderi*, new subspecies

FIGURES 6, 35

HOLOTYPE MALE.—Same as description of *fenyesi* and the *fenyesi* group, plus the following.

PRONOTUM.—Sides more arcuate than in *fenyesi fenyesi*; ratio of length to width 0.91.

SIXTH ABDOMINAL STERNUM OF MALE (fig. 6).—Apical edge thickened, but lobe nearly obsolete.

AEDEAGUS (fig. 6).—Compared with *fenyesi fenyesi* sensu stricto, right paramere smaller, narrower, not so evenly tapering at tip. Median lobe with ventral surface more concave; ventral surface and right side meeting more abruptly to form a low carina that extends to middle of base of ventral surface; in lateral view, right side bisinuate; tip sharper. Internal sac apparently identical.

LENGTH OF BODY.—7.0 mm.

ALLOTYPE FEMALE.—Same as male except ratio of pronotal length to width 0.90, and usual female differences.

VARIATION.—The 19 other specimens measured have the pronotal ratio 0.88–0.92, median 0.91, in males; ratio 0.85–0.94, median 0.89, in females. Length of body 6.0 to 7.5 mm.

TYPE.—USNM 69600.

TYPE-LOCALITY.—Two miles northwest of Petrolia, Humboldt County, Calif.

SPECIMENS EXAMINED.—21.

DISTRIBUTION (fig. 35).—Holotype, male, and allotype, female, 2 miles northwest of Petrolia, T. 1 S, R. 2 W, Humboldt meridian, elev. 200 ft., Humboldt County, Calif., Jan. 26, 1962, H. A. Hacker. Also the following paratypes: 2 males, 2 females, same data as holotype; 1 male, 1 female, 1 mile south of Capetown, T. 1 N, R. 3 W, elev. 500 ft.; 1 male, 2 females, 9 miles southwest of Ferndale, T. 2 N, R. 2 W, elev. 1100 ft.; 1 male, 1 female, 7 miles southwest of Ferndale, T. 2 N, R. 2 W, elev. 1400 ft. Eight other specimens came from localities farther to the south; only a single female is known from the southernmost locality, Russian Gulch, Mendocino County.

REMARKS.—The differences between this subspecies and *fenyesi fenyesi* sensu stricto are differences in degree rather than in kind. The sample examined was not large, only 57 specimens of the two

subspecies, of which 29 were males. The characteristics separating the two do not seem to undergo clinal variation within the two groups. The two groups are not known to overlap or to intergrade in morphological characteristics along their common boundary (see fig. 35). Not many specimens are known from the boundary area, but it does seem likely that no more than a small area of intergrading might exist. When more specimens have been collected from the boundary area, the status of the two groups will be resolved. I think it is safe to consider the two populations to be at least separate subspecies.

I take pleasure in naming this subspecies for Mr. Kenneth M. Fender.

7. *Pterostichus (Leptoferonia) cochlearis*, new species

FIGURES 7, 35

HOLOTYPE MALE.—Same as the description of *fenyesi* group plus the following.

PRONOTUM.—Midline not abruptly impressed, surface adjacent to midline tumid; ratio of pronotal length to width 0.93.

SIXTH ABDOMINAL STERNUM OF MALE (fig. 7).—Apical margin thickened and produced into well-defined and ventrally directed lobe.

ÆDEAGUS (fig. 7).—Right paramere relatively large and bulbous. Median lobe broad; ventral surface slightly concave; right side and ventral surface not meeting sharply; tip blunt, rounded, not directed to left; internal sac with sclerotized lobe and tooth not the same shapes as in *fenyesi*.

LENGTH OF BODY.—8.0 mm.

ALLOTYPE FEMALE.—Same as holotype except pronotal ratio 0.88, and usual female differences.

VARIATION.—The 75 other specimens measured have the pronotal ratio 0.86–0.96, median 0.91, in the males; 0.84–0.92, median 0.89, in the females. Length 7.0 to 8.5 mm. In Oregon males, the lobe of the sixth sternum tends to be defined less abruptly and to be slightly emarginate in the middle. Variation in the pronotal ratio does not seem to be clinal.

TYPE.—USNM 69601.

TYPE-LOCALITY.—Weitchpec-Orick Road, Humboldt County, Calif.

SPECIMENS EXAMINED.—83.

DISTRIBUTION (fig. 35).—Holotype, male, and allotype, female, Weitchpec-Orick Road, T. 11 N, R. 1 E, sec. 36, Humboldt meridian, elev. 1400 ft., Humboldt County, Calif., Sept. 2, 1959, H. A. Hacker. Also the following paratypes: 7 males, 2 females, same data as holotype; 3 males, 3 females, Weitchpec-Orick Road, T. 10 N, R. 2 E, sec. 18, elev. 2000 ft.; 3 males, 3 females, Prairie Creek Redwoods State Park, T. 12 N, R. 1 E, Humboldt County, Calif. Sixty additional

specimens were examined from Gold Beach, Curry County, Oreg., south to Patrick's Point, Humboldt County, Calif. and to the elevation of 2000 ft.

REMARKS.—This species has been separated from *fenyesi* primarily on the basis of the aedeagal characteristics. The differences between *cochlearis* and *fenyesi fenyesi* appear to be greater than the differences between *fenyesi fenyesi* and *fenyesi fenderi*. The median lobe, including the internal sac, is clearly different. More than half the specimens of *cochlearis* can be separated from all known specimens of *fenyesi fenyesi* on the basis of the pronotal ratio. Four specimens of *fenyesi fenyesi* were collected seven miles from the nearest specimens of *cochlearis*. I do not know if actual overlapping of their ranges occurs. No intermediate males are known. The name *cochlearis* refers to the spoonlike shape of the median lobe of the aedeagus.

The *fuchsi* Group

FIGURE 41

This group includes *fuchsi* Schaeffer; *marinensis*, new species; *lobatus*, new species; *mattolensis*, new species; *trinitensis*, new species; and *humilis* Casey. These species are very similar and probably are closely related. The most distinctive differences among the six are found in the male aedeagus and sixth abdominal sternum. The shape of the pronotum also differs among the six, but it is difficult to distinguish the taxa on this basis alone unless one has a series for comparison. The characteristics below are common to all six species.

COLOR OF BODY.—Rufous or piceous.

HEAD.—Eyes normally large and prominent; trace of triangular impression on front; microreticulate.

PRONOTUM.—Posterior pair of setiferous punctures at subrectangular hind angles; outer pair of longitudinal impressions absent; basal transverse impression complete; base bisinuate; disc partly microreticulate.

ELYTRON.—Scutellar stria and puncture present; setiferous punctures on eighth stria consisting of six anterior, one intermediate, eight or occasionally seven, in posterior series; two setae at posterior end of seventh stria; intervals usually somewhat convex; striae inpunctate; microreticulate.

VENTRAL SURFACE.—Coarse punctures on mesepisternum; scattered punctures on metepisternum and sides of metasternum.

LEGS.—Hind trochanter blunt, about half the length of hind femur.

SIXTH ABDOMINAL STERNUM OF MALE.—Apical edge thickened; tubercles and/or carina or lobe before apical margin.

AEDEAGUS.—Right paramere elongate. Median lobe with ventral surface with unsclerotized area on left side and diagonal, lightly sclerotized strip. Internal sac with large microtrichiate lobe below gonopore; usually small, weakly sclerotized tooth in gonopore.

LENGTH OF BODY.—6.0 to 9.0 mm.

REMARKS.—Distribution data are not as complete for members of the *fuchsi* group (see figs. 36, 37, 41) as for members of the *inopinus* group in Oregon. The range of *lobatus* is known to overlap the ranges of its two neighbors. There is geographical variation in the right paramere of *lobatus* (see fig. 10), but no other character shows any evidence of possible interbreeding. Since *lobatus* does overlap, apparently without interbreeding, it should definitely have species rank. Four of the other species presumably come into contact with each other in three areas in Humboldt and Mendocino Counties. Unfortunately, no specimens are known from these three areas, and so there is no direct evidence that the species come into contact or overlap without interbreeding. The gaps are small, however; only five or 10 miles separate the known ranges of *trinitensis*, *mattolensis*, and *humilis* in some places. If there are intermediate individuals, one would have expected a few among the approximately 170 males examined of *trinitensis*, *humilis*, *mattolensis*, and *fuchsi*. Instead, the structure of the aedeagus seems to be constant within each population and different among the six; hence, all six taxa have been given species rank. The six species inhabit California north of San Francisco Bay, within about 50 miles of the coast, and extreme southwestern Oregon. Five of the species live essentially within the redwood belt. The sixth, *trinitensis*, lives to the east of the redwoods.

3. *Pterostichus (Leptoferonia) fuchsi* Schaeffer

FIGURES 8, 36, 41

Pterostichus fuchsi Schaeffer, 1910, p. 392.—Casey, 1913, p. 128.—Van Dyke, 1925, p. 75.—Csiki, 1930, p. 582.—Hatch, 1936, p. 704.

Leptoferonia fuchsi (Schaeffer).—Casey, 1918, p. 337.—Leng, 1920, p. 56.

Leptoferonia fugax Casey, 1918, p. 337 [not Morawitz, 1862, p. 212].—Leng, 1920, p. 56.

Pterostichus fugax (Casey).—Van Dyke, 1925, p. 75 [fide synonymy of *fuchsi*].

Pterostichus fugiens Csiki, 1930, p. 582 [new name for *Leptoferonia fugax* Casey].—Leng and Mutchler, 1933, p. 12.

Pterostichus fugens [sic].—Hatch, 1936, p. 704 [misspelling of *fugiens* Csiki].

SPECIES DESCRIPTION.—Characteristics of *fuchsi* group plus the following.

HEAD.—Frontal impressions nearly straight except noticeably re-curved posteriorly, divergent, forming an angle of approximately 80°.

PRONOTUM.—Sides arcuate, then oblique or slightly sinuate for a short distance before hind angles; single pair of longitudinal impres-

sions shorter and shallower than in *inopinus* group; area lateral to impressions slightly convex.

ELYTRON.—Humerus strongly dentate.

LEGS.—Male hind femur robust, obtusely angulate along lower posterior margin, or occasionally tuberculate; no setae on ventrolateral margins of last article of tarsus.

SIXTH ABDOMINAL STERNUM OF MALE (fig. 8).—Three tubercles present before apical margin; the right small and blunt, sometimes connected with middle tubercle by low carina; middle large and blunt; left tubercle of equal size, more abruptly defined; apical edge between left and middle tubercles slightly emarginate; usually vague impression in vicinity of right tubercle.

AEDEAGUS (fig. 8).—Right paramere with basal portion bulbous, then abruptly narrowed in about middle. Median lobe with tip rather broad; ventral surface with small unsclerotized area on left side.

LENGTH OF BODY.—6.5 to 8 mm.

TYPES.—*Pterostichus fuchsi*, male, USNM!; *Leptoferonia fugax*, male, USNM!

TYPE-LOCALITIES.—California, presumably Sonoma or Mendocino County.

SPECIMENS EXAMINED.—68.

DISTRIBUTION (fig. 36).—Specimens were collected from Russian River, Sonoma County, north to eight miles west of Willits, Mendocino County, Calif., and to an elevation of 900 feet.

REMARKS.—The holotype male of *fugax* Casey definitely belongs to the taxon described above. Judging primarily by the frontal impressions of the head (tarsal setae not examined) the holotype of *fuchsi* belongs to this taxon also, rather than to the taxon described as *marinensis*, new species.

9. *Pterostichus (Leptoferonia) marinensis*, new species

FIGURES 9, 36, 41

HOLOTYPE MALE.—Characteristics of *fuchsi* group plus the following.

HEAD.—Frontal impressions slightly curved, not noticeably recurved at posterior ends, not nearly as divergent as in *fuchsi*, forming an angle of about 45°.

PRONOTUM.—Sides at middle less arcuate than in *fuchsi*; sides arcuate in basal third to immediately before hind angles; basal transverse impression faint towards middle; longitudinal impressions slightly shallower and shorter than in *fuchsi*.

ELYTRON.—Humerus strongly dentate.

LEGS.—Hind femur robust but not obtusely angulate; small setae present on ventrolateral margins of last article of tarsus.

SIXTH ABDOMINAL STERNUM OF MALE (fig. 9).—Low carina before evenly arcuate apical edge; two sharp tubercles at ends of carina; no distinct impression on face.

AEDEAGUS (fig. 9).—Right paramere gradually tapering; a slight bend at about middle. Median lobe with ventral surface flat; unsclerotized area on left side larger than in *fuchsi*; distal portion and tip narrower than *fuchsi* and curved to left. Internal sac with lips of gonopore weakly sclerotized, but apparently no tooth present.

LENGTH OF BODY.—7.5 mm.

ALLOTYPE FEMALE.—Same as holotype except for usual female differences; hind femur noticeably less robust; length of body 7.0 mm.

TYPE.—USNM 69602.

TYPE-LOCALITY.—Two miles northwest of Pan Toll Camp, Marin County, Calif.

SPECIMENS EXAMINED.—78.

DISTRIBUTION (fig. 36).—Holotype, male, allotype, female, 2 miles northwest of Pan Toll Camp, west slope of Mount Tamalpais, elev. 1700 ft., Marin County, Calif., July 11, 1965, H. A. Hacker. Also the following paratypes: 10 males, 6 females, same data as holotype; 3 males, 1 female, same data as holotype except Feb. 4, 1961; 4 males, 3 females, 3 miles northwest of Pan Toll Camp. Fifty other specimens were collected from other localities in the southern half of Marin County.

REMARKS.—Aside from male characteristics, the frontal impressions of the head and the tarsal setae provide the most distinctive differences between *marinensis* and *fuchsi*. There is not much forested land in the northern half of Marin County; *marinensis* and *fuchsi* currently may not be in contact with each other.

10. *Pterostichus (Leptoferonia) lobatus*, new species

FIGURES 10, 37, 41

HOLOTYPE MALE.—Characteristics of *fuchsi* group plus the following.

HEAD.—Frontal impressions slightly curved, not noticeably recurved at posterior ends, forming an angle of about 45°.

PRONOTUM.—Sides arcuate in middle, oblique, then sinuate immediately before hind angles; longitudinal impressions longer and more sharply impressed than in *fuchsi*.

ELYTRON.—Side arcuate; humerus sloping and not strongly dentate; intervals slightly convex; only faintly microreticulate.

LEGS.—Hind femur somewhat robust, not obtusely angulate; no setae on ventrolateral margins of last article of tarsus.

SIXTH ABDOMINAL STERNUM OF MALE (fig. 10).—A long, narrow, abruptly truncate lobe extending beyond edge, directed downward;

low tubercles merging into base of lobe; vague impression in vicinity of right anal seta.

AEDEAGUS (fig. 10).—Right paramere not elbowed, narrowed in about middle. Median lobe twisted about 45° ; distal portion and tip narrow, curved to left; right side of basal portion forming a sharp carina that extends partly across ventral surface toward large unsclerotized area.

LENGTH OF BODY.—7.0 mm.

ALLOTYPE FEMALE.—Same as above description of holotype except for usual female differences.

VARIATION.—Some of the other specimens examined differ from the above description in having the elytral intervals flat. The right paramere of the aedeagus is broad and then abruptly narrowed in the distal third in southern specimens; it is narrowed more gradually closer to the base in more northern specimens. Length of body ranges from 6.5 to 8.0 mm.

TYPE.—USNM 69603.

TYPE-LOCALITY.—Three miles south of Rockport, Mendocino County, Calif.

SPECIMENS EXAMINED.—29.

DISTRIBUTION (fig. 37).—Holotype, male, and allotype, female, 3 miles south of Rockport, T. 22 N, R. 18 W, Mount Diablo meridian, elev. 800 ft., Mendocino County, Calif., Mar. 22, 1964, H. A. Hacker. Also the following paratypes: 1 male, Rockport, elev. 100 ft.; 2 males, 1 mile north of Rockport, elev. 100 ft.; 1 male, 1 female, 4 miles north of Rockport, elev. 400 ft.; 3 males, 4 females, 1 mile south of Caspar, T. 17 N, R. 17 W, elev. 100 ft., Mendocino County. Other specimens were collected from the mouth of the Navarro River north to the Rockport area. Twelve specimens were found seven miles southwest of Ferndale, Humboldt County, elevation 1400 feet, about 60 miles from Rockport.

REMARKS.—The range of this species overlaps the ranges of *fuchsi* to the south and of *mattolensis* to the north. The Ferndale specimens apparently do not differ from the Rockport area specimens. If they are not a recent introduction, it is surprising that no specimens of *lobatus* were found among the 50 specimens of *Leptoferonia* collected near the coast between Ferndale and Rockport. The name refers to the lobe on the male sixth abdominal sternum.

11. *Pterostichus (Leptoferonia) mattolensis*, new species

FIGURES 11, 37, 41

HOLOTYPE MALE.—Characteristics of *fuchsi* group plus the following.

HEAD.—Frontal impressions nearly straight and not recurved posteriorly, forming an angle somewhat less than 80° .

PRONOTUM.—Sides arcuate in middle, oblique posteriorly, sinuate immediately before hind angles; anterior angles more prominent than in *fuchsi*.

LEGS.—Hind femur robust but not obtusely angulate; small setae present on ventrolateral margins of last article of tarsus.

SIXTH ABDOMINAL STERNUM OF MALE (fig. 11).—Two large blunt tubercles, left somewhat larger; no carina or third tubercle between.

AEDEAGUS (fig. 11).—Right paramere bisinuate, of nearly equal width for entire length. Median lobe with large unsclerotized area on ventral surface.

LENGTH OF BODY.—8.0 mm.

ALLOTYPE FEMALE.—Same as holotype except for usual female differences; elytral humeri slightly more rounded; length of body 7.5 mm. Other specimens range in length from 7.5 to 9.0 mm.

TYPE.—USNM 69604.

TYPE-LOCALITY.—Four miles south of Honeydew, Humboldt County, Calif.

SPECIMENS EXAMINED.—81.

DISTRIBUTION (fig. 37).—Holotype, male, and allotype, female, 4 miles south of Honeydew, T. 3 S, R. 1 E, Humboldt meridian, elev. 1500 ft., Humboldt County, Calif., July 3, 1964, H. A. Hacker. Also the following paratypes: 1 male, 3 females, same data as holotype; 2 males, 1 female, 1 mile south of Honeydew, T. 3 S, R. 1 E, elev. 200 ft.; 3 males, 2 females, 3 miles northwest of Upper Mattole, T. 2 S, R. 1 W, elev. 100 ft.; 2 males, 3 females, 2 miles southeast of Petrolia, T. 2 S, R. 2 W, elev. 100 ft. Other specimens were collected from as far south as the Rockport area in Mendocino County, as far north as McCann, Humboldt County, and to an elevation of 2300 feet.

REMARKS.—This species resembles *fuchsi* more than it resembles *lobatus*. In addition to the male differences, it differs from *lobatus* in the following characteristics: shallower pronotal longitudinal impressions; larger elytral humeri; stronger elytral microsculpture; more robust metafemora; and a less bulbous body outline. Externally it differs from *marinensis* in the following: more nearly rectangular elytral humeri; sides of the pronotum oblique, rather than arcuate in the basal third; anterior and posterior angles more prominent; longitudinal impressions slightly sharper; and transverse impression strong. The name is derived from the Mattole River, near which the types were collected.

12. *Pterostichus (Leptoferonia) trinitensis*, new species

FIGURES 12, 37, 41

HOLOTYPE MALE.—Characteristics of *fuchsi* group plus the following.

HEAD.—Frontal impressions curving, forming an angle of somewhat less than 80°, not recurving posteriorly.

PRONOTUM.—Sides broadly sinuate, then parallel before rectangular hind angles; longitudinal impressions fairly sharp; base not strongly bisinuate, making hind angles more prominent than in other species of group.

ELYTRON.—Humeral tooth small.

LEGS.—Hind femur not obtusely angulate; no setae on ventrolateral margins of last article of tarsus.

SIXTH ABDOMINAL STERNUM OF MALE (fig. 12).—Apical margin evenly rounded; strong carina joining the three tubercles; right tubercle nearly obsolete; middle and left tubercles only slightly prominent.

AEDEAGUS (fig. 12).—Right paramere broad, narrowed laterally in about middle; basal portion concave where left paramere rests against it. Median lobe stout, twisted, but not as abruptly as in *lobatus*; narrow tip curved to left; unsclerotized area large.

LENGTH OF BODY.—7.5 mm.

ALLOTYPE FEMALE.—Same as holotype except for usual female differences. Other specimens range in length from 7.0 to 9.0 mm.

TYPE.—USNM 69605.

TYPE-LOCALITY.—Eight miles northeast of Zenia, Trinity County, Calif.

SPECIMENS EXAMINED.—95.

DISTRIBUTION (fig. 37).—Holotype, male, and allotype, female, 8 miles northeast of Zenia, T. 2 S, R. 6 E, Humboldt meridian, elev. 3500 ft., Trinity County, Calif., July 1, 1964, H. A. Hacker. Also the following paratypes: 2 males, 3 females, same data as holotype; 3 males, 2 females, 16 miles northeast of Zenia, T. 2 S, R. 7 E, elev. 3400 ft.; 1 male, 1 female, 4 miles northeast of Zenia, elev. 4000 ft.; 1 male, 1 female, 3 miles northeast of Zenia; 4 males, 7 miles southeast of Zenia, T. 4 S, R. 6 E, elev. 3100 ft. Other specimens were collected from as far south as five miles south of Willits, Mendocino County, as far east as Plaskett Meadows, Glenn County, and from elevations between 300 and 6500 ft. This species is found to the east of the redwood belt in woods of *Pseudotsuga menziesii* (Mirb.) Franco with *Libocedrus decurrens* Torrey and *Pinus lambertiana* Douglas or various *Abies* at higher elevations. Specimens from eastern Mendocino and western Glenn Counties were collected too late to be shown on the distribution maps.

REMARKS.—The aedeagus of *trinitensis* resembles that of *lobatus* more closely than those of the other species in the *fuchsi* group. Otherwise *trinitensis* does not appear very similar to *lobatus*. It differs from *mattolensis* in the following pronotal characteristics: longitudinal impressions sharper, anterior angles less prominent, sides sinuate well before the prominent hind angles (rather like *pumilus willamettensis*).

13. *Pterostichus (Leptoferonia) humilis* Casey

FIGURES 13, 37, 41

Pterostichus humilis Casey, 1913, p. 128.—Van Dyke, 1925, p. 75.—Csiki, 1930, p. 582.—Hatch, 1936, p. 704.

Leptoferonia humilis (Casey).—Casey, 1918, p. 337.—Leng, 1920, p. 56.

Leptoferonia larvalis Casey, 1918, p. 337.—Leng, 1920, p. 56.

Pterostichus larvalis (Casey).—Van Dyke, 1925, p. 75 [fide synonymy of *humilis* Casey].—Csiki, 1930, p. 582.—Hatch, 1936, p. 704.

SPECIES DESCRIPTION.—Characteristics of *fuchsi* group plus the following.

HEAD.—Frontal impressions nearly straight, not recurved, forming an angle less than 80° .

PRONOTUM.—Sides evenly arcuate in middle, oblique in basal third, then sinuate immediately before hind angles; area lateral to shallow longitudinal impressions often flat.

ELYTRON.—Humerus and humeral tooth small; side more arcuate than in other species of group except *lobatus*.

VENTRAL SURFACE.—Coarse punctures essentially confined to mesepisternum.

LEGS.—Hind femur somewhat robust, not obtusely angulate; no setae on lateroventral margins of last article of tarsus.

SIXTH ABDOMINAL STERNUM OF MALE (fig. 13).—Two tubercles small, joined by prominent curved carina; apical margin somewhat truncate between tubercles.

AEDEAGUS (fig. 13).—Right paramere sharply elbowed. Median lobe not twisted; unsclerotized area large, triangular.

LENGTH OF BODY.—6.0 to 8.0 mm.

TYPES.—*Pterostichus humilis*, male, USNM!; *Leptoferonia larvalis*, female, USNM!

TYPE-LOCALITIES.—Hoopa Valley, Humboldt County, Calif.

SPECIMENS EXAMINED.—151.

DISTRIBUTION (fig. 37).—From seven miles south of Gold Beach, Curry County, Oreg., south to Weott, Humboldt County, Calif., and to the elevation of 3100 feet. It is sympatric with *fenysei* or *cochlearis* over most of its range.

REMARKS.—Casey described his types of *humilis* and *larvalis* as testaceous; mature specimens are dark rufous. Aside from male characteristics, *humilis* can be distinguished from *mattolensis* by the following: elytral humeri smaller and more rounded, area lateral to longitudinal impressions on pronotum usually at least partly flat.

14. *Pterostichus (Leptoferonia) angustus* (Dejean)

FIGURES 14, 31, 38

Feronia angusta Dejean, 1828, p. 328.—LeConte, 1857, p. 8.

Pterostichus angustus (Dejean).—LeConte, 1852, p. 239; 1863a, p. 8; 1873, p. 303.—Schaeffer, 1910, p. 392.—Casey, 1913, p. 126.—Van Dyke, 1925, p. 75.—Csiki, 1930, p. 582.—Hatch, 1936, p. 704.

Leptoferonia angustus (Dejean).—Casey, 1918, p. 321, 337.—Leng, 1920, p. 56.

Pterostichus linearis LeConte, 1852, p. 239; 1873, p. 303 [fide synonymy of *angustus* Dejean].—Casey, 1913, p. 126.—Csiki, 1930, p. 582.

Pterostichus crucialis Casey, 1913, p. 126.—Van Dyke, 1925, p. 75 [fide synonymy of *angustus* Dejean].—Csiki, 1930, p. 582.—Hatch, 1936, p. 704.

Leptoferonia crucialis (Casey).—Casey, 1918, p. 337.—Leng, 1920, p. 56.

COLOR OF BODY.—Rufous.

HEAD.—Eyes smaller than in *inopinus* group, though longer than length of second antennal segment, not prominent; frontal impressions subparallel in basal half, then diverging; microreticulate.

PRONOTUM.—Sides in basal third broadly sinuate; hind angles slightly reflexed, rectangular; apical angles prominent, more so than in *hatchi*; posterior pair of setiferous punctures at angles; basal transverse impression weak or absent in middle; base bisinuate; inner pair of longitudinal impressions from distinctly impressed lines to shallow depressions; outer longitudinal impressions similarly variable, sometimes reaching basal margin, rarely absent; area between impressions and lateral margin slightly tumid; distinct midline often reaching basal margin; disc more convex than in *hatchi*; disc partly microreticulate.

ELYTRON.—Humerus strongly dentate; scutellar stria present; scutellar puncture present on both elytra in only a third of sample from north and east of San Francisco Bay; sides subparallel in middle third; setiferous punctures on eighth stria consisting of six anterior, no intermediate, six or occasionally five in posterior series; two setae at posterior end of seventh stria; microreticulate.

VENTRAL SURFACE.—Sparse punctures on mesepisternum in specimens from south and east of San Francisco Bay, additional punctures on mesepisternum and metepisternum in others.

LEGS.—Hind trochanter with tip pointed, about half the length of hind femur; hind femur not particularly robust; setae usually absent on ventrolateral margins of last article of tarsus in specimens from north of San Francisco Bay, present in southern specimens; males

with tibia of middle leg with about five tubercles along inner margin, giving a saw-toothed appearance.

SIXTH ABDOMINAL STERNUM (fig. 14).—Males with apical edge thickened; carina before truncate edge about straight, sometimes interrupted in middle; large impression to right of center on face. Females with apical margin subtruncate; often a small impression on face; a slight bulge or low carina before apical margin in *linearis* type and a few others.

AEDEAGUS (fig. 14).—Right paramere short, bulbous. Median lobe smaller in proportion to body than in most other *Leptoferonia*; twisted; basal portion with ridge where parameres meet when folded; tip small, shallow, barbed at right; lightly sclerotized strip present. Internal sac with small, lightly sclerotized tooth in gonopore.

LENGTH OF BODY.—7.0 to 8.5 mm.

VARIATION.—As noted above, specimens from north of San Francisco Bay show a tendency to lose the scutellar and tarsal setae. There is geographical variation among specimens from the southern part of this species' range. Thirteen specimens from the Carmel, Monterey County, area differ from more northern specimens as follows: eyes slightly larger; sides of pronotum more arcuate, then more strongly sinuate before hind angles; anterior angles not so prominent; pronotal impressions tend to be weaker; sides of elytra more arcuate; scutellar puncture always present on both elytra; carina on sixth sternum deeply interrupted and apical edge broadly emarginate in all seven males; average size larger. Specimens from Santa Cruz County exhibit these characteristics to a lesser degree; of 31 specimens, 28 have scutellar setae on both elytra. The aedeagus seems to be constant throughout the species' range.

TYPES.—*Feronia angusta* Dejean, apparently lost (see Lindroth, 1955, pp. 10-15); *Pterostichus linearis*, female, MCZ!; *P. crucialis*, male, USNM!

TYPE-LOCALITIES.—*Feronia angusta*, California; *P. linearis*, San Francisco, Calif.; *P. crucialis*, Santa Cruz Mountains, Calif.

SPECIMENS EXAMINED.—108.

DISTRIBUTION (fig. 38).—Specimens have been collected from five miles south of Carmel, Monterey County, north to Montgomery Woods State Park, Mendocino County, and east to Mount Diablo, Contra Costa County. This species is sympatric with *fuchsi* and *marinensis* in the northern part of its range. Three apparently normal males in the California Academy of Science bear the labels "Dunsmuir, Siskiyou County," and "Castella, Shasta County." If they are labelled correctly, this species should also be found in the eastern part of the Coast Range in Lake County and northward.

REMARKS.—Dejean's type-specimen probably was from the coats;

it was collected by Eschscholtz while he was on a sailing expedition. Dejean's description seems to fit the coastal species described above better than the Sierran *hatchi*, new species, or *stapedius*, new species. LeConte (1863a) and Chaudoir considered *linearis* LeConte to be a synonym of *angustus* Dejean. Hatch (1936) and Van Dyke confused this coastal species with the Sierran species. Hatch's (1936) description of "*angustus*" is drawn, at least in part, from specimens of *hatchi*.

The *hatchi* Group

The *hatchi* group includes two species, *Pterostichus hatchi*, new species, and *P. stapedius*, new species. The aedeagi of the two look very different superficially. *Pterostichus stapedius*, new species, also differs from *P. hatchi*, new species, in having the pronotum and elytra more convex and in having more numerous punctures on the ventral surface of the thorax. In the past, the two have been confused with the species that occurs in the California Coast Range and that is described in this paper as *angustus*. Dejean's *angusta* holotype apparently is lost. It was collected by Eschscholtz from "Californie" and probably was collected from the coast rather than from the Sierra Nevada in the interior, where *P. hatchi*, new species, and *P. stapedius*, new species, occur. Dejean's original description could apply to the Sierran species, however. The *hatchi* species group differs from the coastal species in several respects including a broader body outline and more protruding eyes. The members of the *hatchi* group share the characteristics listed below.

COLOR OF BODY.—Dark rufous.

HEAD.—Eyes protruding, but smaller than in *inopinus* group; frontal impressions somewhat curved, diverging posteriorly; a faint triangular impression on front; microreticulate.

PRONOTUM.—Sides arcuate in middle, then broadly sinuate and subparallel, or slightly divergent, somewhat before rectangular hind angles; posterior pair of setiferous punctures at angles; base bisinuate; weak basal transverse impression absent between inner pair of longitudinal impressions; outer pair of impressions usually faint, sometimes deep and fairly long, sometimes absent; deep midline not reaching either margin; disc partly microreticulate; sometimes vague longitudinal wrinkles in vicinity of midline toward base.

ELYTRON.—Humerus nearly rectangular; humeral dentation large and acute; scutellar stria normally short, sometimes complete, sometimes absent; scutellar puncture absent; setiferous punctures on eighth stria consisting of six in anterior series, usually no intermediate, usually six in posterior series; two setae at posterior end of seventh stria; intervals convex except toward base; microreticulate.

LEGS.—Hind femur not robust; hind trochanter blunt and relatively short, slightly less than half the length of hind femur; no setae on ventrolateral margins of last article of tarsus; in males, tibia of middle leg with truncate tubercles along inner margin.

SIXTH ABDOMINAL STERNUM OF MALE.—Apical edge thickened; broad transverse lobe between anal setae reaching to edge of sternum; no well-defined impression on face.

AEDEAGUS.—Right paramere at least somewhat elongate. Internal sac with small, lightly sclerotized tooth in gonopore.

LENGTH OF BODY.—5.5 to 8.0 mm.

15. *Pterostichus (Leptoferonia) hatchi*, new species

FIGURES 15, 30, 39

Pterostichus (Leptoferonia) angustus.—Hatch, 1936, p. 704 [in part; not Dejean, 1828, p. 328]. [New synonymy.]

HOLOTYPE MALE.—Same as description of *hatchi* group plus the following.

HEAD.—Frontal impressions subparallel in anterior half.

PRONOTUM.—Sides slightly divergent before hind angles; area lateral to inner longitudinal impressions nearly flat except for short outer impressions.

ELYTRON.—Sixth puncture in anterior series on one side detached, no intermediate puncture on either side; striae impunctate.

VENTRAL SURFACE.—Mesepisternum, metepisternum, and sides of metasternum with coarse, deep punctures; shallow, sparse punctures on proepisternum; tip of prosternum partly margined.

SIXTH ABDOMINAL STERNUM OF MALE (fig. 15).—Area in front of strong lobe concave, but no well-defined impression.

AEDEAGUS (fig. 15).—Right paramere elongate, curved, tapering gradually to point. Median lobe with deep concave area in about middle of ventral surface; right side and ventral surface meeting in sharp ridge adjacent to concavity; left side of ventral surface with small unsclerotized area; lightly sclerotized strip present; short tip tapering to sharp point; no raised area on basal portion where parameres rest.

LENGTH OF BODY.—8.0 mm.

ALLOTYPE FEMALE.—Same as above description of holotype except outer longitudinal impressions on pronotum absent and usual female differences; length of body 7.5 mm.

VARIATION.—Some of the other specimens, including some of the paratypes, differ from the holotype and allotype in one or more of the following characteristics, in addition to the characters of the *hatchi* group: pronotum with area between inner impression and

lateral margin sometimes convex; occasional vague shallow punctures present around longitudinal impressions. Elytron with scutellar stria complete; scutellar stria absent; only five punctures in posterior series on eighth stria; striae faintly punctate; length of body 6.0 to 8.0 mm. None of the variable characteristics seem to be geographical variations. The aedeagus appears to be constant throughout the range of this species.

TYPE.—USNM 69606.

TYPE-LOCALITY.—Two miles southwest of Ganns, Calaveras County, Calif.

SPECIMENS EXAMINED.—157.

DISTRIBUTION (fig. 39).—Holotype, male, and allotype, female, 2 miles southwest of Ganns, T. 6 N, R. 16 E, sec. 11, Mount Diablo meridian, elev. 6500 ft., Calaveras County, Calif., Sept. 7, 1964, H. A. Hacker. Also the following paratypes: 10 males, 5 females, same data as holotype; 4 males, 4 females, Ganns, elev. 6600 ft.; 11 males, 7 females, 1 mile west of Big Meadow Forest Service Camp, T. 7 N, R. 17 E, sec. 32, elev. 6700 ft. Other specimens were collected from Robb's Valley, T. 13 N, R. 14 E, El Dorado County, south to 1 mile southwest of Strawberry, T. 4 N, R. 18 E, Tuolumne County, and from elevations of 2800 to 6900 ft.

REMARKS.—I take pleasure in naming this species for Dr. Melville H. Hatch.

16. *Pterostichus (Leptoferonia) stapedius*, new species

FIGURES 16, 39

This species comprises two populations described herein as two subspecies: *P. stapedius stapedius*, the nominate new subspecies, and *P. stapedius yosemitensis*, new subspecies. This species differs from *P. hatchi*, new species, primarily in the structure of the aedeagus.

HOLOTYPE MALE.—Same as description of *hatchi* group plus the following.

HEAD.—Frontal impressions diverging for entire length, not parallel in anterior half; depression on front elongate but not widened posteriorly.

PRONOTUM.—Sides subparallel before hind angles; outer longitudinal impression absent on one side, vague on other; area between inner impression and lateral gutter mostly tumid; longitudinal wrinkles faint, no discal punctures; disc more convex than in *hatchi*.

ELYTRON.—Scutellar stria complete; striae subpunctate; surface more convex than in *hatchi*, especially noticeable toward base.

VENTRAL SURFACE.—Coarse punctures on sides of prosternum; punctures on thorax coarser and denser than in *hatchi*.

SIXTH ABDOMINAL STERNUM OF MALE (fig. 16).—Lobe before apical margin slightly smaller than in *hatchi*.

AEDEAGUS (fig. 16).—Right paramere elongate, crescent shaped. Median lobe with ventral surface not concave; unsclerotized area not extending onto ventral surface; no diagonal strip; tip very elongate, broad, spatulate, in lateral view almost parallel to axis of basal portion.

LENGTH OF BODY.—7.0 mm.

ALLOTYPE FEMALE.—Same as above description of holotype except pronotum with scattered punctures around longitudinal impressions; elytron with only five punctures in posterior series; length 6.5 mm; and usual female differences.

VARIATION.—Some of the other specimens of *stapedius stapedius* differ from the holotype and allotype in the following: head with depression on front elongate posteriorly and then widening to form a faint anchor-shaped depression; pronotum with outer longitudinal impressions weak or absent, never long or deep, longitudinal wrinkles and coarse punctures usually evident at base of pronotum; elytron with striae rarely impunctate; length of body 5.5 to 7.5 mm.

TYPE.—USNM 69607.

TYPE-LOCALITY.—Beasore Meadows, Madera County, Calif.

SPECIMENS EXAMINED.—80.

DISTRIBUTION (fig. 39).—Holotype, male, and allotype, female, Beasore Meadows, T. 6 S, R. 23 E, sec. 5, Mount Diablo meridian, elev. 6700 ft., Madera County, Calif., May 30, 1965, H. A. Hacker. Also the following paratypes: 16 males, 12 females, same data as holotype: 3 males, 1 female, 2 miles east of Gordon's Cabins, T. 6 S, R. 23 E, sec. 3, elev. 6300 ft. Other specimens came from this area in Madera County, and from around Huntington Lake, Fresno County. Two males collected by Van Dyke in the California Academy of Sciences are from Illilouette Canyon, Yosemite Park, Mariposa County. This subspecies is known to occur from elevations of 6300 to 8000 feet. It also may occur farther south in Fresno County.

REMARKS.—In addition to aedeagal characteristics, the main differences between *hatchi* and *stapedius* are found in the convexity of the pronotum and elytra and in the punctures on the ventral surface. Superficially, the aedeagi appear very different. The extraordinary tip in *stapedius* may be just an elongation of the short tip in *hatchi*. Such a tip might require more support, and this may be why there is no lightly sclerotized strip present. The internal sacs of the aedeagi are similar.

The name *stapedius* means "stirrup" and refers to the shape of the median lobe of the aedeagus in lateral view.

17. *Pterostichus (Leptoferonia) stapedius yosemitensis*, new subspecies

FIGURES 17, 39

HOLOTYPE MALE.—Same as description of *stapedius* plus the following.

HEAD.—Frontal depression very faint.

PRONOTUM.—Outer longitudinal impressions weak; longitudinal wrinkles numerous.

AEDEAGUS (fig. 17).—Compared to *stapedius stapedius* right paramere thicker and shorter. Median lobe with basal portion more slender; tip longer, directed forward rather than parallel to axis of basal portion; extreme tip widened, directed to right. Internal sac not examined.

ALLOTYPE FEMALE.—Same as holotype except pronotum with longitudinal wrinkles less evident; a few faint punctures around longitudinal impressions; and usual female differences.

TYPE.—USNM 69608.

TYPE-LOCALITY.—One-half mile north of Crane Flat Ranger Station, Tuolumne County, Calif.

SPECIMENS EXAMINED.—5.

DISTRIBUTION (fig. 39).—Holotype, male, $\frac{1}{2}$ mile north of Crane Flat Ranger Station, T. 2 S, R. 20 E, sec. 7, Mount Diablo meridian, elev. 6100 ft., Tuolumne County, Calif., Sept. 20, 1964, H. A. Hacker; allotype, female, Carlon Forest Service Camp, T. 1 S, R. 19 E, sec. 35, elev. 4300 ft., Sept. 19, 1964. Also the following paratypes: 1 male, 1 female, 2 miles northeast of Crane Flat Ranger Station, T. 2 S, R. 20 E, sec. 9, elev. 6800 ft.; 1 male, 2 miles south of Carlon Forest Service Camp, T. 2 S, R. 19 E, sec. 2, elev. 4500 ft. There is also part of a dead female from the type-locality. Two of the males are teneral, and the aedeagus of one collapsed on drying.

REMARKS.—The only differences between the two subspecies of *stapedius* seem to be in the aedeagus. Since this structure is stable within other subspecific populations in *Leptoferonia*, it seems advisable to depend on it in this case also. The nearest specimens of *stapedius stapedius* are from Illilouette Canyon, a distance of about 15 miles from Crane Flat. The paratypes have been deposited in the California Academy of Sciences.

18. *Pterostichus (Leptoferonia) caligans* Horn

FIGURES 18, 29, 38

Pterostichus caligans Horn, 1891, p. 33.—Casey, 1913, p. 126.—Van Dyke, 1919, p. 6; 1925, p. 75.—Csiki, 1930, p. 582.—Hatch, 1936, p. 705.

Leptoferonia caligans (Horn).—Casey, 1918, p. 337.—Leng, 1920, p. 56.

COLOR OF BODY.—Light rufous.

HEAD.—Head large in proportion to body; mandibles large, but not especially elongate or toothed; clypeus and labrum normal; frontal impressions fairly deep; occipital prominence normally large; groove above eye prominent; posterior pair of setiferous punctures farther removed from groove above eye than in other *Leptoferonia*; pigmented eyes very small, about as long as second antennal segment; disc with sparse, fine punctures, faintly microstrigulose.

PRONOTUM.—Narrow, widest just behind prominent anterior angles; posterior pair of setiferous punctures at rectangular or acute angles; transverse basal impression entirely absent; area between shallow inner longitudinal impression and lateral margin nearly flat; outer impression absent; disc flattened along midline, which is incised deeply; microsculpture same as head.

ELYTRON.—Humerus dentate; scutellar stria present; scutellar puncture absent; setiferous punctures on eighth stria consisting of six in anterior series, no intermediate, four or five in posterior series; only one seta on seventh stria; microreticulate.

VENTRAL SURFACE.—Mesepisternum with coarse punctures; metepisternum and sides of metasternum with sparser punctures; proepisternum and sides of prosternum with finer, sparser punctures.

LEGS.—Hind trochanter tapering to point, about half the length of hind femur, reaching nearly to setiferous puncture on femur in males; hind femur obtusely angulate along posterior margin in males; no setae on ventrolateral margins of last article of tarsus.

SIXTH ABDOMINAL STERNUM OF MALE (fig. 18).—Unmodified.

AEDEAGUS (fig. 18).—Right paramere short. Median lobe flattened; tip evenly rounded; no lightly sclerotized strip; small lobe on right side of ventral surface. Internal sac without sclerotized tooth.

LENGTH OF BODY.—9.0 to 12.0 mm.

TYPE.—Not seen.

TYPE-LOCALITY.—“Sylvania” [Camp Meeker, Sonoma County], Calif.

SPECIMENS EXAMINED.—22.

DISTRIBUTION (fig. 38).—Most known specimens are from the Glen Ellen-St. Helena area with individual specimens from as far north as five miles west of Comptche, Mendocino County, Calif.

REMARKS.—The three species *caligans*, *beyeri*, and *falli* resemble each other in having large heads and mandibles and small eyes. They differ in a number of other characteristics, however; I doubt that they are closely related.

19. *Pterostichus (Leptoferonia) beyeri* Van Dyke

FIGURE 19

Pterostichus beyeri Van Dyke, 1925, p. 71.—Csiki, 1930, p. 711.—Leng and Mutchler, 1933, p. 12.—Hatch, 1936, p. 705; 1953, p. 112.

Pterostichus (Leptoferonia) idahoensis Hatch, 1936, p. 704, 706; 1953, p. 112 [fide synonymy of *beyeri*].

COLOR OF BODY.—Dark rufous.

HEAD.—Large in proportion to body; mandibles large, tips narrower than in *caligans*; frontal impressions obsolete; genae bulbous; eyes small, flattened, larger than in *caligans*; microreticulate.

PRONOTUM.—Narrow; sides feebly arcuate in anterior third, thence oblique except slightly sinuate before small rectangular hind angles; posterior pair of setiferous punctures at hind angles; when present, transverse basal impressions not extending between shallow inner longitudinal impressions; outer pair of impressions absent or very faint; midline shallow; microstrigulose.

ELYTRON.—Humerus subrectangular; humeral dentation small, acute; scutellar stria present; scutellar puncture absent; setiferous punctures on eighth stria consisting of six in anterior series, one intermediate; five to seven in posterior series; two setae at posterior end of seventh stria; microreticulate.

VENTRAL SURFACE.—A few coarse punctures on mesepisternum.

LEGS.—Hind trochanter blunt, about half the length of hind femur; hind femur robust; setae absent on ventrolateral margins of last article of tarsus.

SIXTH ABDOMINAL STERNUM OF MALE (fig. 19).—Unmodified.

AEDEAGUS (fig. 19).—Right paramere short. Median lobe with ventral surface nearly flat; ventral surface and right side not meeting sharply; no lightly sclerotized strip; ridge on basal portion where parameres meet when folded; tip fairly long and narrow. Internal sac with prominent sclerotized tooth.

LENGTH OF BODY.—10.0 to 12.5 mm.

TYPES.—*Pterostichus beyeri*, male, CAS 1823!; *P. idahoensis*, not seen.

TYPE-LOCALITIES.—*Pterostichus beyeri*, Bitter Root Mountains, Montana. *P. idahoensis*, Pierce, Clearwater County, Idaho.

SPECIMENS EXAMINED.—3.

DISTRIBUTION.—Known form northern Idaho and extreme western Montana;

20. *Pterostichus (Leptoferonia) falli* Van Dyke

FIGURE 20

Pterostichus falli Van Dyke, 1925, p. 73.—Csiki, 1930, p. 712.—Leng and Mutchler, 1933, p. 12.—Hatch, 1936, p. 705.

COLOR OF BODY.—Light rufous.

HEAD.—Large in proportion to body; mandibles long; frontal impressions short and shallow; eyes fairly prominent, small but longer than second antennal segment; disc microstrigulose with fine sparse punctures.

PRONOTUM.—About as long as wide; sides feebly arcuate in middle, broadly sinuate before rectangular hind angles; anterior angles narrow and prominent; base proportionately narrower than in *caligans*; posterior pair of setiferous punctures at hind angles; basal transverse impression, when present, not reaching between shallow inner longitudinal impressions; outer impressions small; microsculpture as on head.

ELYTRON.—Humerus somewhat rounded; humeral dentation not large; sides subparallel; scutellar stria and scutellar puncture present; intervals nearly flat; setiferous punctures on eighth stria consisting of six in anterior series, one intermediate, seven or eight in posterior series; two setae at posterior end of seventh stria; microreticulate.

VENTRAL SURFACE.—A few coarse punctures on mesepisternum.

LEGS.—Hind trochanter blunt, short, about one-third the length of hind femur; legs slender, but not as slender as in *termitiformis*; setae present on ventrolateral margins of last article of tarsus.

SIXTH ABDOMINAL STERNUM OF MALE (fig. 20).—Unmodified.

AEDEAGUS (fig. 20).—Right paramere small, flattened, tapering to point in lateral view. Median lobe with sharp carina extending from right side to middle of ventral surface; area adjacent to carina tumid; probably a lightly sclerotized strip present. Internal sac with prominent sclerotized tooth.

LENGTH.—9.0 to 11.0 mm.

TYPE.—*Pterostichus falli*, male, CAS 1824!

TYPE-LOCALITY.—Hills east of Hollywood, Los Angeles County, Calif.

SPECIMENS EXAMINED.—8.

DISTRIBUTION.—Known only from type-series collected by Van Dyke from hills east of Hollywood 50 years ago.

21. *Pterostichus (Leptoferonia) sphodrinus* LeConte

FIGURE 21

Pterostichus sphodrinus LeConte, 1863, p. 10.—Schaeffer, 1910, p. 393.—Casey, 1913, p. 129.—Leng, 1920, p. 56.—Darlington, 1931, p. 158.—Hatch, 1936, p. 704; 1953, p. 112.—Lindroth, 1966, p. 469.

Monoferonia idahoanus Casey, 1924, p. 78.—Leng and Mutchler, 1927, p. 10.—Darlington, 1931, p. 158 [fide synonymy of *sphodrinus*].—Hatch, 1936, p. 704; 1953, p. 112.

Monoferonia idahoensis [sic].—Leng, 1933, p. 78 [misspelling of *idahoanus* Casey].

COLOR OF BODY.—Dark piceous.

HEAD.—Eyes normally large and prominent; frontal impressions shallow, subparallel; microreticulate.

PRONOTUM.—Sides entirely arcuate before obtusely rounded hind angles; posterior pair of setiferous punctures forward, similar to *inopinus*; transverse basal impression incomplete; shallow inner longitudinal impressions not reaching base of pronotum; outer pair of impressions absent; partly microreticulate.

ELYTRON.—Humerus very rounded; humeral tooth small, not acute; scutellar stria and scutellar puncture present; eighth stria with six punctures in anterior series, one intermediate, nine in posterior series; three setae at posterior end of seventh stria; microreticulate.

VENTRAL SURFACE.—Coarse punctures on mesepisternum and metepisternum; a few punctures on propisternum.

LEGS.—Hind trochanter blunt and about half the length of hind femur; legs relatively slender compared to *inopinus*; setae present on ventrolateral margins of last article of tarsus.

SIXTH ABDOMINAL STERNUM OF MALE (fig. 21).—Unmodified except occasionally a small impression on face in about middle.

AEDEAGUS (fig. 21).—Right paramere short. Median lobe broad, sides subparallel in ventral view; ventral surface and right side meeting sharply; low carina present along right side of ventral surface; tip shallow, blunt; no lightly sclerotized strip. Internal sac with prominent sclerotized tooth.

LENGTH OF BODY.—9.0 to 11.5 mm.

TYPES.—*Pterostichus sphodrinus*, MCZ; *Monoferonia idahoanus*, USNM.

TYPE-LOCALITIES.—*Pterostichus sphodrinus*, "Nebraska," which probably includes Idaho and Montana (see Hatch, 1936, p. 704); *Monoferonia idahoanus*, Moscow Mountains, Idaho.

SPECIMENS EXAMINED.—20.

DISTRIBUTION.—Southeastern British Columbia, southern Alberta, northeastern Washington, northern Idaho, and probably northwestern Montana.

REMARKS.—Superficially, this species resembles the species in the *inopinus* group. This is due to the rounded elytral humeri, rounded pronotal hind angles, and the posterior pair of pronotal punctures being forward. The aedeagus and other characteristics show no similarity to those found in the *inopinus* group. Probably *sphodrinus* should be placed in the subgenus *Hypherpes*. Casey's (1924, p. 78) reference to "*osculans*" actually was to specimens of *sphodrinus*. Darlington (1931, p. 159) lists the original *osculans* as a synonym of *Monoferonia diligendus*.

22. *Pterostichus (Leptoferonia) idahoae* Csiki

FIGURE 22

Pterostichus elongatus Schaeffer, 1910, p. 391 [not Duftschmid, 1812, p. 128; not Chaudoir, 1859, p. 116].—Casey, 1913, p. 126.—Van Dyke, 1925, p. 75.—Csiki, 1930, p. 582.—Hatch, 1936, p. 705; 1953, p. 113.

Leptoferonia elongatus (Schaeffer).—Leng, 1920, p. 56.

Pterostichus (Leptoferonia) idahoae Csiki, 1930, p. 582 [new name for *P. elongatus* Schaeffer, which Csiki spelled as *elongatulus*].—Hatch, 1936, p. 705; 1953, p. 113.

Pterostichus (Leptoferonia) idahoae [sic].—Leng, 1933, p. 12 [misspelling of *idahoae* Csiki].

COLOR OF BODY.—Dark rufous.

HEAD.—Not unusually large; eyes normally large and prominent; frontal impressions shallow, divergent, forming an angle greater than 45°; microreticulate.

PRONOTUM.—Sides very arcuate in anterior two-thirds, then subparallel or slightly divergent before prominent hind angles; anterior angles not prominent; transverse basal impression incomplete; outer longitudinal impressions usually present; posterior pair of setiferous punctures at angles; microstrigulose.

ELYTRON.—Humerus somewhat rounded; humeral dentation small; scutellar stria faint or absent; scutellar puncture absent; surface convex, noticeably so toward base; setiferous punctures on eighth stria consisting of five in anterior series, intermediate present in about half the specimens examined, usually seven in posterior series; two setae at posterior end of seventh stria; microreticulate.

VENTRAL SURFACE.—Coarse punctures confined to mesepisternum.

LEGS.—Hind trochanter blunt and about half the length of hind femur; hind femur robust; setae present on ventrolateral margins of last article of tarsus.

SIXTH ABDOMINAL STERNUM OF MALE (fig. 22).—Apical edge somewhat thickened; apical margin evenly arcuate; no carina; shallow impression on face.

AEDEAGUS (fig. 22).—Right paramere short. Median lobe small, ventral surface slightly concave; tip short, symmetrically rounded; probably lightly sclerotized strip present. Internal sac with sclerotized tooth.

LENGTH OF BODY.—8.5 to 9.5 mm.

TYPE.—Not examined.

TYPE-LOCALITY.—Moscow Mountains [Latah County], Idaho.

SPECIMENS EXAMINED.—20.

DISTRIBUTION.—Northern Idaho and western Montana.

REMARKS.—The names *Monoferonia idahoanus* Casey and *Pterostichus idahoensis* Hatch are synonyms of *P. sphodrinus* LeConte and *P. beyeri* Van Dyke, respectively, and do not apply to this species.

23. *Pterostichus (Leptoferonia) inanis* Horn

FIGURES 23, 24, 25

Pterostichus inanis Horn, 1891, p. 32.—Casey, 1913, p. 125.—Van Dyke, 1925, p. 75.—Csiki, 1930, p. 582.—Hatch, 1936, p. 705; 1953, p. 113.

Leptoferonia inanis (Horn).—Casey, 1918, p. 337.—Leng, 1920, p. 56.

COLOR OF BODY.—Piceous.

HEAD.—Eyes normally large and prominent; frontal impressions sharp, divergent, sometimes double posteriorly; disc faintly microreticulate, with sparse fine punctures.

PRONOTUM.—Sides arcuate in anterior two-thirds, oblique in basal third, sometimes slightly sinuate just before subrectangular hind angles; base bisinuate; basal transverse impression extending from outer impression to about inner impression; carina present between strong outer impression and lateral margin; area between inner and outer impressions tumid; microreticulate.

ELYTRON.—Humeral tooth usually not acute; scutellar stria usually complete, sometimes entirely absent; scutellar puncture absent; setiferous punctures on eighth stria consisting of six in anterior series, no intermediate, normally six, occasionally seven or eight, punctures in posterior series; one seta at posterior end of seventh stria; intervals usually convex; microreticulate.

VENTRAL SURFACE.—Coarse punctures confined to mesepisternum.

LEGS.—Hind trochanter long and evenly tapering to point, two-thirds the length of hind femur and usually reaching beyond the second setiferous puncture in males, somewhat shorter in females; setae present on ventrolateral margins of last article of tarsus.

SIXTH ABDOMINAL STERNUM OF MALE.—Unmodified.

AEDEAGUS (fig. 23).—Right paramere short. Median lobe stout; tip blunt and short; no well-defined strip. Internal sac with prominent sclerotized tooth.

LENGTH OF BODY.—9.5 to 11 mm.

VARIATION.—The above description and figure 23 are of Oregon specimens from Lane County northward. I have not seen the holotype; it probably is not from Oregon. This species occurs in at least four forms; perhaps after further study, some of them should be named subspecies or even full species.

Specimens from three localities in Siskiyou and Lassen Counties, Calif., have the same form of hind trochanter as Oregon specimens, but the median lobe of the aedeagus is slightly longer and narrower.

Specimens from nine localities from El Dorado County through central Tuolumne County, Calif., have the hind trochanter much more attenuate and longer. The median lobe of the aedeagus is definitely longer and more slender, and the tip is narrower and extends farther beyond the edge of the sac (see fig. 24). The elytral humeri are more strongly defined and the dentation larger and often acute.

Specimens from 15 localities, including two of the same localities in El Dorado County, Calif., show further differences. They are from El Dorado, Alpine, eastern Tuolumne, Madera, and Fresno Counties. They also have attenuate hind trochanters. The median lobe is stouter than in Oregon specimens and the tip is narrower (see fig. 25). The tip of the median lobe is more abruptly narrowed in northern specimens as compared to southern ones. The microreticulation on the head is stronger and the micropunctures less evident. The elytral striae are somewhat shallower, especially toward the apices. The elytral humeri are strong; the scutellar stria usually is absent. Occasionally, there are five punctures in the posterior series on the eighth stria, never more than six. The length is frequently less, ranging from 7.0 to 10.0 mm.

TYPE.—Not examined.

TYPE-LOCALITY.—Not known to me.

SPECIMENS EXAMINED.—112.

DISTRIBUTION.—The Cascade Range from British Columbia through Washington and Oregon and into northern California and the Sierra Nevada of California. Also recorded from Reno, Nev. In northern Oregon specimens have been found as low as 3000 feet; in Fresno County, Calif., as high as 9400 feet.

24. *Pterostichus (Leptoferonia) termitiformis* Van Dyke

FIGURES 26, 28, 33

Pterostichus termitiformis Van Dyke, 1925, p. 74.—Csiki, 1930, p. 713.—Leng and Mutchler, 1933, p. 12.—Hatch, 1936, p. 705; 1953, p. 113.

COLOR OF BODY.—Light rufous.

HEAD.—Large; eyes small, flat, about half length of first antennal segment; frontal impressions shallow; antennae long; mandibles long, distal half of left with two broad teeth; clypeus and labrum short; labrum broadly emarginate, not straight along apical margin; penultimate segment of maxillary palpus with four setae; faintly microstrigulose.

PRONOTUM.—Sides sinuate before rectangular hind angles; hind angles rather reflexed; posterior pair of setiferous punctures absent (one female has a non-ocellate setiferous puncture on one side somewhat forward from angle); inner pair of longitudinal impressions shallow; outer impressions and transverse basal impression absent; faintly microstrigulose.

ELYTRON.—Humerus very rounded; humeral dentation obsolete; scutellar puncture present; usually no trace of scutellar stria; intervals nearly flat; setiferous punctures on eighth stria consisting of six in anterior series, usually no intermediate, usually seven in posterior series; two setae at posterior end of seventh stria; striae faint toward apices; microstrigulose.

VENTRAL SURFACE.—Scattered coarse punctures on thorax, density variable.

LEGS.—Hind trochanter blunt, short, about one-third the length of hind femur; legs long and slender; three pairs long setae present on ventrolateral margins and three pairs on dorsal surface of last article of tarsus.

SIXTH ABDOMINAL STERNUM OF MALE (fig. 26).—Unmodified.

AEDEAGUS (fig. 26).—Right paramere cylindrical, slightly elongate. Median lobe broad, almost symmetrical; no well-defined strip. Internal sac without sclerotized tooth.

LENGTH OF BODY.—7.0 to 9.0 mm.

TYPE.—Male, CAS 1826!

TYPE-LOCALITY.—Marshfield [now Coos Bay], Coos County, Oreg.

SPECIMENS EXAMINED.—12.

DISTRIBUTION (fig. 33).—All specimens except one (Carpenterville, elevation 1700 feet) came from elevations near sea level. They were collected from a variety of habitats including a dense forest of *Picea sitchensis* (Bong.) Carr., sandy soil under bushes adjacent to the seabeach, sea dunes, and a stream, and in open woods of *Pseudotsuga menziesii* (Mirb.) Franco, *Arbutus menziesii* Pursh, and *Quercus* species.

REMARKS.—This species keys out to Agonini or Licini [sic] in Hatch (1953, p. 70) because of its short hind trochanters, emarginate labrum, and short clypeus. The teeth on the mandible and the setae on the maxillary palpus probably do not occur in any other species in the *Leptoferonia-Hypherpes-Anilloferonia* complex of *Pterostichus*. A new subgenus should be established for *termitiformis*.

Summary

The original purpose of this paper was to redescribe several species about which there had been some confusion. In the course of the study, 10 new forms were discovered. Seven of these are described as new species and three as new subspecies.

Sixteen species from western Oregon and California were the main subjects of study. The geographical ranges of these species are now fairly well known and are shown on distribution maps.

I have used the subgeneric name *Leptoferonia* in its traditional sense. I do not believe that all 21 species now included in the subgenus have a common immediate ancestor. Perhaps when the whole genus *Pterostichus* and especially the subgenus *Hypherpes* are revised, the subgenus *Leptoferonia* will be redefined to include fewer species.

Future studies of chromosomal karyotypes, immature forms, and zoogeography may help to clarify the relationships within *Leptoferonia* and between *Leptoferonia* and *Hypherpes*.

Literature Cited

BALL, GEORGE E.

1960. Carabidae. Fasc. 4 *in* Arnett, The beetles of the United States: A manual for identification, pp. 55-210. Washington, D.C.: Catholic University of America Press.
1965. Two new subgenera of *Pterostichus* Bonelli from western United States, with notes on characteristics and relationships of the subgenera *Paraferonia* Casey and *Feronina* Casey (Coleoptera: Carabidae). *Coleopt. Bull.*, vol. 19, pp. 104-112.
1966. A revision of the North American species of the subgenus *Cryobius* Chaudoir (*Pterostichus*, Carabidae, Coleoptera). *Opusc. Ent.*, suppl. 28, 166 pp.

CASEY, THOMAS LINCOLN

1884. Contributions to the descriptive and systematic coleopterology of North America, pt. 1, pp. 1-60. Philadelphia: Collins Printing House.
1913. Studies in the Cicindelidae and Carabidae of America. *In* *Memoirs on the Coleoptera*, vol. 4, pt. 1, pp. 1-192. Lancaster, Pa.
1914. Miscellaneous notes and new species. *In* *Memoirs on the Coleoptera*, vol. 5, pp. 355-378.
1918. Studies among some of the American Amarinae and Pterostichinae. *In* *Memoirs on the Coleoptera*, vol. 8, pt. 2, pp. 224-393.
1924. Additions to the known Coleoptera of North America. *In* *Memoirs on the Coleoptera*, vol. 11, pp. 1-347.

CHAUDOIR, MAXIMILIEN DE, BARON

1859. Beitrag zur Kenntniss der europäischen Feroniden. *Ent. Zeit. Stettin*, vol. 20, pp. 113-131.
1868. Observations synonymiques sur les carabiques de l'Amérique septentrionale et descriptions d'espèces nouvelles de ce pays. *Rev. Mag. Zool.*, ser. 2, vol. 20, pp. 161-345.

CSIKI, ERNST

1930. Carabidae: Harpalinae IV. *In* *Junk, Coleopterorum catalogus*, pars. 112, pp. 529-737.

DARLINGTON, PHILIP JACKSON, JR.

1931. On some Carabidae, including new species, from the mountains of North Carolina and Tennessee. *Psyche*, vol. 38, no. 4, pp. 145-164.
1936. An interesting *Pterostichus* and a new *Colpodes* from Arizona (Coleoptera: Carabidae). *Bull. Brooklyn Ent. soc.*, vol. 31, no. 4, pp. 150-153.

DEJEAN, PIERRE FRANÇOIS MARIE AUGUSTE

1828. *Spécies général des coléoptères de la collection de M. le Comte Dejean*, vol. 3, 556 pp. Paris: Mequignon-Marvis.

DUFTSCHMID, KASPER ERASMUS

1812. *Fauna austriae, oder Beschreibung der österreichischen insecten für angehende freunde der entomologie*. K. K. Priv. Akad. kunst-, musik-, und buchh., vol. 2, 311 pp. Linz and Leipzig.

HATCH, MELVILLE HARRISON

1936. Studies on *Pterostichus* (Carabidae: Coleoptera). Ann. Ent. Soc. America, vol. 29, no. 4, pp. 701-706.
1953. The beetles of the Pacific Northwest, pt. 1: Introduction and Adephaga. Univ. Washington Publ. Biol., vol. 16, 340 pp.

HORN, GEORGE HENRY

1891. New species and miscellaneous notes. Trans. American Ent. Soc., vol. 18, pp. 32-47.

LECONTE, JOHN LAWRENCE

1852. Synopsis of the species of *Pterostichus* Bon. and allied genera inhabiting temperate North America. Journ. Acad. Nat. Sci. Philadelphia, ser. 2, vol. 2, pp. 225-256.
1857. Report upon insects collected on the survey. In Reports of explorations and surveys . . . for a railroad from the Mississippi River to the Pacific Ocean . . . 1853-5, 72 pp. Washington, D.C. [A preprint of vol. 12, pt. 3, pp. 1-72; the report was not published in full until 1860.]
1861. New species of Coleoptera inhabiting the Pacific district of the United States. Proc. Acad. Nat. Sci. Philadelphia, vol. 13, pp. 338-359.
- 1863a. List of the Coleoptera of North America. Smithsonian Misc. Coll., vol. 6, publ. no. 140, pp. 1-49.
- 1863b. New species of North American Coleoptera. Smithsonian Misc. Coll., vol. 6, publ. no. 167, pp. 1-86.
1869. List of Coleoptera collected in Vancouver's Island by Henry and Joseph Matthews, with descriptions of some new species. Ann. Mag. Nat. Hist., ser. 4, vol. 4, pp. 368-385.
1873. The Pterostichi of the United States. Proc. Acad. Nat. Sci. Philadelphia, pp. 302-320.

LEECH, HUGH BOSDIN

1935. British Columbian records of Carabidae and Hydrophilidae. Pan-Pacific Ent., vol. 10, pp. 120-124.

LENG, CHARLES WILLIAM

1920. Catalogue of the Coleoptera of America, north of Mexico, 470 pp. Mount Vernon, N.Y.: J. D. Sherman, Jr.

LENG, CHARLES WILLIAM, and MUTCHLER, ANDREW JOHNSON

1927. Supplement 1919 to 1924 to catalogue of the Coleoptera of America north of Mexico, 78 pp. Mount Vernon, N.Y.: J. D. Sherman, Jr.
1933. Second and third supplements 1925 to 1932 (inclusive) to catalogue of the Coleoptera of America, north of Mexico, 112 pp. Mount Vernon, N.Y.: J. D. Sherman, Jr.

LINDROTH, CARL HILDEBRAND

1955. Dejean's types of North American Carabidae. Opusc. Ent., vol. 20, pp. 10-34.
1966. The ground-beetles of Canada and Alaska, pt. 4. Opusc. Ent., suppl. 29, pp. 409-648.

MORAWITZ, AUGUST VEDOROVITSH

1862. Vorläufige Diagnosen neuer Coleoptera aus Südost-Sibiren. Mélang. Biol. Tirés Bull. Acad. Imp. St. Petersbourg, vol. 4, pp. 180-228.

MOTSCHULSKY, T. VICTOR IVANOVICH VON

1859. Coléoptères nouveaux de la California. Bull. Soc. Imp. Nat. Moscou, vol. 32, pt. 2, pp. 122-185, 357-410.

1865. Énumération des nouvelles espèces de coléoptères rapportés de ses voyages. Bull. Soc. Imp. Nat. Moscou, vol. 38, pt. 4, pp. 227-313.
- REITTER, EDMUND
1884. Neuer Beitrag zur Käferfauna Griechenlands. Deutsche Ent. Zeit., vol. 28, pp. 17-100.
- SCHAEFFER, CHARLES FREDRIC AUGUST
1910. Additions to the Carabidae of North America with notes on species already known. Mus. Brooklyn Inst. Arts Sci. Mus., Sci. Bull., vol. 1, no. 17, pp. 391-405.
- SCHAUPP, FRANZ G.
1882. Synoptic tables of Cicindelidae and Carabidae. Bull. Brooklyn Ent. Soc., vol. 5, pp. 69-74.
- VAN DYKE, EDWIN COOPER
1919. The distribution of insects in western North America. Ann. Ent. Soc. America, vol. 12, no. 1, pp. 1-12.
1925. New species of Carabidae in the subfamily Harpalinae, chiefly from western North America. Pan-Pacific Ent., vol. 2, no. 2, pp. 65-76.

TABLE 1.—*Ratios of body proportions for seven species and subspecies in the subgenus Leptoferonia (pronotal base measured through posterior setiferous puncture)*

Species		Head width: pronotal width		Pronotal width: pronotal length		Pronotal base: pronotal width	
		range	median	range	median	range	median
<i>inopinus</i>	49 ♀	0.69-0.76	0.72	0.86-0.97	0.92	0.71-0.79	0.75
	51 ♂	.69-.77	.72	.91-.99	.95	.72-.79	.75
<i>pumilus</i>	37 ♀	.68-.77	.72	.86-.98	.92	.66-.77	.73
<i>pumilus</i>	41 ♂	.71-.78	.74	.90-1.00	.96	.70-.76	.73
<i>pumilus</i>	64 ♀	.68-.76	.72	.88-1.00	.93	.71-.79	.75
<i>willamettensis</i>	71 ♂	.70-.76	.72	.91-1.04	.96	.71-.79	.75
<i>infernalis</i>	25 ♀	.66-.75	.70	.89-.96	.93	.78-.85	.81
<i>northern</i>	25 ♂	.67-.73	.70	.90-1.00	.96	.77-.83	.80
<i>infernalis</i>	25 ♀	.67-.75	.70	.92-1.00	.98	.71-.78	.74
<i>southern</i>	25 ♂	.68-.75	.71	.93-1.00	.97	.70-.80	.74
<i>fenyesi</i>	11 ♀	.71-.74	.73	.92-.98	.94	.80-.84	.81
<i>fenyesi</i>	24 ♂	.71-.76	.74	.93-1.00	.97	.77-.86	.81
<i>fenyesi</i>	10 ♀	.71-.76	.74	.85-.94	.89	.78-.83	.81
<i>fenderi</i>	11 ♂	.72-.77	.74	.88-.92	.91	.79-.84	.81
<i>cochlearis</i>	32 ♀	.68-.75	.72	.84-.92	.89	.76-.83	.80
	43 ♂	.68-.77	.72	.86-.96	.91	.76-.84	.80

TABLE 2.—*Ratios of body proportions for nine species and subspecies in the subgenus Leptoferonia*

Species		Head width: pronotal width		Pronotal width: pronotal length		Pronotal base: pronotal width	
		range	median	range	median	range	median
<i>fuchsi</i>	29 ♀	0.68-0.74	0.71	0.92-0.99	0.94	0.73-0.83	0.79
	36 ♂	.66-.73	.71	.90-1.00	.97	.75-.83	.80
<i>lobatus</i>	17 ♀	.67-.72	.71	.85-.91	.89	.75-.79	.77
	25 ♂	.66-.71	.69	.86-.92	.89	.74-.82	.77
<i>trinitensis</i>	24 ♀	.67-.73	.69	.85-.92	.90	.74-.82	.78
	33 ♂	.65-.72	.69	.87-.95	.90	.75-.82	.78
<i>humilis</i>	33 ♀	.66-.71	.68	.87-.95	.90	.76-.83	.80
	32 ♂	.65-.71	.68	.87-.94	.91	.74-.84	.79
<i>angustus</i>	46 ♀	.68-.77	.72	.95-1.08	1.01	.76-.89	.84
	52 ♂	.67-.76	.72	.97-1.08	1.04	.77-.89	.84
<i>hatchi</i>	40 ♀	.64-.70	.68	.88-.96	.92	.77-.86	.82
	60 ♂	.64-.72	.68	.90-1.03	.96	.78-.86	.82
<i>stapedius</i>	33 ♀	.65-.70	.67	.86-.96	.90	.78-.83	.81
	<i>stapedius</i>	44 ♂	.65-.70	.67	.88-.98	.93	.77-.85
<i>caligans</i>	5 ♀	.84-.88	.86	.99-1.06	1.02	.76-.80	.77
	4 ♂	.85-.88	.87	1.06-1.08	1.07	.74-.77	.76
<i>termitiformis</i>	5 ♀	.88-.95	.91	.80-.90	.85	.63-.69	.64
	3 ♂	.91-.94	.92	.85-.86	.86	.62-.64	.63

TABLE 3.—*Ratios of body proportions for seven species and subspecies in the subgenus Leptoferonia (pronotal base measured through posterior setiferous puncture)*

Species		Pronotal apex: pronotal base		Pronotal width: elytral width		Humeral width: elytral width	
		range	median	range	median	range	median
<i>inopinus</i>	49 ♀	0.90-1.02	0.96	0.77-0.84	0.80	0.62-0.68	0.65
	51 ♂	.90- .98	.95	.79- .87	.82	.63- .69	.66
<i>pumilus</i>	37 ♀	.94-1.06	1.00	.75- .82	.79	.63- .69	.65
<i>pumilus</i>	41 ♂	.93-1.06	1.00	.76- .83	.79	.64- .71	.66
<i>pumilus</i>	64 ♀	.90-1.02	.97	.76- .84	.80	.61- .69	.66
<i>willamettensis</i>	71 ♂	.91-1.03	.96	.77- .86	.82	.65- .71	.67
<i>infernalis</i>	25 ♀	.83- .92	.88	.76- .83	.79	.64- .68	.66
<i>infernalis</i>	25 ♂	.84- .93	.88	.77- .84	.81	.60- .70	.68
<i>infernalis</i>	25 ♀	.91-1.00	.98	.75- .81	.78	.63- .70	.66
<i>infernalis</i>	25 ♂	.90-1.01	.95	.75- .82	.79	.66- .70	.68
<i>fenyesi</i>	11 ♀	.87- .91	.90	.79- .83	.81	.61- .66	.64
<i>fenyesi</i>	24 ♂	.86- .92	.89	.80- .88	.84	.63- .68	.66
<i>fenyesi</i>	10 ♀	.89- .92	.91	.78- .83	.80	.59- .63	.62
<i>fenderi</i>	11 ♂	.87- .94	.90	.79- .85	.84	.62- .68	.65
<i>cochlearis</i>	32 ♀	.87- .98	.90	.77- .85	.81	.58- .66	.61
	43 ♂	.86- .96	.91	.79- .86	.82	.59- .65	.63

TABLE 4.—*Ratios of body proportions for nine species and subspecies in the subgenus Leptoferonia*

Species		Pronotal apex: pronotal base		Pronotal width: elytral width		Humeral width: elytral width	
		range	median	range	median	range	median
<i>fuchsi</i>	29 ♀	0.85-0.94	0.90	0.76-0.83	0.79	0.67-0.72	0.70
	36 ♂	.84- .94	.89	.78- .87	.81	.69- .74	.71
<i>lobatus</i>	17 ♀	.91- .95	.93	.73- .77	.74	.61- .67	.64
	25 ♂	.85- .96	.90	.72- .79	.76	.62- .70	.65
<i>trinitensis</i>	24 ♀	.83- .96	.90	.73- .80	.76	.64- .70	.67
	33 ♂	.86- .96	.90	.73- .81	.77	.64- .72	.68
<i>humilis</i>	33 ♀	.85- .94	.88	.73- .79	.77	.64- .72	.68
	32 ♂	.83- .91	.88	.75- .82	.78	.66- .71	.69
<i>angustus</i>	46 ♀	.81- .96	.87	.79- .90	.85	.72- .85	.80
	52 ♂	.80- .95	.87	.81- .91	.86	.73- .86	.80
<i>hatchi</i>	40 ♀	.82- .93	.88	.75- .83	.80	.71- .80	.75
	60 ♂	.84- .92	.88	.76- .86	.80	.72- .82	.76
<i>stapedius</i>	33 ♀	.87- .95	.91	.76- .83	.80	.70- .77	.74
<i>stapedius</i>	44 ♂	.85- .96	.91	.76- .84	.81	.73- .78	.75
<i>caligans</i>	5 ♀	1.05-1.08	1.06	.79- .86	.84	.75- .78	.76
	4 ♂	1.09-1.15	1.12	.84- .86	.85	.76- .78	.77
<i>termitifformis</i>	5 ♀	1.16-1.29	1.20	.73- .77	.76	.58- .63	.61
	3 ♂	1.24-1.29	1.28	.75- .78	.76	.59- .62	.59

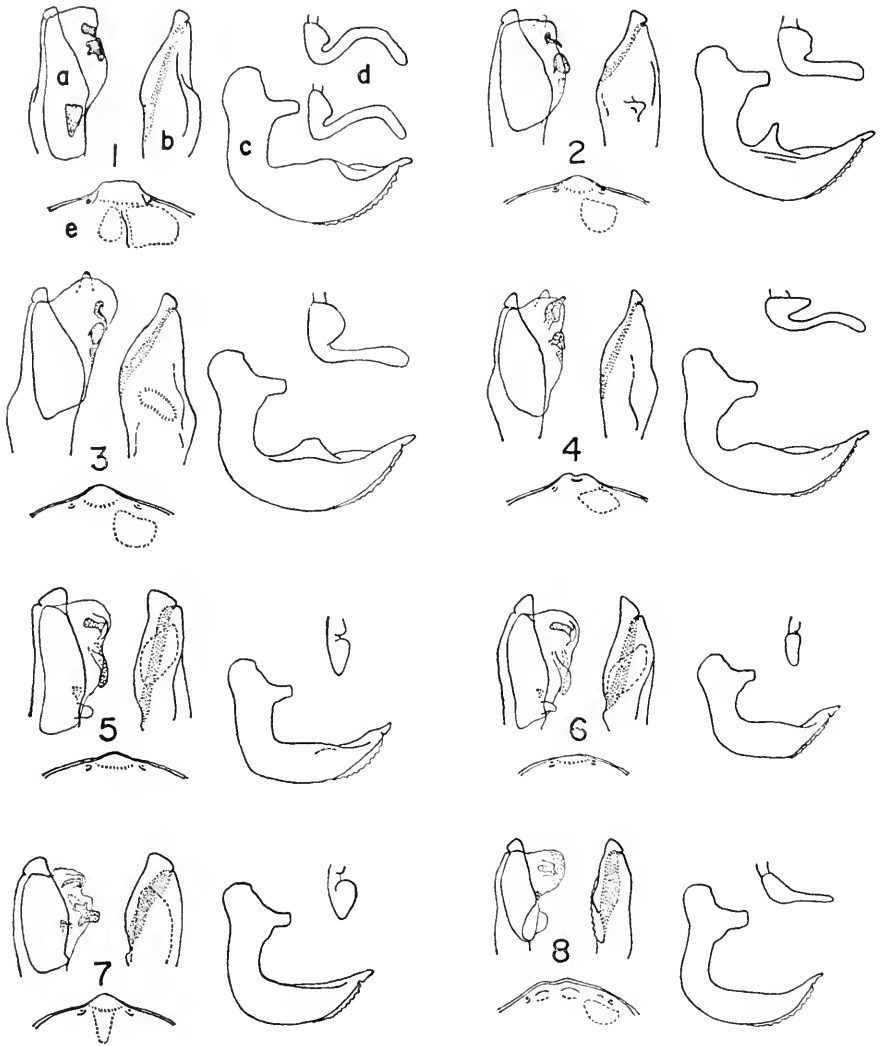

FIGURES 1-8.—1, *Pterostichus (Leptoferonia) inopinus* (Casey); 2, *P. pumilus pumilus* Casey; 3, *P. pumilus willamettensis*, new subspecies; 4, *P. infernalis* Hatch; 5, *P. fenyese fenyese* Csiki; 6, *P. fenyese fenderi*, new subspecies; 7, *P. cochlearis*, new species; 8, *P. fuchsi* Schaeffer. (a=everted sac of aedeagus; b=median lobe, ventral view; c=median lobe, lateral view; d=right paramere, lateral view; e=sixth abdominal sternum of male.)

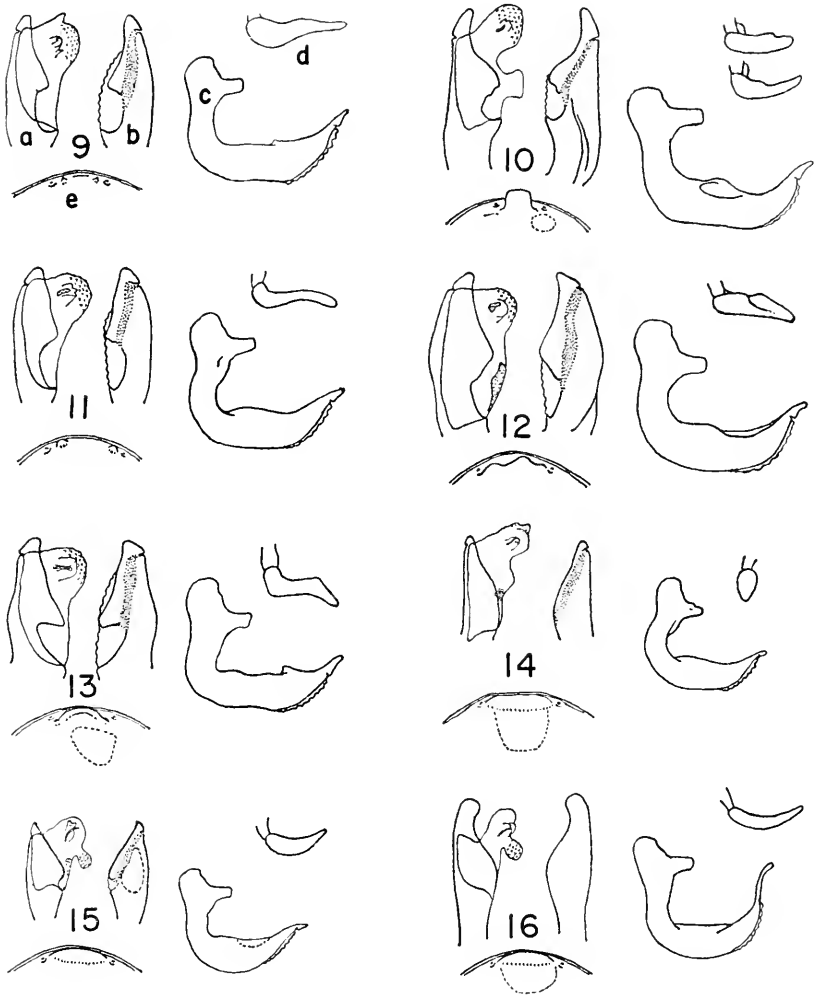

FIGURES 9-16.—9, *Pterostichus (Leptoferonia) marinensis*, new species; 10, *P. lobatus*, new species; 11, *P. mattolensis*, new species; 12, *P. trinitensis*, new species; 13, *P. humilis* Casey; 14, *P. angustus* (Dejean); 15, *P. hachi*, new species; 16, *P. stapedius*, new species. (See figs. 1-8 for key to letters.)

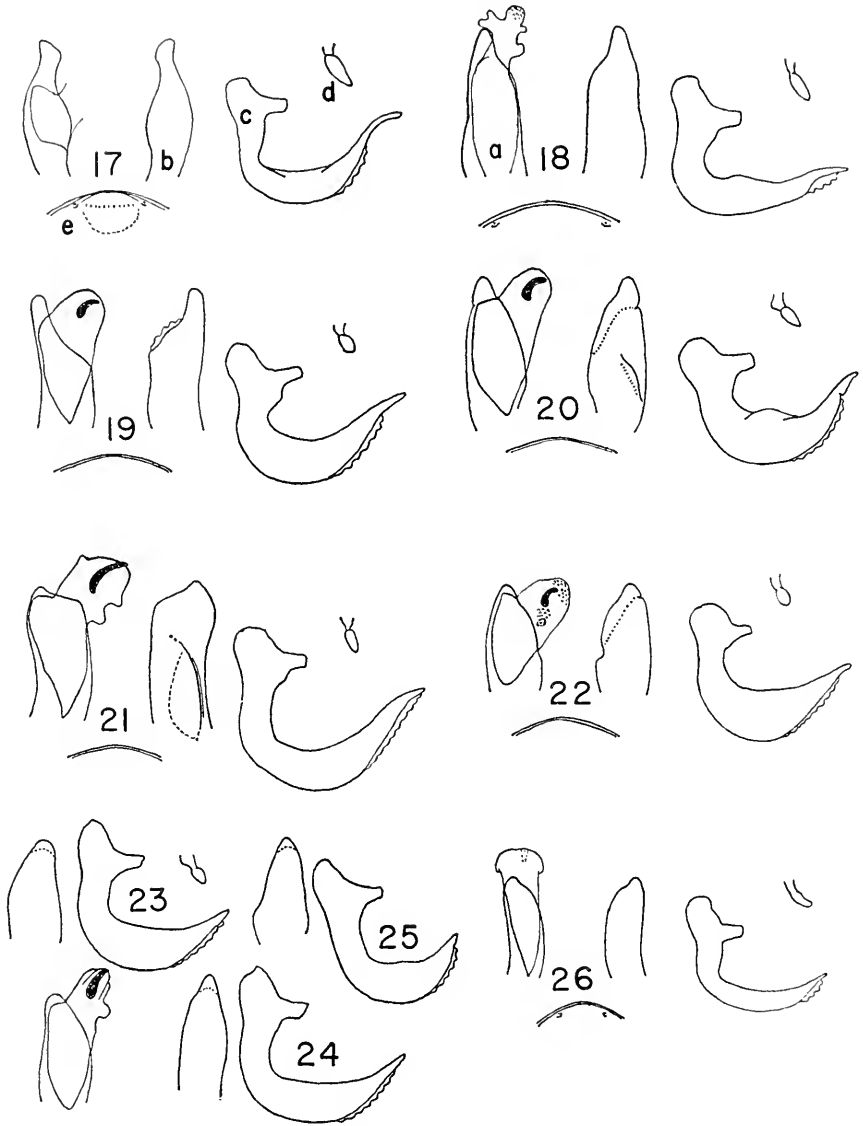

FIGURES 17-26.—17, *Pterostichus (Leptoferonia) stapedius yosemitensis*, new subspecies; 18, *P. caligans* Horn; 19, *P. beyeri* Van Dyke; 20, *P. falli* Van Dyke; 21, *P. sphodrinus* LeConte; 22, *P. idahoae* Csiki; 23, *P. inanis* Horn, northwestern Oregon; 24, *P. inanis*, El Dorado County, Calif.; 25, *P. inanis*, Fresno County, Calif.; 26, *P. termitiformis* Van Dyke. (See figs. 1-8 for key to letters.)

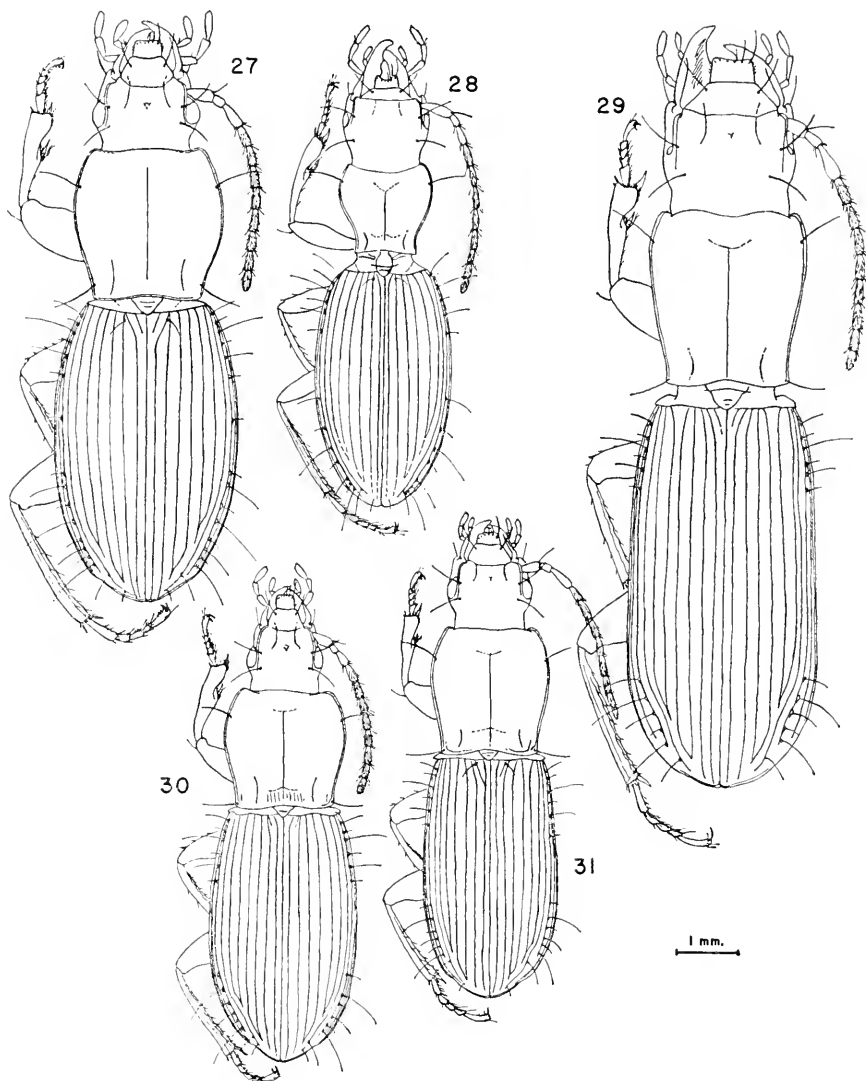

FIGURES 27-31.—27, *Pterostichus (Leptoferonia) pumilus willamettensis*, new subspecies; 28, *P. termitiformis* Van Dyke; 29, *P. caligans* Horn; 30, *P. hatchi*, new species; 31, *P. angustus* (Dejean).

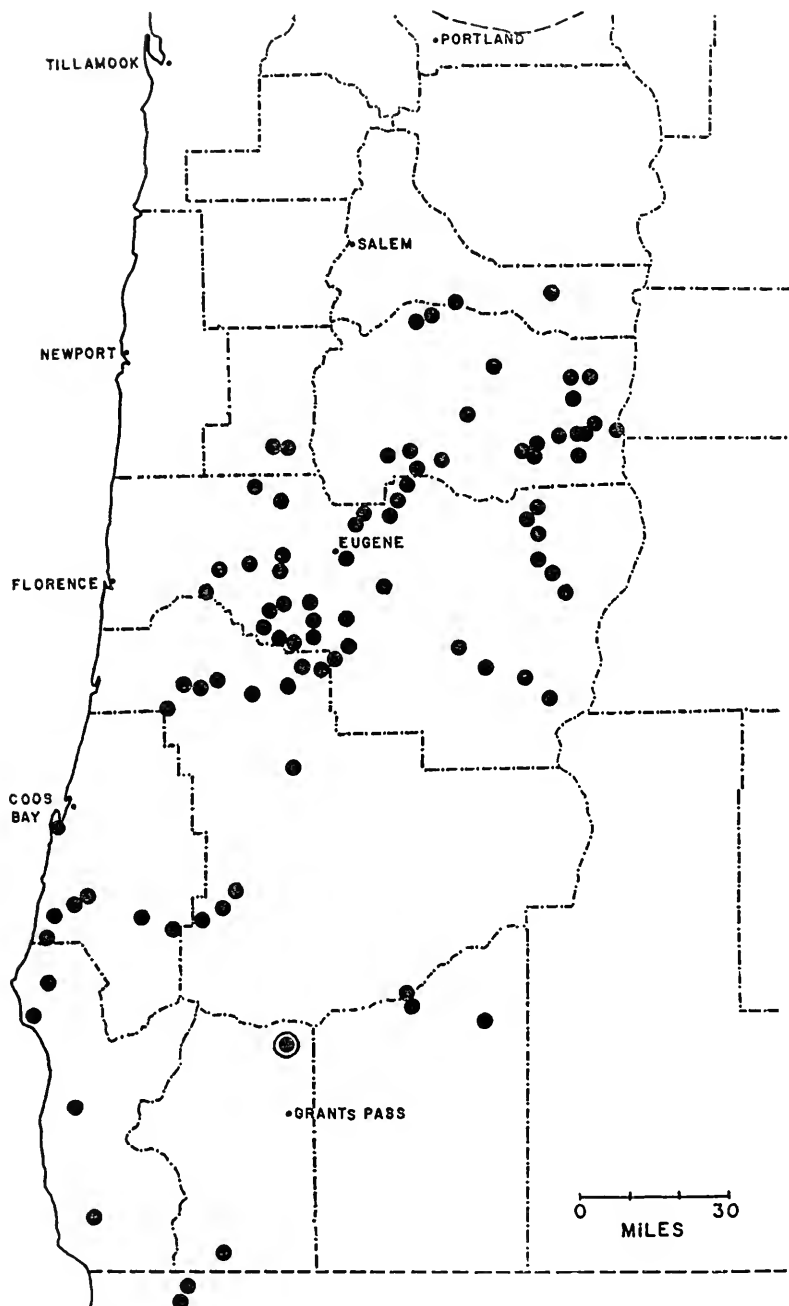

FIGURE 32.—Distribution of species of *Leptoferonia* in western Oregon.

● *Pterostichus (Leptoferonia) inopinus* Casey
 Type-locality encircled

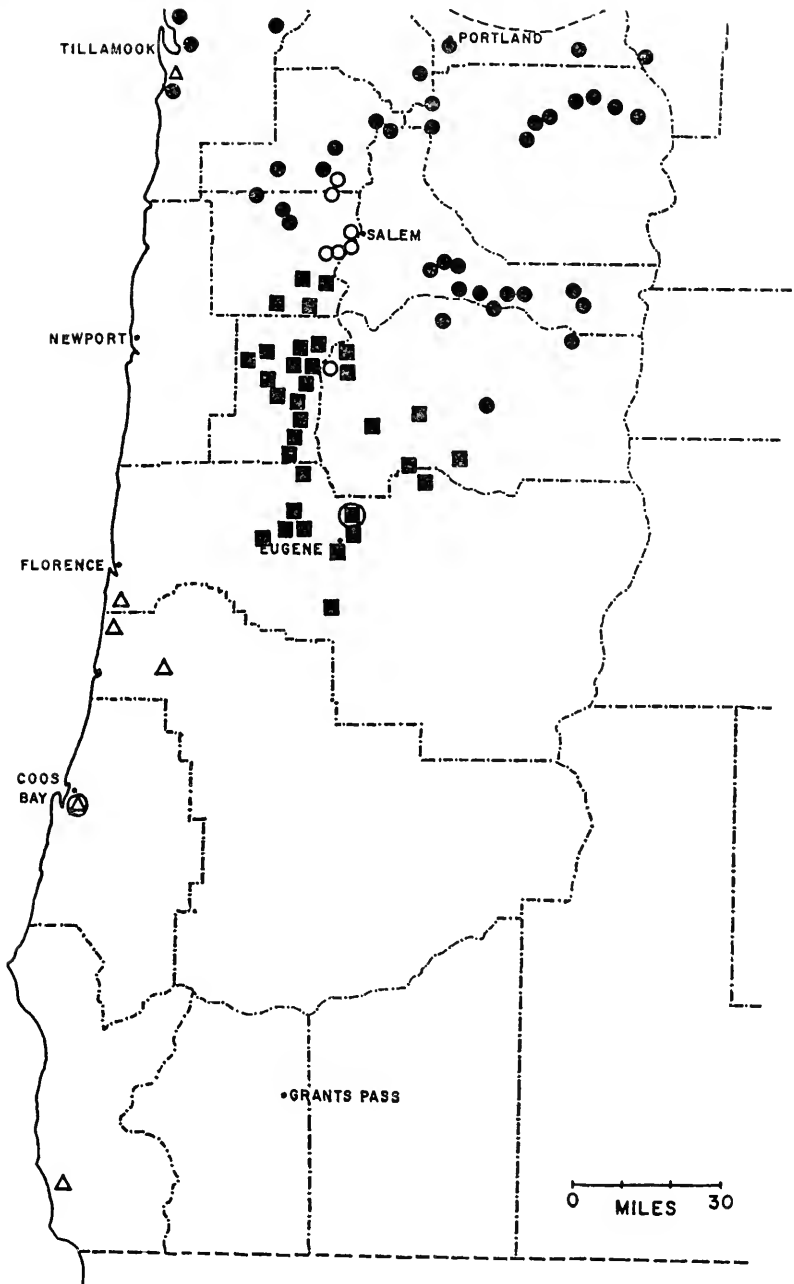

FIGURE 33.—Distribution of species of *Leptoferonia* in western Oregon.
 △ *Pterostichus (Leptoferonia) termitiformis* Van Dyke ● *P. pumilus pumilus* Casey
 ■ *P. pumilus willamettensis*, new subspecies ○ *P. pumilus* intermediates between
willamettensis and *pumilus* sensu stricto
 Type-localities encircled

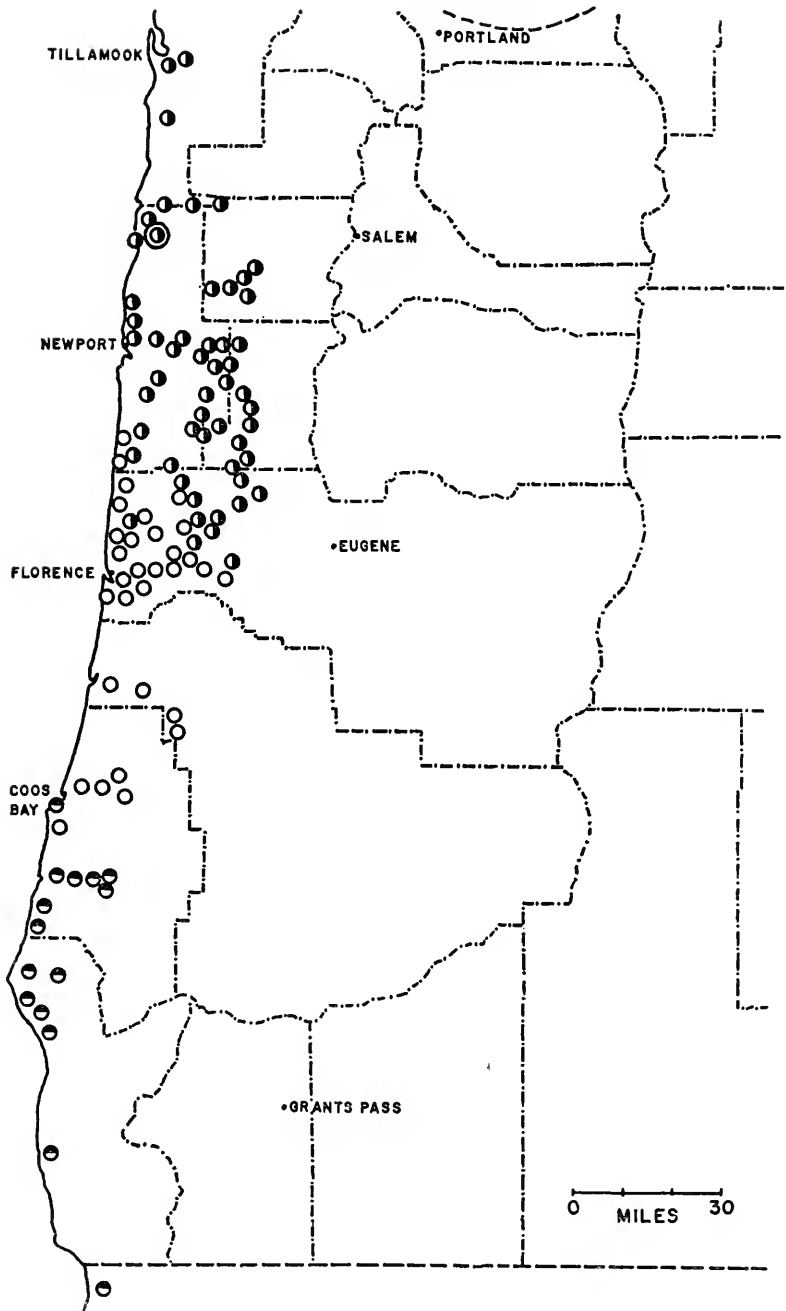

FIGURE 34.—Distribution of species of *Leptoferonia* in western Oregon.

- *Pterostichus (Leptoferonia) infernalis* Hatch, northern form
 - ◐ *P. infernalis*, southern form
 - *P. infernalis*, middle form
- Type-locality encircled

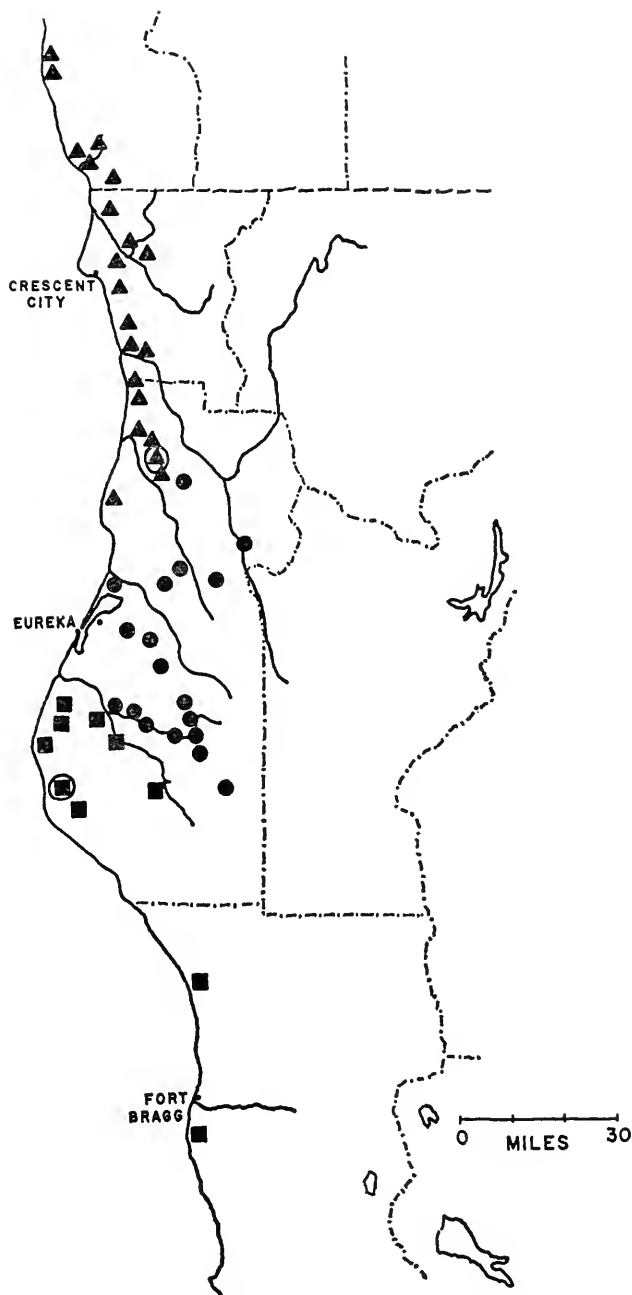

FIGURE 35.—Distribution of species of *Leptoferonia* in northwestern California.
 ▲ *Pterostichus (Leptoferonia) cochlearis*, new species ● *P. fenyesei fenyesei* Csiki
 ■ *P. fenyesei fenderi*, new subspecies
 Type-localities encircled

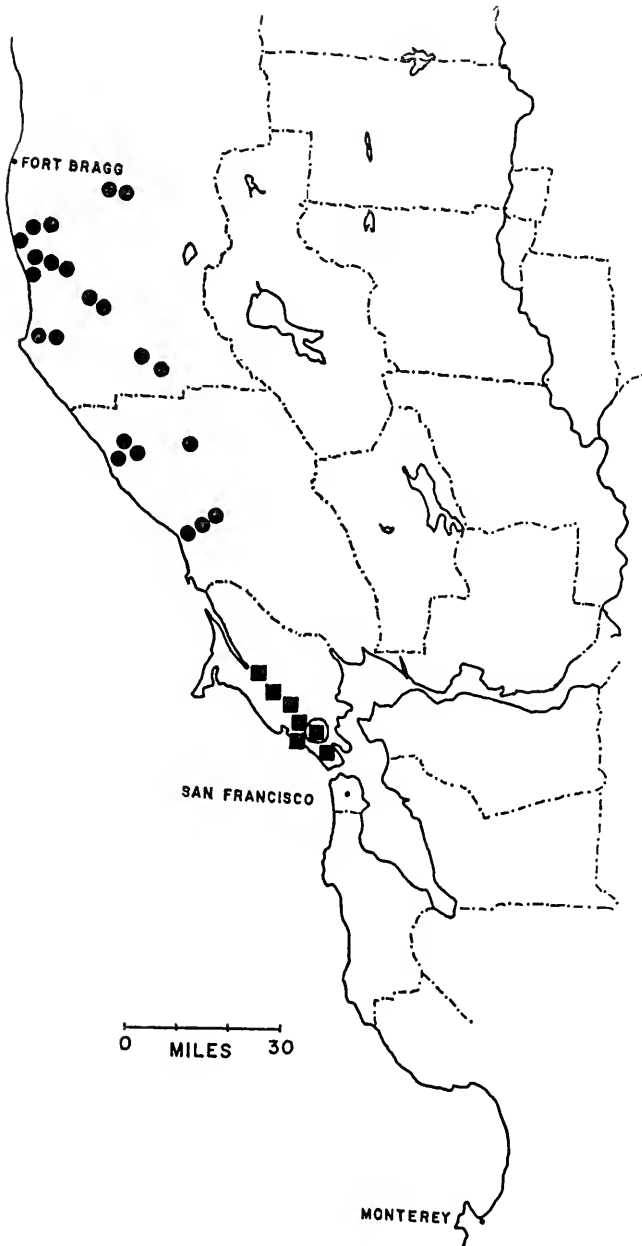

FIGURE 36.—Distribution of species of *Leptoferonia* in central western California.
 ● *Pterostichus (Leptoferonia) fuchsi* Schaeffer ■ *P. marinensis*, new species
 Type-locality encircled

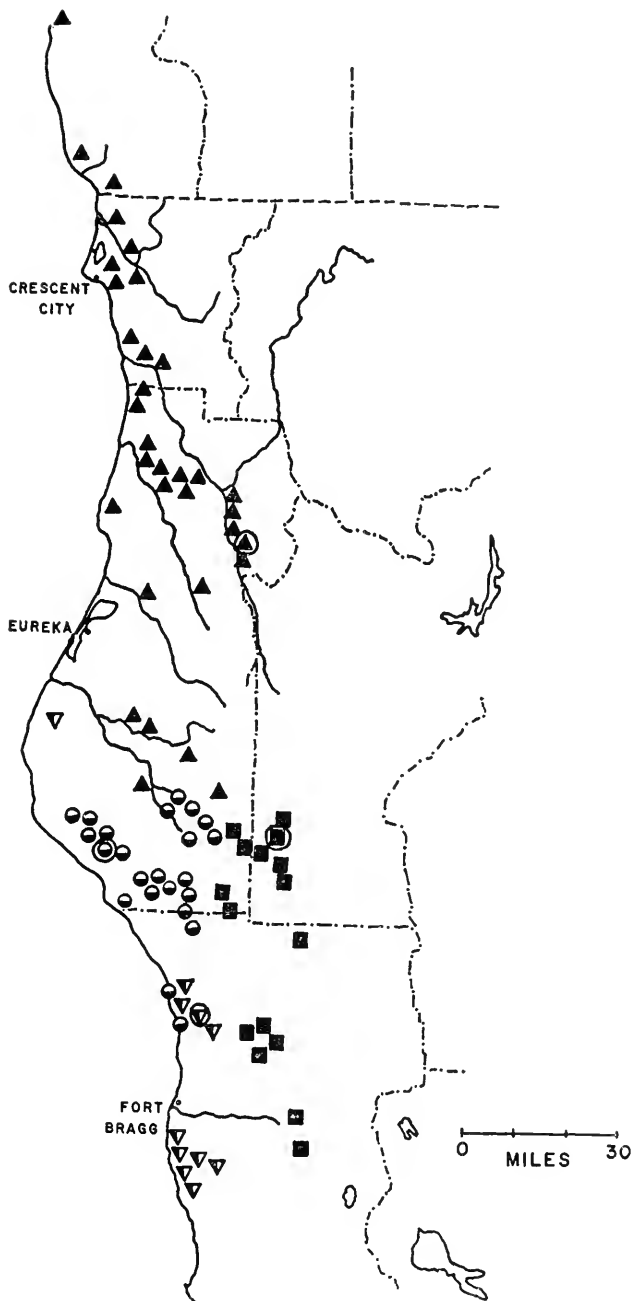

FIGURE 37.—Distribution of species of *Leptoferonia* in northwestern California.
 ▲ *Pterostichus (Leptoferonia) humilis* Casey ● *P. mattolensis*, new species
 ■ *P. trinitensis*, new species ▽ *P. lobatus*, new species
 Type-localities encircled

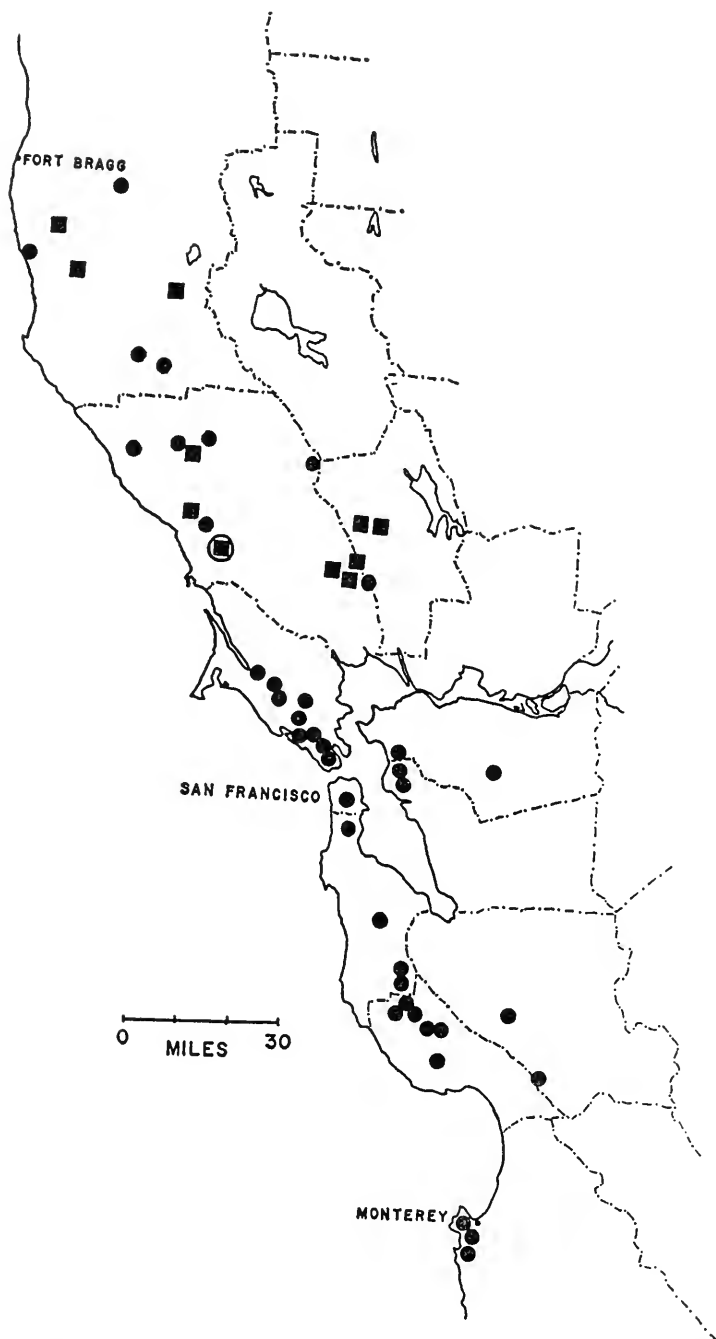

FIGURE 38.—Distribution of species of *Leptoferonia* in central western California.

● *Pterostichus (Leptoferonia) angustus* (Dejean) ■ *P. caligans* Horn
Type-locality encircled

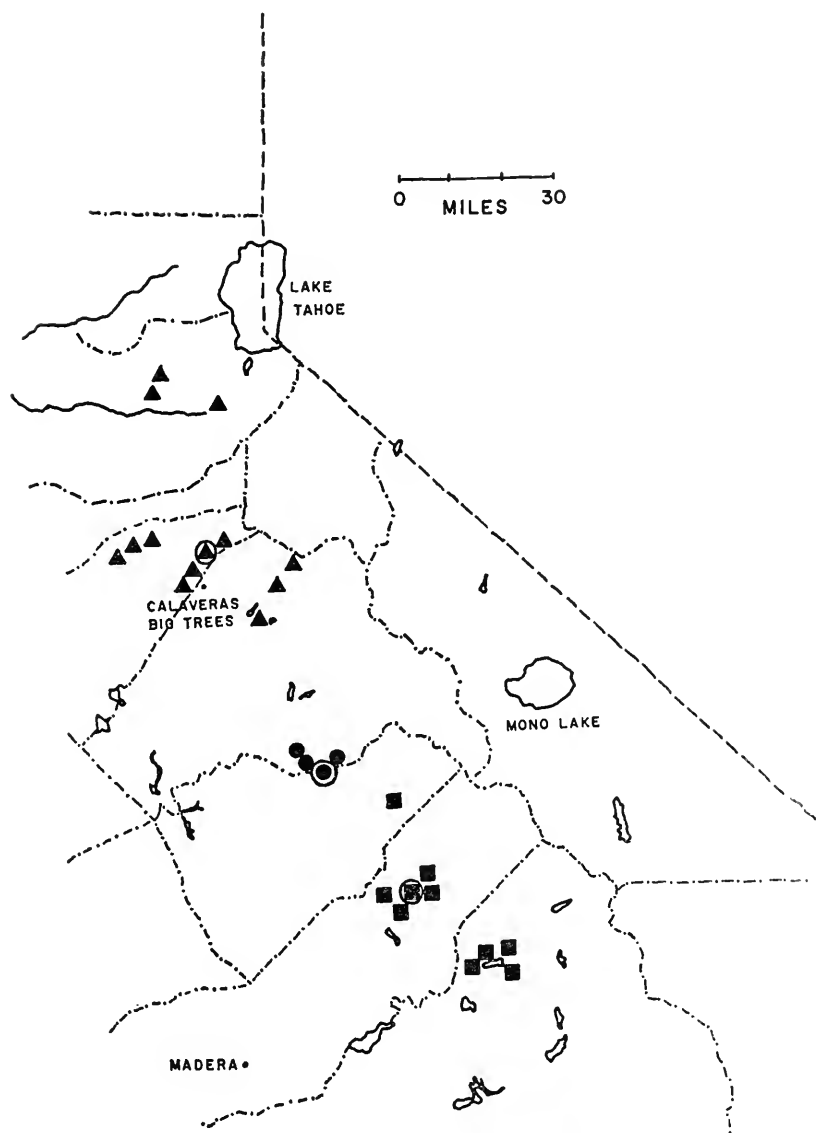

FIGURE 39.—Distribution of species of *Leptoferonia* in central eastern California.
 ▲ *Pterostichus (Leptoferonia) hatchi*, new species ■ *P. stapedius*, new species
 ● *P. stapedius yosemitensis*, new subspecies
 'Type-localities encircled

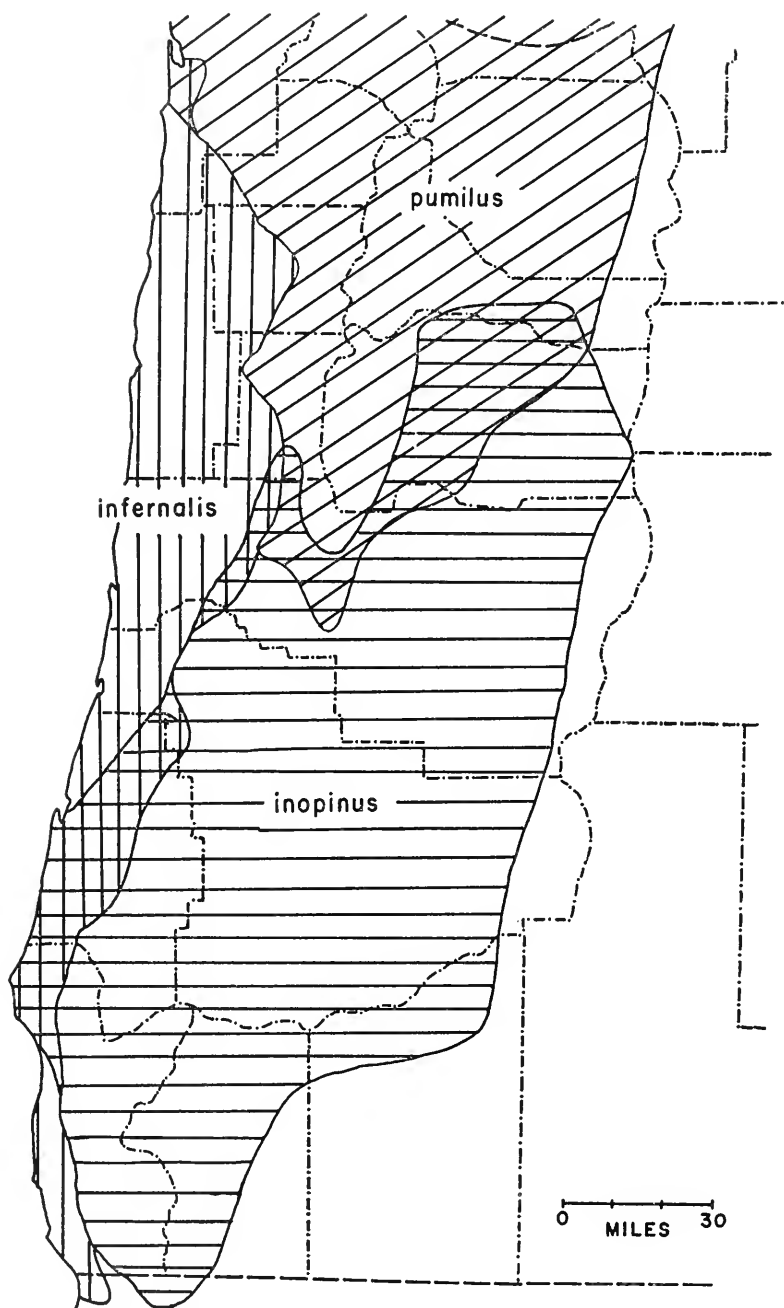

FIGURE 40.—Approximate distribution of species of *inopinus* group in western Oregon.

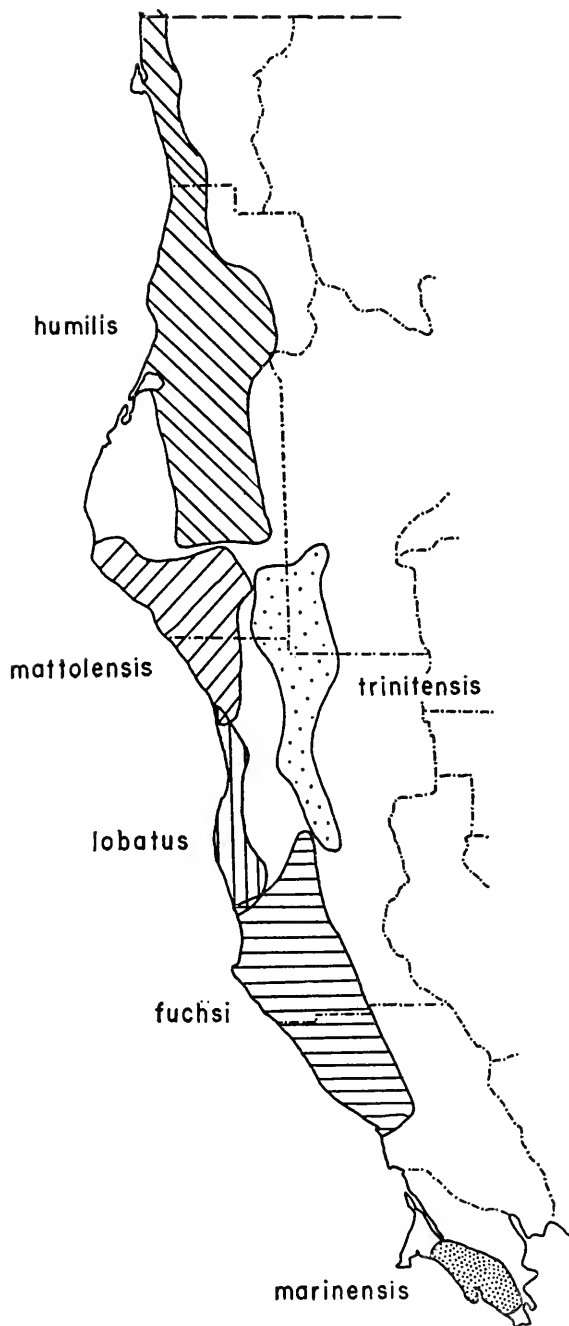

FIGURE 41.—Approximate distribution of species of *fuchsi* group in northwestern California.

Proceedings of
the United States
National Museum



SMITHSONIAN INSTITUTION • WASHINGTON, D.C.

Volume 124

1968

Number 3650

Loxosomella from *Tedania ignis*,
the Caribbean Fire Sponge

By Klaus Rützler

Associate Curator, Division of Echinoderms

Although several species of *Loxosomella*—in fact, most of those hitherto referred to the abandoned (Nielsen, 1964) genus *Loxocalyx* Mortensen—live on the surface or in the canal systems of sponges, they are not encountered too commonly. If not particularly searched for, single specimens can be overlooked easily when one is collecting and studying sponges. In two instances, however, mass colonization of *Loxosomella* has been observed in the tropical west Atlantic on *Tedania ignis* (Duchassaing and Michelotti), the fire sponge.

While collecting sponges in April 1967, I took one specimen of *Tedania ignis* from pilings of the south boat dock of the marine biological laboratory on Maguëyes Island, off La Parguera, Puerto Rico. A conspicuous, fluffy, whitish coating on the sponge surface turned out to be a dense layer of *Loxosomella bimaculata*, new species, described herein. An average of 500 specimens per cm² was counted, with a total of almost 100,000 specimens on a host sponge twice the size of a human fist. Strewn among them were a few dozen specimens of a taller, brownish species described herein as *Loxosomella parguerensis*, new species. The examination of other sponge species growing nearby did not reveal loxosomatids of any kind.

In December and January of 1966-67, I observed an even more impressive mass development of *Loxosomella* in Church Bay, Harrington Sound, Bermuda. The rocky littoral, with numerous, typical flame-red fire sponges, merged with a slightly sloping silty bottom in about two meters of depth, where a blackish "variety" of a similarly shaped sponge was abundant on lumps of dead coral rock. It later was discovered that these specimens were covered densely with *Loxosomella tethyae*, new species, also described herein. Between 500 and 2500 specimens were counted per cm², totaling about 20,000 per specimen of host sponge. No other sponge species was infested, nor was the same species infested when growing in water shallower than one meter.

METHODS.—*Loxosomella bimaculata* and *L. parguerensis* from Puerto Rico were relaxed with magnesium sulfate and then fixed in Bouin's fixative. *Loxosomella tethyae* from Bermuda could not be relaxed and was fixed directly and preserved in 4 percent formalin in sea water or 70 percent alcohol. The specimens in formalin remained in fairly natural shape; the ones in alcohol showed strong shrinkage in girth.

All measurements were made on specimens stained with Mayer's hemalum and mounted in "Preservaslide." The total length was measured from the edge of the tentacular membrane to the "toe" of the foot; calyx length, from the edge of the tentacular membrane to the lower point of the stomach; stalk length, from the lower point of the stomach to the "toe"; calyx width (stomach), at the widest part of the stomach; and calyx width (lophophore), at the widest part of the lophophore (edge of tentacular membrane). For histological sections, a celloidin-paraffin technique was used as described by Antonius (1965).

ACKNOWLEDGMENT.—I wish to thank Dr. Paul R. Burkholder, Lamont Geological Observatory of Columbia University, N.Y., who provided funds that made collections of these specimens possible.

Loxosomella bimaculata, new species

FIGURES 1-3

HOLOTYPE.—USNM 11928 (slide mount).

PARATYPES.—USNM 11929, USNM 11930 (slide mounts), USNM 11931 (alcohol).

LOCALITY.—Together with *L. parguerensis*, new species, on one specimen of fire sponge (*Tedania ignis*) from pilings (just below low tide level) of the south dock on Magueyez Island, off La Parguera, Puerto Rico. Collected Apr. 7, 1967.

DESCRIPTION.—Hundreds of small specimens covered the surface of the host sponge with a density of between 200 and 900 specimens

per cm^2 . They are white (also when living) with the exception of two blackish, symmetrical, anterior swellings at the level of the budding points; hence, the specific name. Maximum total length is 650μ , the ratio of calyx length to stalk length is approximately 1 : 1. Ten long tentacles arise from the upwardly directed lophophore and are enclosed by a characteristic collar-shaped membrane. The stalk is only

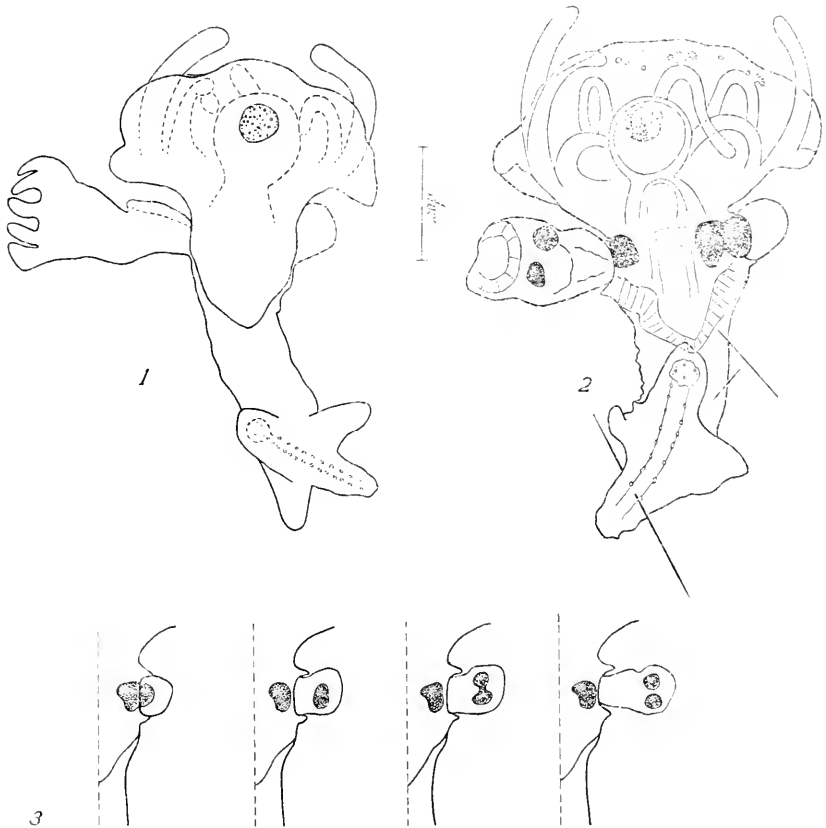

FIGURES 1-3.—*Loxosomella bimaculata*, new species: 1, posterior view; 2, anterior view showing the pigmented swellings, spicules of the host sponge protruding from stalk and foot; 3, four budding stages demonstrating pigment distribution from the anterior swellings.

slightly smaller in diameter than the calyx in the region of the stomach. The foot is fleshy and provided with distinct wings. Table 1 shows comparative measurements of 11 specimens.

The nature of the anterior swellings is not clear. They are placed just above the anterolateral budding points and are covered with a dark granular pigment. They are present in all specimens, including the buds. Very young buds, when growing out of the mother animal,

TABLE 1.—Comparative measurements (in microns) of 11 specimens of *Loxosomella bimaculata*, new species (PR II/3=newly freed bud from PR IV/4; PR II/13=holotype)

Specimen	PR II/2	PR II/3	PR II/4	PR II/5	PR II/7	PR II/13	PR II/15	PR II/20	PR II/27	PR II/35	PR II/36
Total length	400	168	385	315	272	480	580	540	400	305	650
Calyx length	225	100	215	165	175	290	300	300	240	180	325
Calyx width (stomach)	98	58	90	68	75	125	125	115	85	68	125
Calyx width (lophophore)	220	100	237	175	200	330	310	320	254	200	318
Stalk length (including foot)	175	68	170	150	100	190	280	240	160	125	325
Stalk width	65	38	70	45	54	88	90	90	68	50	88
Tentacular membrane width	215	100	240	175	185	300	290	300	240	190	156

take a small spot of pigment "along" that, in a certain state, stretches sideward, assumes a dumb-bell shape, and divides, thus again covering two symmetrical swellings that develop simultaneously (fig. 3). This happens even before tentacles become apparent. The swellings contain a granular substance that stains uniformly blue in Azocarmin-Pasini. The pigment is not fluorescent; it bleaches in acidified potassium permanganate and stains in acidified solution of toluidin blue. It seems to be melanin, since it also reacts positively when treated with Lillie's ferrous ion. (Techniques after Barka and Anderson, 1965.)

DISCUSSION.—Because of its morphological appearance, this species must be very close to *Loxosomella cricketae* Nielsen (1966a). The conspicuous tentacular membrane particularly can not be found in any other loxosomatid. *Loxosomella bimaculata* is much smaller and has well-developed wings on the foot. Since the anterolateral swellings are pigmented so characteristically and passed on to the buds, I do not believe they are only seasonal appearances or products of certain developmental stages. Whether or not "a pair of red swellings at the anterior part of the hyposphere" (Nielsen, 1966a, p. 256) on larvae of *L. cricketae* (observed in November) are homologous remains to be proven.

Loxosomella parguerensis, new species

FIGURES 4-6

HOLOTYPE.—USNM 11932 (slide mount).

PARATYPES.—USNM 11932 (on same slide as holotype), USNM 11933 (slide), USNM 11931 (alcohol).

LOCALITY.—Together with *L. bimaculata*, on the same specimen of *Tedania ignis* from pilings (just below low-tide level) of the south

dock on Magueyez Island, off La Parguera, Puerto Rico. Collected Apr. 7, 1967.

DESCRIPTION.—Specimens of this species are of medium size, few exceeding 700μ in total length. They are brownish and occur in moderate numbers on the surface of the sponge. The calyx is only slightly shorter than the stalk. Comparative measurements of six specimens are shown in table 2.

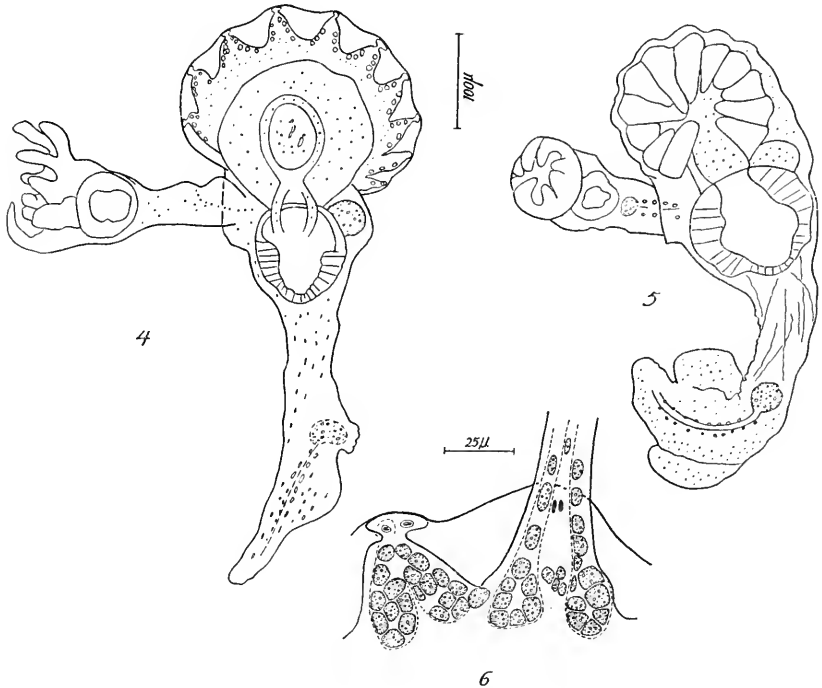

FIGURES 4-6.—*Loxosomella parguerensis*, new species: 4, posterior view; 5, anterior view; 6, bases of two tentacles, with tentacular membrane and gland cells.

The lophophore is directed forward and bears 14 (in rarer cases only 12) long tentacles. At the base of each tentacle there are two groups of large gland cells that extend as 1-cell rows into the tentacle (fig. 6). A rather conspicuous tentacular membrane is present and is 30μ to 40μ wide. The calyx is thin and tapers gradually but strongly toward the stalk, thus having a triangular appearance. In cross section, the stalk is circular below the stomach but thicker than wide just above the "heel" of the foot. The comparatively long foot has two delicate but distinct wings and a large bean-shaped gland.

The budding points are lateral on a level with the rounded stomach. A maximum of one bud on each side was observed in April. They sit in deep pockets and have eight tentacles.

TABLE 2.—Comparative measurements (in microns) of seven specimens of *Loxosomella parguerensis*, new species (PR I/5=holotype)

Specimen	PR I/1	PR I/2	PR I/3	PR I/4	PR I/5	PR I/7	PR I/8
Total length	540	555	580	625	710	490	680
Calyx length	240	200	330	300	315	240	330
Calyx width (stomach)	—	150	175	120	148	—	162
Calyx width (lophophore)	—	165	230	280	300	—	200
Calyx thickness	90	55	65	95	75	110	90
Stalk length (including foot)	300	255	250	325	295	250	350
Stalk width	—	38	80	55	43	—	88
Foot length ("heel" to "toe")	175	165	220	200	125	—	220
Tentacle number	12	12	12	14	14	—	14

DISCUSSION.—*Loxosomella parguerensis* has a foot comparable in shape and size to that of *L. teissieri* (Bobin and Prenant, 1953), described from the northeast Atlantic. The latter species, however, is only half the size, bears 8–10 tentacles and possesses two characteristic alae along the sides of the calyx. Another close form, *L. sawayi* (Marcus, 1939), from Brazil has outstanding rhomboidal foot and eight tentacles.

Loxosomella tedaniae, new species

FIGURES 7–10

HOLOTYPE.—USNM 11926 (slide mount).

PARATYPES.—USNM 11926 (on same slide as holotype) and USNM 11927 (alcohol).

LOCALITY.—On fire sponges (*Tedania ignis*) between two and three meters deep, west flank of Church Bay, Harrington Sound, Bermuda. Collected Dec. 25, 1966.

DESCRIPTION.—Specimens rather large (total size approximately 1 mm), blackish brown, and the detritus-filled rectum appearing as a lighter spot at the back. It densely covered the surface of the host sponge, with the result that the flame-red color of the latter could not be recognized. The ratio of calyx length to stalk length is 1:3 in relaxed specimens. Table 3 shows comparative measurements of five specimens.

The lophophore points forward and bears 12 to 14 long tentacles provided with conspicuous long cilia. The calyx is flattened and almost as wide as high and tapers distinctly in the region of the stomach. The muscular stalk is about as thick as it is wide and has epithelial cells arranged in 12 to 16 longitudinal rows. The fleshy foot is pro-

vided with a large beanlike gland. There are two distinct ear-shaped lateral wings on the foot that contain several conspicuous pear-shaped glands. In stained histological sections of sponge tissue with *Loxosomella tedaniae*, a certain amount of mucus that might have originated from these glands is apparent around the foot.

The calyx, stalk, and foot of the animals are penetrated frequently by the spearlike spicules of the host sponge. The buds are formed in two anterolateral pockets just above the oval stomach. A maximum number of 2+1 buds has been observed in December. They reach a size of 750μ possessing 8–10 tentacles.

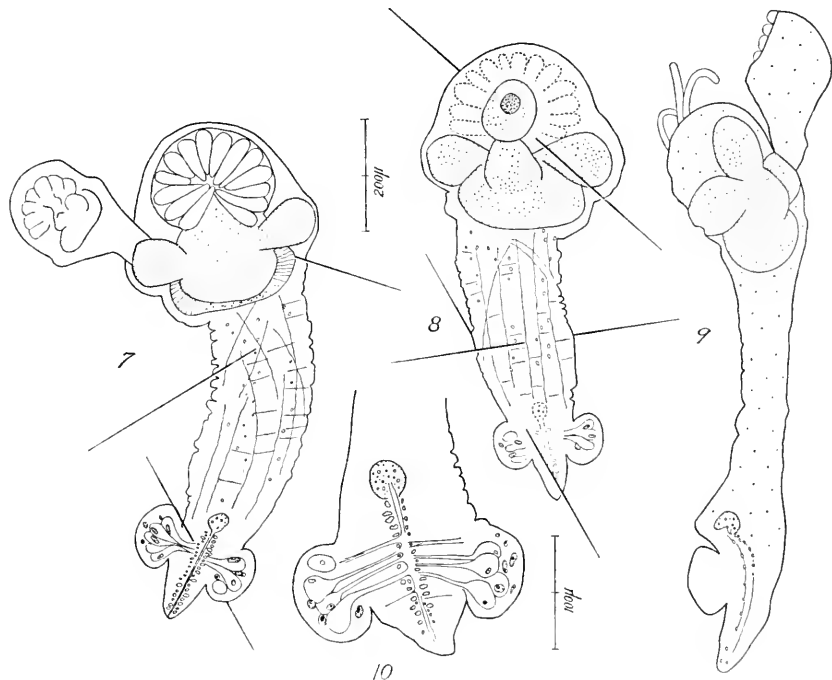

FIGURES 7–10.—*Loxosomella tedaniae*, new species: 7, frontal view; 8, posterior view, both pierced by spicules of the host sponge; 9, posterolateral view of a freshly fixed unmounted specimen; 10, frontal view of the foot with foot gland, groove, and additional glands in the wings.

DISCUSSION.—Many morphological characters of this species, particularly the comparatively long stalk, resemble *Loxosomella tethyae* (Salensky) from the Mediterranean. Nielsen (1966a) identified specimens from North Carolina as the same species. *Loxosomella tedaniae* differs from specimens from both of the above locations by its considerably smaller size [1125μ maximum in comparison to more than 2 mm (Prenant and Bobin, 1956) and 1710μ (Nielsen, 1966a)], by having 12–16 rows of epithelial cells on the stalk instead of eight,

TABLE 3.—Comparative measurements (in microns) of five specimens of *Loxosomella* tedianae, new species (BE 45/6=holotype)

Specimen	BE 45/5	BE 45/6	BE 45/7	BE45/8	BE 45/10
Total length	1050	735	720	1010	1125
Calyx length	320	285	280	360	325
Calyx width (stomach)	175	300	230	240	—
Calyx width (lophophore)	275	250	250	270	—
Stalk length (including foot)	730	450	440	650	800
Stalk width	90	190	155	160	85
Foot length ("heel" to "toe")	300	—	—	240	200
Tentacle number	14	14	14	12	12

by the absence of the row of large gland cells on the back edge of the lophophore, which is typical for *L. tethyae*, and by the presence of conspicuous gland cells in the wings of the foot instead.

Interspecific Relation Between *Loxosomella* and Host Sponge

Large numbers of the following two loxosomatids also have been reported to have covered sponges from Bogue Sound, near Beaufort, N.C., by Nielsen (1966a): *Loxosomella tethyae* (Salensky) on *Microciona prolifera* (Ellis and Solander); and *L. cricketae* Nielsen on *Lissodendoryx isodictyalis* (Carter), *Adodia tubifera* (George and Wilson), and *Hymeniacidon heliophila* (Parker).

It has been noted before (Cori, 1936, p. 83) that loxosomatids particularly dwell abundantly in stagnant or even polluted water. This is true also of the specimens of Nielsen in North Carolina and the present records. Most of the older findings in the Mediterranean come from harbor areas such as Naples and Trieste. Ali (1960) reports the common association between epi- and endobionts and sponges as a characteristic feature of Madras harbor. A combination of factors is likely to be responsible for this phenomenon. A certain resistance against pollution must be assumed, and as ciliary detritus feeders, the loxosomatids find most favorable feeding conditions in rather stagnant and detritus-rich waters. Since, in such environments, the high sedimentation rate (in connection with little water movement; see Rützler, 1965, p. 71) causes burying of all suitable dead substrates or endangers survival by causing the animal to choke, sponges must prove to be the most suitable hosts. It seems practical that those species are selected (or act selective) that occur in abundance because the loxosomatid larva has a very limited dispersal range (Nielsen, 1964, p. 73). By what chemical affinities the host specificity is established and how they have evolved can not be determined in our present state of knowledge.

A combination of the above-mentioned favorable conditions and protection from natural enemies could lead to a population explosion such as the ones observed. Protection from predators might be provided by the highly toxic properties of *Tedania ignis*. Not much is known about the chemistry of the toxic substance, but it kills mice if aqueous extracts are injected intraperitoneally (Halstead, 1965, p. 275) and engraulid fishes 2 cm long are killed in less than one hour when placed in petri dishes containing 2 cc of *Tedania ignis* and 200 cc of seawater (pers. observ.). Most human beings, when handling the sponge, experience skin irritations of varying degrees. A severe erythema multiforme reaction on a man after handling *Tedania ignis* from Bermuda was reported by Yaffee and Stargardter (1963).

The only other loxosomatid so far reported to live on *Tedania ignis* is *Loxosomella vivipara* Nielsen (1966b). This species also has been found on *Ircinia fasciculata* (Pallas), *Aaptos aaptos* Schmidt, and *Chondrilla nucula* Schmidt. Among these, *Ircinia fasciculata* also has been found to have toxic properties (Halstead, 1965).

Sponge-dwelling species of *Loxosomella* never have been found associated with organisms of other groups. The following list summarizes substrate, geographical distribution, and latest detailed description:

species of <i>Loxosomella</i>	host sponge	geographical distribution	source
<i>alata</i> (Barrois)	<i>Dysidea</i> species (<i>Desidea</i> species) <i>Hymedesmia dujardini</i> (Bowerbank) (<i>Dendoryx dujardini</i>)	northeast Atlantic	Prenant and Bobin (1956)
<i>bimaculata</i> , new species	<i>Tedania ignis</i> (Duchassaing and Michelotti)	tropical west Atlantic	present paper
<i>cochlear</i> (Schmidt)	<i>Spongia officinalis</i> Linnaeus <i>Cacospongia</i> species	Mediterranean	Prenant and Bobin (1956)
<i>cricketae</i> Nielsen	<i>Lissodendoryx isodictyalis</i> (Carter) <i>Adocia tubifera</i> (George and Wilson) <i>Hymeniacidon heliophila</i> (Parker)	tropical west Atlantic	Nielsen (1966a)
<i>lineata</i> (Harmer)	<i>Halichondria</i> species	Indo-West Pacific	Harmer (1915)
<i>parquerensis</i> , new species	<i>Tedania ignis</i> (Duchassaing and Michelotti)	tropical west Atlantic	present paper
<i>pes</i> (Schmidt)	<i>Spongia officinalis</i> Linnaeus <i>Cacospongia</i> species	Mediterranean	Prenant and Bobin (1956)
<i>raja</i> (Schmidt)	<i>Spongia officinalis</i> Linnaeus	Mediterranean	Prenant and Bobin (1956)

<i>species of Loxosomella</i>	<i>host sponge</i>	<i>geographical distribution</i>	<i>source</i>
	<i>Cacospongia scalaris</i> Schmidt		
	<i>Fasciospongia cavernosa</i> (Schmidt) (<i>Cacospongia cavernosa</i>)		
<i>sawayi</i> (Marcus)	<i>Mycale</i> species	southwest Atlantic	Marcus (1939)
<i>studiosorum</i> (Toriumi)	"Monaxon Sponge"	southwest Pacific	Toriumi (1951)
<i>teissieri</i> (Bobin and Prenant)	<i>Dysidea fragilis</i> (Montague)	northeast Atlantic	Prenant and Bobin (1956)
<i>tedaniae</i> , new species	<i>Tedania ignis</i> (Duchassaing and Michelotti)	tropical west Atlantic	present paper
<i>tethyae</i> (Salensky)	<i>Tethya</i> [<i>aurantium</i> (Pallas)]	Mediterranean	Prenant and Bobin (1956)
	<i>Stylotella</i> species	tropical west	Nielsen (1966a)
	<i>Microciona prolifera</i> (Ellis and Solander)	Atlantic	
<i>vivipara</i> Nielsen	<i>Ircinia fasciculata</i> (Pallas)	tropical west Atlantic	Nielsen (1966b)
	<i>Tedania ignis</i> (Duchassaing and Michelotti)		
	<i>Chondrosia collectrix</i> (Schmidt)		
	<i>Chondrilla nucula</i> Schmidt		

Literature Cited

- ALI, M. A.
1960. Influence of environment on the distribution and form of sponges. *Nature*, vol. 186, pp. 177-178.
- ANTONIUS, A.
1965. Methodischer Beitrag zur mikroskopischen Anatomie und graphischen Rekonstruktion sehr kleiner zoologischer Objekte. *Mikroskopie*, vol. 20, pp. 145-153.
- BARKA, B., and ANDERSON, P. J.
1965. *Histochemistry*, 660 pp. New York: Harper and Row.
- BOBIN, G., and PRENANT, M.
1953. Sur deux *Loxocalyx* des côtes françaises. *Arch. Zool. Expér. Gén.*, vol. 78, pp. 381-387.
- CORI, C.
1936. Kamptozoa. In *Bronns Klassen und Ordnungen des Tierreichs*, vol. 4, pp. 1-119.
- HALSTEAD, B. W.
1965. *Venomous marine animals of the world*, vol. 1, 994 pp. Washington, D.C.: United States Government Printing Office.
- HARMER, S. F.
1915. The Polyzoa of the Siboga Expedition, pt. I: Entoprocta, Ctenostomata and Cyclostomata. In *Siboga Expedition Monographs*, vol. 28a, pp. 1-180.
- MARCUS, E.
1939. Bryozoarios Marinhos Brasileiros, III. *Bol. Fac. Filos. Ciénc. Letr.*, vol. 13, pp. 111-299.
- NIELSEN, C.
1964. Studies on Danish Entoprocta. *Ophelia*, vol. 1, pp. 1-76.
1966a. Some Loxosomatidae (Entoprocta) from the Atlantic coast of the United States. *Ophelia*, vol. 3, pp. 249-275.
1966b. On the life-cycle of some Loxosomatidae (Entoprocta). *Ophelia*, vol. 3, pp. 221-247.
- PRENANT, M., and BOBIN, G.
1956. Bryozoaires. In *Fauna de France*, vol. 60, pp. 1-398.
- RÜTZLER, K.
1965. Systematik und Ökologie der Poriferen aus Litoral-Schattengebieten der Nordadria. *Z. Morph. Ökol. Tiere*, vol. 55, pp. 1-82.
- TORIUMI, M.
1951. Some entoprocts found in Matsushima Bay. *Sci. Rep. Tokoku Imp. Univ. Biol.*, vol. 19, pp. 17-22.
- YAFFEE, H. S., and STARGARDTER, F.
1963. Erythema multiforme from *Tedania ignis*. *Arch. Dermat.*, vol. 87, pp. 601-604.

SMITHSONIAN INSTITUTION LIBRARIES



3 9088 01421 0074