



This is a digital copy of a book that was preserved for generations on library shelves before it was carefully scanned by Google as part of a project to make the world's books discoverable online.

It has survived long enough for the copyright to expire and the book to enter the public domain. A public domain book is one that was never subject to copyright or whose legal copyright term has expired. Whether a book is in the public domain may vary country to country. Public domain books are our gateways to the past, representing a wealth of history, culture and knowledge that's often difficult to discover.

Marks, notations and other marginalia present in the original volume will appear in this file - a reminder of this book's long journey from the publisher to a library and finally to you.

Usage guidelines

Google is proud to partner with libraries to digitize public domain materials and make them widely accessible. Public domain books belong to the public and we are merely their custodians. Nevertheless, this work is expensive, so in order to keep providing this resource, we have taken steps to prevent abuse by commercial parties, including placing technical restrictions on automated querying.

We also ask that you:

- + *Make non-commercial use of the files* We designed Google Book Search for use by individuals, and we request that you use these files for personal, non-commercial purposes.
- + *Refrain from automated querying* Do not send automated queries of any sort to Google's system: If you are conducting research on machine translation, optical character recognition or other areas where access to a large amount of text is helpful, please contact us. We encourage the use of public domain materials for these purposes and may be able to help.
- + *Maintain attribution* The Google "watermark" you see on each file is essential for informing people about this project and helping them find additional materials through Google Book Search. Please do not remove it.
- + *Keep it legal* Whatever your use, remember that you are responsible for ensuring that what you are doing is legal. Do not assume that just because we believe a book is in the public domain for users in the United States, that the work is also in the public domain for users in other countries. Whether a book is still in copyright varies from country to country, and we can't offer guidance on whether any specific use of any specific book is allowed. Please do not assume that a book's appearance in Google Book Search means it can be used in any manner anywhere in the world. Copyright infringement liability can be quite severe.

About Google Book Search

Google's mission is to organize the world's information and to make it universally accessible and useful. Google Book Search helps readers discover the world's books while helping authors and publishers reach new audiences. You can search through the full text of this book on the web at <http://books.google.com/>



ROY
6528

Bound 1938

HARVARD UNIVERSITY



LIBRARY

OF THE

MUSEUM OF COMPARATIVE ZOOLOGY

4454

Exchange

APR 4 1929

PROCEEDINGS

OF

THE ROYAL SOCIETY

OF

EDINBURGH.

VOL. XI.

NOVEMBER 1880 TO JULY 1882.

EDINBURGH:
PRINTED BY NEILL AND COMPANY.

MDCCLXXXII.

CONTENTS.

| | PAGE |
|---|------|
| Election of Office-Bearers, | 1 |
| Introductory Address by the President, the Right Hon. Lord Moncreiff, | 2 |
| On the Structure of <i>Euplectella</i> . By Dr F. E. Schütze. Communi- cated by Sir Wyville Thomson, | 2 |
| On Equidifferent Multiples of Irrational Quantities. By Mr E. Sang, | 2 |
| Algebra of Relationship. Part II. By A. Macfarlane, M.A., D.Sc., F.R.S.E., | 5 |
| On Dust, Fogs, and Clouds. By Mr John Aitken, | 14 |
| Solar Eclipse, 31st December 1880. By Mr E. Sang, | 18 |
| On the Preparation of Adamantine Carbon or Diamond. By R. Sydney Marsden, D.Sc., F.R.S.E., F. Inst. Chem., &c., | 20 |
| Note on an Electric Sonometer. By Professor James Blyth, | 28 |
| Theory to account for certain movements exhibited by low forms of Animal Life, and termed Amœboid. By John B. Haycraft, Senior Demonstrator of Physiology in the University of Edinburgh, | 29 |
| On the Effect of Permanent Elongation on the Specific Resistance of Wires. By Mr T. Gray. Communicated by Sir William Thomson, | 31 |
| Meconic Acid. By Mr D. B. Dott. Communicated by Professor Crum Brown, | 31 |
| On the Crystallisation of Silica from Fused Metals. By R. Sydney Marsden, D.Sc., F.R.S.E., F. Inst. Chem., &c., | 34 |
| On Phosphorus Betaines. By Professor E. A. Letts, | 37 |
| On the Action of Haloid Compounds of Hydrocarbon Radicals on Phosphide of Sodium and on the Salts of Tetra-Benzyl-Phos- phonium. By Professor Letts and N. Collie, Esq., | 46 |
| Notice of an Easy Method for determining the Position of the Principal Focus of an Object-Glass. By Mr Edward Sang, | 50 |
| Note on the Temperature Changes due to Compression. By Prof. Tait, | 51 |

| | PAGE |
|--|--------|
| Preliminary Report on the <i>Tunicata</i> of the "Challenger" Expedition. Part III. By W. A. Herdman, D.Sc., | 52 |
| On the Histology of the Pedicellariæ and the Muscles in <i>Echinus sphaera</i> , Forbes. By Mr Patrick Geddes, F.R.S.E., Lecturer on Zoology in the School of Medicine, Edinburgh, and Mr Frank E. Beddard, B.A., Assistant-Demonstrator of Zoology, Oxford, | 88 |
| Additional Note on an Ultra-Neptunian Planet. By Professor George Forbes, | 89 |
| On some Effects of Rotation in Liquid Jets. By Professor Tait, | 94 |
| Note on the Influence of Temperature-Change of Conductivity on the Conduction of Heat in Solids. By Professor Tait, | 94 |
| Obituary Notices of Fellows who died in the course of Session 1880-81:—Mr Thomas Key, Dr William Lassell, Mr Maurice Lothian, Mr Mungo Ponton, Mr Thomas Knox, the Hon. Lord Ormidale, Professor Sharpey, | 95-116 |
| On a Simple and Accurate Method of determining the Longitude of a Place by a Single Observer, without the aid of any instrument for measuring time. By Professor G. Forbes, | 117 |
| Stilbite, from Kerguelen's Island. By A. Liversidge, Assoc. Royal School of Mines, Professor of Geology and Mineralogy, University of Sydney. Communicated by Mr J. Y. Buchanan, | 117 |
| On a Simple Form of Selenium Cell, and Experiments therewith. By Professor James Blyth, | 119 |
| Dust, Fogs, and Clouds. By Mr John Aitken, | 122 |
| Note on Thermal Conductivity, and on the Effects of Temperature-Changes of Specific Heat and Conductivity on the Propagation of Plane Heat Waves. By Professor Tait, | 126 |
| Note on a Simple Method of Showing the Diminution of Surface Tension in Water by Heat. By Professor Tait, | 131 |
| On the Cell-Walls of Hepatic Cells. By John Berry Haycraft, M.B., B.Sc., F.R.S.E., Senior Demonstrator of Physiology in the University of Edinburgh, | 131 |
| Effects of Strain on Electric Conductivity. By M. August Witkowski. Communicated by Sir William Thomson, | 135 |
| On the Effect of Moistening with Water the opposed Metallic Surfaces in a Volta-Condenser, and of substituting a Water-Arc for a Metallic-Arc in the Determining Contact. By Sir William Thomson, | 135 |
| On Vortex Sponge. By the Same, | 135 |
| On some Transformations connecting General Determinants with Continuants. By Mr Thomas Muir, | 135 |
| Note on the preceding Paper. By Professor Chrystal, | 135 |
| Introductory Address by the President, the Right Hon. Lord Moncreiff. (Continued from p. 2), | 136 |
| On the Intrinsic Muscles of the Mammalian Foot. By Dr D. J. Cunningham, | 162 |
| On the Expansion of Rational Fractions, &c. By Mr A. H. Anglin, | 162 |
| Algebra of Relationship. Part III. By A. Macfarlane, M.A., D.Sc., F.R.S.E., | 162 |

Contents.

| | PAGE |
|---|------|
| Note on a Singular Problem in Kinetics. By Professor Tait, | 173 |
| The Earthquake of 28th November 1880 in Scotland and Ireland. By Charles Alexander Stevenson, B.Sc. Edin. Communicated by Professor Geikie (Plate Ia.), | 176 |
| On the Classification of Statistics. Part I. By Mr P. Geddes, | 187 |
| On Professor Cayley's Theorem regarding a Bordered Skew Determinant. By Mr Thomas Muir, M.A., | 187 |
| The Law of Extensible Minors in Determinants. By Mr Thomas Muir, M.A., | 187 |
| Additional Note on a Problem of Arrangement. By Mr Thomas Muir, M.A., | 187 |
| On the Oxidation of Ferrous Salts. By Mr J. Y. Buchanan, | 191 |
| On some Space-Loci. By Professor Tait, | 197 |
| On the Pressure-Errors of the "Challenger" Thermometers. By Professor Tait, | 199 |
| The Action of Heat on Thioformanilid. By W. W. J. Nicol, M.A., | 199 |
| On the Classification of Statistics. Part II. By Mr P. Geddes, | 202 |
| On Galvanic Polarisation. By Professor Helmholtz, | 202 |
| On the Average Pressure due to Impulse of Vortex Rings on a Solid. By Sir William Thomson, | 204 |
| On the Crushing of Glass by Pressure. By Professor Tait, | 204 |
| On the Cause of the Sounds produced in the Microphone Receiver. By Professor James Blyth, | 206 |
| On the Classification of Statistics. Part III. Results. By Mr Geddes, | 209 |
| On the Motion of a Storm in an Easterly Direction being only possible as a Circular Atmospheric Wave. By Robert Tennant, | 209 |
| On Chemical Nomenclature and Notation. By Professor Crum Brown, | 211 |
| Note on a <i>Phoronis</i> dredged in H.M.S. "Challenger." By W. C. M'Intosh, | 211 |
| Additional Researches on the Structure of the <i>Palæoniscidæ</i> and <i>Platysomidæ</i> . By Dr R. H. Traquair, | 217 |
| Note on the Heating produced by Compression. By Professor Tait, | 217 |
| On the Structure of the Skeleton of <i>Tubipora musica</i> , and on the Relation of the Genus <i>Tubipora</i> to <i>Syringopora</i> . By Professor H. Alleyne Nicholson, M.D., D.Sc., | 219 |
| On an Iodine Battery. By Mr A. P. Laurie. Communicated by Professor Tait, | 230 |
| Note on Chemical Affinity and Atomicity. By William Durham, | 231 |
| On the Physical and Biological Conditions of the Channel between Scotland and the Farö Islands. By Sir C. Wyville Thomson, | 233 |
| On a Class of Sturmian Functions. By Professor Chrystal, | 233 |
| Preliminary Report on the <i>Tunicata</i> of the "Challenger" Expedition. Part IV. By W. A. Herdman, D.Sc., | 233 |
| On Comenic Acid. By D. B. Dott. Communicated by Professor Crum Brown, | 241 |

| | PAGE |
|--|------|
| On Morgan's Systems of Consanguinity and Affinity. By Dr Macfarlane, | 245 |
| Note on a Proposition in the Theory of Numbers. By Professor Tait, | 245 |
| An Address on the Island of Socotra. By Professor I. Bayley Balfour, | 245 |
| On some new species of Fossil Scorpions from the Carboniferous Rocks of Scotland and the English Borders, with a Review of the genera <i>Eoscorpium</i> and <i>Mazonia</i> of Messrs Meek and Worthen. By B. N. Peach, | 245 |
| Report of the Boulder Committee, with Remarks by the Convener, Mr D. Milne Home. (Plates I., II., III.), | 246 |
| On the Compression of Gases by High Pressures. By Professor Tait, | 293 |
| Determination of Longitude without a Chronometer. By Dr Menzies. Communicated by Professor Tait, | 293 |
| Electric Discharge through Colza Oil. By A. Macfarlane, M.A., D.Sc., F.R.S.E., | 293 |
| On Quaternion Integration. By Professor Tait, | 293 |
| Chairman's Concluding Remarks at the Close of the Session, | 293 |
| On the Classification of Statistics and its Results. By Patrick Geddes, F.R.S.E., | 295 |
| Election of Office-Bearers, | 323 |
| Obituary Notices of Dr John Hill Burton, Rev. Dr Cumming, Dr P. D. Handyside, Professor Sanders, Dr Andrew Wood, | 324 |
| On a Particular Case of the Symbolic Cubic. By Dr Gustav Plarr. Communicated by Professor Tait, | 342 |
| On Mirage. By Professor Tait, | 354 |
| Macdougall-Brisbane Prize, | 361 |
| On the Application of the Rocks of Ben Nevis to Ornamental Art. By Sir R. Christison, Bart., <i>Hon. V.P.</i> , | 365 |
| On the State of Carbon in Iron and Steel : a New Hypothesis of the Hardening of Steel. By R. Sydney Maraden, D.Sc., F.R.S.E., &c., | 368 |
| Some Physical Experiments bearing upon the Circulation of the Blood-Corpuscles. By D. J. Hamilton, M.B., F.R.C.S.E., F.R.S.E., | 370 |
| On the Nature and Functions of the "Yellow Cells" of Radiolarians and Coelenterates. By Patrick Geddes, | 377 |
| On the Thermodynamic Acceleration of the Earth's Rotation. By Sir William Thomson, | 396 |
| Notes on a Cist discovered at Parkhill, Dyce, Aberdeenshire, in October 1881. By William Ferguson of Kinmundy. With Notes on the Bones by Dr Fife Jamieson, M.B., | 405 |
| On a Class of Permanent Symmetric Functions. By Thomas Muir, M.A., | 409 |
| Optical Notes. By Professor Tait, | 418 |
| The Historic Evidence for the Destruction of Pompeii and Herculaneum. By the Rev. Dr Cazenove, | 421 |

| | PAGE |
|---|------|
| On a Specimen of Sowerby's Whale (<i>Mesoplodon bidens</i>) captured in Shetland. By Professor Turner, | 443 |
| On Respiration in the Roots of <i>Avicennia officinalis</i> (Linn.) and other Shore Plants; with Observations on the Functions of the Lenticels. By Joseph Bancroft, M.D. Communicated by Professor Balfour, <i>V.P.</i> , | 456 |
| (a) Diagnoses Fungorum novorum in Insula Socotra a Bayley Balfour, Carolo Cockburn et Alexandro Scott, lectorum, quas elaboravit Dr M. C. Cooke. Communicated by Dr Bayley Balfour, | 456 |
| (b) Diagnoses Algarum novarum Socotrensium a Bayley Balfour, Carolo Cockburn et Alexandro Scott, lectorum, quas elaboravit Dr G. Dickie, <i>F.R.S.</i> , | 456 |
| (c) Diagnoses Lichenum Socotrensium novorum a participibus expeditionum Prof. Bayley Balfour et Dr Schweinfurth, lectorum, quas elaboravit Dr J. Müller. Communicated by Dr Bayley Balfour, | 457 |
| On the Colour of the Mediterranean and other Waters. By Mr John Aitken, | 472 |
| The Surface Geology of Mid-Lochaber. By Professor Duns, <i>D.D.</i> , | 483 |
| Remarks on Dielectric Strength. By Professor Chrystal, | 487 |
| Diagnoses Plantarum novarum et imperfecte descriptarum Phanerogamarum Socotrensium; quas elaboravit Bayley Balfour, Scientiæ Doctor et in Universitate Glasguensi rerum botanicarum regius professor. Pars Prima, | 498 |
| On a Specimen of <i>Balanoptera borealis</i> or <i>laticeps</i> captured in the Firth of Forth. By Professor Turner, | 515 |
| On Minding's Theorem. By M. G. Plarr. Communicated by Professor Tait, | 528 |
| Chapters on the Mineralogy of Scotland. Chapter VII. By Dr Heddle, | 549 |
| On the Dimensions of Cast Iron at various Temperatures, with more especial reference to the Phenomena of the Solid floating on the Molten Metal. By W. J. Millar, <i>C.E.</i> , Secretary Inst. Engineers and Shipbuilders in Scotland, | 549 |
| On an Oxycyanide, and a New Oxide, of Bismuth. By M. M. Pattison Muir, <i>M.A.</i> , Fellow, and Prælector in Chemistry, of Gonville and Caius College, Cambridge, | 557 |
| Mathematical Note. By Mr T. B. Sprague, | 566 |
| On the Manner in which Silicon, Phosphorus, Manganese, and other elements exert their influence upon Steel. By R. Sydney Marsden, <i>D.Sc.</i> , <i>F.R.S.E.</i> , <i>F.C.S.</i> , &c., | 566 |
| The Effect of Flame on the Electric Discharge. By Dr A. Macfarlane and Mr D. Rintoul. (Plate IV. a.), | 567 |
| Observations on Vegetable and Animal Cells; their Structure, Division, and History. Part I., The Vegetable Cell. By J. Macfarlane, <i>B.Sc.</i> Communicated by Professor A. Dickson, | 576 |
| On some Points in the Anatomy of the Nervous System of the Pond Snails, Planorbis and Lymnæus. By F. E. Beddard, <i>B.A.</i> , New College, Oxon. Communicated by Mr P. Geddes, | 576 |

| | PAGE |
|--|------|
| A Critical Examination of two Cases of unusual Atmospheric Refraction described by Professor Vince. By Mr Edward Sang, . . . | 581 |
| On a Case of Dyspeptic Vertigo. By Professor Crum Brown, . . . | 594 |
| Note on the Carboniferous Rocks of the South of Scotland. By Archibald Geikie, F.R.S., . . . | 598 |
| Additional Contributions to our Knowledge of the Fossil Fishes of Eskdale and Liddesdale. By Dr R. H. Traquair, . . . | 603 |
| Further Researches among the Crustacea and Scorpions of the Carboniferous Rocks of the Scottish Border. By Mr B. N. Peach, . . . | 603 |
| Report on the Fossil Plants collected by the Geological Survey of Scotland in Eskdale and Liddesdale. By Robert Kidston, F.R.P.S., . . . | 603 |
| On the Formation of Serpentine from Dolomite. By J. J. Dobbie, M.A., D.Sc., Assistant to the Professor of Chemistry, University of Glasgow, and G. G. Henderson, B.Sc., . . . | 606 |
| On a Rotating Mass of Fluid. By Sir William Thomson, . . . | 610 |
| Notes on Atmospheric Electricity. By Professor C. Michie Smith, . . . | 613 |
| Recent Test of Swan's Lamp for Fall of Resistance, with increase of Electromotive Force, and Ratio of Candle-power to work expended. By Mr A. Jamieson. Communicated by Professor Chrystal, . . . | 615 |
| Communication of Preliminary Observations made by the Committee appointed by the Highland and Agricultural Society, to investigate the Nature and Causes of the Sheep Diseases known as Louping-ill and Braxy, . . . | 615 |
| On the Definite Article in Greek, with special reference to the Revised Version of the New Testament. By Professor Blackie, . . . | 622 |
| On the Action of the Microphone. By Professor James Blyth, M.A., . . . | 622 |
| Experiments to Determine the Lowering of the Maximum Density Point of Water by Pressure. By Professor D. H. Marshall, Professor C. Michie Smith, and Mr R. T. Omond, . . . | 626 |
| On some Points in the Meteorology of Madeira, both Absolute and Comparative. By the Astronomer-Royal for Scotland, . . . | 629 |
| On the Anatomy and Histology of <i>Pleurochæta Moseleyi</i> . By F. E. Beddard, B.A., New College, Oxford, . . . | 629 |
| Geological Notes. By Professor Heddle, . . . | 630 |
| Note on the Absorption of Sea Water. By Mr John Aitken, . . . | 637 |
| Exploration of the Faroe Channel, during the Summer of 1880, in H.M.'s hired ship "Knight Errant." By Staff-Commander Tizard, R.N., and Mr John Murray; with Subsidiary Reports. (Plate VI.), . . . | 638 |
| Notice of the Solar Eclipse of the 17th May, with Remarks on the Calculation. By Mr Edward Sang, . . . | 720 |
| Some Experiments on a New Secondary Cell. By Mr A. P. Laurie, B.Sc., . . . | 724 |
| Obituary Notices of Mr David Smith, Dr William Lauder Lindsay, and Professor Benjamin Peirce, . . . | 734 |

Contents.

ix

| | PAGE |
|---|------|
| On Miraga. Part II. By Professor Tait, | 743 |
| Report of the Boulder Committee, with Remarks by the Convener, Mr Milne Home. (Plates IV., V.), | 743 |
| Supplement to the Eighth Report of the Boulder Committee, | 787 |
| On Miraga. Part III. By Professor Tait, | 799 |
| On a Red Resin from <i>Dracæna Cinnabari</i> (Balf. fil.) Socotra. By Messrs J. J. Dobbie, Assistant to the Professor of Chemistry, University of Glasgow; and G. G. Henderson, B.Sc. Communi- cated by Dr Bayley Balfour, | 799 |
| On Voice-Effort and Rhythm. By the Rev. J. L. Blake. Communi- cated by Professor Crum Brown, | 799 |
| The Effect of Moisture on the Electric Discharge. By A. Macfarlane, M.A., D.Sc., and D. Rintoul, M.A., | 801 |
| The Heats of Combination of the Metals with the Halogens. By Messrs A. P. Laurie and C. I. Burton. Communicated by Prof. Crum Brown, | 804 |
| On the Kinetic Theory of Gases in relation to Dissociation. By Professor Tait, | 806 |
| On the Change in the Peltier Effect due to Variation in Tempera- ture. By Mr Albert Campbell. Communicated by Dr Knott, | 807 |
| On the Lowering of the Maximum Density Point of Water by Pressure. By Professor D. H. Marshall, Professor C. Michie Smith, and Mr R. T. Omond, | 809 |
| Note on the Preceding Paper. By Professor Tait, | 813 |
| Vocalisation and Articulation. By the Rev. J. L. Blake. Com- municated by Dr Crum Brown, | 815 |
| On the Order of Succession of Rocks in the North-West Highlands. By Professor Heddle, | 815 |
| On the Rotation of the Plane of Polarisation by Quartz, and its relation to Wave-Length. By Mr W. J. Peddie. Communicated by Professor Tait, | 815 |
| On the Condition of Ammonium Salts when dissolved in Water. By W. W. J. Nicol, M.A., B.Sc. Part I., | 819 |
| On a Solar Calorimeter, and some Observations made with it in Upper Egypt. By Mr J. Y. Buchanan, | 827 |
| On the Heats of Combination of the Metals with the Halogens. By Messrs A. P. Laurie, B.Sc., and C. I. Burton, | 830 |
| On the Nature of Solution. By Mr W. L. Goodwin. Communi- cated by Professor Crum Brown, | 834 |
| Diagnoses plantarum novarum et imperfecte descriptarum Phanero- gamarum Socotrensium, quas elaboravit Bayley Balfour, Scientiæ Doctor et in Universitate Glasceusi rerum botanicarum regius professor. Pars altera, | 834 |
| Review of the Session, | 843 |
| Donations to the Library, | 845 |
| Index, | 871 |

۳۸/۳
۳۳

Monday, 17th.

- On the Embry of the *Tum*
hypocistis. Part III. By
 On the Histology of the Pedicella.
 By
 F. Forbes. By
 F. Forbes, Lecturer on Zoology in
 the Edinburgh, and Mr FRANK I
 Assistant Demonstrator of Zoology, O.
 A Preliminary Note on an Ultra-Neptunian F
 By Professor GEORGE FORBES,
 On the Effects of Rotation in Liquid Jets.
 Note on the Influence of Temperature-Change of Con
 ductivity on the Conduction of Heat in Solids. By Profes
 sor TAIT.

Monday, 7th February 1881.

- Obituary Notices of Fellows who died in the course of
 Session 1880-81:—Mr Thomas Key, Dr William
 Macleod, Mr Maurice Lothian, Mr Mungo Ponton, Mr
 Thomas Knox, the Hon. Lord Ormisdale, Professor
 Murray. 95-116
- On a Simple and Accurate Method of determining the
 Longitude of a Place by a Single Observer, without the
 use of any instrument for measuring time. By Profes
 sor GEORGE FORBES, 117
- Stilbite, from Kerguelen's Island. By A. LIVERSIDGE, Assoc.
 Royal School of Mines, Professor of Geology and
 Mineralogy, University of Sydney. Communicated by
 Mr J. Y. BUCHANAN, 117
- On a Simple Form of Selenium Cell, and Experiments there
 with. By Professor JAMES BLYTH, 119
- Dust, Fogs, and Clouds. By M. JOHN AITKEN, 122
- Note on Thermal Conductivity, and on the Effects of Tem
 perature-Changes of Specific Heat and Conductivity on
 the Propagation of Plane Heat Waves. By Professor
 TAIT, 126
- Note on a Simple Method of showing the Diminution of Sur
 face Tension in Water by heat. By Professor TAIT, 131
- On the Cell-Walls of Hepatic Cells. By JOHN BERRY HAY
 CRAFT, M.B., B.Sc., F.R.S.E., Senior Demonstrator of
 Physiology in the University of Edinburgh, 131

Monday, 21st February 1881.

- Effects of Strain on Electric Conductivity. By M. AUGUST
 WITKOWSKI. Communicated by Sir WILLIAM THOMSON, 135
- On the Effect of Moistening with Water of Exposed Metallic
 Surfaces in a Volta-Condenser. By substituting a
 Water-Arc for a Metallic-Arc in a Galvanic Con
 tact. By WILLIAM THOMSON, 135
- On Vortex Motion. By the same Sar

PROCEEDINGS
OF THE
ROYAL SOCIETY OF EDINBURGH.

VOL. XL

1880-81.

No. 108.

NINETY-EIGHTH SESSION.

GENERAL STATUTORY MEETING.

Monday, 22d November 1880.

PROFESSOR DOUGLAS MACLAGAN, Vice-President,
in the Chair.

The following Council were elected :—

President.

THE RIGHT HON. LORD MONCREIFF.

Vice-Presidents.

| | |
|----------------------------------|-------------------------------------|
| Principal Sir ALEX. GRANT, Bart. | Prof. DOUGLAS MACLAGAN, M.D. |
| DAVID MILNE HOME, LL.D. | Prof. H. C. FLEEMING JENKIN, F.R.S. |
| Sir C. WYVILLE THOMSON, LL.D. | Rev. Dr LINDSAY ALEXANDER. |

General Secretary—Professor TAIT.

Secretaries to Ordinary Meetings.

Professor TURNER.

Professor CRUM BROWN.

Treasurer.—A. GILLIES SMITH, C.A.

Curator of Library and Museum—ALEXANDER BUCHAN, M.A.

Councillors.

| | |
|----------------------------|----------------------------------|
| J. Y. BUCHANAN, M.A. | Rev. Dr CAZENOVE. |
| Rev. THOMAS BROWN. | DAVID STEVENSON, M.I.C.E. |
| ROBERT GRAY, Esq. | Professor CHRYSAL. |
| Dr WILLIAM ROBERTSON. | ALEXANDER FORBES IRVINE of Drum. |
| Professor CAMPBELL FRASER. | Professor A. DICKSON. |
| Professor GEIKIE. | The Right Rev. Bishop COTTEBILL. |

By a Resolution of the Society (19th January 1880) the following Hon. Vice-Presidents, having filled the office of President, are also Members of the Council :—

HIS GRACE THE DUKE OF ARGYLL, K.T., D.C.L.

SIR ROBERT CHRISTISON, BART., M.D., D.C.L.

SIR WM. THOMSON, LL.D., D.C.L., F.R.S., Foreign Associate of Inst. of France.

VOL. XL.

A

Monday, 6th December 1880.

The Right Hon. LORD MONCREIFF of Tulliebole, LL.D., President, occupied the Chair, and opened the Session with an Introductory Address on the Rise of the Constitutional Idea.* Bishop Cotterill proposed that the Society record a vote of thanks to the President, which was agreed to.

The following Communications were read:—

1. On the Structure of *Euplectella*. By Dr F. E. Schültze.
Communicated by Sir Wyville Thomson.

2. On Equidifferent Multiples of Irrational Quantities.
By Mr E. Sang.

Our attention, naturally, is most drawn to the difficult parts of an inquiry; the easier steps are apt to be overlooked. Thus, while much attention and deep thought have been bestowed on the solution of equations, on the computation of logarithms, on the construction of astronomical canons; such a simple process as the repeated addition of some known quantity, has not been considered worthy of the notice of arithmeticians. Yet the tables constructed by help of this process are much more numerous, and are as important as the others, often indeed serving as their foundation.

The case when the quantity to be added is expressed accurately in numbers, needs no remark; but when that quantity is represented only approximately, we have to consider the accumulation of that part which is unavoidably left off, and to see that this does not lead to an error of so much as the half of unit in the last place that is to be retained.

The obvious and indeed the common plan is to carry the scroll calculations to several places beyond what are to be preserved, and to rewrite the whole leaving off the surplus figures, only taking care to augment the last figure whenever those to be rejected exceed 5000 Or, if the scroll calculation be put in the compositor's hands, to trust to his care and to that of the reader, in making the requisite augmentations.

* The first part of the President's Opening Address will be given along with the second part.

Thus, let it be proposed to construct a table of the Sun's mean daily motion in longitude, true to the nearest hundredth part of a second of the modern division. Taking the length of the equinoctial year as 365·242217 mean solar days, the motion in one day is 1' 09' 51" 63''' 6513585 or, as is far within the accuracy of our knowledge,

$$1' 09' 51'' 63''' 65136.$$

We should then write this number on the lower edge of a card, and make the successive additions as under:—

| | | | | | |
|----|----|----|----|----|-------|
| 1 | 1 | 09 | 51 | 63 | 65136 |
| 2 | 2 | 19 | 03 | 27 | 30272 |
| 3 | 3 | 28 | 54 | 90 | 95408 |
| 4 | 4 | 38 | 06 | 54 | 60544 |
| 5 | 5 | 47 | 58 | 18 | 25680 |
| 6 | 6 | 57 | 09 | 81 | 90816 |
| 7 | 7 | 66 | 61 | 45 | 55952 |
| 8 | 8 | 76 | 13 | 09 | 21088 |
| 9 | 9 | 85 | 64 | 72 | 86224 |
| 10 | 10 | 95 | 16 | 36 | 51360 |

separating the redundant figures by a line, and afterwards making the requisite augmentations.

In order to lessen the labour of such work, I have for many years used two simple artifices, and find among my papers that these were applied in 1845 to the formation of tables of the equivalent values of solar and sidereal time.

The first of these artifices is to augment the initial value by ·50000; by this means the requisite augmentations are made throughout, and we have only to reject the surplus figures; or, if these have been written on a slip of paper placed alongside, to remove that slip:—thus

| days. | ' | ' | " | ''' | |
|-------|----|----|----|-----|-------|
| 0 | 0 | 00 | 00 | 00 | 50000 |
| 1 | 1 | 09 | 51 | 64 | 15136 |
| 2 | 2 | 19 | 03 | 27 | 80272 |
| 3 | 3 | 28 | 54 | 91 | 45408 |
| 4 | 4 | 38 | 06 | 55 | 10544 |
| 5 | 5 | 47 | 58 | 18 | 75680 |
| 6 | 6 | 57 | 09 | 82 | 40816 |
| 7 | 7 | 66 | 61 | 46 | 05952 |
| 8 | 8 | 76 | 13 | 09 | 71088 |
| 9 | 9 | 85 | 64 | 73 | 86224 |
| 10 | 10 | 95 | 16 | 37 | 01360 |

The second artifice is founded on the well-known properties of chain-fractions.

When we use Lord Brouncker's process in approximating to the value of an irrational quantity, we obtain a series of fractions alternately too great and too small, having this property that the difference between two contiguous members of the series is a fraction having unit for its numerator, and for its denominator the product of the two denominators. Hence it follows, that the error of the last obtained fraction is much less than unit divided by the square of its denominator; and thus a Brounckerian fraction having only three figures in its denominator will give as much precision as a decimal fraction of five places.

On treating the above residue $\cdot 6513585$ by Brouncker's method we get the fraction $\frac{1097}{1546}$, of which the value is $\cdot 65135834$; hence if we use the addend $1\ 09\ 51\ 63\ \frac{1097}{1546}$, beginning with $00\ \frac{773}{1546}$, we shall obtain the required table on merely rejecting the fractions.

We also avoid the need for writing the denominator by placing on the lower edge of the card the equivalent expressions:—

| | | | | | | |
|-----|----|----|----|-----|---|------|
| | ' | ' | '' | ''' | | |
| | 1 | 09 | 51 | 63 | + | 1007 |
| and | 1 | 09 | 51 | 64 | - | 539 |
| | 0 | 0 | 00 | 00 | | 773 |
| | 1 | 1 | 09 | 51 | | 234 |
| | 2 | 2 | 19 | 03 | | 1241 |
| | 3 | 3 | 28 | 54 | | 702 |
| | 4 | 4 | 38 | 06 | | 163 |
| | 5 | 5 | 47 | 58 | | 1170 |
| | 6 | 6 | 57 | 09 | | 631 |
| | 7 | 7 | 66 | 61 | | 92 |
| | 8 | 8 | 76 | 13 | | 1099 |
| | 9 | 9 | 85 | 64 | | 560 |
| | 10 | 10 | 95 | 16 | | 21 |

Here we observe that for the 773d day the fractional remainder will be 0, and that, therefore, we are in doubt whether to write $03''' \cdot 0$ or $02''' 1546$. From the rank of the fraction in the Brounckerian series we perceive that it is in defect; wherefore we choose the former of the two. The same thing will recur at the 2319th day. Had the fraction been in excess, we should have written $02''$ with 1546 over.

When the denominator of the approximate fraction is small, the same series of remainders may recur often during the work. In

that case it is convenient to write them on a joined ribbon of paper, which may be passed over and under the page on which we are working; in this way the repeated writing of the remainders is saved. The saving thereby is considerable; thus in the computation of the tables for converting solar into sidereal time, and conversely, the writing of eighty-six thousand figures was spared.

The above example sufficiently explains the principles and the application of the artifice.

3. Algebra of Relationship.—Part II. By A. Macfarlane, M.A., D.Sc., F.R.S.E.

(Received October 19, read December 6, 1880.)

At the end of my previous paper on the Algebra of Relationship (Proc. Roy. Soc. Edinb., vol. x. p. 224), I promised to return to the investigation of the subject, as it seemed capable of further extension. This anticipation has proved correct, and I have now the honour of bringing before the Society the further developments I have made.

In this investigation we consider a particular class of objects, and that class is in its widest extent *mankind*, by which term I mean the entire number of men who have existed, exist, or will exist. The universal properties of the symbols are deduced from the universal properties of mankind. In our consideration of this universe of mankind, we restrict our attention to the classes into which it is divided by qualities depending on ties of anterior or of posterior relationship, that is, of consanguinity or of affinity.

The italic capitals *A*, *B*, *C*, &c., are used to denote the names of the individuals within this universe. They are singular terms, or, in other words, selective symbols which operating within or upon *U*, select each only one individual. They are subject to the laws

$$A + B = B + A ;$$

$$A^2 = 0 ;$$

$$\text{and } AB = 0, \text{ unless } B = A ;$$

where the sign = means *identical with*.

In my previous paper, I based the investigation on four fundamental symbols α , d , σ , δ , denoting respectively *sons of a man*,

daughters of a man, sons of a woman, and daughters of a woman. For example, sA was used to denote the sons of the man A . Thus the symbol sA selects a portion of the universe of mankind, and that portion embraces no, one, or more than one individual. We have seen that the symbol A is also selective, but embracing only one individual. The symbol s is different; it may be considered as indicating to the mind to pass from A to sA . It is convenient to have words to express the relations of these symbols to one another. The expression sA may be called a *term*, A the *origin* of the term, and s the *relationship* of the term. In this paper I proceed mainly by means of the two more general fundamental relationships c and γ , where c denotes *the children of a man*, and γ *the children of a woman*.

Let $cA = B + C + D$. This statement is a logical equation; it asserts that the children of the man A are B and C and D , and only these. Let $cA > B + C + D$. This statement is a logical inequation; it asserts that the children of the man A include B and C and D . Let $cA < B + C + D$. This statement is a logical inequation; it asserts that the children of the man A are included in B and C and D .

What is the proper meaning of $\frac{1}{c}A$ and $\frac{1}{\gamma}A$? The term $\frac{1}{c}A$ means *the father of the person A*. It is a singular term by reason of physiological laws which apply to mankind. There are other functional symbols, whose reciprocals may form plural terms; for example, let eA denote the employés of A , then $\frac{1}{e}B$ may denote the employers of B .

The meaning of ccA follows from the meaning we have attached to cA . It means the children of the sons of the man A . Similarly the terms γcA , $c\gamma B$, $\gamma\gamma B$ denote respectively the children of the daughters of the man A , the children of the sons of the woman B , and the children of the daughters of the woman B . The symbol c operating on cA , directs us first to select the male children of A , and then to take the children of each of these. Similarly γ , operating on cA , directs us first to select the female children of A , and then to take their children. Thus the symbols c and γ , in so far as they are selective in their operation, partake of the nature of the quaternion symbols S and V .

The relationship cc may be denoted without ambiguity by c^2 , and $\frac{1}{c}$ by c^{-1} ; and generally an index may be used to denote the number of times c or γ is repeated, whether directly or inversely.

The meaning of each of the permutations of the four symbols $c, \gamma, c^{-1}, \gamma^{-1}$ two together, with one another, and with themselves, is given in Table II. (p. 12.) In the first row we have the different species of grandchildren. In the second row we have $c^{1-1}A$ and $\gamma^{1-1}A$, which denote respectively the children of the father of A , and the children of the mother of A ; hence the two species of brothers and sisters, the origin being included as a special case. We have also $c\gamma^{-1}A$ and $\gamma c^{-1}A$, which denote the children by male descent of the mother of A , and the children by female descent of the father of A ; each of which must always have the value 0, on account of the monœcious nature of mankind. Any term in which either $c\gamma^{-1}$ or γc^{-1} occurs whether singly or in combination has the value 0, on account of the morphological law referred to. In the third row we have $c^{-1+1}A$ and $\gamma^{-1+1}B$, which denote respectively the father of the children of the man A , and the mother of the children of the woman B ; they are therefore equivalent to A and to B . Of the other two terms $c^{-1}\gamma B$ denotes the fathers of the children of the woman B , and $\gamma^{-1}cA$ denotes the mothers of the children of the man A . Thus the terms of this row break up into two groups denoted respectively by *consorts* and *self*. The terms belonging to the latter group are enclosed. In the fourth row we have the expressions for the grandparents.

In Table III. I have written out all the terms which are expressed by three symbols, omitting those which are null from containing $c\gamma^{-1}$ or γc^{-1} . The terms in the first row are the terms of the expansion of $(c+\gamma)^3$; those in the second row of $(c+\gamma)^2 \left(\frac{1}{c} + \frac{1}{\gamma}\right)$; those in the third of $(c+\gamma) \left(\frac{1}{c} + \frac{1}{\gamma}\right) (c+\gamma)$, and so on. The method of deriving the terms is evidently exhaustive, and it supplies us not only with a means of denoting all possible relationships, but also of classifying them in a scientific manner. It will be convenient to have words to denote the different classes and sub-classes, and for this purpose I propose to employ the classificatory terms—Order, Genus, Species, Variety. By the *order* of a relationship I mean the number of symbols required to express it; for example, those of

Table III. are all of the third order. The classes in one row may be said to form one *genus*, and each class itself to be a *species*. Let c and γ be considered equivalent, then the index of each term in one row is the same; this is the generic property. The specific property depends on the differences expressed by c and γ . The *varieties* of a species are obtained by introducing the distinction of gender at any place where the form of expression for the species has left it unrestricted. For example, c^3A admits of two varieties, namely sc^2A and dc^2A —the sons of the sons of the sons of A , and the daughters of the sons of the sons of A .

The notions for the different genera of the third order are exhibited in the side column. That for the first genus is *great grandchildren*; that for the second is, in its widest extent, *grandchildren of parents*, but if the cases in which the species reduce to species of the first order be removed, then the genus-notion is that of *nephews* and *nieces*. The notion of the third genus is *children of parents of children*. The enclosed species, which are affected by containing c^{-1+1} or γ^{-1+1} express only *children*; the other species express *step-children* or *children*. Similarly for the other genera.

Another notion useful to consider and for which a name is required, is the number of generations between the individuals represented by a term and the origin of the term. For example, in c^3A the individuals represented by c^3A are removed by three generations from A ; in $c^{2-1}A$ by only one generation. This number may be called the *interval* of the relationship. It is the sum of the indices of the term, and is constant for all the species of one genus.

Relationships may also be classified according to the direct or inverse form of the first symbol, and the subsequent number of changes from the one to the other. For instance, in $c^{2-2}A$ we have the first symbol direct, and only one subsequent change. Here A and the individuals represented by the term, have a common ancestor; in $c^{-2+2}A$ they have a common descendant. In the expressions for the relationships, let c and γ be considered equivalent, and the indices summed in accordance; then by neglecting the numbers but retaining the signs of the index, we shall obtain an expression for the quality we are considering, which may be called the *sign* of the relationship. The sign may begin with either + or -, and may end with either, but it must have

them in alternate succession. The sign of cyc is +, of $c^2^{-1} + -$, of $c\gamma^{-1}c^{-1} + -$, of $c^{-1}\gamma^{-1}c - + - +$, and so on. The term *degree* may be used to denote the number of pluses and minuses in a sign, and *positive* to denote that the sign begins with + and *negative* to denote that it begins with minus.

Relationship terms, inasmuch as they select a number of individuals from the universe of mankind in such a way that the same individual is selected only once, are qualitative symbols of the kind first discussed by Boole, and which I have treated of in my book on the "Algebra of Logic." They are therefore subject to the laws and processes of that Algebra.

That Algebra supplies us with the mode of formation of a compound term. Suppose that cA and γB have some members in common; these are classed together by the expression $cA\gamma B$, where cA and γB stand to each other in the relation of simultaneous multiplication, a relation quite different from that existing between c and A in cA . We may have compound terms of any degree of complexity, and the word *degree* may be used as meaning the number of simple terms in a compound term. The number of origins in a compound term is the same as the degree, but some of them may be coincident. The different compound terms of the second degree, each simple term being of the first order, are the following:—

| | | | |
|------------------|-----------------------|-----------------------|----------------------------|
| $cBcA$ | $cB\gamma A$ | γBcA | $\gamma B\gamma A$ |
| $cBc^{-1}A$ | $cB\gamma^{-1}A$ | $\gamma Bc^{-1}A$ | $\gamma B\gamma^{-1}A$ |
| $c^{-1}BcA$ | $c^{-1}B\gamma A$ | $\gamma^{-1}BcA$ | $\gamma^{-1}B\gamma A$ |
| $c^{-1}Bc^{-1}A$ | $c^{-1}B\gamma^{-1}A$ | $\gamma^{-1}Bc^{-1}A$ | $\gamma^{-1}B\gamma^{-1}A$ |

The permutations $cB\gamma A$ and γBcA are not different in form; for the order of the components in a compound term is inessential. In the case of the extremes of the first row, the origins B and A must be identical, else the terms are null. In the case of the middle terms of that row the origins must be different, and different in sex. In the case of the terms of the second and third rows, the origins must be different. In the fourth row the extreme terms may have origins the same or different, and the middle terms never exist.

Thus certain compound terms are non-existent on account of natural laws; there are others which are non-existent, where certain

moral laws are observed. For example, $cA\gamma c^{1-1}A$ and $cA\gamma^{2-1}A$ are necessarily non-existent where the Christian laws of marriage are observed.

As an example of the manner in which the notation of this paper may be used, I shall employ it to find the different compound genera species and varieties of the term *cousin*. The word *cousin* in its general sense means any relationship of the sign $m - n$ where m and n is each not less than 2. When both of them are two, we have the relationship *cousin* in its strictest sense; when both are 3 we have *second cousin*, and I suppose that $2 - 3$ and $3 - 2$ have to be expressed by means of the same phrase. But by putting in the particular numbers for m and n , we obtain a simple and perfect means of specifying all the possible elementary forms of the notion. I shall restrict the elementary form of the word to the form $2 - 2$, which coincides with the fourth genus of the fourth order of relationships (the notion of which is grandchildren of grandparents), provided we exclude all the instances in which that genus reduces to genera of a lower order.

The different species are,

$$c^{2-2}, c^{2-1}\gamma^{-1}, c\gamma^{1-1}c^{-1}, c\gamma^{1-2}, \gamma c^{1-2}, \gamma c^{1-1}\gamma^{-1}, \gamma^{2-1}c^{-1}, \gamma^{2-2};$$

and suppose them numbered consecutively from left to right. The different combinations of these species two together form the compound genus of the second degree. The number of species in this compound genus is 28, but certain of them do not exist on account of the moral laws

$$c^{-2}Ac^{-1}\gamma^{-1}A = 0 \text{ and } \gamma^{-1}c^{-1}A\gamma^{-2}A = 0,$$

or their equivalent forms,

$$\gamma c A c^2 A = 0, \text{ and } \gamma^2 A c \gamma A = 0.$$

The non-existent species are 12, 15, 26, 34, 37, 48, 56, 78. There are 20 left. The number of species in the compound genus of the third degree is naturally 56, but by the above laws it is reduced to 16. For that of the fourth degree the numbers are 70 and 4 respectively. The four are 1368, 1467, 2358, 2457, each of which represents what ought to be meant by the phrase a *full cousin*; for all the higher compound genera are non-existent. Each species of each of these compound genera may contain four varieties; for the

individuals of the term may be male or female, and the origin of the term may be male or female. Thus the word *cousin*, restricted to mean having one or more common ancestors two generations back on either side, may have any one of 48 significations when it expresses a relationship between two persons each of given sex; and when the sex of neither is given it may have any one of 192 significations.

The method of this paper gives us a scientific classification of a man's feminine relations, which is of special interest at the present time, when the laws of marriage are under consideration. He is excluded by the table of degrees from marrying any one belonging to the classes marked with an asterisk.

ORDER

- I. Gen. 1, Daughter*; 2, Mother*.
- II. ,, 1, Granddaughter; 2, Sister*; 3, Wife; 4, Grandmother*.
- III. ,, 1, Great-granddaughter*; 2, Niece*; 3, Stepdaughter*; 4, Aunt (by consanguinity*); 3, Wife of son*; 6, Stepmother*; 7, Mother of wife*; 8, Great-grandmother.
- IV. ,, 1, Great-great-granddaughter; 2, Great-granddaughter of parent; 3, Daughter of step-child*; 4, Cousin; 5, Daughter of child-in-law; 6, Daughter of step-parent; 7, Sister of wife*; 8, Daughter of great-grandparent; 9, Wife of grandson*; 10, Wife of brother*; 11, (Necessarily masculine); 12, Step-grandmother*; 13, Grandmother of grandchild; 14, Mother of step-parent; 15, Grandmother of wife*; 16, Great-great-grandmother.
- V. ,, 1. Great-great-great-granddaughter; 2, Granddaughter of nephew or niece; 3, Great-granddaughter of wife; 4, Daughter of cousin; 5, Granddaughter of consort of child; 6, Granddaughter of consort of parent; 7, Niece of wife*; 8, Niece of grandparent; 9, Daughter of consort of grandchild; 10, Daughter of consort of brother or sister; 11, Daughter of husband of wife; 12, Daughter of consort of grandparent; 13, Sister of consort of child; 14, Sister of consort of parent; 15, Aunt of wife*; 16, Aunt of grandparent; 17, Wife of great-grandson; 18, Wife of nephew*; 19, Wife of stepson; 20, Wife of uncle*; 21, Wife of husband of daughter; 22, Wife of husband of mother; 23, Wife of father of wife; 24, Wife of great-grandfather; 25, Mother of consort of grandchild; 26, Mother of consort of brother or sister; 27, Mother of husband of wife; 28, Mother of consort of grandparent; 29, Grandmother of consort of child; 30, Grandmother of consort of parent; 31, Great-grandmother of wife; 32, Great-great-great-grandmother.

I have to express my obligations to Professor Jevons' "Principles

of Science" for references to the papers on the Logic of Relation by Peirce, De Morgan, Ellis, and Harley. The philosophers mentioned discuss relation in general; I have restricted myself to the more definite subject of relation of men by consanguinity or affinity.

TABLE I.—Relationships of the First Order.

| | | |
|-------------------|---|--|
| Children, | c Children of a man. | γ Children of a woman. |
| Parents, | $\frac{1}{c}$ Father of a person. | $\frac{1}{\gamma}$ Mother of a person. |

TABLE II.—Relationships of the Second Order.

| | | | | |
|--|---|--|--|---|
| Grandchildren, . . . | c^2 Children of sons of a man. | $c\gamma$ Children of sons of a woman. | γc Children of daughters of a man. | γ^2 Children of daughters of a woman. |
| Children of parents } (Brothers and sisters), } | c^{1-1} Children of the father of. | $c\gamma^{-1}$ = 0. | γc^{-1} = 0. | γ^{1-1} Children of the mother of. |
| Parents of children } (Consorts—self.) } | c^{-1+1} = 1. | $c^{-1}\gamma$ Fathers of the children of a woman. | $\gamma^{-1}c$ Mothers of the children of a man. | γ^{-1+1} = 1. |
| Grandparents, . . . | c^{-2} Father of the father of. | $c^{-1}\gamma^{-1}$ Father of the mother of. | $\gamma^{-1}c^{-1}$ Mother of the father of. | γ^{-2} Mother of the mother of. |

TABLE III.—Relationships of the Third Order.

| | | | | | | | | |
|---|--------------|------------------|------------------------|-----------------------|-----------------------|--------------------------------|------------------|-------------------|
| Great-grandchildren, . . . | c^3 | $c^2\gamma$ | $c\gamma c$ | $c\gamma^3$ | γc^3 | $\gamma c\gamma$ | $\gamma^3 c$ | γ^3 |
| Grandchildren of parents (Nephews and nieces), | c^2-1 | | | $c\gamma^1-1$ | γc^1-1 | | | γ^2-1 |
| Children of parents of children (Stepchildren—children), | c^1-1+1 | $c^1-1\gamma$ | | | | | γ^1-1c | γ^1-1+1 |
| Children of grandparents (Uncles and aunts by blood), | c^1-2 | $c^1-1\gamma-1$ | | | | | γ^1-1c-1 | γ^1-2 |
| Parents of grandchildren (Children-in-law—children), | $c^{-1}+2$ | $c^{-1}+1\gamma$ | $c^{-1}\gamma c$ | $c^{-1}\gamma^2$ | $\gamma^{-1}c^2$ | $\gamma^{-1}c\gamma$ | $\gamma^{-1}+1c$ | $\gamma^{-1}+2$ |
| Parents of children of parents (Stepparents—parents,) | $c^{-1}+1-1$ | | | $c^{-1}\gamma^1-1$ | $\gamma^{-1}c^1-1$ | | | $\gamma^{-1}+1-1$ |
| Grandparents of children (Parents-in-law—parents), | $c^{-2}+1$ | $c^{-2}\gamma$ | $c^{-1}\gamma-1c$ | $c^{-1}\gamma^{-1}+1$ | $\gamma^{-1}c^{-1}+1$ | $\gamma^{-1}c^{-1}\gamma$ | $\gamma^{-2}c$ | $\gamma^{-2}+1$ |
| Great-grandparents, . . . | c^{-3} | $c^{-2}\gamma^1$ | $c^{-1}\gamma^{-1}c-1$ | $c^{-1}\gamma^{-2}$ | $\gamma^{-1}c^{-2}$ | $\gamma^{-1}c^{-1}\gamma^{-1}$ | $\gamma^{-2}c-1$ | γ^{-2} |

BUSINESS.

Dr T. A. Wise and Mr Thomas Gray were balloted for, and declared duly elected Fellows of the Society.

Monday, 20th December 1880.

SIR WYVILLE THOMSON, F.R.S., Vice-President, in
the Chair.

The following Communications were read:—

1. On Dust, Fogs, and Clouds. By Mr John Aitken.

(Abstract).

Dust, fogs, and clouds seem to have but little connection with each other, and we might think they could be better treated of under two separate and distinct heads. Yet I think we shall presently see that they are more closely related than might at first sight appear, and that dust is the germ of which fogs and clouds are the developed phenomena.

This was illustrated by an experiment in which steam was mixed with air in two large glass receivers; the one receiver was filled with common air, the other with air which had been carefully passed through a cotton-wool filter and all dust removed from it. In the unfiltered air the steam gave the usual and well-known cloudy form of condensation, while in the filtered air no cloudiness whatever appeared. The air remained supersaturated and perfectly transparent.

The difference in the behaviour of the steam in these two cases was explained by corresponding phenomena, in freezing, melting, and boiling. It was shown that particles of water vapour do not combine with each other to form a cloud-particle, but the vapour must have some solid or liquid body on which to condense. Vapour in pure air therefore remains uncondensed or supersaturated, while dust-particles in ordinary air forms the nuclei on which the vapour condenses and forms fog or cloud-particles.

This represents an extremely dusty condition of the air, as every

fog and cloud-particle was formerly represented by a dust-particle, which vapour by condensing upon it has made visible. When there is much dust in the air but little vapour condenses on each particle, and they become but little heavier, and easily float in the air. If there are few dust specks each gets more vapour, is heavier, and falls more quickly.

These experiments were repeated with an air-pump, a little water being placed in the receiver to saturate the air. The air was then cooled by slightly reducing the pressure. When this is done with unfiltered air a dense cloudiness fills the receiver; but when with pure air no fogging whatever takes place, there being no nuclei on which the condensation can take place. In this experiment, and in the one with steam, the number of cloud-particles is always in proportion to the dust present. When the air is nearly pure and only a few dust-particles present, then only a few cloud-particles form, and they are heavy and fall like fine rain.

The conclusions drawn from these experiments are—1st, That whenever water vapour condenses in the atmosphere it always does so on some solid nucleus; 2d, that dust-particles in the air form the nuclei on which the vapour condenses; 3d, that if there was no dust there would be no fogs, no clouds, no mists, and probably no rain, and that the supersaturated air would convert every object on the surface of the earth into a condenser on which it would deposit; 4th, our breath when it becomes visible on a cold morning, and every puff of steam as it escapes into the air, show the impure and dusty condition of our atmosphere.

The source of the fine atmospheric dust was then referred to, and it was shown that anything that broke up matter into minute parts would contribute a share. The spray from the ocean, when dried and converted into fine dust, was shown to be an important source. Meteoric matter also probably contributed a proportion. Attention was then directed to the power of heat and combustion as a source of this fine dust.

It was shown that if there is much dust, then each particle only gets a little vapour condensed upon it, that when the particles are numerous they become but little heavier, and easily float in the air, and give rise to that close packed but light form of condensation which constitutes a fog, and therefore whatever increases the amount

of dust in the air tends to increase fogs, and that when the dust-particles are not so numerous the cloud-particles are larger, and settle down more quickly.

It was shown that by simply heating any substance such as a piece of glass, iron, brass, &c., a cloud of dust was driven off, which, when carried along with pure air into the experimental receiver, gave rise to a dense fog when mixed with steam. So delicate is this test for dust, that if we heat the one-hundredth of a grain of iron wire, the dust driven off from it will give a distinct cloudiness in the experimental receiver, and if we take the wire out of the apparatus and so much as touch it with our fingers and again replace it, it will again be active as a cloud-producer. Many different substances were tried, and all were found to be active fog-producers. Common salt is perhaps one of the most active.

Heat, it is well known, destroys the motes in the air, and it might be thought that flame and other forms of combustion ought to give rise to a purer air. Such, however, is not the case. Gas was burned in a glass receiver, and supplied with filtered air for combustion, and it was found that the products of combustion of pure air and dustless gas gave rise to an intensely fog-producing atmosphere. It may be mentioned here that the fog-producing air from the heated glass, metals, and burning gas, were each passed through the cotton-wool filter, and the air was in all cases made pure, and did not give rise to cloudiness when mixed with steam.

It will be seen that it is not the dust motes which are revealed to us by a beam of sunlight when shining into a darkened room, that form the nuclei of fog and cloud-particles, as these may be entirely removed by heat, and yet the air remain active as a cloud-producer. The heat would seem to break up the larger motes which reflect the light into smaller and invisible ones. When speaking of dust, it is to these infinitesimally small and invisible particles we refer. The larger motes which reflect the light will no doubt be active nuclei, but their number is too small to have any important effect.

It is suggested, and certain reasons are given for supposing that the blue colour of the sky is due to this fine dust.

Other experiments were made to test the fog-producing power of the air and gases from different sources. The air to be tested was

introduced into the experimental receiver and mixed with steam, and the relative densities of the fog produced were noted. It was found that the air of the laboratory where gas was burning always gave a denser fog than the air outside, and that the air outside varied, giving less fog during wet than during dry weather. The products of combustion of gas burned in a Bunsen flame, a bright flame, and a smoky flame, were all tested and found to be about equally bad, and all much worse than the air in which they were burned. Products of combustion from a clear fire and from a smoky one gave about equal fogging, and both much worse than the air of the room.

Experiments were made by burning different substances. Common salt when burned in a fire or in alcohol flame gave an intensely fog-producing atmosphere, but burned sulphur was the most active substance experimented on. It gave rise to a fog so dense it was impossible to see through a thickness of 5 cm. of it.

The vapours of other substances than water were tested to see if they would condense in the cloud form without nuclei on which to deposit. All the substances experimented on, which included sulphuric acid, alcohol, benzole, and paraffin, only gave a cloudy condensation when mixed with ordinary unfiltered air, and remained perfectly clear when mixed with filtered air, all these acting like water vapour.

Before referring to fogs, which have now become so frequent and aggravated in our large towns, it was pointed out that caution was necessary in applying the results of the experiments.

The conditions of a laboratory experiment are so different, and on so small a scale, that it is not safe to carry their teaching to the utmost limits, and apply them to the processes which go on in nature. We may, however, look to the experiments for facts from which to reason, and for processes which will enable us to understand the grander workings of nature.

It having been shown that vapour, by condensing on the dust-particles in the air, gives rise to a fogging, the density of which depends on the amount of fine dust in the air, the more dust the finer are the fog-particles, and the longer they remain suspended in the air. It having been also shown that all forms of combustion, perfect and imperfect, are producers of fog nuclei, it is concluded

that it is hopeless to expect that, adopting more perfect forms of combustion than those at present in use, we shall thereby diminish the frequency, persistency, or density of our town fogs. More perfect combustion will, however, remove the pea-soup character from the fogs and make them purer and whiter, by preventing the smoke which at present mixes with our town fogs and aggravates their character, and prevents them dissolving when they enter our rooms. Smoke descends during a fog, because the smoke particles are good radiators, and soon get cooled and form nuclei on which the water vapour condenses. The smoke thus becomes heavier and falls. This explains why it is falling smoke is often a sign of coming rain. It indicates a saturated condition of the atmosphere.*

Sulphur when burned has been shown to be an intensely active fog-producer. Calculation shows that there are more than 200 tons of sulphur burned with the coal every winter day in London, a quantity so enormous as quite to account for the density of the London fogs. It is suggested that some restriction ought to be put on the amount of sulphur in the coal used in towns.

Before utterly condensing the smoke and the sulphur, it was pointed out that it would be necessary thoroughly to investigate, and fully to consider the value of smoke as a deodorizer, and also the powerful antiseptic properties of the sulphurous acid formed by the burning sulphur. The air during fogs is still and stagnant. There is no current to clear away the foul smells and deadly germs that float in the air, and which might be more deadly than they are were it not for the suspended soot and burned sulphur. We must therefore be on our guard lest we substitute a great and hidden danger for an evident but less evil.

2. Solar Eclipse, 31st December 1880. By Mr E. Sang.

The elements for the computation of eclipses are given in the "Nautical Almanac" with precision sufficient for all ordinary purposes; but, when we wish to compare the lunar ephemeris with actual observation for the purpose of verifying or of improving our data, we must go somewhat more minutely into the investigation.

Thus, in the List of Elements, p. 403, the changes in the right-ascension and declination of the sun and moon are supposed to be

proportional to the times, while the moon's geocentric semidiameter, as well as the horizontal parallax, is supposed to be constant during the eclipse. In this way some exceedingly small errors are introduced into the calculation.

In order to take full advantage of the admirably minute and exact ephemerides given in the body of the "Almanac," I thence, using second differences wherever they had any influence, computed the geocentric positions of the sun and moon, and the moon's parallax and semidiameter, for intervals of 10 m. during the eclipse.

From these again I deduced strictly the declinations, hour angles, semidiameters, and separations, as seen from the Royal Observatory of Edinburgh, using 300 : 299 as the ratio of the earth's oblateness. Lastly, from these results, and with the same precautions, I calculated the instants of the first and last contacts, and that of the closest approach. My table of the values of circular segments enables me also, with great ease, to determine the part of the sun's disc hid by the moon.

The following are the results :—

| | H. | M. | s. | |
|------------------|----|----|----|-------------------|
| First contact at | 1 | 30 | 10 | Green. M. S. Time |
| Greatest phase, | 2 | 29 | 26 | „ |
| Last contact, | 3 | 26 | 15 | „ |

Portion of sun's diameter uncovered 17' 03". Ratio of uncovered to covered portions of sun's disc 631 : 369, the whole surface being 1,000.

I may remark that the moon's parallax and semidiameter, as given among the elements, have been obtained by simple interpolation from those for 0 h. and 12 h. ; whereas the moon is in perigee during the eclipse, and the parallax instead of decreasing uniformly from 0 h. till 12 h., actually increases to a maximum and then decreases ; so that in place of 61' 27".3 we should have had 61' 27".6.

The comparison of these predictions with the times observed at the Calton Hill will be interesting, should the weather permit.

2. On the Preparation of Adamantine Carbon or Diamond.

By R. Sydney Marsden, D.Sc., F.R.S.E., F. Inst. Chem., &c.

(Preliminary Notice.)

The preparation of adamantine carbon or diamond has exercised the genius of philosophers from the very earliest times; but it was not until the middle of the last century (1772) that Lavoisier established the diamond's true nature—notwithstanding the simplicity of the experiments required to demonstrate the fact—and showed it to consist of pure carbon in a crystallised state. Since that time very many attempts have been made to prepare it artificially, but until the recent and now famous experiments of Mr J. B. Hannay there has not been the slightest approach towards the solution of this problem. Great obstacles stood in the way of success, the chief being the complete insolubility of carbon in all known liquids, coupled with its non-volatility and infusibility; while the subject was rendered even more difficult and obscure, by ignorance of the conditions under which the diamond is produced in nature, its peculiar crystalline form, together with extreme rarity, indicating a probable very slow formation, and rare natural existence of the conditions necessary for its formation.

The process employed by me for the production of this substance is identical with the one for the preparation of pure adamantine boron which was worked out by Dr R. M. Morrison and myself, and communicated to this Society in a paper read June 17, 1878. It consists in dissolving the amorphous variety in fused silver or an alloy of platinum and silver, and allowing it to crystallize out again on cooling. This is effected in the following manner:—

First of all we take a graphite crucible and line it inside with a layer of pure carbon half an inch in thickness—the carbon employed for this purpose is pure sugar charcoal mixed with a solution of gum into a firm paste and then tightly packed into the crucible, this is then very slowly dried and ultimately heated red-hot and allowed to cool again—the centre portion scooped out leaving the lining of half an inch thick, firm, solid, and compact, and without any cracks or holes; to this special attention must be paid.

The amorphous carbon (which is pure sugar charcoal prepared by

calcining sugar) is then reduced to an impalpable powder in an agate mortar, and laid in alternate layers with the metal (in small lumps) in the carbon crucible as already described, great pains being taken to secure that the metal is well surrounded with carbon. The carbon lid is then tightly fitted, and any little crevice filled up with pure charcoal. The graphite crucible lid luted on with the mixture of carbon and gum and the whole again carefully dried. This graphite cru-

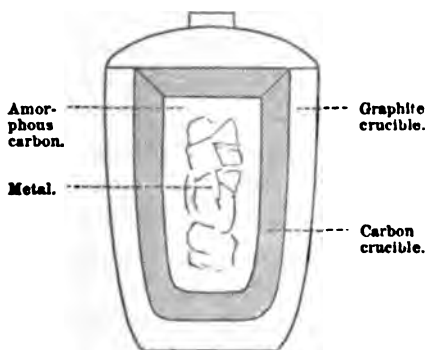

cible is then placed in an ordinary steel melting crucible (to facilitate its being handled) and surrounded with charcoal and coke-dust. The whole then placed in a Siemens' regenerative gas furnace and kept at the temperature of melting steel for from nine to ten hours. It is then taken out and the crucible buried in hot sand, to allow of very gradual cooling and thus give every chance for the formation of crystals, in this way it was found possible to extend the cooling over from fourteen to eighteen hours.

During the heating the melted metal becomes thoroughly saturated with the carbon, which again crystallises out on cooling. On opening the crucible the metal is found in a single lump towards the bottom, and still surrounded by the undissolved carbon, from which it comes away quite easily and cleanly, and only requires to be washed with water and a small brush to remove the adhering carbon, when it is ready for extracting the crystallised carbon from its interior. On examining the metal at this stage of the operation, marked lines of crystallisation can be distinctly seen crossing the silver in two directions at right angles to one another.

The metal is now dissolved in nitric acid, when we obtain the dissolved carbon from its interior in the form of a greyish black powder possessing a beautiful graphitic lustre. On examining this powder under the microscope we find it to consist of three different kinds of substances—first of graphite, which forms the larger proportion; secondly of a number of small crystalline bodies of

octahedral form, also present in a fairly large quantity ; and thirdly a quantity of a brownish substance probably amorphous carbon or a carbide of silver, which occurs in little flocks. It would appear from this that dissolved carbon, on crystallising slowly, takes the graphitic form in the hexagonal system in preference to the octahedral form of the diamond. I judge this from the fact of its occurring in so much larger a quantity. By washing this mixed powder by decantation, and then treating it first with hydrofluoric acid and then with ammonia, and further with caustic potash, the greater portion of the brown flocculent substance is thus got rid of, leaving the graphitic and adamantine carbon behind, and thus much more easy to examine.

These crystals then are found after the above treatment to have the following properties, viz. :—

1. They are unacted upon by ordinary acids and alkalies.
2. They remain unattacked even after boiling with hydrofluoric acid and being treated with it for some days, (these crystals were left under hydrofluoric acid from Friday morning until Monday morning).
3. They are extremely hard, and scratch glass and quartz quite easily, and I believe also the sapphire ; but being so minute it is not possible at present to speak absolutely on this point, though I am under the impression that scratches were certainly made.
4. When heated in a platinum crucible before the blowpipe, under a stream of oxygen they quickly glowed away.

Such are the properties of this powder.

It has already been stated that the larger proportion of the powder consisted of graphite, and of this it is not necessary to say more here ; but to turn again to the other crystals, on making a closer examination under the microscope we find them to consist of two different kinds, some being dark-coloured whilst others are perfectly transparent ; we will examine each of these two kinds of crystals separately.

First, the dark-coloured crystals, which are in most cases black, have a perfect octahedral form with curved edges, or in other words have the crystalline form peculiar to the diamond, and to that

substance alone. These crystals I believe to be true diamonds, which are coloured black by amorphous carbon being disseminated through them; indeed, a number of them are not entirely dark-coloured but transmit light, although not sufficiently to admit of their action on polarised light being given. To account for their being coloured in this way, it may be conceived to have occurred in the following manner, as far as the present experiments show:—

The metal on being fused and kept at a temperature considerably above its melting-point, and thus very liquid, dissolves the amorphous carbon until it becomes a perfectly saturated solution. In this state it can take up no more carbon, but there being a large excess of that substance in the impalpable amorphous state present, it becomes disseminated throughout this liquid mass, and when the latter crystallises the amorphous carbon is naturally enclosed in the crystals both of carbon and silver, and thus colours the former. This is also the source from which the amorphous carbon comes that as before-mentioned occurs stuck together in little flocks, along with these crystals, on dissolving the metal, only that of course it was enclosed in the crystals of the metal. This is so perfectly evident that it is unnecessary to say more about it here.

The question to be decided, then, is as to whether these dark crystals are really diamonds? If we consider their method of preparation from pure sugar charcoal, in charcoal crucibles, with pure metal, we see that the only substances they can possibly be are carbon, silver, or platinum (when an alloy of silver and platinum is used). I have not been able to detect the presence of either of the latter substances in them, and consequently believe them to be pure carbon. Moreover, their crystalline form, the perfect octahedra with *curved* edges, is the form of crystal peculiar to the diamond and to it alone, which makes one the more certain that these crystals are real diamonds though coloured. Again, the presence of graphite makes it more probable, and shows that the carbon must have been in such a state of molecular disaggregation as to allow it to pass from the amorphous form to the crystalline condition, and if so, why should it not take the diamond form as well as the graphitic one? which is in fact what has actually taken place. Although, as I have remarked above, the tendency is for the greater portion of this dissolved carbon to crystallise in the hexagonal or graphitic

form when cooling is extended over a long time, probably because working under some to us at present unknown law, it is easier for it to crystallise in that form than in the octahedral or cubical one. This might indeed form a subject for a very interesting research, "Whether any preference is shown by a body crystallising in two forms, to crystallise in one of the forms rather than in that of the other, and under what conditions it takes place to most advantage?"

From what has been said there can now be but little doubt as to whether these crystals are diamonds or not—that in point of fact they certainly are—and the questions now naturally arise as to whether they can be made of sufficient size to be of any practical use or value? if so, at what cost? and finally, whether they can be produced on a large scale without colour and with the lustre of the natural gem, so as to be available for ornamental purposes?

With regard to the first of these questions, Whether they can be made of sufficient size to be of any practical use? It is impossible at present to answer this question, these experiments having been made with only very small quantities of metal (in no case exceeding more than ten ounces), so that it can hardly be said that they have had given them a fair chance. I believe that if experiments were made with large quantities, say with 200 or 300 ounces of metal, one might obtain large crystals which, if even they were coloured, might be of immense value for drills and mining instruments, &c.

Then as regards the cost of production, that would be very slight, indeed only the cost of producing the sugar charcoal in an impalpable powder, as the silver (and platinum in case of an alloy) is all regained from its solution with very trifling loss, so that if the process on a large scale were to be a success, with practice it might be worked with but small expense. The third question as to whether they can be produced transparent and with the lustre of the natural diamond on a large scale is one purely of experiment. I am under the impression that this could be done as soon as one had learnt by practice just the amount of carbon necessary for the complete saturation of the metal and no more—it is probable that then these crystals might be obtained in a perfectly transparent condition possessing adamantine lustre—but after all it is a matter of experiment, and even though they were not produced of this kind so as to be serviceable for ornamental purposes, still if these

“carbonado” diamonds can be produced of sufficient size they will be of immense value.

The greatest advantage of this method of production is its simplicity, there being no difficulty about it, and absolutely no danger. It is exceedingly economical, in point of fact everything that could be desired, there being no useless bye-products formed, as everything can be reclaimed and used over again.

At the time that the preliminary experiment of this research was made, Dr Morrison and I were working together on the solubility of boron in silver, and after the success attending our experiments with boron we were led to try an experiment with carbon also; indeed the original idea with which we started on the research was to try the solubility of the three substances—carbon, boron, and silicon—in the different fused metals. Our first experiment with carbon was most successful, and at the end of our paper on the “Preparation and Properties of Pure Graphitoid and Adamantine Boron,”* we made the following statement:—“The success of the boron experiments led us to try with carbon also, and the results have quite equalled our expectations. We are at present engaged with these experiments, and hope at some future time to lay the results before the Society.” I quote this paragraph to show that as far back as June 17, 1878, when that paper was read, we had produced these bodies and felt justified in making the statement that we had done so, and intimated our method. At this stage of our joint operations we obtained a grant of £20 from the research fund of the Royal Society of London to enable us to continue the research. This we were unable to do jointly, on account of Dr Morrison’s other engagements, and so he finally handed it over to me alone, grant and all complete, to work out by myself. The result has been that after eight months continuous work at it, and the performance of very many experiments, I am now able to lay these results before the Society. I think it right to say, that although after our first experiment Dr Morrison and I felt justified in making the statement above quoted, still I do not pretend to say that we were in a position to make any absolute statement about our results.

Secondly, on examining the transparent crystals, these are found to possess a beautiful adamantine lustre and high refractive and dis-

* Transactions of the Royal Society of Edinburgh, vol. xxviii. p. 689.

persive power, so as to be easily visible even when mounted in Canada balsam. They appear to be of octahedral form, but so far none of them seem to possess curved edges like the dark ones. Unlike the diamond they have a small action upon polarised light; this might, however, be caused by their too rapid cooling. What these crystals are I cannot at present say.

Finally, let me now call attention to the accompanying sketches which I have prepared to show the colour and perfect crystalline form of these different crystals:—

- No. 1 is a crystal of very perfect octahedral form with curved edges, it is almost black, and is magnified about 520 diameters.
- No. 2 is another crystal of the same form but not quite so dark in colour, being more brown; it is magnified to the same amount as the first one.
- No. 5 is another of the same, only in this crystal the third edge can be distinctly seen.
- No. 4 is a crystal of perfect octahedral form but without the curved edges; it is also magnified as the others.
- No. 3 is a fragment of a crystal which exhibits a number of scratches in its surface, most likely caused by the curved edged crystals rubbing against it. It is magnified some 78 times. The scratches were seen by reflected light.
- No. 6 is a sketch of one of the transparent octahedral crystals as already described, and shows its perfect crystalline form and truncated corners; it is magnified some 520 diameters. It was mounted in Canada balsam, but its high refractive power rendered it easily visible. It had a slight action on polarised light.

In conclusion, I may state that a friend who has to deal with large quantities of gold and silver has kindly offered me the opportunity for making experiments on a large scale with 300, 400, or 500 ounces of metal at a time, so this method of production will shortly be put to a practical test. On the completion of these experiments I will bring any further results before the Society.



4. Note on an Electric Sonometer. By Prof. James Blyth.

The apparatus consists of an ordinary sonometer with five feet clear space between the two end bridges, and having a wire stretched from one end to the other. A current from eight or ten Grove's cells, interrupted by a tuning fork which vibrates 128 times per second, is sent through the wire. At a distance about a fifth of its length from the end of the wire a large electro-magnet, with pointed poles, is placed so that the line joining the poles is at right angles to the wires. The poles are also put close to the wire, but leaving it freedom to vibrate. When a current from eight Grove's cells is sent through the coils of the electro-magnet, the wire begins to sound, and by altering its tension the fundamental note of the wire comes out loud and clear. The wire is also seen to be vibrating as a whole; and the vibrations are also seen to be in the plane perpendicular to the line joining the poles. By shifting the electro-magnet a little, and regulating the tension of the wire, it is seen to divide into nodes and loops with one, with two, with three nodes in its length, thus giving the harmonics of the fundamental note.

This effect is due to the interrupted current causing the wire to vibrate across the lines of force due to the electro-magnet; in fact, the magnet appears very much to perform the function of the bow when employed to agitate the wire in the ordinary way.

I have tried different wires—iron, steel, and copper—all with the same result, which shows that the effect is not confined to wires formed of the magnetic metals alone.

This experiment helps to explain the action of the wire telephone, and shows that it is due mainly, if not entirely, to the transverse and not to the longitudinal vibrations of the wire.

By damping the wire at the requisite points along its length, the various notes of the scale can be distinctly reproduced.

All the notes produced are remarkably clear and beautiful, and the effect of a slight alteration of tension in altering the tone is very marked.

It is easy to see how an apparatus on this principle could be constructed for repeating Helmholtz's experiments on the vowel sounds.

5. Theory to account for certain movements exhibited by low forms of Animal Life, and termed Amœboid. By John B. Haycraft, Senior Demonstrator of Physiology in the University of Edinburgh.

A large number of unicellular plants and animals, and many of the cellular units which make up the complex tissues of man and more evolved animals, exhibit certain movements. These are termed "Amœboid," as they are well seen, and were at an early period studied in the Amœba.

If an amœba or a white blood corpuscle of the newt be examined with a good lens, the following facts, among others, may be made out. The corpuscle looks like a granular lump of jelly containing two or three nuclei, and it is, we will suppose, spherical to begin with. Soon the shape changes, for a little process is seen to protrude at one side, which may become retracted, or go on elongating. In the substance of the cell and in the processes, movements may be observed, consisting evidently of a flowing of the protoplasm, as indicated by the embedded granules which are carried along. The little processes are termed pseudopodia, and vary much in shape, some being thick and either pointed or club-shaped, others are filamentous, as in the perforated Foraminiferæ, where large numbers of these are seen radiating from the test. These movements may be automatic, and they are modified by various external forces; for example, heat and electricity.

I shall now endeavour to account for the throwing out and subsequent retraction of these little pseudopodia, pointing out, it may be, but one factor, but that a probable one.

Various theories have been already advanced (Brücke, Hermann, Engelmann), which, for want of a better name, we may call geometrical: they would account well enough for the protrusion of processes had we the slightest evidence to suppose the imagined structures to exist.

The simplest of these supposes that, if at a certain spot on the surface of the cell a pseudopodium is to be protruded, contraction occurs along a chord of the segment, including this spot. Such a contraction could no doubt produce a protrusion, but it is gratuitous

to suppose that these creatures can extemporise chords of contractile tissue at will, and it explains in no way the subsequent retraction of the process.

Within the last ten years, histologists, working at the ultimate structure of the cell, have brought to light facts which may bear upon this point,—facts in morphology the functional significance of which is not yet clearly known.

Flemming, Strassburger, Klein, and others, have shown that “protoplasm” consists of two parts,—(1) a network or stroma, and (2) an interstromal matter filling up the meshes of the stroma. All cells which have as yet been examined show these two parts both in the mass of the cell and in the nucleus. This stroma is an anatomical whole, although no doubt subject to slow changes during growth and division, as is the cell itself. In various cell-units the arrangement differs somewhat, but these general points may be alluded to.

The stroma is a closed meshwork (not a stellate arrangement of particles), the tissue of which it is composed joining and anastomosing often, and at short intervals. The stroma is in connection with the nuclear wall, and with that of the cell if it be present.

Now, in many cells this network has a distinct mechanical function. In the ciliated cell, as Klein believes, the stroma is the mechanism productive of the movements of the cilia. In involuntary non-striped muscular fibres the fibrils are homologues of the stroma, although they do not anastomose, being arranged in parallel series. The same holds good for the voluntary striped fibre, where the fibrillæ representing the stroma (the cement is the homologue of the interstromal substance) perform the important function characteristic of the tissue—namely, contraction. It is seen then that in many cells the *stroma has a mechanical action possessing the power of contractility*, which, however, is not the case with the interstromal matter.

In those corpuscles which exhibit amoeboid movements, may not these be due to some contractions of the stroma which they, in common with other cells, possess?

I may mention here that movements of the stroma of the white

corpuscles have been observed (Stricke) ; and in cell division, which is always associated with very slow change of shape or movement, the stroma certainly alters in a very marked manner (Flemming, Klein).

It may at first sight be thought that a pseudopodium is produced by a change (either of shortening or elongation) of part or the whole of the stroma, whereby a part of it protrudes as a process. This may be the case, but there are certain difficulties in accepting this view. The stroma is a closed network, and therefore the meshes must be broken up in order to allow of a portion of it at the surface to be separated from the rest in the form of a process ; the superficial parts must be, in fact, torn away from those subjacent. Besides this, the substance of the pseudopodium is more fluid than that of the cell mass, looking in general very hyaline and uniform, although in some cases granules may be observed in its substance. The pseudopodia, moreover, are often very fine, quite as fine in fact as a strand of the meshwork itself.

Although no doubt a cell can change very considerably in form, due to the contractility of the stroma, the relations between the stroma and interstromal matter being inconsiderably altered, yet probably many at least of the pseudopodia, for the reasons given above, are formed in another way. They consist probably of the interstromal matter, or portions of it, projected outwards by the contractions of the stroma, which I imagine to occur in the following manner :—The stroma contracts at every part except where the pseudopodium springs from, forcing the interstromal matter at this point through the aperture left patent.

This accords well with the fact that the pseudopodia seem actually to be projected always as radia from the cell, and that they are of a very hyaline nature. The difficulty is to comprehend the forces engaged in their retraction. There are probably at least three, —(1) the relaxation of the stroma ; (2) the viscosity of the substance, and (3) surface tension, in virtue of which a body tends to assume the spherical shape.

Now this may be very well theoretically, but are these three factors equal to the occasion is the question before us ? I have imitated the structure of the amœba in the following way :—

An india-rubber ball is pierced by two or three holes near together; these should be about the diameter of a common darning needle. A larger aperture (half-an-inch across) is then made in the ball, but opposite to the smaller holes, and the ball half-filled with white of egg (unboiled) tinted with magenta. The ball represents the stroma, while the white of egg takes the place of the inter-stromal matter. The ball is now dipped into a beaker of water to which sugar has been previously added, until its specific gravity is equal to that of white of egg. Place a finger over the aperture through which the ball was filled, and press upon it with the other fingers of the same hand. Beautiful little magenta-stained pseudopodia will be projected from the small apertures into the sugar solution, and on relaxing the pressure, still keeping the finger over the aperture above, the pseudopodia will be completely retracted. I have been able in this way to project them three or four inches, and afterwards they have been completely retracted (the experiment was thus successfully performed in the Society's rooms).

One might use common water in place of the sugar solution, but as the specific gravity of the white of egg is greater than that of the water, the pseudopodia, when they have been projected more than an inch or so, break off and fall to the bottom. The size of the aperture is also rather a nice point, for there is one size—roughly $\frac{1}{8}$ th inch in diameter—which is best suited for the white of egg, although any sized aperture will answer, though not so well. This no doubt varies with the fluid used;—ordinary ink may be substituted for the white of egg, and oil for the sugar solution.

I cannot but believe, that in the stroma the active cause for these movements is to be sought for, and, as far as I can see, it must act in one or other of the two ways described above, of which I think the last is least in antagonism to known facts.

While, no doubt, many of the bulgings seen in the white corpuscle of the newt's blood are due to changes in shape of the whole cell, probably with slight local accumulation of interstromal matter; yet may it not be that many of those fine hyaline processes are but interstromal matter projected from the cell?

There are, of course, many other phenomena exhibited by these cells, which I do not attempt to explain. For instance, there are stream movements seen in the cell, and even in the pseudopodia themselves. These are probably purely molecular, and may be the result of heat; for many curious movements and currents are to be observed in heating liquids, and especially a mixture of dissimilar ones.

If oil suspended in water, or acetic acid on a glass slide, be heated, as certain temperatures are reached flowing movements of a very curious nature are to be observed not unlike the streaming of protoplasm. This explanation has received a wider extension by Professor Rindfleisch ("Centralblatt," Oct. 23, 1880), who would account for much more upon this one factor.

That the above views are merely speculative, and views which may have eventually to be withdrawn, I need hardly say. It is natural and right to ask, when a new anatomical structure is discovered, What are its functions?

The paper of Professor Rindfleisch was not in my possession when I introduced this subject to the Society. I have taken, however, the liberty of mentioning its main contents.

Monday, 3d January 1880.

Professor DOUGLAS MACLAGAN, M.D., Vice-President,
in the Chair.

The following Communications were read:—

1. On the Effect of Permanent Elongation on the Specific Resistance of Wires. By Mr T. Gray. Communicated by Sir William Thomson.
2. Meconic Acid. By Mr D. B. Dott. Communicated by Professor Crum Brown.

Although meconic acid is constantly taken, even in the most recent handbooks of chemistry, as an instance of a tribasic acid, it is

by no means certain that it possesses that nature. Some years ago, Dittmar and Dewar* investigated the matter, and came to the conclusion that meconic acid is dibasic though triatomic; but their experiments are not supposed to completely elucidate the subject. All published statements regarding this acid are consistent with it being only dibasic, if we except one or two analyses of its metallic salts. Only two ethyl ethers are known, while hydromeconic acid, which is formed from meconic acid by the action of sodium-amalgam, forms dibasic salts alone. With morphia and with aniline tribasic compounds are not known, though the dibasic salts are easily prepared.

There can be no doubt that the chief reasons for assuming the tribasic nature of meconic acid, are the statements which have been made concerning the composition and properties of the silver and lead salts, notably of the former. The object of the present paper is to prove that the alleged facts regarding these compounds do not rest upon solid ground.

The meconic acid used in the experiments hereafter described was carefully purified, being obtained in the form of well-defined prisms perfectly free from colour. No impurities for which it was tested were found to be present, and the acid neutralized the required proportion of standard alkali.

I. *Meconates of Lead.*

(1.) Prepared by adding solution of lead acetate in excess to aqueous solution of meconic acid. Even after long-continued washing the precipitate still yielded to the filtrate lead and meconic acid, showing that the salt is not insoluble, as is sometimes stated. After drying at 120° C. the meconate was ignited, and the residue ignited with ammonic nitrate to oxidize the metal.

8.295 grs. gave 4.22 grs. PbO = 50.87 per cent.

8.260 „ 4.20 „ = 50.84 „

(2.) This salt was prepared in the same way as the above, at least there was no difference noticed in the method of procedure.

47.50 grs. gave 26.70 grs. PbO = 56.21 per cent.

* Proc. Roy. Soc. Edin. 1867.

(3.) Another salt similarly prepared.

20.11 grs. gave 12.06 grs. = 59.96 per cent.

(4.) In this case the precipitate was produced by mixing solutions of lead acetate and neutral ammonium meconate

22.60 grs. gave 14.64 grs. PbO = 64.77 per cent.

(5.) This salt was prepared by adding solution of lead acetate to solution of neutral morphia meconate.

6.69 grs. gave 4.07 grs. PbO = 60.76 per cent.

$\text{PbC}_7\text{H}_2\text{O}_7 = 55.06$ per cent. PbO.

$(\text{PbC}_7\text{H}_2\text{O}_7)_2\text{PbO} = 64.76$ per cent. PbO.

$\text{Pb}_3(\text{C}_7\text{HO}_7)_2 = 65.91$ " "

$\text{PbC}_7\text{H}_2\text{O}_7\text{PbO} = 71.01$ " "

From these results it is manifest that the precipitates obtained as above described are of variable composition, and are probably mixtures of different salts. Stenhouse* prepared several basic salts, one of them containing as much as 64.7 per cent. of lead oxide. I believe it is this tendency of meconic acid to form basic salts, which has led to the belief in its tribracidity.

II. Meconates of Silver

(1.) Prepared by adding nitrate of silver in excess to solution of neutral ammonium meconate. Precipitate dried at 100° C.

9.82 grs. gave 3.44 grs. Ag = 35.03 per cent.

12.77 " 4.47 " = 35.00 "

(2.) This precipitate was produced by adding excess of silver nitrate to alkaline solution of ammonium meconate, the product being dried at 120° C.

10.050 grs. gave 4.86 grs. Ag = 48.35 per cent.

9.745 " 4.72 " = 48.38 "

(4.) Prepared by mixing solutions of ammonium meconate and silver nitrate, the former being in excess. Precipitate dried at 100° C.

10.215 grs. gave 5.195 grs. Ag = 50.85 per cent.

9.310 " 4.705 " = 50.53 "

* Gmelin's Handbook, xii. 428.

(5.) Prepared by mixing solutions of meconic acid and nitrate of silver, the resulting precipitate being dried at 120° C.

6.46 grs. gave 3.42 grs. Ag = 52.94 per cent.

(6.) Prepared by adding argentic nitrate to solution of neutral meconate of ammonia. Dried at 120° C.

8.035 grs. gave 3.385 grs. Ag = 42.12 per cent.

(7.) Prepared in the same way as the preceding.

12.410 grs. gave 5.705 grs. Ag = 45.97 per cent.

(8.) Prepared by mixing solutions of silver nitrate and neutral morphia meconate. Precipitate dried at 120° C.

6.11 grs. gave 3.41 grs. Ag = 55.81 per cent.

(9.) A quantity of argentic meconate prepared by precipitation was boiled for a few hours with water, the residue then dried and ignited.

6.075 grs. gave 3.785 grs. Ag = 56.45 per cent.

(10.) Another portion of the same salt was boiled in water for twenty-four hours.

2.840 grs. gave 1.725 grs. Ag = 60.73 per cent.

(11.) Another portion boiled for forty hours, and the residue similarly ignited.

6.065 grs. gave 5.390 grs. Ag = 88.87 per cent.

(12.) A quantity of argentic meconate, formed by mixing solutions of nitrate of silver and meconate of ammonia, was boiled with water for forty hours and the resultant substance ignited.

3.67 grs. gave 2.84 grs. Ag = 77.38 per cent.

$\text{AgC}_7\text{H}_3\text{O}_7 = 35.17$ Ag per cent.

$\text{Ag}_2\text{C}_7\text{H}_2\text{O}_7 = 52.17$ „

$\text{Ag}_3\text{C}_7\text{HO}_7 = 62.18$ „

When the experimental results above described are compared with the numbers just given, it will be noticed that in no case do

the figures correspond, while in Nos. 11 and 12 the percentage of silver is far above that required for the triargentate salt. Wackenroder* appears to have been the first to afford the information that a tribasic meconate of silver is produced by precipitation, when the ammonium meconate is used, and that the same salt is formed by boiling the diargentate meconate with water. These statements, though generally accepted as correct, are not borne out by anything I have observed. Doubtless, if in boiling the meconate of silver with water the operation be stopped at a certain point, the product will have apparently the composition of the triargentate salt; but then, if the boiling be continued, the percentage of silver increases, until probably there is nothing but oxide of silver left. There is therefore no evidence that a tribasic meconate has been prepared, and we are not, so far as I can see, in possession of any information which should lead us to suppose that meconic acid is tribasic.

3. On the Crystallization of Silica from Fused Metals. By R. Sydney Marsden, D.Sc., F.R.S.E., F. Inst. Chem., &c.

The crystallization of silica from fused metals, although at first sight appearing to be of little importance, nevertheless presents some features of peculiar interest. It also constitutes a field almost entirely new to the investigator, though the subject is one which, from a technical point of view, may prove to be of very considerable importance.

I have therefore undertaken the examination of some of the facts relating to this subject—at first more particularly inquiring into the nature of the change which occurs when silica itself is kept at a high temperature for a number of hours and subsequently submitted to a process of very slow cooling.

The substance which formed the basis of these operations, and in which the changes hereafter mentioned were noticed, consisted of several Berlin porcelain crucibles, in which, in the course of some other experiments, I had reason to keep metallic silver and amorphous carbon at a temperature considerably above the melting point of the former, for a number of hours, and subsequently

* Gmelin's Handbook, xii. 430.

submit them to a cooling process extending over some twelve or fourteen hours.

Whilst pursuing the other experiments, on dissolving the silver afterwards in nitric acid, it yielded from its interior a number of very beautiful laminae or leaf-shaped crystals of the hexagonal system, and varying in colour from light yellow to dark brown or even black, which at first sight I mistook for graphite, formed by the solution of the carbon in the silver and crystallizing out from it in this characteristic form.

There were also present a number of other crystals in the form of hexagonal prisms or crystalline aggregates, but these were in many, if not in all cases, perfectly colourless and transparent. It may be mentioned that some of them appeared to possess the curved form sometimes met with in quartz, and given in fig A.

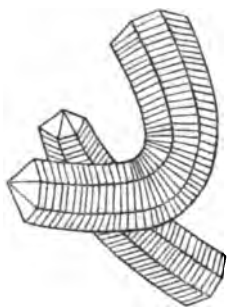

Neither hydrochloric acid nor nitric acid had any action upon them, but on treating them with boiling hydrofluoric acid for some time, they quietly dissolved, and the same thing occurred when they were boiled with a strong solution of caustic potash.

This perplexed me at first with regard to the leaf-like forms, for it was perfectly clear that they were not graphite, and I could not find that silica was known to crystallize in that manner. It was evident the silver must therefore have been in contact with the porcelain crucible, and these crystals in this way derived from it.

The thing to be done then was to have some microscopic sections made of the different crucibles,—first of one which had not been heated, and then of those which had been used in the experiments in order to see what effect the heat had had upon them. In this way it was possible to compare the two side by side, and what I found was this, that the alumina portion of the crucible had undergone little or no change, but that the glaze of the crucible, consisting of silica, which, in the original condition, was in a perfectly homogeneous and vitreous state after the heating, had become one mass of little crystals in the form of hexagonal prisms. Here then was a clue to what these unknown crystals were, namely, silica.

The prismatic crystals were evidently derived from this source, and simply occurred diffused through the silver by having been taken in through the action of convection currents, which still operated—after they had been produced through the cooling of the silica to the temperature necessary for their formation—whilst the silver yet remained in a perfectly liquid condition.

The leaf-like crystals, it was easily to be conceived, were from the same source; but the question naturally arises, as to what led the portion of the silica of which they were composed to crystallize in this peculiar graphite-like form instead of in its usual prismatic one, as it had done in the glaze of the crucible, where it had not been in contact with the metal?

To account for this, it is conceivable that here we had silica in quite a different state from what it is when heated by itself—namely, in a state of *solution*, in the silver (not suspension), and that in this condition of solution it is capable of undergoing what we may designate as a molecular disaggregation, owing perhaps to some influence of the silver, and thus to be capable of arranging itself in these new forms.

At first I thought that possibly these crystals might be composed of silicide of silver, for it is stated (“Watts’s Dictionary,” vol. v. p. 241) that “silica is decomposed by carbon in the presence of silver at a white heat, carbonic acid and a silicide of silver being formed.”

Be this as it may, these experiments do not appear to confirm this statement; for although they were conducted at a temperature a little above the melting point of steel, yet, on testing the solution of these crystals for silver, it was not possible to detect the slightest trace of that metal.

Their colour I believe to be due either to amorphous-carbon in a state of extremely minute division being disseminated through them, or perhaps to the presence of a very slight trace of iron which might be derived from the other part of the crucible. Accompanying this paper are some sketches showing the beautiful form and colour of several of these crystals, and in which they are enlarged about 320 diameters.

A study of the crystallization of silica from iron, and the effects which it produces in so doing, seems likely to yield some results of

a most interesting nature. While the subject of the solution of different bodies in fused metals, although up to the present time it

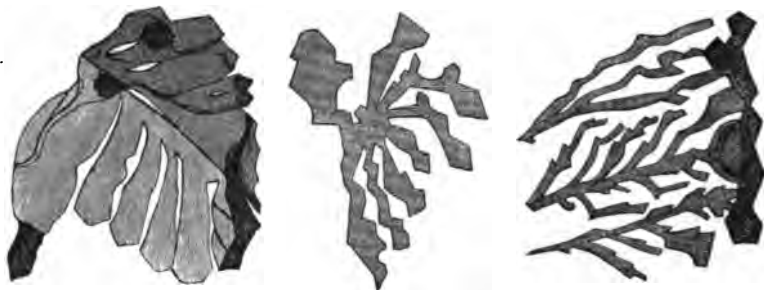

appears to have been almost entirely neglected, will also probably yield a rich harvest, and explain to us many things which are at present but imperfectly understood.

The further development of this research is in progress.

4. On Phosphorus Betaines. By Professor E. A. Letts.

(Abstract.)

The experiments of Professor Crum Brown and the author on the "Thetines" and their derivatives* have clearly shown that very striking analogies exist between certain compounds of nitrogen and sulphur. Thus sulphide of methyl closely resembles trimethylamine (and ammonia), in many of its reactions, and in the products which it gives rise to. Like trimethylamine it combines with a molecule of bromacetic acid, and the resulting product, which was named hydrobromate of dimethyl-thetine, behaves in certain respects like the compound of bromacetic acid and trimethylamine (hydrobromate of betaine).

Analogous phosphorus compounds have been obtained: in the ethyl series by Hofmann,† in the methyl series by A. H. Meyer.‡ The latter compound is simply the betaine salt in which the

* *Trans. Roy. Soc. Ed.* xxviii.

† A. W. Hofmann, "*Proc. Roy. Soc. Lond.*" xi.

‡ A. H. Meyer, "*Berichte d. deutsch. chem. Ges.*" iv. 734.

nitrogen is replaced by phosphorus, and may be called a salt either of *phosphorus-betaine* or of *trimethyl-phosphorus-betaine*. In the paper before alluded to by Professor Crum Brown and the author, the opinion was expressed that the compounds of thetine would probably show greater analogies with these bodies than with the compounds of betaine itself.

The author's experiments were undertaken with the view of testing the correctness of this opinion.

As the phosphorus betaines had only been subjected to a cursory examination by Hofmann and Meyer, it was deemed essential, in the first place, to prepare them in the pure state and in large quantities, and to determine their chief properties. This has been done, but has necessitated a large expenditure of time, owing to the difficulties experienced in preparing the material necessary for the research. The author's first experiments were made in the methyl series, but, owing to the difficulty he experienced in preparing the necessary trimethyl-phosphine, it was decided to operate in the ethyl series.

The triethyl-phosphine was prepared by Hofmann and Cahours' method, viz., by treating zinc ethyl with terchloride of phosphorus. This method the author has found to give excellent results, and recommends it as far more certain than the later process which Hofmann discovered, viz., heating alcohol to 180° with phosphonium iodide.

The earlier attempts which the author made to prepare the compounds of phosphorus betaine, were made with bromacetic acid and triethyl-phosphine, but without success. An interesting body was however obtained, which will be described in another communication.

Action of Chloracetic Acid on Triethyl-phosphine.—Triethyl-phosphine, when added cautiously to chloracetic acid, dissolves the latter, and on shaking the mixture a dense oily layer separates; much heat is evolved, and it is necessary to cool the vessel in which the operation is conducted by immersion in cold water. If the experiment is properly conducted, the oily liquid solidifies in about an hour to a mass of colourless crystals. This is easily soluble in alcohol, but is precipitated in long colourless needles by the cautious addition of ether to the hot solution.

The analysis of the body thus purified, and of its chloroplatinate, leaves no doubt as to its composition. It is the hydrochlorate of triethyl-phosphorus-betaine, $(C_2H_5)_3PO_2HCl$, formed by the direct union of one molecule of chloroacetic acid with one of triethyl-phosphine

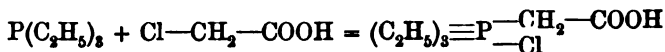

Contrary to expectation and to Hofmann's statement, it is not perceptibly deliquescent, and may be exposed to the air for days without liquefying. It has a sour taste and acid reaction.

Its *chloroplatinate*, $(C_2H_5)_3PO_2HCl)_2PtCl_4$, forms somewhat soluble crystals of a light orange colour, which may be obtained of large size.

The *sulphate*, $(C_2H_5)_3PO_2)_2SO_4$, obtained by acting on the hydrochlorate with sulphate of silver and evaporating the solution *in vacuo*, forms a solid crystalline mass. It was not analysed owing to its deliquescence.

The *base*, $(C_2H_5)_3PO_2)OH$, was obtained from the hydrochlorate by the action of oxide of silver and subsequent evaporation of the solution *in vacuo*. It is crystalline but extremely deliquescent. Exposed for some months *in vacuo* over sulphuric acid, it loses a molecule of water, and is converted into the anhydrous base*

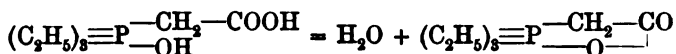

The anhydrous base was analysed.

Ethyl-chlorate of Triethyl-phosphorus-betaine. — According to Hofmann (*loc. cit.*) chloroacetic ether combines with triethyl-phosphine with the evolution of heat, and formation of a brownish liquid of considerable consistency. On repeating this experiment the author obtained a colourless syrup which solidified after a few minutes to a colourless crystalline mass.

The ethyl-chlorate thus obtained is extremely deliquescent, and cannot be recrystallised.

Its composition was verified by the analysis of its platinum salt,

* The base dimethyl-thetine behaves in a similar manner.

which is easily obtained in light orange-coloured plates on mixing aqueous solutions of the ethyl-chlorate and chloride of platinum. It is somewhat soluble, and may be recrystallised from boiling water. Its composition is represented by the formula.



Action of Oxide of Silver on Ethyl-chlorate of Triethyl-phosphorus-betaine.—Hofmann states (*loc. cit.*) that the following reaction occurs when oxide of silver acts on the ethyl chlorate.

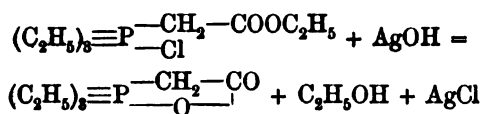

The author finds that this statement is correct, but noticed that when the two bodies are mixed (in aqueous solution) a strong smell of acetic ether is developed. He thinks it probable that a second reaction occurs which may be represented thus—

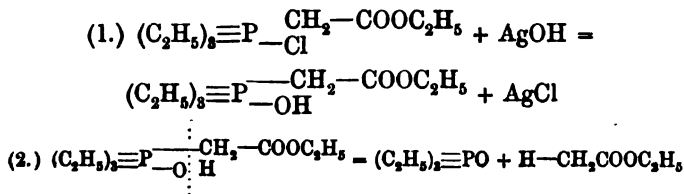

Ethyl-bromate and Ethyl-iodate of Triethyl-phosphorus-betaine were obtained by the direct union of bromacetic and iodacetic ether with triethyl-phosphine: they resemble the ethyl-chlorate in their properties and reactions.

Action of Heat on the compounds of Triethyl-phosphorus-betaine.—In his paper on the action of heat on the compounds of dimethyl-thetine* the author showed that the latter experience two kinds of decomposition when heated: the *haloid* salts yield thio-diglycollic acid and a compound of trimethyl-sulphine, whilst the *oxy* salts split up into carbonic anhydride and a salt of trimethyl-sulphine.

* Trans. Roy. Soc. Edin. vol. xxviii.

Thus the hydrochlorate and hydrate decompose in the following manner:—

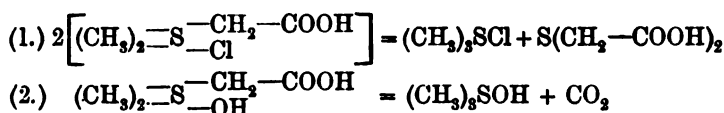

The author has investigated the action of heat on the compounds of triethyl-phosphorus-betaine to ascertain whether they would behave like the thetine compounds.

Action of Heat on Ethyl-bromate of Triethyl-phosphorus-betaine.
—The ethyl-bromate, when heated, fuses, effervesces, grows brown, and solidifies after some time. When this has occurred but little more gas is evolved. The solid product may be crystallised from chloroform, and its analysis shows that it is the bromide of triethyl-methyl-phosphonium $(\text{C}_2\text{H}_5)_3(\text{CH}_3)\text{PBr}$. The chloroplatinate obtained from it by the action of oxide of silver, and then of chloride of platinum on the filtered solution, crystallises in very characteristic orange-coloured octohedra with truncated edges. The formula

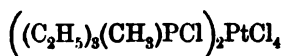

was verified by analysis.

The gas evolved consists in large measure of carbonic anhydride. The *ethyl-chlorate* behaves, when heated, like the ethyl-bromate, yielding chloride of triethyl-methyl-phosphonium. The author carefully examined the gaseous products of the reaction, and found that they consisted mainly of carbonic anhydride and ethylene. The decomposition which the ethyl-chlorate suffers when heated, may be represented by the equation

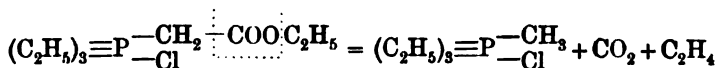

and that of the ethyl-bromate in a similar manner.

Action of Heat on Hydrochlorate of Triethyl-phosphorus-betaine.—The action of heat on the hydrochlorate is much more definite than in the case of the bodies just mentioned. The hydrochlorate, when

heated, fuses, effervesces, and suddenly solidifies, giving a pure white product. The gas evolved consists of pure carbonic anhydride. The decomposition occurs quantitatively according to the equation

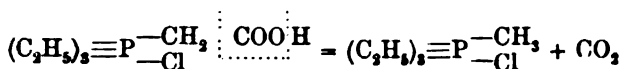

The composition of the phosphonium salt was verified by the characteristic crystalline form, and by the analysis of its chloroplatinate.

Action of Heat on Sulphate of Triethyl-phosphorus-betaine.—The sulphate behaves, when heated, in the same manner as the hydrochlorate, the products of its decomposition consisting of carbonic anhydride and sulphate of triethyl-methyl-phosphonium.

Action of Heat on the Base Triethyl-phosphorus-betaine.—The decomposition which the base suffers when heated is very interesting.

When preparing the base it was noticed that, if its aqueous solution be concentrated by boiling, a faint odour of triethyl-phosphine is developed, and that when the concentrated solution is placed *in vacuo* it effervesces and eventually solidifies.

It now, when treated with acids (even tartaric acid), effervesces, and has a faint *acid* reaction. In fact, it behaves as a *bicarbonate*, and there can be little doubt that the base when heated, suffers an isomeric change — bicarbonate of triethyl-methyl-phosphonium resulting—

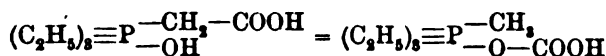

The production of the phosphonium salt was proved by the analysis of the chloroplatinate, as well as by the characteristic crystalline form of the latter.

The experiments just described show that a close and interesting analogy exists between the compounds of phosphorus-betaine and of thetine.

This is the more interesting, as the same analogies do not exist between these two classes of compounds, and the corresponding nitrogen compound (betaine), the salts of the latter when heated

suffering dissociation into trimethylamine and a derivature of acetic acid, or simply volatilizing without change.

The predictions of Dr Crum Brown and the author have thus been verified.

5. On the Action of Haloid Compounds of Hydrocarbon Radicals on Phosphide of Sodium and on the Salts of Tetra-Benzyl-Phosponium. By Professor Letts and N. Collie, Esq.

(*Abstract.*)

The difficulty of preparing tertiary phosphines either by heating alcohols with phosphonium iodide or by acting on zinc ethers with terchloride of phosphorus, of which we have had much experience, induced us to seek for other and less troublesome methods for obtaining these bodies in considerable quantity.

The ease with which phosphorus combines with certain metals, and the readiness with which the resulting compounds react on haloid ethers of hydrocarbon radicals led us to think that, if only comparatively pure metallic phosphides could be obtained by a simple process, we should have no difficulty in preparing the tertiary phosphines and phosphonium compounds.

This is no new notion,—all the earlier experiments* to obtain phosphines having been made by the action of metallic phosphides on the chlorides and iodides of hydrocarbon radicals. Hofmann employed sodium phosphide, but eventually gave up the method on account of the uncertainty of the reaction, the frequent explosions in operating on the phosphide of sodium, and the great difficulties experienced in separating the resulting phosphines from each other, "not to speak of the difficulty of obtaining the phosphide of sodium fit for the reaction."

In experiments which we have made with this method in the ethyl and benzyl series we have not experienced the difficulties of which Hofmann and others speak.

* Paul Thenard, "Compt. Rend.," xx. 144, and xxv. 892; Berlé, "Journ. für prak. Chem.," 66, 73; Cahours and Hofmann, "Compt. Rend.," xli. 818; Drechsel and Finkelstein, "Ber. deut. Chem. Ges.," iv. 352.

Our researches on the action of iodide of ethyl on phosphide of sodium are still proceeding, but those on the action of chloride of benzyl on the same body are sufficiently advanced to warrant us drawing attention to them.

The preparation of phosphide of sodium is accomplished without difficulty or danger by melting sodium in xylol and adding phosphorus in small pieces. It depends, however, entirely on the manner in which the phosphide is made, and on the proportions of phosphorus, sodium, chloride of benzyl and xylol taken as to the quantity and nature of the resulting phosphine compounds.

The chief product of the reaction is the chloride of tetra-benzyl-phosphonium, which is probably formed according to the equation

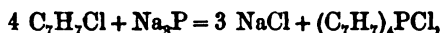

but the quantity formed may in an ill conducted experiment be as low as 1 per cent. of the theoretical amount, whereas with proper proportions of the substances giving rise to it we have succeeded in obtaining over 40 per cent. with certainty.

The proportions and exact method of procedure we propose to give in another paper, contenting ourselves for the present by saying that it is possible to prepare 60 grammes of almost pure chloride of tetra-benzyl-phosphonium in about five hours. We believe that this result could not be obtained by either of the ordinary methods for preparing phosphines.

Hofmann* has investigated mono- and di-benzyl phosphine, but so far as we are aware tri-benzyl-phosphine and the salts of tetra-benzyl-phosphonium have not hitherto been obtained.

Chloride of tetra-benzyl-phosphonium, $(\text{C}_7\text{H}_7)_4\text{PCl}$, is dissolved out of the product of the action of chloride of benzyl on phosphide of sodium by boiling water and crystallises when the filtered aqueous solution cools in magnificent needles which may attain the length of an inch and a half.

By recrystallisation from boiling water it may be obtained colourless and pure. It contains water of crystallisation which it loses when heated. The dried compound melts at about 224° —

* Hofmann, "Ber. deut. Chem. Ges.," iv

225° C. (uncor.). Its composition was verified by determinations of carbon, hydrogen, and chlorine.

Chloroplatinate of tetra-benzyl-phosphonium, $2(C_7H_7)_4P\text{Cl}, PtCl_4$.—Mixed with chloride of platinum the preceding body yields in alcoholic solution insoluble leaflets of a light orange colour, in aqueous solution a light yellow precipitate of the chloroplatinate of tetra-benzyl-phosphonium.

Its formula was verified by determination of its carbon and hydrogen.

The chloroplatinate is very slightly soluble in water and alcohol.

Acid sulphate of tetra-benzyl-phosphonium, $(C_7H_7)_4PHSO_4$.—Up to the present time the normal sulphate has not been obtained. The acid sulphate is formed either by treating a solution of the chloride with sulphate of silver, or warming the dry chloride with strong sulphuric acid. It is more soluble than the chloride, and separates in plates from a hot and somewhat concentrated aqueous solution.

Its analysis (carbon, hydrogen, and sulphuric acid) showed that it has the composition

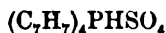

It is remarkable that the acid sulphate is obtained from the chloride and sulphate of silver instead of the normal sulphate.

Action of Caustic Baryta on Acid Sulphate of Tetra-Benzyl-Phosphonium.—The action which occurs when solutions of these two bodies are mixed, varies in a remarkable manner with the conditions of the experiment.

In our earliest attempt to prepare the hydrate of tetra-benzyl-phosphonium by this reaction, we failed to obtain any body easily soluble in water as we expected the hydrate would be. On repeating the experiment we however obtained an easily soluble body which turned out to be the hydrate, but on attempting to prepare more of it we were again unsuccessful.

We found, however, that although no body soluble in water was formed, boiling alcohol took up from the precipitated sulphate of barium a considerable quantity of a substance which was deposited in crystals as the solution cooled.

Later experiments have shown us that the hydrate is only formed

when very dilute solutions of the acid sulphate and caustic baryta are taken, whilst on the other hand the insoluble body appears to be the only product when concentrated solutions are employed.

The analysis of the insoluble product led us to the very unexpected result that it was the oxide of tri-benzyl-phosphine. The formation of this body is only intelligible on the assumption that it arises from the breaking up of the hydrate, and that toluol is produced along with it—

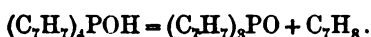

That this is the explanation of its formation was easily verified by mixing the solutions of the acid sulphate and caustic baryta in a distilling flask connected with a condenser, and boiling the mixture.

An oily liquid passed over which was lighter than water, and had all the properties of toluol, and its amount agreed with the quantity demanded by theory. This reaction which we have described is perfectly analogous to the behaviour of tetrethyl phosphonium hydrate when heated*

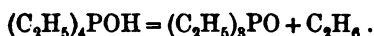

But we think it remarkable that the hydrate of tetra-benzyl phosphonium should break up so easily.

Hydrate of tetra-benzyl-phosphonium.—This body is obtained when boiling solutions of the acid sulphate and caustic baryta are mixed—provided as just stated the solutions be very dilute. It separates from the solution filtered off from the sulphate of barium, (formed at the same time) after considerable concentration, *which we always effected by boiling.*

The hydrate is very soluble, and crystallises easily in transparent tables of striking refractive power. Its composition was verified by determinations of hydrogen and carbon.

Like other soluble compounds of tetra-benzyl-phosphonium the hydrate, even in very dilute solutions, is precipitated by hydrochloric acid, the chloride resulting.

We are engaged in preparing other salts of tetra-benzyl-phosphonium, and in investigations on them, especially the action of

* Hofmann, "Phil. Trans.," 1857.

heat, which in one or two cases has already given interesting results.

We propose also to study the action of phosphide of sodium on other haloid derivatives—especially on chloride of phenyl.

6. Notice of an Easy Method for determining the Position of the Principal Focus of an Object-Glass. By Edward Sang.

Just as the past progress of astronomy has, in a great measure, been due to the improved construction of our instruments, so its future progress must depend much on the accurate confection of our telescopes, and most of all on the excellence of the object-glasses.

In the actual formation of a compound lens, after the thicknesses and curvatures have been fixed, we have to make the tools to the proper shapes and with those to grind and polish the glass. It is impossible, even with the greatest care, to bring the workmanship so close to the computations as that appreciable differences may not be found, and hence the finished lens hardly ever comes so near to our expectations as that it may not be necessary to test it by actual trial. One important matter to be so settled is the exact position of the principal focus, since that is needed for determining the length of the tube.

The obvious course of procedure is to place the lens in a temporary frame and to direct it to the sun, to a star, or to some very remote terrestrial object. This, however, requires clear air and open space such as is not always to be had in a large town. To bring the whole operation within the limits of the workshop I have had recourse to the following expedient:—

The lens, in its setting, is secured against the surface of a flat mirror or speculum, and is set up on a table of sufficient length. A well illuminated object is then placed approximately in the focal plane. The light from this object, after having passed through the lens is reflected from the mirror and again passes through the lens, being converged to form an inverted image.

If the object be placed within the focal distance, the image will

be formed beyond ; the true focal distance for parallel rays being the harmonic mean between the two. Hence, if we modify the position until the object and its image coincide, we shall have the exact position of the principal focus ; always, however, subject to the condition that the mirror be quite flat.

A convenient plan is to draw two strong lines crossing each other on a piece of stiff paper, repeating them exactly on the other side, and then to cut the paper in two through the centre of the cross ; using only the one part. The exact completion of the half-cross by its image is a severe test of the adjustment, and the motion of the eye across the field at once detects any parallax. A hand eye-glass of say one inch in focal length should be used in the examination.

7. Note on the Temperature Changes due to Compression.

By Professor Tait.

The author described the results of a number of experiments, made during the examination of the "Challenger" Deep-Sea Thermometers, with the view of testing, at pressures of 3 tons weight per square inch and upwards, Thomson's formula for the heat developed by compression (Proc. Roy. Soc., 1857, p. 568).

When, for instance, the bulb of one of the thermometers was surrounded by a shell of lard upwards of half an inch thick, the total effect produced by a pressure of $3\frac{1}{2}$ tons weight was 5° F. ; while for the same pressure, without the lard, the effect was only $1^{\circ}8$ F. The temperature of the water in the compression apparatus was 43° F., so that the temperature effect due to the compression of water was less than $0^{\circ}2$ F. In obtaining this number it was assumed from Kopp's experiments that the coefficient of expansion of water at a temperature t° C., near its maximum density point (roughly, 4° C.), is about $\frac{t-4}{72,000}$. Hence the effect due to the compression of the lard was $3^{\circ}4$ F., or about 1° F. per ton weight. This is subject to corrections (which will *increase* its value) depending on the heat developed by friction in the pump and in the narrow connecting tubes, and on another cause not yet fully ascertained.

The author proposes to continue these experiments, at still higher pressures, with a modified apparatus, which will enable him to measure the temperature effects by means of a thermo-electric junction. The present process, with thermometers, is applicable only to liquids and to semi-liquid substances like lard.

BUSINESS.

Dr G. A. Gibson was balloted for, and declared duly elected a Fellow of the Society.

Monday, 17th January 1881.

PROFESSOR FLEEMING JENKIN, Vice-President,
in the Chair.

The following Communications were read:—

1. Preliminary Report on the TUNICATA of the "Challenger" Expedition. Part III. By W. A. Herdman, D.Sc., F.L.S.

(By permission of the Lords Commissioners of the Treasury.)

III. CYNTHIADÆ.

This family includes two of Savigny's genera—*Boltenia* and *Cynthia*, and may be defined by their common characters if we omit or modify one point on which considerable stress is usually laid, namely, the number of lobes round the branchial and atrial apertures.

The amended definition of the family is as follows:—

Body attached, sessile or pedunculated; apertures four-lobed, or having less than four lobes.

Test coriaceous; rarely cartilaginous or gelatinous.

Branchial sac folded; internal longitudinal bars present, no papillæ; stigmata straight (rarely absent).

Tentacles simple or compound.

In the "Mémoires sur les animaux sans vertèbres," the genus *Cynthia* is broken up into four tribes, viz., *Cynthia Simplicis*, *Cynthia Casira*, *Cynthia Styelæ*, and *Cynthia Pandocia*. Of these the second contains only one species, *Cynthia dione*, which does not belong to this family but to the MOLAULIDÆ. Another tribe, the *Cynthia Pandocia*, containing three species, *Cynthia mytiligera*, *C. solearis*, and *C. cinerea*, was distinguished from the *Cynthia Styelæ* solely by the position of the ovary in the intestinal loop. R. Hartwig* has, however, shown that the body which Savigny took for the ovary is really merely a fold of the lining membrane. The *Cynthia Pandocia* may therefore be merged in the *Cynthia Styelæ*. The remaining two of Savigny's tribes, the *Cynthia Simplicis*, and *Cynthia Styelæ* are natural groups, and as it has been necessary to divide them both into genera, should be retained as subfamilies which may be called *Cynthina* and *Styelina*.

To these I add a third sub-family, the *Boltenina*, representing the old genus *Boltenia*, and including, in addition, a new genus, *Culeolus*, and probably also Macleay's *Cystingia*.

The following table shows the arrangement of the sub-families and genera of the CYNTHIADÆ.

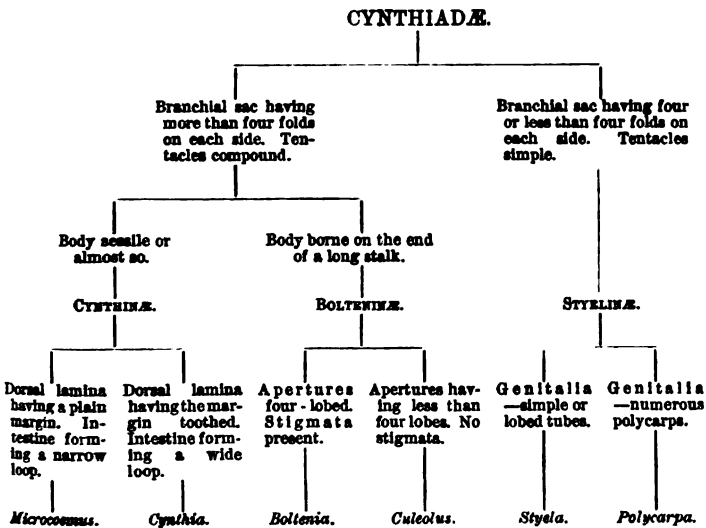

* Jenaische Zeitschrift, Bd. viii. p. 96.

Microcosmus, Haller.

This genus is distinguished from *Cynthia*, according to Haller,* by the possession of a plain-edged dorsal lamina and a narrow intestinal loop; while in all species of *Cynthia* proper the dorsal lamina is denticulated on the free margin, and the intestine forms a wide loop.

It is undoubtedly convenient to separate the two groups of species, and they form very natural sections of *Cynthia*; but whether the denticulation of the dorsal lamina, and the amount of curvature in the intestine are sufficient characters for the formation of a separate genus is, I think, rather doubtful.

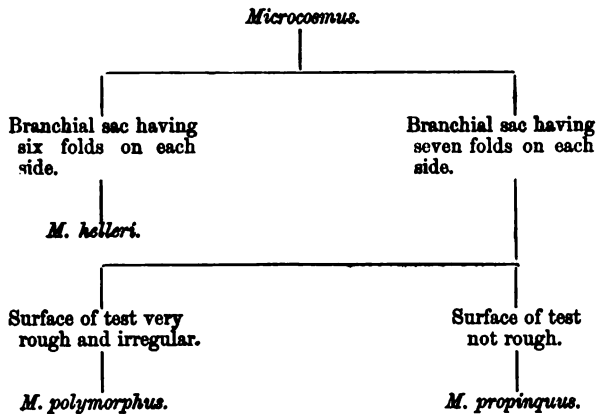
*Microcosmus helleri*, n.sp.

External appearance.—Shape longish, elliptical, with a projection at the anterior end; posterior end broad and rounded. Attached by a small area at the posterior end of the ventral edge. Branchial aperture at the anterior end of the dorsal edge, terminal, on a large projection, directed anteriorly. Atrial aperture on the dorsal edge, two-thirds of the way down, on a hemispherical projection, not so prominent as the branchial aperture, directed dorsally and posteriorly. Surface wrinkled and rough, but not covered with excrescences; branchial and atrial projections much corrugated and thickened; a few zoophytes, polyzoa, &c., adhering, especially on

* Heller, Untersuchungen über die Tunicaten des Adriatischen und Mittelmeeres, iii. Abth., Wien, 1877, p. 3.

the left side and posterior end. Colour, dull gamboge yellow, with a little reddish-brown at the posterior end and the left side. Length, 8 cm. ; breadth, 4 cm.

Test leathery, rather thin except at the area of attachment and on the siphons. Inner surface white, with a few yellowish-brown patches.

Mantle strongly muscular on the right side and the dorsal part of left, membranous on the ventral part ; musculature strong and regular.

The muscular band at the base of the branchial siphon, and just above the tentacle ring, bears four large bluntly conical processes projecting into the lumen of the tube.

Branchial sac with six folds on each side. The alternate transverse vessels larger than the intermediate ones. Internal longitudinal bars numerous, eight or nine on the folds and about twelve on the interspace, which has six wide and six narrow rows of meshes. The largest meshes have each six to eight stigmata.

Dorsal lamina plain.

Tentacles compound, twenty in number, large and small alternately.

Olfactory tubercle broadly cordate, both horns rolled inwards.

One specimen from Station 188 (between Australia and New Guinea), 28 fathoms.

This species externally is not unlike *Microcosmus polymorphus*, Heller, but differs from it notably in having only six folds in its branchial sac, in the condition of the test, and in having projections n the branchial siphon above the circlet of tentacles.

Microcosmus polymorphus, Heller.*

One large specimen from Station 162 (Bass' Strait), 38 to 40 fathoms.

Microcosmus propinquus, n. sp.

External appearance.—Shape oblong-ovate, or almost triangular, flattened laterally ; anterior end narrow, dorsal and ventral edges

* Heller, *loc. cit.* p. 6.

sloping backwards to the broad and rounded posterior end. Attached by the posterior two-fifths of the ventral edge. Branchial aperture terminal, on a large projection turned ventrally and to the left side; atrial aperture also prominent, on the dorsal edge, three-fourths of the way down, and directed dorsally. Surface wrinkled and minutely grooved, but not covered with excrescences; somewhat corrugated round the apertures, a few foreign bodies adhering. Colour pale yellow, with a reddish-brown tinge here and there. Length, 7.5 cm.; breadth, 5 cm.

Test leathery, tough, rather thin. Inner surface white and glistening.

Mantle strongly muscular on the right side; membranous over the viscera. A narrow membrane projects into the branchial siphon above the tentacular circlet; it is slightly crenated, but does not bear large conical processes as in *M. helleri*.

Branchial sac with seven folds on each side. Internal longitudinal bars numerous; about six on the folds, and the same number on the interspaces. Meshes transversely elongated, containing each about twelve stigmata; generally a fine transverse vessel divides the mesh horizontally.

Dorsal lamina not broad, but rather thick; edge plain.

Endostyle very broad.

Tentacles about twenty in number—six large, six small, and some intermediate very minute ones not present in all the interspaces.

Olfactory tubercle irregularly cordate; both ends turned in.

One specimen from Station 162 (Bass' Strait), 38 to 40 fathoms.

This species is nearly allied to *M. helleri*, from which it differs chiefly in having fourteen folds in its branchial sac instead of twelve, and in the condition of the diaphragm in the branchial siphon.

Cynthia, Savigny.

This genus is used here in the most restricted sense, as proposed by Heller: *—

* Untersuch. u. d. Tun. Adriat. u. Mittelm., iii. Abth. p. 9.

| | | | | | | | | | | | | | | | | | |
|---|------------------------------------|---|----------------------|-----------|-----------|--------------------|--------------------------|--|-----------|-----------|-----------|--------------------------|--------------|-----------|-----------|-----------|------------------------|
| Branchial sac with six folds on each side. | Tentacles simply pinnate | Opening of olfactory tubercle lateral; horns much coiled. | | | | <i>C. fissa.</i> | | | | | | | | | | | |
| | | | | | | | Tentacles much branched. | Opening of olfactory tubercle anterior; horns slightly coiled. | | | | <i>C. cerebriformis.</i> | | | | | |
| Branchial sac with seven folds on each side | | | | | | <i>C. formosa.</i> | | | | | | | | | | | |
| | | | | | | | " " eight " " | | | | | <i>C. arenosa.</i> | | | | | |
| | | | | | | | | | | | | | " " nine " " | | | | <i>C. irregularis.</i> |
| | | | | | | | | | | | | | | | | | |
| | | | <i>C. hispidula.</i> | | | | | | | | | | | | | | |
| | | | | | | | <i>C. complanata.</i> | | | | | | | | | | |

Cynthia cerebriformis, n. sp.

External appearance.—Shape irregularly pyriform; anterior end wide and bent over greatly to the right side, which is concave, while the left is prominent and convex; posterior end drawn out into a short stalk, tapering to the point of attachment. Apertures not distant, both terminal, at the anterior edge of the right side, slightly projecting, directed to the right and a little anteriorly. Surface sulcated all over so as closely to resemble the convoluted surface of a brain; four large convolutions lead up to each aperture; posterior end and stalk wrinkled, but not sulcated like the rest. Colour dirty yellowish-white, becoming brown on the stalk. Length, 6.5 cm.; breadth, 4.7 cm.

Test thick, very stiff and solid; white on section and on the inner surface.

Mantle very thick; muscular at the anterior end. Branchial siphon short and wide; atrial narrower, but nearly twice as long.

Branchial sac with six folds on each side. Internal longitudinal bars numerous, about nine on a fold, and the same number in the interspace. Meshes occasionally divided by narrow horizontal membranes, and containing each six stigmata.

Dorsal lamina represented by a series of closely-placed stout tapering languets.

Tentacles branched, twenty in number—ten large and ten small placed alternately.

Olfactory tubercle rather large, elliptical in outline, placed with

its transverse axis directed anteriorly and posteriorly, the opening being at the right side; both horns turned in and forming moderately large spirals.

Viscera—Esophageal opening very far forwards in the branchial sac.

One specimen from Port Jackson, 6 to 15 fathoms.

Cynthia fissa, n. sp.

External appearance.—Shape ovate, with a deep cleft at the anterior end of the dorsal edge extending nearly half-way down, slightly flattened laterally; attached by the posterior end and nearly the posterior half of the left side. Apertures prominent, at the extremities of the two projections formed by the cleft; branchial projection terminal, atrial on the dorsal edge, fully half-way down, not so long as the branchial. Surface very irregular, much wrinkled and rough; on the right side the chief wrinkles run transversely. Colour yellowish-brown. Length, 2 cm.; breadth, 1.6 cm.

Test strong and stiff; white on the inner surface.

Mantle thick.

Branchial sac with six folds on each side. Six internal longitudinal bars on a fold, and three in the interspace. Meshes containing each six to eight stigmata, and sometimes divided by a narrow horizontal membrane.

Dorsal lamina with tentacular languets.

Tentacles simply pinnate, about twelve in number.

Olfactory tubercle large, irregularly oblong, aperture anterior; both horns turned to the left.

Several specimens adhering to the test of *Microcosmus polymorphus*, from Station 162 (Bass' Strait), 38 to 40 fathoms.

Cynthia formosa, n. sp.

External appearance.—Composed of a spherical body and a narrow stalk. Posterior end of the body rounded, anterior rather flatter; dorsal edge slightly more convex than ventral. Stalk about as long as the body, twisted, narrow, expanding slightly at the lower end where it is attached. Apertures both at the anterior end,

not distant, prominent. Surface smooth on the posterior half of the body; covered with fine silky spines on the anterior half, these increase in size towards the anterior end and culminate in sheaves of long bristles, which surround and hide the apertures. Colour grey. Length of body, 1.5 cm.; breadth, 1.3 cm.; length of stalk, 1.6 cm.

Test thin but tough; semi-transparent on the posterior half of the body.

Mantle thin but muscular; muscle bands forming a close network.

Branchial sac with six folds on each side. Internal longitudinal bars ribbon-like, about eight on a fold and four in the interspaces. Meshes transversely elongated, divided horizontally by three narrow membranes, and containing each nine or ten stigmata.

Dorsal lamina consisting of a series of small closely-placed languets borne on the edge of a broad lamina.

Tentacles large and much branched, about twelve in number.

Olfactory tubercle simple, transversely elliptical, opening anterior, horns turned inwards.

One specimen from Torres Straits, 3 to 11 fathoms.

Cynthia arenosa, n. sp.

External appearance.—Shape irregularly ovate or sub-triangular, elongated transversely, not compressed laterally; posterior end broad and rather flat, anterior narrow; dorsal and ventral edges convex; unattached. Apertures both at the anterior end, inconspicuous, placed close together, cross-slit. Surface entirely covered, with the exception of the siphons, by a close layer of sand grains. Colour grey. Length, 1.5 cm.; breadth, 1 cm.

Test thin, but very stiff on account of the imbedded sand.

Mantle thin, but strong; muscle bands well developed.

Branchial sac with six folds on each side. About five internal longitudinal bars on each fold, and the same number in the interspace. Meshes square, containing each about four stigmata, divided horizontally.

Dorsal lamina formed of a series of small tentacular languets.

Tentacles compound, few, long and short alternately.

Olfactory tubercle simple, rudely cordate in outline, opening anterior, both horns turned inwards.

Several specimens from Station 186 (Torres Straits), 1 to 8 fathoms.

Cynthia irregularis, n. sp.

External appearance.—Shape very irregular. Attached to a fragment of a shell by the right side near the dorsal edge and half-way up from the posterior end. Posterior end small, nearly flat; anterior end broad, deeply cleft between the large divergent siphons, on the extremities of which the apertures are placed. Branchial aperture at the ventral edge of the anterior end, prominent, turned ventrally and a little to the left; atrial aperture at the dorsal edge of the anterior end, not quite so prominent as the branchial, turned dorsally and a little to the left. Surface very uneven, deeply wrinkled, and rather rough. Colour yellow and dark brown. Length, 4.5 cm.; breadth, 3 cm.

Test thin, except at the posterior end where it is thickened, tough, and opaque; white on section and on the inner surface.

Mantle rather strong and muscular.

Branchial sac with the folds very slight and distant, seven on each side. Internal longitudinal bars numerous, about nine on a fold and eight in the interspace, which has four wide and four narrow rows of meshes. Meshes containing each four stigmata, and often divided by a narrow horizontal membrane.

Dorsal lamina formed of a series of narrow tentacular languets.

Tentacles compound, very small, twelve larger ones with either one or two very minute ones between each pair of these.

Olfactory tubercle very large but irregular; broken up into a number of curved pieces.

One specimen from Port Jackson, 2 to 10 fathoms.

Cynthia pallida, Heller.*

One specimen of this species from Simon's Bay, 10 to 20 fathoms; two from Kandavu, Fiji; and several small specimens from Papeete Harbour, Tahiti, 10 fathoms.

* Beiträge zur nähern Kenntniss der Tunicaten, p. 14, Taf. iii. figs. 17, 18 (Sitzb. d. k. Akad. d. Wiss., lxxvii. Bd., i. Abth., 1878).

The curious spicules mentioned by Haller as occurring in the mantle and branchial sac of this species are present in all the specimens. Smaller ones are also to be observed in the test. Similar spicules occur in a new species of *Cynthia* still to be described.

The specimens from Tahiti may turn out to be a new but closely allied species.

Cynthia hispida, n. sp.

External appearance.—Shape ovate or irregularly circular, flattened laterally, nearly as broad as long; dorsal and ventral edges strongly convex; anterior end broadish, straight. Attached by the rather narrow posterior end. Apertures both at the anterior end, moderately far apart, on short dome-like projections, the ends of which are conspicuously four cleft and covered with strong echinated hairs, which fringe the apertures; branchial directed anteriorly; atrial directed dorsally. Surface more or less wrinkled, and closely covered with a short down of prickly hairs, which occasionally at the posterior end, and most markedly round the apertures, increase in size and form large branched bristles. Colour dull brown, rather lighter round the apertures. Length, 6.6 cm.; breadth, 5.6 cm.

Test not thick, leathery, tough; smooth and glistening on the inner surface.

Mantle thick, musculature very strong and close, especially on the siphons.

Branchial sac with nine folds on each side, the ventral folds, or those next the endostyle on each side, being very slight, and only reaching half-way to the dorsal lamina. The alternate transverse vessels wider than the intermediate ones. Internal longitudinal bars numerous, about twelve on a fold, and the same number in the interspace. Meshes containing each about four stigmata.

Dorsal lamina formed by very small languets.

Tentacles compound, about fourteen in number, and all about the same length.

Olfactory tubercle small, but very prominent, situated on a hemispherical projection, elongated transversely; both horns coiled inwards.

Two specimens from Station 162 (Bass' Straits), 38 to 40 fathoms. The larger specimen has the surface considerably more wrinkled and the apertures more prominent than in the other. Both are attached to the interior of bivalve shells.

Cynthia complanata, n. sp.

External appearance.—Shape elongated, oblong, pointed at the anterior end, flattened laterally; dorsal edge straight or slightly concave, ventral convex; posterior end wider than anterior, but narrow. Attached by the ventral edge of the posterior end. Branchial aperture terminal, quadrangular, tubular, wide; atrial on the dorsal edge one-third of the way down, slightly projecting, also quadrangular and wide. Surface irregular but smooth, slightly creased. Colour dirty white. Length, 5.6 cm.; breadth, 2.7 cm.

Test soft, cartilaginous; varies greatly in thickness; is thin on the anterior half, then becomes thicker, and the posterior third is a solid mass of test substance.

Mantle thin; musculature rather feeble; siphons very wide. Spicules in the mantle like those in *Cynthia pallida*, Heller, but longer and thinner.

Branchial sac with eleven folds on each side. Eight internal longitudinal bars on a fold and four in the interspace. Meshes slightly elongated transversely, containing each about five stigmata, and generally divided horizontally.

Dorsal lamina formed of short blunt membranous languets.

Tentacles branched, nine large and nine small placed alternately, and about eighteen very minute intermediate ones.

Olfactory tubercle.—Outline nearly circular, both horns turned inwards, much coiled.

One specimen from Port Jackson, 6 fathoms.

Styela, Macleay.

This term was proposed by Savigny to denote a tribe of the genus *Cynthia*, and was first, I believe, used as a generic name by Macleay * in 1823.

* Trans. Linn. Soc., vol. xiv.

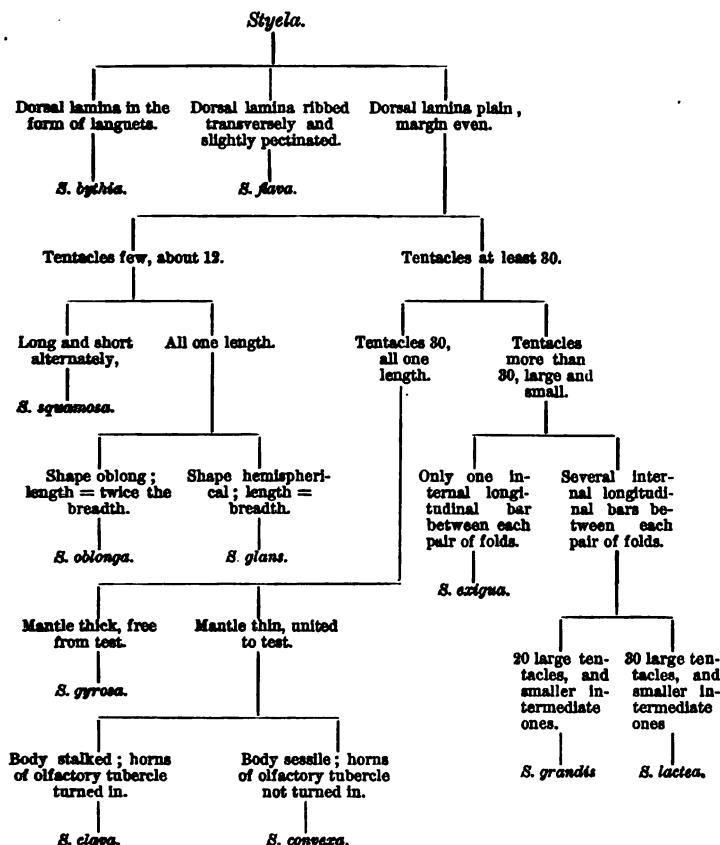

Styela bythia, n. sp.

External appearance.—Shape between cubical and hemispherical; anterior end broad and obtuse, dorsal and ventral edges sloping backwards and slightly outwards. Attached by a wide posterior end slightly expanded at the margin. Apertures sessile, inconspicuous, four cleft; branchial at the ventral and atrial at the dorsal end of the anterior extremity. Surface of the test flat but rough, especially at the anterior end. Colour dark-brown, paler at the posterior end. Length, 2 cm.; breadth, 1 cm.

Test thick, very stiff, but rather brittle; white on section and on the inner surface.

Mantle reddish-brown, moderately thick, closely united to the test.

Branchial sac with four folds on each side. There is a considerable space on each side between the endostyle and the ventral fold. Internal longitudinal bars extremely numerous and much crumpled. Meshes small, elongated vertically, containing each one or two stigmata, and divided horizontally.

Dorsal lamina in the form of languets.

One specimen from Station 160 (South of Australia); 2600 fathoms.

Styela flava, n. sp.

External appearance.—Shape rudely spherical, slightly elongated laterally; anterior end convex. Attached by the posterior end and half of each side to a piece of coral; dorsal and ventral edges free and rounded. Apertures sessile, 4-lobed, moderately far apart, at the opposite ends of the anterior extremity. Surface of the test flat, but minutely scaly; scales largest and most distinctly marked round the apertures. Colour light yellow, with a brownish tinge at the apertures; white on the area of attachment. Length (antero-posterior), 1.6 cm.; breadth (from side to side), 2.4 cm.; thickness (dorso-ventral), 2 cm.

Test thin, but very tough, opaque; white and glistening on the inner surface.

Mantle rather thin. Muscular bands numerous, but very fine.

Branchial sac with four folds on each side; folds very slight, being merely the approximation of a number of internal longitudinal bars. There are about ten at these places, and ten in the intermediate opener parts. Meshes square or elongated vertically, containing each four stigmata, and divided by a narrow horizontal membrane.

Endostyle conspicuous, rather wide, reddish-brown.

Dorsal lamina ribbed transversely, and slightly toothed at the edge.

Tentacles simple; three sizes—fifteen large, fifteen small, and about thirty very minute ones.

Olfactory tubercle, placed at the bottom (posterior extremity) of a rather deep peritubercular area; small and irregular in shape.

Intestine rather narrow ; loop open.

One specimen from Station 320 (off the coast of Buenos Ayres), 600 fathoms.

Styela oblonga, n. sp.

External appearance.—Shape oblong, erect, broadest in the middle, tapering slightly towards the anterior end and more towards the posterior; anterior end straight, dorsal and ventral edges slightly convex; posterior end by which it is attached narrow. Apertures four-lobed, sessile, placed at the extremities of the anterior end. Surface finely wrinkled and rough on rather more than the anterior half, smoother and slightly encrusted with sand on the posterior part. Colour yellowish-brown, dull on the anterior half, brighter posteriorly. Length, 3.5 cm.; breadth, 2 cm.

Test not thick, but tough on the upper part; thinner below, except at the posterior end, where it is considerably thickened.

Mantle thin, musculature very delicate.

Branchial sac with four folds on each side, formed, as in the last species, merely by a crowding together of the internal longitudinal bars, six to nine being placed close together, and separated by wide spaces containing only three bars. Meshes elongated vertically, containing each only three stigmata, divided by a narrow horizontal membrane.

Dorsal lamina narrow, much crumpled, neither ribbed nor toothed.

Tentacles simple, rather large, twelve.

Olfactory tubercle rather prominent, cup-shaped; opening anterior, wide.

One specimen from Station 320 (off the coast of Buenos Ayres), 600 fathoms.

This species was probably buried in sand for nearly half its length.

Styela glans, n. sp.

External appearance.—Shape regular, between conical and hemispherical, the highest point at the ventral edge of the anterior

end; posterior end large and flat, attached to a piece of coral; dorsal edge more convex than ventral. Branchial aperture anterior, at the highest part near the ventral edge; atrial on the dorsal edge two-thirds of the way down; both are sessile and inconspicuous. Surface roughish, but regular. Colour dark reddish-brown. Length, 1.5 cm.; breadth, 1.2 cm.

Test not thick but tough, white on the inner surface.

Mantle very thin and membranous.

Branchial sac with four slight folds on each side, about five internal longitudinal bars being crowded together, and the same number placed further apart alternately. Meshes elongated vertically, containing each three stigmata, divided by a narrow horizontal membrane.

Dorsal lamina narrow.

Tentacles simple, few, of a moderate size.

Olfactory tubercle simple, nearly circular in outline.

One specimen from Station 320 (off the coast of Buenos Ayres), 600 fathoms.

Styela squamosa, n. sp.

External appearance.—Shape roughly hemispherical, the anterior end very large and rising somewhat to its ventral extremity; ventral edge nearly straight, dorsal gently convex. Attached by the wide posterior end. Apertures sessile, distant, and inconspicuous; branchial at the ventral end and atrial at the dorsal end of the anterior extremity. Surface smooth but scaly. Colour creamy white, slightly yellow in parts. Length, 2 cm.; breadth, 1.5 cm.

Test thick and solid, but soft.

Mantle very thin, adhering slightly to the test.

Branchial sac with two distinct folds on each side near the dorsal edge, and one or two more indistinct ones ventrally. Internal longitudinal bars numerous. Meshes slightly elongated vertically, containing each four or five stigmata, and divided horizontally.

Dorsal lamina plain; no ribs or teeth.

Tentacles larger and smaller alternately. The larger ones are short and stout.

Olfactory tubercle a simple elliptical tubercle, with no visible markings.

One specimen from Station 160 (South of Australia), 2600 fathoms.

Styela gyrosa, Heller.*

A considerable number of specimens, many of them united into masses and supported by a common stalk, from Port Jackson, 6 fathoms.

Styela grandis, n. sp.

External appearance.—Shape irregularly pyriform, the anterior end being large and somewhat globular, while the posterior narrows into a short thick stalk, by which the animal is attached. Ventral edge straight or slightly concave, dorsal long and strongly convex. Branchial aperture a little to the ventral edge of the anterior end, directed ventrally; atrial on the dorsal edge about one-third of the way down, directed dorsally and slightly anteriorly; both apertures sessile, and not distinctly lobed, but conspicuous. Surface irregular, but not rough, towards the base much corrugated transversely, the rest of the surface more or less seamed and wrinkled. Colour dirty-white, becoming slightly darker towards the base. Length, 9.5 cm.; breadth, 6 cm.

Test thin and soft, but fairly strong.

Mantle very delicate; closely united to the inner surface of the test. Musculature consisting chiefly of a number of fine bundles of fibres running longitudinally.

Branchial sac with four folds on each side, the most dorsal one on each side placed very close to the dorsal lamina. There are three internal longitudinal bars on each side of a fold, and about six in the interspace. The alternate transverse vessels are wider than the intermediate ones. The meshes are immensely elongated transversely, and contain each about twenty stigmata.

Dorsal lamina rather wide and perfectly plain, having no ribs or teeth.

* C. Heller, Untersuchungen über die Tunicaten des Adriatischen und Mittelmeeres, iii. Abth. p. 15, 1877.

Tentacles simple, there are twenty long ones with occasional small intermediate ones.

Olfactory tubercle heart shaped, both horns turned inwards.

Two specimens from Station 150 (south of Kerguelen Island), 150 fathoms.

Styela lactea, n. sp.

External appearance.—Shape nearly rectangular, from oblong to spherical, erect, not compressed; anterior end straight and wide; posterior end straight and nearly as wide; dorsal and ventral edges slightly convex. Attached by the whole of the posterior end. Apertures both anterior, nearly sessile, four cleft; branchial at the ventral edge of the anterior end, directed ventrally; atrial at the dorsal edge of the anterior end, directed anteriorly and dorsally. Surface smooth, but seamed with transverse creases and slight folds, longitudinal ones here and there. Colour creamy white. Length, 4.5 cm.; breadth, 3.5 cm.

Test thick, but soft and flexible, quite opaque.

Mantle closely attached to the test. Musculature fine, longitudinal and transverse bands intersecting at right angles.

Branchial sac with four folds on each side. Internal longitudinal bars rather few; about six on a fold, few and distant in the interspace. Meshes greatly elongated transversely, some of those near the endostyle containing thirty to forty stigmata, they are occasionally divided by a narrow horizontal membrane.

Dorsal lamina plain, no ribs, margin even.

Tentacles filiform, about thirty very long thin ones, with intermediate shorter ones.

Olfactory tubercle large, transversely elliptical; both horns rolled inwards and forming large spiral coils.

Three specimens from Kerguelen Island, 10 to 100 fathoms.

Styela exigua, n. sp.

External appearance.—Shape quadrangular, a little longer than broad, somewhat compressed laterally; anterior end broad and nearly flat; posterior rather narrower and more rounded. Attached

slightly by the posterior end of the left side. Apertures sessile, inconspicuous; branchial terminal and median; atrial on the dorsal edge, one-fourth of the way down. Surface even, but partially covered by a thin coating of sand. Colour dirty grey. Length, 1 cm.; breadth, .8 cm.

Test cartilaginous, thick but soft.

Mantle very thin, closely united to the test.

Branchial sac wide, with four folds on each side. The alternate transverse vessels wider than the intermediate ones. Internal longitudinal bars stout, six on each fold, and only one in the interspace. Meshes transversely elongated, containing each about six stigmata.

Dorsal lamina narrow, margin plain.

Tentacles simple, numerous, long and short alternately.

One specimen from Port Jackson, 2 to 10 fathoms.

Styela convexa, n. sp.

External appearance.—Shape rudely hemispherical or bluntly conical, not flattened; anterior end and sides convex, posterior end large, attached to a stone and slightly expanded at the edge. Branchial aperture terminal, rather to the ventral side of the middle of the anterior end, but forming its most prominent point; atrial aperture moderately distant, at the dorsal edge of the anterior end; both are sessile and inconspicuous. Surface moderately smooth, finely creased in all directions, especially round the apertures. Colour dull yellowish-brown, lighter on the margins of the posterior end. Length, 2 cm.; breadth (dorso-ventral), 2.6 cm.

Test thin but very tough, white on section.

Mantle closely united to the test, musculature fine but close.

Branchial sac with four folds on each side. About eight internal longitudinal bars on a fold, and the same number in the interspace. Meshes elongated vertically, containing each about three stigmata, and divided by a narrow horizontal membrane.

Dorsal lamina slightly crimped but plain, edge even.

Tentacles simple, stout, rather curled, about thirty in number, and all of much the same length.

Olfactory tubercle simply oval, aperture at the narrower anterior end; horns not coiled, nearly touching.

One specimen from Station 150 (South of Kerguelen Island), 150 fathoms.

Styela clava, n. sp.

External appearance.—Club-shaped, the pyriform body being supported on a stalk of variable length, erect, not compressed; anterior end narrow but generally straight for a short distance, from this the body widens rapidly for the first two-fifths of its length and then narrows more gradually in the remaining three-fifths, the posterior end being prolonged into the stalk, which is generally about equal to the body in length. Apertures at the anterior end, four cleft, more or less projecting, but minute and inconspicuous; branchial at the ventral edge of the anterior end, directed ventrally; atrial at the dorsal edge of the anterior end, more prominent than the branchial, and therefore more anterior, directed anteriorly. Surface very irregular; posterior half of the body and stalk creased longitudinally, anterior half of the body nearly covered by irregularly-shaped but smooth and blunt knobs mostly directed anteriorly. Colour dirty white, with occasionally a slight yellowish tinge. Length (total), about 7 cm.; breadth (at broadest part of head), about 2 cm.

Test tough but thin, and almost papery except on the knobs and processes.

Mantle very delicate and closely united to the test, musculature very feeble.

Branchial sac with four narrow folds on each side. Internal longitudinal bars rather numerous, about nine on a fold and twelve in the interspace. Meshes transversely elongated, containing each six stigmata, and occasionally divided by a narrow horizontal membrane.

Dorsal lamina smooth and plain, no ribs and no teeth.

Tentacles about thirty, rather closely placed, not large, all about the same length, but some rather stouter than others.

Olfactory tubercle transversely elongated, horns simply curled inwards,

Several specimens from Station 233a (Kobé, Japan), 8 to 50 fathoms.

Polycarpa, Heller.

This genus is very closely allied to *Styela*. It is convenient, however, to separate them on account of the large number of species in the *Styelinæ*. The chief difference between the two genera is in the condition of the genital glands.

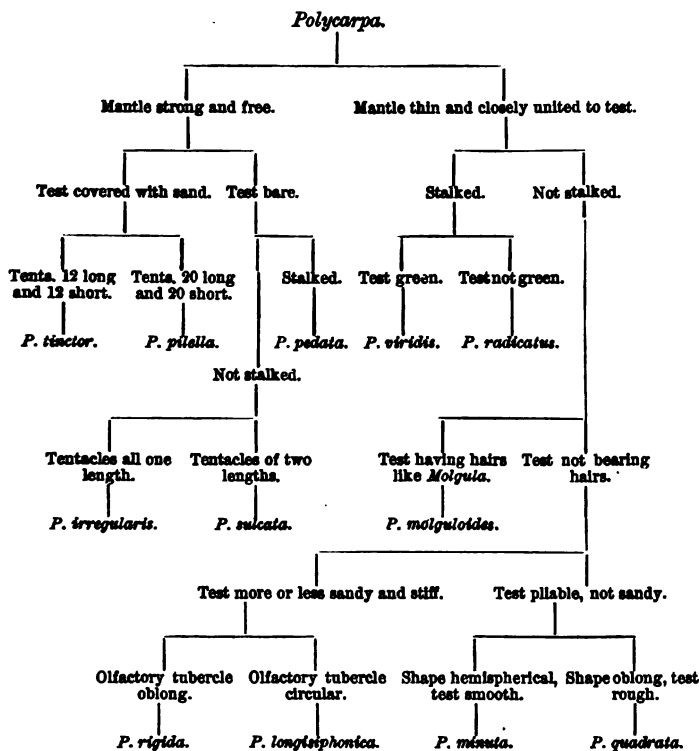

Polycarpa pedata, n. sp.

External appearance.—Irregularly club-shaped, consisting of a long stalk supporting a somewhat globular body produced anteriorly; posterior end broad and rounded, passing rapidly into the narrow stalk which is nearly as long as the body; ventral edge nearly straight, dorsal strongly convex in its posterior half, straight in the

anterior part. Attached by the extremity of the long narrow stalk. Branchial aperture terminal, very prominent, directed anteriorly; atrial on the dorsal edge about half-way down the body, projecting, directed anteriorly and dorsally; both are distinctly four cleft. Surface smooth but grooved and creased somewhat. Colour yellowish-white with a tinge of red on the stalk. Length (total), 10.5 cm.; breadth, 4 cm.

Test thin but tough.

Mantle moderately thick, adhering here and there to the test; musculature close but not strong.

Branchial sac with four folds on each side. Transverse vessels all one size. Internal longitudinal bars numerous. Meshes slightly elongated transversely, containing each five or six stigmata.

Dorsal lamina plain.

Tentacles long, of a brown colour, twenty-five, all one length.

Polycarps large; tentacular endocarps present.

One specimen from Station 212 (Philippine Islands), 10 to 20 fathoms.

Polycarpa irregularis, n. sp.

External appearance.—Shape irregularly oblong, somewhat pyriform, erect, rather compressed laterally. Anterior and posterior ends narrow, middle two-fourths wide, and having the dorsal and ventral edges parallel; ventral edge straight throughout, dorsal sloping in its anterior and posterior fourths, straight in its central two-fourths. Attached by the narrow but irregular posterior end. Branchial aperture terminal, prominent, surrounded by four large lobes and four small ones; atrial on the dorsal edge, rather more than one quarter of the way down, distinct. Surface very irregular, cut up by deep grooves and folds, and partially covered by foreign bodies. Colour dirty yellowish-white. Length, 6 cm.; breadth, 3.5 cm.

Test rather thick, tough; white and glistening on inner surface.

Mantle thin, musculature not strong.

Branchial sac with four folds on each side. Three narrow transverse vessels between each pair of wide ones. About eight internal longitudinal bars on the folds and twelve in the interspace. Meshes transversely elongated and containing each six stigmata.

Dorsal lamina narrow and smooth.

Tentacles linear, rather distant, twenty-four in number, coloured black, some rather smaller than others but not placed alternately.

Olfactory tubercle ovate, but with the narrow end placed posteriorly, much convoluted and marked with black. Intestinal loop wide.

Endocarps numerous, yellow, and rather small.

One specimen from Station 208 (Philippine Islands), 18 fathoms.

Polycarpa sulcata, n. sp.

External appearance.—Shape between ovate and pyramidal, not compressed; anterior end narrow but rounded, posterior end broad and rounded; ventral edge very convex, dorsal convex posteriorly and concave anteriorly. Attached by the posterior end of the ventral edge. Branchial aperture not terminal but twisted round to the dorsal edge, prominent, directed dorsally; atrial on the dorsal edge about half-way down, directed dorsally; both four-lobed, wide and conspicuous. Surface smooth but uneven, cut up by deep creases and folds into rounded pad-like projections. Colour dull creamy-white. Length, 5.5 cm.; breadth, 3.5 cm.

Test thick and tough but soft, not stiff. Inner surface white, with small dark dots over it.

Mantle thin, not adhering to the test, dark brown; musculature not strong.

Branchial sac with four narrow folds on each side. Three narrow transverse vessels between each pair of wide ones. Internal longitudinal bars few. Meshes transversely elongated, containing each about eight stigmata.

Dorsal lamina smooth, very narrow.

Tentacles, twelve, rather large but not very long, distant, with two or three very minute ones between each.

Olfactory tubercle large and irregular, spongy.

Three specimens from Banda, 17 fathoms.

Polycarpa pilella, n. sp.

External appearance.—Shape a little variable but generally spherical or ellipsoidal, occasionally rather pyriform, the posterior

end being narrower ; not compressed, erect ; anterior end wide, convex. Attached by the posterior end. Apertures both at the anterior end, moderately far apart, not conspicuous. Surface entirely covered by a layer of sand. Colour yellowish-brown. Length, 6 mm. ; breadth, 4 mm.

Test thin but strong.

Mantle rather strong, muscular fibres delicate but very numerous, forming a close network.

Branchial sac with four folds on each side. Transverse vessels all equal in size. About eight internal longitudinal bars on the folds and the same number in the interspaces. Meshes vertically elongated, containing each three stigmata.

Dorsal lamina plain.

Tentacles filiform, about twenty large ones, with one or two smaller between each pair.

Olfactory tubercle irregularly horse-shoe shaped, both horns rolled inwards.

About a dozen specimens from Bahia, 7 to 20 fathoms.

Polycarpa tinctor, Quoy and Gaimard.*

About a dozen specimens of this species from Port Jackson, at depths varying from 2 to 15 fathoms.

Polycarpa viridis, n. sp.

External appearance.—Shape more or less pyriform, the anterior end being the broadest, and the posterior forming a short stalk, sometimes more elongated and twisted, by the lower end of which the animal is attached. Both apertures at the anterior end, generally a little to the right side ; branchial terminal, or subterminal ; atrial a short way down the dorsal edge, not distant from branchial ; both four-lobed, sessile, inconspicuous. Surface not uneven but generally more or less covered by animals, sand, shell fragments, &c., adhering to it. Colour dull green, darkest in the neighbourhood of the apertures. Length, 3 cm. ; breadth, 2.5 cm.

Test not thick but tough, rough externally from adhering sand, &c., of a beautiful dark-green colour throughout. Vessels very numerous, anastomosing frequently.

* Voyage de l'Astrolabe, Zoologie, tom. iii. p. 608, pl. xci. figs. 1, 2.

Mantle muscular, united to the test, of a dull green colour.

Branchial sac with four folds on each side. Three small transverse vessels between each pair of large ones. About eight internal longitudinal bars on the folds and four in the interspace. Meshes transversely elongated, containing each nine to twelve stigmata.

Dorsal lamina narrow, not ribbed, margin plain.

Tentacles simple, filiform, crowded, about seventy, long and short alternately.

Olfactory tubercle rudely circular in outline; left horn coiled outwards, the right inwards.

Polycarps numerous, on the inner surface of the mantle, 1 to 3 mm. in length.

Several specimens from Port Jackson, at depths of 6, 2 to 10, and 6 to 15 fathoms.

Polycarpa radicans, n. sp.

External appearance.—Club-shaped, erect; consisting of a globular body, supported on a narrow stalk equalling it in length. Anterior end rather broader than posterior, which is continuous with the stalk; edges convex; stalk long and narrow, spreading out somewhat at the lower end, where it is attached. Apertures both at the anterior end, sessile, inconspicuous, lobes indistinct; branchial on the ventral edge of the anterior end, atrial about the centre, and slightly the more anterior of the two. Surface even, slightly sandy. Colour dull greyish-yellow. Length (total), 3·5 cm.; breadth, 1·7 cm.; length of body, 2 cm.

Test moderately thick, strong but not stiff.

Mantle closely united to test, thin.

Branchial sac with four folds on each side. Three narrow transverse vessels between each pair of wide ones. Internal longitudinal bars ribbon-like, close and numerous on the folds, few between. Meshes transversely elongated, and containing each six to twelve stigmata.

Dorsal lamina narrow.

Tentacles simple, numerous, about fifty, crowded, of different sizes, but not alternating.

Olfactory tubercle circular, one end turned out and one turned in.

Polycarps well-marked, yellow.

One specimen from Station 163 (off the south-east coast of Australia), 120 fathoms; and one specimen from Port Jackson, 6 fathoms.

Polycarpa molguloides, n. sp.

External appearance.—Shape transversely ovate or sausage-shaped; elongated dorso-ventrally and depressed; attached by the wide posterior end. Apertures distant, both on the anterior end (upper surface), inconspicuous. Surface entirely covered by a thick layer of sand, shells, &c. Colour dark-brown. Length (antero-posterior), 3 cm.; breadth (dorso-ventral), 7 cm.; thickness (lateral), 4 cm.

Test moderately thick, leathery, covered with branched hair-like processes, like these of *Molgula*, to which the sand-grains, &c., are attached.

Mantle closely adhering to the test, thick and rough, musculature feeble.

Branchial sac with four folds on each side. Transverse vessels all of one size. Six internal longitudinal bars on the folds, and four on the interspace. Meshes transversely elongated, containing each twelve stigmata.

Dorsal lamina plain.

Tentacles numerous, crowded, all one length, of a dark-brown colour.

Polycarps only slightly projecting, imbedded in the thick mantle.

Two specimens from Station 163 (Bass' Straits), 38 to 40 fathoms.

Polycarpa rigida, n. sp.

External appearance.—Shape oblong, erect, anterior end pointed, dorsal and ventral edges nearly straight and parallel, posterior end nearly straight, moderately wide; attached by the posterior end. Branchial aperture terminal, projecting; atrial on the dorsal edge, fully one-third of the way down, projecting; both very indistinctly lobed. Surface even, but roughish, and partly covered by foreign bodies. Colour dull greyish-brown, dull yellow round the apertures. Length, 8 cm.; breadth, 3 cm.

Test not very thick, and not tough, but very stiff, like cardboard ; white on section and on the inner surface.

Mantle thin and closely adhering to the test, musculature feeble.

Branchial sac with four folds on each side. Transverse vessels all one size. About twelve internal longitudinal bars on the folds, and six on the interspace. Meshes transversely elongated, and containing twelve stigmata each.

Dorsal lamina narrow, plain ; edge even.

Tentacles simple, close, crowded, stout, about forty, all one length.

Olfactory tubercle oblong, lying in a very large triangular peritubercular area, and directed forwards and to the left.

Polycarps deeply imbedded in the mantle. Intestinal loop very wide.

Two specimens from Station 162 (Bass' Straits), 38 to 40 fathoms.

Polycarpa longisiphonica, n. sp.

External appearance.—Shape oblong or somewhat flask-shaped, erect, posterior end large and rounded, anterior end narrow and pointed. Apparently not attached, or only slightly by the posterior third of the left side. Apertures conspicuous, at the ends of very long siphons ; branchial terminal, directed anteriorly ; atrial on the dorsal edge half-way down, directed dorsally and anteriorly, fully as long as the branchial siphon. Surface covered, except on the siphons, by a fine coating of sand and shell fragments. Colour dark-brown. Length, 7 cm. ; breadth, 4 cm.

Test thin and brittle, but rather stiff.

Mantle thin, closely adhering to the test ; musculature feeble.

Branchial sac with four folds on each side. Every fifth or sixth transverse vessel wider than the intermediate ones, which are all one size. Eight internal longitudinal bars on the folds, and about the same number on the interspace. Meshes square, occasionally divided by a narrow horizontal membrane, containing each four to six stigmata.

Dorsal lamina narrow and plain edged.

Tentacles not very long, rather distant, about eighteen, some shorter than others, but not placed alternately.

Olfactory tubercle circular in outline.

Polycarps numerous and large, yellow.

Three specimens from Port Jackson, 6 to 15 fathoms.

Polycarpa quadrata, n. sp.

External appearance.—Shape oblong or oval, erect, somewhat compressed laterally, both ends broad and rounded, dorsal and ventral edges nearly straight and parallel. Attached by the posterior end. Branchial aperture terminal, sessile, inconspicuous, minute; atrial more than one-third of the way down, on the dorsal edge, also minute and inconspicuous. Surface considerably creased in all directions, especially round the apertures. Colour dirty white. Length, 2 cm. ; breadth, 1.6 cm.

Test not thick, tough and strong, but not stiff; white and glistening on the inner surface.

Mantle closely adhering to the test, very thin.

Branchial sac with four slight folds on each side. Internal longitudinal bars very numerous and close in the places where they form the folds. Meshes vertically elongated, usually divided by a narrow horizontal membrane, and containing each one to three stigmata.

Dorsal lamina plain.

Tentacles simple.

Olfactory tubercle ovate, very minute, placed at the posterior end of a deep peritubercular area.

Polycarps few, only three or four on each side. *Endocarps* numerous. Intestinal loop wide.

Three specimens adhering to the spicules of *Labaria hemispherica* from Ki Island, 129 fathoms.

Polycarpa minuta, n. sp.

External appearance.—Dome-shaped or nearly hemispherical; anterior end convex, posterior wide, flattened, attached, slightly expanded at the margin. Apertures both anterior, not distant, sessile but distinct. Surface perfectly smooth and even. Colour pale yellowish-brown. Length, .6 cm. ; breadth, .9 cm.

Test thin, but tough and strong.

Mantle closely adhering to the test, very thin.

Branchial sac with four folds on each side. Transverse vessels all of the same size. Internal longitudinal bars very few, there being only two between each pair of folds. Meshes transversely elongated, containing each six to eight stigmata.

Dorsal lamina plain.

Tentacles many, filiform.

One specimen from Station 150 (south of Kerguelen Island), 150 fathoms.

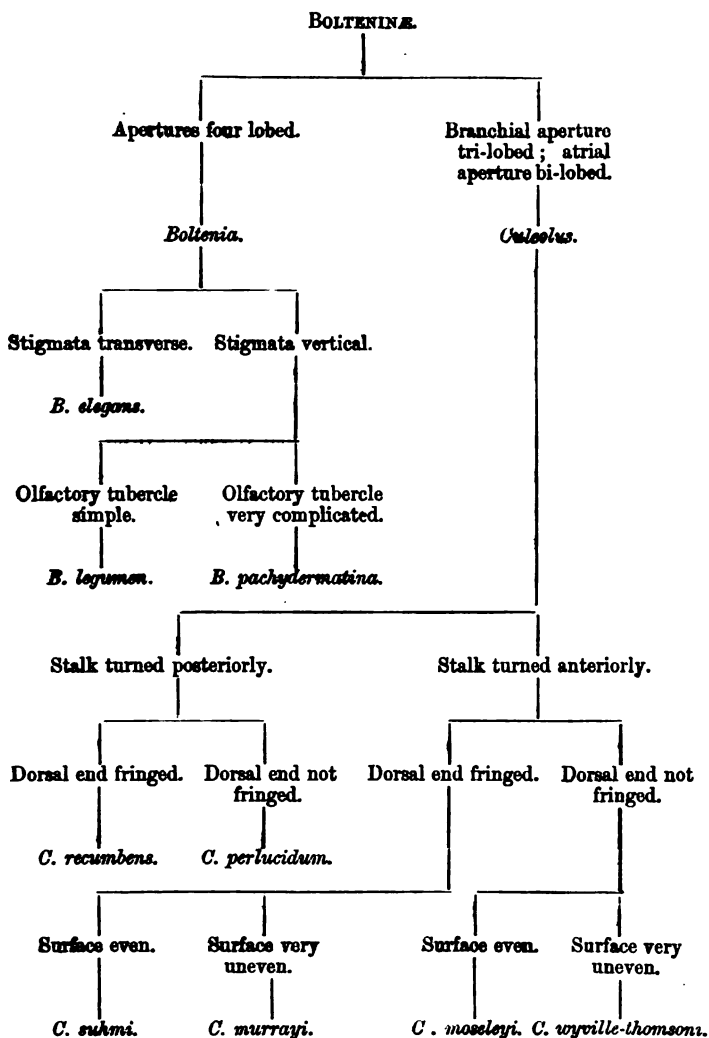

Boltenia elegans, n. sp.

External appearance.—Shape of body quadrangular ovate, not flattened; anterior and posterior ends bluntly rounded, dorsal and ventral edges nearly straight. Peduncle long and thin, wiry, attached to the ventral edge of the anterior end, and turned slightly ventrally. Apertures conspicuous, branchial at the dorsal edge of the anterior end, directed anteriorly and dorsally; atrial on the dorsal edge, two-thirds of the way down, directed dorsally and posteriorly; behind the atrial aperture the dorsal edge sinks in somewhat towards the posterior end. Surface smooth and glistening, marked by a few creases. Colour of the body white, with a satiny lustre; stalk light yellowish-brown. Length of body, 5.5 cm.; breadth of body, 4 cm. Length of stalk, 36 cm.; thickness of stalk, 2 mm.

Test thin but tough.

Mantle strong, musculature regular.

Branchial sac with nine folds on each side, those next the endostyle being closer than the dorsal ones. Transverse vessels wide and distant. Stigmata transverse, running between narrow longitudinal bars which connect the transverse vessels. Internal longitudinal bars narrow but well marked, running at right angles to the transverse stigmata. Stigmata rather long and narrow, about fifteen in each mesh.

Dorsal lamina represented by a series of closely-placed, large, tapering languets.

Tentacles large, branched, sixteen in number, placed long and short alternately.

Olfactory tubercle large and distinct, elongated transversely but directed vertically, the opening being on the right side; both horns coiled inwards.

Two specimens from Station 48 (south of Halifax, N.S.), 51 fathoms.

This species is probably nearer to Savigny's *Boltenia ovifera* than to any other known species, but differs from it in many particulars.

Boltenia legumen, Lesson.*

Station 312 (Straits of Magellan), 10 to 15 fathoms, one specimen.

Station 315 (East of Falkland Islands), 5 to 10 fathoms, eight specimens.

Station 316 (East of Falkland Islands), 4 to 5 fathoms, one specimen.

Boltenia pachydermatina, n. sp.

External appearance.—Shape of body ovate to fusiform, compressed laterally; posterior (upper) end bluntly pointed, anterior end narrow, becoming gradually continuous with the stalk; dorsal edge more convex than ventral. Stalk long, thick, twisted, and creased, rather tapering downwards towards the point of attachment. Apertures conspicuous but not prominent, not distant, placed at the points of junction of the middle with respectively the anterior and posterior thirds of the body. Surface of body smooth but deeply grooved longitudinally, stalk closely wrinkled transversely. Colour of the body dull creamy-white, of the stalk yellowish-brown. Length of body, 10 cm.; breadth, 5 cm.; length of stalk about 20 cm.

Test very thick and stiff, between cartilaginous and coriaceous, tough; white and glistening on the inner surface.

Mantle thin but muscular, slightly adhering to the test.

Branchial sac with about six folds on each side. Internal longitudinal bars numerous, about eight on the folds and six in the interspace. Meshes transversely elongated, containing each about nine stigmata, always divided horizontally by a narrow bar.

Tentacles compound, densely branched, sixteen in number, placed large and small alternately. One tentacle much larger than any of the others.

Olfactory tubercle large, circular, the surface marked with a close and elaborate pattern.

One large and one small specimen from Canterbury, New Zealand.

* *Centurie Zoologique*, p. 149, pl. liii. fig. 1, 1830.

Culeolus, n. gen.

Body more or less ovate, stalked.

Branchial aperture three-lobed.

Atrial aperture bi-lobed.

Branchial sac longitudinally folded, consisting of longitudinal and transverse bars. No stigmata, the fine longitudinal vessels being absent.

Tentacles compound.

This genus is formed for the reception of a remarkable little group of six deep-sea species of stalked Simple Ascidians, which were at the first glance referred to *Boltenia*. They must still be considered as near allies of that genus but they differ from it in several important details of structure.

In addition to the characters in the above description, mention must be made of a system of branched calcareous spicules found

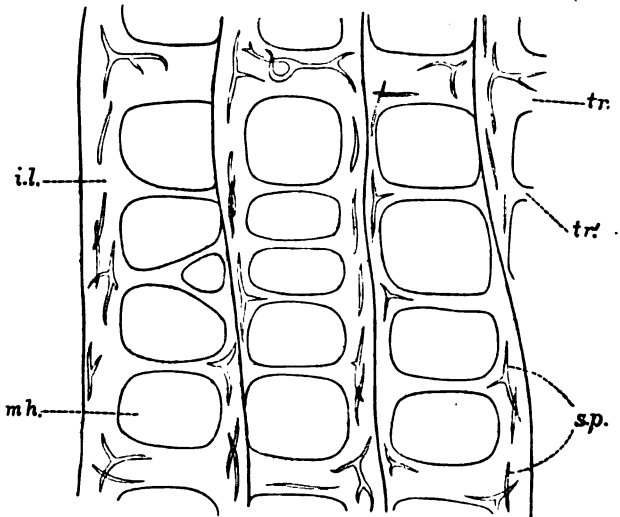

Branchial sac in *Culeolus*.

tr., Large transverse vessel; *tr.*, small transverse vessel; *i.l.*, internal longitudinal bar; *m.h.*, mesh; *sp.*, spicula.

in the vessels of the branchial sac, &c., and more or less developed in all the species (see woodcut).

The most remarkable peculiarity of this genus is the structure of the branchial sac. It is merely a skeleton compared with that organ in other Simple Ascidiata. The system of fine longitudinal or inter-stigmatic vessels is entirely wanting, so that the large meshes are not broken up into true stigmata. It seems probable from Macleay's description * that the branchial sac of *Cystingia griffithsi* has a similar simple structure.

Culeotus murrayi, n. sp.

External appearance.—Shape of the body irregularly pyriform, anterior end attenuated, ending in the stalk; posterior end blunt and broad, dorsal and ventral edges nearly straight and parallel in their posterior two-thirds, tapering suddenly in the anterior third. Stalk of moderate length, turned towards the branchial aperture. Branchial aperture placed rather on the dorsal side of the anterior end, being under the stalk, which is terminal. Atrial aperture in the middle of the posterior end, and directed posteriorly. Surface very irregular, thrown into deep creases; a belt of close-set minute projections surrounds the atrial opening, cutting off the posterior third by a very irregular line. The rest of the surface is finely granulated, the granulations being larger in the neighbourhood of the apertures. Length of body, 6 cm.; breadth, 4 cm.; length of stalk, 15 cm.

Test moderately thick, tough but soft and flexible; quite opaque.

Mantle adhering to the test, but easily separated, thin; muscle bands strong, but distant.

Branchial sac large and delicate, having six folds on each side, those at the dorsal edge closer and more distinct than those at the ventral, the pair next the endostyle being very slight. Transverse vessels alternately larger and smaller. Internal longitudinal bars wide, four between each pair of folds. Meshes vertically elongated, large. Spicules in the vessels large and branched.

Endostyle conspicuous, white, and very irregular in its course; richly supplied with large and much branched spicules, having a definite arrangement.

* Trans. Linn. Soc., vol. xiv. 1823.

Dorsal lamina represented by a series of large languets placed close together.

Tentacles much branched, of various sizes, some being very large.

Olfactory tubercle small but distinct, crescentic in shape, with the opening on the left side; both horns rolled inwards.

Viscera.—Wall of stomach remarkably folded. Genital masses about twelve in number, united in pairs and placed on the inner side of the mantle on both sides of the endostyle, the majority being on the right side.

Two specimens from Station 241 (Pacific Ocean, east of Japan); 2300 fathoms.

Culeolus wyville-thomsoni, n. sp.

External appearance.—Shape of the body irregularly pyriform or wedge-shaped, the anterior end being narrow, while the posterior is broad and blunt; dorsal and ventral edges sloping irregularly from the broad posterior end to the narrow anterior end, where the stalk is attached. Stalk thin, not long, wiry, running a slight way along the ventral edge from its point of attachment, turned towards the branchial aperture. Branchial aperture a little dorsal to the anterior end, being behind the stalk, directed anteriorly and a little dorsally; atrial aperture in the centre of the posterior end, directed posteriorly. Surface irregular, deeply seamed and raised between the seams into eminences, capped with slight papillæ. Colour pale slaty grey. Length of body, 5 cm.; breadth, 4 cm.; thickness (lateral), 3.5 cm.; length of stalk, 10.5 cm.

Test cartilaginous, thick but soft, not flexible.

Mantle thin; muscle bands strong, but rather distant.

Branchial sac with six folds on each side, diminishing in size from the dorsal to the ventral edge, those next the endostyle being very slight. Transverse vessels of three sizes placed in the following manner:—a large one, three small ones, a middle-sized one, three small ones, and then a large one; thus, any two large ones are separated by a middle-sized one and six small ones. Meshes small, transversely elongated. Spicules smaller and not so much branched as in *Culeolus murrayi*, but more numerous.

Dorsal lamina separated by a series of close-set large languets.

Tentacles about sixteen in number, branched, large and small alternately, but rather irregular in size; the tentacle at or just to the left of the olfactory tubercle is gigantic.

Olfactory tubercle distinct, cordate, opening on the right side, both ends turned in.

One specimen from Station 170 (north of the Kermadec Islands, South Pacific Ocean), 500 fathoms.

Culeolus recumbens, n. sp.

External appearance.—Shape of the body irregularly quadrate, with the angles rounded, both ends blunt; anterior rather narrower than posterior, and posterior rather more convex than anterior; dorsal and ventral edges nearly parallel, tapering slightly anteriorly, dorsal nearly straight, ventral a little convex. Stalk attached at the anterior end, on the ventral side of the branchial aperture from which it turns; it is long, thin, and like a piece of string. Branchial aperture terminal and medium; atrial on the dorsal edge two-thirds of the way down, directed dorsally. Surface even and pretty smooth, here and there slightly granulated, a band of close-set slight projections forming a line cutting off about a fourth at the hinder end, from the atrial apertures dorsally to the edge of the posterior end ventrally. Colour pale yellowish-white. Length of body, 2.5 cm.; breadth, 1.7 cm.; thickness, 1.5 cm.; length of stalk about 14 cm.

Test thin but tough, semi-opaque.

Mantle very thin, closely adhering to test, musculature feeble.

Branchial sac.—Folds very straight. Transverse vessels all the same size. Internal longitudinal bars wide. Meshes large, elongated vertically. Spicules very small but ramifying and numerous.

Dorsal lamina formed by large triangular languets.

Tentacles very long, about twenty-four in number, large and small alternately.

Olfactory tubercle small, ellipsoidal, with no aperture.

Viscera. Three genital glands on each side of cloaca.

Several specimens from Station 146 (between Cape of Good Hope and Kerguelen Island), 1375 fathoms.

Culeolus perlucidum, n. sp.

External appearance.—Shape of body ovate, the anterior end being narrow, while the posterior is round but not very broad; dorsal edge slightly, and ventral edge extremely convex. Stalk long and thin, attached to the anterior end, which tapers into it, turned away from the branchial aperture. Branchial aperture on the dorsal edge about one-fourth of the way down from the stalk; atrial at the dorsal edge of the posterior end, directed dorsally and posteriorly; both apertures prominent. Surface even and nearly smooth, being slightly granulated here and there. Colour light grey. Length of body, 2 cm.; breadth, 1.4 cm.; length of stalk about 11 cm.

Test very thin but tough, quite transparent.

Mantle thin, not adhering to the test, musculature fine but irregular.

Branchial sac very delicate. Transverse vessels wide and narrow alternately. Meshes nearly square. Spicules minute and very few.

Dorsal lamina.—Languets rather close and wide, tapering to a point.

Tentacles numerous; a few rather large, much branched, and a considerable number of small intermediate ones of different sizes.

Viscera.—One large genital gland on each side.

Several specimens from Station 147 (between Cape of Good Hope and Kerguelen Island), 1600 fathoms.

Culeolus suhmi, n. sp.

External appearance.—Shape of body between ovate and wedge-shaped; anterior end narrow, posterior end wide; ventral edge nearly straight, dorsal edge strongly convex. Stalk attached a little on the ventral side of the anterior end and turned towards the branchial aperture, of moderate length, thin. Branchial aperture prominent, terminal, and medium; atrial, on the dorsal edge, fully two-thirds of the way down, directed dorsally and slightly posteriorly. Surface even, granulated all over, and having a band of close-set projections cutting off a third of the body posteriorly and dorsally, being directed obliquely from about half-way down

the dorsal edge to the posterior end of the ventral edge, where it forms a projection. Colour dark-brown. Length of body, 1·5 cm.; breadth, ·9 cm.; length of stalk, 6 cm.

Test thin but stiff, quite opaque.

Mantle very delicate, musculature feeble.

Branchial sac.—Folds slight. Transverse vessels all one size. Internal longitudinal bars wide. Meshes nearly square, usually rather elongated transversely. Spicules large and branched, not very numerous.

Dorsal lamina formed of large blunt languets.

Tentacles branched, sixteen in number, long and short alternately.

One specimen from Station 44 (off the east coast of North America), 1700 fathoms.

Culeolus moseleyi, n. sp.

External appearance.—Shape of body regularly pyriform, anterior end attenuated and produced, being continued into the long thin stalk; posterior end wide and rounded; dorsal and ventral edges similar, convex, the anterior half of each tapering. Stalk turned towards the branchial aperture, which is on the dorsal edge, nearly one-fourth of the way down, and directed dorsally and anteriorly; atrial in the centre of the posterior end, directed posteriorly. Surface even but rough, being equally granulated all over. Colour pale yellow. Stalk marked with a fine reticulation of a brown colour. Length of body, 2 cm.; breadth, 1·2 cm.; length of stalk about 9 cm.

Test rather thick and stiff, quite opaque.

Mantle thin, muscle bands strong, but distant.

Branchial sac.—Folds slight. Transverse vessels all the same size. Internal longitudinal bars wide. Meshes square. Occasional fine transverse and longitudinal bars cross the meshes, but they are rarely seen, and do not extend for any distance. Spicules very large and branched, numerous.

Dorsal lamina. Languets.

Tentacles small, very delicate, with only occasional minute branches.

Olfactory tubercle with the opening turned towards the right side; anterior horn turned outwards, posterior coiled outwards.

One specimen from Station 271 (in the centre of the Pacific Ocean), 2425 fathoms.

These six species of *Culeolus* are all from upwards of 500 fathoms; five of them are from over 1000 fathoms, four from over 1500, and two from upwards of 2000 fathoms. They all belong to the abyssal zone.

In connection with the uniformity of the abyssal fauna, it is interesting to note that these six species, the only deep-water Bolteninæ, all belong to one genus, notwithstanding their wide distribution in space;—one species being from the North Atlantic, two from the Southern Ocean, one from the South Pacific, one from the North Pacific, and one from the centre of the Pacific Ocean on the equator.

Besides *Culeolus*, the only genus in the Cynthiadæ represented at depths of over 500 fathoms is *Styela*. Three species, *S. flava*, *S. oblonga*, and *S. glans*, were obtained from 600 fathoms, and two, *S. bythia*, and *S. squamosa*, from 2600 fathoms; these are perfectly normal members of the large and widely distributed shallow-water genus *Styela*. The great majority of the remaining species described in the present part are from depths of less than 50 fathoms.

2. On the Histology of the Pedicellariæ and the Muscles in *Echinus sphaera*, Forbes. By Patrick Geddes, F.R.S.E., Lecturer on Zoology in the School of Medicine, Edinburgh, and Frank E. Beddard, B.A., Assistant-Demonstrator of Zoology, Oxford.

(Abstract.)

This paper contains a detailed account of the structure of the soft parts of the four varieties of Pedicellariæ in this species describes particularly certain new pseudo-skeletal structures, and concludes with a reconciliation of the hitherto contradictory views as to the structure of Echinoderm muscles.

3. Additional Note on an Ultra-Neptunian Planet. By Professor George Forbes.

On the 16th of February 1880 I communicated to the Society a research upon Comets, which led me to believe in the existence of two new planets outside the orbit of Neptune. This memoir was not published in the "Transactions," and only a short abstract appeared in the Proceedings of the Society. A small number of copies were privately printed; but any one wishing for information on the subject will find it most readily in the "Observatory," 1880, June 1.

The decided tendency of the aphelia of comets to group themselves at distances from the sun equal to those of the planets could leave no doubt about the *existence* of these two new planets. The only doubtful point was as to the positions of the planets in their orbits. Meantime this research gives us greater confidence in the accuracy of the orbits of comets which have been calculated. This is most especially the case with the periods of revolution of comets when those periods are long, an element which has hitherto been very generally mistrusted. The most remarkable case is that of the comet 1861, which was calculated by Oppolzer to have a period of 415 years, and which I showed to have returned three times at such an interval.

It is well here to remark that, even in those cases where planetary perturbations may have occurred, it is seldom that the omission to take account of these could give rise to serious error, since a mistake of ten years in the date of reaching the aphelion would affect the longitude of the planet only to a trifling extent.

At present I have to speak only of the nearest of the two new planets. It was shown in the previous research to lie, in the year 1880, either close to the ecliptic in longitude 174° , or else on an orbit inclined to the ecliptic at 53° , with the longitude of the ascending node at 253° , the longitude of the planet on this orbit being 185° . The coincidences in the times of the comets arriving at their aphelia, and the times of a hypothetical planet reaching those positions, were so striking as to leave little doubt about one of these two being the true position.

This result was confirmed in a second research communicated to the Society, 1880.

Here I treated of the disturbances produced by the new planet on the longitude of Uranus, as shown by its residual tabular errors, favouring the hypothesis of the new planet moving nearly on the ecliptic. This research leaves not the slightest doubt about the longitude of the new planet, agreeing precisely with my previous work on comets.

I was able further, by a comparison of the periodic fluctuations in these residual errors with the periodic fluctuations in the longitude of Uranus, produced by the action of Neptune (for which I am indebted to Professor Newcomb's "Theory of Uranus," p. 100, &c.), to compare directly the map of Neptune with that of the new planet. By an easy harmonic analysis, the effect of Neptune is found to be about ten times that of the new planet. But the new planet is three times farther from the sun than Neptune, and the action is proportional inversely to the cube of the distance in equal times. Moreover, in the case of Neptune, the period during which this action lasts is 75 years, while in the case of the new planet it is only 45 years; and the effects are proportional to the squares of the times. Hence the mass of the new planet is to that of Neptune in the ratio of

$$\frac{1}{10} \times 3^3 \times \frac{75^2}{45^2} : 1 = 10 : 1 \text{ nearly.}$$

The mass of Neptune adopted by Newcomb was $\frac{1}{17816}$. This makes the mass of the new planet $= \frac{1}{17816}$, the mass of the sun being unity. This is the newest result at which I have arrived after a most careful examination. The new planet is then the largest but one in the solar system.

It occurred to me lately that, with these well-defined perturbations, it will be easy to decide between the two hypotheses discussed in my first memoir. For if the new planet be at present in a position so very far from the ecliptic as is indicated by the first hypothesis, then we should expect to find periodical fluctuations in the residual tabular errors of the latitude of Uranus. In fact, we might even hope by this means to determine its latitude approximately. [As a first approximation the latitude of the new planet may without serious error be considered constant during a period of

half a century.] The period of revolution of Uranus is 84 years, whilst its period synodical with the new planet is 92 years. It is unfortunate that these periods are so nearly alike, because it makes it difficult for harmonic analysis to discriminate between those errors of latitude due to errors in the assumed inclination and longitude of ascending node, and those which are due to the action of the new planet. Nevertheless, any large effect as we should expect upon the first hypothesis ought clearly to be distinguished. The errors of latitude are taken from Newcomb, p. 176. They are very small in the last 50 years, but show a marked periodic fluctuation of about 92 years. There are two dates, however—1861 and 1864—when the errors are completely discordant. I think we may with reason reject these two on the ground that up to 1861 the observations used were almost entirely those of Greenwich and Paris. Those after 1868 are almost entirely Greenwich and Washington; while between these dates those of Greenwich, Paris, Washington, and Leyden are used. We have then residual periodic fluctuation, due to the action of the new planet from which we are able to determine its latitude. In this way I find its probable latitude to be about 2° south.

This may not, perhaps, be extremely accurate, but it completely establishes the truth of the *second* hypothesis.

Although from my study of Uranus I had no doubt about the accuracy of the conclusions in my first memoir, still it was with some gratification that I received the following letter from Mr D. P. Todd, of the Nautical Almanac Office in Washington:—

“NAUTICAL ALMANAC OFFICE,

“NAVY DEPARTMENT, WASHINGTON, 15th June 1880.

“DEAR SIR,—About a month ago I read with intense interest a copy of your memoirs ‘On Comets and Ultra-Neptune Planets,’ which came to this office. You cannot fail of understanding my enthusiasm about the matter, in so far at least as it relates to the prediction of position, when I tell you that some three years ago I was engaged on a provisional treatment of residuals of longitude of Uranus and Neptune, having in view the detection of possible exterior perturbations. On my first reading of your paper I took the notion in some way that your assigned longitude was a long

way different from mine, and I thought nothing more about it for several days; but then, on referring to my papers, what was my astonishment and delight on finding that your position for the interior of the two planets differs *only four degrees* from the position which I had assigned from my own work, and marked upon a slip of paper on the morning of the 10th October 1877. Of course all my work was necessarily inconclusive, as there are not, even up to the present moment, any well-marked residuals in the case of either Uranus or Neptune; so I have never yet published the investigation. But, at the same time, I thought well enough of the work to attempt a practical search for a trans-Neptunian planet. It was conducted with the great refractor of the Naval Observatory during the latter part of 1877 and early in 1878. By reference to my observing book, I find that the investigation to which I have alluded led me to begin the search at longitude 146° . I have not my papers here at the office; but, if my memory is right, I arrived at a position in longitude somewhat less than 170° , on a date later by a few days than that I previously mentioned; and I further believe that I decided to begin the search at a point some fifteen to twenty degrees preceding that indicated as most probable by my research. I found the practical search much the most arduous task that I had ever set myself about, and the matter was the more aggravating because my regular day work could suffer no interruptions, and the great telescope was not at my service until after midnight. Furthermore, my residence was something like two miles distant from the Observatory, and I had no assistance whatever in the dome. The search was abruptly terminated, by circumstances beyond my control, at longitude 186° . But as I took only a narrow zone, at a given inclination so elliptic, I have never regarded the search definitive. I have not yet fully concluded what I shall do—if anything—with my investigation. I think, however, that if I have leisure during the next few months, I shall repeat the work quite independently of what I previously did, and publish at least the results, if there seems to be anything worth the while.—I am, dear Sir, yours, with much respect,

“(Signed)

D. P. TODD.

“To Professor GEORGE FORBES, M.A.,
“Anderson’s College, Glasgow, Scotland.”

Mr Pliny Earle Chase, of Haverford College, forwarded a post-card, dated July 30, 1880, to the Royal Society of Edinburgh, which was handed to me, whose contents are as follows :—

“ *Ultra-Neptunian Planets.* — Professor George Forbes’ hypothetical planets are represented by my $\frac{\pi^n}{32}$ series (Proc. Amer. Phil. Soc., xiii. 140).

| | Theoretical. | | Observed. |
|----------------------|--------------|-------------------------|------------|
| $\frac{\pi^2}{32} =$ | ·31 | Mercury, perihelion, | = ·31 |
| $\frac{\pi^3}{32} =$ | ·97 | Earth, „ | = ·98 |
| $\frac{\pi^4}{32} =$ | 3·04 | Asteroids (= 2 + Mars), | = 3·04 |
| $\frac{\pi^5}{32} =$ | 9·56 | Saturn, | = 9·54 |
| $\frac{\pi^6}{32} =$ | 30·04 | Neptune, | = 30·04 |
| $\frac{\pi^7}{32} =$ | 92·79 | Forbes, I, | = 100·00 |
| $\frac{\pi^8}{32} =$ | 296·52 | Forbes, II, | = 300·00.” |

In May 1880, the Earl of Craufurd and Balcarres, then Lord Lindsay, sent a circular from Dunecht, stating that I would forward a copy of my memoir to those who were likely to assist in the practical search. This led to a distribution of about 100 copies; in consequence of which a large number of excellent telescopes are now being employed in the search, and a considerable number of charts of that region have been forwarded to me. But hitherto the observations have been too few to expect results. Mr Newall kindly lent me his gigantic refractor; but during six weeks that I was on the watch I had not a single really good night.

With regard, then, to the future search for the planet, I would recommend (1) a search over a zone extending over about five degrees on each side of the position indicated by me, and going at least to two degrees south of the ecliptic. (2) I would recommend a special search in the position indicated by the stars observed by Rümker at Paramatta, mentioned in my last communication on this subject

to the Society, which I there surmised to be the new planet. I find that these stars were generally observed only once. The dates are not given in the catalogue, but they all lie on one great circle quite close to the ecliptic. They have never been observed by other astronomers. The mean position of these three stars is about 10h. 39m. R.A. I believe that the mean time of observation of these stars was about the year 1835. In 46 years the new planet would move over 15.5° , or 1h. 2m. This would make the present position of the new planet = 11h. 41m., agreeing within 1m. of the theoretical time.

4. On some Effects of Rotation in Liquid Jets. By Professor Tait.

The author had noticed that a jet of mercury from a funnel, falling horizontally and nearly tangentially on a slightly inclined glass plate, seemed to *roll upwards* along the plate. Attributing this to a rotation of the jet, he endeavoured, with success, to reproduce the phenomenon with water jets escaping from a rapidly rotating tube, and falling on a slightly inclined glass surface covered with a thin layer of paraffin.

Another curious fact was observed when the efflux was slow, and the tube rotated very rapidly. The water, on escaping from the rotating tube, instead of proceeding as a jet, crept round the fixed tube in which the rotating tube was enclosed, and escaped by dropping off at a distance of nearly half an inch from its open end.

5. Note on the Influence of Temperature-Change of Conductivity on the Conduction of Heat in Solids. By Professor Tait.

(The substance of this note is incorporated in the first of Professor Tait's papers of February 7, below.)

BUSINESS.

Sven Lovén, Director of the Museum and Professor of Natural History at Stockholm; Simon Newcomb, Professor, United States Navy, Washington; Émile Plantamour, Professor of Astronomy,

Observatory, Geneva; Johannes Iapetus Smith Steenstrup, Professor of Zoology at Copenhagen, were balloted for, and declared duly elected Foreign Honorary Fellows of the Society.

The Hon. Justice Grove, M.A., D.C.L., LL.D., and the Rev. George Salmon, D.D., D.C.L., LL.D., Regius Professor of Divinity, Trinity College, Dublin, were balloted for, and declared duly elected British Honorary Fellows of the Society.

Monday, 7th February 1881.

PROFESSOR DOUGLAS MACLAGAN, Vice-President,
in the Chair.

The Chairman read Obituary Notices of Mr Thomas Key, Dr William Lassell, Mr Maurice Lothian, Mr Mungo Ponton, Mr Thomas Knox, The Hon. Lord Ormidale, Professor Sharpey—deceased Fellows of the Society.

OBITUARY NOTICES.

THOMAS KEY. By J. Sanderson, Deputy Inspector-General of Hospitals.

MR THOMAS KEY, Licentiate of the College of Surgeons of Edinburgh, was a son of Dr Patrick Key, Physician in Forfar. He was born in that town in 1803, and received his early education there. He attended the literary classes at the St Andrews University before coming to the University of Edinburgh to study medicine. At the age of nineteen he received his diploma of Surgeon from the College of Surgeons of that city. In the following year he received the appointment of assistant-surgeon in the Madras Medical Service of the Honourable the East India Company.

Very shortly after his arrival in India, he was appointed to the Hyderabad Contingent Forces in the Deccan, in which he served sixteen years. During this time he held the office of medical store-keeper, and was also superintendent of the Medical School at Bolarum, which position he held till 1842. In that year he was compelled, from the state of his health, to resign his office and return to Europe.

During his service in the Nizam's Army in the Deccan, he several times received the thanks of the Resident for the efficient manner in which he had discharged his official duties, and also for having introduced a method of preparing certain medicines, which rendered it unnecessary to procure supplies of them from England.

While at home he attended the classes of *Materia Medica* and *Pharmacy and Chemistry* in the Edinburgh University.

In 1845 he returned to India, and was called upon to do military duties with a native regiment for a short time.

In 1846 he was appointed Professor of *Chemistry and Materia Medica* to the Madras Medical School, of which school he became, in 1849, superintendent. When in that position he published a *Manual of Chemistry* for the use of the students, a second edition of which was called for in 1852.

He forwarded to the great Exhibition of 1851 specimens of Fixed Oils which he had prepared, and for which he had the honour of having awarded to him by the Commissioners one of the Medals of Merit of the Exhibition.

On promotion to the superintending surgeon grade, he ceased by the existing rules of the service to be longer attached to the Medical School, and discharged the duties of this office in the above capacity till his health compelled him to leave India in 1854.

During his residence at Madras he devoted much time to several institutions, among which may be mentioned the Military Male Orphan Asylum; the Monegar Choultry, an institution for the medical treatment of the native poor, of which he was secretary and treasurer for seven years; and the Madras Medical Fund, of which he was secretary for four years.

For his very valuable services in these capacities, he had the honour of receiving, on his retirement from the service, the thanks of the Government and of the Boards of these institutions.

Since 1854 he resided chiefly at Edinburgh. He was elected a Fellow of the Society in 1868, and died suddenly at Edinburgh on Sunday, 18th January 1880, at the age of 76.

WILLIAM LASSELL. By the Rev. T. R. Robinson, D.D., F.R.S.,
Armagh Observatory.

WILLIAM LASSELL belonged to a class of men which is (as far as I know), peculiar to these Islands; men who, while carrying on commercial or manufacturing business with energy and success, join to it higher pursuits, seeking recreation in devotion to some department of science, some doing this at much sacrifice of time and labour, and frequently at a princely expenditure of money, and often rewarded by results of the highest importance to knowledge. Such persons deserve all honour, and of such none more than the subject of this notice, whose services to what may be called Optical Astronomy were so great as fairly to entitle him to rank with Sir William Herschel and Lord Rosse. He first became known to the astronomical world in 1840 by his description of a Newtonian of nine inches aperture, which he mounted on an Equatorial of his own contrivance at his residence near Liverpool. The specula were polished by hand, but must have been of surpassing light and definition, for he saw with it (having no previous knowledge of the star's existence) the sixth star of the trapezium in Orion, which the elder Struvè had failed to detect with the renowned Dorpat *Achromatic* nine and half inches aperture!

With this instrument he did good work for some years, till the success of the late Lord Rosse, in figuring specula of very large size by machinery, made him wish for a larger telescope. After visiting Parsonstown and studying Lord Rosse's work, he constructed a two feet Newtonian by processes which he has described in the "Astronomical Society's Memoirs" (vol. xviii.) with singular precision and clearness of detail. He was far from copying Lord Rosse's method (and his mode of forming the alloy was objectionable, when arsenic was used, even dangerous), and although his machine was found by himself and also by Warren De La Rue to be imperfect, yet his minute observation of even the most trifling facts and his intelligent appreciation of their bearings on the result, enabled him to obtain in this instance also an admirable telescope; though ultimately he used another machine whose action nearly resembled Lord Rosse's.

This telescope showed seven stars in the Orion trapezium, which

from my acquaintance with that object in Lord Rosse's six feet, I consider a real feat. With it he discovered the obscure ring of Saturn, his eighth satellite, two satellites of Uranus, and one of Neptune, besides making a number of valuable observations on the physical aspects of the Planets.* In 1850 he applied to the specula of this telescope a system of lever counterpoises intended to support their weight laterally and prevent any of the distortions which he thought the usual hoop supports might produce at low altitudes. But it may be questioned whether they were less likely to do harm than the hoop, which acts very well. Latterly, dissatisfied with the smoky atmosphere of Lancashire, he established this telescope at Malta, where he observed with it for a year. The wonderful clearness of the sky excited in him a desire for yet more powerful optical means, and he constructed another Newtonian of four feet aperture, which he has described in the "Memoirs of the Astronomical Society, vol. xxxvi." Its equatorial is similar to the mountings of the former telescopes, but it would not be sufficient for the present demands of Astronomy, though it met all his requirements then. Yet it was a noble piece of engineering (and its low cost as compared with that of more recent equatorials is not unimportant). The tower which carries the observer is well worthy of notice. It was erected at Malta in 1862, and Lassell worked with it for four years, when failing health compelled him to renounce open air observations, and to return to England. In proof of the excellence of this telescope it may suffice to quote the words of Otto Struvé :—

"The way in which it showed the satellites of Uranus and Neptune gave me a very high idea of the excellence of this telescope. . . . Several double stars which I examined convinced me that in respect of sharpness of image Mr Lassell has obtained a remarkably favourable result; χ Aquila 7 and 8 magnitudes and 0.6 apart, were clearly separated in dark night. . . . And the images were equally perfect at all altitudes."

The observations at Malta occupy a large part of vol. xxxvi. of "Astronomical Memoirs," and are of great value, in particular those of Nebulæ, with their accompanying illustrations; for the correctness

* Some of these were simultaneously observed by Bond in America, with the Harvard fifteen inch aperture Achromatic.

of several I can vouch from my acquaintance with them in the Parsonstown six feet.

It is greatly to be regretted that this noble telescope was not acquired by some national Observatory. Lassell was willing to dispose of it to the Victoria authorities, who were thinking of establishing a great telescope at Melbourne; but an unhappy misunderstanding prevented them from accepting his offer. After a few years the instrument was broken up, and its materials sold. On his return to England he re-erected the two-feet Equatorial and continued to observe with it till his sight failed him. He died October 5, 1880, in his 82nd year. He was not less active as a writer than as an observer. In the Royal Society Catalogue his name occurs seventy-seven times, and there is scarcely one of those papers that does not contain valuable information. And his work was well appreciated. The University of Cambridge conferred on him the degree of LL.D. He was a member of many celebrated scientific Societies, and was President of the Astronomical Society, whose gold medal he received; he received also a royal medal from the Royal Society of London.

I conclude this notice by stating that my intercourse with him gave me the impression that he was a good and noble-minded man of high purpose, and utterly unclouded by any of that jealous and contentious spirit which too often darkens scientific life.

MAURICE LOTHIAN. By Sheriff Hallard.

MAURICE LOTHIAN, formerly Procurator-Fiscal of this county, died at St Catherine's, in the neighbourhood of this city, on 15th July last, in his 85th year.* He became a Fellow of the Royal Society in 1869, having then for some years outlived that critical moment in old age mentioned by the Psalmist. For him, as for others, our diploma was one of the crowning honours of an active and well-spent life.

* Born in the end of the eighteenth century, he was wont to tell of a family incident which connected him with its beginning. His grandfather was in the Porteous mob. Disguised in his wife's clothes, this ancestor took his share in the business transacted in the Grassmarket on that memorable night, came home before dawn, resumed his male attire, went down to Leith, took ship, and never was heard of more.

A shrewd lawyer, an effective speaker for a popular audience, keen in his aims, fertile in resources for attaining them, he rapidly achieved that local notoriety which some slight change of circumstance and a higher ambition might perhaps have developed into fame. But he was content with that pre-eminence which he quite irresistibly won in his own surroundings, with the admiration of some and the respect of all. His busy professional and official life left him little leisure to cultivate literature and science, much as he, from a popular point of view, was able to appreciate both, though he recoiled somewhat from the audacities of modern thought. Many years ago he contributed to the eighth edition of the *Encyclopedia Britannica* an article on "Master and Servant," a short treatise, clearly and vigorously written, with reliable and sufficient information upon the law of that important subject as it then stood. Whenever the cause of morality and religion seemed to invite his services, Maurice Lothian stood forth as an energetic and impressive lay preacher. In that connection one is apt to picture to one's self that fine head and presence which we all remember.

For many years he was one of the leading directors of an institution which, among other things, aims at popularising some of the results of scientific enquiry. As a vice-president of the Philosophical Institution, Maurice Lothian will be long remembered. We desire that as a Fellow of the Royal Society of Edinburgh he may not be forgotten.

MUNGO PONTON, W.S.

(From materials chiefly supplied by Mrs Ponton.)

MUNGO PONTON was born at Balgreen, near Edinburgh, in the year 1801. He was educated for the legal profession, and, in due course, became a Writer to the Signet. He was one of the founders of the National Bank of Scotland, and it was in his office that the plans were matured for the establishment of that institution. He held the office of legal adviser to the Bank, and subsequently that of secretary. The strain of the double duties thus imposed on him proved too much for his strength, and a serious attack of illness compelled him to retire from active life while yet comparatively a young man. Since that time he continued more or less of an invalid, but his

intensely active mind found congenial occupation in scientific and literary pursuits. He discovered the peculiar effect of light on gelatine when treated with the bichromate of potash, which was afterwards practically applied in the autotype process. Indeed, it is upon the sensitiveness of this salt to light, under certain conditions, that all the processes of permanent printing of the present day are based; and this discovery of his consequently marks the commencement of an era in photography, and renders his name as closely connected with the history of that art as are those of Niépce, Daguerre, and Talbot. It was in 1839—the very year in which the wonderful process of Daguerre was announced to the world—that Mungo Ponton called attention to bichromate of potash as a photographic agent, and described a process—the foundation of every subsequent permanent printing process—whereby, through that agent, durable impressions on paper might be produced. This discovery, which had been first announced to the Scottish Society of Arts on 29th May 1839, was given to the world in the *Edinburgh New Philosophical Journal*, vol. xxvii., 1839, under the title, “Notice of a Cheap and Simple Method of Preparing Paper for Photographic Drawing.”

In December 1838, he obtained the Honorary Silver Medal of the Society of Arts of Scotland, “for the ingenuity displayed by him in the Model and Description of his Improved Electric Telegraph; read and exhibited 10th January and 20th June 1838, when Mr Ponton presented his elegant model to the Society, to be placed in their Museum.”

His inventive turn of mind led him to take a great interest in the proceedings of the Scottish Society of Arts. He was admitted a Fellow of that Society in 1833, and shortly afterwards was made Foreign Secretary. He was elected their Vice-President in 1837, and again in 1844. He also acted for some time as editor of their *Transactions*. His first scientific paper, “On a Method of increasing the Adhesion of the Wheels of Locomotives to the Rails” was communicated to that Society in 1837.

He was the first who employed the photographic method for registering automatically the fluctuations in thermometers and other instruments, and for this invention he received also the Silver Medal of the same Society in 1845.

On the 20th of January 1834, he was elected a Fellow of the Royal Society of Edinburgh, and in December preceding he contributed a paper to our Proceedings (vol. i. p. 31), "On a New Species of Coloured Fringes developed between certain pieces of Plate-Glass, exhibiting a new Variety of Polarisation, and a peculiar Property which renders them available for the purposes of Micrometry." The author found that the fringes presented the appearance of three rectilinear bands, each consisting of black, white, and coloured stripes, but the central band was afterwards found to be composed of two united into one. There is thus a band for each of the four surfaces of the plates, and these bands possess a property which he thought might be available for micrometry. When the surfaces of the plates are parallel, two of the bands are united into one at the centre; but if a film be introduced between the plates, so as to cause them slightly to diverge, the two bands in the centre will be separated, and move laterally from each other, still preserving parallelism. A film, $\frac{1}{800}$ of an inch in thickness, causes the central bands to separate to the distance of an inch, so that every $\frac{1}{80}$ of an inch of separation is equivalent to $\frac{1}{16,000}$ of an inch in thickness.

On the 16th of January 1837, he read a paper to our Society on the condition of the earth, as it is first described in the Mosaic account of the creation. In this paper, he held that in a philological point of view, the most correct translation of the words rendered "without form and void," is *immeasurable and imponderable*. He seemed to lean to the opinion that the strata of the earth containing organic remains were formed during the very epoch embraced in the Mosaic narrative, and that the primitive condition of the earth was properly gaseous. In this connection, it may be mentioned, that his theoretical knowledge of music was uncommon, and that he arranged to music a metrical translation of the Psalms from the original Hebrew.

Having proposed the micrometer above described, Mr Ponton subsequently devised a photometer, which he described in a paper read to this Society on the 14th of March 1856, and published in our Transactions (vol. xxi. p. 363). The principle of this instrument consisted in comparing lights of different intensities by judging of the relative brilliancies of two definite surfaces when illuminated from two sources of light to be compared, care being

taken to have the illumination homogeneous. This condition was secured by causing the light from each source to pass through a combination of blue glass and blue paper steeped in a solution of sulphate of copper. This combination of glass and paper was enclosed in two tubes. If the apertures were equal, the blue spots seen on admission of a source of light were exactly of the same tint and intensity; but if one of the apertures were a little smaller, one spot not only seemed darker, but of a slight difference of colour. This peculiarity, when combined with a definite modification of the aperture of the tube next the source of light to be compared, enabled the observer to determine gradations of light with fully more exactitude than the method of equal shadows.

Mr Ponton was much occupied with the laws of chromatic dispersion, and read papers on that subject at the meetings of the British Association held in 1859 and 1860. At the latter meeting he also read a paper "On the Laws of the Wave-Lengths corresponding to certain points in the Solar Spectrum." Indeed, it is a remarkable circumstance, that at the time of his death, notwithstanding his advanced age, he was engaged in constructing an instrument for making apparent to the eye the different lengths of the waves of light emanating from two differently coloured media.

In addition to the scientific papers enumerated, he wrote several treatises. His most important work is entitled "The Beginning, its When and its How."

He endured his protracted affliction with exemplary patience, and endeared himself to all who knew him by his cheerfulness and thorough kindness of disposition.

It was on the 3d of August 1880 that Mungo Ponton, who will ever be remembered along with Daguerre and Fox Talbot, as one of the fathers of photography, passed away.

THOMAS KNOX. By the Hon. Lord Shand.

Mr THOMAS KNOX was born at Greenlaw in Berwickshire in 1818. At an early age he left his father's house and came to Edinburgh, where he was apprenticed as a draper. Soon after having completed his apprenticeship he went to Dundee, where he remained for some time as an assistant in an extensive warehouse. It was there he

gave evidence of that public spirit which was so conspicuous through life, and where the foundation of that career of usefulness for which he was distinguished was laid. At that time the hours of shopmen were excessive, and impressed with the evils of this, he, in union with others, inaugurated the movement for shorter hours. It was at a meeting of young men that Mr Knox set himself to expose the bad effects of protracted hours of labour, and to point out the importance of intellectual improvement of the class interested. Before he left Dundee his gifts as a public speaker attracted attention, while his aspirations after mental culture and social reform secured for him the position of a trusted leader among the young men with whom he associated. After a few years spent in Dundee, he returned to Edinburgh, and ultimately commenced business as a partner in the well-known firm of Knox, Samuel & Dickson. Mr Knox was a man of remarkable strength, both mentally and physically, and there were few public men better known or more generally respected among his fellow-citizens. His appearance was commanding; he had fine features, an open frank countenance, a high forehead and dark expressive eyes which gave an impression of intense earnestness to all who met him. He was distinguished by a breadth of thought and enthusiastic attachment to every movement that aimed at the moral, educational, and social elevation of the people, and he was attracted to almost every platform which sought to correct public abuses or lend a helping hand to the struggling and helpless. There was at the same time a geniality of feeling and kindness of disposition, stirred by generous impulses, which secured for him a hearty welcome among all classes. As a politician he belonged to the advanced Liberal or Radical section of reformers, but he was at the same time tolerant of the opinions of those who differed from him, whether Whigs or Conservatives. As a sanitary reformer he was a fellow-worker with Dr Begg, Dr Guthrie, Dr James Cowan, and latterly with Dr William Chambers, who found in him a hearty coadjutor in carrying out the grand scheme for the improvement of the city, by substituting open well-aired streets for ill-ventilated and confined lanes and closes. In order to the enterprise for that object being carried out, a large amount of preliminary education was necessary to prepare the public mind. With one or two other social reformers, Mr Knox explored the slums and dark places of the city by day and night, and by the

use of his pen he laid bare the true state of matters, by which the citizens were taken by surprise. The exposure which he thus made, by speeches and pamphlets, and through the columns of the press, were the necessary precursors of the City Improvement Act. It was the explorations carried on by him and others among the masses crowded in the lowest localities of the city which also paved the way for the formation of the Association for Improving the Condition of the Poor,—an association which has for a number of years been the means of relieving great distress amongst the deserving poor. The old town was divided into districts, and the sad truth ascertained, by personal visitation, regarding the depth of misery and immorality in the city slums. The result of their labours was to produce a series of pointed and striking articles in the daily press, and also a report of the most melancholy and startling character, and as previously stated these were followed by the formation of the above Association. No sooner had the Improvement Act become operative than Mr Knox cast about for other fields of philanthropic effort. His free winter dinners for the street Arabs of the city, which have gladdened many a half-starved child, and his warm and enthusiastic interest in the Edinburgh Industrial Brigade and the Mars Training Ship as schools for discipline and moral and industrial education, for several years engaged very much of his attention.

As a temperance reformer he was well known throughout Scotland, and the practical results of his labours are to be seen in several clauses of the Forbes Mackenzie and the Public House Amendment Acts. His fearlessness and utter disregard of personal consequences in the proclamation of the truth and exposure of local abuses brought him enemies and detractors amongst those whose personal interests were affected; but, besides the approval of a good conscience, he never failed to secure the trust and confidence of his fellow-citizens, who recognised the noble and generous motives which inspired him.

In his latter years the influence of Mr Knox was powerfully felt in the educational world. The interest and labour which he manifested, in conjunction with the late Mr James Duncan and Lord Provost Boyd, while each in their time were Master of the Merchant Company, were largely instrumental in moulding the educational system as realised in the Merchant Company Schools, which have

proved so successful. Again, so far back as about twenty years ago, he inaugurated an agitation by delivering speeches and publishing pamphlets on the necessity for the introduction of temperance teaching into school books. This proposal was at first treated as too Utopian to be seriously entertained; but before he died he was privileged to see Dr Benjamin Richardson's *Temperance Manual* largely introduced into many of the public schools, while temperance lessons were being introduced into the school books published by Messrs W. & R. Chambers, Collins & Son, Nelson & Sons, and other noted publishers.

The institution which had the benefit of a large share of Mr Knox's interest and effort during the last few years of his life was the Watt Institute and School of Arts, the earliest of the Mechanics Institutes founded in the United Kingdom. He was appointed Hon. Treasurer in November 1876, and since that time a complete revolution has been effected in the interesting history of the School. The time and labour which he gave in supporting and co-operating with Lord Shand, the President of this People's College, in efforts to extend the usefulness of the school amongst the industrial classes it would be difficult to overestimate: the result was an accession of students in increasing numbers in a degree perhaps unprecedented in the history of any educational institution. Having regard to the general interest taken in the School at the present time by all sections of the citizens, it may be mentioned that the number of students in 1875-76 was 1098; in 1876-77, 1404; 1877-78, 1977; 1878-79, 2185; and 1879-80, 2375. Thus in four years the increase was 1280. In that short period the attendance was more than double, and nothing tended to this result more powerfully than Mr Knox's constant attendance at the classes in the evening when his business labours were over, and his kind words of encouragement to the students. It is an interesting fact that the last few hours of Mr Knox's life were devoted by him to this institution. Before retiring to rest on the night of his death, he wrote out the draft of the Annual Report, in which he made an earnest appeal that the directors might be supported in their endeavours, by means of a union with the Heriot Trust, not only to maintain the School in a state of efficiency, but to extend it greatly, so as that it should become a People's College for Technical Education, really worthy of

the nation and the metropolis. He died on the 4th of December 1879, in the 61st year of his age, having devoted the best part of his life in earnest endeavours to promote the welfare of others.

LORD ORMIDALE. By the President.

ROBERT MACFARLANE, a judge of the Court of Session, under the title of Lord Ormidale, died on the 2d of November 1880, in his seventy-ninth year. He was in many respects a remarkable man, and his life had elements of interest and variety apart from his professional success. Vigour of thought and force of character were the principal features which distinguished him, and these enabled him, through many changing scenes and some vicissitudes, to assert a foremost rank at the Bar and on the Bench.

He was born in Glen Douglas, on Loch Lomond, on the 30th of July 1802, among some of the grandest and most beautiful scenes of the Scottish Highlands. Nor were the traces of such a birth-place without a reflection in his character. The quick, ardent, intense enthusiasm which marked the man, were the natural fruit of a boyhood spent by mountain and flood; and the cloud and sunshine flitted across his impressionable spirit, as he must have seen them pass over his native hills.

He attended the University of Glasgow in the four sessions from 1816 to 1819, and then came to Edinburgh. Shortly afterwards he went on a voyage to the West Indies, in connection with the affairs of a relative, and after a short residence in Jamaica he spent four or five months in the United States, before returning to this country.

Having on his return resolved to prosecute the legal profession, he became bound as apprentice to Mr James Greig, W.S. In this occupation he was associated with two men who were afterwards very eminent in their respective careers, and very distinguished members of this society. One was the late Lord Neaves, one of the most brilliant of our body, and the other our late lamented Treasurer, Mr David Smith, the loss of whose invaluable services we so deeply deplore.

On finishing his apprenticeship, Mr Macfarlane resolved to enter the body of Writers to the Signet, and for more than ten years, from 1827 to 1838, carried on business in that capacity, as a

member of the firm of Mackenzie & Macfarlane. He passed at the Bar of Scotland in 1838, thus commencing his career as a barrister at the age of thirty-six,—12 or 14 years later than the average age of entrants to the Faculty of Advocates. Such an experiment is always hazardous, for all pursuits require a period of initiation; and the advantages of experience are usually more than counterbalanced by the absence of the elasticity of youth, the formation of confirmed habits of thought, and the necessary disparity between the age and the professional standing of the man. But Mr Macfarlane's energy, industry, and knowledge enabled him to surmount without an effort difficulties which so often prove fatal; and he was very quickly abreast of the general body of well-employed counsel. This position was rapidly gained, and firmly maintained and increased, and his previous legal training had been so thorough, and his knowledge of the practical application of law so complete, as to give him many advantages in the field. He was at one time the best employed junior in the Parliament House. As a counsel in jury trials he was eminent and successful, a department in which his natural sagacity and extensive knowledge of men, and of the springs of action, came to his aid with great effect. He had, in 1837, before entering the Faculty of Advocates, published a work on "Jury Practice," and he followed this up in 1841 by an important volume of "Reports of Cases tried by Jury," and in 1844-49, in conjunction with Mr Thomas Cleghorn, he published a well known treatise on "The Forms of Issues in Jury Trials."

In 1853 Mr Macfarlane was appointed to the important Sheriffship of Renfrewshire, a county, the judicial affairs of which he administered for nine years with great efficiency and popularity. He was elevated to the Bench in 1862, by the title of Lord Ormidale, remaining twelve years in the Outer House, and removing in 1874 to the Second Division of the Inner House.

On the Bench he more than maintained the reputation he had vindicated at the Bar. His conscientious labour, thorough knowledge of business, and clear common sense, were qualities which he combined with a complete mastery of all branches of the profession. In legal dialectics he engaged sparingly, fixing his attention exclusively on the practical questions and interests in the case immediately before him, and throwing aside with unusual facility

collateral and adventitious surroundings. No judge ever commanded more completely the confidence and respect of the profession. On the Bench his previous training behind the Bar came to be of material assistance, as it assured practitioners of the familiarity of the judge with details with which the Bench and Bar are not always conversant. Accordingly, while he sat as a single judge in the Outer House, his Bar was popular, and his judgments, carefully considered, commanded a large measure of confidence; while his short but efficient career in the Inner House was one of unbroken ability and power. He was vigorous to the last, although on the verge of fourscore years. Neither his intellect nor his athletic frame indicated any abatement of his strength when he last appeared on the Bench, but a few weeks before his fatal illness commenced. He has left behind him that inheritance for which all honourable aspirants after forensic distinction strive, a reputation for judicial ability and integrity which will be long remembered.

Lord Ormidale married a daughter of his friend, Mr Greig. He survived her many years, and has left a large family. In private he was a warm-hearted, genial, and pleasant companion, of a kindly, generous nature, indulgent to error, but intolerant of meanness or deception. His hot Celtic blood was easily quickened by anything like injustice or oppression; but even just resentment did not long retain its hold on him. Kindly and generous, he was a firm friend, and a sagacious, as he was an experienced, counsellor. Although he had reached an age beyond the usual limits of life, no one ever associated with the impulsive and ready vigour of his thoughts and his demeanour the decrepitude of age. His was a useful as well as a successful life to the end: and while the public gratefully remember, and deeply regret the loss of so valuable a servant, many a friend will long think, with a heavy heart, that his animated features, cheerful voice, and ready sympathy, will meet them no more.

For myself, I render this slender tribute to his memory under a sense of a grave personal bereavement. I sat side by side with him for six years, and no man could have had a more loyal and trustworthy colleague, or a truer, more trusted, or more attached friend.

DR WILLIAM SHARPEY. By Dr Allen Thomson.

DR WILLIAM SHARPEY was born at Arbroath in Forfarshire on the 1st of April 1802. His father was an Englishman, and belonged to Folkestone in Kent; but in the year 1794 he migrated to Arbroath, and married Mary Balfour, a native of that town. Mr Sharpey having died shortly before the birth of his son William, his widow was afterwards married to Dr William Arrott, a medical practitioner of Arbroath, in whose family the subject of this notice was brought up.

William Sharpey's education was carried on up to the age of fifteen at the public school of Arbroath. In November 1817 he entered the University of Edinburgh, as a student in the Faculty of Arts, attending the Greek and Natural Philosophy classes.

In 1818 he commenced his medical studies in the University and the Extra-academical School of Edinburgh; and in 1821, at the early age of nineteen, he obtained the diploma of the Edinburgh College of Surgeons. He then studied anatomy for some months at Brooke's School in London, and subsequently passed nearly a year in surgical and medical study at Paris. Returning to Edinburgh in the end of 1822, he graduated in medicine in August 1823, his printed inaugural dissertation bearing the title "De Ventriculi Carcinomate;" after which he again spent some time in Paris in attendance on the Hospitals and on classes at the Garden of Plants.

From 1824 to 1826 his plans appear to have remained undecided; but having finally resolved to devote himself to anatomical and physiological pursuits, for which he had long had a predilection, he was desirous to improve himself still more by foreign travel, and especially to make himself thoroughly acquainted with the system of instruction in the Universities of Italy and Germany. With this view he spent more than fifteen months in Switzerland, Italy, Austria, and Germany, often journeying on foot with knapsack on his back, and storing up in his wonderfully tenacious memory that fund of information, anecdote, and incident which surprised and delighted those who heard him in after life narrate his travels.

Reaching Berlin in the autumn of 1828, he gave his whole time during nine months to the careful dissection of the human body and the study of scientific anatomy, in which he had the inestimable

advantage of the friendship and assistance of the learned and genial Rudolphi.

On his return from the Continent in the autumn of 1829, Dr Sharpey established himself in Edinburgh, and was for a time engaged in anatomical researches. In 1830 he became a Fellow of the College of Surgeons there, upon which occasion he presented a probationary essay, "On the Pathology and Treatment of False Joints." In the summer of 1831 he again spent some time in Berlin for the purpose of collecting specimens to illustrate the course of lectures on anatomy, which it was his intention to deliver in the following winter. After embarking in this enterprise he continued to give systematic instructions as a teacher in the extra-academical School of Edinburgh, during five years, or from 1831 to 1836; and while his success as a lecturer was evinced by the large and progressive increase in the number of his pupils, his scientific reputation both at home and abroad had advanced in a still greater degree by the known care and accuracy of his observations, and the extent of his scientific knowledge.

In the summer of 1836 the Chair of Anatomy and Physiology in the then University of London having become vacant by the resignation of Dr Jones Quain, and the authorities and leading medical professors of the university being desirous to give greater prominence than previously to the teaching of Physiology and Physiological Anatomy, Dr Sharpey was, in the month of July, selected to fill the chair; it being determined that while he, as Professor of Anatomy and Physiology, should give full instructions in Physiology and in minute Anatomy and the structure of the Viscera, his colleague, Mr Richard Quain, should, as Professor of Anatomy, undertake the more purely descriptive and practical anatomical department. There was thus established in London for the first time the full and systematic teaching of Physiology, which had previously been only imperfectly treated as an appendage to the courses of Anatomy.

Dr Sharpey applied himself to the performance of his new duties with all the care and diligence which was to be expected from so conscientious a teacher, with a range of knowledge of his subject rarely equalled, and with powers of exact observation and critical judgment of the highest order; so that it was not to be wondered

at that, as he soon became more closely identified with all the interests of the institution to which he belonged, his influence increased in proportion, and he came to be regarded not merely as one of the best teachers of his department, but as one of the highest authorities in biological science.

Dr Sharpey continued to perform the duties of his chair during the long period of thirty-eight years, maintaining to the last the same scrupulous care in the preparation of his lectures and the performance of all his academic duties which had distinguished the earlier and more vigorous parts of his career. And all his pupils, many of whom occupy very high places in science and medicine, acknowledge with pleasure their debt of gratitude to their teacher, not alone for the exact and solid information which they derived from his instructions, but also for the scientific spirit and love of truth which he endeavoured to instil into their minds.

Dr Sharpey's wide range of information, together with his remarkably wise and fair judgment, were such as to inspire great reliance on his opinion, and naturally led to his being called upon to take an active part in the management of other scientific institutions of the metropolis.

In 1840, when the London University obtained its charter to grant degrees, he was appointed one of the examiners, and he retained that office during the unusually long period of twenty-three years. He was at a later period a member of the Senate of the University. During fifteen years he was a member of the General Medical Council of Education and Registration. He was a trustee of the Hunterian Museum of the Royal College of Surgeons, and a member of the Science Commission which met under the presidency of the Duke of Devonshire from 1870 to 1875. And it need scarcely be said that in the affairs of these several bodies, as in all others with which he was concerned, his extensive knowledge, clear sagacity, and sound judgment aided greatly the deliberations of those with whom he was associated, and contributed to the advance of science and the promotion of measures of public utility.

But the body with the management of which, next to University College, Dr Sharpey was most closely connected, was the Royal Society of London, which he joined as Fellow in 1839, and of

which he was one of the secretaries from 1853 to 1872. Those who were most fully acquainted with the affairs of the Society know best the anxious care and judicious labour which he bestowed upon its business, and readily distinguish the mark of his able assistance in the promotion of various measures having important relations to the interests of the Society and the advance of science which were the subjects of deliberation during his tenure of office.

Dr Sharpey became a Fellow of the Royal Society of Edinburgh in 1834. He was member of many other societies in this country and on the Continent; and he received the honorary degree of LL.D. from the University of Edinburgh in 1859.

Dr Sharpey was by no means a copious writer, nor could he be regarded as the author of many new discoveries, yet it is universally acknowledged that great value is to be attached to his original observations and the productions of his pen.

He never wrote out his lectures fully, but made use only of jottings on small slips of paper, and only two or three of his introductory lectures have been published in the medical journals.

During the time of his residence in Edinburgh, or from 1829 to 1836, he was actively engaged in original research; and among the earliest and in one sense the most important of his observations were those relating to Ciliary Motion, first described in his paper "On a Peculiar Motion excited in Fluids by the surfaces of Animals" (*Edin. Med. and Surg. Journ.*, 1830, vol. civ.), and which formed the basis of his very able and complete article "Cilia," which appeared in the *Cyclopædia of Anatomy and Physiology* in 1836. It is true that Dr Sharpey, as he afterwards found, had been anticipated in several of his observations, and further, that, from the want of sufficiently high magnifying powers in his microscope, he failed to detect the actual existence of cilia in the larvæ of Amphibia in which he had observed the motions,—a discovery which was made by Purkinje and Valentin in 1834,—but it cannot be doubted that, by the numerous original observations which Dr Sharpey described in his earlier paper, he was the first to point out distinctly the general prevalence of ciliary motion among animals, and the important relations of its phenomena to respiration and some other functions. The article "Cilia," as also that and "Echinodermata," which in 1837 he contributed to the

Cyclopædia, both contained a large amount of original matter, and gained for Dr Sharpey a high reputation as a scientific observer and writer.

In 1833 Dr Sharpey gave in the "Edinburgh New Philosophical Journal" an account of Ehrenberg's Researches on Infusoria. In 1834 he took part in the proceedings of the British Association for the Advancement of Science which met at Edinburgh, and contributed a paper founded on his own observations on the peculiar distribution of the arterial vessels in the Porpoise.

He delivered the "Address in Physiology" at the Thirtieth Annual Meeting of the British Medical Association held in London in 1862; and in 1867, as president of the Biological section of the British Association at the Dundee meeting, he delivered an address in which, as in the one previously mentioned, he ably reviewed the progress of Physiology, more especially as regards the application of exact methods of research to the solution of physiological problems.

But Dr Sharpey was extremely fastidious as an author, and though his style was clear and his language eminently appropriate, yet he shrank from frequently appearing in print: and accordingly much of his original observation and thought on scientific subjects, though involving laborious research, was made known by him only through his lectures, or was published in a more or less fragmentary form in connection with such systematic works as Baly's translation of Müller's Physiology and the later editions of Quain's Anatomy. In the first of these works it is well known that the excellent translator, who was a distinguished pupil of Dr Sharpey's class, derived much assistance in his labours from his teacher, and several notable additions were made to the work by contributions from Dr Sharpey's pen. Among these one of the most important is that, in the modest form of a note, in which he gave an account of original observations made by himself on the structure of the uterine glands and membrana decidua.

In 1843-46 Dr Sharpey published as joint editor with Professor Richard Quain the fifth edition of Dr Jones Quain's Elements of Anatomy, which, from the amount of new matter introduced and changes made by the editors, assumed almost the character of a new work. In this edition the General Anatomy was entirely rewritten

by Dr Sharpey, and this part has ever since been looked upon as a standard work on the subject of which it treats, containing the record of a large number of original observations on the minute structure and growth of bone and on many other topics. The anatomy of the brain and heart, of the organs of respiration and voice, of digestion and reproduction, were also from his pen. With the three subsequent editions of this work Dr Sharpey remained connected as one of the editors till the time of his death.

Up to the age of sixty-nine or seventy years Dr Sharpey retained most of the vigour of his earlier life. But about the year 1871 some signs of advancing age showed themselves, and more especially the rapid increase of cataract, affecting both eyes, began to interfere with the easy and efficient performance of his official duties, and led to his retirement from the secretaryship of the Royal Society in 1872, and from his professorship in University College in 1874. His blindness was only partially remedied by the extraction of the cataractic lens of one eye in May 1873, and of the other in October 1876. About the same time Dr Sharpey became subject to attacks of bronchitis from any unusual exposure to cold. One of these had nearly proved fatal in the winter of 1878, and he at last succumbed to an attack of the same malady on the 11th of April of the present year (1880), ten days after he had completed his seventy-eighth year. He was buried in the Abbey Graveyard of Arbroath, his native town, on the 17th of April.

In 1869 the friends and former pupils of Dr Sharpey, being desirous of showing their regard for him and establishing a permanent memorial of his services to University College and to science, raised by subscription a sum of money for endowing a "Sharpey Memorial Scholarship" in connection with University College, and for presenting to the college his portrait in oil and a marble bust.

In 1872 Dr Sharpey made over his large and well-chosen biological library to University College, and at his death he bequeathed from the small property which he left a sum of £800 to increase the endowment of the Scholarship in Physiology.

Upon his retirement from his professorship in 1874, Mr Gladstone's government accorded Dr Sharpey an annual pension of £150 on account of his eminent services as a public teacher and man of science.

Looking back upon the career of our much esteemed fellow, we have first to remark the characteristic caution with which he abstained from entering upon any active or responsible sphere of exertion till he had attained his twenty-eighth year, and the care with which he prepared himself by long continued literary and scientific study in this and other countries for the duties of his after life.

In his work as a scientific investigator and systematic writer, there is everywhere apparent a scrupulous accuracy and full knowledge of his subject, a clearness of statement and appropriateness of language, a critical acumen and soundness of judgment which have given high and lasting value to his productions.

In the administration of the affairs of the various public bodies with which he was connected, Dr Sharpey's wide range of knowledge, his unbiassed judgment and strict impartiality, while they gave weight to his opinions and suggestions, contributed in a remarkable degree to the efficiency and usefulness of his services.

It was however especially as a teacher that the influence of Dr Sharpey's superior mental qualities was most conspicuous. Devoting himself with the utmost diligence and care to the perfecting of his public instructions, he was uniformly listened to with the closest attention, and regarded as the highest authority in his department; and the effect of his teaching was further enhanced by the feeling of friendly attachment, amounting almost to filial affection and reverence, which was inspired in the minds of his pupils by his uniform kindness, justice, and candour.

In private life, while Dr Sharpey was universally admired for the extent and accuracy of his acquirements and respected for the soundness of his judgment, he was not less esteemed and beloved for the gentleness of his disposition, the kindness of his heart, and the geniality of his nature. His powers of memory, naturally good, were carefully cultivated by the systematic turn of his mind, and strengthened by exercise. His friends remember with delight the readiness with which in the course of conversation he could call up a desiderated quotation, or supply a fact on some doubtful point in history, philosophy, or science, or tell humourously some anecdote which was equally apposite and amusing. He had not a single enemy, and he numbered among his friends all those who ever had the advantage of being in his society.

The following Communications were read:—

1. On a Simple and Accurate Method of determining the Longitude of a Place by a Single Observer, without the aid of any instrument for measuring time. By Professor G. Forbes.
2. Stilbite, from Kerguelen's Island. By A. Liversidge, Assoc. Royal School of Mines, Professor of Geology and Mineralogy, University of Sydney. Communicated by Mr J. Y. Buchanan.

I am indebted to the kindness of my friend Mr J. Y. Buchanan, M.A., the chemist and physicist to the "Challenger" expedition for the specimen which forms the subject of this note.

In speaking of the geology of Kerguelen Island, Mr Buchanan thus describes the occurrence of this zeolite (*vide* Proc. Roy. Soc., vol. xxiv. p. 617).

"The horizontal beds which form the mass of the land are basaltic, and vary from 10 to 20 feet in thickness, being generally compact; but, in ascending the hill, beds are met with frequently, which contain large amygdaloidal cavities filled with zeolites, principally analcite and heulandite (stilbite). These minerals are very plentiful in this part of the island, and when rounded by the action of the water they form remarkable white pebbles on the otherwise dark-coloured volcanic sand. Up to the summit the alternation of beds of compact sub-columnar rock of amygdaloid is pretty regular.

"The amygdaloid is of two kinds: in the one the cells are small, very thickly disseminated, and completely filled up by a zeolitic mineral; the other has larger cavities, less thickly spread, and generally only coated with crystals, while seams filled with crystalline matter are also frequently met with. The cavities contain generally analcite; the seams, heulandite" (stilbite).

In quoting the above extract, I have ventured to insert the name stilbite after heulandite, since both names have been applied to the same mineral. Personally, I should call the specimen stilbite, inasmuch as it agrees with the mineral known as stilbite by English

mineralogists both in form and chemical composition, and not with heulandite. It is rather unfortunate that heulandite is known as stilbite by some mineralogists; stilbite is also known as desmine (Breithaupt) by others.

The lower part of the small specimen is in the form of an incrustation of about $\frac{1}{8}$ to $\frac{3}{16}$ of an inch in thickness, from which flat plate-like crystals project at various angles. The lower layer is compact, and presents a mammillated surface where exposed to view, and its fractured edges present a series of small radiate fan-shaped cleavage planes, with a well-marked pearly lustre.

The larger of the projecting platy crystals are about $\frac{1}{2}$ inch long by from $\frac{1}{4}$ to $\frac{5}{16}$ broad, and not more than about $\frac{1}{16}$ inch thick. They are built of plates of more or less imperfectly developed flattened prismatic crystals. This structure tends to impart a sheaf-like appearance so common in stilbite. The crystals are semi-transparent and practically colourless. Parallel to the principal cleavage planes the lustre is strongly marked and pearly; vitreous on the other faces. They are brittle and cleave readily parallel to the brachydiagonal; less readily parallel to the macrodiagonal.

The faces developed in the specimen are the brachy- and macropinacoids capped with the planes of the pyramid. The planes of the pyramid and of the macropinacoid are small; the brachypinacoids are large; the basal pinacoids, so commonly present, are undeveloped. Hardness about 4.

The specific gravity of the mineral in fragments was found to be 2.24 to 2.25, but when reduced to powder it rose to 2.29, thus showing the presence of sensible cavities.

Before the blow-pipe it exfoliates, intumesces, curves outward into vermicular forms, and fuses to a white enamel, and is decomposed by boiling hydrochloric acid without gelatinising. The lower incrusting portion of the specimen colours the flame much more strongly yellow, does not intumesce to the same degree, and is decomposed by hydrochloric acid, with the separation of gelatinous silica. It is therefore apparently not the same zeolite as the crystals, but is most probably sphaero-stilbite. I much regret that I had not sufficient to permit a quantitative analysis being made of it also.

ANALYSIS.

| | I. | II. | Mean. |
|-------------------|-------|-------|--------|
| Water, | 17·42 | — | 17·42 |
| Silica, | 56·46 | 56·58 | 56·52 |
| Alumina, | 16·28 | 16·40 | 16·34 |
| Lime, | 8·12 | 8·01 | 8·06 |
| Magnesia, | ·12 | ·16 | ·14 |
| Soda, | — | 1·76 | 1·76 |
| | | | 100·24 |

which corresponds to the usual formula of stilbite. viz. :—

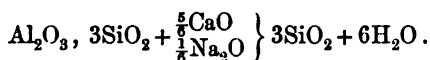

3. On a Simple Form of Selenium Cell, and Experiments therewith. By Prof. James Blyth.

The cell is constructed as follows :—

Take a brass crop-comb of the kind usually worn by little girls. Cut off from it two equal parts, each about 4 inches long. From each part cut out each alternate tooth, and bend round each part in the form of a cylinder, soldering the ends together with hard solder. Take a glass tube about 4 inches long and having a diameter equal to the diameter of the cylinder. Place the brass cylinders upon the glass tube, with the teeth facing each other, and adjust them so that each tooth left takes the place of one which has been cut out, taking care that the teeth do not touch each other nor the solid parts of the cylinder.

Now heat the cylinder in a Bunsen flame to a temperature sufficient to melt selenium—about 220° C—and rub a stick of selenium over the spaces between the teeth, so that each space gets filled with selenium, which will now be in an amorphous condition. To anneal it, place the whole in an air-bath at a temperature of about 150° C for an hour or so, when the selenium will assume a metallic and crystalline appearance. Allow it to cool gradually, and then solder on two copper wires to the solid part of each brass cylinder to serve as electrodes. The cell is now ready for use.

In order to show the action of light on the cell, I placed it over

a glass tube containing a singing flame, and connected it in circuit with a battery of six Grove's cells and an ordinary telephone, or still better a Gower Bell telephone. The note produced by the singing flame was faintly but distinctly heard in the telephone placed in a distant room. It will be readily seen, that, in this experiment, we take advantage both of the heat and light effect upon the selenium, and that the action is increased by the close proximity of the cell to the flame.

If the indiarubber tube carrying the gas to the singing flame be rapidly pinched and let free, the increase and decrease of the flame is instantly indicated by the telephone; and if the pinches are made rhythmically, a corresponding rhythm is heard in the telephone.

The above experiment can also be performed very well by attaching the singing flame jet by an indiarubber tube to one of Koenig's manometric capsules screwed on to an organ pipe. The note of the pipe is then heard in the receiving telephone.

Having obtained a cell which was sensitive to a singing flame, it was an easy step to try if it would be equally sensitive to the variations of the flame of a Koenig's capsule produced by singing and speaking. To test this, I placed the cylindrical cell over the flame, so that the flame was in the axis of the cylinder and exactly opposite the selenium. When the cell was now joined up in circuit with fifteen Grove's cells and a telephone, not only singing, but speaking was distinctly reproduced in the telephone.

This experiment is very remarkable, as it shows that the resistance of the selenium must vary with very great rapidity; otherwise it could not transmit articulation.

Flat cells of the comb form are very easily constructed by simply screwing the combs upon a flat piece of wood, taking care that the teeth do not touch each other. The whole is then heated up to the melting point of selenium, which is then rubbed carefully between the teeth. The annealing is a matter of great importance. It can be done very well in an air-bath, whose temperature can be regulated by a thermometer. During the time the cell should be joined up in circuit with a Wheatstone's bridge, and its resistance carefully tested all through the annealing process. It will be found that the resistance of the cell gradually diminishes with a rise of temperature, and finally attains a minimum, after which it begins to rise

again. At that particular point further heating should be avoided, and the cell allowed to cool slowly. During the cooling the resistance rises, and does not appear to reach its final value till the cell has been some time in use.

It is obvious that what is wanted, to make a selenium cell as sensitive as possible, is to have a long thin layer of it between two parallel conductors forming the electrodes, and so to arrange it, that as great a length of that layer as possible can be brought at once under the influence of the source of light. These conditions are well fulfilled in what may be called the *radial* cell, which consists of a series of brass sectors with very acute angles fixed upon the end of a wooden cylinder, and having narrow radial slits between them. This form is easily made by first fixing a disc of brass about 3 inches in diameter upon the wood, and then cutting it right through by a saw along a series of diameters equally inclined to each other. The odd number sectors are connected by one wire which forms the one electrode, and the even numbers by another wire which serves for the other electrode.

My first supply of selenium running done, I ordered a second, and proceeded to make another cell exactly in the same way as I had made the previous one. This cell, however, when finished, presented some very troublesome and perplexing peculiarities, inasmuch as its resistance during annealing fell very low—to something like 120 ohms—and yet it was almost entirely insensitive to the action of light. This effect is, without doubt, due to some impurity in the selenium, which I hope to detect by a chemical analysis which is being made for me.

The failure to get good selenium led me to think if anything else would serve as a substitute, and the first thing I determined to try was amorphous phosphorus. I took a radial cell and packed the slits full of the phosphorus, and then proceeded to test its resistance in the ordinary way, but was surprised to find that I could not get a balance. This led me to see that the cell itself was acting as a battery, and on trying it directly through the galvanometer, the needle was deflected off the scale. I also observed that the current varied with pressure on the phosphorus; and this suggested to me that it might be made to serve the double purpose of battery and loose contact in the ordinary form of microphone transmitter.

For this purpose, I made a special transmitter, which consists of a shallow wooden box, having a disc of brass in its bottom, to which one electrode is attached. Above this is placed a thin layer of the red phosphorus, and the whole enclosed by very flexible brass plate, bound down round the edges, and having the other electrode attached to it. A mouthpiece is arranged so as to direct the voice against the centre of the thin brass plate. When this transmitter is joined up in circuit with a telephone, singing and articulation are distinctly reproduced. When a battery is included, the sounds come out of the telephone with singular clearness and loudness; and there is also a very remarkable want of any rattling, such as is usual with an ordinary microphone. I have also found that the cell, which is really a form of loose contact, can act as a receiver as well as a transmitter; but my experiments on it in this capacity are as yet incomplete.

4. Dust, Fogs, and Clouds. By Mr John Aitken.

(Abstract.)

Since I made my first communication to this Society on Dust, Fogs, and Clouds, most of the experiments have been repeated under different conditions.

Taking advantage of the late extremely cold weather, the apparatus was placed in the open air, and experiments made with it, the temperature of the air at the time being 8° Fahr. The result was the same as at higher temperatures. Cloudy condensation with dusty air; no condensation with filtered air.

The experiment in which dustless gas was burned in dustless air was repeated. The glass jet which was used for burning the gas in the first experiment, being now replaced by a platinum one, as it was thought possible the dust produced when the glass jet was used might be the result of the decomposition of the glass by the heat. Before making the experiment, the platinum jet was highly heated, to cleanse and make it inactive. The result, however, was as before. Dense fogging whenever the gas was lit, and the fogging continued so long as the gas was kept burning.

The experiment for detecting small quantities of dust has also

been altered and improved. Instead of detecting the dust by the cloudy condensation of steam, the saturated air of the receiver was cooled by slightly expanding it. Working in this way, it was found that the dust driven off by heat from a piece of iron wire, the $\frac{1}{30000}$ of a grain gave such an evident and abundant result, that if the $\frac{1}{1000000}$ of a grain of iron could be manipulated the effect would be perfectly definite and decided. This indicates an extremely small size of some of the condensation nuclei. Thousands of particles driven off the $\frac{1}{30000}$ of a grain of iron, and the iron afterwards not perceptibly lighter, indicates almost molecular dimensions. It was pointed out that some of these nuclei may be driven off as gases, which afterwards condense and form nuclei for the vapour to condense upon.

In the first paper attention was called to the composition of the atmospheric dust. It was pointed out that some kinds of dust would have a greater attraction for water vapour than other kinds, and that chloride of sodium dust would probably condense water vapour before the vapour was cooled to the saturated point.

It was shown that there are two distinct ways in which dust acts as a centre of condensation, and causes vapour to condense before it is saturated. The first is the chemical affinity between the dust and the water vapour. The second is the condensing power possessed by the surfaces of some bodies. This power is different in different kinds of matter.

Some experiments have lately been made to see to what extent this attraction of the nuclei for water vapour would cause condensation to take place in air which was not saturated. A little sulphur was lighted, and an open-mouthed glass receiver held over it for a few seconds, and then placed on the table. At first scarcely any effect was noticed, but after a time a haze or fog appeared. The density of this fogging depended on the humidity of the air experimented on. The damper the air the thicker the fogging.

If the inside of the receiver was wetted so as to moisten the air, the sulphur products on entering are a little more evident, and on placing the receiver on the table a thin haze can be seen. After a time, however, this haze gradually grows denser, and at the end of fifteen or twenty minutes the receiver becomes full of a very dense white fog, which remains for a long time. A similar result is got

with chloride of sodium vapour, by highly heating the salt in a platinum tube, and afterwards cooling and drawing the vapour along with air into the experimental receiver.

Many other salts—such as chloride of calcium, bromide of potassium, &c.—when highly heated, have also the power of determining cloudy condensation in unsaturated air. Potassium and sodium, when burned, give also similar results, and the fogging is, in all cases, proportional to the moisture in the air.

Experiments have also been made on a larger scale in a cellar, the air in which was damp but not saturated. The temperature was about 45° Fahr., and the wet and dry bulb thermometers showed a difference of from $\frac{1}{2}$ ° to 1° during the experiments. A short time after a little sulphur had been burned the whole cellar was filled with a dense white dry fog, which remained for some hours. A similar result was also got by sprinkling some salt over an alcohol flame. The salt dust so produced determined a decidedly foggy condensation in the unsaturated atmosphere.

Experiments were also made by burning sulphur in the open air. When the air is dry, the fumes can only be traced a short distance; but when there is more moisture the condensation is more evident, and in certain conditions of the atmosphere the products of combustion can be seen floating away in the passing air, leaving the sulphur in a pale thin stream of vapour, which gradually increases in size and rolls away in a horizontal cloudy column ten or fifteen feet in diameter, clearly marked out from the surrounding air.

This fog-producing power was shown to be probably due to the affinity which the sulphuric acid, resulting from the combustion of the sulphur, has for water vapour.

It was shown that cloudy condensation may take place without dust particles being present. It will probably take place in a highly supersaturated atmosphere. It will also happen when some substance is vaporised in dustless air and cooled to a temperature far below that corresponding to its tension. When the substance condenses and forms nuclei of condensation for the water vapour, cloudy condensation will also take place in dustless air. When there are gases present which combine and form new compounds, and the temperature is much too low for them to remain as vapours, the molecular strain seems under these conditions to be sufficient to

cause them to condense and form nuclei on which the water vapour deposits. These nuclei may be solid or liquid, and may or may not have affinity for water vapour.

It is concluded from the experiments, first, that as regards cloudy and foggy condensation there is dust and dust. Some kinds of dust have the power of determining condensation in an atmosphere which is not saturated; other kinds only form nuclei in supersaturated air, and from other experiments it is probable that some degree of supersaturation is necessary before some other kinds of dust are active. In highly supersaturated air all kinds of dust will form nuclei and determine cloudy condensation, but in unsaturated air only some kinds are active. This was illustrated by corresponding phenomena in freezing, melting, and boiling. Second, that dry fogs may be produced by some form of dust in the air, such as sodic chloride dust, condensing the aqueous vapour in air which is not saturated. Third, this condensing power or attraction which some kinds of dust have for aqueous vapour explains why our breath and condensed steam dissolve even in foggy weather. Fourth, that as the products of combustion of sulphur determine the condensation of water vapour in unsaturated air, and give use to a very fine textured dry fog, they are probably one of the chief causes of our town fogs, as they have a much greater condensing power than the products of combustion of coal.

It is not claimed that these experiments prove that dry fogs in the country are produced by salt dust. The experiments only prove salt dust can produce a dry fog. As water vapour only condenses in some nucleus, it is in the highest degree probable that some nuclei, having strong affinities for water vapour, are the cause of dry fogs, and from the great amount of salt dust ever present in our atmosphere, it seems almost certain that it plays some part in the phenomena. There may be, and probably are, some other kinds of condensative nuclei which give rise to dry fogs in the country. The nature and composition of these will probably be best arrived at by analysis of the dried fog particles.

There seems to be very little doubt but that sulphur products are most powerful fog-producers, and are probably the chief cause of our town fogs. Yet, it must not be forgotten that there may be other causes at work, of which we are at present ignorant.

The paper concludes with some speculations as to the growth of ice crystals and the evaporation and condensation of aqueous vapour at water surfaces of various curvatures.

Since making the experiments above described, the fog-producing powers of the products of highly heated chloride of magnesium have been tested, and are found to possess a much greater fog-producing power than any other substance experimented with. A few grains of this salt heated in an alcohol flame, in the unsaturated air of the cellar already referred to, gave rise to a fog many times denser than that produced by the sulphur or chloride of sodium, and remained hanging in the air of the cellar for more than six hours. When the experiment is made in the saturated air of the glass receiver, the fog rapidly grows so thick that in a few minutes it is impossible to see through more than 2 or 3 inches of it. The results are similar whether the salt is heated in a flame or in the platinum tube. This intense fog-producing power of highly heated chloride of magnesium would seem to be produced by highly concentrated hydrochloric acid, produced by the decomposition of the water and chloride of magnesium.

[*Added March 8th 1881.*]

It is found that the fog-producing power of the products of combustion of sulphur are greatly increased when these are mixed with other gases and vapours. For instance, a little ammonia—another of the products of combustion of our fires—when added to the sulphurous fumes, makes the fog many times more dense than that produced by the sulphur fumes alone.

5. Note on Thermal Conductivity, and on the Effects of Temperature-Changes of Specific Heat and Conductivity on the Propagation of Plane Heat Waves. By Professor Tait.

In the great majority, at least, of investigations (experimental or mathematical) connected with conduction of heat, it has been assumed that the known changes of specific heat of metals do not require to be taken into account. Thus Ångström says, even in his paper on the *Change of Conductivity with temperature* (*Pogg.* 118, 1863):—"Da indess diese Veränderungen, soweit man sie kennt,

wenigstens innerhalb der bei den Beobachtungen vorkommenden Temperaturgränzen, nicht bedeutend sind, so müssen dieselben den Werth des Wärmecoefficienten nur unbedeutend afficiren können." In my paper on *Thermal and Electric Conductivity* (Trans. R.S.E., 1878), I said that "the change of specific heat with temperature would *increase* the values of *k* at higher temperatures, and thus reduce the change in conductivity in iron, and increase the small changes indicated for the other substances." But I had not at hand the means of applying these corrections. Recent discussions as to the comparative merits of different experimental methods have led me to investigate the amount of this effect, by the aid of the best data I could procure. A comparison of these seems to leave no doubt that the specific heat of iron *increases* by somewhere about $\frac{1}{100}$ of its amount for each degree of rise of temperature; at least from 0° to 300° C., between which limits the investigations of conductivity have hitherto been carried on.

Besides this result, which I have gathered from various scientific journals, I may adduce from my Laboratory Book for 1868 the following determinations: which were made with great care by the late Mr J. P. Nichol, by means of the method of mixtures. The nature of the process employed is such that the results *must* all err in defect, and the more so the higher the temperature. The iron was heated sometimes in oil, sometimes in paraffin.

Specific Heat of Iron.

| | | | |
|-----------------|-----|--------|----------|
| 15° to 100° C., | . . | 0·1154 | } Mean. |
| | | 0·1127 | |
| | | 0·1158 | |
| | | 0·1168 | |
| 15° to 150° C., | . . | 0·1193 | } 0·1189 |
| | | 0·1189 | |
| | | 0·1186 | |
| 15° to 200° C., | . . | 0·1208 | } 0·1213 |
| | | 0·1214 | |
| | | 0·1218 | |
| 15° to 250° C., | . . | 0·1234 | } 0·1237 |
| | | 0·1240 | |
| 15° to 300° C., | . . | 0·1274 | } 0·1275 |
| | | 0·1276 | |

From the first two of these means we find that the specific heat at 15° is 0·109 nearly, and that it increases by $\frac{1}{110}$ th for each degree.

Now, Forbes' experiments on iron indicated that the quantity $\frac{k}{c}$, the ratio of the conductivity to the specific heat, *diminishes* by about $\frac{1}{110}$ th part for each degree from 0° C. to 200° C. Hence it is clear that, in this case at least, the alteration of specific heat cannot be neglected in estimating that of conductivity. For it follows from the numbers just given that the diminution per 1° in the conductivity of iron is really only about $\frac{1}{1100}$ th of the whole amount. My own experiments with Forbes' bars gave an average change of $\frac{k}{c}$ less than that due to the increase of c alone, thus indicating an increase of conductivity with rise of temperature. Ångström's result, on the other hand, is considerably greater than that of Forbes. But the range of temperatures he employed was not above forty degrees. For reasons pointed out in my paper above referred to, I consider Forbes' estimate of the value of $\frac{k}{c}$, from 0° to 150° C., to be probably very near the truth. In other metals the change of specific heat is usually less than in iron. But so is also that of $\frac{k}{c}$. It would thus appear that we cannot yet state positively that there is any metal whose conductivity becomes less as its temperature rises; and thus the long-sought analogy between thermal and electric conductivity is not likely to be realised.

In the method devised and carried out by Forbes, the change of specific heat must be attended to during the calculations. Thus we cannot, without going over again the whole numerical work connected with what he called the *Static Curve of Cooling*, estimate accurately what will be the effect of this element upon the values of the conductivity. But we can easily show that its influence upon Ångström's results is to be calculated, at least approximately, by the simple process above.

To avoid the error introduced by supposing rate of surface loss to be proportional to v , we take (instead of a bar) a plane slab heated and cooled periodically over one surface.

The equation for the consequent distribution of temperature is

$$c \frac{dv}{dt} = \frac{d}{dx} \left(k \frac{dv}{dx} \right).$$

If we assume

$$c = c_0(1 + av),$$

$$k = k_0(1 - \beta v),$$

where a and β are small positive constants ;

and put

$$\kappa = \frac{k_0}{c_0},$$

$$v = u + \omega,$$

where ω depends upon first powers of a and β only, higher powers being neglected ; the equation splits into two as follows :—

$$\frac{du}{dt} = \kappa \frac{d^2u}{dx^2} \quad \dots \dots \dots (1).$$

$$\frac{d\omega}{dt} - \kappa \frac{d^2\omega}{dx^2} = -\kappa(a + \beta)u \frac{d^2u}{dx^2} - \kappa\beta \left(\frac{du}{dx} \right)^2 \quad \dots \dots (2).$$

For our present purpose it is sufficient to take

$$u = -Bx + C\epsilon^{-mx} \cos(2\kappa m^2 t - mx),$$

which satisfies (1), and shows the ultimate effect of a persistent simple harmonic application of heat to one side of the slab, whose temperature is taken as our temporary zero ; the other side being kept at the temperature $-Bs$, where s is the thickness of the slab. Here s must be supposed so large that $C\epsilon^{-ms}$ is insensible ; else the value of u would be so complicated that (2) would become unmanageable.

Substituting the above value of u in (2), and integrating, we obtain the value of ω . It consists of three parts.

We have, first, terms containing x only :—

$$\beta B^2 \frac{x^2}{2} + \frac{\beta}{4} C^2 \epsilon^{-2mx}.$$

These terms show how the mean temperature is altered throughout.

Next, we have the single term

$$\frac{a + 2\beta}{4} C^2 \epsilon^{-2mx} \cos(4\kappa m^2 t - 2mx).$$

This is a small wave of half period, which we need not farther consider,

Finally we have, as the modification of the original wave,

$$C\epsilon^{-m_2x} \left\{ \left(\frac{\alpha - 3\beta}{4} Bx + \frac{m(\alpha + \beta)}{4} Bx^2 \right) \cos(2\kappa m^2 t - mx) - \frac{m(\alpha + \beta)}{4} Bx^2 \sin(2\kappa m^2 t - mx) \right\}$$

These terms, when combined with the harmonic part of the assumed value of u , may be put in the form

$$C\epsilon^{-m_1x} \cos(2\kappa m^2 t - m_2 x),$$

where

$$m_1 = m \left(1 - \frac{\alpha - 3\beta}{4m} B - \frac{\alpha + \beta}{4} Bx \right),$$

$$m_2 = m \left(1 - \frac{\alpha + \beta}{4} Bx \right).$$

We thus see the effects of the introduction of the quantities α and β upon the amplitude and phase of the wave; and it is evident that they are of the greater consequence the greater is the difference of mean temperature at the sides of the slab.

Hence the only legitimate mode of applying Ångström's method is to keep the mean temperature the same throughout the slab. This can easily be effected.

It is obvious, moreover, from the values of m_1 and m_2 above, that Ångström's method gives the value of $\frac{k}{c}$ for the mean of the mean temperatures indicated by the two thermometers. Only, there is always the extraneous factor

$$1 + \frac{\alpha - 3\beta}{4m} B$$

which is usually very nearly unity.

I have worked out by the above method the case of two harmonic waves (in the value of u), one of half the period of the other. New terms are thus introduced into m_1 and m_2 . They are such as to seriously affect the values of these quantities when x is small, but they rapidly diminish by increase of x .

If the new term in u be

$$D\epsilon^{-m_2x\sqrt{2}} \cos(4\kappa m^2 t - mx\sqrt{2} + E),$$

the additional terms in m_1 are

$$-\frac{\alpha + \beta}{4m} D\epsilon^{-m_2x\sqrt{2}} \sin X - \frac{\beta}{2\sqrt{2} - 1} \frac{D}{m} \epsilon^{-m_2x\sqrt{2}} \cos X.$$

Those in m_2 are formed from these by making the first term positive, and interchanging the sine and cosine of

$$X = mx(\sqrt{2} + 1) - E.$$

It appears from this investigation that Ångström's method, when applied with proper precautions, is theoretically capable of giving very good results. But it is probable that, in practice, the thermometers will have to be supplanted by thermoelectric junctions and a good dead-beat galvanometer. The best thermometers, when employed for rapidly varying temperatures, work by sudden starts.

6. Note on a Simple Method of showing the Diminution of Surface Tension in Water by Heat. By Prof. Tait.

A hot bar of iron was brought near the surface of a thin sheet of water covered with *Lycopodium* seed. The effect was precisely similar to that produced by ether vapour.

7. On the Cell-Walls of Hepatic Cells. By John Berry Haycraft, M.B., B.Sc., F.R.S.E., Senior Demonstrator of Physiology in the University of Edinburgh.

Since Henle and Purkinje first described the cells which form the great mass of the liver, microscopists have maintained that these are what are termed "naked protoplasts"—that is, they possess, like the white blood corpuscle, no differentiated cell-walls. I may mention the names of Dr Lionel Beale, Ewald Hering ("Stricker's Histology," section on the Liver), and Dr Klein ("Atlas of Histology"), who all agree in denying its existence. Indeed, the absence of this structure is emphatically insisted upon in most works on microscopical anatomy.

If a liver-cell be examined with a power of about 300 diameters, it is seen to be a granular mass, of a somewhat spherical shape, containing a very distinct nucleus and nucleolus. The granules are but the optical expression of a delicate reticulum or stroma, which may be seen as such on using a higher power.

If a section of hardened liver be examined, the cells are seen to be polygonal from mutual compression, and both in the hardened and fresh condition they are bounded by a distinct and well-defined contour.

Nevertheless, there is nothing which would lead an observer to

say that they are enclosed in cell-membranes, however well the lens be focused and the light adjusted. No doubt, the well-defined border would suggest such a structure, but it cannot be seen.

Because no membrane is apparent, it does not follow that one may not exist. If a glass tube be filled with water, and held between the light and the eye of the observer, the column of water will appear thicker than it really is. This depends upon the fact that the refractive index of the glass is greater than that of the water. Now, it will be easily seen that the glass tube might be of such a thickness that the column of water will appear as thick as the outer border of the tube itself; in fact, the tube will be no longer seen. In the case of the liver-cell, a like explanation may account for the apparent absence of a structure, the presence of which the sharp contour, remaining so even after distortion of the cell, would seem to suggest. These considerations led me to an investigation of the subject, and I have been able to demonstrate the existence of an investing membrane by a very simple procedure. With the point of a scalpel a scraping is taken from the unhardened liver of an ox; this is mixed on a glass slide with a small drop of magenta fluid, and it is then covered. A slip of blotting paper is folded and refolded until a thick square pad is formed, which is placed over the cover-glass. With the handle of a needle or a pencil pressure is applied through the pad to the preparation, or it may be hammered, for there is little fear of breaking the cover-glass, the pressure being diffused through the paper. The object may be now examined with a power of 400 diameters. If the pressure has been too great all the cells will have been destroyed, and the whole field will be covered by a magenta-stained débris, in which disengaged nuclei are seen, in this case the preparation is of little use, and a fresh trial must be made. If successful, unbroken cells will be seen at the border of the cover-glass, a granular mass in the centre, and midway between the centre and border many half-broken ones, in which latter the most satisfactory evidence of the existence of the cell-membrane is to be sought. If one of these be examined, a granular mass will be seen projecting from the rent, or in close proximity to it. This is part of the contents of the cell which has been squeezed through the aperture. Generally, the cell still contains its nucleus, surrounded by the greater mass of the protoplasm.

If the border of the tear be now examined (a $\frac{1}{10}$ th or $\frac{1}{15}$ th immersion lens is here desirable), a beautiful investing membrane may be seen projecting, often for some distance from the rent. It can be traced on to the cell itself, and is evidently the projecting lip of a membrane which invests it, and which has been torn through at this part. Often, again, one may see the collapsed membranous bags, containing merely the nucleus and a very small portion of the granular protoplasm which filled it, and which may now be seen scattered around.

That the investing membrane or cell-wall is very thin, it is needless to say; yet, when demonstrated by the above method, it can most clearly be made out, and in almost every preparation several entire but empty cell-walls may be seen about the field, showing that, although very fine, they are tough and resisting. Scattered among the liver-cells other tissue elements are to be seen. There are blood corpuscles, both white and coloured, and connective tissue corpuscles, the protoplasm of which is deeply tinted by the magenta. Torn capillaries are also to be seen, and they may at first sight be mistaken for the cell-walls which have been described above. There should be, however, no difficulty in recognising their tubular shape, and the fact that they have in these walls tissue which is tinted with the magenta. This is the protoplasm of the so-called nuclei of the epithelial plates of which they are composed.

I have been able to demonstrate these facts in the human liver and in that of the rabbit, as well as in the ox. The existence of the investing membrane is probably universal.

The addition of magenta is not necessary, although it is a great help, for the same points can be shown without its use. Of course a fresh preparation of the liver must be taken for examination, for it is conceivable that the hardening fluid might of itself produce a condensed outer layer which would simulate a membrane.

BUSINESS.

Mr Walter Whitehead, Mr A. H. Anglin, Mr J. A. Harvie Brown, Dr W. A. Herdman, Mr Thomas William Rumble, and Mr Robert Lawson, were balloted for and declared duly elected Fellows of the Society.

PROCEEDINGS
OF THE
ROYAL SOCIETY OF EDINBURGH.

VOL. XI.

1880-81.

No. 109.

NINETY-EIGHTH SESSION.

Monday, 21st February 1881.

PROFESSOR FLEEMING JENKIN, Vice-President,
in the Chair.

The following Communications were read :—

1. Effects of Strain on Electric Conductivity. By M. August Witkowski. Communicated by Sir William Thomson.
2. On the Effect of Moistening with Water the opposed Metallic Surfaces in a Volta-Condenser, and of substituting a Water-Arc for a Metallic-Arc in the Determining Contact. By Sir William Thomson.
3. On Vortex Sponge. By the same.
4. On some Transformations connecting General Determinants with Continuants. By Mr Thomas Muir.
5. Note on the preceding Paper. By Professor Chrystal.

Monday, 7th March 1881.

The Right Hon. LORD MONCREIFF of Tulliebole, LL.D., President of the Society, occupied the Chair, and read the second part of the following Address, the first part having been read on 6th December 1880 :—

I.

The subject of the address with which I am to open the present session of the Royal Society has been announced in your notices as the "Dawn of the Constitutional Principle." Such, indeed, was the general tenor or complexion of the thoughts which led me into the field of inquiry on which I intend to dwell to-night, and such the topic round which I propose to weave a very fragmentary and imperfect *excursus* or dissertation. I had long thought that the rise and growth of the constitutional principle in this island,—a plant nurtured in many storms and watered by the best blood of the land,—might be worth tracing in these more stable and peaceful times. It might also be interesting to recall the gradual progress and direction of opinion in the two ends of the island, and of the conflict or concord out of which so powerful and thorough a fabric has been consolidated. But my theme to-night is necessarily less ambitious than its title indicates. I am limited both by the place in which and the audience to which I speak, and also by the time which it would be reasonable for me to occupy.

At present I mean only to say some things about some famous but forgotten political treatises and their authors, not indeed with the intention (as you may well suppose) of entering into any political disquisition on my own part, or of indicating any opinion upon the subjects with which these authors deal. I mean merely to describe the writings and their authors, and draw together as well as I can some particulars respecting both, which, as not being familiar, may prove not uninteresting. Addressing, as I presume I do, men of all shades of political opinion, I shall say nothing that can touch the susceptibilities of any. Tros Tyriusve, Roundhead or Cavalier, Passive Obedience or Fifth Monarchy men, if there are any such among my audience, shall have nothing to complain of,

as I mean only to gossip about biography and bibliography, and mainly of the characters and lives of the men whose writings I have taken as my text.

The famous and forgotten treatises to which I refer are substantially five:—1st, Buchanan's tract "De jure regni apud Scotos;" 2^d, Milton's "Defensio pro populo Anglicano" against Salmasius; 3^d, Samuel Rutherford's dissertation entitled "Lex Rex;" 4th, Harrington's "Oceana;" and 5th, Algernon Sydney's volume on "Government." These writings were all of them famous in their day. I don't think that I am wrong in saying that they are all thoroughly forgotten now,—so completely forgotten that even the existence of some of them is unfamiliar to most general readers, although the names of their authors are remembered. I doubt if many of my hearers ever read one of them throughout, and most of them I suspect never read a word of any of them.

The two which stand first on my list are the works of very celebrated men—the memory of whom is green and fresh to this day—Buchanan for his prodigious scholarship and his mastery of the Latin language; Milton for a muse which will make him famous to all time, while our language survives. Yet Bayle, in his Dictionary, treats Buchanan's tract as the most renowned of his famous works, and recognises in Milton only the antagonist of Salmasius; nor is it until the later notice in his article under Milton's name, that he condescends even to mention the "Paradise Lost," and then only in reference to a tradition or rumour that Dryden thought well of it. Had the reputation of these two great men rested only on performances which made them the literary heroes of the day, their chance of immortality would have been slight. Brunet, in his "Manuel du Libraire,"—a publication, as is well known, of the present century,—while he fully describes many editions of the works of both, does not guide the collector to a single separate edition of discourses which made such a stir in Europe, and which were separately the subject of more than one continental printing-press. Both Buchanan's treatise and Milton's "Defensio" were printed by the Elzevirs more than once; and yet even these productions of a celebrated press have been apparently forgotten. The other works which I have mentioned have also sunk into utter oblivion, although they also had their share of

reputation and influence, and their authors were men of considerable mark ; still, forgotten as they are, it is important to remember that they were once famous, and though it may sound like a paradox, the fact of their being forgotten may in some sense be attributed to their power. The ruins of great controversies are almost always worth exploring, although the fabric itself may have perished. These works made their mark, and whether they failed or took effect, they are alike forgotten,—if in failure, because they failed ; if in success, because posterity has built on their foundations. These things do more than point the moral of the fleeting nature of popularity. Contemporaneous fame means contemporaneous impression, and if that impression has been deep enough to mould and influence the opinions or the policy of a generation, the next no doubt may wonder at all the trouble bestowed on what seems to them so slight an affair. *Grandiaque effossis mirabitur arma sepulchris.*

More important, however, to the main object of my theme to-night, is the light which such inquiries afford to the student of history. Words which have arrested and absorbed the attention of the public at any given period, are not necessarily possessed of interest at any other. But their celebrity goes far to indicate of what topics people thought, and spoke, and wrote intensely, while that reputation, although ephemeral, lasted. Opinion, social, moral, and political, may be very surely ascertained and tested by the applause accorded to works of contemporaneous controversy. In the present instance the dissertations I have chosen as my theme were the progeny of mighty and convulsing political and social events in both ends of the island. They are strokes of the hammer wielded by vigorous and powerful arms, in times which called for vigour and strength,—times in which the labyrinth of politics could only be safely threaded by the courageous and the wary. Whether my authors found the safest track, or missed their way in devious mazes lost, I shall not try to determine ; I only take their words as an index to the times.

The author of the first of these treatises, to which most if not all of my attention to-night must be directed, George Buchanan, was one of the most remarkable men any country in Europe ever produced, and his life was as remarkable as his abilities. Sprung of a humble stock, the son of a farmer in the Lennox,

he started on his career with none of the advantages of fortune in his favour. His father having died early, in embarrassed circumstances, he was sent, by the liberality of an uncle, and when only fourteen years of age, to the University of Paris, in the year 1520. He there remained two years, when his kind relative died, and he himself was the victim of a serious illness, aggravated by being left in poverty in a foreign land. He returned home in 1522, when he enlisted as a soldier, and accompanied the Duke of Albany's ill-fated expedition to Berwick in 1523, and thereafter studied under the celebrated John Mair or Major at St Andrews, with whom, after taking a degree as Bachelor of Arts in 1525, he returned to Paris in 1527. After many discouragements and some amount of success, we find him in 1529 as a regent or professor in the College of St Barbe, at the age of twenty-three. The position, however honourable, seems to have been respectable poverty, and one of rather thankless toil; for he thus concludes an elegy, the first of the series in his works, written during his tenure of office, after descanting mournfully on the miseries of a teacher of letters:—

"Itē igitur, musæ steriles, aliumque ministrum
Quærite; nos alio sors animusque vocat."

In 1532 he became the preceptor of the young Earl of Cassilis, and after residing with him in France for five years, returned with him to Scotland in 1537, and rose to considerable favour with the king, James V. But his sharp pen and evil fortune brought him into trouble; and having incurred the wrath of the Franciscan clergy by his two satires, still famous, of the "Somnium" and the "Franciscanus," he with difficulty made his escape from prison, and after many adventures returned to France in 1539. Finding himself even in Paris pursued by the enmity of Cardinal Beaton, he accepted the invitation of Andrew Govea, a native of Portugal, and a man of great learning, to fill the office of professor in the College of Guienne, in Bordeaux, in which Govea was principal. There he spent three years in the heart of a cluster of distinguished men, including the elder Scaliger, who resided in the neighbourhood of Bordeaux, and for whom he contracted a warm attachment. While at Bordeaux he wrote his tragedies of "Jephtha" and "Baptistes," mainly as exercises for his students, and among the

youthful actors was no less a celebrity than Michel Montaigne. He remembered Buchanan with respect in after years, and names him among the greatest poets of the day. Buchanan returned to Paris in 1544, and was there associated with Turnebus and Muretus in the College of Cardinal le Moine, in that city, and there he seems to have remained with great distinction till 1547, when he was induced to remove with Govea to the University of Coimbra. He was there persecuted by the officers of the Inquisition, who had not forgotten "Franciscanus," and he was ultimately confined to a monastery, where he commenced his renowned translation of the Psalms, which won for him the well-known title conferred by Henry Stephans, "Poetarum hujus sæculi facile princeps." After two years he was released, and ultimately returned to Paris in 1553. Soon afterwards he became attached to the family of the Comte de Brissac, who governed the French dominions in Italy, whither Buchanan accompanied him as tutor to his son, and after five years residence with that nobleman, having been his companion throughout his campaigns, he at last, as serious trouble threatened France, returned to his native country in 1560, after a continuous absence of twenty-one years. He was now fifty-four years of age, having spent more than thirty of them in continental life.

The passage in which Montaigne mentions his remembrance of Buchanan is worth referring to. It does credit to his self-esteem. He is speaking of his proficiency in Latin, and enumerates among his preceptors Buchanan, calling him that great Scottish poet. Of all these he says, "they often told me that I had that language (Latin) in my youth so ready to my hand that they were afraid to address me." He goes on to say, "Buchanan, whom I afterwards saw in the suite of M. le Maréchal de Brissac, told me that he had a design of writing a book on the education of children, and meant to take me as an example." ("Essays," 1-25).

I have thus hastily sketched the career of Buchanan before he again, and finally, set foot in his native land, to be involved in the eddies of the recent Reformation, and the still more exciting troubles of Queen Mary's reign, mainly because I was anxious to outline his previous vicissitudes, and to show what manner of man he was, among what scenes he had been trained, whose words form my theme to-night. When he returned to Scotland, he found that

country in the midst of the agitation consequent on the Reformation of 1560. Its political aspect and prospect were troubled in the extreme. In no country in Europe was the *jus regni* more worthy of philosophical, patriotic, and practical thought. From the first of the Stuarts down to the fair and unfortunate princess whose reign was about to commence, misfortune, violence, and treachery had surrounded the Scottish throne. James the First of Scotland, the ablest and wisest of his race, was cut off prematurely by the sword of an assassin. James the Second was killed by the accidental bursting of a cannon. James the Third was murdered by his rebel subjects. James the Fourth fell at Flodden; and James the Fifth died of a broken heart about the time of which we now speak. Although Scotland had the framework—whence derived it is perhaps not easy to say—of constitutional government, it had nothing which deserved the name of constitutional liberty. The people had no voice whatever, and government seemed to consist of a perpetual struggle between the nobility and the crown. When Buchanan returned to Scotland, it was, however, plain that the waters were being stirred. The Reformation had set men thinking, and the free circulation of the Scriptures, and the preaching of the reformed clergy, had given tone and temper to the times. Events rapidly succeeded each other, which in the end threw the kingdom into the convulsions of civil war; but it is not my purpose to trace in any detail that most interesting but melancholy period of the history of this country. A few sentences will bring me abreast of the date of Buchanan's work. I stop for a moment to conclude this chapter of his life by remarking on the singular position held by men of letters in European society in the sixteenth century.

The circles in which Buchanan moved seem to have been very brilliant, very genial, and very poor. Their acquired learning seems to have been prodigious, and considering that the art of printing was not a century old, indicates how intense was the hunger and thirst after knowledge in that generation. Indeed, almost any celebrated work of that time so bristles with learning, culled chiefly from the ancients, but still so minute, and indicating so wide a range, as to fill the modern student's heart with something approaching to despair.

It has no doubt some want of variety, and in some of the controversies to which I have alluded, each combatant bespatters the other with the same kind of arrows drawn from the same quiver, spears belonging to the same armoury; but still their mastery of these weapons is in the last degree admirable. As to how the wise men of those days lived, and what was the tone of their private and social intercourse, it is not easy to form an adequate conjecture. One is apt to fancy that if the Latin language was that of learned conversation—when you complimented your host in Latin elegiacs if he had been civil, and lampooned him in Latin epigram if he had given you offence, the general social atmosphere must have been somewhat pedantic and wanting in ease, as it is certain it was wanting in refinement. Probably, however, this would be an erroneous conclusion, and although without the canons of modern good breeding, it is probable that these circles had brightness, vivacity, and humour. Buchanan is specially mentioned as charming and witty in conversation; and it was said of him that there was not an agreeable man in Europe with whom he was not familiar. In later life he was described by the unfriendly as rustic, "*agrestis*" in his appearance and demeanour, and slovenly in his dress; but age, broken health, and incessant turmoil may have given his bachelor habits, for he was never married, a stronger hold on him than they had when he charmed the fastidious circles of Paris, twenty years before. He had almost ceased to be a Scotchman. The great De Thou claimed him as a countryman—"a native of the banks of the Blane in Scotland, by birth," he says of him, "but one of us by choice." Buchanan probably thought more in Latin and in French than in his mother tongue.

On his first arrival the queen was unquestionably partial to him. He read classics with her, and she confided to him the charge of her son,—for whose benefit indeed the treatise I have spoken of was afterwards composed,—and he dedicated to her the first edition of his Psalms, in an epigram, as he styles it, full of grace. Into the troubles which followed, and the part he took in them—whether he was ungrateful, as one section of critics maintain, or patriotic as the other side says, I do not stop to inquire. He was unquestionably in the front, whatever were the merits of the conflict. But in 1579 the battle was over. His royal pupil was on the throne when he wrote this celebrated treatise. The direct object which

Buchanan had in view was to vindicate the course which the nobility and the parliament had followed in regard to Queen Mary. And when he comes to apply the general views which are announced and enforced in the course of his argument, it is to this conclusion that he wishes to bring his readers. I am not, however, to inquire here how far he succeeds in his main attempt, but I am rather concerned with his work as a philosophical discourse on the principles of government, and whatever opinion one may form of the scope of his performance, there can be but one estimate of its extreme ability, and also looking at him in the light of the times in which we live, of its moderation also. That his ideas on government were to some extent swayed by his own individual experience, perhaps his individual peril, may be assumed. But I think all must see, in this most thoughtful composition, the fruit of long reflection amid many vicissitudes. One peculiarity it has deserving notice; it is a purely political essay. Although he deals with the power of the pope and the Roman Catholic clergy, the views illustrated are hardly tinged at all with the ecclesiastical controversies of the time, and indeed Buchanan was little of an ecclesiastic, although he and Knox appear to have been intimate. The sketch which he gives of his ideal ruler is worked out in Latinity of wonderful elegance and power, with a subtle continuity of reasoning which marks the weight and depth of a true statesman.

The treatise itself is cast in the form of a dialogue between Buchanan and a friend—Thomas Maitland—a brother of Maitland of Thirlstane, himself a man of letters of some repute. This machinery of dialogue gives, especially at the outset, an impression of restraint and weariness to the reader, and excites a wish that the author would come to the point much sooner. Indeed, he takes the lion's share of the conversation to himself, and his friend can hardly have been flattered by the interjectional and fractional utterances assigned to him as his contribution to the discourse. But there was an ingenious design in this. This supposed listener, or disputer, is used to modify, qualify, and illustrate Buchanan's own propositions, to wear off their edges and prevent them being too bluntly and ungraciously presented. Maestellanus, or Maitland, has a leaning for monarchy, and a fear of the many-headed monster, without carrying these to excess: he likes "the divinity that doth

hedge a king," and the pomp and circumstance of royalty; and Buchanan, while maintaining his own view, is pleased to grant great weight and some sympathy to that of his friend. He starts with the propositions—not new in these days, but in those audacious and dangerous—that all government exists for the people and from the people, and lays this down as a fundamental axiom, admitting of no controversy. His friend does not directly assent to the principle, or impugn it; but he says "Oh, I understand you. You are one of those who like republics, like Venice or Rome, or the Massilians." "No," rejoins Buchanan, "you do me great injustice; that is not my opinion. It is not the form of government in these states which I think commendable, but the equity of their institutions. The doge of Venice is as much a king as any other, and we need not quarrel about names." He goes on, perhaps a little tediously, and interrupted by brief sounds of assent from his friend, to illustrate these principles. He takes the analogy of a physician, who must know the laws of nature before he can apply them; and of science and the arts, which must be studied and mastered before they are successfully reduced to practice, and maintains that government is an art. He recurs frequently to both these illustrations, and it is amusing to surmise that from the last his royal pupil, who did not carry out his preceptor's lessons otherwise, probably derived that idea of kingcraft of which he considered himself so great a master. He goes on to consider the just place of constitutional law, and the authority of parliaments in their relation to kingly authority, holding the monarch not to be above the law, but yet with a power of tempering by his royal prerogative, the necessary inequalities of its letter. He then proceeds to point out how much a monarch's personal observance of law tends to encourage the obedience and good order of his subjects. This part of his theme he winds up with the most striking passage of the treatise, a passage of splendid Latinity, and of the truest and highest eloquence. His friend sneers, or is made to sneer, at the constitutional safeguards with which he surrounds his monarch. Buchanan, in reply, draws a picture of his ideal ruler. He breaks out into an impassioned description of a patriot king. "Can any honour, dignity, might, or majesty be described or be conceived in any man greater than to be able by speech, intercourse, reputation, aspect, and the tacit influence of example, to bring back the dissolute to moderation, the

violent to justice, the senseless to reason?" "Do I now," he exclaims, "appear to think meanly of your king? Do I represent him as loaded with chains and confined in a prison house of laws? Do I not bring him out into the theatre of the human race?" The rest is conceived and expressed with such spirit that I give it in Buchanan's own words: "Non superbo spiculatorum coetu, sericatisque nebulonibus stipatum, sed sua tutum innocentia, nec armorum terrore, sed populi amore, munitum; nec modo liberum et erectum, sed honoratum, sed venerabilem, sacrosanctum, et augustum; cum bonis ominibus et faustis acclamationibus prodeuntem, et quocumque progrediatur, omnium ora, et oculos, et animos in se convertentem." "Not surrounded by a proud escort of javelin men, or an imposing band of knaves, but secure in his own innocence; guarded not by the terror of arms, but by the love of his people; not only free and erect, but honoured, venerable, sacred, and august; going forth with all good omens, and happy acclamations, and, wherever his steps are directed, turning all faces, and eyes, and hearts towards him." This noble passage quite melts the heart of his friend Maitland, who assures him that nothing more magnificent could be conceived. This was his ideal in 1580. In 1880, I think we may say that Buchanan only lived before his time, and that the ideal has changed into reality.

Buchanan has some views on the powers of parliament, and the obligation of laws passed by them, which would hardly find acceptance in the present day, and which were sharply canvassed at the time. He had a notion that the tacit assent of the people was necessary to give efficacy to the laws passed by parliament; from which it would follow that at the time the law was passed it was not binding. But we must remember this was but the dawn of Constitutionalism.

If Buchanan hoped to raise his immediate reputation by this masterly performance, he must have been greatly disappointed. He died in 1582, and before his history was in the hands of the public. But he was assailed from all quarters, abroad and at home. Every calumny that malignity could suggest was levelled at his private character. He had been a Franciscan friar, they said, and therefore was a renegade. He was in private life one of the vilest of men. His book was a scandal to his race. The Scottish Parliament in 1584, two years after Buchanan's death, condemned it and his

history to be burned by the common hangman. He was met by numberless replies, the most pungent of which was written by Barclay, the father of the author of the "Argenis." Even the Protestant party on the Continent began to speak of him as a man of no consequence, as they did not wish their religious opinions to be mixed up with questions on government. They said he had recanted on his deathbed, and this was kept up for a century, and I suppose lives still, as a controversy which cannot be settled. "Nevertheless," says Bayle, in his caustic vein, "Buchanan's 'Dialogue' made a great noise; and some of those who most strongly condemned him were found quoting maxims from it before five years were over."

It may be questioned whether the times were ripe for such views, and indeed there is no question at all that the first effect of the publication was to delay the advent of constitutional liberty. But the courage of the man who thus openly proclaimed them cannot be denied; and in this respect, perhaps, he is entitled to stand on a higher level than some of the authors to whom I mean now to proceed.

On the whole, as Bayle says, he cannot be denied the praise of an elegant genius and an admirable style. For myself, I think his intellectual power was immense, but that a vein of harshness and hardness ran through his powerful character, which was more strongly developed in his later years. He had imagination and taste, but little sentiment; a strong sense of duty, but too little flexibility for a successful politician. I end these cursory remarks with quoting Thuanus' (or De Thou's) character of him, a tribute from such a quarter being quite sufficient to attest his contemporaneous reputation and his real merit.

Thuanus says, in book lxxvi. of his "History," at page 415* :—
 "Ante eum Georgius Buchanan, 4 Kal. Oct. exacta Aetate, et 76 annum supergressus, decesserat, vir ingenii felicitate, et scribendi facultate, quod ejus scripta ad omnem eternitatem victura vel fatente invidia, testantur, nostra aetate incomparabilia." After giving a short sketch of his life, and claiming him, as I have said, for a countryman, he thus concludes :—"in senili otio patriam historiam aggressus est; quam tanta puritate, prudentia et acumine

* Edition, Francofurti, M.DC.XXV.

scripsit, quamvis interdum libertate genti innata contra regium fastigium acerbior, ut ea scriptio non hominem in pulvere literario versatum, sed in media hominum luce, et in tractandis reipublicæ negotiis tota vita exercitatum redolet."

II.

I propose to-night, with the leave of the Society, to conclude the paper the first part of which I submitted to them on a former occasion. My theme, as I expressed it, was to consider some famous and forgotten treatises on government and their authors, with the view of elucidating the rise, nurture, and maturing of the constitutional principle in this island. I confined myself in that paper to the consideration of Buchanan's treatise "*De jure Regni apud Scotos*," along with some passages in the career of that remarkable man. I now part from him and his period and, stepping over half a century, come to the eventful year of 1644.

The interval, however, counts for a great deal in the political education of this country. In Buchanan's time, constitutional liberty was little known in our end of the island. We had our nominal representation in parliament, but as far as any real popular control was concerned, it was little but a name. What with intrigue, political faction, and family feuds, the phantom of representative government flitted round the Parliament House, but the real principle of power resided in the favourites and satellites of the palace. I showed in my last paper that Buchanan, although bold and outspoken, was by no means anti-monarchical, although deducing, as all constitutional writers have done since his time, the regal power from the popular will. But, considering the temper of the times, and the arbitrary tone of the Scottish monarchs, it is creditable to Buchanan's courage, as well as to his foresight, that he did not hesitate to proclaim the distasteful doctrine in ears to which he knew its sound would be unpalatable.

As it was, however, and as often happens, the force and earnestness with which the preceptor of James VI. had laboured to bend this stubborn and ungainly royal branch, proved to have inclined it strongly in another direction. Of his preceptor's learning, James VI. had imbibed a considerable share. His own intellect,

although not lofty, was acute and sagacious; and the kingcraft he had learned at the feet of Buchanan, he applied to an end very remote from that intended by his instructor. If the Scottish monarchs of old were less fettered by the restraints of constitutional law and parliamentary privilege than their brothers in England, the latter had one advantage, of which James, when in 1603 he took possession of his new dominions, was not slow to avail himself. The king of England was a far more remote and inaccessible potentate than his royal brother of Scotland. The latter was never secure from being invaded, scolded, and rebuked by some faithful counsellor, at any hour of any day. Thus his ordinary life was superintended and criticised by his subjects, and his plans and projects were discussed with a freedom which the regal state of Whitehall rendered impossible. James, with the Tweed safely between him and his loving Scots, breathed freely, and matured gradually but effectively, in private and unmolested, those visions of kingly power which had been the fruit of the lessons of his ardent master.

Very slowly, but very deliberately and skilfully, did the king develop his policy. To diminish the power of parliament in one end of the island, and that of the Presbyterian party in the other, was the instrument by which he hoped to make the British throne the seat of a true king—not such a monarch as Buchanan's ideal of a patriot king presented, but an embodiment of that divine essence of royalty which could place him alongside the arbitrary models on the Continent. Such was his ambition, and had he not died prematurely it is possible he might have succeeded. He went to work so cautiously that he excited no public, and hardly any private, discontent. He temporised, he flattered, he threatened, but never struck until he was certain he could do so safely. The invisible threads of the royal cobweb stretched across and across the island without the nation perceiving, from one day to the next, how far they had gone on their way to despotism, or how much more dim and distant were their liberties.

But the fabric perished at his death. The unpractised and clumsy hand of his son tore away the slender filaments, and in 1644 the contest between the king and the parliament was at its height.

I turn from the projects of kings to a treatise by a man whose name is not now trumpeted by general fame; but, nevertheless, that of one who in his day contributed not a little to the historical events of that time. His name is well remembered in the cottage population of our land, but is probably chiefly familiar to the general reader by the scornful lines of one greater than he:—

“Dare ye for this renounce the civil sword
To force our consciences which Christ set free,
And side us with a classic hierarchy,
Taught ye by mere A. S. and Batherford.”

So wrote John Milton, in the height of a controversy in which he was destined to be worsted in the end, but which still casts its lengthened shadow over our civil institutions.

While the Westminster Assembly of Divines was still in the midst of its labours, a book was published by one of its members, entitled “*Lex Rex*”; or, the Law and the Prince. It made a great noise at the time. The author was Samuel Rutherford, a Scottish divine of great ability, who was one of the delegates sent to the Assembly by the Presbyterians of the north. He was of humble birth, but his career in such learning as the University of Edinburgh could at that time afford, was so rapid that, at the age of twenty-three, he was elected one of the regents of the college. He afterwards became minister of the parish of Anwoth. Having written an ecclesiastical treatise which gave offence to the authorities, he was for some time imprisoned in Aberdeen, and during his confinement he wrote a volume of letters, which is still a very popular book with the lower orders in Scotland. His talents having marked him out as one of the foremost among the Scottish divines, he was sent by the Scottish Assembly to that of Westminster in 1643, along with Henderson, Gillespie, and others. He took a leading part in its proceedings, and especially in the controversy between the Presbyterians and the Independents, to which he contributed a publication which earned for him the sarcastic lines I have quoted.

It may be as well, however, before I draw attention to this work, to look for a moment at the surrounding circumstances in which it was composed, which were not without a material influence on the opinions expressed in it. For this purpose I would withdraw your attention for a moment from the author and his work, and fix it on

the position of the Westminster Assembly in 1644, as graphically described in Baillie's "Letters."

These letters of Baillie, apart from the object for which I refer to them now, are a perfect mine of historical anecdote at a very critical time. Baillie was Principal of the University of Glasgow; he wrote well, and was apparently a great correspondent. These, his familiar letters, contain many amusing descriptions of the impressions made on him by English institutions and manners. I stumbled on a passage of some interest in the present day. He says, writing in 1644, "The heat and clamorous confusion of the Assembly is oftentimes greater than with us,—the reason I think is their way both in Assembly and Parliament, to divest the speaker and prolocutor of all authority, and turn them into a very and mere CHAIR, as they call them," an inconvenience which it seems two centuries and a half have not altogether removed. In another place he says that he finds the English a strange people, in wishing to be different from any other nation. In the midst of their labours on the Confession and the Catechism, the great grievance of the dominant Presbyterian party, was the pretensions of the Independents. They wanted, forsooth, to be tolerated, a thing not to be thought of. It is in his capacity of a champion of that party that Cromwell first appears on the scene, and greatly does he trouble the worthy Principal's repose. He cannot disguise from himself, and his correspondents, that he is an able man. "The man," he says "is a very wise and active head, universally well beloved as religious and stout"—but he cannot forgive him his independency. He grudges him every battle he wins for the parliament. At the battle of Naseby, he recounts with undisguised glee that Prince Rupert made "the Independent Colonels Pickering and Montague flee like men," as he expresses it; and while he tells with some triumph of Cromwell's victory, he cannot resist the reflection—"Some fears the insolence of others, to whom alone the Lord has given the victory of that day." It is plain that even then Cromwell had distinctly indicated his own democratic views. Speaking of the misunderstanding between the Earl of Manchester and Cromwell, which occurred about this time, Baillie says, "Always my Lord of Manchester has cleared himself in the Lords, and hath recriminate Cromwell as one who has avowed his desire to abolish the nobility

of England, and has threatened to make a party of sectaries, to extort by force, both from King and Parliament, what conditions they thought meet."

So stood, during the lifetime of Charles, the controversy between the Presbyterians and the Independents in the English parliament, when the treatise of which I now speak was written.

It was first printed in 1644. It is written in good, nervous, vernacular English, and is evidently the work of a man of learning and culture. Bishop Burnet sneers at the attainments of the Scots delegates Henderson, Rutherford, and Gillespie, but there is no doubt they were men of mark in an assembly which boasted Selden as one of their number. This treatise is full of traces of extensive erudition; somewhat overlaid with quotation and example from ancient authority, as the fashion of the time was; but the style is clear and manly, and the continuity of the reasoning well sustained. The author, although without much acknowledgment, follows the line of Buchanan, as the next and more famous treatise follows largely the illustrations of Rutherford. The work professes to be a reply to a pamphlet by Maxwell, the deposed Bishop of Ross, in which he undertakes to establish the divine right of kings, and the unlawfulness of resistance on the part of the people. Maxwell entitles it "*Sacro-sancta Regum Majestas*." I of course do not mean to follow Rutherford through his demonstration. My main object is to show, that in proving that law is king, the author had in view throughout the true constitutional principle, as we now understand it, and gives his vote, with no uncertain sound, for King, Lords, and Commons. One or two quotations from his work will place this beyond question. He says in one passage, "Power and absolute monarchy is tyranny, unmixed democracy is confusion, untempered aristocracy is factious dominion." And when he comes to consider the question which he propounds "Whether monarchy be the best of governments," he thus resolves it—

"Nothing more unwillingly do I write than one word of this question. It is a dark way; circumstances in fallen nature make things to be *hic et nunc* evil, though it appears to me probable that monarchy in itself, monarchy *de jure*, that is, lawful and limited monarchy, is best even now, if other circumstances be considered." Then, after illustrating various views of this proposition, he thus

sums up:—"Every government hath something wherein it is best. Monarchy is honourable and glorious-like before men; aristocracy for counsel is safest; democracy for liberty, and possibly for riches and gain, is best." "A limited and mixed monarchy, such as is in England and Scotland, seems to me the best government, when parliaments, with the king, have the good of all the three. The government hath glory, order, unity, from a monarch; from the government of the wisest it hath safety of counsel, stability, and strength; from the influence of the commons it hath liberty, privileges, promptitude of obedience."

These quiet, well chosen, moderate words contain the first enunciation, as far as I know, in the English language, of the true estimate of the British Constitution. Written as it was, when the king of England was at war with the parliament, the clear good sense of the Scottish divine brushed away the numberless fallacies by which the daily round of political life was then beset, and moved neither by divine right, or theocracy, or republicanism, announced in these unfaltering words the doctrine which was to raise Britain among the nations.

What part the early dawns of Cromwell's ambition played in inciting Rutherford to this demonstration, we can hardly tell; but so it is that while Scotland sounded the first note of resistance, she never was republican. Rutherford's book, like Buchanan's, was, after the Restoration, condemned to be burnt by the hands of the common hangman; and he himself only escaped punishment by his supervening death.

Of the work itself, Bishop Guthrie says, that "every member of the Westminster Assembly had in his hand that book lately published by Mr Samuel Rutherford, which was so idolised that whereas Buchanan's treatise 'De Jure Regni apud Scotos' was looked upon as an oracle, this coming forth, it (Buchanan's) was slighted as not anti-monarchical enough, and Rutherford's 'Lex Rex' only thought authentic."

In regard to the views of the Scotch Presbyterians and the English Independents, it has been too little considered that these different schools of thought arose from different roots. The Presbyterian opinions were those of the successful Reformers, the Independents reflected those of the persecuted Puritans. There was no tinge of

republicanism in the polity of Knox, while the oppressions of Elizabeth in England were never forgotten.

But subsequent events, and the progress of opinion, soon threw Rutherford's simple and manly tenets into the shade. Five years afterwards came the trial and death of the king, an event which shook European society to its centre, and threw round the principle of absolute monarchy a tinge of romance and sentiment not yet extinct. True to the principles of monarchy, and by no means sympathising with the more advanced opinions of the Independent party, Scotland, on the king's death, had proclaimed Charles II. But in England the Commonwealth arose on the ruins of the monarchy, and the absolutist and republican elements confronted each other in a war of words which rang throughout Europe. In the midst of the excitement and consternation which the proceedings of the English parliament had produced, two champions stepped into the lists who drew the eyes of all onlookers. One was a Frenchman of the name of Saumaise, or Salmasius, according to his Latinised patronymic; the other was John Milton, Cromwell's secretary, and the author of the "Paradise Lost."

Jean Saumaise was a professor at Leyden, and was attached to the court of Queen Christina of Sweden. He had the reputation of being the most learned man in Europe; and notwithstanding the frantic personalities of the controversy which ensued, undoubtedly deserved his fame. He was originally a barrister, but ultimately pursued the avocation of a grammarian and schoolmaster. In 1749 and 1750 he was in great repute, and Charles II., when a fugitive abroad, retained him to write a treatise in defence of the late king, and gave him a *honorarium*—I suppose a considerable sum in those days—of a hundred Jacobuses.

This famous work was published in 1649, the year of the king's death. It is entitled, "Defensio Regia pro Carolo Primo, ad Serenissimum Magnæ Britanniæ Regem Carolum Secundum, Filium natu majorem, Heredem et Successorem legitimum. Sumptibus Regiæ." Such is the title page. I quote the title page for a reason which will immediately appear.

I have no intention of travelling through this bulky, but with us, at least, forgotten volume. The tenets which it advocates are

those of the highest supporters of the doctrine of divine right, enforced by the same arguments, analogies, and illustrations as those to which Buchanan replied, and almost, in some instances, in the very words which Father Maxwell, Rutherford's opponent, had used. But Salmasius in two respects earned the greater and almost solitary celebrity which his work attained. In the first place, it cannot be denied the praise of flowing and elegant Latinity, and a lively vivacity of style. Hobbes of Malmesbury said of it and of Milton's reply, that it was hard to determine which of them wrote best, or reasoned worst. It is worthy of a great scholar, and indicates a keen penetrating judgment. It is, of course, the work of an advocate, evincing no knowledge whatever of the true science of government, but the advocate is clever and not undignified. But doubtless the book would never have commanded the attention, or produced the excitement which followed it, apart from the startling and tragical circumstances which called it forth.

It is far from the province of this paper, and would be entirely out of place, if I were to enter or express any opinion on that remarkable event. Scotland was no party to it. Looking back from our present point of view, there is probably little difference of opinion on its political and moral character. At the time it produced a shock in every court, or political circle, or intelligent community in Europe, such as no public event had ever caused previously. From treating a king as a divine vicegerent, and treating him as a culprit at the bar of his subjects, there was of course a wide chasm. But this bold and audacious proceeding startled and shocked even the advanced statesmen of that day, and gave to sentiments and opinions, which might have passed for platitudes or extravagance, an importance and acceptance they could not otherwise have commanded. Carlyle, in his own singular but expressive language, expresses the general effect on society. "It did in effect," he says in his "Letters and Speeches of Cromwell," "strike a damp into the heart of Flunkeydom throughout the universe." Hence the indignant periods of Salmasius, couched in the elegant language of learning, at that period created an immense sensation, and, as may be supposed, in England, then under the Commonwealth, no little resentment.

Milton, who at that time was acting as Cromwell's Latin

secretary, was selected to prepare a reply. He performed his task, although delayed, as he himself explains, by the state of his health ; and in 1651 he published his "Defensio pro populo Anglicano," in reply to Salmasius. Whatever were the intrinsic merits of his work, or whatever the temper of the times in 1649, when the tragedy was recent, two years had elapsed, and Milton's essay was by universal consent admitted to have the best of it. Bayle says of it that it made Milton spoken of throughout the whole world by everyone. Europe was probably unconvinced, but it was amused. It laughed, if it did not assent. Queen Christina herself joined in the general enjoyment of the pungent and effective retort, and looked coldly on her discomfited protégé. The book is now unread and forgotten, but, as I pointed out the other evening, Bayle in his "Dictionary" mentions Milton as the opponent of Salmasius, as if that were his chief and almost his only title to a place in his work.

Nevertheless, had we been to pronounce judgment now on this celebrated tract, putting aside the political views maintained and defended in it, I am not sure that our verdict would be the same. In point of reasoning on the principles of government it follows the lines, up to a certain point, of Buchanan and Rutherford, borrowing largely from both. In this part of the subject there is nothing in his views which would ever have acquired for him the celebrity which followed him. The real characteristic of the treatise, such as it is, consists in the hearty, unrestrained, and amusing abuse which the author, from beginning to end, showers on his antagonist and his book, and the diverting use which he makes of the sonorous and dignified language in which his thoughts are clothed, as the vehicle for an unremitting volley of gibes, sarcasms, grim jokes, and even puns, at the author's expense.

One or two specimens of his style will serve to illustrate this estimate, and place both the majestic poet and the powers of the Latin language in a novel point of view. I quote, for the most part, Walsingham's translation.

In his preface he starts with the strain which he sustains, with unabated spirit, to the end. After quoting the title of his enemy's book, which I have read, he says :—" You undertake a wonderful piece of work, whoever you are, to plead the father's cause before his own son ; a hundred to one but you carry it. But I summon you,

Salmasius, who heretofore skulked under a wrong name, and now go by no name at all, to appear before another tribunal, and before other judges, when perhaps you may not hear those little applauses which you use to be so fond of in your own school." Then, going to the foot of the title-page, he finds "*Sumptibus Regiis*," on which he goes off:—"At the king's charge. O mercenary and chargeable advocate! Could you not afford to write a defence for Charles the father, whom you pretend to be the best of kings, to Charles the son, the most indigent of all kings, but it must be at the poor king's charge? But though you are a knave, you would not make yourself ridiculous in calling it the king's defence; for you having sold it, it is no longer yours, but the king's indeed; who bought it at the price of a hundred Jacobuses—a great sum for a poor king to disburse. I know very well what I say, and it is well known enough who brought the gold, and the purse wrought with beads. We know who saw you stretch out greedy fists under pretence of embracing the king's chaplain who brought the present; but, indeed, to embrace the present itself, and by accepting it, to exhaust almost the king's treasury."

"But now the man comes himself—the door creaks—the actor comes on the stage."

In this strain of personality, badinage, and abuse, he continues to the end; not dignified certainly, but the Latin dress takes somewhat off its scurrility. He has one or two stock subjects of allusion. One is that Salmasius has a termagant wife. In Salmasius' work he quotes, as Father Maxwell had quoted, the example of the lower animals in favour of absolute monarchy:—"The bees have a king over them, the bees of Trent you mean; do you remember? All other bees you yourself confess to be Commonwealths." "But leave off playing the fool with bees—they belong to the muses, and, you see, confute such a beetle as you are." "Now you begin to be personally concerned. 'Gallus Gallinaceus,' you say, 'has both cocks and hens under him.' How can that be? since you who yourself are Gallus" (a Frenchman) "by report cannot govern your own single hen, but let her govern you." Again:—"I will throw you a great many barleycorns, if in ransacking this dunghill book of yours you can show me but one jewel. But why should I promise you barley, that never

pecked at corn, as that honest plain cock that we read of in *Æsop*, but at gold, as that roguery cock in *Plautus*, though with a different event, for you found a hundred *Jacobuses*, and he was struck dead with *Euclid's* club, which you deserve more than he did."

These hundred *Jacobuses* crop up perpetually. *Salmasius* says, "Betwixt the two extremes of kingly power there are three more temperate species interposed, as there lie three zones betwixt the torrid and the frigid." "Pretty rogue!" says *Milton*, "what ingenious comparisons he always makes us; may you for ever be banished whither you condemn an absolute kingdom to be, that is to the frigid zone, which, when you are there, will be doubly cold." And so he discusses these zones to the end of the chapter, which he ends thus:—"You deny that there was any light in *Moses'* heaven before the sun; and in *Aristotle's* you make three temperate zones. How many zones you observed in that golden and silken heaven of the king's I know not, but I know you got one zone (punning on the Latin word)—a purse—well-tempered by a hundred golden stars, by your astronomy."

It is difficult in translation to give the full effect of these gibes as they appear in the Latin version, although *Walsingham's* rendering is very faithful and spirited; what I have given may serve as a specimen. The book is full of them; some more humorous, but less decorous; and, in short, it is the last book one would have supposed to have been written by the author of the "*Paradise Lost*." Of course, by what I have said, it may be inferred *Milton* is not satisfied with refuting the theory of divine right, but justifies the action of the nation in abolishing, not the monarchy only, but the House of Lords also. But had he foreseen that his book would not be many years in print before the government of this country would be more absolutely in the hands of one man, and that man his own master, than it ever was in those of the monarchs he condemns, it might somewhat have tempered the profound admiration he expresses for the great, and, as he thought, permanent work which he attributes to the English people.

One other passage he has worth my alluding to. *Salmasius* says that "the *Presbyterians* may justly challenge the glory of its beginning and progress" (referring to the execution of the king). "Hark! ye *Presbyterians*," says *Milton*, "what good has it done

you? How is your innocence and loyalty the more cleared by your seeming so much to abhor the putting of the king to death? You yourselves, in the opinion of this everlasting talkative advocate of the king, your accuser, went more than half-way towards it. Woe be to you, in the first place, if ever Charles or his posterity recover the crown of England; assure yourselves you are like to be placed in the black list." He was not far wrong; but our friend Principal Baillie retained till the Restoration his ancient grudge against the Independents, and all their doings. He welcomes Charles II., in 1661, in words in which we hardly recognise the original. "The king, in moderation, wisdom, piety, and grave carriage, giving huge satisfaction to all," and takes his last leave of the Independents and our author, with this rather malignant chuckle, "It was but the justice of God, to disgrace the two Goodwins, blind Milton, Owen, Norris, and others of that maleficent crew."

I need not follow the fate of this controversy or the combatants farther. The dispute did not stop there; nor was the event fortunate for either. Milton lost his sight shortly afterwards in some measure from his labours in this cause. Salmasius lost both reputation and favour, and died within two years. The war of words was carried on, and Milton had to make another rejoinder to more ignoble antagonists, until the conflict degenerated into the lowest personal abuse.

As an example of Milton's power over the language he wielded, his "Defensio" is worthy of the highest praise. It is not the composition of a man who thought in Latin, as Buchanan did; and possibly Salmasius, who writes gravely, was more severely classical. But Milton's power of Latin expression, for ease and ductility, is something wonderful, and proves a familiarity with all moods of the language which few have ever excelled.*

The following anecdote, which I take from Todd's preface to Milton's works, is worthy the attention of scholars. Ellwood, the

* "The Swedish ambassador again complained of delay in his business, and that when he had desired to have the articles of this treaty put into Latin according to the custom for treaties, that it was fourteen days they made him stay for that translation, and sent it to one Mr Milton, to put them into Latin." (Whitelocke, p. 645, "Minutes of the House of Commons.")

quaker, acted as his reader after his blindness, and says :—"At my first sitting to him, observing that I used the English pronunciation, he told me if I would have the benefit of the Latin tongue, not only to understand and read Latin authors, but to converse with foreigners, abroad or at home, I must have the foreign pronunciation," and accordingly Milton proceeded to teach him what I fancy our old High School masters taught us—a striking testimony from so great a master of the language.

Altogether this treatise, of which I now take my leave, does not rise to the height of the great argument, clever and entertaining as it is. One or two noble sentiments in praise of liberty are to be found scattered up and down its pages; and its power is undeniable, in its own style, but it is captious and hypercritical. Butler, who was a strong royalist, was not without reason when he wrote :—

"Some polemics use to draw their swords
Against the language only, and the words,
As he who fought at barriers with Salmasius,
Engaged with nothing but his style and phrases,
Waived to assert the murder of a prince,
The author of false Latin to convince."

Fortunately Milton's mighty name rests on a more enduring and firmer pedestal. Yet in this work we may see combined his love for those two companions of whom he says :—

"In thy right hand lead with thee
The mountain nymph, sweet Liberty,
And if I give thee honour due,
Mirth, admit me of thy crew."

I must, however, try to draw this essay to a conclusion. There were published about this time two other political treatises of some celebrity—the first Hobbes's "Leviathan," and the second, Harrington's political romance, entitled "Oceana." But I do not stop to analyze them, because their views are too fanciful for practical affairs. Hobbes would have none of the democratic element. Democracy, he maintained, had not even the merit of being the government of the many, but was merely the government of half-a-dozen orators. Harrington, on the other hand, is all for a Commonwealth; and he sketches in considerable detail, and with great ingenuity and acuteness, his ideal constitution for "Oceana." One peculiarity of it was that the elections were to be taken by ballot. His book was

published during the Protectorate, and dedicated to Cromwell. But I pass on to the last on my list, Algernon Sydney's "Treatise on Government," and a few words on that work will bring my remarks to a close.

Algernon Sydney, the second son of the Earl of Leicester, as we all know, was one of the last victims of political oppression before the Revolution. He was convicted of accession to the Ryehouse plot, and executed in 1683. He had been a strong opponent of Cromwell's tyranny, and whatever his complicity in the alleged plot may have been, there can be no doubt of the iniquity of his trial and sentence, which was solemnly reversed by parliament after the Revolution. But my only concern at present is with his contribution to the constitutional idea or principle.

The discourses on government were not published until five years after Sydney's death. They were written in opposition to the views of a royalist writer, Sir R. Filmer, a defender of absolute monarchy, and of the doctrine that kings are above the law. Sir R. Filmer's tracts were published anonymously in 1652, and this series of discourses by Algernon Sydney probably was written some years afterwards. It shows a great advance towards maturity in the thoughts and opinions of men on these important topics. The collision of published thought, and still more the irresistible logic of events, had done much to dispel many visionary and enthusiastic tenets. The country had seen the doctrine of divine right develop into general revolt. They had seen the republican spirit of the Independents develop, by a rapid transition, into military despotism of the most arbitrary kind. It was time to profit by the lessons of experience, and to fall back on less excited and more moderate counsels. This work of Algernon Sydney is a philosophical, thoughtful, practical work. Take it altogether, it is the best of the series; and, while it combats with great learning and power the dogmas of Sir R. Filmer, breathes a tone of reflective moderation which contrasts strongly with the subacute excitement which pervades the others.

The exhaustive table of contents which is prefixed to his volume, containing the heads of his discourse, furnishes a very clear analysis of the principles contained in it. I extract one or two of them, which indicate the colour of the whole.

Chap. ii., Sec. 16. The best governments in the world have been composed of monarchy, aristocracy, and democracy.

Chap. ii., Sec. 28. Men living under popular or mixed governments are more careful of the public good than in absolute monarchies.

Chap. ii., Sec. 30. A monarchy cannot be well regulated, unless the powers of the monarch are limited by law.

Chap. iii., Sec. 37. The English government was not ill constituted; the defects more lately observed proceeding from the change of manners, and the corruption of the times.

On the form of government he says under the first head:—

“As for democracy, I believe it can only suit with the convenience of a small town, accompanied by such circumstances as are seldom found. But this no way obliges men to run into the other extreme, inasmuch as the variety of forms between mere democracy and absolute monarchy is almost infinite; and if I should undertake to say there never was a good government in the world that did not consist of the three simple species of monarchy, aristocracy, and democracy, I think I might make it good.”

“On the other side, in a popular or mixed government every man is concerned; every one has a part, according to his quality or merit. All changes are prejudicial to all; whatsoever any man conceives to be for the public good, he may propose it in the magistracy, or to the magistrate; the body of the people is the public defence; the advantages of good success are communicated to all, and every one bears a part in the losses. This makes men generous and industrious, and fills them with love to their country.”

This is well thought and expressed. One quotation more on the English constitution will end this paper.

“Our ancestors may evidently appear not only to have intended well, but to have taken a right course to accomplish what they intended. Taking our affairs at the worst, we shall soon find that if we have the same spirit they had, we may easily restore our nation to its ancient liberty, dignity, and happiness, and if we do not, the fault is owing to ourselves, and not to any want of virtue and wisdom in them.”

These words have the true ring. They were published in 1688, and the experience of two centuries of great prosperity has confirmed their sagacity.

The following Communications were read :—

2. On the Intrinsic Muscles of the Mammalian Foot. By Dr D. J. Cunningham.
3. On the Expansion of Rational Fractions, &c. By Mr A. H. Anglin.
4. Algebra of Relationship. Part III. By A. Macfarlane, M.A., D.Sc., F.R.S.E.

§ 1. In my previous papers on this subject* I used the relationship terms, not in a representative but in a class sense; for instance, cA was employed to denote the children of the man A , and U was employed to denote the total assemblage of mankind, or a limited portion of that assemblage. I have found it useful for the purpose on hand to analyse these symbols into their component elements. Let U denote a man representatively, that is, *any man*, then mankind is appropriately represented by ΣU , where Σ has its ordinary mathematical meaning of taking the sum. Also U_A is the appropriate mathematical expression for the man who has the name A , and A standing by itself is to be regarded as a contraction for U_A . This notation is useful where, as in the present case, the universe of the investigation is composed of individuals; but since the universe may be continuous in its nature, by taking U to denote *the whole*, a more general basis is given to the Algebra of Logic, and accordingly I adopted that notation in my work on the subject.

§ 2. Similarly, let c denote *child* in its representative sense, then ΣcA denotes all the children of A ; and with the aid of the numerical and certain other symbols we can express one, two, three, &c., children of A ; or the only, the two, the three, &c. (as the case may be), children of A ; or the first, the second, &c., child of A .

First. $1cA$, $2cA$, $3cA$, &c., may be used to denote a certain child

* Proc. Roy. Soc. Edinb., vol. x. p. 224, and vol. xi. p. 5.

of A , two children of A , three children of A , and so on. These may be called *partial or indefinite numbers*, as the first corresponds to the indefinite article.

Second. A dot placed over a number may be used to express that it is the complete number; as $1c\dot{A}$ the only child of A , $2c\dot{A}$ the two children of A . These may be called *complete or definite numbers* as they involve the definite article in their meaning.

Third. The proper mathematical expression for the eldest child of A will be c_1A ; for the second c_2A , and so on.

When there is no quantitative symbol attached to c , the particle *any* is to be understood.

§ 3. There are in all four kinds of fundamental relationships. Of these I have already discussed the set of four s , σ , d , δ , denoting respectively the relationship of a man to his father, of a man to his mother, of a woman to her father, and of a woman to her mother; and also the set of two c , γ , denoting respectively the relationship of a person to his or her father, and of a person to his or her mother. There is another set of two, namely, the relationship of a man to his parent, and of a woman to her parent; and there is finally the relationship of greatest generality, *child of a person*, which is the relationship obtained by considering c and γ as equivalent (Part II. p. 8). Each of these relationships has its appropriate reciprocal.

§ 4. Let c be used to denote the relationship of *child*, then c^{-1} denotes *parent*. These symbols, together with m and f to express *male* and *female*, suffice to express the other fundamental relationships, and consequently (with the aid of auxiliary symbols) any relationship whatever. Thus—

| | |
|----------------------------------|--|
| ${}_m c$ denotes son of a person | ${}_m c^{-1}$ denotes father of a person |
| ${}_f$ „ daughter of a person | ${}_f c^{-1}$ „ mother of a person |
| c_m „ child of a man | c_m^{-1} „ parent of a man |
| c_f „ child of a woman | c_f^{-1} „ parent of a woman |
| ${}_m c_m$ „ son of a man | ${}_m c_m^{-1}$ „ father of a man |
| ${}_m c_f$ „ son of a woman | ${}_m c_f^{-1}$ „ father of a woman |
| ${}_f c_m$ „ daughter of a man | ${}_f c_m^{-1}$ „ mother of a man |
| ${}_f c_f$ „ daughter of a woman | ${}_f c_f^{-1}$ „ mother of a woman |

§ 5. We evidently have

$$\Sigma cU = \Sigma_m cU + \Sigma_f cU,$$

that is, all the children of any person are identical with all the sons of that person, together with all the daughters of that person.

This equation may be written—

$$\Sigma cU = \Sigma_{m+f} cU \quad . \quad . \quad . \quad (1),$$

similarly

$$\Sigma cU = \Sigma c_{m+f} U \quad . \quad . \quad . \quad (2),$$

and

$$\Sigma cU = \Sigma_{m+f} c_{m+f} U \quad . \quad . \quad . \quad (3).$$

We also have

$$\Sigma c^{-1}U = \Sigma_m c^{-1}U + \Sigma_f c^{-1}U,$$

that is, all the parents of a person are identical with all the fathers of the person, together with all the mothers. Here Σ on the left-hand side has the value 2, and in each case on the right-hand side the value 1. The equation may be written

$$\Sigma c^{-1}U = \Sigma_{m+f} c^{-1}U \quad . \quad . \quad . \quad (4).$$

Also

$$\Sigma c^{-1}U = \Sigma c^{-1}_{m+f} U \quad . \quad . \quad . \quad (5),$$

and

$$\Sigma c^{-1}U = \Sigma_{m+f} c^{-1}_{m+f} U \quad . \quad . \quad . \quad (6).$$

§ 6. Let us consider a genus-relationship of the second order, such as *grandchild*. We have

$$\Sigma ccU = \Sigma ({}_m cc + {}_f cc) U \quad . \quad . \quad . \quad (1),$$

$$= \Sigma (c_m c + c_f c) U \quad . \quad . \quad . \quad (2),$$

$$= \Sigma ({}_m c_m c + {}_m c_f c + {}_f c_m c + {}_f c_f c) U \quad . \quad . \quad . \quad (3).$$

Equation (1) expresses that all the grandchildren of a person are identical with all the grandsons of the person, together with all the granddaughters of the person. Equation (2) expresses that the same are identical with all the children of the sons of the person together with all the children of the daughters of that person; and equation (3) expresses that they are identical with all the sons of the sons, together with all the sons of the daughters, together

with all the daughters of the sons, together with all the daughters of the daughters. The relationship can be expanded in other five ways by putting m or f after the last c .

It is not impossible, biologically, for certain individuals who are present in the first group of equation (3), that is in $\Sigma_m c_n c U$, to be present also in the second group, that is, in $\Sigma_m c_f c U$; and when we take the term *great-grandchild* and expand it in a similar manner there is no legal reason (according to the English Law) to prevent one and the same individual from appearing in two groups. The terms are mutually exclusive in respect of the *relations*, but not necessarily in respect of the individuals in which the relations exist. In the same man A there may be two great-grandsons of B . When it is necessary to denote the persons in which the relations exist, the Greek γ may be used instead of the corresponding c .

§ 7. To find the number of genus-relationships in the n^{th} order.

The first part of the Table of such relationships is as follows:—

| Order. | Expression. | Index Expression. | Meaning. |
|--------|---------------------------|-------------------|-----------------|
| 0 | 1 | c^0 | self |
| I | c | c^1 | child |
| | $\frac{1}{c}$ | c^{-1} | parent |
| II | cc | c^2 | grandchild |
| | $\frac{1}{c}c$ | c^{1-1} | child of parent |
| | $\frac{1}{c}c$ | c^{-1+1} | parent of child |
| | $\frac{1}{c} \frac{1}{c}$ | c^{-2} | grandparent |

It will be observed that the terms for any order are derived from those of the preceding order by first prefixing c , and secondly by prefixing $\frac{1}{c}$ before each term. Hence the number of genus-terms for the n^{th} order is 2^n .

§ 8. To find the number of the elementary relationships of the n^{th} order.

The n^{th} order has 2^n genus-relationships. Consider any one of these. A distinction of sex can be introduced before each c or

c^{-1} , and also after the term. Hence, the number of different ways in which a distinction of sex can be r times introduced is equal to the number of combinations of $n+1$ things r together. The number of different relationships obtained by the expansion of a term in which a distinction of sex has been r times introduced is 2^r . Hence, the number of terms for one genus-notion is

$$1 + (n+1)2 + \frac{(n+1)^n}{1 \cdot 2} 2^2 + \dots + 2^{n+1},$$

that is, 3^{n+1} . Hence, the total number for the n th order is $2 \cdot 3^{n+1}$. The number for the 5th order is 23,328.

Cor. 1. The number of varieties for the n th order is 2^{n+1} .

Cor. 2. The number of elementary relationships included in the first n orders is $\frac{18}{5}(6^n - 1)$. For n being 5 the number is 27,990.

There have been those who have conceived the idea of framing a philosophical language (Max Müller, "Science of Language," vol. ii. lect. 2). The fact that without going beyond relationships involving more than seven generations, and without taking into account any combination of relationships, we have more than one million different elementary relationships in which two persons can be said to stand to one another, may serve to give some idea of the difficulties inherent in that task. At the same time it shows how mathematical analysis can step in where ordinary language fails.

§ 9. I shall now state briefly the properties of the different kinds of symbols required in this analysis, and first of the relationship symbols.

The order in which two fundamental symbols occur in a relationship is in general essential; that is, the symbols are in general *non-commutative* with one another. Thus cc^{-1} is not equivalent to $c^{-1}c$.

A relationship is not altered by varying the mode of *association* of its fundamental symbols. Thus $(c^2)c = c(c^2)$, that is, grandchild of child is equivalent to child of grandchild. Again $c^2(c^{-1}) = c(c^{-1})$, that is, grandchild of parent is equivalent to child of brother or of sister or of self.

The symbol c has already been defined (§ 6) in such a manner as to satisfy the *distributive* law, and the symbol γ in such a

manner as not to satisfy that law. For a complete investigation of the subject both symbols are required.

§ 10. Three kinds of indices are required; one kind to express the number of times a relationship symbol is repeated; a second to express the number of times one genus-relationship is present in a compound relationship; and the third to express the Boolean index which denotes the combination of the same relationship with itself. The first of these may be called the order-index, and the second the degree-index.

§ 11. *The Order-index.*—It follows from the preceding laws that $c^{p+q} = c^{q+p}$ and $c^{-p-q} = c^{-(q+p)}$, but c^{p-q} is not $= c^{-q+p}$.

The forms to which c^{p-q} can reduce are $c^{(p-1)-(q-1)}$, $c^{(p-2)-(q-2)}$, $c^{(p-3)-(q-3)}$, &c., until one of the indices is reduced to 0. It is evident that a relationship of an odd order, if reducible, can reduce only to one of an odd order, and one of an even order only to one of an even order.

It also follows from the preceding laws that $(c^p)^q = (c^q)^p$; that $(c^p)^{p-q} = c^{pp-qq}$; but that $(c^{p-q})^p$ is not $= c^{pp-qp}$. For example $(c^2)^{2-1} = c^2c^2c^{-2} = c^{4-2}$ that is, grandchild of grandchild of grandparent = great great grandchild of grandparent. But $(c^{2-1})^2 = c^{2-1}c^{2-1}$ not $= c^{4-2}$ that is, grandchild of parent of grandchild of parent is not equivalent to great great grandchild of grandparent.

§ 12. *The Degree-index.*—The nature of this index may be best explained by taking an example. The relationship of full brother or sister is compounded of the relationship of half brother or sister on the father's side, and of half brother or sister on the mother's side, and may be expressed by

$$\overline{\frac{1}{c}} = c_m \frac{1}{c} \cdot c_f \frac{1}{c}.$$

Here the introduction of the vinculum or some such sign is necessary to distinguish the index of the degree from the index of the order. I use the sign \cdot to denote logical combination. The index of the degree is not the Boolean index (which satisfies the law $x^2 = x$), for the one quality is not wholly equivalent to the

other quality, but agrees with it only to the extent of being a relationship of the same genus.

§ 13. *Partial numbers.*—Let r denote any relationship, and N a partial number; in counting NrA each rA counted must be different from any preceding one counted. But in such an expression as $(3+2)rA$, where two partial numbers are connected by $+$, it is not necessary that each of the individuals counted in the $3rA$ should be different from each of the individuals counted in the $2rA$. Hence $(3+2)rA$ is equivalent either to $5rA$, or $(3+2\cdot1)rA$, or $(1+2\cdot2)rA$ where the parts connected are now exclusive of one another. Similarly, $(3-2)rA$ is not necessarily equivalent to $1rA$; the expression is either irreducible or reducible, and if reducible may be either $(2-1)rA$ or rA .

A partial number placed before a sum of terms connected by the signs $+$ or $-$ is non-distributive. For example,

$$\Sigma c_n A = 2(c_p B + c_f C)$$

is best viewed as meaning that the children of the man A are identical with two children either of the woman B or of the woman C , rather than meaning that they are identical with two children of the woman B together with two children of the woman C . Upon this view the above equation means that

$$\Sigma c_n A = 2c_p B, \text{ or } = 1c_p B + 1c_f C, \text{ or } = 2c_f C.$$

§ 14. *Complete numbers.*—If, as before, r denote any relationship, then such an expression as $(\hat{3}+2)rA$ must be equivalent to $(1+2\cdot2)rA$ where the former 2 is a coefficient. This follows because the sum of the rA is three. Similarly, $(\hat{3}-2)rA = 1rA$. A definite number is similar to an indefinite number in being non-distributive when placed before a sum of terms. Thus $\hat{3}(c_p B + c_f C)$ means that the children of the woman B together with those of the woman C amount to three.

§ 15. The symbol Σ expresses any complete number without denoting what the number is. For example, the equation

$$\Sigma c \text{ Henry VIII.} = \Sigma c \text{ Catherine of Arragon} + \Sigma c \text{ Anne Boleyn} \\ + \Sigma c \text{ Jane Seymour,}$$

is a less definite form of the statement

$$3c \text{ Henry VIII} = 1c \text{ Catherine of Arragon} + 1c \text{ Anne Boleyn} \\ + 1c \text{ Jane Seymour.}$$

Thus Σ placed before a sum of terms is distributive, but its arithmetical value changes.

§ 16. Let N be used to denote any partial number in the same way as Σ is used to denote any complete number. The simplest kind of equation is where we have got one term equated to one term. Of this kind there are three forms according as, 1st, Σ occurs on both sides, 2d, Σ on the one, and N on the other side, 3d, N on both sides. Examples are

$$5c \text{ Edward III.} = 5c \text{ Philippa of Hainault.} \\ 3c \text{ John of Gaunt, Duke of Lancaster} = 3c \text{ Blanche.} \\ 1c \text{ Margaret Tudor} = 1c \text{ Archibald, Earl of Angus.}$$

The first of those equations can be written in the form

$$\frac{5}{5} c \text{ Edward III.} = 1c \text{ Philippa,}$$

that is, each of the five children of Edward III. was a child of Philippa, and conversely. The second can be written in the form

$$\frac{3}{3} c \text{ John of Gaunt} = 1c \text{ Blanche.}$$

Each of three children of John of Gaunt was a child of Blanche, the converse being each of the three children of Blanche was a child of John of Gaunt.

§ 17. The next simplest kind of equation is that in which one term is equated to two terms, as

$$5c_m A = 3c_f B + 2c_f C$$

that is, five children of the man A are identical with three children of the woman B together with two children of the woman C . This equation can be written in the other two forms

$$3c_f B = 5c_m A - 2c_f C,$$

and

$$2c_f C = 5c_m A - 3c_f B.$$

The rule for transforming such an equation is:—*Any symbol may be taken from the front of one side provided its reciprocal be placed in front of the other side; the reciprocal of the qualification m being m, and of f being f.* For instance, this rule applied to the first form of the above equation gives us

$$c_m A = \frac{1}{5} (3c_f B + 2c_f C)$$

each of three children of *B* and two children of *C* was a child of *A*.

$${}_m A = c^{-1} \frac{1}{5} (3c_f B + 2c_f C)$$

the man *A* was the parent of each of, &c.,

$$A = {}_m c^{-1} \frac{1}{5} (3c_f B + 2c_f C).$$

A was the father of each of, &c.

§ 18. If the sex symbols preceding and succeeding the expression $c \frac{1}{c}$ are the same, the expression may reduce to 1; but if the sex symbols are different, the expression cannot reduce to 1. If the sex symbols preceding and succeeding the expression $\frac{1}{c} c$ are the same, the expression must reduce to 1; and if these symbols are different the expression cannot reduce to 1. These laws apply to all states of society, with the exception that $\frac{1}{m} c_m$ does not necessarily reduce to 1 in communities where polyandry prevails.

Should the transformation of an equation result in bringing *mm* or *ff* between two relationship elements, as in $c_{mm}c$, such an expression is consistent, and *mm* is equivalent to *m* and *ff* to *f*; but should the transformation result in bringing *mf* or *fm* between two elements, the expression is contradictory.

§ 19. *Compound terms.*—The factors in a compound relationship are commutative with one another. For example, the relationship $c_m A.c_f B$ is equivalent to the relationship $c_f B.c_m A$. In

connection with such an expression we have two kinds of quantitative symbols, 1st, those of the resultant; 2d, those of the components. Thus in $\Sigma(c_{m}A.c_{p}B)$ the compound representative term is first formed, and then the sum taken; whereas in $\Sigma c_{m}A.\Sigma c_{p}B$ the sum of each component is taken separately, and then the sums are combined. The results must be identical; hence $\Sigma(c_{m}A.c_{p}B) = \Sigma c_{m}A.\Sigma c_{p}B$. The Σ of the resultant is conditioned by the Σ 's of the components in the following manner:—It cannot be greater than either of them; it cannot be less than their sum minus the Σ of ΣU ; and it cannot be less than 0.

§ 20. Let r denote any relationship, and ρ an individual in which such a relationship exists (§ 6), then

$$\Sigma_{\rho} U = \Sigma \left\{ r^{-1} + r^{-2} + r^{-3} + \dots + r^{-n} \right\} U;$$

where the degree-index 1 denotes that the genus relationship occurs once and once only in the person; 2, that it occurs twice and twice only, and n that it occurs as often as is physically possible. For example,

$$\Sigma_{\gamma} \frac{1}{\gamma} U = \Sigma \left\{ c \frac{1}{c} + c \frac{1}{c} \right\} U,$$

that is, the brothers and sisters of any person are identical with the half-brothers and sisters, together with the full-brothers and sisters. Again,

$$\begin{aligned} \Sigma_{\gamma^2} U &= \Sigma \left\{ c^2 + c^2 \right\} U; \\ &= \Sigma c^2 U, \end{aligned}$$

in all countries where the marriage of brother and sister is prohibited.

This notation gives us the degree-index 0 as the proper symbol to express the negative particle *non*; for it means that the kind of relationship in question is not found at all in the person.

$\overline{\Sigma c \frac{1}{c}}^0 A$ expresses all the non-brothers and non-sisters of A to be

found within the community of persons considered. Hence we have the following identity:—

$$\Sigma U = \Sigma \left\{ \frac{0}{r} + \frac{1}{r} + \frac{2}{r} + \dots + \frac{r}{r} \right\} A.$$

For example,

$$\Sigma_m U = \Sigma \left\{ \frac{0}{m \cdot c} + \frac{1}{m \cdot c} + \frac{2}{m \cdot c} \right\} A$$

that is, all the men are identical with all the non-brothers of A , together with all the half-brothers of A , together with all the full-brothers of A . The equation can also be written in the form

$$\Sigma_m U = \Sigma \left\{ \frac{0}{m \cdot c_m} \cdot \frac{0}{m \cdot c_f} + \frac{1}{m \cdot c_m} \cdot \frac{1}{m \cdot c_f} + \frac{2}{m \cdot c_m} \cdot \frac{2}{m \cdot c_f} \right. \\ \left. + \frac{1}{m \cdot c_m} \cdot \frac{1}{m \cdot c_f} \right\}$$

which agrees with the Boolean form of development.

§ 21. The biological law that a person cannot be his or her own descendant is expressed by the equation $1 \cdot c^n A = 0$, where n denotes any integer from 1 upwards, and A denotes any person. The reciprocal aspect of this truth is that $1 \cdot c^{-n} A = 0$, that is, a person cannot be his or her own ancestor. The most general statement of the law is $\Sigma c^m \cdot c^{-n} A = 0$, provided m and n are not both 0. This equation denies the possibility of the transmigration of souls, if A be considered to denote the identity of soul without necessary continuity of body.

§ 22. The effect of the laws of marriage of a nation is to annul within that nation certain compound relationships of the second degree. For example, $\Sigma c_m \cdot c_f \cdot c_m A = 0$, whoever A is. This means that the children of any man A who are also children of any daughter of the man A are none. Since A may be any man, substitute instead $\frac{1}{c} \cdot B$; the equation then becomes

$$\Sigma c_m \frac{1}{c} \cdot c_f \cdot c_m \frac{1}{c} B = 0$$

which means that a child of the father of any woman B cannot be the child of a daughter of the father of B . Hence $\sum c_m \frac{1}{c} c_f B = 0$, that is, a child of the father of any woman B cannot be the child of B . And this equation is equivalent to the preceding, because fB may be any woman. Again, it follows from the original equation that $\sum_f \frac{1}{c} c^m \cdot \frac{1}{c} c_f c_m A = 0$, that is, a mother of a child of the man A cannot be a mother of a child of a daughter of the man, hence

$$\sum_f \frac{1}{c} c_m \cdot c_m A = 0.$$

It is evident from § 18 that an equation of this kind can be transformed by operating both in front and at the end of a factor, and hence the following rule:—*To transform a universal equation which has a compound term of the second degree equated to 0, suppose all the symbols brought to one factor in accordance with the Rule of § 17, then removing a symbol from the front gives one derived equation, and removing a symbol from the end gives another derived equation. Transform each of these two in a similar manner, then each of their four resultants, and so on until all the terms have been brought to the other factor. The total of these derived equations is the total number of transformations of the given universal equation.*

5. Note on a Singular Problem in Kinetics.

By Professor Tait.

The following problem presented itself to me nearly thirty years ago. I cannot find any notice of it in books, though it must have occurred to every one who has studied the oscillations of a balance:—

Two equal masses are attached to the ends of a cord passing over a smooth pulley (as in Atwood's machine). One of them is slightly disturbed, in a vertical plane, from its position of equilibrium. Find the nature of the subsequent motion of the system.

The interest of this case of small motions is twofold. From the peculiar form of the equations of motion, it is of exceptional mathematical difficulty. This is probably the reason for its not having

been given as an example in Kinetics. And from the physical point of view it presents a very beautiful example of excessively slow, but continued, transformation of mixed potential and kinetic energy into kinetic energy alone.

If r and θ denote the polar coordinates of the disturbed mass, we have (supposing the curvature of the pulley to be large) by Lagrange's method—

$$2\ddot{r} - r\dot{\theta}^2 = -\frac{1}{2}g\theta^2,$$

$$\frac{d}{dt}(r^2\dot{\theta}) = -gr\theta.$$

Writing $\frac{1}{2}gr$ for r , and $\theta\sqrt{2}$ for θ , these become—

$$\ddot{r} - r\dot{\theta}^2 = -\theta^2,$$

$$\frac{d}{dt}(r^2\dot{\theta}) = -2r\theta.$$

Hence, the motion of the disturbed mass is the same as that of a particle of unit mass under forces $-\theta^2$ along, and -2θ perpendicular to, the radius vector.

[The work done by or against this system, along any arc of a curve, is the difference between the values of $r\theta^2$ at its ends.]

Changing to rectangular coordinates (x vertical), and maintaining the same degree of approximation as before, we have—

$$\left. \begin{aligned} \ddot{x} &= \frac{y^2}{x^2}, \\ \ddot{y} &= -\frac{2y}{x}. \end{aligned} \right\} (1.)$$

The first suffices, without farther analysis, to show that the vertical acceleration of the disturbed mass is persistently *downwards*. Hence, the result of the disturbance must be the continuous transformation of the mixed potential and kinetic energy, of the vibration originally given to the disturbed mass, into kinetic energy of translation of the whole system.

The equation of energy is easily seen to be—

$$\frac{1}{2}(x^2 + y^2) + \frac{y^2}{x} = C;$$

and here the term $\frac{y^2}{x}$ has an infinite series of successively diminishing maxima.

From some rough calculations I find that the amplitude of y increases, but much more slowly in percentage value than does x ; so that the maximum inclination of the vibrating part of the string to the vertical constantly diminishes.

It would be interesting to obtain an approximate solution of the equations (1), and to compare the motion of the vibrating mass with that of a *simple pendulum whose cord is uniformly lengthened*. The equation for the latter case has been fully treated by Fourier in his *Théorie de la Chaleur*.

When both masses (in the original problem) are simultaneously disturbed, it appears from the equations of motion that that mass whose end of the cord vibrates through the greater *angle* will have downward acceleration. As this in the former case was found to be accompanied by a diminution of the angle, the angle of the ascending mass should increase; and thus it would seem that after a time the downward acceleration will change sign. Thus (if the string were long enough) the vertical motions of the system would be oscillatory. But this curious result cannot be verified without proceeding to a formal approximation. I have not found time to carry out this laborious but not difficult work.

Another variety of the problem is easily formed by seeking the requisite *ratio* of the two masses, so that the motion shall be wholly periodic, with a period equal to that of the vibration of the disturbed mass. This is, relatively to the above, a very simple question.

BUSINESS.

The following candidates were balloted for, and declared duly elected Fellows of the Society:—Mr John Horne and Mr B. Neeve Peach.

Monday, 21st March 1881.

SIR WYVILLE THOMSON, Vice-President, in the Chair.

The following Communications were read:—

1. The Earthquake of 28th November 1880 in Scotland and Ireland. By Charles Alexander Stevenson, B.Sc. Edin.—
(Communicated by Professor Geikie).

In 1877, my father, Mr David Stevenson, communicated to the Society a notice of earthquake shocks in Argyllshire (see Proceedings, vol. ix.) from observations made by the keepers at several lighthouses, which the late Dr Bryce undertook to use in his intended visit to the west of Scotland, to trace the source of the earthquake waves of 1877, an intention which, however, was suddenly terminated by his lamented accidental death at Inverness.

Another earthquake shock, which visited Scotland and the north of Ireland on the 28th November 1880, has afforded the means of acquiring further observations, of which I think (in connection with those formerly given) the Society may consider it not unimportant to have a record in their Proceedings. These observations, as communicated from the lighthouse stations, are in the following terms :—

Butt of Lewis.—"On the 28th we felt a shock of earthquake ; it made the bed I was lying in tremble. Those who were in the kitchen felt the shock quite distinctly ; it made the dishes on the dresser ring. It was also felt by a number of other people throughout the parish. There was a gale at the time accompanied by lightning and heavy showers of hail and sleet."

Island Glass.—"At 5.30 P.M. on the 28th, during a lull, the tower received a severe shock, which caused the glass of the mechanical lamp to shake, also the table and apparatus. During the night of 28th observed vivid flashes of lightning."

Monach.—"On Sunday evening the 28th November, at 5.20 P.M., the assistant, when on watch in the light-room, felt a strange shock, which shook the tower and made the glass on the lamp rattle. The motion was quite different from what is caused by a fierce blast of wind. The motion in gales is more of a rocking, but this was like a shake and a tremor throughout the whole building. It only continued for a few seconds. There was no heavy sea or lightning or

thunder to account for it, so that we can only surmise that it has been some shock of earthquake. I felt it myself in my bed, but so slight that it could have been easily mistaken for a gust of wind striking the house."

Ushenish.—"On the 28th, at 5.25 P.M., a slight shock of earthquake was felt distinctly both in the dwelling houses and light-room. It lasted only a few seconds. There was a lull in the wind at the time. It made the tower tremble, making the lamp-glass strike against the chimney, and several articles in the dwellinghouses were shaken at the same time."

Kyleakin.—"On the 28th, at 5.35 P.M., a shock of earthquake was felt in the light-room, causing the tower to shake very much, and the glass of the lamp to rattle against the funnel, which continued seven seconds. Shock felt at same time in Kyleakin village about one mile from the lighthouse."

Barrahead.—"Observed vivid flashes of lightning between 4.30 P.M. and 8 P.M. on the 28th. At a few minutes before 5.30 P.M. the assistant lightkeeper felt the tower shaking so much that everything in the light-room rattled and continued about a minute. We supposed it had been struck with lightning. We examined everything the following day, but could find nothing wrong. We have to-day (2d December) heard that there was a shock of earthquake felt in Barra, the same date and at the same time that the assistant lightkeeper felt the tower shaking."

Ardnamurchan.—"The earthquake of 28th November was not felt at this lighthouse. I had the first watch on the night of the 28th November, and I felt nothing unusual in the light-room, neither did any of the residents at the station feel anything."

Sound of Mull.—"An earthquake occurred here on the 28th about 6 P.M. (Greenwich). The occasional keeper was on watch, and he stated that the light-room and everything in it shook and rattled. In the dwellinghouses there were three distinct shocks in quick succession, accompanied by a noise as if a number of carriages were rapidly driven past. The noise continued a few seconds after the trembling of the earth ceased. The evening was calm and sultry."

Hynish.—"On the 28th, at 6 P.M., a shock of earthquake was felt here; the oscillation being pretty strong the shaking of the houses and floors being plainly felt for about three or four seconds. A rumbling noise, as of distant thunder, was heard immediately preceding the shock."

Skerryvore.—"The lighthouse was visited by a very sharp shock of earthquake on the 28th November, at 5.18 P.M. It commenced with a low rumbling and rolling noise like distant thunder, and in a few seconds increased to a sharp rolling jerking motion. I was on watch at the time, and observed the lamp glass strike the funnel repeatedly. The whole tower from the foundation was in the same motion. The first assistant was in the kitchen at the time, and his description of the feeling was the same. The third keeper was in bed, and was started out of sleep, but could not tell the cause. We are of opinion the trembling motion lasted about eight seconds. The weather at the time was stormy, with strong breezes from S.W. At 8.25 P.M. observed several flashes of lightning, but no thunder heard. Next day we looked over the building, but could not find any damage done. I may state that this is the fifth shock that I have felt since I joined the service, and must say this one was the sharpest of the whole."

Earraid.—"On the 28th, at Earraid, a slight shock of earthquake was felt, and a rumbling sound for about two seconds at or about 6 P.M. also slightly felt on Iona."

Dhuheartach.—"At the rock (Dhuheartach) we felt nothing of the shock."

Phladda.—"On the 28th, at 5.18 P.M. we felt a shock of an earthquake, lasting from five to eight seconds, both in the light-room and dwellinghouses, making everything shake and rattle. The wave motion appeared to us to travel from W.S.W. to E.N.E. There was a long rumbling noise at the time."

Lowlandman's Bay (Shore Station for Skerville Lighthouse).—The lightkeeper writes:—"My wife made the following statement to me on coming ashore from the lighthouse—that on the evening of the 28th, she felt as if the chair on which she sat was being withdrawn from under her, and heard a rumbling noise, the dishes were

shaking. Neither I nor my assistant were sensitive of any shock of earthquake at the lighthouse, but lightning was seen by us that night."

MacArthur's Head.—"On the 28th, at 5.27 P.M. there occurred what appeared to us to be a slight shock of earthquake, which began with a trembling motion, which made the balcony doors and lighting apparatus rattle, immediately after which there was a peculiar wave motion from north to south in the tower, which lasted a few seconds, after which there was a second wave motion in the tower, more distinct than the first, for a few seconds. The lightkeeper in bed also felt the shock, but not so distinctly as the keeper on watch. There was no rumbling noise heard at the time, but the metal shades for adjusting the red light on the Islay side of the sound rattled very much." The time observed at this station is not reliable, as the clock was not in proper adjustment.

Having now given the lighthouse observations, I shall give a mere statement of the other places at which the earthquake was experienced, the information for which has been acquired from newspapers or from private sources:—Ness, Stornoway, Laxadale, Sandwick, Uig, Sheshader, Hyskeir, Barra, Dingwall, Inverness, Strome, Portree, Kyleakin, Loch Duich, Blair Atholl, Fort-William, Ballahulish, Tobermory, Island of Calla, Oban, Dalmally, Iona, Inverary, Callander, Colonsay House, Scallasaig, Port Askaig, Kilmichael, Kilmartine, Foord, Loch Gilphead, Cairnbaan, Loch Gair, Kelvin-side (Glasgow), Motherwell, Rothesay, Brodick Castle, Lamlaash, Campbeltown, Ayr, Fahan, Ramelton, Limavady, Leterkenny, Raphoe, Londonderry, Strabane, Omagh, Belfast, and Armagh.

The following lighthouse stations on the west coast of Scotland either were not visited by the earthquake, or its effects were so slight as not to render itself noticeable by the observers on watch:—Cape Wrath, Stourhead, Stornoway, Rona, Isle Oronsay, Corran, Ardnamurchan, Lismore, Dhuheartach, Rhuval, Skervuille, Lochindaal, Rhinns of Islay, Toward Point, Cumbrae, Lamlaash, Pladda, Devaar, Turnberry, Mull of Kintyre, Sanda, Corsewall, Cairn Ryan, Mull of Galloway, Little Ross.

In the following table are given the state of the barometer and thermometer, and the general results of the observations at the different lighthouse stations, and along with them some of the more

valuable observations which have been acquired from newspapers or private information, and I have to acknowledge the kindness of those who have given me assistance in the preparation of the data in the table, more especially the Commissioners of Northern Lighthouses, in granting access to the Lighthouse Returns; His Grace the

| STATIONS and TIME of SHOCK as mentioned by observers. | Greenwich. | Barometer. | | Thermometer F. | | Duration of the Disturbance. | Rainfall for November. | Direction in which wave appeared to travel. | Character of Sound. |
|---|------------------|------------|--------|----------------|--------|------------------------------|------------------------|---|---|
| | | 9 a.m. | 9 p.m. | 9 a.m. | 9 p.m. | | | | |
| Butt of Lewis, . . . | p.m. | 29.20 | 29.40 | 50° | 45° | .. | Ins. | .. | |
| Island Glass, at 5.30, . . . | 5.56 | 29.20 | 29.50 | 48° | 48° | .. | 5.61 | .. | |
| Monach, at 5.30, . . . | 5.51 | 29.30 | 29.53 | 50° | 49° | a few secs. | 5.7 | .. | |
| Ushenish, at 5.25, . . . | 5.53 | 29.16 | 29.46 | 50° | 50° | a few secs. | 2.1 | .. | |
| Kyleakin, at 5.25, . . . | 5.58 | 29.40 | 29.64 | 50° | 50° | 7 secs. | 6.51 | .. | |
| Barrahead, a few mins. before 5.30, . . . | .. | 28.85 | 28.90 | 50° | 50° | about a min. | 2.85 | .. | |
| Blair Atholl, at 5 mins. before 6, . . . | 5.55 | .. | .. | .. | .. | .. | .. | .. | |
| Sound of Mull, about 6, | .. | 29.61 | 29.74 | 50° | 48° | .. | 1.17 | .. | Rumbling noise during & after shocks. |
| Hynish, at 6, ? . . . | .. | .. | .. | .. | .. | about 3 or 4 secs. | .. | .. | Preceded by rumbling noise as of distant thunder. |
| Skerryvore, at 5.18, . . . | 5.46 | 29.89 | 29.57 | 52° | 51° | 8 secs. | .. | .. | Preceded by rumbling noise like distant thunder. |
| Motherwell, at 6, . . . | 6.0 | .. | .. | .. | .. | .. | .. | .. | |
| Oban, about 5.30, . . . | .. | .. | .. | .. | .. | .. | .. | .. | Rumbling noise. |
| Earrald, at or about 6, . . . | .. | .. | .. | .. | .. | 2 secs.? | .. | .. | Rumbling sound (for about 2 secs.?). |
| Phladda, at 5.18, . . . | 5.42 | 29.80 | 30.00 | 51° | 49° | 5 to 8 secs. | 4.50 | w.s.w. to E.N.E. | Long rumbling noise. |
| Inveraray, b'tween 5.45 and 5.50, . . . | 5.48½ | .. | .. | .. | .. | 2 secs. | .. | .. | Sharp rumbling noise |
| Inveraray, 5.50, . . . | | .. | .. | .. | .. | .. | .. | .. | |
| Callander, a few mins. before 6, . . . | .. | .. | .. | .. | .. | several secs. | .. | w.s.w. to E.N.E. | |
| Colonsay House, . . . | .. | .. | .. | .. | .. | .. | .. | .. | Rumbling sound preceding shock. |
| Lowlandman's Bay, . . . | .. | .. | .. | .. | .. | .. | .. | .. | Rumbling sound. |
| Port Aakalg, between 5.40 & 5.45, . . . | 5.40 } 5.45 } | .. | .. | .. | .. | .. | .. | E.N.E. to S.W.? | { Heavy rumbling sound. |
| MacArthur's Head, at 5.27, | .. | 29.78 | 29.90 | .. | .. | see Report. | 7.04 | N. to S. | |
| Ayr, at 5.50, | 5.50 | .. | .. | .. | .. | several secs. | .. | .. | |
| IRELAND. | | | | | | | | | |
| Ramelton, at 5.15, . . . | 5.46? | .. | .. | .. | .. | about 5 secs. | .. | .. | Preceded by rumbling sound for 3 secs. |
| Londonderry, about 5.30, | 6.1 ? | .. | .. | .. | .. | .. | .. | .. | Rumbling sound. |
| Leterkenny, at 5.25, . . . | 5.56? | .. | .. | .. | .. | ab. 30 secs. | .. | .. | Rumbling noise. |
| Donemana, at 5.27, . . . | 5.57? | .. | .. | .. | .. | .. | .. | .. | Noise resembling distant thunder. |
| Strabane, about 23 mins. to 6, | 6.7 ? | .. | .. | .. | .. | .. | .. | .. | |
| Omagh, about 5.30, . . . | 6.0 | .. | .. | .. | .. | .. | .. | S.W. to N.E. | |
| Belfast, at 5.28, . . . | 5.53 | .. | .. | .. | .. | .. | .. | .. | |
| Armagh, at 5.35, . . . | 6.0 | .. | .. | .. | .. | .. | .. | .. | |

Duke of Argyll; the Rev. Dr Robinson of Armagh; Mr William Philip, resident engineer, Londonderry; Capt. Graham, steamer "Pharos"; Mr David Gordon of Bathgate; and Mr R. L. Mackintosh, Inverness.

I may observe that this earthquake occurred in the month of November, during a wet and stormy period, the average rainfall for the month at the different places of observation being 4·4 inches, which wet period had been preceded by an unusually dry summer and spring; that it was accompanied by a widespread thunder storm, but no sudden change of barometer or thermometer; that the average height of the barometer at the lighthouse stations was, at 9 A.M., 29·4 inches; and at 9 P.M. 29·5 inches; and that the average temperature at 9 A.M. was 50° F. and at 9 P.M. 48° F.

The area over which it was felt from Butt of Lewis in the Hebrides to Armagh in Ireland, and from Barrahead in the Hebrides to Blair Atholl, amounted to at least 19,000 square geographical miles, though to what additional extent it may have been propagated into the Atlantic it is impossible to say.

The effects of this earthquake, as reported by the lightkeepers, show that it was a rather sharp shock, but fortunately that no damage was done, due no doubt to the massive structures of all our exposed lighthouse towers, and, judging generally from the reports of the shock, the undulation seems to have been of an "up and down" character like a wave of the sea.

The "breadth" of the undulation of 1839, which emanated from Comrie, and which is described by Mr David Milne-Home in an article in the "Edinburgh Philosophical Journal" for 1843, was calculated by him to have been about 20 feet, but the wave of the earthquake now under consideration must have very much exceeded the Comrie one in breadth, for a wave 20 feet broad, travelling with a velocity of 568 feet per second (which will be shown afterwards to have been the average velocity of transit of the wave of the earthquake of 1880) would pass a point on the earth's surface in $\frac{1}{28}$ th of a second, which evidently is too short a time to produce the effects observed by the lightkeepers; but, calculating the breadth of this wave from the minimum time its effects were felt, which was two seconds, and from its average velocity of transit it would appear that the breadth of the wave was fully 1100 feet, which I think is a more probable breadth than 20 feet.

The shock was felt very distinctly at some stations, whilst at others only a few miles distant it was not perceived at all. With reference to this fact, it seems necessary to remark that at the time of the shock there happened to be a keeper *on watch* in every lighthouse, as the earthquake occurred after sunset, at a time when the lamps were lighted.

Two instances will be sufficient to show how capricious the indications of the shock were.

1. At Skerryvore the shock was more severe than at any other station, yet not a trace of it was felt at Dhuheartach lighthouse, only twenty miles distant. These two lighthouse towers are very similarly situated, both being absolutely built *into* solid rocks of small extent lying in the open sea, the nearest land to either of them being about ten miles distant.

Being unable to fix the geological ages of the two rocks, I submitted specimens of them to Professor Geikie, who kindly examined them, and states by letter that he finds "the Dhuheartach rock to be a dolerite, identical in external and microscopic characters with the more coarsely crystalline dolerites of Mull, Eigg, &c. I have not the least doubt that it is a portion of the volcanic plateau which extends more or less broken from Antrim up into Faroe Islands and Iceland. The Skerryvore rock is one of the crystalline schists, and of much higher antiquity than the rock of Dhuheartach."

2. Again the earthquake was felt at the Sound of Mull lighthouse, but was not felt at Ardnamurchan, situated on the other side of the Sound of Mull, and only seven miles distant. The Sound of Mull and Ardnamurchan lighthouses are both founded on igneous rocks of the Miocene age. Judging from this case, one might come to the conclusion that the deep cleft or basin of the Sound of Mull had cut off the earthquake wave from Ardnamurchan, but on the same grounds it should have been cut off at Kyleakin, MacArthur's Head, and other places, and after a careful study of the Chart and Geological Map, I have come to the conclusion that it is impossible to account for the different effects of the earthquake, as observed at places within the agitated area, either by the configuration of the land or by the directions or positions of the principal lines of fault or of the trap dykes, but this much is shown that of twenty-two lighthouse observers between Cape Wrath and the Mull of Galloway who were

situated on the older formations (Laurentian, Cambrian, and Metamorphosed Lower Silurian), eleven felt the shock, whilst of thirteen observers situated on newer rocks, it made itself known only to two of them, and it may therefore be assumed that it was more sensibly developed on the older rocks of Scotland than on those of more recent formations. Judging from the times of occurrence of the earthquake, I think I am warranted in coming to the conclusion that the seismic focus was situated near Phladda lighthouse, which it may be remarked lies nearly in the line of the great fracture which runs from Inverness through Scotland in a south-westerly direction. It may be interesting to notice that the earthquake shocks of 1877, communicated by Mr David Stevenson, had their origin in the same district, having been experienced at Phladda, Hynish, Sound of Mull, and Lismore.

| STATIONS. | Distance from Source in Geog. Miles. | Calculated Velocity in Miles per Minute. | |
|----------------------|--------------------------------------|--|---|
| Inverary, . . . | 34 | 3.9 mean | <p>LAND JOURNEYS.*</p> <p>Inverary, Kyleakin, Motherwell, Blair Atholl, Armagh, and Omagh,—mean velocity 4.65 miles per minute.</p> <p>SEA JOURNEYS.</p> <p>Skerryvore, Ayr, Monach and Ushenish, Belfast, and Island Glass,—mean velocity 6.74 miles per minute.</p> |
| Skerryvore, . . . | 38 | 6.4 | |
| Ayr, | 63 | 6.3 | |
| Kyleakin, | 69 | 4.0 | |
| Motherwell, . . . | 75 | 3.75 | |
| Blair Atholl, . . . | 84 | 5.6 | |
| Monach and Ushenish, | 90 | 7.5 mean | |
| Belfast, | 91 | 7.0 | |
| Island Glass, . . . | 104 | 6.5 | |
| Omagh, | 105 | 5.25 | |
| Armagh, | 108 | 5.4 | |

The exact focus, however, is not certain, but as a centre from which to calculate the velocity, a point has been chosen lying S.S.W.

* If the wave in its course passed over a greater extent of land than of sea, it has been classified as a land journey, and *vice versa*.

of Phladda lighthouse and north of MacArthur's Head lighthouse, as the wave motion is described by the lightkeepers at these stations to have come in these directions; and having no less than five observations of time by lightkeepers, and seven trustworthy observations from other places, I have been enabled to determine the following results, as to what may be held to have been the velocity of transit of the earthquake wave, the time at the source being taken as 5.40 P.M. (Greenwich), which assumes that the wave travelled from the source to Phladda at a velocity of 6.74 miles per minute, which is the average velocity over the sea, and the distance from Phladda to the source being only 13 miles, any difference between this assumed velocity and the actual velocity will only affect the general result to a very small extent.

It appears, then, from this table, that the velocity has varied from 3.75 geographical miles per minute to 7.5 miles per minute in different directions from the source, the greater velocities being over the sea, probably due to the fact that in these directions the crust of the earth is thinner and lighter, and consequently more easily thrown into vibration. Thus the average velocity on sea journeys, was 6.74 miles per minute, and on land journeys, 4.65 miles per minute, the mean of the whole being about $5\frac{1}{2}$ miles per minute. On the Chart the dotted line shows roughly the limit or range of the earthquake landwards, in so far as I have been enabled to ascertain it, and it will be seen that the earthquake wave was apparently propagated farthest in directions over the sea-basin, the wave being more quickly dissipated by passing over the land with its mountain chains.

It is interesting to notice, that of the fourteen observers within a radius of 38 miles from the source who felt the shock thirteen of them mention having heard a noise, and no observers in Scotland, at greater distances, mention noise as an accompaniment of the earthquake. The stations where the noise was heard were for the most part situated on hard dense rocks, with little or no soil near them.

The average duration of the disturbance for observers within a 38 mile radius from the source is 4.4 seconds.

The most of the reports received from Ireland by newspaper notices or otherwise I had no means of personally investigating; but all of them, as will be seen in the tabular statement, give the

times at which the shock was felt as later than that reported from Phladda. Three of the Irish reports which I was enabled to inquire into, at Omagh, Belfast, and Armagh, give times which agree almost exactly with those which might be expected on the assumption that the wave felt at those places had been propagated direct from Phladda; and it is therefore probable that the earthquake disturbance in Scotland and Ireland proceeded from one and the same cause. But it is not a little remarkable that in and around Leterkenry "rumbling noises" were heard which, as already pointed out, were only heard in Scotland within a radius of 38 miles of the source, and the shock was also more severely felt than would have been expected in a spot removed so far from the source. This I think can only be accounted for on the hypothesis that the arrival of the earthquake wave from Scotland, generated in the neighbourhood of Leterkenry a second source of disturbance (not at all an improbable event), the effects of which were only local. The exact time, however, of this disturbance has unfortunately not been determined, as the reports from the north of Ireland are not sufficiently exact.

Having thus laid before the Society at some length the facts, so far as I have been able to ascertain them, regarding this very marked earthquake phenomenon, I have only to add in the form of a digest some of the principal conclusions to which this investigation appears to lead.

1. That the earthquake occurred in the month of November, a month in which many of the British earthquakes are recorded to have happened.

2. That it occurred after a wet period which had been preceded by an unusually dry summer and spring. That there was a widespread thunderstorm at the time, and that the barometer was rising slowly over the greater part of the west of Scotland, the average height of the barometer at the lighthouse stations at which the earthquake was felt being at 9 A.M. 29.4 inches, and at 9 P.M. 29.5 inches: The thermometer at 9 A.M. averaged 50° F. and at 9 P.M. 48° F.

3. That the seismic area was about 19,000 square geographical miles, the shock having been felt as far north as the Butt of Lewis, as far south as Armagh in Ireland, as far east as Blair Atholl, and as

far west as Barrahead, though how much farther it was propagated into the Atlantic it is impossible to say.

4. That the range of the earthquake or distance to which the wave was propagated was greater over the sea than over the land.

5. That the earthquake was not a simultaneous shake over the disturbed area, but was produced by a wave propagated from a centre.

6. That the undulation seems to have been chiefly of an "up and down" character like a wave of the sea, and that, calculating the breadth from the mean velocity of transit, and the minimum duration of the shock, it appears to have been fully 1100 feet in breadth.

7. That the observations warrant the assumption that a spot near Phladda lighthouse was the source, and calculating the velocities of transit with a point 13 miles S.S.W. of Phladda as a centre, the wave travelled with a greater velocity over the sea-basin than over the land, probably due to the fact that over the sea there was a thinner and lighter crust to throw into vibration, the average velocity on sea journeys being 6.74 geographical miles per minute, and the average velocity on land journeys 4.65 miles per minute, the mean of the whole being about $5\frac{1}{2}$ miles per minute.

8. That the source of the earthquake lay at or near the great fracture, which runs in a south-westerly direction from Inverness, and that the shock was probably due to a rupture of the crust of the earth at this very distinct line of fracture.

9. That all the observers who heard noises agree in stating that it was a "rumbling" sound.

10. That of the fourteen observers within a radius of 38 miles from the source, who felt the shock, thirteen of them mention having heard the rumbling sound, and none of the other observers in Scotland mention noise as an accompaniment of the earthquake, and hence that the noise was confined chiefly, if not entirely, to places situated near the source.

11. That the stations where the noise was heard were for the most part situated on hard dense rocks with little or no soil near them.

12. That the average duration of the disturbance was 4.4 seconds, for observers within the sound area.

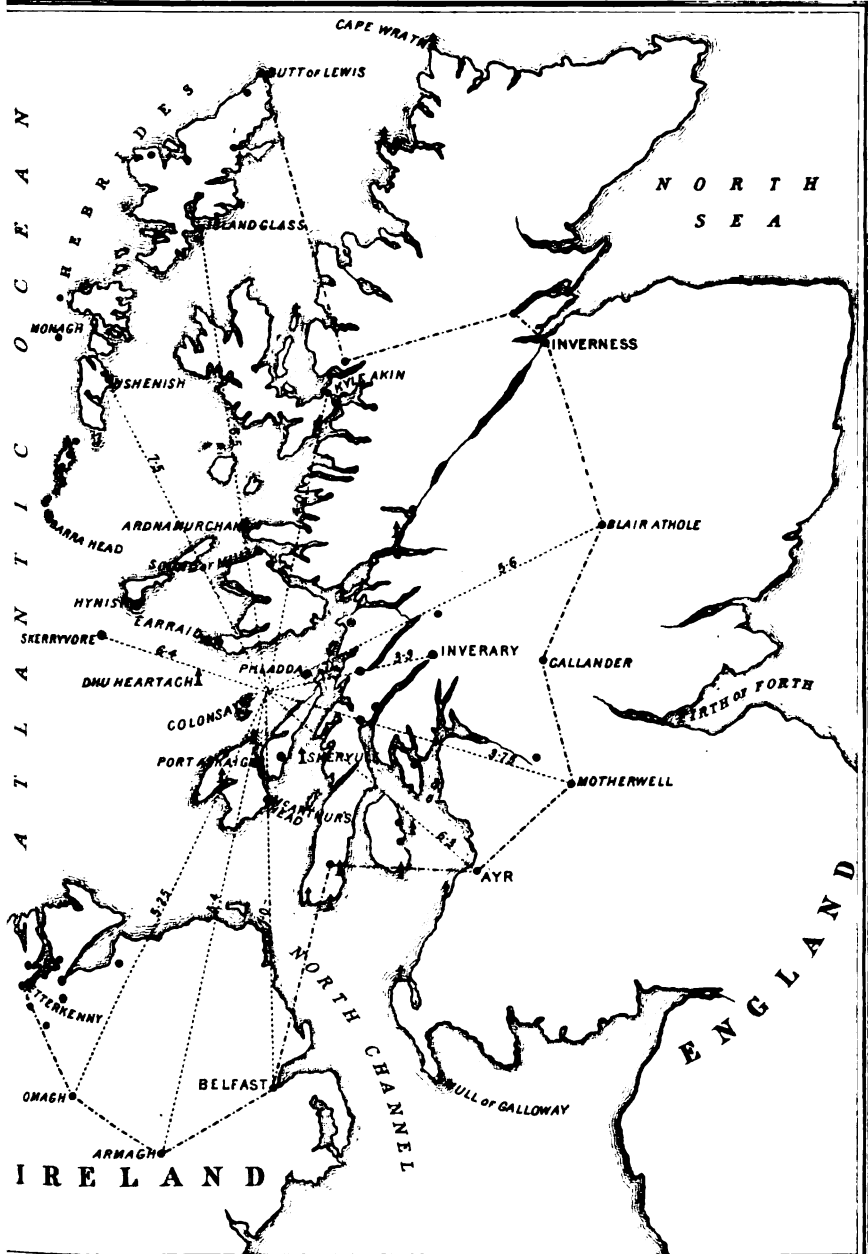

EARTHQUAKE of 28th Nov: 1880.

13. That of twenty-two lighthouse observers between Cape Wrath and the Mull of Galloway, who were situated on the older formations (Laurentian, Cambrian, and Metamorphosed Lower Silurian), eleven felt the shock, whilst of thirteen observers situated on newer rocks, it made itself known only to two of them ; and that the earthquake was therefore more generally felt on the older rocks of Scotland.

14. That stations situated near one another, and on the same formation, did not necessarily both receive the shock, and that faults or trap dykes did not seem to affect the passage or intensity of the wave in any way.

15. That the observations of time at Armagh, Belfast, and Omagh, show that the shocks at these places were most probably propagated direct from Phladda in Scotland, and that the severity of the shock, and the “rumbling” noises heard in and around Leterkenney, were probably due to a second and local source of disturbance, generated by the arrival of the shock from Phladda.

2. On the Classification of Statistics. Part I.

By Mr P. Geddes.

3. On Professor Cayley's Theorem regarding a Bordered Skew Determinant. By Mr Thomas Muir, M.A.

(This paper is to be found in the *Quarterly Journal of Mathematics*, vol. xviii.).

4. The Law of Extensible Minors in Determinants.

By Mr Thomas Muir, M.A.

5. Additional Note on a Problem of Arrangement.

By Mr Thomas Muir, M.A.

1. The present note is a continuation of a short paper which appeared in the Proceedings of the Royal Society of Edinburgh for session 1876–77. The problem in question is that referred to in Professor Tait's “Memoir on Knots,” viz :—*To find the number of possible arrangements of a set of n things, subject to the conditions that the first be not in the last or first place, the second not in the*

first or second place, the third not in the second or third place, and so on.

It being understood that U_n denotes the said number of arrangements, the concluding lines of the paper referred to will shew to what extent the problem was solved.

“Hence for the determination of U_n when U_{n-1} , U_{n-2} , are known we have

$$\left. \begin{aligned}
 U_n = & (n-2)U_{n-1} + (2n-4)U_{n-2} + (3n-6)U_{n-3} \\
 & + (4n-10)U_{n-4} + (5n-14)U_{n-5} \\
 & + (6n-20)U_{n-6} + (7n-26)U_{n-7} \\
 & \dots\dots\dots \\
 & + \frac{1 - (-1)^n}{2},
 \end{aligned} \right\} \quad (1)$$

where the coefficients proceed for two terms with the common difference $n - 2$, for the next two terms with the common difference $n - 4$, for the next two terms with the common difference $n - 6$, and so on.

“And as it is self-evident that $U_2 = 1$, we obtain

$$\begin{aligned}
 U_3 &= 1U_2 + 1 && = 1 \\
 U_4 &= 2U_3 && = 2 \\
 U_5 &= 3U_4 + 6U_3 + 1 && = 13 \\
 U_6 &= 4U_5 + 8U_4 + 12U_3 && = 80 \\
 U_7 &= 5U_6 + 10U_5 + 15U_4 + 18U_3 + 1 && = 579 \\
 U_8 &= 6U_7 + 12U_6 + 18U_5 + 22U_4 + 26U_3 = 4738,
 \end{aligned}$$

and so forth.”

What is aimed at now is to reduce the above equation of differences and thereafter to obtain the generating function of U .

2. From (1) we have

$$\left. \begin{aligned}
 U_{n-2} = & (n-4)U_{n-3} + (2n-8)U_{n-4} + (3n-12)U_{n-5} \\
 & + (4n-18)U_{n-6} + (5n-24)U_{n-7} \\
 & + \dots\dots\dots \\
 & + \frac{1 - (-1)^n}{2},
 \end{aligned} \right\}$$

and therefore by subtraction

$$\begin{aligned}
 U_n - U_{n-2} = & (n-2)U_{n-1} + (2n-4)U_{n-2} \\
 & + (2n-2)(U_{n-3} + U_{n-4} + \dots + U_2) \dots (2).
 \end{aligned}$$

Consequently, of course,

$$U_{n-1} - U_{n-2} = (n-3)U_{n-2} + (2n-6)U_{n-3} + (2n-4)(U_{n-4} + U_{n-5} + \dots + U_3),$$

and thus we are enabled to eliminate $U_{n-4} + U_{n-5} + \dots + U_3$.

The result of doing so is

$$(n-2)(U_n - U_{n-1}) - (n-1)(U_{n-1} - U_{n-2}) = (n-2)^2 U_{n-1} + (n-2)(2n-4) \left\{ U_{n-2} + (2n-2)(n-2) \right\} U_{n-3} - (n-1)(n-3) \left\{ \dots - (n-1)(2n-6) \right\}$$

or

$$(n-2)U_n = (n^2 - 3n + 3)U_{n-1} + (n^2 - 3n + 3)U_{n-2} + (n-1)U_{n-3} \quad (3).$$

Putting $(n-1)$ for n we have also

$$(n-3)U_{n-1} = (n^2 - 5n + 7)U_{n-2} + (n^2 - 5n + 7)U_{n-3} + (n-2)U_{n-4},$$

and therefore from this and (3) by subtraction

$$(n-2)U_n - (n^2 - 2n)U_{n-1} + (2n-4)U_{n-2} - (n^2 - 6n + 8)U_{n-3} - (n-2)U_{n-4},$$

or
$$U_n = nU_{n-1} + 2U_{n-2} - (n-4)U_{n-3} - U_{n-4} \dots \dots (4).$$

Further, partitioning the term $2U_{n-2}$ into $\frac{n}{n-2}U_{n-2} + \frac{n-4}{n-2}U_{n-2}$,

this may be written in the form

$$U_n - nU_{n-1} - \frac{n}{n-2}U_{n-2} = \frac{n-4}{n-2} \left(U_{n-2} - \frac{1}{n-2}U_{n-2} - \frac{n-2}{n-4}U_{n-4} \right)$$

or, say,

$$V_n = \frac{n-4}{n-2}V_{n-2},$$

whence

$$V_n = \frac{n-4}{n-2} \cdot \frac{n-6}{n-4} \cdot \frac{n-8}{n-6} \dots \dots \frac{2}{4}V_4,$$

or

$$= \frac{n-4}{n-2} \cdot \frac{n-6}{n-4} \cdot \frac{n-8}{n-6} \dots \dots \frac{3}{5}V_5,$$

according as n is even or odd. But

$$V_4 = U_4 - 4U_3 - 2U_2 = -2,$$

and

$$V_5 = U_5 - 5U_4 - \frac{5}{3}U_3 = \frac{4}{3}.$$

Hence

$$V_n = -\frac{4}{n-2} \quad (n \text{ even}),$$

$$= +\frac{4}{n-2} \quad (n \text{ odd}),$$

that is

$$U_n - nU_{n-1} - \frac{n}{n-2} U_{n-2} = (-1)^{n-1} \frac{4}{n-2},$$

or

$$U_n = nU_{n-1} + \frac{n}{n-2} U_{n-2} + (-1)^{n-1} \frac{4}{n-2} \dots \quad (5).$$

From this the successive values of U_n are got with ease.

3. To obtain the generating function of U we return to (4), and write it in the form

$$U_n = (n-1)U_{n-1} + U_{n-1} + 2U_{n-2} - (n-3)U_{n-3} + U_{n-3} - U_{n-4},$$

so that if u , a function of x , be the generating function, its differential equation is at once seen to be of the form

$$u = x^2 \frac{du}{dx} + xu + 2x^2u - x^4 \frac{du}{dx} + x^2u - x^4u + \phi(x).$$

By trial, however, $\phi(x)$ is readily found to be $x^5 - 2x^4 + x^3$, consequently the equation is

$$(x^4 - x^2) \frac{du}{dx} + (x^4 - x^3 - 2x^2 - x + 1)u = x^5 - 2x^4 + x^3.$$

Integrating in the usual way we first find

$$\int \frac{x^4 - x^3 - 2x^2 - x + 1}{x^4 - x^2} dx = x + \frac{1}{x} - \log \frac{x^2 - 1}{x},$$

$$\text{and } \therefore u = \exp\left(-x + \frac{1}{x} + \log \frac{x^2 - 1}{x}\right)$$

$$+ \int \left\{ \exp\left(x + \frac{1}{x} - \log \frac{x^2 - 1}{x}\right) \times \frac{x^5 - 2x^4 + x^3}{x^4 - x^2} \right\} dx.$$

$$= \left(x - \frac{1}{x}\right) e^{-(x + \frac{1}{x})} \int \left\{ e^{x + \frac{1}{x}} \times \frac{x}{x^2 - 1} \times \frac{x^3(x-1)^2}{x^2(x^2-1)} \right\} dx$$

$$= \left(x - \frac{1}{x}\right) e^{-(x + \frac{1}{x})} \int e^{x + \frac{1}{x}} \frac{x^2}{(x+1)^2} dx.$$

This does not really differ from Professor Cayley's result (Proc. R.S.E. 1876-7). The apparent difference is due to the fact that in the one case u is assumed to be of the form $U_3x + U_4x^2 + \dots$, and in the other of the form $U_3x^3 + U_4x^4 \dots$.

6. On the Oxidation of Ferrous Salts.

By Mr J. Y. Buchanan.

In this paper the action of permanganate of potash on ferrous salts in hydrochloric acid is studied, and a satisfactory method of titrating such solutions is indicated. Further, a short study is made of the action of chlorates, perchlorates, and nitrates on acid ferrous salts under various conditions. The results have a certain interest for the analytical chemist.

The following solutions were used :—

Ferrous Sulphate.—Ordinary recrystallised green vitriol was used.

(a) 5·857 grammes $\text{FeSO}_4 + 7\text{H}_2\text{O}$ dissolved in water and diluted till the solution weighed 290 grammes. This solution contains 0·0407 grammes iron in 10 c.c.

(b) 4·4600 grammes $\text{FeSO}_4 + 7\text{H}_2\text{O}$ (= 0·8977 grammes iron) were dissolved in water and made up to 145·5 grammes. The solution therefore contains 0·062 grammes iron in 10 c.c.

(c) 25·222 grammes $\text{FeSO}_4 + 7\text{H}_2\text{O}$ were dissolved in water and made up to 508 c.c. When filled up to the mark, and before adding the extra 5 c.c. water, the 500 c.c. solution weighed 514 grammes, therefore the specific gravity of the solution is 1·028 at 15° C. This solution when fresh contains 0·1 gramme iron in 10 c.c. It was used for most of the observations, and extending over nine days, during which time it gradually deposited a little ochreous matter. Compared with permanganate 10 c.c. required

March 11, 17·85 c.c. permanganate.

March 19, 17·6 ,,

Hence the alteration had not been very great, considering that during these nine days the solution had been consumed in portions of 10 c.c. at a time.

Chlorate of Potash.—3·654 grammes recrystallised chlorate of potash were dissolved in water and made up to 1 litre. 10 c.c. of this solution oxidise 0·1 gramme iron from ferrous to ferric salt.

Perchlorate of Potash.—The perchlorate was obtained from the

University laboratory, and was very pure. On analysis the following results were obtained :—

| | |
|-------------------------------------|-----------------|
| Weight of salt, | 0.6208 grammes. |
| Weight of salt after heating (KCl), | 0.3330 „ |
| Difference oxygen, | 0.2878 „ |
| Chlorine in residue, | 0.1581 „ |

Whence we have the following composition per cent. :—

| | Found in Salt. | Calculated in KClO_4 . |
|----------------------|-------------------|------------------------------------|
| Potassium, | 28.18 | 28.22 |
| Chlorine, | 25.46 | 25.61 |
| Oxygen, | 46.36 | 46.17 |
| | 100.00 | 100.00 |

3.0938 grammes KClO_4 oxidise 10 grammes iron from the ferrous to the ferric state. 3.0940 grammes were dissolved in warm water and made up to a litre at 9°C .

Nitrate of Potash.—6.018 grammes KNO_3 oxidise 10 grammes iron from the ferrous to the ferric state. 6.019 grammes were dissolved in water and made up to a litre. The nitrate of potash was purified by recrystallisation.

The *sulphuric acid* used to acidify the solutions was made by diluting 1 part by weight of pure oil of vitriol with 9 parts by weight of water. It contains, therefore, very closely one gramme-molecule per litre (H_2SO_4).

Permanganate of Potash.—This solution was made by dissolving 3.163 grammes crystallised salt in water and making up to a litre. $3.162 \text{ grammes} = \frac{\text{KMnO}_4}{50} = 0.02\text{KMnO}_4$. Tested with the double sulphate of iron and ammonia, 17.9 c.c. were found to be required to oxidise 0.1 gramme iron from the ferrous to the ferric state. 3.163 grammes KMnO_4 oxidise 5.602 grammes iron from ferrous to ferric, therefore 17.9 c.c. of the above solution ought to oxidise 0.1003 gramme iron.

It is well known that the use of permanganate of potash for titrating ferrous salts in hydrochloric acid is discouraged, and indeed prohibited by the highest authorities in analytical chemistry. As a matter of fact, however, there is very little inaccuracy attending its

use in hydrochloric acid solution, which is as dilute as the sulphuric acid solution is when it is commonly titrated. But the chief want of the analyst is the power to titrate strongly acid hydrochloric solutions of iron with permanganate, and I find that this can be done without difficulty. As long as there is ferrous salt in the solution the permanganate devotes itself exclusively to it; but as soon as it is all transformed into ferric salt the permanganate at once attacks the hydrochloric acid, and the characteristic odour of enchlorine is at once perceived. If the permanganate is added with sufficient care to avoid local supersaturation, the appearance of this odour indicates with very considerable sharpness the moment when all the iron has been oxidised. It can, however, also be indicated clearly to the eye. If one or two drops of a dilute solution of pure ferricyanide of potassium be added to the ferrous solution so as to colour it blue without producing a precipitate, then on titrating with permanganate the disappearance of the ferrous salt is indicated by the simultaneous disappearance of the blue colour. This is illustrated in the following table. For each experiment 10 c.c. of ferrous sulphate solution (*a*), containing 0.0407 gramme iron, were acidified either with normal sulphuric acid ($0.5\text{H}_2\text{SO}_4$) or with fuming hydrochloric acid (12.6HCl), diluted with water so as to bring the volume to about 60 c.c., then titrated with permanganate in hydrochloric acid solution, with the addition of enough ferricyanide to colour the solution blue.

TABLE I.

| | Number of Experiment. | | | | | | |
|---|-----------------------|-----|-----|-----|------|-----|-----|
| | 1. | 2. | 3. | 4. | 5. | 6. | 7. |
| Ferrous sulphate (<i>a</i>), . . . c.c. | 10 | 10 | 10 | 10 | 10 | 10 | 10 |
| Sulphuric acid ($0.5\text{H}_2\text{SO}_4$), ,, | ... | ... | 20 | ... | ... | ... | ... |
| Hydrochloric acid (12.6HCl), ,, | 10 | 10 | ... | 25 | 25 | 25 | 25 |
| Water, ,, | 30 | 30 | 30 | 25 | 25 | 25 | 25 |
| Permanganate, . . . ,, | 7.55 | 7.5 | 7.5 | 7.6 | 7.45 | 7.7 | 7.6 |

From this table it will be seen that with 10 c.c. fuming hydrochloric acid the results are quite as good as with sulphuric acid.

With 25 c.c. hydrochloric acid the method becomes a little strained ; but it can be perfectly well carried out if care is taken to add the permanganate slowly so as to avoid a local excess, which would involve oxidation of the hydrochloric acid. This happened in experiment No. 6. In No. 5, which was also otherwise unsatisfactory, the ferrieyanide had produced a precipitate which should always be avoided.

In Table II. will be found the results of experiments on the action of chlorate of potash and of perchlorate of potash solutions on ferrous sulphate in sulphuric acid and in hydrochloric acid solution when left together for a short time.

TABLE II.

| | Number of Experiment. | | | | | | |
|---|-----------------------|------|------|------|------|------|------|
| | 8. | 9. | 10. | 11. | 12. | 13. | 14. |
| Ferrous sulphate (b), . . c.c. | 10 | 10 | 10 | 10 | 10 | 10 | 10 |
| Sulphuric acid (H_2SO_4), . . " | 20 | 20 | 20 | 20 | ... | ... | 20 |
| Hydrochloric acid ($12\text{-}6HCl$), " | ... | ... | ... | ... | 10 | 10 | ... |
| Water, " | 30 | 30 | 30 | 30 | 40 | 40 | 30 |
| Chlorate of potash solution, " | ... | ... | ... | 8.8 | ... | 8.8 | ... |
| Perchlorate of potash, . . " | ... | ... | 6.2 | ... | 6.2 | ... | ... |
| Duration of action, . . min. | ... | ... | 1.5 | 1.5 | 2 | 2 | ... |
| Temperature of mixture, . °C. | ... | ... | 17 | 17 | 16.5 | 16.5 | ... |
| Permanganate, . . . c.c. | 11.2 | 11.3 | 11.3 | 11.0 | 11.3 | 11.2 | 11.2 |

In experiments 11 and 13 the chlorate of potash solution used was not that described above, which is used for all the following experiments, but a somewhat weaker one, of which 14.2 c.c. were required to oxidise 0.1 gramme of iron. It will be seen that the only case which shows any decomposition is No. 11, where 11.0 instead of 11.2 c.c. permanganate have been used. Hence at ordinary temperatures the action of chlorate of potash in dilute acid solutions does not necessarily begin instantaneously.

In Table III. will be found the results of experiments on the oxidising effects of solutions of perchlorate, chlorate, and nitrate of potash acting on ferrous sulphate solution (c) for different lengths of time at ordinary temperatures. The mixture consisted in each case of 10 c.c. ferrous sulphate solution (c), 20 c.c. H_2SO_4 , 30 c.c. water, and 10 c.c. of one of the oxidising solutions.

TABLE III.

| Duration. | Temperature. | Cub. cents. Permanganate. | | | | Chlorate decomposed per cent. |
|-----------|--------------|---------------------------|-----------|----------|--------|-------------------------------|
| | | Perchlorate. | Chlorate. | Nitrate. | Blank. | |
| Hours. | ° C. | | | | | |
| 1 | 18 to 19 | 17.8 | 12.5 | 18.0 | 18.0 | 30.2 |
| 23½ | 14 to 19 | 17.9 | 2.25 | 17.8 | 17.8 | 87.4 |
| 51 | 9 to 16 | 17.7 | 1.2 | 17.8 | 17.8 | 98.2 |
| 168 | 9 to 18 | 17.7 | 0.3 | 17.75 | 17.75 | 98.3 |

From these results it will be seen that ferrous sulphate in sulphuric acid solution, containing 0.1 gramme iron in 60 c.c. is stable at ordinary temperatures in presence of the quantity of nitrate or perchlorate of potash necessary for the complete oxidation of the iron. In the case of chlorate the oxidation goes on at such a rate that in one hour 30.2 per cent., and in seven days 98.3 per cent. of the iron has been oxidised. In connection with these experiments it was observed that a clear solution of bleaching powder saturated in the cold, oxidises ferrous sulphate at once and completely in the cold; and that bromine water resembles chlorate of potash in requiring time, and being accelerated by a high temperature.

The observations in Table IV. were made with a view to gain a closer insight into the behaviour of chlorate of potash solution at ordinary temperatures. The mixture exposed was in all cases 10 c.c. ferrous sulphate (c), 10 c.c. chlorate solution, 20 c.c. H_2SO_4 , and 30 c.c. water. In three blank experiments without chlorate 17.6 c.c. permanganate were used.

TABLE IV.

| | | | | | | | | |
|--------------------------------|-------|-------|-------|-------|-------|-------|-------|-------|
| Temperature of solution, ° C. | 13·5 | 13·8 | 14·0 | 14·2 | 14·9 | 15·0 | 15·1 | 15·2 |
| Duration of action . min. | 16·5 | 33 | 49·5 | 66 | 99 | 132 | 165 | 198 |
| Permanganate used, . c.c. | 16·35 | 15·2 | 14·25 | 13·35 | 11·5 | 10·4 | 9·35 | 8·5 |
| Per cent. chlorate used, . . . | 7·10 | 13·64 | 19·03 | 24·15 | 34·66 | 40·91 | 46·88 | 51·70 |

It will be seen that during this series of observations the temperature rose from 13·5° C. to 15·2° C., in consequence the decomposition has gone on during the short intervals more slowly, and during the long intervals more quickly than it would have done at a mean constant temperature.

In Table V. are given the results of observations on the action of nitrate and perchlorate solutions at higher temperatures. The composition of the solutions was as before, 10 c.c. ferrous sulphate (*c*), 20 c.c. H₂SO₄, 30 c.c. water, and 10 c.c. of perchlorate or nitrate of potash. They were heated for five or six minutes to two intermediate temperatures, and also boiled for a like time. In three blank experiments made during the series 17·55, 17·50, and 17·55 c.c. permanganate were used.

TABLE V.

| Oxidising agent. | Perchlorate. | | | Nitrate. | | |
|-------------------------|---------------------|------|-------|----------|------|-------|
| | Temperature, . ° C. | 46 | 81 | boiling | 56 | 84 |
| Duration in minutes, . | 5 | 5 | 6 | 5 | 5 | 5 |
| Permanganate used, c.c. | 17·5 | 17·6 | 17·55 | 17·45 | 17·6 | 17·55 |

From these results it will be seen, and in the case of nitrate at least with surprise, that even boiling for five minutes has had no effect in bringing about a reaction between the oxidising agent and the ferrous salt. In the case of chlorate it is otherwise. In the following three experiments the chlorate was allowed to act for five minutes. In a blank experiment 17·6 c.c. permanganate were used.

TABLE VI.

| | | | |
|------------------------------|-------|------|------|
| Temperature, . . . °C. | 28 | 47 | 70 |
| Permanganate used . . . | 15·95 | 11·9 | 3·8 |
| Chlorate used, per cent. . . | 9·2 | 83·5 | 77·1 |

The effect of dilution on the rate of action will be apparent from Table VII. For each experiment 10 c.c. of ferrous sulphate (*a*) were allowed to react on 10 c.c. chlorate of potash along with 10 c.c. H_2SO_4 , and different quantities of water, which will be apparent from the figures giving the total volume of the solution. After standing exactly half an hour they were titrated with permanganate. In the last four experiments in this table the sulphuric acid used was formed by diluting 1 part of oil of vitriol with 4 parts of water (both by weight); it may therefore be written $2H_2SO_4$, as there are two gramme-molecules in the litre. Three blank experiments gave 17·6 as the permanganate equivalent to the 10 c.c. ferrous sulphate.

TABLE VII.

| | | | | | | | |
|---------------------------|-------|-------|------|------|------|-------|------|
| Temperature, . °C. | 18 | 17 | 16·7 | 12·8 | 12·7 | 12·7 | 12·8 |
| Volume of solution, c.c. | 40 | 80 | 120 | 30 | 60 | 90 | 120 |
| Permanganate used, ,, | 10·95 | 15·35 | 16·4 | 9·2 | 14·5 | 16·15 | 16·8 |
| Chlorate used, per cent., | 37·7 | 12·7 | 6·8 | 47·8 | 17·8 | 8·5 | 4·8 |

I hope shortly to be in possession of more extensive experimental data, and to discuss them in a future paper.

7. On some Space-Loci. By Professor Tait.

(Abstract.)

The class of problems treated is one to which considerable attention has been paid of late, as for instance by Glaisher and others in this country, and by Mannheim, &c., abroad.

Two years ago (Proc. 1879, p. 200), in connection with Minding's Theorem, I investigated the space-locus of the feet of perpendiculars from the origin on the rays of a complex. These were found to fill the space bounded by the two sheets of the reciprocal of a Fresnel's wave-surface. The method I employed is capable of very extended

application in the same direction, and the following general process is applicable to all the problems I have seen treated by the authors above referred to.

Let $\rho = \alpha + \alpha\beta$,
 where $T\beta = 1$,

be any ray of a complex; and let the scalar condition determining a point on it be

$$F(\rho) = 0.$$

This determines α in terms of β ; and the number of independent scalar variables is reduced by two additional data, such as a relation between α and β (i.e., $S.\alpha\beta = 0$), or a relation among the values of α (i.e., $f(x_1, x_2, \dots) = 0$), according to the nature of the complex.

We have now to make $T\alpha$ a maximum or minimum, subject to the additional condition that

$$U\alpha = \text{constant}.$$

This gives rise to three scalar equations which may be written

$$S.\dot{\beta}\beta = 0,$$

$$S.\dot{\beta}v_1 = 0,$$

$$S.\dot{\beta}v_2 = 0,$$

or, finally,

$$S.\beta v_1 v_2 = 0,$$

i.e., β is coplanar with v_1, v_2 , which are usually normals to surfaces at the points of intersection with a ray of the complex. This is one of the chief points of Mannheim's treatment of the subject. When, as is often the case, the surface on which the complex is made to depend is an ellipsoid

$$S.\rho\phi\rho = 1;$$

the last written equation usually takes the form

$$\beta + y\phi\beta + z\alpha = 0,$$

or

$$\beta = -z(y\phi + 1)^{-1}\alpha,$$

whence

$$-1 = z^2 S.\alpha(y\phi + 1)^{-2}\alpha.$$

In this equation y and z depend upon $T\alpha$, so that the space-locus is closely connected with Fresnel's wave-surface, whose equation is capable of a very remarkable series of transformations, depending on the properties of the expression

$$S.\alpha(\phi + \rho)^{-1}\alpha.$$

Monday, 4th April 1881.

PROFESSOR BALFOUR in the Chair.

The following Communications were read:—

1. On the Pressure-Errors of the "Challenger" Thermometers.

By Professor Tait.

(This paper will appear in the *Challenger Reports*.)

2. The Action of Heat on Thioformanilid.

By W. W. J. Nicol, M.A.

While at work during the past session in the Berlin Laboratory, it was suggested to me by Professor Hofmann, that I should examine the behaviour of thioformanilid

$\left(\begin{array}{c} \text{C}_6\text{H}_5 \\ \text{CSH} \\ \text{H} \end{array} \right) \text{N}$ when submitted to various degrees of heat. The thioformanilid employed was prepared by heating formanilid

$\left(\begin{array}{c} \text{C}_6\text{H}_5 \\ \text{phenylformamid} \\ \text{CHO} \\ \text{H} \end{array} \right) \text{N}$ with pentasulphide of phosphorus, the resulting mass was treated with dilute caustic soda, and the alkaline solution of thioformanilid thus obtained was mixed with excess of hydrochloric acid, when impure thioformanilid separated out; this was purified by crystallisation from hot dilute alcohol. The crystals thus prepared melted at 137°-138° C., the melting-point of pure thioformanilid being 137.5° C. (Hofmann).

Fifteen to twenty grains of thioformanilid were heated in a sealed tube to 180° C. for from six to seven hours. At the end of this time the tube was found to contain a confused mass of crystals, with a small quantity of a colourless liquid, and on opening the tube a considerable amount of sulphuretted hydrogen was evolved. The solid mass dissolved readily in alcohol, leaving no residue, but it was impossible to obtain crystals from this solution. When,

however, the hot alcoholic solution was mixed with just sufficient hot water to render it opalescent, crystals were readily formed on cooling; the greater proportion of these were scales or plates, mixed with some needles of unaltered thioformanilid. A second crystallisation gave a crop of pure crystals which were washed with 60% alcohol and dried in vacuo. Their melting-point is slightly higher than that of thioformanilid, 140° C., and, as is also the case with that body, the point of solidification is very much lower. They are nearly insoluble in hot benzol, and are practically unattacked by hot caustic soda, which first dissolves and then decomposes thioformanilid with formation of aniline, sodium formiate and sulphhydrate. An analysis of this body, dried at 90° C., gave results agreeing very closely with the numbers calculated for the body formed from two molecules of thioformanilid by the abstraction of one molecule of sulphuretted hydrogen. This would have the empiric formula, $C_{14}H_{12}SN_2$.

| | Found mean. | $C_{14}H_{12}SN_2$. |
|------------------------------|-------------|----------------------|
| Carbon, | 69·7 | 70·0 |
| Hydrogen, | 5·3 | 5·0 |
| Nitrogen, | 11·6 | 11·7 |
| Sulphur (by dif.), | 13·4 | 13·3 |
| | 100·0 | 100·0 |

The platinum salt, which, however, was non-crystalline, contained 29·9% platinum, $C_{14}H_{12}SN_2(HCl)_2PtCl_4$ contains 29·8% platinum.

The above analyses settle the composition of this body, and the equation for the decomposition is simple enough.

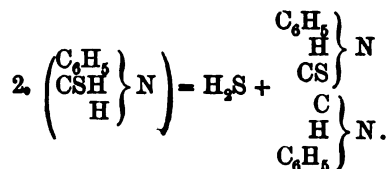

Its constitution, however, is uncertain, owing to the uncertainty with regard to the constitution of thioformanilid. This latter body may be written in either of two ways, according as it is supposed to contain the mercaptan group $(CSH)^{III}$ or the sulphaldehyde group $(CHS)^I$.

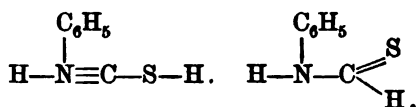

Hofmann, in his paper * describing the preparation of thioformanilid, assigns to it the former of these formulae, and this view of its constitution is borne out by its solubility in alkalies, and by its formation from isocyanide of phenyl by the addition of H_2S .†

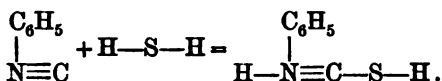

The second view of its constitution is supported by its preparation from formanilid and pentasulphide of phosphorus, formanilid being admitted to have the constitutional formula.

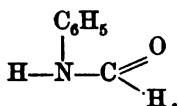

The third method for the preparation of thioformanilid, that from sulphuretted hydrogen and diphenylmethenyldiamine‡

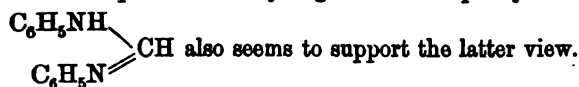

The constitutional formula of this body may therefore be written either

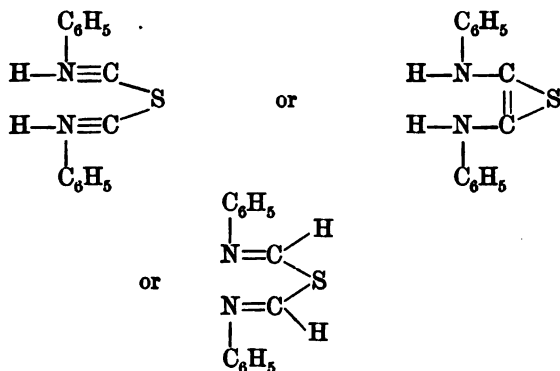

* Hofmann, "Ber. Deut. Chem. Ges.," 1878, p. 838.

† Hofmann, "Ber. Deut. Chem. Ges.," x. 1095.

‡ Berthsen, "Ber. Deut. Chem. Ges.," x. 1241.

according to the view taken of the constitution of thioformanilid, and the position of the abstracted hydrogen atoms. I hope soon to be able to throw additional light on this point by additional experiments on thiacetanilid $\left(\begin{array}{c} \text{C}_6\text{H}_5 \\ \text{CH}_3\text{CS} \\ \text{H} \end{array} \right) \text{N}$ regarding the constitution of which there is no doubt.

3. On the Classification of Statistics. Part II.

By Mr P. Geddes.

BUSINESS.

The following candidates were balloted for, and declared duly elected Fellows of the Society :—D. J. Hamilton, M.B., F.R.C.S.E. ; Dr Leonard Dobbin.

Monday, 18th April 1881.

SIR WILLIAM THOMSON, Hon. Vice-President,
in the Chair.

The following Communications were read :—

1. On Galvanic Polarisation. By Professor Helmholtz.

In 1872 I wrote a paper on galvanic currents, which continue for a long time in an electrolytic cell, under the influence of an electro-motive force, too feeble to effect electrolytic decomposition. I tried at that time to prove that the long duration of these currents was caused by oxygen dissolved in the water of the electrolyte, combining with the hydrogen, which is carried by the electrolytic motion to the cathode. So the oxygen, which existed formerly near the surface of the cathode, is taken away, and instead of it the same amount of oxygen is liberated at the anode. This can return by diffusion to the cathode, and so the same action can go on without end. It appears as a current producing no electrolytic action. I called it "Electrolytic convection."

My experiments, published at that time, were performed with

an electrolytic cell, from which the air was removed by a mercury air-pump ; but I did not succeed in getting it absolutely free of air, because the lubricating grease of the stopcocks allowed some air to get in during the long time through which it was necessary to continue the experiments.

Lately I have had better results with a cell hermetically sealed, containing acidulated water and a vacuum, filled of course with vapour of water. Three electrodes enter the cell ; two of them platinum wires, the third a thin platinum wire, to which a spiral of palladium is fixed. Before closing the glass tube through which I had introduced the liquid, I removed the atmospheric air left in the cell by means of a water air-pump, and sent an electric current through the cell, so that oxygen was evolved at the two platinum wires, and all the hydrogen was occluded in the palladium. Then I closed the tube with the blow-pipe. The traces of oxygen remaining in the interior of the cell combined again slowly with the hydrogen of the palladium, and even if I evolved new quantities of electrolytic gases in the interior of the closed cell, they could be removed again by the electro-motive force of a Daniell's cell, driving the oxygen to the platinum wires and the hydrogen to the palladium. On the contrary, I may charge the two platinum wires with hydrogen, if I connect them for a short time with the palladium wire.

If the platinum wires be freed from all hydrogen, a feeble electro-motive force, of about 0.01 to 0.001 Daniell, gives only a very short deflection ; then the galvanometer returns to zero. Removing the electro-motive force without breaking the circuit, I saw an opposite deflection, equal in magnitude to the former and of the same duration. I have measured the capacity of the two platinum surfaces considered as condensers. They behaved like two condensers, the two electric strata of which were separated by an interval of a ten millionth part of a millimeter. This is a capacity smaller than that found by *Kohlrausch* ($\frac{1}{18.000.000}$ mm. distance) and other observers. But I found that the capacity appeared to be much greater, if only a small quantity of hydrogen were carried by an electric current to the platinum. The same was the case if the wires were newly polarized with oxygen, but this latter modification vanished some hours after the battery had been taken away. In

these latter cases a part of the current produced by the external electro-motive force must be considered as caused by electrolytic convection, and this part vanishes very slowly and never completely.

The quantity of electricity which was carried to the platinum electrodes when they were free of hydrogen, was exactly proportional to the electro-motive force applied to the cell, down to forces of $\frac{1}{1000}$ Daniell. From this is to be inferred that no kind of chemical or molecular force exists in the interior of the electrolytic fluid, which is able to prevent the ions of the electrolyte from moving about in the interior of the fluid, till they have got the distribution required for the equilibrium of the electric forces. For if such a force existed, we ought to find an inferior limit to the electro-motive forces, which are able to charge the electrodes like a condenser.

2. On the Average Pressure due to Impulse of Vortex Rings on a Solid. By Sir William Thomson.

3. On the Crushing of Glass by Pressure.
By Professor Tait.

In the course of my examination of the "Challenger" thermometers, I was once surprised by a sudden bell-like vibration of the massive iron cylinder (nine inches thick) in which the apparatus to be tested was enclosed. This was due to the giving way of the protecting-sheath of one of the thermometers, at a pressure of a little over four tons weight on the square inch. When the pressure was let off, the bulb of the thermometer was found to have been crushed to an almost impalpable powder. I then determined to make a set of experiments with the view of finding under what amount of distortion glass gives way. For this purpose I employed the smaller compression apparatus which I have already described to the Society. Its capacity is about ten cubic inches only, so that a couple of strokes of the pump produce a pressure of three to four tons weight.

I procured a number of pieces of glass tubing, with very varied ratios of external and internal diameter. These were all drawn from the same melting in the Leith Glass-works, and consisted of ordinary lead-glass.

By means of a small telescope, with a micrometer scale in the eye end, the ratio of the internal and external radii was measured for each end of each tube. The tube was then cut into five, seven, or nine lengths, and these were numbered (in order) by marked slips of paper inserted into them. They were then carefully and strongly sealed at each end, a small quantity of shot being put into each to make them sink in water.

By means of the external gauge I have already described to the Society, the pressure at which Nos. 1, 3, 5, &c., gave way was measured, and it was found that when the tube from which they were cut was stronger at one end than at the other, the breaking pressures for the separate pieces were in the proper *order* of magnitude. The results were, as was to be expected, not very accordant; but, as a fair average result, the common lead glass gives way when subjected to a shear of about $1 \pm \frac{1}{230}$

(combined with a compression of about $\frac{1}{600}$ in every direction).

Hence a very thick tube of such glass will not resist more than about 14 tons weight on the square inch of external pressure.

The formulæ from which this was calculated are given in my paper of May 17, 1880 (Proc., vol. x. p. 572). They give, for a pressure of one ton weight per square inch, the following for the innermost layer of a cylindrical tube of external and internal radii a_1 and a_0 :—

$$\text{Radial compression} = \frac{a_1^2}{a_1^2 - a_0^2} \left(\frac{1}{8100} - \frac{1}{3200} \right),$$

$$\text{Tangential} = \frac{a_1^2}{a_1^2 - a_0^2} \left(\frac{1}{8100} + \frac{1}{3200} \right),$$

$$\text{Longitudinal} = \frac{a_1^2}{a_1^2 - a_0^2} \frac{1}{8100}.$$

The first terms of these expressions indicate a uniform compression, the other terms the crushing shear. [It is curious to note that this compression is *less* (for the same pressure) in a solid rod ($a_0 = 0$) where there is no shear, than in a tube.]

The walls of these tubes, when they gave way, were crushed into fine powder, which gave a milky appearance to the water in the compression apparatus. But the fragments of the ends were larger,

and gave much annoyance by preventing the valves of the apparatus from closing. To remedy this inconvenience I enclosed the glass tube in a tube of stout brass, closed at the bottom only, but was surprised to find that it was crushed almost flat on the first trial. This was evidently due to the fact that water is compressible, and therefore the relaxation of pressure (produced by the breaking of the glass tube) takes time to travel from the inside to the outside of the brass tube; so that for about $\frac{1}{10000}$ th of a second that tube was exposed to a pressure of four or five tons weight per square inch on its outer surface, and no pressure on the inner. The impulsive pressure on the bottom of the tube projected it upwards, so that it stuck in the tallow which fills the hollow of the steel-plug. Even a piece of gun-barrel, which I substituted for the brass tube, was cracked, and an iron disc, tightly screwed into the bottom of it to close it, was blown in. I have since used a portion of a thicker gun-barrel, and have had the end welded in. But I feel sure that an impulsive pressure of ten or twelve tons weight would seriously damage even this. These remarks seem to be of some interest on several grounds, for they not only explain the crushing of the open copper cases of those of the "Challenger" thermometers which gave way at the bottom of the sea, but they also give a hint explanatory of the very remarkable effects of dynamite and other explosives when fired in the open air. [It is easy to see that, *ceteris paribus*, the effects of this impulsive pressure will be greater in a large apparatus than in a small one.]

4. On the Cause of the Sounds produced in the Microphone Receiver. By Professor James Blyth.

In the microphone, or loose contact receiver, we have two or more small blocks of carbon resting lightly against each other, through which the interrupted current from the transmitter is passed. At the points of contact, a strong heating and cooling effect must take place every time the current is interrupted or otherwise varied. This heating and cooling will cause corresponding expansions and contractions of the air or other medium surrounding the points. These produce undulations in the medium, which, striking against the sides of the containing vessel, set them

also into a state of vibration, and so reproduce the sounds of the transmitter. To test the truth of this explanation, I have made the following experiments :—

A cylindrical tin box, about four inches in diameter and two inches deep, with a tight-fitting lid, was provided. In the sides of the box three openings for corks were made—two being at the opposite ends of a diameter, and the third in a line at right angles to this diameter. Through the corks in the two opposite openings stout copper wires were passed, connected inside by a spiral of fine iron, or platinum wire. By this means the spiral was completely enclosed in the box, and the interrupted current from the transmitter could be easily sent through it. Through the third opening the box could be filled with water, or with any gas or vapour on which it was desirable to make experiments. The transmitter employed was either a tuning-fork interruptor, which vibrated 256 times per second, or the violin-microphone, and the battery power employed varied from ten to fifteen Groves's cells. When the interrupted current from the fork was sent through the spiral of fine wire, it was seen, on looking through the upper opening, to glow with a beautifully varied glow, and on applying the ear to the end of the box, the sound of the fork was most distinctly heard. The box was then completely filled with water, and still the sound was heard almost as distinctly as before, accompanied, however, with a hissing noise. The electrodes carrying the spiral of fine wire were next removed, and replaced by two gutta-percha covered copper wires, so fixed as to leave a distance, inside the box, of about half an inch between their uncovered ends. The box was then completely filled with mercury, and the interrupted current sent through it. The current was thus made suddenly to heat and cool the line of mercury lying between the exposed ends of the electrodes, and this heating and cooling was distinctly recognised by the sounds heard when the ear was applied to the end of the box. The sounds, however, were not musical, although the tuning-fork was used, but consisted merely of dull thuds, arising, as it seemed from slow waves set up in the mass of the mercury.

It struck me that, in this experiment, the action might be due partly to the repulsion between the end of the wire and the mercury produced by the self-induction of the current. To test this, I had a telephone

constructed so as to isolate this effect, and, if possible, bring it only into view. It consists of a short vertical wooden tube, containing a column of mercury,—the bore being about half an inch in diameter. On the top of the tube, which terminates in a circular enlargement, an ordinary ferrotype plate is placed, which has a copper wire soldered to its centre, dipping vertically downwards for a short distance into the mercury in the tube. The current is led upwards through the mercury column to the copper wire, and thence to the ferrotype plate, which is in metallic connection with one of the poles of the battery. By this arrangement any action from self-induction which takes place will be of the nature of a thrust vertically upwards upon the copper wire, and through it upon the ferrotype plate, which will, in consequence, be made to vibrate in sympathy with the interruptions of the current in the circuit. When the tuning-fork was used, I was able to hear the sounds from it faintly, but still distinctly enough to leave no doubt of the effect.

I next determined to try the effect of exhausting the air from the space surrounding the glowing spiral of fine wire. For this purpose I employed the apparatus known as the *electric egg*. A spiral of fine platinum wire was placed vertically between the two terminals, and I first made sure of hearing the sound of the fork by applying my ear to the outside of the egg. The air was then gradually exhausted, and the sound decreased perceptibly till it became almost inaudible. To get the effect of a more perfect exhaustion, I next employed one of Mr Swan's electric lamps. When the interrupted current from the fork was sent through the lamp, no trace of sound could be heard by applying the ear to the side of it, although the variation of the glow in the carbon fibre from dull red to a very bright red, approaching to white, was most beautifully seen to be produced by the variation of the current. This at once shows that the presence of air or some other medium is necessary, in order that its expansion and contraction, produced by the heating and cooling of the wire, may affect the sides of the vessel, and so give out the sounds.

Monday, 2d May 1881.

PROFESSOR MACLAGAN, Vice-President, in the Chair.

The following Communications were read :—

1. On the Classification of Statistics. Part III.—Results.
By Mr Geddes.
2. On the Motion of a Storm in an Easterly Direction
being only possible as a Circular Atmospheric Wave.
By Robert Tennent.

It is here intended to show how a storm with a diameter of several hundred miles, and with a comparatively low vertical height, can move and only in contact with the resisting surface of the ground, but not on a frictionless surface. Exceptional cases are all here received owing to the complexity of the subject, and also to the comparatively few conclusions which have been arrived at in the millions of observations which have taken place. Let this storm be supposed to be inaugurated in the United States, and be described as being a vast mass of rarefied air enclosed within its surrounding isobarica. In this form, as is well known, it does not cross the Atlantic and to the British Isles; it only alters its position in the form of a circular-atmospheric wave, and by the "Curve of Outward Propagation" in front, described in the paper of 1877-78, page 574, and which is accepted by a well-known continental meteorologist. As shown by the Rev. W. Clement Ley, cirrus clouds aloft move in front and from low to high pressure. This also takes place with the Curve, which, by the alteration of the position of the atmosphere aloft, may thus probably produce these clouds. Opening out of a storm in this way in front, of course fills up in the rear. To enable this to take place, it is of course accompanied by a spiral inflow to its low centre, and with the important and necessary motive force of the central ascending current, on a resisting but not on a frictionless surface, as exhibited in the diagram of the ascending balloon. Spiral inflow differs in its direction, and also with its source of supply in the different segments; how can a depression then remain stationary? It is shown to move in

the direction of the less copious source of supply of the lowest gradients, and of the widest isobars, accompanied of course by high pressure and by steep gradients on the south segment, which there necessarily aids the velocity of the west winds, and in the direction of progress. Owing to the complexity and difficulty of the mode in which spiral inflow takes place, and also of the direction in which it is altered in the different segments, absolutely dependable observations are not to be found. For facility of explanation, it is here taken up in two points of view. First, in the mode of direct inflow which only occasionally takes place; and, secondly, also in the very important mode in which it circulates round the low centre, but which, as exhibited on the surface, takes place in a very different manner on the different segments. It is only by circulation that the structural form of an aerial cavity can possibly be maintained. This circulation, which is in a direction against that of the hands of a watch, is for facility here supposed to take place at the same rate of speed as that of progress, and in an easterly direction. On the north segment, east winds, which here circulate round the low centre and in a direction opposite to that of progress, are necessarily calmed, though only with reference to the surface. On the south segment, where west winds both circulate and blow in the direction of progress and with a consequent amount of velocity, they must necessarily there be accompanied by high pressure, while east winds only require low pressure, and which must also be found in front. The velocity of east and west winds are here supposed to circulate at the same rate of speed round the low centre; with reference to the usual surface observations, they are not here comparable. East winds may thus be regarded as being those of space. It is owing to this, as shown, that there is to be found the remarkable difference in the alteration of the position of the north and south segments in the form of a circular atmospheric wave. This is fully illustrated in the diagrams of the paper, and is here shown how the calm north segment of east winds can only alter its position, and by so doing exhibit the necessary progressive movement.

In a letter received from Ballot, he mentions his great difficulty in ascertaining the comparative velocity of east winds with reference to their gradients as compared with those of other winds. As above described, how can the effect of the gradients of the different

winds not differ with each other? Moreover, as shown in a former paper, the barometer does not always and actually represent the real weight of the atmosphere aloft; how can it not also do so in a rapidly ascending and in a descending current? Under such circumstances the isobars and the gradients cannot be absolutely correct, especially in those which are found at some distance from the low centre. To ascertain the correctness of the barometer much importance must be attached to it, which is accepted by well-known men, and is also opposed by others. It ought therefore to be fully discussed, and suitable observations to be received.

3. On Chemical Nomenclature and Notation. By Professor
Crum Brown.

Monday, 16th May 1881.

PROFESSOR FLEEMING JENKIN, Vice-President,
in the Chair.

The following Communications were read:—

1. Note on a *Phoronis* dredged in H.M.S. 'Challenger,'
By W. C. McIntosh.

[Published by permission of the Lords Commissioners of the Treasury.]

This form, which in many respects is a most interesting intermediate type, was dredged at Station 212, south of the Philippine Islands, on the 30th January 1875, in lat. 6° 55' N., long. 122° 51' E., at a depth of 10-20 fathoms, on a sandy bottom. The total length is about 52 mm., with a variable diameter of about 2 mm. at the blackish anterior region, and 4 or 5 mm. at the posterior. The tentacular or branchial region has a length of 6 or 7 mm.

The body is elongate, smoothly rounded to the naked eye, and generally thrown into several constrictions and enlargements as in *Phascolosoma*, or in certain examples of *Cerianthus* and *Edwardia*, the bulbous posterior end (devoid of all transverse wrinkles) of many making the resemblance to the latter all the more striking. On the other hand, the double branchial fan and general appearance approach the contour of the Eriographididæ and Sabellidæ amongst the Annelids. The anterior third of the body, which is tinted of a blackish hue with a slight metallic lustre fading posteriorly, is most

minutely marked by fine transverse lines, as in the massive muscular proboscis of *Lepidonotus* and *Aphrodita*. These circular striæ are much finer in front, and gradually widen towards the posterior part of the coloured or anterior region, which in almost all the specimens is firmly contracted—from the peculiar structure of the body-wall. The dorsal is distinguished from the ventral surface by a longitudinal furrow (on each side of the median line), which cuts off a ridge or segment overlying the rectum. In many, the body gradually dilates toward the end of the anterior region, and an enlarged pale “bladdery” part often occurs—marked by a close series of longitudinal bands—crossed externally by fine transverse striæ, so that the region has a tessellated appearance. Such an aspect, of course, diverges very much from the eight longitudinal bands in *Edwardia* and *Cerianthus*, though, as will afterwards be noticed, there is a certain structural resemblance between the muscles of the diverse groups. Even in the somewhat narrower region of the *Phoronis*, behind the latter part, traces of these longitudinal bands (the muscular fasciculi) are visible. Finally, the body ends in a more or less clavate or bulbous region, which is generally devoid of such markings.

The contracted anterior region of the body, after the muscles are fully formed, presents externally in transverse sections the chitinous cuticula, then the hypoderm, which even in fine sections is almost opaque from the deposit of blackish pigment. Beneath is a translucent and probably elastic basement-tissue of considerable thickness. The circular muscular coat, which immediately follows, is not much developed at the commencement of the region, the radiating series of fibres which pass from the body-wall between the pennate portions of the next coat and the œsophagus, apparently performing the chief functions necessary. The next or longitudinal coat is regularly arranged in bands, which in transverse section present a most regularly pennate appearance—a pair of dense fasciculi, with a somewhat fan-shaped series of striæ, occurring at the base (externally), within which the arborescent or complexly pennate fibres project. It is interesting to notice a kind of gradation between the lax pennate arrangement of the longitudinal muscular bands in *Peachia*, the coarse pennate system in *Phoronis*, and the more finished pennate plan of the muscles in the Erioglyphididæ.

Towards the posterior part of the foregoing region, the circular muscular coat becomes much thicker, while the radiating fibres diminish, and become of secondary importance in the greatly enlarged visceral area. In the succeeding part of the body, indeed, the muscular layers diminish in proportionate bulk, and as we approach the posterior end the pennate arrangement of the longitudinal fibres disappears, and the latter form a comparatively thin layer under the basement tissue—the circular coat being internal. The termination of the body is thus ensheathed by uniform layers of longitudinal and circular fibres.

The tentacles or branchiæ arise from the slightly-enlarged cephalic end by a somewhat firm basal web, which is entire ventrally, but is widely split dorsally, so as to present the aspect of a double fan, as in the Sabellidæ. Indeed, viewed from this surface, each fan or volution is supported on its own basis, which, moreover, is oblique—elevated in the centre, and sloping downward and outward externally. The basal web remains entire for about a third of the total length of the tentacular arrangement, and then breaks up into a multitude of simple, slightly-tapering filaments, which are pale throughout the greater part of their extent, but tinted of a dark brownish hue towards the tip. Externally, the surface of each is densely coated with cilia, which are somewhat longer toward the tip of the process. As ordinarily seen in the preparations, the branchial fan performs about three volutions. The skeletal elements of the apparatus commence on the sides of the anterior region of the body, as a series of simple longitudinal chitinous processes or rods—the dorsal and ventral regions at first being devoid of them. They lie just within the thick basement-membrane under the hypoderm. Proceeding distally (anteriorly) the chitinous skeleton becomes much more complex, from the fact that it develops tubes for the transmission of the circulatory fluid, extends round the whole circumference of the body except a limited region at the dorsal hiatus, and moreover splits into two or more rows. In the formation of the circulatory channels, the chitinous longitudinal processes would first seem to form a thin arch with two dilated pillars, and then a complete ring with much thinner walls. Before complete separation of the basal folds of the web occurs, the sections show a double row of these channels,

one being on the outer edge of the volution and the other on the inner—a chitinous basement-layer separating the former row and its spongy vascular tissue from the latter. A line intersecting the coils would thus (before separation occurs) pass through four complete series of these channels, and in certain positions (involving the central volution) through six. At the base the inner row at the tip of the central coil is incomplete, but by and by the vessels form a continuous series round the edge. The structure of one of these double basal rows is as follows:—Externally is the cuticular layer, which, however, in the preparations does not seem to be well differentiated, since it forms only a definite boundary to the hypoderm. This feature is probably related to the branchial functions of the region. Within is a layer of hypoderm, which varies in thickness and colour according to the level of the section. Its structure agrees with the hypoderm of the body-wall, and accords with the same tissue in the Annelids and Nemertean. Directly under it are the chitinous arches of the outer row of channels, which are incomplete internally, each debouching into a large vascular channel, which with connective tissue fills up the space between the outer row and the line of basement-tissue separating the two series. In transverse section the chitinous tissue shows the thickened sides formerly alluded to, and is often finely streaked, but the latter is probably only an optical peculiarity. Within the line of basement-tissue are the inner series of channels, which have complete walls (and the outer row would thus seem to be less developed at a given level inferiorly than the inner); and in transverse section present a noteworthy uniformity in appearance, viz., with a dumb-bell-shaped outline of the inner wall from the thickening of the median region or each side, while the lines of the outer wall laterally are nearly parallel. The outer and inner arches of the vessel are thinner. Only a slight quantity of connective tissue separates each chitinous channel from the septum (line of basement-tissue), while the other arch has a thick coat of hypoderm, which soon (as we proceed distally) becomes grouped in a series of fan-shaped masses. The inner surface of the chitinous channels is furnished with an epithelial lining; and since in section the arch next the septum generally has a rounded opaque mass of the circulating fluid, surmounted in many by a granular band as if from

a fine wall, it is possible such represents the vessel (or at least a division or septum) with its contents. Proceeding distally, both sets of vessels (in the double rows) become complete, and the hypoderm covers both the outer and inner edges of each—the somewhat spongy vascular tissue having disappeared. Then each row becomes more individualized—having a thin layer of hypoderm on the inner or concave edge, and a prominent pennate mass (in section), several times thicker, on the outer. The rings are bound together only by a little connective tissue in the middle, and they soon become free,—the outer layer of hypoderm still remaining thicker, while that on the sides (where the densest portion of the chitinous ring exists) is less developed. When viewed longitudinally, this peculiar chitinous wall has a series of very bold and rather regular transverse folds or wrinkles; and an included vessel and its contents are apparent toward the tip.

The mouth opens at the bottom of the ventral (and outer) whorl of the branchial apparatus (which, as formerly mentioned, presents a continuous fold in this region)—the arrangement resembling a spacious funnel. The first part of the alimentary canal has its wall folded transversely in zig-zags, the next and longest region is mostly devoid of them, but they again become very well marked in front of the dilatation generally found at the posterior end of the body. The canal then turns forward along the dorsal aspect to terminate in the anus, on the ridge between the two dorsal branchial fans. The canal is fixed at its commencement by various fibres which pass from the lower curve to the ventral wall of the body, and by a strong band (with an elastic central portion) at each side to the lateral region of the body. The structure of the glandular lining of the canal agrees with that in the Annelids and their allies. Proceeding backward the œsophagus becomes fixed by the radiating muscular fibres passing from the body-wall between the pennate muscles throughout the greater part of the circumference. Dorsally, however, two strong oblique bands cut off a limited area for the rectum, and sling the former region by their attachment to its dorsal wall. These radiating bands would seem to perform an important function both in regard to the calibre of the alimentary canal, the vessels, and the body-wall. The canal retains similar connections throughout the anterior region, though it is more central in position as the body

becomes constricted. In the less rigid region which succeeds, its wall is thinner, its cavity larger, and its connection with the body more lax. Its structure, however, remains the same. Food seldom occurs in the first region of the alimentary canal, but in the dilated posterior part and after it turns round to proceed forward to the anterior end, the granular contents abound with Foraminifera, Radiolarians, diatoms, sponge spicules, and other organic debris. For the most part the intestine is kept *in situ* on the dorsal aspect of the first region of the canal by the oblique fibres passing from the dorsal wall of the body to the upper arch of the digestive tube, and which form, in the contracted region anteriorly, the special chamber formerly alluded to. The terminal portion is generally much contracted—except just at the anus.

The chief point observable in regard to the circulatory organs in the preparations is the presence of the great dorsal trunk, which extends almost, but not quite, from the posterior to the anterior end of the body along the dorsal arch of the first region of the alimentary canal. It gradually increases in size anteriorly, and in the first or contracted division of the body frequently presents a distinct septum, so that there would appear to be two channels, as in *Magelona*. A great lateral sinus occurs on each side, within the body-wall, at the termination of the dorsal trunk, but the exact mode of communication with the branchial vessels has not been observed. On each side of the main (or first) division of the alimentary canal is a considerable lateral trunk, and many large branches occur in the spaces between the body-wall and the former, being especially conspicuous in the interstices of the radiating fibres in the anterior region, and at the tip of the tail,—after the great dorsal and lateral trunks disappear. Many small vessels are apparent beneath the primary division of the alimentary canal, but no large trunk occurs in that position. None of the vessels are so small as to merit the name of capillaries, and all are loaded with large circular granular cells.

The generative apertures occur on each side of the anus, on a lateral elevation which appears just beyond the chitinous elements of the branchial apparatus. These apertures pass into a capacious chamber. The ova are developed in the posterior region of the body in racemose masses above the chief division of the

alimentary canal. They occupy one side, while on the other is a bulky granular structure, which probably represents the male element. The ova occur in great numbers amongst the tentacles.

No observation of note was made on the nervous system.

The species forms a somewhat tough hyaline tube (evidently a secretion of the hypoderm) for itself in the sand, as in other forms having a similar habitat. In this coating sand-grains often occur, but they do not form a regular layer. Even the most translucent portions of the tube show many minute sponge spicules, diatoms, and fragments of silex.

This form of *Phoronis* deviates considerably from those previously described and from the ordinary Gephyreans. If, indeed, the branchial skeleton supporting the vessels were thrown in, and arranged at the side of the anterior region of the body, so that the water would enter by lateral slits, to aerate the circulating fluid, and the digestive canal enlarged and attached as a single tube to the body-wall, a form resembling *Balanoglossus* would be indicated. In both, as they exist, the food passes along the branchial apparatus before reaching the alimentary canal. The branchial arrangement and the flexure of the intestine also show certain analogies with the condition in the Polyzoa.

2. Additional Researches on the Structure of the *Palaeoniscidæ* and *Platysomidæ*. By Dr R. H. Traquair.

3. Note on the Heating produced by Compression. By Professor Tait.

By the help of an iron-copper junction introduced into the smaller compression apparatus lately described to the Society, I have examined for a number of substances the rise of temperature produced by a sudden application of great pressure, and the corresponding fall of temperature when the pressure was very suddenly relaxed. The copper-iron circuit is, however, too little sensitive for very accurate measurements; as, from the nature of the apparatus, the wires must be so thin as to have considerable resistance, and the thermoelectric power of the combination is not large. I hope soon to have wires of cobalt, which (associated with iron) will give

much larger indications on the galvanometer—so that I content myself for the present with a general statement of the results for cork and for vulcanized india-rubber, which are apparently typical of two classes of solids quite distinct from one another in their behaviour.

In the case of india-rubber the rise of temperature was found to be about $1^{\circ}3$ F. for each ton-weight of pressure per square inch, up to four tons at least; and the fall in relaxation was almost exactly the same.

With cork each additional ton of pressure gave less rise of temperature than the preceding ton; and the fall on relaxation of pressure was, for one or two tons, only about half the rise. For higher pressures its ratio to the rise became greater. Two tons gave a rise of about $1^{\circ}6$ F., and a fall of $0^{\circ}9$ F.

With the same arrangement, the fall of temperature in water suddenly released from pressure at a temperature of 60° F. was found to be for

| | | | |
|--------------------------------|---|---|------------------|
| One ton-weight per square inch | | | $0^{\circ}25$ F. |
| Two | ” | ” | $0^{\circ}56$ |
| Three | ” | ” | $0^{\circ}93$ |
| four | ” | ” | $1^{\circ}35$ |

These numbers give the averages of groups of fairly accordant results. I employed cooling exclusively in these experiments, because one of the valves of my pump was out of order, and the pressure could not be raised at a uniform rate. The effects obtained for successive tons of pressure are thus, roughly— $0^{\circ}25$, $0^{\circ}31$, $0^{\circ}37$, and $0^{\circ}42$ F.

If these results may be trusted, they probably indicate a lowering of the maximum density point of water by pressure. But they must be received with caution, because the galvanometer readings were all very small; and specially because the heating effect for one ton at 60° F. should be (by Thomson's formula) $0^{\circ}32$ F., instead of $0^{\circ}25$ F. as observed. Thomson's formula agrees very closely with the result for four tons pressure, so that it is possible that the cooling found for the lower pressures is subject to some error in defect.

I hope to settle this question, with more sensitive apparatus,

during next winter by operating on water at about 39° F. In this case there should be no change of temperature unless the maximum density point is altered by pressure.

Monday, 6th June 1881.

PROFESSOR SIR WYVILLE THOMSON, Vice-President,
in the Chair.

The following Communications were read :—

1. On the Structure of the Skeleton of *Tubipora musica*, and on the Relation of the Genus *Tubipora* to *Syringopora*.
By H. Alleyne Nicholson, M.D., D.Sc.

The object of the present communication is to briefly consider the general and minute structure of the corallum of the recent *Tubipora musica*, with special reference to the association of the genus *Tubipora* with the extinct genus *Syringopora*, as advocated by many modern naturalists. The method of inquiry that I have pursued in carrying out this investigation has been principally that of preparing similar thin and transparent sections of both the recent and the extinct types; and though there are special difficulties in the way of any examination of *Tubipora* by this method, I have been able to overcome these in a satisfactory manner, and to prepare a number of thin sections which answer all the requirements of the case. The results of my observations may be conveniently considered under the following heads :—

1. General structure of the corallum of *Tubipora*.
2. Minute structure of the corallum of *Tubipora*.
3. General structure of the corallum of *Syringopora*.
4. Minute structure of the corallum of *Syringopora*.
5. Supposed relationships between *Tubipora* and *Syringopora*.

1. *General structure of the corallum of Tubipora.*—The corallum of *Tubipora musica*, Linn., is one so familiar to naturalists that the peculiarities of its external form hardly need to be noticed. It consists of a number of fasciculate cylindrical tubes or thecæ, which are separated by small intervals from one another, and are upon the

whole parallel in their course, though they diverge to a greater or less extent as we pass from the fixed base to the surface of the colony. The entire corallum is of a bright red colour, the inner surfaces of the tubes being, however, usually lighter in colour than the outer surface. The cylindrical thecæ are bound together by horizontal calcareous floors (the so-called "external tabulæ") which are placed at varying distances apart in different specimens, but which are often disposed with considerable regularity, so as to form a series of concentric laminæ parallel with the upper surface of the colony. These horizontal floors unite the *outer* surfaces of the corallites; and, as pointed out by Professor Perceval Wright ("Ann. Nat. Hist.," ser. 4, vol. iii. p. 381), they are really produced by the coalescence of periodically-produced horizontal offshoots or extensions from the upper extremity of the tubes. Each offshoot consists of "a fold of the ectoderm, into which some of the endodermic layer is tucked," and by the calcification of the ectodermal layer the connecting-floors are produced. From the upper surfaces of the connecting-floors new corallites are budded forth, the upward expansion of the colony being due to the interpolation in this way of new tubes, as can be readily observed in the dead corallum. Horizontal sections through the connecting-floors show them to be traversed by a system of comparatively large-sized, branching, horizontal canals, which open at their extremities directly into the cavities of the polypes (fig. 1, B). Hence, if we open one of the thecæ at what we may call one of its "nodes"—that is to say, at a point where it is embraced by one of the connecting-floors, we find a ring of rounded apertures corresponding with the openings of the canals just spoken of (fig. 1, A). If, also, we examine the broken or cut edge of one of the connecting-floors, we observe the round and comparatively large orifices of the same canals as they traverse the interior of the floor. By means of this system of canals, the visceral chambers of the polypes composing a colony are placed in direct communication.

Though the connecting-floors of the colony are often spoken of as "external tabulæ," they have in reality nothing in common with the transverse plates or true "tabulæ" which intersect the visceral chambers of the corallites in such forms as *Favosites*. The only structures in *Tubipora* which can be even remotely compared with

the proper tabulæ of *Favosites* or of *Syringopora* are to be found in a peculiar axial calcareous tube which may often be found in the centre of the visceral chambers of the corallites. When present, this tube (fig. 1, c) is never continuously developed throughout the entire length of the thecæ, but becomes dilated at every node (*i.e.*, at the levels corresponding with the external connecting-floors) into

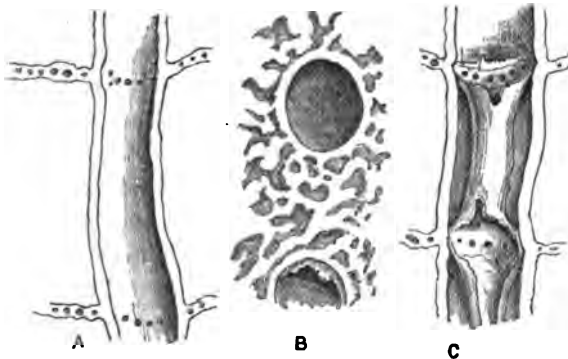

Fig. 1.—A, Part of a tube of *Tubipora musica*, Linn., divided longitudinally, showing the openings of the canal-system of the connecting-floors into the visceral chamber of the polype. B, Part of a horizontal section taken at the level of one of the connecting-floors, showing the canal-system of the connecting-floor. C, Part of a corallite of *Tubipora* divided longitudinally, showing the axial tube; in the lower portion of the figure the axial tube is laid open. All the figures are enlarged five times.

a funnel-shaped expansion, which fuses with the wall of the visceral chamber. The axial tube itself, so far as I have seen, is always open along its entire length, and is not crossed by any internal partitions; nor have I ever observed it to be in any way connected with the inner wall of the visceral chamber, except in the manner above indicated at the nodal points of the theca.

The above-mentioned axial tube seems in some specimens not to be developed in any of the corallites; at other times it is developed in many of the corallites of a colony, but not in others. Its existence was first pointed out by Mr Charles Stewart, F.L.S., in a paper which I unfortunately have not seen, by whom it was compared with the infundibuliform tabulæ and axial tube of *Syringopora*, a view which has been since adopted by Mr Moseley ("Voyage of H.M.S. Challenger," vol. ii. p. 125). I shall, however, subsequently give

the reasons which lead me to believe that there is in reality insufficient ground for this comparison, and that the structures in question are morphologically different.

Finally, no traces of *septa*, either in the form of radiating lamellæ, or of vertically disposed spinules, or even as those plications of the wall which constitute the "pseudosepta" of *Heliopora*, have been detected in *Tubipora*.

2. *Minute structure of the skeleton of Tubipora.*—The microscopic structure of the corallum of *Tubipora* was first investigated by Kölliker ("Die Bindesubstanz der Coelenteraten," p. 169, 1866), and very correctly described and figured. Professor Perceval Wright subsequently showed ("Ann. Nat. Hist.," ser. 4, vol. iii. p. 377), that the corallum is really formed of fusiform calcareous spicula, secreted by the ectoderm. Over the greater part of the theca these spicules become completely amalgamated with one another, so as to form a rigid case; but they remain loosely united or separate at the growing summits of the tubes, which are thus capable of withdrawal, during the retraction of the polypes, into the dense portion of the thecæ.

As the result of my own recent observations, carried on principally by means of thin transparent sections, I find that the entire calcareous skeleton of *Tubipora*, as pointed out by Kölliker, is permeated throughout by a system of minute, parallel, closely approximated tubules or canaliculi, which sometimes bifurcate, and occasionally anastomose. In the walls of the corallites themselves these tubuli (fig. 2 A), run at right angles to the inner and outer surfaces of the thecæ, opening both externally and internally by well-defined, rounded, and slightly dilated apertures (fig. 2, B), which can be readily observed by the examination of any fragment of the skeleton by means of a hand-lens or with a low power of the microscope. In the connecting-floors of the corallum, these tubuli are just as numerous and as well-developed as in the walls of the corallites, but here they run at right angles to the floor, either passing right through from the upper to the lower surface, or, more usually, opening internally into the large ramified canals which run in substance of the connecting-floors, and connect the visceral chambers of adjoining polypes. It follows from the above that the skeleton of *Tubipora* is in reality completely porous, the canaliculi by which it

is penetrated, though minute, being quite large enough to be at once recognised by the use of a lens. The precise appearances presented by these canaliculi in thin slices, vary according to the direction in which the section has been taken. Thus, in sections taken transversely to the corallites (fig. 2, A), the tubuli are cut in

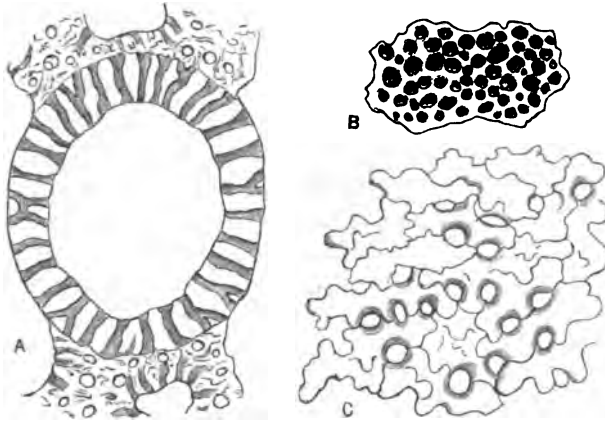

Fig. 2.—A, Transverse section of a corallite of *Tubipora musica*, Linn., taken at the level of one of the connecting-floors, enlarged twenty times, showing the tubuli of the wall. B, Portion of the surface of one of the connecting-floors, enlarged twenty times, showing the external openings of the tubuli of the skeleton. C, Fragment of the corallum of *Tubipora*, enlarged sixty times, showing the composition of the skeleton out of spicules. The figure is taken from a thin section which divides the tubuli of the skeleton at right angles.

the direction of their length ; and the same is true of sections which are taken parallel to the corallites, but which lay open the visceral chambers of the latter. On the other hand, sections through the walls of the corallites taken parallel to the visceral chamber, and sections of the connecting-floors taken parallel to their upper or lower surfaces, cut the canaliculi at right angles, so that these appear as minute rounded or oval pores in the skeleton.

The only other points connected with the minute structure of the skeleton, as revealed by thin sections are,—*firstly*, that it is easy to observe that the corallum is made up, as pointed out by Professor Perceval Wright, of a network of irregular fusiform spicules fused together (fig. 2, c), and *secondly*, that the marked red coloration of the skeleton resides chiefly in outer layer of the thecæ, the inner layer being nearly or quite white.

3. *General structure of the corallum of Syringopora.*—The genus *Syringopora*, Goldfuss, is one well known to naturalists, and its leading structural characters have been fully described by myself, (“Palæozoic Tabulate Corals,” p. 207). As my object on the present occasion is simply to compare it with *Tubipora*, it will be unnecessary for me to do more than merely to draw attention to some of its more striking characters. The corallum in this genus is composed of fasciculate cylindrical calcareous tubes, which are placed at variable but slight intervals, and diverge slightly as the surface of the colony is approached, owing to the interpolation of new tubes. The visceral chambers of adjoining corallites are placed in direct connection by means of hollow, usually cylindrical, horizontal connecting-processes or tubes. These connecting-tubes are generally quite distinct from one another, and placed at tolerably regular and moderately distant intervals; but they are sometimes developed in successive whorls (as in *S. verticillata*, Goldf.), or the verticils may coalesce so as to give rise to almost uninterrupted horizontal connecting-floors (as in *S. tabulata*, Van Cleve). In this latter case, the mere external similarity of the corallum to that of *Tubipora* is very striking.

As regards the internal structure of the corallites of *Syringopora*, the visceral chamber of each tube is always subdivided by a remarkable and well developed system of tabulæ. These tabulæ are, typically, more or less infundibuliform, and they generally become invaginated in such a manner as to give rise to a central cylindrical tube, which occupies the axis of the visceral chamber (fig. 3, A). This axial tube, however, is in no respect a distinct or separate structure; but it is simply a central space left by the union of funnel-shaped tabulæ, and often broken up by the inward prolongation of these across its central cavity. In all the species of *Syringopora*, also, the corallites are provided with a well-developed system of *septa*. The *septa* (fig. 3, A and B), are entirely of the “Favositoid” type, or of the type of the *septa* *Porites*, being never lamellar, but having in all cases the form of slender spines arranged in vertical rows. They never extend more than a limited distance into the visceral chamber, but they vary in length, the larger species seeming to have about twenty rows of septal spines to each corallite.

4. *Minute structure of the corallum of Syringopora.*—The minute structure of the corallum of *Syringopora* is best studied in thin transverse sections of the corallites. When examined in such sections, the wall of the tubes is seen to be composed of dense indistinctly fibrous or granular sclerenchyma (fig. 3, A), and to be

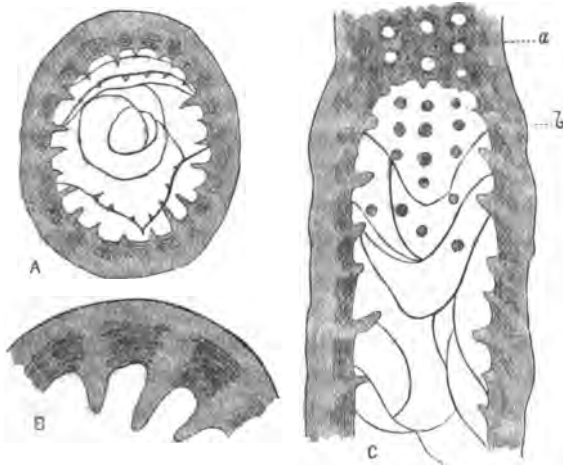

Fig. 3.—A, Transverse section of a corallite of *Syringopora reticulata*, Goldf., enlarged twelve times, showing the thick compact wall, the cut edges of the infundibuliform tabulæ, and the septal spines. B, Part of the same section enlarged still further, showing the composition of the wall out of an outer light layer and an inner dark layer, and the origin of the septal spines from the outer layer. C, Longitudinal section of a corallite of the same, enlarged twelve times. The section passes obliquely through the corallite, and consequently shows different appearances in different parts of its course. At *a* it cuts through the inner layer of the wall, and exhibits the divided bases of the septal spines as rows of light-coloured spots (these are unfortunately left quite white, as if they were actually foramina, whereas they should properly have been faintly shaded); at *b* it cuts through the visceral chamber near its periphery, and shows the cut ends of the septal spines as rows of dark spots; and below this point it becomes more nearly central, and shows the infundibuliform tabulæ. From the Carboniferous Limestone, Westmoreland.

entirely devoid of any system of minute tubuli or canaliculi. The wall, in fact, is quite compact, and the visceral chambers of the polypes communicate with one another at no points except where the connecting-tubes of the colony may be developed. Very generally, the wall is distinctly composed of two layers, viz., the outer dense layer just spoken of and an internal layer of laminated

or markedly fibrous sclerenchyma (fig. 3, A and B). When this is the case, the outer layer is usually of a conspicuously lighter colour than the internal layer, and this gives rise to certain phenomena which deserve a moment's notice. When, namely, these two layers exist, the septal spines (fig. 3, B) always take their origin from the outer light-coloured layer, and penetrate through the inner laminated and dark layer on their way to the visceral chamber. Hence, in longitudinal sections which divide the *wall* of the corallites (fig. 3, C), we observe vertical rows of small rounded spaces, which have a lighter colour than the surrounding tissue. These light circular spaces might easily be mistaken for pores in the wall, or for transverse sections of canals running in the wall; but they are really the cut ends of the spiniform septa divided near their bases.

5. *Supposed relationships between Tubipora and Syringopora.*—Owing to the marked external resemblance which subsists between the corallum of *Tubipora* and that of *Syringopora*, it has been commonly held by naturalists that the two genera are nearly related, and that the latter genus is, therefore, referable to the *Alcyonaria*. Amongst the later authorities who have adopted this view may be mentioned Zittel ("Handbuch der Palæontologie," vol. i. p. 211) and Moseley ("Voyage of H.M.S. Challenger," vol. ii. p. 125). My own view, on the other hand, has been that there is no real affinity between *Tubipora* and *Syringopora*, and that the latter is really referable to the *Zoantharia perforata*, and allied to the Favositidæ ("Palæozoic Tabulate Corals," p. 213). In considering this question with a view to arriving at some decided conclusion, it may be as well to summarise the chief points of likeness and unlikeness between *Tubipora* and *Syringopora*. The points of resemblance between the two genera are as follows:—

(a.) It must be admitted, in the first place, that there exists a very remarkable general likeness of the corallum of *Tubipora* to that of *Syringopora*. In both, namely, the corallum consists of slightly separate cylindrical corallites, of comparatively great length, bound together by horizontal processes or floors.

(b.) A still more striking point of likeness, as of a really much more fundamental character, is to be found in the fact that in both genera the visceral chambers of the polypes are placed in direct

communication by horizontal canals, which run in the interior of the connecting-processes or connecting-floors, to which I have alluded above.

(c.) A third point in which it has been alleged that the corallum of *Tubipora* resembles that of *Syringopora*, is the presence in both genera of an axial tube occupying the centre of the visceral chambers of the corallites. Here, however, we have, in my opinion, to deal with a merely apparent similarity and not with a case of true homology. It is true that the axial tube of *Tubipora*, when it is present, is not unlike in appearance to the axial tube of *Syringopora*, but there are important differences between these structures to be noted. Thus, the axial tube of *Tubipora* is an apparently independent calcareous structure, which has no connection with the wall of the visceral chamber save only at the nodal points of the corallite (*i.e.*, at the points opposite to the origin of the horizontal connecting-floors), where it becomes connected with the inner surface of the theca by a funnel-shaped expansion of both its upper and lower extremities. In my view, therefore, there exist *no* "tabulæ" in *Tubipora*. Moreover, the axial tube entirely resembles the wall of the theca in being composed of fused spicules, and it is penetrated by the same close-set canaliculi. What its precise nature may be it is difficult to say, but it is possibly due to a progressive calcification of the wall of the gastric sac from below upwards as the polype grows upwards in the progressively lengthening theca. At any rate, it is interesting to notice that the only points at which it has any connection with the wall of the theca are just those points which, as shown by Professor Perceval Wright, mark the periodic growth from the summit of the polype of the horizontal outgrowths which give rise to the connecting-floors of the colony. On the other hand, the so-called axial tube of *Syringopora* is not in any way an independent and definite structure, with an independent and definite wall. It is, rather, simply the axial space formed by the fitting into one another of a number of irregular funnel-shaped *tabulæ*; and this difference is well shown by a comparison of a transverse section of a corallite of *Tubipora* with a similar section of a corallite of *Syringopora*. In the former case, we see simply two concentric rings, one representing the wall of the theca, while the much smaller inner ring represents the axial tube, the two having absolutely no

connection with one another. In the latter case, on the contrary, the section of the corallite shows a number of irregularly concentric lines, marking the cut edges of the ensheathing tabulæ, the outer of these lines being in connection (as a rule) with the wall of the theca, while the innermost encloses the cavity of the axial tube.

While the above are the real or supposed points of resemblance between *Tubipora* and *Syringopora*, there are the following very important differences between the two genera to be observed.

(a.) In the first place, there is the very important and remarkable difference in the minute structure of the calcareous skeleton in the two types in question. In *Tubipora* the corallum is made up of fused calcareous spicules, which are so disposed as to give rise to a universally distributed system of minute canaliculi or tubuli, which open on both the outer and inner surfaces of the skeleton by well-marked apertures. The size of these tubuli is comparatively so great that it is quite impossible that their presence could be overlooked in thin sections of *Syringopora*, if they really existed in this genus. On the other hand, the skeleton of *Syringopora*, as regards its minute structure, is quite compact, and shows no signs whatever either of being penetrated by a system of tubuli, or of being formed by the fusion of ectodermal spicules.

(b.) True tabulæ are always present in *Syringopora*, and, in all the typical forms of the genus, have the character of a series of invaginated cones, which give rise centrally to an axial tube. In no specimens that I have ever seen, can there be recognised any similar series of funnel-shaped tabulæ in *Tubipora*. I cannot, in fact, recognise that any true tabulæ are present in *Tubipora*, so far as my own observations enable me to come to a conclusion on this point, and, as already stated, I do not regard the axial tube of *Syringopora* as being formed in the same way as the somewhat similar-looking structure in *Tubipora*, or as really being homologous with it.

(c.) The corallites of *Syringopora* are provided with a well-developed septal system, of which absolutely no traces can be recognised in *Tubipora*. Moreover, the septa of *Syringopora* are not mere marginal plicæ, such as form the "pseudosepta" of *Heliopora*, but they are in the shape of vertically-arranged rows of spines which may be well compared with the septal spines of such

undoubted Zoantharians as *Porites*. A still closer comparison might be made with the septal spines of many species of *Favosites*, but it is unnecessary to do this, as the reference of *Favosites* to the *Zoantharia* would not be universally admitted. Owing to their spiniform character (instead of being lamellar), transverse sections of the corallites can rarely or never show a complete cycle of the septa; and it is, therefore, difficult to determine how many rows of septal spines are present in each corallite. There is, however, no sufficient reason to doubt that the septal spines of *Syringopora* are like those of *Porites* in being really partial calcifications of the mesenteries, so that they are properly of a septal nature.

Taking the whole of the preceding evidence together, I cannot avoid coming to the conclusion that the points of difference between *Tubipora* and *Syringopora* are decidedly more important and fundamental than the points of resemblance. I am not, therefore, at present disposed to alter my previously-expressed opinion that there exists in reality no actual relationship between these two genera, nor am I prepared to admit that *Syringopora* should be rightly referred to the *Alcyonaria*. On the contrary, I think the evidence which is at present available to be decidedly in favour of the view that *Syringopora* belongs to the *Zoantharia perforata*, and that its nearest allies are to be sought for in the Favositidæ, the singular genus *Syringolites* (Hinde), forming a transition between *Favosites* and *Syringopora*. I am aware that Mr Moseley, whose opinion in such a matter deservedly carries exceptional weight, is inclined rather to believe that *Favosites* and its allies should be referred to the *Alcyonaria*. Into this question I cannot enter at this moment; but I hope to be able on a future occasion to show, by means of thin sections of both types, that the affinities of *Favosites* are distinctly with *Porites*, and that the former genus properly belongs, as maintained by Verrill, Zittel, and myself, to the *Zoantharia perforata*.

2. On an Iodine Battery. By Mr A. P. Laurie.

Communicated by Professor Tait.

This is a one fluid battery. The two plates are zinc and carbon. The solution is a solution of iodide of potassium in water, in which iodine is dissolved. The usual strength I use is 1 oz. of iodide of potassium in 2 oz. of water. In this dissolve $\frac{1}{2}$ oz. of iodine, but the strength of the iodine and of the iodide of potassium can be considerably varied without affecting the electromotive force.

The iodine is meant to prevent polarization by uniting with the nascent hydrogen to form hydriodic acid, which will then unite with the caustic potash, to form iodide of potassium and water. In this way the iodide of potassium acts as a carrier of iodine, from the iodine in solution, to the zinc plate.

It is quite possible, however, that the iodine acts directly on the zinc plate.

I made the following experiments :—

On connecting a single cell with a quadrant electrometer, I got a deflection of 60 divisions. The zinc and carbon were then connected by a short wire for ten minutes, and again rapidly connected with the electrometer.

The deflection was now 58. It was joined up for another ten minutes, the deflection was then 57.

The first reading, namely 60, was unusually high, as in no future case did I get more than 58 or 59 to start with.

The following experiment is more trustworthy :—

Initial deflection 58. Current allowed to run for thirty minutes, deflection 57. I tried a whole series of metals, but found none so good as zinc.

The zinc cannot be amalgamated, as the solution acts on mercury. In all these experiments I used commercial zinc. If it is left in the solution it is slowly dissolved, and must therefore be removed from the solution, when the battery is not working.

I made up a Daniell cell with a saturated solution of sulphate of copper, and 1 of commercial sulphuric acid in 12 of water. The Daniell gave a deflection of 54, while my cell gave a deflection of 56. Its electromotive force is therefore about one Volt.

I have lately tried iodide of zinc in place of iodide of potassium. The electromotive force is the same, and in other respects it does as well, iodine being very soluble in it. By using it, the formation of new salts in the cell is avoided.

The advantages of this cell are that it gives a fairly constant electromotive force, and can, if the zinc is removed, be left standing unused for any length of time. This is, of course, impossible in the case of the Daniell.

3. Note on Chemical Affinity and Atomicity.

By William Durham.

(Abstract.)

The theory of "Valency" or "Atomicity," while explaining satisfactorily many chemical phenomena, still leaves unexplained many facts, such, for instance, as the varying atomicities of several elements, the composition of double salts, water of crystallisation, &c. This arises from assuming that chemical affinity acts in an atomic indivisible manner, which is not warranted by the facts. If we take, for instance, nitrogen in the compound, NH_3 and NH_4Cl , it acts in the one case as a triad, while in the other it is said to be a pentad. Now, in the case of the NH_4Cl in this view, we have the chlorine represented as directing all its affinity to the nitrogen, for which it usually has such a feeble affinity, while it has no action on the hydrogen, for which its affinity is usually so intense. Now, if we get rid of the idea of the atomic action of affinity, we may represent the chlorine dividing its action among all the four atoms of hydrogen, giving on the average $\frac{1}{4}$ to each; and the nitro-

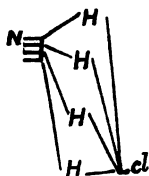

gen, in the same manner, giving $\frac{3}{4}$ to each; and thus, the whole molecule is bound together.

Similarly, the double salts, such as the chloride of potassium and platinum, may be represented thus—

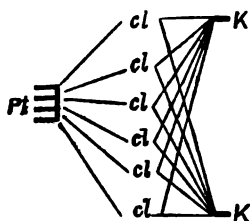

The same principle may be applied to water of crystallisation, &c. If this spreading out of chemical affinity be admitted, it may be extended to include solutions and other weak combinations; thus, a solution of salt in water may be represented thus—

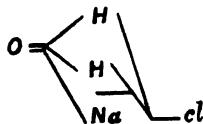

and it is manifest any number of molecules of water may be added; each one, of course, weakening the bonds of union. That some such action as this takes place may be inferred from the behaviour of magnesium chloride in water. The chloride cannot be recovered by evaporation, because, from the strong affinity of the magnesium for oxygen, and of chlorine for hydrogen, double decomposition takes place, and hydrochloric acid is liberated, while magnesium oxide remains. The same principle is illustrated by the phenomena of electrolysis, with the varying resistances of solutions of different strength, causing the concentration or diffusion of the chemical affinity.

Alloys, solution, and occlusion of gases may all be included under the law of the spreading of chemical affinity.

There are also some physical facts on which it may throw some light. Thus, the fact that gases in their behaviour under pressure indicate first an attractive, and then a repellant action among their molecules, may be explained by the influences of the component parts of each molecule acting on its neighbours, and producing attraction; while the repellant action may be accounted for by assuming a motion of revolution round an axis when the

atoms are at molecular distances, and the pressure would increase angular velocity, and, consequently, centrifugal force at a greater rate than the attractive force.

Andrew's critical point may be explained in the same manner.

4. On the Physical and Biological Conditions of the Channel between Scotland and the Farö Islands. By Sir Wyville Thomson.

BUSINESS.

The following candidates were balloted for, and declared duly elected Fellows of the Society:—Mr A. J. D. Cameron, the Right Hon. the Earl of Rosebery, Mr Walter Berry, Mr John Johnston Rogerson, and Surgeon-Major J. E. Tierney Aitchison, M.D.

Monday, 20th June 1881.

PROFESSOR MACLAGAN, M.D., V.P., in the Chair.

The following Communications were read:—

1. On a Class of Sturmian Functions.
By Professor Chrystal.
2. Preliminary Report on the *Tunicata* of the "Challenger" Expedition. Part IV. By W. A. Herdman, D.Sc.
(By permission of the Lords Commissioners of the Treasury.)

IV. MOLGULIDÆ.

The family *Molgulidæ* was established by Lacaze-Duthiers in 1877,* and distinguished from the *Cynthiadae*, with which it had formerly been united by Heller.†

Lacaze-Duthiers divides the species known to him into four genera,—*Anurella*, *Molgula*, *Ctenicella*, and *Eugyra*,—of which *Anurella* forms a sub-family or section the *Molgulidæ anuræ*, the other three constituting the *Molgulidæ urodelæ*. The character by which *Anurella* is distinguished from the other genera is the tail-less

* Arch. Zool. Expér., vol. vi. p. 457.

† Untersuch. ü. d. Tunic. d. Adriat. u. Mittelmeer., Abth. III. p. 1.

amoeboid larva; but this most interesting developmental difference does not seem to be accompanied by any structural features in the adult animal, and consequently it becomes impossible to distinguish the genus unless one examines the animal alive and at the breeding season.

I have therefore found it impossible to follow Lacaze-Duthiers in his primary division of the Molgulidæ, and have been compelled in classifying the "Challenger" species to consider *Anurella* and *Molgula* as one genus. Whether *Ctenicella*, separated from *Molgula*, on account of its lacinated lobes round the apertures, will stand as a good genus, I am uncertain. The character is a useful one for working with, and the structure of the apertures seems always an important point in the Tunicata. *Ctenicella* does not occur in the "Challenger" collection. The two remaining genera, *Molgula* and *Eugyra*, seem natural groups, and are both represented in the collection.

In addition to the above, I have had to found a new genus *Ascopera* for the reception of two large species from the Antarctic. Stimpson's *Glandula*, usually considered one of the Molgulidæ, belongs to the sub-family Styalinæ of the Cynthiadæ.

Molgula gigantea, Cunningham.

This large species, first found by Professor R. O. Cunningham in the "Nassau" expedition, and described by him as *Cynthia gigantea*, was taken in considerable numbers by the "Challenger" in the Strait of Magellan.

Station 313; 55 fathoms.

Molgula gregaria, Lesson.

The *Cynthia gregaria* of the "Centurie Zoologique" seems identical with specimens dredged by the "Challenger" at Station 315 (Falkland Islands), 5 to 10 fathoms. The species was also obtained at this locality by Professor Cunningham in the "Nassau."

Molgula pedunculata, n. sp.

External appearance.—Shape ovate or pyriform, elongated transversely, the ventral edge forming a short thick stalk, the rest of the

body globular, slightly compressed laterally; dorsal edge and posterior end convex, attached by extremity of ventral edge. Apertures both on wide anterior end, sessile, not conspicuous; atrial, regularly lobed. Surface smooth. Colour white, with a hyaline tinge. Length, 4 cm.; breadth, 5 cm.

Test cartilaginous, thickish, strong; smooth and glistening on inner surface.

Mantle not very thick; muscle bands distinct, but distant.

Branchial sac with seven folds on each side. Internal longitudinal bars strong, placed between as well as on the folds. Transverse vessels variable. Stigmata arranged in irregular transverse rows, rarely in spirals.

Dorsal lamina short, but very wide; plain.

Tentacles large, branched, about twelve in number, placed larger and smaller alternately. One very large one occurs at the ventral edge, just anterior to the extremity of the endostyle.

Olfactory tubercle a long way posterior to the tentacular circlet, equidistant from the branchial and atrial siphons; horns simply turned in, opening directed dorsally and to the left.

One specimen from Station 150 (south of Kerguelen Island); 150 fathoms.

Molgula horrida, n. sp.

External appearance.—Shape rudely ovate; posterior end rounded, wide; anterior end narrower; ventral edge very convex, dorsal concavo-convex going from the anterior to the posterior end. Attached by the ventral part of the left side. Apertures both at the anterior end, not distant, slightly projecting, lobes irregular. Surface rough, almost entirely covered with sand, and other animals adhering. Colour—Where visible, the test is dull brown. Length, 5 cm.; breadth, 5 cm.

Test thick and solid, very stiff; smooth and glistening on the inner surface.

Mantle very thick, but not very muscular; siphons wide, tubular.

Branchial sac of a dark green colour, very thick; seven folds on each side. Internal longitudinal bars prominent, connected by horizontal membranes; transverse vessels irregular; meshes square, and cut up by an irregular network, formed by vessels arising from

the transverse and internal longitudinal bars. In this network lie the delicate, coiled interstigmatic vessels.

Dorsal lamina short, quite plain; no ribs nor teeth.

Tentacles large and branched, dark green, ten in number, with a few additional very small intermediate ones.

Olfactory tubercle prominent, both horns much coiled, forming large spirals.

Two specimens from Station 315 (Falkland Islands); 5 to 12 fathoms.

Molgula forbesi, n. sp.

External appearance.—Shape globular, slightly elongated dorso-ventrally, not compressed laterally; posterior end regularly rounded; edges convex; anterior end slightly projecting and flattened, not attached. Apertures both at anterior end, not distant; atrial rather more prominent than branchial, both slightly projecting, branchial pointing ventrally. Surface entirely covered with a close coating of sand grains. Colour dull brown. Length, 1.8 cm.; breadth, 2 cm.

Test not thick, but stiff; quite opaque.

Mantle thin, transparent, viscera seen through distinctly; muscle bands numerous, but very fine.

Branchial sac with seven folds on each side. Internal longitudinal bars strong, three or four on each fold. Stigmata very irregular—being straight, and arranged in transverse rows in some places, while in others they are curved and arranged in spirals or irregularly. Transverse vessels varying greatly in size and position, often quite irregular. Delicate horizontal membranes frequently present between the folds.

Dorsal lamina, a short and narrow membrane, with a plain edge.

Tentacles compound, about twelve large and twelve small placed alternately.

Olfactory tubercle simple, placed at the posterior end of a deep and irregular peritubercular area. The left side extending further forwards than the right; both horns turned to the left.

One specimen from Port Jackson, Australia; 2 to 10 fathoms

Molgula pyriformis, n. sp.

External appearance.—Shape pyriform, almost triangular; anterior end wide, truncated; posterior narrow, pointed; both edges convex.

The widest part is one-third of the way down, and from there both dorsal and ventral edges taper rapidly to the posterior end; not attached. Apertures at the extremities of the flat anterior end, not projecting, inconspicuous; branchial rather the more anterior of the two. Surface entirely covered with a close coating of sand grains. Colour dark brown. Length, 2 cm.; breadth, 1.5 cm.

Test thin, but stiff.

Mantle thin. Musculature moderately developed.

Branchial sac, with seven folds on the right side and six on the left. These folds have no stigmata, but consist merely of an open network formed by internal longitudinal bars and transverse vessels, which are frequently joined across the intervening stigmatic region by horizontal membranes. Fine interstigmatic vessels, arranged in rather distant and irregular rows of spirals. Stigmata curved in the spirals, and more or less linear between.

Dorsal lamina narrow and plain.

Tentacles branched, of many sizes.

Olfactory tubercle tubular, having a wide funnel-shaped aperture anteriorly; no horns.

One specimen from Station 320 (off the coast of Buenos Ayres), 600 fathoms.

Eugyra kerguelenensis, n. sp.

External appearance.—Shape globular; very slightly elongated dorso-ventrally; not compressed laterally; posterior end rounded, not attached. Apertures both anterior, conspicuous, not distant; branchial sessile; atrial prominent, forming a short cylindrical projection. Surface smooth; slightly wrinkled round the apertures. Colour light transparent grey. Length, including atrial siphon, 2 cm.; breadth, 1.8 cm.

Test very thin and transparent, except on the atrial siphon.

Mantle thin. Muscular fibres few, radiating from the apertures.

Branchial sac strong; not folded. Internal longitudinal bars broad and thin bands. Transverse vessels slight and irregular; narrow horizontal membranes usually present. Spirals large and much coiled, having from ten to thirty turns (generally fifteen to twenty). Radiating vessels slight; a few short intermediate ones frequently present.

Dorsal lamina, a plain broad membrane.

Tentacles branched, thin, about twelve large and twelve smaller, and three orders of simple and very minute ones placed alternately to the others.

Olfactory tubercle having an elongated oval cavity, ending in a quadrangular aperture anteriorly. No horns.

Four specimens from Kerguelen Island; 10 to 110 fathoms.

Ascopera, n. gen.

Body pyriform, more or less pedunculated; attached.

Test thin, between membranous and leathery.

Branchial sac, with seven folds on each side. Stigmata straight or curved, but not arranged in spirals.

Ascopera gigantea, n. sp.

External appearance.—Shape roughly pyriform, not compressed laterally. Anterior end wide, truncated, slightly cleft in the centre, ending in a siphon at each extremity. Behind the siphons the body swells out into a globular form, and then becomes continuous with the wide stalk formed by the posterior two-fifths of the test. Dorsal edge rather more convex than ventral. Attached by the extremity of the posterior end. Apertures both at anterior end, distant, conspicuous, wide; branchial at the ventral edge, very large, funnel-shaped; bent round so that the opening is directed posteriorly; atrial at the dorsal edge, more anterior than branchial, wide, directed anteriorly. Surface even; finely roughened all over. Colour pale yellowish grey-green. Length, 30 cm.; breadth, 12 cm.

Test thin and almost membranous, but tough; semi-transparent; smooth on inner surface.

Mantle delicate and membranous, with a few distant, rather strong muscle bands running transversely over the anterior half or so of the right side and the left side; only absent on the dorsal part of the left side and the posterior end.

Branchial sac very thin and delicate, seven folds on each side; those next the endostyle are rather slighter than the others. Internal longitudinal bars wide and delicate. These and the wide and distant transverse bars give off vessels which branch and anastomose, forming an irregular network, the spaces of which are the stigmata.

Dorsal lamina short, 4 mm. wide, and rather thick. No ribs nor teeth.

Tentacles branched; eight large and eight small placed alternately, and about sixteen very minute ones placed between the others; the largest are of considerable size, and are strong.

Olfactory tubercle large, prominent. Both horns much coiled.

One specimen from Station 150 (south of Kerguelen Island); 150 fathoms.

Ascopera pedunculata, n. sp.

External appearance. — Club-shaped, consisting of a rudely diamond-shaped body on a thick stalk, somewhat compressed laterally. Anterior end straight, wide, truncated; dorsal and ventral edges nearly straight, sloping outwards and backwards to the wide posterior end; posterior end prolonged into the long stalk which springs from its ventral edge, and is twice as long as the body. The stalk is thin, being compressed laterally. It is narrow where it joins the body, and increases gradually in width as it proceeds backwards, till, at the posterior end, where it is attached, it is more than twice its original width. Apertures at the extremities of the anterior end, distant, conspicuous, slightly projecting, distinctly lobed; branchial at ventral edge, directed ventrally; dorsal at dorsal edge, directed dorsally. Surface even, slightly roughened all over. Stalk smooth. Colour pale grey. Length of body, 7.5 cm.; breadth of body, 7 cm.; length of stalk, 17 cm.; breadth of stalk, 4.6 cm.

Test moderately thick and tough on body; very thin and membranous on stalk.

Mantle thin and membranous, or semi-gelatinous. The posterior part is prolonged for 13 cm. into the peduncle.

Branchial sac with seven folds on each side. Internal longitudinal bars delicate, not distant. Transverse vessels rather irregular; generally several more or less perfect smaller vessels between the larger ones. Meshes greatly elongated transversely. Stigmata of different lengths, but all running longitudinally.

Dorsal lamina broad but thin and short.

Tentacles large, branched, sixteen in number; placed long and short alternately.

Olfactory tubercle prominent, elongated transversely, having the aperture placed laterally. Horns large, both coiled outwards.

One specimen from Station 150 (south of Kerguelen Island); 150 fathoms.

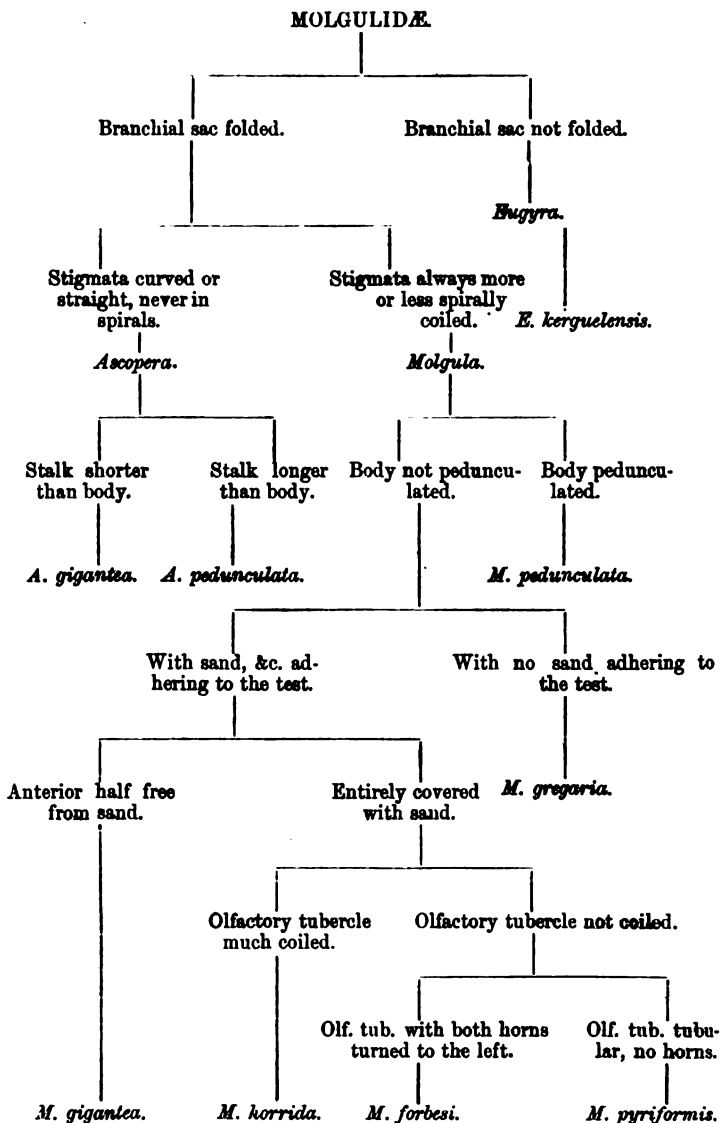

3. Comenic Acid. By D. B. Dott. Communicated by
Professor Crum Brown.

In continuation of a short paper on meconic acid previously communicated to the Society, I submit the following notice of some of the salts of comenic acid.

As is well known, comenic acid is formed from meconic acid by elimination of carbonic anhydride, according to the equation $-C_7H_4O_7 = C_6H_4O_5 + CO_2$. This change may be effected by heat alone, but a better product is obtained by the action of boiling aqueous hydrochloric acid. It was by the latter method that the acid used in my experiments was prepared. Comenic acid is easily purified by crystallisation from boiling water, in which it is sparingly soluble, and by conversion into ammonium salt, which is likewise purified by recrystallisation. Comenate of ammonia forms long well-defined prisms, which are much less soluble in water than the corresponding salt of meconic acid.

I have endeavoured to prepare most of the salts of comenic acid as described by How* and others, with results generally in accordance with their experiments. I have also succeeded in obtaining two crystalline comenates of silver, or rather the same salt crystallised in two different forms. The silver salts hitherto noticed were amorphous.

Silver Salt.

(1.) This was prepared by adding nitrate of silver to solution of ammonium comenate, the precipitate being dried in water-bath. 8.205 grs. gave by ignition 3.190 grs. Ag = 38.87 per cent.

(2.) Prepared by adding excess of nitrate of silver to solution of ammonium comenate. The air-dry precipitate dried in air-bath at 120° C.

10.78 grs. gave by ignition 4.44 grs. Ag = 41.18 per cent.

5.04 grs. ,, 2.08 grs. Ag = 41.26 ,,

(3.) Nitrate of silver was mixed with solution of ammoniac

* Ed. Phil. Trans., xx. 225.

comenate rendered alkaline by ammonia, the precipitate being dried at 120° C.

8.01 grs. gave by ignition 4.60 grs. Ag = 57.42 per cent.

Of another quantity, prepared in the same way, 8.86 grs. give 5.02 grs. Ag = 76.65 per cent.

(4.) Aqueous solutions of argentic nitrate and ammoniacal comenate were mixed, the precipitate produced being washed by decantation. The beaker containing the same was then covered and placed in the dark. After a few days crystals had appeared, and these gradually increased in number until the whole of the original amorphous precipitate had disappeared. These crystals were removed from the beaker and dried on blotting paper and by exposure to the air. They have the form of hexagonal prisms, and are of a brown colour. The weight was not altered by exposure to a temperature of 100° C.

14.21 grs. gave by ignition 5.43 grs. Ag = 38.21 per cent.

(5.) The amorphous precipitate above mentioned was boiled with water for several hours, and then filtered. On cooling the filtrate deposited small white crystals, which under the microscope presented the appearance of flat four-sided prisms. These crystals after drying in the air at the ordinary temperature lost no weight at 120° C.

6.07 grs. gave 2.32 grs. Ag = 38.22 per cent.

Another portion, exposed to temperature of 160° C. until it had almost ceased to lose weight, became darker in colour as if slightly decomposed.

10.15 grs. gave 4.175 grs. Ag = 41.13 per cent.

(6.) A quantity of the amorphous silver comenate was boiled with water for thirty hours, the residue collected on filter, washed with hot water, and dried in water-bath.

8.03 grs. gave 7.95 grs. Ag = 99.00 per cent.

$C_6H_2AgO_5H_2O$ = 38.43 Ag per cent.

$C_6H_3AgO_5$ = 41.06 Ag „

$C_6H_2Ag_2O_5H_2O$ = 55.67 Ag „

$C_6H_2Ag_2O_5$ = 58.37 Ag „

From these results it is manifest that the amorphous precipitate produced in solution of ammoniacal comenatate, as likewise the crystalline salt above described, are the monobasic silver salt. The only product that approximates in composition to di-argentic comenatate is the precipitate produced in the *alkaline* solution of comenatate of ammonia. From experiment (6) it is evident that when argentic comenatate is boiled with water, the silver is reduced to the metallic state; reduction taking place much more readily than with the corresponding meconate.

Copper Salt.

This was prepared by adding excess of cupric sulphate to a hot solution of ammoniacal comenatate. A crystalline precipitate separated immediately, increasing in quantity as the solution cooled. The crystals dried at 120° were ignited, the residue dissolved in hot nitric acid, and caustic soda solution added to the boiling nitrate of copper. The precipitated oxide was washed by boiling with water, then on the filter with hot water, and finally ignited. 8.615 grs. gave 2.910 grs. CuO = 33.77 per cent. $C_6H_2CuO_4H_2O$, is = 33.73 CuO per cent.

Calcium Salts.

(1.) Prepared by adding solution of calcic chloride to warm solution of ammoniacal comenatate. The salt so obtained was recrystallised from boiling water, and after drying in the air, exposed to heat of air-bath at 120°.

9.870 grs. lost 2.515 grs. = 25.48 per cent.

The dried substance was ignited, converted into sulphate, and again ignited. It gave 2.81 grs. $CaSO_4$ = 0.826 grs. Ca = 8.36 per cent.

$(C_6H_2O_5)_2Ca7H_2O$ would yield 26.47 H₂O, and 8.40 Ca per cent.

(2.) A strong solution of ammonium comenatate was rendered alkaline by addition of ammonia, and poured into saturated solution of calcic chloride. An indistinctly crystalline precipitate separated. When dried at 120° C.

11.26 grs. gave 7.24 grs. $CaSO_4$ = 2.98 CaO = 26.45 per cent.

12.28 grs. gave 7.40 grs. $CaSO_4$ = 3.047 CaO = 26.42 ,,

(3.) By adding alkaline solution of ammoniacal comenate to dilute solution of calcic chloride, a precipitate was obtained which separated for the most part gradually.

3.64 gra. gave 0.99 gra. CaO = 27.19 per cent. in the salt dried at

120°.

$C_6H_2CaO_5$ = 28.86 per cent. CaO.

$C_6H_2CaO_5H_2O$ = 26.41 „

None of the other salts described in the books was prepared, as the analyses given of them did not afford promise of any good result. It occurred to me that it would be interesting to observe the behaviour of comenic acid when digested with a strong alkaloid, and the experiments though inconclusive are worth noting. With morphine, which is not a very powerful base, only the mono-morphine comenate is formed, just as with meconic acid it forms the di-morphine meconate. Codeine, which is a very strong alkaloid, when digested in water with comenic acid in the proportions to form di-codeine comenate, readily dissolves, and when the solution is evaporated it remains for days in a syrupy state without any separation of codeine. As however the salt refuses to crystallise, there is no proof that the di-basic salt is really formed. The result may simply be due to the solubility of codeine being greatly increased by the presence of the mono-basic comenate. At the same time it must be observed, that when codeine (in excess of the quantity required to form the di-basic salt) is digested with comenic acid, very little more of the alkaloid is taken up than is required to form the di-codeine comenate, and this excess is easily explained by the solubility of codeine in water. In like manner, meconic acid takes up very nearly the proportion of base required for the tri-codeine meconate. The only other alkaloid tried was thebaine, and it behaved exactly as morphia.

In view of the results above described, I think we must admit that the evidence is distinctly in favour of the di-basic nature of comenic acid, and apparently of the tri-basic nature of meconic acid, although the last combining power in each of them must be very feeble. Knowing that carbonic anhydride is evolved in the formation of comenic from meconic acid, it is naturally assumed that the former contains an oxatyl radicle less than the latter; but as we do

not know the constitution of either of them, we are not compelled to accept this conclusion. It must, however, be allowed that if comenic acid is shown to be di-basic, there is strong presumption that meconic acid is tri-basic. One of the circumstances which at first led me to form an opinion different from that which I now hold, is the fact that, in a solution supersaturated with ammonia, the acid comenate of ammonium crystallises out; but I suppose this must be explained by the law, according to which the most insoluble compound always tends to form. There are several experiments which suggest themselves in connection with this subject, such as the use of different solvents, evaporation *in vacuo*, and the like, but in the meantime I cannot further follow the investigation.

4. On Morgan's Systems of Consanguinity and Affinity.

By Dr Macfarlane.

5. Note on a Proposition in Theory of Numbers.

By Professor Tait.

Monday, 4th July 1881.

MR D. MILNE HOME, Vice-President, in the Chair.

At the request of the Council, an Address on the Island of Socotra was given by Professor I. Bayley Balfour.

The following Communication was read:—

2. On some new species of Fossil Scorpions from the Carboniferous Rocks of Scotland and the English Borders, with a Review of the genera *Eoscorpilus* and *Mazonia* of Messrs Meek and Worthen. By B. N. Peach.

Monday, 18th July 1881.

SIR ALEXANDER GRANT, Bart., Vice-President,
in the Chair.

The following Communications were read:—

1. Report of the Boulder Committee, with Remarks by the Convener, Mr D. Milne Home. (Plates I, II, III.)

NOTES BY CONVENER.

ARGYLESHIRE—CRINAN CANAL.

1. Between Crinan Bay on the north and the head of Loch Fyne on the south, there is a trough or hollow now occupied by the Crinan Canal. The highest point along this trough, is about 150 feet above the sea. A series of locks occur at this summit-level, to allow of the passage of vessels between the two sea-lochs.

At the summit-level, the rocks form a sort of ridge across the valley, with smooth surfaces towards the north, and rough surfaces towards the south.

On both sides of this rocky ridge, there are large boulders; on the north side, I counted between forty and fifty, on the south side, there are not more than two or three. The boulders are a syenitic gneiss; the rocks *in situ*, are shivery clay slate, nearly vertical, dipping steeply towards the south.

Three or four of the boulders on the north side, I found pressed or squeezed up against the rocks *in situ*, in such a way as to show that they had come from the north, and had been obstructed in their farther progress southwards by the rocky ridge. In one case, the boulder lies with its longer axis N.N.W., which is about the direction of the valley at this place. There is a hollow on the north side of the ridge, as if made by the force with which the boulder had been pushed or driven against it. Other two boulders were in size $10 \times 5 \times 4$ feet, with the longer axis W.N.W., and $9 \times 5 \times 4$ feet, with longer axis and sharpest end due north.

Many others were blocked in a similar manner. Plate III., figs. 1 and 2, represent two of these boulders.

The boulders on the south side of the ridge, are of much the same size, but are not close to the ridge; they may have tumbled over the ridge by falling from the agent which brought them when it stranded on the ridge. The spot now referred to adjoins the small stream which flows down from the tanks for supplying the Crinan Canal. These tanks a number of years ago burst, and many large fragments of rock came down with the torrent, but these are quite distinguishable from the boulders above mentioned.

In reference to the agent which may have brought these boulders from the north, there is nothing to suggest the action of a glacier, as the trough forming the bed of the Crinan Canal, towards the north, unites with an arm of the sea at the distance of only about 2 miles. That, at some former period of the earth's history, this Crinan Canal trough was occupied by the sea, through which floating ice might flow, is evident from the well-known traces of old sea-margins visible on the adjoining coasts up to at least 300 feet above the present sea-level. At the summit-level in this Crinan Canal trough, the width of the valley is narrower than anywhere else—probably not more than 300 yards, so that floating ice passing through this Kyle would easily choke there.

Mr Jamieson, in one of his papers published in the London Geological Society's Journal, alludes to this trough, now the bed of the Crinan Canal, and states that he found smoothed rocks on the east side of the valley, and striations running N.W. and S.E. I did not see these markings. They are not inconsistent with the theory above suggested as to the transport of the boulders.

2. *Oban.*—At the south end of the town there is a large number of huge blocks of the Old Conglomerate rock, which forms high and steep cliffs both east and south of the town.

On Plate I, there is a sketch of the district occupied by the town and by a portion of the hills to the east and south, copied from the Ordnance Survey Map. The cliffs on the east side of the town (A B C) have nearly vertical fronts, facing the sea. They reach to a height of from 120 to 150 feet above the sea-level. At C these cliffs take a sudden turn to the eastward. The rocks at B C are a

coarse red conglomerate, which face about due west. At E F there are hills reaching to a height of 300 feet above the sea. Between the cliffs B C and the hills E F, the distance is about one-third of a mile, and the ground between is so flat, that the sea at spring tides flows on to it. There is a meadow up to Dunans, the surface of which nowhere exceeds 20 feet above the sea. At Dunans, however, there is a knoll of conglomerate rock, the top of which reaches to a height of 212 feet above the sea.

The green-coloured dots indicate spots where boulders occur. It will be perceived that they abound on the hill-slopes at H and K facing the N. and N.W. They are almost all grey granite, pretty well rounded, and having a diameter from 5 to 7 feet. One boulder, out of about twenty which I examined, was of porphyry, with white felspar crystals in a basis of purple alumina.

In the meadow or valley to the north of the hills G H K many boulders of grey granite are lying about. The largest I found was on Dunans Knoll, and on the side of the knoll facing N.W.

To the south of the conglomerate cliffs at C, there is a *trainée* of conglomerate boulders (coloured brown), evidently derived from these cliffs. They form a line running about S.E.; most of them are about 80 or 100 yards from the cliff, and one or two occur in the low ground about 200 yards from the cliff.

Some of these boulders are buried in a mass of gravel (as shown in Plate II, fig. 1) 10 or 12 feet thick, lying on the edges of the vertical strata of dark-coloured clay slate. The pebbles in the gravel are chiefly grey granite and gneiss. There is a quarry at this place which shows well, a section of the gravel. In another part of the quarry, there is a bed of laminated clay, 4 feet thick, lying between the rocks and the gravel. The workmen in the quarry informed me, that they had seen sea shells in this clay bed, but I was unable to reach the bed to search for shells, on account of its inconvenient position.

One of the conglomerate boulders lies against a rocky knoll A, which has apparently obstructed the progress of the boulder farther south. Several others lie to the S.E., in the meadow, as if tumbled off the agent, whatever it was, which carried them.

The new railway from Oban to Dalnally cuts through a portion of the hill composed of dark blue slate rocks (see F, Plate I).

Over these rocks lies a bed of boulder clay containing granite boulders. One which I found undisturbed, measured $5 \times 3 \times 3$ feet, with its longer axis pointing N. by E. and S. by W.

On walking over the hills E F (Plate I.), situated above Professor Blackie's cottage, I fell in with a valley about three-quarters of a mile long, opening towards the north. The bottom of the valley is about 80 feet above the sea, with hills on each side reaching to about 300 feet, and blocked at its south end by a range of hills about 600 feet above the sea. In this valley, I found two or three granite boulders, from 3 to 4 feet in diameter, on the east side of the valley, at a height of about 120 feet above the sea, lying on slate rocks. These granite boulders could not have come into this valley except from the north. The width of the valley is from 300 to 400 yards. From the peculiar position of the boulders on the east side of the valley, it may be very probably inferred, that they had come from some north-westerly point.

The sides of the valley where these boulders lie, are at present exceedingly steep, and it seemed marvellous that if they fell on the surface where they now lie, they did not roll to the bottom. It occurred to me that probably when these boulders arrived, the valley was filled with gravel, and that as the gravel was scoured out by streams, the boulders slowly subsided to their present positions.

On the west side of the valley, there is another grey granite boulder, at a level about 30 feet higher than the site of those just mentioned. It is $4 \times 3 \times 3$ feet, and with its longer axis pointing N.N.E.

At the north end of Oban Bay, the grey granite boulder is situated, which was mentioned in last year's Report (p. 11). Its position is indicated on Plate I. by the green-coloured dot near the letter A. Its position close to the high conglomerate cliff raises a presumption that it had come from the westward, and had been intercepted in its farther progress by the cliff. This is strengthened by the fact mentioned in last year's Report, that its longer diameter points W. by N. It probably came by the same agency, whatever that was, which brought the other grey granite boulders shown in Plate I.

I examined the small island in Oban Bay opposite to Professor Blackie's cottage, near the east side of Kerrera Island (L in Plate I.).

Professor Duns having landed on this island in a previous year, had noticed several boulders, and suggested that I should visit it. I found on it four or five grey granite boulders, the rock of the island being entirely conglomerate. One or two of the boulders were in positions indicating probable transport from the north.

I proceeded next round the north end of *Kerrara Island* as far as Bal-na-bok Bay; landing, on my way there, at parts of the shore where boulders were observable. At the north end of Kerrara, where the rocky cliffs of conglomerate reach a height of about 100 feet, I found four or five large boulders of granite, all grey but one, which was red. Their position close to these high cliffs suggested that they had come from some northern point, and had been intercepted there.

On a small island near the same place, there is a grey granite boulder, $8 \times 5 \times 4$ feet, and in such a position as also to indicate transport from the north.

On reaching Bal-na-Bok, I found the shepherd and his daughter (M'Kinnon) very willing to guide me across the hills, and point out a number of boulders known to them. Accordingly, in the course of a three hours' circuit among hills about 300 feet above the sea, I examined about twenty boulders, all granites except one, which was a greenstone. Some of the granites had a pinkish tinge of colour. Most of the boulders were lying with their longer axis N. and S., but there was nothing in their positions to show from which quarter they had come.

The late Robert Chambers (Edin. New Philosoph. Journal for 1853, p. 254), mentions having seen in Kerrera Island "numerous smoothed (rock) surfaces dipping into the sea, with striations from N. 60° W., being nearly the same direction as Mr Maclaren's W.N.W." I did not fall in with any of these. He mentions "that on the high grounds above Tobermory, in Mull, there are striæ pointing from N. 60° W."

3. Having been informed of a large boulder on the hills on the south side of the road between Oban and Connal Ferry, on the farm of *Dunbeg*, I called on Mr Brown the tenant, and induced him to guide me to the place. The hill-slopes here face the north, and the boulder was on one side of a niche in this range of hills. The Linnhe Loch is on the north side of the range.

Its position between the hills is indicated by x on the annexed diagram (fig. 1), which shows the ground plan of a narrow valley,

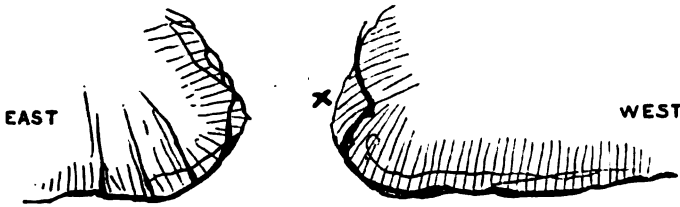

Fig. 1.

open at each end, about 500 yards in length, about 50 yards wide, and with sides from 200 to 300 feet high. Fig. 2 shows a section

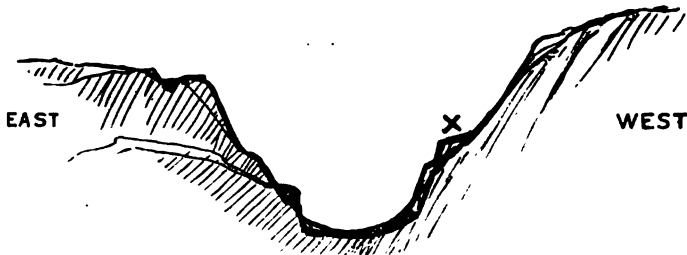

Fig. 2.

across this valley, with the boulder on the west side, upon a shelf, at the height of about 250 feet above the sea. The boulder measures 11 x 6 x 5 feet, and the longer axis points N.N.W. and S.S.E.

The axis of the valley, which rises to the south, is N.W. and S.E.

The rocks here are clay slate, the boulder is grey granite.

In reference to the transporting agent, it is almost certain that the boulder must have been brought into the valley, by either its north or its south end.

From the boulder, Ben Cruachan is visible, bearing E.S.E. at a distance of about 10 miles. If a glacier be thought of to bring it from Cruachan, there are hills and valleys in the way, rendering the course of a glacier along that line most improbable. The more natural course of a glacier would be down Loch Etive. On the other hand, there seems to be nothing improbable in the supposition, that it may have been brought by floating ice from the north.

In making a short tour across the adjoining hills, I found many other boulders of grey granite, and mostly on hill slopes facing the north. One of these boulders, $6 \times 4 \times 4$ feet, lay on a sort of shelf blocked at its S.E. end.

4. At *Dunstaffnage*, about 5 miles N.E. of Oban, there is a conglomerate rock on which the old castle stands, as shown on fig. 3.



Fig. 3.

The rock at the west end is about 30 feet above the general level of the land, and it extends horizontally for about 50 yards. On its east side the rock, though extremely tough, and full of large pebbles of quartz and other hard rocks, has been well smoothed by some agent of great weight and power which has come from the eastward.

The conglomerate rocks on the beach below the castle, present similar smooth surfaces facing the east.

Having learnt from the keeper of the castle, that smooth rock surfaces occur on a small island a few hundred yards to the east of *Dunstaffnage*, I procured a boat, and found two high knolls of conglomerate rock, as shown in fig. 4, smoothed in a similar manner.



Fig. 4.

In going along the south bank of *Loch Etive*, one sees at numerous places great sheets of similarly smoothed rock, indicating, apparently, the action of a glacier which had moved down the valley now occupied by the loch. In the Fifth Report of the Committee (page 45), notice is taken of the *Airde Point*, on the west side of *Loch Etive*, where the rocks facing the south, *i.e.* up the glen, were found smoothed up to a height of 276 feet above the sea.

In passing along the new line of railway, between Oban and Loch Awe, one can notice many smoothed rocks, all like those before-mentioned, facing Loch Awe. A number of these smoothed rocks are covered by beds of fine gravel, sections of which, showing rock and gravel, are well seen on both sides of the railway which cuts through them. The best examples are near the village of Stonefield, to the east of Connal Ferry. The height above the sea here is about 40 feet, and traces of the well-known sea-terrace, so prevalent around the coast, are here observable. As one advances towards Taynuilt and Bridge of Awe, the detritus occurs in larger quantities. At Bridge of Awe it forms mounds, which are no doubt due to the removal of other portions of the detritus by the rains and streams descending the steep sides of Cruachan on the one side, and of the hills on the opposite side of the Etive valley. The Awe itself has on its banks, scours of detritus 20 to 30 feet in depth, and there are marks showing that the river has run in a different course and at a higher level.

The whole of this valley is full of boulders of granite, mostly grey, but occasionally red. These boulders generally lie on the detritus, and in many cases are covered by peat which has grown in the pools, or what had been pools, in the detrital hollows.

On ascending the hills on the west side of Bridge of Awe, which I did to the height of about 400 feet above the sea, I found boulders, especially on the slopes facing the north and east. They may, no doubt, have crossed the valley from Cruachan. I measured several of the largest, which were 5 or 6 feet in length by 3 or 4 feet in width and height. There were among them small boulders of well-rounded quartzite, which suggested a northern origin.

The large granite boulder on the roadside between Taynuilt and Bridge of Awe, nicknamed Sir Walter Scott, lies on detritus.

5. *Loch Sweyn*.—Having heard of some large-sized boulders in this neighbourhood I went there, accompanied by Mr Alexander of Loch Gilphead.

At Ardna, on the farm of Mr Macmillan, near Kilmory Bay, I examined a surface of smoothed slate rocks, covered by long and deep striations running W. by S. and E. by N. Unfortunately I omitted to observe from what direction the striating agent had moved, but as the smoothed surface of the rock sloped

down towards the west, it is probable that the striating agent had come from the west.

On this smoothed and striated rock, there were large boulders of grey granite; I measured two, of the following dimensions, viz., $15 \times 12 \times 5$ feet and $13 \times 5 \times 5$ feet. Their longer axis was the same, viz., W.S.W. It is proper to remark, that the sea-lochs in this part of the coast occupy troughs which lie in a direction W.S.W. and E.N.E., and that the ridges of land which separate these lochs run in a similar direction.

The boulders and striated rock just mentioned are on the S.E. side of the ridge which divides Loch Sweyn from Loch Killesport. But on crossing the ridge north towards Loch Sweyn, I found most of the boulders on the hill slopes which face the N.W. all lying in the same manner, viz., with their longer axis parallel to the loch and to the ridge of high ground. On *this* slope, the boulders are in *thousands*. I measured a few of the largest,—one was 15 feet square and 8 feet high, another $18 \times 7 \times 5$ feet. The ridge between the two lochs rises gradually to the eastward inland to a height of from 500 to 700 feet.

In this district I saw no detritus. If there ever had been detritus it had been swept off, as the rocks *in situ* were everywhere visible, and the boulders were lying mostly on the bare rock. Of moraines I saw no appearance. Sitting on this hill slope, and pondering from what quarter these boulders in such numbers could have come, it appeared to me that, in order to reach and remain on this hill slope, they could have come only from the N.W. If the agent which brought them, had come *down* the loch from the N.E. there was nothing to cause them to stop and remain where they now are;—they would have gone on towards the open sea at the lower end of the loch. If they had come from the S.W. there was nothing to obstruct their further progress up the loch.

In walking further up the loch, Mr Alexander and I passed a rock surface, pretty steep, and sloping down southwards, on which there were many deep striæ running W.S.W. and E.N.E., parallel with the general axis of the valley. The striating agent seemed to have come up the loch. This was at a place named on the Ordnance Map "*Doide*." Here we obtained a boat and crossed over to *Dinna Island*, to examine a large boulder which gives its name to the farm "*Danna na Cloiche*."

The boulder would be of the shape of a pear, were a horizontal section made through its widest part (fig. 5). Its sharpest end



Fig. 5.

points S.W. Its height is about 15 feet, and it has three sides tolerably flat, each about 15 feet wide. I calculated its weight at from 60 to 70 tons.

Its axis coincides with the general direction of the valley, and its sharpest end is towards the sea, creating a presumption that something floating up the loch may have put it and left it in that position.

The boulder is nearly opposite to Castle Sweyn, which is on the south bank of the loch. There is a rocky knoll about 40 feet above the loch on which the castle had been built. On the west side of this knoll there is a great number of huge angular boulders, which seem to have come from the westward, and been intercepted by the knoll in their progress eastwards. The narrowest part of the loch is at Castle Sweyn, so that it was the most likely place for an obstruction of ice rafts from the west.

Mr Alexander of Lochgilphead, to whom the Committee are indebted for much valuable assistance in giving information about boulders on the west coast of Argyle, told me of a cluster of boulders on the farm of Taynish, about 4 miles to the south of Tayvallich, on Loch Sweyn. There is one large boulder from 9 to 10 feet high, surrounded by a number of small boulders. They lie on a bit of bare rock. The land slopes towards S.W. They are about 30 feet above the level of the sea, and distant from it about 300 yards.

Immediately to the east of the boulders there is a level plateau or beach, which may have been formed by the sea, when it stood at a higher level.

These boulders, Mr Alexander says, appear to have been transported from a S.W. direction. There are low hills to the north-eastward, which probably obstructed them in their further progress to the eastward.

6. *Ardrihaig*.—In ascending the hill to the west, on the lands of Auchindarroch, accompanied by Mr Alexander of Loch Gilphead, I had pointed out to me by him a gneiss boulder, $9 \times 7 \times 6$ feet, lying on a smoothed rock of clay slate. Its longer axis lay N. and S., its sharpest end being to the north. Another boulder, somewhat higher up, was seen, $16 \times 13 \times 6$ feet, with its axis also N. and S. The slope of the hill here is down towards the S.E. These were at a height of about 300 feet above the sea.

On going higher up the hill and coming to a slope facing N.N.E., I fell in with many other boulders of such sizes as the following— $9 \times 7 \times 6$ feet, $8\frac{1}{2} \times 7 \times 4$ feet. These two were on the same slope, and one above the other, at a distance of about 15 yards. They must certainly have come from some northern point.

BERWICKSHIRE.

In July 1880, I was requested by Captain Norman, R.N., to examine some boulders which he had discovered in a ditch on a roadside situated about a mile to the north of Berwick-on-Tweed.

Having accompanied him to the spot, I found four boulders, each weighing from half a ton to one ton. Two of the boulders were of fine-grained granite,—one of them grey in colour, and the other with a shade of pink. They had most probably come from Cockburn Law, situated about 15 miles (as the crow flies) to the N.W.—the only hill of granite in this S.E. district of Scotland. The other two boulders were a dark porphyry. Lamberton Hill, situated to the N. and N.N.W., about 2 miles off, is composed of porphyry of several varieties. The site of these boulders is about 250 feet above sea-level.

BUTE.

1. W. J. Millar, C.E., Glasgow, having, during the last two years, had occasion to be frequently in Bute, and having taken notes of the boulders lying about the coast near *Rothesay*, and to the north of it, had the kindness to draw out for the Committee the following list of boulders observed and studied by him.

(1.) On the shore to the east of *Rothesay*, at *Glenburn*, a chlorite schist boulder $6 \times 5 \times 5$, with large veins of quartz, weighing probably about 7 tons. It rests on the red conglomerate of this part of the island.

(2.) Near *Craigmore pier*, east of *Rothesay*, about 30 feet above sea-level, a boulder of very coarse pebbly schist, about $3\frac{1}{2}$ feet long, well rounded and smoothed on lower side. It was near the mouth of a disused whinstone quarry, among conglomerate gravel.

(3.) Farther east, and south of a point of land a little below high-water mark, there is a boulder of trap, 6 feet long, resting on red conglomerate rocks.

(4.) On ascending the hill from the last-mentioned place, several micaceous schist boulders are met with, two measuring about 3 feet across, one about 70 feet, and the other 120 feet above sea-level.

(5.) Still farther up the hill, and on road towards *Rothesay* through a wood, at 150 feet above sea-level, there are many schist boulders, well rounded and smoothed, some about 3 feet in length.

At 180 feet above sea-level, there is a coarse schist boulder $5 \times 2\frac{1}{2}$ feet, one end round and smooth, the other end rough and angular—longer axis E.N.E. by compass.

(6.) Nearer *Rothesay*, on same road, at about 200 feet above sea-level—a mica schist boulder, about 6 feet long, rounded at one end and rough at other end.

(7.) In great sandpit above and behind *Queen's Hotel*, *Rothesay*, a mass of coarse gravel lies above sand, forming a bed about 12 feet thick. The underlying sand is of unknown depth, but a face of it is seen for about 30 feet vertically, with a length of about 200 yards. Several boulders of gneiss occur in the sand, the largest about $5 \times 3 \times 2$ feet. North-west of this sandpit, and near it, there is a smoothed rock about 120 feet above sea-level. As its smoothed

surface looks northwards, the smoothing agent must have come from some northerly point.

(8.) At Ardbeg, north of Rothesay, there are many boulders on the shore—one $9 \times 8 \times 5$ feet, another $10 \times 7 \times 5$ feet; one is quartz or chlorite schist, the other trap. The rocks *in situ* are chloritic slate, dipping S.E. 56° . First-mentioned boulder has its longer axis pointing N.W. and S.E.

(9.) Near the head of Port Bannatyne Bay, there are hundreds of boulders on the shore seen at low water, all well rounded. Those which are long shaped generally lie S.E. and N.W.

Near the head of Port Bannatyne, in a field about 30 feet above sea-level, there is a coarse schist boulder $4 \times 2 \times 2$ feet, one side finely smoothed, with ruts on it parallel to longer axis.

(10.) At Ardmaleish Point (entrance to Kyles of Bute) there are many schistose boulders, some coarse and pebbly, others fine-grained. The largest is $8 \times 8 \times 6$ feet. They lie on blue slate rocks.

(11.) At north end of Bute, opposite to Colintravae, the rocks, up to 230 feet above sea-level, are rounded and smoothed. They consist of mica schist, in some parts coarse and pebbly. Some of them quite resemble the boulders at and near Ardmaleish Point.

At 380 feet above sea-level, the rocks are smooth on their sides facing the N.W., but rough and fissured on their eastern sides. Blocks lie below them on these east sides.

(12.) Around Bull Loch, the rocks, at 560 feet above sea-level, are well smoothed, and form a steep wall facing N.W.

(13.) Notes applicable to district about 3 miles south of Rothesay:—

(a.) *Ascog Loch*, about 100 feet above sea-level; at north-east end, a great number of schistose boulders; at north-west end, a large quantity of schistose stones. The rocks *in situ* here are red conglomerate.

(b.) *Loch Fad*.—On the N.W. of this loch, there is a hilly range running N.E. and S.W., and reaching heights of from 400 to 450 feet above sea-level. In one part, there is a gorge through which something has passed, smoothing and striating the rocks. The striae point S.E. and N.W. On the south slopes of this range, lie a number of blocks which seem to have been transported, being too distant from any cliffs from which they could have fallen by mere gravitation.

To the south of this hilly range, and perhaps an extension of it, there is a hill (not named in Ordnance Map) about 480 feet high on the north side of *Dhu Loch*. This hill on its north side presents rock-surfaces, rounded and smoothed. On its south slopes there are boulders, two of which I measured, viz., $6 \times 5 \times 2$ feet, and $6 \times 4 \times 2$ feet.

Close to *Dhu Loch*, there is another boulder, $6 \times 5 \times 4$ feet, at about 320 feet above the sea.

The rock composing these boulders is apparently similar to that of the hills to the south of which they lie. What occurred to Mr Millar was, that they had been riven from the rocks of these hills by some agent, which passed over and across them from the north.

2. The Convener having in October last gone to *Rothesay* for a few days, examined several of the boulders on the east coast, mentioned by Mr Millar in the foregoing notes:—

One day was devoted, in company with Mr Millar, to a portion of the *West Coast north from Ettrick Bay*. A great many large boulders were found along the shore, showing transport from the north-west.

In Ettrick Bay itself, there are only a few boulders, and these are situated at the north side of the bay. The coast to the north of the bay runs in a line about N.N.W. by compass. To the south of that bay the coast-line runs about S.S.W. The position of the boulders is indicated on the annexed diagram (fig. 6) by x x x.

At the north end of Ettrick Bay, there is a compact ridge of rock, a sort of trap dyke, which stands from 10 to 15 feet above

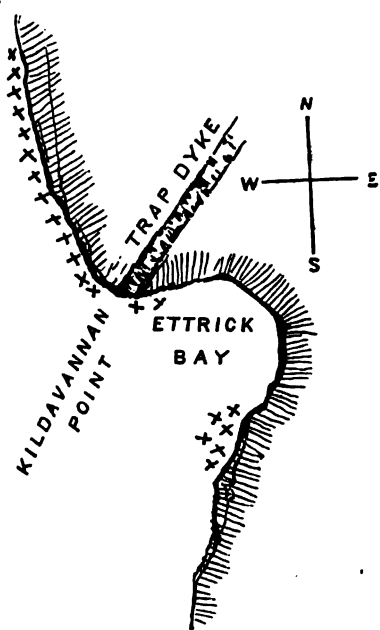

Fig. 6.

the adjoining surface of the land with vertical walls. The public road runs along the coast both north and south from Ettrick Bay, so that there is ample opportunity of studying the boulders lying on the shore.

At or very near Kildavannan Point a boulder of pure quartz first attracted attention, $6\frac{1}{2} \times 5\frac{1}{2} \times 4$ feet, weighing about 10 tons. From the way in which it was blocked on its east side, it seemed to us probable that the parent rock would be found to the west. Accordingly, at a distance of about 100 yards, a very large mass of quartz rock was found *in situ* among the slate rocks.

The boulder next met with was one of gneiss, $11\frac{1}{2} \times 7 \times 5$ feet, weighing about 30 tons. Its sharpest end pointed N.N.W. There was vertical slate rock under its east end, which seemed to have obstructed its progress eastward (see fig. 3, Plate III.).

There was another gneiss boulder $8 \times 7 \times 6$ feet, also on slate rocks, and blocked in a similar manner at its east end.

At one place the slate rocks, which are nearly vertical, and running in a direction about S.W. and N.E., presented a vertical wall on the beach of several feet in height, facing the north; a gneiss boulder, $12 \times 8 \times 5$ feet, weighing about 35 tons, rested against this north wall in such a way as to show it had been pushed from the north, and had been stopped by the rock. A number of smaller gneiss boulders were on the beach close to the north side of the slate rocks (see fig. 4, Plate III.).

Many more examples of the same kind were observed along the coast for about 3 miles. The boulders are larger in size towards the north.

On returning back to Ettrick Bay, a visit was paid to the coast, on the south side of the bay. It has been already mentioned that in Ettrick Bay, on the shore, there are no boulders, but to the south of the bay they again occur, most of them gneiss, though there are also some of granite. A sea-wall, lately built to protect the high road, contained a large number gathered off the shore, and others were showing their heads above water at a distance from the shore. The same agent which had carried or pushed the boulders along the coast north of Ettrick Bay, had continued its S.S.E. course across the mouth of the bay, and dropped boulders on the coast beyond the bay. The high ridge of rock at Kildavannan Point,

before referred to, had probably to a certain extent protected the bay from any influx of boulders. If the transport of the boulders was due to ice floating on a current of the sea from N.N.W., this may have occurred when the sea stood several hundred feet above its present level, in which case the Kildavannan ridge might still have acted in the way now suggested, as it runs up the land, in a north-easterly direction, to a considerable distance.

All along the part of the west coast just described, the 40 feet old sea-margin is exceedingly distinct. Those at higher levels, seen elsewhere on the West Coast of Scotland, were not observed in this part of Bute.

3. On the following day the Convener, under the guidance of Mr Millar, paid a visit to *Barone Hill*, situated about 2 miles to the S.W. of Rothesay, and reaching to a height of about 530 feet above sea-level. Plate II, fig. 2, gives a sectional outline of the hill in an east and west direction. The hill was first approached by us from the eastward, and there was a close examination of the bare rocks on the north side in search of smoothed faces. One or two were found, though not of so decided a character as to deserve special notice. Beyond the principal hill, about half a mile farther west, there is another hill, reaching a height of about 430 feet, with a gully between the two, on which Mr Millar discovered markings of a very interesting character, and called to me to come and examine them. This gully is about 30 yards wide, having sides of bare rock more or less vertical—the rocks on the east side higher than on the west side. On entering this gorge (A figs. 2 and 3), it was at once seen that something had passed through it from the north, leaving unmistakable traces. What first attracted attention was the smoothing of the rocks at *d* on the principal hill, and on the opposite side of the gorge at *eee* (see figs. 2 and 3 in Plate II.).

On the west side of the gorge, the number of places ground down and smoothed are more numerous, one reason for which might be that the rocks appeared less hard than on the opposite side. On that side, there are some isolated patches of rock, well smoothed, because they had apparently encountered the full force of the agent which had passed through the gorge; but there are other patches, as at *f*, quite rough, because apparently under the shelter of others.

land about 250 feet above sea-level. There also a portion of rock was discovered, consisting of strata nearly vertical, and ground down so as to form a flat surface. The edges of the strata were all abraded and smoothed in such a way as to show a passage over them of some hard and heavy body from the north.*

ISLAND OF COLONSAY.

1. *Notes by Mr William Stevenson, 12 Meadowfield Place, Edinburgh.*

(1.) The rocks of the island generally are of a slaty nature, in some places curiously bent or twisted.

There are also places where granite rocks occur, as at and near the small boat harbour of Scalasaig, on the east side of the island.

The rocks inland from the harbour are in a sort of glen, through which a road passes. The granite rocks are seen there.

The walls of the harbour are built of this granite rock. It is of a grey colour; but being somewhat soft in texture, it was faced with a yellow-coloured granite brought from Mull in ships.

(2.) On the west side of the island is Port Mor. It is only a bay. Its shores are thickly strewn with boulders of all sizes, up to several tons in weight. They are mostly covered with sea-weed.

* Since this report was written, I have discovered a reference to the glaciations of this part of Bute, in a valuable paper by Professor Geikie, "On the Glacial Drift in Scotland," in the first volume of the Glasgow Geological Society's Transactions. The following extracts may be given, as confirmatory of what is said in the Committee's report:—

"A most wonderful exhibition of worn mammilated and striated rocks in this part of Scotland, occurs among the slate hills to the north of Loch Fad, one of a chain of lakes which nearly cut the Island of Bute into two. The hard silurian strata dip at high angles towards the S.E., and present in consequence their upturned edges towards the N.W. But instead of forming rough-rugged crags, as these rocks when left to themselves tend to do, the slates and grits are thrown down into the most perfectly smooth-faced knolls. The edges of the beds have been planed off obliquely. Moreover, on *Barone Hill*, the top of which is about 520 feet above the sea, the abrasion has been done by an agent which came up the steep northern face of that eminence, went right over its summit, and pursued its course down into the next valley beyond. The striations run from N. 15° W. to N. 20° E.

I was informed by Mr Donald M'Neill, a very intelligent farmer, long resident on the island, that many of the boulders in that bay resemble yellow Mull granite.

Mr M'Neill pointed out to me several boulders on his farm of Lower Kilchattan, which have distinctive names, some of them weighing from 2 to 3 tons.

He also spoke of a large boulder on the west shore, about a mile to the south of Port Mor, between Dun Gallon and Ardkinnish, called Fingal's Putting-Stone.

He mentioned that at Kiloran, on the north-west part of the island, there is a sandy bay which leads to another bay called Port Shipness, where there are many boulders.

Some large boulders are said to lie on the small islands to the east of Oronsay Island, where the old cathedral stands.

On several ridges of Colonsay, sloping towards the west, boulders occur, as at Mullbuie and Schoolhouse Brae. Those on Mullbuie are about a ton in weight.

All the hill tops are smoothed. On *Carnan-re-Erium*, the highest hill in Oronsay, there are said to be tracings of ice-markings; but I had not time to search for them.

In different parts of the coast there are shingle beaches composed of well-rounded, whitish-coloured hard stones, about the size of a man's head, and under. Ships come sometimes to take away these stones, to be used for paving-stones.

2. Notes by Mr Donald M'Neill, Lower Kilchattan, Colonsay.

(1.) At the north-east of the island, on the farm of Balnahard, there are granite rocks.

At Scalasaig there is granite rock on the shore, and not far inland.

The granite rocks in Colonsay are everywhere of a dark grey colour.

(2.) The yellow granite used for building the harbour at Scalasaig was brought from Mull by ships—a distance of about 12 or 13 miles.

(3.) There are boulders in various parts of Colonsay.

Those which are granite are (in my opinion) foreign to the island, being of a lighter colour than the rocks of the island. By some unknown means, they have been brought to where they now lie.

(4.) There are boulders of granite, whinstone, and quartz. Those of granite are generally on hill tops.

Those which I mostly noticed, are lying on hill tops and slopes of hills. There are also a number along the shore, on the west side of the island.

(5.) The boulders like paving-stones are mostly on the north and west sides of the island, along the shore.

They are all rounded, and of an oblong shape generally, from the size of fine gravel, till some would rank amongst boulders. The highest bank of these heaps of paving-stones above the sea shore that I know, will be some 80 feet.

The Colonsay shingle beaches are the same as Jura's for nature of the stone ; but I believe Jura's are longer in extent, but not any higher above sea-level.

(6.) The Putting-Stone of the Fingalians lies on the sea side of Ardsकिनिश. It is one of the largest boulders in Colonsay. I believe it is whinstone, and weighs some 4 tons at least. It is round in shape. Tradition says the Fingalians used to throw it across the bay from where it lies, to Dungallon on the opposite side.

The boulders that I am mostly acquainted with, are on hills sloping towards the south.

Boulders are lying on Colonsay's highest hills. I don't know how high above sea-level they are.

The foregoing notes, though supplied by gentlemen, neither of whom has geological knowledge or experience, appear to me exceedingly valuable. They show that on Colonsay there are boulders well deserving of study, in order to ascertain from what quarter they have come. From the fact stated by Mr Stevenson, that many boulders lie on hill sides sloping towards the west, it is probable that the boulders came from some westerly point,—perhaps from the Island of Mull. But by an examination of the manner in which the boulders have been set down or placed, by

the agent which brought them, a conclusion on this point may be arrived at.

The thanks of the Committee are due to Mr Stevenson and Mr McNeill for their attention to the Convener's application to them in this matter.

LINLITHGOWSHIRE.

1. Two years ago, the Convener, having been kindly invited by Mr James Melvin, tenant of Bonnington Farm, to examine some boulders near his farm, went there under his guidance.

On *Pumpherston* Estate there is a bit of ground higher than any adjoining district, on which there is still a considerable number of boulders, though formerly there were more. The height of the spot is about 430 feet above the sea.

The largest goes by the name of the "*Ballengeich Boulder*." It is in girth 10 or 12 feet. The spot on which it lies is about 3 feet above the adjoining ground. The boulder, though at one time an entire mass, now consists of eight fragments. How it has been broken, and when, is of course matter only of conjecture. It seems due to some natural cause. It may have been caused by atmospheric action, or by falling from a height.

It is evidently an erratic,—being a coarse dolerite—of which there are no rocks known nearer than the Bathgate hills to the N. W.

The eight fragments combined would produce a mass of from 50 to 60 tons.

Mr Maclagan, M.P., the proprietor of the land, having been so obliging as to send a labourer with a pick and spade, a pit was dug in two places adjoining the boulder to ascertain the nature of the substance on which it was lying. Boulder clay of a blueish yellow colour was below. The block had sunk into it about a foot.

2. Not far from this boulder there is another, about a quarter of a ton in weight, of quartzite with crystals of green mica, most probably from the Highlands.

The other boulders were smaller in size, and of ordinary trap,—a rock abounding in many of the adjoining hills.

3. On the farm of *Bonnington*, there is a boulder known as the "*Witch's Stone*," about the same size as that on *Pumpherston*, at a height of about 431 feet above the sea.

It is on *Tornain Hill*, and on a slope, which faces W.N.W.

It is a dolerite, though not so coarse as that on Pumpherton.

Mr Melvin had an excavation made under the boulder, and ascertained that it rested partially on the trap rock of the hill; this rock, however, being different in composition from that of the boulder. The nearest rock of the same kind, known to Mr Melvin, he stated to be in the Bathgate hills, situated about 5 miles to W.N.W.

There is a valley between these hills and Tornain Hill, across which the boulder must have been transported.

This boulder, like that at Ballengeich, has been broken, and consists of six fragments. The principal mass lies to the west of the fragments, as if they had been broken off by some force from the westward; or they may have been broken off by concussion if the original mass fell from a height.

The fragments have certainly not come off at any recent period. Judging by their surfaces they look quite as ancient as the principal mass.

The principal mass is well rounded on all its sides, suggesting much rough treatment ere it reached its site.

Some interest attaches to the boulder on account of a set of "cup markings" on it, of which an account is given by Mr Smith in a late volume of the "Transactions of the Scotch Society of Antiquaries."

It is right to add that if a line be drawn from Tornain Hill to the Bathgate hills, it passes close to the site of the Ballengeich boulder.

4. Mr Melvin mentioned to the Convener that, on the S.E. side of this Tornain Hill, there was once a dolerite boulder (which he had seen) measuring $21 \times 5 \times 4$ feet, lying with its longer axis E. and W., and at a height of about 300 feet above the sea.

If it came from the Bathgate hills (which was probable), it could, in his opinion, have come only by floating ice, through the valley between Tornain and the Crow hills, *i.e.*, from the westward.

5. Mr Melvin further informed the Convener, that in the channel of the River Almond, below Kirkliston, there is a boulder of Old Red Sandstone conglomerate,—the nearest parent rock of which was probably the well-known belt of conglomerate crossing

Scotland in a N.E. direction from Dumbarton. This conglomerate boulder, $5\frac{1}{2} \times 4\frac{1}{2} \times 4$ feet, had its corners well rounded. The nearest point to the parent rock *in situ*, would be at or near Callander, a distance of about 40 miles, in a direction about N.W., with several ranges of hills and valleys intervening.

6. Mr Melvin, at Ratho Railway Station, drew the Convener's attention to the greenstone rocks there, how they are well rounded and smoothed on their sides facing the W. whilst on their sides facing the E. they were rough.

He also pointed out how, on several of those smoothed surfaces, there are numerous striæ and ruts running in a direction W.N.W. and E.S.E. (magnetic).

Portions of these smoothed and striated rocks are covered by boulder clay or till, containing many small boulders and hard pebbles, which, by passing over and pressed down on the rocks, might have produced both effects.

A number of large trap boulders were lying about. The largest examined, weighing between 2 and 3 tons, has horizontal striæ on its side, which faced N.N.W. These striæ might have been formed by a force coming in a direction from W.N.W. and striking obliquely on that side of the boulder.

This locality is at a height of from 180 to 190 feet above the sea.

NOTES BY PROFESSOR FORSTER HEDDLE,
OF ST ANDREWS UNIVERSITY.

LOWLANDS.

In April 1880, whilst there was still so much snow on the Highland hills as to render explorations on them impossible, the Professor went to Dumfriesshire, having received notice of two boulders among the Wanlockhead hills.

(1.) The first he examined, called "The Crooked Stone," lies in a field on the right bank of the Clyde, about 3 miles above Elvanfoot Station. The stone protrudes above the surface about 5 feet. Its width is nearly 5 feet; its thickness about $1\frac{1}{2}$ feet.

It is on a knoll projecting somewhat above the adjacent river-terrace.

The rocks about *in situ*, are Greywacke. The boulder is also Greywacke, but much more gritty than any of these rocks in its neighbourhood.

In walking some distance up the valley, at the mouth of which the boulder lies, gritty rock, similar to that of the boulder, was met with on the slopes of Dunlaw Hill.

(2.) The other boulder lies within a field on the north side of Cranwich Water, about half way between the farm of Crossbank and Spango Bridge.

This stone protrudes about 4 feet above the ground,—and is nearly rectangular, the breadth of the sides being each about $2\frac{1}{2}$ feet.

It is a Dolerite, formed of platy augite in large crystals, with very little felspar. It has an unusually rough surface. It differs from any rocks in the neighbourhood, but resembles the rock of three Dolerite dykes which cross the country some miles to the north.

(3.) To try and discover the parent rocks of these boulders, a walk was taken along the central ridge of the Lowthers, as well as along several of the spurs and valleys stretching on the one hand to the Clyde, and on the other to the Nith, but without result.

To save trouble to future explorers, it may be mentioned that the following hills were ascended, viz., Lowther Hill, Green Lowther, Dungrain Law, Dunlaw, Hawk Wood, Broad Law, Hunt Law, Slough Hill, Stoor Hill, Glen Gober Hill, Low Mill Knowe, Clock-hill Hill, The Dods.

HIGHLANDS.

For the reason just assigned, the Professor notes in detail the various mountains visited, though no boulders were found on them. He observes, that had this practice been followed by previous geological surveyors, he would probably have been saved many a toilsome climb during the last two years.

But he states an additional reason for indicating the mountains where no boulders were discovered.

From last year's Report it will be seen, that he had observed, in at least two districts of Argyleshire, distinct "*streams of boulders*," while the districts adjoining these streams contained none.

The fact of there being two such streams, suggested the probability of there being others; so, as both of these streams indicated a direction about east and west, he resolved to cross the country in a north and south direction elsewhere, at the same time following, as much as possible, the ridges of the hills lying that way, and climbing to the summits, for the sake of having an extensive view. Being accompanied in this expedition by two or three friends, each provided with a binocular, it was not likely that boulders of any size, visible within half a mile of the route followed, would be missed.

Professor Heddle carried with him an Ordnance map with contour lines, which at once indicated the heights of the hill ranges, and on these he has drawn, with a thick red line, the exact route taken. This map he has sent to the Convener. To him it has been of much service by enabling him to follow the Professor's notes.

But, before specifying the names of the hills visited, and the results, it is not unimportant to notice some remarks by the Professor of a general nature bearing on the best way of boulder hunting.

He states that former explorations had impressed upon him the advantages of making a search chiefly along hill ridges, and of scaling hills to their summit. In the *first* place, a more extended range of observation is obtained, and in the *second* place there is more probability of finding the boulders in their original positions.

If boulder hunting is carried on in glens or valleys, as has hitherto usually been the case, the range of observation is exceedingly limited;—whereas, from a hill top, a panorama of a wide range of country may be obtained, which, besides showing boulders, makes the gradients of the country more intelligible, and indicates where there may have been passages for ice, whether land or sea ice.

Another advantage is, that if boulders are met with on hill tops or hill ridges, it is almost certain that they occupy the position in which they were originally placed by the agent, whatever it was, which brought them. But boulders in a valley, or on the sides of a valley, may have rolled down from a higher level, and thus afford far fewer data for safe reasoning.

Professor Heddle observes that there are ranges of hills of con-

siderable elevation, more or less continuous, which stretch northward, commencing near Rowardennan, to the south of Ben Lomond, and reaching to the neighbourhood of the Dochart and Loch Tulla, where the stream of boulders was first recognised by him in the previous year.

1. This accordingly was the general line of route he decided to take, and the following is a diary of his explorations.

First Day.—Rowardennan to Invermaid, by *Ben Lomond* (3192 feet).

Near Rowardennan, much appearance of glaciation along banks sloping to the loch, showing a southerly movement.

A dyke of Diorite strikes eastward above Rowardennan to a height of about 450 feet. A few small blocks from this dyke lie a short distance from it on its south side;—but there are none on the north side.

At the foot of the north slope of *Ben Lomond*, a very unusual and characteristic Greywacke rock *in situ* was noticed. It contains nodules of milk-white quartz larger than almonds. It will be referred to when an excursion along the Ochils comes to be mentioned.

No noticeable boulders were found.

Second Day.—Crossed Loch Lomond, and went along the whole ridge of *Ben Vorlich*, and over its two summits (3092 and 3055 feet) on to Inverarnan. *No boulders were seen.*

Third Day.—Ferried the River Arnan, and went along the terribly rough ridge of *Ben-a-Chabair* (3054 feet); then down into the col between it and *Ben-a-Chastle*; then up to the top of *Ben-a-Chastle* (3265 feet); then down along its ridge (where saw the *Brocken*, for the second time in Scotland) to Crianlarich. *No boulders.*

Fourth Day.—Went over *Crag Loisgte* (2750 feet), *Ben Challum* (3354 feet), down to Strath Lochy; then over *Stron-nan-Eim* (2747 feet) and *Creag Mhor* (3387 feet); then, down into the col between its second top and *Cam Chreag* (2887 feet); next, over the latter into *Glen Choilleun*, then, over *Beinn Odhar* (2848 feet) and down its ridge, back to Crianlarich. *No boulders seen.*

But in the col between the second top (name not given in inch map) of *Creag Mhor* and *Cair Chreag*, some interesting and puzzling appearances attracted attention, which the Professor says he had noticed in other parts of Scotland.

At the very head of the col (2480 feet), just where it folds over to the watershed, where streams rise to flow in opposite directions, "there are numerous heaps of gravel similar to what are known among the Swiss glaciers as 'dirt cones.' These were higher and larger in the sides of the trench than in its centre. They continue but a short distance down the valley on each side, diminishing in size towards the lower levels."

If "dirt cones" (as is generally alleged) be formed by running water on the surface of ice, carrying stones over the edges of the crevasses and depositing them at the bottom, may it not be inferred that there was a mass of ice here which, at the col, broke into two divisions, forming a glacier for each valley?

(The Professor remarks, that this was the second hardest walk during one day which he ever took, the distance travelled being 26 miles, and the amount of ascent being 7900 feet.)

Fifth Day.—Returned to re-examine the col, going by the valley between *Ben Chaluum* and *Ben-nan-Marsen* to top of *Creag Mhor's* second top, then over the col to *Cram Creag*, and back by *Glen-a-Clachain*.

No boulders seen.

Sixth Day.—From Tyndrum over *Ben Doreann* (2523 feet) to Inverarnan. *No boulders* were seen, except some mentioned in last year's Notes (these apparently omitted to be noticed in last year's Report), near the bridge over the Orchy.

Seventh Day.—Examined the sides of *Ben More* (3843 feet), *Stob Luib*, and the trench of the Dochart. Found the highest glacial markings to be upon *Stob Luib* at a height of 750 feet above Luib Railway Station.

From the material of the till, and the closed nature of the country, the Professor concluded all to be due to a local glacier rising in *Ben Laogh*, and largely fed from *Ban-nan-Imarean* (2769 feet) and other hills north of the Dochart; the glacial striae on *Stob Luib* pointing more to these hills than directly up the glen. *Ben Laogh* bears W.N.W.

Eighth Day.—Went over *Ben More*, *Am Binnean* (3827 feet), *Stob Choire an Lochan* (3497 feet), *Am Mam* (2500 feet) *Meal Monachyle* (2122 feet), down the *Braes of Balquhidder* to Loch Earnhead. *No boulders* and *no glaciation* over the great

col between *Ben More* and *Am Runican* (2800 feet) were seen.

Ninth Day.—Went over *Ben Vorlich*, then over *Stuch a Chroin*, *Meal Odhar*, to Callander. *No boulders.*

Tenth Day.—From Callander over *Ben Ledi* (2882 feet); a hill ridge to *Ben Vane*, and down to *Strathyre*. *No boulders*, except some of gneiss near Callander. (On three of these days Professor Heddle was alone, on the others he was accompanied by a party of never smaller than four. The sides and ridges of the hills were swept by binoculars.)

Professor Heddle's notes next mention his return to Arrochar, and on the *first* day ascending the *Cobler* (2400 feet), making the circle of its summit, and descending to the col between *Ben Narnan* and *Beinn Ime* (3318 feet), and returning by the valley between *Ben Narnan* and the *Cobler*. He observed glaciation (ill-defined) passing north-eastward. There were a few rounded blocks of Syenite lying on the col, which seemed to have been moved in a north-easterly direction, from veins of that rock in the col.

On the following day he ascended *Ben Narnan*, through and by the sides of what he terms a "*Cradle Cup*," to its summit, and then down to the col between it and *Ben Ime*, over its summit to the col between it and the north hill (name unknown), down by *Choiregrogain* and back by *Glen Loin*. Boulders of the same Syenite were seen on several parts of *Choiregrogain*. Several veins or dykes of this Syenite were found, especially a very large one protruding from the north shoulder of *Crois* (2785 feet). Assuming that the boulders came from these dykes, they had by some agency been transported eastward.

The "*Cradle Cup*," lying between *Crois* and *Ben Arnan*, is described as "an elevated and confined little valley," with a rocky dam, which if *nevé* was formed there, might have retained it long enough to allow of it being converted into ice, supposing the climate to have been suitable. Not even in the contracted portion of valleys, is there so marked an amount of grinding, grooving, and polishing seen, as was seen upon the inner side of the rock dam of this "*Cradle Cup*." These evidences of ice action, at an elevation of only 1500 feet above the sea, are all the more remarkable, on account of the total absence of glaciation

throughout the whole sweep of *Choiregrogain* from its extreme altitude of 1700 feet down to the level of Loch Long.

The manner in which this little *Choire Sugach* is shut in from the west—*first*, by the spur which connects *Ben Narnan* with *Crois*; and *secondly*, by the towering bulk of *Ime* to the back of this; and *thirdly*, the palpable shedding of its ice to the eastward, out of a hollow surrounded with craggy and rough-edged rocks, and in a district which nowhere else shows glacial action, is unfavourable to the supposition that the ice which had been grinding the rocks had come either from any floating sheet from the west, or from any enveloping mantle from the east. The parts here seem to show that though elsewhere there may be examples of either or both of these agencies, there is evidence that the temperature of the country was at one period such that glaciers, however small, were generated and cradled among its hills.

From *Arrochar* Professor Heddle walked across the range of hills towards *Loch Gailhead*; one day was spent in visiting *Loch Restil* and *Ben Lochan* (2955 feet). On the following day he went up *Corry Corran*; then, over the shoulders of *Beinn Lochain* (2304 feet); then, into the trough of *Corry Lochain*; over the ridge and top of *Beinn Bheula* (2557 feet); over the north shoulder of *Cnoc na Trieriche*, down to *Lochan nan Onaimh*, over *Crauch nan Miseag* (1989 feet) and back to *Loch Gailhead* by the shore. No boulders, moraines, or traces of glaciation were seen during these two days.

Professor Heddle, on a review of the whole of the foregoing explorations, states that the South-Western Highlands appeared to be singularly barren of boulders at high elevations, and that the only traces of ice afforded evidence of glaciers of small size, formed in some of the valleys and hollows among the higher hills.

He thereafter decided to return to the more northern district of the Highlands, where in the previous summer he had met with boulders of large size, not only perched upon ridges, but forming streams, stretching for miles continuously.

As one of these streams had been found on the Moor of Rannoch, and extended eastward to and beyond Loch Tulla, he went to Fortingall, that he might from that point follow the chain of hills which block more or less the moor at its eastern end.

The course lay over *Ben Dearg* (2000 feet), *Creag Mhor* (3000 feet), an unnamed hill west of this (3240 feet), *Carn Mairg* (3419 feet), *Malharran Odhar* (2230 feet), *Geal Charn* (2595 feet), *Creag Mhor* (2250 feet).

Nothing was discovered on any of these hills till *Geal Charn* was reached. After the top of it was passed, and about 400 yards beyond it, at the height of 2498 feet, two boulders were found, about 100 yards from each other, and weighing each about 7 tons. This hill of *Geal Charn* with *Creag Mhor* to the north, forms a continuous ridge running nearly north and south, crossing therefore the great central trough, of which the Moor of Rannoch forms part, the general level of which moor is not more than from 900 to 1000 feet above the sea. If, as the explorations of the previous year showed, boulders had been dropped by some means from the west along Rannoch Moor in the form of a stream, none were likely to be found on any of the hills to the south of *Geal Charn*, as these hills were blocked by higher hills to the west, such as *Meall Garbh* (3048 feet) and *Meall Bnear* (2291 feet). On examining the rock composing these two boulders, Professor Heddle was of opinion that it was the same as that of the boulders lying near Loch Tulla, and which he had tracked, from one hill to another, till a rock *in situ* the same in composition was found on the high hill called *Albannach*, about 12 miles to the west. The only difference which he could detect was, that the rock of the *Geal Charn* boulders was "somewhat of a coarser grain."

Conceiving that this hill of *Geal Charn*, by lying transversely across the trench, had caught some of the boulders, it occurred to Professor Heddle, that as the loftier mountain of Schehallion, situated about 3 miles to the east, was also in such a position, that it may have intercepted some of the *Albannach* boulders, he ascended it on the following day.

He had not much expectation of finding boulders on it, as it forms an elongated range in a nearly east and west direction. However, when he was about 140 feet from the summit (that is 3407 feet above the sea), he did find at its west end, a boulder of *Albannach* granite, of about three-quarters of a ton in weight.

Professor Heddle states that he looked about for more granite blocks, but did not fall in with any. The sides near the top,

especially on the north side, he says, are covered by "loose blocks of the porcelain porphyry of which the hill is formed."

The Convener can on this point supply information obtained by himself some years ago, on the occasion of his ascent of Schehallion. He gives the following extract from his geological diary :—

"1872, August 27.—Went up Schehallion, in company with Principal Shairp of St Andrews and Professor Blackia. We began ascent at 1^h 50^a, and reached summit at 5^h 10^a.

"We went up by a ridge of the mountain running east and west. The height of hill I made by aneroid, 3450 feet. I believe Professor Nicol made it 3561.*

"For the first 1000 or 1500 feet, from where we began our ascent (at Braes of Forss) on east side, beds of sand and gravel were observed. Near the top, there were quantities of small pebbles, apparently fragments of the hill rock, which is a sort of hard sandstone, somewhat like quartzite. Near top, *observed a few small granite boulders.*

"The upper part of the hill, especially on side facing N.W. by W. (magnetic), was comparatively smooth, but saw no striations. On that side, however, the angles were more rounded than on any other side.

"On descending, we did not return along the ridge or back-bone by which we had ascended. We slanted down in a S.E. direction. On the way, I noticed *various granite boulders*, but none exceeding a ton in weight. I chipped some, and found them to be all a fine-grained gray granite. These were most numerous, at a height of from 2000 to 3000 feet above the sea.

"Observed also in our descent, that there were smoothed rocks, and chiefly at a height of about 2500 feet. I was struck with the fact, that I saw no smoothings *above* that height.

"Observed in the banks of the burns flowing down the south side of Schehallion, high cliffs of boulder clay, at a height of about 1200 feet above the sea.

"On showing my chips of the boulders to Principal Shairp, and asking if he had ever seen elsewhere rocks of a similar composition, he said he had been at Loch Sunart last year, and had noticed granite rocks there very similar to that of the boulders."

* By Ordnance Surveyors it is made 3547 feet.

The contour lines on the ordnance map indicate that the longer axis of Schehallion runs about W.N.W. and E.S.E. It has a large flank facing the W.S.W., which could, therefore, readily intercept any boulders brought from any point between S. and W.N.W.

Since the foregoing paragraphs were written, I have found further proof of there being granite boulders on Schehallion, in the following extract from a paper by the late Robert Chambers in the "Edinburgh New Phil. Journal for 1855" (vol. i. p. 101).

"Schehallion is composed of quartz rock. It is abrupt to the west, and tails away to the east. I found surfaces at several places bearing that peculiar streaking which I had remarked as a glacial phenomenon peculiar to quartz rock, on the mountain of Queenaig in Assynt. At about the height of 2200 feet above the sea, there is a fine group of examples. There is another similarly striated or streaked surface, a few hundred feet below the summit of the hill. The *direction of the striation* in both instances is W. 30° N. About 800 feet below the summit, I found a *block of granite*; and in several other places there are blocks of other rocks, likewise different from those of which the hill consists. From all I have seen, I entertain no doubt that Schehallion owes its form to a glacial agent, which has engulfed the whole range."

These observations by Dr Chambers and me confirm Professor Heddle's statements:—*first*, as regards the existence of granite boulders on Schehallion; *second*, as regards the direction of the stream which brought them; for there can be little doubt that the transport of boulders and the striation of rocks on such an isolated mountain as Schehallion can be well accounted for by the same agency.

The result of these explorations in the Black Mount district has, therefore, been to confirm the correctness of the conclusions come to in the previous year, that boulders had been strewed over the district in a sort of *trainée* from Albannach Hill in an easterly direction, and that portions of the stream had reached Schehallion. Some of these boulders were in last year's Report stated to have been found at a height of 2530 feet above the sea. This year's explorations showed them in positions 2498 feet (on Geal Charn) and 3407 feet (on Schehallion) above the sea.

Albannach Hill reaches to a height of 3425 feet above the sea.

Some hesitation may be felt in assuming that the boulder on Schehallion, being only 18 feet below the highest summit of Albannach, could have come from Albannach; but it is quite possible that Albannach Hill may, since the boulder epoch, have been lowered by denudation.

A sketch of the Rannoch district is given on Plate IV., with red dots to show the positions of the boulders seen and identified by Professor Heddle.

Professor Heddle adds, that having heard that other observers had found boulders on Schehallion, and which were supposed to have come from the Ben Alder district, he thinks it right to mention that there is in fact no granite in the hills of that district, except at one locality, where Prince Charles's Cave is situated, at which place the granite is composed of crystals an inch or more in size, by which it is quite distinguishable from the boulder he found on Schehallion, and from the Albannach granite.

2. Another district examined last year by Professor Heddle, was both banks of the Linnhe Loch to the S.W. of Fort William.

It will be seen from last year's Report, that at two places, there were appearances for which he could not account, except on the supposition that some agent had brought boulders across the Linnhe Loch, from the district of Glen Tarbert, to the districts at the head of Glen Crerar and Glen Etive.

In order to seek for symptoms of glaciation in the Glen Tarbert district, Professor Heddle last year crossed by the Connal Ferry.

That glen, and several hills and valleys adjoining it, were examined with little success. Boulder clay only was found, viz., in Glen Tarbert itself.

At length a valley called *Coir Syveamhael*, running in a N.W. and S.E. direction, was found "tremendously glaciated" between the altitudes of 950 feet and 1550 feet.

Marks of glaciation were also strong between *Meall Challium* and *Meal-a-Chairean Zuachraid*. These marks showed movements not only over the col (1680 feet) but for a certain distance up the north slopes of Meal Challium, the rocks of which had been powerfully acted on. The course of the ice, judging from the smoothings of these rocks, seemed to have been from W.N.W.

The glaciation extends down into the valley called *Coirs Meall*

Challium, the sides of which are so marked, down to a level of about 950 feet.

No boulders were found on these hills or in the valleys.

From these glaciated hills a view across the Linnhe Loch was obtained; and in particular, looking along the groovings of the rocks on the sides of *Coire Maell Challium*, the eye catches a sight of the trench of the *River Durer*, and hits upon "the very spot in the small *col* in the spur of *Fraochaidh*, where, at almost the same altitude, glacial *striae* were observed in 1879."—(See p. 42 of last year's Report.)

3. Another set of hills visited on the north side of the Linnhe Loch are those embracing *Glen Conar*. Having followed up the glen for 3 miles without finding boulders or marks of glaciation, Professor Heddle states that he struck off by hills marked on the ordnance map, *Sgur an Lubhair*, *Stob Coire Riach* and *Stob Choire a Chearachail*. On the last-mentioned hill, he found so remarkable a *trainée* of boulders that it at first occurred to him they might possibly have been derived from a natural dyke or vein which had disintegrated. He searched carefully for such, but could see no traces of any. The boulders—for such he now considered them to be—lay on and along a ridge of the hill for nearly a mile, at heights varying from 2400 to 1800 feet, below which last level none were found. The directions of the *trainée* was N.N.W. and S.S.E. The boulders were generally not larger in size than a cubic yard, and consisted mostly of a peculiar syenite with some of the felspar crystals of a red colour, and with hornblende of a lively green colour. He counted nineteen boulders of that kind. There were also other boulders interspersed, of ordinary syenite, gneiss, and trap.

As it appeared, to him that the ice which brought these boulders had crossed the Linnhe Loch, Professor Heddle next visited several hills on the opposite or south side of the Loch, in hopes of discovering boulders of the same peculiar syenite. One of the many hills visited was *Bein Bhan*, reaching to a height of 1500 feet. The rocks in this hill are of clay slate, and at its summit, on the east side, there is quartzite with embedded crystals of hornblende. Another hill, not far off, is *Beinn na Gucaig*, reaching to a height of 2017 feet, composed of quartzite overlying clay slate.

On both of these hills, boulders of the peculiar syenite seen on

the *Stob a Chearchaill* ridge were found, up to their respective summits.

On the *Bein Bhan* hill a ridge runs up from the north-east towards its summit, on which ridge one of the boulders was found in so peculiar a position, that a sketch of it was taken, the shading being filled in by Mr Colin Phillip (an artist) who accompanied Professor Heddle. (Plate III., figs. 5 and 6).

The boulder consisted of six pieces, the smallest being lowermost. The question arose, What had fractured the boulder? Atmospheric action did not seem the agent. The surfaces of the fragments where rent, were somewhat conchoidal in shape, and indicated rupture by violence done to the under part of the boulder. The most probable explanation which suggested itself was, that it had tumbled off the raft which carried it, and, being of great weight, had broken by concussion against the rock of the hill. The size of the boulder was $8 \times 7 \times 6$ feet.

If this boulder formed part of the stream which had crossed the valley now occupied by the Linnhe Loch, it must have been floated on ice,—in which case the fall of the boulder would be through water. At the sea-bottom, the concussion upon rock might still produce a fracture of the boulder; and the fragments would remain closer to one another, than if they had fallen in air.

A representation of the hill ridge on which the boulder rests, and of the fragments composing it, is given on Plate III. fig. 5, and indicates the position of the boulder on the N.E. ridge of the hill. Fig. 6 represents the boulder in its different fragments lying on a notch of the hill.

The Convener who has made the foregoing extracts from Professor Heddle's notes, thinks it only due to him to mention that these extracts give no idea of the enormous amount of labour which the Professor has undergone in his boulder researches. During the summer and autumn of 1880, he must have walked several hundred miles over districts many of which are not accessible to ordinary pedestrians. This is shown by the tracks of his surveys laid down by him on the ordnance maps, and by the names given in his notes of the hills and valleys visited. A great part of these expeditions were unsuccessful and disappointing; but he has specified them in full detail, in case the committee might deem it useful to record in their Report the districts visited, for the information of future observers.

The Committee, at a meeting held on 24th June 1881 for the adjustment of the Report, where Professor Heddle's notes were shown, and some portions read to the Committee, were of opinion that they had been too much abbreviated by the Convener; and they requested him, on revising the proofs of the Report, to give more copious extracts, which accordingly has been done.

NOTE BY RALPH RICHARDSON, Esq.

Loch Skene.—A letter from Mr Ralph Richardson to the Convener, dated 11th March 1881, gives an interesting account of boulders, at a considerable height, near Moffat:—

“ *R.S.E. Boulder Committee.*

“ I beg, as desired, to report to you, as Convener, that when visiting Loch Skene, Dumfriesshire, last August, I observed some large boulders, about 200 feet above the Loch, in the valley traversed by the Midlaw Burn, between the Mid-Craig and White Coomb hills. These boulders are situated about 1900 feet above the sea-level, and appear generally to belong to the local Silurian rocks. I measured one, and found it to be 30 feet in circumference, 9 feet in height, and 9 feet in breadth. There were others of similar size. The valley in question is dotted with what seem to be moraine heaps, and similar mounds are found damming back the waters of Loch Skene. Scott in ‘Marmion’ refers to these ‘rude barriers.’

“ An admirable description of the Geology of this district is given in a paper by Dr John Young in the ‘Quarterly Journal of the Geological Society of London,’ vol. xx. p. 452 (1864).

“ The boulders to which I have referred are evidently not far travelled rocks, but they are interesting as ‘perched blocks’ occurring at an altitude of 1900 feet. I infer, from the adjacent moraine evidence, that they were transported by a local glacier, which had its *névé* or gathering-ground at the head of the Midlaw valley; which descended to Moffatdale along the present drainage-line, viz, the courses of the Midlaw and Tail Burns; and the northern lateral moraines of which formed barriers to the drainage from the north, resulting in the formation of a sheet of water now known as Loch Skene.”

EXTRACTS FROM PAPERS BY THOS. F. JAMIESON (ELLON).

ABERDEENSHIRE AND PERTSHIRE.

As it is an object of the Committee to collect information about boulders from all reliable sources, the following notices are taken from papers by Thomas F. Jamieson, Esq., published some years ago in the Proceedings of the London Geological Society:—

(1.) In his paper "On the Pleistocene Deposits of Aberdeenshire" ("Quart. Journ." for 1858, p. 512), Mr Jamieson describes the "*mounds and ridges of coarse ferruginous shingle and gravel, all water rolled,*" situated to the north of the town of Aberdeen, near the seashore. "The fields abound with *large boulders*, mostly of syenitic greenstone and other varieties of trap, similar in quality to rock *in situ*, a few miles to the west, near the Menie coastguard station; I found these large boulders of trap, granite, and gneiss, *resting on the top and surface of the gravel ridges*, some of them measuring 6 feet in length, and more or less rounded in form. I traced them also among the low hillocks of blown sand, occurring sometimes singly, sometimes in clusters, and of various sizes up to 11 or 12 feet in length. In a field on the farm of Drums, a gigantic granite boulder occurs, known as 'the grey stone.' I found it to measure 54 feet in circumference, with a height of about 7 feet above the ground. It has no sharp angles, and most of its exterior is rounded. Another immense block, also apparently a transported mass, is seen—78 feet in circumference, and projecting 6 feet out of the ground—a coarse-grained greenstone.

"These ridges consist of highly rolled fragments of rock of all sizes, from coarse gravel up to boulders 2 feet in diameter. On the top of one of these gravel ridges, a little to the north of Drums, I found a boulder of coarse crystalline rock measuring 8 × 5 feet; no sharp angles occur on its surface; a layer of red clay, about 9 inches thick, overlies the gravel at this spot. This boulder rested immediately upon the gravel, but clay encircled its base; another large boulder of greenstone lay beside it.

"These are instances of large transported boulders sitting on the top of abrupt ridges of water-worn shingle."

(2.) In his paper "On the Drift and Rolled Gravel of the North of Scotland" ("Quart. Journ." for 1860, p. 365), Mr Jamieson, referring to "a great ridge of *mica-slate* stretching in an east and west direction, between Loch Tummel and the valley of the Tay," says, that "all along the northern slope of this ridge, from Meal Uaine at one extremity, westward for 10 miles to Hioch Vore at the other, I remarked many boulders of *granite* and *porphyry*, at heights exceeding 2000 feet, the highest being one of granite, at an elevation of 2390 feet.

"Now I examined the greater part of that ridge, crossed it at several points, and walked along its crest for miles, but saw no indication anywhere of this granite or porphyry *in situ*. I think, therefore, they must have been carried to their present position from a considerable distance, and, knowing that such rocks occur in the high mountains situated to the *northward* (as, for instance, Glen Tilt), it is probable, that *there* lies the source from whence they have come.

"It is not at 2000 or even 2400 feet, that we cease to find such transported fragments. In the Braemar district I met with them much higher.

"A remarkable instance of this occurred on the hill of Morven, a few miles to the north of the village of Ballater. The average of four measurements makes the height of it 2953 feet above the sea, the highest value being 3048. It stands many miles apart from any hill of like elevation; in fact, there is none so high within 10 miles, and it greatly surpasses any eminence to the north and east between it and the sea. All the upper part of the mountain, so far as I could ascertain, is composed of one sort of rock, which seems to be a mixture of *greenish hornblende* and *white felspar*. No *gneiss*, *quartz-rock*, or *granite* came under my notice, although the last-mentioned rock occurs about its base. The late Professor Magillivray had, I find, examined the hill, and pronounced it to be hornblende rock. It was therefore with no small degree of wonder that I remarked several rounded boulders of *granite*, together with some of *quartzose gneiss*, or *laminated quartz*, lying here and there on the western brow of the mountain, and I traced them up to the very summit—one or two, indeed, are built into the cairn that

marks the highest point. The largest of these fragments did not exceed 2 feet in diameter.*

“Again, there is a hill close to the village of Braemar, named Cairn-a-Drochet, reaching an elevation of 2700 feet. Seventy yards to the north of the cairn that marks the summit, there sits a *block* of coarse *red granite* 12 feet in length, while many boulders of the same kind are scattered all around. Now the upper part of this hill is chiefly composed of *quartzose gneiss*, intersected with dykes and masses of felspar porphyry, and although *granite* also occurs *in situ* a short way down the hill, yet it is of a different quality from this block, containing a much smaller proportion of quartz, while the felspar is of a paler tint, and, upon the whole, I think it likely that this block and many of the other boulders near it have been derived from the mountains to the north, the granite of which is identical in character. Whilst not meaning to press this too strongly, I would remark that the fragments of quartz, felspar, porphyry, and granite on the flat top of the hill are mingled in such a way as to indicate exposure to some shifting agency, as if they had been washed about together while under water.

“The only other instance of high-lying fragments, apparently transported from a distance, that I shall adduce, relates to the mountain called *Ben Uarn More* (3587 feet). It forms the culminating peak of the great ridge that divides the shires of Aberdeen and Perth, and is composed of *quartz rock*; no other rock occurred, as I clambered up the steep northern slope, but I observed here and there, as I went along, fragments of a peculiar kind of *porphyry* that I had not met with *in situ* lower down. These fragments continued to occur, though sparingly, high up on the shoulder of the mountain, but on the very top I looked some

* The Convener having sent to Mr Jamieson a proof of this part of the Report for his revision, he returned it, with the following note:—“The Rev. J. G. Michie of Dinnet, accompanied by the Rev. Mr Davidson of Logie-Coldstone, paid a visit to Morven on the 12th October 1874, in order to make a special examination as to the occurrence of these boulders. Mr Michie wrote to me, that they saw some large blocks of *granite* at the base of the mountain, and small boulders of *granite* were likewise found sparingly all over the top of the hill, up to the very summit; but there was a considerable space about half way up, where there seemed to be an absence of these boulders. No granite rock was found *in situ* on Morven itself; the rock, so far as could be seen, being of the nature of hornblende schist.”

time for them in vain. A cairn on the summit, apparently the work of the Ordnance surveyors, showed nought but quartz, the sharply angular *debris* of which strewed the protruding edges of the strata. Searching about among the quartz *debris*, I did, however, find on the very top of the hill a small lump or two of the same *porphyry*; and other fragments of it occurred as I descended the shoulder of the mountain."

(3.) In his paper "On the last Changes of Scotland" ("Quart. Journ. of Lond. Geol. Soc." for 1865, p. 165), Mr Jamieson states, that "the detached mountain of Schehallion (Perthshire), 3500 feet high, is marked near the top as well as on its flanks, and this not by ice flowing down the sides of the hill itself, but by ice pressing over it from the north. On the top of another isolated hill, Morven, about 3000 feet high, situated a few miles to the north of Ballater (Aberdeenshire), I found *granite boulders* unlike the rock of the hill, and apparently derived from mountains to the west.

"Again, on the highest watersheds of the Ochils (a range of trap-hills stretching from Stirling towards Perth), at altitudes of about 2000 feet, I found pieces of *mica schist* full of garnets, which seem to have come from the Grampian Hills to the north-west, showing that the transporting agent had overflowed even the highest parts of the Ochil ridge.

"On the Perthshire hills, between Blair-Athole and Dunkeld, I found ice-worn surfaces of rock on the tops of hills, at elevations of 2200 feet, as if caused by ice pressing over them from the north-west, and *transported boulders* at even greater heights."

Referring to boulders in brick-clays, Mr Jamieson (p. 178) mentions that in "the Paisley brick-clay, which abounds in sea-shells (all of them Arctic), boulders of from 1 to 3 feet in length are not uncommon. I saw one 6 feet in length. Many of them show the glacial *striae*. These boulders occur imbedded here and there at various depths. It is common to find a crust of *Balani* attached to one of these boulders. It has generally been supposed that the *Balani* are confined to the upper surface and sides of the stone, as if they had grown upon it after it had been dropped into its present position. I satisfied myself, however, that this is not always the case, for I found that *Balani* do occasionally occur all over the lowermost side. For example, I observed one heavy stone,

measuring $32 \times 18 \times 14$ inches, imbedded in the clay about 15 feet from the surface. This boulder had not been moved out of its original position, and there were remains of *Balani* on various parts of the surface. I dug round it, and heaved it out of its bed, and found that the whole under side of it was covered with a close, thick crust of entire *Balani*, the points of which were sticking downwards into the soft clay beneath, showing clearly that they must have grown upon the stone, before it was dropped into its muddy bed. Other instances of the same kind were observed by me. I conclude, therefore, with regard to some of these boulders at least, that *Balani* grew on them before they came to be lodged in the clay (probably when they lay on some shore) and that afterwards they had got encrusted with ice, and being floated off, had dropped to the bottom when the ice about them melted."

Mr Jamieson, in a footnote, adds—"I believe the species of *Balanus* on the under side of the boulder above-mentioned was *B. balanoides* of Darwin's monograph, which is a species that lives only between tide-marks. If this is correct, then, it could scarcely have grown on stones lying in water so deep as is indicated by the shells in this clay, and its presence could be explained only by some such theory as I have suggested. It would be an interesting fact should the *Balanus* on the upper surface prove to be of a deep-water species, and those on the lower of a tidal one."

REMARKS BY MR MILNE HOME.

After presenting the Seventh Boulder Report, and giving a verbal account of its principal contents, Mr Milne Home, with the permission of the Council, read the following remarks, bearing on the objects of the Committee :—

First.—In reference to further explorations, I entirely concur in the opinion of Professor Heddle, given in the Report, that the boulders most deserving of being sought for and studied are those perched at great heights, and especially on the ridges and tops of hills. (An example of one of these "perched blocks," as described in last year's Report, was shown by a diagram on the walls.)

It is quite certain that boulders in such positions had been put there and left there by the transporting agent (whatever that was)

which brought them; and therefore whatever inferences their position indicates, these inferences may be relied on as correct.

Boulders in valleys, or at the foot of a hill, on the other hand, may by mere atmospheric action have lost their original positions, by having rolled to a lower level; in which case, they can afford no true data for inference.

They may, however, when found in valleys, have come there by local glaciers; and such cases are mentioned in previous Reports of the Committee. But where boulders are on hill ridges or hill tops, at heights exceeding 2000 or 3000 feet above the sea (and cases of that kind have been mentioned in our Reports), in districts where there are no hills much exceeding that height, local glaciers as transporting agents are inconceivable; and equally so seems to me the agency of a general ice-sheet moving over the country; for such a raft would have the effect, not of depositing boulders on hill tops, but of sweeping everything off them.

Second.—The discovery by Professor Heddle of one or more streams or *trainées* of boulders, in the Highlands, is very important by affording additional data towards the solution of the problem, what was the transporting agent? The late Hugh Miller speaks of having seen boulders in a continuous line at two places in Mid-Lothian ("Edinburgh and its Neighbourhood," p. 35); but the best examples, which I can specify, of boulders in continuous streams, occur in the United States. They have been described by Hitchcock, Henry Rodgers, and Dana, all well-known American geologists. One of these places was visited by Sir Charles Lyell, who, in a lecture at the Royal Institution, London, in the year 1855, gave an interesting account of it.

This lecture I have found in a volume of pamphlets in our library. It contains a diagram, which I have caused to be copied on a scale large enough to be seen on the walls, thinking it might be of service in suggesting further explorations in our own country.

(The diagram was here shown and described.)

The explanation of these Massachusetts boulder streams, implies the submergence of the country to the extent of about 2000 feet, under an arctic sea, capable of allowing ice to be formed. Now it

is generally agreed, that Scotland, England, and Ireland was, during the Glacial period, submerged, so that most of our hills were covered; and judging by the types of molluscs, and skeletons of seals (of a species existing only in an arctic sea) found in our clay beds, the submerging ocean must have been of an arctic character.*

With reference, therefore, to such *trainées* of boulders, as have been found by Professor Heddle, among the Highland hills, the same explanation is, to say the least, admissible.

Third.—But there are other districts covered with boulders to which this explanation is not applicable. I refer to the Western Islands and the Hebrides (Islay, Tiree, Barra, Uist, and Harris), all of which have numerous boulders on hill slopes facing the Atlantic, and which, judging by the peculiar position and attitude of many of them, clearly show that they have come from a westerly or north-westerly direction. On these islands, with no ranges of hills on them of the necessary height, local glaciers are out of the question. On the north-west coast of Argyleshire, there are, in like manner, boulders in positions which convinced the late Robert Chambers, the late Dr Bryce, the late Professor Nicol, and Mr Jameson of Ellon, all of whom personally examined them, that they also had come across the sea, and not from any inland district.

But where in a direction west or north-west, is there any land from which these boulders could have come, and how could they have traversed the wide Atlantic? Though there are probably entire hills of granite and gneiss in Labrador and Greenland, it is hardly conceivable that any ice-bergs or ice-floes obtaining boulders there, could reach our shores to discharge their cargoes upon them, even though there had then been no Gulph-Stream to intercept and melt them.

Is no other hypothesis possible?

(1.) There now exists, about 190 miles to the west of the Hebrides, a range of submarine granite hills, whose peak, called in our charts "*Rockall*," stands above the sea-level to the height of 80 feet; and within about 2 miles from it, there are two rocks,

* See an interesting article by Professor Turner of Edinburgh University, on these fossil seals, in "*Journal of Anatomy*," vol. iv. p. 270.

apparently parts of the same range. That "Rockall" is granite was attested by the late Captain Basil Hall,* and subsequently by the surveying officer of H.M.S. "Porcupine"; the latter stating in his memoir to the Admiralty, that he had sent specimens of the rock to several museums in Ireland. The soundings show, that the 100 fathom line extends N.N.E. about 20 miles, and S.S.W. 32 miles, whilst in a transverse direction, the shorter axis is only 12 miles, so that this granitic range is approximately parallel to the axis of the Hebrides.

Of course these rocks would not, *at their present level*, have supplied the boulders now in the Hebrides and coasts of Argyle. But there is a very general belief among those who have studied the subject, that at or about the period when these boulders came, land did exist in the North Atlantic, which is now submerged.

The late Edward Forbes, in a remarkable memoir published in the year 1844,† was the first to express this opinion, founded on a consideration of the flora and fauna of Scotland and Ireland. He says, "There could not always have been such a separating abyss between Northern Europe and Boreal America as now divides them. The sea through a great part, must have been a shallow sea; and somewhere, probably to the far north, there must have been either a connection or such a proximity of land, as would account for the transmission of a non-migratory terrestrial and a littoral marine fauna." In another part of his memoir, he says, "Although I have made ice-bergs and ice-floes the chief agents in the importation of flora southward, I cannot but think, that so complete a transmission of that flora as we find on the Scottish mountains, was aided, perhaps mainly, by land to the north, *now submerged.*"

(2.) This opinion, since it was expressed, has received support from other considerations. Thus in 1853, the late Sir Charles Lyell expressed his belief, founded on observations by a Danish captain, that the west coast of Greenland was subsiding. More extended observations have since been made by two American men of science, Dr Kane‡ in 1855, and Dr Hayes in 1860, which show clearly that whilst the north part of Greenland had long been rising, the south part

* *Fragments of Voyages.*

† "Memoirs of the Geological Survey of Great Britain for 1844," vol. i. p. 388.

‡ Kane's "Arctic Explorations," London, 1875. Dr Hayes's "Open Polar Sea," London, 1867.

of the continent was and had been subsiding. They inferred the position of the centre of oscillation to be between latitudes 76° and 77°. The elevation of the *northern* portion, they thought, was indicated by old sea terraces, forty-one in number, reaching up to 480 feet above the sea, and at a distance of about 120 miles from the axis of oscillation. To the *south* of this axis, no such terraces are visible, but on the other hand there are remains of human habitation, and other appearances indicating submergence. Dr Kane mentions that subsidence had also been observed on the eastern coast of South Greenland. The distance to what is now the south cape of Greenland, from the axis of movement, is about 1000 miles; and if it be assumed that the amount of subsidence on the north side of the axis is the same as that of elevation on the south side, the subsidence at the south cape would be about 3200 feet. But this subsidence would most probably not be confined to Greenland. It might have extended into what is now the bed of the North Atlantic, verifying therefore Forbes's remarkable inference, founded on physiological data, "that land had at one time existed there, now submerged."

(3.) On the east side of the North Atlantic, there are also traces of subsidence.

Thus Jukes says, that "Around all the shores of Ireland, there is found evidence of a comparatively recent depression of the land, in the occurrence of undisturbed peat bogs beneath the sand of the sea, stretching below the level of the lowest spring tides. The stumps and roots of trees in the position of growth are found in this peat, clearly showing that it grew on dry land, and is now beneath the sea in consequence of depression" ("Manual of Geology," p. 686).

O'Flaherty, in reference to a traditionary belief existing in 1630,* says that "Lough Lurgan is an inlet of the sea between Tuam and West Connaught, at the mouth of the Galway, stretching into the land, which was formerly dry land, until the Western Ocean broke over it. The remains of the barrier, are the three Isles of Aran. This traditional name (Lough Lurgan) is still used for Galway Bay; and margining the bay, below low-water mark of spring tides, there are numerous bogs with oak corks *in situ* at their base, in places over 12 feet deep."

Mr Kinahan, in his "Geology of Ireland," records that "the Rev. W. Kilbride, vicar of Aran, has discovered in the principal

* "Ogygia," seu "Rerum Hibernicarum Chronologia," London, 1685.

island, human habitations and other structures below low water of spring tides" ("Journal of the Royal Geological Society of Ireland for 1880," vol. v. p. 180).

(4.) Reference has been made to "*Rockall*," which at present consists of only *one* rocky peak. But a chart exists dated in 1634,* which represents the place as consisting of two islets, a larger and a smaller, but the smaller is now exposed to view only at half tide,† suggesting subsidence.

(5.) Another discovery recently made, is the finding in several parts of the North Atlantic, molluscs which betoken *littoral* conditions. Thus on the Porcupine Bank—a shoal situated about 120 miles west of Galway (Ireland), a specimen of "*Littorina littorea*" was dredged up, with regard to which Professor King of Queen's College, Ireland, asks, "How has this shell, which lives between ordinary tide marks, got into 80 or 90 fathoms of water, and at a distance of 120 miles from the shore?"†

A similar case occurs in a part of the North Atlantic, about half-way between the south end of Greenland and *Rockall*, where a number of *star-fish* were brought up by the sounding line from the sea bed at a depth of 748 fathoms. Dr Wallich, in the "*Bull Dog*" surveying ship, employed in 1860 to make these soundings, drew out an exceedingly interesting memoir‡ (published by the Admiralty), in which he gives his "reasons for believing that although originally a shallow-water species, these star-fishes had gradually, and through a long series of generations, accommodated themselves to the abnormal conditions incident on the subsidence of the sea bed" ("Memoir," p. 141).

Dr Wallich further observes, that "no proof of subsidence could be more complete, than the detection of a colony of acclimatised star-fishes belonging to a species typical of the Boreal province, well known to range from the confines of the Arctic circle to our own shores, and shown to have accommodated themselves to a depth of 200 fathoms without variation; whilst the fact of subsidence being

* The chart alluded to is a French navigating chart, of which a copy is given in the 5th volume of the Royal Irish Geological Society.

† "Report of Soundings by H.M.S. 'Porcupine' in 1862."

‡ "North Atlantic Sea-bed," by G. C. Wallich, F.L.S. and F.G.S., naturalist to expedition under Sir F. L. M'Lintock, "to survey the proposed North Atlantic route for a telegraphic wire between Great Britain and America."

general through the whole area, is rendered probable by the discovery of *sessile annelids*, also belonging to known shallow-water species, at a depth of 620 fathoms, half way between Iceland and the Faroe Islands" (p. 152).

"The occurrence of a shallow-water *Serpula* at such a depth is important, from the evidence it yields of the subsidence having been gradual, and not merely the result of local and temporary submarine volcanic action; for whilst creatures having powers of locomotion might have evaded the consequences of sudden subsidence by migration to shallow water, the *sessile annelids* must inevitably have been destroyed. The detection of shallow-water species on isolated submerged areas of sea bed, may enable us to determine, whether such areas have been nearer the surface at some anterior period, and may thus afford a glance, otherwise unattainable, at the lost land-marks of a bygone geological epoch" (p. 151).

One other circumstance, bearing in the same direction, though I confess that I do not attach much value to it, may be mentioned, viz., the existence of old French and Norwegian charts, which represent an island not far from the place where the *star-fishes* were dredged up.

These circumstances induced Dr Wallich to express an opinion somewhat similar to that which Forbes had, on separate grounds, formed, that "an ancient barrier had stretched across from East Greenland towards the shores of Northern Europe. On reference to the map it will be seen, that a vast area of sea bed to the south of Iceland, extending to the 30th degree of west longitude on the one hand, and to the Faroe Islands and Hebrides on the other, gradually diminishes in depth as it advances northwards; in all probability constituting the boundary of an archipelago rather than a continuous continent, across which the various species of animals and plants made their way southwards. When that archipelago existed, the Hebrides and Faroe Islands were probably united, whilst Rockall formed a large but distinct island; and another still larger island rose up out of the sea between the 57th and 60th degrees of latitude, and about the 30th degree of west longitude. On the northern flank of this island, the star-fish sounding was taken" ("North Atlantic Sea-bed," p. 150).

If these speculations are well founded, there need be little difficulty in understanding from what quarter the Hebrides and Argyle-

shire boulders have come; whilst the fact, if it be verified, that they did come across the Atlantic from the west, is an additional link in the circumstantial chain which supports a theory advocated by the distinguished naturalists to whom I have referred.

The inquiry, however, being of considerable geological interest, I should wish that the positions of the boulders on the west coast of Scotland did not rest on my personal observation (as at present they chiefly do), but that they would engage the attention of others, and who, I hope, will report the result of their enquiries to the Boulder Committee.

2. On the Compression of Gases by High Pressures.
By Professor Tait.

3. Determination of Longitude without a Chronometer.
By Dr Menzies. Communicated by Professor Tait.

4. The Electric Discharge through Colza Oil.
By A. Macfarlane, M.A., D.Sc., F.R.S.E.

(Abstract.)

The dielectric strength of colza oil (specific gravity $\cdot 91$) was found to be 2.7, that of air at the ordinary pressure being unity. The rest of the paper is taken up with a description of the phenomena accompanying under different conditions the spark discharge through the oil.

5. On Quaternion Integration. By Professor Tait.

The Chairman closed the session with the following remarks :—

I have now, in a very few words, to close this session, and in so doing I beg to remind you that it is the ninety-ninth session of the Royal Society of Edinburgh. This Society, which was originally an offshoot of the University of Edinburgh, was first started, on the suggestion of Principal Robertson, towards the close of 1782. So that in the latter part of next year you will be able to announce your hundredth birthday. The Society came into existence just one year after its late distinguished President, Sir David Brewster,

who was born in December 1781. While individuals pass away, age brings no decrepitude, but rather the reverse, to universities and scientific bodies. For, owing to the growth of population and national wealth around them, there is a constantly increasing class of persons demanding the higher branches of education, and with leisure for scientific pursuits. It might, however, be the case that a Society like this, while flourishing in numbers, might fall into the condition of the army of Xerxes, of which it was said that there were πολλοὶ μὲν στρατιῶται, παῦροι δὲ ἄνδρες—"numerous troops, but few real men among them." This, however, can by no means be now said of the Royal Society of Edinburgh. The past session has exhibited an amount of vitality and productive energy which does great credit to the Fellows, and, I may add, to the Secretaries, to whose assiduity and tact the flourishing condition of the Society is greatly due. I believe that few previous sessions on our records show a better tale of work done than the session which we are now concluding. During its course no less than seventy-three papers have been furnished, upon the most varied topics, almost entirely by Fellows or Honorary Fellows of the Society. The series was opened by the noble President with a literary address, recalling to notice some once famous, but now nearly forgotten, works; and then followed seventy-two papers, of which 17 are Mathematical; 20 Physical; 12 on departments of Natural History; 10 Chemical; 3 on Astronomy; 1 Mineralogy; 1 Geology; 1 Anatomy; 1 Meteorology; 6 Logic, &c. To appreciate the matter and contents of all these various papers would require the many-sided intellect and universal accomplishment of a Humboldt. And even Alexander von Humboldt, could he have come to life again and attended our meetings, would have heard things not dreamed of in his philosophy—so progressive is science. I venture to offer no further word beyond congratulating you on the amount of work done during the session. In a week or two we shall be all dispersed—some to foreign lands, some in the country, or among the mountains, or by the sea. I doubt not that the Fellows of this Society, wherever they are, will find the truth of the often-quoted sentence: "Hæc studia delectant domi, non impediunt foris, pernoctant nobiscum, peregrinantur, rusticantur." And I trust that your hundredth session may reap the fruit of new ideas which shall have suggested themselves during the ensuing recess.

On the Classification of Statistics and its Results. By Patrick Geddes, F.R.S.E., Lecturer on Zoology in the School of Medicine, Edinburgh, and Demonstrator of Botany in the University.

(Sections 1-16 read on 21st March ; 17-26 on 4th April ; 27-31 on 2d May 1881.)

§ 1. Every one may readily notice that the collection of statistical information goes on around us to a vast and constantly increasing extent ; not simply in the periodic census, but in the daily labours of the Registrar-General's Department, of the Board of Trade, and the like. Such functions are carried on in every civilised country by many special statistical bureaux ; a statistical society exists in almost every great intellectual centre, and an International Statistical Congress, which has proposed to itself the vast object of accumulating, co-ordinating, and comparing the whole body of national statistics, has met periodically since 1853.

Though no one will probably question the desirability and usefulness of such a task, it may be well to point out that in the words of a veteran statistician *—" By this means light will be thrown on every branch of statistical science. All social phenomena of every kind may be investigated by comparisons of the different causes from which they arise, under different conditions, and in countries presenting wide spheres of observation and opposing influences at work. Knowledge will thus be increased, laws of social life eliminated, true scientific inquiries promoted, the work of government simplified, and the progress and prosperity of nations fixed upon sure bases of observation and reason, instead of dangerous experiments or doubtful theories."

Again, regarding the importance of uniformity (*i.e.*, of orderly classification) in all statistical publications, the same authority † has insisted that " What was wanted, above all things, was uniformity.

* S. Brown, F.S.S., " Report on the Eighth International Statistical Congress, St Petersburg, 1872 " ; Journ. Statist. Soc. Lond., vol. xxxv., Dec. 1872, p. 457.

† Quoted by Mouat, " Prelim. Report of Ninth International Statistical Congress, held at Buda-Pesth, 1876 " ; Journ. Statist. Soc. Lond., vol. xxxix., Dec. 1876, p. 645.

Hundreds, we might say thousands, of volumes—collected and printed at great expense by the different Governments, by societies, or by individuals, were rendered almost useless, in an international point of view, for want of some uniform method of classifying and showing the results. It was impossible to make comparisons, and so to educe the laws of probability of occurrence of large classes of events in social or political economy. Yet, without the discovery of these laws, the social, moral, and intellectual condition of a people cannot with any certainty be traced.”

§ 2. It thus becomes necessary to examine and compare the modes of classification of statistics actually in use in the statistical annuals of different countries. This has been done by M. Deloche,* chief of the Statistical Department of the Ministry of Agriculture and Commerce, and also by Dr Mouat, Foreign Secretary of the Statistical Society of London †; and it will be useful to borrow a few examples, placing the condensed headings in parallel columns. (See opposite page.)

§ 3. After pointing out the utter discord which exists among these systems, and the necessity of some fundamental scientific idea to introduce uniformity, Deloche goes on to propose a classification, based upon the idea of the human organisation. Of this classification a detailed account is given by Mouat, from whom the following summary also is borrowed:—

I. *Double Synthesis of the Territory and its Population.*

1. Territory (topography, geology, hydrography, meteorology).
2. Census and movement of population.

II. *Facts relating to the Exercise of the Moral Faculties.*

1. Religion.
2. Civil and criminal justice.
3. Prisons and penitentiary establishments.
4. Public aid.
5. Benefit societies.

(Continued on page 298.)

* Quoted by Mouat, “Report on the Fourth Session of the Permanent Commission of the International Statistical Congress, held in Paris, 1878”; Journ. Statist. Soc. Lond., xlii., p. 12.

† *Ibid.*

| BELGIUM. | AUSTRIA. | HUNGARY. | UNITED KINGDOM. | COLONIAL AND OTHER POSSESSIONS. | BRITISH INDIA. |
|---|---|--|--|---|---|
| <p>I. Territory and Population.</p> <ol style="list-style-type: none"> 1. Territory. 2. Population. <p>II. Political, Moral, and Intellectual State.</p> <ol style="list-style-type: none"> 1. General Elections. 2. Provincial Elections. 3. Communal Elections. 4. Provincial Administration. 5. Criminal Administration. 6. Primary Instruction. 7. Higher Education. 8. Letters and the Fine Arts. 9. Worship. 10. Medicine. 11. Benevolent Institutions. 12. Civil Justice. 13. Criminal Justice. 14. Civil Guards. 15. Militia. 16. Army. <p>III. Agriculture, Industry, Commerce.</p> <ol style="list-style-type: none"> 1. Agriculture. 2. Industry. 3. Commerce. 4. Banks, &c., Miners. 5. Communication. 6. Post and Telegraph. | <ol style="list-style-type: none"> 1. Superficies, population, dwelling-places, movement of population. 2. Rural economy, cattle, market prices, export commerce. 3. Manufacturing industry. 4. Railways, roads, river and sea navigation. 5. Clergy, education, press. 6. Civil and criminal justice, &c. 7. State administration, public debt, &c., communal administration. 8. Joint-stock Co. banks, sale of property and mortgages. 9. Savings banks. 10. Hygienic and charitable institutions, areas. 11. Army and navy. | <ol style="list-style-type: none"> 1. Movement of the population. 2. Rural economy. 3. Mines. 4. Movement of commerce, market prices. 5. Modes of communication. 6. Flea. 7. Public health. 8. Justice. 9. Worship and public instruction. 10. Government. | <ol style="list-style-type: none"> 1-19. Public and local revenue and expenditure; national debt, income-tax, customs, tariffs, &c. 13-14. Imports and exports. 15-21. Imports. 22-29. Exports. 30-31. Bullion. 32-35. Transshipments. 36-42. Shipping. 43-44. Excise. 45-46. Prices and sale of corn. 47. Acreage under crops and live stock. 48. Coinage. 49. Post office savings banks. 50. Savings banks under trustees. 51-57. Bank of England. 58-61. Post-office. 62. Population. 63. Births, marriages, deaths. 64-65. Education. 66-69. Peasants. 70. Crime. 71. Emigrants. 72. Railways. 73. Mines. | <ol style="list-style-type: none"> 1. Area and population. 2. Revenue and expenditure; debts and obligations, provincial and local finances, municipalities. 38-48. Shipping. 44-46. Imports. 46-49. Exports. 54-56. Government stores. 57-60. Gold and silver. 61-62. Customs Tariffs. 63. Coinage. 64-68. Paper currency. 69. Emigrants. 70-79. Guaranteed and State railways. 80-83. Public works. 84. Telegraphs. 85-92. Post-offices. 93-98. Army. 99-100. Education. 101. Publications. 102. Vaccination. 103-104. Wild beasts. | <ol style="list-style-type: none"> 1. Area and population. 2. Revenue. 3. Expenditure. 4. Public debt. 5. Shipping. 6. Imports. 7. Exports. 8. Banks. 9. Railways. 10. Agriculture. 11. Births, deaths, and marriages. <p><i>Australian Colonies.</i></p> <ol style="list-style-type: none"> 12. Meteorology. 13. Import duties. 14. Export duties. |

III. *Facts relating to the Exercise of the Intellectual Faculties.*

1. The three degrees of public instruction.
2. Literary and scientific productions, printing, books, libraries, museums ; newspapers and reviews.
3. The fine arts.

IV. *Facts relating to the Application of the Physical Faculties and of the Intellectual Faculties to Natural Objects.*

1. Agriculture.
2. Lands built upon and land without buildings.
3. Extractive and manufacturing industry. Fisheries.
4. Professions and salaries.
5. Means of communication.
6. Commerce and navigation.
7. Public works, public health, and the food supply of towns.
8. The circulation of men, of things, of valuables, and of thought. Post offices and telegraphs.
9. Credit institutions (except State banks).
10. Accidents and assurances.

V. *Facts common to the three above-mentioned orders of faculties.*

1. Political rule, its organs and assemblies.
2. General administration.
3. Administration and assemblies of provinces, departments, districts, communes, and minor subdivisions.
4. Army.
5. Navy.

VI.

1. The finances of the State.
2. The finances of provinces or departments.
3. Finances of communes or inferior districts. Town dues and articles consumed.
4. State banks—*les caisses de dépôts*—mints.

VII. *Colonies or Extra Continental Possessions.*

Dr Mouat, while admitting this scheme to be "undoubtedly the best attempt yet made to reduce to order and precision that which

is at present deficient in both these qualifications," yet holds it to be impracticable, since it is doubtful whether there could be any approach to general consent, either as to the divisions themselves or to the subdivisions placed in each. M. Deloche's fifth division seems to him to be fatal to the plan, and the reader will readily notice many other objections.

§ 4. He then goes on to suggest a temporary and provisional classification, which is summarised as follows:—

"I. *Territory and Population.*

"All geographical and demographical statistics, including areas, soils, climates, possessions, and territorial arrangements, movements and divisions of the population, and the purely social arrangements, such as trades, professions, &c., everything contained in the registrar-general's returns, and what is beginning to be known as sociology generally.

"II. *Revenue and Commerce.*

"All the sources of the collection, production, and distribution of wealth, the statistics of the precious and other metals, all facts relating to the use and abuse of money, exchange operations, all manufactures and industries, and commerce in its widest sense, including means of transport, navigation, &c., &c.

"III. *Laws and Government.*

"All relating to legislation and policy of nations, which would include the making and breaking of laws, the constitution of imperial and local governing bodies, armies, navies, police forces, and the like; education and religion, and all facts tending to show the state of civilisation of each nation as distinguished from other nations.

"IV. *Miscellaneous* (arranged alphabetically).

Such an arrangement is, of course, as Dr Mouat indeed admits, the despairing abandonment of all pretence of scientific arrangement; and it is curious to notice that this—the latest development of statistical classification,—is closely analogous, save for the *omnium gatherum* with which it concludes, to that earliest classification with which botanists commenced their labours, that of the

vegetable world into herbs, shrubs, and trees. Under these circumstances the interference of the naturalist may be less impertinent than might at first sight seem probable.

§ 5. Before attempting classification, it is necessary to come to some definite agreement as to the nature of statistics; and after laying aside the popular belief that it is an inexpressibly dreary accumulation of numbers by which anything whatever may be proved, we find that at least two hundred non-coincident definitions have been given by statisticians. Many of these assert statistics to be a *science*, many again regard it as a *method*; while some, including the most recent foreign authorities, claim that it is at once both. But the sciences (using even the widest classification, that of Herbert Spencer) are logic, mathematics, physics, chemistry, astronomy, geology, biology, psychology, sociology, and ethics; the methods of science (according to Bain) are simply observation and definition (classification), induction and deduction. We do not find statistics in either category. Some statisticians, however, hold the sound view that statistics is simply a quantitative record of the observed facts or relations in any branch of science,* and I have ventured to condense and define this view into a diagram, as follows:—

Record of Facts (at given time).

| | | | | |
|--------------|--|---------|--------|--------|
| Qualitative. | Quantitative. | | | |
| Verbal. | Numerical. | Linear. | Plane. | Solid. |
| Statements. | <div style="display: flex; justify-content: center; align-items: center;"> <div style="border-top: 1px solid black; border-right: 1px solid black; border-left: 1px solid black; width: 100%; height: 10px;"></div> <div style="margin: 0 5px;">}</div> <div style="margin: 0 5px;">}</div> <div style="margin: 0 5px;">}</div> <div style="margin: 0 5px;">}</div> </div> <p style="text-align: center;">Graphic</p> <p style="text-align: center;">Statistics.</p> | | | |

§ 6. If this definition be correct, we obtain history by superposing or combining successive records, and this view is identical with that

* For a valuable discussion of recent opinion as to the nature of statistics, in which this latter view is substantially maintained, see Hooper, "On the Method of Statistical Analysis"; Journ. Statist. Soc. Lond., vol. xlv., March 1881.

expressed in the famous aphorism of Schlözer, one of the earliest writers on the subject—"Statistics is history in repose, history is statistics in movement." Applied to sociology, it practically agrees too, with the division of the subject into social statics and social dynamics established by Comte.

§ 7. The field of history might at first sight seem co-extensive with that of statistics, and both might seem to extend to all the sciences ; but since logic involves no idea of quantity, and since mathematical, physical, and chemical conditions and properties are constant, the scope of statistics and history becomes restrained, as shown in the following diagram :—

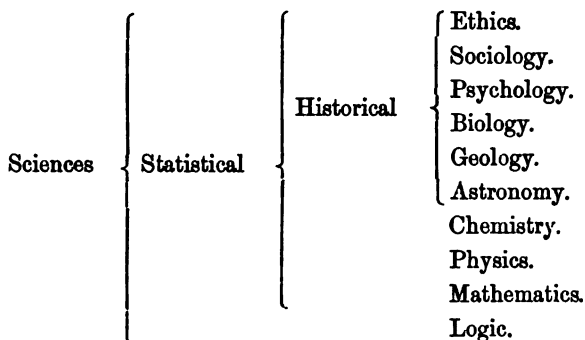

It is thus clear that statistics and history are, within the above limits, the common property of the sciences, and that the current use of these words, which restricts them to social phenomena, is simply one of colloquial convenience, while their use in the sense of distinct sciences or of distinct scientific methods is entirely erroneous.*

§ 8. Statistics being thus defined, the need for collection and classi-

* The preceding general conceptions may be traced into interesting detail. The application of the above diagrammatic definition of statistics to all the sciences clearly illustrates the continual progress which goes on in each from mere qualitative to quantitative knowledge, and the increase of definiteness which qualitative knowledge is always tending to assume. For instance, the name of a chemical compound, say sulphate of iron, expresses only a qualitative relation, its ordinary chemical formula $FeSO_4$ reaches the numerical state, its graphic and glyptic formulæ are respectively the plane and solid representation of the same *statistic*, as we may conveniently term any such relation of quantity. So, too, the astronomer has his star-maps and orrery, the geologist his maps and models, the biologist his figures and diagrams, while the sociologist so often requires similar aid that the French Government has recently established a *Bureau de Statistique graphique*. So by piling up successive graphic representations of statistical observations, a solid historical

fication being granted, and the unsatisfactoriness of existing and proposed schemes of classification being shown, we must now proceed to consider the desiderata of a system of classification. Our classification must be natural, not artificial; must be capable of complete specialisation, so as to include the minutest details, and capable, too, of the widest generalisation; it must be universal in application, and it must be, as far as possible, simple of understanding, and convenient in use. But how shall we obtain such a classification? What phenomena in the whole field of human knowledge have as yet been classified in this way? A moment's consideration will show that it is biological science which alone answers the question satisfactorily. None of the preliminary sciences is wanting in order or definiteness, but to biology above all is presented the problem of an innumerable multitude of actual phenomena demanding arrangement. Take an instance from zoology. Birds and reptiles, fishes and worms, are groups which the common sense of probably every rational human being enables him to form with considerable approach to correctness; yet at this point the task of the zoologist is only beginning. He has to work in two directions, to specialise until every member of these groups is known in the greatest detail, and also to generalise these groups into larger and larger ones. The two lines of research may be represented thus:—

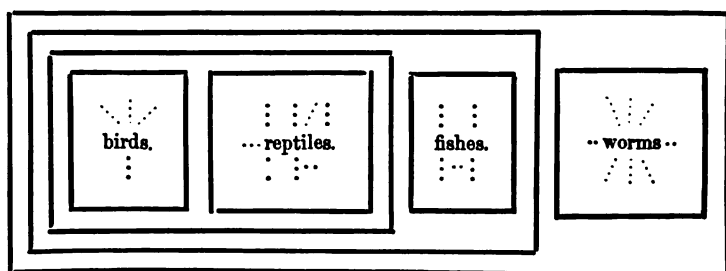

letting the dots represent the details of the various groups, and the large rectangles the successive generalisations which combine

model might often be constructed. A geologist, for instance, by piling map upon map of a given island at successive times (the margin being of course removed) would thus construct a solid model which would clearly exhibit the changes throughout the whole period. Where the area was increasing per unit time, the solid would widen upwards and overhang its base; where decreasing it would narrow, and thus even the minutest local increase or decrease would be represented with extreme vividness.

these into larger and larger alliances. Such a method of classification is obviously, therefore, that of which we are in search. It accepts our ordinary conceptions as far as possible, and systematises them; it is in real accordance with the order of nature, it pushes specialisation and generalisation to the uttermost limits of possibility, it is universal in application, and, as far as possible, simple of understanding and convenient in use.

§ 9. Using, therefore, the ordinary method of the classificatory sciences, let us take a concrete case—let us examine some actual statistics. For this purpose nothing is better than the useful little *Annuaire*, published by the *Bureau des Longitudes*.* Some of its principal contents are as follows:—Calendar, times of eclipses, sunrise and sunset, tides, &c.; tables of weights, measures, and money; heights of mountains, depths of rivers; superficies and population of European and other countries, special statistics of France, her colonies and Paris, laws of mortality, &c. Then come “*Tables diverses*” in great number, of which the few following instances will suffice:—Magnetic inclination, chemical elements, specific gravities of elements, rocks, gems, thermo-chemistry, velocity of sound, indices of refraction.

At first there is no difficulty. We simply separate out in order the statistics of each of the preliminary sciences, physical, chemical, astronomical, geological (including geographical, meteorological, &c.), and leave these to their special cultivators. It will be noticed that even this simple step disposes of a not inconsiderable part of the actual statistics of various countries (*e.g.*, see *Austria, Colonies, &c.*, p. 297). Social statistics now alone remain; how are they to be classified in accordance with our canons?

§ 10. Let us first inquire what is the fundamental scientific idea of a society. Some statisticians and economists answer exchange, others division of labour, others find it in history, others in the rights of man or the like. This diversity of opinion makes it unnecessary to criticise each in detail, and we are thrown back upon our own resources—our knowledge of the preliminary sciences. Just as the biologist is accustomed to classify man along with inferior organisms, and to trace the fundamental resemblances in structure and function which his organisation presents to theirs, so he may reasonably inquire

* Paris: Gauthier-Villars.

wherein human society resembles the societies formed by the lower animals, the more so as no one disputes that these fall strictly within his province.* As the term society indeed assumes, some general truths must be common to societies of *Formica*, *Apis*, *Castor*, and *Homo* alike—to ant-hill, bee-hive, beaver-dam, and city, and this must therefore underlie our classification of social facts.

§ 11. First, then, a society obviously exists within certain limits of time and space. Secondly, it consists of a number of living organisms. Thirdly, these modify surrounding nature, primarily by seizing part of its matter and energy. Fourthly, they apply this matter and energy to the maintenance of their life, *i.e.*, the support of their physiological functions.

It is here clearly to be understood that no attempt is made completely to define a society. A society may be much more than all this, in which case more general truths are discoverable, but in any case these four generalisations are obviously true, neither hypothesis nor metaphysical principle being involved. These will therefore henceforth be termed sociological axioms. What aid can they afford us?

§ 12. They enable us to classify out the facts relating to each and every society as follows :†—

(A.) Those relating to the limits of (1) time and (2) space occupied by the given society.

(B.) Those relating to the matter and energy utilised by the society from surrounding nature.

(C.) Those relating to the organisms composing the society.

(D.) Those relating to the application of the utilised matter and energy by the given organisms.

* “The Biological sciences are those which deal with the phenomena manifested by living matter; and though it is customary and convenient to group apart such of these phenomena as are termed mental, and such of them as are exhibited by men in society under the heads of Psychology and Sociology, yet it must be allowed that no natural boundary separates the subject matter of the latter sciences from that of Biology. Psychology is inseparably linked with Physiology; and the phases of social life exhibited by animals other than man, which sometimes curiously foreshadow human policy, fall strictly within the province of the biologist.”—Huxley, “Anatomy of Invertebrated Animals,” London, 1877, p. 1, Introduction.

† For better agreement with the order of the sciences (see p. 301), it is convenient to transpose the classes of facts derived from the second and third axioms.

§ 13. We may now proceed briefly to discuss these in order, not tracing them into more detail than is essential for clearness.

A. (1.) Of the extreme limits of time either or both may or may not be known, but the time at which our record of facts is taken can be, and usually is, stated definitely at the outset as a date.

(2.) Limits of space. Leaving all purely physiographical questions to the preliminary science of geology, the essentially social space relations may be arranged as follows:—

A. Territory of given society.

I. Quantity at given time.

1. Persistent since last unit time.

2. Added since last unit time.

(a) By geologic agency (upheaval, deposition, &c.).

(b) By social agency (discovery, conquest, reclamation, purchase, &c.).

II. Quality at given time.

1. Unused.

2. Used.

(a) Unspecialised (for such and such functions).

(b) Specialised (for such and such functions).

III. Decrease since last unit time.

1. By geologic agency.

2. By social agency.

§ 14. Let us now pass to the body of facts which our third axiom enables us to co-ordinate—those (B) relating to the matter and energy utilised by the given society.

The primary sources of energy in nature, so far as we at present know, are four—first, the primitive chemical affinity of the uncombined elements; secondly, the internal heat of the earth; thirdly, the rotation of the earth; fourthly, the sun. Of these the last is, of course, by far the most important; and its energy exists either active in sunshine, moving air, or water, or latent in the earth's crust, or in the organisms surrounding or composing society. The energy of the earth's rotation has been used to some small extent in tide-mills; that of the earth's internal heat, as manifested in hot springs, volcanoes, &c., of course still less; while the

first source, that of primitive chemical affinity, is scarcely used at all, since the elements (with the partial exception of sulphur) are desired for the sake of other properties than their capacity of yielding energy.

The next portion of the same table, that intended for the arrangement of our knowledge of the substances used, not for the production of energy, but for the sake of their physical, chemical, physiological, or other properties, may most simply be divided according as the substances are animal, vegetable, or mineral. The mineral sources may conveniently be grouped as non-metallic, metallic, rocks, and soils; the vegetable and animal by natural groups. But the matter and energy seized from nature are mere raw materials, as yet unfitted for application to the maintenance of the society. From this state, in which they may be termed potential products, they must be developed into that of ultimate products. And a little consideration will show that this process of development has generally three stages,—the first, of exploitation, including agriculture, mining, engineering, &c.; the second, of manufacture; the third, of movement by the agencies of transport and exchange to the place of ultimate application to the wants of the society—protection, alimentation, nervous stimulus, &c. These propositions are exhibited and somewhat extended in Table B 1.*

§ 15. In complex societies, however, a large proportion of raw materials has to be converted into apparatus for service in exploitation, manufacture, and transport; these may be termed mediate products. We have now the main principles of an exhaustive classification of all products whatsoever; thus—

a. Potential Products.

See Table B 1.

β. Mediate Products, used in—

1. Exploitation.
2. Manufacture.
3. Movement.
 - (a) Transport.
 - (b) Trade.

γ. Ultimate Products.†

* This table is essentially borrowed from Tait and Balfour Stewart. See Balfour Stewart, "Elementary Treatise on Heat."

† The details of the above classification would involve the printing of a con-

§ 16. A farther large proportion of energy and matter is prematurely dissipated and disintegrated by various agencies, and at various stages of development, and thus never becomes used at all. Such premature dissipation is termed loss, and of course needs to be balanced against the gain recorded in the two preceding tables. The details arrange themselves as follows :—

| | | | | | | |
|------|---|---|---|----|---|---|
| Loss | { | <ol style="list-style-type: none"> 1. Of raw materials 2. In exploitation 3. In manufacture 4. In transport 5. In exchange 6. Of ultimate products 7. In remedial effort | } | by | { | <ol style="list-style-type: none"> 1. Physical agencies, <i>e.g.</i>, Avalanche. Earthquake. Volcano. Flood. Storm, &c. 2. Biological agencies, <i>e.g.</i>, Insects. Fungi, &c. 3. Social agencies, <i>e.g.</i>, Crime. War. Folly, &c. |
|------|---|---|---|----|---|---|

§ 17. The second axiom—that a society consists of living organisms—leads us to the classification of their statistics. These arrange themselves in a way very analogous to that used for the statistics of territory (see p. 305, and Tables A I., II., III.) as follows :—

C. Organisms composing society.

I. Number at given time.

1. Surviving since last unit time.
2. Added since last unit time.
 - (a) By birth.
 - (b) By immigration.

siderable number of minor tables, and are therefore omitted, as tending to exceed the limits and divert attention from the main purpose of the present paper.

II. Quality at given time,

1. *Biological.*

(a) Structural.

α. Ethnological.

(Race, aspect, &c.).

β. Anthropometric.

(Size, weight, &c.).

(b) Functional.

α. Efficiency of non-cerebral functions.

β. Efficiency of cerebral functions (*Psychological*).

(c) Distributional.

2. *Social.*

(a) Mutual relations.

III. Decrease since last unit time.

1. By death.

2. By emigration, &c.

§ 18. Since the organisms composing the society have by our first axiom certain time-relations, since by our third axiom they seize upon the matter and energy of nature, a new idea comes in, that of their occupations. In a complex society like the human, more time-relations or occupations are to be observed than those which concern the direct utilisation of nature. By the aid of these considerations and of the preceding tables, the occupations arrange themselves as follows:—

I. Operations on matter and energy, *i.e.*, concerned in

1. Exploitation.

2. Manufacture.

3. Movement.

(a) Transport.

(b) Trade.

II. Operations on organisms composing given society.

1. Service of non-cerebral functions.

(a) Menial, domestic.

2. Service of cerebral functions.

(a) *Æsthetic*, intellectual, moral.

3. Service of co-ordination.

III. (For this third class no completely satisfactory term exists. Its scope and limits are, however, as will afterwards be seen, none the less definite.)

1. Unemployed.

(By reason of youth, misadventure, refusal, &c.).

2. Disabled.

(By disease, defect, age, &c.).

3. Destructive.

(War, crime, &c.).

4. Remedial.

(Of disaster, disablement, destruction, &c.

§ 19. Knowing now the number and quality of the members of the society, and their respective occupations, and considering that they apply the resources of nature to the satisfaction of their wants, the manner in which these are divided—in other words the partition of products, comes next to be classified. This partition, it must be observed, may be either of territory of services of potential, mediate, or ultimate products, or of tokens or claims for these.

These facts may be thus tabulated:—

I. Mediate partition to classes A, B, C (and to members of various occupations contained in these).

1. Of claims (currency, &c.).
2. Of potential products.
3. Of mediate products.

II. Ultimate partition to A, B, C.

1. Of territory.
2. Of ultimate products.
3. Of services.

In some cases the partition is *nil*; that is to say, the products, territory, &c., are held in common.

§ 20. The partition of products to the members of the society being now disposed of, there next comes to be considered the mode of their consumption or use, for which a separate but similar set of tables is therefore provided.

§ 21. Finally, since the members of society are modified (1) in

accordance with their modes of life or occupations, and (2) by their food and other material circumstances, since, in biological language, the organism is modified by its environment,* it is now necessary to inquire as to the results of the given occupations, and the given partition and use to the members following these. The biologist has accumulated a considerable body of knowledge respecting these results among animals, but comparatively little is known of human society in this respect. The foundation of an exhaustive knowledge of these results has, however, long ago been laid by the labours of the physician, the hygienist, and in a less degree by those of the educationist and philanthropist.

§ 22. These, then, are the primary tables, and we are now in a position to inquire how far our task of classifying the whole body of social statistics has been successful.

The scheme is scientific throughout—in accordance with the known truths of physical and biological science—is capable on the one hand of complete specialisation by the aid of minor tables, into the most trivial details of common life, and on the other, of generalisation into a colossal balance-sheet. Its systematic and generalised character appears clearly from a survey of the whole sheet of tables. It will be observed in the first place that the successive sets of tables, three each, may be read in horizontal rows, thus—Territory, Production, Organisms, Occupations, Partition, Use, Result. Secondly, that these sets of tables are related to each other: Organisms being treated on the same plan as Territory; the tables of Occupations being derived largely from those of Production, and the tables of Partition, Use, and Result, being in such close relation to those of Occupations that the ruling of each of the latter is exactly copied in all the four lower series; while the third, and by far the most important general view is obtained by looking at the left hand and middle vertical series (at least as far down as Occupations inclusive, and in some respects all the way), as entries on the debtor side of the balance-sheet, and similarly at the right hand vertical series as entries on the creditor side. Again, the scheme is universal in application—the tables will serve equally well for arranging our knowledge concerning any society—animal or

* This might, perhaps, more conveniently have been stated as a separate axiom.

human, civilised or savage :—for savage and animal societies, some columns here and there of course simply remaining blank. It is extremely simple, too, of understanding, and may, therefore, on all these grounds, satisfying as it does all the desiderata of a classification, legitimately claim a trial of convenience in use. In so far as the author's own studies have extended, it has proved eminently serviceable and suggestive ; and, moreover, if it be admitted to be a better classification than its predecessors, it is entitled provisionally to supersede them for working purposes, according to the universal practice of the preliminary sciences, even although itself open to criticism.

§ 23. Such, then, being the classification in its most general and abstract form, its completion—a task even more than that of any of the preliminary sciences—needing innumerable lifetimes broad and long, would require subclassification into the minutest details of social life and the filling up all the major and minor tables for each given society, with the facts of which so many are already gathered into economic and statistical libraries, and so many are being periodically collected, but of which perhaps even more await investigators, and the notation of all these by all the resources of graphic statistics. Thus, with the comparison, too, of each record with those of other communities and of antecedent times—in other words the comparison of statistics with statistics, and history with history, it is hard to speculate how vast would be the outcome of elucidated laws.*

But while this complete application is not within our reach, it must not be supposed that no application is or can be made to practice, nor that the present is a mere untested scheme. On the contrary, a very considerable number of volumes of actual statistics, journals of societies, census returns, and works on special subjects, have been gone through, without the discovery of any facts relating to any given society which could not be immediately referred to their places on the tables, while the facts relating to relations between different societies arranged themselves conveniently as links between their respective sets of tables.†

* It is interesting to compare these with the in many respects similar tables employed by Mr Spencer. See his "Descriptive Sociology."

† The reader may conveniently verify this statement by running through any such book, say a number of the Journal of the Statistical Society, or a

§ 24. Again, these tables, as the reader must already have noticed, embody much more than a mere classification for statistics in the narrower sense, and attempt nothing short of an organisation of the whole facts presented by the social sciences into a more definite and coherent body of knowledge than they have formed heretofore. The first series of tables, those of Territory, is intended to include the facts of political geography, while the second series is still more comprehensive. Its first table, that of Energy and Matter, includes the subjects commonly termed economic physica, economic geology, economic botany, and zoology, of which there is a large, but inco-ordinated literature.*

The table (B II.) entitled Development of Products, generalises a classification of the facts and processes of technology in the widest sense, including all the arts, coarse and fine, together with the processes of transport and exchange which the products undergo; the developmental history of any given product (which is in many respects analogous to that of an organism), being written across the table from left to right. The minor tables, as yet unpublished, of which the most important is outlined at page 306, contain a classification of all material products, potential, mediate, and ultimate. And it must not be supposed that these are mere *à priori* constructions, inapplicable to practice, the table of Development having really been worked out with a constant reference to the contents of technological encyclopædias (of which the present arrangement is usually merely alphabetic), while the minor tables are the result of many weeks' continuous attempt to classify the multitudinous contents of the last Paris Exposition, and of various smaller previous and subsequent museums of production.

In like manner the three tables devoted to the organisms com-

copy of the Proceedings of Section F. of the British Association. At most he will only occasionally have a temporary difficulty in finding where to assign any subject, and this merely for want of the minor tables.

* The names of these subjects are unsatisfactory, since scientific physics, geology, and biology have no economic aspects at all. The biologist, for instance, divides his subject into morphology, physiology, distribution, and ætiology, and finds no place for economic considerations. These subjects are really sociological ones, and should therefore be termed respectively physical economics, geological economics, botanical and zoological economics. The change is no mere verbal one, but involves a radical alteration of the point of view and mode of treatment, and indeed demands the handing over of these subjects to other cultivators.

posing society generalise the results of the daily labours of the Registrar of births, deaths, and marriages, with those of the periodic census, and there again with anthropological and educational statistics, while the three tables immediately following offer a solution of two long outstanding and highly important problems,—first, that of the classification of occupations;* and second, that of the nature of productive and unproductive labour.

Lastly, the tables of Production, Partition, and Use aim respectively at including the facts of the usual divisions of political economy—the production, distribution, and consumption of wealth; while the last—those of Result—cover, as before stated, a large but incomplete and unsystematised body of knowledge accumulated by biologists, physicians, educationists, and philanthropists, and relating to the reaction of the environment upon the organisms composing the society.

§ 25. If, therefore, it has been admitted that the series of tables are placed in order and organised into a whole, it becomes evident that the subjects just enumerated, viz, the facts of political geography, of physical, geological, botanical, and zoological economics, of technology and the fine arts, of anthropology, of demography, and of political economy have similarly been placed in order and organised into a whole. This whole body of facts treated statistically and historically, and the generalisations obtained from them, together with an account of intersocial relations, would constitute a complete account of the society, or group of societies.

§ 26. While it is evident that in our ascending progress from the preliminary sciences no shock has been felt, and no difficulty found, in the successive assimilation of the facts of political geography, physical and biological economics, technology and demography, a vast hiatus becomes evident on our approach to political economy. For here we find not a definite record of observed phenomena aiming at exhaustiveness, together with the generalisations obtained therefrom, but a multitude of contending

* See the very interesting alphabetic list of occupations in the London Directory, and the discussions as to classification in the Report of the United States Census, 1870, and Report of Census of Scotland, 1871, where detailed classifications are also given.

systems, bearing sometimes geographical names, as British school, Italian school, sometimes named after their founders, or sometimes designated by some prominent aspect of their doctrine, as Socialism, Communism, &c., each claiming orthodoxy and opposing its contemporaries obliquely or diametrically. This state of things, fortunately unique in science, makes desirable an exhaustive study and classification of all these rival systems; but within our present limits it is only possible to attempt a brief glance at their main points of difference and of agreement.

First, then, they differ as to whether the subject be a science at all, some authors regarding it as an art, others as something distinct from both. Restricting ourselves henceforth to the great majority of schools which hold the first-mentioned opinion, we find them agree in the extensive adulteration of their scientific matter with irrelevant discussions, which are occasionally of a theological nature, but much oftener metaphysical, and most frequently practical—a peculiarity which helps to explain the low esteem into which the subject has been steadily falling during the last generation, among theologians and metaphysicians, practical and scientific men alike. Such digressions are, however, common to the infancy of every department of knowledge, and must not, therefore, be too hardly dwelt upon. A more serious difficulty lies in the want of unanimity among the various schools as to the position of their subject with respect to other sciences, some spending no little labour in an endeavour to isolate it from other branches of knowledge altogether, while others claim it to be a logical science, others a mathematical, others a physical, others a biological, others a psychological, others a sociological, others an ethical science, while some hold it to belong partly to one and partly to another. In other words, the subject has been referred to every possible position in the classification of the sciences with the exceptions of astronomy, chemistry, and geology. And while it must be admitted that the teachers of these various systems are usually admirable as logicians, and that many also freely use mathematical reasonings and illustrations, they do not apply their knowledge to any great extent in the quantitative study of phenomena nor to the analysis of the facts recorded by statisticians. And again, although political economy is said to deal largely with material

things, and largely with organised beings, there is probably no department of modern literature, not even poetry or romance, so little leavened by the recent advances of our knowledge of the laws of matter and of life. To judge from their writings the economists would seem to be unconscious of the very existence of such doctrines as those of the conservation and dissipation of energy, of evolution, and the like, and of the evident fact that the students of the physical and biological sciences can hardly much longer delay a combined invasion of their territory.* Moreover, although archaic psychological conceptions—frequently, of course, of fundamental importance—are tenaciously retained, the economist usually holds aloof from considering the important constructive sociological efforts already made from the side of the preliminary sciences, while the only ethical allusion to be found in many a lengthy economic treatise is a contemptuous dismissal of “sentiment.”

Passing lightly over these disputes as to whether the subject is to be treated purely by deduction, or by induction, or by both, and evading the interminable discussions about the definition of terms, since they compel the abandonment of most of these altogether, we are arrested by the most serious discrepancy of all—that relating to the very scope and nature of political economy. We find that some schools narrow the subject to industry alone, others to government, others to value, others to exchange, so that it has actually been proposed within recent years to confine the title to the study of the commercial phenomena of the present industrial period in England, that is to say in the language of our tables, to little more than certain of the phenomena of movement at a given time in one society; while even many of those systems which take a wider view and seek to investigate production, partition, and use are often justly reproached with ignoring the organisms composing the society altogether, or at the very least with too scanty attention to the all-important results of production, occupation, partition, and use upon these organisms, while they are prone to state their generalisations of the local and the temporary as absolute laws. And, finally, we find that many of these widest systems concern themselves little with actual periodic detailed and quantitative observation of

* See Presidential Addresses to Sections A, F, G of the British Association, York, 1881.

current phenomena, and still less with historical studies, that is to say, with what we saw at the outset to be the two real aspects of the subject; while even the schools which pay most attention to statistics and to history are still far from basing their labours on the foundation of the preliminary sciences.

§ 27. But is not the preceding criticism altogether too completely destructive? In no wise, for it is only levelled against the economic systems as systems, each with pretensions to intellectual completeness. But when the claim to system and completeness is withdrawn all at once become entitled to a respectful examination. Valuable materials have been collected, constructive of scientific economics. Statistical and historical inquiry have long been in active progress; wider and wider conceptions of the range and place of social science are daily gaining ground, while those very schools which we have just been criticising for their narrowness of observation have in some respects all the more clearly focussed the subjects within their range, and have traced for us many of the most important phenomena of industry or commerce, of finance or government. And if our present limits had admitted of any detailed criticism, it would have been easy to show a certain degree of real progress on the part of many recent political economists towards the acceptance of scientific methods and ideas.*

And the real claim of the system outlined in the preceding pages lies not in its newness, for it indeed contains probably no new ideas at all, but in its serving as far as consistent with truth to represent the doctrine of each, and to harmonise the labours of all the schools. Thus, for instance, it is one of the most marked advantages of the tables that it would be easy to monograph on this principle a city or a village, a single household or even an individual, as well as a nation, to compare these facts of personal and domestic economy among each other, and to generalise bodies of these; yet this is simply a return to the conception from which political economy arose and departed, that of the study of household management and law.† Again, the postulation of the preliminary sciences, the idea of territory yielding matter and energy which manufactures and commerce

* Ex. gr. Marshall, "Economics of Industry," London, 1880. Guyot, "La Science Economique," Paris, 1881.

† Πολιτεία, οικία, οίκος, νομος.

can only develop into ultimate products ; these, with the classification of occupations, are the ideas of the leader of the economic Renaissance, the physician and physiologist De Quésnay, although the more advanced science of our day enables us to avoid the errors into which he fell : so, too, the larger view of industry and commerce, the detailed examination of products and processes, of mediate and ultimate partition and the like, the statistical, historical, and comparative inquiries, and, above all, the treatment of economic questions as forming not a totally isolated department of knowledge, but an integral part of the general study of man and of society, form the very essence of the "Wealth of Nations."

It would be easy to multiply examples, to show how complete and detailed a harmony of the matter and spirit of the various schools, statistical as well as economical, the scheme affords us, and how it solves so many apparently difficult and long-disputed problems ; how, for instance, the fundamental conception of organisms utilising the matter and energy of nature clears up such time-honoured disputes as those concerning the nature of interest and of intrinsic value, or how light is thrown upon such phenomena as those of competition and co-operation by the biological conceptions of struggle for existence, of physiological differentiation, of polymorphism, and of functional change. But space does not permit any further development of the scientific aspects of the subject, and it is necessary at once to proceed to the investigation of practical economics.

§ 28. Since the organisms composing society are largely occupied in utilising matter and energy ; since, moreover, every action and every movement involves some disintegration and dissipation of energy—produces, that is to say, an economic result—it is evident that an exhaustive study of practical economics would involve a quantitative record and classification of every action going on in the society. Such exhaustiveness is, of course, impossible ; but without going to any such extreme it is desirable and interesting to make some attempt. Much can, of course, be done by observing and classifying the activities we see going on around us ; but as a convenient periodic record in which most of the more important actions going on in the community find at least occasional mention is furnished by the daily newspaper, it will suffice for the present

to take it as an example, and refer each item of news to its place in our classification. Thus, taking a few at random : *—

| Subject. | Society. | Subject of Table. | Minor Table. |
|--|-------------------------------|--|-------------------------------|
| 1. Irish Land Bill. | Ireland. | Ultimate Partition. | Territory. |
| 2. Opening of Leith } Dock. | Scotland. | Mediate Products. | Movement (Trans- port). |
| 3. Funeral of — | England. | Organisms. Loss. | Death. |
| 4. Amount of Revenue. | Britain. | Mediate Partition. | Nil, Co-ordination, &c. |
| 5. Wreck of Shetland } Fishing Fleet. | Scotland. | {(a) Products. Loss. | Exploitation, by Storm. |
| 6. American Wheat } Crop. | United States. } Canada. } | {(b) Organisms. Loss. | Death. |
| 7. Daring Murder. | England. | Energy. | Exploitation. Veg. Food. |
| 8. Opening of New } Hospital. | England. | {(a) Occupations. C. | Destructive Crime. |
| | | {(b) Organisms. Loss. | Death. |
| | | Ultimate Partition of Ult. Prod. and Services. | Occupations C. Dis- abled. |

But such an arrangement of the actual passing economic actions, though instructive, is quite insufficient. As from our system of astronomical knowledge it is necessary to deduce the art of navigation, so from our system of sociological knowledge we must derive the art of conduct. This want has been thoroughly felt by all the different economic schools—so thoroughly indeed, as to lead, as was before remarked, to the frequent obscuring of the scientific object altogether. A classification and criticism of the practical projects of the various schools should here find place, if space permitted. This, however, may for the time being be dispensed with, since we find complete absence of unanimity, individualism being opposed by socialism, free-trade by protectionism, and so on. Thus, as we have as yet no criterion of morals or expediency, but simply our knowledge of the preliminary sciences, and since it is not the practice of the preliminary sciences to accept mere authority, such opposing schools must for the time being be considered as neutralising each other.

What, then, is to guide us in the construction of rules of practical economics? Shall we rest contented with such a survey of practical action as our classified newspaper affords us, and do as others do? This is an important principle of action, as custom and fashion bear witness, yet hardly needs detailed exposure of its

* With the limitation stated at page 311, note 2, the reader may continue this with any journal. See also author's paper, Brit. Ass. 1881, and "Nature," 29 Sept. 1881, for similar classification of anthropological and economic papers.

unscientific character or of the consequences into which it might lead. Shall we do, then, as others advise? Much advice certainly is current from newspapers, economic schools, and other quarters; but such authority, however often good, has already been dismissed. We are thus thrown back upon our scientific knowledge. Why should we not act upon that? Since nature yields matter and energy, let us utilise nature. Since organisms struggle for existence, let us compete; since, too, they join in united action, let us co-operate. This seems more hopeful, and might be largely developed to furnish practical axioms, tolerably coincident on the whole with the majority of existing customs and precepts. Practical rules of conduct may be made corresponding, for instance, to the table of energy, counselling us to utilise tides, coal, timber, plants, and animals. Yet if these preceding scientific grounds be accepted as sufficient for these practical actions, consistency demands the similar utilisation of the organisms composing society—that is to say, of our fellow-men, as machines, food, &c.; courses, moreover, for which there exist in many societies abundant precedents, both of custom and of counsel. Competition, too, as might easily be shown, would lead us to similar courses of action, and so on with the rest. In short, then, the development of scientific knowledge into practical action is in many cases serviceable, yet here and there without warning leads us into a course where we find ourselves confronted by a difficulty of a new order—the moral.

§ 29. How is it that every proposed course of action has thus led us into difficulties? Because we are seeking rules of action without having defined any aim of action. As we required axioms for scientific economics, so now we require postulates for action, and the latter are readily derivable from the former; thus from our first axiom that the society exists within limits of space and time, the corresponding postulate is evident—let the society exist within limits of space and time, while from the second, third, and fourth axioms the respective postulates arise—(2) let the society consist of living organisms, (3) let them seize the matter and energy of surrounding nature, (4) let them apply this to the purposes of their life, and so on; for, as it was pointed out, that as our knowledge of the nature of societies in general and in particular progresses, new axioms would necessarily be added to the most general ones with

which we started, so corresponding postulates for action would be derived from these, for in every art our code of action is the necessary complement of our scientific knowledge. This principle of practical conduct must not be mistaken for the principle last criticised, and which was seen to lead us into difficulties, that of acting upon any portion of scientific knowledge irrespective of its importance to society; this proposes the adaptation of our action to our whole knowledge of society, and the consequent infringement of no axiom, and recognises the necessary imperfection of such action in proportion as our knowledge is incomplete. This most highly abstract form of practical economics is capable of development into detail.

§ 30. But a higher order of considerations than the sociological came lately into view—the ethical. Reversing our usual order and beginning with the practical considerations, we recognise here as before a vast multiplicity of actions in course of actual performance in each society, termed good or bad, right or wrong, the application and definition of these terms differing somewhat in different societies and schools, custom and counsel too differing as before. An examination of these actions to which moral importance has been assigned, shows that at least many, for instance crime, remedial effort, &c., have already been included in our survey of practical economics, while a reconsideration of our economic phenomena shows that moral significance is constantly attached to common acts, say of commerce or husbandry. The interesting detailed examination of the economic aspects of actions commonly termed moral, and of the moral aspects of actions commonly termed economic, which must be left to the reader, leads to the conclusion that at least the majority of the actions going on in the society (probably indeed all) possess both aspects. Without going so far, if it be granted that certain practical actions have both economic and ethical aspects, it follows that in these given respects both moral and economic action must coincide. For if the action based upon economic science do not coincide with the action based upon ethical science (assuming such science to exist), it follows that the two sciences of sociology and ethics are not in unity; and inversely, if this denial of the unity of science be not made, economic action must harmonise and coincide with moral action.

This coincidence of practical economics with practical ethics, of economy with morality, being implied in such common conceptions as those of conduct, duty, and the like, and indeed in almost every application of these terms, and having been often pointed out by philosophers and moralists should need little illustration, were it not that the introduction into practice of ethical conceptions, for various reasons of greater or less cogency, has been proclaimed irrelevant by not a few political economists, of whom some would indeed almost seem to have believed in a veritable antagonism of these two aspects of conduct. Such views of ethics and economics are harmonious with that want of relation to the preliminary sciences referred to in § 26 as characteristic of such economists.

Such a comparison of the two aspects of proposed actions instead of being avoided should indeed invariably be adopted. Since we saw that economic action should be based upon scientific knowledge and that not fragmentary but complete, and since our sociological knowledge is dangerously incomplete, while action is inevitable, the utility of the moral check already referred to in § 28 becomes apparent. When the counsel of economics and of morals coincide the action may be regarded as ratified and its grounds as verified, while a discord between the two must similarly be regarded as indicating that the proposed course of action whether ethical or economic must be in error. Though the course of action proposed on ethical grounds may sometimes be even more liable to error than that proposed on those of our as yet so imperfect economic knowledge, yet cases frequently occur more or less analogous to those taken for example in § 28 in which the former course is to be adopted, its accompanying emotional state then serving as a help not as a hindrance.

§ 31. Having thus reached the ethical platform we find a new series of ethical systems inviting study and criticism, but a single instance chosen almost at hazard must suffice. If practical economic action coincides with ethical action, our most general principle of economic action, which we have seen to be "act upon postulates," is also a general principle of ethical action. But this principle is essentially similar to the most abstract law of the Intellectualist system of ethics,—the Categorical Imperative of Kant,—especially when developed into its individualistic and concrete forms.

But such comparisons of the various ethical systems, however interesting, would lead into ground for unnecessary controversy. The object of the present paper, probably the first which has attempted to organise the whole body of our recorded social knowledge into a form presentable to the cultivators of the preliminary sciences, will have been sufficiently gained if the unity and continuity of these, with the social and moral sciences, has been made in some respects clearer than heretofore, and if the mode of treatment and arrangement of the facts of social science therein proposed be admitted as satisfactory and serviceable.

1.

ULTIMATE

| | | | |
|--|--|--|--|
| | | | |
| | | | |
| | | | |

US

| | | | |
|--|--|--|--|
| | | | |
| | | | |
| | | | |

RES

| | | | |
|--|--|--|--|
| | | | |
| | | | |
| | | | |

DISTRICT EAST AND SOUTH OF OBAN

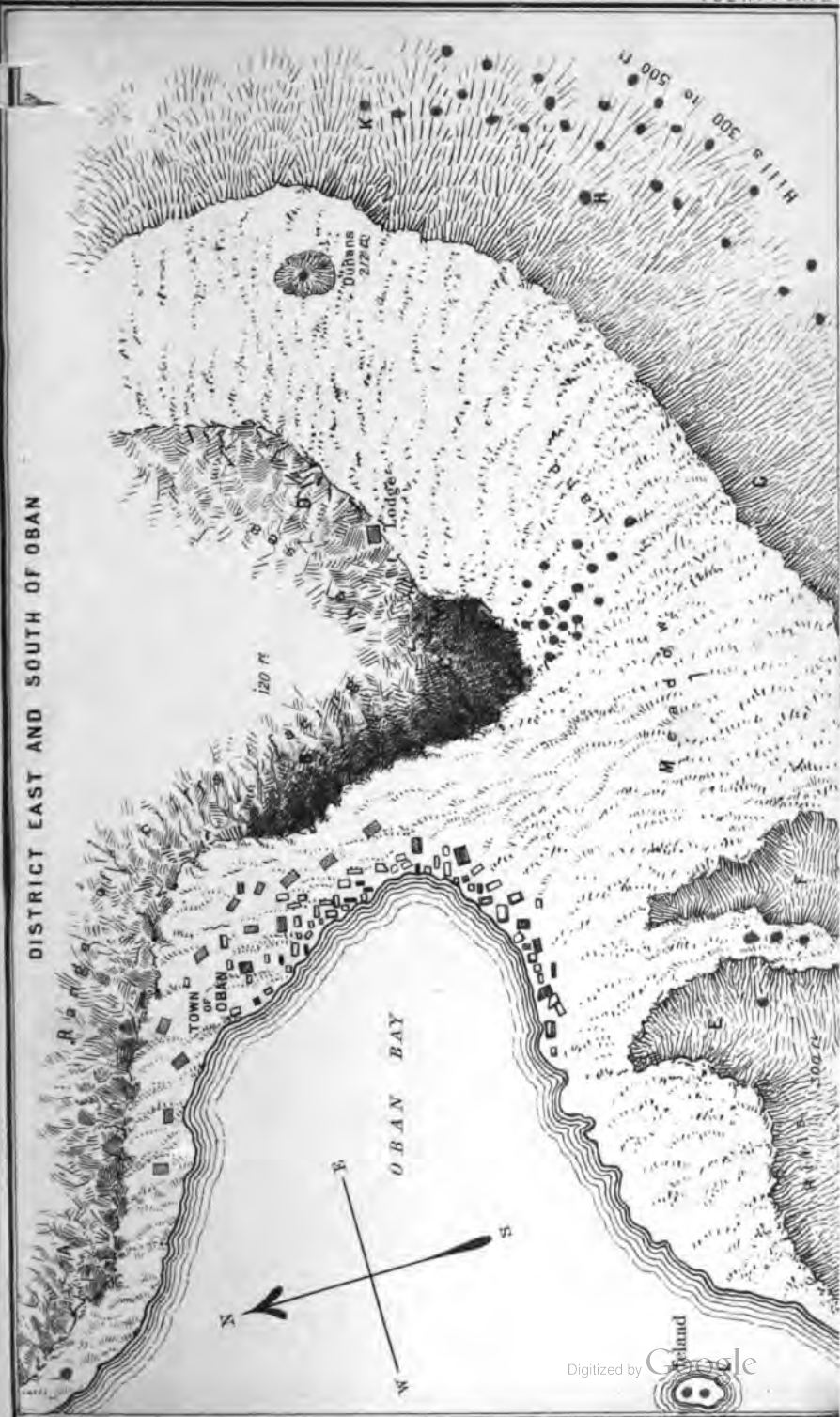

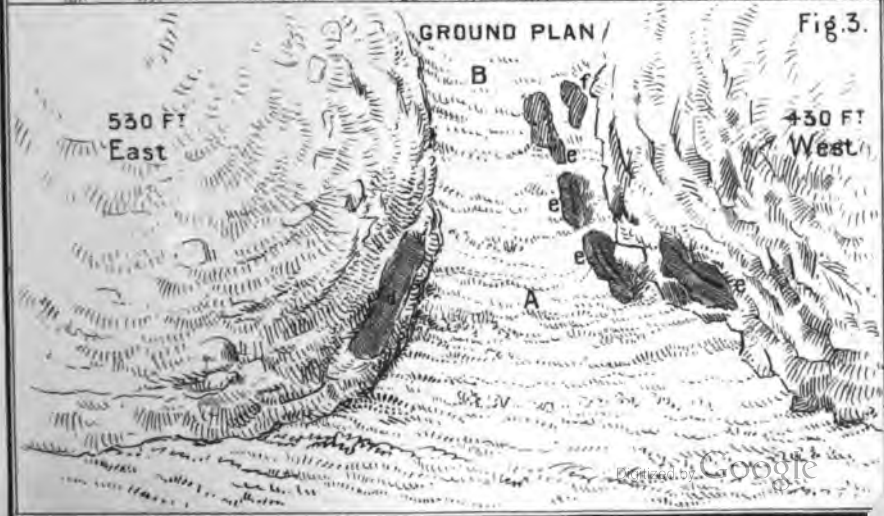
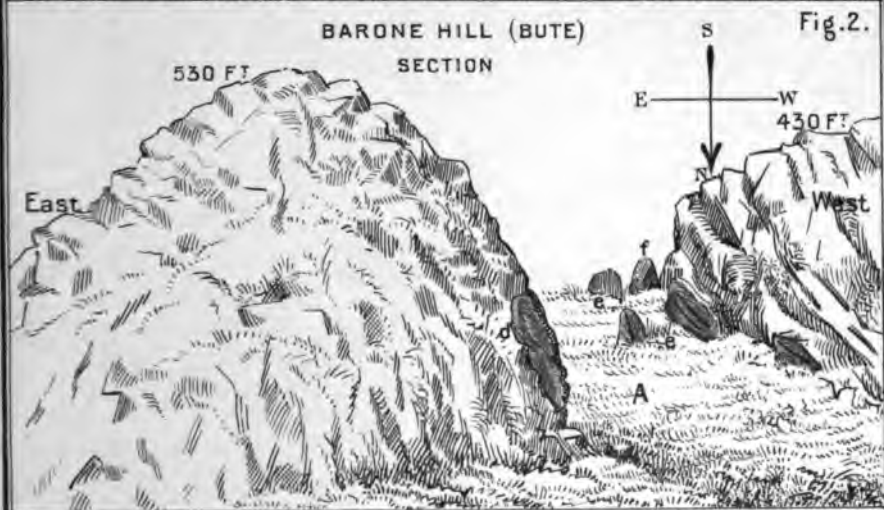
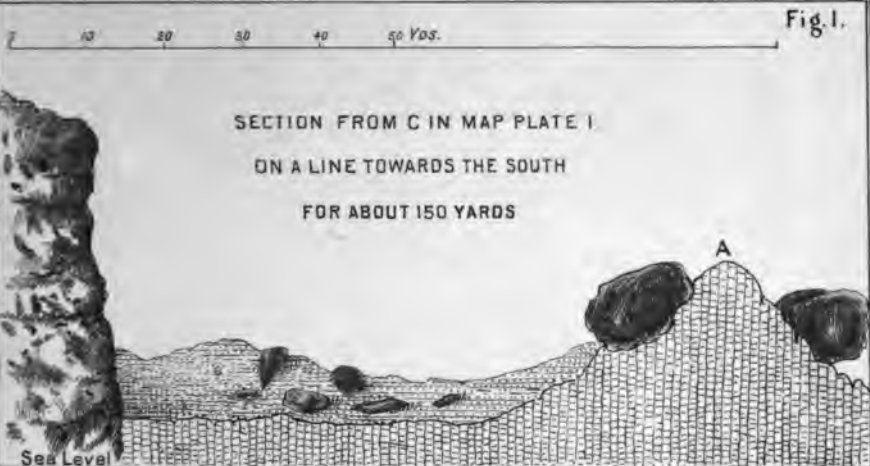



Fig. 1.

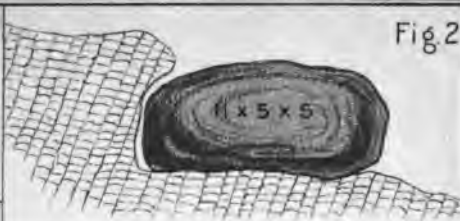

Fig. 2.

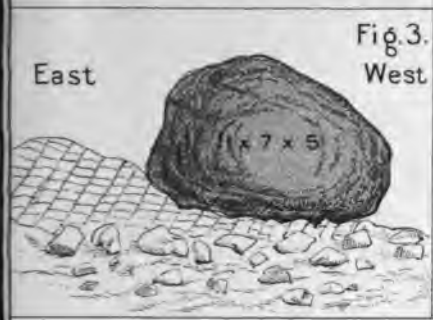

Fig. 3.

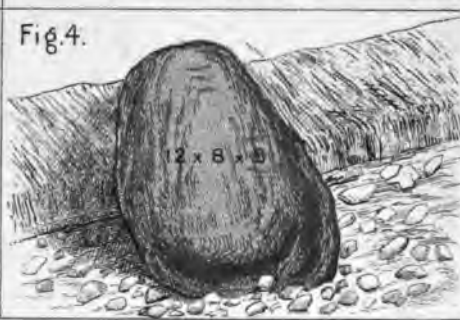

Fig. 4.



Fig. 5.



Fig. 6.

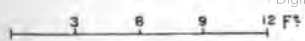

| | PAGE |
|--|------|
| On some Transformations connecting General Determinants with Continuants. By Mr THOMAS MUIR, . . . | 135 |
| Note on the preceding Paper. By Professor CHRYS TAL, . . . | 135 |
| <i>Monday, 7th March 1881.</i> | |
| Introductory Address by the President, the Right Hon. Lord MONSIEUR. (Continued from p. 2), . . . | 136 |
| On the Intrinsic Muscles of the Mammalian Foot. By Dr D. J. CUNNINGHAM, . . . | 162 |
| On the Expansion of Rational Fractions, &c. By Mr A. H. ANGLIN, . . . | 162 |
| Notes of Relationship. Part III. By A. MACFARLANE, M.A., F.Sc., F.R.S.E., . . . | 162 |
| Notes on a Singular Problem in Kinetics. By Professor TAIT, . . . | 173 |
| <i>Monday, 21st March 1881.</i> | |
| The Earthquake of 28th November 1880 in Scotland and Ireland. By CHARLES ALEXANDER STEVENSON, B.Sc. Edin. Communicated by Professor GEIKIE (Plate 10), . . . | 176 |
| On the Classification of Statistics. Part I. By Mr P. GEDDES, Professor Cayley's Theorem regarding a Bordered Skew Determinant. By Mr THOMAS MUIR, M.A., . . . | 187 |
| The Law of Extensible Minors in Determinants. By Mr THOMAS MUIR, M.A., . . . | 187 |
| Additional Note on a Problem of Arrangement. By Mr THOMAS MUIR, M.A., . . . | 187 |
| On the Oxidation of Ferrous Salts. By Mr J. Y. BUCHANAN, On some Space-Loci. By Professor TAIT, . . . | 191 |
| | 197. |
| <i>Monday, 4th April 1881.</i> | |
| On the Pressure-Errors of the "Challenger" Thermometers. By Professor TAIT, . . . | 199 |
| The Action of Heat on Thioformanilid. By W. W. J. NICOL, M.A., . . . | 199 |
| On the Classification of Statistics. Part II. By Mr P. GEDDES, . . . | 202 |
| <i>Monday, 18th April 1881.</i> | |
| On Galvanic Polarisation. By Professor HELMHOLTZ, . . . | 202 |
| On the Average Pressure due to Impulse of Vortex Rings on a Solid. By Sir WILLIAM THOMSON, . . . | 204 |
| On the Crushing of Glass by Pressure. By Professor TAIT, . . . | 204 |
| On the Cause of the Sounds produced in the Microphone Receiver. By Professor JAMES BLYTH, . . . | 206 |
| <i>Monday, 2d May 1881.</i> | |
| On the Classification of Statistics. Part III. Results. By Mr GEDDES, . . . | 209 |
| On the Motion of a Storm in an Easterly Direction being only possible as a Circular Atmospheric Wave. By ROBERT TENNENT, . . . | 209 |
| On Chemical Nomenclature and Notation. By Professor CRUM BROWN, . . . | 209 |

- (a) Diagnoses Fungorum novorum in Insula Scotia a BAYLEY BALFOUR, CAROLO COOKBURN et ALEXANDRO SCOTT, lectorum, quas elaboravit Dr. M. C. COOKE. Communicated by Dr. BAYLEY BALFOUR, 43
- (b) Diagnoses Algarum novarum Scotiensium a BAYLEY BALFOUR, CAROLO COOKBURN et ALEXANDRO SCOTT, lectorum, quas elaboravit Dr. G. DICKIE, F.R.S., 45
- (c) Diagnoses Lichenum Scotiensium novorum a participibus expeditionum Prof. BAYLEY BALFOUR et Dr. SCHWEINFURTH, lectorum, quas elaboravit Dr. J. MÜLLER. Communicated by Dr. BAYLEY BALFOUR, 47

Monday, 6th February 1882.

- On the Colour of the Mediterranean and other Waters. By Mr. JOHN AITKEN, 49
- The Surface Geology of Mid-Lochaber. By Professor DUNS, D.D., 49
- Remarks on Dielectric Strength. By Professor CRYSTAL, 49
- Diagnoses Plantarum novarum et imperfecte descriptarum Phlegmarogamarum Scotiensium; quas elaboravit BAYLEY BALFOUR, Selenitiae Doctor et in Universitate Glasguensi rerum botanicarum regius professor. Pars Prima, 49

Monday, 20th February 1882.

- On a Specimen of *Balanoptera borealis* or *laticeps* captured in the Firth of Forth. By Professor TURNER, 51
- On Minding's Theorem. By M. G. PLARR. Communicated by Professor TAIT, 52
- Chapters on the Mineralogy of Scotland. Chapter VII. By Dr. HEDDLE, 54
- On the Dimensions of Cast Iron at various Temperatures, with more especial reference to the Phenomena of the Solid floating on the Molten Metal. By W. J. MILLAR, C.E., Secretary Inst. Engineers and Shipbuilders in Scotland, 54
- On an Oxycyanide, and a New Oxide of Bismuth. By M. M. PATTISON MUIR, M.A., Fellow, and Praefector in Chemistry, of Gonville and Caius College, Cambridge, 56
- Mathematical Note. By Mr. T. B. SPRAGUE, 56
- On the Manner in which Silicon, Phosphorus, Manganese, and other elements exert their influence upon Steel. By R. SYDNEY MARDEN, D.Sc., F.R.S.E., F.C.S., &c., 56

Monday, 6th March 1882.

- The Effect of Flame on the Electric Discharge. By Dr. A. MACFARLANE and Mr. D. RINTOUL. (Plate IV. a), 57
- Observations on Vegetable and Animal Cells; their Structure, Division, and History. Part I., The Vegetable Cell. By J. M. MACFARLANE, B.Sc. Communicated by Professor A. DICKSON, 57
- On some Points in the Anatomy of the Nervous System of the Pond Snails, Planorbis and Lymnaeus. By F. E. REEBARD, B.A., New College, Oxon. Communicated by Mr. P. GROSS, 57
- A Critical Examination of two Cases of unusual Atmospheric Refraction described by Professor Vincennes. By Mr. ROBERT SANG, 58

P R O C E E D I N G S
OF THE
ROYAL SOCIETY OF EDINBURGH.

VOL. XL

1881-82.

No. 110.

NINETY-NINTH SESSION.

GENERAL STATUTORY MEETING.

Monday, 28th November 1881.

PROF. MACLAGAN, Vice-President, in the Chair.

The following Council were elected :—

President.

THE RIGHT HON. LORD MONCREIFF.

Vice-Presidents.

| | |
|-------------------------------|------------------------------------|
| DAVID MILNE HOME, LL.D. | Prof. H. C. FLEMING JENKIN, F.R.S. |
| SIR C. WYVILLE THOMSON, LL.D. | Rev. Dr. LINDSAY ALEXANDER. |
| Prof. DOUGLAS MACLAGAN, M.D. | J. H. BALFOUR, M.D., F.R.S. |

General Secretary—Professor TAIT.

Secretaries to Ordinary Meetings.

Professor TURNER.

Professor CRUM BROWN.

Treasurer.—A. GILLIES SMITH, C.A.

Curator of Library and Museum—ALEXANDER BUCHAN, M.A.

Councillors.

| | |
|----------------------------------|----------------------------------|
| Professor CAMPBELL FRASER. | Professor A. DICKSON. |
| Professor GEIKIE. | The Right Rev. Bishop COTTEBILL. |
| Rev. Dr. CAZENOVE. | Rev. Professor DUNS. |
| DAVID STEVENSON, M.Inst.C.E. | Dr. RAMSAY TRAQUAIR. |
| Professor CRYSTAL. | JOHN MURRAY. |
| ALEXANDER FORBES IRVINE of DRUM. | WILLIAM FERGUSON, of Kilnmundy. |

By a Resolution of the Society (19th January 1880) the following Hon. Vice-Presidents, having filled the office of President, are also Members of the Council :—

HIS GRACE THE DUKE OF ARGYLL, K.T., D.C.L.

SIR ROBERT CHRISTISON, BART., M.D., D.C.L.

SIR WM. THOMSON, LL.D., D.C.L., F.R.S., Foreign Associate of Inst. of France.

VOL. XL

2 T

Monday, 5th December 1881.

THE RIGHT HON. LORD MONCREIFF, President,
in the Chair.

The President read Obituary Notices of Dr John Hill Burton, Rev. Dr Cumming, Dr P. D. Handyside, Professor Sanders, Dr Andrew Wood—deceased Fellows of the Society.

OBITUARY NOTICES.

JOHN HILL BURTON. By James Gordon, *Asst. Librarian.*

JOHN HILL BURTON, one of the most eminent men of letters that Scotland has produced, was born on the 22nd of August 1809, at Aberdeen. While he was still young, his father, an officer in the 94th regiment, died; but his mother, who was the daughter of an Aberdeenshire laird, though left, on her husband's decease, with very slender means, successfully exerted herself to give her children an education befitting their social position. He had the advantage of being taught by Melvin, the famous scholar and schoolmaster; and on leaving school, continued his studies at Marischal College. He ever afterwards gratefully acknowledged his obligations to his Alma Mater. In the course of his education at Aberdeen, he laid the foundations of that extensive acquaintance with English literature for which he was afterwards so notable, and also acquired a familiar knowledge of the Latin language. Sir Theodore Martin mentions that Burton used always to carry about with him in his pocket a small edition of Horace. Among his associates at school and college were several young men afterwards destined to distinguish themselves by their contributions to the history of their country, and whose predilections for this department of literature doubtless influenced his future literary career. These fellow-students were, Joseph Robertson, the historical antiquary; Dr John Stuart, the author of the splendid volume *The Sculptured Stones of Scotland*; Canon Robertson, the ecclesiastical historian; Dr Grub, the author of the *Ecclesiastical History of Scotland*; Professor Cosmo Innes; and Dr John Cumming, of whom an obituary notice

will be read to-night. In conjunction with some of these, Burton, while still at college, contributed several articles to the *Aberdeen Magazine*.

At the close of his college career he took the degree of M.A., and was apprenticed to a solicitor in his native town. Conscious, however, of an ability for higher work than the drudgery of a provincial solicitor's office, he resolved to abandon it for the higher grade of the legal profession, and was admitted to the Scottish bar in 1831. It was fortunate for the prosecution of his plans of extensive study that he now settled in Edinburgh, and was only a visitor to the great metropolis of the south, for had he resided permanently there, his experience might have been like that of Bishop Thirlwall, who said that the want of time for reading is the great misery of London life. As an advocate, Burton never got practice, but he wrote two legal works of value in their day, one on *Bankruptcy*, and the other a *Manual of the Law of Scotland*, whilst his legal training and knowledge were of immense use to him in his historical works.

In 1833 he began to contribute articles to the *Westminster*, and afterwards to the *Edinburgh* and *North British Reviews*. During recent years he wrote numerous articles—literary, antiquarian, and topographical—for *Blackwood's Magazine*.

Burton's contributions to literature are too many and varied to be enumerated here, but it should be noted as an epoch in his career, that in 1846 he made his first appearance in independent authorship, when he published his *Life and Correspondence of David Hume*. This is universally admitted to be one of the best biographies ever written. In this work details of much literary and antiquarian interest, calculated to throw light on the career of the great Scottish philosopher, are gleaned from sources multitudinous and recondite, and evince such a profound and extensive acquaintance with the literature of the last century, as only one who was not merely a book-hunter, but an indefatigable reader of books, could have brought to bear on the subject. Noticeable, also, is his little work, published in 1849, entitled *Political and Social Economy: its Practical Application*, which is considered to be remarkable, not only for the soundness of its teaching, but for the grace of its style.

His appointment in 1854 as Secretary of the Scottish Prison Board gave him a secure income, independent of literature, and he faithfully discharged the duties of that office, which were somewhat lessened in 1860, when the chief control of prisons in Scotland was assumed by the Home Office. In 1877 he resigned the secretaryship, but continued his connection with this department as a commissioner of prisons till his death. He was accustomed to lay stress on the advantage a historian derives from acquaintance with the machinery of government, and the conduct of affairs in the present, as enabling him to judge more fairly of institutions and men of the past.

He commenced his *History of Scotland* by the publication in 1853 of two volumes, treating of the period from 1688 to 1748, and completed it by seven volumes from Agricola's invasion to 1688. Of this work an anonymous biographer says—"The *History of Scotland* is undoubtedly the work that will carry Hill Burton's name to posterity. At the present day it is recognised as pre-eminently the history of Scotland, and it is one of the few books of the multitude which this age has produced which are likely to live by reason of their enduring merit. He investigated every point for himself, and his *History* is therefore the result of a vast amount of patient and honest work. He possessed in a rare degree the historian's faculty—the power, that is to say, which leads the student of men and events to seize as if by an intuition on those features of character and those currents of opinion which stamp an epoch and the men who moulded it." Professor Æneas Mackay thus refers to it:—"In this *History* he has given us, in a sober style, an eminently plain and truthful account of the main facts in the career of a nation which, in spite of the smallness of its territory, preserved its independence, and when permanently united to England, contributed some new and valuable elements to the British character." He was appointed by the Government Historiographer-royal for Scotland.

His *History of the Reign of Queen Anne*, recently published, though possessing great merit, is considered to be a less successful effort than his *History of Scotland*.

The *Scot Abroad* and *The Book-hunter* have both been very popular. Indeed the latter could not but be popular, abounding

as it does in interesting notices of curious books and their collectors. It tells, in a pleasant and graceful style, of the characteristics, it may possibly be the blunders, that have made certain editions prized by collectors—for even certain editions of the Bible have been largely increased in value by some strange accidental error of the printer. In short, it is a thesaurus of the curiosities of bibliography, and of the eccentricities of bibliomaniacs. It has long been out of print, but a new edition will shortly appear, which will contain a memoir of the author written by Mrs. Hill Burton.

The following allusions to his personal habits may not be uninteresting. It is stated by those who knew him that in pedestrian excursions he had walked over the greater part of Scotland, and as he was a geologist as well as an antiquary and a lover of the picturesque, he found varied sources of interest in the course of his rambles. His library did not mean a particular room; it wandered over his whole house. The principal rooms were all filled or covered with books. The shelves were put up with his own hands, and the books were so arranged that he knew where to find any of them even in the dark. He used to mention that the pecuniary value of the works he had received as presents from contemporary authors amounted to upwards of £400, and this is a proof that he was on the most friendly terms with other literary men.

One who knew him well says,—“He was very hospitably inclined, and very kind of heart, although his blunt manner often wronged him in the eyes of strangers. His varied knowledge, his fund of anecdote, and his quaint humour made him a delightful companion.” More than most hardworking men, he felt a positive pleasure in his unceasing intellectual activity, and like our former president, Sir Walter Scott, considered “the capacity to labour as part of the happiness he had enjoyed.” It was doubtless owing to this peculiarity of temperament that to the last he preserved much of the freshness of youth, as evinced by an unfailling buoyancy of spirit, and the lively intellectual interest he took in a vast variety of subjects; for as Burton’s friend, Sir Theodore Martin, observed in his rectorial address at St Andrews—“It is no paradox to say that there is nothing like work for maintaining the elasticity of mind, and preparing it for what we should all aim at—the carrying on

the spirit of youth, the freshness of enjoyment into riper years, and even into old age."

He was elected a Fellow of this Society on 1st February 1847, and was also a member of the Geological and Antiquarian Societies. He received the degree of LL.D. from the University of Aberdeen. He was also a D.C.L. of Oxford. He died on 10th August 1881, at Morton House, near Edinburgh.

REV. JOHN CUMMING, D.D. By the Rev. Professor Flint.

THE REV. DR. JOHN CUMMING, who died at Chiswick on the 4th of last July, was elected a Fellow of this Society on 21st February 1853. The deceased was born in Aberdeen on 10th November 1810. He was educated in the Grammar School of his native city, and afterwards in King's College, of which he became a graduate.

At the early age of twenty-three he was called to the pastorate of the Scottish Church, Crown Court, Covent Garden, London, and the duties of this office he discharged for almost fifty years. The attractiveness of his preaching, his zealous opposition to Roman Catholicism, High Churchism, and Rationalism, and the popularity of the religious writings which flowed in rapid succession from his pen, not only gathered round him a large and influential congregation, but gained him a multitude of admirers in all parts of the kingdom; while, at a somewhat later period, the definiteness and singularity of the conclusions to which he was led by his study of prophecy made him, perhaps, more talked about than any other man in the clerical world.

The Hammersmith discussion of 1839 showed his readiness and skill in public debate. As early as 1840, in the preface to his edition of John Knox's Book of Common Order, he advocated nearly the same changes in the public worship of the Church of Scotland for which Dr. Robert Lee contended in Presbytery and Assembly about twenty years later. It was about 1846 that he began to attempt to unfold the course of unfulfilled prophecy, and from about 1860 that his interpretations became startlingly definite and particular. The year 1868 was fixed on as that in which very marvellous events were to occur. It was not an uneventful year, yet when Dr. Cumming sought to show in 1870 that every incident

foretold as then to happen had actually taken place, the task was generally recognised to be one of hopeless difficulty. Even should it be thought, however, that he was not very successful in his apocalyptic researches, the members of the Royal Society cannot need to be reminded that in the same department of investigation Sir Isaac Newton himself somewhat signally failed.

Dr. Cumming's publications were very numerous, and several of them passed through many editions and were very widely read. They may be distributed into three classes:—(1) Works of practical religious edification—such as those entitled *Daily Life*, *Voices of the Night*, *Sabbath Morning Readings*, &c.; (2) Controversial Works—of which the *Hammersmith Discussion* and the *Popular Lectures on Essays and Reviews* may be mentioned as examples; and (3) Works on Prophecy—such as the *Apocalyptic Sketches* of 1847, 48, and 49, and *The Great Tribulation, Redemption draweth Nigh*, and *Seventh Vial*, of a later period.

Dr. Cumming found relaxation and pleasure in tending bees, and was the author of the letters on apiculture, signed "Bee-master," which appeared in the *Times*.

Upwards of two years before his death, his powers of mind and body began perceptibly to fail, and even before there were any signs of waning vigour, fashion and popularity had gone to flatter others; but the announcement of his decease must have carried sadness to many, as they remembered the conspicuousness of the position which he had long held, the abundance of his labours and the multitude of his works, the charm of his speech and the popularity of his writings, his bold and tenacious advocacy of his convictions, and his amiable and estimable personal qualities.

DR. P. D. HANDYSIDE. By Dr. J. H. Balfour, F.R.S.

PETER DAVID HANDYSIDE was born on 26th October 1808. He was the son of William Handyside, Writer to the Signet in Edinburgh. He died on 21st February 1881, at 16 Lansdowne Crescent, Edinburgh, after a lengthened illness.

He was educated in Edinburgh, and took his degree in medicine in the University of Edinburgh in 1831. He was a distinguished student, as is evinced by the fact that he was elected Senior Presi-

dent of the Royal Medical Society, and also that he was a Medallist of the Harveian Society.

Having been an apprentice of Mr. Syme, the eminent surgeon, his attention became specially devoted to the study of anatomy and surgery. After getting his medical degree he prosecuted his anatomical studies for a time in Paris, and in Heidelberg under Tiedeman. On his return to Edinburgh in 1833, he was admitted to the Fellowship of the Royal College of Surgeons of Edinburgh, after undergoing two public examinations, and submitting a probationary essay on "Osteo-Aneurism," which was published and circulated. In the session 1833-34 he commenced a course of lectures on anatomy at 4 Surgeons' Square, Edinburgh, and became a popular and successful teacher. About six years afterwards he became one of the surgeons in the Edinburgh Royal Infirmary. He was deeply impressed with the relation between anatomy and surgery, and in the summer session he gave a full course of operative surgery. At this time he commenced a course of lectures on surgery at No. 1 Surgeons' Square, and gave up his lectures on anatomy.

A vacancy having occurred in the chair of General Pathology by the resignation of Dr Thomson, Dr Handyside became a candidate, but was not successful. In 1842 a vacancy occurred in the chair of Surgery by the sudden death of Sir Charles Bell, and Dr Handyside came forward as a candidate. The vacancy, however, was filled up by the election of Mr James Miller. Dr Handyside considered that extra-mural teaching on this subject would be much affected thereby, he therefore recommenced his lectures on anatomy, and, along with Mr Spence and Dr Lonsdale, took up the School of Anatomy in Surgeons' Square, vacated by the recent appointment of Dr Allen Thomson to the chair of the Institutes of Medicine in the University. This school easily took the lead among the other schools of anatomy in Edinburgh. The appointment of Mr John Goodsir to the chair of Anatomy in the University on the retirement of the third Monro in 1846, altered very considerably the circumstances of the Extra-mural School, and after conducting a class during the session 1846-47, Dr Handyside relinquished anatomical teaching, and devoted himself entirely to his medical practice.

Unfortunately Dr Handyside's health gave way under the strain of his practice, and he was forced to go abroad for rest and change. In 1863, however, on the appointment of Dr Struthers to the chair of Anatomy in Aberdeen, he was persuaded to resume his anatomical teaching at Surgeons' Hall, and he continued to conduct his class there until within a few weeks of his death.

Dr Handyside was clear and emphatic as a lecturer, and possessed the esteem and respect of his students, to whom he was ever most attentive and courteous. He was an excellent draughtsman, a most important talent for an anatomical teacher. He was surgeon to the Edinburgh hospital for four years, and was a clinical lecturer there. He performed some most skilful operations, of some of which accounts were published. Dr Handyside was elected a Fellow of the Royal Society of Edinburgh on 20th February 1847.

Dr Handyside was intimately connected with the Edinburgh Medical Missionary Society from the first year of its existence, and he was for forty years on its committee or on the board of its directors. He himself opened and conducted for some years a dispensary on medical mission principles at Main Point, between West Port and Lauriston. Much good work was done, and Dr Handyside exercised a most wholesome moral and religious influence over the students whom he gathered round him there. In 1858 Dr Handyside transferred this private dispensary to 39 Cowgate, and it was three years afterwards formally adopted by the directors of the Edinburgh Medical Missionary Society.

He devoted much attention to Comparative Anatomy, and was particularly interested in the structure of fishes. In connection with this subject he contributed to our *Proceedings* in 1873 a paper "On the Anatomy of a new species of *Polyodon* (*P. Gladius, Martens*);"* and he resumed the subject in a continuation of the above paper in 1878. In these contributions he gave an anatomical description of the respiratory, circulatory, and pneumatic systems in this remarkable fish, and also noticed shortly its alimentary and other viscera. He proposed, in a further continuation of the paper, to give an account of its articular system and endo-skeleton, but unfortunately did not live to overtake this part of the subject.

In 1869 he contributed a paper to our *Proceedings*, "On Traces in the Adult Heart of its Transitions in form during Foetal Life."*

He also contributed to the *Edinburgh New Philosophical Journal*,† "A History of the Sternoptixinæ, a family of the Osseous Fishes, and their anatomical peculiarities, with a description of the *S. celebes*."

In the *Edinburgh Medical and Surgical Journal*, he wrote an "Account of a case of Hermaphroditism."

He published in the *Journal of Anatomy*,‡ "A Notice of Quadruple Mammæ—the lower two rudimentary—in two adult Brothers."§

The following is also a list of other articles published by Dr Handyside as reported by Professor Struthers in his biographical notice in the *Edinburgh Medical Journal* :—

Cases in Surgery, including Necrosis of the Thigh Bone (*London and Edinburgh Monthly Journal of Medical Science*, 1845).

Spasmodic Affections of the Larynx, including a case in which Tracheotomy was performed through a Bronchocele.

Amputation at the Hip-Joint, with Figures of the Tumour and Stump.

Caries of the Tarsus and the Ankle-Joint, in which is described and figured a method of performing Syme's Amputation at the Ankle by antero-lateral flaps.

Outlines of Anatomy.

Engravings and Description of the Blood-Vessels.

Experimental Essay on Venous and Lymphatic absorbent Systems.

Theory of Death from Air admitted into the Veins.

Encephalocoele.

Acrania.

Cyclo-cephalian Form of the Etmoccephaloids.

* *Proceedings of the Royal Society of Edinburgh*, vol. viii. pp. 50-51, 136-37; vol. ix. p. 660.

† Vol. vi. 499.

‡ Vol. xxvii. pp. 324-331.

§ Vol. vii. pp. 56-59.

Subarachnoid Serous Sac.

Arrested Liver Development.

(*Edinburgh Medical Journal* 1866 and 1869.)

Hypospadias with Cleft Scrotum (*Edinburgh Medical Journal* 1873).

Professor SANDERS. By Professor T. R. Fraser.

WILLIAM RUTHERFORD SANDERS was born in Edinburgh on the 17th of February 1828. His father was a medical practitioner whose name is associated with a valuable and extensive series of observations on the action of digitalis. He received a portion of his general education at the High School of Edinburgh, under the late Dr. Bryce, and completed his classical and literary training at the University of Montpellier, where he graduated with distinction as Bachelor in Letters in 1844. Soon afterwards he returned to Scotland, and in the winter of 1845 he began his medical studies in the University of Edinburgh.

Even at this early period the characteristics which distinguished William Sanders at a later period of his life were manifested. He devoted himself to his work, taking a leading part, for example, in the debates of the Royal Medical Society, which led to his being elected a President of the Society in 1848. He also found time during his studies to engage in an investigation on the structure of the spleen, the results of which were presented as a thesis, when he graduated as Doctor of Medicine in 1849, and obtained for him the reward of a gold medal. This thesis was published in Goodsir's *Annals of Anatomy and Physiology*, and has since retained an authoritative position in medical literature. It constituted the foundation of other and subsequent researches, which have led to the association of his name with those of Gairdner and Virchow in the first descriptions of the now well-known waxy or amyloid process of degeneration.

Soon after his graduation in medicine, Dr Sanders proceeded to Paris and Heidelberg for the purpose of acquiring, under the direction of distinguished teachers, as thorough a training as possible in the most advanced methods of investigation in pathology and microscopic anatomy. On his return to Edinburgh he

applied himself diligently to pathological and clinical work, holding for a short time the interim appointment of Pathologist to the Royal Infirmary, and engaging with much success in tutorial instruction in connection with the University class of clinical medicine.

In 1851 and 1852 two papers worthy of note were published by him. In the first he summarised the valuable labours of Claude Bernard on the production of sugar in the liver of man and animals; and in the second he gave a description of the speculum invented by Helmholtz for examining the fundus of the eye, thereby introducing into Britain an instrument which has now become indispensable for the diagnosis of diseases of the eye.

The conservatorship of the museum of the Royal College of Surgeons having become vacant, Dr. Sanders was in 1853 appointed to this office, and during his tenure, extending from this time to the date of his appointment to the chair of General Pathology in the University (1869), he amply vindicated the wisdom of his selection by his devotion to the interests of the museum, his industrious study of the valuable means of pathological training which it affords, and his efforts to render these means available for the education of the students and practitioners of Edinburgh by a series of demonstrations and lectures, which met with much success.

In 1855 he added to his other duties that of a lecturer on the Institutes of Medicine in the Extra-Academical School; and in 1861 he began, as physician to the Royal Infirmary, a course of instruction in clinical medicine which formed a material foundation for his after success as a great physician. The writer of this notice well remembers the many evidences which Dr. Sanders gave, even during the first years of his hospital work, of indomitable perseverance and determination to spare no trouble in ascertaining to the utmost of his power the exact condition of the maladies of his patients. His time and thoughts were ungrudgingly bestowed upon his cases, and for several years it was his custom to spend from two to three hours daily in the wards of the hospital. Among other results of this devotion to bedside observation, he acquired materials for communications to the literature of practical medicine; and from the time of his appointment to the hospital his published papers rapidly grew in number, and included many important

papers and monographs, such as those on coalminers' phthisis, on Addison's disease, on several forms of diseases of the nervous system, and on diseases of the heart and kidneys. The greater number of these publications appeared in the *Edinburgh Medical Journal*, with which he was officially connected as joint-editor from 1859 to 1861, and as sole-editor from 1866 to 1869.

Dr. Sanders had now acquired a high reputation as a scientific observer and a physician, and on the chair of General Pathology in the University becoming vacant by the resignation of Professor Henderson in 1869, his acknowledged eminence as a pathologist secured for him the appointment. He entered upon the duties of his new office with the same spirit as had characterised all his other undertakings. He determined, in the first place, that his teaching should be thorough. His great anxiety was that he should place before his students such an account of his subject as would adequately represent every important doctrine and fact, and he spared no trouble in collecting from all sources the materials that were required for this object. His previous training in scientific observation and in teaching had placed him in an advantageous position for ensuring success. His knowledge was great, his judgment and critical genius well-balanced, and the familiarity resulting from long experience had enabled him to overcome a diffidence which was natural to him, and to impart to his lectures a decision in statement and earnestness in manner which were peculiarly attractive to his hearers.

On his appointment to the professorship of General Pathology he retired from the office of Ordinary Physician to the Royal Infirmary, but continued the teaching of clinical medicine in the wards of the Infirmary assigned for this purpose to the University. The medical school of the University had already entered upon that course of rapid growth and reviving importance which has been uninterruptedly maintained to the present time; and although the teaching of medicine in its most practical aspect was then in the hands of such masters as Bennett and Laycock, the accession of Dr. Sanders proved of the greatest value. Afterwards, when the failing health of his colleagues interfered with their sharing in the work of clinical teaching, the value of his ripe experience as a teacher became the more apparent. For a time, indeed, the entire responsibility of conduct-

ing the University class of clinical medicine devolved upon him ; and then, as well as during the whole time that he acted as a clinical teacher, he amply sustained the reputation he had acquired before his appointment in the University. Recollecting the difficulties which he had been led to appreciate while he acted as a clinical tutor in the earlier years of his professional life, he introduced a class of tutorial instruction, for the purpose of ensuring that his students should have an opportunity of acquiring a fundamental training in the elements of medical diagnosis, without which that thoroughness of teaching which he always aimed at could not be effected.

An earnest wish that his students should also be thoroughly trained in pathology, led to his adopting the system of practical teaching in connection with his lectures on that subject. In the first session of his professorship he instituted practical classes, where students were trained to observe for themselves the naked-eye and microscopic characters of morbid conditions, of which they could acquire only a superficial knowledge in the lecture-room. The advantages of this training were soon so highly appreciated that the practical classes were attended not only by the greater number of his students, but also by many graduates.

Thoroughness in teaching, thoroughness in all the work he undertook, was, indeed, one of the most prominent traits of Dr Sanders' character. It gained for him the confidence of his students. It gained for him also the confidence of his fellow practitioners ; and when, in the course of time, the opportunity was given to him for entering upon consultation practice, he reaped the advantages of a well-merited confidence by quickly attaining a foremost position in this country as a consulting physician. And here the writer of this notice would venture to quote a passage written by one who was long associated with Dr Sanders in professional and personal interests, and whose recognised authority as an eminent physician lends a peculiar value to his opinion :—“ One important aspect of Dr. Sanders' precept and example as a teacher deserves a word of notice. He was entirely superior throughout to the affectation which often leads men aiming at eminence as practitioners to speak disparagingly of the science of medicine as opposed to the art. . . . Dr. Sanders' first care as Professor of General Pathology was to see

that his students had the opportunities and guidance necessary for securing an ample basis of demonstrated fact, on which, in due time, a superstructure of pathological science might be erected; and his latest as well as his earliest work bears testimony to the prominence in his mind of that essentially pure love of scientific truth for its own sake, which has been in all ages the guiding star of truly great practitioners of medicine. . . . Even amid the pressing calls of consulting practice, and amid distractions of a yet graver kind, . . . he never forget the ladder by which he rose to fame, the only true ladder, it may be added, by which any man ought to rise on whom the training of the younger medical mind in any large degree depends; and no doubt it may be said of him that the confidence reposed in him by a wide circle was largely founded on the belief that he had so gained his eminence, and that a position attained by only the most legitimate scientific methods would never be abused to lower and baser ends."

The graver distractions referred to by the writer of this quotation were the evidences of decaying health, which first manifested themselves in January 1874, or little more than four years after Dr. Sanders was appointed a professor. In their first manifestations they caused the gravest anxiety to his friends, unfortunately but too clearly confirmed when, after several intervals of apparent restoration to health, during which he resumed for a time his duties as a teacher and physician, a sudden attack of hemiplegia of the right side, with nearly complete aphasia, occurred on the 8th of September 1880. He remained in this condition, with occasionally some improvement in the paralytic symptoms, and with an intellect apparently unclouded, until February of the following year, when a second attack occurred, attended on this occasion with loss of consciousness, and in less than twenty-four hours afterwards he expired on the 18th of February 1881, the day following the anniversary of his fifty-third birth-day.

Cut off in the prime of his life, Dr. Sanders' loss is lamented by a widow and a family of two sons and three daughters. It is lamented also by a wide circle of friends. The universal respect entertained for him was exhibited by the large gathering that took place at his funeral on the 23rd of February—a gathering which comprised representatives of all classes of society, and in

which were conspicuous many in the poorest ranks who had derived advantage from his skill as a physician. It has also been exhibited in the successful realisation of a scheme to commemorate his life by a monument to be placed over his grave in the Dean Cemetery, and a bust to be preserved in the University, which have been executed by Mr. Hutchison, R.S.A.

His friends and associates lament the death of a sincere, truthful, and warm friend. His colleagues recognise that the profession of medicine has lost one of its most eminent representatives, an earnest denouncer of abuses, and a powerful advocate for reforms; a man of science, diffident in self-assertion, but influential because of the merits which he himself was slow to assert.

DR. ANDREW WOOD. By Professor Maclagan.

DR. ANDREW WOOD was the representative, in the fourth generation, of a family which for considerably above a century and a half has been identified with the medical profession in Edinburgh, and especially with the Royal College of Surgeons. His great-grandfather, William Wood, entered the college in 1716; his grandfather, Andrew Wood, in 1769; his father, William Wood, in 1805; and he himself in 1831. It does not appear that the first William Wood ever was chosen President of the College, but all his three descendants obtained that honour, two of them being twice elected.

The subject of the present notice was born on 1st September 1810. He was educated at the High School, being, according to the then existing system, four years under Mr. Lindsay, and then two years under the Rector Dr Carson, his place in his last year's class being a high one, and showing that even as a boy he had a taste for the ancient classics which were to him a source of enjoyment to the end of his life. After having gone through the humanity classes he entered upon the study of medicine, and took his degree of M.D. in August 1831, when he was not quite twenty-one years of age, under a custom then in force, which permitted those to receive their degree whose twenty-first birthday occurred before the commencement of another academic session. Very soon after his twenty-first birthday he was admitted to the Royal College of Surgeons, his probationary essay being upon

Cataract, a Latin version of it having been presented by him as his thesis to the Medical Faculty of the University. Though without any special predilection for ophthalmology, or indeed for pure surgery in any form, he was probably induced to select this subject for his thesis from his having for some time studied in Dublin, especially under the celebrated oculist Dr. Jacob, of whom frequent mention is made in his probationary essay.

Two circumstances connected with Andrew Wood's earlier professional days call for notice, because they exercised a marked influence on his future career. The first, which belongs to his undergraduate period, was his joining the time-honoured students' institution, the Royal Medical Society. He did not long remain a silent member on its benches, but soon threw himself, with that energy which was part of his nature, into the business of the Society, both private and public, taking a large share in its debates and being a most zealous and valuable business man in its committees. He was a member of that sub-committee of three to whom was entrusted the final revision and correction of the *Catalogue Raisonné* of the Society's valuable library, which was published in 1837. To the Royal Medical Society, Andrew Wood was always ready to assign, as many others have had reason to do, that fluency in speaking and readiness in debate which he afterwards so fully manifested, nor did he forget the benefit which it conferred upon him in giving him the habits of business which he acquired in its finance, library, and other committees. The youth was here truly the father of the man; for to those who were associated with him in those days of youthful activity, it seemed to be only the necessary development of Andrew Wood when he became a leading and influential member of the General Medical Council of the United Kingdom and Chairman of its Business Committee. His fluency on all sorts of occasions, whether he spoke after preparation or on the spur of the moment, was conspicuous. He spoke as he felt—that is, strongly—on every matter on which he had made up his mind; but perhaps there may be permission for the friendly criticism of one who, as a life long intimate, knew and valued him, that he not unfrequently spoke *ore rotundo* when a less oratorical style might have sufficed.

The second circumstance which powerfully influenced Wood's future for good, was his appointment when a young practitioner to

be one of the medical officers of the New Town Dispensary. There his natural energy found an ample field for its exercise, and here he found, as many of his fellow practitioners can testify that they have done, the value to them of being thrown on their own resources, and having to apply on their own responsibility those clinical instructions which they had acquired under their teachers in the Royal Infirmary. Andrew Wood laboured hard among the poor, and soon acquired that self-reliance and decidedness as a practitioner which characterised him in after life, and which made him to be trusted and valued in the large practice which he enjoyed, partly as an inheritance but chiefly from his own professional worthiness. He held several important professional appointments, such as the surgeoncy of Heriot's Hospital and of the Merchant Maiden and Trades Maiden Hospitals, and the Inspectorship of Anatomy for Scotland.

His most conspicuous public position was that of a member of the General Medical Council. His hereditary as well as personal attachment to the College of Surgeons of Edinburgh, and the active share which he had taken in all its work, alike as a fellow, as president, and as an examiner, pointed him out as the fitting representative of that body in the General Council, and the College neither sought nor needed any other representative so long as he lived. He was soon recognised as an important and useful member of the Council, the best proof of which was his selection as the Scottish member of its Executive Committee. This entailed upon him much work, and frequent visits to London. To most people these last would have been a trial and discouragement, but his energetic nature knew no such impediments. He would make a night journey up, have a day's business in the metropolis, and come back next night by the express, reappearing as usual in his professional rounds in the forenoon of the second day, apparently as fresh as if he had enjoyed two successive nights of undisturbed repose. It was these rapid movements of his which gained for him from his friends, both here and in London, the sobriquet of the "Flying Scotsman."

Andrew Wood through his whole life had a keen enjoyment of the classics both ancient and modern, his favourite languages being Latin and German, and his love for them led him to write and publish translations from Horace and also from Lessing and Schiller. He

had a retentive memory, and often in conversation or discussion produced an apt quotation especially from Horace or Lucretius. It was his work as a member of the Medical Council rather than his literary efforts which led his Alma Mater, the University of Edinburgh, to confer upon him the degree of LL.D.

In the matter of general politics, Dr. Wood had, as was usual with him, very decided opinions. Other people called him a Conservative; he avowed himself to be a Tory. He never, however, allowed politics to make any difference for him in the amenities of private life, and thus it came that many of those who were his most loved and loving friends were entirely of opposite political opinions. In both these respects he was a close follower of his genial and esteemed father, William Wood. In medical politics he followed no system which could be designated as Conservatism. His position in medical politics would best be expressed by a term borrowed from the German Parliamentary vocabulary; he was a Progressist. His great desire was to see the medical profession not merely maintained but elevated in public and social estimation. Fully estimating the necessity for the rising generation of medical men being thoroughly equipped in all that pertains to modern advances in professional knowledge, he was particularly anxious that good preliminary education should be insisted on, and that the young doctor should first of all be a well-educated gentleman.

His ecclesiastical position was that of a member of the Scottish Episcopal Church, as his forefathers had been. He was not one of those who carry their profession of faith on their sleeve. He never paraded his religion before the world. He would and did talk earnestly and piously on religious topics with his intimate friends, and being in his private relations a loving husband, an affectionate father, an attached friend and an upright straightforward man, he was a capital example of the unpretentious sincere Christian gentleman.

In the social relations he was esteemed by all who had the privilege of his friendship. A certain almost boyish exuberance of animal spirits made him the centre of a hilarious group, whenever he foregathered with his friends in the University Club, or at the festive board of the *Æsculapian* or the *Medico-Chirurgical* Club. He had the true clubbable quality of being able to give and

take a repartee; he would "nothing extenuate nor set down ought in malice."

It was when in the midst of an apparent health and vigour which promised more years of public usefulness, that his friends who knew him intimately, and the public who knew him by name only, were startled and shocked by the news of his sudden death, due, as was afterwards ascertained, to rupture of the heart, on the 25th January of this year, and consequently when he was in the seventy-first year of his age.

Another generation of Edinburgh doctors must be created and become extinct, before it will be forgot that the character of an excellent practitioner, a valuable servant of the public and the profession, an amiable domestic man, a genial friend, and a true Christian gentleman, were united in the person of Andrew Wood.

The following Communications were read:—

1. On a Particular Case of the Symbolic Cubic. By Dr. Gustav Plarr. Communicated by Professor Tait.

§ 1. The method by which Hamilton has established the sym-
bolic cubic

$$(1) \quad m - m_1\phi + m_2\phi^2 - \phi^3 = 0,$$

and more particularly the relation

$$(2) \quad m\phi^{-1} = m_1 - m_2\phi + \phi^2,$$

is founded on a generalisation of the result

$$(3) \quad m\phi^{-1}(\nabla\lambda\mu) = \nabla(\phi'\lambda\phi'\mu),$$

where ϕ represents a linear and vector function, and ϕ' its conjugate according to the definition

$$S\rho\phi'\sigma = S\sigma\phi\rho.$$

In the most general case of $\phi\rho$ the expression of this function is reducible to a vector sum of *three* terms of the form $aSa_{1\rho}$, and the directions which $\phi\rho$ is susceptible of representing are generally not limited in space.

We may now conceive a class of cases in which the expression of $\phi\rho$ is reducible to the sum of *two* terms only, and in which the

directions which the function is susceptible of representing are limited to those which may be comprised in a given plane. In this case we may assume the expressions

$$(4) \quad \phi\rho = aS\alpha_1\rho + \beta S\beta_1\rho,$$

$$(5) \quad \phi'\rho = \alpha_1 S\alpha\rho + \beta_1 S\beta\rho.$$

In virtue of these definitions the coefficient m in the cubic, whose definition is

$$mS\lambda\mu\nu = S\phi'\lambda\phi'\mu\phi'\nu,$$

will vanish, because the factors $\phi'\lambda$, $\phi'\mu$, $\phi'\nu$ are all three coplanar.

The value $m=0$ characterises in a more general way the class of functions $\phi\rho$ which we have in view. But in the case $m=0$ the equations (2) and (3) lose their definite signification because we do not know *a priori* what the result

$$m\phi^{-1}\rho$$

will become when one of its factors vanishes.

If we eliminate the unknown term

$$m\phi^{-1}V\lambda\mu$$

from the relations (3) and (2) (this last being written then for $V\lambda\mu$) we get the relation

$$V\phi'\lambda\phi'\mu = (\phi^2 - m_2\phi + m_1)V\lambda\mu,$$

and there cannot be a doubt as to the validity of this equation when $\phi\rho$ is constituted so as to be susceptible of representing any direction in space. But when $\phi\rho$ is of the more particular class, represented by (4), then it seems to us that the last written equation requires a verification, and the present paper effects this verification by two methods, adding a few applications.

We remark that the expressions (4) and (5) may be looked upon as theoretical and not actually given. The true *data* for the class of functions which we consider will be the vectors γ and γ_1 , namely :

$$(6) \quad V\alpha\beta = \gamma, \text{ and } V\alpha_1\beta_1 = \gamma_1,$$

to which the directions represented respectively by $\phi\rho$ and by $\phi'\rho$ will be perpendicular.

We assume thus

$$(7) \quad S\gamma\phi\rho = 0 \quad \text{and} \quad S\gamma_1\phi'\rho = 0$$

for any direction of ρ .

The theoretical expressions (4), (5) show also that

$$\phi(V\alpha_1\beta_1) = 0 \quad \text{and} \quad \phi'(V\alpha\beta) = 0,$$

namely

$$(8) \quad \phi\gamma_1 = 0, \quad \text{and} \quad \phi'\gamma = 0.$$

These relations comprise the relation (7), because we have

$$S\gamma\phi\rho = S\rho\phi'\gamma = S\rho \times (\text{zero}) = 0,$$

$$S\gamma_1\phi'\rho = S\rho\phi\gamma_1 = 0.$$

We see thus that the properties derived from expression (4) of $\phi\rho$, namely

$$\left. \begin{array}{l} 1^\circ \quad m = 0 \\ 2^\circ \quad S\gamma\phi\rho = 0 \\ 3^\circ \quad \phi\gamma_1 = 0 \end{array} \right\} \left\{ \begin{array}{l} 1^\circ \quad m = 0 \\ 2^\circ \quad S\gamma_1\phi'\rho = 0 \\ 3^\circ \quad \phi'\gamma = 0, \end{array} \right.$$

are all consequences of each other, and one of the equations enumerated in 1°, 2°, 3° will have the others for consequences.

§ 2. For the verification of the equation

$$(9) \quad V\phi'\lambda\phi'\mu = (\phi^2 - m_2\phi + m_1)V\lambda\mu,$$

in our particular case of ϕ , let us first calculate the coefficients m_1 and m_2 , as they are defined in § 147 of Professor Tait's *Elementary Treatise on Quaternions*.

If we take

$$v = \gamma,$$

then, owing to $\phi'\gamma = 0$, the values become

$$(10) \quad \begin{cases} m_1 S\lambda\mu\gamma = S\gamma\phi'\lambda\phi'\mu \\ m_2 S\lambda\mu\gamma = S(\phi'\lambda \cdot \mu\gamma + \phi'\mu \cdot \gamma\lambda). \end{cases}$$

By the help of the theoretical expressions (4), (5) we get

$$\begin{aligned} V\phi'\lambda\phi'\mu &= V(\alpha_1 S\alpha\lambda + \beta_1 S\beta\lambda)(\alpha_1 S\alpha\mu + \beta_1 S\beta\mu) \\ &= V\alpha_1\beta_1 S \cdot V\alpha\beta V\mu\lambda \end{aligned}$$

$$(11) \quad V\phi'\lambda\phi'\mu = -\gamma_1 S\gamma V\lambda\mu.$$

Thus we get

$$m_1 S \lambda \mu \gamma = - S \gamma \gamma_1 S \gamma \lambda \mu,$$

namely

$$(12) \quad m_1 = - S \gamma \gamma_1.$$

Further

$$\begin{aligned} S \phi' \lambda . \mu \gamma + S \phi' \mu . \gamma \lambda &= S a_1 \mu \gamma S a \lambda + S (\beta_1 \mu \gamma) S \beta \lambda \\ &+ S a_1 \gamma \lambda S a \mu + S \beta_1 \gamma \lambda S \beta \mu \\ &= S . (V a_1 \gamma . V \lambda \mu . a) + S . (V \beta_1 \gamma . V \lambda \mu . \beta) \\ &= S . V \lambda \mu [V (a V a_1 \gamma) + V (\beta V \beta_1 \gamma)] \\ &= - (S \lambda \mu a_1 S a \gamma + S \lambda \mu \beta_1 S \beta \gamma) S \lambda \mu \gamma [S a a_1 + S \beta \beta_1]. \end{aligned}$$

But

$$S a \gamma = S a V a \beta = 0;$$

likewise

$$S \beta \gamma = 0.$$

Thus we get

$$(12 \text{ bis}) \quad m_2 = S a a_1 + S \beta \beta_1.$$

It is clear that these values of m_1 and m_2 are those which would be derived from the values of the same coefficients in the case of the expression of $\phi \rho$ by three terms instead of by two only.

Let us now calculate the second member of (9), which for abbreviation sake we will designate by $\xi V \lambda \mu$, putting

$$(13) \quad \xi = \phi^2 - m_2 \phi + m_1.$$

We have by (4) and (12 bis)

$$\begin{aligned} (\phi - m_2) &= \rho a S a_1 \rho - \rho S a a_1 \\ &+ \beta S \beta_1 \rho - \rho S \beta \beta_1 \\ &= V (V a \rho . a_1) + V (V \beta \rho . \beta_1). \end{aligned}$$

Then as

$$\xi \rho = [\phi (\phi - m_2) + m_1] \rho$$

we have

$$\begin{aligned} \xi \rho &= a S a_1 [V (V a \rho . a_1) + V (V \beta \rho . \beta_1)] \\ &+ \beta S \beta_1 [V (V a \rho . a_1) + V (V \beta \rho . \beta_1)] + m_1 \rho. \end{aligned}$$

Two terms vanish, there remains :

$$\begin{aligned} \xi \rho &= a S (a_1 V \beta \rho . \beta_1) + \beta S (\beta_1 V a \rho . a_1) + m_1 \rho \\ &= - a S . \beta V (\rho V a_1 \beta_1) + \beta S . a V (\rho V a_1 \beta_1) + m_1 \rho \\ &= V . V (\rho V a_1 \beta_1) V a \beta + m_1 \rho \\ &= V (V \rho \gamma_1 . \gamma) + m_1 \rho \\ &= \rho [S \gamma \gamma_1 + m_1] - \gamma_1 S \rho \gamma. \end{aligned}$$

By the value (12) of m_1 the factor of ρ vanishes. There remains

$$(14) \quad -\gamma_1 S\gamma\rho = (\phi^2 - m_2\phi + m_1)\rho = \xi\rho.$$

This gives us also

$$\xi V\lambda\mu = -\gamma_1 S\gamma\lambda\mu,$$

and the second member is precisely the value (11) of $V\phi'\lambda\phi'\mu$.

We have thus verified the equation (9) in the case $m=0$. In like manner we may verify the corresponding equation

$$(15) \quad V\phi'\lambda\phi\mu = (\phi'^2 - m_2\phi' + m_1)V\lambda\mu$$

derived from :

$$(16) \quad -\gamma S\gamma_1\rho = (\phi'^2 - m_2\phi' + m_1)\rho = \xi'\rho.$$

These relations (14) and (16) when treated respectively by the operator ϕ and ϕ' will give the corresponding cubics (1) in which $m=0$, because the terms

$$\phi\gamma_1 S\gamma\rho, \text{ and } \phi'\gamma S\gamma_1\rho,$$

vanish whatever be ρ , in virtue of the equations (8) to which ϕ and ϕ' satisfy.

These relations (14) and (16) cannot give the inverse functions ϕ^{-1} or ϕ'^{-1} , because from

$$m_1\phi^{-1}\rho = (m_2 - \phi)\rho - \phi^{-1}\gamma_1 S\gamma\rho$$

$$m_1\phi'^{-1}\rho = (m_2 - \phi')\rho - \phi'^{-1}\gamma S\gamma_1\rho$$

we cannot conclude anything so long as we are unable to determine the unknown vectors

$$\phi^{-1}(\gamma_1) \text{ and } \phi'^{-1}(\gamma),$$

in the case when

$$\phi(\gamma_1) = 0, \text{ and } \phi'(\gamma) = 0.$$

§ 3. On the other hand, when ρ is coplanar with the plane to which the directions of $\phi\rho$ belong, then calling ρ_0 such a vector, we have :

$$S\gamma\rho_0 = 0,$$

and consequently

$$\xi\rho_0 = (\phi^2 - m_2\phi + m_1)\rho_0 = 0,$$

so that the equation (14) becomes in this case a *quadratic*.

This remark enables us to construe the equation (14) by a direct process. Let namely vector ρ , of any direction, be decomposed into

the two components, the one ρ_0 perpendicular to γ , and the other ρ_1 parallel to γ_1 , so that, if $\rho_1 = z\gamma_1$, we have

$$\rho = \rho_0 + z\gamma_1,$$

z being a scalar.

Taking of both members the function ξ , we have

$$\xi\rho = \xi\rho_0 + z\xi\gamma_1.$$

First we remark that, as $\phi\gamma_1 = 0$, we have also $\phi^2\gamma_1 = 0$. Thus $\xi\gamma_1$ reduces itself to $m_1\gamma_1$. If we treat by $S(\)\gamma$ the expression of ρ , we get by $S\gamma\rho_0 = 0$:

$$S\gamma\rho = zS\gamma\gamma_1;$$

and as $S\gamma\gamma_1 = -m_1$ by (12), we get

$$z = -\frac{S\gamma\rho}{m_1}.$$

Hence

$$(18) \quad \rho = \rho_0 - \gamma_1 \frac{S\gamma\rho}{m_1},$$

and

$$(19) \quad \xi\rho = \xi\rho_0 - \gamma_1 S\gamma\rho.$$

We propose now to show, by a direct method, that $\xi\rho_0 = 0$, and for this purpose we apply the method of Hamilton, under the form by which it is explained in § 147 of Professor Tait's *Elementary Treatise on Quaternions*.

As $\phi\rho$ for any vector ρ , and so also for ρ_0 , is perpendicular to γ , we may represent $\phi\rho_0$ by

$$\phi\rho_0 = V\gamma\lambda,$$

λ being quite arbitrary, except that it must be different from γ . This gives besides

$$S\gamma\phi\rho_0 = S\rho_0\phi'\gamma = 0,$$

which is identically vanishing, the relation

$$S\lambda\phi\rho_0 = S\rho_0\phi'\lambda = 0.$$

We have also by hypothesis

$$S\gamma\rho_0 = 0.$$

From these two last equations we draw

$$n\rho_0 = V.\gamma\phi'\lambda,$$

n being a scalar.

We determine n by treating the last expression by

$$S(\)\phi'\mu,$$

μ being not coplanar with γ and λ . This gives

$$nS\rho_0\phi'\mu = S\gamma\phi'\lambda\phi'\mu.$$

The first member becomes

$$nS\mu\phi\rho_0 = nS\mu.V\gamma\lambda = nS\gamma\lambda\mu.$$

The second member expresses, according to (10), the value of

$$m_1S\gamma\lambda\mu.$$

We have therefore

$$n = m_1.$$

We then generalise the relation

$$\phi\rho_0 = V\gamma\lambda$$

into

$$(20) \quad (\phi + g)\rho_0 = V\gamma\lambda.$$

From this we deduce, as above,

$$(21) \quad n_g\rho_0 = V\gamma(\phi' + g)\lambda.$$

This equation has now to serve for two purposes.

First we treat both members by

$$S(\)(\phi' + g)\mu.$$

This gives for the first member

$$n_gS\rho_0(\phi' + g)\mu = n_gS(\phi + g)\rho_0.\mu = n_gS\gamma\lambda\mu.$$

The second member of (21) treated likewise gives us then :

$$S\gamma(\phi' + g)\lambda(\phi' + g)\mu = n_gS\gamma\lambda\mu.$$

If we develop the first member according to the powers of g , we see that n_g takes the form

$$(22) \quad n_g = m_1 + m_2g + g^2,$$

because the coefficient of g becomes m_2 according to the expression (10) of this coefficient.

In the second place we treat the equation (21) by the operator $(\phi + g)$. This gives, by (20),

$$n_gV\gamma\lambda = (\phi + g)V\gamma(\phi' + g)\lambda.$$

Developing the second member we get

$$n_g V\gamma\lambda = \phi V(\gamma\phi'\lambda) + g[V\gamma\phi'\lambda + \phi V\gamma\lambda] + g^2 V\gamma\lambda.$$

If we substitute for n_g its expression (22), and identify the coefficients of the same powers of g in both members, we get the two conditions :

$$(23) \quad \begin{cases} m_1 V\gamma\lambda = \phi \cdot V(\gamma\phi'\lambda) \\ m_2 V\gamma\lambda = V(\gamma\phi'\lambda) + \phi(V\gamma\lambda). \end{cases}$$

From these two relations we eliminate $V(\gamma\phi'\lambda)$ by treating the second equation by ϕ . Thus we get :

$$m_1 V\gamma\lambda - m_2 \phi V\gamma\lambda = -\phi^2 V\gamma\lambda$$

or

$$(\phi^2 - m_2 \phi + m_1) V\gamma\lambda = \xi V\gamma\lambda = 0.$$

Now $V\gamma\lambda$ represents any vector perpendicular to γ . Calling it ρ_0 , we have

$$(24) \quad \begin{cases} \text{for } S\gamma\rho_0 = 0 \\ \xi\rho_0 = (\phi^2 - m_2\phi + m_1)\rho_0 = 0. \end{cases}$$

From this equation we may also draw the inverse function

$$(25) \quad \begin{cases} m_1 \phi^{-1} \rho_0 = (m_2 - \phi) \rho_0, \\ \text{when } S\gamma\rho_0 = 0. \end{cases}$$

To these equations (24), (25) correspond similar equations for the conjugate ϕ' , namely, for $S\gamma_1\rho_1 = 0$ we have :

$$(26) \quad \begin{cases} \xi' \rho_1 = (\phi'^2 - m_2 \phi' + m_1) \rho_1 = 0 \\ m_1 \phi'^{-1} \rho_1 = (m_2 - \phi') \rho_1. \end{cases}$$

It is evident by the expressions (12) and (12 bis) of m_1 and m_2 that the coefficients in the relation (26) are the same as in the relation (24).

§ 4. The equations (24) and (26) may be applied in order to find the directions of the vectors which coincide with the direction of the corresponding function ϕ or ϕ' .

Calling σ the vector, which satisfies

$$V\sigma\phi\sigma = 0,$$

or

$$(27) \quad (\phi - h)\sigma = 0,$$

we see that σ must satisfy

$$S\gamma\sigma = 0,$$

because $\phi\sigma$ is perpendicular to γ , and so σ must be as it is parallel to $\phi\sigma$.

If we treat (27) by $S(\)\lambda$ we get, (λ being different from γ)

$$S\lambda(\phi - h)\sigma = 0,$$

namely

$$(29) \quad S\sigma(\phi' - h)\lambda = 0.$$

Thus, if we call N a scalar, we get by (28) and (29)

$$N\sigma = V.\gamma(\phi' - h)\lambda.$$

By the second equation (23) the second member in the value of $N\sigma$ becomes

$$(30) \quad N\sigma = (m_2 - \phi - h)V\gamma\lambda.$$

We will now consider the value of h . The relation (27) when treated by ϕ gives

$$\phi^2\sigma = h\phi\sigma = h^2\sigma.$$

Thus by (24), the factor σ being suppressed, we get :

$$(h^2 - m_2h + m_1) = 0.$$

Calling h' and h'' the two roots, we have

$$h' + h'' = m_2,$$

and calling σ' , σ'' the corresponding directions of σ , the expression (30), in which we change the sign of N , will give now

$$N'\sigma' = (\phi - h'')\omega,$$

$$N''\sigma'' = (\phi - h')\omega,$$

where

$$S\gamma\omega = 0.$$

These are the vectors, namely, σ' , σ'' , which satisfy

$$\phi\sigma = h\sigma.$$

When ϕ is self-conjugate they are necessarily real, because then the roots h' , h'' , are real. We may show this in the following way.

We have for the roots :

$$2h = m_2 \pm R,$$

$$R^2 = m_2^2 - 4m_1$$

$$= S^2(aa_1 + \beta\beta_1) + 4SVa\beta V a_1\beta_1,$$

by the expressions (12) and (12 bis).

We have also, when

$$\begin{aligned}(\phi - \phi')\rho &= V\epsilon\rho, \\ \epsilon &= V(aa_1 + \beta\beta_1).\end{aligned}$$

Squaring ϵ and subtracting it from R^2 , we get, when all is developed :

$$\begin{aligned}R^2 - \epsilon^2 &= T^2.aa_1 + T^2.\beta\beta_1 \\ &+ 2Saa_1S\beta\beta_1 - 2Sa\beta_1Sa_1\beta \\ &\quad + 2Sa\beta S\alpha_1\beta_1 \\ &+ 4Sa\beta_1Sa_1\beta - 4Saa_1S\beta\beta_1.\end{aligned}$$

The five double products of scalars reduce themselves to

$$\begin{aligned}2Sa[\beta S\alpha_1\beta_1 - \alpha_1 S\beta\beta_1 + \beta_1 S\alpha_1\beta] \\ = 2S\alpha V\beta\alpha_1\beta_1 \\ = 2T(aa_1)T.(\beta\beta_1)S.U\alpha U\beta U\alpha_1 U\beta_1.\end{aligned}$$

We may put

$$S.U\alpha U\beta U\alpha_1 U\beta_1 = -\cos \omega,$$

because the absolute value of this scalar cannot outpass unity.

Thus, putting

$$R_0^2 = T^2.aa_1 - 2T.aa_1T.\beta\beta_1 \cos \omega + T^2.\beta\beta_1,$$

we have

$$R^2 = R_0^2 - T^2.\epsilon.$$

This expression of R^2 shows that when $T\epsilon = 0$, namely, when ϕ is *self-conjugate*, then the value of R^2 is *essentially positive*, $= R_0^2$, and the roots h are real *à priori*. It is true that when $T\epsilon$ is comprised within the proper limit, then R^2 remains positive, so that the roots h and the solutions σ may remain real, even when ϕ is not self-conjugate, provided :

$$T\epsilon < TR_0.$$

§ 5. We will apply our equations (14) and (15) to two corresponding cases; the first to the case of the example of § 159 of the *Elementary Treatise on Quaternions*; the second to the case of the construction of equation (8) of Professor Tait's paper on *Minding's Theorem* (*Trans. R.S.E.* 1880).

The Example of § 159 demands the solution of

$$V.\epsilon\rho = \delta.$$

We put

$$\phi\rho = V\epsilon\rho.$$

Then we have

$$\phi\epsilon = 0.$$

Also, because of $\phi'\rho = -\phi\rho$, we have

$$\phi'\epsilon = 0.$$

We may assume

$$\epsilon = V\alpha'\beta';$$

then we get :

$$\phi\rho = V(V\alpha'\beta'.\rho) = \alpha'S\beta'\rho - \beta'S\alpha'\rho.$$

If we liken this with our former expression (4) we get

$$\alpha = \alpha', \quad \alpha_1 = \beta', \quad \beta = \beta', \quad \beta_1 = -\alpha',$$

and we have

$$V\alpha\beta = V\alpha_1\beta_1 = V\alpha'\beta' = \epsilon.$$

Then we get by (14)

$$(\phi^2 - m_2\phi + m_1)\rho = -\epsilon S\rho\epsilon.$$

We have of course $m = 0$, and then

$$m_1 = -SV\alpha\beta V\alpha_1\beta_1 = -\epsilon^2,$$

$$m_2 = S(\alpha\alpha_1 + \beta\beta_1) = S(\alpha'\beta' - \beta'\alpha') = 0.$$

Also

$$\phi^2\rho = \phi.V\epsilon\rho = \phi\delta = V\epsilon\delta = \epsilon\delta,$$

because $S\epsilon\delta$ must vanish in virtue of $V\epsilon\rho = \delta$. Therefore our equation gives :

$$\epsilon\delta - \epsilon^2\rho + \epsilon S\rho\epsilon = 0.$$

And as $S\rho\epsilon$ remains indeterminate $= x$, we have the solution :

$$\rho = \epsilon^{-1}(x + \delta),$$

which is the same as the one obtained by indirect processes.

Our second application will be to establish the equation (8) above quoted, namely :

$$bt\rho = x\beta + e_1e_2\beta' - \pi\beta,$$

which, when translated into another notation (to be explained further), will be

$$-m_2\sigma = xk + V\phi i\phi j - \pi k.$$

We introduce, namely, for $\beta = U\bar{\beta}$ of Professor Tait's *Memoir*, the letter k ; we put also

$$\rho T\beta = \rho b = \sigma.$$

Then we call η the vector $\Sigma V_{\alpha\beta}$. The equation (5) from the quoted memoir will then be

$$V_{k\sigma} + \eta = 0 \tag{a}$$

with the conditions

$$S_{k\eta} = 0, \tag{b}$$

$$\phi k = 0. \tag{c}$$

By the definition of $\phi\rho$,

$$\phi\rho = \Sigma a S\beta\rho,$$

and by that of η , we have

$$(\phi - \phi')\rho = V.\eta\rho. \tag{d}$$

In the particular case $\rho = k$ this gives, by (b) and (c)

$$\phi'k = k\eta; \tag{e}$$

so that, it is to be remarked, the system η , $\phi'k$, and k form a triangular system, variable it is true; and $T\phi'k = T\eta$.

Treating (a) by $S(\)k$, and remembering $k^2 = -1$, we get

$$\sigma = \phi'k - kS_{k\sigma}. \tag{f}$$

Now by our equation (15), in which we introduce

$$\lambda = i, \quad \mu = j, \quad \forall \lambda\mu = k,$$

we get

$$\phi'^2k - m_2\phi'k + m_1k - \nabla\phi i\phi j = 0.$$

Eliminating $\phi'k$ from this and $m_2\sigma = m_2\phi'k - m_2kS_{k\sigma}$, we get

$$m_2\sigma = \phi'^2k + (m_1 - m_2S_{k\sigma})k - \nabla\phi i\phi j. \tag{g}$$

Moreover we have by (d) :

$$\begin{aligned} (\phi - \phi')\phi'k &= \nabla\eta\phi'k \\ &= kT\eta T\phi'k \\ &= -k\eta^2. \end{aligned}$$

Hence

$$\phi'^2k = \phi\phi'k + k\eta^2.$$

This gives:

$$(h)m_2\sigma = \phi\phi'k - \alpha k - \nabla\phi i\phi j,$$

where we put

$$\alpha = -m_1 + m_2S_{k\sigma} - \eta^2.$$

Now this equation (h) represents, with changed sign, the equation (8) in question. Namely, if we apply the function ϕ to

$$\rho = -iS_i\rho - jS_j\rho - kS_k\rho,$$

we get, because of (c), or $\phi k = 0$,

$$\phi\rho = -\phi i S i\rho - \phi j S j\rho.$$

We assimilate this with our former expression (4) of $\phi\rho$, and we put in consequence :

$$a = -\phi i, \quad \beta = -\phi j, \quad a_1 = i, \quad \beta_1 = j.$$

Hence we have, first :

$$m_2 = -(S i\phi i + S j\phi j) = -t.$$

Secondly, we have, as

$$\begin{aligned} S k\phi'k &= S k\phi k = 0, \\ \phi\phi'k &= \phi(-i S i\phi'k - j S j\phi'k) \\ &= -\phi i S k\phi i - \phi j S k\phi j \\ &= \varkappa k = \varkappa\beta \end{aligned}$$

(by its definition, page 678.)

Finally, if

$$T\phi i = e_1, \quad T\phi j = e_2,$$

we have

$$V.\phi i\phi j = e_1 e_2 \beta', \quad \text{when } \phi i \perp \phi j, \quad \beta' \text{ representing } U.\phi i\phi j.$$

Thus all the terms of (h) correspond to the terms in the primitive equation (8) which we have thus established by a method different from that of the quoted memoir.

2. On Mirage. By Professor Tait.

(Abstract.)

While seeking for a good elementary illustration of Hamilton's general methods in optics, the author was led to consider, from a somewhat novel point of view, the path of light in a medium whose refractive index is a function of the distance from a plane. This is, at least approximately, the case of the peculiar atmospheric arrangements to which are due the phenomena of *Mirage*, so long as the curvature of the earth can be neglected.

A considerable improvement in the usual theoretical treatment of this subject was introduced by Professor J. Thomson in 1872, and afterwards developed by Professor Everett in *Phil. Mag.*, 1873.

The main feature of this improvement is the study of the *curvature* of the ray in terms of the rate of change of refractive index in the medium.

It seemed, however, to the author that a still simpler and, for some purposes, more powerful method could be made to depend upon the study of the curve on which lie the vertices of all rays passing through a point and confined to one plane perpendicular to the strata of equal refractive index. For the path of every ray is necessarily symmetrical about an axis perpendicular to these strata.

Now suppose the strata to be horizontal, which is the common case, two rays, slightly inclined to one another, leaving any point in a common vertical plane, will in general intersect one another before they again reach the level of the starting-point, if, and not unless, the vertex of the higher ray be *horizontally* nearer to the starting-point than that of the lower ray; *i.e.*, if the part of the curve of vertices concerned leans *towards* the starting-point. Also, as is well known, when two rays, slightly inclined to one another, cross once *between* the eye and the object, the image formed is an inverted one.

Hence the following simple graphical method for finding the number and characters of the images of an object situated at or near to the horizon. Draw the curve of vertices for all rays leaving the eye in the vertical plane containing the object. Draw also a vertical line midway between the eye and the object. The intersections of this line with the curve of vertices are the vertices of all the paths by which the object can be seen when the eye is in the assigned position.

It is easy to see that at these intersections the curve of vertices must alternately lean from, and towards, the eye, *i.e.*, the images seen are alternately erect and inverted; their number depends of course upon the form of the curve of vertices, which, in its turn, depends not only upon the law of refractive index in terms of level, but also upon the position of the eye.

Thus, as has long been known, the vertices of all the paths in which a projectile, fired with a given velocity, can move, with different elevations of the piece, lie in an ellipse whose major axis (double the minor axis) is horizontal. The lower half of this ellipse leans *from* the gun, the upper half *towards* it, and these correspond

to angles of elevation of the piece, respectively less and greater than 45° . In the former case (when the elevation is less than 45°) a slight increase of elevation increases the range on a horizontal plane, so that the new path is wholly above the old one. In the latter case a slight increase of elevation shortens the range, so that the two paths must intersect.

It is then shown that the equation of the curve of vertices is

$$\xi = \sqrt{f(\eta)} \int_{\eta}^b \frac{dy}{\sqrt{f(y) - f(\eta)}};$$

where the refractive index is

$$\mu = \sqrt{f(y)}$$

(the axis of y being vertical), and b is the vertical distance of the eye from the axis of x .

The author first tried the case of an arrangement of strata with *one* stratum of minimum refractive index. As the ordinary change of a quantity near its minimum value is proportional to the square of its distance from the minimum, the assumption made was

$$\mu = \sqrt{a^2 + y^2},$$

without any inquiry into the dynamical stability of such an arrangement in air.

Here, of course,

$$\xi = \sqrt{a^2 + \eta^2} \log \frac{b + \sqrt{b^2 - \eta^2}}{\eta}.$$

This curve is easily traced by drawing, separately, the rectangular hyperbola

$$\xi = \sqrt{a^2 + \eta^2},$$

and the curve (whose ordinates are the reciprocals of those of a catenary)

$$\xi = \log \frac{b + \sqrt{b^2 - \eta^2}}{\eta},$$

or

$$\eta = \frac{2b}{e^{\xi} + e^{-\xi}};$$

and multiplying together the values of ξ for each value of η .

It was then seen that whenever b is greater than $3.68a$, this

curve can be cut in three points by a vertical line. Thus it was seen that the triple images of ships in the offing, described by Vince in the *Bakerian Lecture* for 1799, can be explained by the assumption of one plane of minimum index; or rather, as the effective rays never reach this plane, one plane of (approximately) *stationary* index. But this particular assumed law leads to variations of refractive index far more rapid than can possibly exist in still air, and shows the two upper images (where they exist) at a very great elevation.

Other assumptions were then made, such as

$$\mu = \frac{\sqrt{a^4 + y^4}}{c},$$

$$\mu = \sqrt{a^2 \sec^2 \frac{y}{e} - c^2},$$

$$\mu = \sqrt{a^2 - c^2 \cos \frac{\pi y}{e}}, \text{ \&c.}$$

These forms were assumed so as to give a stationary plane, and also to give expressions (in the equation of the curve of vertices) integrable by circular, logarithmic, or elliptic functions. They all gave results more or less resembling that already described, showing three images, but giving changes of refractive index not likely to occur in nature.

The author then tried the supposition of a *transition stratum* of finite thickness, in which the refractive index should vary continuously from that of the uniform denser fluid below to that of the uniform rarer fluid above. This is obviously the sort of arrangement which is most likely to occur in nature. Also the calculations already made for the former assumptions could be utilised for this by assuming the former laws of variation of refractive index to hold *in the transition stratum only*. Then it was at once evident that the curve of vertices in the transition stratum is asymptotic to both boundaries of the stratum, its vertex being turned towards the eye, provided the upper boundary be a *stationary* one, and it therefore admits of being cut in two points by any vertical line which is distant from the eye by more than a certain calculable amount. This arrangement is easily shown to account completely for the two upper images seen by Vince. The lower one is, of course,

seen directly through the nearly uniform air below the transition stratum. When the upper boundary is not at least nearly a stationary one, the upper erect image is not formed. The figure, then, if inverted, gives the explanation of the ordinary mirage as seen in the desert.

The author has since seen Wollaston's account of his successful reproduction of Vince's phenomenon in the stratum of air immediately below a hot poker. It is quite clear that the explanation above given applies at once to this experiment, as well as in part to the other device employed by Wollaston, viz., the formation of a transition layer between two masses of liquid of different densities which gradually diffuse into one another. The circumstances are here, however, not identical with the atmospheric ones, unless the vessel containing the liquids is of considerable length; so that both object and eye are below the intermediate stratum. Of course, although a transition stratum is spoken of as the main cause of the phenomenon, it must not be supposed that above and below that stratum there is no change of refractive index. Any law of refractive index which makes a comparatively rapid decrease (ending with a nearly stationary state) through a limited stratum is sufficient to account for the phenomena observed.

The equation of the curve of vertices becomes in the case of a transition stratum of thickness b ,

$$\xi = \sqrt{f(\eta)} \left\{ \frac{c}{\sqrt{f(b) - f(\eta)}} + \int_{\eta}^b \frac{dy}{\sqrt{f(y) - f(\eta)}} \right\},$$

where c is the height of the lower boundary above the eye.

The rest of the paper treats of the application of Hamilton's methods, the modifications of the above results due to the earth's curvature, the apparent size, distance, brightness, &c., of the various images, and refers to other forms of the mirage phenomenon as observed, for instance, in distortions of the disc of the setting sun.

Professor Everett, to whom the author had communicated some of the above results, had favoured him with the following letter (dated Dec. 3, 1881), expressing a desire that it should be read to the Society along with the author's paper:—

“The following seems to me the best way of treating the medium

$$\mu = \sqrt{a^2 + y^2}.$$

We have

$$\frac{d. \log \mu}{dy} = \frac{y}{a^2 + y^2}.$$

This is the curvature of a nearly horizontal ray at distance y from plane of minimum μ . It vanishes for $y=0$ and $y=\infty$, and takes a maximum for $y=a$. Hence rays, which are nearly horizontal at distance approximately a from the plane, will go on to meet rays whose distance from the plane is considerably greater than a . If a vessel with parallel glass sides be filled with a liquid in which this law holds it will behave like a cylindrical lens, with a section like this—

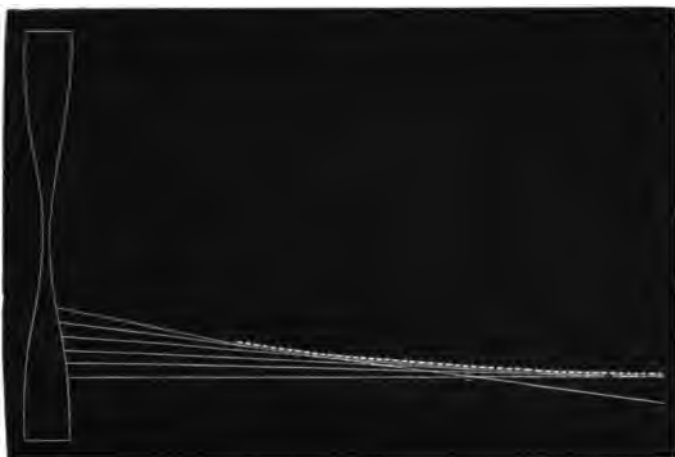

the points of inflexion of the section being at distances a from the axis. The caustic will be something like a golf-club, and two tangents can be drawn to it from an eye in the position shown (by the small circle), one of which is the line of vision of a real and inverted image, and the other of an erect image.

“In tracing the analogy between a continuously varying medium and a lens, *deviation* in the case of the lens corresponds to curvature of ray in the case of the medium. The lens in the present case gives no deviation at the axis; the deviation increases till we come to the point of inflexion, and then diminishes indefinitely as the sides tend to parallelism, which they would attain at an infinite distance.

“In my arrangement (suggested by Maxwell) of three liquids, the corresponding lens would be of this shape—

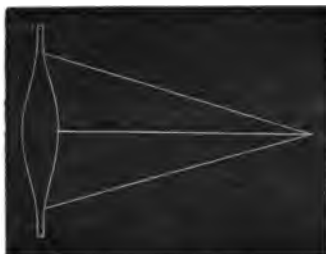

and gives triple images seen in the three lines of vision shown. The middle one comes through the convex portion and gives a real inverted image; the other two come through concave portions and give erect images.

“The medium

$$\mu = \sqrt{a^2 \sec^2 \frac{y}{c} - c^2},$$

is an unnatural monster, giving infinite curvature of rays, as well as infinite values of μ .

“The equation of a ray in the medium

$$\mu = \sqrt{a^2 + y^2},$$

may be any one of the three

$$y = \frac{1}{2} \sqrt{c^2 - a^2} \left(\epsilon^{\frac{x}{c}} + \epsilon^{-\frac{x}{c}} \right),$$

$$y = \epsilon^{\pm \frac{x}{a}},$$

$$y = \frac{1}{2} \sqrt{a^2 - c^2} \left(\epsilon^{\frac{x}{c}} - \epsilon^{-\frac{x}{c}} \right),$$

according to the value of c for the ray in question; this quantity c being the value of $\mu \cos \theta$ for the ray. The second equation is what we get when $c = a$.

“Your ‘locus of vertices’ belongs, I presume, to the curves represented by the first of these equations, but the tracing of it by points would take more time than I have at my disposal. Your result obtained from the ‘locus of vertices’ seems to agree with mine obtained by the foregoing methods, except that you profess to get three images, and I only get two.

“Some of the properties of the medium

$$\mu = \sqrt{a^2 + y^2}$$

(but not the double-image property) are deduced in my second paper on ‘Mirage’ (*Phil. Mag.*, April 1873), sect. xvii. (6). See also Bradford B. A. Report, p. 37, for a triple image effect obtained experimentally with an arrangement of two liquids—brine below, water above.”

Note added by Professor Everett, December 31, 1881.

Having had an opportunity of reading the foregoing abstract, I desire to express my appreciation of the precision with which Professor Tait’s method determines how many images, and whether erect or inverted, will be visible from a given point. Its practical application, however, appears to be somewhat laborious.

The investigation given in the abstract really confirms my result, that with the assumption

$$\mu = \sqrt{a^2 + y^2}$$

not more than two images can be seen from a given point in the air; for the value of μ at a point from which three are seen must exceed $\sqrt{5}$, whereas in reality μ in the atmosphere never exceeds 1.0005.

BUSINESS.

The following candidates were balloted for, and declared duly elected Fellows of the Society:—Sir Peter Coats, and Mr Andrew Young.

Monday, 19th December 1881.

DAVID MILNE HOME, LL.D., Vice-President,
in the Chair.

MAKDUGALL-BRISBANE PRIZE.

The Council having awarded the Makdougall-Brisbane Prize, for the biennial period 1879-80, to Professor Piazzi Smyth, Astronomer-Royal for Scotland, for his Memoir, entitled “The Solar Spectrum in 1877-78, with some practical

idea of its probable temperature of origination," published in the Society's Transactions, vol. xxix. p. 285, the Medal was presented to him by the Chairman, with the following remarks:—

The first matter of public business for to-night is to present the Makdougall-Brisbane prize to Professor Piazzi Smyth, Astronomer-Royal for Scotland.

The terms of the bequest are—that "this prize is to be awarded biennially by the Council of the Royal Society of Edinburgh, to such person, for such purposes, for such objects, and in such manner as shall appear to them most conducive to the promotion of the interests of science."

The Council, after duly considering the various papers published in our Transactions during the biennial period, were unanimously of opinion that it would be conducive to the interests of science, at this time, to award the prize to Professor Piazzi Smyth, on account of the merit of his memoir, published in the last volume of our Transactions, entitled "The Solar Spectrum in 1877-78, with some Practical Idea of its Probable Temperature of Origination."

Though the adjudication of the prize rests entirely with the Council, it has always been the practice not only to present the prize publicly at a general meeting of the Society, but also to indicate briefly the reasons for which the prize was so adjudged.

In endeavouring to discharge the duty which falls on me this evening, let me just say, with reference to the subject of Professor Piazzi Smyth's paper, that whilst the telescope is most valuable, indeed indispensable for giving a knowledge of the heavenly bodies, the spectroscope, invented only twenty years ago, affords information of an important nature regarding these bodies which the telescope cannot supply.

By the telescope we discover the exact shape, size, and colour, of the heavenly bodies, and can descry many which are not visible to the naked eye.

By the spectroscope we have already ascertained something of the actual materials composing these bodies, especially those bodies which shine by their own light. At all events, we have ascertained by means of that instrument, that numerous substances, both solid

and gaseous, which exist on our planet exist also in many of these bodies. It can also indicate, that some of these far distant suns are moving through space in certain directions, and what is their rate of motion.

Our own sun, as the source to us of heat and light, is naturally and properly the body to which this wonderful instrument has been most directed ; with the view of detecting the different substances which enter into its structure, as well as the density, state of aggregation, &c., in which they occur, and the rates at which they are moving.

The result of these spectroscopic researches has been to discover the nature of many of these substances ; indications of them being found in the rays of the sun,—when these rays are so divided and expanded by prisms as to show the well-known different colours extending from red to violet. Among these colours, about eighty years ago, certain black lines, *i.e.*, lines devoid of light, were discovered, which long puzzled philosophers.

Though our own Brewster in the year 1841 conjectured a possible explanation, which was afterwards found correct, I understand that the true discovery of the cause of these black lines is due to Professor Stokes and to the German philosopher Kirchhoff. They explained that the black lines were due to the absorption or retention in the sun's atmosphere of certain definite rays of light coming from the incandescent surface of the sun below its atmosphere.

By a set of ingenious chemical experiments, which it would be irrelevant at present to explain, even were it possible for me to do so, it was ascertained what these substances are whose light is so interrupted and absorbed by the sun's atmosphere.

It is sufficient for me to say that astronomers and chemists are agreed as to the nature of many of the substances ; and accordingly we find in the table appended to Professor Piazzi Smyth's memoir the names of these substances as indicated by the black lines in the solar spectrum.

Before this table was constructed, the best one available was that of Professor Angström of Upsala. But that table was defective in several respects, as Professor Piazzi Smyth points out. Some of the most important black lines, at each end of the prismatic scale, are wanting in it. Professor Smyth has supplied these blanks, and has

been able to enlarge the number of lines distinctly characterised from 1400 to 2000.

The reason why Angström's table was deficient in these respects probably arose from the less favourable position at Upsala for obtaining the sun's rays. When the body of the sun is near the horizon, as it always is in Northern Europe, its rays before reaching the earth must pass through a thicker and denser portion of the earth's atmosphere than when it is at a greater angle of elevation. At Lisbon the observations could be, and were, taken by Professor Smyth when the sun was at an altitude of 70° , whereas at Upsala it would be much lower even at noon.

Professor Smyth's tables of these black lines interspersed among the different prismatic colours are of a most elaborate, comprehensive, and evidently trustworthy character. When he had doubts whether any of the black lines might not have been produced, or at all events affected, by the vapours of the earth's atmosphere, he says so.

The great astronomical value of this table will be at once recognised by men of science when it becomes known; for it will afford the means of ascertaining whether any secular change takes place in the composition or condition of the sun's atmosphere, or in the more solid subjacent parts of that luminary.

I understand that there are certain fixed stars known to astronomers under the name of *variable*, on account of changes taking place in their appearance as seen from the earth. These stars being in regions of space far beyond our planetary system, any change in them, I presume, can have little or no influence on our system. But it might be greatly more serious for us were important changes to occur in our sun, the centre of our system;—and these changes would no doubt be at once detected by means of the spectroscope, and the comprehensive diagrams which Professor Piazzi Smyth has constructed of the solar spectrum, as it now exists.

Having offered these explanations, which, however, I have done with the utmost diffidence both as regards this subject generally, and the merits of the paper before us, it only remains for me to deliver the prize into the hands of the distinguished author; and at the same time to offer to him my humble, respectful, but very

hearty congratulations on his receiving to-night one of the highest marks of scientific distinction which it is in the power of our Society to bestow.

1. On the Application of the Rocks of Ben Nevis to Ornamental Art. By Sir R. Christison, Bart., *Hon. V.P.*

Many hundred tourists annually climb Ben Nevis, and shudder when they cast their eyes down its profound precipices ; but no one seems to bethink him that, to view a great precipice aright, he should behold it from below, rather than from above, and consequently that the great North-Eastern Precipice should be seen from the valley opposite its base. No one, tourist or guide, visits the narrow rugged glen into which it descends ; few of the neighbouring gentry—of my acquaintance at least—have made the excursion ; and the only visitors I have heard of have been a few solitary geologists at long intervals of time. Nevertheless, in the year 1810, in the first volume of the *Edinburgh Wernerian Society Transactions*, the late Reverend Dr. Macknight, one of the ministers of this city,—a gentleman of many accomplishments, and, among these, skilled in geology,—has interspersed his geological account of the rocks of the mountain with a description, in the most glowing language, of many magnificent scenes in its great North-Eastern Precipice. But he appears to have thus encouraged only his geological successors to follow his example.

Encouraged by his narrative and by my persuasion, one party of four from my autumnal residence at Ballachulish, and afterwards another of three from the house adjoining, made out the excursion last September ; and all returned with the impression that they had beheld one of the most sublime scenes of the kind, which they had enjoyed in the Highlands of Scotland. My own belief is that the views of the precipice of Ben Nevis from below are the grandest in the whole island.

Of the rocks composing the mountain, and especially of those of the precipice, Dr. Macknight has given a clear and satisfactory account, according to what was known in his time of the composition and nomenclature of rocks. He says the mountain rests

on a plain consisting of gneiss and mica-slate; that the base of the mountain itself is a beautiful granite, or rather syenite; that this is succeeded by a bed of pale felspathic porphyry, consisting of a pale reddish matrix of compact or amorphous felspar, with numerous crystals of still paler felspar; that, when we arrive at the base of the great North-Eastern Precipice, this rock acquires a greenish-black colour, apparently owing to the felspathic matrix becoming "impregnated with the matter of hornblende"; that the whole immense mass of the precipice, a mile and a half in extent, and 1500 feet in height, is composed of this dark porphyry, variously modified; and that sometimes the porphyrising crystals of pale felspar are so scanty, if not altogether wanting, that the rock becomes difficult to distinguish from basalt or clinkstone.

This description may be applied to the structure of the mountain in the present day; but a more recent geology looks differently at the composition and nomenclature of its rocks. I have not seen a later publication on this subject. But Mr. Clement L. Wragge has favoured me with a perusal of a MS. account of it by Professor Judd of London, who writes from recent observation, and whose views agree with those of other geologists whom I have consulted. The whole mass of the mountain is a volcanic protrusion through the gneiss and mica-slate of the plain below on which the mountain rests. I may here observe in passing, that, as this substratum has a dip from south to north, mica-slate shows itself as part of the mountain at its southern face, where it forms the steep rugged north slope of the second reach of Glen Nevis. Here there is an extensive lofty terraced cliff, consisting of a tough fine-grained mica-slate,—if one may judge from examination of the enormous blocks which strew the bottom of the cliff, or the nature of the fixed beds that underlie it. The base of the mountain itself is granitic porphyrite; the porphyrising ingredient being hornblende in numerous crystals. The whole prodigious mass above, composing the great North Eastern Precipice, is felsstone porphyrite, coloured greenish-black by the admixture of some other mineral, sometimes assuming the external characters of a simple porphyry by porphyrisation with crystals of greyish-red felspar,—often putting on the characters of volcanic tuff or breccia owing to disappearance of the felspar crystals more or less,—and then occasionally becoming so dark that its structure as

a breccia is scarcely recognisable with the naked eye, though it becomes distinct when the rock is polished. In the latter condition it resembles clinkstone, as Macknight had shown. In its more distinctly brecciated form, it resembles serpentine; but it is quite unassailable with the point of the knife, while true serpentine is scratched with great ease.

No one has yet tried to discover by modern methods the nature of the dark greenish-black matter which gives the rock of the precipice its characteristic colour, and which Macknight assumed to be hornblende. But Professor Geikie will probably be able to settle that question by examining, microscopically, fine transparent sections made according to the method of the late Mr. Nicol.

It is singular that hitherto no one has tried whether the rocks of Ben Nevis can be put to use. Some curiosity-monger at least might have been thought desirous of attempting to produce some memorial of his visit to these curious monuments of ancient volcanic agency. He would then have been surprised by the discovery that all of them are ornamental stones of considerable and sometimes great beauty.

In the autumn of 1880 my sons brought down to me from the very summit of the mountain a hand-specimen broken off from the solid rock, where it protruded through the surrounding wilderness of loose stones and blocks. The fresh fracture showed it to be a very pretty felstone-porphyrite; and I felt sure it would prove a fine ornamental stone, if hard enough to take on a high polish. Our skilful lapidary, Mr. Sanderson, found it to be the hardest rock he had ever worked; and he produced the little pyramid, which has been already shown to many members of this Society, to their entire satisfaction. Last autumn I resolved to obtain, if possible, larger masses of all the forms assumed by the rock of the precipice; and my sons, entering into my wishes, brought down from their excursion, already mentioned, ample specimens for showing the characters of all the chief varieties, besides materials sufficient for exercising the ingenuity of Mr. Sanderson in constructing an obelisk, in which he has been eminently successful. These specimens are now exhibited to the Society. In the obelisk the first step of the basement is granitic-porphyrite, the second a well-marked felstone-porphyrite of the dark kind. The plinth is an equally

well-marked serpentinite breccia. The shaft is also the same breccia, but so dark that its nature is scarcely recognisable in the rough state of the stone, or until it is finely polished, and viewed with bright light. The separate pyramid is feldspar porphyrite, with its porphyrising feldspar crystals very small. This is the only specimen taken from the solid rock. But any block or stone of the confusion covering the whole summit, or the slopes of the corries which cut the precipice, will furnish the curious with specimens equally characteristic; for the weathering does not go deeper than the thickness of fine pasteboard.

Let me add that any one who may be inclined to make the excursion to the base of the precipice, should by no means, unless himself an experienced mountaineer, attempt it without a good guide; for the way up the rugged precipitous glen,—chiefly on the south-west bank of the valley stream, the Allt'-a-Mhui (mill burn) linn,—is tortuous, scarcely marked, and, in the frequent unexpected mists of the mountain, such as would be apt to lead into embarrassment and danger. A good view of the whole precipice is obtained by crossing to the north-east bank of the stream when about 2000 feet above Fort-William. But the opportunity should not be lost of ascending into the Corrie-na-Ciste, opposite the beholder, about 1200 feet higher, and surrounding himself with a wild amphitheatre of shattered precipices, rocks, blocks, and stones, without any trace of the works or habits of man within his sight.

2. On the State of Carbon in Iron and Steel: a New Hypothesis of the Hardening of Steel. By R. Sydney Marsden, D.Sc., F.R.S.E., &c.

(*Abstract.*)

This paper first treats of the composition and properties of the different kinds of iron, known as wrought iron, steel, and cast iron, and especially of the changes which steel undergoes on being heated to redness and then suddenly cooled by plunging it into water, mercury, or oil, and known as *hardening*; also of the peculiar property known as *tempering*, by which the hardness and brittleness can be removed.

After having passed in review the chief properties of the different kinds of iron, the paper goes on to discuss the different theories that have been proposed to account for these properties.

An objection is raised against the different theories which consider the iron and carbon as chemically united together, on the grounds that if these hypotheses be true, we are then presented with an anomaly unknown in any other instance, viz., that of two elements uniting together in all proportions up to a certain point, and then suddenly losing this power, and it is very difficult to believe that such can be the case, whilst another difficulty is the fact of the carbon being capable of changing its condition and passing in and out of combination under the action of heat or different methods of cooling, in a manner at once extraordinary and totally different from anything else with which we are acquainted in the whole range of chemistry.

A new hypothesis is then given with regard to the nature of the different kinds of iron.

The carbon is considered to be in a state of solution in the iron, and it is shown (by analogy of what takes place in the case of a solution of carbon in silver) how if the metal be cooled slowly the carbon by preference crystallises in the graphitic form, which accounts for the carbon in slowly cooled steel and cast iron being chiefly in that condition. But how if the cooling be rapidly effected by plunging the metal in water or running it into a cold mould (as in chill casting) then the carbon is not as it were given the option as to which form of crystallisation it will take, but is caused to crystallize in the diamond form, and in this way the hardness of steel and chilled cast iron is accounted for by the presence of an innumerable quantity of excessively minute diamond points disseminated over the whole surface of the hardened metal. It is then shown how (supposing this hypothesis to be correct) such points of difficulty as the following can be explained, namely :—

1. What constitutes the difference between steel and white cast iron, and between white and grey cast irons ?
2. Why steel requires some time after fusion of the metal to become good steel ?
3. How the hardening of steel takes place ?

4. Why hardened steel has a less sp. gr. than unhardened steel, and why it is so brittle?
5. How tempering is effected?
6. How the passage of carbon from one condition to another can be accounted for?
7. How rehardening takes place?
8. How the brittleness of steel is removed by tempering?
9. Why hardened steel instruments when used gradually lose their hardness?
10. Why iron containing from 0.4 to 1.7 per cent. of carbon only presents these properties of hardening and more particularly of tempering that are peculiar to steel?
11. How damascened steel is produced?

Steel is regarded as a normal solution of carbon in iron, and cast iron as a supersaturated solution, and it is shown how the difference between a normal and a supersaturated solution is sufficient to account for differences as great as these between steel and cast iron. Objections to this hypothesis are then discussed, particularly the the two strongest, viz., (1) the production of hydrocarbons when hardened steel or white cast iron is dissolved in acids; and (2) the reversed analogy of the copper and tin alloys in favour of the physical theory.

3. Some Physical Experiments bearing upon the Circulation of the Blood-Corpuscles. By D. J. Hamilton, M.B., F.R.C.S.E., F.R.S.E.

(Abstract.)

When the circulation of the blood is observed in the transparent tissues of an animal, it is noticed that the coloured corpuscles run in the axial part of the stream, while the colourless mostly keep in the peripheral still current. The coloured corpuscles move much faster than the colourless; they have also a gliding, while the colourless have a rotatory, motion. Further, if the frog's web be examined in the upright position, with the microscope inclined so as to be horizontal with the table on which it is placed, it is noticed that the great majority of the leucocytes not only flow in

the peripheral stream, but *on the upper surface of the vessel*. From a number of observations of blood-vessels in the frog's web, examined in this position, it was found that for every 13 leucocytes which are seen running along the lower surface, there is an average of 92 on the upper. In fact, the only time, apparently, in which a leucocyte gets to the lower surface, is in passing round a curved capillary, where, in changing its position, the stream of coloured corpuscles prevents it from gaining the upper surface of the vessel for some distance. If followed along the stream, sufficiently far, such a leucocyte is eventually found to make its way through the stream of coloured blood-corpuscles and to gain the upper surface of the vessel.

If the freshly-shed blood of a triton be passed through a capillary glass tube, in the horizontal position, or examined with the microscope inclined as in the above observation, the leucocytes are found, almost without exception, to run on the upper surface of the tube, the hæmocytes in the middle of the stream; and, when the circulation in the tube ceases, the leucocytes remain on the upper surface, while the coloured blood-corpuscles have a slight tendency to sink to the bottom of the tube.

If a capillary vessel, capable of admitting only a single file of blood-corpuscles, be examined in the upright position, the colourless corpuscles are still found to be pressed against the upper surface of the vessel and to rotate, while the coloured pass along without pressing against either the upper or lower surface, and have, even here, a gliding motion.

From these facts the conclusion is drawn that the leucocytes are considerably lighter than the coloured blood-corpuscles *in blood circulating through blood-vessels or in freshly-drawn blood*. The coloured blood-corpuscles must also be *in circulating blood*, (as proved by the following experiments) of almost exactly the same specific gravity as the blood-plasma. If any divergence between the two exists the coloured blood-corpuscles are slightly the heavier. The colourless, on the other hand, must be specifically considerably lighter than the blood-plasma in the living condition.

The reason of the colourless corpuscles not all coming to the upper surface when blood is freshly drawn is (as shown experimentally), that the coloured blood-corpuscles are in so much greater

abundance than the colourless. The coloured, by their preponderance and slight downward tendency in shed blood, retain the lighter colourless corpuscles in any position in which they may have been placed, unless at the immediate surface, where there is a possibility of escape. All observations on this subject must be made on freshly-drawn blood, or on the blood as it circulates through the vessels.

With these data a series of experiments was shown on the circulation of bodies through tubes. The circulating liquid was water, and the bodies employed for circulating in it were made of wax and different heavy colouring matters. Experimenting first with spheres, it was found that, if a series of these be taken made of wax and a metallic powder, so as to be specifically considerably heavier than water, the smaller the sphere is the longer it takes to pass along the tube. This is explained entirely upon the relationship between the specific gravity of the liquid to the objects suspended in it. The sphere, when dropped into the tube in which the water is circulating, is acted upon mainly by two forces, the one is its

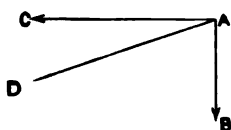

Fig. 1.

specific gravity acting in this case in a downward direction, and which may be represented in magnitude and direction by the line AB (fig. 1); while the other force is comprised in the strata of water acting in direction AC.

If the lines AB, AC then represent in magnitude and direction the two forces which influence the sphere when dropped into the current, it is evident that the direction which the sphere will take, immediately after being immersed, will be that of the diagonal AD; and consequently the heavy sphere

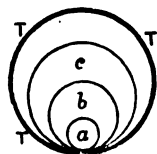

Fig. 2.

always comes, in the course of time, to the bottom of the tube. When in this situation, the smaller it is the more it is placed in the slow strata of liquid circulating at the periphery of the tube, while the larger it is, within bounds which will allow it freely to rotate, the more of the swift axial filaments of liquid impinge upon it. Hence the large moves faster than the small sphere. Fig. 2 will illustrate this, where TTT represents a section of the tube, and abc the spheres of different sizes. With spheres of specific gravity lighter than water the

same phenomena are noticed, the only difference being that they run along the upper instead of the lower surface of the tube. The diagram representing them is seen in fig. 3.

In the case of spheres which are of the same specific gravity, or which differ only very slightly from the specific gravity of the liquid in which they are immersed, the relationship is quite different. Here specific gravity being alike between spheres and liquid, one of the forces which formerly acted upon the sphere is removed, and the only force now acting

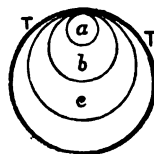

Fig. 3.

upon it is horizontal, and is represented by the strata of liquid. The friction is least at the centre of the tube, greatest at the periphery. The pressure is greatest where the resistance is least. Such spheres, of specific gravity equal with the liquid, always, therefore, tend to be pressed into the centre of the stream. Hence, *the smaller they are the faster they will circulate*, because the small sphere comes in contact only with the swift filaments of liquid in the axis, while the larger it is the more it becomes arrested in its movement by the slow strata at the periphery of the tube. This is represented in fig. 4.

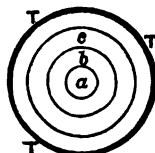

Fig. 4.

Discs show exactly the same phenomena, the only qualification being, that when they are lighter or heavier than the liquid they sometimes tend to fall over on their side rather than run on their edge, and this of course creates a fallacy. When they are of specific gravity equal with the liquid it does not matter how they lie.

The *lighter* and *heavier* spheres, further, *rotate*, while those of *equal* specific gravity with the liquid have the *gliding* motion of the coloured blood-corpuscles. The former come in contact with the wall of the tube, the friction against which causes them to rotate; while the latter not touching the tube wall, instead of rotating, have a smooth gliding motion.

Experiments with numbers of finely divided bodies in a capillary tube, such as those employed by Schklarewsky (*Pflüger's Archive*, i., 1868), are fallacious in many respects, specially in the fact that the *exact* relationship between the specific gravity of each particle and the liquid in which it is immersed is not known. Capillary

experiments made by the author completely bear out those made with a larger tube. He has been unable to verify some of Schklawsky's statements.

To summarise the conclusions arrived at in this first part of the paper they are the following :—

1. If the specific gravity of several different sized spheres is greater or less than the liquid in which they are suspended, the larger the sphere, provided it does not exactly fill the tube, the quicker it circulates.
2. If the specific gravity of several different sized spheres is equal with, or approaches close to, that of the liquid in which they are suspended, the larger the sphere the slower it circulates.
3. Spheres of the same size, all specifically heavier or lighter than the suspending liquid, and differing from each other in specific gravity, move less rapidly the more they diverge in specific gravity from that of the liquid in which they are immersed.
4. The nearer the suspended body approaches to the specific gravity of the liquid in which it is suspended, the more it tends to occupy the centre of the stream.
5. If a sphere is of the same specific gravity as the liquid in which it is immersed, whatever its size in relation to the tube, it will circulate quicker than any other sphere of the same size.
6. The same statements essentially hold good for discs.
7. Bodies so much heavier or lighter than the suspending liquid as to cause them to come in contact with the wall of the tube, rotate. Those whose specific gravity is equal with that of the suspending liquid, running as they do in the axis, glide. This holds good whether the body be a sphere or a disc.
8. A disc and a sphere, each of the same specific gravity as the liquid, of equal absolute weight and of equal diameter, circulate in the same time, and both have a gliding motion.
9. In bodies heavier or lighter than the liquid in which they are immersed, provided they are so constructed as to be acted

upon by the same filaments of liquid, the greater the mass the slower the progress.

From these data it is evident that if the coloured blood-corpuscles were not of the same, or very nearly the same specific gravity as the blood-plasma, the circulation would be a physical impossibility. The essence of the blood circulation is, that the majority of the corpuscles never touch the walls, and hence undue friction is avoided.

It is further probable that, in hydræmia or other blood disease, where the specific gravity of the plasma is altered, the evidences of vascular disturbance may be due to obstruction to the onflow of the corpuscles owing to an abnormal relationship between them and the plasma.

The dropy of albuminuria may be accounted for by the increased friction of the circulating blood, caused by the alteration of the specific gravity of the plasma, from loss of albumin, giving rise to increased tension. This may also account for the passive congestions and inflammations which occur under these conditions.

That a proper relationship between the specific gravity of the blood-plasma and the bodies suspended in it is absolutely necessary for the easy circulation of the blood, is shown by several striking observations. Milk, if injected into a vein, has the greatest difficulty in passing through the pulmonary capillaries; its particles are too light, and become arrested. Oil globules, when they gain entrance into the circulation, as after fracture of certain bones, and in the lipæmia of diabetes mellitus, frequently produce fatal results, for the same reason. The entrance of air into the circulation brings about a fatal result, probably from the same cause. It gives rise to *air embolism*.

Experiments were next shown with a curved tube to illustrate how it is that, as the blood-current becomes retarded in inflammation, and as stasis is approached, the leucocytes tend to accumulate at the periphery of the vessel. A light sphere, introduced into the curved tube with a slow stream cannot pass the first curve of the tube, and becomes arrested at its periphery. A sphere of the same specific gravity as water, however, passes through the curved tube with the greatest ease. A filtering action is thus exerted by the

tube, as regards the leucocytes, *when the current becomes slow*, while the coloured blood-corpuscles pass onwards without impediment. When the stream is rendered more powerful the lighter spheres are also carried along.

Another experiment was shown to illustrate how it is that in inflammation the leucocytes, after they have accumulated in the peripheral layer, are driven through the wall of the vessel. A tube was employed from which a portion, 6 inches long and for about half its circumference, had been cut out. This was covered with a membrane in which were several pin-point apertures. Pieces of a thin solution of gelatine, about half an inch square, were introduced into the tube. So long as the distal end of the tube is freely open, the water has only a slight tendency to exude from the apertures, and the pieces of gelatine have not any tendency to do so. When, however, the end of the tube is closed or partially obstructed, the membrane becomes distended. From the apertures in it little jets of water issue, and very soon the pieces of gelatine are attracted to the apertures, and are extruded from them in great numbers, though the pieces of gelatine are probably from thirty to sixty times as large as the apertures through which they make their exit. There is first noticed a little bud-like process outside the aperture; this enlarges, and soon the whole mass is pushed through exactly like a leucocyte in an inflamed part.

The conclusions from this experiment, and from other considerations are:—

1. That the leucocytes in inflammation are driven through the natural apertures in the vessel wall by the diverted blood-pressure.
2. That the reason of their being extruded in numbers greater than the coloured blood-corpuscles is that in the slowing of the blood stream, previous to their diapedesis, they have accumulated at the periphery, and are applied over the apertures in the vessel in preference to the coloured corpuscles, which are still circulating in its axis. If the circulation is suddenly arrested, as by ligature of a vein, the coloured corpuscles pass through the wall in much greater numbers than the colourless, the reason being that there has not been time to form a peripheral layer of leucocytes.

3. The amoeboid movements of the leucocytes may assist in their extrusion, but they are certainly not the primary factor in the act. Any soft pliable bodies would similarly be extruded under the same circumstances. In lipæmia oil globules pass through the vessel walls, where there is obstruction, in great numbers, and form abscess-like collections of oil outside and around it.

Mr Geddes exhibited living specimens of *Convoluta Schultzzi*, his paper (*vide infra*) being postponed on account of the lateness of the hour.

Monday, 16th January 1882.

SIR WILLIAM THOMSON, Hon. Vice-President,
in the Chair.

The following Communications were read :—

1. On the Nature and Functions of the "Yellow Cells" of Radiolarians and Coelenterates. By Patrick Geddes.

It is now nearly forty years since the presence of chlorophyll in certain species of Planarians was recognised by Schultz.* Later observers recognised that the green colour of certain Infusorians, of the common fresh-water hydra (*Hydra viridis*), and of the fresh-water sponge (*Spongilla fluviatilis*), was due to the same pigment, but little more attention was paid to the subject until Ray Lankester applied the spectroscope to its investigation. He thus confirmed the presence of chlorophyll in those animals, and extended the list of chlorophyll-containing animals as follows :†—

Infusoria, *Stentor Mulleri*, &c. ; Foraminifera ; Radiolaria,

* Beiträge z. Naturgeschichte d. Turbellarien, 1851.

† Sachs, *A Text-Book of Botany* (English edition), p. 687, note.

Raphidiophrys viridis, *Heterophrys myriapoda*; Cœlenterata, *Spongilla fluviatilis*, *Hydra viridis*, *Anthea cereus*, v. *smaragdina*; Vermes, *Mesostomum viride*, *Bonellia viridis*, *Chaetopterus Valenciennesii*; Crustacea, *Idotea viridis*.

The main interest of the question, of course, lies in its bearing on the long-disputed relations between plants and animals; for, since neither locomotion nor irritability are characteristic of animals, since many insectivorous plants habitually take in and digest solid food, since cellulose—that most distinctive of vegetable products—is practically identical with the tunicin of Ascidians, it becomes of the greatest interest to know whether the chlorophyll of animals, as believed by Claude Bernard, preserves its ordinary vegetable function of effecting, or at any rate aiding, the decomposition of carbonic anhydride in sunlight, and the synthetic production of starch.* For although it had long been known that *Euglena* evolved oxygen in sunlight, the animal nature of such an organism was thereby rendered more doubtful than ever.

In 1878, however, while working at the zoological station of M. de Lacaze-Duthiers at Roscoff, I had the good fortune to find material for the solution of the problem in the chlorophyll-green Planarian (*Convoluta Schultzei*, O. Schm.), of which multitudes are to be found in certain localities on the coast, lying on the sand covered by only an inch or two of water, and apparently basking in the sun. It was only necessary to expose a quantity of these animals to direct sunlight to observe the rapid evolution of bubbles of gas, which, when collected and analysed, yielded from 45 to 55 per cent. of oxygen. Both chemical and histological observations showed the abundant presence of starch in the green cells, and thus these animals, and presumably also *Hydra*, *Spongilla*, &c., were shown to be truly "vegetating animals."†

Being at Naples early in the spring of 1879, I exposed to sunlight such of the other reputedly chlorophyll-containing animals as I could obtain there, namely, *Bonellia viridis* and *Idotea viridis*,‡

* "Certain animals (*Infusoria*, *Cœlenterata*, *Turbellaria*) possess chlorophyll, but there is no evidence to show what part it plays in their economy." Huxley, *Anat. of Invert. Animals*, 1877, p. 43.

† "Sur la Chlorophylle Animale," &c., *Archives de Zool. Exp.*, 1880, and *Proc. Roy. Soc. Lond.*, 1879.

‡ *Ibid.*, Postscriptum.

while Krukenberg had been making the same experiment with *Bonellia* and *Anthea cereus* at Trieste.* Our results were totally negative, but so far as *Bonellia* was concerned this was scarcely to be wondered at, since the later spectroscopic investigations of Sorby and Schenck had corroborated the opinion of Lacaze-Duthiers† as to the complete distinctness of its pigment from chlorophyll. Krukenberg, too, who follows Sorby in terming it *bonellein*, has recently figured the spectra of *Anthea*-green,‡ which also differs considerably from chlorophyll, while I am strongly of opinion that the pigment of the green Crustaceans (*Idotea*, &c.), is even more distinct, having not improbably a merely protective resemblance. I have also exposed to light the green shrimp (*Palæmon viridis*), the green polychæte annelid (*Phyllodoce viridis*), *Chaetopterus Valenciennesi*, and a small greenish Tectibranchiate mollusc, *Dolabella* sp., but as I had expected, without finding the slightest evolution of oxygen take place.

We may now pass to the discussion of the proper subject of the present paper, the long outstanding enigma of the nature and functions of the "yellow cells" of Radiolarians, &c. These bodies, which were first so called by Huxley in his description of *Thalassicolla*, are small bodies of distinctly cellular nature, with a cell-wall, well-defined nucleus, and protoplasmic contents saturated by a yellow pigment. They multiply rapidly by transverse fission, and are present in almost all Radiolarians, but in very variable number. Johannes Müller at first supposed them to be concerned with the reproduction of the Radiolarian, but afterwards gave up this view. In his famous monograph, Hæckel§ suggests that they are probably secreting cells or digestive glands in the simplest form, and compares them to the liver-cells of *Amphioxus*, and the liver-cells described by Vogt,|| in *Veleva* and *Porpita*. Later, he made the remarkable discovery that starch was present in notable quantity in these yellow cells, and considered this as confirming his view

* *Vergleichend Physiologische Studien*, Bd. I. Abth. 1, p. 167.

† "Anat. de la Bonellie," *Ann. d. Sci. Nat. Zool.*, 4 Sér. tom. x.

‡ *Vergl. Physiol. Studien*, Bd. I. Abtheil 2, p. 76.

§ *Die Radiolarien*, p. 136.

|| "Sur les Siphonophores," &c., *Inst. Nat. Gênévois*, tom. i. 1854.

that these cells were in some way related to the function of nutrition,* particularly as stores of reserve-material.

In 1871 a very remarkable contribution to our knowledge was made by Cienkowski,† who strongly expressed his opinion that these yellow cells were parasitic algæ, pointing out that our only evidence of their Radiolarian nature was furnished by their constant occurrence in most members of the group. He showed that they were capable not only of surviving the death of the Radiolarian for a week or more, but even of multiplying, and of passing through an encysted and an amœboid state (phenomena which, while not indeed deciding the significance of the yellow cells, are yet in the highest degree foreign to the life processes of the Radiolarians), and urged their mode of multiplication, and the great variability of their number within the same species, as further evidence of the justice of his view.

The next important work was that of Richard Hertwig,‡ published five years later. He inclined to think that these cells sometimes developed from the protoplasm of the Radiolarian, and failed to verify the observations of Cienkowski, suggesting that, as in higher organisms, one portion might continue in life for some time after the rest, without thereby proving its distinctness, and concluding with Hæckel, that the yellow cells "für den Stoffwechsel der Radiolarien von Bedeutung sind," and that their main function was to store up reserve-material, starch, &c., until the organism should require it. In a later publication, however,§ he hesitates to decide as to "this most controverted point of Radiolarian morphology," and limits himself to suggesting two considerations in favour of their parasitic nature; first, that yellow cells are to be found in Radiolarians which possess only a single nucleus, and that the origin of their nuclei from that of the Radiolarian is highly improbable; and secondly, that they are absent in a good many species.

A later investigator, Dr. Brandt|| of Berlin, has completely con-

* "Amylum in d. gelben Zellen d. Radiolarien," *Jena Zeitschr.*, 1870, p. 532.

† "Ueber Schwärmerbildung bei Radiolarien," *Archiv. Mikr. Anat.*, 1871.

‡ *Zur Histologie d. Radiolarien*, Leipzig, 1876.

§ "Der Organismus d. Radiolarien," *Jena Denkschriften*, 1879.

|| "Untersuchungen an Radiolarien," *Monatsb. Akad. Wiss.*, Berlin, 1881, p. 388.

firmed the main discovery of Cienkowski, since he finds the yellow cells to survive for no less than two months after the death of the Radiolarian, and even to continue to live in the gelatinous investment from which the protoplasm had long departed in the form of swarm-spores. He sums up strongly in favour of their parasitic nature, urging, besides the arguments of Cienkowski and Hertwig, their great agreement in families otherwise widely different. The existence of similar cells in certain Actinians, and their resemblance to a parasitic organism discovered by him in *Actinosphaerium*, as well as the fact that they first make their appearance in the outer parts of the jelly of the young *Collozoum*, and gradually make their way inwards. He found, too, that the nuclei of the yellow cells stains more deeply with carmine than that of the Radiolarian, and, although failing to confirm Hæckel's discovery of starch, he concluded that the membrane consists of cellulose, since it gave a bluish tinge with acid solution of iodine.

Meanwhile similar paradoxical bodies were being described by the investigators of other animal groups. Hæckel had already compared the yellow cells of Radiolarians to the liver cells of *Verella*,* but the brothers Hertwig† first called attention to the subject by expressing their opinion that the well-known "pigment bodies" described by Heider‡ and others in the endoderm cells of the tentacles of many sea-anemones were also parasitic algæ. This opinion was founded on their occasional occurrence outside the body of the anemone, on their irregular distribution in various species, and on their resemblance to the yellow cells of Radiolarians. But they failed to demonstrate the presence of starch, cellulose, or chlorophyll. My friend, Dr. Angelo Andres, has also studied them in many genera and species of anemones. Korotneff§ has recently described and figured similar cells from the endoderm of *Myriothela*, and M. de Merejkowsky informs me that he has made similar observations in two Infusorians, *Ceratium tripos* and *Vorticella*, n. sp. Moseley|| has observed somewhat similar bodies in *Orbitolites*, and Lankester¶

* *Loc. cit.*

† "Die Actinien," *Jena Zeitschr.*, 1879, p. 495, plate xix.

‡ "Ueber *Sagartia troglodytes*," *Sitzungsb. d. Wien. Akad.*, 1877, p. 385.

§ On "*Myriothela* (Russian)," *Soc. Nat. Hist. Moscow*, 1881.

|| *Notes of a Naturalist on the Challenger*, p. 293.

¶ "On *Haliphysema*," *Quart. Jour. Micro. Sci.*, 1879, p. 482.

in *Haliphysema*. All these naturalists hold more or less strongly the same view as the brothers Hartwig.

The last of this long series of researches is that of Hamann,* who has investigated the similar structures which occur in the oral region of many Rhizostome Medusa. While adopting the view of Cienkowski as to the parasitic nature of the yellow cells of Radiolarians, he maintains that those of anemones and jelly-fishes give quite different chemical reactions, and are to be regarded as unicellular glands.

In the hope of clearing up these contradictions, I returned to Naples in October last, and first convinced myself of the accuracy of the observations of Cienkowski and Brandt as to the survival of the yellow cells in the bodies of dead Radiolarians, and their assumption of the encysted amoeboid states. Their mode of division is thoroughly algaoid; just as in rapidly dividing *Protococcus* one finds not unfrequently groups of three and four. Starch is invariably present in notable quantity, as described by Hæckel; the cell-wall is of true plant cellulose, and yields a magnificent blue with iodine and sulphuric acid, while the yellow colouring matter is identical with that of diatoms, and yields the same greenish residue after treatment with alcohol. So, too, in *Verella*, in sea-anemones, and in a Rhizostome medusa (*Cassiopeia borbonica*) in all cases the protoplasm and nucleus, the cellulose, starch, and chlorophyll, can be made out in the most perfectly distinct way. The failures of former observers in obtaining these reactions (in which I at first also shared) have been simply due to neglect of the ordinary botanical precautions.† Such reactions will not succeed until the animal tissue has been preserved in alcohol, and macerated for some hours in a weak solution of caustic potash. Then, after neutralising the alkali by means of dilute acetic acid, and adding a weak solution of iodine, followed by strong sulphuric acid, the presence of starch and cellulose can be successively demonstrated in the same preparation. Thus, then, the chemical composition, as well as the structure and mode of division of these yellow cells are those of unicellular algae. I therefore propose for this alga the generic name of *Philozoom*, and distinguish four species, differing slightly in size, tint, mode

* "Die Mundarme d. Rhizostomen," *Jena Zeitschr.*, 1881.

† Pfeffer, "Pflanzenphysiologie," Bd. I. p. 196.

of division, &c., to which the names of *P. radiolarium*, *P. siphonophorum*, *P. actinarium*, and *P. medusarium*, according to their habitat, may conveniently be applied.

It now remains to inquire what is the mode of life and what the function of such organisms. I accordingly exposed a quantity of Radiolarians, chiefly *Collosum inerme*, to sunshine, and was delighted to find them soon studded with tiny gas bubbles. Although it was not possible to obtain enough for a quantitative analysis, I was able to satisfy myself that the gas was not absorbed by caustic potash, but was partly taken up when pyrogallic acid was added. Thus little or no carbonic acid was present; but a fair amount of oxygen was present, diluted, of course, by nitrogen. The exposure of a shoal of the beautiful blue pelagic siphonophore *Veella* for a few hours enabled me to collect a large quantity of gas, which yielded from 21 to 24 per cent. of oxygen, that subsequently squeezed out of the interior of the chambered cartilaginous float, giving only 5 per cent. But the most startling result was obtained by the exposure of the common *Anthea cereus*, which yielded great quantities of gas, containing on an average from 32 to 38 per cent. of oxygen.*

At first sight it might seem impossible to reconcile this copious evolution of oxygen with the completely negative results obtained from the same animal by so careful an experimenter as Krukenberg, yet the difficulty is more apparent than real. I was at length able to obtain, through the kindness of Dr. Andres, a large and beautiful specimen of *Anthea cereus*, var. *smaragdina*, which has its tentacles tipped with purple, and of a far more beautiful green than that with which I had before been operating, the dingy brownish olive var. *plumosa*. The former owes its colour to a green pigment diffused chiefly through the ectoderm, but has comparatively few algæ in its endoderm, while in the latter the ectodermic pigment is present in much reduced quantity, but the endoderm cells are crowded with algæ. The specimen just referred to, and also one of *plumosa*, were placed in similar vessels side by side, and exposed to full sunshine; by afternoon the specimen of *plumosa* had evolved gas enough for

* The amount of gas taken for analysis varied between 2 and 5 c.c., and averaged about 3.5 c.c.

an analysis, while the larger and finer *smaragdina* had scarcely produced a bubble. Two varieties of *Ceriatia aurantiaca*, one with, the other without, yellow cells, were next exposed, with a precisely similar result. The complete dependence of the evolution of oxygen upon the presence of algæ, and its complete independence of the pigment proper to the animal was still farther demonstrated by exposing as many as possible of those known to contain yellow cells (*Aiptasia chamaeleon*, *Helianthus troglodytes*, &c.), side by side with a large number of forms from which these are absent, such as the green *Actinia cari*, *Actinia mesembryanthemum*, *Sagartia parasitica*, *Cerianthus*, &c. The former never failed to yield abundant gas rich in oxygen, while in the latter series not a single bubble ever appeared.

Thus, then, the colouring matter of *Anthea*, described as chlorophyll by Lankester, has really been mainly derived from that of the endodermal algæ of the variety *plumosa*, which predominates at Naples, while the *Anthea*-green of Krukenberg must mainly consist of the green pigment of the ectoderm, since the Trieste variety evidently does not contain algæ in any great quantity. But since the Naples variety, contrary to the opinion of the brothers Hertwig,* does contain a certain amount of ordinary green pigment, and since the Trieste variety is tolerably sure to contain some algæ, Heider having indeed shown the presence of yellow cells in *Sagartia*, both spectroscopists have thus been operating on a mixture of two wholly distinct pigments—one vegetable, the other animal—diatom-yellow and *Anthea*-green.

But what is the physiological relationship of the plants and animal thus so curiously and so intimately associated? Everyone knows that the colourless cells of a plant share the starch formed by the green cells, and, in fact, subsist at their expense, and it seems impossible to doubt that the animal cell must similarly profit by its labours. In other words, when the vegetable cell dissolves its own starch, some must needs pass out by osmosis into the closely enveloping protoplasm of the surrounding animal cell, nor must it be forgotten that the latter possesses abundance of amylolytic ferment. Then, too, the *Philozoon* is subservient in another way to the nutritive functions of the animal, for it dies and is

* Cf., Hæckel, *Jena Zeitschr.*, 1870, p. 582.

digested; the yellow masses supposed by various observers to be developing cells, being sometimes, no doubt, Tintinnoids in process of digestion, as supposed by Cienkowiaki, but much more frequently specimens of Philozoon in progress of solution and disappearance.

Again, the animal cell is constantly producing carbonic acid and nitrogenous waste, but these are the first necessities of life to our alga, which removes them, so performing an intracellular renal function, and, of course, reaping an abundant reward, as its rapid rate of multiplication shows.

Nor do the services of the *Philozoon* end here, for during sunlight it is constantly evolving nascent oxygen directly into the surrounding animal protoplasm, and thus we have actually foreign vegetable chlorophyll performing the respiratory functions of native animal hæmoglobin. And the resemblance becomes closer when we bear in mind that it has been shown that hæmoglobin frequently lies as a stationary deposit in certain tissues like the tongue muscles of certain mollusca,* and the nerve-cord of *Aphrodite* and Nemerteans.

The importance of this respiratory function is well shown by comparing specimens of the common red and white *Gorgonia*, which are usually considered as being mere varieties of the same species, *G. verrucosa*. The red variety is absolutely free from algæ, which of course could not exist in such deeply coloured light, while the white variety, which I am inclined to think usually the commoner, larger, and better grown of the two, is perfectly crammed. Just as with the anemones above referred to, the red variety evolves no oxygen in sunlight, while the white yields abundance, and we have thus two widely contrasted *physiological varieties*, as we may call them, without the least morphological difference. The white specimen, placed in spirit, yields a strong solution of chlorophyll; the red again gives a red solution, which was recognised as containing "tetronerythrin" by my friend M. Merejkowsky, who was at the same time and place investigating the distribution and properties of that remarkable pigment, so widely distributed in the animal kingdom. This substance, which was first discovered in the red patches which decorate the neck and head of many birds, has recently been shown by Krukenberg† to be one of the most

* Lankester, *Brit. Ass.*, 1871, p. 140.

† *Vergleich. Physiol. Studien*, Bd. I. Abth. 2.

important of the colouring matters of sponges, while Merejkowsky * now finds it in fishes and in almost all classes of invertebrate animals. It has been strongly suspected to be an oxygen-carrying pigment, an idea to which these observations seem to me to give considerable support. It is, moreover, readily bleached by light, another analogy to chlorophyll.†

When one exposes an aquarium full of *Anthea* to sunlight, the creatures, hitherto almost motionless, begin to wave their arms, as if pleasantly stimulated by the oxygen which is being developed in their tissues. Specimens which I kept exposed to direct sunshine for days together in a shallow vessel placed on a white slab, soon acquired a dark unhealthy hue, as if being oxygenated too rapidly, although I protected them from any undue rise of temperature by keeping up a flow of cold water. So, too, I found that Radiolarians were killed by a day's exposure to sunshine even in cool water, and it is to the need for escaping this too rapid oxidation that I ascribe their remarkable habit of leaving the surface and sinking into deep water early in the day. We may readily understand the mechanics of this phenomenon by remembering that the starch formed during the morning's exposure to sunshine would increase the specific gravity of the Radiolarian, and so sink it, while its digestion and oxidation would again lighten it.

It is easy, too, to obtain direct proof of this absorption of a great part of the evolved oxygen by the animal tissues through which it has to pass. The gas evolved by a green alga (*Ulva*) in sunlight may contain as much as 70 per cent. of oxygen; that evolved by brown algæ (*Haliseris*), 45 per cent.; that from diatoms about 42 per cent. That, however, from the animals containing *Philozoon*, gave a much lower percentage of oxygen, e.g., *Velella*, 24 per cent.; white *Gorgonia*, 24 per cent.; *Ceriactis*, 21 per cent.; while *Anthea*, which contains most algæ, gave from 32 to 38 per cent. This difference between the amount of oxygen evolved by free and imprisoned algæ is naturally to be accounted for by the avidity for oxygen of the animal protoplasm.

* *Comptes rendus*, 1881.

† Krukenberg, however, disputes the identity of Merejkowsky's pigment with that which he has investigated, as well as the analogy of the former to hæmoglobin. See his *Vergleich. Physiol. d. Verdauung.*, Heidelb., 1882.

Thus, then, for a vegetable cell no more ideal existence can be imagined than that within the body of an animal cell of sufficient active vitality to manure it with abundance of carbonic anhydride and nitrogenous waste, yet of sufficient transparency to allow the free entrance of the necessary light. And conversely, for an animal cell there can be no more ideal existence than to contain a sufficient number of vegetable cells, constantly removing its waste products, supplying it with oxygen and starch, and being digestible after death. For our present knowledge* of the power of intracellular digestion possessed by the endoderm cells of the lower invertebrates removes all difficulties both as to the mode of entrance of the algæ and as to its fate when dead. In short, we have here the economic interrelations of the animal and the vegetable world reduced to the simplest and closest conceivable form.

It must be by this time sufficiently obvious that this remarkable association of plant and animal is by no means to be termed a case of parasitism. If so, the animals so infested would be weakened, whereas their exceptional success in the struggle for existence is evident. *Anthea cereus*, which contains most algæ, probably far outnumbers all the other species of sea-anemones put together, and the Radiolarians which contain yellow cells, are far more abundant than those which are destitute of them. So, too, the young gonophores of *Velella*, which bud off from the parent colony, and start in life with a provision of *Philozoon* (analogous to, yet far better than, a yolk-sac), survive a fortnight or more in a small bottle,—far longer, so far as my observations go, than any other small pelagic animals. So, too, a Rhizostome medusæ like *Cassiopeia*, which is well provided with *Philozoon*, lives for weeks in an aquarium, while *Pelagia*, which has no algæ, dies in a day or two. *Anthea*, too, can be exposed to light all day in stagnant water without apparent inconvenience, but dies if left in it over night. Such instances, which might no doubt easily be multiplied, show how beneficial the association is to the animals concerned.

The nearest analogue to this remarkable partnership is found in the vegetable kingdom, where, as the researches of Schwendener, Bornet, Stahl, and others have shown, we have certain algæ and

* Krukenberg, *Z. Kritik des Schriften ueb. sog. intracell. Verdauung b. Coel. Vergl. Physiol. Studien*, ii., 1 Abth., 1882, p. 139.

fungi associating themselves into the remarkable colonies known as lichens, so that we may not unfairly call our agricultural Radiolarians and Cœlenterates *Animal Lichens*, an alliance as to the possibility of which Semper * has already speculated. And if there be any parasitism in the matter, it is by no means of the alga upon the animal, but of the animal, like the fungus, upon the alga, and this utilisation of plants by animals contrasts curiously with the inverse case of the utilisation of animals by vegetables shown us by carnivorous plants. Yet the association of *Anthea*, &c., with *Philozoon*, exhibits a far more complex balance and interaction than either lichen or insectivorous plant, and stands unique in physiology as the highest development of the reciprocity between the animal and the vegetable kingdom.

Thus, then, the list of supposed chlorophyll-containing animals with which we started breaks up into three categories:—first, those which do not contain chlorophyll at all, but green pigments of unknown function (*Bonellia*, *Idotea*, &c.); secondly, those vegetating by their own intrinsic chlorophyll (*Hydra*, *Spongilla*, *Convoluta*); thirdly, those vegetating by proxy, if one may so speak, rearing copious crops of algæ in their own tissues, and profiting in every way by their vital activities.

It might be objected that the chlorophyll of *Convoluta*, &c., is also derived from some alga more highly modified than our *Philozoon* by sojourn within the tissues of the animal. Only an embryological investigation would of course furnish *absolute* proof of the animal nature of chlorophyll; but pending this, I was enabled, through the kindness of M. de Lacaze-Duthiers, while returning home through Paris in November, to re-examine specimens of this Planarian. Its green cells, however, bear not the slightest resemblance to *Philozoon*, or any other alga known to me; are not irregularly scattered, but form an almost continuous definite layer in every individual; are not of definite shape, nor bounded by any cellulose coat, but are irregularly ellipsoidal, semi-fluid, naked; are rarely, if ever, to be seen multiplying by transverse division, and do not survive the death of the animal for any length of time. It is also evident, on the most superficial examination, that the chloro-

* *Animal Life* (Internat. Sci. Series), Lond., 1881, p. 74.

phyll corpuscles of *Hydra* and *Spongilla* are quite different from algae.

To the Zoological Station Committee of the British Association, especially as represented by its secretary, Mr. Sladen, my best thanks are due and tendered, as also to my friends Drs. Andreae, Eiaig, and Mayer.

Postscript, 21st April 1881.

Having concluded this investigation, and having forwarded on 26th October last my manuscript containing my results precisely as given above [minus only the hypothetic explanation given at p. 386 of the mode of floating and sinking of Radiolarians, and of the concluding paragraph (p. 388) referring to *Convoluta*, which were added when the paper was read] to the medical faculty of the University of Edinburgh, as trustees for the quinquennial Ellis Physiology Prize, which they have since awarded it, as well as notice of the title of the paper to the Secretary of the Royal Society of Edinburgh, I naturally paid no further attention to the subject. An opportunity for reading of the paper however, unfortunately, was not afforded me until 16th January last, and it was not until after the publication of an abstract in *Nature* for 26th January that I learned, first from a remarkable pseudonymous communication in *The Academy* for 29th January, and more satisfactorily from a note by Professor Moseley in *Nature* for 8th February, that a new paper by Dr. K. Brandt had appeared in the meantime dealing with the same subject.*

In the succeeding number of *Nature* (16th February 1882) I gave a full summary of Dr. Brandt's results, which have now been very largely republished, and which are as follows:—

1. His observations are upon the green bodies of *Hydra*, *Spongilla*,

* (a) "Ueber das Zusammenleben von Thieren und Algen," *Verhandl. d. Physiol. Gesellsch. zu Berlin*, 2 Dec. 1881.

(b) *Sitzungsber. d. Gesellsch. naturforsch. Freunde z. Berlin*, 15 Nov. 1881.

(c) "Die Symbiose niederer Tiere mit Algen," *Der Naturforscher*, 14 Jan. 1881.

(d) *Biologisches Centralblatt*, 4 Jan. 1882.

(e) "Ueber die Morphologische und physiologische Bedeutung des Chlorophylls bei Thieren," *Archiv. f. Anat. u. Physiol.*, Physiol. Abtheil., April 1882.

a fresh-water planarium, and numerous infusora. He finds that these green bodies are masses of hyaline protoplasm, containing a nucleus and a peculiarly curved chlorophyll granule. Sometimes two to six are present; these he considers as states of division. He regards these facts as proving that these bodies are unicellular algæ, and erects the genus *Zoochlorella*. He finds them survive isolation, and even develop starch in light. Specimens from *Spongilla* were taken in by infusors, but were either digested or ejected, those from *Hydra* were, however, retained by *Paramæcium*, *Coleps*, &c. He believes that the chlorophyll never belongs to the animals, but always to algæ.

I have, on the other hand, stated my opinion above, that in certain animals, such as *Hydra*, *Spongilla*, and *Convoluta*, the green bodies do belong to the animals and are not algæ, and I do not yet see sufficient reason for withdrawing that view. Dr. Brandt's figures of *Zoochlorella* show no resemblance to any unicellular algæ hitherto described, but (as has recently been clearly pointed out by Mr. Lankester, to whose paper * I shall subsequently refer) closely resemble in form and mode of division the chlorophyll-granules of plants. Moreover, although he finds the green cells of *Hydra* to survive isolation he has not observed any morphological changes similar to those undergone by the yellow cells of Radiolarians. His experiments upon the infection of *Paramæcium* by the green bodies of *Hydra* are also to my mind quite inconclusive, since the remarkable indigestibility of chlorophyll must not be forgotten. Any one who examines, for instance, a scrap of *Ulva* which has passed through the digestive tract even of an *Echinus* or an *Aphysia*, will often find the chlorophyll grains scarcely appreciably altered either in form or colour. It is not however altogether inconceivable that chlorophyll-granules should survive transference from one living protoplasmic matrix to another.

Further consideration of this portion of Dr. Brandt's paper, especially in presence of Mr. Lankester's recent elaborate destructive criticism, † seems unnecessary.

* On "the Chlorophyll-Corpuscles and Amyloid Deposits of *Spongilla* and *Hydra*," *Quart. Jour. Micro. Sci.*, April 1882.

† "On the Chlorophyll-Bodies and Amyloid Deposits of *Hydra* and *Spongilla*," *Quart. Jour. Micro. Sci.*, April 1882.

2. For the yellow cells of Radiolarians and Coelenterates he proposes the name *Zooxanthella*, to which I do not object, especially seeing that he so ably argued for their algal nature in his first paper.

3. He observes that large Radiolarian colonies show no signs of digesting foreign bodies, that these and also *Spongilla* can be kept best in filtered water, and that the latter did not live in a half-darkened room.

These statements are all doubtless true, but they constitute an extraordinarily slender foundation for the doctrine of "symbiosis." Many Radiolarians can be easily observed to digest foreign bodies; every sponge, whatever its colour, requires great quantities of thoroughly pure water to keep it alive, while of course every one who has worked with living Radiolarians must have felt the necessity of transferring them when he wished to prolong their life from the impure water of the "Auftrieb," teeming as it is with dead and dying Crustaceans, fragments of Siphonophores, and all manner of other impurities, to pure water. I am not surprised that Dr. Brandt did not mention this trivial fact as evidence for the algal nature of the yellow cells in his first paper.

4. Upon the above evidence, Dr. Brandt concludes that the algae maintain their hosts; that so long as the animals contain few or none they feed in the ordinary way, but when sufficient algae are present, they are nourished like plants. This may perhaps be the case in *Collozoum* and some other Radiolarians, but *Anthea*, *Velella*, &c., are quite as voracious as their congeners unprovided with chlorophyll. He further indicates an analogy to lichens (an hypothesis which, as I also state above, was first ventured by Semper, and which can hardly fail to have suggested itself to every observer since Cienkowski), and points out a distinction, since in a lichen there is an association of an alga with a true parasite, here a "symbiose" of algae with animals accustomed to independent life, which they however give up, and take in no further nutriment. Thus "in a morphological sense the algae, in a physiological sense the animals, are the parasites."

I have already (p. 380) given Dr. Brandt full credit for the valuable observations contained in his first paper. So I should be extremely sorry to depreciate the theoretic insight of the present

one. I must, however, point out that the theory stated by Dr. Brandt of symbiosis between animals and algæ is, by his own showing, founded upon two lines of argument, first, that relating to "*Zoochlorella*," which we have seen to be no alga at all, and secondly that from the very simple fact that captive Radiolarians live longer in pure water! Such being the case, it is evident that (1) the demonstration of the truth of Cienkowski's view that the yellow cells of Radiolarians and Coelenterates are algæ, (2) the development of Semper's hypothesis of the lichenoid nature of the alliance between alga and animal into a theory of mutual interdependence, and (3) the transference of that hypothesis from the region of plausible speculation into that of experimental science, remain with my paper.

For it will not do to ignore, with Dr. Brandt, such weighty opposing evidence as (1) the recent direct statement of Hamann that the yellow cells of *Medusæ*, &c., are not algæ, but unicellular glands, (2) the observation of Krukenberg that *Anthea cereus* did not evolve oxygen in sunlight, or (3) the failure of himself and others to prove the presence of cellulose and chlorophyll, or even to confirm Haeckel's discovery of starch in Radiolarians, observations which rendered the whole matter so utterly dubious that no botanist had ever accepted it, although its value, especially to disciples of Schwendener, is obviously great. But for the necessity of meeting these objections point by point, I might have published the doctrine of reciprocal accommodation before going to Naples at all. The temptation was strong, but then the subject would have remained as with Semper and indeed also with Dr. Brandt, in the region of unproved hypothesis, instead of demonstrated fact.*

Nor is the theory of complete reciprocal accommodation between plant and animal entitled to supersede the at first sight more natural view held by Cienkowski, and formerly also by Dr. Brandt, of simple parasitism of the yellow bodies, until it has been shown, (1) that animals containing algæ are actually successful beyond

* I must also point out with reference to Dr. Brandt's latest republication (*Archiv. f. Anat. u. Physiol.*, 1882, p. 125), that the identity of *Hydra fusca* and *Hydra viridis* was made known several years ago by Duplessis, and with respect to the plate, that his figures of green infusors and their chlorophyll grains have been anticipated by Claude Bernard, *Leçons sur les Phénomènes de la Vie*, &c., Paris, 1878.

their fellows in the struggle for existence, (2) that the starch is actually consumed, and (3) that the algæ are of importance in the function of respiration; for which, again, it is necessary to show (a) the evolution of oxygen by the algæ, (b) the absorption of a large percentage by the animal, and (c) the displacement of the pigment to which the respiratory pigment is usually assigned, by the algæ when the former is normally present.

B. In the very next number of the *Biologisches Centralblatt*,* after the publication of Dr. Brandt's paper, and the reading of my own, there appeared a very interesting article by Dr. Geza Entz, pointing out that he had anticipated, as far back as 1876, most of the observations of Dr. Brandt's paper, as well as the theoretic views we have both expressed. As, however, Dr. Entz's paper seems unfortunately never to have been translated from the original Magyar, it is not altogether surprising that both Dr. Brandt and myself should have overlooked it.

Dr. Entz has been able, for instance, to cultivate green bodies taken from the bodies of numerous infusors, and to trace their development into forms recognisable as belonging to the genera *Palmella*, *Tetraspora*, *Glaucocystis*, *Pleurococcus*, &c., and the entrance of spores of these into Infusorians. He too points out that the algæ cannot be regarded as parasites, but that the Infusorians must rather live at their expense; obtaining oxygen and supplying carbonic acid; so that we have to do as in lichens "with a quite peculiar consortial relation of two wholly different organisms."

Although impugning, for reasons above stated at length, the justice of most of Dr. Brandt's views respecting his *Zoochlorella*, of *Hydra* and *Spongilla*, there is of course the very greatest probability that just as "yellow cells" are sometimes to be found in marine Infusorians, so a similar association between fresh-water algæ and animals should also sometimes occur. This Dr. Entz, by actually observing the change and growth of the green bodies after their removal from the animal, appears to have settled. But such facts by no means invalidate the arguments for the existence, in some other cases, of true animal chlorophyll.

C. Since Dr. Entz shows that so many different algal forms may

* "Ueb. d. Natur d. Chlorophyll Körperchen niederer Tiere," *Biol. Centralbl.*, 20 Jan. 1882.

form consortial relations, it also becomes evident that the attempt which has been made independently by Dr. Brandt and myself, at generic and specific definition of the yellow cells, pending more complete investigation of the forms they may assume when cultivated in the free state, is doubtless premature, and I think it preferable to withhold for the present the diagnoses of species, prepared as a note at p. 383. It may suffice to say that, as Professor De Bary has suggested to me, the "yellow cells" may have some affinity to Woronin's* *Chromophyton Rosanoffii*, which they at any rate resemble in colour.

D. Mr. George Murray † has pointed out the interesting analogy which exists between the young gonophores of *Veella*, which start in life provided with a stock of algæ,—“to the hymenial-gonidia of such lichens as *Dermatocarpon*, *Polyblastia*, &c., as described by Stahl. The hymenial-gonidia, which are the offspring of the thallus-gonidia, are carried up in the formation of the apothecia, and are cast out along with the spores. Falling in the same neighbourhood, the spores, on germinating, enclose with their filaments the hymenial-gonidia, which ultimately become the thallus-gonidia of the new lichen. The fact that among the animals the most closely allied to each other morphologically differ thus widely physiologically bears comparison with the near relations of the fungal parts of the lichens with the other ascomycetous fungi.”

E. Professor Perceval Wright, in a letter ‡ commenting on the subject of consortism or symbiosis, announces that he has observed that the spores of *Chlorochytrium*, and other algæ, frequently also enter the bodies of animals. He also suggested in 1877 the possible relation of such cases to the lichen-gonidia question.

A few years ago I was greatly perplexed by observing the zoospores of *Ulva* not being eaten, but vigorously burrowing their way into the bodies of the large and almost quiescent *Amœbe* which abounded in the same aquarium. No doubt this was a case of the same kind as those observed by Dr. Entz and Dr. Perceval Wright.

F. M. Max Cornu § has called attention to the fact that not

* *Bot. Zeitung*, 1880.

† *The Academy*, No. 508 (1882), p. 67; and *Jour. Roy. Micr. Sci.*, April 1882, p. 245.

‡ *Nature*, 16th February 1882.

§ *Comptes rendus*, Dec. 1881, No. 26.

only do the algal constituents of lichens thrive better and live longer in association with fungi than similar algae living free, but that the same takes place in other cases, thus in the leaves of numerous phanerogams, where those parenchyma cells, which are directly attacked by the hypha of the parasite, live much longer than the rest. He explains this "par le retour des matières nutritives vers les centres de réserve que le mycélium contre-balance," an expression which I do not very clearly understand. He further explains that in the algae of lichens reproduction and development of spores is impeded, and vegetative life thus prolonged and enhanced, just as by preventing flowering the life of annuals may be prolonged. This is all doubtless true, but it seems to me likely that a very important factor in the healthy nutrition of the alga would be afforded by the endosmose of the waste products of the fungal protoplasm in return for the exosmose of its starch, &c. Doubtless this is included in Van Tieghem's view of "mutual parasitism," to what M. Cornu alludes, but to which I have not been able to refer.

G. So far as I am aware, the only remaining recent contribution to the literature of this subject is the paper by Professor Ray Lankester,* above referred to, in which he gives a full description, with figures, of the chlorophyll corpuscles and amyloid deposits of *Hydra* and *Spongilla*, together with a criticism of the views of Dr. Brandt to which I have already concurred. Mr. Lankester, however, lays what appears to me undue stress on the importance of the spectroscopic identification and analysis of chlorophyll, a mode of research which, as shown above, and as he indeed freely admits, has led to faulty results, and he has overlooked that I have clearly stated that the green colouring matter of *Convoluta* † is true chlorophyll, having the usual solubility and fluorescence, and giving a spectrum closely resembling that of vegetable chlorophyll. I have also described the structural form in which the pigment occurs, ‡ as uniformly diffused through the semi-fluid protoplasm of nucleated and granular cells, lying below the muscular layers of the integument, not collected into granules as in plants, nor in drops as

* *Quart. Jour. Micro. Sci.*, April 1882.

† "Observations on the Physiology and Histology of *Convoluta Schultzei*," *Proc. Roy. Soc. Lond.*, No. 194, 1879, p. 452.

‡ *Ibid.*, p. 454.

in the green cells of *Vortex viridis*. I hope, however, shortly to figure these cells and the spectrum of their chlorophyll.

I consider that experiment upon the living organism by exposure to sunlight is not only the best, but the only absolutely safe and certain way of recognising any pigment as chlorophyll. And the entire absence of any evolution of gas from *Bonellia*, *Idotea*, and various other green animals (p. 379), disproves, at any rate, the extreme form in which Pringsheim's "screen" theory is sometimes stated, although, as Lankester points out, and as Pringsheim doubtless intends, it is more probable that it should only be applied to true chlorophyll.

H. I have omitted in the body of the paper to call attention to the great importance of consortism in the economy of nature, for, since the Radiolarians, and doubtless also, at least to a large extent, the Foraminifera, are thus chiefly maintained, and since they serve as nutriment directly or indirectly to most of the higher pelagic animals, the apparently disproportionate abundance of animal life in the open sea becomes no longer enigmatical.

2. On the Thermodynamic Acceleration of the Earth's Rotation. By Sir William Thomson.

It has long been known, having been first, I believe, pointed out by Kant, and more recently brought very near to a practical conclusion by Delaunay, that the earth's rotational velocity is diminished by tidal agency, in virtue of the imperfect fluidity of the ocean. An integral effect of all the consumption of energy by fluid friction (or more properly speaking by continued deformation of fluid matter) in the tidal motions, is to cause the time of high water on an average for the whole earth to be not exactly either transit, or 6 o'clock, as it would be were the ocean a perfect fluid, but to be some time after transit, and before 6 o'clock.* Thus we may

* For brevity, I use the word "transit" to denote a time of transit of the tide-generating body (whether sun or moon), or a time of transit of the point of the heavens opposite to the tide-generating body, across the meridian of the place; and the word 6 "o'clock," to denote the middle instant of the interval of time between consecutive transits. If, to fix the ideas, we first think of the

imagine the average lunar tide for the whole earth to consist of a displacement of the water, presenting protuberances, not exactly towards moon and anti-moon, but in a line inclined at an angle to the line joining moon and anti-moon, in the direction indicated by

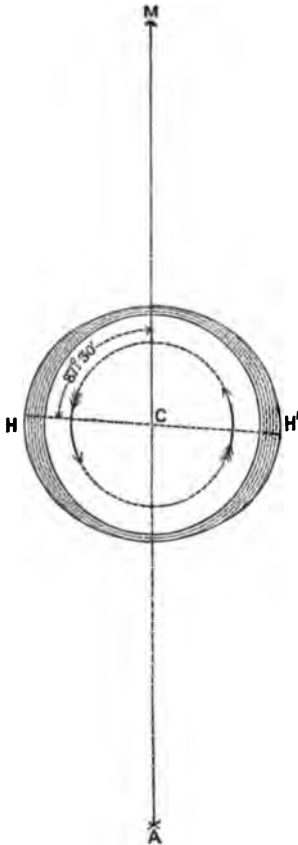

Fig. 1.

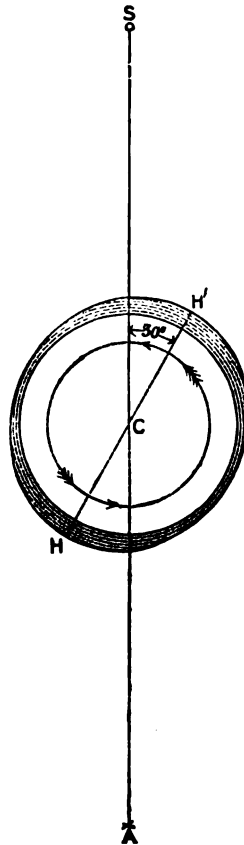

Fig. 2.

the drawing (fig. 1), in which M, A represent the directions of moon and anti-moon, and H, H' the crowns of the ideal spheroid, representing the average water-level for the whole earth. The angle HCM is made $87^{\circ} 30'$, which would be actually the case if

lunar tide alone as if there were no solar tide, 6 o'clock will mean 6 lunar hours before or after a lunar transit.

4 o'clock lunar time were the average time of high water for the whole earth. It is obvious that the resultant force of the moon, on the whole mass of the solid and liquid constituting the earth, is not a single force, exerted in the line MC, but that, after the manner of Poinso't, it may be represented by a single force in this line, and a couple in a direction opposite to that of the arrows, indicating in the diagram the direction of the earth's rotation. Thus the lunar attraction produces, as it were, the action of a friction brake resisting the earth's rotation. The same is no doubt also the case in respect to the sun and the water of the ocean.

If HH' were inclined to the line of the attracting body, on the other side from that shown in the first diagram, the effect of the attraction would be to accelerate the earth's rotation. Now this, which is represented in the second diagram (fig. 2), is found by observation to be actually the case in respect to the sun and (not the waters of the ocean, but) the earth's atmosphere. The accompanying table and formula show the result of the Fourier Harmonic Analysis applied for the diurnal period by Mr. G. H. Simmonds to barometric observations collected from all parts of the world. In the formula, E denotes the excess of the barometric pressure above its mean value for the day, at the time θ reckoned in degrees from midnight, at the rate of 15° per mean solar hour: R_1c_1 , R_2c_2 , R_3c_3 denote the ranges and angles, corresponding to the times of maximum height, for the first three terms of the Fourier expression which the formula exhibits. The table shows the values of R_1c_1 , R_2c_2 , R_3c_3 , calculated for the different places, from observations at the times stated in column 5.

It is a very remarkable result of this analysis that the amplitude R_2 of the semidiurnal term is for most places, especially those within 40° of the equator, considerably greater than the R_1 of the diurnal term. The cause of the semidiurnal variation of barometric pressure cannot be the gravitational tide-generating influence of the sun, because, if it were, there would be a much larger lunar influence of the same kind, while in reality the lunar barometric tide is insensible or nearly so. It seems therefore certain that the solar diurnal variation of the barometer is due to temperature. Now the *diurnal* term, in the Harmonic Analysis of the variation of

$E = R_1 \cdot \cos(\theta + c_1) + R_2 \cdot \cos(2\theta + c_2) + R_3 \cdot \cos(3\theta + c_3)$.
 Extracted from the *Quarterly Journal of the Meteorological Society* for January 1880. "The Diurnal Range of Atmospheric Pressure,"
 by Robert Strachan, F.R.S.

Harmonic Constituents of the Diurnal Variation of Atmospheric Pressure, calculated by G. H. Simmonds, F.M.S.

| Name of Place. | Latitude. | Longitude. | Height. | Time of Observation. | | Diurnal Constituents. | | Semi-diurnal Constituents. | | Ter-diurnal Constituents. | |
|--------------------|-----------|------------|-----------|--------------------------|---|-----------------------|----------------|----------------------------|----------------|---------------------------|----------------|
| | | | | Years from 1841 to 1845. | Time of Observation. | E ₁ | c ₁ | E ₂ | c ₂ | E ₃ | c ₃ |
| Singapore. | 1° 37' N | 108° 49' | Feet. | 5 | Years from 1841 to 1845. | Incches. | ° | Incches. | ° | Incches. | ° |
| Travancorum. | 8° 81' N | 77° 0' | Small No. | 7 | June 1837 to May 1842. | 0210 | 380.3 | 0897 | 66.0 | 7015 | 338.3 |
| Bombay. | 18° 4' N | 80° 14' | 194 | 7 | 1844 to 1850. | 0154 | 389.8 | 0434 | 68.3 | 7018 | 338.1 |
| Calcutta. | 18° 53' N | 78° 48' | 38 | 17 | 1846 to 1852. | 0234 | 368.9 | 0452 | 67.5 | 7007 | 370.0 |
| Calcutta. | 22° 31' N | 88° 31' | 18 | 15 | 1855 to 1863. | 0188 | 348.9 | 0882 | 66.4 | 7014 | 338.3 |
| Shimla. | 31° 6' N | 77° 13' | 6953 | 5.5 | June 1843 to December 1844. | 0870 | 389.9 | 0384 | 61.4 | 7013 | 358.5 |
| Lahore. | 38° 43' N | 9° 8' | 325 | 6.9 | January 1844 to November 1870. | 0100 | 185.7 | 0210 | 69.1 | 7003 | 373.4 |
| Pekin. | 39° 57' N | 116° 26' | 101 | 6 | 1850 to 1855. | 0285 | 345.5 | 0317 | 64.3 | 7028 | 316.0 |
| Washington. | 38° 54' N | 77° 8' | 108 | 9 | 1861 to 1869. | 0188 | 345.5 | 0201 | 73.8 | 7028 | 317.9 |
| Glard College. | 39° 53' N | 75° 31' | 112 | 7 | June 1842 to June 1845. | 0183 | 348.3 | 0179 | 71.3 | 7018 | 339.1 |
| Toronto. | 43° 40' N | 79° 31' | 242 | 7 | 1841 to 1847. | 0140 | 342.4 | 0137 | 81.3 | 7020 | 331.7 |
| Tilsa (Avlaha). | 41° 43' N | 44° 40' | 1601 | 7.3 | January 1868 to April 1868. | 0246 | 326.6 | 0142 | 70.9 | 7021 | 343.2 |
| (Khal). | 41° 43' N | 44° 40' | 1645 | 7.9 | May 1868 to December 1871. | 0896 | 324.2 | 0122 | 70.9 | 7012 | 367.1 |
| Vienne. | 46° 13' N | 16° 23' | 650 | 7 | 1849 to 1856 (less one month of April). | 0680 | 327.5 | 0135 | 49.5 | 7002 | 327.2 |
| Prague. | 50° 4' N | 19° 48' | 212 | 27 | 1859 to 1866. | 0660 | 327.5 | 0135 | 49.5 | 7002 | 327.2 |
| Cracow. | 50° 5' N | 14° 25' | 351 | 27 | 1843 to 1868. | 0100 | 371.5 | 0086 | 66.1 | 7011 | 331.3 |
| Brussela. | 50° 51' N | 4° 28' | 190 | 26 | 1848 to 1869. | 0019 | 368.8 | 0096 | 68.1 | 7012 | 378.7 |
| Grenwich. | 51° 29' N | 1° 15' | 169 | 16 | 1855 to 1847. | 0011 | 328.9 | 0104 | 67.9 | 7004 | 386.6 |
| Oxford. | 51° 46' N | 1° 15' | 212 | 16 | 1855 to 1870. | 0046 | 315.7 | 0086 | 68.1 | 7018 | 373.3 |
| Nerchnak. | 51° 18' N | 119° 30' | 2920 | 19 | 1843 to 1845, 1848 to 1865, and 1868 to 1869. | 0136 | 328.1 | 0098 | 71.0 | 7016 | 386.0 |
| Berna val. | 53° 30' N | 83° 87' | 400 | 17 | 1843 to 1845, 1850 to 1855, and 1866 to 1867. | 0046 | 186.2 | 0044 | 73.0 | 7011 | 383.3 |
| Catharinenburg. | 56° 50' N | 60° 84' | 813 | 18 | 1843 to 1845, 1849 to 1855, and 1866 to 1867. | 0086 | 328.4 | 0085 | 63.8 | 7008 | 313.7 |
| Sicks. | 57° 9' N | 135° 18' | 15 | 10 | 1848 to 1845, 1848, 1860 to 1864, and 1866. | 0028 | 128.9 | 0087 | 67.3 | 7003 | 147.3 |
| St. Petersburg. | 59° 57' N | 30° 28' | 15 | 23 | 1841 to 1862. | 0014 | 140.7 | 0045 | 67.3 | 7006 | 306.9 |
| Batavia. | 6° 11' S | 106° 50' | 24 | 7 | 1866 to 1872. | 0029 | 248.6 | 0089 | 67.3 | 7016 | 331.6 |
| Ascension. | 7° 55' S | 0° 58' | 188 | 2 | September 1863 to August 1865. | 0106 | 287.4 | 0079 | 66.5 | 7004 | 306.6 |
| St. Helena. | 16° 57' S | 5° 41' | 1764 | 6 | 1841 to 1845. | 0071 | 224.1 | 0093 | 63.4 | 7014 | 348.0 |
| Santiago de Chile. | 33° 36' S | 70° 38' | 1790 | 3.9 | November 1846 to September 1847. | 0065 | 248.6 | 0157 | 77.3 | 7014 | 105.0 |
| Cape of Good Hope. | 33° 56' S | 16° 39' | 39 | 5.2 | April 1841 to June 1844. | 0047 | 237.8 | 0192 | 73.0 | 7014 | 261.8 |
| Hobarton. | 43° 52' S | 147° 37' | 105 | 7 | 1841 to 1847. | 0123 | 317.5 | 0137 | 64.1 | 7018 | 267.6 |

temperature, is undoubtedly much larger in all, or nearly all, places than the semidiurnal. It is then very remarkable that the *semi-diurnal term of the barometric effect* of the variation of temperature should be less, and so much less as it is, than the diurnal. The explanation probably is to be found by considering the oscillations of the atmosphere, as a whole, in the light of the very formulas which Laplace gave in his *Mécanique Céleste* for the ocean, and which he showed to be also applicable to the atmosphere. When thermal influence is substituted for gravitational, in the tide-generating force reckoned for, and when the modes of oscillation corresponding respectively to the diurnal and semidiurnal terms of the thermal influence are investigated, it will probably be found that the period of free oscillation of the former agrees much less nearly with 24 hours than does that of the latter with 12 hours; and that therefore, with comparatively small magnitudes of the tide-generating force, the resulting tide is greater in the semidiurnal term than in the diurnal. Now, if we look to the values of c_2 in the table, we see that, with one exception (Sitka, a place far north, where R_2 is very small), they are all positive acute angles: and we find $61^\circ.3$ as the mean of all the 30. If we assign weights to the different values of c_2 , according to the corresponding values of R_2 , we should find a somewhat larger number for the true mean value of c_2 . It is enough for our present purpose to say that the mean is 60° or a little more. Looking now to the formula, we see that the meaning of this is that the times of maximum of the semidiurnal variation R_2 are a little before 10 o'clock in the morning and a little before 10 o'clock at night (exactly at 10 o'clock if c_2 were exactly 60°). Without more of observation, or of observation and theory, than has yet been brought to bear on the subject, we cannot tell the law of variation of R_2 with the latitude. The observations in the table seem to show, what Laplace's Tidal Theory prepares us to expect, that it diminishes more in the Polar regions than it would if it followed the elliptic spheroidal law of proportionality to the square of the cosine of the latitude. We may, however, take by inspection from the table $R_2 = \cos^2 \text{lat} \times .032$ inch as a rough estimate of a barometric variation distributed over the whole earth in the form of an elliptic spheroid, which would give the same resisting couple in the calculation of the solar gravitational influence on the

disturbed atmosphere; or (getting quit of the intolerable British inch),

$$R_2 = \cos^2 \text{lat} \times \cdot 08 \text{ cm.}$$

Now the height of the barometer corresponds always to the mass of the air over a given horizontal area of the locality, independently of the temperature of the air; and, in averages for the different places, no doubt independently of the wind also.* Thus for every centimetre of higher or lower mercury in the barometer, there is more or less mass of air over the locality to the extent of 13.596, or say 14 grms. over every square centimetre of horizontal surface. Thus the second diagram with its angle of 30° (corresponding to $c_2 = 60^\circ$) represents the state of things, as regards the quantity of air over different parts in the circle of any parallel of latitude, or at all events of any circle farther from the pole than 60° north or south latitude. It represents the state of things for every parallel of latitude in the imagined elliptic spheroid, constituting the terms we have to deal with in the spherical harmonic expression of the actual effect: and definitively, if we suppose half the excess of the greatest above the least radius of the elliptic spheroid in the diagram to be equal to the square of the sine of the latitude multiplied into $\cdot 08$ cm., the diagram shows the distribution of a mass of matter of the same density as mercury, over the whole surface of the earth, which would experience the same resultant couple from the sun as does the earth's atmosphere in reality. To evaluate this couple we may use the known formula (*Thomson and Tait's Natural Philosophy*, vol. i. § 539) relative to the mutual attraction between a mass M , not con-

* In strong winds the barometer may stand sensibly above or below the proper value for the weight of the atmosphere over the place, according as the room containing the barometer is more exposed by openings on the windward or on the leeward side of the house in which it is placed. The error due to this cause may be sensible in the diurnal averages for one particular barometer, because of the daily periodic variations in the direction of the wind; but it is not probably large for any well-placed barometer, and, such as it is, it must be fairly well eliminated in the averages for different barometers in variously arranged buildings and in different parts of the world. In passing, it may be remarked, that it is probably not a matter of no importance that the barometer-room of a well-appointed meteorological observatory should be as nearly as may be symmetrically arranged in respect to openings to the external air in different directions, and in respect to shelter against wind from other parts of the building.

centrated in a point, and a portion of matter m , concentrated in a very distant point—

$$L = 3m \frac{(B - C) yz}{(x^2 + y^2 + z^2)^{\frac{3}{2}}} \dots \dots \dots (1),$$

where x, y, z denote coordinates of m relatively to rectangular lines OX, OY, OZ coincident with the principal axes of inertia of M through its centre of inertia; B and C the moments of inertia of M round OY and OZ; and L the component round OX, of the couple obtained by transposing, after the manner of Poinsot, the resultant attraction of m , from its actual line through x, y, z , to a parallel line through o , the centre of inertia of M. Suppose now M to be a homogeneous ellipsoid of revolution, having for semi-axes a, b, c , we have

$$\begin{aligned} B - C &= \frac{1}{5} M (c^2 - b^2) \\ &= \frac{1}{5} M (c + b) (c - b). \end{aligned}$$

Hence for a prolate spheroid of the dimensions stated above, we have

$$B - C = \frac{1}{5} Mr \cdot 0.32 \dots \dots \dots (2),$$

where r denotes the earth's radius in centimetres. To fit the formula (1) to the case represented by the diagram in fig. 2, we have

$$yz = D^2 \sin 30^\circ \cos 30^\circ \dots \dots \dots (3),$$

where D denotes the sun's distance from the earth. With this and (2), (1) becomes

$$L = \frac{3}{5} \frac{mMr \cdot 0.32^{\sin 30^\circ \cos 30^\circ}}{D^3} \dots \dots \dots (4),$$

where M denotes the mass of a quantity of mercury equal in bulk to the earth, so that if E denotes the earth's mass $M = 2.5 E$. Now $\frac{mE}{D^2}$ is the attraction of the earth on the sun: hence if we call this force F,

$$L = \frac{3}{5} \cdot 2 \cdot 5 \frac{r}{D} F \cdot 0 \cdot 32^{\text{cm}} \cdot \sin 30^\circ \cos 30^\circ$$

$$= \frac{r}{D} F \cdot 0 \cdot 21^{\text{cm}}.$$

Now if S denote the number of grammes in the sun's mass, we have

$$F = \frac{r^2}{D^2} S \cdot 980 \text{ dynes,}$$

since the earth's attraction on a gramme of matter at its surface is about 980 dynes; and so we find

$$L = \frac{r^3}{D^3} S \cdot 980 \cdot 0 \cdot 21 = \frac{r^3}{D^3} S \cdot 207 \quad \dots \quad (5),$$

Now if ω denote the acceleration of the earth's angular velocity produced by this couple, we have

$$\omega = \frac{L}{I} \quad \dots \quad (6),$$

where I denotes the earth's moment of inertia; and, allowing for the increase of the earth's density from the surface inwards, according to Laplace's probable law, we have, approximately,

$$I = \frac{1}{3} r^2 E$$

(instead of $I = \frac{2}{5} r^2 E$, as it would be if the mass were homogeneous),

E denoting the earth's mass. Hence

$$\omega = 3 \frac{r^3}{D^3} \frac{S \cdot 207}{E \cdot r^2}.$$

Now $D^3/r^3 = 12 \cdot 3 \cdot 10^{12}$, $S/E = 31 \cdot 9 \cdot 10^4$, $r = 6 \cdot 370 \cdot 10^8$ centimetres which gives $r^2 = 40 \cdot 6 \cdot 10^{16}$. Hence

$$\omega = 3 \frac{31 \cdot 9 \cdot 10^4}{11 \cdot 3 \cdot 10^{12}} \frac{207}{40 \cdot 6 \cdot 10^{16}} = 4 \cdot 0 \cdot 10^{-28}.$$

This is the rate per second of gain of angular velocity. The earth's angular velocity at present is $\frac{2\pi}{86400}$, or approximately $\frac{1}{13700}$.

Calling this ω , we have

$$\frac{\dot{\omega}}{\omega} = 5 \cdot 5 \cdot 10^{-3}$$

for the proportionate gain per second. There are 31·5 million seconds in a year, and 3150 in a century. Hence the ratio to the earth's present angular velocity, of the gain per second, amounts to

$$1\cdot73 \times 10^{-9}.$$

To interpret the result, suppose two chronometers, A and B, to be kept going for a century, according to the following conditions :—

Chronometer A to be an absolutely perfect timekeeper, and to be regulated to sidereal time at the beginning of the century, in the usual manner, by astronomical observation.

Chronometer B to be kept constantly regulated to sidereal time by astronomical observations from day to day, and from year to year, during the century.

At the end of the century B will be found to be gaining on A to the amount of $1\cdot73 \times 10^{-9}$ of a second per second. This rate of gain has been uniformly acquired ; and, therefore, on the average of the century, B has been going faster than A, at the rate of $\cdot86 \times 10^{-9}$ of a second per second. Hence, in the whole century (or $3\cdot16 \times 10^9$ sidereal seconds), B has gained on A to the extent of 2·7 seconds.

In reality a tenfold greater difference, in the opposite direction, would be observed between the two chronometers. Adams, from his correction of Laplace's dynamical investigation of the acceleration of the moon's mean motion, produced by the sun's attraction, found that our supposed chronometer B, regulated to sidereal time, would be 22 seconds behind the perfect chronometer A at the end of a century. (See *Thomson and Tait's Natural Philosophy*, 1st ed., § 830 ; or 2nd ed., vol. i. part 1, § 405.) The retardation of the earth's rotation thus definitively specified, which may be regarded as a well-established result of observation and theory, received from Delaunay what we cannot doubt to be its true explanation,—retardation by tidal friction. The preceding formulas, with the proper change of data, may be readily modified to show the tidal retardation instead of the thermodynamic acceleration. Thus if we go back to fig. 1, and suppose the spheroidal layer to be water, instead of the earth's atmosphere, and take 100 cms. as the excess of the greatest above the least semi-diameter, we have what we may fairly assume to be a not improbable

estimate of the equivalent, over the whole earth's surface, to the true tidal deformation of the water of the oceans. If the obliquity HCS were the same in the two cases, and if the sun were the external attracting body in each case, the value of L would be $(50/08.13.596 =)45.9$ times greater in the second case (fig. 1) than in the first case (fig. 2). Suppose now the moon, instead of the sun, to be the influencing body in the second case (fig. 1), other things being the same, the couple will be 91.8 times as great in the second case (fig. 1) as in the first case (fig. 2). (Because the moon's mass, divided by the cube of her distance from the earth, is about double the sun's mass divided by the cube of his distance from the earth.) Now, we must make the couple to be only 10 times as great in the second case (fig. 1) as in the first case (fig. 2) to bring out Adams' result, according to Delaunay's explanation of it. Hence we must suppose, in fig. 1, $\sin HCM \cos HCM$ to be $1/10$ of $\sin 30^\circ \cos 30^\circ$; and we may fulfil this condition by taking $HCM = 87^\circ 30'$.

Thus with the approximate results of observation used above in respect to the earth's atmosphere, and the assumptions we have now made regarding the lunar tide, we have a state of things in which our supposed chronometer B gains on A 2.5 seconds in the course of the century through the thermodynamic acceleration, and loses 25 seconds through the tidal retardation; that is, loses in all 22.5 seconds, or say 22 seconds, which is Adams' result.

3. Notes on a Cist discovered at Parkhill, Dyce, Aberdeenshire, in October 1881. By William Ferguson of Kinmundy. With Notes on the Bones by Dr. Fife Jamieson, M.B.

The station of Parkhill, on the Great North of Scotland Railway, is seven and a half miles from Aberdeen, and the cist which is the subject of these notes was situated in a mound of gravel and sand to the north-east of, and within one or two hundred yards of, the station. This is the second which has been uncovered at the same spot,—a previous one having been disclosed in 1867, the contents of which—a vase and some bones—are preserved in the Anatomical Museum, Marischal College, University of Aberdeen.

The gravel mound belongs to the railway company, and is quarried from time to time for ballast. In the course of the night of the 3rd October 1881, the men who were digging the gravel came upon the cist at the depth of about one and a half to two feet from the surface. The upper part of the mound is roughish gravel, and below the gravel it is sand. The cist was just below the gravel, but in the sand. The sides were formed of four large slabs, one of which fell down as the workmen removed the sand from below. The length of the cist was 3 feet 9 inches, the breadth 2 feet 3 inches, and the depth 18 inches at the ends, and 27 inches in the centre. The contents were an urn and certain bones. The urn is small, $5\frac{1}{2}$ inches high and $4\frac{1}{4}$ inches diameter at the mouth. It is of graceful shape and elaborately carved.

The other contents of the cist were bones. Surrounding many of the bones was a coating apparently vegetable in structure. It was said that the bones were wrapped in a piece of bull's hide, with the hair still upon it; but examination seems to settle that this is only another instance of an error that has been common, of mistaking the matted mycelium of a cryptogamous plant for hair. In the previously discovered cist there was true hair found.

"The base of the cist was covered with small pebbles—not so uniformly as to form a continuous floor, but quite close enough to show that it was not the result of chance, while scattered about were fragments of wood charcoal." Only a very small portion of the charcoal was preserved, and doubt having been expressed as to whether it was really charcoal, I requested Dr. Jamieson to examine it carefully and also to send me a portion of it, both of which requests he has kindly complied with. Dr. Jamieson says:—"It is undoubtedly vegetable charcoal. I have examined it microscopically. Chemically there is no very decisive test. I send you also a sample as you desired, and am sorry that it is so small, but in my ignorance of the importance of such a phenomenon as the presence of charcoal in a cist, I carried off only two or three little fragments. There were no pieces, as far as I can recollect, of any size, most being about the size of the specimen sent to you ($\frac{1}{2}$ -inch by $\frac{1}{4}$ -inch).

"In examining microscopically a piece of the charcoal, I thought I had stumbled on a 'a find.' With a high power, seemingly embedded in a little fragment of charcoal, were two or three isolated

structures marvellously like striped muscular fibre. I began to weave a nice theory about some of the flesh (human or boar's), having somehow got impacted in the charcoal, which by its preservative or antiseptic power, had retained the muscular fibre all these ages. The preparation was in clove oil, as it was only a temporary examination, and before I could show it to the professor of botany, as to whether it was vegetable or not, the clove oil had so cleared it up as to obliterate all the previous structural-like appearance. In all probability it was some vegetable cell with which I am unacquainted; the other theory is too fine to be true."

Mr. Joseph Anderson of the Society of Antiquaries of Scotland informs me that this interment is one of the less common class, and that it has these two *very rare* features connected with it:—first, the occurrence of charcoal; and second, that of the bones of an animal other than the human bones.

Mr. Anderson divides the sepulchral urns of Scotland into four groups. Groups 1 and 2 are found with burned bodies, and (1) large cinerary urns, and (2) small cup-shaped urns. Groups 3 and 4 are usually, though not exclusively, formed with unburned bodies. They are called (3) food vessels, and (4) drinking cups. The Parkhill Urn seems to belong to group 4—the drinking cup.

At the request of Professor Struthers, Dr. Fife Jamieson has been good enough to give me the following notes upon the bones found in the cist along with the urn. They are those of a man along with fragments of the left fore limb bones of a boar.

The bones are deficient in number and in mass, chiefly from decomposition by natural agencies; but partly from the rough handling to which they were subjected by sight-seers, prior to their removal to the Anatomical Museum.

The cranium is very deficient, though enough remains to show that it was large and well shaped, with frontal sinuses prominent, but insignificant occipital protuberances. The basi-occipital and basi-sphenoid segments were firmly ankylosed together; they are so normally after the age of twenty-two.

The facial bones are still more deficient; enough of the jaws is left, however, to show that the teeth had to all probability dropped out only after death. Four teeth, two still in their sockets, all fairly worn, were obtained.

None of the cervical vertebræ were to be seen; fragments of eleven dorsal and five lumbar were easily recognised, as well as the upper half of a strong well-formed sacrum.

The sternum was entire with the exception of the lower half of the pre-sternum and the whole meta-sternum. The first segment of the meso-sternum, which normally anchyloses to the rest of the meso-sternum below at from twenty-five to thirty years, and to the pre-sternum above at about forty years, was here separate, and had at no time been anchylosed on either end.

Fragments of but a few ribs, and these unimportant, were obtained.

The innominate bones were incomplete, specially at the pubic arch, so that no accurate estimate could be formed, either of the capacity or of the form of the pelvic cavity. There was no trace of epiphysial suture.

Of the two femurs one was almost entire, and measured in length $18\frac{1}{4}$ inches. Both were well marked, though not indicative of very special muscular strength.

All the remaining bones of the lower limb were more or less incomplete, with exception of the left os calcis, scaphoid, and first metatarsal, all of which were unusually large and strongly marked. The scaphoid shows a large and well-formed facet, just external to that for the external cuneiform, and apparently for articulation with the cuboid.

No phalanges of the foot were got. Sufficient fragments of both clavicles and scapulæ were got to show that they were by no means powerfully marked. One humerus, almost complete, measured about $13\frac{1}{2}$ inches. All the bones of the upper limb were more or less incomplete with the exception of three phalanges of the first row.

It is probable that the subject was a male, evidenced specially by the prominence of the frontal sinuses, and the general size and strength of the different bones. His age at death seems to have been from twenty-five to thirty, judging specially from the condition of the sternum. His height must have been about four feet nine inches. Of fairly muscular build, and specially developed in the lower limbs.

Fragments of the left fore limb bones of a boar—the humerus,

radius, and metacarpal of the third finger were got. Their original position in the cist with reference to the human remains could not be ascertained, as they had been repeatedly changed by visitors. The humerus showed the upper epiphysis unanchylosed, so that the animal, large as it must have been, was not fully developed.

4. On a Class of Permanent Symmetric Functions.

By Thomas Muir, M.A.

1. By Cauchy the word "symmetric," as applied to functions, was used in a more general sense than that in which we ordinarily use it now, or than that in which it was used before his time. He spoke* of "fonctions symétriques permanentes" and "fonctions symétriques alternées:" we apply the word symmetric only to certain of the first of these; the second we call simply "alternating functions." Thus the expression

$$a_1 b_1 + a_2 b_2 + a_3 b_3$$

was called by him a permanent symmetric function, since if a_1, a_2, a_3 are interchanged in order with b_1, b_2, b_3 , the function remains unaltered. It would be more definite to say that it is a permanent symmetric function *with respect to* a_1, a_2, a_3 and b_1, b_2, b_3 . Again,

$$(a_1 - b_1)(a_2 - b_2)(a_3 - b_3)$$

he called an alternating symmetric function, since if the same change is made the function remains unaltered in magnitude but not in sign. As before, for the sake of definiteness, it is better to speak of it as an alternating function *with respect to* a_1, a_2, a_3 and b_1, b_2, b_3 .

2. Under the latter class of functions it is evident that determinants may be placed. Thus the determinant

$$\begin{vmatrix} a_1 & a_2 & a_3 \\ b_1 & b_2 & b_3 \\ c_1 & c_2 & c_3 \end{vmatrix}$$

is an alternating symmetric function with respect to its three rows

* *Journ. de l'École polyt.*, Cah. xvii. p. 80.

of elements. It was in this light that determinants were viewed and treated of by Cauchy.

On the other hand, if all the negative signs of a determinant be made positive we obtain a permanent symmetric function with respect to the same groups of the same quantities. It is functions of this kind, resembling determinants, which we wish to consider in the present paper. Two notations have before this been used for them: the above instance may be specified, after Cauchy, by

$$\Sigma(a_1 b_2 c_3),$$

or, after Cayley, by

$$\begin{pmatrix} a_1 & a_2 & a_3 \\ b_1 & b_2 & b_3 \\ c_1 & c_2 & c_3 \end{pmatrix}.$$

As however the contraction, $\{a_1 b_2 c_3\}$ for the latter form is not sufficiently distinctive, it would be better perhaps to use instead the notation

$$\begin{vmatrix} a_1 & a_2 & a_3 \\ b_1 & b_2 & b_3 \\ c_1 & c_2 & c_3 \end{vmatrix}$$

which is very conveniently contracted into

$$\dagger a_1 b_2 c_3 \dagger.$$

For shortness, in speaking of the functions, we may agree temporarily to call them PERMANENTS.

3. The Permanent $\dagger a_1 b_2 c_3 \dagger$ is evidently equal to

$$(a_1 i_1 + a_2 i_2 + a_3 i_3)(b_1 i_1 + b_2 i_2 + b_3 i_3)(c_1 i_1 + c_2 i_2 + c_3 i_3),$$

if $i_1 i_2 i_3 = 1$ and i_1, i_2, i_3 be symbols subject to the laws of ordinary algebra, except that $i_1^2 = i_2^2 = i_3^2 = 0$.

It is almost the same to say that $\dagger a_1 b_2 c_3 \dagger$ is the coefficient of xyz in the expansion of the product

$$(a_1 x + a_2 y + a_3 z)(b_1 x + b_2 y + b_3 z)(c_1 x + c_2 y + c_3 z).$$

Either of these propositions may be viewed as a consequence of the definition above implied, or as an alternative form of the definition.

4. Of course at the outset it is evident that from the theory of determinants there is suggested the possibility of analogous theorems regarding Permanents. As evidently, however, the number of such analogous theorems must be small: for no analogue can exist when the theorem in determinants depends upon the property of change of sign consequent upon the interchange of two rows. As an example of such analogues, we have evidently

$$\begin{aligned} \left| \begin{matrix} a_1 & b_2 & c_3 & d_4 \\ a_2 & b_1 & c_3 & d_4 \\ a_3 & b_1 & c_2 & d_4 \\ a_4 & b_1 & c_2 & d_3 \end{matrix} \right| &= \left| \begin{matrix} a_1 & b_2 & c_3 & d_4 \\ a_2 & b_1 & c_3 & d_4 \\ a_3 & b_1 & c_2 & d_4 \\ a_4 & b_1 & c_2 & d_3 \end{matrix} \right| + \left| \begin{matrix} a_1 & b_2 & c_3 & d_4 \\ a_2 & b_1 & c_2 & d_4 \\ a_3 & b_1 & c_3 & d_4 \\ a_4 & b_1 & c_2 & d_3 \end{matrix} \right| + \left| \begin{matrix} a_1 & b_2 & c_3 & d_4 \\ a_2 & b_1 & c_2 & d_4 \\ a_3 & b_1 & c_3 & d_3 \\ a_4 & b_1 & c_2 & d_4 \end{matrix} \right| + \left| \begin{matrix} a_1 & b_2 & c_3 & d_4 \\ a_2 & b_1 & c_2 & d_3 \\ a_3 & b_1 & c_3 & d_4 \\ a_4 & b_1 & c_2 & d_4 \end{matrix} \right| \\ &= \left| \begin{matrix} a_1 & b_2 \\ a_2 & b_1 \end{matrix} \right| \left| \begin{matrix} c_3 & d_4 \\ c_2 & d_3 \end{matrix} \right| + \left| \begin{matrix} a_1 & b_2 \\ a_3 & b_1 \end{matrix} \right| \left| \begin{matrix} c_3 & d_4 \\ c_2 & d_4 \end{matrix} \right| + \dots + \left| \begin{matrix} a_1 & b_2 \\ a_4 & b_1 \end{matrix} \right| \left| \begin{matrix} c_1 & d_2 \end{matrix} \right|, \end{aligned}$$

and so on throughout the whole range of Laplace's expansion-theorem.

The following, however, are properties of a different kind.

5. *The product of two Permanents of the nth order is expressible as the sum of n! Permanents of the same order.* Thus—

$$\begin{aligned} \left| \begin{matrix} a_1 & a_2 & a_3 \\ b_1 & b_2 & b_3 \\ c_1 & c_2 & c_3 \end{matrix} \right| \cdot \left| \begin{matrix} x_1 & x_2 & x_3 \\ y_1 & y_2 & y_3 \\ z_1 & z_2 & z_3 \end{matrix} \right| &= \left| \begin{matrix} a_1 x_1 & a_2 x_2 & a_3 x_3 \\ b_1 y_1 & b_2 y_2 & b_3 y_3 \\ c_1 z_1 & c_2 z_2 & c_3 z_3 \end{matrix} \right| + \left| \begin{matrix} a_1 x_1 & a_2 x_2 & a_3 x_3 \\ b_1 z_1 & b_2 z_2 & b_3 z_3 \\ c_1 y_1 & c_2 y_2 & c_3 y_3 \end{matrix} \right| \\ &+ \left| \begin{matrix} a_1 y_1 & a_2 y_2 & a_3 y_3 \\ b_1 x_1 & b_2 x_2 & b_3 x_3 \\ c_1 z_1 & c_2 z_2 & c_3 z_3 \end{matrix} \right| + \left| \begin{matrix} a_1 y_1 & a_2 y_2 & a_3 y_3 \\ b_1 z_1 & b_2 z_2 & b_3 z_3 \\ c_1 x_1 & c_2 x_2 & c_3 x_3 \end{matrix} \right| \\ &+ \left| \begin{matrix} a_1 z_1 & a_2 z_2 & a_3 z_3 \\ b_1 x_1 & b_2 x_2 & b_3 x_3 \\ c_1 y_1 & c_2 y_2 & c_3 y_3 \end{matrix} \right| + \left| \begin{matrix} a_1 z_1 & a_2 z_2 & a_3 z_3 \\ b_1 y_1 & b_2 y_2 & b_3 y_3 \\ c_1 x_1 & c_2 x_2 & c_3 x_3 \end{matrix} \right|. \end{aligned}$$

Any element of the first Permanent on the right is obtained by multiplying together the corresponding elements in the two Perma-

nents on the left; the second Permanent on the right is obtained in the same way from $\dagger a_1 b_2 c_3 \dagger$, $\dagger x_1 z_2 y_3 \dagger$; the third from $\dagger a_1 b_2 c_3 \dagger$, $\dagger y_1 x_2 z_3 \dagger$; and so on throughout the remaining possible permutations of the rows of the second Permanent on the left.

This theorem may be established as follows:—Taking the principal term of the first Permanent on the right along with the corresponding terms of the other five Permanents, we see that the sum must be

$$a_1 b_2 c_3 \Sigma(x_1 y_2 z_3),$$

that is, the product of $\dagger x_1 y_2 z_3 \dagger$ and the principal term of $\dagger a_1 b_2 c_3 \dagger$. In like manner, taking any other term of the first Permanent on the right along with the corresponding terms of the other five Permanents, we must obtain the product of $\dagger x_1 y_2 z_3 \dagger$ and the term of $\dagger a_1 b_2 c_3 \dagger$ corresponding to the said six terms. Hence, when this process is completed, we must have in all

$$\dagger a_1 b_2 c_3 \dagger \cdot \dagger x_1 y_2 z_3 \dagger.$$

6. *The product of two Determinants of the n^{th} order is expressible as an aggregate of $n!$ Permanents of the same order.* Thus—

$$\begin{aligned} \begin{vmatrix} a_1 & a_2 & a_3 \\ b_1 & b_2 & b_3 \\ c_1 & c_2 & c_3 \end{vmatrix} \cdot \begin{vmatrix} x_1 & x_2 & x_3 \\ y_1 & y_2 & y_3 \\ z_1 & z_2 & z_3 \end{vmatrix} &= \dagger \begin{vmatrix} a_1 x_1 & a_2 x_2 & a_3 x_3 \\ b_1 y_1 & b_2 y_2 & b_3 y_3 \\ c_1 z_1 & c_2 z_2 & c_3 z_3 \end{vmatrix} \dagger - \dagger \begin{vmatrix} a_1 x_1 & a_2 x_2 & a_3 x_3 \\ b_1 z_1 & b_2 z_2 & b_3 z_3 \\ c_1 y_1 & c_2 y_2 & c_3 y_3 \end{vmatrix} \dagger \\ &- \dagger \begin{vmatrix} a_1 y_1 & a_2 y_2 & a_3 y_3 \\ b_1 x_1 & b_2 x_2 & b_3 x_3 \\ c_1 z_1 & c_2 z_2 & c_3 z_3 \end{vmatrix} \dagger + \dagger \begin{vmatrix} a_1 y_1 & a_2 y_2 & a_3 y_3 \\ b_1 z_1 & b_2 z_2 & b_3 z_3 \\ c_1 x_1 & c_2 x_2 & c_3 x_3 \end{vmatrix} \dagger \\ &+ \dagger \begin{vmatrix} a_1 z_1 & a_2 z_2 & a_3 z_3 \\ b_1 x_1 & b_2 x_2 & b_3 x_3 \\ c_1 y_1 & c_2 y_2 & c_3 y_3 \end{vmatrix} \dagger - \dagger \begin{vmatrix} a_1 z_1 & a_2 z_2 & a_3 z_3 \\ b_1 y_1 & b_2 y_2 & b_3 y_3 \\ c_1 x_1 & c_2 x_2 & c_3 x_3 \end{vmatrix} \dagger. \end{aligned}$$

The mode of formation of the Permanents here is exactly the same as in § 5; the sign preceding any one of them is + or - according

as there has been in its formation an even or an odd number of interchanges in the rows of $\begin{vmatrix} x_1 & y_1 & z_1 \\ x_2 & y_2 & z_2 \\ x_3 & y_3 & z_3 \end{vmatrix}$. The proof is on the same lines as that of the former theorem.

7. *The product of a Permanent and a Determinant both of the nth order is expressible as an aggregate of n! Determinants of the same order.* Thus—

$$\begin{vmatrix} a_1 & a_2 & a_3 \\ b_1 & b_2 & b_3 \\ c_1 & c_2 & c_3 \end{vmatrix} \cdot \begin{vmatrix} x_1 & x_2 & x_3 \\ y_1 & y_2 & y_3 \\ z_1 & z_2 & z_3 \end{vmatrix} = \begin{vmatrix} a_1x_1 & a_2x_2 & a_3x_3 \\ b_1y_1 & b_2y_2 & b_3y_3 \\ c_1z_1 & c_2z_2 & c_3z_3 \end{vmatrix} - \begin{vmatrix} a_1x_1 & a_2x_2 & a_3x_3 \\ b_1z_1 & b_2z_2 & b_3z_3 \\ c_1y_1 & c_2y_2 & c_3y_3 \end{vmatrix} \\ - \begin{vmatrix} a_1y_1 & a_2y_2 & a_3y_3 \\ b_1x_1 & b_2x_2 & b_3x_3 \\ c_1z_1 & c_2z_2 & c_3z_3 \end{vmatrix} + \begin{vmatrix} a_1y_1 & a_2y_2 & a_3y_3 \\ b_1z_1 & b_2z_2 & b_3z_3 \\ c_1x_1 & c_2x_2 & c_3x_3 \end{vmatrix} \\ + \begin{vmatrix} a_1z_1 & a_2z_2 & a_3z_3 \\ b_1x_1 & b_2x_2 & b_3x_3 \\ c_1y_1 & c_2y_2 & c_3y_3 \end{vmatrix} - \begin{vmatrix} a_1z_1 & a_2z_2 & a_3z_3 \\ b_1y_1 & b_2y_2 & b_3y_3 \\ c_1x_1 & c_2x_2 & c_3x_3 \end{vmatrix}.$$

Here the Determinants on the right are formed exactly like the Permanents in §§ 5, 6, and the signs preceding them are determined exactly as in § 6.

8. The last of these three theorems is, so far as one can at present see, the most important. It leads, for example, to the following valuable application.

When the elements in the first row of the Permanent are all powers of one variable, the elements in the second row the like powers of another variable, and so on, the Permanent takes the form of a single symmetric function of the said variables, the degree of the function being given by the sum of the indices of the powers in question. Thus—

$$\begin{vmatrix} a^m & a^n & a^p \\ \beta^m & \beta^n & \beta^p \\ \gamma^m & \gamma^n & \gamma^p \end{vmatrix}$$

is the single symmetric function which we are in the habit of denoting by $\Sigma a^m \beta^n \gamma^p$.

In the like case the Determinant on the left and all the Determinants on the right take the well-known form of simple alternants.

We thus obtain a new and widely general theorem in regard to the latter functions, viz. :—*The product of a simple alternant and a single symmetric function of its variables is expressible by a sum of simple alternants, whose indices are got by arranging the variables in every term of the symmetric function in the same order, and adding the indices of each term to the indices of the original alternant, the first to the first, the second to the second, and so on.*

As an exceedingly simple instance of this we may show how to find by means of it the cofactor of

$$\begin{vmatrix} 1 & a & a^2 \\ 1 & \beta & \beta^2 \\ 1 & \gamma & \gamma^2 \end{vmatrix} \text{ in } \begin{vmatrix} 1 & a^2 & a^5 \\ 1 & \beta^2 & \beta^6 \\ 1 & \gamma^2 & \gamma^5 \end{vmatrix}.$$

Since both divisor and dividend are alternating functions, the quotient must be a symmetric function. And looking to the principal terms of divisor and dividend it is evident that $\beta\gamma^3$, and therefore $\Sigma\beta\gamma^3$, is a part of the quotient. But the product of the divisor and this part of the quotient is by the foregoing

$$\begin{vmatrix} 1 & a^2 & a^5 \\ 1 & \beta^2 & \beta^6 \\ 1 & \gamma^2 & \gamma^5 \end{vmatrix} - \begin{vmatrix} 1 & a^3 & a^4 \\ 1 & \beta^3 & \beta^4 \\ 1 & \gamma^3 & \gamma^4 \end{vmatrix} - \begin{vmatrix} a & a^2 & a^4 \\ \beta & \beta^2 & \beta^4 \\ \gamma & \gamma^2 & \gamma^4 \end{vmatrix}.$$

Subtracting this from the dividend and writing the remainder in a shorter notation, we have

$$| a^0 \beta^3 \gamma^4 | + | a^1 \beta^2 \gamma^4 |.$$

In this the divisor is, as before, seen to be contained $\beta^2 \gamma^2$ times, and therefore $\Sigma \beta^2 \gamma^2$ or $| a^0 \beta^2 \gamma^2 |$ times. Multiplying the divisor by this new portion of the quotient we obtain

$$| a^0 \beta^3 \gamma^4 | - | a^1 \beta^2 \gamma^4 |;$$

so that our new remainder is

$$2 | a^1 \beta^2 \gamma^4 |.$$

In this the divisor is evidently contained exactly $2\Sigma a\beta\gamma^2$ times. Hence the complete quotient is

$$\Sigma\beta\gamma^2 + \Sigma\beta^2\gamma^2 + 2\Sigma a\beta\gamma^2.$$

9. When the factors on the left in the theorems of §§ 5, 6, 7 are identical as to their elements, the expansions on the right become of course simpler in form, the simplification being more marked in the last of the three theorems on account of the vanishing of a determinant when two rows are identical. Thus we have

$$\begin{aligned} & \begin{vmatrix} + & & & + \\ a_1 & a_2 & a_3 & a_4 \\ b_1 & b_2 & b_3 & b_4 \\ c_1 & c_2 & c_3 & c_4 \\ d_1 & d_2 & d_3 & d_4 \end{vmatrix} \cdot \begin{vmatrix} a_1 & a_2 & a_3 & a_4 \\ b_1 & b_2 & b_3 & b_4 \\ c_1 & c_2 & c_3 & c_4 \\ d_1 & d_2 & d_3 & d_4 \end{vmatrix} \\ = & \begin{vmatrix} a_1^2 & a_2^2 & a_3^2 & a_4^2 \\ b_1^2 & b_2^2 & b_3^2 & b_4^2 \\ c_1^2 & c_2^2 & c_3^2 & c_4^2 \\ d_1^2 & d_2^2 & d_3^2 & d_4^2 \end{vmatrix} + 2 \begin{vmatrix} a_1c_1 & a_2c_2 & a_3c_3 & a_4c_4 \\ b_1a_1 & b_2a_2 & b_3a_3 & b_4a_4 \\ c_1b_1 & c_2b_2 & c_3b_3 & c_4b_4 \\ d_1^2 & d_2^2 & d_3^2 & d_4^2 \end{vmatrix} + 2 \begin{vmatrix} a_1^2 & a_2^2 & a_3^2 & a_4^2 \\ b_1d_1 & b_2d_2 & b_3d_3 & b_4d_4 \\ c_1b_1 & c_2b_2 & c_3b_3 & c_4b_4 \\ d_1c_1 & d_2c_2 & d_3c_3 & d_4c_4 \end{vmatrix} \\ & + 2 \begin{vmatrix} a_1d_1 & a_2d_2 & a_3d_3 & a_4d_4 \\ b_1a_1 & b_2a_2 & b_3a_3 & b_4a_4 \\ c_1^2 & c_2^2 & c_3^2 & c_4^2 \\ d_1b_1 & d_2b_2 & d_3b_3 & d_4b_4 \end{vmatrix} + 2 \begin{vmatrix} a_1d_1 & a_2d_2 & a_3d_3 & a_4d_4 \\ b_1^2 & b_2^2 & b_3^2 & b_4^2 \\ c_1a_1 & c_2a_2 & c_3a_3 & c_4a_4 \\ d_1c_1 & d_2c_2 & d_3c_3 & d_4c_4 \end{vmatrix} \quad (a). \end{aligned}$$

A further simplification is possible in the important case where the element in the r^{th} row and s^{th} column is $(x_r - y_s)^{-1}$. Then we have

$$\begin{aligned} & \begin{vmatrix} + & & & + \\ (x_1 - y_1)^{-1} & (x_1 - y_2)^{-1} & (x_1 - y_3)^{-1} & (x_1 - y_4)^{-1} \\ (x_2 - y_1)^{-1} & (x_2 - y_2)^{-1} & (x_2 - y_3)^{-1} & (x_2 - y_4)^{-1} \\ (x_3 - y_1)^{-1} & (x_3 - y_2)^{-1} & (x_3 - y_3)^{-1} & (x_3 - y_4)^{-1} \\ (x_4 - y_1)^{-1} & (x_4 - y_2)^{-1} & (x_4 - y_3)^{-1} & (x_4 - y_4)^{-1} \end{vmatrix} \\ & \begin{vmatrix} (x_1 - y_1)^{-1} & (x_1 - y_2)^{-1} & (x_1 - y_3)^{-1} & (x_1 - y_4)^{-1} \\ (x_2 - y_1)^{-1} & (x_2 - y_2)^{-1} & (x_2 - y_3)^{-1} & (x_2 - y_4)^{-1} \\ (x_3 - y_1)^{-1} & (x_3 - y_2)^{-1} & (x_3 - y_3)^{-1} & (x_3 - y_4)^{-1} \\ (x_4 - y_1)^{-1} & (x_4 - y_2)^{-1} & (x_4 - y_3)^{-1} & (x_4 - y_4)^{-1} \end{vmatrix} \end{aligned}$$

$$= \begin{vmatrix} (x_1 - y_1)^{-2} & (x_1 - y_2)^{-2} & (x_1 - y_3)^{-2} & (x_1 - y_4)^{-2} \\ (x_2 - y_1)^{-2} & (x_2 - y_2)^{-2} & (x_2 - y_3)^{-2} & (x_2 - y_4)^{-2} \\ (x_3 - y_1)^{-2} & (x_3 - y_2)^{-2} & (x_3 - y_3)^{-2} & (x_3 - y_4)^{-2} \\ (x_4 - y_1)^{-2} & (x_4 - y_2)^{-2} & (x_4 - y_3)^{-2} & (x_4 - y_4)^{-2} \end{vmatrix} \dots (\beta),$$

the four other determinants on the right being equal to zero. For example, the first of the four

$$= \begin{vmatrix} (x_1 - y_1)^{-1}(x_3 - y_1)^{-1} & (x_1 - y_2)^{-1}(x_3 - y_2)^{-1} & \cdot & \cdot \\ (x_2 - y_1)^{-1}(x_1 - y_1)^{-1} & (x_2 - y_2)^{-1}(x_1 - y_2)^{-1} & \cdot & \cdot \\ (x_3 - y_1)^{-1}(x_2 - y_1)^{-1} & (x_3 - y_2)^{-1}(x_2 - y_2)^{-1} & \cdot & \cdot \\ (x_4 - y_1)^{-1}(x_4 - y_1)^{-1} & (x_4 - y_2)^{-1}(x_4 - y_2)^{-1} & \cdot & \cdot \end{vmatrix}$$

from which, if we remove the factor

$$\begin{aligned} & (x_1 - y_1)^{-1}(x_2 - y_1)^{-1}(x_3 - y_1)^{-1}(x_4 - y_1)^{-1} \\ & \times (x_1 - y_2)^{-1}(x_2 - y_2)^{-1}(x_3 - y_2)^{-1}(x_4 - y_2)^{-1} \\ & \times (x_1 - y_3)^{-1}(x_2 - y_3)^{-1}(x_3 - y_3)^{-1}(x_4 - y_3)^{-1} \\ & \times (x_1 - y_4)^{-1}(x_2 - y_4)^{-1}(x_3 - y_4)^{-1}(x_4 - y_4)^{-1} \end{aligned}$$

there remains the cofactor

$$\begin{vmatrix} (x_2 - y_1)(x_4 - y_1) & (x_2 - y_2)(x_4 - y_2) & \cdot & \cdot \\ (x_3 - y_1)(x_4 - y_1) & (x_3 - y_2)(x_4 - y_2) & \cdot & \cdot \\ (x_1 - y_1)(x_4 - y_1) & (x_1 - y_2)(x_4 - y_2) & \cdot & \cdot \\ \cdot & \cdot & \cdot & \cdot \end{vmatrix}.$$

Diminishing each element of the first row in this by the corresponding element of the second row, and each element of the second by the corresponding element of the third, we can remove the factors $x_2 - x_3$, $x_3 - x_1$, and have resulting a determinant with its first two rows identical.

(β) is the well-known theorem of Borchardt* regarding double alternants.

10. The case of (α) for the 3rd order, which was first given by Cayley,† is worthy of a little special attention, on account of a

* *Orell's Journal*, liii. p. 194.

† *Ibid.*, lvi. p. 184.

simple deduction which can be made from it. The number of determinants on the right is then only two. Taking the reciprocals of a, b, c, \dots for the elements of the factors on the left we have

$$\begin{vmatrix} \frac{1}{a} & \frac{1}{b} & \frac{1}{c} \\ \frac{1}{d} & \frac{1}{e} & \frac{1}{f} \\ \frac{1}{g} & \frac{1}{h} & \frac{1}{k} \end{vmatrix} \cdot \begin{vmatrix} \frac{1}{a} & \frac{1}{b} & \frac{1}{c} \\ \frac{1}{d} & \frac{1}{e} & \frac{1}{f} \\ \frac{1}{g} & \frac{1}{h} & \frac{1}{k} \end{vmatrix} = \begin{vmatrix} \frac{1}{a^2} & \frac{1}{b^2} & \frac{1}{c^2} \\ \frac{1}{d^2} & \frac{1}{e^2} & \frac{1}{f^2} \\ \frac{1}{g^2} & \frac{1}{h^2} & \frac{1}{k^2} \end{vmatrix} + 2 \begin{vmatrix} \frac{1}{ag} & \frac{1}{bh} & \frac{1}{ck} \\ \frac{1}{da} & \frac{1}{eb} & \frac{1}{fc} \\ \frac{1}{gd} & \frac{1}{he} & \frac{1}{kf} \end{vmatrix}$$

The last determinant here, however,

$$= (abcdefghk)^{-1} \begin{vmatrix} d & e & f \\ g & h & k \\ a & b & c \end{vmatrix}$$

So that if any determinant of the third order with non-zero elements vanishes identically, the product of the Permanent and Determinant whose elements are the reciprocals of the elements of the said determinant is equal to the determinant whose elements are the squares of these reciprocals. For example, we have identically

$$\begin{vmatrix} a & a+d & a+2d \\ a+3d & a+4d & a+5d \\ a+6d & a+7d & a+8d \end{vmatrix} = 0;$$

hence

$$\begin{vmatrix} a^{-1} & (a+d)^{-1} & (a+2d)^{-1} \\ (a+3d)^{-1} & (a+4d)^{-1} & (a+5d)^{-1} \\ (a+6d)^{-1} & (a+7d)^{-1} & (a+8d)^{-1} \end{vmatrix} \cdot \begin{vmatrix} a^{-1} & (a+d)^{-1} & (a+2d)^{-1} \\ (a+3d)^{-1} & (a+4d)^{-1} & (a+5d)^{-1} \\ (a+6d)^{-1} & (a+7d)^{-1} & (a+8d)^{-1} \end{vmatrix} \\ = \begin{vmatrix} a^{-2} & (a+d)^{-2} & (a+2d)^{-2} \\ (a+3d)^{-2} & (a+4d)^{-2} & (a+5d)^{-2} \\ (a+6d)^{-2} & (a+7d)^{-2} & (a+8d)^{-2} \end{vmatrix}.$$

11. As the interchange of rows and columns has no effect either in Permanents or Determinants, it is evident that we may have more than one form for the developments in §§ 5, 6, 7. From the

equating of such equivalent forms interesting identities arise, and this is especially true of the case we have considered where the Determinants take the form of alternants.

12. It has only to be added, in conclusion, that there seems to be no easy way of simplifying a Permanent so as to find its value for particular values of the elements. The second alternative definition given in § 3 is, however, sometimes useful for this purpose, viz., when it is possible to find the coefficient of xyz in the product by other means. A most curious instance is that of the Permanent

$$\begin{vmatrix} + & & & & + \\ 2 \cos \frac{2\pi}{2n+1} & 2 \cos \frac{2 \cdot 2\pi}{2n+1} & \dots & 2 \cos \frac{n \cdot 2\pi}{2n+1} & \\ & 2 \cos \frac{2 \cdot 2\pi}{2n+1} & 2 \cos \frac{4 \cdot 2\pi}{2n+1} & \dots & 2 \cos \frac{2n \cdot 2\pi}{2n+1} \\ & \dots & \dots & \dots & \\ & 2 \cos \frac{n \cdot 2\pi}{2n+1} & 2 \cos \frac{2 \cdot n \cdot 2\pi}{2n+1} & \dots & 2 \cos \frac{n^2 \cdot 2\pi}{2n+1} \\ - & & & & - \end{vmatrix}$$

or

$$\begin{vmatrix} + & & & & + \\ 2 \cos \frac{1 \cdot 1 \cdot 2\pi}{2n+1} & 2 \cos \frac{2 \cdot 2 \cdot 2\pi}{2n+1} & \dots & \dots & 2 \cos \frac{n \cdot n \cdot 2\pi}{2n+1} \\ - & & & & - \end{vmatrix}$$

which in this way we know must be equal to -1 for odd values of n .

5. Optical Notes. By Professor Tait.

1. On a Singular Phenomena produced by some old Window-Panes.

The second figure in Professor Everett's note (*ante*, p. 360) has reminded me of my explanation of a phenomenon which I have repeatedly seen for more than twenty years in the College. When sunlight enters my apparatus-room through a vertical chink between the edge of the blind and the window-frame, the line of light formed on the wall or floor shows a well-marked *kink*. Similar phenomena, though not usually so well marked, are often seen in old houses, when the sun shines through the chinks of a Venetian blind. They are obviously due to inequalities (*bull's-eyes*) in the glass which was used more than a generation ago for window-panes. Professor Everett's figure, which was drawn for a cylindrical lens,

represents the general form of a central section of such a bull's-eye. It is evident that the focal length of successive annuli of such a piece of glass, treated as a lens, increases from the central portion to the circumference, where it becomes infinite. For an approximate study of its behaviour we may assume that the focal length of an annulus of radius r is $b^2/(a-r)$, where a is the extreme radius, at which the sides of the pane become parallel. Suppose sunlight, passing through a narrow slit, to fall on such a lens at a distance e from its centre, and to be received on a screen at a distance c from the lens. It is easy to see that the polar equation of the illuminated curve on the screen is (the pole being in the axis of the lens)

$$\rho = -\frac{e \sec \theta}{l^2}(ac - b^2 - ce \sec \theta).$$

This curve can be readily traced by points for various values of the constants. In fact, if r be the radius vector of a straight line, the vector of any one of these curves (drawn in the same direction) is proportional to $r(A-r)$, and the curve can therefore be constructed from a straight line and a circle. Here the value of A is $(ac - b^2)/c$; i.e., it is a fourth proportional to c , a , and the distance of the screen from the focus of the central portion of the lens. When A is small compared with the least value of r , the curve has a point resembling a cusp, but as A increases the kink appears. This is easily observed by gradually increasing the distance of the screen from the lens; and the traced curves present forms which are precisely of the general character of those observed.

2. On the Nature of the Vibrations in Common Light.

One of the few really unsatisfactory passages in Airy's well-known "Tract" on the *Undulatory Theory of Optics* is that which discusses the nature of common light. To explain the production of Newton's rings in homogeneous light to the number of several thousands, it is necessary that at least several thousand successive waves should be almost exactly similar to one another. On the other hand, we cannot suppose the vibrations (which will in general be elliptic) to be similar to one another for more than a small fraction of a second; if they were so, we should see colour pheno-

mena in doubly refracting plates by the aid of an analysing Nicol only.

And, moreover, the nature of the vibration can have no *periodic* changes of a kind whose period amounts to a moderate fraction of a second. Nor can it have a slow *progressive* change. Either of these would lead to its resolution into rays of *different* wave-lengths. Airy suggests, as consistent with observation, some thousand waves polarized in one plane followed by a similar number polarized in a plane at right angles to the first. But no physical reason can be assigned for such an hypothesis.

The difficulty, however, disappears if we consider the question from the modern statistical point of view, as it is applied for instance in the kinetic theory of gases. We may consider first a *space* average taken for the result due to each separate vibrating particle near the surface of a luminous body. When we remember that, for homogeneous light, of mean wave-length, a million vibrations occupy only about one five hundred millionth of a second; it is easy to see that the resultant vibration at any point may not sensibly vary for a million or so of successive waves, though the contributions from individual particles may very greatly change. But when we consider the *time average* of about a hundred millions of groups of a million waves each, all entering the eye so as to be simultaneously perceptible,—in consequence of the duration of visual impressions,—we see that the chances in favour of a deviation from apparently absolute uniformity are so large that, though possible, such uniformity is not to be expected for more than a very small fraction of a second. The improbability of its occurrence for a single second is of the same nature as that of the possible, but never realised, momentary occurrence of a cubic inch of the air in a room filled with oxygen or with nitrogen alone.

[*Added; May 1, 1882.*—I am indebted to Professor Stokes for a reference to his paper "On the Composition and Resolution of Streams of Polarized Light from Different Sources" (*Camb. Phil. Trans.*, 1852), in which the nature of common light is very fully investigated. I find I was not singular in my ignorance of the contents of this paper, as the subject has quite recently been proposed as a Prize Question by a foreign society.]

PRIVATE BUSINESS.

The Society adopted the amendment of Law XIV. proposed by Professor Crum Brown, and decided that in that law the words *December to July* shall be substituted for the words *November to June*.

Mr. Sang moved the addition to Law XIV. of the following words:—"Excepting when there are five Mondays in January, in which case the meetings shall be held on the third and fourth Mondays of that month."

Mr. D. B. Dott and Dr. James Clerk Rattray were balloted for, and declared duly elected Fellows of the Society.

Monday, 30th January 1882.

EMERITUS PROFESSOR BALFOUR, Vice-President,
in the Chair.

The Chairman referred in feeling terms to the great loss sustained by the Society in the death of Sir Robert Christison, late President of the Society.

The Right Hon. the Earl of Rosebery was admitted a Fellow of the Society.

1. The Historic Evidence for the Destruction of Pompeii and Herculaneum. By the Rev. Dr. Cazenove.

(An Address given at the request of the Council.)

It will conduce to clearness if, before making any remarks, I take the liberty of reproducing the title of this address in a slightly enlarged form. In order to convey a precise idea of my object, it will be desirable to frame it thus:—

"On the Evidence (prior to the Excavations commenced in A.D. 1755) for the Destruction of Pompeii and Herculaneum by the Eruption of Vesuvius in A.D. 79."

It will be seen from this way of putting the case, that I propose to confine my attention to documentary evidence. The reference to Vesuvius is also important, because it might conceivably be maintained, and indeed it has been maintained within the present century, that these cities were destroyed by other agencies, and not by the outburst of the neighbouring volcano.

The inquiry, which I propose to enter upon this evening, appears to me to be interesting in itself, and also to possess some importance in its relation to at least one problem connected with the general study of historic evidence. I am very sensible of the honour conferred by the Council of the Royal Society in inviting me to lay the case before you, and also of its courtesy in according me such ample time for its statement. Allow me to express the hope that this generous confidence may not prove to have been misplaced.

A large part of my paper must be occupied with questions on which there is fair room for considerable difference of opinion. On these points, while offering my own view, I am very far from wishing to dogmatise. On the contrary, I not only expect, but I desire to be listened to in a free and critical spirit; and I trust that I shall not be found to encounter opposing theories in the spirit of that disputant who is reported to have said, "I am perfectly open to conviction, but show me the man who can convince me."

Before diverging into paths confessedly obscure, it is necessary to take our stand for a moment upon ground which is recognised as firm and clear. Accordingly, I start from the enunciation of a statement, for which I may fairly claim a general and undisputed acceptance. It is this:—

"The cities of Pompeii and of Herculaneum were overwhelmed by masses of volcanic matter poured forth from Mount Vesuvius in an eruption, which took place in A.D. 79."

The evidence on which this assertion *now* rests does not require any detailed examination. I am probably by no means the only person here present who has enjoyed the good fortune of visiting the remarkable ruins of these cities. In our days of cheap and rapid locomotion, it is in the power of numbers to travel to the sunny land and to gaze upon these disinterred remains. A comparison of the information thus obtained with that derived from the records of antiquity amounts to a virtual demonstration. Those who prefer the less troublesome, but less direct proof gained by study, may find ample accounts of the matter in any good *Encyclopædia*, or in hand-books for travellers to Southern Italy. A more lavish expenditure will enable them to purchase volumes richly illustrated with pictures of the works of art discovered in the buried cities. The arguments of Signor Lippi in 1816, to the effect that water without any igneous

eruption was the agent of destruction, have been fully answered by men of science ; and the real nature of the catastrophe has been impressed upon the public imagination through the popular work of fiction by the late Lord Lytton, entitled *The Last Days of Pompeii*.

But I am concerned to-night with the *written* evidence alone. That evidence, happily for my audience, is not overwhelming in bulk. Nor is it conflicting in its character. Further, it has not been thus far entangled with prepossessions arising out of any such controversy, religious, political, or even literary or scientific, as sometimes evokes the passions and obscures the judgment.

Is there, then, it may be asked, any difficulty in fairly weighing this evidence? I answer, "Yes ; there is a difficulty,—a difficulty very real and very considerable ; and one that assuredly is in nowise diminished by the circumstance that it is for the most part unacknowledged and unfelt." Herein it lies, that students of the records still extant approach them with an unconscious bias. While the eye wanders over the page, the mind's eye is busily employed elsewhere. It recalls the unearthed tombs and pillars of Pompeii, or the torch-lit recesses of Herculaneum, as known to it through actual vision or else by picture and photograph. The dry light, on which Bacon lays such stress, is tinted by coloured glasses ; and numbers, I am convinced, read information *into* these documents, and afterwards persuade themselves and others that they obtained it *out of* the documents. They arrive, indeed, at conclusions which in the main are just ; but they are mistaken as regards the ground of their inferences. I may, of course, be told that such a condition of affairs is often inevitable ; that multitudes of men will be found, on a vast variety of subjects, to be right in their conclusions, but wrong in their apprehension of the means by which they reached them. Be it so ; but, however capable of palliation may be such a mental condition in the case of the many, it certainly is not one which deserves to be cherished among educated men.

Is there any peril lying in a contrary direction to that which has just been indicated? Certainly there is. It is conceivable that a student of the evidence in question may have been so much struck by the carelessness and unconscious prejudice of ordinary critics as to rush into an opposite extreme, and to minimise the importance and definiteness of information which it really does afford. This

danger may be enhanced, if he has been deeply impressed by the force of observations of such a tendency which have proceeded from the pen of any single vigorous and competent author.

Let me at once confess that this last named extreme is the one into which I feel that I am most liable to fall. It is possible that I may have allowed myself to be unduly influenced by the following comment of Sir Charles Lyell, in his well-known work entitled *Principles of Geology* (vol. ii. bk. ii. part 2, chap. ii.) :—“ We have no hesitation in saying, that had the buried cities never been discovered, the accounts transmitted to us of their tragical end would have been discredited by the majority, so vague and general are the narratives, or so long subsequent to the event ” (2nd edit.).

I have read these words in the form in which they have long been known to me. But it is right to reproduce them in the slightly modified shape in which they are given by their author in the latest edition of his work :—“ It is worthy, however, of remark, that had the buried cities never been discovered, the accounts transmitted to us by their tragical end *might well have been* discredited by the majority, so vague and general are the narratives, or so long subsequent to the event ” (ed. 12th, 1875).

How far would such unbelief have been reasonable? This is the question which I desire to submit to the present assembly. We hear judges imploring juries (with what success I know not) to banish from their minds all extraneous considerations, and listen to the evidence alone. With a similar request, I proceed to summon the witnesses in the case before us.

They belong to a band of men of considerable eminence in literature ; some of them coming near the highest rank, some perhaps actually attaining it. I mention them in the order in which I propose to call them. They are as follows:—the poet Martial ; the biographer and philosopher, Plutarch ; the poet Statius ; the historians Tacitus, Josephus, Suetonius ; and the letter-writer, the younger Pliny. These are all in the strictest sense of the words contemporary witnesses, having been in A.D. 79, some 1800 years ago, all young men, or in the prime of life. Seneca, who might have proved useful to us, had been put to death by Nero sixteen years earlier, in A.D. 63 ; and the elder Pliny, the naturalist, who would probably have saved us from all trouble in the matter, perished, as I shall have

occasion to remind my audience at a later point, in the actual conflagration that ensued. Other distinguished contemporaries, who have preserved a total silence on the subject, such as Juvenal and Epictetus, I of course pass over. One non-contemporary historian must be reserved for a later stage in the investigation.

1. To begin then with Martial. Born in A.D. 43, he must have been in his thirty-sixth year at the time when the eruption took place. He has left behind him epigrams to the number of 1523; of which the majority might have been spared with advantage to his reputation, both moral and poetical. To the subject before us he has dedicated one composition only. It is to be found in book iv. No. 44 (or, as some editions seem to make it, 43). It consists of six lines, and bears the title *On Mount Vesuvius*. The word Vesuvius, let me observe in passing, though employed by Latin prose writers, as, e.g., the younger Pliny, cannot be brought into Latin verse, because all its syllables are short. Accordingly we find the forms Vesevus (Virgil), Vesbius or Vesvius, with the adjective Vesuvinus* (Stattius), and in Greek, τὸ βέσβιον ὄρος. It is almost needless to observe, that Romans, especially in the lower classes, seem to have identified the sounds represented by the letters *b* and *v*, as do the Spaniards of the present day.†

The gist of the epigram is, that Campania had been a smiling region, dearer to some deities than seats which they were supposed specially to affect; but that these same divinities have reduced it all to ashes.

I have found a fairly correct versified translation in a book of the last century.‡ It runs thus:—

Here verdant vines oppress'd Vesuvio's sides ;
The generous grape here pour'd her purple tides.
This Bacchus lov'd beyond his native scene [*i. e.* Nysa] ;
Here dancing satyrs joy'd to trip the green.
Far more than Sparta this in Venus' grace ;
And great Alcides once renown'd the place ;
Now flaming embers spread dire waste around,
And gods regret that gods can thus confound.

* Jamque et flere pio Vesuvina incendia cantu Mens erat.—Stattius, *Silvæ*, lib. v. carm. iii. 205, 6.

† The illiterate often wrote *Bia Noba* for *Via Nova*. We usually speak of Sebastopol; our regiments have, I believe, Sevastopol.

‡ In a note to Melmoth's translation of Pliny's *Letters*.

Only the two last lines are of much importance. They stand in the original as follows :—

Cuncta jacent flammis et tristi mersa favillâ,
Nec superi vellent hoc licuisse sibi.

Now I trust that I shall have the court entirely with me, when I maintain that in these lines the evidence for the overthrow of Pompeii and Herculaneum is simply *nil*. Ruin of a rural district is there; of loss of human life, of buried cities, there is not so much as a hint. Indeed, so far as it goes, it might be plausibly argued, if Martial were our only witness, that such a destruction could not have taken place; for that, if it had occurred, he would have surely made at least some passing allusion to an event so startling and remarkable.

2. Lyell refers to the *narratives* of the event. The next two pieces of evidence, in my opinion by far the strongest among the contemporary ones, are *not* narratives. These are those of Plutarch and of Statius. And first as regards Plutarch.

His name has been immortalised by his famous parallel biographies of Greeks and Romans,—a book which has charmed many eminent men in various generations; to which Milton, and still more Shakespeare, were largely indebted, and which has been perhaps a more important factor in the formation of modern thought and character than has always been recognised. But Plutarch was also a moralist and a philosopher; a light in which he has been justly represented in a pleasant little volume by Dr. Trench, the Archbishop of Dublin.

Among his treatises is one generally known by its Latin title, *De serâ numinis vindictâ*. It is highly theological, and might almost be called an essay, from a heathen's standpoint, on at least one half of the second commandment. Two theologians of this century, in most opposite camps, the ultramontane Count Joseph De Maistre, and a Lutheran convert from Judaism, the historian Neander, used to derive consolation from its pages during the years when the power of the first Napoleon was at its zenith. De Maistre translated it into French.* Another treatise of Plutarch's pen discusses the question, why the Pythian priestess no longer, as formerly, delivers the oracles in verse (*περὶ τοῦ μὴ χρᾶν ἕμμετρα νῦν τὴν πυθίαν*).

* For the references to De Maistre and Neander, I am indebted to the above-mentioned work of Archbishop Trench.

Reiske assigns this latter treatise, on reasonable grounds of probability, to A.D. 80-90, when the author was between 30 and 40.

Plutarch has written strongly against superstition. I suspect that the Epicureans of his day must have considered many of his treatises, and these two among them, to be replete with superstition. It will be time for us to find fault with his inconsistency, when we have quite agreed among ourselves where *we* draw the line of demarcation between true religion and superstition.

In both of these essays Plutarch makes reference to the subject now before us. As a Greek, though a travelled Greek, he calls the districts by the names most familiar to him, viz., the parts about Cumé and Dicæarchia. This need not surprise us. We say of such an one that he is a native of Germany, and the French tell us that he comes from Allemagne,—neither pausing to reflect that the gentleman would himself call his native country *Deutschland*.

Plutarch's reference in the more elaborate and better known treatise, the one on Divine Chastisements, is of the briefest. He relates that a man heard the voice of a Sibyl in the moon singing certain prophecies, among which was that concerning Mount Vesuvius and Dicæarchia. But in the other treatise, which is in the form of a dialogue, he makes one of the speakers claim it as a proof of the real prophetic power of the Sibyl, that she had distinctly foretold the coming catastrophe. His words translated run thus:—"These recent and strange calamities of the region around Cumé and Dicæarchia, hymned long ago and sung in the Sibylline verses, time, as if paying a debt, has issued forth; outbursts of mountain fire, seethings of ocean, heavings up of rocks and of burning masses by the violence of the wind, and *withal a destruction of so many and so great cities*, that men, who subsequently came to the spot, were reduced to a state of uncertainty and ignorance respecting their own dwelling-place, as the region was in a state of entire confusion. The occurrence of such events is difficult to credit; prediction of them could not possibly have been made without divine assistance."

3. Thus far Plutarch. His testimony, important and weighty as it is, may, I fancy, be considered less cogent than that of the next witness I have to summon, namely, the poet Statius. Of the life of this writer we are exceedingly ignorant. He was a native of Neapolis, probably somewhat senior to the younger Pliny, who tells us that he

was in his eighteenth year at the time of the eruption. The part of the works of Statius which concerns us is known not to have been composed earlier than A.D. 59, sixteen years after the event. Passing over two casual allusions, one of which does intimate loss of life among high-born families, I turn to the fourth epistle of the fourth book of a collection of poems, entitled *The Woods (Sylvæ)*; a set of compositions which, though thrown off in haste and regarded by their author as trifles, have been pronounced by an excellent judge, the late Professor Ramsay of the University of Glasgow, to be far more pleasing than his completed epic the *Thebais*, and his incomplete one, the *Achilleis*. The lines (78–86) present scarcely any difficulty, and I offer the following prose rendering. They are addressed to a friend of the poet named *Victorius Marcellus*; and the region is called Chalcidian, because it was believed to have been colonised by emigrants from Chalcis, in Eubœa. Two other spots mentioned in these verses, namely, Teate (now Chieti) and the Marrucinian mountains, were on the eastern side of Italy, at least 70 miles from the volcano.

“Such are the strains which I pour forth to thee, Marcellus, from these Chalcidian shores, where Vesuvius has enacted his shattering deeds of wrath, kindling a conflagration that rivals the flames of Etna. A marvellous demand on faith [for so I venture to paraphrase the words *mira fides* !]. Will future generations of men believe, when crops are again flourishing and these deserted spots are green, that cities and populations lie buried beneath (*infra urbes populosque premi*), and that ancestral fields have vanished in mid-ocean? not even yet does the mountain's crest refrain from deadly threats: far from thy Teate be such a fate, and may this fury never reach the Marrucinian mountains.”

Hæc ego Chalcidicis, ad te, Marcelle, sonabam
Littoribus, fractas ubi Vesbius egerit iras,
Æmula Trinacriis volvens incendia flammis.
Mira fides! credetne virum ventura propago,
Cum segetes iterum, cum jam hæc deserta virebunt,
Infra urbes populosque premi, proavitaque toto
Rura abiisse mari! necdum letale minari
Cessat apex: procul ista tuo sint fata Teate,
Nec Marrucinos agat hæc insania montes.

Sylvæ, lib. iv. carm. iv. 78–86.*

* Dean Merivale calls attention to the other allusions made by Statius to a subject “peculiarly interesting to him as a native of Neapolis.” They also

These are certainly remarkable verses. The poet tells us, some eight lines before this passage, that he is tending towards old age (*vergimur in senium*). Our idea of what old age means has been greatly altered, I believe, during the three last centuries. But Statius seems to have enjoyed the fulfilment of the wish of a great English poet, who desired to live

Till old experience do attain
To something like prophetic strain.

The unbelief foretold by Statius did actually arise. To say nothing for the moment of Lyell, even so late as 1816, an Italian geologist, Signor Lippi (as I have already observed), entirely denied that the two cities had been destroyed by the action of Vesuvius. In this connection it must be remarked, that the allusion to Sicilian flames is not without some measure of significance. For the serious character of the eruptions of Etna was well known. Unlike Vesuvius, which had been quiet for many centuries, and which (singularly enough) was not included by Pliny in his list of active volcanoes, Etna had an alarming reputation. Thucydides, in the last chapter of the third book of his history, refers to three eruptions of Etna within the memory of man, and specifies one as having happened in his own day,—in B.C. 425; which, he tells us, greatly damaged the property of the people of Catana (now Catania). An eruption which happened fifty years earlier seems to be referred to by the poet Pindar in his first Pythian ode, and by Æschylus, in his *Prometheus Bound*. The volcanic wrath of Etna is also recognised by Virgil and by Lucretius.

But at this point, a sceptical critic, such as Lyell seems to imagine, might naturally enough make a request for something more. He might, I conceive, plausibly argue as follows:—"For an event which is *à priori* improbable, we demand evidence of *extra* clearness and cogency. This principle is based upon common sense and the experience of life. It is admitted by men of science—it is constantly implied and acted upon in our law courts. Now you are asking me to accept as true a very unheard-of event, and so far what have you produced? A poet, occur in the *Sylva* (lib. v. carm. iii. 305; lib. iv. carm. viii. 4). In the last named passage the poet congratulates Julius Menecrates on the birth of a third child:—

"clari genus ecce Menecratis auget
Tertia jam soboles: procerum tibi nobile vulgus
Crescit, et insani solatur damna Vesuvi."

who only speaks of the eruption; a moralist, or rather a theologian, who seems anxious to prove the correctness of the Sibyl, as a prophetess.* Very excellent and able men are sometimes in such cases inclined to see what they wish to see; and to exaggerate, even when they do not actually invent. Then comes another witness. Statius may not be untruthful, but poetic licence has passed into a proverb, and a few houses with their inhabitants may have been exaggerated into 'cities and peoples.' Surely I may fairly ask for more distinctness in point of date; above all, *I have a right to demand some plain historical contemporary narrative, which may supply us not only with the date of the event, but also with the names of the buried cities.*"

How far can these demands be satisfied? This will be seen, when as we pass on to the grave historians of the period.

4. The first whom I adduce is indeed one of lofty renown, *Cornelius Tacitus*. In the production of brief lightning-like phrases for the expression of the bitterest scorn or of the deepest pathos, Tacitus is unsurpassed, I had almost said unrivalled. It must suffice, in passing, to remind you of his description of the world beyond the grave as the home "where fierce indignation can no longer lacerate the heart" (*ubi sæva indignatio cor ulterius lacerare nequit*), or his description of his father-in-law Agricola, hoping on his death-bed to meet the countenance of his daughter and her husband Tacitus: "And in thy latest glance thine eyes looked longingly for something" (*et in novissimâ luce aliquid desideravere oculi tui*; an expression for which a famous master of fiction thanked Rogers, though surely Rogers must have first borrowed it from this earlier source.†

But in the power of simple and lucid narrative, of a plain statement of plain facts, Tacitus is by no means equally pre-eminent. The case before us needed such a narrative. What do we actually

* It is true that Plutarch introduces an objector, but the tendency of the treatise appears to me to be unmistakably in the direction of belief in the Sibylline predictions.

† "For a beautiful thought in the last chapter but one of *The Old Curiosity Shop*, I am indebted to Mr Rogers. It is taken from his charming tale *Genevra*.

"And long might'st thou have seen
An old man wandering as in quest of something—
Something he could not find—he knew not what."

Charles Dickens, Preface to *Barnaby Rudge*, in
Master Humphrey's Clock, vol. iii. (ed. 1841).

find? The historian was about nineteen years of age when the catastrophe took place, and he doubtless intended to leave us a full and detailed record of the event. This intention, however, was not carried out. In the prefatory chapter of his *Historiæ*, which were meant to embrace a period of some one-and-twenty years, beginning with the accession of Galba in A.D. 68, our author describes this era as one which, in the conversational language of our day, might be described as abounding in sensational events (*opimum casibus*). The assassinations, the wars civil and foreign, with other startling casualties, are briefly summed up; and amidst them we come upon the following sentence,—“*Haustæ aut obrutæ urbes fecundissimæ Campaniæ orâ*” (lib. i. cap. 2).

My own rendering of these words would be as follows:—“Cities in the most fertile district of Campania were engulfed or overwhelmed.” The date is left uncertain; and if I might venture for a moment to regard Vesuvius in the light of a culprit, I can see nothing in the language of Tacitus, as it has come down to us, to connect the accused with the destruction of the unnamed cities to which the historian refers. I submit that the term *obrutæ* (overwhelmed) might naturally be supposed to indicate an inundation or a landslip. The preceding participle is somewhat less clear. *Haurio* primarily means to draw; and as the water thus obtained from a well, or the wine from a cask, may be drunk, the verb acquires in a secondary sense the significations to *drink in*, to *imbibe*, to *engulf*, or *swallow up*. Thence it may be applied to the effect of an earthquake, and we find it so employed in the works of the elder Pliny: “*hauriri urbes terræ hiatusibus*, that cities were swallowed up by gapings of the earth.” Pompeii had suffered terribly from an earthquake in A.D. 63. This we learn from an earlier work of Tacitus, the *Annals* (xv. 22):—“A notable city of Campania, Pompeii, was to a great extent overthrown by an earthquake. *Motû terræ celebre Campaniæ oppidum Pompeii magnâ ex parte proruit.*” Indeed Seneca, though dating the event one year later, heard that it had settled down (*desedisse*), and, I presume, actually disappeared. This was an exaggeration; but what had *almost* happened, in A.D. 63, might really have come to pass some sixteen years later.

I am bound to confess that very high authority *appears* to be against me as regards the evidence of Tacitus. That Lipsius, in his notes

on the passage, should connect the calamity with the eruption of Vesuvius is, with our present knowledge, almost a matter of course. But an admirable scholar and distinguished historian, the present Dean of Ely, seems to go somewhat further (*Romans under the Empire*, ed. 1876, chap. lx. p. 308, note 2), and writes thus,—“*Haustæ aut obrutæ urbes*,” “in the one case swallowed up in streams of lava, in the other overwhelmed by showers of ashes.” If Dr Merivale means that these were the thoughts in the mind of Tacitus, and that contemporaries may possibly have so understood him, I am perfectly willing to admit it. But if I am asked to recognise this as the natural and obvious interpretation of the passage as it stands, I must (while fully conscious of my boldness in so doing) venture to express a respectful dissent. The “streams of lava” and the “showers of ashes” seem to me to be read *into* the page of Tacitus, but not by any grammatical or linguistic process to be fairly deducible from it.

5. The two next witnesses, Josephus and Suetonius, need not detain us long. The Jewish historian, in the twentieth book of his *Antiquities* (cap. vii. § 2, ed. Richter), informs us that Drusilla, of whom we read in the Acts of the Apostles, was induced, through the influence of Simon Magus, to desert her husband Azizus, king of Emesa, and marry the Roman governor of Judæa, Felix. From this marriage was born a son, whom his mother called Agrippa. Josephus then adds:—“How this young man with his wife disappeared at the time of the conflagration of mount Vesuvius, in the reign of the Emperor Titus, I will explain hereafter.” Like Tacitus, he left his promise unfulfilled. But of all my witnesses this is the first who has spoken at all definitely in regard to the *date* of the eruption. For as the reign of Titus lasted only two years and two months, the time is hereby brought within a narrow limit. Further, the announcement that persons of high social position disappeared in connection with the eruption, suggests, as a natural inference, that many of humbler rank and of the slaves may have perished likewise. For a youthful couple of the station occupied by Agrippa and his wife would have the best chance of escape afforded them. I am not, of course, forgetting that great loss of life is implied in the language of Statius, Plutarch, and Tacitus. But their statements are in this respect vague and general.

6. Suetonius is also brief, but somewhat more explicit. Among the sad events of the brief reign of Titus, he enumerates the *conflagratio Vesuvi montis in Campania*, and proceeds to praise the not merely princely, but even parental solicitude displayed by the emperor towards the sufferers by this, as by other calamities. "He chose by lot from the list of men of consular dignity *Curatores* for the restoration of Campania. The goods of those who perished on Vesuvius, but left no heirs, he assigned to the restoration of the damaged cities (*restitutioni afflictarum civitatum*)." This language also gives the reign of Titus, and distinctly connects with the eruption damage done to some unnamed cities. But so far as this biographer of the Cæsars is our guide, the cities have been damaged only. Who would have supposed that they had been swallowed up or overwhelmed?

7. It is high time to come to the last contemporary witness on my list. I have mentioned in conversation to at least a dozen scholars the unsatisfactory character of the evidence for the destruction of Pompeii and of Herculaneum by Vesuvius, and they have one and all replied:—"Surely, Pliny has told us all about it." About what? I am compelled to ask. About the death of his uncle, about the destruction of the small town of Stabiae, about his misgivings respecting his conduct in not accompanying his uncle, about his devoted care for the safety of his mother, about his feelings during the escape? *Yes*. About the destruction of these two considerable cities? *No*. The two letters, which the younger Pliny wrote at the request of Tacitus, occupy in ordinary editions some six pages. But there is only one sentence which contains so much as a reference to the overthrow of Herculaneum and Pompeii; and even that sentence is expressed in terms of a most vague and general character.

Now in such a case it is easy, through the influence of a conscious or unconscious bias, to warp an author's words, and make a translation serve the purpose of a commentary. Distrustful of myself, I appealed to a brother Fellow of this Royal Society, one whose authority will be recognised far beyond the limits of these walls or even of Scotland, the Professor of Humanity in the University of Edinburgh. The kindly interest evinced by Professor Sellar in the matter induced me to ask his opinion on so many other points, that I almost began to fear that he would wish the cities re-buried. On

every point but one I have found my own judgment confirmed by his, and I now read with entire acceptance the Professor's version of the particular sentence in question :—" For although he perished by a memorable casualty, like cities and their populations, in a calamity which overtook the most beautiful regions, and is thus destined, as it were, to live for ever ; though too he himself was the author of very many works which the world will not allow to die ; yet the continued existence of his writings will be more ensured by the immortality which awaits yours." *

With Sir Charles Lyell, with Mr. Bunbury, with (I cannot help thinking) the vast majority of those who will examine the letters impartially, I fail to detect in these words anything like a proof that two great cities were actually then and there destroyed. Tacitus may have understood the allusion well enough ; but would any reader of the passage as it stands before us so understand it? Why, Casaubon actually proposed to alter the nominative plural *urbes* into the genitive singular *urbis*. That was a mere conjecture, which later editors have rightly rejected. But even the mistakes of clever men are often suggestive ; and I suspect that this famous scholar not only thought that the grammar would be simplified by the proposed change, but likewise that the epistle would be rendered more consistent with itself. He only saw in the letter a reference to one city, namely *Stabiæ* ; and consequently could not imagine why the plural number should be used. Let us try to place ourselves in the position of the men of Casaubon's day, none of whom had seen the ruins which are now known so well. We might possibly have thought his conjectural emendation to be highly plausible.

Let me not, however, be supposed for one moment to underrate the interest and value of these two famous letters. Tacitus asked for an account of the death of the elder Pliny from his nephew, and obtained even more than he asked. The cloud first issuing from the

* It seems right to give the original. " *Quamvis enim pulcherrimarum clade terrarum, ut populi, ut urbes memorabili casu, quasi semper victurus occiderit ; quamvis ipse plurima opera et mansura conderit, multum tamen perpetuitati ejus scriptorum tuorum æternitas addet.*" Mr Lewis's version is substantially identical with that given above ; that of Melmoth is too much of a paraphrase to be cited in evidence. Professor Sellar has observed, I should think with perfect justice, that the Latinity of this silver age had certainly lost much of the precision which characterised the writers of the Augustan epoch.

long dormant volcano, and assuming the shape of a pine tree ; its alternate brightness and discoloration by earth and cinders ; the offer of the uncle to take his nephew in the vessel ordered for his own use ; the whispered apology for his continuance of his studies, couched in the remark that "by chance he had given me something to write" (which I agree with Dean Merivale in thinking delicious) ; the uncle's change of purpose in consequence of a message from an inhabitant of Retina ; the night's rest there, and the flight of the party at dawn with pillows tied around their heads, as some defence against the showers of stones ; the thick darkness, deeper than that of night, which soon obscured the daylight ; the fall and suffocation of the uncle ; the flight of the mother and her son from their home, on the just ground that it must be the wish of their relative that *they* should live, whatever had been *his* fate ; the terrified crowds ; the earthquake which rocked the chariots ; the withdrawal of the sea, leaving many marine animals on the shore ; the dark cloud behind, with its serpentine outbursts of flame ; the shrieks of women, the screams of children, the cries of men for parent, wife, and child ; the discharge, of which the bulk happily missed them, but yet showered ashes so heavily that it was needful to shake them off from time to time ; the conviction of all (which to Pliny himself was a consolation) that the world's last day had come,—all this and more is told with wondrous power.—I only say, that it is not evidence upon the question now before us.

Recognising the just praise due to Tacitus for his inquiries, and the amount of good feeling as well as literary skill displayed in this, as in so many of the younger Pliny's epistles, let me be pardoned if I prolong this digression one moment longer by a brief reference to the elder Pliny. Influenced at least in theory, I fear, by that Epicurean philosophy which had undermined belief in the future, he was Stoical, in the best sense of the word, in the nobleness of his attachment to the idea of duty. One of the defenders of his country,—he was admiral of the Roman fleet stationed off Misenum,—Pliny, without neglect of the service, devoted all his leisure to study, a combination of pursuits not unknown in the annals of this Society. Inferior in the true scientific temper, I suppose, to an Aristotle or an Archimedes, he nevertheless produced a work on natural history which still lives, and which has been translated into all European,

and into some Eastern languages. On this occasion he started at all risks, that he might ascertain the meaning of the phenomena before him, but changed his course at the request of the alarmed inhabitants of Retina, for whom he did all that lay in his power. He died a martyr to the cause of science,—a martyr to the cause of humanity. And therefore within these walls—could there be a more fitting spot?—I ask leave to pay to his memory one passing tribute—not of pity, I can never associate the thought of pity with the close of a life sacrificed in the service of fellow-creatures—but of reverence, homage, sympathy. With him were lost to posterity the best hopes of a full and accurate account of the results of the catastrophe by which he perished.

Let me not, however, seem to forget that a just objection has been made against reasonings, which, because no one piece of evidence is conclusive in itself, evade and ignore the force which the testimonies may possess, when considered as a connected whole. It must be admitted, that in the case before us the items, though variant, are not discordant; that they come from Greek and Jew as well as Roman, and that in their combinations they certainly do point to a great and memorable calamity. There is a fierce eruption of the long dormant volcano (Martial, Plutarch, Statius, Josephus, Suetonius, Pliny); the destruction of cities, not distinctly connected, I think, with the eruption by Tacitus or Pliny, but connected with it by Plutarch and Statius; great loss of life expressed or implied by Plutarch, Statius, Tacitus, and perhaps Josephus. The date of Titus on the throne is supplied by Josephus and Suetonius; and rightly calculated thence, I doubt not, by Clinton and others, for the *first* year of that reign, namely, A.D. 79. The younger Pliny adds the day, namely, the 24th of August, a day to be made memorable in after ages by an eruption of another kind in a country north of Italy, in the France of 1572; for the 24th of August is the Festival of St. Bartholomew.

Such is the sum—I believe, the complete sum—of all the contemporary evidence. I pass on to the statements of a witness of a later period. But “Hold,” cries out an important and gifted school of inquirers, “you have no business to take such a step. All history must rest upon contemporary written evidence, and what is beyond this is of little worth.” Of this school I must regard the late Sir

George Cornwall Lewis as (at any rate in Britain) the most able and consistent representative. He would fain have thrown aside all inquiries into the earlier periods of Roman history, and have begun with the war of Pyrrhus against Rome in B.C. 280. It is right to say that, with Polybius, Lewis fully granted a man's competency to record events which happened at least twenty years before his birth, on the ground that so many of us have received information from our grandfathers, or from persons of their generation, though few of us have any distinct personal recollections of our great-grandfathers.* This theory is so simple, so trenchant as to possess attractions for many minds; and I must own to having been much impressed by it, when Lewis' two volumes on *The Credibility of Early Roman History* first appeared in 1855. But it does not now, I fancy, represent a winning cause; and I have come to regard it as decidedly too rigid and narrow. Accordingly, I pass onward.

Seventy-six years after this great calamity, there was born at Nice, in Bithynia, one who in after life thought himself called upon by a dream to write the history of the Romans of his time, Dion Cassius. He did not begin to collect materials until 122 years after the fall of Pompeii, and it must have been 140 years after (four times the most liberal allowance for contemporary evidence) that he published his work.

Dion Cassius comes before us with many drawbacks. Not merely does he write long after the event, but he informs us that just before the outburst giants (or figures like the pictures of giants) stalked on the mountain, were seen in the air, and visited the neighbouring districts by day and night; that not only droughts, earthquakes, and rumblings preceded the eruption, with roarings of sea and sky, but that also these gigantic visions were seen amidst the smoke, and the sound of trumpets was heard. A plague burst upon man and beast; birds and fishes also perished; the ashes flew as far as Rome, and were the cause of the pestilence which undoubtedly did prevail; and further, "it buried two entire cities, Herculaneum and Pompeii, while their inhabitants were sitting in the theatre."

Here then at last, when a hundred and forty years have passed away, after all these hints, after assertions of a vague and general character,

* Lewis would extend this term beyond Polybius. I should be inclined to go as far as thirty-five years.

we at length learn the names of the two unfortunate cities that were overwhelmed. But let us place ourselves back in imagination at the time of the revival of classic learning in the 16th century, and ask what would have been our verdict? With sincere diffidence, judging from such canons of credibility as I have been able to form for my own guidance, I believe that I should have said, that beneath these varied testimonies there must most probably lie some real kernel of truth, but that, although it was possible to underrate the amount of the evidence,—Lyell, for instance, omits Plutarch and Statius,—the manifest admixture of legendary matter justified one in withholding a full credence; and that serious damage to the cities and considerable loss of life had been magnified into this absolute destruction. In other words, without absolutely discrediting the story, I should have supposed it to have been woefully exaggerated.

And yet, on the main point, it was, after all, the contemporary annalists who had been reticent and vague; it was the non-contemporary one who was correct. From the single eye-witness, Pliny the younger, the *testis oculatus*, whom a Roman proverb declared to be worth more than ten who went by hearsay, we get virtually nothing; from the man who published a narrative four generations afterwards (supported no doubt by two contemporaries, a poet and a moralist) we obtain names, dates, and all that is most requisite for the production of a positive and definite statement. There came a day when the words of Dion Cassius were to be proved truthful. First a glimpse of some columns, then a shaft sunk in Herculaneum with the object of making a well, and at length, in 1755, after a silence (broken only by some more general statements of a few historians) which had lasted for 1676 years, Pompeii was at length disclosed. The streets, the tombs, the baths, the forum, the school for gladiators, the temples, the shops, the fountains, all were there,—preserved, as has been truly said, by the very catastrophe which seemed to have wrought their destruction. Not grand as a whole, yet not wanting in the signs of elegance and luxury in domestic architecture, or in the marks of culture and civilisation, Pompeii was once more visible. The lamps, the buckles, the loaves, the roll about to be made into pills, the greaves and cuirasses, the statuettes, the coggled dice, the candelabra, the ornaments for female dresses, could all be recognised. So far the number of skeletons found has not been large. The reason

for this is still a disputed question. Some buildings inquirers did not expect to find, and did not find; there was no hospital or infirmary,—that was a feature of life unknown to Greek or Roman civilisation. But much that was unexpected was found, as, for instance, beautiful glass windows and objects made of blown glass. Herculaneum has been less excavated; the modern town of Portici stands above it, and the expense of penetrating the harder material is greater. Still none can doubt but that few discoveries have thrown more light upon the details of the manners of those times than these marvellous and unexpected disclosures.

In conclusion, I would venture to lay down four positions as naturally arising out of this inquiry.

1. It does not appear to lend support to the views of a school, somewhat fashionable just at present, which would represent history as simply one vast falsehood. Several of our witnesses have certainly been vague, and so far misleading, but they have not in any case been proved false; and two among them, Tacitus and Josephus (to say nothing of the elder Pliny), intended to have told us more. By all means let both premises and conclusions in history be examined with due severity. Its assertions may never reach demonstration; but they may in some cases fall short of it by an amount less than any assignable quantity. Let me repeat, on this head, the words which I heard uttered by Dr. Arnold almost forty years ago:—"If historical testimony be really worth nothing, it touches us in one of the very divinest parts of our nature, the power of connecting ourselves with the past." *

2. This inquiry does, if I am not mistaken, deal a serious blow at the view of that school which would limit our historical researches to the study of contemporary written evidence. It is true that such a principle cannot adequately be judged by any single instance; but there are plenty more to be had, as for example, the narrative of the Indian campaign of Alexander the Great, for which we now depend mainly upon Arrian, who was born four hundred years after the death of Alexander. Still the case before us supplies an exceedingly crucial test. It is but seldom that we can hope to confront the statements of historians with such evidence as has been afforded by the excava-

* *Lectures on Modern History*, lect. viii.

tion of Herculaneum and of Pompeii. And here, as we have seen, it was the non-contemporary, Dion Cassius, who alone gave precise information. From no other author could Lord Lytton have taken, as he did, a clear and emphatic motto for his tale.

3. We must expect to find a wide difference in the amount of testimony accessible before and after the invention of printing. Not only has printing saved many documents from perishing, and induced numbers to write, who would not otherwise have taken the trouble, but publication—witness that of the Greville memoirs in our own day—calls forth counter criticism, and lends fresh aid to investigation. This remark may appear too obvious to be worth making. But I am convinced that, for us, who live in an age of cheap newspapers and telegrams, it requires a real effort of the imagination to conceive the lack of information in the ages when printing was unknown. And this effort is not always made when it ought to be.

4. My closing assertions open up a distinct chapter in the history of the human mind. It cannot be more than suggested, but it is impossible to pass it by. The comparative silence of antiquity respecting the fate of these unfortunate cities was not caused solely by the want of the printing press, the railway, and the telegraph; it also arose from a limitation of sympathy. In our own day we cannot imagine such a catastrophe so heedlessly passed by. The Emperor Titus, to his lasting honour, did do something for the sufferers; but I cannot find a hint of such an idea occurring to any one besides. The first impulse arising out of such a belief is one of satisfaction at the improved condition of mankind. And yet I feel, with Dean Merivale, that there is a real danger of our overstating the case against classic paganism: and if I could suppose an advocate on its behalf to arise and to challenge us with full knowledge of our past, as well as of his own side, he might possibly address us in language of this sort,—“You claim the possession of a purer light, of a truly philanthropic creed. For that very reason we have a right to ask for justice at your hands. State, if you will, the case that can be made out against us, and for yourselves; but state it fairly, and state it as a whole.” To examine the problems here suggested would be not merely an unwarrantable demand upon your time, which I have already occupied so long, but it might involve, I fear, something like a breach of trust as introducing themes unsuited for

the calm discussion befitting this Society. Thus much only let me remark, that any student of these questions would do well to ask whether this extension of sympathy has not been a plant of somewhat tardy growth. Let him look at the feudalist historians, such as Froissart and De Comines: let him read the comments upon the letters of Madame de Sevigné, made in one of the great books of this century, the *American Democracy* of De Tocqueville.

In the very year 1755, in which the ruins of the Campanian cities were first excavated, Europe was startled by a catastrophe no less terrible,—by that earthquake at Lisbon (at first discredited even by such a man as Dr. Johnson), but which, when proved, produced a profound impression, as well it might, when we remember that it destroyed one-third of an European capital, and caused the death of 15,000 persons. Let the inquirer read the accounts not only as given by British historians, but also in Sismondi's *Histoire des Français*. He will find himself in the presence of questions connected with the proper limits of sympathy and of tolerance, of which I will only venture to say here, that I cannot regard them as yet fully solved; and that I can hardly believe that they ever will receive their solution from any who imagine them to be simple elements which can be easily disengaged from the complex structure of modern civilisation.

APPENDIX.

(*Added during Printing.*)

At the conclusion of the above paper, Dr. Donaldson, Professor of Humanity in the University of Aberdeen, after kindly thanking its author for his address, made two exceptions to its line of argument. In the first place, urged the Professor, the gaps in the history of those times are so great that one would hardly wonder if the destruction of these cities had remained entirely unnoticed. The wall of Antoninus between the Forth and the Clyde was only mentioned by one author, and he did not write until a century after its formation. Moreover, one important passage bearing upon the question had been overlooked. The emperor Marcus Aurelius, in his well-known *Meditations*, written about a century after the event, refers to the destruction of Pompeii and Herculaneum as an event perfectly well known.

I have tried to consider these remarks with the respect due to their own force and to the high claims of the speaker. But they do not seem to me to be fatal to the positions taken up in my address, for the following reasons :—

1. The formation of a vallum, though an interesting and important event, was nothing very novel. Hadrian, the predecessor of Antoninus, had made one nearly twice as long between the mouth of the Tyne and the Solway Firth. Nor can it be considered to have any such startling and sensational character, as to make a very vivid impression upon the imagination of contemporaries. It was effected more than 1000 miles from Rome, among tribes regarded by the Romans as wild barbarians. But the event discussed in the above address occurred in Italy itself; it fell upon two well-known cities not 200 miles from Rome, where eminent Romans possessed villas; and it was, so far as the Italian peninsula is concerned, something eminently startling and previously unheard of.

2. By the kindness of Dr. Donaldson, I am in possession of the precise words of M. Aurelius, which I had certainly overlooked. Literally translated, they run thus :—“How many entire cities, so to speak, have perished [or, are dead]; Helicé and Pompeii and Herculaneum and numberless others.”*

Let it be observed that this is not contemporary evidence; for it is a century after the event. Further, forasmuch as Helicé, in Achaia, perished suddenly by an earthquake, it might be inferred that the Campanian cities had probably been destroyed in like manner. No student of these words, at the time of the revival of learning, would detect in them a hint that Vesuvius was in anywise implicated, although the contemporaries of the imperial author might happen to be well aware of it. But is it evidence which could be produced in a court of justice as on a level with that of Dion Cassius? Do not the words “numberless others” imply that Pompeii and Herculaneum had been destroyed in some way which was not very uncommon? I would still respectfully submit, that the passage would be justly classed by Lyell among the testimonies, which are not merely non-contemporary, but likewise somewhat vague and general.

* Πόσαι δι πόλεις δλαι, Ἴν, οὕτως εἶπω, τεθνήκασιν, Ἐλικη καὶ Πομπηῖοι καὶ Ἡρκλάνον, καὶ ἄλλαι ἀναρίθμητοί.—*Marci Antonini Commentariorum*, lib. iv. cap. 48.

The following Communications were read :—

2. On a Specimen of Sowerby's Whale (*Mesoplodon bidens*)
 . captured in Shetland. By Professor Turner.

Sowerby's whale is one of the rarest of the cetacea which frequent the British seas. It was first recognised as a distinct species by Mr. James Sowerby, from a specimen cast ashore in 1800 on the coast of Elgin, and named by him *Physeter bidens*.* From that time to the present no properly authenticated specimen has been obtained in Scotland, although it is not unlikely that a skull in the Museum of Science and Art in this city, a description of which I gave to this Society in 1872,† may have belonged to an animal captured in the Scottish seas. Two, if not three, specimens have been obtained on the Irish coast, but I know of no example of this whale having been caught in England. In my former communication to this Society, I referred to two specimens taken in France (Havre, Calvados), one at Ostend, one on the coast of Norway, and one on the coast of Sweden, and this completed the record of this animal so far as I could find a reference in zoological literature. I was not aware at that time that a specimen had been stranded on Nantucket Island, Massachusetts, U.S., about the year 1867, and that the cranium was in the Museum of Comparative Zoology, Harvard College.‡ The animal was said to be new to America.

More recently,§ Professor Reinhardt of Copenhagen has described

* Sowerby's *British Miscellany of New or Rare Animals*, vol. i. p. 1, 1806.

† "On the occurrence of *Ziphius cavirostris* in the Shetland seas, and a comparison of its skull with that of Sowerby's Whale," *Trans. Roy. Soc. Edin.*, vol. xxvi.

‡ See reference by Prof. Agassiz, in *Proc. Boston Soc. Nat. Hist.*, Nov. 16, 1867. Mr. J. A. Allen, "Catalogue of the Mammals of Massachusetts," in *Bulletin of the Museum of Comparative Zoology at Harvard College*, vol. i., 1863-1869, p. 205. MM. Van Beneden and Gervais, *Ostographie des Cétacés*, p. 396.

§ Prof. Van Beneden referred, in *Bull. de l'Acad. Roy. de Belgique*, Février, 1880, tom. xlix., to a female cetacean captured in December 1879 at Hillion, on the west coast of France (Côtes du Nord), which, from the description sent to him, might, he thought, be either *Ziphius cavirostris* or *Mesoplodon sowerbyi*.

and figured* a female cetacean, *Mesoplodon bidens*, which he identifies with Sowerby's whale. It was captured on the 3rd February 1880, at Hevringholm Strand, on the east coast of Jutland. As naturalists have possessed so few opportunities of seeing this animal, I append an abstract of Professor Reinhardt's account of this specimen :—

“ It was 13 feet 9 inches (Danish) long, and nearly full grown. Except in a few places, nearly all the cuticle was removed, for the animal had been dead for over a month. The remains of the epidermis and the interior of the mouth were blackish. The body in front of the dorsal fin was rounded transversely, but a little behind the head it was compressed laterally, and towards the dorsal mesial line. Behind the dorsal fin the body was compressed into a sharp dorsal keel, which faded away on the upper surface of the tail. A sharp keel did not exist on the under surface, though it was also somewhat compressed. The tail did not have a mesial notch between its lateral lobes. The anteriorly converging furrows in the throat ran together in this animal similarly to what was described by Mr. W. Andrews in an Irish specimen. The external auditory meatus was large and conspicuous, its size perhaps depending on the circumstance that the epidermis was removed. The external nares were semilunar and not mesial, but more to the left, so that scarcely a third was on the right side of the mesial line. Moreover, it cut the middle line a little obliquely, so that the end of the right cornu reached a little more forwards than the left, and the want of symmetry showed itself also in the left side of the crescent, being somewhat more curved than the right. The contour of the head, when looked at from above, showed a greater convexity to the outer side of the spiracle on the left side than on the right. As is well known, the mandible of this whale possesses a pair of compressed teeth, large in the male, smaller in the female. On first seeing this specimen no teeth were recognised, for the mandibular teeth were covered and concealed by the skin. But some days later when the integument was more shrunk, two small functionless teeth, of about the size of a pin's head, were also seen on each side of the upper jaw about to emerge from the skin, in which they were so loosely lodged that they were freely movable. The more anterior tooth was 9" 3" from the tip of the superior maxilla, the second 5" behind the first, and at a similar distance behind the second a third could be felt on cutting into the skin, and, more posteriorly, apparently a fourth. No small functionless teeth were seen in the mandible, though they were also probably

In a letter which he has favoured me with, in reply to a query for further information, he states that, having bought the skeleton, he found it to be a *Hyperoodon*.

* Oversight over d. K. D. Vidensk. Selsk., Forhldl. 1880.

present in this specimen. The skeleton, unfortunately, was not preserved."*

On the 9th November 1881, it was reported to Professor A. W. Malm of Göteborg, that a small whale had been found dead off Vanholmen, near Marstrand, Sweden. Dr. A. H. Malm went to see the specimen, and acquired the skeleton for the Göteborg Museum. †

He reports that the animal was a male, 4500 millimetres (nearly 15 feet) long, and that it was a Sowerby's whale. It was found floating by the fisherman in a narrow creek—dead, but fresh. The animal had been partially flensed before Dr. Malm saw it. The colour was dark slate, with greyish-white irregularly scattered spots, especially on the ventral aspect. The lobes of the tail measured transversely 1200 mm. The tail was not strongly concave posteriorly, as is figured by Dumortier in the Ostend specimen, but was almost transverse, with a convexity forming an obtuse angle, and not a mesial notch between its lateral lobes. The snout tapered more rapidly from the corner of the mouth. Behind the teeth the slit of the mouth resembled a bow turned upwards, but in front it was at first like a bow turned downwards, and then it was straight to the tip of the snout. The upper lips were drawn up so that the palate sank below them, and fitted into the furrow of the mandible. The teeth projected outside the lips when the mouth was shut. Only two teeth were present, one in each mandible, but an alveolar furrow extended for about 7 mm. behind each tooth, as if for the lodgment of a smaller tooth, such as was found in the Swedish specimen previously described by Professor A. W. Malm. ‡ The tongue was fixed to the mandible, so that only the point was free. The external nares were semilunar, concave forwards, and formed a third of a circle. Anterior to the nares, the head had a fine rounded shape. The dorsal fin pointed backwards; its posterior edge considerably falcated; its length 450 mm., its height 200 mm. The anterior limbs were very small; the anterior

* Professor Reinhardt refers in his paper to two American specimens of Sowerby's whale, the one taken at Dennis, Massachusetts, in 1869, the other at Newport, Rhode Island, in the same year. But in a letter which he has favoured me with, he informs me that he is now satisfied that these animals were not *Mesoplodon bidens* (Sow.) but *Hyperoodon rostratus*.

† Göteborg's *Naturhistoriska Museum, Zool. Zool., Afdelningarna*, 1882. Through the courtesy of Dr. A. H. Malm, I received an early copy of his paper, which reached me a few days after my communication was read to the Royal Society. To give sequence to the narrative, I have incorporated in the text the above analysis of Dr. Malm's paper. I am indebted for a translation of Dr. Malm's description, and of that in Professor Reinhardt's paper, to a young Swedish gentleman, one of my pupils, Mr. Arwid Kellgren.

‡ *Hvaldjur i Sveriges Museum* an 1869

edge was bent slightly back; the posterior formed at the middle a rounded projecting angle. It was almost the same size as the previous Swedish specimen, also in the Göteborg Museum, but the head was a little longer, though not quite so broad, and the teeth were lower but longer (along the mandible) than in the earlier specimen.

In September 1881, the Rev. George Gordon of Birnie, Elgin, wrote to me, that when on a visit recently to Hillswick, Shetland, he had seen the skull of a small cetacean, which he was led to think was a Sowerby's whale, and that the skeleton was in the possession of Mr. John Anderson of Hillswick. I accordingly wrote to Mr. Anderson to request him to present the skeleton to the Anatomical Museum of the University, and at the first opportunity he most courteously forwarded the bones to me, when the accuracy of Mr. Gordon's diagnosis of the species was at once confirmed. I desire to express my thanks to Mr. Gordon for having so generously given me information of the specimen, and to Mr. Anderson for his liberality in presenting the skeleton to the Museum.

This whale was captured in April 1881 by Mr. Thomas Anderson, who has kindly furnished me with the following particulars. He saw it struggling near the shore in the Urafirth Voe, Northmavine, on the west coast of the main island of Shetland, and his attention was directed to it by hearing at short intervals a deep groan. A rifle was then fired at it, and the animal swam into a narrow creek, where it was harpooned. It was a male, 14 feet in length. The back was dark bluish-grey or slate-coloured, becoming lighter on the sides and whitish on the belly. Grey or whitish streaks and spots, often circular, were irregularly scattered over the sides. The skin was smooth, except on the belly, which was ribbed not unlike a stocking: this ribbed appearance began near the jaw and passed back beyond the flipper. A deep crevice was between the two halves of the lower jaw, which came to a point in front, but became wider and shallower behind. The beak was elongated and pointed. The mouth slit was straight in front of the teeth in the lower jaw, but behind the teeth it was curved with the convexity upwards and backwards. The blowhole was semicircular in shape, and with a flap which seemed to close it at will. The pectoral flipper seemed to be $1\frac{1}{2}$ or 2 feet long, but no measurement was made. A dorsal fin projected from about the middle of the back. The tail measured

3½ feet between the tips of the two lobes. The two mandibular teeth projected upwards from between the lips at the sides of the snout, even when the mouth was shut; and a bunch of barnacles, about 6 inches long, was firmly attached to each tooth. The stomach was empty, and appeared very small for the size of the animal.

It is interesting to note that Urafirth Voe, where this *Mesoplodon bidens* (Sowerby) was caught, is only 4 miles from Hamna Voe, where the specimen of *Ziphius cavirostris* was obtained which I described to this Society in 1872, and for the skull of which I am also indebted to Mr. Anderson.

The following table gives, so far as is known, the sex of the different specimens which have been captured, the localities, the dates of capture, the naturalists who have described them, and the museums where the skeletons, or part of the skeletons, are preserved:—

| | Sex. | Locality where Captured. | Date. | By whom Described. | Where Preserved. |
|-----|-------|---|-------|--|---|
| 1. | Male. | Brodiehouse, Elgin, . . . | 1800 | J. Sowerby, . . . | Oxford. |
| 2. | Fem. | Havre, | 1825 | { De Blainville and } Cuvier, | Paris. |
| 3. | Male. | Sallenelles, Calvados, . . | 1825 | Dealongchamps, . . | Caen. |
| 4. | Fem. | Ostend, | 1835 | { Dumortier and } Van Beneden, . . . | Brussels. |
| 5. | Male. | Brandon Bay, Ireland, | 1864 | W. Andrews, . . . | Dublin. |
| 6. | ... | Norway, | 1866 | Van Beneden, . . . | Christiania. |
| 7. | ... | { Nantucket Island, } { Mass., U.S., } | 1867 | Agassiz and Allen, | Harvard. |
| 8. | Male. | Skagerak, | 1869 | A. W. Malm, . . . | Göteborg. |
| 9. | Male. | Brandon Bay, | 1870 | W. Andrews, . . . | Dublin. |
| 10. | Fem. | Scotland (?), | 1872 | W. Turner, | { Museum, Science } { and Art, Edin. } |
| 11. | Fem. | { Hevringholm Strand, } { Jutland, } | 1880 | Reinhardt, | |
| 12. | Male. | Vanholmen, Sweden, . . . | 1881 | A. H. Malm, . . . | Göteborg. |
| 13. | Male. | Shetland, | 1881 | W. Turner, | { Univ. Museum, } { Edinburgh. } |

The circumstances under which this animal has been seen have not been favourable for the determination of its external characters, as, before it has been examined by zoologists, it has either been much decomposed or partially or wholly flensed or dismembered. From the several fragmentary descriptions by different naturalists, I have compiled the following summary of its external appearance:—

Length in adult, 14 to 16 feet. Beak long and slender. Head swelling out considerably behind the beak. Body elongated. Back dark bluish-grey or slate-coloured, sides lighter, belly whitish.

Grey or whitish streaks and spots scattered irregularly on the sides. Dorsal fin nearer the tail than the head, falcate posteriorly. A dorsal keel in front of tail. No median notch between lobes of tail. Flipper small; both its anterior and posterior borders convex. Blowhole semilunar, concave forward, not quite symmetrical. Mouth slit straight in front, but concavo-convex further back. A pair of furrows converging in front on the under surface of the throat. A pair of laterally compressed triangular teeth protruding in the male between the lips at the side of the beak; not visible in the female. Rudimentary functionless teeth present in the gum both of the upper and lower jaws.

Of the thirteen specimens which have been captured, the whole of the skull, or a portion only, has been kept in twelve instances; but in six specimens only, including the one from Shetland, have the other bones of the skeleton been more or less perfectly preserved, viz., in the Brussels, Caen, Dublin, Göteborg, and Edinburgh University Museums. Only one skeleton has been described and figured in detail, viz., the immature female in the Brussels Museum, originally by M. Dumortier,* but subsequently and more in detail by M. Van Beneden.† Several of the crania have also been figured and described, viz., the Oxford, Paris, Caen, and Edinburgh Museum of Science and Art specimens; whilst some facts connected with the other bones of the skeleton in the Caen and Göteborg skeletons have been recorded by M. Gervais‡ and the Messrs. Malm.§

The animal captured in Shetland was an adult male. All the epiphysial plates were fused with the vertebral bodies, and the teeth were fully erupted. Three of the lumbar vertebræ had irregular osseous excrescences on the bodies. One lumbar spine had a ridge crossing obliquely about its middle, as if it had been fractured and repaired during life.

The end of the rostrum of the skull had unfortunately been broken off to the extent probably of 5 or 6 inches, and the anterior end of the mandible had also been broken away. Owing to this injury I cannot give the full length of the cranium; but the skull

* *Mem. de l'Acad. Roy. de Belgique*, xii. 1839.

† *Mem. Couronnés de l'Acad. Roy. de Belgique*, Oct., xvi. 1864.

‡ *Ostographie des Cétacés*, p. 397.

§ *Opera citata*.

as it came into my hands was $23\frac{1}{2}$ inches long. It is not my intention to give a detailed description of the Shetland skull, as the cranial characters of this animal have already been recorded at considerable length by MM. F. Cuvier, Van Beneden, Gervais, and myself. But as these specimens were all females, it may be useful to point out some features of difference which it presented, and I shall especially compare it with the female skull in the Museum of Science and Art, Edinburgh.

In the first instance, I give a table of comparative measurements of the two crania, expressed in feet and inches.

| Table of Cranial Measurements. | Skull in* Museum of Science and Art. | Shetland, <i>Macoplo-</i> <i>don</i> <i>bidens.</i> |
|--|---|--|
| Greatest height of cranium from vertex to pterygoids | $9\frac{1}{2}$ | 10 |
| Breadth of cranium across middle of superior margin of orbits | $11\frac{1}{2}$ | $10\frac{1}{2}$ |
| Breadth of cranium between zygomatic processes of squamosals | $11\frac{1}{2}$ | $11\frac{1}{2}$ |
| Breadth between antorbital notches | $7\frac{3}{4}$ | $7\frac{1}{2}$ |
| Breadth of occipital condyles | $4\frac{1}{2}$ | 4 |
| Premaxillæ, greatest width behind anterior nares | 5 | $4\frac{1}{2}$ |
| Premaxillæ, least width opposite anterior nares | $4\frac{1}{2}$ | 4 |
| Premaxillæ, greatest width in front of anterior nares | 4 | 4 |
| Width of anterior nares | $1\frac{3}{8}$ | $1\frac{1}{10}$ |
| Mandible, length of ramus | $18\frac{1}{2}$ | $18\frac{1}{2}$ |
| Mandible, length of symphysis | $9\frac{1}{2}$ | $7\frac{3}{4}$ † |
| Mandible, greatest vertical height of ramus | $4\frac{1}{2}$ | 4 |

The cranial sutures were not quite so distinct as in the skull in the Museum of Science and Art. The upper borders of the rostral portions of the two premaxillæ were not so much turned inwards, and the widest interval between these borders, near the base of the beak, was $1\frac{1}{10}$ inch, and not $\frac{5}{8}$ th inch, as in that specimen. Instead of an open meso-rostral canal, a distinct meso-rostral bone occupied but did not entirely fill up the hollow between the premaxillæ; for this bone was divided into two not quite symmetrical halves by a mesial superior furrow, in which probably an unossified part of the meso-rostral cartilage had been lodged. This furrow was bounded behind by the anterior end of the mes-ethmoid bone, which extended

* These measurements of this skull have already been published in my Report on the Bones of the Cetacea collected by H. M. S. "Challenger," 1880.

† This mandible is imperfect.

into the base of the beak for $1\frac{1}{4}$ inch beyond the pre-maxillary foramen, whilst in the skull in the Museum of Science and Art it did not extend more than half an inch. The pre-maxillary foramen was immediately in front of the maxillary foramen in both specimens, and the lateral border of the base of the beak was in both a sharp ridge and not grooved. In the Shetland specimen the meso-rostral bone was fused both with the vomer and the pre-maxilla, though grooves on the surface showed the line of demarcation from the premaxilla. The meso-rostral bone became attenuated anteriorly, and ended in a fine point immediately behind the broken end of the beak. In the type skull in the Oxford Museum, if I may judge from a cast of that specimen, the ossification of the meso-rostral cartilage had extended very completely for nearly 6 inches in front of the mes-ethmoid, and less completely for 3 additional inches. The presence of a meso-rostral bone and of large mandibular teeth are therefore characteristics of the adult male. The vomer, where it appeared mesially on the under surface of the beak, was somewhat thicker than in the skull in the Museum of Science and Art. The tympanic bones were lost, but the left petrous bone was preserved. It closely resembled the petrous bone of *Mesoplodon layardi* figured by me in the Reports of H.M.S. "Challenger."*

The pair of mandibular teeth projected nearly 2 inches beyond the alveolus. They were triangular and laterally compressed. The anterior border sloped very obliquely forward; the posterior border was almost vertical. The surface of the fang was rough, with ridges passing obliquely downwards. The crown was smooth, terminating in a point, and was separated from the fang by a well-marked line. Each tooth was partly opposite and partly immediately behind the posterior end of the elongated symphysis. A groove in the alveolar border of the bone passed for 2 inches backwards behind the erupted tooth, and in it rudimentary denticles had at one time probably been lodged.

The discovery by Professor Reinhardt of a row of rudimentary functionless teeth on each side of the upper jaw of his specimen of *Mesoplodon bidens*, is of great interest. The New Zealand *Mesoplodon grayi*, mainly on the possession of a row of minute teeth in the upper jaw, has been made, by Dr. Von Haast, a new genus,

* Report on the Bones of Cetacea, pl. i. fig. 5, Zoology, vol. i. 1880.

Oulodon; but Reinhardt's observation, as he himself has pointed out, shows that this can no longer be regarded as a ground for generic distinction between it and *Mesoplodon*.

In writing the description of the other bones of the skeleton, I have followed the method which I pursued, in framing the account of the skeleton of the *Mesoplodon layardi* for the Reports of H.M.S. "Challenger," so that the skeletons of these two animals may now be compared with each other. But it must be remembered that Layard's *Mesoplodon*, though 14 feet in length, was an immature animal, whilst the Shetland Sowerby's whale of the same length was an adult male.

SPINAL COLUMN.—Only 39 vertebræ have as yet reached me, viz, C₇, D₁₀, L₁₁, and eleven caudala. In the Brussels skeleton there are 46 vertebræ, and the formula is C₇, D₁₀, L₁₀, Cd₁₉. In Professor Malm's specimen, which was adult, as the epiphyses were united with the vertebral bodies, the formula is C₇, D₁₀, L₉, Cd₂₀ = 46; and in the second Göteborg skeleton, obtained by Dr. A. H. Malm, there are also 46 vertebræ, but of these only 9 are dorsal vertebræ, and consequently there are only 9 pairs of ribs. The ribs, therefore, of this whale are either 9 or 10 pairs, and the vertebral formula is 46, so that seven caudal vertebræ are missing in my specimen. In Layard's *Mesoplodon* the vertebral formula is 44 or 46, and the ribs are either 9 or 10 pairs.

The length of the macerated spine—the vertebral bodies being placed in apposition—was 9 feet 11 inches. The discs varied from half to five-eighths of an inch in thickness, so that 20 inches in addition may be allowed for them, and about 8 inches for the missing vertebræ with their discs, which would make the spine a little more than 12 feet long. In the centre of each disc was a distinct and relatively large cavity, lined by a smooth synovial-like membrane, and containing a deep yellow fluid, which in the discs between the larger vertebræ might amount to about half an ounce. The arrangement resembled what I saw in 1869 in the discs of *Balenoptera sibbaldii*.

Cervical Vertebræ.—The antero-posterior diameter of the cervical series of vertebræ was 5½ inches. The body, lamina, and spine of the axis were completely fused with the corresponding parts of the

atlas, and formed a massive bone $5\frac{1}{2}$ inches in its greatest transverse, 5 inches in its greatest dorso-ventral, and $2\frac{1}{4}$ inches in its greatest antero-posterior diameter. The transverse processes of these vertebræ were not ankylosed with each other. The transverse process on each side of the atlas was single, but that of the axis consisted of a short superior and a longer inferior limb, which were not united at their outer ends. The sub-occipital groove on the anterior lamina of the atlas was converted into a foramen by a bridge of bone. The last five cervicals were all free. The bodies of the 3rd, 4th, 5th, and 6th ranged from $2\frac{1}{4}$ to $2\frac{3}{4}$ inches in transverse diameter, and measured about half an inch antero-posteriorly. In each the superior and inferior limbs of the transverse process were separated from each other externally by a wide interval, which was also the case in the Brussels skeleton; but as this skeleton was perfectly adult, it may now be stated that no foramen exists at the root of the transverse process in the cervical vertebræ of this animal. The superior limb was a stunted plate; the inferior limb was more elongated; in the 3rd and 4th vertebræ it projected slightly backwards; in the 5th and 6th it projected downwards and outwards, and in the 6th it was $1\frac{1}{4}$ inch long. In the 3rd, 4th, and 5th vertebræ, the laminae were not united mesially, so that they had no spines. In the 6th a slender stunted spine was present; the 7th had a slender spine $1\frac{3}{4}$ inch long; its superior transverse process was $1\frac{1}{2}$ inch long and pointed, whilst the inferior was a mere tubercle. Its body was elongated transversely beyond the articular surfaces for the vertebræ in front and behind, and on each side it had an articular facet 1 inch by $\frac{3}{4}$ inch for the head of the first rib. The fusion of the atlas with the axis, and the free condition of the other cervicals, is obviously a character of this animal, as it was also seen in the Brussels and in both the Göteborg skeletons.* The condylar articular surfaces of the atlas were separated below by an interval of $\frac{4}{10}$ ths inch, whilst in the young Layards' *Mesoplodon*, the interval was less than $\frac{3}{10}$ ths inch.

Dorsal Vertebræ.—In this region the bodies increased in size from before backwards. The first had a pair of rudimentary tubercles

* M. Gervais, in his account of Sowerby's whale in *Ostéographie des Cétacés*, states that the first three cervicals are fused together, but he does not say in which skeleton this has been seen.

projecting from the inferior surface of the body in series with, but smaller than, the inferior transverse tubercles of the 7th cervical. A mesial ridge appeared on the ventral surface of the 8th dorsal, as in the Brussels skeleton, which became stronger in the vertebræ behind. The laminae and spines were complete in all the dorsals, and the spines, as a rule, increased in length and massiveness from before backwards, the 1st being $4\frac{1}{2}$ inches and the 10th $8\frac{1}{2}$ inches long. The spines of the 1st and 2nd were almost vertical, those of the rest were inclined backwards. The articular surfaces for the heads of the 2nd, 3rd, 4th, 5th, 6th, and 7th ribs were very distinct on the anterior six dorsals at the junction of the pedicle with the posterior part of the side of the body. No articular surface for the head of the 7th rib was present on the left side of the body of the 7th dorsal, but on the right side a small articular facet was situated on a slight elevation, in series with the projecting articular process for the 8th rib, on the side of the body of the 8th dorsal. The anterior seven dorsals had each a strong transverse process, for articulation with the tubercle of a corresponding rib, projecting from the pedicle close to the anterior zygapophysis. These transverse processes projected forwards in the anterior six, and outwards in the 7th. The long axis of the articular surface on the transverse process was vertical on the 1st and 2nd dorsals, oblique on those immediately behind, and horizontally antero-posterior on the 7th. No transverse process projected from the side of the neural arch of the 8th, 9th, and 10th dorsals, but a transverse process for articulation with a corresponding rib projected from the side of the body, nearer its anterior than posterior surface. It measured half an inch in the 8th, $2\frac{1}{2}$ inches in the 9th, and 4 inches in the 10th vertebra. Zygapophyses were present as far back as the anterior pair on the 8th dorsal. A pair of strong metapophyses projected forward from the laminae of the 10th, 9th, and 8th dorsals, to overlap the laminae of the vertebra immediately in front, and rudimentary metapophyses were present on the 7th and 6th dorsals. The 7th dorsal was the vertebra of transition.

Lumbar Vertebrae.—The ten lumbar were almost uniform in shape, but increased in size from before backwards; the body of the last lumbar measured 5 inches in its antero-posterior diameter, and 3.2 in its transverse. The bodies were keeled on the ventral sur-

faces. The antero-posterior diameter of each body was markedly greater than the transverse. In the more anterior vertebræ the transverse process was distinctly larger than the width of the body, but in the more posterior they were almost equal. The base of this process sprang from the anterior half of the side of the body in series with the transverse processes of the last dorsals; the processes projected outwards and a little forwards, and the free end was convex. The spines were long, laterally compressed and sloped slightly backwards. The length of the 10th lumbar spine was 10 inches. The height of the last lumbar vertebra was 15 inches. A pair of broad lamelliform metapophyses projected forwards from the anterior border of the laminae close to the root of the spine, but did not articulate with the vertebra in front; from the anterior edge of the laminae of which a pair of much smaller processes projected backwards. The neural arches sprang from the centre of the bodies.

Caudal Vertebrae.—Twelve only were present, seven being missing. They diminished in size from before backwards. The 1st was 14 inches high, and 10 inches between the tips of its transverse processes. In the anterior three the spines were massive, and then rapidly diminished in size to the 11th, in which the spine was a slight ridge, and the neural canal admitted only a crow quill. The transverse processes were strong in the anterior five, and then rapidly diminished in size, so that in the 9th only a faint ridge was seen. Metapophyses, which were non-articular, projected forwards from the anterior edge of the laminae of the anterior nine, but none from the posterior edge. The 1st caudal was transitional in its characters between the lumbar and caudal series, for whilst the ventral surface of the body was keeled in its anterior two-thirds, it was grooved in the posterior third, and possessed an articulation for the 1st chevron bone. The vertebræ behind the first, so far as they were present, were grooved ventrally, and on at least nine bodies articulations for chevron bones were present. Only six chevron bones reached me. No vertical foramen was present in the root of a transverse process.

Ribs.—Of the ten pairs of ribs only four pairs were entire, the rest had been broken or sawn across. The first was the broadest, and measured 12 inches in a straight line. The anterior seven had each a head, neck, and tubercle, but in the 1st the neck was stunted. The

head of the 1st rib articulated with the body of the 7th cervical, its tubercle with the transverse process of the 1st dorsal. From behind forwards the head articulated with the body of the vertebra in front of that, with the transverse process of which the tubercle articulated; but whilst the head of the 7th left rib articulated with the body of only the 6th dorsal vertebræ, that of the 7th right rib articulated with the body of both the 6th and 7th dorsals. The 8th, 9th, and 10th ribs articulated with the transverse processes of their corresponding vertebræ.

Hyoid Bone consisted of a body and great cornua ankylosed together. It had a well-marked U form, and measured $6\frac{1}{4}$ inches between the tips of the horns.

Sternum.—This bone was $19\frac{1}{2}$ inches in length and $6\frac{5}{8}$ inches at the broadest part, and it diminished in transverse diameter from before backwards. The ventral aspect was slightly convex, and with a faint mesial keel. Each lateral border was festooned, being most projecting where it articulated with the ribs. The sternum consisted of five segments; the 4th and 5th were ankylosed together, the others articulated with each other laterally, but in the mesial third a rounded aperture of some size was interposed, and this aperture also existed between the 4th and 5th segments. This sternum corresponded with the first Göteborg skeleton in the ankylosis of these two segments, but differed both from the Brussels skeleton, in which they were still separate, and in which the 5th was divided into two lateral halves, and from the second Göteborg skeleton, in which the sternum possessed only four segments. This sternum did not display that marked inequality in the height of the opposite sides of the bone seen in the Brussels skeleton. Articulations for five pairs of ribs were at the lateral borders, one on the manubrium and four at the junction of the sternal segments.

Scapula.—This was a broad triangular plate-like bone, measuring 8 inches from the glenoid fossa to the vertebral border, and $12\frac{1}{4}$ inches from the anterior to the posterior angle. The coracoid process was $3\frac{1}{2}$ inches long; the acromion was 4 inches long, and 1.7 inch wide, being twice as broad as the coracoid.

Humerus.—The epiphyses of this bone were ankylosed to the shaft. The bone was only $5\frac{3}{4}$ inches long, and the surfaces of the

shaft were flattened. The bones of the forearm and manus have not yet reached me.

3. On Respiration in the Roots of *Avicennia officinalis* (Linn.) and other Shore Plants; with Observations on the Functions of the Lenticels. By Joseph Bancroft, M.D. Communicated by Professor Balfour, V.P.

4. (a) Diagnoses Fungorum novorum in Insula Socotra a Bayley Balfour, Carolo Cockburn et Alexandro Scott, lectorum, quas elaboravit Dr. M. C. Cooke. Communicated by Dr. Bayley Balfour.

✓ STERIVM RETIBUGUM, *Cke.* : coriaceo-membranaceum, murinum; pileo effuso e cupulari explanato, confluentē, marginato; ambitu pallide fimbriato; bymenio subvelutino, reticulato-venoso, murineo.

Ad ramos. B.C.S. Nos. 1310 (junior), 1341 bis.

✓ THAMETES SOCOTRANA, *Cke.*, pileo sessili semiorbiculari, tenui, coriaceo zonato-sulcato, velutino, albo; contexto, concolore, poris magnis dentatis, demum confluentibus, umbrinis.

Ad truncos. B.C.S. No. 1342.

(b) Diagnoses Algarum novarum Socotrensium a Bayley Balfour, Carolo Cockburn et Alexandro Scott lectorum, quas elaboravit Dr. G. Dickie, F.R.S.

MICROTHAMNION BREVIARTICULATUM, *Dickie*, ramulis alternis, articulo diametro æqualibus vel duplo-longioribus, diam. .0002 unc.

LYNGBYA SCABROSA, *Dickie*, cæspitosa, viridi-nigrescens, trichomatibus flexuosis, ærugineo-cæruleis, articulis diametro duplo-brevioribus, vaginis scabrosis, achrois, diam. .001 unc.

- (c) Diagnoses Lichenum Socotrensium novorum a participibus expeditionum Prof. Bayley Balfour et Dr. Schweinfurth lectorum, quas elaboravit Dr. J. Müller. Communicated by Dr. Bayley Balfour.

Obs. Diagnoses specierum novarum ampliores et observationes variæ, enumeratio completa omnium Lichenum a participibus expeditionum oculatiss. Balfourio (B.C.S.) et Schweinfurthio (Schweinf.) in hac neglectissima insula lectorum mihiq̄ benevole submissorum, nec non indicatio locorum accurata in Balfourii opere integro corrente anno edendæ sunt.

OMPHALARIEÆ.

ANEMA EXIGUUM, Müll. Arg.: thallus suborbicularis, $\frac{1}{4}$ - $\frac{3}{4}$ mm. latus, crassus, monocarpicus; apothecia $\frac{3}{8}$ mm. lata, arcte adnata, plana; asci cylindrici, 8-spori; sporæ globosæ, diametro 6-9 μ æquantes.—Calcicola: B.C.S.

COLLEMEÆ.

SYNECHOBLASTUS FLACCIDUS, Körb. v. *SUBNIGRESCENS*, Müll. Arg.: thallus nudus, margine minus adscendens quam in forma genuina europæa, minor et distincte sed non crebre subradiatim rugosoplicatus; sporæ 22-30 μ longæ, 6-8 μ latæ.—Ramulicola: Schweinf.

SYNECHOBLASTUS FLACCIDUS, Körb. v. *LEVIS*, Müll. Arg.: thallus ut in præcedente sed levis v. obsolete gibboso-rugosus.—Extus *S. japonicum*, Müll. Arg. fere simulat.—Cum præcedente ramulicola: Schweinf.

SYNECHOBLASTUS FLACCIDUS v. *SUBFURVUS* Müll. Arg.: lobi adscendentes et subundulati, parce et leviter plicato-rugosi, plus minusve copiose furfuracei.—Ramulicola: B.C.S. et Schweinf.

CALICIEÆ.

CALICIUM LEUCINUM, Müll. Arg.: thallus lutescenti-albus, sat crassus, minute rimulosus, superficie farinulentus; stipites cum

capitulis $\frac{1}{2}$ mm. longi, 58–80 μ lati, fusco-nigri, opaci, nonnihil fusco-pellucidi, clavatim in capitula $\frac{12-16}{100}$ mm. lata abeuntes; capitula fusco-nigra, nuda; sporæ 6–10 μ longæ, 5–6 μ latæ, biloculares, atro-fusæ.—Lignicolum: B.C.S.

ROCCELLEÆ

ROCCELLA BALFOURII, *Müll. Arg.*: thallus candide opaco-albus, 2½–5 cm. altus, suberectus, firmus, lacinia tenuiores teretes, reliquæ compresso-teretes, subleves, apice et lateraliter fructigeræ; apothecia primum innata, dein subpodicellato-sessilia et basi constricta, margo lecanorinus et crassus, discus albo- v. cæσιο-velatus, demum nudatus et fumoso-niger; sporæ 4-loculares, circ. 23 μ longæ, 6–7 μ latæ.—Combeam molluscam simulat.—Saxicola: B.C.S.

PARMELIÆ

RAMALINA DEBILIS, *Müll. Arg.*: thallus 3½ cm. altus, lacinia in sectione anguloso-teretes, 1 mm. latæ, parce ramosæ v. simplices, crebre foveolato-impressæ, flaccidæ; spermogonia atra; apothecia 2–3 mm. lata; sporæ 14–16 μ longæ, 3½–4 μ latæ, graciliter fusiformes.—Affinis *R. testudinaria* americana.—In insula Socotra lectam misit cl. Egeling.

RAMALINA DENDRISCOIDES, *Nyl. v. MINOR, Müll. Arg.*: lacinia compressæ v. tereti-compressæ, humiliores; apothecia 1–2 mm. lata, in ramulis terminalia, plana, demum convexa; sporæ 12–15 μ longæ, 5½–6 μ latæ, rectæ v. leviter curvulæ.—Ramulicola: Schweinf.

RAMALINA DENDRISCOIDES v. NODULOSA, *Müll. Arg.*: lacinia circ. centimetrales, breviter ramulosæ, suberectæ, subirregulares, subtuloso-nodulosæ et albido-soredioso-tuberculatæ.—Saxicola: B.C.S.

PARMELIA TILIACEA, *Ach. v. RIMULOSA, Müll. Arg.*: thallus adpressus, glauco-albescens, mox subincrassatus et crebre rimulosus, minute et parce isidiophorus et soredia cæσιο-alba majuscula v. tubercula isidioideo-aspera sparsa gerens.—Corticola: B.C.S.

PARMELIA CONVEXULA, *Müll. Arg.*: thalli lacinia exigua, subcon-

tigæ, 2-4 mm. longæ, $\frac{3}{4}$ - $\frac{3}{4}$ mm. latæ, adpressæ, subpinnatifidæ, flavido-cinerascentes, convexæ, leves et opacæ, subtus fusco-pallidæ et brevissime et parce rhinosæ; apothecia ignota.—Affinis *P. Mougeotii* et *P. constrictanti* Nyl.—Quartzicola: B.C.S.

PARMELIA SCHWEINFURTHII, Müll. Arg.: habitus ut in *P. perlata* v. *ciliata*, sed thallus ochroleuco-albescens, subtus atrofuscus, fere usque ad marginem sat copiose et longiuscule rhinoso-crinatus, ad ipsos margines longe nigro-ciliatus; lacinie ad margines isidiosolacinulatæ; apothecia podicellata, alte urceolaria, ore conniventia et integra, demum $\frac{3}{4}$ -1 cm. lata, dorso aspera, discus pallide fuscus; sporæ octonæ, 22-25 μ longæ, 12-15 μ latæ, valde pachydermæ.—Ramulicola: Schweinf.

PHYSICIA OBSCURELLA, Müll. Arg.: similis *Ph. adglutinata*, sed minor, lacinie $\frac{1}{5}$ - $\frac{1}{3}$ mm. latæ, discretæ, adplanatæ, adpressæ, obscure olivaceo-virentes; apothecia valde minuta, hypothecium hyalinum; sporæ 12-15 μ longæ, 7-8 μ latæ. Inter *Ph. affixam* Nyl. et *Ph. disjunctam* Krph. quasi medium tenens.—Quartzicola: Schweinf.

PHYSICIA OBSCURELLA, Müll. Arg. v. FUSCA, Müll. Arg.: thallus olivaceo-fuscus.—Cum forma genuina crescens: Schweinf.

PHYSICIA ENDOPYXINEA, Müll. Arg.: similis var. *acrita* *Ph. stellaris*, sed hypothecium fusco-atrum et apothecia crassius marginata. Sporæ ut in *Ph. picta*, ubi lamina multo altior et hypothecium subangustum.—Ramulicola: B.C.S.

PLACODIÆ.

PLACODIUM BULLATUM, Müll. Arg.: *Lecanoram atram* aut *Physciam ægialitam* simulans, sed thallus ambitu demum distincte effiguratus et sporæ simplices, hyalinæ, 10-12 μ longæ, 5-8 μ latæ; apothecia crasse albido-marginata.—Granitica: B.S.C.

AMPHILOMA DEPLANATUM, Müll. Arg.: thallus forma et magnitudine ut in *A. callopismate* Mass., sed totus miniato-fulvus, lacinie tenuiores, magis adpressæ, undique æqualiter confluentes et magis adplanatæ, undique concolores; sporæ 12 μ longæ, 7 μ latæ;

apothecia quam in comparata specie paullo minora, magis innato-adpressa et discus cum margine concolor.—Calcicola : B.C.S.

AMPHILOMA BALFOURII, Müll. Arg. : thallus orbicularis, $\frac{1}{2}$ –1 cm. latus, medio simpliciter areolatus, margine late radiatim applanato-lacinatus, aurantiaco-fulvus v. vitellino-fulvus, levis ; sporæ 12–14 μ longæ, 6–7 μ latæ, medio ventricosæ, utrinque obtuse acutata.—Calcicola : B.C.S.

AMPHILOMA GRANULIFERUM, Müll. Arg. : thallus vix 1 cm. latus, miniato-fulvus, medio late areolato-diffractus, margine applanato-radians, lacinia et præsertim margines areolarum tuberculis graniformibus acute prominentibus exiguis concoloribus ornata, apothecia ignota.—Graniticola : Schweinf.

AMPHILOMA GRANULIFERUM v. *SUBVITELLINUM*, Müll. Arg. : thallus e fulvo vitellinus.—Cum forma genuina : Schweinf.

PSOREÆ.

PYXINE CONVEXA, Müll. Arg. : thallus ut in *P. cocoes*, levis et intus similiter albus, sed lacinia undique convexula, nec ultima plano-concava, apothecia tenuius marginata, demum convexa et subimmarginata, e nigrescente cæcio-pruinosa ; sporæ ut in comparata specie.—Ramulicola : B.C.S.

LECANOREÆ.

LECANORA NOTHA, Müll. Arg. : similis *L. atræ*, sed thalli areolæ leviter rugulosæ, magis flavo-cinerascentes, lamina (omnino alia) hyalino-virescens, epithecium æruginoso-nigricans et sporæ tantum 8–10 μ longæ, 7–8 μ latæ.—Graniticola : Schweinf.

LECANORA SOCOTRANA, Müll. Arg. : thallus albido-flavicans v. sulphurescens v. decolorato-albescens, limitatus, crassiusculus, tenuiter rimulosus, levis, nudus, intus e flavescenti albus ; apothecia 1–1 $\frac{1}{2}$ mm. lata, adpresso-sessilia, margo integer, cum thallo concolor, discus planus v. leviter convexus, fuscescenti-carneus v. subgilvus ;

sporæ 9-11 μ longæ, 5-5½ μ latæ.—Ad *L. orosteam* accedens.—
Quartzicola, frequens : B.C.S. et Schweinf.

LECANORA SOCOTRANA f. *LIVIDO-NIGRICANS*, Müll. Arg. : discus apotheciorum e fuscescente livido-nigricans.—Cum forma genuina speciei : B.C.S.

RINODINA SUBSTELLULATA, Müll. Arg. : thallus obscure cinereus, tenuis, areolato-rimosus, areolæ contiguæ, planæ, leves, opacæ ; apothecia adpressa, $\frac{2}{3}$ -½ mm. lata, plana, margo lecanorinus, demum fere lecideinus, discus madefactus et junior fuscus ; hypothecium hyalinum ; sporæ 15-20 μ longæ, 9-11 μ latæ, 2-loculares, fuscæ.—Quodammodo *Buelliam stellulatam* simulans.—Quartzicola : Schweinf.

RINODINA GRANULARIS, Müll. Arg. : thallus crebre granulari-subareolatus, albidus, areolæ valde exiguæ, angulosæ, convexæ, leves, centro monocarpicæ ; apothecia $\frac{1}{3}$ -½ mm. tantum lata, immersa, vertice haud emergentia et ipsa areola late albido-marginata, discus fuscus ; hypothecium e fuscescente demum hyalinum ; sporæ octonæ, 11-12 μ longæ, 5-6 μ latæ, biloculares et fuscæ.—Valde minutula, primo intuitu crustam sterilem granularem simulans.—Calcicola : B.C.S.

PERTUSARIA SCHIZOSTOMA, Müll. Arg. : thallus albescenti-flavus, continuus, minute rugulosus, undique minutissime ulcerato-puncticulatus, verrucæ 1½-1½ mm. latæ, hemisphæricæ, gibboso-irregulares, vertice depressæ, 5-7-carpicæ, ostiola e punctiformi oblongata ; sporæ geminatae, 130-190 μ longæ, 50-89 μ latæ, intus valide costulatæ.—Ramulicola : B.C.S.

PERTUSARIA SUBFLAVENS, Müll. Arg. : thallus sulphureo-flavens, tenuis, rugulosus, verrucæ hemisphæricæ, sat regulares, monocarpicæ, 1 mm. latæ, opacæ, ostiola haud emergentia, cum thallo concoloria, demum obscure carnea ; sporæ in ascis 2 v. rarius 1, 110-130 μ longæ, 55 μ latæ.—Ramulicola : Schweinf.

PERTUSARIA CICATRICOSA, Müll. Arg. : eadem est ac *P. communis* v. *neo caledonica* Nyl. : thallus flavescenti-albidus, rugulosus ; ver-

rucæ 1-3-carpicæ, hemisphæricæ, gibboso-subirregulares, ostiolum pallidum, tarde nigrescens, modice depressum, asci (1-) 2-spори; sporæ 110-160 μ longæ, 45-60 μ latæ, intus valide subreticulatum costatæ.—Ramulicola: B.C.S. et Schweinf.

PERTUSARIA SOCOTRANA, Müll. Arg.: thallus pallide cinereo-flavus, tartareus, rimoso-areolatus, areolæ planiusculæ, gibboso-inæquales, cæterum leves, verrucæ 1-1½ mm. latæ, hemisphæricæ, regulares, v. ostioliis mammoso-gibbosæ, 2-5 carpicæ; ostiola pallida, subclausa, impressa, demum mammoso-prominentia; asci 4-spори; sporæ 45-80 μ longæ, circ. duplo longiores quam latæ.—Ad saxa et calcarea et granitica vulgatissima: B.C.S. et Schweinf.

PERTUSARIA XANTHOLEUCA, Müll. Arg.: thallus ochroleucus, rimosus, areolæ planæ v. concaviusculæ, verrucæ innatæ, lecanoroidæ, $\frac{2}{3}$ - $\frac{3}{4}$ mm. latæ, albæ, monocarpicæ, discus late apertus, nigrescens, crasse albo-velatus, subplanus; asci 1-spори; sporæ 100-130 μ longæ et 53-60 μ latæ.—Graniticola: Schweinf.

LECIDEEÆ

BLASTENIA ALBIDO-CERULESCENS, Müll. Arg.: thallus cinereo-albidus, discreto-areolatus, areolæ angulosæ, planæ, levigatæ, in hypothallo coerulescente sparsæ; apothecia vix $\frac{1}{2}$ mm. lata, planiuscula, nigro-marginata, discus rufus v. ferrugineo-fuscus, sporæ orculiformes 11-13 μ longæ, 6-7 μ latæ.—Affinis *B. polioteræ*, quæ ibidem etiam obvia.—Ad saxa quartzosa: B.C.S.

BLASTENIA CRETACEA, Müll. Arg.: thallus cretaceo-albus, farinulentus, tenuis; apothecia $\frac{1}{3}$ - $\frac{1}{2}$ mm. lata, prominenter nigro-marginata, discus planus et rufo-nigricans, nudus; epithecium cærulescens, sporæ orculiformes 9-10 μ longæ, 5-6 μ latæ.—Affinis aegyptiacæ *B. melanocarpæ* Müll. Arg.—Calciola: B.C.S.

BLASTENIA VARIABILIS, Müll. Arg.: thallus flavescenti-cinereus, continuus et levis; apothecia $\frac{2}{5}$ - $\frac{1}{2}$ mm. lata, primum læte fulva et margine crasso concolore cincta, mox] fusciscentia et margine tenuiore nigrescente prædita, demum fusca et tenuissime nigro-

marginata; sporæ orculiformes 12-14 μ longæ, 6-8 μ latæ.—Ad saxa granitica: B.C.S. et Schweinf.

LECIDEA (sect. *Biatora*) *CONTRACTULA*, Müll. Arg.: thallus cinereo-flavicans, continuus, leviter rugulosus; apothecia vulgo in depressionibus leviusculis thalli sita, subinnato-adpressa, obscure fusca et plana, madefacta fusca, convexa et immarginata, lamina 55 μ alta, apice olivascens, cæterum cum hypothecio hyalina, paraphyses liberæ; sporæ octonæ, 9 μ longæ, 5 μ latæ.—Quartzicola: Schweinf.

LECIDEA (sect. *Biatora*) *PLUMBELLA*, Müll. Arg.: thallus pallide virenti-plumbeus, continuus, levigatus; apothecia innata, haud emergentia, discus $\frac{1}{4}$ - $\frac{2}{8}$ mm. latus, concavusculus, fusco-nigricans, epithecium fuscescens, lamina cum hypothecio hyalina, circ. 100 μ alta; sporæ 8-næ, 9-11 μ longæ, $4\frac{1}{2}$ -6 μ latæ.—Brasiliensi *L. impressæ* Krph. affinis.—Ad saxa granitica: Schweinf.

PATELLARIA (sect. *Biatorina*) *OBFUSCATA*, Müll. Arg.: thallus obscure rufescenti-fuscus, tartareo-leprosus, rimoso-areolatus; apothecia $\frac{1}{2}$ mm. lata, plana, margo primum cum thallo concolor, mox nigrifactus, integer, discus niger, planus, opacus; epithecium fuscum, lamina cum hypothecio hyalina; paraphyses sat liberæ; sporæ octonæ, 18 μ longæ, $2\frac{1}{2}$ μ latæ, 2-loculares, valide bacillares.—Juxta *P. lenticularem* locanda.—Graniticola: B.C.S.

PATELLARIA (sect. *Catillaria*) *SIGMOIDEA*, Müll. Arg.: thallus tenuiter tartareus, demum rimoso-areolatus, lacteo-albus, hinc inde hypothallo perspicuo cœrulescens; apothecia nigra, intus inferne atro-grisea, 1 mm. lata, demum convexa et tenuiter marginata; epithecium aeruginoso-atrum, lamina vinoso-fuscescens, hypothecium crassum, atrofuscum; sporæ 2-loculares, fusiformi-ellipsoideæ, utrinque acutatae et sigmoideo-curvatae.—Ad saxa granitica: B.C.S.

PATELLARIA (sect. *Raphiospora*) *DECUSSATA*, Müll. Arg.: thallus tenuis et depauperatus, minute leproso-granularis, argillaceus, lineis nigris hypothallinis peragratus; gonidia glomerulosa; apothecia $\frac{1}{4}$ - $\frac{2}{7}$ mm. lata, atra, crasse et prominenter nigro-marginata, discus planus; epithecium virenti-nigrescens, hypothecium inferne fusces-

cens, paraphyses capillares, tantum $1-1\frac{1}{2}$ μ crassæ; sporæ octonæ, 55 μ longæ, 4 μ latæ, $11-15$ -loculares, aciculari-fusiformes.—*Calcicola*: B.C.S.

BUELLIA PARASEMA, *Körb. v. OBLONGATA*, *Müll. Arg.*: thallus cum fibris ligni mixtus maculam albidam levigatam formans, apothecia nonnulla orbicularia, $\frac{1}{3}$ mm. lata, reliqua numerosiora triente longiora quam lata v. longiora; sporæ $14-16$ μ longæ, $7\frac{1}{2}-8\frac{1}{2}$ μ latæ.—*Ad ramulos decorticatos*: Schweinf.

BUELLIA PARASEMA, *Körb. v. SUBÆRUGINOSA*, *Müll. Arg.*: thallus albicans, rugoso-areolatus, apothecia obsolete v. leviuscule æruginoso-pruinosa.—*Ramulicola*: Schweinf.

BUELLIA PARASEMA, *Körb. v. CONTORTA*, *Müll. Arg.*: thallus crassus, subrugoso-areolatus, demum ochraceo-cinereus; apotheciorum margo valde contortus, discus æruginascens.—*Ramulicola*: B.C.S.

BUELLIA BRACHYSPORA, *Müll. Arg.*: apothecia parasitica, superficialia, $\frac{1}{4}-\frac{1}{3}$ mm. lata, tota nigra, subdepresso-plana, prominenter marginata, margo nitidulus, discus planus et nudus, opacus; epithecium fuscum, lamina hyalina, hypothecium superne hyalinum, cæterum profunde atrofuscum; sporæ $7-9$ μ longæ, $4\frac{1}{2}-6\frac{1}{2}$ μ latæ, in ascis circ. 6.—*In thallo Buellie innatæ*: Schweinf.

BUELLIA ALBINEA, *Müll. Arg.*: omnia ut in *B. stellulata* v. *prothallina*, sed areolæ candide albæ, 2-3-plo majores, hinc inde contiguæ, angulosæ, rimis atris segregatæ; apothecia primum albo-marginata, dein crebre diplotommoideo-crenulata, mox nigra, hypothecium hyalinescens; sporæ 9 μ longæ, 5 μ latæ.—*Ad saxa quartzosa*: B.C.S.

BUELLIA LEUCINA, *Müll. Arg.*: thallus tenuiter tartareus, levigatus, albus, rimoso-areolatus, areolæ majusculæ, 1-3-carpicæ, fissuris nigris separatæ; apothecia innata, primum margine accessorio albo-pulverulento crenato cincta, dein nuda et e superficie thalli leviter emergentia, tota concoloria, extus intusque nigra, tenuiter nanomarginata; epithecium late atrofuscum, lamina vitreo-hyalina, hypo-

thecium infere late fuscum ; sporæ 12μ longæ, 6μ latæ.—Ad saxa quartzosa : B.C.S.

BUELLIA SUBSTIGMATEA, *Müll. Arg.* : thallus tenuissimus, continuus, levis, olivaceo-virens, demum subrimoso-areolatus ; apothecia arcte sessilia, $\frac{1}{6}$ — $\frac{1}{4}$ mm. lata, plana, prominenter marginata, nigra ; epithecium fuscum, lamina hyalina, hypothecium hyalino-subfuscum ; sporæ octonæ, 10 — 13μ longæ, 7 — 8μ latæ.—Ad saxa granitica : B.C.S.

BUELLIA SUBSTIGMATEA, *Müll. Arg. v. OBFUSCATA*, *Müll. Arg.* : thallus magis distincte rimoso-areolatus et olivaceo-fuscus.—Ibidem : B.C.S.

BUELLIA INNATA, *Müll. Arg.* : thallus tenuiter tartareus, argillaceo-albidus, continuus, mox quoad partem superficialem rimoso-areolatus, areolæ contiguæ, planæ, leves, opacæ ; apothecia immersa, atra, obsolete nigro-marginata, evoluta $\frac{1}{3}$ — $\frac{2}{5}$ mm. lata, discus leviter concavus ; epithecium et hypothecium atro-fusca, lamina hyalina ; sporæ 9 — 10μ longæ, $5\frac{1}{2}$ — $6\frac{1}{2} \mu$ latæ.—Ad saxa granitica : Schweinf.

GRAPHIDEÆ.

DIRINA CINEREA, *Müll. Arg.* : thallus cinereus v. flavescenti-cinereus, madefactus virens, intus argillaceo-pallidus et e flavescente et cinnabarino variegatus ; apothecia et sporæ ut in *D. repanda*, sed margo tenuior demumque subaurantiacus.—Calicicola : B.C.S.

DIRINA CINEREA, *Müll. Arg. f. SOREDIOSA* : thallus sorediis circ. 1 mm. latis demum granuloso-efflorescentibus ornatus.—Cum planta genuina speciei : B.C.S.

DIRINA IMMERSA, *Müll. Arg.* : thallus tartareus, tenuis, levis et continuus v. demum obsolete rimulosus, cærulescenti-cinereus v. incanus ; apothecia immersa et prominentia thallina circulari cincta, $1\frac{1}{2}$ mm. lata, demum vix distincte emergentia, discus planus, cinereo-pruinosis ; sporæ octonæ, 18 — 19μ longæ, 6 — 8μ latæ, 4-loculares.—Calicicola : B.C.S.

DIRINA IMMERSA, Müll. Arg. f. *SOREDIA*TA, Müll. Arg.: thallus sterilis, minute sorediosus.—Cum forma genuina speciei, calcicola : B.C.S.

OPEGRAPHA (sect. *Lecanactis*) *VESTITA*, Müll. Arg.: thallus albus, tenuis, levigatus, nitidulus; apothecia primum orbicularia, dein 1–1½ mm. longa et varie oblongata, simplicia v. altero latere uniramea, sessilia, late adnata, primum undique crasse thalino-vestita, margines proprii lecideini dein emergentes et minus conniventes, discus crasse albido-pruinosis; sporæ octonæ, 20–28 μ longæ, 6–7 μ latæ, fusiformes, 8-loculares.—Lignicola : B.C.S.

OPEGRAPHA (sect. *Lecanactis*) *ELEGANS*, Müll. Arg.: similis *O. lynceæ*, a qua differt thallo albiore, apotheciis multo gracilioribus et sporis brevioribus, 18–27 μ longis, absque halone 4 μ latis, 7–8 septatis.—Lignicola : B.C.S.

OPEGRAPHA (sect. *Lecanactis*) *SUBCALCAREA*, Müll. Arg.: thallus tartareus, crassiusculus, continuus et levigatus, virescenti-albus, intus cretaceo-albus; apothecia ½ mm. lata et regulariter orbicularia, demum radiatim abbreviato 2–3-ramulosa, omnino immersa, cæσιο-pruinosa, demum nigricantia; sporæ 20–25 μ longæ, 5 μ latæ, dactyloideæ, 4–6-loculares.—Calcicola : B.C.S.

OPEGRAPHA (sect. *Lecanactis*) *CRETACEA*, Müll. Arg.: thallus crassiusculus, supra subfarinosus, continuus, junior levigatus, cretaceo-albus; apothecia primum innata, orbicularia, pruinosa, dein subinnato-sessilia, mox angulosa et reniformia v. abbreviatim lobulata, discus planus, cæσιο-velatus, margo acute prominens et niger, latere extus albo-farinulentus; sporæ 30–34 μ longæ, 4–5 μ latæ, dactyloideæ, 7–9 septatæ.—Calcicola : B.C.S.

OPEGRAPHA DRACÆNARUM, Müll. Ar.: g thallus tenuis, albus, levis, demum rugulosus; apothecia ½ mm. lata, pluries longiora quam lata, elongata et varie flexuoso-curvata, primum plane innata, thallo tecta, demum denudata, sed non emersa, atra, opaca, rima angusta depressa albo-pruinosa, demum atrata, margines angusti haud sulcati; hypothecium fuscum; sporæ 15 μ longæ, 4 μ latæ, fusiformes, 4–5-loculares.—In ramis *Dracænarum* : Schweinf

OPEGRAPHA MICROSPORA, Müll. Arg.: thallus flavescenti-albus, subtenuis, levigatus et continuus (demum evanescens); apothecia semi-immersa, dein superficialia, $\frac{1}{2}$ mm. lata, demum 2 mm. longa, subsimplicia, evoluta late aperta, discus albo-pruinosis, demum denudato-niger; sporæ 11-13 μ longæ, 3-3 $\frac{1}{2}$ μ latæ, 3-5-septatæ.—Corticola: B.C.S.

OPEGRAPHA SORORIELLA, Müll. Arg.: thallus tenuissimus, indeterminatus, argillaceo-albus, levis, subfarinulentus; apothecia sessilia, 1 $\frac{1}{2}$ -2 $\frac{1}{2}$ mm. longa, $\frac{3}{20}$ mm. lata, linearia, arcuato-curvata, simplicia v. 3-4-radiata, pro latitudine sat elata, undique nigra et opaca, nuda, margines arcte conniventes, discus angustus, niger; sporæ 16 μ longæ, 6 μ latæ, 4-loculares, late dactyloideæ.—Ramulicola: B.C.S.

MELASPILEA STIGMATEA, Müll. Arg.: apothecia in thallo alieno immersa, nonnisi margine tenuissimo nigro-fusco leviter emergentia, orbicularia v. orbiculari-elliptica, $\frac{1}{10}$ - $\frac{1}{8}$ mm. longa, plana, nuda, fusco-nigra, opaca; margo subtus continuus, tenuis; sporæ evolutæ pallide fuscæ, ovoideæ, 12-14 μ longæ, 7-8 μ latæ, inæqualiter 3-loculares, sc. bilocularium locus inferior paullo longior et angustior mox ipse transversim divisus.—In thallo *Dirinæ repandæ*: B.C.S.

GRAPHIS BRACHYCARPA, Müll. Arg.: thallus cœrulescenti-albus, tenuis, levis et continuus; lirellæ breves, $\frac{1}{3}$ - $\frac{2}{3}$ v. sæpe 1 mm. longæ, sæpius 2-3-plo longiores quam latæ, emersæ, rigidæ, rectæ v. subrectæ, lateraliter altiuscule thallino-vestitæ, rima angusta, perithecium basi deficiens, discus niger subocclusus; sporæ 8-næ, 20-27 μ longæ, 7-8 $\frac{1}{2}$ μ latæ, 9-loculares.—Ramulicola: Schweinf.

GRAPHIS INUSTA, Ach. v. **RADIANS**, Müll. Arg.: apothecia mediocria, stellato-radiantia, radii semel v. bis dichotome divisi, ramuli acuti.—Ramulicola: Schweinf.

GRAPHINA BALFOURII, Müll. Arg.: thallus giganteus, crassus; corticiiformis, 2-3 v. hinc inde usque 5 mm. crassus, abrupte limitatus, continuus et levis, argillaceo-nigricans v. pallidior, intus pallidior; apothecia 8-12 mm. longa, radiatim divisa, immersa et

crassiuscule thallino-tecta, labia thallina tegenti conniventia, discus madefactus rufo-fuscus, perithecium inferne deficiens; asci 1-spori; sporæ 190 μ longæ, 50-60 μ latæ, utrinque obtusæ, copiosissime parenchymatice divisæ, locelli in quaque serie transversali 8-12.—Species valde insignis.—Truncicola: B.C.S.

GRAPHINA VARIANS, Müll. Arg.: thallus tenuis, albus v. albescens, sublevia, obsolete farinosus; lirellæ oblongato-ellipsoideæ, $\frac{1}{4}$ - $\frac{1}{3}$ mm. latæ, $1\frac{1}{2}$ -3-plo longiores quam latæ, evolutæ emerso-sessiles, lateraliter spurie thallogice vestitæ, demum denudatæ, rimoso-apertæ, margines tumidi nigri, discus albo-pruinosis, demum denudatus, angustus; perithecium subtus deficiens; sporæ octonæ, 23-26 μ longæ, 8 μ latæ, 8-loculares, loculi transversim 2-3 locellati.—Fere *Opegrapham variam* simulans.—In truncis Dracænæ: Schweinf.

DIORYGMA SOCOTRANUM, Müll. Arg.: thallus tenuis, e pallido-argillaceo albus, continuus, levis, subpulverulentus; apothecia thalli labiis emergentibus et conniventibus recepta, $\frac{1}{2}$ mm. longa, sæpius triente longiora quam lata, simplicia, elliptica, perithecium deficiens, discus latus, planus, carneus, cinereo-pruinosis; asci 2-6-spori, sporæ hyalinæ, 27-40 μ longæ, 13-16 μ latæ, loculi 6-10 parenchymatici.—Corticola: B.C.S.

ARTHONIA CALOSPORA, Müll. Arg.: thallus albus, subtenuis, leviusculus, circa apothecia tumidus; apothecia $\frac{1}{2}$ -1 mm. lata, orbicularia, angulosa, convexo-plana, atra, opaca, madefacta nigro-fusca; asci 8-spori, sporæ 50-60 μ longæ, 18-20 μ latæ, vulgo incurvæ, 10-12-loculares, loculi subæquilongi.—Ramicola: B.C.S.

ARTHONIA COMPLANATULA, Müll. Arg.: thallus hypophloeodes; apothecia $\frac{1}{2}$ -1 mm. lata, orbicularia v. leviter angulosa, deplanata, atra, opaca, intus concoloria, juniora griseo-velata; sporæ 8-næ, 10-12 μ longæ, 4-5 μ latæ, 4-loculares, locus superior reliquis haud major.—Corticola: B.C.S.

ARTHOTHELIUM LEUCOCARPUM, Müll. Arg.: thallus albus, crassiusculus, rugulosus; apothecia hemisphærica, subregularia, $\frac{1}{2}$ -1 mm.

lata, tota extus intusque alba, albo-farinosa; sporæ octonæ, 75 μ longæ, 18 μ latæ, 8-loculares, loculi semel v. bis cruciatim divisi.—Corticola: B.C.S.

ARTHOTHELIUM EMERSUM, Müll. Arg.: thallus albus, tenuissimus, lævis, subfarinulentus; apothecia $\frac{1}{2}$ – $\frac{2}{3}$ mm. longa, orbicularia v. dimidio longiora quam lata, atra, nuda, depresso-convexa; sporæ octonæ, 15–17 μ longæ, 7–9 μ latæ, ovoideo-fusifformes, 6-loculares, loculi nonnulli longitrorsum semel divisi.—Truncicolum: B.C.S.

ENTEROGRAPHA AFFINIS, Müll. Arg.: thallus tenuiter tartareus, gleboso-inæqualis, argillaceo-cinereus; apothecia immersa, ore orbicularia v. elliptica v. irregulariter angulosa, plana, nuda, atra, madefacta atro-fusca, circ. $\frac{5}{10}$ – $\frac{6}{10}$ mm. lata; perithecium tenuissimum, olivaceo-fuscum, basi deficiens; lamina undique hyalina; sporæ 8-næ, 20–23 μ longæ, 4–5 μ latæ (sc. absque halone), 6-loculares.—Corticola: B.C.S.

ENTEROGRAPHA LACTEA, Müll. Arg.: thallus cum verrucis apotheciigeris lacteo-albus, tenuis, polito-levigatus, nitidulus; verrucæ $\frac{1}{2}$ mm. latæ, orbiculares, obtuse angulosæ, leviter convexæ; apothecia sparsa, haud emergentia, $\frac{1}{15}$ – $\frac{1}{10}$ mm. lata, regulariter orbicularia, nigra, nuda; perithecium lateraliter tenuissimum, fuscum, basi deficiens; sporæ 8-næ, 23–28 μ longæ, 4 μ latæ (sc. absque halone), 8–10-loculares, loculi subæquilongi.—Corticola: B.C.S.

ENTEROGRAPHA FRATERCULANS, Müll. Arg.: thallus crassiusculus, leviter albo-flavicans, verrucæ thallinæ subirregulariter orbiculares, depresso-hemisphæricæ; apothecia in centro verrucarum conferta, $\frac{1}{10}$ mm. lata, immersa et leviter depressa, demum magis sensu radiali verrucarum oblongata, pro parte confluentia, fusca, nonnihil cinereo-pruinosa, perithecium tenue, fuscum, basi deficiens; sporæ 8-næ, dactyloideæ, 24–27 μ longæ, 6–8 μ latæ, 3-septatæ.—Corticola: B.C.S.

MINKSLA, Müll. Arg. gen. nov.

Thallus crustaceus, areolatus, areolæ demum pro parte verruciformes et fertiles, gonidia chroolepoidea; apothecia in verrucis thallinis sita, gymnocarpica, perithecium simplex, proprium, immer-

sum, completum, basi crassius, epithecium distinctum, paraphyses connexæ, sporæ hyalinæ, parenchymaticæ.—Ab *Enterographa* et *Chiodectone* differt sporis parenchymaticis. Genus clarissimo de anatomia et morphologia Lichenum meritissimo Doctori Minks grato animo dicatum est.

MINKSIA CÆSIELLA, Müll. Arg.: thallus cinereus v. cinereo-albus, crassiusculus, levis, dein rimosus aut diffractus et pulverulentus; apothecia orbicularia et irregulariter elliptica, $\frac{1}{3}$ – $\frac{1}{2}$ mm. lata aut minora, plana, cæsiio-velata, demum atra et convexula; perithecium integrum, fuscum, basi paullo crassius; sporæ 20–28 μ longæ, $6\frac{1}{2}$ –7 μ latæ, (6-) 8-loculares, loculi intermedii nonnulli longitrorum semel divisi.—Corticola: B.C.S.

MINKSIA CANDIDA, Müll. Arg.: thallus albus, depresso-verrucosus; apothecia oblonga, sigmoideo-curvata, depressa et semper albidopruinosa; sporæ ut in præcedente.—Corticola: B.C.S.

CHIODECTON NANUM, Müll. Arg.: thallus albus, crassiusculus, levigatus; apothecia subseriatim disposita, immersa, extus punctulis depressis fumoso-nigricantibus tantum $\frac{1}{10}$ – $\frac{1}{20}$ mm. latis distincta, demum fere astroideo-confluentia, tota in sectione verticali fere $\frac{1}{2}$ mm. lata, basi profunde conico-angustata; sporæ 8-næ, fusiformes, 21–24 μ longæ, 5 μ latæ, 5–7-septatæ, loculi æquales.—In ramis Dracænæ: Schweinf.

CHIODECTON CIRCUMSCISSUM, Müll. Arg.: thallus agillaceo-virens, lineis nigris crebre decussatus, tenuis, levis; apothecia in verrucis convexis mediocribus conferta, orbicularia v. oblongata, depressa, pruinosa, mox denudata, $\frac{1}{3}$ – $\frac{1}{2}$ mm. lata, a thallo circumscisso-libera, perithecium lateraliter tenue, basi valde incrassatum; sporæ 8-næ, 36 μ longæ, 5 μ latæ, 9–12-loculares.—Corticola: B.C.S.

CHIODECTON SOCOTRANUM, Müll. Arg.: thallus tartareus, albus, demum areolato-rimosus, farinulentus, verrucæ fertiles albo-virentes, thallo leviores, depresso-hemisphæricæ, parum emersæ, 1–5-carpicæ; ostiola punctiformia, nigra, astroideo-subconfluentia, perithecium lateraliter tenue; sporæ 23–27 μ longæ, $5\frac{1}{2}$ – $6\frac{1}{2}$ μ latæ, 3-septatæ.—Calcicolum: B.C.S.

VERRUCARIEÆ.

VERRUCARIA RUPESTRIS, Schrad. v. *ALOCIZOIDES*, Müll. Arg. : thalli plagulæ irregulariter anguloso-orbiculares, vix $\frac{1}{2}$ cm. latæ, varie confluentes, linea nigra cinctæ et thallum collectivum crebre geographicum formantes. Sporæ 18-24 μ longæ, 11-15 μ latæ.—Callicola : B.C.S.

VERRUCARIA PROMINENS, Müll. Arg. : thallus tenuis, continuus, lævis, olivaceo-virens; apothecia $\frac{1}{8}$ - $\frac{1}{7}$ mm. lata, elato-semiglobosa, basi truncata, nigra, scabridula, primum thallo leviter velata, mox prominenti-emersa et nuda, vertice rotundato-obtuso integra, perithecium integrum sed basi attenuatum; paraphyses molliusculæ, superne clavatæ et ibidem 3 μ latæ, septatæ; sporæ 8-næ, oblongato-ovoides v. ellipsoideæ, 15-21 μ longæ, 7-8 μ latæ.—Graniticola : B.C.S.

MICROGLÆNA SAXICOLA, Müll. Arg. : similis *M. Wallrothianæ*, sed thallus subfusco-olivaceus, mox rimoso-diffractus, verrucæ thallinæ paullo minores, circa ostiolum fuscum minus cinerascens, sporæ ambitu angustiores, 28-33 μ longæ, 9-11 μ latæ, transversim 7-9-septatæ, loculi longitrorsum 2-4-divisi.—Graniticola : Schweinf.

PYRENULEÆ.

PYRENULA OBSCURATA, Müll. Arg. : thallus subcartilagineus, olivaceo-fuscus, superficie undulato-inæqualis; apothecia sparsa, omnino immersa, oblecta, demum vertice denudata; perithecium integrum, globosum, crassum, basi incrassatum, $\frac{4}{10}$ mm. latum; paraphyses capillares, asci cylindrici, 8-sporei; sporæ 23 μ longæ, 10-12 μ latæ, 4-loculares, fusæ.—Corticola : B.C.S.

POLYBLASTIA TROPICA, Müll. Arg. : thallus hypophloeodes; apothecia depresso-hemisphærica, $\frac{1}{2}$ mm. lata, $\frac{1}{10}$ - $\frac{1}{8}$ mm. alta, superne nitidula, perithecium dimidiatum, basi incurvatum et simul extorsum attenuatum; asci 3-4-sporei; sporæ hyalinæ, 25-28 μ longæ, 10 μ latæ, 6-8-loculares, loculi 2-4-locellati.—Ramulicola : B.C.S.

BATHELIUM PAUPERRIMUM, Müll. Arg. : thallus hypophloeodes, perithecia epidermide tecta, demum vertice paullo denudata, solitaria v. pauca confluentia et tum stroma minutulum fusco-nigricans

distincte sed leviter prominens formantia, dimidiata, depresso-hemisphærica, $\frac{1}{3}$ – $\frac{2}{7}$ mm. lata, basi autem in sectione $\frac{1}{10}$ mm. lata; paraphyses tenues, laxè clathratim ramosæ; sporæ in ascis 2–8-næ, hyalinae, 25 μ longæ, 4–10 μ latæ, 4–5-septatæ, loculi 1–3-locellati.—Ramulicolum: B.C.S. et Schweinf.

BATHELIUM VELATUM, *Müll. Arg.*, thallus vix nisi hyphemoideus circa perithecia; stromata suborbicularia, $1\frac{1}{2}$ –2 mm. lata, depresso-hemisphærica, vertice velata; perithecia immersa, dimidiata, basi inflexa; paraphyses connexæ, sporæ in ascis 1–8, hyalinae, 25–38 μ longæ, 10–15 μ latæ, 6–8-loculares, loculi 2–3-locellati.—Corticolum: B.C.S.

There was laid on the table a Note on the Constitution of the Lines forming the Low Temperature Spectrum of Oxygen, by Professor Piazzzi Smyth, Astronomer Royal for Scotland.

Monday, 6th February 1882.

PROFESSOR BALFOUR, Vice-President, in the Chair.

The following Communications were read:—

1. On the Colour of the Mediterranean and other Waters.

By Mr. John Aitken.

(Abstract.)

The investigation was at first undertaken with a view of determining how the blue colour of the water of the Mediterranean is produced, and of finding the explanation of the different colour phenomena seen in that sea. The investigation was afterwards extended to other waters.

The experiments were made with a special view of determining whether the *selective reflection* or the *selective absorption* theory gave the correct explanation of the blueness seen in water. According to the *selective reflection* theory the colour is due to the light reflected by extremely small particles of matter suspended

in the water. These particles being so small they can reflect only the short waves of light, or those which belong to the blue end of the spectrum. The other theory explains the colour by supposing that water has a selective absorption for the rays of the red end of the spectrum—that water is in fact a blue transparent medium.

Three different methods were adopted of testing the correctness of these rival theories, and all three proved the water of the Mediterranean to be blue by selective absorption, and show that light in passing through the water has the rays of the red end of the spectrum absorbed, and only those of the blue end transmitted.

The first method tried was to find out what is the colour of the illumination of submerged objects. This was done by taking a long metal tube, closed at the end with a glass plate, and sinking it vertically in the water, and looking through it at white and different coloured objects fixed near the end of the tube. When this was done, it was found that a white object appeared of a most beautiful deep and delicate blue at a depth of 6 m. If the selective reflection theory was true, submerged objects would be illuminated with a colour complimentary to that reflected by the fine particles, and would therefore appear orange or yellow, the exact colour depending on the amount of green in the reflected blue.

If the blue colour of the sky, as generally supposed, is due to the reflection of the blue rays by small particles of matter suspended in the air, it obviously follows that light in passing through our atmosphere must become of a colour complimentary to the blue of the sky; and it is asked, may not this be one of the reasons why the sun when near the horizon, and all artificial lights when seen at a great distance, appear more or less yellow?

The second method of experimenting was by looking at a white surface through a considerable length of water contained in a blackened tube. The light transmitted was found to be blue, thus showing the water to have a selective absorption for the rays of the red end of the spectrum.

The third method was, by sinking white and different coloured surfaces under the water, and noting the change which took place in the colours. The colours selected were—red, yellow, and purple. It was found that these colours when seen through the water

changed in the same way as when seen through a blue transparent medium, such as a piece of glass. The white changed to blue. The red darkened very rapidly as it descended, a very small depth of water being sufficient to destroy all the colour. At a depth of about 2 m. a very brilliant red was so darkened as to appear a dark brick red. Yellow changed to green, by the water absorbing the red component of the yellow. An orange, as it sunk in the water, appeared to become more and more unripe, while a lemon became quite green. The purple surface quickly changed to a dark blue or violet by the selective absorption of the water. These changes, being all due to the cutting out of the red component of the colours, showed the water to have a selective absorption for the rays of the red end of the spectrum.

If the water had been coloured blue by selective reflection, then those test colours would all have appeared deficient in blue when sunk in the water, as the fine particles would reflect and scatter the blue rays. Experiments are described which show that when these colours are sunk in water coloured blue by reflection from small particles, that white changes to yellow, while yellow simply deepens in colour, and purple grows redder.

All these different methods of experimenting show this water to be a blue transparent medium, and that it acts in the same way as a solution of a blue salt or as a blue tinted glass. It is then shown that this selective absorption theory is not enough to account for the different colour phenomena seen in water. A piece of blue glass or a blue solution have but little colour when viewed from the side on which the light is falling, and it seems certain that light will penetrate pure water till it is all absorbed, and the water will look dark and colourless. Something more, and that of great importance, is obviously necessary to explain the different colour phenomena seen in different waters, and in the same water at different times.

If the water of the Mediterranean, when brilliantly coloured, is examined by means of a concentrated beam of light, it is found to be full of fine solid particles in suspension. It is shown that it is to this dust of the sea—so to speak—that the Mediterranean owes its fine and varied colouring. The particles of this aquatic dust are large, and reflect not only the blue rays, like the supposed particles of the selective reflection theory, but they reflect rays of

all colours, and the water, by its selective absorption, strikes down the red rays, and only the blue rays are reflected to the surface and to the eye. These solid particles determine the brilliancy, and the selective absorption of the water determines its colour.

The colour and the amount of the suspended particles is then considered. It is shown that the colour of the particles will have a marked influence in the appearance of the water. If the particles are yellow—sand particles for instance—then a blue coloured water will appear to be green, as the light reflected by the yellow particles is deficient in the rays of the violet end of the spectrum.

In the Mediterranean the solid particles are whitish, and all the different colour phenomena are easily explained by the different amounts of the reflecting particles at the different places. Where the colour is deep blue there are few particles in the water, and but little light reflected; and, further, the light passes through a great amount of water, and undergoes a great amount of selective absorption before it is reflected to the surface and to the eye. But if there are many particles in the water much light is reflected, and the colour is chalky blue-green, as the light does not pass through so great a depth of water, and is therefore not so deeply coloured, nor has it so many of the green rays cut out as in the water where the particles are few and far separated.

Colour experiments on a small scale with a solution of Prussian blue and a fine white powder are described. If the solution of Prussian blue is placed in a vessel, the bottom and sides of which are dark and reflect no light, then the coloured solution appears dark and colourless; but if a little of the white powder is added then the solution at once becomes brilliantly coloured. By varying the amount of the powder in the water all the varied colour effects of the Mediterranean can be reproduced, a little powder causing the solution to appear deep blue, and as more powder is added the brilliancy of the water increases, and its colour changes from blue to chalky blue-green.

The presence and the abundance of white reflecting particles is shown to be a characteristic of all finely coloured waters, and the wave-washed shores of the Mediterranean are shown to be the factories in which are prepared its reflecting particles. The waves, as they beat on the shore, grind up the stones and rocks, and stir

up a great amount of fine whitish solid matter, which gives the water along the shore a milky appearance.

With the assistance of these whitish particles, we understand how it is that the brilliant blue-green of this sea depends so much on the continuance of sea-breezes. The longer the wave mills have been at work the more fine powder has been produced along the shore, and more time given for the particles to be carried seaward, by the wave-mixed and wind-driven waters, and the blue green which only extended in a narrow band along the shore, when the wind began to blow, is, after a few days of inshore wind, seen to extend far to sea. We also understand how it is that the colour near shore is so brilliant and so much greener than outside. Near the shore there is a greater quantity of white solid matter in suspension; there is therefore more light reflected, and further, the light does not penetrate through so great a depth of water, and has not so much of the light of the red end of the spectrum cut out, and therefore looks greener than the water outside, the light from which has to penetrate a greater depth of the absorbing medium. The blueness and beauty of the Mediterranean would thus appear to be due to the blue transparency of its waters, coupled with the presence of white reflecting particles, and the variety in its colouring to the amount of the suspended particles at different places and at different times.

From this we see the important influence which the geological formation of the shore has on the appearance of the water of a sea, as it determines the nature of the solid suspended particles. This is beautifully illustrated by the difference of colouring in the Mediterranean at Mentone and at Cannes. At Mentone, limestone is everywhere abundant along the shore, and this limestone, when ground up by the waves, produces an extremely fine and white powder, which, mixed with the water, causes the sea at Mentone to be far more brilliantly coloured than it is at Cannes, where there is but little limestone, and the shore is almost everywhere covered with sand, the debris of the surrounding rocks.

In the experiments in the Mediterranean it was found that the solid particles were so abundant that they prevented the sun's rays penetrating in a direct line to any great depth. This was shown by the illumination of the white surface placed at some

distance under the water, and seen through the empty tube, being the same, whether the surface was turned towards the sun or away from it. It was also shown by the fact that at a depth of 6 m. these solid particles were found to reflect about as much light as a white surface did. These solid particles act like a fog, and, while they stop the light penetrating in a direct line, yet allow it to penetrate much further by internal reflection. The sun's rays get entangled—so to speak—among the particles, and are reflected from particle to particle, becoming a deeper blue with each reflection, so that the particles become illuminated with blue light. From this it is obvious that the more transparent the water, and the greater the reflecting power of the particles, the more deeply coloured will the water appear.

The Lake of Como was the next water visited. A white surface seen through its waters, showed it to be as deeply coloured as the Mediterranean, yet the absence of white reflecting particles in its waters and its dark-coloured bottom, cause it to appear comparatively dark and colourless. When a quantity of white reflecting particles was artificially mixed up with the water in this lake a fine blue-green cloud was formed, which remained visible for some time amidst the darker waters, and showed that all this lake required to make it brilliantly coloured was the presence of white suspended particles in its waters. The waters of Como, in their passage from the lake to form the river Adda, change to a fine blue. This sudden alteration in the appearance of the water is shown to be probably due to the addition of fine reflecting particles to the water on entering the river.

Lago Maggiore, compared with Como and the Mediterranean, looks greener than either, but reflects more light than Como.

The Lake of Geneva, whose waters have been so highly praised by all writers, was next visited, and the explanation given of the colouring of the Mediterranean was found to apply here also. Near Bouveret, where the Rhone enters the lake, all the variety of colour phenomena seen in the Mediterranean were repeated. The light coloured muddy waters of the entering river, as they stretched far into the lake, represented the whitish waters near shore in the Mediterranean, and where this whitish stream mixed with the waters of the lake, the bright blue-green of the Mediterranean was

reproduced, while further out the waters were deeper blue, rivalling in brilliancy those of the Mediterranean. The work done by the waves along the shores of the Mediterranean, in manufacturing the light-reflecting particles, is for the Lake of Geneva, done by the grinding of the glacier mills and streams of the Rhone valley.

The silt brought down by the Rhone was found to be composed of clean white particles, like fine white sand. Many of the particles are thin polished plates, and when examined by means of a concentrated beam of light, while in suspension in water, are seen to flash brilliantly in the strong light. This white solid matter brought down by the Rhone is constantly being deposited all over the bottom of the lake, and it is this whitish deposit which gives to the Lake of Geneva one of its peculiarities. The light reflected from the whitish bottom causes the water of the lake, all along the shore to appear of a peculiar light blue-green colour, and enables us to judge of the depth of the lake at depths far beyond that to which we can see the bottom. We can only see a white surface of 15 cm square to a depth of about 7 m., yet the light reflected from the bottom affects the appearance of the water at depths far beyond 7 m., showing that light penetrates by diffusion in these waters to far greater depths than it can directly.

The brilliancy and beauty of the Lake of Geneva would thus appear to be due to the purity and transparency of its waters, coupled with the presence of an enormous amount of white reflecting surfaces, both in suspension in its water and deposited all over the bottom of the lake, the effect being intensified by the brilliancy of the reflecting particles.

The colour of the water in Lake Bourget was found to be similar to that in the Lake of Geneva, though at the time it was visited it was slightly more turbid. A white surface could not be seen to so great a depth as in Geneva, and the water, even in the middle of the lake, when examined by means of a concentrated beam of sunlight, was found to be very full of suspended light-reflecting particles similar to those brought down by the Rhone.

The examination of the water in these lakes was confined to the coloured surface experiments, and to a spectroscopic examination of the internally reflected light. The results were all similar to those in the Mediterranean.

In the beginning of autumn the sea off the west coast of Scotland, near the village of Ballantrae, and also in Brodick Bay, was visited, and the waters examined by means of submerged coloured surfaces, and by means of the spectroscope. The water was here found to be much greener than any previously examined. A large quantity of this water was filtered, when it was found that most of the suspended particles were fine grains of sand. From this it is concluded that the greenness of our northern seas is in part due to the reflecting particles being yellow, and the reflected light, therefore, deficient in the more refrangible rays. These yellow sand particles not only explain part of the greenness of our northern seas, but they also explain their comparative darkness and deadness, the yellow sand particles reflecting so little light. The importance, however, of even these bad reflectors was very evident during the time the observations were being made. It was noticed that the water was much more brilliantly green during and immediately after an inshore wind, and when the filter showed the water to have a good deal of sand in suspension, than after a calm, when many of the particles had settled out. Some water collected about a mile seaward from Ballantrae was examined in a glass tube $7\frac{1}{2}$ m. long, and was found to be of a blue green colour.

The water of Loch Lomond was next examined, and found to be a perfect contrast to any previously described, being of a colour nearly complementary to that of the Lake of Geneva. A white surface seen through its waters appearing yellow, and the submerged coloured surfaces showed its waters to have their greatest absorption for the rays of the violet end of the spectrum. Its waters reflect a slightly yellowish light, its spectrum being brightest in the yellow. This water is so deficient in reflecting particles that its brightness is never greater than what we call brown. If it was supplied with abundance of reflecting particles Loch Lomond would be a yellow lake.

Well waters were also examined for colour by placing them in long tubes, and looking through the water at white and at coloured surfaces. The tubes were in pieces, so that they could be fitted up in lengths of from 3 m. to 15 m., to suit the transparency of the water under examination. The tubes were fixed horizontally, and at a convenient height for looking through them, and the water to

be tested was poured in till the tube was half full, so that by looking through the upper half of the tube the coloured surface could be seen, and through the lower half the effect of the absorption of the water on the colour, and on the brilliancy, of the transmitted light. The transmitted light was also examined by means of a spectroscope.

The colours of the different waters were found to vary greatly. One sample was of a fine blue, others were green-blue, some green, whilst others were of colours between green and yellow, but all were of colours between blue and yellow. It was observed that the more transparent a water was, the nearer its colour was to blue. Scarcely any light could be seen through 7 m. of any of the yellowish waters, whilst through this length all the bluish waters were quite transparent, and the spectroscope showed that some of the waters transmitted almost the entire light of the blue end of the spectrum, and only stopped the rays of the red end. When one of the bluish waters was examined in a tube 15 m., or nearly 50 feet long, it appeared of a fine blue green as transparent as a piece of glass.

Only very little relation could be traced between the colour of a water—when tested in long tubes—and its suitability for dietetic purposes.

The *cause* of the colour of water has been a frequent subject of speculation. Every substance which has been discovered in water has in turn been suggested as the cause of the colour. When no useful purpose could be given for its presence, it was told off to do the ornamental, and make the water beautiful to the eye. All these speculations assume that the colour is due to some impurity in the water. This, however, is obviously begging the whole question. It is first necessary to find out whether water has any colour in itself, and what that colour is, before we can say anything about the effect of impurities.

As it would be impossible to prepare absolutely pure water, and as we might still be in doubt as to whether any colour seen in purified water was due to the water or to the impurities, the following method of experimenting was adopted:—Distilled water was prepared in two sets of apparatus; in one set the condensing tube, the collecting bottle, and the testing tube were all of glass; in the other set they were all made of brass. If the waters prepared in these two sets of apparatus have the same colour, then the proba-

bility is that the colour is due to the water, as the impurities will be different in the two samples, and they would probably give different colours. The result was, the colour of the samples of water prepared in both sets of apparatus was the same—namely, blue. This conclusion was further confirmed by preparing another sample of water, and condensing it this time in a platinum tube. The water so prepared was also found to be of a fine blue. All three samples were almost exactly the same colour as Prussian blue. Standards of colour were kept with which the different samples of water were compared, both for the colour and for the amount of the colour. As all the different samples of distilled water—after the apparatus was thoroughly purified—had the same colour and amount of colour, it seems almost certain that water is a blue transparent substance, and that the colour in these experiments could not be due to impurities, which must have varied both in kind, and in amount in the different samples of water. Further, as the amount of colour in the Mediterranean water, and in the bluish well waters, was as near as could be judged the same as in pure water, it does not seem necessary to call in the aid of impurities to account for the blue colour seen in lakes and seas, the colour being principally due to the water itself, and the different substances in solution, instead of making the water blue, tend to change its proper colour and make it green, or yellow.

The addition of impurities to water seems generally to change its colour from blue to green, or to yellow, though there seems to be no reason why some impurity may not change it to a deeper blue. The selective-absorption of the water remains the same, while the impurities add their selective-absorptions to that of the water, and while they change the colour they also decrease its transparency. This explains why it is that the yellow well waters are so much less transparent than the blue. This must necessarily be so, as a very small depth of water destroys the rays which give yellow, and the transparency of yellow waters can only be the transparency of water for yellow light, which is very much less than for blue light.

No attempt was made to find out what the different discolouring substances in water are. The task would evidently be an endless one, and of little value.

The effect of the light reflected from the surface of the water is

then referred to. It is shown that when the sky is covered with white clouds, the surface reflection is so strong as to mask the colour of the water, and that when the sky is deep blue the sky-reflected light intensifies and deepens the apparent colour of the water. The importance of the surface-reflected light is best seen when the sky is covered with clouds, and glowing with a colour different from that of the water, as at sunset when the clouds are richly coloured all over the sky and deeply down towards the horizon. The water will then, especially if calm, appear like a sea of molten metal glowing with sky-reflected light, so powerful and brilliant as entirely to overpower the light internally reflected by the water.

Pure water having been shown to be perfectly transparent to the more refrangible rays, and as it absorbs the red rays, water, when looked at from the side on which the light is falling, must necessarily be dark, and cannot reflect any perceptible amount of blue light. We must, therefore, look to the solid particles in suspension in the water as the cause of the light reflected by water, and while the selective absorption of the water principally determines its colour, its brilliancy is entirely determined by the suspended particles.

It is shown why it is that though we have waters of many colours, that yet we only observe the colour when it is blue or green, and never when it is yellow. Amongst other reasons given is the much less brilliancy of yellow waters, this less brilliancy being due to the less transparency of the yellow waters compared to blue; only the reflecting particles near the surface are active in the yellow water, whereas the particles to a considerable depth in the blue can reflect their light to the surface. This is one reason why Loch Lomond is so much darker than the Lake of Geneva. Loch Lomond certainly has fewer and less powerful reflecting particles than the Lake of Geneva, but it is darker also, because only the particles to a much less depth can reflect their light to surface.

The waters of our northern seas, when provided with proper reflecting particles, such as air-balls and white particles, are shown to be much bluer than they generally appear. The brightness and blueness of the waters off the coast of Cornwall, are shown to be due to the beaches along this coast being at many points covered with a whitish coloured sand, which gets mixed up with the water by the action of the waves. As the water of the sea is constantly

circulating, it seems impossible that the same water can be one colour at one place, and a different colour at another, but we can easily see how the different colours and degrees of brilliancy can be produced by the colour and the amount of suspended matter at the different places,—where the water is mixed with whitish particles being bluish, and where mixed with yellow particles, appearing greener,—whilst its brilliancy is determined by the amount of suspended particles which may be present at the time in the water.

In conclusion, a lake in the Cordilleras is referred to as combining all the conditions necessary for producing fine and brilliantly blue coloured water. The traveller in describing this lake says, “Its waters were of the most extraordinarily brilliant blue I ever beheld.” From the description, this lake is in many respects like the Lake of Geneva. It is provided with an abundant supply of pure glacier water, free from discolouring impurities, but laden with abundance of white-reflecting particles, whose presence is evidenced by a “white strip” around the lake.

2. The Surface Geology of Mid-Lochaber.

By Professor Duns, D.D.

(Abstract).

An attempt is made in this paper, mainly from the point of view of the Society's “Boulder Committee,” to examine and classify the surface-deposits of a comparatively small compact area, which is bounded on the north and north-east by the river Spean, on the south and south-west by the river Nevis, on the west and north-west by the Lochy and the Caledonian Canal, and on the east and south-east by the Nevis range of Mountains. Reference is also made to the district between the Nevis and Loch Linnhe, including Auchintore and part of Glen Nevis. The body of the paper is limited to the statement of phenomena. It is felt, however, that the chief value of a record of facts is to lead to a definite knowledge of the forces which underlie them, and of the laws of which they are the expression.

I. PEAT.—The chief deposits occur in Corpach Moss, and on the low ground which stretches on both sides of the Kingussie road

between the Nevis and the Spean. It varies in thickness from a few inches to 16 feet. In a general way, when looked at in section, a layer of coarse sand and gravel, with lumps of bullet-like granites, porphyries, porphyrites, and mica schists, lies on the rock; higher up, beds of coarse sand, on the top of which are stones not generally so much rounded; above this the peat. In many places the remains of trees are abundant. Occasionally thin beds occur almost as fine in the grain and as hard as lignite. It was shown that the level of Corpach Moss is yearly becoming lower.

II. SAND AND GRAVEL.—These are met with in irregular ridges, in long undulating mounds, in short squat heaps, and in conical hillocks. The Auchindall hills determine, to a large extent, the lie of these heaps. Section, beginning below—(a) rolled stones and gravel, stones about twice the size of the head; (b) waved sand; (c) fine gravel; (d) waved sand; (e) horizontal bed of sand; (f) peat; (g) surface soil. It was shown that the deposits left on the shore, after an exceptionally high tide had met the Lochy in flood, bear great resemblance to many of these heaps, excepting the marine debris.

III. ANGULAR DEBRIS ON THE MOUNTAINS.—This was described, and it was asked—(1) Are the angular boulders, and the angular debris which often accompany them, of the same age, and expressive of the same forces? (2) When both angular and rounded boulders accompany the debris, must we co-ordinate the former with the angular debris only?

IV. BOULDER HEAPS OR CLUSTERS.—These terms were chosen in preference to lateral, medial, and terminal moraines, morainic matter, morainic aggregations, and the like, which were held to be misleading at this stage of the inquiry. A typical boulder heap, near the foot of the south-west slope of *Meall an t'Suidhe*, was described and represented by a drawing. Drawings were shown of circular heaps high up the mountains, and their chief features were pointed out.

V. SINGLE BOULDERS.—These were fully illustrated by a series of drawings. Several of them bear a strong resemblance to the fine-grained pinkish granites near Loch Ness. Of the boulders which lie *near* but not *in* the heap now mentioned, those of granite, granitic porphyry, and porphyry, lie for the most part in a line of their own, while those of mica schist, micaceous gneiss, and some

porphyrites, lie on either side of the former—schists nearest the mountain, granites and porphyries next, and schists again between the granites and the Nevis. This apparent order may be exceptional, but it might come to have significance in relation to theories of deposit at different times. The lines in which they lie slope to the north-west. Many on the low slopes and in the plain are of great size, and present distinct marks of striation and polishing. The prevalent direction of the larger axis is north-north-west and south-south-east. Reference was made to the frequent occurrence of cup-like markings on porphyry boulders especially, and it was shown how these are formed. In most of the boulders described their angle to the horizon was noted, mainly to show that boulders may rest on slopes where one could not have expected to find them. The angles vary from 5° to $40^{\circ} 10'$, and the boulders in size from those twice as big as the human head to such as are $17 \times 5 \times 6$, or even larger. The girth of one, taking in irregularities of surface, is 160 feet. The peculiar forms of many of the boulders were traced to cleavage fracture, and drawings of some were exhibited. Reference was made to the series of rocks from *Meall an t'Suidhe*, north to *Crag Duibh* and the *Dorney* crystalline limestone, and a section was shown. In the comparatively low ground above the rocks shown in this section the erratics are all rounded and polished, while the boulders of the rocks in the immediate neighbourhood are angular or subangular. The boulders below the part which was shown in section are of gneiss, limestone, mica schist, micaceous gneiss, porphyry, light grey, fine-grained granite, pinkish granite, coarse grey granite—many being much polished and almost circular.

The boulder and shingle-covered face of Ben Nevis, which looks down on *Lochan Meall an t'Suidhe*, was closely examined to ascertain if, as had been reported, these were true erratics on this part of the mountain, but none were found.

Some general remarks were made in conclusion :—

1. The peat has been formed subsequently to the deposit of the gravel heaps. What is the significance of the fact, that at the bottom of many of the gravel heaps a layer occurs of large bullet-like pieces of granite and porphyry resembling those at the bottom of the chief deposit of peat, Corpach Moss, into which the heaps do not extend ?

2. The gravel heaps consist of sand of different degrees of fineness, and of stones varying in size from small pebbles to such as are twice or thrice larger than the head. The coarse sand can be traced to the wear of the district rocks, but there are beds of very fine sand, which seems to differ wholly from these. In the rare instances in which large boulders were met with in these heaps, there were subangular specimens of rocks in the neighbourhood. The erratics occur on the heaps.

3. Blocks abound high up the mountains, many of enormous size and weight, for whose position no explanation can be found in any of the forces at present active in the locality.

4. The position of boulders in the plain may have as great significance to the glacialist as that of those high up the mountains. This was illustrated. If the position of that on the plain is one to which it could not have rolled, the face of the country being at the time of its deposit as it is now, the supposition is admissible that both the boulder on the high level and that on the low ground may have been dropped by an agent on which the inequalities of the surface could have no bearing.

5. Both angular and round boulders occur together at high levels.

6. Boulders are met with the same as the rocks in which they lie in heaps whose form and position no theory of weathering or of rolling can explain.

7. In many places the striation is much hatched, and it is difficult to make out the initial direction. That the striæ are very often in the line of the larger axis, and most frequently, by the compass, north-west and south-east, is almost all that can be said. Some large boulders present comparatively symmetrical grooving or striation over the whole surface. When this occurs above only, the readiest explanation is found in tracing it to the action of another boulder carried in the direction of the striæ.

8. In ascending Ben Nevis, and when on the summit, most observers are struck with the great extent of the angular debris and the immense number of great cornered stones. Snow or ice gliding over this loose surface might, at first thought, be expected to sweep it all away. Even snow melting suddenly might be held likely to carry it down to the valleys. But the temperature which determines the formation and the fall of the snow determines also

the compacting of the loose material. The moisture among it and the first snow that falls on its surface freeze. And thus a thoroughly compact moss is provided to resist snow-slips and to permit the water, from the melting snow when the thaw comes, to flow over it into the courses which feed the mountain torrents.

9. A careful examination of the deposits within this area, so far as they have any bearing on former Arctic conditions of climate and a glacial surface, begets the belief that the bulk of the phenomena may ultimately find their explanation in the recognition of two movements—one from the west, north-west, or north-north-west, inwards to the Ben Nevis range, and another, subsequently, outwards from Ben Nevis as a centre.

3. Remarks on Dielectric Strength. By Professor Chrystal.

The phenomena accompanying the disruptive discharge of electricity are, in the present state of electric science, among the most interesting known, because they are the least understood, and, so far as we know, the least concordant with our preconceived ideas. The simplest way of representing the facts is to imagine with Faraday that the non-conducting medium, or dielectric, between two charged conductors is the seat of mechanical stress, consisting of tension along, and pressure perpendicular to, the lines of force. The rupture of the dielectric may then be conceived as a phenomenon precisely analogous to the rupture of an elastic body under stress. We are thus led to the conclusion that the commencement of the rupture happens at that particular point where the tension first reaches a certain value, called the breaking tension or dielectric strength, which depends merely on the material of the dielectric, and on its physical condition at the time being. The main thing in any experiment on dielectric strength is to know the tension at the point where the rupture begins. According to Maxwell's rendering of Faraday's theory, the tension is $\frac{K}{8\pi}R^2$, where R is the resultant electric force and K the specific inductive capacity of the dielectric. If the dielectric be uniform, R will be a maximum at the surface of some conductor. If then σ be the surface density, since $KR = 4\pi\sigma$, we have at the point of rupture,

$$\tau = \frac{K}{8\pi} R^2 = \frac{2\pi}{K} \sigma^2;$$

and the discharge will begin at that point of some conductor of the system whose surface density first reaches the value $\sqrt{\frac{K\tau}{2\pi}}$.

In this view the beginning of disruptive discharge is conditioned solely by the nature of the dielectric in the immediate neighbourhood of a certain point on the surface of the discharging body, and by the electrical surface density at that point. This is, in the first instance, unquestionably the simplest and most scientific analysis of the phenomena, but it has not as yet, I think, been shown that it will account for all the observed facts. Experimenters have mainly themselves to blame for this; for they have in too many cases simply worked at random, and have consequently fallen among circumstances so complicated that a theoretical examination of their results is out of the question. Some, for instance, have apparently imagined that the breaking tension or dielectric strength of a medium could be inferred from the difference of potential required to produce a spark of given length between two bodies in it, no matter what their form or surroundings. The most casual observation of course proves the contrary. I am not aware whether any definite experiments have ever been made to show the influence of the *electrical condition* of surrounding conductors. The following extracts from notes of some experiments made last summer,* may perhaps be of some interest as illustrating this point. P and Q are

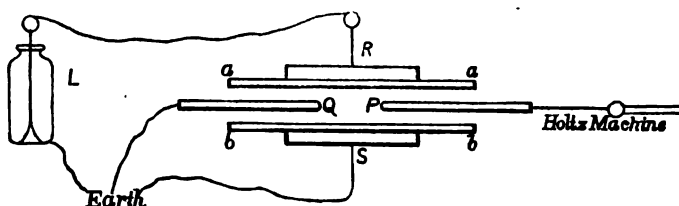

two rounded terminals between which the spark was taken. P was charged by means of a Holtz machine to a potential, which was measured by means of an electrometer, the method employed being a modification of that used by Dr. Macfarlane in his experiments

* With the valuable assistance of Dr. Macfarlane.

on disruptive discharge. R and S are two parallel metal discs faced with plates of glass *aa* and *bb*, to prevent discharge between them and P or Q. R can be raised to any required potential by charging the Leyden jar L. Q and S, the outer coating of L, and the other electrode of the Holtz machine, are all connected with the earth.

For a given distance PQ of 6 mm. or so, provided the distance, RS is not too small, the mere presence of R and S does not sensibly increase or diminish the difference of potential required to produce a spark between P and Q. But the case is very different if R be raised to a considerable potential, as will be seen by the following tables. In the columns headed P and R, the sign of the charge of these conductors is given; under V, the difference of potential (in an arbitrary unit) required to produce the spark; in the last column the difference between the two values of V.

| P | R | V | Difference. | |
|---|---|-----|-------------|----------------|
| + | - | 129 | -20 | } PQ = 6 mm. |
| + | 0 | 149 | ... | |
| + | + | 160 | +27 | } RS = 25 mm. |
| + | 0 | 183 | ... | |
| + | + | 142 | +22 | } PQ = 8 mm. |
| + | 0 | 120 | ... | |
| + | - | 107 | -25 | } RS = 25 mm. |
| + | 0 | 182 | ... | |
| - | + | 140 | -30 | } PQ = 5.5 mm. |
| - | 0 | 170 | ... | |
| - | - | 190 | +20 | } RS = 25 mm. |
| - | 0 | 170 | ... | |

A modification of the experiment was made by insulating S, and charging and discharging it along with R, with the following result:—

| P | R | S | V | Difference. | |
|---|---|---|-----|-------------|---------------|
| + | + | + | 195 | + 56 | } PQ = 7 mm. |
| + | 0 | 0 | 139 | ... | |
| + | + | 0 | 163 | + 27 | } RS = 28 mm. |
| + | 0 | 0 | 136 | ... | |

It appears very clearly from these experiments, that the presence of an independently charged body affects considerably the potential required to produce rupture. When the neighbouring body has a similar charge to the discharging one, a higher potential is required; and, when it has an opposite charge, a lower potential is required than when the neighbouring body is neutral or absent. The effect becomes smaller, *ceteris paribus*, when the distance PQ is diminished, and increases when the distance RS is diminished. If we bear in mind that it is the surface density at extremity of P, which determines the rupture, and not the difference of potential between P and Q merely, this result is precisely what we ought to expect.

If we assume that in the cases above quoted the charging of R and S affected the whole charge on P without sensibly altering its relative distribution, which must have been approximately true since the mere presence of R and S in the neutral state did not affect the discharge, then the surface density at every point of P will be proportional to its whole charge. Let p be the capacity of P depending almost entirely on the presence of Q; $-q$ the coefficient of induction between R and P, which is the same as that between S and P; V_0 the potential of P corresponding to rupture when R and S are at potential zero, V the corresponding value when R and S are at potentials U and U' respectively. Then we have, since the surface density at the point of rupture is the same in both cases, and therefore by our assumption the whole charges also the same,

$$pV_0 = pV - q(U + U'),$$

$$V - V_0 = \frac{q}{p}(U + U').$$

In the cases where R alone was charged we have

$$V - V_0 = \frac{q}{p} U.$$

When both R and S were charged to the same potential,

$$V - V_0 = 2 \frac{q}{p} U.$$

These formulæ reproduce all the results quoted above; they further indicate that the differences are proportional to the potential of the disturbing body, as was found to be the case in some rough experiments which were tried to test this conclusion.

The fact that the presence of an oppositely charged body facilitates discharge from a conductor, suggests the curious conclusion that a spark may under certain circumstances be caused to pass between two bodies by merely bringing up near them a body oppositely charged to that on which the point of maximum surface density is to be found. This experiment was repeatedly tried with perfect success. P was gradually charged up until the electrometer indicated that it was near the potential of rupture. Then the machine was stopped and R suddenly charged oppositely to P by connecting it with a large Ledyen jar standing ready for the purpose. The result was to cause disruptive discharge between P and Q. A similar phenomenon no doubt sometimes occurs in nature. Suppose there were a positively charged thunder cloud at some distance from the earth, near, but not quite at, the point of discharging; the advent of another cloud negatively charged, but at a smaller height, might cause the lightning to pass down from the higher cloud to the earth.

Among the various circumstances that might affect the strength of a dielectric I thought, for reasons needless to relate, that it would be interesting to examine whether its magnetic state be material. With this view I arranged two spark terminals between the poles of a powerful electromagnet in different positions relatively to the lines of magnetic force and measured the difference of potential required to produce a spark when the magnet was excited and when it was not. The result was entirely negative. Although the magnetic force* employed went as high as 6000 absolute C. G. S. units, I

* For the rough measurement of the strength of the magnetic field I am indebted to Mr. Albert Campbell.

could detect no difference amounting to 1 per cent. which was about the uncertainty in my best experiments.

The earliest measurements in absolute units, from which the dielectric strength of air could be deduced, were those of Sir William Thomson (1860), who measured the electromotive force between two parallel plates required to produce a spark varying in length from .0025 cm. up to .15 cm. De La Rue and Müller (1877), Macfarlane (1878), and T. B. Baille (*Comptes Rendus*, Jan. 1882, pp. 38 and 130), have followed in his footsteps. The following table contains some selections from their results :—

| Spark Lengths in Centimetres. | Potential Required to produce the spark in C. G. S. Electrostatic Units. | | | | |
|----------------------------------|---|--------------------------|-------------|---------|------------------------|
| | Thomson. | De La Rue and Müller. | Macfarlane. | Baille. | Water Electrometer. |
| .01 | 2.33 | ... | ... | 3.16 | ... |
| .05 | 7.28 | 7.69 | 7.48 | 8.71 | ... |
| .10 | 13.30 | 14.47 | 11.56 | 14.67 | ... |
| .30 | ... | 34.44 | 25.56 | 35.35 | ... |
| .61 | ... | ... | 45.61 | 64.81 | 55.00 |

It will be seen that the agreement between the different experimenters is far from perfect. To those familiar with the manifold difficulties attending measurements of this kind, this is not surprising. I may mention that the result in the last column was obtained last summer by Dr. Macfarlane and myself, by means of a new form of absolute electrometer which I was led to devise during a course of experiments of which we hope to give an account hereafter. The instrument consists simply of an insulated plane disc, suspended parallel to a surface of water connected with the earth. When the disc is raised to a high potential, the water rises up and forms a plateau, whose height is measured by observing with a micrometer eyepiece the displacement of the image of a fixed point seen by reflection at the surface of the water. From this we can calculate at once the difference of potential between the disc and the water in absolute units. The instrument is very direct and ready in its ap-

plication, and promises well so far. If it continues to answer our expectations I shall take the liberty of laying a detailed description of it before the Society.

There is one point of great interest on which all these experimenters are agreed, viz., that the curve whose abscissæ is the spark length, and whose ordinate is the spark potential, is not a straight line as it ought to be by the ordinary electrostatic theory, combined with the notion of dielectric strength above explained, the air between the plates being assumed to be a *uniform* dielectric. There can be no question that at very short distances the falling off from this law is very great. I think that there has been a slight tendency to overstate the discrepancy for distances over .1 cm. Taking Baille's numbers, excluding all distances under .2 cm., I calculated by the method of least squares the formula of the form $V' = as + b$, which would best reproduce his observations. V' denotes calculated spark potential for s centimeters; V the observed spark potential. The formula found was

$$V' = 99.593s + 4.997 .$$

The following Table gives the comparison :—

| s | V | V' | $V - V'$ |
|-----|--------|--------|----------|
| .1 | 14.67 | 14.96 | -.29 |
| .2 | 25.51 | 24.92 | +.59 |
| .3 | 35.35 | 34.88 | +.47 |
| .4 | 44.77 | 44.83 | -.06 |
| .5 | 54.47 | 54.79 | -.32 |
| .6 | 63.82 | 64.75 | -.93 |
| .7 | 73.78 | 74.71 | -.93 |
| .8 | 84.86 | 84.67 | +.19 |
| .9 | 94.72 | 94.63 | +.09 |
| 1.0 | 105.50 | 104.59 | +.91 |

The error nowhere exceeds 3 per cent., and if we consider the increased probability of error from leakage at the high potentials,

the arrangement of the negative signs in the middle of the difference column, indicating a slight curvature, may be said to be accounted for. I find a similar result on reducing some of Macfarlane's Tables in the same way, so that it would scarcely be unreasonable to say that for distances beyond .1 cm., the curve is straight within the limits of experimental error.

If this be allowed, there remains to be accounted for only the admitted curvature for distances under .1. Two explanations have been suggested, and others might be or perhaps may already have been advanced.

1. That the air in the immediate neighbourhood of a solid conductor is condensed, and therefore dielectrically stronger. This explanation, if I understand it aright, appears to me to fail altogether. For the beginning of rupture is conditioned by the strength of the layer next the conductor, and, even on this explanation, that would be the same at all distances, and the curve ought to be a straight line.

2. That there is a difference of potential between the conductor and the air. This hypothesis would still give a straight line although not passing through the origin, it would therefore still leave the curvature near the origin unexplained, which in the case of air at least is the main difficulty. Still this possible cause should not be lost sight of. It may be *part* of the explanation.

3. It might be that the air near the conductor is electrified, in which case the characteristic equation of the potential between the plates would become

$$\frac{d^2V}{dx^2} + 4\pi\rho = 0.$$

Without entering into a discussion of this hypothesis in the meantime, I may mention that it is subject to the initial objection, that it seems difficult to reconcile it with the fact, proved by the best modern results, that there is nothing of the nature of slow conduction or even convective discharge through air at the atmospheric pressure, so long as the electromotive force does not surpass a certain limit.

4. There is yet another hypothesis which seems to me well worthy of examination, viz., that the *Specific Inductive Capacity* of the air, undergoes a rapid variation from the surface of a solid

outwards. The most natural assumption in the first instance would be that so long as the curvature of the surface is finite, K is a function simply of the distance from the surface, and independent of its curvature, that it starts with a value K_0 just at the surface, and very rapidly reaches a value K_1 , which it retains until the immediate neighbourhood of another solid is reached. The equation of the potential now becomes

$$\frac{d}{dx} \left(K \frac{dU}{dx} \right) = 0 \dots \dots \dots (1),$$

x being measured perpendicular to the two parallel plates, from the one at higher potential to the one at lower. We thus get

$$K \frac{dU}{dx} = A \dots \dots \dots (2),$$

where A is a constant.

Whence
$$U = A \int \frac{dx}{K},$$

and if V denotes the difference of potential between the plates, and s the distance between them,

$$V = -A \int_0^s \frac{dx}{K} \dots \dots \dots (3).$$

The resultant force at the surface is

$$R = -\frac{A}{K_0} = -\frac{V}{K_0 \int_0^s \frac{dx}{K}} \dots \dots \dots (4).$$

If s be less than a certain distance (comparable with a millimetre, to judge by the experimental results) the integral $\int_0^s \frac{dx}{K}$ may be

broken up into two equal parts $\int_{\frac{s}{2}} \frac{dx}{K}$ and $\int_0^{\frac{s}{2}} \frac{dx}{K}$ each of

which is the same function of $\frac{s}{2}$, the whole is therefore some function of s , so that we may write $\int_0^s \frac{dx}{K} = \frac{s}{K_0} f(s)$, where $K_0 f(s)$ has a value intermediate between K_0 and K_1 , we thus get

$$R = \frac{V}{s} f(s) \dots \dots \dots (5),$$

which is general enough to represent the experimental results for small distances.

Next let s be greater than α , where α is the distance from a conductor at which K ceases sensibly to vary, then,

$$\int_0^s \frac{dx}{K} = \int_{s-\alpha}^s \frac{dx}{K} + \int_\alpha^{s-\alpha} \frac{dx}{K} + \int_0^\alpha \frac{dx}{K}.$$

Here the first and last integrals are equal and constant, say each = $\frac{\alpha}{K'}$, where K' is intermediate between K_0 and K_1 . In the second integral K is constant throughout, and equal to K_1 , we thus get

$$\int_0^s \frac{dx}{K} = \frac{2\alpha}{K'} + \frac{s-2\alpha}{K_1}.$$

Whence

$$R = \frac{V}{\frac{K_0}{K_1}s + 2\left(\frac{K_0}{K'} - \frac{K_0}{K_1}\right)\alpha} \dots \dots \dots (6),$$

or

$$V = R \left\{ \frac{K_0}{K_1}s + 2\left(\frac{K_0}{K'} - \frac{K_0}{K_1}\right)\alpha \right\} \dots \dots \dots (7).$$

This gives a straight line for distances greater than α , and accords with the interpretation which I am inclined to put upon the results of experiment.

This theory then would allow us to retain the notion of a definite dielectric strength for air, and at the same time to reproduce the results of experiment. The only question to be settled is whether the assumed variation of the specific inductive capacity actually exists. Equation (5) would of course allow us to find the nature of the variation, if any such existed. Since, in the case of air, by the unanimous testimony of experimenters, the intercept on the axis of V is positive, we must have $K_1 > K'$, and hence, since K' is intermediate to K_1 and K_0 , $K_1 > K_0$, *i.e.*, the specific inductive capacity of air in the neighbourhood of a conductor is less than in free air. This seems at first sight a somewhat startling conclusion; but on reflection I see nothing against it except perhaps prejudice. At all events it will scarcely be said that the kinetic theory of gases settles it immediately either way.

The above theory may at once be subjected to a very interesting

experimental test; indeed, it is on this account mainly that I have ventured to bring it forward.

Let C denote the capacity per square centimetre of two parallel plates at a distance s apart. Then, since the surface density is given by

$$\sigma = \frac{K_0}{4\pi} R,$$

we get by (4)

$$C = \frac{\sigma}{V} = \frac{1}{4\pi \int_0^s \frac{dx}{K}} \dots \dots \dots (8).$$

Hence, V being the *spark potential* corresponding to the same distance s , since by hypothesis R is always the same, being in fact

$\sqrt{\frac{8\pi r}{K_0}}$, we have

$$V = RK_0 \int_0^s \frac{dx}{K};$$

whence

$$CV = \frac{K_0 R}{4\pi} = \sqrt{\frac{K_0 r}{2\pi}} \\ = \text{constant.}$$

This reciprocal relation between the capacity and spark potential shows that the capacity of the plates for very small distances apart, ought, if the above theory be correct, to be much smaller than the value calculated by the usual assumption of a uniform dielectric, for experiment has already shown that the spark potential is very much greater. I have devised an arrangement for putting this conclusion to an experimental proof, and hope in the course of next summer to be able to lay the result before the Society.

There is one other point on which I should like to remark. However good the methods of Sir William Thomson may be, I think that little is to be gained by following them to the exclusion of others. It is clearly desirable to experiment with other forms of terminals for which the surface density can be calculated, and to examine whether the results can be explained in all cases by a common hypothesis. I think it might be possible by careful attention to insulation, to measure with some accuracy the potential at which disruptive discharge begins at the sharpest extremity of an

ellipsoid of given form, and from this to reduce a measure of the dielectric strength of air. Some curious problems of mathematical physics arise here in connection with the assumption of varying specific inductive capacity, which I can only mention in passing. I find on a certain rough assumption that ovary ellipsoids of reasonable dimensions ought to give practically measurable results, and propose to try the experiment.

With the same end in view I think it would be desirable to reduce the experiment of Baille and others with spheres, in cases where the surface density can be calculated, and to examine the values of the dielectric strength in these cases. Until this or something equivalent is done, it is clear that we have really no experimental ground for asserting the existence of such a constant as the dielectric strength of a medium, and therefore cannot take the very first step towards a physical theory of the disruptive discharge, which appears to me to be the next great advance to be made in the science of electricity.

4. *Diagnoses plantarum novarum et imperfecte descriptarum Phanerogamarum Socotrensium; quas elaboravit Bayley Balfour, Scientiæ Doctor et in Universitate Glascuensi rerum botanicarum regius professor. Pars Prima.*

Plena descriptio Botanices Socotrensium quantum nobis cognitæ, brevi tempore subjicietur Societati Regiæ Edinensis ut in suis Actis in lucem emittatur et divulgatur. Quoniam verum spatio certo temporis opus erit ut singulæ partes et minutæ Floræ tam abundantis et copiosæ plene elaborentur et perlustrentur, et quoniam perplures formæ endemicæ tam generum quam specierum in ea Flora comprehenduntur, oportet et congruit opportunis temporis intervallis, opere progrediente, breves diagnoses novarum plantarum in medium proponere, ut prioritas vindicetur nominibus quæ his novis tribuantur, et quæ in volumine Actorum Societatis Regiæ publicè emittentur.

Nunc igitur in medium profero aliquas diagnoses novarum generum et specierum. In hac parte prima plantas novas Dicotyledonearum Polypetalasarum solum descripsi; in partibus subse-

quentibus illas sectionum aliarum Phanerogamarum in apertum efferam.

Haud ab re duxi enarrare ex quibus originibus derivatur materia quæ nostris descriptionibus occasionem dat. Primo perpauca specimina imperfecta et fragmentaria quæ a Huntero,* quando munere legati fungens insulam Socotram invisebat, collecta sunt, et quæ ab illo partim herbario Kewensi missa sunt, partim vero a Hayo,† Universitati Edinensi donata sunt. Pauca specimina etiam fragmentaria et imperfecta ex insulâ a Wykeham Perryo ‡ ablata sunt et nunc in herbario Kewensi inveniuntur. In sequentibus descriptionibus technicis abbreviationes “*Hunt.*” et “*Perry*” collectiones illi et alteri proprias indicant.

Deinceps, habemus collectionem relatam a participibus nostræ expeditionis,—hi fuerunt Carolus Jacobus Cockburnus,§ Alexander Scottus|| atque ego ipse. Species a nobis repertæ signo “*B. C. S.*” designantur.

Postremo, possidemus collectionem Doctoris Schweinfurthii viatoris et botanici celeberrimi. Plantæ ab eo collectæ abbreviatione “*Schweinf.*” notantur. Huic Societati Regiæ jam promissionem ejus munificam memoravi, se sua specimina illis nostræ expeditionis additurum esse. Promissionem ejus observavit et præstitit, et ab eo magnum numerum splendorum speciminum conservatorum recepi. Horum, alia nos ipsi dum in Socotra morabamur non ibi obtinuimus, alia autem nobis facultatem dederunt ad certas plantas plene describendas, quarum nostra exempla imperfecta seu fragmentaria erant. Atque adeo collectiones ejus perutiles et magni aestimandæ in conficienda enarratione Botanices Socotrensis fuerunt.

Superest ut hic moneam, quamvis ego pro majoritate nominum plantarum posthac enarrandarum solus sponsor sim, aliquas earum tamen nomine “*Schweinf.*” designatas esse. Hoc evenit ubi planta certa nos ipsi propria indagazione non omnino potiti sumus, vel ubi nostra specimina ad recognitionem certæ plantæ non sufficiebant. Adeo honor inveniendarum harum plantarum Schweinfurthio rite tribuendus est. Nonnunquam, sed raro, nomina aliorum

* Captain Hunter, Assistant Political Resident at Aden.

† George Hay, M.D., Port Surgeon, Aden.

‡ Commander Wykeham Perry, R.N., late Senior Naval Officer at Aden.

§ Lieutenant Cockburn, 6th Royal Regiment.

|| Alexander Scott, gardener in the Royal Botanic Garden, Edinburgh.

authorum speciebus subjuncta sunt. Hoc evenit ubi characteres alicujus plantæ Socotrensis occasionem dederunt substantiali modificationi certæ prioris descriptionis, aut ubi nomen plantæ antea datum est nulla tamen descriptione comitante.

MENISPERMACEÆ.

1. *COCCULUS BALFOURII*, Schweinf.: dumetosa, cladodifera, spinosa; foliis elliptico-oblongis v. subobovatis, breviter petiolatis, mox deciduis; floribus subsessilibus in brevissime-pedunculatis cymis confertis; fl. ♀: staminodiis senis.

Nom. vern. Kiomhan.

Socotra, in montibus altioribus crescens. B.C.S. No. 439.
Schweinf. No. 754.

CRUCIFERÆ.

2. *DICERATELLA INCANA*, Balf. fl.: herba incana; foliis oblongis v. ovatis, obtusis, repandis; racemis laxis elongatis; floribus magnis; siliquis tetragonis.

Socotra, locos arenosos incolans. B.C.S. No. 136.

3. *FARSETIA PROSTRATA*, Balf. fl.: herba prostrata; foliis obovatis obtusis, sæpe apiculatis, crassis, strigosis; siliquis linearibus.

Socotra, in locis arenosis. B.C.S. No. 205.

4. *BRASSICA ROSTRATA*, Balf. fl.: herba annua; foliis lyrato-pinnatisectis; floribus albis; siliquis patentibus torulosis, valvis trinerviis, rostro longo monospermo.

Socotra, sub umbra scopulorum in montibus crescens. B.C.S. No. 245.

LACHNOCAPSA, Balf. fl.

Sepala erecta, lateralia basi saccata. Petala unguiculata. Stamina libera, edentula. Siliqua brevis, plano-compressa, subcordata v. orbicularis, tomentosa, subsessilis, foliis similissima, 2-locularis, loculis interdum bilocellatis, 1-3 sperma; valvis sæpe septulatis, apteris, crassis, spongiosis, septo contrarie compressis; septum lineare, emervium, chartaceum; stylo prope nullo; stigmatibus bilobis. Semina

in locellis solitaria, suspensa, oblonga, subcompressa, immarginata; testa nonmucosa; radícula incumbens.—Fruticulus diffusus, ramosus, albide tomentosus, cortice rumpente decidenteque. Folia alterna, integra. Flores axillares, subsessiles, lutei.

Genus monotypicum dubiæ affinitatis, forsan ad viciniam Lepidii referendum.

5. *L. SPATHULATA*, *Balf. fl.*: species unica in locis arenosis Socotræ prope Gollonsir crescit. B.C.S. No. 587.

CAPPARIDEÆ

6. *CLEOME SOOCTRANA*, *Balf. fl.*: herba erecta; foliolis obovatis v. oblongo-obovatis; petalorum limbo subdeltoideo; siliquis adscendentibus; seminibus pubescentibus.

Socotra, in campis calcareis. B.C.S. No. 76. Schweinf. No. 659, 710.

RESEDACEÆ

7. *RESEDA VIRIDIS*, *Balf. fl.*: fruticulosa, glaberrima; foliis ellipticis v. oblongis, v. subobovatis, obtusis, sinuatis, interdum tripartitis, longe-petiolatis; pedicellis floribus brevioribus; sepalis 6 integris deciduis; petalis albis; filamentis deciduis; capsulis breviter tridentatis; seminibus tuberculatis.

Socotra, in declivitatibus montium circa Gollonsir ad 1500 ped. alt. B.C.S. No. 230.

CARYOPHYLLEÆ

8. *GYPSOPHILA MONTANA*, *Balf. fl.*: perennis, glabra v. plus minusve glanduloso-pilosa; foliis crassiusculis obovato-spathulatis; cymis laxis ramosis; pedicellis calyce et bracteis foliaceis longioribus; calyce campanulato ad medium 5-fido; petalorum limbo distincto truncato; capsulo calyci æquilongo; seminibus punctulato-tuberculatis.

Socotra, montes altissimos incolans. B.C.S. No. 442. Schweinf. No. 658.

Distrib. Aden.

9. *POLYCARPÆA CÆSPITOSA*, *Balf. fl.*: perennis, subcæspitosa, glabra; caulibus prostratis v. subterraneis; foliis subcrassis anguste-spathulatis v. oblanceolatis, stipulis fimbriatis; floribus sessilibus in spicas paucifloras ad apices rhachium longarum congestis; sepalis ovato-acutis infra late scariose-alatis; petalis sepalis subæquilongis, et capsulis longioribus.

Socotra, in locis arenosis non infrequens. B.C.S. No. 683.

10. *POLYCARPÆA DIVARICATA*, *Balf. fl.*: annua, viridis, glabra, ramiosissima, erecta; foliis submembranaceis apice setosis, radicalibus rosulatis spathulatis, ramalibus longe-oblanceolatis v. filiformibus; stipulis acuminatis; floribus sessilibus in spicas imbricatas ad extremitates rhachium longarum positas; sepalis ovato-lanceolatis petalis capsulisque longioribus.

Socotra, in locis siccis florens. B.C.S. No. 684. Schweinf. No. 543.

HYPERICACEÆ

11. *HYPERICUM TORTUOSUM*, *Balf. fl.*: suffruticosum, glabrum, glaucum, ramulis quadrangulis; foliis obovatis v. elliptico-oblongis v. subrotundis, obtusis v. subacutis, inferioribus petiolatis, superioribus sessilibus amplexicaulibus decurrentibus, decussatis, sempervirescentibus, coriaceis, pellucido-punctatis; floribus in cymas terminales dispositis; sepalis elongato-ellipticis, imbricatis, eglandulosis; staminibus stylis brevioribus; capsulis verrucosis; seminibus lineato-punctatis.

Socotra, inter rupes Haggier montium ad 2000 ped. alt. B.C.S. No. 607. Schweinf. No. 757.

12. *HYPERICUM SCOPULORUM*, *Balf. fl.*: suffruticosum, glabrum, glaucum, ramulis quadrangulis; foliis oblongo-ovatis, obtusis, sessilibus decussatis, sempervirescentibus, coriaceis, glanduloso-punctatis; pedunculis unifloris axillaribus; sepalis basi subconnatis, laciniis ensiformibus valvatis, eglandulosis; staminibus stylis brevioribus; capsulis longitudinaliter vittatis; seminibus lineato-punctatis.

Socotra, in montibus Haggier cum specie priore repertum. B.C.S. No. 405. Schweinf. Nos. 622, 756.

MALVACEÆ.

13. *HIBISCUS (Ketmia) SCOTTI, Balf. fl.*: arborescens; foliis petiolatis ellipticis v. ovatis, obtusis, basi cordatis v. cuneatis, subtus pilis trifurcatis faciliter avulsis vestitis; floribus in racemos axillares solitarios breves validos paucifloros dispositis; calyce cyathiformi bracteolas 10 v. plures lineares trinervas liberarum sequente; corolla magna; capsulis 5-valvis levibus; seminibus pilosis.

Socotra, in montibus Haggier rarus. B.C.S. No. 705. Schweinf. No. 535.

14. *HIBISCUS STENANTHUS, Balf. fl.*: suffruticosus; foliis cordatis obtusis dentato-crenatis, pilis trifurcatis dense subtus vestitis; pedunculis unifloris curtis solitariis petiolum breviter excedentibus; calyce poculiformi bracteolas 8-12 lineares dimidio superante; petalis infra anguste-convolutis, supra patentibus.

Socotra, locos siccos calcareos incolans. B.C.S. No. 706.

15. *HIBISCUS MALACOPHYLLUS, Balf. fl.*: arborescens; ramulis ferrugineo-tomentosis; foliis late ovatis, obtusis, dentatis, crassis, dense pubescentibus; pedunculis unifloris, solitariis, brevibus; bracteolis 10-12 liberis, linearibus.

Nom. vern. Dera foo.

Socotra, infrequens in convalle prope Adho Dimellus, ad altitudinem ultra 2000 ped. B.C.S. No. 488.

STERCULIACEÆ.

16. *MELHANIA MURICATA, Balf. fl.*: suffruticosa molliter tomentosa; foliis petiolatis variantibus ab formis linearibus ad ellipticas, apice truncatis v. retusis sæpe apiculatis, crenato-serratis, subtus glanduloso-punctatis; cymis bifloris; bracteolis cordato-reniformibus accrescentibus membranaceis; capsulorum loculis bispermis; seminibus muricatis.

Socotra, circa Gollonsir abundans. B.C.S. No. 230.

TILIACEÆ.

17. *GREWIA TURBINATA*, *Balf. fl.*: arbor parva; foliis longe petiolatis ovato-lanceolatis basi obliquis, serratis, subtus incanis; cymis trifloris, oppositifoliis; drupis turbinatis, glabrescentibus, nitidis, pyrenis 1-pluri locularibus.

Nom. vern. Eireit.

Socotra, in ripis fluviorum. B.C.S. No. 373. Schweinf. No. 475 (pro parte).

18. *GREWIA BILOCULARIS*, *Balf. fl.*: arborescens, glabra; foliis breviter petiolatis, magnis, ovatis acutis, basi cordatis æquilateralibus, crenato-serratis; cymis bifloris fere oppositifoliis; pedunculis petiolo subæquilongis; drupis 4-pyrenis 4-lobatis, subcubicalibus, glabrescentibus nitidis; pyrenis bilocularibus.

Socotra, in convallibus rara. B.C.S. No. 498. Schweinf. No. 475 (pro parte).

19. *CORCHORUS ERODIOIDES*, *Balf. fl.*: perennis, tenuis, ramosissimus, depressus; foliis diversè-pinnatisectis, longe-petiolatis, leviter pilosis; pedunculis longis unifloris extra-axillaribus; sepalis petalisque quatuor; staminibus pluribus; capsulis rectis v. parum curvatis, brevibus pubescentibus, bilocularibus, bivalvia.

Socotra, in campis arenosis circa Gollonsir atque Tamarida frequens. B.C.S. No. 48. Schweinf. No. 381.

20. *ELEOCARPUS TRANSULTUS*, *Balf. fl.*: arbor alta resinifera ramis terminalibus crassis cicatricosis; foliis versus apices ramorum aggregatis, lanceolatis, elongatis, apice basique angustatis, obtusis integris, subundulatis, subobliquis, fere 6 poll. longis, 2 poll. latis, breviter petiolatis, sparse stellatim-tomentosis, subtus pallidioribus, venulis prominulis, petiolo dense tomentoso 5-6 lin. longo; stipulis ovatis, caducis; floribus ignotis; racemis fructiferis 1½-2 poll. longis, pedicellis 2 lin. longis, paucicarpicis; drupis ellipticis, 4 lin. longis, glabris, pyrenis bilocellatis extus tuberculatis.

Nom. vern. Kemhar.

Socotra, circa Gollonsir atque Tamarida. B.C.S. Nos. 267, 409.

RUTACEÆ.

21. *THAMNOSMA SOCOTRANA*, *Balf. fl.*: suffruticosa, graveolens, glanduloso-papillosa; foliis simplicibus, integris, oblanceolatis v. anguste obovatis; floribus solitariis, extra-axillaribus; ovario sessili; seminibus longe muricatis.

Socotra, in summis montibus Haggier. B.C.S. No. 395. Schweinf. No. 619.

BURSERACEÆ.

22. *BOSWELLIA AMEERO*, *Balf. fl.*: arborea cortice papyraceo; foliis magnis multifoliolatis pubescentibus rhachi tereti, foliolis subsessilibus oblongo-ellipticis obtusis crenato-dentatis subrevolutis; racemis densis foliis multo brevioribus, pedicellis longis flores excedentibus; capsulis 4-5-gonis turbinatis breviter stipitatis.

Nom. vern. Ameero.

Socotra, arbor balsamiflua ubique per montes crescens. B.C.S. No. 349. Schweinf. No. 540.

23. *BOSWELLIA ELONGATA*, *Balf. fl.*: arborea cortice papyraceo; foliis magnis multifoliolatis rhachi tereti tomentosa, foliolis sessilibus elongato-oblongis obtusis crenato-serratis revolutis; racemis ramosis elongatis foliis fere duplo-longioribus, pedicellis crassis floribus brevioribus; capsulis maturis non visis.

Socotra, arbor balsamiflua in clivis montium frequens. B.C.S. No. 657.

24. *BOSWELLIA SOCOTRANA*, *Balf. fl.*: arborea cortice nonpapyraceo; foliis parvis multifoliolatis glabris rhachi alato, foliolis sessilibus oblongo-ellipticis obtusis sæpe emarginatis integris revolutis; paniculis paucifloris breviter pedunculatis foliis brevioribus, pedicellis brevibus floribus brevioribus; capsulis trigono-ovoideis sessilibus.

Socotra, tertia species nova arboris balsamifluæ quæ in montibus insulæ crescit. B.C.S. No. 466. Schweinf. No. 530.

25. *BALSAMODENDRON SOCOTRANUM*, *Balf. fl.*: arbuscula ramis ultimis pubescentibus, interdum spinosis; foliis 5-10 v. pluribus

ad apices ramorum lateralium brevium fasciculatis, plerumque 1-foliolatis rarius 3, petiolatis, foliolis oblongis v. oblongo-ellipticis v. subobovatis obtusis integris undulatis v. rarius ad apicem vix dentatis, submembranaceis, pellucido-venulosis; inflorescentia sessili 1-3-flora; floribus sessilibus minutis; staminibus 4 basi disci magni albi undulati insertis, antheris ellipticis.

Nom. vern. Logahem.

Socotra, abundans. B.C.S. Nos. 252, 256. Schweinf. No. 514.

26. *BALSAMODENDRON PARVIFOLIUM*, *Balf. fl.*: arborea ramis ultimis subpuberulis nonnunquam spinescentibus; foliis puberulis imparipinnatis ad ramos laterales contractos fasciculatis 3-7 foliolatis, rhachi inter foliola subalata, foliolis sessilibus oppositis v. suboppositis ellipticis obtusis planis integris venulosis; floribus sessilibus præcoccibus; staminibus 4 ad marginem disci scutelliformis depressi brunnei insertis, antheris oblongis.

Socotra, in campis. B.C.S. No. 656.

27. *BALSAMODENDRON PLANIFRONS*, Schweinf.: arbuscula inermis, ramis densis horizontaliter expansis juvenilibus dense tomentosis; foliis breviter petiolatis, imbricato-pinnatis ad apices ramorum lateralium brevium confertis, foliolis 5-10-jugis subæqualibus ellipticis v. ovatis obtusis late revolutis, bullois; floribus præcoccibus solitariis v. binis, sessilibus minutis; staminibus 4 disci margini 4-lobati insidentibus, antheris oblongo-cordatis; fructu oblongo-acuto, glaberrimo, apiculato.

Socotra, arbuscula rara. B.C.S. No. 709. Schweinf. No. 671. Hunter, No. III.

AMPELIDEÆ.

28. *VITIS SUBAPHYLLA*, *Balf. fl.*: dumetosa densa, ramulis complanatis ad nodos contractis nonalatis carnosis; foliis paucis integris subspathulatis v. oblanceolatis in petiolum attenuatis, glabris, carnosis, mox deciduis; cymis brevibus umbellatim ramosis; pedicellis tenuibus; floribus tetrameris; fructu conico viridi.

Nom. vern. Atarha.

Socotra, in campis calcareis prope Gollonsir abundans. B.C.S. No. 81. Schweinf. No. 244.

29. *VITIS PANICULATA*, *Balf. fil.*: late scandens, caulibus anguste alatis, juvenilibus quadrangulatis carnosis; foliis magnis breviter palmatim 3-5 lobatis basi cordatis, late crenatis, carnosulis, glabris; cymis subumbellatim paniculatis; pedicellis tenuibus; floribus tetrameris; fructu conico nigrescente.

Nom. vern. Atarha.

Socotra, in locis umbrosis inter arbusculas in declivitatibus montium frequens. B.C.S. No. 413. Schweinf. No. 510.

SAPINDACEÆ

30. *ALLOPHYLLUS* (*SCHMIDELLA*) *RHUSIPHYLLUS*, *Balf. fil.*: arborea plus minusve pubescens; foliis trifoliolatis, foliolis obovatis v. oblongo-obovatis v. oblongo-ellipticis, obtusis v. emarginatis, basi cuneatis, revolutis sinuato-crenatis, subtus petiolisque pubescentibus; racemis densis foliis subæquilongis; pedicellis floribus irregularibus vix longioribus; petalis staminibusque declinatis.

Nom. vern. Zirkin.

Socotra, ubique frequens. B.C.S. Nos. 247, 248, 421. Schweinf. Nos. 413, 474.

ANACARDIACEÆ

31. *RHUS THYRSIFLORA*, *Balf. fil.*: arborea, glabra; foliis trifoliolatis v. unifoliolatis, foliolis oblongis, v. oblongo-ellipticis v. oblongo-obovatis, obtusis, integris, v. obscure sinuato-lobatis, perspicue reticulatis; inflorescentia thyrsoides, ramosissima; pedicellis subtilibus floribus longioribus; sepalis petalis multo brevioribus; disco plano, obscure crenato.

Nom. vulg. Zöref.

Socotra, frequens in declivitatibus montium. B.C.S. No. 369. Schweinf. Nos. 480, 736.

32. *ODINA ORNIFOLIA*, *Balf. fil.*: arborea, ramis pubescenti-velutinis; foliis magnis 5-7 foliolatis, foliolis ovatis obliquis subcuspidatis sessilibus v. subsessilibus, pilis simplicibus velutinis; racemis vix ramosis axillaribus in fructu foliis æquilongis velutinis, pedicellis brevibus; calyce 4-partito persistente; fructu globoso velutino-pubescente.

VOL. XL

3 T

Nom. vern. Uksha.

Socotra, species fraxinoidea quae per montes omnes insulae crescit.
B.C.S. No. 276. Schweinf. No. 504.

33. ODINA ASPLENIFOLIA, *Balf. fl.*: arborea, ramis glabris interdum spinosis; foliis parvis 13-21-foliolatis, ad apices ramulorum lateralium abbreviatorum confertis, rhachi alata; foliolis subrhomboidis v. obcuneatis v. subobovatis apice dentatis v. subintegris sessilibus v. subsessilibus sursum sensim minoribus, glabris, glaucis; racemis tenuibus axillaribus.

Socotra, species gummifera in montibus frequens. B.C.S. No. 710.

LEGUMINOSÆ

34. CROTOLARIA STRIGULOSA, *Balf. fl.*: omnino strigulosa ramis elongatis tenuibus prostratis; foliis unifoliolatis, angustis linearibus v. latis et ellipticis v. oblongo-ellipticis subsessilibus; stipulis setiformibus; racemis terminalibus elongatis, oppositifoliis, pedicellis brevibus; calycis lobis tubo longioribus; corolla exserta; legumine oblongo breviter exserto pubescente 6-spermo.

Socotra, in campis ubique crescit. B.C.S. Nos. 72, 663. Schweinf. Nos. 656, 721.

35. CROTOLARIA DUBIA, *Balf. fl.*: omnino strigulosa ramis tenuibus copiosis late patentibus; foliis petiolatis palmatim trifoliolatis, foliolis sessilibus terminali longissimo, lineari-lanceolatis et ad formas obovatas variantibus, acuminatis v. mucronulatis; stipulis subulatis minutis; racemis elongatis oppositifoliis paucifloris, pedicellis capillaribus brevibus; calycis lobis tubo quadruplo-longioribus; corolla longe exserta; legumine oblongo, submembranaceo, venuloso, pubescente 12-spermo.

Socotra, in campis cum priore frequens. Species affinitatis dubia, an hujus generis. B.C.S. No. 149. Schweinf. No. 722.

Distrib. Aden.

36. CROTOLARIA PTEROPODA, *Balf. fl.*: herba procumbens sericeo-canescens; foliis petiolatis alterne digitatim trifoliolatis, foliolis ellipticis v. obovatis obtusis sæpe mucronulatis; stipulis obsolete;

floribus solitariis oppositifoliis ; pedicellis tetraquetris crebris ; calyce bilabiato corolla longiore, labio superiore profunde bifido, inferiore trifido ; corollae petalis vexillum excedentibus ; legumine tumido pubescente polyspermo.

Socotra, species dubie ad *Crotalaria* adscripta, B.C.S. No. 180.

37. *PRIOTROPIS SOCOTRANA*, *Balf. fl.* : fruticosa ; foliis trifoliolatis, foliolis oblongo-allipticis obtusis, emarginatis, brevissime petiolatis, supra glabris, infra strigulosis ; pedicellis brevibus ; legumine longe stipitato, longitudine dimidio latitudinem excedente, pubescente, 2-spermo.

Socotra, in declivitatibus montium. B.C.S. No. 688. Schweinf. No. 645.

38. *TRIGONELLA FALCATA*, *Balf. fl.* : annua ; foliis trifoliolatis, foliolis obovato-cuneatis, terminali longe petiolato ; stipulis semi-sagittatis infra incisus ; inflorescentia capitato-racemosa, 2-5-flora, foliis brevioribus ; calycis laciniis linearibus tubo multobrevioribus ; stylo ovario multobreviore ; legumine falcato, longo, tenui.

Socotra, in locis arenosis. B.C.S. No. 665.

39. *LOTUS (ONONIDIUM) ONONOPSIS*, *Balf. fl.* : diffusa, fere omnino glabra, subcrassa ; foliis subsessilibus trifoliolatis ; foliolis lanceolatis et ad formas suborbiculares variantibus, exstipulatis ; floribus pedicellatis solitariis axillaribus ; calycis lobis subæqualibus ; corolla exserta ; stigmatibus capitato ; legumine lineari, glabro, 8-12-spermo.

Socotra, in montibus altioribus. B.C.S. Nos. 400, 491. Schweinf. No. 555.

40. *LOTUS (ONONIDIUM) MOLLIS*, *Balf. fl.* : diffusa, cana, densè strigosa ; foliis sessilibus, trifoliolatis, foliolis oblanceolatis v. obcuneatis, exstipulatis ; floribus sessilibus v. subsessilibus, solitariis, axillaribus ; calycis lobis subæqualibus ; corolla longe exserta ; stigmatibus capitato ; legumine lineari, glabro, 8-spermo.

Socotra, in rupibus calcareis prope Gollonsir. B.C.S. No. 670.

41. *INDIGOFERA NEPHROCARPA*, *Balf. fl.* : depressa, canescens, ramosissima, ramis humifusis ; foliis alterne trifoliolatis, petiolatis,

strigosis; stipulis inconspicuis; racemis paucifloris, subsessilibus v. filiforme pedunculatis; legumine minuto 1-spermo reniformi, strigoso; stylo persistente.

Socotra, in campis arenosis frequens. B.C.S. Nos. 85, 104. Schweinf. No. 237.

42. *INDIGOFERA LEPTOCARPA*, *Hochst. et Steud. in Herb. Arab. Schimp.* No. 778 (*nom. sol.*): herba lignosa prorsus strigosa, basi ramosa; ramis decumbentibus; foliis digitatim-trifoliolatis, breviter petiolatis; stipulis minutis; racemis elongatis multifloris, rhachi basi nuda, pedicellis brevibus; legumine longo, polyspermo.

Socotra, in campis calcareis apud Tamarida sed infrequens. B.C.S. No. 674. Schweinf. No. 389.

Distrib. Arabia.

43. *INDIGOFERA MARMORATA*, *Balf. fil.*: suffrutex, argenteo-canescens; ramis complanatis; foliis alterne trifoliolatis v. pinnatis, petiolatis; foliolis 3-7 terminali maximo, oblanceolatis v. obovatis, supra marmorato-strigosis; stipulis obliquis subfimbriatis; racemis brevibus, axillaribus, paucifloris; floribus secundis; legumine brevi subtetraquetro, rostrato, bispermo.

Nom. vern. Sidere.

Socotra, in clivis elevatis montium rara. B.C.S. No. 370. Schweinf. No. 503.

44. *TAVERNIERA SERICOPHYLLA*, *Balf. fil.*: suffruticosa, argenteo-sericea; foliis alterne trifoliolatis dense sericeis; foliolis ellipticis; stipulis magnis late amplexicaulibus non-scariosis.

Socotra, in locis littoralibus arenosis apud Gollonsir atque Kadhab. B.C.S. Nos. 103, 338.

ARTHROCARPUM, *Balf. fil.*

Calycis decidui tubus brevis angustus supra ovarium connivens, lobi in labia 2 æquilongia dispositi, superior 4-dentatus latior, inferior integer angustior. Vexillum orbiculatum, unguiculatum; alæ oblique oblongæ; carina angusta, incurva, obtusa, alas subæquans, petalis vix coherentibus. Stamina omnia in vaginam supra

fissam connata; antheræ uniformes. Ovarium sessile ∞ -ovulatum; stylas filiformis, longissimus, leviter curvatus; stigmatibus minuto, terminali. Legumen compressum sericeo-pubescentibus, articulis subellipticis utrinque alatis et bi-trinervoso-angulatis lignosis, endocarpio spongioso. Semina anguste obovoidea, strophiolata.—Arbor parva. Folia imparipinnata foliolis paucis exstipellatis. Stipulæ persistentes. Flores flavi axillares, solitarii v. rarius cymosebiflori. Involucrum 4-bracteolatum persistens.

Genus monotypicum habitu et characteribus generalibus *Ormocarpo* accedens.

45. *A. GRACILE*, Balf. fil.: species unica montes Socotras incolans. B.C.S. No. 368, 449. Schweinf. No. 511.

46. *ORMOCARPUM CÆRULEUM*, Balf. fil.: fruticosum, ramis angulosis; foliis imparipinnatis subsessilibus, foliolis 5-7 crassis, obtusis, glabris medio subtus porphyreo puberulo excepto; stipulis sublanceolatis striatis; racemis brevibus paucifloris, pedicellis tenuibus sub florem bibracteolatis; calyce glabro; corolla cærulea; legumine brevi, venoso, glabro.

Socotra, frutex frequens. B.C.S. Nos. 80, 98, 293, 485. Schweinf. Nos. 375, 498.

47. *DICHRISTACHYS DEHISCENS*, Balf. fil.: fruticosus; ramulis foliisque juvenilibus pubescenti-hirtis; pinnis 2-5-jugis glandulis stipitatis, foliolis 8-15 jugis oblongis obliquis; spicis cylindraceis; legumine $\frac{1}{2}$ poll. lato dehiscente, valvis recurvis.

Socotra, apud Tamarida non infrequens. B.C.S. No. 365. Schweinf. 689.

48. *ACACIA SOCOTRANA*, Balf. fil.: suffruticosa, glabrescens; spinis primum tomentosius rectisque, demum albidis glabris apiceque lente recurvis, foliis æquilongis; pinnis 7-8 jugis, foliolis 10-20 jugis parvis oblongis obtusis; involucello infra medium pedunculi persistente; legumine stipitato foliis duplolongiore, vix curvo, marginibus planis, valvis velutinis nervosis lignosis.

Socotra, in campis arenosis apud littus frequens. B.C.S. No. 191. Schweinf. No. 260.

CRASSULACEÆ

49. *KALANCHOE FARINACEA*, *Balf. fl.*: caulescens, glauca caule subtereti sæpe procumbente; foliis obovato-orbicularibus integris sessilibus subfarinaceis; inflorescentia terminali bipartim corymboso-paniculata compacta; calyce 4-partito; corollæ flammæ tubo 4-5 lin. longo; staminibus corollis vix æquilongis; squamulis linearibus obtusis integris; carpellis tubo corollæ æquilongis.

Socotra, in campis elevatis calcareis frequens. B.C.S. No. 521. Schweinf. No. 753. Hunter, No. 15.

50. *KALANCHOE ABRUPTA*, *Balf. fl.*: caulescens erecta valida, glauca; foliis ad apicem caulis crassi aggregatis late insertis spatulatis magnis integris; floribus in terminales erectos crebros thyrsoides paniculos dispositis; calyce 4-partito; corolla cinnabarina, tubo $\frac{3}{4}$ lin. longo; staminum filamentis tubo corollæ brevioribus versus apicem abrupte attenuatum; squamulis latis suborbicularibus integris; carpellis corollæ æquilongis.

Socotra, in regione orientali calcarea solum crescens. B.C.S. No. 512.

51. *KALANCHOE ROBUSTA*, *Balf. fl.*: caulescens erecta robusta, caule tereti griseo rugoso; foliis ad apices ramorum evolutis ellipticis v. oblongis obtusis vix petiolatis glaucis; inflorescentia terminali paniculata; calyce 4-partito; corolla flammeo-rubra, tubo $1\frac{1}{2}$ poll. longo, angusto; staminibus exsertis; squamulis rotundatis, subcrenatis; carpellis corollæ æquilongis.

Socotra, in regione Haggier. B.C.S. No. 151.

LYTHRACEÆ

52. *PUNICA PROTOPUNICA*, *Balf. fl.*: arbuscula ramis sæpe spinescentibus; foliis ellipticis v. oblongis nunc obovatis nunc orbicularibus obtusis sæpe emarginatis integerrimis; bracteis subfloris oblongis obtusis; petalis obcordatis; carpellis uniseriatim verticillatis, placentis horizontalibus basalibus.

Socotra, species nova insignis quæ abundanter per insulam crescit. B.C.S. Nos. 263, 505. Schweinf. No. 506. Hunt. No. III.

CUCURBITACEÆ.

DENDROSIYOS, Balf. fl.

Flores monoici. Fl. ♂ paniculati. Calycis tubus infundibuliformis, dentibus 5 patentibus subulatis integris. Corolla in fauce calycis inserta ad basin 5-partita segmentis lanceolatis integris. Stamina 3 ori calycis inserta corollæ adnata filamentis liberis; antheræ arcte cohærentes, una 1-locularis, ceteræ 2-loculares, loculis rectis, connectivo nonproducto. Ovarii rudimentum 0. Fl. ♀ . . . Arbor parvus trunco magno atque ramis paucis ad apicem fasciculatis. Folia palmatim 5-lobata v. partita, aculeata, scabrida. Cirrhi 0. Flores ♂ magni straminei.

Genus anomalum ab omnibus notis generibus habitu arboreo insigniter differt.

53. D. *SOCOTRANA, Balf. fl.*: ubique per campos Socotræ crescens. B.C.S. No. 210. Schweinf. No. 243.

UMBELLIFERÆ.

NIRARATHAMNOS, Balf. fl.

Calycis dentes minuti, acuti. Petala lata acumine longo bifido induplicato, ob costam impressam emarginata. Discus margine subrenato cum stylopodiis conicis confluens; styli breves. Fructus ovoideus utrinque ad commissuram angustam constrictus; carpella 5-gona; juga primaria prominula, subæqualia, exalata; vittæ ad valleculeas solitariae. Carpophorum bipartitum. Semen semiteres, ad vittas sulcatum, facie leviter concavum.—Suffrutex lignosus, rigidus, glaberrimus, aromaticus. Folia rotundata, margine revoluta, crenata, reticulato-venosa. Umbellæ compositæ pauciradiatæ. Involucri et involucellorum bracteæ subfoliaceæ persistentes radiantæ. Flores albo-virentes, pedicellati.

Genus *Bupleuro* maxime affine sed forma petalorum, stylopodiis conicis, et fructu noncompressa differt.

54. N. *ASARIFOLIUS, Balf. fl.*: Socotræ incola. B.C.S. No. 440.

55. *CARUM* (*TRACHYSPERMUM*) *PIMPINELLOIDES*, *Balf. fil.* : herba glabrescens diffusa parva ; foliis petiolatis tripartitis, segmentis in laciniis lanceolatas acutas 1-2-trifidis glabrescentibus, vagina petioli ciliata ; umbellis breviter pedunculatis, oppositifoliis 6-7-radiatis, bracteis 4-6 radiis æquilongis subulatis sparse puberulis, pedicellis 5-7 validis, angulosis, bracteolis brevioribus ; petalis ciliatis acumine bifido ; fructu oblongo v. suborbiculari, jugis prominulis, glabris v. hispidis, commissura multo constricta ; stylopodo conico.

Socotra, in littore inter Kadhab atque Tamarida. B.C.S. No. 367.

56. *CARUM* (*TRACHYSPERMUM*) *CALCIOOLUM*, *Balf. fil.* : herba glabrescens nuda erecta bipartim ramosa, caulibus angulosis ; foliis basalibus longe petiolatis in laciniis longas lineares tripartitis v. bitripartitis, superioribus filiformibus sessilibus ; umbellis longe pedunculatis oppositifoliis sparse puberulis 2-4-radiatis, radiis capillaribus bracteis 2-4 multo longioribus, pedicellis 8-12 tenuibus bracteolis brevioribus ; petalis ciliatis acumine integro ; fructu ovoideo, jugis nonprominulis hispidis, commissura non multo constricta ; stylopodio conico.

Socotra, in campis calcareis littoralibus commune. B.C.S. No. 190.

57. *PEUCEDANUM CORDATUM*, *Balf. fil.* : glabrum, annuum, erectum, caule tereti striato ; foliis bipinnatisectis, segmentis latis planis plerumque sessilibus palmatim trifidis, laciniis acute dentatis v. subincisis basi subcordatis v. sæpe subcuneatis, membranaceis ; involucris involucellisque polyphyllis ; umbellis primariis 10-20-, secundariis 8-12-radiatis ; fructu pedicello breviora, elliptico, basi alte-cordato, vittis vallecularibus solitariis, commissuralibus binis approximatis, alis fructui æquilatis.

Socotra, in montibus abundanter crescens. B.C.S. No. 290. Schweinf. No. 572.

BUSINESS.

Mr. Alexander Leslie, M. Inst. C.E., Mr. J. S. Mackay, M.A., and Dr. Henry Barnes, were balloted for, and declared duly elected Fellows of the Society.

PROCEEDINGS
OF THE
ROYAL SOCIETY OF EDINBURGH.

VOL. XI.

1881-82.

No. 111.

Monday, 20th February 1882.

PROFESSOR MACLAGAN, M.D., Vice-President,
in the Chair.

The following Communications were read:—

1. On a Specimen of *Balænoptera borealis* or *laticeps* captured in the Firth of Forth. By Professor Turner.

In September 1872 a whale of some magnitude was seen floundering in shallow water at Snab, Kinneil, about a mile from Bo'ness, on the Firth of Forth. Some men proceeded to the spot and fastening a rope round its tail, hauled it closer to the shore, and then killed it. I was not at home at the time, but on reading a notice of its capture in the *Scotsman* of September 26, I wrote to my assistant, the late Mr A. B. Stirling, to go and see the animal. He reported to me that it was a whalebone whale, ribbed and grooved on the belly, and he was able to make the following notes on its colour and dimensions:—

The animal was black on the back of the head and body and dorsum of the tail. The belly was pinkish white, with a shade of yellow, from chin to anus. Behind the anus it was patched with white to three feet from the tail. Behind this again the colour varied from lead grey to black, and the under as well as the upper surface of the tail was black. The breadth of the dorsum of the head at the tip of the upper lip was 2 inches; one foot further back it was 9 inches; two feet back 18 inches; and at the blowholes, 3 feet. The dorsal fin had a falcate posterior border, and its long

diameter along the anterior border to the tip was 1 foot 8 inches, whilst its height was 11 inches. The flipper, when disarticulated at the shoulder, was 4 feet 10 inches in length. The breadth of the tail was 8 feet 8 inches: its anterior border was convex, its posterior border festooned. From the root of the tail to the mesial notch was 2 feet 5 inches, and the depth of the notch was 5 inches. The lower jaw projected both in front of and to the sides of the upper jaw. The length of the animal, from the tip of the beak to the end of the tail, was about 37 feet, and the girth round the belly about 15 feet.

The whale was taken possession of by the Custom House officials, and was then sold by public auction.

When I saw it a few days afterwards the blubber and baleen had been removed from the animal. The baleen consisted of numerous plates, the biggest of which were about 1 foot 3 inches in length and about 6 inches wide. They were black, striped with grey and white, and the hairs projecting from the lower free border were greyish-white.

The fluted state of the belly and the presence of a dorsal fin proved it to be one of the *Balænopteridæ*, or Finner whales. It was evident, both from the colour of the whalebone and the shape of the upper jaw, the lateral borders of which were straight, that the animal was not the *Balænoptera sibbaldii*, a magnificent example of which had been stranded at Longniddry only three years before.* Its size and the colour of its baleen distinguished it also from the lesser piked whale, *Balænoptera rostrata*. The absence of yellowish and greenish tints in the plates of the whalebone threw some doubt on its being *Balænoptera musculus*, but I was not in a position, in the condition the animal then was, to discriminate between *Balænoptera musculus* and *B. borealis*. I decided, therefore, to buy the carcass, and to have the skeleton prepared for the Anatomical Museum of the University. Accordingly men were engaged to take the flesh off the bones, and to separate it into pieces of convenient size for transport into Edinburgh. I regret to say that the sternum and pelvic bones were lost amidst the masses of flesh, and could not be recovered; but with these exceptions, and that of a carpal bone, some of the smallest phalanges, and perhaps one or two chevrons, the skeleton is, I believe, perfect. As the bones of the large cetacea are, from the quantity of oil which they contain,

* See my account of this animal in *Trans. Roy. Soc. Edin.*, 1870, vol. xxvi.

difficult to clean, I obtained permission from my colleague, Professor Balfour, to bury them in the Botanic Gardens in a mixture of leaves and earth. They remained there until the summer of last year, when they were disinterred, clean and free from grease and smell. The examination which I have subsequently made of the skeleton has satisfied me that the animal was the cetacean named by zoologists *Balænoptera borealis* or *laticeps*.

The only specimen captured in the British seas, which has been referred to this species by some zoologists, is one stranded at Charmouth, Dorsetshire, in 1840. From the colour of its baleen and the number of its vertebræ (60), it was much more likely to have been *Balænoptera musculus*. But as the skeleton has not been preserved, its identification is now rendered difficult. As no properly authenticated specimen of *B. borealis* had therefore previously been captured in the seas of our islands, I have the satisfaction of adding this mammal to the British Fauna.

In the Museum of the Royal College of Surgeons of England are some vertebræ and other bones of this species, but nothing is known of their history. In the University Museum, Cambridge, are the skull and one scapula of a whale cast ashore on the island of Islay, in 1866, which Professor Van Beneden referred at one time to this species.* Mr. J. W. Clark has, however, pointed out† that it is the skull of a very fine *Balænoptera rostrata*, and Professor Flower tells me that he is of the same opinion. Skeletons of *B. borealis* are preserved in the Museums at Leyden, Berlin, Bergen, Brussels, and Bayonna. The Leyden specimen was taken in 1811, near to Moniken Dam, in the Zuider Zee, and the characters of the skeleton have been given by Professor Flower.‡ The Berlin specimen, figured and described by Rudolphi,§ was taken in 1819 on the coast of Holstein, near to Gromitz. Two skeletons are at Bergen, the one was described by Lilljeborg,|| from a young animal captured on the Norwegian coast; the other came from the Loffoden Islands,¶ and

* *Ostographie des Cétacés*, p. 202.

† See reference in *The Fauna of Scotland*, "Mammalia," by E. R. Alston, Glasgow, 1870. Also, in a letter to myself, in reply to a communication on the subject.

‡ *Proc. Zool. Soc. London*, Nov. 8, 1864.

§ Rudolphi named this animal *Balæna rostrata*. *Abhand. der Akad. der Wissensch. zu Berlin*, 1820, 1821.

|| Translation of Lilljeborg's *Memoir on the Scandinavian Cetacea*, in publications of Ray Society.

¶ *Ostographie des Cétacés*, p. 201.

has apparently not yet been described. The Brussels skeleton was obtained by Eschricht from the North Cape, and has been described by Van Beneden.* The skeleton in the Museum at Bayonne is a young male specimen, which M. P. Fischer states was stranded near Biarritz in July 1874.† The animal was 7·83 mètres long (about 26 feet). *B. borealis* is therefore a denizen of the North Atlantic Ocean.‡

It is not my intention on this occasion to enter in detail into the description of the skeleton of this whale stranded near Bo'ness, but it will be necessary to refer to such points in its anatomy as will give certainty to the identification of the species. The bones of this animal were less massive, smoother on their surface, and less porous than the bones of either *B. musculus* or *B. sibbaldii*. The vertebral plates were not ankylosed to their respective bodies, and the epiphyses of the radius, ulna, and humerus were not united to the shafts of their respective bones.

The entire length of the skull and spine was 35 feet 2½ inches, viz., the skull, 8 feet 1½ inches; the spine, without the intervertebral discs, 26 feet 7 inches. If to this be added 2 feet for the probable thickness of the intervertebral discs, and 8 or 10 inches for the projection of the lower jaw beyond the upper and the thickness of the skin, the length of the animal would have been about 38 feet, which closely approximates with what was reported

* *Ostéographie des Cétacés*, p. 302.

† *Comptes Rendus*, 27th Dec. 1876, p. 1298, vol. lxxxiii.; and *Journal de Zoologie*, vol. v. p. 462, 1876.

‡ In *Nature*, 12th Oct. 1876, is a reference to the *Schriften der naturforschenden Gesellschaft in Dantzig*, which contains photographs of the skeleton of a whale, said to be *Pterobalæna laticeps* (Gray), stranded in Dantzig Bay in 1874, but as I have not been able to obtain a copy of the Dantzig publication, can make no further reference to it. I observe that in the *Archiv für Naturgeschichte*, 1875, 41st year, third part, p. 338, is an elaborate description, by Professor Zaddach of Königsberg, of a female fin whale, stranded in August 1874, between Neufahrwasser, the harbour of Dantzig, and the village of Heubude. He names it *Balenoptera musculus*. Its vertebral formula is $C_7D_{14}L_{18}Cd_{24}$ —60, and the baleen is described as yellow like horn, with bluish-green or blackish spots at the outer border. Its length was 10·98 mètres (about 36 feet English). Professor Zaddach states that he does not give a detailed description of the skeleton, as the Dantzig Society of Natural History had decided to publish a description of it, with drawings and photographs, in their *Schriften*, from the pen of Professor Menga. Can this be the specimen referred to in *Nature*? The colour of the baleen and the vertebral formula (probably the last two caudals had not been ossified and preserved) show its affinity to *B. musculus* rather than to *B. laticeps*.

as its length before being flensed. Although the condition of the epiphyses proved that the animal had not reached adult life, or probably attained its full dimensions, yet this skeleton is larger and more advanced in its ossification than the other skeletons which have been described. The Leyden specimen is said to have been 32 feet long, and Professor Flower gives its skeleton as 29 feet 7 inches, without the intervertebral discs, for the thickness of which an additional 2 feet should be allowed. Professor Rudolphi states that the Berlin skeleton is 31 feet 1 inch Rhenish measurement. The young skeleton in Bergen described by Lilljeborg is 30 feet 2 inches; and Professor Van Beneden names 32 feet as the length of the specimen in the Brussels Museum. From these measurements, M. Van Beneden concludes that this species of whale does not appear to exceed 35 feet in length. But the dimensions of the specimen now before us, which is obviously not an adult, would lead one to say that this animal may attain a length of 40 feet, or even more. Whilst larger than *B. rostrata*, it is considerably smaller than *B. musculus*, and still more than *B. sibbaldii*.

Spine.—The vertebræ numbered in this specimen fifty-six; and as the last caudal was only $1\frac{1}{2}$ inch in its transverse and $1\frac{1}{4}$ in its antero-posterior diameter, it is probable that all the vertebræ were secured. The formula was as follows:— $C_7D_{14}L_{14}Cd_{21} = 56$. In the Leyden specimen there were also fifty-six vertebræ, the two last caudals being fused together, viz., C_7D_{13} or $_{14}$, L_{16} or $_{15}$, Cd_{20} . Rudolphi states that the Berlin skeleton had fifty-four vertebræ, though Eschricht says fifty-five, and one was probably missing. Lilljeborg states that the young skeleton in Bergen had fifty-five vertebræ, viz., $C_7D_{13}L_{14}Cd_{21}$. In the Brussels specimen the terminal caudals were lost, but the vertebræ present were $C_7D_{14}L_{15}$, and fifteen caudals. The Bayonne skeleton had only fifty-four vertebræ, but the animal was young, and the two terminal caudals were probably not ossified. Fifty-six is probably, therefore, the normal number of vertebræ, and of these fourteen are dorsal, so that there are fourteen pairs of ribs, which is the number present in my specimen. The vertebral formula, therefore at once distinguishes *B. borealis* from the other species of the genus; for in *B. rostrata* the formula is $C_7D_{11}L_{13}Cd_{17} = 48$, and there are only eleven pairs of ribs. In *B. musculus* the formula is $C_7D_{15}L_{15}Cd_{25} = 62$, and there are, as a rule, fifteen pairs of ribs. In *B. sibbaldii* the vertebræ are sixty-

three or sixty-four, and the formula is C_7D_{15} or $16, L_{15}Cd_{26}$, and there are fifteen or sixteen pairs of ribs. *Balaenoptera borealis* is, therefore, intermediate in length, in the number of its vertebræ and of its ribs to *B. rostrata* on the one hand, and to *B. musculus* and *B. sibbaldii* on the other.

The seven cervical vertebræ of my specimen are all separate bones, except that the right lateral mass of the atlas is ankylosed to the body of the axis. This is an exceptional arrangement in the fin whales, and has not apparently been seen in any of the other skeletons of *borealis*. The atlas has a transverse process, short, twisted, and compressed from before backwards, and a median backward-projecting ventral process corresponding with Professor Flower's description of the Leyden specimen. The ring is markedly divided into an inferior part for the rudimentary odontoid, and a superior rachidian part by a process projecting inwards on each side. This character is also well seen in the atlas in the Museum of the College of Surgeons, London. The height of the atlas is $10\frac{1}{2}$ inches; that of the axis 13 inches. The extreme transverse diameter of the atlas is $14\frac{1}{2}$ inches; that of the axis $21\frac{1}{2}$ inches. The axis has a thick spine. The transverse process has a slender upper and a plate-like lower limb, which unite externally to form a broad plate-like process directed backwards and outwards. The vertebrarterial foramen is only $1\frac{1}{2}$ by $2\frac{1}{2}$ inches, and is placed near the upper border of the process. The rachidian ring is $4\frac{1}{2}$ by $3\frac{1}{2}$ inches. In the 3rd and 4th vertebræ the vertebrarterial foramen is completed by the junction externally of the superior and inferior limbs of the transverse process. In the 5th vertebra these processes are separated externally by an interval of $\frac{1}{2}$ inch; in the 6th, by an interval of $1\frac{1}{2}$ inch; in the 7th, whilst the superior limb is long and curved downwards and outwards, the inferior limb is represented by a mere tubercle. In the Leyden specimen the vertebrarterial foramen is incompletely bounded in the 2nd to the 7th inclusive. In the Berlin and Bergen skeletons only the axis has the foramen completely bounded by bone. In the Brussels skeleton only the axis and 3rd vertebra. The ossification is therefore more advanced in this region in my specimen than in these other skeletons.

The flat surfaces of the upper transverse processes are almost vertical; those of the lower transverse process of the 6th cervical are

almost horizontal. From the root of the lower transverse process of the 4th, 5th, and 6th a stout conical process projects forwards.

The dorsal vertebræ increased in magnitude from before backwards. The 1st had a vertical diameter to the summit of the spine of $13\frac{1}{2}$ inches, and a transverse, between the tips of the transverse processes, of $19\frac{1}{2}$ inches. The last dorsal had a vertical diameter of $22\frac{1}{2}$ inches, and a transverse of 30 inches. All the dorsal vertebræ were marked by an articular surface for a rib at the free end of the transverse process. They were not keeled on the ventral surface of the body.

The lumbar vertebræ were, as a rule, somewhat bigger than the hinder dorsal, and reached their maximum at the 8th, 9th, and 10th. The 9th lumbar had a vertical diameter of $24\frac{1}{2}$ inches, and a transverse of 31 inches. Behind the 10th the transverse and spinous processes gradually diminished in their amount of projection as they passed back into the caudal region, and in the 12th vertebra from the end of the tail the transverse process was represented by a faint ridge on the side of the body, and the spine was rudimentary. In the 9th vertebra from the end of the tail the spine and laminae had disappeared, and the neural canal was represented by a groove, which was faintly seen on the two vertebræ next behind, and then disappeared. In the 12th vertebra from the end of the tail a foramen, directed vertically, was situated at the root of the rudimentary transverse process, and a similar foramen was found in the caudals up to and including the 18th from the end of the tail. This arrangement closely resembles that figured by Rudolphi in the Berlin skeleton. The lumbar were all keeled on the ventral surface of the body, though, as a rule, the keel was slight in relation to the size of the bone.

Eleven chevron bones were present. The articulations for the chevron bones began on the 15th vertebra of the lumbo-caudal series (counting from the front) in a pair of surfaces situated at the posterior border of the ventral surface of the body of that vertebra; and distinct articulations for these bones could be seen as far back as the 27th lumbo-caudal vertebra. Hence I have regarded all the vertebræ behind the 14th lumbar as caudal vertebræ. In the 1st caudal the ventral keel was very slight, and a shallow groove was seen posteriorly between the articulations for the 1st chevron bone.

The caudals behind the first were all grooved on the ventral surface, and the groove in many instances possessed considerable depth. The spines of some of the lumbar and the more anterior caudals had sharp bony outgrowths projecting from the posterior border.

Ribs.—There were fourteen pairs of ribs. The 1st was flattened, and measured in a straight line $25\frac{1}{2}$ inches on the left side and 25 inches on the right; the breadth of the sternal end of the 1st left was $4\frac{3}{4}$ inches. The 2nd rib was $37\frac{3}{4}$ inches long on the left side and $33\frac{1}{4}$ inches on the right side. The ribs increased in length, as far back as the 6th rib, which measured 4 feet 3 inches in a straight line; from the 7th to the 14th they diminished in size, and the last rib was 2 feet 3 inches in length; they were slender rod-like bones. All the left ribs were separate bones, but the right 1st rib was fused with the 2nd at the sternal end, where they formed a plate of bone $13\frac{3}{4}$ inches broad. The breadth was partly due to a broadening of the sternal end of the 2nd rib, and partly to the formation of bone in the 1st intercostal space, for a distance of 6 inches from the sternal end, which was fused with the borders of both the 1st and 2nd ribs, and, together with them, formed the broad plate above referred to. On the 3rd and 4th ribs well-marked capitular processes extended from the vertebral articular surface towards the body of the vertebra. Rudimentary capitular processes were present on the 2nd and 5th, but were absent on all the other ribs.

In all the skeletons of *B. borealis* which have previously been described, the 1st rib had the peculiarity of possessing two heads. In the Leyden specimen the cleft which separated these heads from each other had a depth of 5 inches (Flower). From the figure given by Rudolphi of this rib in the Berlin skeleton, it is probable that the cleft had a similar depth. In Lilljeborg's Bergen skeleton the 1st pair are considerably wider than the others, with the upper end forked or "biceps," and the lower rather dilated and much wider than the upper. In the Brussels skeleton, as figured by Van Beneden, one of the first ribs has the same character, and in the Museum of the Royal College of Surgeons of England are the first ribs of two individuals of this species, which are also bicipital. M. Fischer does not describe the skeleton of the Bayonne specimen, but notes that the spinal end of the 1st rib is bicipital. M. Van Beneden had the

advantage of seeing the ribs in place before the flesh was removed. He states that on the right side an elongated, compressed movable bone, curved like a rib, was applied to and articulated with the anterior surface of the 1st true rib, and on the left side a similar rudimentary rib was present, which was fused with the body of the first true rib, so as to give it a bicipital appearance. Both Professors Flower and Van Beneden regard this supplementary part of the 1st rib as a cervical rib, so that the double vertebral end of this rib articulates with both the 7th cervical and 1st dorsal vertebræ. In my skeleton no supplementary cervical rib was present. The two ribs which were fused together on the right side, at the sternal end, were the 1st and 2nd thoracic ribs, and differed therefore from the condition described in the other skeletons. The constancy with which the bicipital form of the 1st rib had been seen, in the skeletons of this animal previously described, had given rise to the impression that it might almost be regarded as a specific character, and the late Dr. J. E. Gray even went so far as to give it generic importance, and named Rudolphi's whale *Rudolphius laticeps*.¹ In a criticism which I made some years ago on the value of this character for purposes of classification,² I argued that the presence of a cervical rib, whether blended or not with the 1st thoracic rib, was only an individual variation, and, as cervical ribs occasionally occur in men as well as in whales, that one should as little think of classifying men who possess cervical ribs as distinct from those who do not possess them, as found a genus of whales on the presence of these bones. The absence of a cervical rib in the skeleton now described, which is an undoubted specimen of *B. borealis* or *laticeps*, shows that the bicipital form of the 1st rib is not constant in this species; but as the majority of the skeletons which have been examined have two heads to this rib, its bicipital character would seem in this animal to be the rule, and not, as in man, the exception.

Skull.—The skull resembled, both in its general configuration and in detail, the figures of the skulls of this animal published by Rudolphi and Van Beneden. The sides of the beak were straight;

¹ *Catalogue of Seals and Whales, and Supplement.*

² The so-called two-headed ribs in Whales and in Man, *Jour. of Anat. and Phys.* vol. v.

the premaxillaries projected 6 inches beyond the superior maxillaries. The upper surface of each nasal bone was $8\frac{1}{4}$ inches long, flattened in the posterior third, but slightly concave in the anterior two-thirds, owing to the inner border of that part of the bone being raised into a low longitudinal ridge. The anterior borders of the two bones were truncated, and formed together almost a straight line. The breadth of each bone at its posterior end was 1 inch, and at its anterior end $2\frac{1}{2}$ inches. The premaxilla passed back as a thin plate between the nasal and superior maxilla, as far as the posterior end of the nasal. The superior maxilla passed back for 3 inches beyond the posterior end of the nasal.

The orbital border of the frontal bone was 14 inches in length; the antero-posterior diameter of the inner part of this bone was 16 inches. The anterior borders of this bone sloped outwards and slightly backwards, whilst the posterior border was almost transverse.

The anterior border of the occipital bone was $10\frac{1}{2}$ inches wide, and almost transverse; the posterior border was $31\frac{1}{2}$ inches, and presented on each side from the foramen magnum outwards two cavities separated by an intermediate convexity.

The malar was 12 inches long, inclusive of the thin plate between the lachrymal and superior maxilla; the part which formed the proper lower boundary of the orbit was 8 inches. The lachrymal, $8\frac{1}{2}$ inches long, was a thin plate of bone except at the anterior end, which was tuberculated.

The beak arched in the antero-posterior direction from base to tip, and the highest point of this arch was 5 inches above the chord of the arc.

The mandible was not strongly curved. The length of the lower jaw in a straight line was 8 feet $5\frac{1}{2}$ inches; and along the outer convex surface 8 feet 8 inches. The superior border was 11 inches at its farthest point from the chord of the arc. The coronoid process was low and triangular, its base was $8\frac{1}{2}$ inches long, and its height from the base line was $3\frac{1}{2}$ inches. The depth of the mandible, including the coronoid process, was $11\frac{3}{4}$ inches.

The hyoid closely resembles Rudolphi's figure, and, as it has not hitherto been properly described, and is so characteristic of this species, I shall give an account of it. The inferior surface of the

middle of the body was slightly concave from side to side, and slightly convex from before backwards. The posterior border of the body was convex, and projected backwards considerably behind a line drawn across between the posterior border of the two great cornua. In this character it differed very markedly from both *B. sibbaldii* and *B. musculus*. The great cornu was flattened on its upper and slightly convex on its under surface, with the anterior border a little more rounded than the posterior; its antero-posterior diameter was almost uniform until near the tip. In *B. sibbaldii*, again, the great cornu swelled out so as to assume a remarkable fusiform shape, and to a less degree this is also seen in *B. musculus*. The stylohyals were flattened on both surfaces and $13\frac{1}{2}$ inches long. The hyoid measured between the tips of the great cornua 21 inches.

The following table gives, in feet and inches, the principal dimensions of the skull:—

| | FT. | IN. |
|--|-----|-----|
| From anterior border of foramen magnum over vertex to tip of beak, | 8 | 9½ |
| From nasal end of superior maxilla to tip of beak, | 6 | 9 |
| From anterior border of foramen magnum to nasal end of superior maxilla, | 2 | 0½ |
| Breadth across posterior ends of superior maxillæ, | 0 | 8½ |
| Greatest breadth of skull, | 3 | 10½ |
| Breadth of skull at base of beak, | 2 | 6 |
| Breadth of skull at middle of beak, | 1 | 5½ |
| Breadth of skull between middle of orbital borders of frontals, | 3 | 7½ |
| Length of skull in a straight line (condylo-premaxillary), | 8 | 7½ |
| Length of beak, | 5 | 9 |
| Length of superior maxilla, | 6 | 3 |
| Length of premaxilla, | 6 | 6½ |
| Greatest breadth of superior maxilla behind base of beak, | 3 | 7 |
| Greatest breadth between outer borders of both premaxillæ, | 0 | 10 |
| Greatest breadth of space between both premaxillæ, | 0 | 8 |
| From foramen magnum to upper border of occiput, | 2 | 0 |

I have compared the tympanic bones with those of *B. rostrata*—the smallest—and *B. sibbaldii*—the largest—of the fin whales. Their dimensions expressed in inches were as follows:—

| | Immature. | Adolescent. | Immature. | Adolescent. |
|--------------------|---------------------|---------------------|----------------------|----------------------|
| | <i>B. rostrata.</i> | <i>B. borealis.</i> | <i>B. Sibbaldii.</i> | <i>B. Sibbaldii.</i> |
| Length, | 3.5 | 4.8 | 4.7 | 5.3 |
| Breadth, | 1.8 | 2.2 | 2.5 | 2.6 |

In *B. rostrata* the breadth index was 51, in *borealis* 46. The

greater relative breadth of *rostrata* was due to both the outer and inner surfaces being generally more convex; but the anterior part of the outer surface of *rostrata* possessed a concave area more distinctly marked than in *borealis*. In *rostrata* the superior border between the two attachments of the petrosal was more horizontal than in *borealis*, and in the same specimen the posterior attachment of the petrosal was nearer the hinder end of the bone, which was more rounded in *rostrata* than in *borealis*. In *rostrata* the entrance to the tympanic cavity was relatively wider, with the rounded border relatively thicker; whilst the inferior border was less distinctly keeled than in *borealis*. In the adolescent *B. sibbaldii* the tympanic was broader in relation to the length than in *borealis*, and this greater relative breadth was still more strongly marked in the immature *sibbaldii*, the breadth indices in the two specimens being respectively 49 and 53. The greater breadth of *sibbaldii* was especially seen in the posterior third of the bone, which bulged considerably on the inner surface in *sibbaldii*, and was almost flat in *borealis*. This bulging caused a broadish concave surface at the root of the posterior attachment of the petrosal bone in *sibbaldii*, whilst the corresponding area in *borealis* was a narrow groove. In *sibbaldii* the entrance to the tympanic hollow was more sinuous, and the rounded border of the bone much thicker than in *borealis*. In *sibbaldii* the anterior and posterior ends were less attenuated than in *borealis*. Through these characters there was no difficulty in distinguishing between the tympanics of these species, and the character which most impressed me in making this comparison was the relative want of breadth of *borealis*. I have not a tympanic bone of *B. musculus* at hand with which to compare my specimen, but from my recollection of a specimen I saw in the Royal Museum, Brussels, in May of last year, I should say that in *musculus* the tympanic had a greater breadth than in *borealis*.

Pectoral Limb.—The scapula was a triangular plate, measuring 29 inches between its superior and inferior angles, and $17\frac{1}{2}$ inches in its glenoido-vertebral diameter. The coracoid was $\frac{3}{4}$ inch long, and $2\frac{1}{4}$ in its greatest breadth. The acromion was $6\frac{3}{4}$ inches long, and 4 in its greatest breadth. The humerus was only 11 inches long, and 1 foot $2\frac{1}{4}$ inches in circumference at the middle of the shaft, the surfaces of which were somewhat flattened. The

ulna was 11 inches long, $5\frac{1}{2}$ broad at the upper end, measured across the olecranon, $3\frac{1}{2}$ at the lower end, and only $2\frac{1}{2}$ in breadth in the middle of the shaft. The radius was $20\frac{1}{2}$ inches in length, and with much less difference in breadth between the upper and lower ends and the middle of the shaft than was seen in the ulna.

Thirteen carpal bones were present, and one was probably missing. Five pairs of these bones were nodular, in part tuberculated on the surface, and in part with flattened articular-looking surfaces, well marked in four pairs, very imperfect in one pair. One pair and the single bone were flattened, elongated, and uniformly tuberculated, without any appearance of an articular surface.

Thirty-three finger bones were present, and some of the smaller phalanges were either unossified or probably missing.

The comparison which I have so far made of the Bo'ness whale with other specimens has been with skeletons admittedly those of *B. borealis*, and obtained in the North Atlantic. But in the Leyden Museum is a skeleton brought from the north-west coast of Java, named, after Professor Schlegel, *Balænoptera Schlegelii*, which Professor Flower, who first described it, regarded as closely allied to, if not specifically identical with, *B. borealis*, though, on account of its *habitat*, he had a difficulty in placing it with *borealis*.¹ This skeleton was more perfectly ossified than in my specimen, and belonged to an animal probably about 45 feet long. I have compared my skeleton with Professor Flower's description and figures, and with the additional description and illustrations of its skeleton in Pls. XIV. and XV., and on p. 221 of the *Ostéographie des Cétacés*, and without doubt the resemblance is in many particulars very striking.

The mandible with its low coronoid process, the profile outline of the skull, the flattened stylo-hyals, the general form of the tympanic, the cervical vertebræ, the general form of the dorsals and lumbaris (the latter with their spiculated spines), the scapula, the humerus, radius, and ulna, all closely corresponded. The Java specimen possessed also fourteen pairs of ribs and fifty-four vertebræ, C₇ D₁₄ L₁₄ Cd₁₉. Professor Flower thinks that three or four caudals are wanting, but Professor Van Beneden considers only one or two are missing.

¹ *Proc. Zool. Soc.*, London, Nov. 8, 1864.

On the other hand, the nasal bones are obviously flatter and longer; the antero-posterior diameter of the orbital border of the frontal is relatively not so long; the double curve of the posterior border of the occipital is not so marked, and its base is wider (Van Beneden) in *Schlegelii* than in *borealis*. Again, my specimen does not have a pair of strong tubercles projecting from the posterior border of the body of the hyoid, as in the Java specimen, and the first rib is not bicipital.

Some of these differences may be due to the more advanced ossification of the Java skeleton, and the longer and stronger spines of the dorsal and lumbar vertebrae, which M. Van Beneden refers to, are obviously due to the same cause. The greater length of the Java skeleton has not the importance which Van Beneden attaches to it, as I have already maintained that *borealis* may attain a length of 40 feet or upwards, and the ribs in the Java specimen corresponded in number with those in my skeleton.

At the time when Professor Flower wrote his description, there was a greater tendency, on the part of cetologists, to limit the area of distribution of the individual species of cetacea, than now exists, and to confer specific value upon specimens which, though in many respects similar in characters, yet came from distant seas. The wider range of distribution of some of the species of the marine mammals is now more generally recognised, and the remoteness of the habitat of Schlegel's *Balaenoptera* ought not, if the anatomical arrangements correspond, to bar its association with *B. borealis*.

2. On Minding's Theorem. By G. Plarr.

In treating, by the method of quaternions, the question which forms the basis of *Minding's Theorem*, I had the advantage of being guided by Professor Tait's paper on that subject (*T. R. S. E.*, 1880), and it is only by varying his method that I could hope to present the question under a new aspect.

§ 1.

Let us apply the operator

$$p()q$$

of a conical rotation, where $q = p^{-1}$, to a system of given vector-

forces $\beta_0, \beta'_0, \beta''_0$, &c., p being a versor, the results of the rotation being $\beta, \beta',$ &c., respectively.

By the expressions

$$(1) \quad \beta = p\beta_0q, \quad \beta' = p\beta'_0q, \quad \&c.,$$

we submit the forces at once to two of Minding's conditions; namely, 1^o the magnitude of each of the forces remains unchanged by the rotation, and 2^o the mutual inclinations of the forces, considered two by two, remain also unvaried.

The resultant of the forces being

$$\Sigma\beta = p(\Sigma\beta_0)q,$$

remains also unchanged as to its tensor, and we may, without loss of generality, assume at once that the unit of force has been chosen so as to give

$$T\Sigma\beta = 1 = T\Sigma\beta_0.$$

We put

$$\begin{cases} U\Sigma\beta = k' \\ U\Sigma\beta_0 = k'_0. \end{cases}$$

This gives

$$(2) \quad k' = pk'_0q.$$

We call a, a', a'' , &c., the vectors drawn from a certain origin to the points of application of the forces. A *third* condition will be the rigidity of the system of these vectors, so that they remain immobile in respect to one another, and to their origin.

The *fourth* condition to which *Minding's System of Forces* are to be submitted demands that the action of the system be reduced to that of a single force, and consequently that the moment of the resulting couple $\Sigma V.a\beta$, in respect to the origin, be perpendicular to the direction of the resultant of the forces.

This condition, expressed by

$$(3) \quad S k' \Sigma V.a\beta = 0,$$

or in virtue of (1) and (2) by

$$\Sigma S a p (\nabla \beta_0 k'_0) q = 0,$$

constitutes a relation between the data $a, a',$ &c., $\beta_0, \beta'_0,$ &c., k'_0 , on the one hand, and between the *three* scalar elements of the ver-

sor p on the other : by this relation (3) the number of the arbitrary scalar elements of the question becomes reduced to *two*. Obviously the scalar elements on which the unit-vector k' depends are also two in number ; but as the system may, in virtue of the variations of $p(\)q$, possibly turn round the very direction of k' , it will be more convenient to consider the elements of $p(\)q$ as the true independent parameters, at least two of them.

§ 2.

The position of the single resultant of the system will be that of the straight line

$$(4) \quad \Sigma V(a - \rho)\beta = 0,$$

where ρ designates the vector of a point of that line, the origin of ρ being the same with that of the vectors a, a', \dots

Having

$$\Sigma V\rho\beta = V\rho\Sigma\beta = V\rho k',$$

and putting generally, with Professor Tait,

$$(5) \quad \begin{cases} \phi\omega = \Sigma aS\beta\omega, \\ \phi'\omega = \Sigma\beta S a\omega, \end{cases}$$

we get the solution of (4) by

$$\rho = \phi'k' - \phi k' + uk'$$

where u is an arbitrary scalar on which the position of the extremity of ρ on the line depends.

We remark now that $\phi k'$, owing to $pq = 1$, becomes

$$\phi k' = \Sigma aS\rho\beta_0 p k'_0 g = \Sigma aS\beta_0 k_0;$$

namely, $\phi k'$ will be constant in direction and value, whatever be the state of rotation of the system.

This result permits of a change of origin of the vectors $a, a', \&c.$, and ρ , by which the *new* value of $\phi k'$ will vanish. The new origin will be at the extremity of the former ($-\phi k'$). This change of origin will not affect $k' = \Sigma\beta$, but it will change the vector moment.

Not to change notations, we assume that the origin O was from the beginning at the point for which

$$(6) \quad o = \phi k' = \Sigma aS\beta_0 k'_0.$$

This origin, which is analogous to the centre of a system of parallel forces, has been called by Minding *the central point* of a system of non-parallel forces.

We have now, owing to (6),

$$(7) \quad \rho = (\phi' + u)k'.$$

We also designate by η the vector moment of the forces in respect to the origin now chosen, so that

$$(8) \quad \eta = \Sigma V\alpha\beta;$$

and the condition (3) will be

$$(9) \quad Sk'\eta = 0.$$

Owing to the definitions (5) and (8) we have now generally for any vector ω ,

$$(10) \quad (\phi - \phi')\omega = V\eta\omega.$$

Hence for $\omega = k'$, by (6),

$$- \phi'k' = V\eta k',$$

In virtue of (9) this becomes simply,

$$(11) \quad \phi'k' = k'\eta.$$

From this, and from (6), we deduce

$$S\eta\phi'k' = 0, \text{ and } Sk'\phi'k' = 0.$$

These relations show that the direction of k' , η , $\phi'k'$ are trirectangular, and that

$$(12) \quad T\phi'k' = T\eta.$$

§ 3.

Let i', j' , be two unit-vectors forming a trirectangular system with k' , and let i'_0, j'_0 be their initial directions, so that

$$i' = pi'_0q, \quad j' = pj'_0q.$$

From

$$\rho = -i'Si'\rho - j'Sj'\rho - k'Sk'\rho$$

we deduce, owing to (6),

$$\phi\rho = -\phi i'Si'\rho - \phi j'Sj'\rho,$$

where the results $\phi i'$, $\phi j'$ are constants for the same reason as $\phi k'$.

Owing to (6) the coefficients of the cubic may be expressed by

$$(13) \quad \begin{cases} m = 0, \\ m_1 = -Sk' \phi_i' \phi_j'', \\ m_2 = -(S_i' \phi_i'' + S_j' \phi_j''). \end{cases}$$

We have now from (7)

$$k' = (\phi' + u)\rho^{-1};$$

and putting

$$(14) \quad m_u = +m_1 u + m_2 u^2 + u^3,$$

we get

$$m_u k' = [m \phi'^{-1} + u(m_2 - \phi') + u^2] \rho.$$

The term $m \phi^{-1} \rho$ being indeterminate, owing to $m=0$, we consider

$$m \phi'^{-1} \nabla \lambda \mu = \nabla \phi \lambda \phi \mu;$$

and putting $\nabla \lambda \mu = \rho$, we get

$$(m \phi'^{-1} \rho) = -\nabla \phi_i'' \phi_j'' S k' \rho$$

(See also *Proc. R. S. E.*, Dec. 1880, on the case $m=0$).

We remark that by (7) we have

$$S k' \rho = -u.$$

Substituting this in the preceding term we get

$$(15) \quad \frac{m_u}{u} k' = \nabla \phi_i'' \phi_j'' + (m_2 + u)\rho - \rho.$$

Effecting the combination

$$\left(\frac{m_u}{u} k' + \phi' \rho \right) - \left(\nabla \phi_i'' \phi_j'' + (m_2 + u)\rho \right)^2 = 0,$$

and remarking $S k' \phi' \rho = S \rho \phi k' = 0$, we get

$$(16) \quad \begin{cases} 0 = (\phi' \rho)^2 - \left(\frac{m}{u} \right)^2 - \nabla^2 \phi_i'' \phi_j'' - (m_2 + u)^2 \rho^2 \\ \quad - 2(m_2 + u) S \rho \phi_i'' \phi_j''. \end{cases}$$

We obtain a relation between $\frac{m_u}{u}$ and $(m_2 + u)$ independent of m_1 .

Namely, we introduce into $S k' \eta = 0$ the value

$$\eta = \nabla (i' \phi_i'' + j' \phi_j'').$$

This gives

$$(17) \quad S_j'' \phi_i'' = S_i'' \phi_j''.$$

By the use of this equality the value (13) of m_1 becomes

$$\begin{aligned} m_1 &= S V_j'' i'' \nabla \phi_i'' \phi_j'' \\ &= S_j'' \phi_j'' S_i'' \phi_i'' - S_j'' \phi_i'' S_i'' \phi_j'', \end{aligned}$$

the last term being now a square in virtue of (17). We also observe that

$$\begin{aligned} \phi'k' &= -i'' S_i'' \phi'k' - j'' S_j'' \phi'k' \\ &= -i'' S_k' \phi_i'' - j'' S_k' \phi_j''. \end{aligned}$$

Introducing these values, and that of m_2 into the sum

$$m_2^2 - 2m_1 - (\phi'k')^2,$$

the result will be

$$\begin{aligned} &S^2 i'' \phi_i'' + S^2 j'' \phi_j'' + S^2 k' \phi_i'' \\ &+ S^2 i'' \phi_j'' + S^2 j'' \phi_i'' + S^2 k' \phi_j'', \end{aligned}$$

namely,

$$-(\phi_i'')^2 - (\phi_j'')^2.$$

We put

$$(18) \quad \begin{cases} M_2 = T^2 \phi_i'' + T^2 \phi_j'', \\ M_1 = T^2 \nabla \phi_i'' \phi_j'', \end{cases}$$

and the relation will be

$$(19) \quad m_2^2 - 2m_1 - (\phi'k')^2 = M_2.$$

Further, by (7) we get

$$(\phi'k')^2 = \rho^2 + u^2.$$

Substituting this into (19), and adding and subtracting $2m_2 u + u^2$, we get

$$(20) \quad (m_2 + u)^2 - 2 \frac{m_2 u}{u} - \rho^2 = M_2.$$

Hence also

$$(m_2 + u)^2 \rho^2 + \left(\frac{m_2 u}{u}\right) = \left(\frac{m_2 u}{u} + \rho^2\right)^2 + M_2 \rho^2.$$

The equation (16) now takes the form

$$(21) \quad \left\{ \begin{aligned} (\phi' \rho)^2 - M_2 \rho^2 - \left(\frac{m_u}{u} + \rho^2 \right)^2 + M_1 \\ - 2(m_2 + u) S \rho \phi_i' \phi_j'' \end{aligned} \right\} = 0,$$

where $(m_2 + u)$ depends on $\left(\frac{m_u}{u} + \rho^2 \right)$ by

$$(22) \quad (m_2 + u)^2 = M_2 - \rho^2 + 2 \left(\frac{m_u}{u} + \rho^2 \right).$$

§ 4.

The relation (21) depends through (22) explicitly on $\left(\frac{m_u}{u} + \rho^2 \right)$ and on ρ only. The term $(\phi' \rho)^2 = S \rho \phi \phi' \rho = S \rho \omega \rho$ depends on ρ only and on the constant vectors ϕ_i'', ϕ_j'' , because we have

$$\phi' \rho = - \Sigma_i'' S_i \phi' \rho = - \Sigma_i'' S \rho \phi_i'';$$

hence

$$(23) \quad \phi \phi' \rho = \omega \rho = - (\phi_i'' S \rho' \phi_i'' + \phi_j'' S \rho \phi_j'').$$

Through (13) and (14) the quantity $\frac{m_u}{u}$ contains the three arbitraries of the question, namely, u , and the two independent parameters of the operator $p(\)_q$.

The equation (21) represents now, by the extremity of ρ , any point on the resulting force of the system in any of its positions.

If we submit the three just named arbitraries to a relation of condition, then we "pick out" so to say a particular point on every one of the resultants, and the aggregate of these points will form a definite surface.

The equation of condition which gives the surface of the lowest possible degree will be of course $\frac{m_u}{u} + \rho^2 = \text{a constant parameter}$.

For convenience sake we put

$$(24) \quad \left\{ \begin{aligned} h + \frac{m_u}{u} + \rho^2 &= 0, \\ g + m_2 + u &= 0, \end{aligned} \right.$$

- h being the parameter introduced (h being identical with the x

of Professor Tait's paper), and g depending on h through (22) which becomes

$$(25) \quad g^2 + 2h = M_2 - \rho^2.$$

The equation of the surface will be

$$(26) \quad \left\{ \begin{array}{l} S\rho = \rho - M_2\rho^2 + M_1 - h^2 \\ + 2gS\rho\phi_i''\phi_j'' \end{array} \right\} = 0,$$

and the elimination of g by (25) will raise the degree in ρ to the 4th.

This equation is concordant with that numbered (10) of Professor Tait's paper: this last one is transformable into ours (26) by the elimination of t (which is our $-m_2$). The elimination can be founded on the equation (9) of the quoted paper, and by treating by $S.\phi_i''\phi_j''$ the equation (8') so as to give (in our notation)

$$hm_1 - m_2S\rho\phi_i''\phi_j'' + M_1 = 0.$$

The value resulting for t (or of our m_2) will be in our notation

$$m_2n = H,$$

n containing then a double signed radical, but, as we shall find, the sign of it will be definite, and (in *anticipation* to our own use) we state that we shall have

$$(27) \quad \begin{aligned} n &= gh + S\rho\phi_i''\phi_j'' \\ H &= h^2 - M_2h + M_1. \end{aligned}$$

If, on the contrary, we wish to form the equation of the locus of the feet of perpendiculars from the origin on the single resultants, then we are no more free to establish a relation between the parameters of $p(\)q$ and u . The condition of the perpendicularity between the line (7) and ρ itself will be

$$Sk'\rho = 0.$$

The equation (7) will give its *first* scalar relation

$$(28) \quad u = 0.$$

Then (21) with this value of u will constitute a *second* scalar relation (equivalent with $k'^2 = -1$).

A *third* scalar relation will be obtained in treating by $S(\)\phi_i''\phi_j''$ not (7) itself, but a transformation of it derived from (15). Finally,

we have the condition (17) equivalent with $Sk'\eta = 0$. We have thus *four* equations between the three parameters of $p(\)q$ by which to eliminate (theoretically at least) these parameters, and the result will be an equation in ρ representing a *definite surface*.

Practically the elimination may be effected by eliminating h_0, g_0 [h_0, g_0 being the values of h, g in the relations (24) for $u=0$] from (25), (26), and the third scalar relation spoken of derived from (15). We reserve this question for another occasion.

§ 5.

Let us now transform the expression (15) of k' so as to render it dependent on h and ρ alone.

Taking the function ϕ' of both members we get

$$(29) \quad 0 = -\frac{m_u}{u} \phi'k' + (m_2 + u)\phi'\rho - \phi'^2\rho,$$

because $\phi' \cdot \nabla \phi i' \phi j' = 0$, by considering (23).

By (10) and (11) we have

$$(\phi - \phi')\phi'\rho = \nabla \eta \phi'\rho = \nabla \cdot \phi'k'k'\phi'\rho.$$

And considering that $Sk'\phi'\rho = S\rho\phi k' = 0$, developing $\nabla \cdot \phi'k'k'\phi'\rho$, and replacing $\phi'k'$ by $\rho - uk'$, we get

$$\phi'^2\rho = \phi\phi'\rho + k'S\rho\phi'\rho.$$

We get $S\rho\phi'\rho$ by treating (15) by $S \cdot \rho$. This gives, by $Sk\rho' = -u$,

$$S\rho\phi'\rho = m_u + S \cdot \rho \phi i' \phi j' + (m_2 + u)\rho^2.$$

In (29) also we replace $\phi'k'$ by $\rho - uk'$ and eliminate $\phi'\rho$ between (29), so modified, and (15). This gives

$$\begin{aligned} 0 = & -\frac{m_u}{u}(\rho - uk') \\ & + (m_2 + u) \left[-\frac{m_u}{u}k' + \nabla \phi i' \phi j' + (m_2 + u)\rho \right] \\ & - \phi(\phi'\rho) - k'[m_u + S\rho\phi i' \phi j' + (m_2 + u)\rho^2]. \end{aligned}$$

With the notations of g, h, n (24), (27), this becomes

$$(30) \quad 0 = nk' + \pi\rho + (h - M_2)\rho - \nabla \phi i' \phi j' g,$$

g being related to h by (25) and n given by (27).

The equations (26) and (30) solve the question of finding the positions of the resultant force for any given point of space. When namely, ρ is given, the scalar-equation (26) will give theoretically four values of h , after the elimination of g by (25), and the vector-equation will give the four directions k' corresponding.

Before attacking this question we will find it very convenient to have to deal with rectangular coordinates, and we make use of one of the solutions of Professor Tait's of the equation of condition,

$$(31) \quad 0 = S\phi i' \phi j' = S j' (\phi' \phi) i' = S i' (\phi' \phi) j'.$$

We consider, namely, $\phi i'$, $\phi j'$ by their expressions

$$\begin{aligned} \phi i' &= \Sigma' a S \beta i' = \Sigma a S \beta_0 i'_0 \\ \phi j' &= \quad \quad = \Sigma a S \beta_0 j'_0, \end{aligned}$$

and designating in particular

$$\Sigma a S \beta_0 \omega \text{ by } \phi_0 \omega$$

we take for i'_0 , j'_0 the solutions of the equation

$$\nabla \omega (\phi'_0 \phi_0) \omega = 0,$$

the third being k'_0 .

The function $(\phi'_0 \phi_0)$ is self-conjugate, and its principal axes are at right angles to one another; we designate by i'_0 , j'_0 perpendicular to k'_0 , the unit vectors in the direction of these axes. The cubic, reduced to a quadric (because of $\phi'_0 k'_0 = 0$), corresponding will be

$$w^2 - M_2 w + M_1 = 0.$$

Calling a , b , the absolute values of $\phi_0 i'_0$, $\phi_0 j'_0$, we have by (18)

$$(32) \quad \begin{cases} M_2 = a^2 + b^2, \\ M_1 = a^2 b^2, \end{cases}$$

because now $\nabla \phi_0 i'_0 \phi_0 j'_0 = \phi_0 i'_0 \phi_0 j'_0$ owing to (31).

We have therefore

$$(\phi'_0 \phi_0) i'_0 = i'_0 a^2, \quad (\phi'_0 \phi_0) j'_0 = j'_0 b^2.$$

We now call i , j , k , the system of trirectangular unit vectors in the directions of $\phi_0 i'_0$, $\phi_0 j'_0$, and of $\nabla \phi_0 i'_0 \phi_0 j'_0 = \phi_0 i' \phi_0 j'_0$. This gives us

$$(33) \quad \begin{cases} \phi i' = ia = \phi_0 i'_0, \\ \phi j' = jb = \phi_0 j'_0, \\ \phi i' \phi j' = kab = \phi_0 i'_0 \phi_0 j'_0, \\ \phi k' = 0 = \phi_0 k'_0. \end{cases}$$

Comparing $(\phi'_0 \phi_0) i'_0 = i'_0 a^2$, with $\phi'_0 (\phi_0 i'_0) = a \phi'_0 i$, &c., we get the corresponding relations

$$\phi'_0 i = i'_0 a, \quad \phi'_0 j = j'_0 b.$$

But generally we have

$$\phi' \omega = \Sigma \beta S a \omega = p(\Sigma \beta_0 S a \omega) q = p(\phi'_0 \omega) q.$$

Hence forming i' , j' , by applying the operator $p(\)q$ to i_0 , j_0 (as it has already (2) been applied to k_0 for obtaining k'), we get

$$(34) \quad \begin{cases} \phi' i = i' a, \\ \phi' j = j' b, \\ \phi' i \phi' j = k' ab, \\ \phi' k = 0. \end{cases}$$

Here the unit vectors i , j , k , represent directions which are invariably fixed, whereas i' , j' , k' rotate with the forces β , β' , &c.

§ 6.

We introduce now

$$\rho = ix + jy + kz,$$

x , y , z , being the Cartesian coordinates of the point ρ on the single resultant of the system of forces, these coordinates being referred to axes which are fixed in space, and passing through the central point of the system.

We have also, by introducing (33) into the expression (23) of $\phi \phi' \rho$,

$$(35) \quad \begin{cases} \phi \phi' \rho = \pi \rho = -ia^2 S i \rho - jb^2 S j \rho \\ \quad \quad \quad = ia^2 x + jb^2 y. \end{cases}$$

By this the equations (26) and (30) become

$$(36) \quad \left\{ \begin{array}{l} b^2 x^2 + a^2 y^2 + M_x x^2 + M_1 - h^2 \\ - 2gabz \end{array} \right\} = 0,$$

and

$$(37) \quad \begin{cases} -nh' = ix(h - b^2) + jy(h - a^2) \\ \quad + k[z(h - M_2) + gab], \end{cases}$$

where now (by (27))

$$(37 \text{ bis}) \quad n = gh - abz;$$

g^2 being expressed by (25), becomes

$$(36 \text{ bis}) \quad g^2 = M_2 - 2h + x^2 + y^2 + z^2.$$

We abandon the problem of discussing the roots h as expressed in function of xyz , when the elements of ρ are given alone. But we will consider what surfaces the equation (36) represents when h being considered as a parameter receives any value between $-\infty$ and $+\infty$.

The equation (36) when freed of the radical represented by g will be biquadratic in x, y, z . We resolve in respect to z . Putting

$$b^2x^2 + a^2y^2 + M_1 - h^2 = G',$$

$$x^2 + y^2 + M_2 - 2h = g',$$

we get the equation under the form

$$(M_2z^2 + G')^2 - 4z^2M_1(z^2 + g') = 0.$$

The coefficient of z^4 being

$$M_2^2 - 4M_1 = (a^2 - b^2)^2,$$

we introduce c by

$$a^2 - b^2 = c^2,$$

and, without loss of generality, we assume $a > b$ once for all, so that c be real.

We have now, in resolving in respect to z^2

$$c^4z^2 = (2M_1g' - M_2G') \pm R,$$

where we put

$$R^2 = (2M_1g' - M_2G')^2 - c^4G'^2.$$

This being the difference of squares, and as in virtue of (32)

$$M_2 - c^2 = 2b^2$$

$$M_2 + c^2 = 2a^2,$$

we transform R^2 into

$$R^2 = 4a^2b^2(a^2g' - G')(b^2g' - G').$$

Also

$$2M_1g' - M_2G' = b^2(a^2g' - b^2) + a^2(b^2g' - G').$$

By the values of G' , g' , we get

$$(38) \quad \begin{cases} X^2 = a^2g' - G' = c^2x^2 + (a^2 - h)^2, \\ Y^2 = b^2g' - G' = -c^2y^2 + (b^2 - h)^2, \end{cases}$$

where we introduce the letters X^2 , Y^2 , as abbreviations.

We have now

$$c^4z^2 = c^2X^2 + a^2Y^2 \pm 2abXY.$$

The second member being a square we deduce

$$(39) \quad c^2z = \pm bX \pm aY,$$

the double signs being independent from each other, and the four values of the second member constitute the four roots z as functions of x , y and the parameter h , satisfying (36).

§ 7.

For the construction of ρ we introduce

$$\begin{aligned} \rho' &= ix + kz', \\ \rho'' &= jy + kz'', \end{aligned}$$

where z' , z'' represent the two terms of z respectively, say

$$c^2z' = \pm bX, \quad c^2z'' = \pm aY;$$

the double signs showing the possibility for z' and z'' to represent positive and negative values like any other coordinate.

We have then

$$\rho = \rho' + \rho''.$$

If, for a given value of h (leaving out for the present the values $h = a^2$, and $h = b^2$), we construct ρ' and ρ'' separately we get by the former a hyperbola, and by the second an ellipse. The planes of these curves will be *at right angles*. In ordinary coordinates the equations of these curves will be

$$\begin{aligned} \left[\frac{z'}{\left(\frac{h-a^2}{c}\right) \times \frac{b}{c}} \right] - \left[\frac{x}{\left(\frac{h-a^2}{c}\right)} \right] &= 1, \\ \left[\frac{z''}{\left(\frac{h-b^2}{c}\right) \times \frac{a}{c}} \right]^2 + \left[\frac{y}{\left(\frac{h-b^2}{c}\right)} \right]^2 &= 1. \end{aligned}$$

If we take the point ρ' of the hyperbola for the centre of the

ellipse ρ'' , then the sum $\rho' + \rho'' = \rho$ will represent a surface which we may call a *hyperbolic Tore*, that is a hollow canal having everywhere the same elliptical section, parallel namely to the plane j, k , of the ellipse ρ'' , and *equal* to that ellipse; whereas the median line of the canal will be the hyperbola ρ' in the plane i, k .

The two tores corresponding to the two branches of the same hyperbola will be symmetrical in respect to the plane i, j , passing through the centre (at the origin O). The two sheets of the same surface may intersect or not according as the value of h is outside the interval between a^2 and b^2 or inside that interval.

We will not here undertake to prove that through every point of space there must be four surfaces passing, corresponding to four different values of h ; we will only remark that the same hyperbola will correspond to two different values of h , namely, h and h' satisfying to

$$h - a^2 = a^2 - h'.$$

To these values correspond two different ellipses. *Vice versa*, to

$$h - b^2 = b^2 - h'',$$

for the same ellipse correspond two different hyperbolas . . .

All the hyperbolas have the same pair of asymptotes; these lines pass through the origin and have the directions of δ, δ' , defined by

$$a\delta = ic + kb, \quad a\delta' = -ic + kb.$$

Considering now the cases of $h = a^2$ and $h = b^2$, we must remember our assuming of the inequality

$$a > b.$$

In the case $h = a^2$ the two tores transform themselves into two right cylinders, having their axes coincident with the asymptotes just mentioned; their radius perpendicular to the axis = $\sqrt{a^2 - b^2} = c$. This will easily appear when we consider the value of z becoming for $h = a^2$

$$cz = \pm bx \pm a \sqrt{c^2 - y^2},$$

hence

$$(40) \quad (cz \mp bx)^2 + a^2 y^2 = a^2 c^2.$$

We may introduce

$$\begin{cases} j\delta = \gamma = \frac{1}{a}(ib - kc), \\ j\delta' = \gamma' = \frac{1}{a}(ib + kc). \end{cases}$$

When the equations become for γ and γ' ,

$$S^2\gamma\rho + S^2j\rho = c^2,$$

which leaves the component of ρ parallel to δ , or to δ' , indeterminate.

These two cylinders intersect in the planes (j, k) and (i, j) . In the first of these planes the equations become

$$(41) \quad x = 0, \text{ and } \left(\frac{z}{a}\right)^2 + \left(\frac{y}{b}\right)^2 = 1,$$

an ellipse which in the next section we will meet again as *Minding's Ellipse*. The second intersection

$$z = 0, \left(\frac{x}{ac : b}\right)^2 + \left(\frac{y}{c}\right)^2 = 1,$$

has not received, as yet, any physical signification.

In the case of $h = b^2$, or, as we will put it

$$h - b^2 = \text{an infinitely small value,}$$

the values of Y in the expression (39) of z will be real for values of y^2 which do not outpass the limit

$$\left(\frac{h - b^2}{c}\right)^2,$$

and therefore the "tore-surface" represented by $\rho = \rho' + \rho''$ will shrink into an infinitesimally narrow canal embracing the hyperbola represented by

$$\rho' = ix + kz',$$

where we have

$$(42) \quad y = 0, \text{ and } \left(\frac{z'}{b}\right)^2 - \left(\frac{x}{c}\right)^2 = 1.$$

This tore-surface, like all others represented by (39), contains at every one of its points *one* point of the single resultants of the system (generally four of which are passing through every point of space); and the different points of the surface represent the corre-

sponding points of the resultant in the different states of rotation of the system.

To the question, if every one of the surfaces (39) has one point in common with every one of the resultants, we give the answer in § 9, where we show that through every point of space we are able to draw four straight lines meeting the hyperbola (42), and which satisfy moreover the conditions derived from the expression of k' .

We have thus the proof of one part of *Minding's Theorem* as announced at page 37 of *Crelle's Math. Journal*, vol. xv., namely, the resultant in the different, innumerable, positions which it may take, passes constantly through the hyperbola which is the limit of the infinitesimally narrow canal corresponding to $h - b^2 = 0$.

The proofs of the other propositions of the theorem will be gained by the examination of the directions k' of the single resultant.

§ 8.

Writing again the expression (37) containing k' ,

$$0 = nk' + ix(h - b^2) + jy(h - a^2) + k[x(h - M_2) + gab],$$

we introduce into it the hypothesis

$$h - b^2 = \text{an infinitely small value.}$$

For the preparation of n and g as defined in (36 bis) and (37 bis) we have the relations

$$(43) \quad \begin{cases} (ga - bz)^2 = X^2, \\ (az - gb)^2 = Y^2, \end{cases}$$

which become identities if we substitute into them the value of g^2 (36 bis) and the value of $2gabz$ drawn from (36), and having regard to (32) and (38).

As the value of y is to converge to zero, at the same time as $h - b^2$, but independently of it, we put

$$cy = w(h - b^2),$$

calling w an arbitrary scalar.

We have by (43)

$$gb = az - Yf,$$

where the letter f is to stand for either $+1$ or -1 as the case may afford. This gives by (36 bis)

$$\begin{aligned} n &= \frac{1}{b} (gbh - b^2az) \\ &= \frac{1}{b} [(h - b^2)az - hYf]. \end{aligned}$$

Introducing the value y into Y (38) we get

$$Yf = (h - b^2) \sqrt{1 - w^2}.$$

As we need only the terms of the first order in $(h - b^2)$ we may replace hY by b^2Y . Thus

$$\begin{aligned} n &= \frac{1}{b} (h - b^2) [az - b^2 \sqrt{1 - w^2}] \\ n &= (h - b^2) \left[\frac{az}{b} - b \sqrt{1 - w^2} \right]. \end{aligned}$$

The coefficient of k in (37) becomes

$$z(h - M_2) + a \cdot bg = [h - M_2 + a^2]z - (h - b^2)a \sqrt{1 - w^2};$$

and considering the value of M_2 the coefficient of z will be $(h - b^2)$.

Also in the term $ky(h - a^2)$ we replace y by

$$(h - b^2) \frac{w}{c}.$$

The term becomes, for $h - a^2 = b^2 - a^2 = -c^2$,

$$(h - b^2) \frac{w}{c} (b^2 - a^2) = -(h - b^2)wc.$$

We have now the factor $(h - b^2)$ existing in evidence in all the terms of the relation (37), which becomes rigorously as to the first order in $(h - b^2)$,

$$0 = (h - b^2) \left[\begin{array}{c} k' \left[\frac{az}{b} - b \sqrt{1 - w^2} \right] \\ + iz - jcw + k(z - a \sqrt{1 - w^2}) \end{array} \right].$$

As the second member represents the terms of the first order in $(h - b^2)$, and as $h - b^2$ is variable, we are entitled to equate the factor of $h - b^2$ separately to zero.

Before writing the equation we remark that the arbitrary quantities

$$cw, \text{ and } a\sqrt{1-w^2},$$

when substituted into the place of y and z respectively in the equation (41) of the ellipse, satisfy that equation identically. We introduce the coordinates y_2, z_2 , as those of a point of the ellipse, putting $x_2=0$, and

$$y_2 = cw, \quad z_2 = a\sqrt{1-w^2}.$$

Also for distinguishing the coordinates of the hyperbola from those of any point in space we replace x, z' , in (42) by x_1, z_1 , putting $y_1=0$.

The equation in k' now takes the form

$$\left\{ \begin{array}{l} 0 = k' \left[\frac{ax_1}{b} - \frac{bz_2}{a} \right] \\ \quad + ix_1 - jy_2 + k(z_1 - z_2); \end{array} \right.$$

or, if we introduce

$$(44) \quad \left\{ \begin{array}{l} \sigma_1 = ix_1 + kz_1, \quad \left(\frac{z_1}{b}\right)^2 - \left(\frac{x_1}{c}\right)^2 = 1, \\ \sigma_2 = jy_2 + kz_2, \quad \left(\frac{z_2}{a}\right)^2 + \left(\frac{y_2}{c}\right)^2 = 1, \\ N = \frac{ax_1}{b} - \frac{bz_2}{a}, \quad y_1 = 0, \quad x_2 = 0, \end{array} \right.$$

we have

$$(45) \quad k' = \frac{1}{N}(\sigma_2 - \sigma_1).$$

This establishes the second part of *Minding's Theorem*, namely, *all the single resultants pass through the ellipse* because every point of the hyperbola is the summit of a cone, of which the generating lines are the single resultants passing through that point, and the ellipse forms the oblique base of the cone, and *vice versa* every point of the ellipse is the summit of another cone of which the base is formed by the two branches of the hyperbola: moreover, *all these cones are right cones, the axes being the tangent to the curve at the point where the summit of the cone is situated*,—this latter proposition results from the equation of the cone, as, for example, in

the case of its summit being in σ_1 on the hyperbola, when it will be of the form

$$V.^2\theta(\rho - \sigma_1) - c^2(\rho - \sigma_1)^2 = 0,$$

where

$$\theta = -i \frac{c}{b} S k \sigma_1 + k \frac{b}{c} S i \sigma_1,$$

and ρ being now the vector of any point on the line $\sigma_2 - \sigma_1$ or its prolongations.

The last part of Minding's propositions is proved by the comparison of the values of the focal distances of the hyperbola and the ellipse, these being

$$\sqrt{b^2 + c^2} = a, \text{ and } \sqrt{a^2 - c^2} = b$$

respectively, with the corresponding great axes, these being

$$b \text{ and } a.$$

It follows also, from the expressions (44) of the vectors of the hyperbola and the ellipse, that the planes of these curves are at right angles, the line of intersection of the planes passing through the centre of these concentric curves.

§ 9.

We will finally show that the variable vectors σ_1, σ_2 , are very convenient auxiliaries for expressing the solutions of the equation of the fourth degree on which h depends, namely, of the equation (36) from which g has been eliminated by the help of (36 bis).

We will not treat of that equation, but we consider the vector equation (37), from which it can be deduced as one of its scalar equations.

Let ρ designate a point on the line $\sigma_2 - \sigma_1$ or its prolongations, so that we have

$$\rho = \sigma_1 + k't.$$

We have then the two vector equations

$$\frac{\rho - \sigma_1}{t} = \frac{\sigma_2 - \sigma_1}{N} = \left[\begin{array}{l} ix(h - b^2) + jy(h - a^2) \\ + k\{z(h - M_2) + gab\} \end{array} \right] \times \left(\frac{-1}{s} \right).$$

Taking the scalars $S.i$, $S.j$, $S.k$, we get six equations, which form only four distinct ones, because they satisfy *a priori* to $k^2 = -1$, and to $N^2 = -(\sigma_2 - \sigma_1)^2$. From these equations we easily deduce

$$h = b^2 + c^2 \left(\frac{t}{N} \right)$$

and also

$$\frac{t}{N} = S \left(\frac{\rho - \sigma_1}{\sigma_2 - \sigma_1} \right),$$

where we employ the sign S (placed before the quotient of two parallel vectors) simply for preserving the algebraical sign of the quotient.

If we assume σ_1 and σ_2 to be given, then the expression

$$(46) \quad h = b^2 + c^2 S \frac{\rho - \sigma_1}{\sigma_2 - \sigma_1}$$

will represent the values of h for any point ρ situated on the line $\sigma_2 - \sigma_1$, and the coordinates x , y , z of that point, together with the resulting value of h , will satisfy the equation of the fourth degree spoken of.

If we assume ρ to be given, namely, x , y , z to be given, then the question would be to determine first σ_1 and σ_2 independently of h , and this would again lead to an equation of the fourth degree in one of the coordinates x_1 , z_1 , or y_2 , z_2 , and the question as to the reality of the roots would still arise in all its complication.

Instead of following that course, we may by geometrical considerations, and with the help of (46), assure ourselves that for every point of space there exist four corresponding lines $\sigma_2 - \sigma_1$, and consequently four values of h which satisfy to the equation in h , and consequently to the scalar equation deduced from it.

Let us suppose that the two Minding's curves be constructed in their relative position in space, and let them consist of a rigid material. Then drawing a straight line through the extremity M of ρ we may turn that line until it strikes, say, one branch of the hyperbola, then we move the line on, without detaching it from the hyperbola, until it strikes a point E of the ellipse, the point of the hyperbola being H . Then we have a first position of the line $\sigma_2 - \sigma_1$, and a corresponding value of h and of k' .

But we remark that if the points are following each other in the order say

M, H, E,

there will exist another position of the line in which it strikes the ellipse first, and further on the hyperbola, so that we have a second line $\sigma_2 - \sigma_1$, corresponding to the disposition of either

M, E', H',

or, may be, if the first had been

H, M, E,

then there would be a second disposition

M, H', E'.

But we may repeat this reasoning in taking into account the other branch of the hyperbola, and so we get four systems of positions of the line $\sigma_2 - \sigma_1$ and four corresponding values of h , these being real of necessity, because their expression is dependent on the real lines $\rho - \sigma_1$, and $\sigma_2 - \sigma_1$ in

$$h = b^2 + c^2 S \frac{\rho - \sigma_1}{\sigma_2 - \sigma_1}.$$

We see also by this expression that the points corresponding to the value $h = a^2$ can be placed only on one of the cylinders (40), because, apart from the value $\rho = \sigma_2$, which places ρ on the *intersection* of both the cylinders, we have also the points ρ for which we have generally

$$S \frac{\rho - \sigma_1}{\sigma_2 - \sigma_1} = 1, \therefore h = b^2 + c^2 = a^2.$$

As $\rho - \sigma_1$ and $\sigma_2 - \sigma_1$ are to have the same direction, the condition can only be satisfied (excepting always $\rho = \sigma_2$) when σ_1 becomes infinite along the hyperbola. In this case $\rho - \sigma_1$ takes the direction parallel to the asymptotes, and therefore parallel to the generating line of one of the cylinders (40). It follows that, for $h = a^2$, the only surface represented by the primitive equation (4) are the cylinders (40).

3. Chapters on the Mineralogy of Scotland. Chapter VII.

By Dr. Heddle.

In the present chapter Dr. Heddle considers the ores of manganese, iron, chromium, and titanium.

He finds that almost all the manganese in Scotland occurs in the form of an ore of little value—*psilomelane*.

Iron, he has observed in minute laminable specks, in the free or *metallic* condition, at two localities, but sheathed in both cases in magnetite. The quantity was too small for determining the presence or absence of nickel, but he conjectures that these specks may have been minute meteorites, which had fallen into the ocean in which the rock was being formed.

He has found two ores of iron new to Britain,—*turgite* and *mar-tite*,—the one near Oban, the other in Buta.

A series of analyses of *ilmenites* and of *iserines* or “titanic iron sands” are given; and, as a result of a consideration of the modes of occurrence, and of the microscopic features of these minerals, Dr. Heddle concludes that they are specifically distinct; the former being of *chance occurrence* in metamorphosed rocks, while the latter is an almost *invariable constituent* of igneous rocks.

Ilmenite he finds to be very common in Scotland, but to be, for the most part, confined to chloritic and quartzose bands of metamorphic rocks.

He finds that magnetic “black sands” are not unfrequently *chromiferous*, and that to a considerable extent.

4. On the Dimensions of Cast Iron at various Temperatures, with more especial reference to the Phenomena of the Solid floating on the Molten Metal. By W. J. Millar, C.E., Secretary, Inst. Engineers and Shipbuilders in Scotland.

1. In experimenting from time to time on the floating of solid metal on molten metal, the author has observed various phenomena, of which the present paper is descriptive, and this more especially with regard to cast iron and the well-known property of the solid

floating on the molten iron as frequently witnessed in foundry ladles.

Some years ago the author made a number of experiments with pieces of cast iron of different shapes and sizes, which were placed on the surface of a large ladleful of molten cast iron, the results obtained being as follows:—

Several pieces of pig iron were first tried; these at first sank and a rush of hot metal took place upwards, but after a few seconds they rose to the surface, and floated *with very little of their bulk* above the molten metal.

A piece of flattish irregularly-shaped cast iron floated with a small portion only of one of its corners appearing above the surface. Pieces of flat cast iron test-bars were carefully placed on the surface (the latter being well skimmed), these floated *without going below the surface*. One of the test-bar pieces, which was put in end on, kept in this position for a few seconds with its end above the surface, the other end then came up and the piece floated on its flat side.

In another experiment, a cast iron ball, about three inches in diameter, was lowered by means of a wire on the molten surface; the ball at first disappeared, but in a few seconds rose and floated with a small portion of its surface exposed. On being raised out of the molten metal it showed a red glow on the lower part, and when again lowered it did not sink, but floated with a larger portion above the surface than before.

Some pieces of steel rails were put into a Siemens steel-making furnace filled with molten metal; these pieces at first disappeared, but afterwards rose to the surface. Some other pieces, *heated red-hot*, were now put in; these floated without sinking, and showed a little of their bulk above the surface.

2. Different views are held as to the behaviour of cast iron when passing from the molten to the hot solid state, and finally thereafter to the cold (or ordinary temperature) state.

Some hold that the molten metal on solidifying expands, as water does when passing into ice, and that it retains this expansion to such an extent that the cold solid is specifically lighter than the liquid metal. Others hold that no such expansion takes place, but that through cooling the cooled solid becomes specifically heavier than

the molten metal. A third view is that the molten metal on solidifying *expands*, and that it thereafter contracts during cooling until it reaches the ordinary atmospheric temperature, and that in this condition it is specifically *heavier* than in the molten state. In reference to these views it may be remarked that the phenomena of freezing of water and of the solidifying of molten cast iron are not quite suitable for comparison, as the ice formed by the solidification of the water remains at the same temperature; the iron, on the other hand, changes in temperature after solidification, cooling gradually until the temperature of the surrounding air is reached.

It is sometimes argued that the sharpness of the edges of castings from iron and some other metals is due to the assumed expansion on setting, but as this sharpness appears in practice to be attainable by hot run metal, whilst dull run metal gives blunt or rounded edges, it is doubtful how far it can be accepted as proving any change due to expansive action.

Again, it is evident from foundry practice that, so far as the volume of the finally cooled solid and the volume when molten is concerned, that an allowance of about $\frac{1}{8}$ th part (varying somewhat with the size and shape of casting) has to be made in patterns as representing the lineal contraction during such cooling, and that in consequence we must conclude that the cold solid is specifically *heavier* than the molten metal. Under these circumstances we naturally ask why should the solid metal float in metal specifically lighter than itself? It is obvious to any one who has made such experiments that the floating of the solid iron cannot be due to any supposed phenomena of expansion at setting, as the piece would require to be heated up to the white hot condition or critical point at which it would just begin to melt. And it is found when the floating pieces are taken out and broken through, they only in some cases—depending on their size—show a dull redness.

3. From the author's experiments already mentioned, and from others since carried out and to be summarised, it appears that the *bulky pieces sink at first*, reappearing at the surface in longer or shorter times according to their weight and form, and that small pieces either disappear for only a short time, or remain floating on the surface. Indeed, small flat shaped pieces are unsuitable for these experiments, as the constantly forming skin on the molten

surface interferes with their movement, larger pieces, especially those of a ball shape having a maximum of weight with a minimum of surface, being to be preferred.

The conclusions drawn by the author from his experiments were, therefore, that when the cold solid comes in contact with the intensely heated molten metal, sufficient expansion is induced in the solid metal as to give it the required buoyancy to rise to the surface, and that this may occur by part of the surrounding heat being converted into mechanical work, causing a sudden increase in bulk, and partly by a dilatation due to rise of temperature of the solid. Indeed, it also appears likely that the high temperature surrounding the immersed solid (over 2000° F.) may suddenly cause a change in the condition of the particles of the solid which have most probably taken a strained condition during cooling.

That some such condition exists in castings appears probable, as in some cases annealing has to be resorted to, to prevent liability to fracture. And from experiments made by the author on the deflection and set of cast iron test-bars,* it would appear that when such bars are at first loaded and allowed to deflect, a certain amount of set is observed. On further application of the same, or even of greater loads, this set decreases, until ultimately no set is apparent, showing that in all probability the work done by the load upon the bar, has up to this point been one of freeing the particles from a local strained condition due to cooling. The common foundry practice of hammering curved castings on the concave side so as to straighten them, also points to relief of strain in the particles by the vibration set up. Such a strained condition may very well exist even in so simple and regular a form of casting as a test-bar, as the outer surfaces, cooling more rapidly than the inner, must cause compression of the latter.

4. If we take, as in common foundry practice, $\frac{1}{100}$ th part (or $\frac{1}{8}$ of an inch to the foot) as the change in linear dimensions from the molten to the finally cooled solid condition, we may calculate from coefficients of expansion the temperature to which the cold solid would require to be raised to enable it to float on the molten metal. Thus, if we take the rate of expansion per 180° as $\frac{1}{100}$ th part

* *Trans. Inst. Engineers and Shipbuilders in Scotland*, vols. xix. and xxi. *Minutes of Proc. Inst. C.E.*, vol. lviii. part iv.

linear,* we would require a temperature of about 1700° , which would be a bright red heat at least, before the piece would have sufficient increase of bulk to enable it to float. Now, from various experiments made by the author, it appears that many of the pieces which float show little or no redness when taken out, hence some other action seemed necessary to account for the buoyant tendency. Believing, however, that a large part of the heat might disappear as work of expansion, the author has carried out recently a large number of experiments with pieces of cast iron of various sizes and forms. These were carefully callipered before immersion, and as soon as possible after being taken out of the liquid metal in which they had floated (a few seconds in general was all that was necessary for their reappearance), and it was found in every case that a large expansion had taken place, such expansion being about $\frac{1}{100}$ th part at least of linear measurement. Here, therefore, we have a sufficient change of bulk to account for the floating phenomena. And this is the more remarkable, as although the change in dimension is equal to the shrinkage in cooling from the molten to the cooled solid state, yet the temperature is very much below the melting-point, as in some cases the pieces were barely red, and would hardly melt lead.

5. Some of the experiments may be enumerated :—

(1) A piece of a test-bar 2 inches broad by 1 inch thick, and filed down exactly to 12 inches long, was placed in a ladle, floated, and was taken out within half a minute; it just showed redness, and it was now found to be fully $\frac{1}{8}$ of an inch longer than at first. It was callipered from time to time as it cooled, showing a decrease in length. Finally cooled in water, and now being just warm to the touch, was found to be nearly down to 12 inches; when quite cold came back to the 12 inches.

(2) A cutting from an 11-inch pipe was carefully callipered when cold, and found to be exactly 11 inches inside measurement, and outside $12\frac{7}{8}$ inches; it was placed in a ladle holding 3 tons, disappeared for about twelve seconds, came up to surface and was immediately lifted out, was again callipered and found to measure inside $11\frac{1}{8}$ inches, outside 13 inches, and this after it had become quite dark;

* Prof. Rankine, *Manual of Civil Engineering*.

no red visible, as a little time was taken getting any adhering metal knocked off.

(3) A piece of pig iron $8\frac{1}{2}$ inches long floated in about six seconds, and appeared to have gained about $\frac{1}{16}$ of an inch in length.

(4) A piece of test-bar 2 in. \times 1 in. \times 9 in. floated in about four seconds; showed from $\frac{1}{16}$ in. to $\frac{2}{32}$ in. increase in length, and was a dull red; broken through, and a piece of lead laid upon the surface, the lead did not melt, but did so afterwards when pressed between the two broken parts of the bar. As lead melts about 630° F., the temperature of the iron could not have been much above this.

(5) A piece of a casting $18\frac{1}{2}$ inches long and of triangular section was found to measure $18\frac{1}{16}$ inches after floating, equal to $\frac{2}{16}$ of an inch of increase, was dull red; afterwards, when quite black, had $\frac{1}{16}$ in. to $\frac{2}{32}$ in. of expansion. A piece of lead laid upon it did not melt for some time.

(6) Another piece of a test-bar 2 in. \times 1 in. \times 12 in. was tried; after floating, it was taken out and found to measure $12\frac{1}{8}$ inches; here again an increase of $\frac{1}{8}$ of an inch was obtained, and the bar was barely a dull red. This piece was again put in ladle, floated easily, and was taken out somewhat red, callipered, and found to be $12\frac{1}{8}$ inches in length.*

(7) Other experiments have been made, but sufficient instances have been given to prove the large increase of bulk which so rapidly takes place in all these floating pieces of cast iron. The author therefore believes that the *cause of the floatation* is in the *increased bulk* thus obtained, which from its extent is quite sufficient in itself to explain the phenomena satisfactorily, as it will be observed that the increments found to exist were practically equal to the decrement which occurs from the molten to the finally cooled state, and that, therefore, the floating pieces had become of equal bulk to an equal weight of the liquid metal. It may be mentioned that great care was taken to get the real surface of the pieces after being taken out of the ladles, and in some cases the parts to be measured were oiled or coated with blacking to keep the surface free of scum or loose metal.

* From measuring the pattern of these test-bars and the test-bars themselves there appears a difference of $\frac{2}{8}$ of an inch in a length of 42 inches, showing a shrinkage of rather *less* than $\frac{1}{4}$ of an inch to the foot.

(8) With the view of ascertaining the rate of increase due to rise of temperature, some experiments were made by heating pieces of test-bars in a smith's fire, and noting the extension according to the time.

These experiments pointed out that the increase of size is at first rapid, and thereafter comparatively slow; thus a piece of test-bar, 2 in. \times 1 in. \times 13 in., had two centre points marked upon it exactly 12 inches apart; it was placed in a smith's fire and heated for about a minute, when it was found to have gained about $\frac{1}{16}$ of an inch; would not melt lead. Again heated for about same time, and found to have about $\frac{2}{32}$ of an inch of an increase; still black, and did not melt lead; heated again, and now found to have its original length increased by $\frac{1}{8}$ of an inch, it was now a dull red and melted lead, heated once more for two minutes, and now a bright red; but the increase, very little if any over the $\frac{1}{8}$ of an inch; heated again, and taken out white hot, when it broke in two pieces. Another piece, same size, was tried by heating it up to a white heat at once, time about four minutes. The expansion was nearly $\frac{2}{16}$ of an inch; put in fire again, and taken out very white hot showed about $\frac{3}{16}$ of an inch of increase in the 12 inches. Allowed to cool gradually, and in seven minutes it measured 12 $\frac{1}{2}$ inches; it was now quite dark, and melted lead when the latter was rubbed on the bar.

These experiments quite corroborate the floating metal experiments so far as the rate of increase in size goes, viz., that at first, and even at a comparatively low temperature, there is a large increase, and that thereafter the increase is much less in proportion to the greatly increased temperature even at white heat.

The author, therefore, thinks that both experiments prove that a large part of the first applied heat disappears in work of extension, the later applied heat showing more distinctly rise of temperature and change of condition of the metal towards melting.

(9) Some experiments were carried out to determine the question of expansion of cast iron on setting; the results of these are, however, not favourable to such an action, as no special movement could be detected. And, indeed, all the practical men whom the author has consulted, agree in stating that they have not observed

any such action in their experience. Movements of the liquid metal, after pouring, have been occasionally noticed, but these are accounted for by movements of cores or air; the necessity for immediately freeing the metal from the cores on setting, is pointed out as against any such supposed expansion, as the tendency is rather to shrink and tighten up against the inner part or core.

One experiment which the author has recently made may be noted as pointing out the great difficulty in dealing with this subject, so as to get rid of disturbing causes such as air or gas entangled in the metal.

The metal was run into a mould 8 in. \times 5 in. \times 4 in., and a wrought iron bar about 18 in. \times 1 in. \times 1 in. was laid across thus—

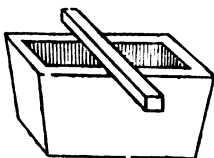

and the metal brought to about touching the bar; after about a minute a thin moulder's trowel could be almost passed between the bar and the still molten metal. After setting, the trowel could hardly be put in as before, and the metal thereafter began to rise up on each side of the bar thus—

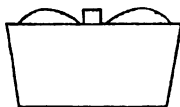

The metal had now assumed an orange colour, the part below the bar being brightest. On examining the metal when cold it was found that the space or difference between the high and low parts was $\frac{1}{8}$ of an inch. A few air holes being observed on the top of the casting, the metal was cut through at the raised and flat parts, when it was found that some honeycombing existed, due apparently to air bubbles.

In some other experiments made, this uprise was not observed, and it appears probable that the uprise of the surface of the metal, as above described, was due to the pressure of air or gas, which by compression due to *shrinkage* was forced upwards, no other means

of escape being possible. The upward force must necessarily have been slight, as it was insufficient to raise the bar lying on surface and weighing about 5 lbs. This view the author finds borne out by the manager of the foundry where this experiment was made, as he states that he has noticed the same action at times, but only *where air was present*, such as when draughts of air played over the surface at casting. The presence of air or gas also accounts for movements which have at times been observed to take place in the hemispherical moulds used for casting balls, as the author has been informed by moulders accustomed to this work, that sufficient opening of the two halves of the mould is noticeable to show the hot solid metal within, but that this is due to air or gases entangled in the casting.

(10) From some experiments made by the author with other metals, it appears that when the solid pieces float that their bulk is also increased as in the case of cast iron. Thus, when a piece of gun metal was placed in a crucible of molten gun metal it sank, but shortly reappeared; on being taken out it was found that it had increased in length by $\frac{1}{10}$ th part, whilst the shrinkage allowed for such an alloy would be even rather less than that.

Phosphor bronze also floated in molten phosphor bronze after sinking, behaving like the cast iron and gun metal. Type metal gave doubtful results with light pieces, heavy pieces going to the bottom of ladle and remaining there till melted. Lead, when tried also with large pieces, sank to the bottom, where the piece could be felt remaining there till melted; and incidentally it may be mentioned that when very large pieces of cast iron are used these remain so long at bottom of ladle as to have their ends melted off before rising to surface.

5. On an Oxycyanide, and a New Oxide, of Bismuth. By
M. M. Pattison Muir, M.A., Fellow, and Prælector in
Chemistry, of Gonville and Caius College, Cambridge.

1. Boedeker (*Annalen*, 123, 61), by the action of potassium cyanide on bismuth nitrate, obtained a reddish-brown salt, to which he assigned the formula $\text{Bi}_2\text{O}_5 \cdot 2\text{H}_2\text{O}$. In an examination of the oxides

of bismuth in conjunction with Hoffmeister and Robbs (*Chem. Soc. Jour.*, 1881; *Proc.*, p. 21), I had occasion to prepare Bodeker's salt; a slight study of its properties proved it to be a compound of no little interest. When a concentrated aqueous solution of potassium cyanide is added to a solution of metallic bismuth in excess of nitric acid, and the mixture is boiled, a brownish-red solid and a more or less dark red liquid are obtained, and quantities of hydrocyanic acid are evolved. When the excess of nitric acid is nearly neutralised by potash before addition of potassium cyanide, the colour of the solid is a much lighter brown, and the supernatant liquid is nearly or quite colourless. When a large excess of nitric acid is present, no solid, but only a red liquid, is produced. After very many trials, this method of preparation was abandoned, and potassium cyanide solution was added to a solution of crystallised bismuth nitrate, in the minimum quantity of dilute nitric acid: much more constant results were thus obtained. Various preparations of the puce-coloured salt were made, using varying quantities of bismuth nitrate and potassium cyanide; in each case the puce-coloured precipitate was washed with boiling water until the washings were free from cyanogen and from potassium; in one or two instances the precipitate was also boiled with extremely dilute sulphuric acid (about 1:300), and again washed free from acid. The temperatures at which the various preparations were dried are noted in the following table.

Inasmuch as Bodeker states that he failed to obtain evidence of cyanogen in the new salt described by him, and as an examination for cyanogen by the ordinary tests confirmed this result, I was convinced that the salt must be an oxide of bismuth.

Bismuth was determined by heating over a Bunsen lamp, whereby the salt was decomposed with production of bismuthous oxide; the loss of weight (of the dehydrated salt) gave, as I supposed, the amount of oxygen in excess of that required to form Bi_2O_3 . Water was determined by heating in a current of dry air, and determining the increase of weight of a calcium chloride tube attached to the apparatus in which the salt was heated.

2. The following table contains the analytical results obtained:—

| No. | Mode of Preparation. | Temp. at which Salt was Dried. | Percentages of Bismuth Found. | Mean Percentage of Bismuth. | Mean Percentage of Loss on Ignition, regarded as Oxygen. |
|-------|--|--------------------------------|--|-----------------------------|--|
| I. | By addition of KCN to Bi in excess of HNO ₃ .* | 150° | 78.53; 82.21 | 80.37 | 19.63 |
| II. | By addition of KCN to Bi ₂ O ₃ in nitric acid (exact proportions not noted), . . . | 150° | 79.33; 80.29 | 79.81 | 20.19 |
| III. | Do. do. † KCy : Bi ₂ O ₃ = 1:1, . . . | 150° | 81.04 | 81.04 | 18.96 |
| IV. | Do. do. KCy : Bi ₂ O ₃ = 3:1, . . . | 150° | { 79.93; 79.88; } { 78.97; 80.49. } | 79.62 | 20.18 |
| V. | Do. do. KCy : Bi ₂ O ₃ = 3.5:1, . . . | 100° | { 78.07; 78.09; } { 78.62; 78.86; } water in this salt = 1.5 per cent. | 79.72‡ | 20.28 |
| VI. | Same salt as No. V. dried at . . . | 150° | 79.08; 79.31 | 79.19 | 20.81 |
| VII. | Do. do. KCy : Bi ₂ O ₃ = 2.5:1, . . . | 100° | { 75.07; 75.69; } { 75.85; water in this salt = 2.1 per cent. } | 77.15‡ | 22.85 |
| VIII. | Do. do. KCy : Bi ₂ O ₃ = 2.5:1, . . . | 150° | { 76.39; 76.69; } { 77.31; 77.80; } 77.88 | 77.20 | 22.80 |
| IX. | Addition of KCN (excess) to Bi ₂ O ₃ in slight excess of HCl, . . . | 150° | 79.45 | 79.45 | 20.55 |

| | Mean of Means. | Calculated for Bi ₂ O ₃ . |
|--|----------------|---|
| Bismuth | - 78.86 | 78.95 |
| Oxygen | - 21.38 | 21.05 |
| Oxygen in excess over Bi ₂ O ₃ = | 12.40 | 12.03 |
| Bi ₂ O ₃ : excess of O . . . | -117.16.2 | 117.16 |

3. These results seemed altogether to confirm the view that the salt to which Boedeker had given the formula Bi₂O₃.2H₂O contained,

* Many other preparations made by this method were analysed, but the results varied considerably; the above is given only as a specimen.

† This salt was considerably lighter in colour than the others.

‡ Calculated on the dry salt.

when dried at 150°, bismuth and oxygen only, and these in the atomic proportion Bi_2O_7 .

But I subsequently found that the supposed oxide, when heated in a closed tube, evolved a little ammonia. I also proved the presence of nitrogen by the sodium test. Determinations were therefore made of nitrogen and of carbon, the former by burning with soda lime, the latter by burning with copper oxide.

1. 0.7075 grm. gave 0.0285 grm. N. = 4.03 per cent. = 7.49 per cent. cyanogen.
2. 0.867 " " 0.0365 " N. = 4.20 " = 7.60 " "
3. 1.113 " " 0.046 " N. = 4.14 " = 7.69 " "
4. 0.8275 " " 0.1275 " $\text{CO}_2 = 0.0348$ grm. $\text{C} = 0.0754$ grm. $\text{CN} = 9.10$ per cent. cyanogen.
5. 1.2435 " " 0.145 " $\text{CO}_2 = 0.040$ " $\text{C} = 0.0866$ " $\text{CN} = 7.00$ " "

Determinations of water made simultaneously with those of carbon gave 4.60 and 4.75 per cent.

Hence mean percentage of cyanogen = 7.61
 Do. do. of water = 4.67

The preparation used in these analyses contained 77.25 per cent. bismuth. The mean percentage of bismuth, calculated from analyses of those preparations which were dried at 120° and contained a little water, is 76.80 per cent.; taking this number and 4.67 as representing the amount of water in the salt, and determining oxygen by difference, the results agree very well with the complex formula $4\text{Bi}(\text{CN})_5 \cdot 5\text{Bi}_2\text{O}_5 \cdot 10\text{H}_2\text{O}$. The analytical numbers agree fairly well with the formula $2\text{Bi}(\text{CN})_5 \cdot 5\text{Bi}_2\text{O}_5 \cdot 9\text{H}_2\text{O}$, which requires bismuth 75.40, cyanogen 7.78, oxygen 11.98, and water 4.85 per cent.

| | Found. | Calculated for $4\text{Bi}(\text{CN})_5 \cdot 5\text{Bi}_2\text{O}_5 \cdot 10\text{H}_2\text{O}$. |
|-------------------------|--|---|
| Bismuth, . . . | 76.80 | 76.72 |
| Cyanogen, . . . | 7.81 | 8.15 |
| Oxygen (by difference), | 10.72 | 10.44 |
| Water, . . . | 4.67 | 4.69 |
| | <hr style="width: 50%; margin: 0 auto;"/> 100.00 | <hr style="width: 50%; margin: 0 auto;"/> 100.00 |

Calculating all the results on the dry salt, numbers are obtained which agree better with the formula $\text{Bi}_7(\text{CN})_6\text{O}_{15}$ than with any other.

| | Found. | Calculated. |
|-------------------------|--|--|
| Bismuth, . . . | 78.86 | 78.78 |
| Cyanogen, . . . | 8.14 | 8.37 |
| Oxygen (by difference), | 13.00 | 12.85 |
| | <hr style="width: 50%; margin: 0 auto;"/> 100.00 | <hr style="width: 50%; margin: 0 auto;"/> 100.00 |

The numbers agree also very well with the formula $2\text{Bi}(\text{CN})_3$, $5\text{Bi}_2\text{O}_3$, which requires bismuth 79.24, cyanogen 8.18, and oxygen 12.58 per cent. Various other formulæ may be found, agreeing more or less closely with the analytical results, but in each the atomic proportion of oxygen to bismuth, in excess of that required to form $\text{Bi}(\text{CN})_3$ or $\text{Bi}(\text{CN})_5$, must be expressed by a formula Bi_2O_x where x is not less than 5; in other words the action of potassium cyanide has been an oxidising action, while at the same time producing a cyanogen compound.

4. Unless a considerable excess of potassium cyanide is added, but little of the new salt is produced. If the liquid be so nearly neutral before adding cyanide that one drop of moderately strong potash solution produces a permanent precipitate, the precipitate produced by the cyanide consists of nearly pure Bi_2O_3 , with small quantities of the new salt. If there be rather more free nitric acid than this, the precipitate produced by the cyanide is rich in an oxide of bismuth to be described in the sequel, viz., Bi_4O_7 (see par. 5).

In one instance one part of potassium cyanide was added to one part of bismuth nitrate, dissolved in the minimum quantity of dilute nitric acid, a portion of the liquid was boiled for three or four minutes, and another portion for twenty-five minutes. The precipitate produced in the latter liquid was darker in colour than that in the former, and contained rather less bismuth; the lighter coloured salt contained 81.59 per cent. bismuth, the darker salt gave bismuth = 80.89 per cent.

When from 2 to 2.5 parts potassium cyanide are used for each part bismuth nitrate in solution, and the liquid is boiled, the precipitate very quickly becomes of a uniform puce-red colour, while the supernatant liquid is reddish-brown. The best results are, I think, obtained with this proportion between cyanide and bismuth nitrate.

When the cyanide solution is added to a cold solution of bismuth nitrate, an almost colourless salt is thrown down, which becomes puce-red on boiling; this colourless salt is perfectly free from cyanogen, and appears to be bismuthous oxide. If, however, anhydrous bismuthous oxide be boiled with potassium cyanide solution,* no change occurs, nor does addition of potash induce any

* This has been confirmed by repeated trials, and by analysis.

reaction. Although the liquid, after addition of the cyanide, is markedly alkaline, nevertheless the presence of free acid in the bismuth solution is necessary; that this acid need not be nitric acid was shown by adding potassium cyanide to solution of bismuthous oxide in slight excess of hydrochloric and sulphuric acids respectively; in each case the puce-red salt was obtained on boiling.

It is, I think, evident, that to ensure production of the new salt, rapid chemical change—partly oxidation, partly formation of bismuth cyanide—must occur; neither bismuthous oxide nor any other salt must be allowed to get permanently produced, the whole system must not settle down into stable equilibrium until it is forced to assume that configuration of which the complex oxycyanide is a component part.

5. *Bismuth Oxycyanide*—probably $2\text{Bi}(\text{CN})_3 \cdot 5\text{Bi}_2\text{O}_3$ —when dried at 140° – 150° is a reddish-brown solid, somewhat similar in appearance to lead dioxide, but showing a more decided puce colour than that salt. It begins to undergo change at about 200° , but the loss of weight at that temperature is small; about half a gram of the salt lost 3.50 per cent. at 210° , and 7.50 per cent. at 350° (the oxycyanide in changing to Bi_2O_3 loses about 12 per cent.). When a large quantity of the salt is heated in a crucible, a considerable amount of metallic bismuth is produced; but when quantities of from 0.5 to 1.0 grams are so heated the residue consists only of bismuthous oxide.

The oxycyanide scarcely takes up water when exposed to ordinary or to moist air; thus about half a gram increased only 1.80 per cent. in weight after 144 hours' exposure over water. It does not suffer change when covered with water and exposed to the action of sunshine.

Bismuth oxycyanide is dissolved by hot concentrated nitric or sulphuric acid, with production of dark-red liquids, from which water causes precipitation of red substances containing bismuth, and soluble in hot potash solution. Hydrochloric acid dissolves the oxycyanide more slowly, a portion remaining undissolved even after continued action. When heated with a *slight* excess of potash these liquids yield reddish precipitates, which are mostly soluble in hot concentrated potash solution, and when any of these deep red acid solutions is boiled it is *very slowly* decomposed with ultimate

production of bismuthous nitrate, sulphate, or chloride. When sulphuric acid is employed as solvent, the salt which separates after concentration is probably $\text{BiHSO}_4 \cdot 3\text{H}_2\text{O}$ (47.9 per cent. bismuth was obtained instead of 45.95 per cent. required by this formula). The specific gravity of bismuth oxycyanide at 20° is 4.64 referred to water at the same temperature (mean of 4.67 and 4.61; weighings done in benzene, specific gravity at $20^\circ = 0.8804$).

6. Bismuth oxycyanide is readily acted on by hot, and more slowly by cold, concentrated aqueous potash, with production of a very deep red liquid. So far as I have examined this action, about 75 per cent. of the oxycyanide is invariably converted into the oxide Bi_2O_3 , while 25 per cent. goes into solution. This change appears to be independent of the quantity of potash, provided there be excess, and of the time of action of the hot liquid on the oxycyanide.

When the strongly alkaline red liquid is neutralised, preferably by hydrochloric acid, a reddish-brown flocculent precipitate is formed, which, after washing with hot water, contains the whole of the bismuth originally in solution, but is free from potassium. When the precipitate has been dried at 100° , it appears as a nearly black hard crystalline substance resembling magnetic oxide of iron, and is now only dissolved by long-continued boiling in strong acids, with formation of deep red liquids, which are scarcely decomposed except by evaporation to dryness. This salt is strongly decomposed when heated to redness in air, with production of bismuthous oxide; heated in a limited supply of air a portion remains as metallic bismuth; the salt contains a considerable quantity of water; it is unchanged, otherwise than that it loses water, at 300° . It may be readily dissolved and decomposed by treatment with bromine and aqueous potash.

I have made many analyses of this peculiar substance, but the results show great variations; inasmuch, however, as the preparation of this substance in quantity involves the use of much potassium cyanide, which is an extremely disagreeable reagent to work with, especially when added to hot acid liquids, and the expenditure of a great deal of time, I think it may be well to put on record a synopsis of the results obtained.

| No. | Preparation. | Temp. at which Dried. | Percentage of Bismuth. | | Total Loss when Heated over Blowpipe. Per cent. | Percentage of Water; determined by Heating in Dry Air with CaCl_2 Tube attached. |
|------|--|-----------------------|---|--|---|---|
| | | | By Precipitation as Carbonate. | By Ignition in Air, and weighing Residue as Oxide. | | |
| I. | Made in earlier part of investigation, . . . | 150° | 23·7; 21·0 | 24·0 | 73·4 | ... |
| II. | Made at later part of investigation, . . . | 300° | 25·5; 27·5 | ... | ... | ... |
| III. | Made from same oxycyanide as No. II., . . . | 300° | ... | { 7·08; 6·70; 7·17; 7·77 | { 92·1; 91·4; 92·0; 91·8 | { 18·75; 28·28; 28·10; 31·0; 20·0 |
| IV. | Made from same oxycyanide as No. II., . . . | 300° | ... | ... | ... | 16·9 |
| V. | Made from another preparation of oxycyanide, . . . | 300° | ... | 6·7 | ... | 17·5 |
| VI. | From another preparation of oxycyanide, . . . | 250° | { Burned with soda lime, gave 36·84 per cent. N. = 67·47 per cent. CN. | | | |
| VII. | From another preparation of oxycyanide, . . . | 250° | { Burned with soda lime, gave 36·32 per cent. N. = 67·45 per cent. CN. Burned with CuO , gave 15·80 per cent. C. = 34·23 per cent. CN. | | | |

From the three last determinations I conclude that the salt probably contains a considerable quantity of nitrogen, in addition to a large percentage of cyanogen. The variations in the quantities of bismuth found are remarkable; to attempt the construction of a formula from these results would be useless.

7. It has been already stated, that under certain conditions (see par. 4) the precipitate formed by the action of aqueous potassium cyanide on bismuth nitrate contains considerable quantities of the oxide Bi_4O_7 ; also that the same oxide is produced by the action of hot concentrated aqueous potash on bismuth oxycyanide; the formation of this oxide in the first of these reactions is almost certainly to be traced to a secondary change proceeding after the production of the oxycyanide.

Various preparations of the new oxide were made; when thoroughly washed with hot water the salt contains no potassium, it is very difficult to remove every trace of cyanogen; after the analyses detailed in the following table had been made, it was

found that the various preparations when mixed contained about 0.25 per cent. cyanogen (mean of three determinations—two of nitrogen, and one of carbon). The salt after drying at 100° is anhydrous. The analytical results are collected in the following table:—

| No. | Mode of Preparation. | Temp. at which Salt was Dried. | Percentage of Bismuth Found. | Mean Percentage of Bismuth. | Mean Percentage of Oxygen. | Mean Percentage of Oxygen in excess of that to form Bi ₂ O ₃ . | Proportion of Bi ₂ O ₃ : excess of O. |
|------|---|--------------------------------|------------------------------------|-----------------------------|----------------------------|--|---|
| I. | Addition of KCN to Bi in HNO ₃ , and boiling precipitate in concentrated KOH, | 100° | 88.59; 89.05 | 88.82 | 11.16 | 0.91 | 117; 1.1 |
| II. | Similar to No. I., but precipitate by KCN boiled with very dilute H ₂ SO ₄ before treatment with KOH, | 100° | 88.34; 88.73 | 88.53 | 11.47 | 1.22 | 117; 1.5 |
| III. | KCN to BiONO ₃ in dilute HNO ₃ , and subsequent boiling precipitate with KOH | 100° | 88.43 | 88.43 | 11.57 | 1.32 | 117; 1.6 |
| IV. | No. I., II., and III. mixed, again boiled with KOH, &c., | 160° | {88.59; 88.72;} {88.81; 88.90;} | 88.75 | 11.25 | 1.00 | 117; 1.3 |

| | Mean of Means. | Calculated for Bi ₄ O ₇ . |
|--|----------------|---|
| Bismuth | - 88.64 | 88.24 |
| Oxygen | - 11.36 | 11.76 |
| Oxygen in excess over Bi ₂ O ₃ | - 1.11 | 1.65 |
| Bi ₂ O ₃ : excess of O | - 117; 1.4 | 117; 1.9 |

The best method of preparing this salt is to boil a solution of bismuth nitrate in the minimum quantity of dilute nitric acid, with three or four times its weight of potassium cyanide dissolved in a little water, to add a considerable excess of potash, and to continue boiling for some time; to pour off the red liquid and boil again with potash as long as the liquid becomes coloured, to wash with hot water till the washings are quite free from alkali, and to dry at about 150°.

This salt is quite unacted on by hot potash.

8. *Bismutho-hypobismuthic oxide* (I think the oxide Bi_4O_7 may be thus named) is a heavy dark grey crystalline salt; the specific gravity varies, according to the method of preparation, from 7.8 to 8.5 (at 20° referred to water at the same temperature, weighings made in benzene), which is higher than that of any other oxide of bismuth. This oxide suffers no loss of weight at 300° ; it gives off oxygen at a red heat with production of Bi_2O_3 . It undergoes no change either in ordinary or in moist air, nor is it affected when covered with water and exposed to direct sunlight for some days. Strong hot nitric acid readily dissolves this oxide with formation of a purple-red liquid, which is *slowly* decomposed on evaporation. A solution of the salt in strong hydrochloric acid, which solution is also red-coloured, is more quickly decolorised on boiling; hot concentrated sulphuric acid partly dissolves this oxide, forming a brown-red liquid, and partly converts it into an almost colourless salt, which, after being washed free from acid, appeared to be $(\text{BiO})_2\text{SO}_4\text{H}_2\text{O}$ (Bi found = 75.0 per cent.; calculated = 74.21 per cent.). The sulphuric acid solution, on evaporation, yielded colourless crystals which, after drying on a porous tile, contained about 56 per cent. of bismuth ($\text{Bi}_2\cdot 3\text{SO}_4$ requires 59.32 per cent.). I think it very probable that the green oxide of bismuth described by Arppe, (*Pogg.* 64, 237) as produced by the action of boiling nitric acid on (so-called) bismuthic acid, consisted of Bi_4O_7 , containing a little undecomposed Bi_2O_3 .

6. Mathematical Note. By Mr. T. B. Sprague.

7. On the manner in which Silicon, Phosphorus, Manganese, and other elements exert their influence upon Steel.
By R. Sydney Marsden, D.Sc., F.R.S.E., F.C.S., &c.

(Abstract).

This paper is a continuation of the author's previous paper on "The state of carbon in iron and steel, a new hypothesis of the hardening of steel" (read on the 19th December 1881, see p. 368), and is an attempt to give an explanation in accordance with the

views given out in that paper of the manner in which the various elements most common in steel exert their influence in so materially modifying the properties of the metal.

The following are the elements the action of which is considered, viz., silicon, sulphur, phosphorus, manganese, chromium, tungsten, and titanium.

PRIVATE BUSINESS.

Mr. Sang's motion of January 16th, that Law XIV. be amended by the addition of the words, "Excepting when there are five Mondays in January, in which case the meetings shall be held on the third and fifth Mondays of that month," was adopted by the Society, with a verbal emendation. The following words were accordingly added to Law XIV.: "Excepting when there are five Mondays in January, in which case the meetings for that month shall be held on the third and fifth Mondays."

Monday, 6th March 1882.

PROFESSOR H. C. FLEEMING JENKIN, F.R.S.,
Vice-President, in the Chair.

The Chairman intimated that a letter had been received from the Imperial Society of Naturalists of Moscow, inviting the Society to be represented on the 14/2 May 1882, at the celebration of the fiftieth anniversary of the graduation of its Vice-President, Dr. Charles Renard.

The following Communications were read:—

1. The Effect of Flame on the Electric Discharge. By Dr. A. Macfarlane and Mr. D. Rintoul. (Plate IV. a).

The properties of flames of various kinds as generating electricity and as serving to conduct a voltaic current, as also their behaviour under the influence of a charge of electricity, have been investigated

by several philosophers.* But, so far as we know, the effect of flame on the electric spark has not been methodically observed, or at all events has not been methodically measured. This was the problem which at the opening of the College session presented itself to us, and the results now attained by a course of experimenting appear capable of throwing some light on the solution.

We first made a number of tentative experiments, for the purpose of finding out the general aspect of the phenomena, and the conditions most favourable for exact measurement. An ordinary Bunsen burner served to supply a flame luminous or non-luminous. It was always connected with the earth, and the charged body was in general a disc of 4 inches diameter, connected along with a large Leyden jar to the insulated conductor of a Holtz machine. We tried the disc in a position above the flames, but found that the disturbing conditions introduced were, as was to be expected, rather numerous, namely, the heating of the disc and the covering of it with soot, and the melting of the gutta-percha covering of the connecting wire. Hence for a series of measurements we preferred the disc placed in a position at the side, as represented in the accompanying figures. (See Plate IV. *a*).

The series of observations finally attained are recorded in Tables I. and II.; they are supported by the more preliminary observations. The charged disc was throughout placed at the side of the Bunsen tube in a vertical plane, and so as to have its centre on the same level with the mouth of the tube. The conditions varied were—*first*, the nature of the flame; *second*, the sign of the charge on the disc; *third*, the height of the flame; *fourth*, the distance of the disc from the tube. As regards the first variation two states were observed, the one being the clear flame without any luminosity, the other being the flame as luminous as possible. The height of the flame was varied through a range from 1 cm. to 8 cm., but sometimes the range was extended to the maximum height of the flame (about 20 cm.). In the case of the non-luminous flame, it was the height of the apex of the cone that was measured off; while in the case of the luminous, it was the extreme tip. The total height of the former flame may be taken as double that of the cone. The

* A summary of what has been done is given in a recent paper by Holtz, *Carl's Repertorium*, vol. xvii. p. 269.

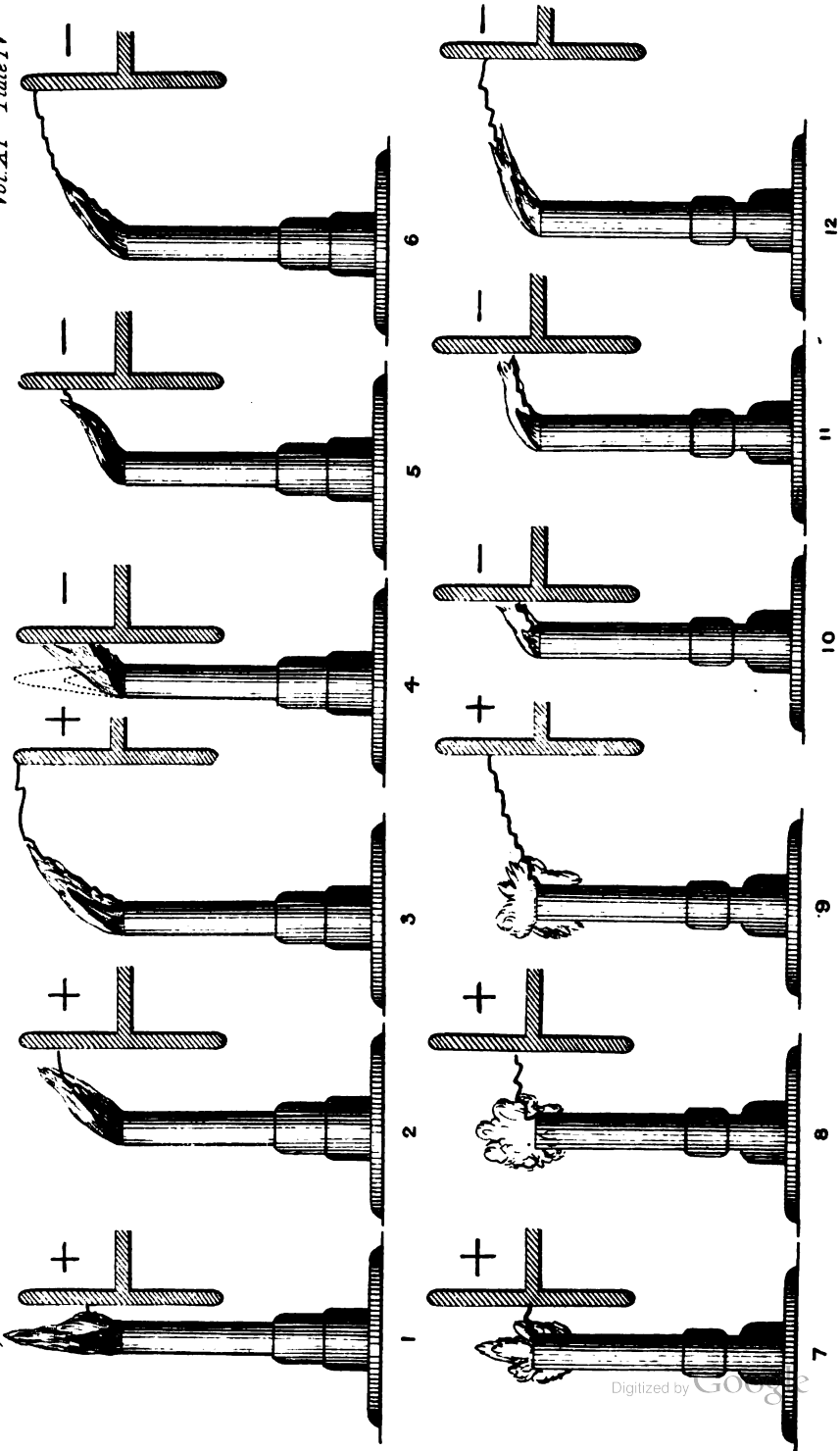

Figs. 1-6. Flame non-luminous, electricity on disc positive.
 Figs. 7-12. Flame luminous, electricity on disc negative.

Figs. 1-12. Height of flame constant.

distance of the tube was varied through a range extending from 1 cm. to 7 cm.

The method of measuring the potential required to produce the spark was that employed in Macfarlane's previous experiments.* The special arrangement of the apparatus is indicated by the accompanying plan.

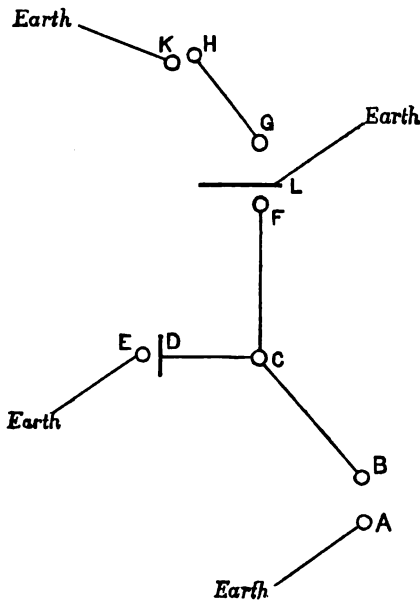

A and B are the two electrodes of a Holtz machine, of which one, say A, was connected with the earth. An insulated wire joined B to the knob of a large Leyden jar C, and C was similarly connected with the disc D and with the insulated ball F. G, the other insulated ball, was connected with one of the electrodes H, of a Thomson quadrant electrometer, the other electrode K being earthed. An uninsulated metallic plate L, with a hole in the middle of it, was placed between F and G, for the purpose of diminishing the influence of F on G. This is a modification of an idea introduced by Professor Chrystal, namely, the placing of F inside a metallic cube having a hole in the side next G.

* *Trans. Roy. Soc. Edin.*, vol. xxviii. p. 633, or *Phil. Mag.*, s. 5, vol. x. p. 389.

Having decided upon our variables, we drew out the logical plan exhibited in the Tables, and proceeded to fill in the observations systematically. We first observed the behaviour of the flame under the influence of the charge, and also the mode of passing of the spark, and then proceeded to note the readings of the electrometer for three separate discharges. It will be observed, that where the flame was in a steady state the three readings differ only by small quantities, but that where the flame was in what may be called a critical condition, the differences are relatively larger. The sign of the electricity was changed by interchanging the connections at A and B, and that was always accompanied by a simultaneous interchange of the connections at H and K, in order that any bias due to the electrometer might be eliminated. The mean differences of potential obtained were reduced to absolute measure by taking the mean of the differences of potential required to produce several sparks between two parallel plates at a distance of 6 mm. apart. For such a spark the absolute value of the difference of potential is 46.52 C.G.S. units.*

The figures sketched (Plate IV. *a*) indicate the behaviour of the flame, and the path of the spark in 24 representative cases. They are drawn in proportion to the exact dimensions.

The results for a flame of constant height (Table I.) are represented on diagram 1. The first conclusion that may be drawn is, that the difference of potential is greater when the disc is negatively electrified, excepting that for small distances there may be an equality or even a small difference the other way. The next conclusion is, that it is greater for the non-luminous flame at the smaller distances, but very much the opposite at the greater distances, particularly in the case of the negative luminous. If we look at the notes or at the sketches, we shall find decided differences of behaviour coexisting with these differences in electromotive force. In the case of the negative electrification, the flame in general assumes a pointed form, becomes diminished, and loses its luminosity partially or wholly, or if already clear, becomes more bluish. But at the smaller distances, the flame being able to form a bridge over to the disc, remains with its tip in contact, and there are none of the above changes. On the other hand, in the case of the positive

* *Trans. Roy. Soc. Edin.*, vol. xxviii. p. 652.

electrification, the non-luminous flame is not attracted powerfully, and it retains its original size and character, while the luminous one is thrown down into and over the mouth of the tube, and retains its luminosity. If there are convection currents they must be such as to throw oxygen into the flame in the former case, but not in the latter.

The observations recorded in Table II were undertaken to test whether the difference of potential required for the spark depended largely upon the height of the flame. Where the conditions are in common with cases in the former series, the observations serve as a test of consistency; the agreement is satisfactory. Diagram 2, representing the results, in addition to confirming the conclusions drawn from the preceding diagram, shows that the variation of the height of the flame produces little change in the electromotive force, when the flame is non-luminous; also when the flame is luminous and the electrification positive, but that it produces a great difference in the remaining case, when the flame is luminous and the electrification negative, so long as the flame is not sufficiently high to reach the disc. Though the flame is attracted so as to be in contact with the disc, the discharge still passes in the form of a spark.

This investigation was made in one of the fine suite of rooms recently added to the Physical Laboratory, and in conducting it we had every facility given us by Professor Tait.

TABLE II.—HEIGHT OF FLAME VARIED.

| Date. | Nature of Flame. | Sign of Charge on Disc. | Height of Flame. (cone.) 1 cm. | Deflection. | Zero. | Difference. | Mean Diff. of Potential. | Abs. Value of Diff. of Potential. | Remarks on Appearance of the Flame. |
|--------------|------------------|-------------------------|--------------------------------------|-------------|-------|-------------|--------------------------|-----------------------------------|---|
| 24th Jan. | non-luminous. | + | (cone.) 1 cm. | 790 | 395 | 385 | 390 | 31·73 | Slightly attracted, scintillations; spark passes through the flame. |
| | | | | 786 | 385 | 375 | | | |
| | | | | 785 | 385 | 410 | 386 | 31·32 | |
| | | | | 790 | 390 | 380 | | | |
| | | | | 775 | 395 | 390 | 410 | 33·35 | |
| | | | | 780 | 385 | 395 | | | |
| | | | | 830 | 390 | 490 | 392 | 31·99 | |
| | | | | 790 | 390 | 390 | | | |
| | | | | 750 | 390 | 410 | | | |
| | | | | 820 | 410 | 410 | | | |
| | | | | 805 | 400 | 405 | | | |
| | | | | 770 | 390 | 380 | 378 | 30·75 | |
| | | | | 765 | 390 | 390 | | | |
| | | | | 740 | 390 | 350 | 369 | 30·02 | |
| | | | | 765 | 395 | 370 | | | |
| | | | | 778 | 390 | 388 | | | |
| | | | | 760 | 390 | 370 | 375 | 30·51 | |
| | | | | 780 | 400 | 380 | | | |
| | | | | 765 | 390 | 375 | | | |
| | | | | 750 | 400 | 350 | 357 | 29·04 | |
| 760 | 390 | 390 | | | | | | | |
| 760 | 400 | 390 | 365 | 29·70 | | | | | |
| 748 | 390 | 358 | | | | | | | |
| 768 | 390 | 378 | | | | | | | |
| 725 | 395 | 340 | 363 | 23·63 | | | | | |
| 780 | 390 | 340 | | | | | | | |
| 765 | 390 | 375 | | | | | | | |
| 790 | 390 | 410 | 415 | 33·76 | | | | | |
| 810 | 390 | 430 | | | | | | | |
| (off scale.) | | | | | | | | | |
| 840 | 390 | 460 | 462 | 35·14 | | | | | |
| 805 | 400 | 405 | | | | | | | |
| 890 | 430 | 430 | | | | | | | |
| 710 | 390 | 390 | 368 | 29·04 | | | | | |
| 745 | 390 | 320 | | | | | | | |
| 800 | 390 | 440 | | | | | | | |
| 840 | 400 | 440 | | | | | | | |
| 890 | 460 | 430 | 467 | 35·55 | | | | | |
| 900 | 460 | 460 | | | | | | | |
| 860 | 415 | 445 | | | | | | | |
| 845 | 410 | 455 | 410 | 35·80 | | | | | |
| 830 | 410 | 440 | | | | | | | |

2. Observations on Vegetable and Animal Cells; their Structure, Division, and History. Part I., The Vegetable Cell. By J. M. Macfarlane, B.Sc. Communicated by Professor A. Dickson.

3. On some Points in the Anatomy of the Nervous System of the Pond Snails, Planorbis and Lymnæus. By F. E. Beddard, B.A., New College, Oxon. Communicated by Mr P. Geddes.

The best figures of the nervous system of these animals are those of Lacaze-Duthiers, in his Paper *Sur les Otocystes des Mollusques*, and in that *Sur le Système Nerveux des Gastéropodes*.* By a careful study of the nervous system of these two gasteropods, chiefly by cutting sections, I have discovered one or two small points in their anatomy which, as far as I can make out, have hitherto escaped attention.

These two types, though so closely allied, differ to a considerable extent in the arrangement and structure of certain of their ganglia; compare the figures given by Lacaze-Duthiers of the nervous system of Lymnæus on Plate xvii. in Volume i. of his *Archives* with that of Planorbis on Plate iii. of the same volume. It will be seen at once that the cerebral ganglion of Lymnæus is far more complicated than that of Planorbis, consisting of five separate lobes, while that of Planorbis appears to be made up of not more than two.

Otherwise, the number of ganglia in the two is the same, but the asymmetry is different, the larger parietosplanchnic ganglia being on the right side in Lymnæus and on the left in Planorbis.

By cutting several series of sections of the whole nervous system of Planorbis and Lymnæus, and arranging them carefully in order, one or two more points of difference in structure have been noticed. In fig. 1, which represents a complete section taken through the nerve collar of Lymnæus at the level of the pedal ganglia, it will be seen that these ganglia are united by a double commissure, the lower of the two commissures is much slighter than the upper, and was far more difficult to find; the upper stouter

* *Archives de Zool. Expériment. et Générale*, vol. i. 1872.

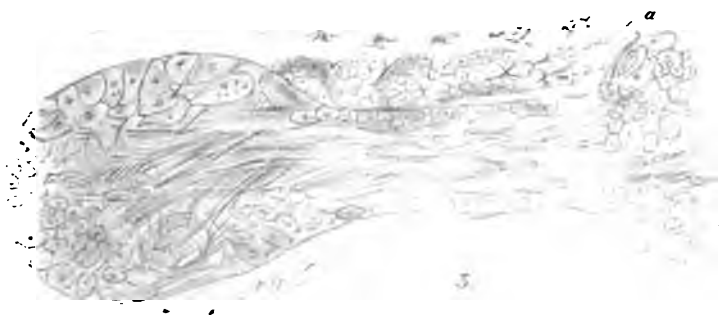
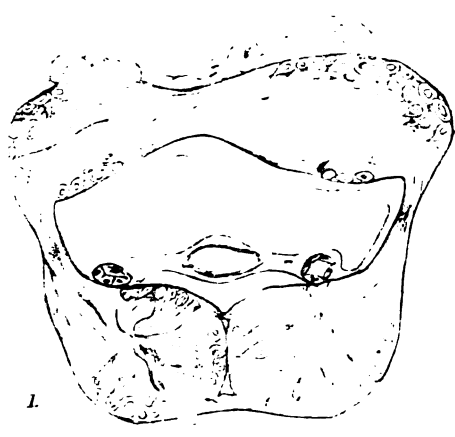

commissure is shown in every series of sections prepared. M. de Lacaze-Duthiers* figures and describes three distinct commissures, of which the two upper are stout, while the lower one, which evidently corresponds to the lower one of the two that I have described, is slender, and gives off from the middle an unpaired nerve running backwards, the distribution of which was uncertain. Whether this double (or treble) commissure is an expression of the compound nature of the pedal ganglia, which are generally supposed to have originated from a primitive ventral ganglionated chain by the fusion of some of the ganglia and the suppression of others, is doubtful; judging from analogous cases, it would appear probable that it is not so. M. Yung,† in a paper on the nervous system of the Decapod Crustacea, describes the abdominal ganglia as being joined by three commissures; as there is one ganglion to each abdominal segment in the *Macrura*, it does not seem possible that they can have been originally represented by several ganglia. So much for *Lymnæus*. In *Planorbis* the arrangements are a little different, there are the same two commissures (fig. 2), but the lower one is much stouter than it is in *Lymnæus*, and therefore is much more easily seen, though it seems to have escaped notice.

The great point of difference between the two types studied is, that in *Planorbis* there is a small unpaired median ganglion which, lying between the pedal ganglia and on the lower of the two commissures, unites them. This is itself connected with one or both of the pedal ganglia by a commissure, which, though independent of that uniting the two pedal ganglia, yet, as is shown in the figure (fig. 6), lies upon it. This ganglion is shown in figure 2 in position, and in figure 6 more highly magnified, so as to bring out its constituent cells. It is very small in extent, not more than four or five cells in thickness, but is almost impossible to miss in a carefully-cut series of sections; the cells are of uniform size, and not large. From the under surface an unpaired nerve is given off, which is no doubt homologous with that described and figured by M. de Lacaze-Duthiers in *Lymnæus*, but in *Lymnæus* I have found no trace of this small unpaired lobe. The unpaired nerve, on the contrary, does not seem to be peculiar

* *Loc. cit.*, pl. xvii. fig. 4.

† Emile Yung, "Système Nerveux chez les Crustacées Décapodes," *Arch. Zool. Expér.*, 1878, vol. vii.

to these two species; it is figured by Spengel* in *Gastroteron* and *Aplysia*, and by Von Ihering† in these two types as well as in *Bulla* and *Acera*. A double commissure between the pedal ganglia is very general, and in a few cases, as in *Lymnæus*, according to Lacaze-Duthiers, there is a treble commissure; a glance at Von Ihering's plates will show this. Whether this ganglion just described is limited to *Planorbis*, or whether it is general, I do not at present know, but hope to study the nervous systems of a number of *Mollusca*, with a view of determining its nature and distribution.

In the same two sections (figs. 1 and 2) may be seen a mass, unpaired in *Planorbis* and paired in *Lymnæus*, lying above the cerebral ganglia, on the commissure uniting them. It has been hitherto regarded merely as a part of the cerebral ganglion, and if it is really so, its structure is very peculiar; from studying it in sections and by teasing, it appears to me to be rather of a glandular nature, judging from its structure and relations.

It will be best to commence with a description of this structure in *Lymnæus*, and I may say that the description below refers to *Lymnæus stagnalis*, while the species of *Planorbis* described is *Planorbis corneus*. Fig. 5 represents the cerebral ganglion of *Lymnæus*, and that portion of it lettered *a* is now under discussion; it will be seen that the commissure *b*, uniting the ganglion to its fellow, has in reality nothing to do with this lobe, but takes its origin from the larger part of the ganglion, and merely passes under the lobe *a*. In the fresh ganglion this part is readily distinguishable from the rest from its being of a whitish colour, containing none of the red pigment which is distributed universally in the cells and their processes of the rest of the cerebral ganglion and in the other ganglia. Lacaze-Duthiers says of it: † "Il se fait distinguer sur l'animal vivant par son opacité et sa teinte blanchâtre, très saillant surtout dans le *Lymnæus stagnalis*, il l'est un peu moins dans les deux autres espèces. Il est formé de corpuscles relativement fort petits et qui ressemblent à ceux que

* "Die Geruchsorgane und das Nervensystem der Mollusken," *Zeitschr. für Wissensch. Zool.*, 1881, plate xvii. figs. 7, 8.

† *Nervensystem der Mollusken*, Leips., 1877, plates iii. and iv.

‡ *Loc. cit.*, p. 443.

l'on trouve mélangés aux gros corpuscles du milieu du ganglion. La grandeur de ces corpuscles est uniforme. Ils semblent être des noyaux qui ne dépassent pas de faibles proportions. Aussi ne trouve-t-on jamais mêlés à eux ces grands corpuscles ganglionnaires qui occupent le milieu du cerveau. . . . Arrondi du côté de la commissure, ce lobule semble séparé par deux lignes formant un angle du côté du ganglion en dehors, on croirait que le névrilème l'entoure et l'isole."

The author goes on to say that this mass is found in all the Pulmonata, and that researches are wanted to establish its functions and relations with other parts of the ganglion. It is therefore evidently something distinct from the rest of the ganglion. The absence of the red pigment, which is so characteristic of the nervous system of *Lymnæus*, is so very remarkable, if this lobe is to be regarded as merely a part of the cerebral ganglion; and again the fact that it is divided off from the rest by a connective tissue lamella, while none of the other lobes into which the cerebral ganglia are portioned show any signs of such a complete separation, seem to point to its being a distinct structure.

Fig. 4 represents a vertical section taken through the cerebral ganglion of one side; *b* is the commencement of the commissure which unites it to the other cerebral ganglion; *c* is the commissure uniting it with the pedal ganglion; *a* is the "white lobe" of the ganglion. A glance at this drawing will show at once how different it is in general appearance from the rest of the cerebral ganglion; it is made up of small rounded cells packed closely together, so as to give the appearance occasionally of being polygonal. When separated by maceration in weak chromic acid and subsequent teasing, each of these cells is oval or roundish, occasionally three-cornered with the corners rounded off; the nucleus is large, but not nearly so large in proportion as the nucleus of the ordinary nerve cells from the ganglia; they are very similar in general appearance to certain glandular cells from the penis of the same animal, but a good deal smaller. No signs of any nerve fibres either within the mass or connecting the two were visible.

In sections of the nervous system prepared with different reagents the appearances presented by the "white lobe" are very different from the rest of the ganglion. When stained with gold chloride, the ordinary nerve cells are coloured with various shades of blue and purple, the nuclei being left altogether unstained, while the

cells of the "white lobe" are tinted of a uniform pale lilac, there being but a very slight distinction between the nucleus and the cell protoplasm. This "white lobe" also presents the appearance of a firm solid cellular mass, while the other part of the cerebral ganglion consists of an outer sheath of nerve cells of various sizes, and an inner core of nerve fibres. When hardened and stained by osmic acid, there is still a noticeable difference; the ordinary nerve cells within the ganglia are coloured brown, the nucleus being left unstained, or coloured more or less faintly; while the cells making up the white lobe are coloured on the whole much more faintly than the ganglion, but the nuclei are rendered conspicuous by being stained more deeply than the surrounding protoplasm.

The homologous structure in *Planorbis* (see figs. 1, 2) is a large single mass lying over the commissure uniting the two cerebral ganglia; it is figured by Lacaze-Duthiers,* but is not specially described by him. Though this mass in *Planorbis* is single, it has a deep depression in the middle, which gives it a kidney-shaped outline in transverse section. In structure it is altogether similar to the corresponding part in *Lymnæus*, that is to say the cells which make up the mass are quite alike in both animals, but their arrangement is rather different in *Planorbis*. As is shown in figure 3, the whole mass is distinctly lobulated, the lobules being separated from each other by trabeculae of connective tissue; it is not unlike the salivary gland of the same animals, but in a number of sections both structures were visible in the field of the microscope at once, and then there was no possibility of confounding them; the cells of which the salivary gland is composed are a great deal larger, and the nucleus is far more distinct—there are of course numerous other minute points of difference; but what I wish to dwell on in the present paper are the points of resemblance rather than difference, to show that this "white lobe" must be considered as a gland.

The facts then about the anatomy of the "white lobe" in *Planorbis* appear to point to one conclusion—that this part of the cerebral ganglion must not be considered as really forming a part of the cerebral ganglion, but as being distinct and of a glandular nature; and if this is granted in the case of *Planorbis*, it must be the same with *Lymnæus*, as their position and general resemblance leaves no room for any other view than that they are homologous

* *Loc. cit.*, pl. iii. fig. 10.

structures. Moreover, there is really nothing which would make it unlikely on *a priori* grounds that this interpretation is the right one. M. Joliet has recently come to the conclusion that the so-called ganglion of *Melicerta* * is not a ganglion at all, but a gland. What the nature and homologies of this gland may be, is a question which can only be decided by a careful study of other Mollusca and of its development; several views as to its nature obviously suggest themselves, but in the absence of any more comprehensive information than is contained in this paper, it would be mere waste of time to consider any of them.

PLATE I.

- Fig. 1. Transverse section through nerve collar of *Lymnæus*, $\times 20$.
 Fig. 2. Transverse section through nerve collar of *Planorbis*, $\times 20$.
 Fig. 3. Transverse section through cerebral ganglia of *Planorbis*, showing glandular mass (a) lying above commissure, $\times 120$.
 Fig. 4. Transverse section through one cerebral ganglion of *Lymnæus*, showing glandular mass (a) lying above commissure, $\times 120$.
 Fig. 5. Cerebral ganglion of *Lymnæus*, showing commissure (b) which unites it to its fellow, and glandular mass (a), $\times 20$.
 Fig. 6. Transverse section through pedal ganglion of *Planorbis* (a), is the unpaired small medium ganglion, $\times 75$.
 Fig. 7. Single "acinus" from glandular mass of *Planorbis*, $\times 300$.
 Fig. 8. Nerve cell (a) from cerebral ganglion of *Lymnæus* and "gland cells" (b), $\times 300$.

4. A Critical Examination of two cases of unusual Atmospheric Refraction described by Professor Vince. By Edward Sang, C.E.

The two phenomena, the subjects of the present paper, have found a place in the current popular scientific literature of the day, and exercise a considerable influence on the opinions of the casual votaries of science, and even of some of those who are its regular cultivators. For that reason I shall go more into detail than otherwise would have been needed.

* *Comptes Rendus*, Nov. 7, 1881.

In the beginning of the session Professor Tait read a paper on *Mirage*, and exhibited to the Royal Society of Edinburgh an enlarged representation of an aerial phenomenon described by Professor Vince. The Professor of Mathematics inquired of me my opinion as to the explanation offered; and I now reply to Mr. Chrystal's inquiry indirectly, not by discussing in any way Mr. Tait's analysis, but by examining the major proposition, the reality of the phenomenon.

The sight of the enlarged representation recalled to my mind matters connected with my college and even with my school days. The name of Vince is to me a familiar one; his elementary treatise on *Astronomy* was our text-book at school and I had read, with not less pleasure than profit, his little work on *Hydrostatics*; his large work on *Astronomy* stands on my book-shelf for frequent reference. Any observation made by Vince thus naturally arrested my attention and pre-secured my confidence. Nevertheless, there were features in that drawing which awakened a long-confirmed distrust, and which seemed to me to need a careful examination.

We boys of twelve or thirteen years, had determined the latitude by our own observations made with the school sextant and artificial horizon. We knew of the augmentation of the moon's diameter, and by actual measurement had satisfied ourselves that the enlargement of the horizontal moon is only an error in judgment due to the seeming increase of distance. The stories of phantom ships and giant spectres were classed among those of ghosts and hobgoblins.

During my first session at college, an incident occurred to intensify this chronic distrust. One misty morning, while going to class from my lodgings in Gayfield Square, and when at Picardy Place, I was startled by the apparition of enormous spectres walking in the sky. The first momentary astonishment being over, the apparition had to be scrutinised. The outline of the Calton Hill was with difficulty traced through the mist; the spectres were walking thereon; it was therefore a case of atmospheric magnification analogous to the seeming enlargement of the horizontal moon; so by moving so as to bring the figures to contrast with the houses near, it was easy to see that the angular magnitude was that of human beings on the hill. The illusion was due to the false idea of distance, but the vividness of the first impression showed how readily a mistake may be made, and left on my mind a deep conviction of the absolute need for a close scrutiny of all such appearances.

I am then, necessarily, in the position of an advocate on the opposite side engaged in cross-examining a witness.

In the article OPTICS of the eighth Edition of the *Encyclopædia Britannica*, an article by Sir David Brewster, there is recounted a case of Atmospheric Refraction observed and described by Professor Vince; it is illustrated by a copy of a view of the phenomenon. A single glance at that picture, by any one habituated to observation, is enough to convince him that the phenomenon thereby depicted could never by possibility have been seen. It is a view of Dover Castle as seen from Ramsgate, and represents a



rectangular building with a square turret at each corner. Passing by, for the present, its most glaring feature, I remark that the faces to the right hand are in deep shadow, the shadow of the building itself upon the ground is also to the right. The faces toward us are in sunshine, and the tower on the left throws its shadow on the centre wall as if from a sun behind us to the left at an azimuth of some 40° . The side-wall again forms a shadow on the right hand distant tower at an elevation of some 60° . Now Dover is almost exactly S.S.W. from Ramsgate, wherefore the sun must have been in the N.E. at an elevation of 60° ; a direction from which the sun never shone upon Great Britain. The time of the observation is stated to have been 7 o'clock in the evening of the 6th August. At that time the sun was about to set in the W.N.W. Surely the Professor of Astronomy at Cambridge could not have made a blunder which puts the sun in the neighbourhood of the star Vega, circumpolar to us! The article in the *Encyclopædia* concludes with "See *Edinburgh Transactions*, vol. iv. p. 245;" and as evidence at first hand is better than evidence by hearsay, we shall consult the *Transactions*. We there find the original description of the phenomenon as read before the Royal Society of Edinburgh, on the 5th of Janu-

ary 1807, accompanied by an engraving well executed by D. Lizars.

The engraving shows a rectangular structure with a tower at each corner, drawn in what is usually called *perspective*. The west faces of the building are in bright sunshine; the north faces are less brilliantly lit, but are not in shade, and the N.W. turret casts a shadow on the middle North Wall.

Brewster had changed the direction of the source of light from W. to E.; he had put a gate-way in the north wall where Vince has none; had altered considerably the style of the architecture, and had, in one respect to be afterwards noticed, improved the drawing.

Recollecting that Dover is S.S.W. from Ramsgate, we perceive that the trend of the picture plane is W.N.W.; now the west face of the building is shown as inclined to the line of sight toward the west; its trend must be about S.W. by S., and therefore that of the N. face about N.W. by W. Hence, looking at the shadow upon that north face, we judge the sun to have been in the N.W.; and, looking at the slope of that shadow, to have had an altitude of about 44° , and this at 7 h. on the 6th of August. On putting the celestial globe into position for the time stated, we find that the sun must have been shining from among the small stars of the Great Bear. The shadow of the building upon the ground to the east, corroborates the story. Thus far the Astronomer; next the Architect; he says, and at a glance, there is no member of the structure which could, under any circumstances, have caused the shadow as shown in the figure.

Let us go more carefully into the matter. When a drawing of any rectangular structure is given in perspective, it is easy to deduce the distance of the point of sight from the picture, as well as the relative positions and proportionate sizes of the parts. Taking the extreme bounding lines as the basis, we find the vanishing point for the north face to be 193.2 inches to the left; that for the west face to be 3.7 to the right, counting from the middle of the picture. These give 26.6 inches for the eye's distance from the paper, and an inclination of $7^\circ 50'$ of the north face to the picture plane.

The bearing of Dover from Ramsgate, computed from the geographical positions, is $20^\circ 4'$, west of south, hence the trend

of the north face must be $27^{\circ}54'$ north of west. But the sun's amplitude at 7 h. on the 6th of August is only $21^{\circ}57'$, and the altitude 4° ; wherefore the north faces of the building should have been in shadow.

The distance between the two places is $14\frac{1}{2}$ miles, which on the scale of the drawing is represented by 26.6 inches. Computing thence the dimensions of the building, we find its

| | | | | |
|---------|---|-------------|---|-----------|
| Length | = | 16,000 feet | = | 3.2 miles |
| Breadth | = | 7,346 | „ | = 1.4 „ |
| Height | = | 4,895 | „ | = 0.9 „ |

which would make Dover Castle to be, not the Eighth, but THE wonder of the world.

There are many unacquainted with the laws of perspective drawing; for their sake we may take another view. It is generally known, that the apparent size of an object, its space upon the picture, diminishes as the distance increases. Now the breadths, measured on the paper, of the north-west and south-west towers are 51 and 28 hundredths of an inch; the nearer is $14\frac{1}{2}$ miles away, wherefore, since $28 : 51 :: 14.5 : 26.4$, it follows that the other is 26.4 miles off; so that from north face to north face of the towers must be 11.9 miles, or the whole length more than 12 miles! The drawing must be sadly out, for this is nearly four times what was previously found.

Again, if we look at the western sides of the turret-tops, we observe the depth of the parapet to decrease rapidly toward the south. On the north-west tower the diminution is almost exactly as two to one; wherefore its farther corner must be twice as far from us as the nearer, and so the top of the tower must measure 14 miles. In Brewster's drawing this most outrageous of all the blunders is rectified.

These prodigies, however, are far outshone by the artistic extravagance of the foreground; there the blades of grass expand at our feet, and the very veins of the leaves are seen.

All this was seen through a good telescope which the Professor could hand to his companion. I have somewhere read of a spyglass bringing people so near that you could hear them speak; this one must have had the equally wonderful property of transporting the user bodily to within a hundred fathoms of a building fourteen miles away.

Evidence of this character would not be received in support of the most common-place assertion ; but the phenomenon in question, far from being common-place, may, rather, be described as miraculous. Dover Castle is situate on the south side of a hill ; Ramsgate is far away on the north side ; and the tops of the turrets of the Castle are usually seen from Ramsgate just above the hill. But, on this occasion, the Castle was seen as if it had been brought to the north side, and, apparently, in its natural position with regard to the turrets. Vince tells us that the light from the hill undoubtedly reached the eye, but that it was so overpowered by the greater light from the Castle as to be unperceived ; he places before us this drawing to represent the Castle as he saw it, and proceeds to explain how this vision may have been brought about.

For this purpose he constructs an abstract figure in which AB represents the Castle, T the top of the hill, E the place of the spectator ; and he draws two curved lines AyE , $BzwE$ to represent the paths of the light from the top and bottom of the Castle to the eye. He draws also the curve $TxzE$ as the path of the light emanating from the top of the hill, crossing $BzwE$ at the point x , and having its part zxE between the two first mentioned lines. He says, "Then it is manifest that such a disposition of rays will produce the observed appearance The phenomenon cannot otherwise be accounted for."

According to his explanation, AyE and $BzwE$ are the paths of the light in the usual state of the atmosphere, and the phenomenon in question is produced by the rapid curvature of the part zx of the ray $TxzE$; this rapid curvature being due to a variation in the density of the air between ytE and xwE .

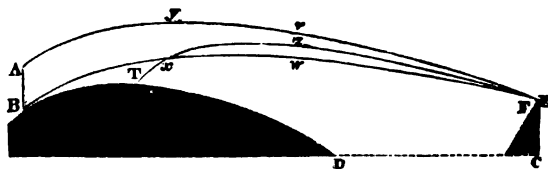

Supposing, merely for the sake of fixing our ideas, the height of the tower BA to be 100 feet ; the separation of the curves at x and y may be say 60 feet, within which distance this extraordinary disposition of the air must exist, and not beyond on either side, for otherwise the paths AyE , BzE would be deranged. In

the ordinary state of the air, the light would pass in the usual way below the curve *BwE*; and even now, since the extraordinary condition does not extend below that line, it will still so pass. Wherefore, according to this explanation, T should have been seen double. Moreover the picture* tells us that light from between B and A reaches the eye in directions intermediate between *vE* and *wE*, and now we have this most wonderful fact that the air situate between the extreme rays has two indices of refraction, one for Dover Light, one for Hill Light. But more absurd still;—the rays *AyE*, *BzE* are the usual paths of light, whence it necessarily follows that the point B is usually visible from E, and thus the phenomenon made clear by this explanation is:—"that the Castle being usually seen clear above the top of the hill, was, on this occasion, seemingly imbedded in it, the ridge having been apparently raised," exactly the opposite of what Vince imagined himself to be explaining.

We may get a clear view of the matter by considering the broken branch in the foreground of the picture. This branch is, in reality, beyond yon far-off hills B; and we have to explain how it can come to be seen as represented.

One, indeed the obvious, supposition is, that the matter forming the hill had become translucent for Dover Light, which hypothesis will account also for the feebleness of the Hill Light. Or we may suppose that the rays of light from Dover had skimmed over the high ground B, had descended on the northern side until they found out, each the true continuation of its path, and then had come straight on to the eye. Of the two hypotheses, the former appears to me to be the simpler and the more comprehensible.

Having thus far discussed the information given to us by Professor Vince, we may examine what is to be got from other sources.

On a small map of Dover published by Messrs. Johnston, the Castle is shown as consisting of several detached buildings, none of which can be reconciled with the form and position inferred from the perspective drawing; but, in the course of three quarters of a century, the buildings may have been changed. To the north of the Castle, in the direction of Ramsgate, there is marked St. Mary's church in ruins, which surely should have been seen in the foreground of the Castle.

* The proprietors of the *Encyclopædia* have kindly lent the preceding woodcuts.

On consulting the Ordnance map of the district, done in 1818, and brought up to 1880, and drawing on it a line from Dover Castle to Ramsgate, we find at the distance of 12 miles from the latter place, a village called East Langdon with 22 buildings; a little farther north, another called Marten with 17; then Appleton with 6. The absence of contour lines prevents me from determining the heights; but, taking Vince's statement that the hill is 12 miles away, these villages must be just in such a position as to occupy seemingly the position of the lower parts of the Castle.

Which then is the more credible:—That all the wonders just discussed should have been real:—or that an indiscriminating observer should have deluded himself by the fancy that some of these buildings were parts of the Castle?

Such things do not often occur in the history of physical science. Generally assertions by whomsoever made can be and are tested by the reproduction of the alleged circumstances; but in a case such as that before us, no one can repeat or verify the observation, nor even make one analogous thereto; and therefore it behoved the observer to have been particularly careful as to what he saw, and as to how he recorded it. We have seen that the record is an aggregate of impossibilities.

It is indeed strange that such a gross substitution should not have been instantly detected; and still more strange that Brewster should have transferred the account into the *Encyclopædia*, and even improved the drawing, without having perceived that the mere fact of its being in perspective is absolute proof of its untruth. Just as a story is the less credible, so there would seem to be the less need for examination. This is seen also in the succeeding paragraph, wherein Sir David supports the idea of an atmospheric mirror by the evidence of a girl who, while gathering flowers on the hill-side, saw her image and her very features reflected from a thin mist rising from a marsh; and he strengthens that evidence by the inquiry of her friends who were waiting for her below as to "who was with you on the hill?" never perceiving that this question supplies the simple intelligible solution of the mystery:—that the young woman had mistaken another person for her own image. By such careless treatment of evidence the growth of these phantasies is encouraged.

In a popular work on Astronomy which has had a considerable

circulation, these two among other cases are given of wonderful atmospherical phenomena, and an experiment is detailed exhibiting the marvellous powers of reflected light. A bottle half filled with liquid is held before a concave mirror, when lo! the inverted image has the liquid in its lower half! the mirror is able to invert the bottle, but cannot reach its contents. With the author of this work the stellar nebulae become huge concave reflectors. He exhibits also a drawing of a stately ship, her sails well filled by the breeze, and below, heeling over symmetrically, her inverted image, and below that again the topmasts of a ship hull down: he tells us that the unseen ship is the reality, the others only her images caused by atmospheric refraction. It has not entered into his head to consider that such a breeze would blow to the winds all the thereunto necessary refracting surfaces. This is an improved edition of the second phenomenon, the subject of the present paper.

In the 89th volume of the *Philosophical Transactions*, Professor Vince describes a phenomenon seen by him from Ramsgate; the appearance was that of the mast-head and upper rigging of a ship hull down, in the air above which an inverted image was seen, having above it again an erect image of the same ship. He explains the conditions of the atmosphere needed to produce such appearances in the following manner:—

Having drawn a straight line bz to represent the surface of the water, raised a perpendicular ba for the ship's mast, and placed the eye e above z to indicate the observer's height above the sea-level, he draws two curved lines bsE , arE for the usual paths of light from the hull and from the top-mast. The directions of the tangents to these two curves define the apparent position $b' a'$ of the vessel. Here the dominant idea is the curvature of the rays; and this idea has led him to show the paths as curved while the surface of the sea is flat. Had he intelligently considered the matter he must have seen that his illustration demonstrates the impossibility of our seeing a ship hull-down. If the path of light were more curved than the surface of the ocean, we should be able to see all round, and, with transparent air and good glasses, to view our own backs, twenty-four thousand miles off. The line bz , instead of having been drawn straight, should have risen from b to graze the line arE and should then have descended to z , completely intercepting the ray bsE .

In order to explain the unusual images, Vince represents rays proceeding from the points *b* and *a*, rising in the air and then bending down to reach the eye. This reflexure is caused by a rapid change in the refractive power of the atmosphere.

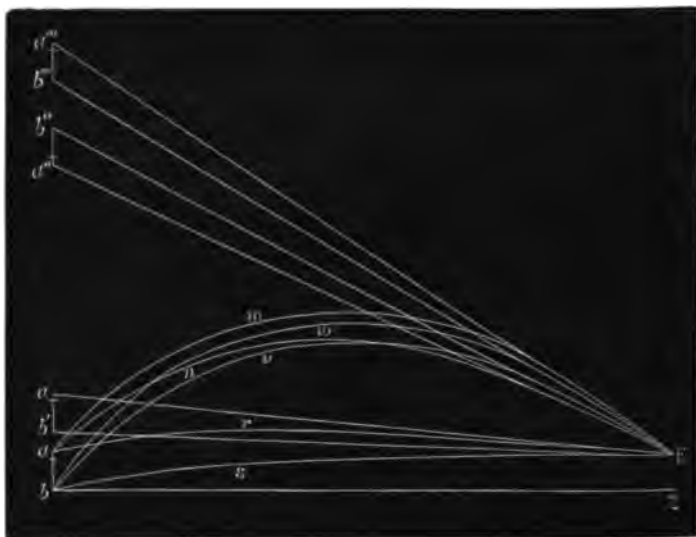

He has not, however, given any measurement by help of which we may estimate the extent and manner of the refraction; he only mentions that the proportions of the distances were noted; yet the measurements were at his hand. He was using a telescope magnifying 30 or 40 times, and we infer from his narrative that the instrument was on a stand. Now, with scarcely any trouble, he might have ascertained exactly the power, and have measured the angular aperture of the field; indeed to an astronomer these are matters of course. He could easily have compared the sizes and distances with the width of the field-bar. As it is, we cannot tell what may be the angle of elevation of the upper image.

The drawing is that of a fore-and-aft rigged sloop, a kind of coasting vessel never built very large; the existence of ratlines would indicate it to be a large one of its class, and, for the purpose of a rough estimate, we may take the top-mast as 60 feet above the water.

The eye was 25 feet above the sea-level, wherefore the edge of the actual horizon must have been distant $6\frac{1}{2}$ miles. In proportion, there must have been about 35 feet of the height concealed, so that

the ship must have been $7\frac{1}{2}$ miles beyond the horizon or altogether 14 miles away. Taking the proportions shown in the figure, the top-mast of the upper image must have appeared at the height of 210 feet above the water edge, giving an angular elevation of about ten minutes of a degree ($9' 46''$).

The ray of light in rising from the ship, encountered air of less and less refractive power, and so was bent downwards to become horizontal, after which the same curvature was repeated inversely; hence it follows that the index of refraction of the air at the top of the curve must have been less than that of the air below, in the ratio of cosine $10'$ to radius. Assuming for the season of the year, the temperature at the ground to have been 15° or 59° Fahr.; its index of refraction comes out 1.0000283; wherefore the upper air must have had the index 1.0000232, and its density must have been what is due to a fall of 5.1 inches with the same temperature or to a rise of 86 degrees Fahrenheit with the same pressure.

If we suppose the air to have been of its usual density almost up to the limit of height and then to have become suddenly rare, the path of the light would have consisted of two straight lines united by a short and quick curve, and the height would have been the half of 210 feet. But, if the change of density be assumed as gradual, the ultimate height must have been less than the half; for a parabolic curve it would have been the fourth part. But all analogy tells us that the curvature becomes less as we ascend; wherefore the vertex must have been at not more than 50 feet above the sea-level.

Thus, in order to produce any phenomenon like that described by Vince, either the barometric pressure must have decreased at the average rate of one tenth of an inch for each foot of rise, or the temperature must have increased at the rate of $1^\circ.7$ Fahr., or nearly one degree centigrade for each foot, ultimately to reach the extraordinary heat of 145° Fahr. And this condition of the

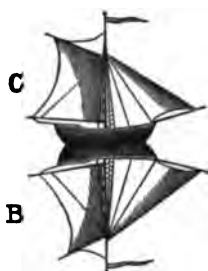

air's density must, according to the narrative, have subsisted for hours over the whole sea-reach of Ramsgate, yet, in the course of his observations, the Professor himself went to the height of 80 feet, and has not recorded anything remarkable in the state of the air there. Nor is this all; the ships came and went; there must have been a fresh breeze blowing, notwithstanding of which this wonderful, this inconceivable condition of the atmosphere continued.

Though at such a great distance, the minute details of the upper rigging are visible. Not only must the telescope have had extraordinarily good definition, the air also must have been unusually clear and free of tremor. But this distinctness is not confined to the actual ship, it is also exhibited in the unusual images in each of which even the ratlins between the shrouds are seen; that is to say the stratification of the air must have been so exquisitely arranged and so undisturbed by fluctuations that horizontal lines not an inch in diameter appeared distinct and crisp at the distance of 14 miles.

Now if the stratification had been in concentric layers the curvature of these would necessarily have caused great distortion in the images, for that curvature bears a large proportion to the angular extent of the object. To produce, by any possible arrangement of strata, an undistorted image, that arrangement must be plane. Here we are face to face with another inconceivable state of the atmosphere; the physical explanation bristles with impossibilities.

Although there be no details in measurement, Mr. Vince has favoured us with important details in construction. This drawing shows, in the first place, the top-mast and parts of the rigging of a sloop with the mainsail and jib well filled by the breeze; the foresail is not set; we must infer that the craft was making way enough without it. Here the end of the gaff is connected to the top-mast by an elegantly curved line, reproduced in the images. In an actual sloop under sail, the gaff is held up by a strong tackle, which has to carry the weight of the mainsail, and to resist the tension caused by the wind. The resulting strain on the top-mast if the arrangement were as in the drawing, would be too great for that spar, and appropriate fore-stays would be needed. This part of the drawing is not a representation of reality.

The exceeding clearness of the two images is remarkable; daylight is seen between the mainsail and the mast in the intervals of the reeving rings; the wind must have been strong. The end of the boom is connected to the stern of the vessel by a loose line; yet the duty of this line is to resist the pressure of the wind upon the mainsail, keeping that sail to the proper inclination. Again the pressure of the mainsail, and the pull of the foresail and jib tend to break the mast; this pressure is usually resisted by the shrouds, which, for that purpose, are placed abaft the mast. No sloop, nor indeed any other craft was ever rigged with the shrouds before the mast, as is seen in these images; the arrangement is nonsensical. Yet again, the jib is shown as if it were reeved to the fore-stay. If this were actually done the sail, being in the ship's mesial plane, could be of no service for propulsion; it could only keep the ship's head from the wind. The lower edge of the jib is shown curved away from the bowsprit as it should be, but the sheet is hauled close to the stem. More than all this, the ship should have a rudder, the rudder should have a tiller, and at the end of the tiller there should be the steersman, who, standing between the spectator and the main-sail, should have been a conspicuous object on board. Judging from the other minutiae we should have been able to recognise the articles of his dress. But neither helm nor steersman is to be seen.

This drawing does not represent any thing that was seen through the telescope.

While attending to the ship, we have been forgetting the sea on which it floats. The rays forming the images in the air must have passed at heights of from 40 to 70 feet above what appears as the edge of the horizon; they must have been representations of the vessel as seen from these heights. Now, from a height of 70 feet the visible horizon is 10 miles off; that is $2\frac{1}{2}$ miles beyond the sloop; therefore each of the images should have been accompanied by a horizon; of these, however, there is no trace.

The intricacy of the arrangement of strata needed, within these narrow limits, to have produced with such wonderful clearness, both an inverted and an erect image, needs only to be mentioned.

From whatever point of view we regard the matter, we find inaccuracy, incongruity, impossibility; the psychological aspects of the narrative being identic with those of the vision of Dover Castle

seen eight years later. In each case there is the palpable substitution of an ideal picture for the supposed reality ; in each case the technical explanation is opposed to the narrative itself as well as to the known physical laws ; it being noteworthy that, in both, the concealed part of the object is represented as always visible ; and in such case the obvious absurdity of the substitutions shows clearly the absence of any conscious intention to deceive. Mr. Vince has told, in perfect good faith, the impressions on his own mind ; impressions so strong as to have shut out every consideration of probability or of possibility, and to have completely overpowered his better judgment. The mastery over his mind, acquired by this delusion, is well exemplified by the proposal seriously made, that, on the recurrence of such a phenomenon, a ship be sent out provided with barometers on deck and at the mast head, to ascertain the difference of pressure. He expected wind enough to carry the ship to sea, forgetting that perfect calm is essential to the stratification ; he forgot too that no then existing barometer could be accurately read on ship-board.

The dominant idea was in both cases that of the great curvature of the rays of light. In his *Complete System of Astronomy*, 1823, Vince shows that the curvature is only one-seventh part of the curvature of the earth. It is pleasant to think that these early occasional illusions had passed away, to leave his mind clear for the performance of such great and good work in furtherance of Astronomical Science.

5. On a Case of Dyspeptic Vertigo.

By Professor Crum Brown.

The dyspepsia was, as far as I know, of a very ordinary kind. It began with loss of appetite, discomfort after meals, and general sense of weakness and uselessness. Then came a crisis. Waking in the middle of the night with pain and nausea, an hour or two of this, thorough evacuation of the stomach, great discomfort next day, and then no symptom of any thing wrong as long as I adhered to the diet which experience soon led me to, viz., very simple food and very little of it. To this I adhered for about four weeks. Now and then, perhaps three times altogether, feeling quite well, I ventured to eat like other people, and was at once taught by

abdominal pain and diarrhoea, that I must still consider myself an invalid, or at best a convalescent. After about four weeks I found that I could venture on a chop or a potato, and gradually felt my way back to the usual diet. In all this there is nothing I suppose at all uncommon. It is the first time I experienced any thing of the kind, but I have no doubt others have often gone through the same or worse, and my dyspepsia can have no sort of interest in itself to a physician.

Accompanying the dyspepsia there was, however, a symptom, which may be common, but which, as far as I know, has not been described, at all events does not seem to have been felt by any one sufficiently interested in physiology to lead him to make careful observations on it. This was a very well-marked but not very violent vertigo. This symptom did not make its appearance at first,—in fact, it was two days after what I have called the crisis before any trace of vertigo appeared. I was nearly quite well, though of course my wellness depended on my adherence to the sparing indulgence in beef tea and custard pudding, when I first felt the vertigo.

Walking along the street, my attention was suddenly called to a dog at the side of the pavement, and I turned my head sharply to the left side and downwards, to look at him. I immediately felt a very distinct attack of vertigo, and it was with some effort that I preserved my equilibrium. I walked home without the least difficulty, as the vertigo passed off very quickly, and I found that if I avoided sudden movements of the head I could keep clear of such attacks. All that remained was a feeling of constraint and want of confidence. The same evening, after putting out the gas in the lobby and staircase, I was going to bed when I found I had to go downstairs again, having forgotten something or other. I ran down without thinking of the vertigo, and when I reached the foot of the stair was much surprised by what I saw. Above my front door there is, as there is in most Edinburgh houses, an oblong pane of glass, and when the house is in darkness, the light from the lamps in the street shines in by this window. Now what I saw was an oblong illuminated area, not with horizontal and vertical sides, but inclined so that its long sides made an angle, as far as my recollection enables me to estimate it, of about 20° at least with the horizontal. While wondering what this could be, I suddenly saw that it must be the window, and the instant this idea occurred to

me, it in a moment regained its right position. All this did not take half a minute. I went to bed and slept soundly, as indeed I always did through the whole course of the illness, except on the two or three occasions when an attempt to return to ordinary diet produced a disturbance of the digestive organs. Next morning, on getting out of bed, I found that that movement of the body had produced a vertigo much more severe, and lasting a much longer time than either of those of the day before, and although it passed away on my remaining quiet for some time, every attempt to move set it up again. I accordingly went back to bed, and after lying quiet for a few minutes felt quite well; but getting up was out of the question. To occupy myself I sent for the morning newspaper. When it arrived I was lying on my right side, facing the window. To read it comfortably I had to turn round, so that the light should fall on it. I accordingly rolled myself over, and holding out the paper tried to read it. This, however, I could not do, the letters seemed to fly across the paper, and while I could see that it was print, and could make out the size of the letters, I could not distinguish one of them. This optical vertigo was not accompanied by any feeling of nausea or of insecurity. Reflecting upon what produced it, I thought I might undo it. If I rolled round to my right side again that might put it right, but then I wished to have the window behind me. I tried while keeping my body at rest, rolling my head quickly to the right, and then slowly back again, and found that an effectual remedy, and from that time, as long as I remained in bed or on the sofa, viz., about ten days, I could always neutralise an abnormal apparent rotation, by rotating the head about the axis of the apparent rotation, quickly in one sense, and then slowly back again. The sense in which the quick rotation had to be made was that in which surrounding bodies seemed to move. The first correction was sometimes too much, sometimes not enough; in such cases a second smaller correction was easily made. Day by day the intensity and duration of the vertigo became less. Once or twice a day, I made an experiment by making a whole rotation, and lying still to observe how long the apparent motion of external things continued. At last I found that I could walk about, not without some difficulty and feeling of insecurity. This gradually diminished until a week or so before my return to ordinary food it was practically gone.

During my recovery, I frequently experimented upon the optical vertigo. These experiments were suggested by an accidental observation. Having put out the drawing-room gas one evening, as I was leaving the room I saw the reflection of outside gas lamps in the glass of a picture hanging on the drawing-room wall, and these lights seemed to me to be moving exactly as if the picture were swaying on its cord. I then turned and stood before the picture. I satisfied myself that the picture was motionless. I then made about half a rotation, that is, I turned slowly till my back was to the picture, and quickly turned and faced it. I then saw the lights move to the right or left as the case might be, the sense of the apparent rotation of the lights being the opposite of my real rotation. This experiment I frequently made to find how I was getting on, but found that I could not repeat it on real lights seen directly through the window.

Quite lately I tried whether I could produce any trace of the feelings which were so familiar to me then. By rapidly spinning round three or four times, I find that I can produce very much the same sensation which half a turn produced when I was just well enough to walk. The sensation now lasts two or three seconds, then it lasted sometimes one, sometimes more than two minutes.

It is worth noting that during the whole course of the illness there was never any disturbance or irregularity in the sense of hearing.

So far for the facts of the case. The points of interest seem to me to be:—(1) That the vertigo never occurred unless provoked by a real rotation of the head. (2) That the phenomena were perfectly symmetrical. (3) That the axis of the apparent rotation was always the same as that of the real rotation which had provoked it, while its sense was the opposite. The vertigo was in fact only a very much exaggerated form of a perfectly natural phenomenon. It might, therefore, be supposed that the morbid condition was a sort of hyperæsthesia of the sense of rotation. This, however, was not the case. The direct sensitiveness to ordinary rotations was if anything diminished, it was the after effects of rotations that were greatly increased both in intensity and in duration. (4) Visual vertigo often ceased when there was sufficient evidence that external bodies were really at rest. Thus, as soon as the illuminated rectangle was recognised as the window, the displacement of the vertical ceased, and the window was seen in its real position.

Again visual vertigo occurred when the reflexions of the gas lights in the glass of a picture frame were looked at, but not with the gas lights looked at directly.

It is unfortunate that no observation of the eyes was made during the continuance of visual vertigo, as for instance, when the printed characters seemed to fly across the newspaper. It would have been important to determine in such a case the presence or absence of *nystagmus*. It is to be hoped that any one who may fall in with a similar case will not make this omission.

The relation of *nystagmus* to visual vertigo is of great importance and interest, but it would be out of place to discuss it in a note of this kind. I hope to have an opportunity before long of dealing with it in a special paper.

PRIVATE BUSINESS.

Mr James Sorley, Mr William Thomson, M.D., B.Sc., Mr Thomas Graham Young, and Mr W. Dyce Cay, M. Inst. C.E., were balloted for, and declared duly elected Fellows of the Society.

Monday, 20th March 1882.

PROFESSOR DOUGLAS MACLAGAN, M.D., Vice-President,
in the Chair.

The following Communications were read:—

1. Note on the Carboniferous Rocks of the South of Scotland.
By Archibald Geikie, F.R.S.

The well-known northward attenuation of the massive Carboniferous Limestone of Lancashire and Yorkshire, and the gradual replacement of its thick calcareous groups by sandstones, shales, and seams of coal, with interstratifications of marine limestone, can be advantageously studied in the southern counties of Scotland. In these districts a characteristic and recognisable base for the Carboniferous system is presented by the deep red Sandstones and marles of the Upper Old Red Sandstone, which pass up conformably into that system, but rest with a violent unconformability upon every formation older than themselves, including even the Lower Old Red Sandstone of Berwickshire and the Cheviot Hills. These red rocks contain few organic remains; but here and there they yield scales of *Holoptychius* and other fishes, which suffice to define their

geological horizon. The striking unconformability of these Upper Old Red Sandstones is connected with great inequalities in the surface upon which they were deposited. In some places they swell out to a thickness of many hundred feet; but elsewhere they may be seen rapidly to die out against an underlying prominence of older rocks round which the earlier Carboniferous groups overlap. The general contours of the ground must consequently have been remarkably varied. It is possible even yet to define approximately the outlines of some of the shores of the period.

The Upper Old Red Sandstone is overlaid by a volcanic zone, consisting mainly of various porphyrite lavas, with occasional tuffs. This zone forms a marked feature in the geology of Berwickshire and Roxburghshire, running in a line of conspicuous eminences, and serving as a convenient platform to mark the base of the Carboniferous system. It can be followed from the southern edge of the Lammermuir chain to near the mouth of the Nith, and it reappears even on the west side of that river in Kirkcudbright. Associated with it are numerous "necks," marking some of the vents from which the volcanic material was ejected, and as these "necks" occur among Silurian hills, at some distance from the present edge of the porphyrites, it is evident that these latter once covered a much wider area, from which, together with much of the overlying Carboniferous rocks, they have been denuded. The volcanic rocks in the south of Scotland agree in general character with those which occupy a similar geological position in Ayrshire, Renfrewshire, Dumbartonshire, and Stirlingshire, and both are probably referable to the same period in the volcanic history of the country. In the Eskdale district the porphyrite band consists of one or two separate flows, with an aggregate thickness of from 40 to 100 feet.

From the top of the volcanic zone the Carboniferous system may be followed in many excellent natural sections up into the Scar or Main limestone of the English Carboniferous Limestone series. In Berwickshire there is a great development of that peculiar phase of the Lower Carboniferous rocks to which the name of "Cement-stone group" has been given by the Geological Survey of Scotland. The strata consist of grey, white, and yellow, less frequently reddish, sandstones, with blue, grey, and greenish shales and clays, bands and nodules of cement-stone or impure limestone, and occasional veinings of gypsum. On the west side of the Cheviot Hills, which

must have stood up as an important geographical boundary in early Carboniferous times, this "cement-stone" type of sedimentation also occurs but less extensively, and with a curious blending of characters lithological and palæontological, which give to the basin of Eskdale and Liddesdale an exceptional geological interest.

In this district the following general section in descending order is observable:—

*General Section of the Carboniferous Rocks of Eskdale
and Liddesdale.*

| | Feet. |
|---|------------------|
| Scar (Scaur) Limestone of Northumberland. | |
| 11. Fell Sandstones probably more than | 1000 |
| 10. Horizon of Plashetts and Lewisburn coals, | |
| 9. Upper cement-stone group, | about 300 to 400 |
| 8. Horizon of Canobie coals, | 800 |
| 7. Gilnockie (marine) limestone group, | 400 or 500 |
| 6. Zone of volcanic tuff, | 10 to 20 |
| 5. SCORPION SHALES, | 50 |
| 4. Zone of volcanic tuff and porphyrite, | 50 to 100 |
| 3. Sandstones of Irvine Burn, | 200 |
| 2. Lower cement-stone group (Tarras), | 200 to 300 |
| 1. Whita Hill Sandstone, | 500 to 600 |
| Volcanic band (Porphyrites, &c.), | 40 to 100 |
| Upper Old Red Sandstone lying uncom- formably or Upper Silurian rocks, | 300 |

A few remarks may be offered upon the characters of these successive platforms.

1. The White Sandstone, well seen on Whita Hill above Langholm, consists chiefly of massive beds of hard white, yellow, and pinkish calcareous sandstones, often full of concretions ("galls") of a pale clay, which dropping out gave a honeycombed aspect to weathered surfaces. The sandstones are sometimes separated by thin shale partings, and occasional seams of impure limestone or cement-stone.

2. In the Tarras water a lower group, of true "cement-stone" facies, attains a thickness of probably from 200 to 300 feet. It consists of blue clays and shales with impure limestone or cement-stones and beds of shaly sandstone. These strata have yielded numerous remains of fishes, eurypterids and ostracods, but none of the ordinary marine organisms of the Carboniferous limestone bands.

3. This lower cement-stone group is overlaid by a set of sandstones, chiefly coarse brown and friable, with pebbles of white vein-quartz. These strata become more fossiliferous towards the top, and contain courses of shale and bands of cement-stone.

4. A second volcanic platform appears on this horizon. It consists sometimes of slaggy porphyrite, evidently a contemporaneous outflow, and sometimes of a fine volcanic tuff. It can be followed for some distance from the valley of the Esk up Liddesdale. With it and a still higher volcanic zone should be associated the "necks" by which the older Carboniferous rocks of the district are pierced, and which no doubt represent some of the volcanic vents of the time. At the top of the tuffs comes a band of black cherts, which may perhaps be referable to the deposit of some thermal siliceous springs connected with the volcanic eruptions.

5. This zone of fine grey shale, about 50 feet thick, is that which has yielded the remarkable series of fossils already described, and from which others since obtained have now to be brought to the notice of the Society. In the lower and central parts of the zone there occur numerous specimens of undoubtedly marine organisms, such as *Orthoceras*, *Aviculopecten*, *Myalina*, *Lingula*, *Discina* and *Palechinus*. With these are mingled remains of fishes, crustacean and scorpions. Mr. Peach has observed, however, that towards the upper part of the bed where plants occur in some quantity, most of the Scorpions, Eurypterids, and Limuli have been discovered.

6. A third zone of volcanic tuff 10 to 20 feet thick overlies the Fossiliferous or Scorpion Shales. This is the highest platform on which contemporaneous volcanic action has been observed in this part of Scotland.

7. Above the third volcanic platform we enter upon a totally distinct type of strata—sandstones and shales with several bands of true crinoidal limestone, exactly like those of the ordinary Carboniferous Limestone, and containing many of the same fossils. These limestones form conspicuous features in the Esk below Canobie and at Penton Linns. One of them is 30 or 40 feet thick. Associated with them are seams of coal exactly as in the lower part of the Carboniferous limestone series of central Scotland. One of the most interesting features in this marine group is the evidence that it dies out towards the north-east in Liddesdale; while, on the other hand, it increases in thickness towards the

south-west. In Liddesdale, therefore, the lower and upper cement-stone groups form one continuous series, with no intervening zones of marine limestone. The open sea must have stretched towards the south and west, while the land lay to the north, traces of its margin being still recognisable about the flank of Carter Fell.

8. The Canobie Coal group comprises a series of strata about 800 feet thick, containing thirteen coal-seams, which include an aggregate thickness of 39 feet of coal. The lower seams are intercalated with marine limestones, so that their low position in the Carboniferous series admits of no doubt. It is remarkable, however, that the plants associated with these coals are true Coal-measure forms, as determined by Mr. R. Kidston. The Canobie group is overlaid by reddened sandstones lying below the Permian (St. Bees) sandstones, which cover them unconformably. It is therefore impossible to follow the upward section further in the Esk valley. In Liddesdale, however, the Canobie coals may be traced running towards the north-east, and becoming much attenuated in their progress. They dip below the upper cement-stone group No. 9.

9. Over the horizon of the Canobie coals in Liddesdale comes a group of blue shales and cement-stones, with several thick bands of sandstone and seams of coal on different horizons. These beds present this ordinary "cement-stone" facies of the upper division of the Scottish Calciferous sandstones.

10. The Plashetts and Lewisburn coal lie above the cement-stone group No. 9.

11. The southern margin of Liddesdale is marked by a conspicuous group of sandstone, of which the bottom beds cap the eminence of the Larriston Fells, and likewise rise into Peel Fell. The name of "Fell Sandstones" has been given to them. They must vary much in thickness, owing to the very lenticular character of their individual beds. In Liddesdale they may be 1000 feet thick. They cover a large area in Northumberland, and form a well-marked geological group lying immediately below the Main or Scar limestone, where the ordinary phase of the Carboniferous limestone reappears.

It is evident that the central part of the thick cement-stone groups of Upper Liddesdale lies on the same horizon as the marine zone of Gilnockie below Langholm. There can be little doubt that the Scottish cement-stone series generally is a less thoroughly

marine representative of the lower part of the Carboniferous Limestone of England.

2. Additional Contributions to our Knowledge of the Fossil Fishes of Eskdale and Liddesdale. By Dr. R. H. Traquair.
3. Further Researches among the Crustacea and Scorpions of the Carboniferous Rocks of the Scottish Border. By Mr. B. N. Peach.
4. Report on the Fossil Plants collected by the Geological Survey of Scotland in Eskdale and Liddesdale. By Robert Kidston.

(*Abstract.*)

Through the kindness of Professor Geikie, Director-General of the Geological Survey of Great Britain, I have had the pleasure of examining the fossil plants collected by the Scottish Geological Survey in Eskdale and Liddesdale.

The collection contains about four hundred and fifty specimens, a number of which, however, were too imperfect for further identification than that of the genus.

Eight of the plants I believe to be new species, and a few of the others, as far as I am aware, are now recorded for the first time as occurring in Scottish rocks.

The following is a list of the genera and species; those I consider to be new to science are marked with an asterisk:—

PLANTS FROM ESKDALE AND LIDDESDALE.

(*Calcareous Sandstone Series.*)

THALLOPHYTA.

ALGÆ.

- 1.* *Chondrites plumosa*, Kidst.
- 2.* *simplex*, Kidst.
- 3.* *Crossochorda carbonaria*, Kidst.
- 4.* *Bythotrephis*, sp.

FILICACEÆ.

SPHENOPTERIDÆ.

5. *Sphenopteris linearis*, Brong.
6. *furcata*, Brong.

- 7.* *Sphenopteris Geikiei*, Kidst.
8. *bifida*, L. & H.
9. *excelsa*, L. & H.
10. *Hibberti*, var. L. & H.
11. *Höninghausi*, Brong.
- 12.* *decomposita*, Kidst.
13. sp.
14. *Staphylopteris Peachii*, Carr.
15. *Eremopteris (Sphenopteris) erosa* (?) Morris.
- 16.* *Macconochii*, Kidst.
17. *Rhacophyllum Lactuca*, Sternb.

PALÆOPTERIDÆ.

18. *Adiantites Lindseæformis*, Bunbury.

NEUROPTERIDÆ.

19. *Neuropteris cordata*, Brong.
20. (*Cyclopteris*) *Trichomanoides* (?), Brong.

STIPES FILICINÆ.

- 21.* *Caulopteris minuta*, Kidst.

EQUISETACEÆ.

22. *Volkmania*, sp.

LYCOPODIACEÆ.

23. *Lepidodendron Sternbergii*, Brong.
24. sp.
25. *Lepidostrobos variabilis*, L. & H.
- 26.* *imbriatus*, Kidst.
27. *Lepidophyllum lanceolatum*, L. & H.
28. *Lycopodiaceous sporangia*.
29. *Cordaites*, sp.
30. *Stigmaria ficoides*, Brong.

FRUITS.

31. *Cardiocarpus apiculatus*, Göpp. & Berger.
32. sp.
33. *Schutzia*, sp.

PLANTS FROM CANONBIE.

FILICACEÆ.

SPHENOPTERIDÆ.

1. *Sphenopteris multifida*, L. & H.
2. *obtusiloba* (?), Brong

3. *Sphenopteris*, sp.
4. *Staphylopteris*, sp.

NEUROPTERIDÆ.

5. *Neuropteris heterophylla*, Brong.

ALETHOPTERIDÆ.

6. *Alethopteris heterophylla*, Sternb.

PECOPTERIDÆ.

7. *Pecopteris nervosa*, Göpp.
8. sp.

EQUISETACEÆ.

9. *Calamites*, sp.

LYCOPODIACEÆ.

10. *Lepidodendron*, sp.
11. *Lepidophyllum lanceolatum*, L. & H.

In comparing the first part of the list of the species in this collection with the fossil plants from the Calciferous Sandstone Series in the neighbourhood of Edinburgh, their similarity will be at once apparent.

This is remarkable when viewed in relation to the fish and crustacean remains which have been already described from Eskdale and Liddesdale by Dr. R. H. Traquair, and Mr. B. N. Peach, which, as far as at present known, are mostly peculiar to these districts.

This points to some local physical conditions, which, though favourable for the growth of plants widely distributed in other parts of Scotland, seem to have favoured the existence of a fauna peculiar to itself.

P.S. 28th July 1882.—Since compiling the above list, a few more specimens have been handed to me for examination. Among them were the two following, which must now be added :—

ALGÆ.

34. *Chondrites Targionii*, Brong.

INCERTÆ SEDIS.

35. *Pothocites*, sp.

5. On the Formation of Serpentine from Dolomite. By J. J. Dobbie, M.A., D.Sc., Assistant to the Professor of Chemistry, University of Glasgow, and G. G. Henderson, B.Sc.

Some time since, specimens of a peculiar-looking rock, found at Fintry, in the Campsie district, were put into our hands for analysis. The specimens were of a light chocolate-brown colour, and apparently homogeneous. They were somewhat harder than ordinary limestone, had a waxy lustre, and broke with a sharp-edged splintery fracture, translucent upon the thin edges. With hydrochloric acid they effervesced slowly, at the same time gelatinising. The specimens were weathered white to a considerable depth.

Analysis proved that the specimens were composed principally of lime, magnesia, silica, carbonic acid, and water, and that, notwithstanding their homogeneous appearance, they varied considerably in composition. Analysis numbers I and II, each of which was repeated several times, represent the limits of this variation.

| I. | | | II. | | |
|--------------------------------|---|-------|--------------------------------|---|-------|
| SiO ₂ | . | 18.50 | SiO ₂ | . | 22.03 |
| Fe ₂ O ₃ | . | 2.67 | Fe ₂ O ₃ | } | 5.90 |
| Al ₂ O ₃ | . | 4.63 | Al ₂ O ₃ | | |
| CaO | . | 25.39 | CaO | . | 24.01 |
| MgO | . | 23.65 | MgO | . | 19.53 |
| CO ₂ | . | 10.95 | CO ₂ | . | 3.20 |
| H ₂ O | . | 14.10 | H ₂ O | . | 25.23 |
| | | <hr/> | | | <hr/> |
| | | 99.89 | | | 99.90 |

It will be observed that in No. I. the amount of water is much less and the amount of carbonic acid much greater than in No. II. The composition of the specimens was thus shown to be intermediate between that of dolomite and of a hydrated silicate of lime and magnesia, since, the carbonic acid being insufficient to combine even with all the lime, the remainder of the lime and the magnesia must have been combined with the silica.

We were at once struck by the similarity between our specimens and certain serpentines occurring at Oxford, Canada (Zirkel,

Petrographie, i. 324), and described by Sterry Hunt as composed of a mixture of serpentine with carbonate of lime and magnesia. One of these serpentines contained 10 per cent. of carbonate of lime with a small percentage of carbonate of magnesia, another was a mixture in almost equal proportions of serpentine and dolomite.

We had been led to believe that the specimens given us for analysis had been found *in situ*, but on inquiring particularly we discovered that they had been broken from some masses lying near a lime-kiln, and in short that they were pieces of the ordinary dolomitic limestone of the district, which had been partially burned in the kiln, and subsequently hydrated by exposure to the weather.

We made careful analyses of the unaltered limestone with the view of ascertaining the precise nature of the change undergone by our specimens. The following numbers may be taken as fairly representing its average composition :—

| | | |
|--------------------------------|-------------|-------|
| SiO ₂ | | 9.22 |
| Fe ₂ O ₃ | } | 3.57 |
| Al ₂ O ₃ | | |
| CaO | | 27.78 |
| MgO | | 18.25 |
| CO ₂ | | 40.90 |
| | | <hr/> |
| | | 90.72 |

Comparing this analysis with those given above of the altered limestone, it will be at once obvious that the difference in composition is exactly of the nature which we should have expected. In one case the carbonic acid has been almost entirely driven off, and in the other case the percentage has been reduced from 40 to 10. In other words, the silica originally present in the impure dolomite has, at the high temperature of the kiln, displaced the carbonic acid and combined with the bases. The carbonic acid in the altered limestone is, as already pointed out, insufficient to combine with all the lime, and, as we shall immediately show, there is good reason for believing that all the remaining carbonic acid is in combination with the lime, and all the magnesia and part of the lime in combination with the silica. If by any means the carbonate of lime could be separated from the silicate, the remainder would be a tolerably pure hydrated silicate of magnesia,

Now the removal of the carbonate of lime from silicate of magnesia admits of easy explanation, on the supposition that the action whereby dolomite limestone is converted into serpentine is, as Mr. James Geikie long ago suggested (*Quart. Jour. Geol. Soc.*, 1866, p. 533), a hydrothermal action.

Many theories have been advanced to account for the formation of serpentine. Petrologists are nearly all agreed in attributing to it in all cases a metamorphic origin. There is, however, some diversity of opinion, as to whether it has in every instance been derived from volcanic rocks by the alteration of magnesian minerals, or whether in certain cases it ought not rather to be regarded as a product of the metamorphism of sedimentary rocks. Of its origin in many cases from volcanic rocks rich in magnesia there cannot be the slightest doubt.

So long ago as 1835, Quenstedt (*Pogg., Ann.* 1835, **xxvi.** 370) showed that the celebrated serpentine crystals of Snarum, in South Norway, were in reality pseudomorphs of serpentine after olivine, and though his views were not universally accepted at the time, they have since been fully confirmed both by mineralogists and by chemists. Gustav Rose (*Pogg., Ann.* 1851, **lxxxii.** 511) showed, from the chemical point of view, that olivine would by a slight alteration in its composition pass readily into serpentine; and since his time numerous microscopists have demonstrated that the olivine of many basalts is in process of undergoing this change. The theory of the alteration of volcanic rocks rich in magnesian minerals into serpentine, affords a satisfactory explanation of its occurrence in veins and dykes. But, on the other hand, its frequent occurrence in beds interstratified with limestone, dolomite, and occasionally schists, would seem to indicate in these cases a different origin. Rose, in the paper already cited, expresses the opinion with regard to serpentine in dolomite, occurring in crystalline schistose rocks in Silesia, that it has been formed by the alteration of the dolomite. Sterry Hunt attributes a similar origin to the serpentines of the Laurentian series in Canada (*Phil. Mag.*, 1857, **xiv.** 388). Volger (*Entwicklungsgeschichte der Mineralien der Talk-glimmer Familie*) adopts the same view, and more recently Mr. James Geikie has applied this theory to explain the formation of the serpentine of Carrick in Ayrshire (*loc. cit.*).

Both on stratigraphical and chemical grounds, the conversion of dolomitic limestone into serpentine seems probable, but, so far as we are aware, no one has as yet pointed out the precise nature of the reactions involved in this change.

Carbonate of magnesia decomposes at a much lower temperature than carbonate of lime, the difference between the decomposing points being so great that it is practically made use of in Pattinson's process for the preparation of magnesia from the magnesian limestone of Durham. The limestone is calcined in close iron vessels at a dull red heat, the carbonate of magnesia alone undergoing decomposition at this temperature (*Pharmaceutical Journal*, 1844, iii. 424). Now it is easy to understand that if a rock, such as the Campsie limestone, containing carbonate of lime, carbonate of magnesia and silica, were heated to a temperature sufficient to decompose the carbonate of magnesia, but not the carbonate of lime, the magnesia at the moment of liberation would combine with the silica, forming silicate of magnesia. Adopting the theory of hydrothermal action, the carbonic acid set free from the magnesia would be taken up by water, and would act as a solvent upon the carbonate of lime, removing it, and leaving behind hydrated silicate of magnesia only.

That the carbonate of lime has not been removed from the specimens of the Campsie limestone which had passed through the kiln, is simply due to the fact that there was no water present to take up the carbonic acid. We do not mean, of course, to assert that in every instance this has been the character of the change, whereby dolomite has been altered to serpentine, but in the case of impure dolomites containing sand, the explanation is more satisfactory than Sterry Hunt's somewhat vague theory of the action of heated solutions of alkaline silicates.

The theory which we have briefly sketched seems to reconcile satisfactorily many of the facts connected with the composition and occurrence of serpentine. It explains—

(1) The peculiar composition of such serpentines as those of Canada, and the frequent occurrence of carbonate of lime and carbonate of magnesia in the serpentine of other localities (*Zirkel*, i. 324).

(2) The occurrence of serpentine in beds interstratified with sedimentary rocks.

(3) The frequent association of serpentine with dolomite and limestone. In these cases in which dolomite contains the requisite amount of silica, all the magnesia would be converted into serpentine, and it would be found associated with limestone only.

(4) Its association with schists, which were probably altered from the clays and sandstones interstratified with the dolomite, by the same agencies as those which converted the dolomite into serpentine.

In conclusion, we may state that we are engaged in making experiments upon the direct conversion of the Campsie limestone into serpentine, and upon the influence exercised by one carbonate upon the decomposing point of another, with which it is mixed.

Monday, 3rd April 1882.

PROFESSOR BALFOUR, M.D., Vice-President,
in the Chair.

The following Communications were read:—

1. On the Figures of Equilibrium of a Rotating Mass of Fluid.
By Sir William Thomson.

(a) The oblate ellipsoid of revolution is proved in Thomson and Tait's *Natural Philosophy* (first edition, § 776, and the Table of § 772) to be stable, if the condition of being an ellipsoid of revolution be imposed. It is obviously not stable for very great eccentricities without this double condition of being both a figure of revolution and ellipsoidal.

(b) If the condition of being a figure of revolution is imposed, without the condition of being an ellipsoid, there is, for large enough moment of momentum, an annular figure of equilibrium which is stable, and an ellipsoidal figure which is unstable. It is probable, that for moment of momentum greater than one definite limit and less than another, there is just one *annular* figure of equilibrium, consisting of a *single ring*.

(c) For sufficiently large moment of momentum it is certain

that the liquid may be in equilibrium in the shape of two, three, four, or more separate rings, with its mass distributed among them in arbitrary portions, all rotating with one angular velocity, like parts of a rigid body. It does not seem probable that the kinetic equilibrium in any such case can be stable.

(d) The condition of being a figure of equilibrium being still imposed, the single-ring figure, when annular equilibrium is possible at all, is probably stable. It is certainly stable for very large values of the moment of momentum.

(e) On the other hand, let the condition of being ellipsoidal be imposed, but not the condition of being a figure of revolution. It is proved in Thomson & Tait's *Natural Philosophy*, that whatever be the moment of momentum, there is one, and only one, revolutionary figure of equilibrium.

I now* find that,

(1) The equilibrium in the revolutionary figure is stable, or unstable, according as $f \left(= \frac{\sqrt{a^2 - c^2}}{c} \right)$ is $<$ or $>$ 1.39457.

(2) When the moment of momentum is less than that which makes $f = 1.39457$ (or eccentricity = .812663) for the revolutionary figure, this figure is not only stable, but unique.

(3) When the moment of momentum is greater than that which makes $f = 1.39457$ for the revolutionary figure, there is, besides the unstable revolutionary figure, the Jacobian figure with three unequal axes, *which is always stable if the condition of being ellipsoidal is imposed*. But, as will be seen in (f) below, the Jacobian figure, without the constraint to ellipsoidal figure, is in some cases certainly unstable, though it seems probable that in other cases it is stable without any constraint.

(f) Referring to Thomson & Tait's *Natural Philosophy*, § 778, and choosing the case of a a great multiple of b , we see obviously that the excess of b above c must in this case be very small in comparison with c . Thus we have a very slender ellipsoid, long in the direction of a , and approximately a prolate figure of revolution relatively to this long a -axis, which, revolving with proper angular velocity round its shortest axis c , is a figure of equilibrium. The

* Proof of these results, (1), (2), and (3) will be found in the forthcoming new edition of Thomson & Tait's *Natural Philosophy*, vol. i. part ii.

motion so constituted, which, without any constraint, is a configuration of minimum energy or of minimax energy or of maximum energy, for given moment of momentum, is a configuration of *minimum* energy for given moment of momentum, *subject to the condition that the shape is constrainedly an ellipsoid*. From this proposition, which is easily verified, in the light of § 778 of Thomson & Tait's *Natural Philosophy*, I infer that, with the ellipsoidal constraint, the equilibrium is stable. The revolutionary ellipsoid of equilibrium, with the same moment of momentum, is a very flat oblate spheroid; for it the energy is a minimax, because clearly it is the smallest energy that a revolutionary ellipsoid with the same moment of momentum can have, but it is greater than the energy of the Jacobian figure with the same moment of momentum.

(g) If the condition of being ellipsoidal is removed and the liquid left perfectly free, it is clear that the slender Jacobian ellipsoid of (f) is not stable, because a deviation from ellipsoidal figure in the way of thinning it in the middle and thickening it towards its ends, or of thickening it in the middle and thinning it towards its ends, would with the same moment of momentum give less energy. With so great a moment of momentum as to give an exceedingly slender Jacobian ellipsoid, it is clear that another possible figure of equilibrium is, two detached approximately spherical masses, rotating (as if parts of a solid) round an axis through their centre of inertia, and that this figure is stable. It is also clear that there may be an infinite number of such stable figures, with different proportions of the liquid in the two detached masses. With the same moment of momentum there are also configurations of equilibrium with the liquid in divers proportions in more than two detached approximately spherical masses.

(h) No configuration in more than two detached masses, has secular stability according to the definition of (k) below, and it is doubtful whether any of them, even if undisturbed by viscous influences, could have true kinetic stability; at all events, unless approaching to the case of the three material points proved stable by Gascheau (see Routh's *Rigid Dynamics*, § 475, p. 381).

(i) The transition from the stable kinetic equilibrium of a

liquid mass in two equal or unequal portions, so far asunder that each is approximately spherical, but disturbed to slightly prolate figures (according to the well-known investigation of equilibrium tides, given in Thomson & Tait's *Natural Philosophy*, § 804), and to the more prolate figures which would result from subtraction of energy without change of moment of momentum, carried so far that the prolate figures, now not even approximately elliptic, cease to be stable, is peculiarly interesting. We have a most interesting gap between the unstable Jacobian ellipsoid when too slender for stability, and the case of smallest moment of momentum consistent with stability in two equal detached portions. The consideration of how to fill up this gap with intermediate figures is a most attractive question, towards answering which I at present can offer no contribution.

(j) When the energy with given moment of momentum is either a minimum or a maximum, the kinetic equilibrium is clearly stable, if the liquid is perfectly inviscid. It seems probable that it is essentially unstable when the energy is a minimax; but I do not know that this proposition has been ever proved.

(k) If there be any viscosity, however slight, in the liquid, or if there be any imperfectly elastic solid, however small, floating on it or sunk within it, the equilibrium in any case of energy either a minimax or a maximum cannot be secularly stable; and the only secularly stable configurations are those in which the energy is a minimum with given moment of momentum. It is not known for certain whether with given moment of momentum there can be more than one secularly stable configuration of equilibrium of a viscous fluid, in one continuous mass, but it seems to me probable that there is only one.

2. Notes on Atmospheric Electricity. By C. Michie Smith.

Before leaving for India, in the end of 1876, it occurred to me that, as almost nothing seemed to be known about atmospheric electricity in the tropics, it would be well if I could take with me the apparatus necessary for making observations on it. I accordingly communicated with Sir William Thomson, who kindly obtained for me a grant from the British Association, for a

portable electrometer. This instrument I took with me, and the following are the results of the observations made with it.

During the voyage a number of observations were made, but of these only two sets were of any special interest. The first of these was made in the Suez Canal, on Dec. 22nd. At 8 a.m., at noon, and again at 8 p.m. the readings showed a negative electrification of from three to eight divisions on the scale, the weather being entered as "fine and bright" and the wind as "S., very light," "E. by S., light breeze," and "E.S.E., light," respectively; while readings taken at 1.30 p.m. and 7.30 p.m. gave a positive electrification of eight divisions on each occasion. This has considerable interest in connection with some observations made in Madras.

The other set was made in the Red Sea, during a rather violent squall. In this case the readings varied very rapidly, from strong negative to strong positive, the readings an hour and a half before having been +18 divisions. The variations took place so rapidly that no quantitative observations could be made, and in a few minutes, when the squall had passed over, the readings were found to be much as before, viz., +17 divisions.

In Madras, a series of observations were made, extending from 17th Jan. to 4th March 1877. These were made at 8.30 a.m. and 6 p.m. and showed a wonderfully steady state of electrification, varying from a maximum of +53 to +19, with an average of 3+3. The morning and evening readings usually agreed very closely. In every case the electrification was positive, and the weather was fine without any rain.

During this time the electrometer had to be recharged every two or three days, an operation which, though very simple in this climate, is by no means so simple in a climate so moist as that of Madras. After a time, I found it impossible to continue the observations at all, and sent the instrument home, to see if it could be in any way modified so as to suit the climate. On its return after a long delay, I found it leaked as badly as before, and so rendered observations almost impossible. The reason is doubtless to be found in the circumstance, that the air of Madras is not only moist, but is also very full of small particles of salt, which are constantly being carried from the surf by the sea breeze. The glass of the jar soon gets coated with these particles, and no

amount of simple drying will then make the insulation good. That the fault did not lie in the jar itself I have tested since my return to this country, for I find that here the leakage is less than 1.5 per cent. per diem, while in Madras it was often over 30 per cent. per diem.

On account of these difficulties, I was unable to make any long series of observations, but in July of last year (1881) I made a few, that were specially interesting as being the only ones in which I have observed negative electrification in Madras, except during thunderstorms.

The observations were as follows :—

| July | | | | Reading. | |
|------|--------|-------------------|--------------|----------|---|
| 5 | 1 P.M. | Strong land wind, | Temp. 94° F. | -74 | } In each case } there were local } showers within } 3 or 4 hours. |
| 6 | " | " | " | -16 | |
| 7 | " | " | " | 0 | |
| 7 | 2.20 | " | " | -15 | |

These observations are, of course, too few to found any theory upon, but those who are acquainted with the peculiar sensations produced by the land wind in Madras, will feel that the point is worth investigation, and I hope on my return to Madras to be able to take with me improved apparatus, with which to continue the observations.

3. Recent Tests of Swan's Lamp for Fall of Resistance, with increase of Electromotive Force, and Ratio of Candle-power to Work expended. By Mr. A. Jamieson. Communicated by Professor Chrystal.

4. Communication of Preliminary Observations made by the Committee appointed by the Highland and Agricultural Society to investigate the Nature and Causes of the Sheep Diseases known as Louping-ill and Braxy.

The two diseases have been long known in Scotland, and are the cause of serious loss to stock owners. Well-informed breeders have estimated the loss at not less than half a million sterling annually.

They resemble each other in being peculiar to certain districts, and in prevailing at certain seasons of the year. Louping-ill is most frequently met with in the southern and western counties, and chiefly affects sheep feeding on rough hill pastures. It occurs during May and early in June, and is most fatal amongst lambs, but old sheep, cattle, pigs, and even poultry are liable to it. A few sporadic cases are met with in October, especially in the Western Highlands, where it is known under the name of *trembling*. Braxy, known also as inflammation and *sickness*, is more general in its occurrence, and affects high and low pastures alike. It is more or less prevalent from October till February, and attacks sheep in good condition. There is thus a summer and a winter visitation, and when these occur in the same district the mortality is often very great, sometimes carrying off nearly half of the stock. In the year 1878 the Teviotdale Farmers' Club began to investigate the nature and causes of louping-ill, and collected a considerable amount of information derived from stock owners, shepherds, veterinary surgeons, and others interested in the subject. They also employed Mr. Brotherston of Kelso to make an examination of pastures where the disease prevailed, and published the results obtained in the form of a pamphlet.

These results showed that nothing very precise was known regarding the nature of the disease, and that the causes ascribed to it were very various. The general causes were said to be cold wet weather, and especially the prevalence of east wind, poverty after the privations of severe winter, the eating of rough decayed grass just before the young grass had become plentiful enough to give a full bite, the sudden transition from old to young grass and other causes.

The result of Mr. Brotherston's investigation led him to think that the disease was caused by ergot and other fungi, which he found growing very generally upon the old withered grasses. Another special cause assigned was the bites of ticks, which are said to be invariably found on sheep affected with louping-ill. Experiments were made to test the ergot theory, but they led to no positive result. In the spring of 1881 the Highland and Agricultural Society was asked to take up the investigation, and it at once appointed a Committee, and voted a fund for the purpose.

The first thing the Committee had to do was to assure themselves

that there was a special disease called louping-ill, and if so, to be able to recognise it. This was a subject of some difficulty, as the sheep and lambs which were found affected lay far and wide among the hills. As was anticipated, a considerable number of diseases were found to be grouped under the name of louping-ill. Among these Professor Williams distinguished joint-ill, navel-ill, impaction of wool in the fourth stomach of young lambs, and other inflammatory ailments incident to the lambing season, or to inclemency of weather. Besides these, however, there was found to be a special kind of disease affecting the nervous system, which had well-marked symptoms and interesting peculiarities, some of which are described in the pamphlet above mentioned. It is found to be frequently very much localised, and to attach itself to special pastures, so that a wall or partition may divide an unhealthy pasture from one in which louping-ill is unknown; and that even without any partition, one side of a hill may be healthy and the other unhealthy; and that the hirsels belonging to the one side of the hill may have many cases of louping-ill, while that belonging to the other side may be free from it, although both hirsels may meet and feed together during some hours every day. Sheep coming from a district where louping-ill is unknown, if put upon what is called louping-ill land, die off very rapidly. Stock owners are well aware of this, and when adding to their stock on louping-ill land, are careful to procure sheep from a district where the disease is known to prevail. On the other hand, cases are recorded where sheep in travelling from one sound pasture to another, having passed over a louping-ill district, have introduced the disease upon land which had previously been exempt from it. Instances are also met with where pastures seriously affected with louping-ill have been rendered healthy by means of liming and draining, and depasturing with cattle instead of with sheep for some years. There seems to be no doubt that the disease is due to something on the land and in the pasture, and the whole circumstances seemed to some of the committee to point strongly to the probability of its being a disease of an organismal kind, comparable with those which have recently been brought to light by the researches of Pasteur and other investigators. The disease is not amenable to treatment, and runs its course sometimes very rapidly. Instances are given in which sheep,

apparently well, have, when startled, fallen suddenly down, and died almost immediately; and it is asserted that the number of deaths from louping-ill may be greatly increased by rough herding. It is probable that death caused in this way may be due to shock, and have nothing to do with louping-ill, for sheep are very nervous animals, and easily frightened. No cases of that kind have come under our notice. More commonly the disease comes on gradually, and the first symptoms noticed are uncertainty of gait and lameness, also loss of appetite, and consequent falling off in condition. If the case is a serious one, the next thing noticed is the inability of the sheep to rise. It struggles to do so, but has lost power in its fore or hind limbs, and lies sprawling. The head is usually thrown back, and the animal grows gradually weaker. It is seen to tremble occasionally, and its lips frequently quiver, its teeth chatter, and there is a frothy discharge from the mouth. These symptoms may continue for a week, or even a fortnight, and recovery is not impossible at almost any stage, but the proportion which recovers is very small.

The following is Mr. Hamilton's diagnosis of a characteristic case of louping-ill, which occurred at Drynoch, in Skye. It was the case of a lamb, which had been ill for five days. It had had joint-ill in the spring, the joint had been opened under antiseptics, and the recovery was satisfactory:—

“ Found lying on right side, eyes open, no squint, pupils of medium size, struggles spasmodically when approached. If hind leg is lifted, and allowed to fall, there is no attempt at motion. If fore leg is treated in similar manner, it is moved to and fro before reaching the ground. When held up by wool of back, it moves freely, and can stand on the fore legs, but the hind feet are fixed in the ground, and there are many clonic spasms in the hind legs, which remain extended. When lying on its side, if one of the hind legs are pricked, there is a slight reflex movement, and the animal seems to feel it slightly. When the fore legs are pricked, they are immediately drawn up and retracted. When pricked on the trunk at various places, there seems to be least sensibility to pain in the hind quarters. It can move its tail. It occasionally grinds its teeth, and

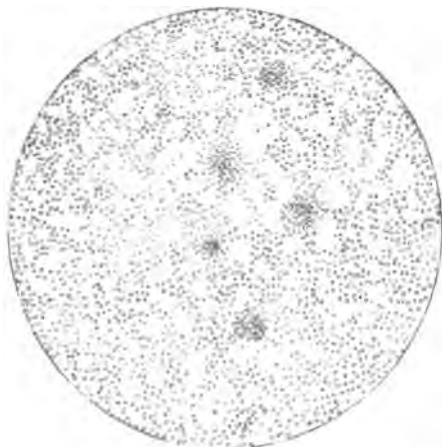

X 350 Diams:

N^o 2

*Culture obtained by inoculating mutton broth
with the blood of sheep affected with louping-ill*

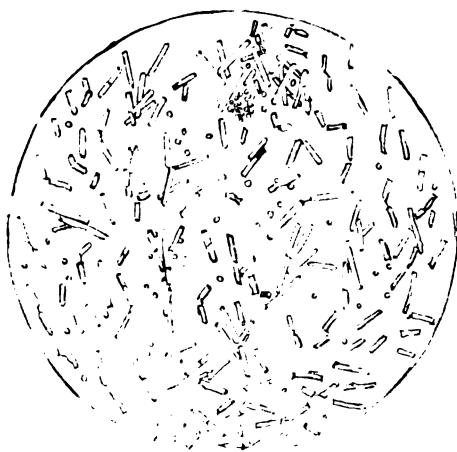

N^o 3.

X 350 Diams:

*Bacilli seen in the mucous coat of the duodenum and
in the peritoneal fluid of sheep ill with "Sickness"*

has slight shiverings. Respirations 30, pulse 104, feeble and intermittent temperature 106° Fahr.

“Hearing and sight unimpaired. Ears move freely and frequently. Nose and lips not unusually dry. It attempts to nibble grass in neighbourhood, and sprawls with the fore legs. Head drawn back. Muscles of extremities relaxed.

“Four hours after these observations, the left hind leg was completely paralysed.”

The lamb was evidently sinking rapidly, and could not recover. Accordingly it was killed, and the *post-mortem* appearances were as follows :—

“Several of the ecchymoses in subcutaneous tissue of lumbar region (probably because it had been lying for several days). Lungs comparatively healthy. Some strongyles. Liver showed at one part several grey-coloured nodules the size of a split-pea (perhaps small incipient abscesses). Kidneys, spleen, and other organs healthy. Small intestine showed several small punctiform ecchymoses in the serous coat. Solitary glands not enlarged. Rumen contained much undigested grass. Small intestine empty. Brain and spinal cord apparently quite healthy.”

These are the symptoms and *post-mortem* appearances of what seemed an undoubted case of louping-ill. Mr. Scott, Drynoch, put his small laboratory at our service, and Mr. Hamilton and I remained for some days, in order to determine whether the disease was one of an organismal kind. We found in the blood, but especially in the cerebro-spinal fluid, a number of exceedingly small rounded organisms frequently going in pairs. We endeavoured to cultivate these in a weak decoction of mutton. The cerebro-spinal fluid was cultivated in drops of the decoction attached to the lower surface of thin cover glasses, which were set on rings of putty that had been arranged on glass slides, so as to form an efficient live-box,



Fig. 1.

as in fig. 1. Three of these, along with other three containing drops of the decoction which had not been inoculated, were put in a

warm chamber for thirteen hours, when it was found that the three which had been touched with cerebro-spinal fluid were cultivating vigorously, while the other three remained barren.

The cultures consisted of little round organisms, which moved about rapidly either singly or in pairs, and were in some places aggregated so as to form a zooglæa, and across the field was stretched a fine branching mycelium.

A second culture was made from one of the slides, and after a few hours it was seen to be growing rapidly, but unfortunately a sudden rise of temperature succeeded the cold weather, for which the baths had been regulated, and all the cultures were exposed for some hours to a temperature over 100° Fahr., which put a stop to all growth.

The blood was cultivated in the same decoction, contained in test tubes plugged with cotton wadding, through which it had been previously boiled. The cultures grew slowly, but the appearances they presented were similar to those obtained with the cerebro-spinal fluid, though not so well marked. One of these which had been put aside for examination escaped the accident above referred to, and the cultures exhibited under the microscopes were derived from that source (fig. 2).

The results we have obtained so far lend strong support to the view that louping-ill is a disease due to, or connected with, an organism whose locus is chiefly in the cerebro-spinal fluid, but which also seems to be found in the blood. Arrangements have been made by Professor Williams, Mr. Hamilton, and myself to pursue this and other lines of inquiry in the season which is now at hand.

Brazy or "Sickness."

This is a disease which has been long known. It prevails over wide districts, and is very fatal. It usually runs a rapid course, and sheep attacked by it are generally found dead before they have been noticed to be ailing. The symptoms are very different from those of louping-ill. The patients display symptoms of great suffering; they are scarcely able to walk, but they stand with their head bent down and their feet drawn together beneath them. The abdomen becomes much swollen, and they lie down, and do not rise again.

After death putrefaction sets in very rapidly, attended with a peculiarly disagreeable and almost intolerable odour.

Post-mortem examination shows all the organs to be normal except the alimentary tract, which contains patches (sometimes very large) of intensely congested mucous tissue. These occur chiefly at the pyloric end of the fourth stomach and along the duodenum, but smaller patches are usually found far along the small intestine. The inflammation is confined to the mucous coat, the serous coat over the patches remaining quite healthy. The swelling is chiefly due to flatus, but the cases we examined also contained a great excess of peritoneal fluid, though no evidence could be found of peritonitis in the form of lymph over the surface or adhesion of the intestines.

A section of the congested mucous coat seen through the microscope presents a most extraordinary appearance. The tissue is densely crowded with large rod-like bacilli, and these especially crowd the interfibrillar spaces of the mucous and sub-mucous coats. The bacilli resemble the *Bacillus anthracis*, and they are found abundantly in the blood (fig. 3).

During the winter we cultivated the bacillus in various media, and find that it cultivates with great facility, even at ordinary temperatures. Under the microscopes on the table are to be seen preservations of the bacillus in its various stages of cultivation. The largest are those obtained by growing the organism in the peritoneal fluid itself; next are those obtained in serum and aqueous humour, and by cultivating from these in thin meat soup the bacillus becomes gradually smaller and more attenuated.

We hope that we may find that the attenuated bacillus may be found capable of being used for inoculating sheep, so as to insure them against death from this disease, in the same manner as has been practised in France with such brilliant success by Pasteur.

Professor Tait's papers on "Beknottedness," on "The Form of the Meridian Sections of Saturn's Ring," and on "The Velocity-Potential," were laid on the table. They will be printed at the end of the volume.

PRIVATE BUSINESS.

Mr J. A. Dixon, Professor D. H. Marshall, Professor C. Michie Smith, and Mr Josiah Livingston, were balloted for and declared duly elected Fellows of the Society.

Monday, 17th April 1882.

The REV. W. LINDSAY ALEXANDER, D.D.,
Vice-President, in the Chair.

The following Communications were read :—

1. On the Definite Article in Greek, with special reference to the Revised Version of the New Testament. By Professor Blackie.
2. On the Action of the Microphone. By Professor James Blyth, M.A.

In the microphone transmitter, as usually employed in circuit with a battery and a Bell telephone, we have essentially two pieces of carbon resting lightly against each other, through which the current passes. That the instrument may work effectively two things are requisite,—first, that the carbons be always in contact, or at least sufficiently near for the current to pass between them; and, secondly, that they be not pressed together so tightly as to prevent any motion of the one relatively to the other. This state of things is sufficiently well described by the term “loose contact,” first used, I believe, by Professor Stokes.

To understand the action of the microphone, we have to find out what effects are taking place at the loose contact when the instrument is acted upon by sonorous waves. These are twofold,—first, the effect produced by the sound waves (that is, the variation of density due to the condensations and rarefactions of the air) which pass directly through the air when they arrive at the loose contact; and, secondly, the effect produced by tremors set up in the

entire instrument, wooden supports and carbons together, by the sound waves which strike against it and are thereby stopped.

For distinction, we may call the first of these the *air effect*, and the second the *tremor effect*.

In my experiments I have endeavoured to arrange the instrument so as to isolate these effects, and, as far as possible, examine each of them separately.

To isolate the air-effect, it is obviously necessary, either to fix the carbons rigidly in their supports, so as to avoid any motion of the one relatively to the other, or to use a strong current, and place them just clear of contact with each other.

The following experiment illustrates how this may be done :—

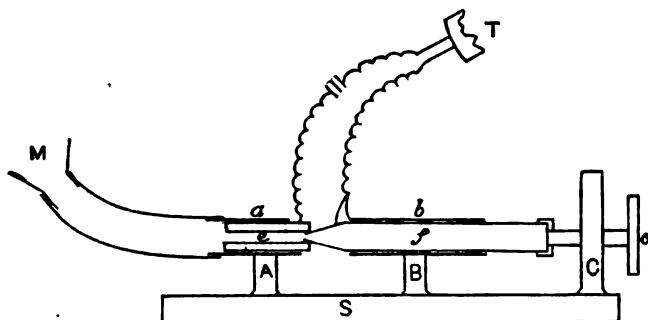

Fig. 1.

A, B and C (fig. 1) are three blocks of brass firmly fixed to a heavy wooden sole-plate S. To the top of A is soldered a piece of brass rod *a* about 2 inches long and $\frac{5}{8}$ inch bore. To the top of B is soldered a piece of similar tube *b* about 4 inches long. Through C passes a fine screw worked by a milled head *c*. A piece of carbon rod *e* is fixed firmly into *a*, and has a hole $\frac{1}{4}$ inch wide drilled through its centre. A long piece of carbon *f* pointed at one end, passes tightly through the tube *b*, and can be moved backwards and forwards by the screw *c*. A piece of india-rubber tube is passed over the left end of the tube *a* and carries the mouth-piece M. By means of the wires *g* and *h*, soldered to the carbon rods, they are put in circuit with the battery (20 Groves cells), and the telephone T, which must either have a small resistance or be placed in a separate circuit from that

containing the battery, so as to be acted upon inductively. When the carbon f is screwed tightly into the hole e , the circuit is completely closed, and no sound uttered into M is heard at T . But when f is drawn gradually back, until small electric arcs are seen to pass between f and e , every sound uttered into M is distinctly reproduced in the telephone T .

Here we have clearly only the air-effect acting, and that solely upon the small electric arcs passing between the carbons. I have found it, as yet, somewhat difficult to get the sounds to last for any length of time, in consequence of the arc distance soon getting too great for the current to pass and requiring re-adjustment. When the arc begins and ends a sharp click is heard in the telephone; but in the interval during which the arc lasts the sounds heard in the telephone are distinct.

As far as the tremor effect alone is concerned, it is obvious that the microphone action must depend, either (1) upon the variation of resistance due to variation of pressure, or (2) to variation in the extent of surface contact due to the elastic yielding of the carbons under pressure.

To test the first of these causes, I made, about two years ago, some experiments on the effect of pressure upon the specific resistance of carbon. For this purpose, I took a short length of carbon rod, and soldered wires to it at a short distance from each end. By means of these wires, the resistance of the carbon rod was balanced in the Wheatstone bridge. Pressure was then applied by means of a lever to the carbon in a longitudinal direction. No appreciable variation in the resistance was observed, even under considerable pressure, and it only became manifest when the pressure was sufficient to bend or crush the carbon.

I have recently repeated these experiments with the greatest care, and found the same results. I observe, also, that similar experiments, with the same result, have quite lately been made by Professor Sylvanus Thomson. Hence we can hardly, I think, believe that variation of specific resistance due to pressure can have the slightest effect in producing the microphone action. To test the second cause above mentioned, that is, the variation of resistance due to variation, in the extent of surface contact due to elastic yielding under pressure, I experimented as follows:—

In the apparatus already described I replaced the tubular carbon by a finely pointed piece, so as to have two fine carbon points exactly opposite each other. The resistance of the points was balanced in the bridge in the usual way. Pressure was then applied by a known number of turns, or parts of a turn, of the fine screw, and the change of resistance noted. The screw was then brought back to its former position and the pressure relieved, so as to allow the elasticity of the carbon to act, and restore the points to their first condition. It is obvious that if the change of resistance were due merely to elastic yielding, it should now be the same as before. This I found not to be the case. From the gritty nature of the carbon, the points of contact I found were perpetually changing, and hence the variation of resistance produced in this way obeyed no regular law.

From this irregularity it is impossible, I think, to conclude that this cause could explain the transmission of musical sounds, far less articulate speech.

As far as my experiments go, the following appears to be something like the true explanation of the microphone action :—What I have termed the air and the tremor effects take place simultaneously. The tremor effect produces a jolting of the carbons, sufficient to allow momentary minute elastic arcs to take place between the points, which are just clear of contact with each other. Simultaneously with this the air effect comes in, and on account of the variations of density due to the condensation and rarefaction of the air, acts upon the minute electric arcs so as to vary their resistance. The tremor effect explains merely the production of the musical pitch of the sounds heard in the telephone, whereas it is to the air effect that we must look for the transmission of the quality of the sounds uttered into the microphone transmitter.

The microphone is thus so far a delicate make and break analogous to the old Reiss' transmitter, with the important addition, however, of minute momentary gaps filled with a material which is sensitive to the harmonic variations of the atmospheric density which constitute sonorous vibrations.

3. Experiments to Determine the Lowering of the Maximum Density Point of Water by Pressure. By Professor D. H. Marshall, Professor C. Michie Smith, and R. T. Omond, Esq.

(Preliminary Notice.)

These experiments were begun in January last at the request of Professor Tait, and have been carried on since then in his laboratory. The subject suggested itself to Professor Tait during his experiments on the effects of great pressures on thermometers carried out for the "Challenger" Expedition Commission, and it was indeed by part of the apparatus purchased by him for this purpose that the experiments were made. The method adopted was of an indirect nature, and consisted in determining first the change of temperature produced by a sudden change of pressure to which the water was subjected. Sir William Thomson has shown that if there be a sudden change of hydrostatic pressure on a body whose temperature is t and pressure p , there will be a change of temperature depending upon the change of pressure, the temperature t , the co-efficient of expansion at pressure p and temperature t , and the specific heat of the body at that pressure and temperature. In the case we are going to consider let t be the absolute temperature of the water, p its pressure, e its co-efficient of dilatation at pressure p and temperature t , and k its specific heat at constant pressure for the same pressure and temperature; let now there be a sudden change of pressure from p to $p - \delta p$, in consequence of which there is a change of temperature from t to $t - \delta t$,

$$\text{then } \delta t \propto \frac{te}{k} \delta p.$$

This formula can be absolutely true only for small changes of pressure. When water is subjected to great changes of pressure, k is possibly a little altered, and we shall show from our experiments that e is certainly so.

Since t and k are always +, on the assumption that k will change only very little by pressure, the sign of δt will depend upon that of e . Thus if e be + (as in the case of water above 4° C.), then for a sudden decrease of pressure there will be a decrease of temperature;

if e be - (as in the case of water under the ordinary atmospheric pressure between 0° and 4°), for a sudden decrease of pressure there will be an increase of temperature; and lastly, if a body have a maximum density point (as water under the ordinary atmospheric pressure) or a minimum density point, then just at that temperature there is no change of temperature for a small sudden change of pressure. If, however, when water at 4° C. is under great pressure, we prove that for a sudden change of pressure e is +, we at once infer that under such pressure water has not a maximum density at that temperature. It is in this way we have proved the lowering of the maximum density point of water by pressure, and also been able to approximate to the maximum density points under a few pressures.

The apparatus we used consisted of four parts: (1) the apparatus for producing the compression, consisting of a strong iron vessel (called the small gun) and a powerful force pump; (2) the gauge; (3) the galvanometer, to measure the changes of temperature following changes of pressure; and (4) an extra thermo-electric circuit, to determine the values in thermometric degrees of the galvanometer deflections.

The first two pieces of apparatus have already been described by Professor Tait in the account of his experiments above alluded to.

The changes of temperature which followed changes of pressure were measured by thermo-electricity. One junction of a thermo-electric circuit of very fine copper and iron wire was placed inside the gun, the wires passing out between two discs of leather well soaked in oil near the bottom, which could be taken off. The others were soldered to thick copper wires in connection with a dead-beat reflecting galvanometer, and placed in a vessel of water, which was kept at as uniform a temperature as possible, one of them being put into a test-tube to prevent the slight voltaic action which disturbed us in our earliest experiments. As we had in some of our experiments to measure extremely small changes of temperature, the galvanometer was made very sensitive by the controlling magnets, and the deflections read on a scale about $2\frac{1}{2}$ metres from the galvanometer. We were enabled in this way to measure as small a change of temperature as $\frac{1}{1000}^{\circ}$ C. even with a single thermo-electric

pair. However, any change in the electric field was at once felt. The rooms we worked in were on the ground flat looking into Chambers Street, and every passing vehicle, on account of its iron fittings, disturbed us. The reader of the galvanometer scale, who was in a darkened room by himself, could generally tell the direction in which a vehicle was moving from the motion of the image on the scale, and on once crying out that a man walking past affected the galvanometer, the experimenter at the pump immediately rejoined that he was carrying some iron on his back. To avoid this change of the magnetic field, we took one set of observations at midnight.

As it was generally impossible to determine directly with a thermometer the temperature of the junction inside the gun, to enable us to interpret the galvanometer readings there was an extra thermoelectric circuit, as nearly as possible the same as that connected with the gun, whose junctions were in vessels of water, so that the temperatures could be directly read with a thermometer and altered at pleasure. Any change in the sensitiveness of the galvanometer was each day detected by this arrangement. During the principal experiments we found it necessary to have three observers, as it was necessary to read the gauge, thermometer, and galvanometer, and let off pressure simultaneously. We think it sufficient in the meantime to indicate briefly the results of a few of the principal experiments made. For example, when the internal junction was at a temperature of $8^{\circ}3$, for a sudden decrease of pressure from 300 atmospheres to 1, there resulted a decrease of temperature = $0^{\circ}17$. As the pressure increased, so did the rate of cooling with pressure; and at a temperature of $9^{\circ}3$ for a sudden change of pressure from 750 atmospheres to 1, there was a cooling = $0^{\circ}74$. We next operated with the internal junction at a temperature less than 4° C. At a temperature of about $1^{\circ}3$ for pressures less than 180 atmospheres there was heating instead of cooling for sudden decrease of pressure, which meant that e was -; at the above pressure and temperature e apparently vanished, which meant that at a pressure of 180 atmospheres the maximum density point was about $1^{\circ}3$; at greater pressures e was +, which meant that the maximum density point was still further lowered.

The experiments we made at midnight corroborate these results.

There are several points to be carefully considered, such as the most satisfactory way of protecting the internal junction from currents produced by change of pressure, convection currents arising from the lowering of the maximum density point, and the possible change of specific heat, which prevent us yet from giving quantitative results. So far as we have gone, our results agree fairly with those of Professor Tait (*ante*, p. 204).

Monday, 1st May 1882.

MR MILNE HOME, Vice-President, in the Chair.

The following Communications were read :—

1. On some Points in the Meteorology of Madeira, both Absolute and Comparative. By the Astronomer-Royal for Scotland.
2. On the Anatomy and Histology of *Pleurochaeta Moseleyi*.
By F. E. Beddard, B.A., New College, Oxford.

(Abstract.)

This earthworm, which is an inhabitant of Ceylon, is 28 inches in length, and consists of about 260 segments. The setae, instead of being arranged in continuous lines round the body as in *Perichaeta*, fall for a short space both dorsally and ventrally. This peculiarity serves to distinguish the genus *Pleurochaeta* from other *Oligochaeta*. The intestine is provided with two sets of specialised glands; the anterior, occupying from segments twenty-two to forty-four, consists of a double series of deeply excavated dorsal pouches on the wall of the intestine, provided with a large development of glandular epithelium; the posterior glands are solid and kidney-shaped, about the size of a grain of wheat. They lie on the dorsal surface of intestine, occupying from the eighty-fifth to the one hundred and first segments; in all, fifteen pairs. They open into intestine by ducts.

The generative system consists externally of a clitellum, occupying in one of the two specimens that I examined as many as nine segments. On this open the generative apertures, three pairs of which are situated close together in a sucker-like structure at the posterior end of the clitellum, upon which there is no development of glands; each pair corresponds to one of the three segments, seventeen, eighteen, and nineteen. The middle pair open into two large "prostates"; no ducts were found in connection with the other two pairs. There is also a fourth pair of apertures on fourteenth segment, with which again no ducts were discovered to be continuous. The testes are a pair of racemose glands occupying twelfth segment. Two pairs of fimbriated organs, occupying eleventh and tenth segments, are perhaps the oviducts, or possibly the vasa deferentia. They open separately on the wall of the segment behind that in which they are situated.

There are no segmental organs present. The vascular system presents no important differences from that of other worms. The dorsal and ventral vessels are connected by six pairs of hearts increasing in size from before backwards, and occupying from the eighth to the thirteenth segments inclusive. There appear to be no intestinal hearts ("cœurs intestinaux" of Perrier), though the supra-intestinal vessel is present, and in that region of the body in which the hearts are developed is double. Capillaries extend into the hypoderm as in the leech, the fibres of the two muscular coats of the body wall as separated into smaller and larger bundles by a meshwork of fibrous connective tissue. The perivisceral cavity is put into communication with the exterior by a series of dorsal pores.

3. Geological Notes. By Dr. Heddle.

Leaf-bed in Canna.

Since the discovery, by His Grace the Duke of Argyll, of the "Leaf-bed" at Ardtun, in Mull, there has not, so far as I am aware, been another found throughout the whole of that extent of land and shore, where we might hope for such a discovery, among the Inner Hebrides.

It was my good fortune to light upon one last summer. While

lying in the harbour of the island of Canna, during a boulder and mineral hunt, I heard that *fuller's earth* had been found at the south-western end of the island. Upon being shown samples of this, I noticed among them fissile schists very similar to those of Ardtun. In proceeding, therefore, round the western cliff-girt coast of the island, to visit the fuller's earth locality, we landed at every accessible point under the great line of precipice, and at one, situated almost at the north-west corner, and immediately under the loftiest point,—more than 730 feet in height,—we found a leaf-bed. There is here a cliff foot, running for some little distance along the shore; this is strewn with numberless masses of rock which have fallen from the cliff, and which fragments give shelter to a colony of auks and puffins.

By the appearances usual to such colonies, the spot may be seen from some distance. Landing can be effected only in the calmest weather.

The leaf-bed can be most easily cut into, if not also most easily seen, in a small cave; this gives shelter alike from what may fall from the cliff, from the skies, and from the birds.

The bed consists of a highly laminated brown clay—almost a mud; for, on account of the water which oozes through the very-vesicular overlying dolerite,—which streams down its face, and which is flung in spray from the sea,—the material of the bed is in its outer portions, and, when first broken into, little harder than putty. Its laminæ are as thin as paper. They split with a tap, or slight pressure from the edge of a knife; this easy cleavage being to some extent due to the extraordinary number of *leaves* which lie, flat-pressed, between the argillaceous layers. Most of these leaves are as pulpy and soft as the rock, and blacken the hands with their fragile fragments.

By working with a pick-hammer a little way under the rock-cover, firmer portions may be reached; and specimens which will endure the friction of carriage obtained. The leaves seem much the same as the species found at Ardtun. A series has been sent to the Industrial Museum.

The whole thickness of the towering cliff is made up of successive layers of igneous rock,—sometimes basalt and basaltic—sometimes amygdaloidal,—sometimes tufaceous. I could distinctly see bands of

plynthisite, which may here represent an overflowed and burnt layer of clay-soil. I also imagined that I could with a binocular make out other beds of the same fissile clay as that which, at the cliff foot, holds the plants.

As there was a gentle dip towards the south-west, I was prepared to find that one or other of these beds had come down to the water edge; to form, when puddled by the waves, the so-called fuller's earth;—and this was very much the true state of matters. A washed-out dyke, conjoined with a small fault, has formed a "geo," terminating in a cave. At flood-mark the waters stand in part of this cave. Surface waters are also constantly sapping into it from above; making it more ample, by reducing to pulp, and carrying away the exposed edge of a bed of much the same rock as that which has been already noted as carrying the leaves. The fuller's earth was found to be, at the time of our visit, of about the same consistence as pea-soup. By taking portions of the dry bed, pounding them, floating off in water, and sedimenting, I *made* some,—decidedly superior to the native article. A sample of this I sent to the Museum.

The Pitchstone-Porphry River of the Scur of Eigg.

The pitchstone plug of the river-cañon of Eigg, forming the singular Scur,—picturesque from certain points of view, weird and fantastic from others,—should be about equally well known to scenery hunters and to geologists. The filled-up water trench is not of great length; somewhere about two miles, as its historian tells us. This is but a short junk of such a mighty river as that must have been, which cut a channel at least 400 feet deep and about 1000 wide. As the eye ranges over a wide expanse of ocean at the spot where this pitchstone cast is shorn off at the *west*,—and as no remaining fragment of the widespread lands from which its waters must have been gathered on the *east*, now remains,—there seemed to be but little hope of our collecting any further fragments of its history. Chance threw the writer upon one such fragment. I was looking for boulders everywhere; Mr. Harvie Brown was looking after grey seals, and birds' eggs, grey, green, or blue; and so we landed upon Hyskier. *Hyskier*—that is, the High Skerry; only 40 feet, but high enough to afford some sort of a shelter to boats which might

fly for safety to the little rock-girt lagoon, which is cinctured by its clustering rocks.

There are two Hyskiers,—one outside Long Island, the other inside. Both are famous for their seals, and both are “rude” enough, if that word was used by Sir Walter to express roughness. It is the *inner* Hyskier that is the subject of these remarks. It is about 9 miles from the nearest land of Canna, with a deep-water channel all round. It consists of a group of skerries, almost united at low water.

Upon landing, myriads of boulders of every variety of rock were seen; and the writer at once recognised the pitchstone porphyry of the Scur of Eigg, as the rock upon which the boulders lay. The whole clustre of skerries is formed of the same rock; which, both in the dun grey of its tone of colour, in the proportional quantity of crystals of imbedded sanidine—and in the size of its basaltic pillars, is unmistakably the same rock as that of the Scur. This is a markedly characteristic one;—one which, in fact, is distinct from all other pitchstones of Scotland.

Standing on these skerries, the eye looks directly on the truncated end of the Scur, which is about 22 miles distant. It ranges also somewhat along its southern flank, as the course of the ancient river of Eigg had been a tortuous one. But its last convolution on that island was a flexure *somewhat more southerly* in its direction than its general course. This direction threw it clear of the south of Rum, and pointed very much to the solitary cluster of pitchstone islets of Hyskier.

The most southerly skerry of the cluster is separated from that nearest to it by a deep wall-sided channel. This, to appearance, was about 4 or 5 fathoms in depth; and the mural cliffs in each side rose to a height of about 23 feet. (It was low water at the time.) The channel was perfectly straight in its course. At first sight it resembles a washed-out dyke. With the knowledge we have, however, of the nature of the Scur, it very much more probably represents what had been a wall-sided islet, which stood midstream in the ancient river; its amygdaloids and tuffs having now been sapped out by the surf, as have the old river banks and the surrounding land.

On a supposed Organism from the Marble of Sutherland.

I have never seen fit to express an opinion upon the vexed question of the *eoazon canadense*. This, not because I have not formed an opinion, but because I have never seen specimens sufficiently characteristic to furnish me with grounds ample enough to enable me to *give force* to my opinion; also because I consider that certain of the grounds adduced by those who hold the same view as my own, are weak, or at least not strong, from a mineralogical point of view.

Having myself found, and being as yet the only one who has studied *the mode of occurrence* of the structure to which I now direct attention, it may be considered that a similar amount of reticence is not in its case either reasonable or justifiable.

The thing of which I write was found in the white saccharine marble of Sutherland last summer. I have during many summers made myself familiar with the modes of occurrence of minerals,—in fact, I have become a successful *mineral hunter*, just in virtue of familiarity with the *modes of occurrence* of minerals; I am perhaps then not going too far in saying that when, after a full consideration of the mode of occurrence and structure of *that thing*, I concluded that it does not accord with minerals, *either in mode of occurrence, or in structure*, it must be at least worthy of the attention of those who are more familiar with structures *not mineral* than I am.

As *the thing* at first sight looked exceedingly like eoazon (what I knew of it), and as its resemblance to eoazon only increased the longer I looked at its sections (which I prepared with my own hands, in all directions), I sent it to Dr. Carpenter, making over to him *in toto* the investigation of its *inner nature*, but reserving to myself—that which he could not do—the telling all the rest about it.

I was well aware that, in concluding that it was wonderfully like, if not identical with, eoazon, I was giving to it a stratigraphical position which many would hold was one “where *nae sic* thing should be;” but, as it is one of the tenets of my geologic faith, that where a thing *is*, is where that thing should be, I was not much disturbed in my conclusions.

I am permitted to say, and it may be well that I should state

this much, that Dr. Carpenter reports that its appearance is very eozoic, while later letters say "exceedingly interesting."

Such are the essentials of its interest which induce me to lay before the Society these notes upon a substance of whose description it is evident that my share must lie only on the mineralogical side.

While endeavouring to discover the bedding of the almost amorphous white marble, my eye was arrested by a dark streak, which promised some aid. Upon approaching it, it presented an appearance similar to what we have been assiduously taught to believe would be presented by a junk of the great sea-serpent. It also somewhat resembled the old "*boas*" worn by ladies, laid horizontally on a face of the marble; and it was *altogether similar* in appearance to the whale cutlets which are hung or stretched in the sun to dry, in the Farøe Islands.

The first portion found lay imbedded in the marble, about 2 feet from its surface. Its length was $16\frac{1}{2}$ feet, and its thickness 4 to 5 inches. When found, I was carrying only a four-pound hammer; but, upon Dr. Carpenter reporting "high interest," I returned to Sutherland with one of more earnest dimensions; and by removing the cover, found that in parts it extended, with almost unvarying thickness, into the rock for $3\frac{1}{2}$ feet.

It lay in the rock in slightly wavy folds; at one spot it threw off, at an angle of about 15° , an arm or *process*; this was about an inch narrower than its mean trunk, and of about 2 feet in length; at another spot it threw off a short process, at right angles.

Its exposed surface was much corroded by the weather, but its structure was unfolded thereby. That boldly displayed structure consisted of gently-plicated but very rough layers of a substance, which evidently was less soluble in rain-water than had been that whose removal left the layers protruding.

The appearance of this exposed surface is precisely that of the representation of eozoon given by Carpenter, in the last edition of his work on the Microscope; and the colour is very much that of printer's ink. When broken into, the rippled structure stands out in blue-black, upon a nearly white ground, which is mottled with granules of yellowish-grey. Occasional patches of greenish-yellow granular precious-serpentine occur; there occasionally are nodules of the latter the size of the fist, and this sometimes is white.

That mineral speaks for itself. As to the others, I found the blue-black in distant octahedral crystals: they are *spinel*, possibly *picotite*, though I have not determined the presence of chromium. The grey-yellow granules are generally rounded on the angles, as is so frequently the case with minerals imbedded in a limestone which has been subjected to the extreme energy of metamorphism. But this substance I have also got in crystals. These are of a pale fawn colour, identical with that of danburite; but the form of the crystal is that of *chondrodite*. The presence of fluorine I have not yet determined; and as there is a form of *sahlite* almost indistinguishable from that of chondrodite, I will not say that these crystals may not be *this* mineral, which is the common ingredient of such marbles. The white matrix (soluble in the rain-water) afforded me, on analysis—

| | | | |
|----------------------------|------------|---|---------|
| Carbonate of lime, | . | . | 46·307 |
| „ | magnesia, | . | 37·632 |
| „ | iron, | . | 1·022 |
| „ | manganese, | . | ·368 |
| Insoluble (chondrodite ?), | . | . | 15·108 |
| | | | <hr/> |
| | | | 100·437 |

and is thus a ferruginous dolomite.

Such are the chemical and mineralogical materials of which this fabric is composed. The fashion and mode of arrangement of these materials I leave others to unfold; inasmuch as they appear to me not to have been subject to the laws which govern molecular arrangement in crystals; and that hence, the thing, as a whole, is not a mineral body, but an organism.

When it shall have been said, in leaving the question at this stage,—standing aside to give the histologists and palæontologists *their* innings at the describing of *the thing*,—that I am merely evading a duty, self-imposed in virtue of the foregoing expression of opinion, I shall be prepared to state the grounds upon which I hold that its structure cannot fall to be considered under crystallipolar arrangement. Meanwhile, I think it well to leave that which is to be seen to those who can describe the complexities of flowing lines and curvilinear outlines, so much better than one who deals with straight lines and angular inclinations.

4. Note on the Absorption of Sea-Water.

By Mr. John Aitken.

In a letter to Professor Tait, dated Mentone, 14th April 1882, Mr. Aitken says :—

Since coming here this time, I have tested the sea with the polariscope and with the spectroscope. With an instrument by Hoffman, which gives coloured bands with polarized light, I have been able to detect small, but decided indications of polarization in the light internally reflected by the water, the surface reflection being, of course, cut off when the observation was made. At present I think the polarization is due to regular reflection from the polished surfaces of some of the particles, which are seen to glance brightly in concentrated sunlight.

I have also detected an absorption band in the green of the spectrum of the light internally reflected by the Mediterranean water. This band is much more distinct in water where there are but few reflecting particles, and the light undergoes a great amount of selective absorption. At about a mile from shore, where I could see a white surface 6 inches square at a depth of 16 metres, the absorption band was quite distinct, but became less and less as I approached the shore, where there was more matter in suspension and the water less transparent, but the spectrum more brilliant. I cannot say whether this band belongs to water or to salt, or to what it is due, never having noticed it before; but I never examined water so transparent, and where the light had undergone so much absorption.

PRIVATE BUSINESS.

Dr. David Pryde, Mr. J. W. Inglis, Mr. F. W. Young, and Mr. T. R. Buchanan, M.P., were balloted for, and declared duly elected Fellows of the Society.

Monday, 15th May 1882.

PROFESSOR BALFOUR, Vice-President, in the Chair.

The following Communications were read:—

1. Exploration of the Faroe Channel, during the Summer of 1880, in H.M.'s hired ship "Knight Errant."* By Staff-Commander Tizard, R.N., and John Murray; with Subsidiary Reports on the—

| | | |
|-------------------------|----|---------------------------|
| <i>Echinoidea</i> | by | Professor Alex. Agassiz. |
| <i>Foraminifera</i> | „ | Mr. H. B. Brady. |
| <i>Copepoda</i> | „ | Dr. George S. Brady. |
| <i>Polyzoa</i> | „ | Dr. Geo. Busk. |
| <i>Fishes</i> | „ | Dr. A. Günther. |
| <i>Radiolaria</i> | „ | Professor Ernst Haeckel. |
| <i>Pycnogonida</i> | „ | Dr. P. P. C. Hoek. |
| <i>Mollusca</i> | „ | Mr. Gwyn Jeffreys. |
| <i>Ophiuroidea</i> | „ | Professor Theodore Lyman. |
| <i>Annelida</i> | „ | Dr. W. C. M'Intosh. |
| <i>Crustacea</i> | „ | Rev. A. M. Norman. |
| <i>Diatomacea</i> | „ | Dr. James Rae, R.N. |
| <i>Deposits</i> | „ | { Mr. John Murray. |
| | | { Professor A. Renard. |
| <i>Asteroidea</i> | „ | Mr. W. Percy Sladen. |
| <i>Holothurioida</i> | „ | Dr. Hjalmar Théel. |
| <i>Sponges</i> | „ | Professor F. E. Schulze. |
| <i>Sea-water</i> | „ | Professor W. Dittmar. |
| <i>Rocks of N. Rona</i> | „ | { Mr. John Murray. |
| | | { Professor A. Renard. |

Communicated by Mr. Murray. (Plate VI.)

I. INTRODUCTION.

The region known as the Faroe Channel is that portion of the Atlantic Ocean to the north of the mainland of Scotland, which is bounded on the N.W. by the Faroe Islands, with their south-west-

* A short preliminary note on the cruise of the "Knight Errant," by the late Sir C. Wyville Thomson, will be found in *Nature* for September 1880.

Most of the materials for the present communication were prepared in December 1880, and handed to the late Sir Wyville Thomson. It was Sir Wyville's intention to describe the Echinoderms, write a general introduction, and arrange the whole for publication. The feeble state of his health, and the pressure of other work, prevented this intention from being carried out.

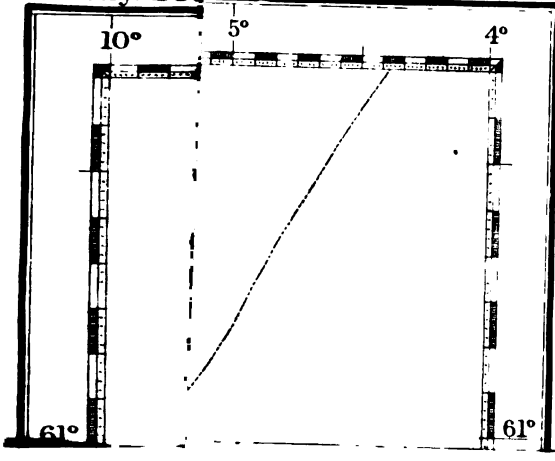

ward extending fishing-banks, and on the S.E. and S. by the Shetland and Orkney Islands, the shores of Caithness and Sutherland, and the Hebrides.

The Faroe Islands are composed of basaltic rocks, while the north of Scotland, and the Scottish Islands, are chiefly made up of Laurentian gneiss, Silurian, and Devonian rocks.

The average width of the Faroe Channel, throughout its more defined and restricted portion, that is to say, between the 100 fathom line of soundings off the coast of Scotland and the Scottish Islands, and that of the Faroe plateau, is between 80 and 90 miles, and the maximum depth rather more than 700 fathoms.

At the south-westerly end the depth increases gradually to the mean depth of the "Cable Plateau" of the North Atlantic, and towards its north-easterly extension it deepens gradually to the lowest bed of the Arctic Ocean.

Up to the time of the recent investigations the bottom was regarded as irregular, as the soundings seemed to indicate one or two dome-like elevations, rising towards the centre of the trough, to within 200 fathoms of the surface.

The Faroe Channel has acquired special interest, because, so far as England is concerned, it is the region where systematic deep-sea investigations were first carried on.

One of the most interesting results of the investigations of the "Lightning" and "Porcupine" expeditions under Dr. Carpenter, Professor Wyville Thomson, and Mr. Gwyn Jeffreys in 1868-69, was the discovery in the deeper water of the Faroe Channel of contiguous areas, having widely different temperature conditions.

This phenomenon is thus described by Dr. Carpenter:—"Among the most important results of the 'Lightning' expedition was the discovery of the fact that two very different submarine climates exist in the deep channel (from 500 to 600 fathoms) lying E.N.E. and W.S.W. between the north of Scotland and the Faroe banks; a minimum temperature of 32° being registered in some parts of this channel, whilst in other parts of it, at the same depths, and with the same surface temperature (never varying much from 52°) the minimum temperature registered was never lower than 46°, thus showing a difference of at least 14°" (*Proc. Roy. Soc.*, 1869, p. 453).

Dr. Carpenter calls the regions indicated above the "cold" and

“warm” areas respectively, but during these early investigations, there seems to have been no suspicion that these two areas might be separated by a submarine barrier. Two bodies of water, differing from one another by 14° Fahr., were, at this early stage of deep-sea investigations, even regarded as abutting against one another without any intervening barrier. Professor Wyville Thomson says:—“In the Faroe Channel the warm water forms a surface layer, and the cold water underlies it, commencing at a depth of 200 fathoms,—567 fathoms above the level of the bottom of the warm water off the Butt of the Lewis. The cold water abuts against the warm—there is no barrier between them. Part of the warm water flows over the cold indraught, and forms the upper layer in the Faroe Channel. What prevents the cold water from slipping, by virtue of its greater weight, under the warm water off the Butt of the Lewis? It is quite evident that there must be some force at work keeping the warm water in that particular position, or, if it be moving, compelling it to follow that particular course” (*Depths of the Sea*, p. 395).

II. ORIGIN AND OBJECTS OF THE “KNIGHT ERRANT” INVESTIGATIONS.

How these early trips of the “Lightning” and “Porcupine” in 1868–69 led to the equipment of the “Challenger” for a circumnavigating cruise is now a matter of history. One or two general considerations with regard to the movements of ocean water, which were established by the “Challenger” observations, may be here referred to, as having led to a reinvestigation of the Faroe Channel.

The waters of the ocean are everywhere in a state of movement,—not a mere state of oscillation by the tides, not a surface movement by shifting winds,—but a steady massive movement, affecting the ocean throughout its whole extent and depth.

The deeper currents are in general so slow that it is impossible to detect their movement directly by the current drag, or any other instrument which has yet been constructed. By means of the thermometer, however, these deep currents can be traced to their source, and their depth and direction determined.

Conduction takes place in masses of water with such extreme slowness, that, when a large mass of water has acquired a given temperature, it may retain it for an almost indefinite period, and move over a vast area without losing much of its heat.

The massive movement of the waters of the ocean is, broadly speaking, from the equator to the poles on the surface, and from poles to equator at the bottom—the cause of this movement being difference of density arising from varying temperature and saltness, and the direction being due to the greater specific gravity of cold than warm salt water.*

The normal distribution of temperature in the great oceans, as found by the "Challenger" may briefly be described as follows :—Towards the surface the warmest water is found, the surface layers being greatly heated by solar radiation; the water cools rapidly downwards for the first 200 fathoms, slowly down to 500 or 600 fathoms, then very slowly to the bottom, where the minimum temperature is reached. This normal vertical distribution of temperature in the ocean is, however, by no means universal.

It is frequently found that the minimum temperature is reached at several hundred or thousand fathoms above the bottom, as, for instance, in the eastern basin of the Atlantic extending along the coasts of Europe and Africa, where the temperature sinks steadily to 36·5° Fahr. at a depth of 2000 fathoms, and then this temperature extends to the bottom at 3150 fathoms. One or two remarkable instances of this abnormal distribution of temperature may be mentioned.

In the Celebes Sea, which attains a depth of 2600 fathoms, the minimum temperature (38·6° Fahr.) is reached at 800 fathoms; the Banda Sea, with a depth of 2800 fathoms, reaches its minimum temperature of 38° Fahr. at 900 fathoms; and the Sulu Sea, which is at least 2550 fathoms deep, has a uniform temperature of 50·5° Fahr. from a depth of 400 fathoms to the bottom. World wide examples of the same phenomenon were found during the "Challenger" investigations. Two neighbouring stations frequently gave water

* See papers by Prof. Tait (May 16, 1881, *Proc. Roy. Soc. Edin.*, vol. xi. p. 217), and by Profs. Marshall and Smith and Mr. Omond (read before Roy. Soc. Edin., July 3, 1882), on the effect of pressure on the maximum density point of water.

at the same depth, at temperatures differing often by many degrees.

Viewing these temperature observations with the indications given by the soundings, we arrived at the generalisation—that contiguous areas with widely different bottom temperatures were separated by submarine barriers, and that *the depth at which the minimum temperature was found in one of the areas, indicated the height of the barrier.*

The following diagram (fig. 1) will illustrate:—

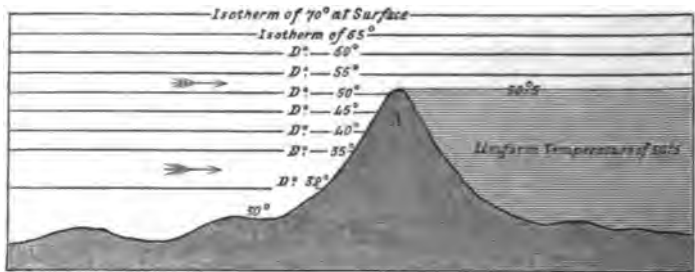

Fig. 1.

The water which is cooled down in the Polar seas, and has thus acquired a high specific gravity, flows along the bottom into the deepest part of the ocean to which it can find access, as shown by the arrows. The surface of the earth below, as well as above the level of the sea is irregular, and the result of this irregularity is that masses of water meet with barriers, over which they must pass, like that represented in the diagram (A).

A barrier like this surrounding a depression, cuts off the lower and colder layers of water, and the basin beyond is filled with water at a uniform temperature by an overflow, the temperature being the same as the water at the height of the ridge, as shown in the diagram.

In any region, then, where we have different bottom temperatures in contiguous areas, and where the minimum temperature in one of the areas is reached at some distance above the bottom, we thought we had reason to believe that the point at which the minimum temperature is found indicates the height of the submarine ridge which cuts off the underflow.

This generalisation induced Captain Tizard to predict the existence

of a ridge rising to within 200 or 250 fathoms from the surface between the warm and cold areas of the Faroe Channel.

This opinion was founded upon the following considerations :—

1. If an imaginary line be drawn from North Rona to the southern end of the Faroe fishing bank, all the bottom temperatures obtained in the cold area were situated to the N.E. of this line, whilst those obtained in the warm area were to the S.W. of it.

2. The warm and cold areas had actually been traced across the channel on either side of this imaginary line with the exception of about thirty miles towards the Faroe fishing-banks.

3. That the serial temperatures in the two areas were nearly similar to the depth of 200 fathoms, but at greater depths showed a marked difference.

The whole direction of the "Challenger's" inquiries was new, and the methods and appliances were hitherto untried; nevertheless, a very fair general idea of many leading phenomena was acquired, and an intelligible basis was laid down for a novel section of the science of Physiography.

Our observations, however, extended over the widest areas, and were restricted to sketching in the merest outline—no single locality was exhaustively examined, no single phenomenon was thoroughly studied.

We had no opportunity of ascertaining by actual soundings the existence and continuity of any one of the ridges, the existence of which we inferred from our temperature observations.

The Faroe Channel afforded an accessible and limited area, with abnormal temperature conditions which might in a comparatively short time be examined in detail, with the probable result of a satisfactory solution of not a few questions of frequent occurrence, of great complexity and of very great interest for science.

These circumstances were set forth in a letter addressed to Sir Frederick Evans, K.C.B., hydrographer to the Admiralty, by the late Sir Wyville Thomson, dated June 16, 1880. (See *Nature*, 2nd Sept. 1880.)

Sir Frederick, whose great interest in deep-sea investigations is well known, had no difficulty, especially as soundings for the general purposes of navigation were required in this region, in recommending this matter to the favourable consideration of the Lords

Commissioners of the Admiralty, with the result that the "Knight Errant"—a hired surveying vessel employed on the west coast of Britain—was instructed to carry out this service.

The object of this cruise was (a) to ascertain by actual soundings (over the space between the positions, where warm and cold bottom temperatures had been obtained in the "Lightning" and "Porcupine") whether a submarine ridge existed, (b) to extend our researches to those portions of the Faroe Channel hitherto unexplored, and (c) to obtain a few serial temperature observations and trawlings in each area.

The plan we proposed to follow in searching for this ridge, was to run sectional lines of soundings at given intervals across the channel N.E. of the warm bottom temperatures previously obtained, and southward of those in the cold area.

In this way the bottom temperature would be ascertained at each depth, and we should then gradually narrow the locality to be sounded over in looking for the ridge itself.

If we obtained a sectional line in which the bottom temperatures were all warm, we should be, according to our theory, S.W. of the ridge, but if the bottom temperatures were cold, N.E. of it.

Thus we hoped to draw the sectional lines nearer and nearer, until, either we proved the existence of the ridge, or ascertained, what appeared to us to be most improbable, that a bank of cold water was in contact with water of a much higher temperature. Having ascertained whether the ridge existed or not we proposed to devote the rest of the time to taking some serial temperature observations, dredgings, and trawlings, both in the warm and cold areas.

III. NARRATIVE OF THE CRUISE.

The "Knight Errant" arrived at Stornoway on the 24th of July 1880, and left that port again for the south on the 20th of August. During this period she made four trips to the Faroe Channel.

The original intention was to confine our attention to sounding operations. We did not, however, like to allow the opportunity to pass of taking a few dredgings and trawlings—consequently Sir Wyville supplied the ship with dredging rope, trawls, and dredges at his own expense, and Messrs. D. & W. Henderson, Engineers,

Glasgow, kindly placed one of their steam winches at Mr. Murray's disposal, and fitted it on board. Sir Wyville remained at Stornoway while some of the investigations were being carried on.

First Trip.

We left Stornoway on Monday the 26th of July, and proceeded out towards Rona Island. On Tuesday the 27th we commenced running a sectional line of soundings towards the S.W. of the Faroe Islands, and obtained on that day eight casts of the lead. The bottom temperatures were similar to those obtained by the "Porcupine" in the warm area.

At 8 P.M. the dredge was put over in 305 fathoms, the wind and sea were moderate, and the weather bright enough to allow the position of the ship to be fixed accurately by astronomical observations.

Several hauls of the tow-net were taken at intervals when sounding. Early on Wednesday the 28th July, the dredge was hauled in and found to contain stones, sponges, polyzoa, &c.

The sectional soundings were resumed, and six casts were obtained before striking the edge of the Faroe fishing-bank, the temperatures continued similar to those obtained by the "Porcupine," in the warm area.

We then proceeded to the north-eastward, and commenced running another sectional line parallel to the first and about eight miles N.E. from it. During the afternoon we obtained three soundings, two of which were in the cold area; the dredge was put over at 8 P.M. in 375 fathoms.

The day was fine but cloudy, slight swell from the eastward; the sun appeared at intervals and allowed us to determine our position with accuracy.

The dredge was hove up at 4 A.M. on the 29th July, and contained a few stones covered with serpulæ and gravel; some of the stones had on their upper surfaces a coating of peroxide of manganese, there were also a few sponges, ophiuroids, cephalopods, and gasteropods.

The sectional soundings were then continued, and three casts were taken in depths varying from 375 to 210 fathoms.

At 10 A.M. the weather, which had not been very favourable since the night before, changed for the worse, the barometer fell, and a fresh N.E. gale sprung up, which raised a high sea, and a portion

of our bulwarks was carried away. It was deemed expedient to bear up for Stornoway, and we arrived at that port on Friday afternoon, after having spent a very unpleasant four and twenty hours.

Second Trip.

The weather having settled, the "Knight Errant" left Stornoway on the 3rd of August, and on the same day carried a line of soundings from the Butt of Lewis to Sulisker Island.

While off the Butt of Lewis, we stopped to shoot some of the sea-birds and to obtain some hauls of the tow-net in the locality where the birds were feeding, in order to ascertain, if possible, the nature of their food.

During the night we dredged in 53 fathoms. The day was very fine and bright, but towards evening a dark bank of clouds rose in the S.W., and the barometer began to fall. At 10 P.M. a drizzling rain commenced and lasted throughout the night.

On Wednesday the 4th August, we commenced running a sectional line of soundings N.N.W. from Rona Islands towards the last sounding obtained on the 29th July. We took nine casts of the lead, which, with one exception, were under 300 fathoms. At 6 P.M. we had completed the second sectional line. As the barometer was steadily falling, and the weather thick, with a long westerly swell, we proceeded towards Stornoway.

Third Trip.

The "Knight Errant" left Stornoway again on the 9th of August, with a rising barometer.

A line of soundings was carried out from the Butt of Lewis towards the "Holtenia ground" of Dr. Carpenter to the north-westward. During the night of the 9th we had a S.W. gale, which necessitated our "laying to."

On the 10th we sounded and trawled in 555 fathoms. There were many animals in the trawl. We had again to lay to in the evening on account of a moderate S.W. gale and thick weather.

On the 11th we sounded and trawled in 515 fathoms. This trawl-

ing was a somewhat barren one. As our observations showed us to be ten miles from the "Holténia ground," we steamed to the northward, and trawled again in lat. $59^{\circ} 37'$ N., long. $7^{\circ} 19'$ W. The trawling here was rather more successful. We also obtained a serial temperature at every 50 fathoms down to 500 fathoms.

In the evening the dredge was put over for the night, the weather being fine.

On Tuesday the 12th, at 5 A.M., the dredge was hove up, and was found to be full of ooze, while to the tangles were attached numerous echini and starfishes. The ship's coal now running short we returned to Stornoway to replenish.

Fourth Trip.

We left Stornoway on Monday the 16th of August, and proceeded to Rona Island, carrying out a line of soundings. We stopped on the east side of Rona, and observing little break upon the shore, landed for a short time. The landing place is on the eastern side of the northern point of the island, where a narrow spur of moderate height projects from the higher land. It is at the entrance of a small cavern, faced by a series of natural steps, which were, in all probability, formerly used when Rona was inhabited.

The remains of a dwelling are visible in the immediate vicinity of the landing place.

The rock of Rona is composed of Laurentian gneiss, but here and there we gathered some fragments of Cambrian sandstone evidently washed up by the sea (see page 657). The power of the waves is here magnificently illustrated; all along the western side of this northern projecting point, at a height of over 50 feet above the level of the sea, is a line of stones, some of them of considerable size, which have evidently been forced up the face of the sloping cliffs during westerly gales.

The island is covered with rich turf, upon which were grazing a considerable number of sheep. There were numerous sea-birds on the cliffs, and several seals were seen near the shore.

On the western side of the projecting point on which we landed is a deep cavern, which extends to such a depth as to point to the probability of a breach being made in the not distant

future which will separate the northern spur from the rest of the island.

During our stay off the island, several casts of the lead, over an uneven rocky ground, were obtained from the ship in 7 to 8 fathoms, with the extremes of Rona S. 38° W. and N. 54° W. (mag.).

On leaving Rona we proceeded to the cold area of the Faroe Channel. At 5 A.M., on the 17th August, we sounded in 540 fathoms, and put the trawl over.

At 10 A.M. the trawl was hauled in and contained a splendid lot of animals, fishes, cephalopods, starfishes, crustacea, sponges, pycnogonids, molluscs, &c.

A tow-net attached to the trawl contained some ooze. A serial temperature sounding was afterwards obtained at every 50 fathoms to the bottom.

For the next two days the ship was engaged in running lines of soundings between Rona Island, the Nun Rock, and Cape Wrath, and left Stornoway on Friday the 20th of August for the south.

We were unfortunate in having bad weather during all these cruises. This circumstance, together with the fact that the "Knight Errant" could not carry a large supply of coal, prevented our doing so much work as was originally intended.

Some most important results were, however, obtained.

IV. RESULTS.

1. *Observing Stations, &c.*—The following (pp. 650–51) is a list of the observing stations during the cruise of the "Knight Errant," with the position, depth, nature of deposit, bottom temperatures, and meteorological observations, with serial temperatures in the warm and cold areas.

The accompanying map of the Faroe Channel shows the soundings obtained by the "Knight Errant," in block figures, thus (540), while those formerly obtained are in ordinary Roman figures. The "cold" area is coloured blue, the "warm" area pink.

2. *Wyville Thomson Ridge.*—The most important result of the "Knight Errant" investigations was the discovery of the ridge predicted from theoretical considerations.

We have named the ridge "Wyville Thomson Ridge" in honour of the late Sir Wyville Thomson.

Its position is shown on the map by the contour lines of 300 fathoms. The exact height and form of the ridge, however, has still to be determined by a series of soundings in cross sections, and this work we hope to undertake during the present season.*

If we trust to the indications given by the serial temperature soundings, we should say that the depth over the ridge cannot much exceed 200 fathoms.

The discovery of this ridge is an important fact in Physical Geography, and is in itself a sufficient justification, if justification were needed, for a thorough reinvestigation of so highly interesting a region in such close proximity to our own shores. The discovery confirms strongly the correctness of the theory that submarine ridges exist in all cases in the ocean, between adjoining areas, the bottom temperatures of which differ materially at equal depths.

What is the Geological nature of the Wyville Thomson Ridge?—Is it an outcrop of ancient rocks like those of the north of Scotland? Is it of volcanic origin? Is it the remains of an ancient moraine? We have no very definite information on this point, but such as we have seems to indicate that the last supposition is the correct one. The two dredgings on the ridge—the one about mid-channel and the other at the north end of the ridge—both gave large stones,—Cambrian sandstone, diorite, micaceous sandstone, mica schist, gneissic rock, limestone, amphibolite, chloritic rock. These were all more or less rounded, and in some cases glacial markings could be detected. The assemblage of stones altogether resembled very much what we would expect to find in a moraine heap, such as would be formed from rocks found in the north of Scotland, rather than from those found in the Faroe Islands, which are volcanic.

We know of no agent at work at present in this region which could transport these stones to their present position. When lying on the bottom many of the stones projected above the deposit; and their

* On the recommendation of the President and Council of the Royal Society of London, and the Hydrographer, the Lords Commissioners of the Admiralty have detached H.M. surveying vessel "Triton" for two months during this summer (1882), to complete the work commenced in the "Knight Errant."

| No. of Sounding. | Date. | Time. | Position. | | Depth in Fathoms. | Nature of Bottom. | Bot. Temp. | | Meteorological Observations. | | | | | | Remarks. | |
|------------------|---------------|------------|-----------|--------|-------------------|----------------------------|---------------|-------------------|------------------------------|--------|----------|------|------------------------|-----------|----------|-------------------------|
| | | | Lat. | Long. | | | No. of Therm. | Reading of Therm. | Wind. | Force. | Weather. | Sea. | Barometer unconnected. | Air Temp. | | Sea Surface Temp. |
| 1 | 1880, July 27 | 5.5 a.m. | 59 15 N. | 6 4 W. | 58 | gravel | 0, 2 | 50.0 | E.N.E. | 2 | c. | mod. | 29.918 | 54.5 | 56.2 | |
| 2 | " " | 6.50 " | 59 21 " | 6 19 " | 88 | shells | 0, 6 | 50.8 | E.N.E. | 3 | f. | mod. | 29.900 | 54.5 | 57.0 | |
| 3 | " " | 8.40 " | 59 23 " | 6 33 " | 178 | hard | 0, 6 | 50.2 | E.N.E. | 3 | c. | mod. | 29.900 | 54.5 | 56.2 | |
| 4 | " " | 10.40 " | 59 37 " | 6 43 " | 400 | hard | 0, 2 | 45.8 | E.N.E. | 2 | b.c. | mod. | 29.800 | 55.5 | 57.8 | |
| 5 | " " | 10.45 p.m. | 59 44 " | 6 55 " | 560 | grey ooze | 0, 6 | 47.2 | E.N.E. | 2 | b.c. | mod. | 29.832 | 55.5 | 57.5 | |
| 6 | " " | 3.0 " | 59 51 " | 7 7 " | 540 | hard | 0, 6 | 45.8 | E.N.E. | 2 | b.c. | mod. | 29.832 | 54.0 | 54.0 | |
| 7 | " " | 5.30 " | 59 53 " | 7 22 " | 300 | mud | 0, 6 | 46.5 | E.N.E. | 2 | b.c. | mod. | 29.832 | 52.5 | 55.0 | |
| 8 | " " | 7.30 " | 60 4 " | 7 37 " | 305 | mud | 0, 6 | 48.5 | E.N.E. | 1 | c. | mod. | 29.080 | 52.0 | 54.8 | Dredging Station No. 1. |
| 9 | " " | 5.40 a.m. | 60 3 " | 7 52 " | 405 | ooze | 0, 2 | 47.7 | E.N.E. | 1 | c. | mod. | 29.760 | 51.0 | 54.0 | |
| 10 | " " | 7.35 " | 60 11 " | 7 53 " | 355 | sand and coral | 0, 2 | 47.0 | East | 2 | c. | mod. | 29.760 | 51.0 | 53.0 | |
| 11 | " " | 9.30 " | 60 19 " | 8 15 " | 270 | sand | 0, 6 | 45.0 | East | 1 | b.o. | mod. | 29.760 | 52.0 | 53.5 | |
| 12 | " " | 11.15 " | 60 25 " | 8 28 " | 335 | sand and gravel | 0, 2 | 43.5 | E.N.E. | 2 | b.c. | mod. | 29.760 | 52.0 | 53.8 | |
| 13 | " " | 1.0 p.m. | 60 31 " | 8 37 " | 245 | gravel, gravel, and shells | 0, 6 | 41.8 | E.N.E. | 2 | b.c. | mod. | 29.760 | 51.5 | 53.0 | |
| 14 | " " | 2.30 " | 60 36 " | 8 43 " | 120 | sand | 0, 2 | 42.5 | E.N.E. | 2 | o. | mod. | 29.760 | 51.0 | 52.5 | |
| 15 | " " | 4.0 " | 60 41 " | 8 34 " | 130 | sand | 0, 2 | 45.0 | E.N.E. | 2 | b.c. | mod. | 29.750 | 51.5 | 52.0 | |
| 16 | " " | 5.30 " | 60 36 " | 8 21 " | 370 | mud | 0, 6 | 47.2 | E.N.E. | 2 | o. | mod. | 29.760 | 51.0 | 52.5 | |
| 17 | " " | 7.10 " | 60 29 " | 8 19 " | 375 | mud | 0, 6 | 34.0 | E.N.E. | 2 | o. | mod. | 29.760 | 51.0 | 53.0 | |
| 18 | " " | 6.0 a.m. | 60 20 " | 8 17 " | 375 | mud | 0, 2 | 31.0 | N.E. | 4 | o.c. | mod. | 29.560 | 50.0 | 53.0 | |
| 19 | " " | 8.0 " | 60 20 " | 8 8 " | 235 | gravel | 0, 2 | 33.5 | N.E. by E. | 4 | o.c. | mod. | 29.560 | 51.0 | 53.0 | |
| 20 | " " | 9.45 " | 60 15 " | 7 40 " | 310 | hard | 0, 2 | 33.0 | N.E. by E. | 4 | o.c. | mod. | 29.560 | 51.0 | 53.0 | Dredging Station No. 2. |

| | | | | | | | | | | | | | | |
|----|--------|-----------|---------|--------|-----|------------|--------------|------------|-----|--------|--------------|--------|------|------|
| 21 | Aug. 4 | 5.15 a.m. | 59 19 " | 6 2 " | 56 | 0.2 0.6 | 51.0 51.5 | South | 1 | o. | mod. | 29-710 | 55.0 | 54.5 |
| 22 | " | 6.30 " | 59 26 " | 6 10 " | 79 | 0.2 0.6 | 50.0 50.8 | South | 1 | o. | mod. | 29-710 | 55.0 | 55.0 |
| 23 | " | 8.0 " | 59 34 " | 6 19 " | 93 | 0.2 0.6 | 50.0 50.8 | South | 1 | o. | mod. | 29-720 | 56.5 | 56.0 |
| 24 | " | 9.30 " | 59 41 " | 6 28 " | 145 | 0.2 0.6 | 49.5 50.3 | South | 1 | b.c.m. | mod. | 29-720 | 56.5 | 55.5 |
| 25 | " | 11.0 " | 59 49 " | 6 37 " | 202 | 0.2 0.6 | 48.2 49.0 | South | 1 | b.c.m. | mod. | 29-720 | 56.5 | 56.0 |
| 26 | " | 0.30 p.m. | 59 54 " | 6 51 " | 460 | 0.2 0.6 | 47.0 48.0 | South | 1 | m. | mod. | 29-720 | 59.0 | 57.0 |
| 27 | " | 2.0 " | 59 59 " | 6 47 " | 255 | 0.2 0.6 | 48.0 48.8 | South | 1 | m. | mod. | 29-720 | 59.0 | 56.2 |
| 28 | " | 3.30 " | 60 02 " | 7 4 " | 285 | 0.2 0.6 | 48.0 48.8 | South | 1 | m. | mod. | 29-720 | 59.0 | 56.5 |
| 29 | " | 5.30 " | 60 8 " | 7 25 " | 260 | 0.2 0.6 | 47.5 48.0 | S.E. | 3 | m. | mod. | 29-680 | 56.3 | 55.0 |
| 30 | " | 8.0 a.m. | 59 33 " | 7 14 " | 555 | 0.2 0.6 | 48.0 48.8 | S.W. | 3 | o.p.q. | westly swell | 29-99 | 66.0 | 57.0 |
| 31 | " | 9.0 " | 59 26 " | 7 19 " | 515 | 0.2 0.6 | 44.0 46.5 | S.W. by W. | 4 | o.m. | " | 30-26 | 65.0 | 56.6 |
| 33 | " | 4.45 " | 60 3 " | 5 51 " | 540 | 0.2 0.6 | 28.0 30.5 | N.N.E. | 1-2 | o. | smooth | 30-40 | 57.0 | 56.5 |

Serial Temperatures.

| | | | | | | | | | | | | | | | |
|----|---------|---------|----------|---------|-------------|-----|--------------|--------|-----|------|--------|-------|------|------|---------------------------------|
| 33 | Aug. 11 | p.m. | 59 37 N. | 7 19 W. | 530 surface | ... | 57.0 49.0 | S.W. | 2 | o.f. | mod. | 30-32 | 59.0 | 57.0 | Dredging Stations Nos. 6 and 7. |
| | | | | | 50 | ... | 50.0 | | | | | | | | |
| | | | | | 100 | 0.2 | 48.8 | | | | | | | | |
| | | | | | 150 | 0.6 | 48.8 | | | | | | | | |
| | | | | | 200 | 0.2 | 48.0 | | | | | | | | |
| | | | | | 250 | 0.2 | 49.2 | | | | | | | | |
| | | | | | 300 | 0.2 | 48.4 | | | | | | | | |
| | | | | | 350 | 0.6 | 48.0 | | | | | | | | |
| | | | | | 400 | 0.6 | 47.5 | | | | | | | | |
| | | | | | 450 | 0.2 | 47.2 | | | | | | | | |
| | | | | | 500 | 0.2 | 46.5 | | | | | | | | |
| 33 | " | 17 a.m. | 60 3 " | 5 51 " | 540 surface | ... | 56.2 | N.N.E. | 1-2 | o. | smooth | 30-40 | 57.0 | 56.2 | |
| | | | | | 50 | 0.2 | 49.2 | | | | | | | | |
| | | | | | 100 | 0.6 | 48.2 | | | | | | | | |
| | | | | | 150 | 0 | 47.5 | | | | | | | | |
| | | | | | 200 | 0.2 | 48.0 | | | | | | | | |
| | | | | | 250 | 0.2 | 47.0 | | | | | | | | |
| | | | | | 300 | 0.2 | 48.0 | | | | | | | | |
| | | | | | 350 | 0.2 | 46.5 | | | | | | | | |
| | | | | | 400 | 0.2 | 31.5 | | | | | | | | |
| | | | | | 450 | 0.2 | 30.5 | | | | | | | | |
| | | | | | bottom | 0.2 | 28.0 | | | | | | | | |

upper surfaces were covered with a coating of peroxide of manganese, and had living serpulæ attached. The line to which a stone was imbedded in the deposit was sharply marked by the manganese deposit. It would seem as if currents existed here towards the north-east strong enough to carry fine mud away from the top of the ridge, and to leave the larger stones exposed, or at least strong enough to prevent a deposit of fine mud from forming.

It is worthy of remark that we dredged no large stones in either the cold or warm area, some distance away from the ridge.

In the deposit of the warm area the average size of the mineral particles is only .15 m.m., and these are nearly all angular fragments of quartz, fellspar, &c., but no fragments of the ancient rocks of the north of Scotland of sufficient size to be detected. In the cold area the mean diameter of the mineral particles is .35 m.m., with many larger fragments of Cambrian (?) sandstone, mica schist, amphibolic gneiss, &c. (see description of deposits, pages 29-33).

3. *Temperature.*—The serial temperatures show that from the surface to a depth of a little over 200 fathoms the temperature of the water is nearly the same over both the warm and cold areas, but at greater depths there are wide differences.

Similar results were obtained by the "Porcupine" in 1869.

It is very probable that throughout the winter, the temperature at the sea surface and to the depth of 200 fathoms in this vicinity, is from 48° to 49°. This temperature is much warmer than that found in the same latitude in any other part of the North Atlantic. It is evidently, therefore, not derived from the locality or from a more northern source, but certainly comes from a southern latitude.

For these reasons we believe that the whole body of water on the south-western side of the Wyville Thomson Ridge is moving toward the north-eastward, and that the layers deeper than 200 fathoms are stopped or deflected, when they come in contact with the ridge, while those less deep than 200 fathoms flow onward to the north-eastward.

The cold water, which fills the deeper part of the basin to the N.E. of the ridge, must come from the Arctic Ocean.

Here we would point out a peculiarity in the distribution of temperature in the Faroe Channel, a peculiarity not met with in any of the regions examined during the "Challenger" expedition.

In the diagram (fig. 1) given on page 5, we have represented that the basin on the right is filled with water of a uniform temperature, which is believed to have flowed over the top of the ridge (A), so that the minimum temperature in this basin is found at a depth the same as that over the top of the submarine ridge.

In the Faroe Channel, however, as is shown in the diagram here given (fig. 2), although the water on the one side of the ridge is

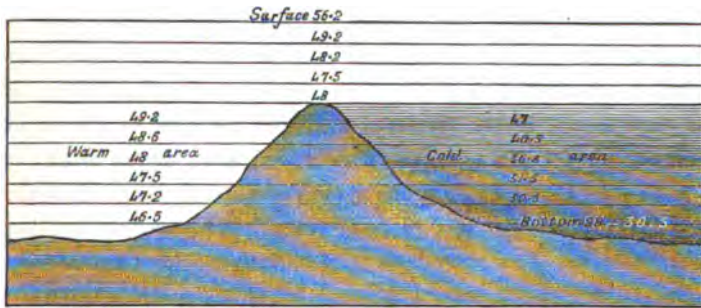

Fig. 2.

warmer, at depths exceeding 200 fathoms, than that on the other side, yet on both sides of the ridge the *minimum temperature is only reached at the bottom*; the water in the right hand basin cannot, therefore, have passed over the ridge, as in the case illustrated by diagram fig. 1. Indeed we have shown that the cold water at the bottom of the N.E. basin must come from the Arctic Ocean or Spitzbergen Sea.

Along the whole eastern side of the Atlantic, from the island of Teneriffe to the Faroe Islands, the isotherm of 40° is at a depth of no less than 900 fathoms from the surface. If we except the enclosed areas of the Mediterranean, Red Sea, and Sulu Sea, this is the only part of the world where so high a temperature is found at so great a depth.

It is owing, doubtless, to the comparative shallowness of the water, that the minimum temperature on the Atlantic side of the Wyville Thomson Ridge is so high. We have every reason to believe that if the depth here exceeded 2000 fathoms the minimum temperature would be 36.5° , as in the whole eastern basin of the Atlantic.

What becomes of the underflow of cold arctic water shown by the

shaded portion of the above diagram (2)? Does any of it pass over the ridge to the west? What becomes of the excess of this cold water? At present we can give no satisfactory answer to this question. A discussion on this point may appropriately be deferred till the further observations and more detailed investigations which it is proposed to undertake during the present season have been completed.

Bearing in mind the peculiarity pointed out above as existing in the Faroe Channel, the doctrine of submarine barriers may be stated in more general terms than those used on page 4, as follows:—*A divergence of temperature between the deep waters of two contiguous areas of the ocean indicates the level of the lowest point of the ridge of a submarine barrier separating the two areas.*

4. *Surface Dredgings by means of the Tow-net.*—During each of the trips the tow-net was worked from the ship whenever the weather would permit. For several days *Acanthometrae* were enormously abundant at, and for several fathoms beneath, the surface: during our last trip to the cold area very few of them were met with. Pelagic foraminifera had never been taken near the British Islands, but relying on our "Challenger" experience, we predicted that they would be captured in the tow-net so soon as the water beyond the Butt of Lewis was reached. Our anticipations were realised. So soon as we got into true oceanic waters globigerinæ were procured in considerable abundance at the surface. Orbulinæ were rare, and we only noticed one *Pulvinulina micheliniana*. All these specimens were dwarfed, and quite similar to the dead shells found at the bottom both with regard to their size and relative frequency. These observations were quite in accordance with those made by the "Challenger" in various parts of the world. The occurrence of these surface forms in the deposits of the cold area shows that the upper layers of water are passing to the north-east; while *Globigerina borealis*, which we believe to be an arctic surface species, does not apparently occur in the warm area deposits, this would seem to show that the arctic water does not pass over the ridge to the south-west.

On one occasion, several miles off the Butt of Lewis, we spent some hours in examining a portion of the sea where numerous puffins, gannets, razorbills, and other birds were feeding, one of those

places, in short, where fishermen go to shoot their herring nets, guided by the presence of the birds and other animals. Here, within one or two fathoms of the surface, the tow-net gave only a few Copepods, Diatoms, and Echinoderm larvæ. When, however, the tow-net was dragged at a depth of from 7 to 10 fathoms, it came up filled and covered with a mass of beautiful yellow or orange-coloured slime. This, on examination, was found to be composed of immense multitudes of *Peridinium tripos*. We may remark that none of these were *in catena*; whereas in the open ocean and more southern latitudes, these organisms are frequently met with in chains consisting of nine or ten individuals. Although these *Peridinia* are often regarded as flagellate infusorians, yet we could never detect either a flagellum or cilia, though we have observed them for several years. Indeed they seem to be undoubted algæ, and their production in enormous abundance most probably depends on certain conditions of sunlight and temperature. Another haul of the tow-net at a depth exceeding 10 fathoms, gave vast numbers of the *megalopa* stage of crabs, together with a good many Copepods, Amphipods and larval fish. The stomachs of these Crustaceans were filled with *Peridinia*, so that these minute Algæ supplied them with food. The herring and mackerel, which we procured from the fishermen, had their stomachs filled with these minute Crustaceans. The birds, again, were feeding upon the herring. Dolphins, whales, and dog fish were also busy upon the same ground, but, unfortunately we had no opportunity of examining their stomachs.

We have here a chain of phenomena, which if carefully worked out, might give much information concerning the habits of many of our food fishes. The abundance of *Peridinia* gives food for the minute animals which are in a process of development in the ocean, and these again serve as food for our edible fishes. A knowledge of the food supply of these fishes, indeed, and of the conditions to which it is subject, would probably give the key to the solution of the mystery which at present surrounds the migrations of many of these fishes. That knowledge can best be acquired by a diligent and continued use of the tow-net, together with an examination of the stomachs of the fish. In the stomach of the herring and mackerel which we examined during our cruises the following were observed:—Young of herring, sprat and other fish, *Zoeas* of crabs,

Galathea, *Algae*, *Mysis*, *Euphausia*, *Thysanopoda*, *Hyperia*, *Cythere*, *Lemora*, *Evadne*, *Larvæ* of Molluscs, *Sagitta*. The Schizopods were sometimes very numerous in the stomachs.

Dr. James Rae, R.N., gives the following list of Diatoms from the "Knight Errant" surface gatherings :*—

| | |
|---------------------------------|--------------------------------|
| <i>Coscinodiscus concinnus.</i> | <i>Hemidiscus cuneiformis.</i> |
| „ <i>radiatus.</i> | <i>Rhizosolenia</i> , sp. (?). |
| „ <i>oculus iridis.</i> | <i>Chetoceras</i> , sp. (?). |
| <i>Campylodiscus costatus.</i> | |

Professor Ernst Haeckel gives the following list of Radiolaria :—

| | | |
|----------------------|-----------------------|-------------------------|
| <i>Acanthometra.</i> | <i>Rhizosphaera.</i> | <i>Actinocyrtis.</i> |
| <i>Xiphacantha.</i> | <i>Actinomma.</i> | <i>Amphilonche.</i> |
| <i>Dorataspis.</i> | <i>Spongocyrtis.</i> | <i>Spongodiscus.</i> |
| <i>Ethmosphaera.</i> | <i>Thalassicolla.</i> | <i>Thalassosphaera.</i> |
| <i>Heliosphaera.</i> | <i>Calcaromma.</i> | |

Dr. George Brady gives the following list of Copepoda and Cladocera :—

| | |
|--------------------------------|-------------|
| <i>Oithona spinifrons</i> ? | Boeck. |
| <i>Calanus finmarchicus.</i> | Gunner. |
| <i>Temora longicornis.</i> | Müller. |
| <i>Dias longiremis.</i> | Lilljeborg. |
| <i>Eucalanus attenuatus.</i> | Dana. |
| <i>Centropages typicus.</i> | Kroyer. |
| <i>Anomalocera patersonii.</i> | Templeton. |
| <i>Evadne nordmanni.</i> | |
| <i>Pleopsis polyphemoides.</i> | Lovén. |

* In a letter Mr. E. Grove gives me the following additional diatoms from the "Knight Errant" surface gatherings in the Faroe Channel :—

| | |
|---|--------------------|
| <i>Hyalodiscus maculatus.</i> | (Podosira, W.S.) |
| <i>Coscinodiscus centralis.</i> | (1 specimen only.) |
| <i>Melosira sulcata.</i> | (scarce.) |
| <i>Actinophycus undulatus.</i> | (1 specimen only.) |
| <i>Actinocyclus ehrenbergii.</i> | (1 fragment.) |
| <i>Biddulphia mobilensis</i> , Bail. | (scarce.) |
| <i>Rhizolenia styliiformis.</i> | (frequent.) |
| „ <i>alata.</i> | (not unfrequent.) |
| „ <i>imbricata</i> ? var. | (scarce.) |
| <i>Chetoceras decipiens</i> ? Cleve. | (common.) |
| (? <i>Chet. bacillaria</i> , Bailey.) | |
| <i>Chet. boreale</i> , Bail. | (scarce.) |
| „ var. <i>brightwellii</i> , Cleve. | (frequent.) |
| <i>Navicula distans.</i> | (1 specimen.) |
| <i>Pleurosigma directum</i> , Grun. | (frequent.) |
| (Scarcely sigmoid, has appearance of a <i>Navicula</i> .) | |
| <i>Synedra thalassiothrix</i> , Cleve. | (frequent.) |

In addition to the above the following were observed :—

| | |
|--|---------------------------------|
| <i>Globigerina bulloides.</i> | } See Mr. H. B. Brady's Report. |
| <i>Globigerina inflata.</i> | |
| <i>Orbulina universa.</i> | |
| <i>Pulvinulina micheliniana</i> (one). | |

Salpæ, Sagittæ, Schizopods, Amphipods, larvæ of *Membranipora*, Lamellibranch, Gasteropod and Echinoderm larvæ, *Peridinium tripos*, and Coccuspheres.

5. *Dredgings, Trawlings, and Soundings.*—For convenience of reference and comparison we divide these into (a) those on the plateau surrounding North Rona and Sulisker, (b) those in the warm area, (c) those in the cold area, and (d) those on the Wyville Thomson ridge.

(a.) *On the Plateau surrounding North Rona and Sulisker.*

(1) *Soundings.*—A great many soundings were taken on the plateau which surrounds North Rona, and between it and the Butt of Lewis and Cape Wrath. The depths were from 30 to 80 fathoms, the average being about 50 fathoms.

The bottom was sometimes a fine calcareous sand, sometimes a quartz sand, and sometimes a fine gravel. These varieties of deposits occurred without any apparent relation to depth. Generally the particles were more or less rolled, and all the materials collected on this plateau out to the 100 fathom line, gave the impression that they were often set in motion and frequently sorted by the action of waves and currents. None of the soundings indicated the presence of mud or argillaceous matter.

The calcareous particles were composed of broken and rolled fragments of mollusc shells, polyzoa, Annelid tubes, echinoderms and foraminifera.

The sandy particles were chiefly rounded fragments of quartz, with some pieces of mica, hornblende, and feldspar.

The gravel was composed of rolled pieces of the older rocks, as amphibolic gneiss, Cambrian sandstone, diorite, and pieces of jasper.

The following were the percentages of carbonate of lime in four of these soundings :—

| | | | | |
|------------|---|-------------|-------------|-----------------|
| S.S.W. of | { | 3rd August. | 53 fathoms. | 80·15 per cent. |
| North Rona | { | 3rd „ | 59½ „ | 31·54 „ |
| W. of | { | 18th „ | 43 „ | 77·00 „ |
| North Rona | { | 18th „ | 54 „ | 22·61 „ |

(2) *Dredgings*.—Two hauls of the dredge were taken N.N.W. of North Rona on the 3rd and 4th August 1880. Lat. 59° 12' N., long. 5° 57' E., in 53 fathoms.

1st haul.—The dredge was lowered at 5.30 P.M. and hauled in again at 8 P.M., it had two swabs and a tow-net attached. The bag of the dredge and the tow-net attached were filled with sand and gravel, and several echini, starfish, ophiurids, polyzoa, lamellibranchs, annelids, hydroids, and attached foraminifera.

2nd haul.—The dredge, with swabs, was put over at 9.30 P.M. on the 3rd, and hauled in at 3.30 A.M. on the morning of the 4th August. The bag of the dredge was burst, or rather the lower surface had been torn away by passing over rough ground, one swab was carried away, and the other was covered with polyzoa. In the dredge and on the swab were several starfish, one comatula, ophiurids, crustacea, gasteropods, and lamellibranchs, many polyzoa, cirripeds, pycnogonids, sponges, hydroids, and attached foraminifera.

The largest pieces of rock were about 4 centimetres in diameter, and all the fragments were more or less rounded.

The following were the principal varieties of rocks observed :—

1. Mica-schist, composed of alternate bands of feldspar and quartz with mica.
2. Quartzite.
3. Micaceous quartzite (Cambrian?).
4. Red micaceous sandstone.
5. Limestone.
6. Syenitic rock containing feldspar and hornblende, quartz, passing to amphibolite.
7. Large grained sandstone (Cambrian?), containing feldspar.
8. Arkose, containing quartz, feldspar, and Muscovite.

The sand is composed of grains of quartz, more or less rounded, feldspar grains are much less abundant, hornblende, small fragments of rocks, quartzite, sandstone, amphibolite. The sand seems to come from the decomposition of granite and gneiss. It is strange, however, that mica appears to be quite absent. We subjoin a list of the animals obtained.

Mollusca.

| | |
|---|-----------|
| <i>Circe minima.</i> | Montagu. |
| <i>Venus fasciata.</i> | Da Costa. |
| <i>Tapes virgineus</i> (young). | Linné. |
| <i>Tellina crassa.</i> | Gmelin. |
| <i>Psammobia costulata.</i> | Turton. |
| <i>Maetra solida</i> , var. (<i>elliptica</i>). | L. |
| <i>Saxicava rugosa</i> , var. (<i>arctica</i>). | L. |
| <i>Eulima polita.</i> | L. |
| <i>Natica montacuti</i> (<i>montagu</i>). | Forbes. |
| <i>Aporrhais pes-pelecani.</i> | L. |

Asteroidea.

| | |
|-------------------------------|-------------|
| <i>Luidia sarsi.</i> | Düb. & Kor. |
| <i>Porania pulvillus.</i> | O. F. Müll. |
| <i>Cribrella oculata.</i> | Linck. |
| <i>Crossaster papposus.</i> | Linck. |
| <i>Asteracanthion rubens.</i> | Linné. |
| „ <i>mülleri.</i> | Sars. |

Crustacea.

| | |
|------------------------------------|----------|
| <i>Stenorhynchus longirostris.</i> | Fabr. |
| <i>Hyas coarctatus.</i> | Leach. |
| <i>Ebalia tuberosa.</i> | Pennant. |
| <i>Munida rugosa.</i> | Fabr. |
| <i>Ligia oceanica.</i> | |
| <i>Eurydice truncata.</i> | Norman. |
| <i>Scalpellum vulgare.</i> | Leach. |
| <i>Balanus.</i> | |

Pycnogonida.

| | |
|------------------------------|--------|
| <i>Pycnogonum littorale.</i> | Ström. |
|------------------------------|--------|

Annelida.

| | |
|---------------------------------|----------|
| <i>Lagisca propinqua.</i> | Mgn. |
| <i>Boarne</i> , n. s. p. | |
| <i>Glycera capitata.</i> | Ersted. |
| <i>Onuphis bilineata.</i> | Baird. |
| <i>Lumbriconereis fragilis.</i> | O. F. M. |
| <i>Ditrypa arietina.</i> | O. F. M. |
| <i>Serpula vermicularis.</i> | L. |

Echinoidea.

| | |
|----------------------------------|-------------|
| <i>Echinus norvegicus.</i> | Düb. & Kor. |
| „ <i>acutus.</i> | Lamk. |
| „ <i>melo.</i> | Lamk. |
| <i>Echinocyamus pusillus.</i> | Gray. |
| <i>Spatangus purpureus.</i> | Leske. |
| <i>Echinocardium flavescens.</i> | A. Ag. |
| „ <i>pennatifidum.</i> | Norm. |

Ophiuroidea.

| | |
|---------------------------------|---------------|
| <i>Ophiocoma nigra.</i> | Müll. and Tr. |
| <i>Ophiopholis aculeata.</i> | Gray. |
| <i>Ophiothrix pentaphyllum.</i> | Ljn. |

Hydroidea.

| | |
|----------------------------|--|
| <i>Thuiaria thuvia.</i> | |
| <i>Tubularia indivisa.</i> | |
| Other Hydroids. | |

| | |
|---|-----------|
| Porifera. | |
| <i>Tetilla cranium.</i> | Müll. |
| Crinoidea. | |
| <i>Antedon rosacea.</i> | |
| Polyzoa. | |
| <i>Bugula flabellata.</i> | J. V. T. |
| " <i>plumosa.</i> | Pallas. |
| <i>Flustra foliacea.</i> | Linn. |
| <i>Cellepora ramulosa.</i> | Linn. |
| <i>Cellepora avicularis.</i> | Hincka. |
| <i>Eschara compressa.</i> | Sowerb. |
| <i>Retepora beaniana.</i> | King. |
| <i>Salicornaria farciminoidea.</i> | Solander. |
| <i>Lepralia unicornis, var. ansata.</i> | |
| <i>Porella levis.</i> | Fleming. |

(b.) Soundings, Dredgings, and Trawlings in the Warm Area.

Sounding No. 5 and dredging stations 4, 5, 6, and 7 are all in the warm area, and are all within a few miles of each other. The depths are nearly the same, and the general character of the deposit in each case is similar.

Station 4. 10th August. 555 fathoms. Lat. 59° 33' N., long. 7° 14' W. Bottom temperature, 44·4°; surface temperature, 57·0°.

A small quantity of a grey calcareous mud came up in the sounding tube. Trawl without swabs or tow-nets was used. It was put over at 8.30 A.M., and hauled in at 11.30 A.M. There were in it several fish, several hundred holothurians, crustacea, annelida, &c., as follows:—

| | |
|--|------------|
| Pisces. | |
| <i>Chimæra monstrosa.</i> | L. |
| <i>Cottus thomsoni, n. sp.</i> | |
| <i>Haloporphyrus lepidion.</i> | Risso. |
| <i>Macrurus, sp. n. (probably young of</i> <i>M. trachyrhynchus).</i> | |
| Echinoidea. | |
| <i>Phormosoma uranus.</i> | Wyv. Thom. |
| " <i>placenta.</i> | " " |
| Asteroidea. | |
| <i>Mimaster tizardi, n. gen. and sp.</i> | |
| Actinia. | |
| <i>Actinia.</i> | |
| Holothurioides. | |
| <i>Lætmogone violacea (about 300 speci-</i> <i>mens).</i> | } Théel. |
| <i>Stichopus (?) tizardi, n. sp.</i> | |

Crustacea.

Munida tenuimana.

G. O. Sara.

Nephropsis atlantica, n. sp.

Annelida.

Empty chitinous tube.

Station 5. 11th August. Lat. 59° 26' N., long. 71° 19' W.
515 fathoms. Bottom temperature 45·4°; surface temperature,
56·6°.

The trawl had a tow-net attached to the beam, but without swabs,
and without a bag in the bottom of the trawl. It was put over at
9 A.M., and hauled in at 11.30 A.M.

The tow-net came up with a small quantity of mud, some surface
organisms, and in the trawl there were some crustacea, holothurians,
and annelids, &c., as follows:—

Mollusca.

Fusus sarsi (young).

Jeffreya.

Holothurioidea.

Leptogone violacea.

Théal.

Crustacea.

Dorhynchus thomsoni.

Norman.

Amathia carpenteri.

Norman.

Munida tenuimana.

G. O. Sara.

Pycnogonida.

Nymphon strömii.

Kröyer.

Annelida.

Boarne johnstoni.

M'Intosh.

Nemertean (*Enopla* and *Anopla*).

Crinoidea.

Rhizoecrinus lofolensis.

M. Sara.

Ophiuroidea.

Ophiacantha tridentata.

Ljn.

Echinoidea.

Echinus (?).

Stations 6 and 7. 11th August. 530 fathoms. Lat. 59° 37'
N., long. 7° 19' W. Bottom temperature, 46·5°. Surface tempera-
ture, 57·0°.

1st haul.—No sounding was taken, the position being the same
as that of a "Porcupine" station in 1869, giving a depth of 530
fathoms.

The trawl was put over at 2 P.M., and hauled in at 6.30 P.M. with
tow-net attached to the beam, but no bag in the bottom of the trawl

nor swabs were used. In the tow-net there was a little of the deposit evidently knocked up by the action of the trawl in passing over the bottom, and in the trawl were many animals.

2nd haul.—Dredge with two swabs attached was put over at 8 P.M. on the 11th, and hauled in at 4 A.M. on the 12th August. The bag of the dredge was full of a grey mud (about 40 litres) with Echinoderms, Annelids, Gasteropoda, &c.

*Description of the Deposit.**

GREY MUD coherent, finely granular, homogeneous, earthy, calcareous, has a greenish tinge when wet.

* The description of these deposits has been made upon the plan which we have adopted in our work in preparation upon the oceanic deposits, to form one of the reports on the scientific results of the "Challenger" expedition.

This is not the place to develop the reasons which have guided us in adopting this mode of description, or to expose, in detail, the methods which we have systematically employed for all the sediments which we are engaged in describing. These will be given in great detail in the introduction to our "Challenger" report. We limit ourselves here, in order to facilitate the comprehension of our descriptions, to describe the order of our tables, and to explain the meanings and arrangement of terms and abbreviations.

The description commences by indicating the kind of deposit (red clay, grey mud, globigerina ooze, &c.), and comprises the microscopic determination of the characters of the deposit, when wet or dry.

When we have not given a complete analysis of the deposit, we have always determined the amount of CARBONATE OF CALCIUM. This determination was generally made in estimating the carbonic acid. We took usually, for this purpose, a gram of the substance, and calculated in this manner the carbonate of calcium. Weak and cold hydrochloric acid was used. However, as, independent of the carbonate of calcium, the deposits often contain carbonates of magnesia and iron, the results calculated in placing the carbonic acid to CaO are not perfectly exact. These carbonates of magnesia and iron are almost always in very small proportion, and the result of the process gives that degree of accuracy which we think necessary. The number which follows the words "carbonate of calcium" indicates the percentage of CaCO₃; we then give the general designations of the principal calcareous organisms forming the carbonate of lime in the deposit. The part insoluble in the acid, after the determination of the carbonic acid, is designated in our descriptions by the name RESIDUE. The number which follows this word indicates its percentage in the deposits; then follow the colour and principal physical properties. This residue is washed and submitted to regular decantations, which permit the several elements of this insoluble portion being separated according to their density. We divide these portions into three groups—(1) *Minerals*, (2) *Siliceous Organisms*, (3) *Fine Washings*.

1. *Minerals*.—The number within brackets indicates the percentage of particular minerals and fragments of rocks. This number is the result of an

CARBONATE OF CALCIUM 32·72 per cent., consists of Coccoliths, Coccospheres, Globigerinas, Pulvinulinas, Orbulinas, Nodosarias, Truncatulinas, Nonioninas, &c. Fragments of Echini, Molluscs, Ostracodes, one or two Pteropod fragments.

RESIDUE 67·28 per cent., greyish-brown, consists of—

Minerals [40·00], *m. di.* 0·1 mm., almost all angular; quartz, hornblende, augite, magnetite, volcanic glass, glauconite, feldspar.

Siliceous organisms [5·00]: Diatoms, Radiolarians, Sponge spicules, and a few glauconitic casts of Foraminifera.

Fine washings [22·28]; argillaceous matter with minute fragments of minerals and siliceous organisms.

Remarks.—The larger portion of the mud was passed through fine approximate valuation, of which we will give the basis in our report. As it is important to determine the dimensions of the grains of minerals which constitute the deposit, we give, following the contraction *m. di.*, their mean diameter in millimetres. This evaluation is made with the micrometer. We give next the form of the grains, if they are rounded, &c., then follows the enumeration of the species of minerals and rocks. In this enumeration we have placed the minerals in the order of the importance of the rôle which they play in the deposit. The specific determinations have been made with the microscope, and with the aid of Nicol's prisms, by parallel or convergent light.

2. *Siliceous Organisms.*—The number between brackets indicates the percentage of siliceous organic remains. We obtain it in the same manner as that placed after the word *Minerals*. The siliceous organisms and their fragments are examined with the microscope. We have also placed under this heading the glauconitic casts of the foraminifera and other calcareous organisms.

3. *Fine Washings.*—We designate under this name the particles which, resting in suspension, pass with the first decantation. They are about 0·05 mm. or less in diameter. We have not been able to arrange this microscopic matter under the category of *Minerals*, because at this small size it is impossible to determine the species. We have always found that the *Fine Washings* is in considerable quantity as the deposit passes to a clay, and it is from this point of view that the subdivision has its *raison d'être*. We often designate the lightest particles by the name argillaceous matter, but usually there are associated with this very small fragments of indeterminate minerals, and fragments of siliceous organisms. The number within brackets which follows the words *Fine Washings* is obtained in the same manner as the similar numbers referred to in the two preceding paragraphs.

These few words will suffice to render our descriptions intelligible. Greater details will be given, as already stated, in our larger work. We may add that in the majority of cases we have solidified the sediments and formed them into thin slides for microscopic examination, and that at all times the examination by transmitted light has been carried on at the same time as the examination by reflected light. Each description is followed by notes upon the dredging or sounding, upon the animals collected, and a discussion of the analysis whenever a complete analysis has been made.

J. M. and A. R.

be referred to tourmaline; some of the arenaceous Foraminifera are uniformly coloured red.

List of the Animals taken at these Stations.

| | | |
|--|----------------|--------------|
| Pisces. | | |
| <i>Haloporphyrus lepidion.</i> | Risso. | Stat. 6. |
| <i>Brosimius broeme.</i> | Müll. | " |
| Mollusca. | | |
| <i>Amusium hoskynsi.</i> | Forbes | " |
| <i>Aporrhais serresianus.</i> | Michaud. | " |
| <i>Fusus fenestratus.</i> | Turt. | " |
| <i>Fusus berniciensis, var. (elegans).</i> | King. | " |
| <i>Arca pectunculoides.</i> | Sc. | Stat. 7. |
| <i>Leda lucida.</i> | Lov. | " |
| " <i>frigida.</i> | Torell. | " |
| <i>Nucula tumidula.</i> | Malm. | " |
| " <i>corbuloides.</i> | Seguenza. | " |
| <i>Cardium minimum.</i> | Ph. | " |
| <i>Neæra striata.</i> | Jeffer. | " |
| " <i>obesa.</i> | Lov. | " |
| <i>Hela tenella (young).</i> | Jeffer. | " |
| <i>Natica montacuti (young).</i> | Forbes. | " |
| <i>Aporrhais serresianus (young).</i> | Mich. | " |
| <i>Cerithium metula.</i> | Lov. | " |
| <i>Columbella halizeti.</i> | Jeffer. | " |
| " <i>costulata.</i> | Cant. | " |
| <i>Cylichna alba.</i> | Brown. | " |
| " <i>ovata.</i> | Jeffer. | " |
| Echinoidea. | | |
| <i>Spatangus purpureus (young) ??</i> | Leske. | Stat. 6. |
| <i>Phormosoma placenta.</i> | W. Th. | " |
| <i>Porocidaris purpurata.</i> | W. Th. | Stat. 7. |
| <i>Dorocidaris papillata.</i> | A. Ag. | " |
| <i>Echinus norvegicus.</i> | Düb. & Kor. | " |
| Ophiuroidea. | | |
| <i>Ophioglypha aurantiaca.</i> | Vll. | Stat. 6. |
| <i>Ophiactis abyssicola.</i> | Ljn. | Stat. 7. |
| Holothurioidea. | | |
| <i>Lastmogone violacea.</i> | Théel. | Stat. 6. |
| <i>Thyone raphanus.</i> | Düb. and Kor. | Stat. 6 & 7. |
| <i>Stichopus (?) tizardi.</i> | n. sp. | Stat. 6. |
| <i>Echinocucumis typica.</i> | Sara. | Stat. 7. |
| Crustacea. | | |
| <i>Geryon tridens.</i> | Kröyer. | Stat. 6. |
| <i>Munida tenuimana.</i> | G. O. Sars. | Stat. 6 & 7. |
| <i>Amathia carpenteri.</i> | Norman. | Stat. 7. |
| <i>Eurydice polydenaria.</i> | N. & Stebbing. | " |
| <i>Haploops setosa.</i> | Boeck. | " |
| <i>Ampelisca compacta.</i> | n. sp. (?) | " |
| Pycnogonida. | | |
| <i>Nymphon stræmi.</i> | Kröyer. | |

| | | |
|--------------------------------------|-------------|--------------|
| Annelida. | | |
| <i>Nothria</i> (small). | | Stat. 6 |
| Empty muddy tubes. | | " |
| <i>Aphrodita aculeata</i> . | L. | Stat. 7. |
| <i>Laetmonice filicornis</i> . | Kbg. | " |
| <i>Leanira hystricis</i> . | Ehlers. | " |
| <i>Maldane</i> , near <i>sarri</i> . | Mgn. | " |
| <i>Ampharete arctica</i> . | Mgn. | " |
| <i>Hydroides norvegica</i> . | Gunn. | " |
| <i>Protula</i> (fragt.). | | " |
| Asteroidea. | | |
| <i>Archaster bifrons</i> . | Wyv. Thom. | " |
| <i>Astropecten andromeda</i> . | Müll. & Tr. | " |
| Porifera. | | |
| <i>Hollentia</i> , sp.? | | |
| Crinoidea. | | |
| <i>Rhizocrinus</i> , fragt. | | " |
| Pennatulida. | | |
| <i>Kophobolemnon mülleri</i> (?) | Sars. | Stat. 6 & 7. |
| <i>Pennatula rosacea</i> . | | Stat. 7. |
| " sp. | | |

Sounding 5. 27th July 1880. Depth, 560 fathoms.

GREY MUD with slight greenish tinge, plastic, granular, calcareous, earthy, with small hard particles.

CARBONATE OF CALCIUM 27·36 per cent., consists of *Coccoliths*, *Coccospheres*, *Globigerinas*, *Pulvinulinas*, *Uvigerinas*, *Cassidulinas*, *Nonioninas*, *Nodosarias*, &c., fragments of *Echini*, *Ostracode* valves.

RESIDUE 72·64 per cent., brownish-grey, consists of—

Minerals [55·00], m. di. 0·15 mm., a few particles nearly ·5 mm.; quartz, hornblende, mica, feldspar, glauconite. The quartz grains are often rounded, the other particles are angular.

Siliceous organisms [2·00]: Diatoms, spicules of Sponges, and casts of Foraminifera of a pale yellow-green colour.

Fine washings [15·64]; argillaceous matter with fragments of siliceous organisms and minute mineral particles.

(c.) *Dredgings and Trawlings in the Cold Area.*

Station 8. 17th August. 540 fathoms. Lat. 60° 3' N., long. 5° 51' W. Bottom temperature, 29·2°. Surface temperature, 56·5°.

In the sounding tube there was a small quantity of blue mud.

The trawl was used with a swab at one end and a tow-net at the other end of the beam, and a bag at the bottom of the netting. In the tow-net there was about a litre of mud, and about 5 litres in the bag of the trawl. In the trawl there were, besides many hundreds of pycnogonids, many fish, some starfish, ophiuroids, echini, &c.

BLUE MUD with greenish tinge, grey when dry, sandy, calcareous.

CARBONATE OF CALCIUM 12.75 per cent., consists of many *Coccoliths* and *Coccospheres*, *Globigerinas*, *Pulvinulinas*, *Nonioninas*, *Lagenas*, &c., fragments of *Echini*, *Ostracodes*, *Molluscs*.

RESIDUE 87.25 per cent., consists of—

Minerals [65.00], m. di. .3 mm., with some particles over 1 mm., often rounded; quartz, often covered with oligist, augite, hornblende, magnetite, mica, fragments of ancient and recent rocks.*

* We will not seek here to justify in detail the employment of the terms *ancient* and *recent* rocks, but limit ourselves to indicating the meaning which we give to these terms, and the reasons which have guided us in introducing into our descriptions this subdivision of massive crystalline rocks into two groups. This is not the place to enter into the discussion, which is being carried on at the present time among a certain number of lithologists, as to whether the same denomination ought to be applied to the same lithologic type without respect to its geological position.

Whatever may be the issue of these discussions, it remains, nevertheless, true, that there exist certain minute details of structure, and certain characters in the constituent minerals of rocks, differences, in short, sufficiently important to indicate generally if a massive crystalline rock belongs to ante-tertiary or tertiary and post-tertiary periods. If, as we think, these two groups can be practically distinguished, even although they present insensible transitions from one to the other, then it is important, for an exact knowledge of the origin of sediments, to take this division into consideration in our descriptions of marine deposits. These sediments we know include at the same time rocks and free minerals produced by the disintegration of these rocks. If we are able to apply the distinction into ancient and recent rocks, then we ought, in a certain sense, to be able to tell whether the isolated minerals found in the deposit come from the one or the other type of rock. We should be able, by the aid of this distinction, to determine with probability whether the mineral fragments found in deposits come from continents, are the result of submarine eruptions, or have been carried by floating ice, &c.

Notwithstanding the care which has been taken to establish these distinctions, we are often unable to pronounce with certainty; for, as we have said, the distinctive characters which we have alluded to are not so well marked, the fragments which are present in the deposits are very minute, and many of the finer details have been removed by decomposition. As to the minerals, with which we have more frequently to deal than with the rocks them-

composed of quartz grains, of which some are milky, and a good many are covered with hydrate of iron. Associated with the quartz are many black particles of hornblende, mica, magnetite, and yellow and

—ante-tertiary, the second (II.) those of *recent* rocks—tertiary and post-tertiary. We only mention those minerals which are found in the deposits.

I.

Quartz—containing many liquid enclosures.

Orthoclase—without inclusions or rare liquid inclusions, dull aspect, and milky colour, crystals tabular and thick, Carlsbad twins.

Microcline.

Plagioclase—in general aspect dull, decomposed in micaceous substance into epidote, in pinitoide, in fibro-radiate zeolithic matter, in quartz, in calcite.

Pyroxene—enstatite, bronzite, diallage and augite, the latter very often decomposed, transformed into ouralite.

Amphibole—greenish colour, often decomposed into epidote, &c., associated with quartz and calcite; fibrous forms, extremely irregular (Hypersthene).

Muscovite.

Wanting.

Wanting.

Wanting.

Tourmaline.

Anatase, Rutile, Brookite.

Cordierite.

II.

Quartz—containing vitreous enclosures.

Sandstone—many vitreous and gaseous inclusions, aspect vitreous and brilliant, structure zonary, characteristic cracks independent of the cleavage; cleavage following $\infty P \infty$. Baveno twins.

Wanting.

Plagioclase—(Microtine), aspect vitreous, in general decomposition less advanced in the Microtine than in the plagioclases of ancient rocks; vitreous and gaseous enclosures more frequent and better marked; enclosures of associated minerals, &c.

Pyroxene—especially augite, slightly decomposed; numerous vitreous enclosures, especially in the augites of basalts, zonary.

Amphibole—deep brownish tint, generally with crystallographic contours more marked, zones of different colours, sections surrounded with magnetite, compact, numerous inclusions.

Wanting or secondary.

Trydimite.

Leucite.

Nosean and Hauzime.

Zeolithes.

Wanting.

Wanting.

Extremely rare.

It is scarcely necessary to mention that all the foregoing refers only to massive crystalline rocks, and when the minerals are in an isolated state we cannot always say whether they come directly from these rocks, or from the disintegration of sedimentary layers, or from schisto-crystalline rocks. These latter frequently occur in the deposits. In these questions we have always taken into consideration the lithological associations and the geographical position of the deposit.

J. M. and A. R.

greenish coloured glauconitic casts of Foraminifera. Most of the quartz particles are seen to be of clastic origin. Sections of a pale green mineral of a lamellar structure are biotite. Some sections have the characteristic cleavage of hornblende; kaolinised feldspar is rare.

Some of the larger mineral particles making up the annelid tubes are about 6 mm. in diameter, these are pieces of quartz, and little pebbles, which last, by transmitted light, are seen to be pieces of Cambrian (?) sandstone, composed of angular quartz, triclinic feldspar, and mica. Others of these fragments are diabase, composed of augite, triclinic feldspar, and quartz, others are tourmaline rock, of which the base is quartz; and finally, other pebbles are fragments of gneiss and amphibolic gneiss.

In the mud in the sounding-tube there was a rolled fragment of gneiss 2 centimetres in diameter.

List of the Animals taken at this Station.

| | |
|---|-------------|
| Pisces. | |
| <i>Cottunculus microps.</i> | Collett. |
| <i>Liparis liparis.</i> | L. |
| <i>Lycodes muræna.</i> | Collett. |
| " <i>pallidus.</i> | " |
| <i>Motella macrophthalma.</i> | Stur. |
| Mollusca. | |
| <i>Arca pectunculoides</i> , var. (<i>septentrionalis</i>). | Sc. |
| <i>Buccinum mörchi.</i> | Friele. |
| " <i>hydrophanum</i> , var. | Hancock. |
| <i>Fusus turritus.</i> | M. Sara. |
| " <i>lachesis.</i> | Mörch. |
| " <i>sabini.</i> | Gray. |
| <i>Mohnia alba.</i> | Fr. |
| Echinoidea. | |
| <i>Pourtalesia jeffreysii.</i> | Wyv. Thom. |
| Ophiuroidea. | |
| <i>Ophioglypha signata.</i> | VII. |
| Asteroidea. | |
| <i>Archaster tenuispinus.</i> | Düb. & Kor. |
| Crustacea. | |
| <i>Bythocaris payeri.</i> | Heller. |
| <i>Hymenodora glacialis.</i> | Bucholz. |
| <i>Diastylis josephinæ.</i> | G. O. Sars. |
| " <i>longipes.</i> | G. O. Sars. |
| <i>Cyclaspis longicaudata.</i> | G. O. Sars. |
| <i>Boreomyxis insignis.</i> | G. O. Sars. |
| <i>Eurycope gigantea.</i> | G. O. Sars. |
| " <i>corunta.</i> | G. O. Sars. |
| <i>Anomys lagena.</i> | Kröyer. |

| | |
|---|---------------|
| <i>Aplys carinatus.</i> | Fabr. |
| <i>Eusirus cuspidatus.</i> | Kröyer |
| <i>Halirages elegans.</i> | n. sp. |
| <i>Haploops setosa.</i> | Böck. |
| <i>Egina spinosissima.</i> | Stimpson. |
| <i>Scalpellum nymphocola.</i> | n. sp. |
| Pycnogonida. | |
| <i>Nymphon stroemii.</i> | Kröyer. |
| " <i>grossipes.</i> | Fabricius. |
| " <i>macronyx.</i> | G. O. Sara. |
| <i>Colossendeis proboscidea.</i> | Sabine. |
| Annelida. | |
| <i>Eunoe equibia.</i> | n. sp. |
| <i>Nephtys longisetosa.</i> | Ørst. |
| <i>Nolhria hyperborea.</i> | Hansen. |
| <i>Trophonia.</i> | n. sp. |
| <i>Thelepus circinatus.</i> | Fabr. |
| <i>Sabella</i> (fragt.). | |
| <i>Nemertes.</i> | n. sp. |
| <i>Phascolosoma.</i> | |
| <i>Tomopteris onisciformis.</i> | |
| Medusæ. | |
| * <i>Lucernaria bathyphila</i> , n. sp. | Hæckel. |
| Porifera. | |
| <i>Stylorhiza stipitata.</i> | Osc. Schmidt. |
| Polyzoa. | |
| <i>Alcyonidium.</i> | |
| Alcyonaria. | |
| <i>Alcyonium.</i> | |

(d.) Soundings, Dredgings, and Trawlings on the Ridge.

Sounding 7. Lat. 59° 58' N., long. 7° 22' W. 27th July 1880.
Depth, 300 fathoms. Surface temperature, 55·0°; bottom temperature, 48·0°.

BLUE MUD, plastic, earthy, with many gritty particles.

CARBONATE OF CALCIUM 11·77 per cent., consists of a few Cocoliths and Cocospheres, Globigerinas, Orbulinas, Pulvinulinas, Truncatulinas, Uvigerinas, Miliolas, &c., fragments of Echini, Ostracodes, Molluscs.

RESIDUE 88·23 per cent., blue-brown, consists of—

Minerals [70·00], m. di. 25 mm., with many much larger particles, many rounded; quartz, mica, augite, hornblende, magnetite, chert, mono- and triclinic feldspar, fragments of sandstone, mica-

* This species is described in Hæckel's "*System der Medusen*," p. 640.

schists, and other rocks, glauconite, and many fragments of highly altered rocks resembling glauconite.

Siliceous organisms [1·00]: one or two Radiolarians and fragments of other siliceous organisms, and a few glauconitic casts.

Fine washings [17·23]; fine mineral particles with argillaceous matter.

Remarks.—The carbonate of lime consists chiefly of the remains of surface organisms.

The feldspar is generally kaolinised; typical glauconite is found in grains more or less mammillated and furrowed; some are quite green, while others are reddish coloured. Among the larger fragments are pieces of feldspathic sandstone (6 mm. in diameter) of granite and fine-grained mica schist.

Sounding 17. Station 2. Lat 60° 29' N., long. 8° 19' E. 28th July. Depth, 375 fathoms. Surface temperature, 53·0°; bottom temperature, 31·0°.

A small quantity of mud came up in the sounding tube, of which the following is a description:—

BLUE MUD, plastic, coherent, with many rather large gritty particles—streak lustrous.

CARBONATE OF CALCIUM 14·20 per cent., consists of a few *Coccoliths*, *Globigerinas*, a few *Miliolinas*, *Rotalias*, *Nonioninas*, *Truncatulinas*, *Ostracode* valves, and fragments of *Echini*.

RESIDUE 85·80 per cent., brownish, consists of—

Minerals [70·00], m. di. 25 mm., with many particles over 1 mm. in diameter—quartz, mica, magnetite, feldspar, hornblende, glauconite, augite, fragments of ancient and recent volcanic rocks.

Siliceous organisms [2·00]: one or two *Sponge* spicules, glauconitic casts of *Foraminifera*, few *Diatoms*.

Fine washings [13·80]; fine mineral particles with argillaceous matter, and a very few fragments of siliceous organisms.

Remarks.—The dredge, with two swabs and a bread bag in the netting, was put over at 8 P.M. on the 28th, and hauled in at 4 A.M. on 29th July.

It contained over a quart of gravel and small stones, and some larger stones—some of them were covered with a thin coating of peroxide of manganese on one of their surfaces, and had many *serpulae* and *polyzoa* attached.

The following are the principal varieties of rocks dredged :—

1. A fine-grained reddish sandstone (Cambrian ?) compact, with lamellæ of mica. This fragment is about $12 \times 8 \times 4$ inches, and had polyzoa, serpulæ, and rhizopods attached to it. The angles are more or less rounded. On the upper surface there are parallel striæ, which may be glacial markings. The whole upper surface and edges are blackened by manganese deposit. This fragment was only very partially imbedded in the mud.
2. A rounded fragment of diorite, fine-grained, containing plagioclase, orthoclase, hornblende, and quartz. This fragment was also blackened by manganese except the under surface, where it evidently rested on the mud, and is about 4 inches in length.
3. A micaceous sandstone, fine-grained; the mica appears to be biotite. This fragment is about 5 inches long and is angular.
4. Mica-schist with biotite.
5. Altered mica-schist.
6. Gneissic rock, with quartz, orthoclase, and mica.
7. Diorite—containing plagioclases, amphibole, and quartz.
8. A fine-grained limestone.
9. Compact crystalline rock, containing hornblende, quartz, and feldspar passing to diorite.
10. Amphibolic rock.
11. Chloritic rock.

The majority of these fragments were covered on one of their surfaces with a black deposit of manganese, and nearly all of them when lying on the bottom most probably projected above the deposit in which they were placed. Some of them were perfectly rolled fragments with smooth surfaces, while others were angular.

List of the animals taken in the dredge.

Mollusca.

| | |
|----------------------------------|-----------|
| <i>Fusus islandicus</i> (young). | Chemnitz. |
| " <i>lachesis</i> . | Mörch |
| <i>Pleurotoma declivis</i> . | Lovén. |

Ophiuroidea.

| | |
|-------------------------------|------------|
| <i>Ophiactis abyssicola</i> . | Ljn. |
| <i>Ophiocolex glacialis</i> . | Müll. & Tr |

Asteroidea.

| | |
|---|--------|
| <i>Crossaster papposus</i> (Linck), var. <i>septentrionalis</i> . | n. sp. |
|---|--------|

| | |
|--|------------|
| Porifera. | |
| <i>Tisiphonia agariciformis.</i> | Wyv. Thom. |
| <i>Reniera</i> , sp. | |
| <i>Hollenia</i> (?) (fragment). | |
| Annelida. | |
| <i>Serpula</i> , attached to stones. | |
| Actinia. | |
| <i>Halcampa clavus.</i> | |
| Hydroida. | |
| <i>Tubularia indivisa.</i> | |
| <i>Hydroid</i> (?) | |
| Cephalopoda. | |
| <i>Cephalopod.</i> | |
| Polyzoa. | |
| <i>Lepralia (Alysidota) alderi.</i> | Bk. |
| „ <i>granifera.</i> | Johnst. |
| „ <i>polita.</i> | Norman. |
| „ <i>dutertrei.</i> | Aud. |
| <i>Aleclo (Stomatopora) granulata.</i> | Hincks. |
| <i>Diastopora obelia.</i> | |
| <i>Discoporella hispida.</i> | Hincks. |
| Pycnogonida. | |
| <i>Nymphon.</i> | |

Sounding 28. Lat. 60° 2' N., long. 7° 4' W. 4th August 1880. Depth, 285 fathoms. Surface temperatures, 56·5°. Bottom temperature, 48·0°.

BLUE-BROWN MUD, slightly coherent with many gritty and sandy particles.

CARBONATE OF CALCIUM 16·29 per cent., consists of Coccoliths, Coccospheres, Globigerinas, Orbulinas, Truncatulinas, Miliolinas, Pulvinulinas, Nonioninas, &c, fragments of Echini, Molluscs, Ostracode valves.

RESIDUE 83·71 per cent., brownish, consists of—

Minerals [70·00], m. di. .25 mm., with fragments over 1 mm. in diameter. Quartz, rounded fragments of sandstone and other rocks, magnetite, hornblende, glauconite, and highly altered fragments of rocks resembling glauconite.

Siliceous organisms [2·00]: a few Diatoms and glauconitic casts.

Fine washings [11·71]; fine mineral particles and argillaceous matter.

Station 1. 27th July. 305 fathoms. Lat. 60° 4' N., long. 7° 37' W. Bottom temperature, 47·1°. Surface temperature, 54·8°.

A little bluish mud came up in the sounding tube.

The dredge was used without bag.

It came up with about a pint of rounded and angular stones,—sandstone, gneiss, mica-schist, diorite,—the same as those taken at Station 2.

List of the animals taken.

| | |
|---|-------------|
| Mollusca. | |
| <i>Platydia anomoides.</i> | Sc. and Ph. |
| <i>Astarte sulcata</i> , var. (<i>minor</i>). | Da Costa. |
| Echinoidea. | |
| <i>Dorocidaris papillata.</i> | A. Ag. |
| <i>Echinus norvegicus.</i> | Düb & Kor. |
| Crustacea. | |
| <i>Munida rugosa.</i> | Fabr. |
| Annelida. | |
| <i>Placostegus tridentatus.</i> | Fabr. |
| <i>Serpula</i> , attached to stones. | |
| Porifera. | |
| <i>Sponges</i> , attached to stones. | |
| Cephalopoda. | |
| <i>Cephalopod.</i> | |
| Corals. | |
| <i>Caryophyllia.</i> | |
| Polyzoa. | |
| <i>Lepralia granifera.</i> | |

CONCLUDING REMARKS.

The dredgings and trawlings during the "Knight Errant's" cruise have, according to the above lists and the supplementary reports which follow, given us 16 new species and one new genus.

The trawlings and dredgings in the warm area (stations 4, 5, 6, and 7) yielded 71 species. The single trawling in the cold area (station 8) yielded 47 species.

It is a somewhat remarkable fact that in these dredgings there are only 2 species common to both areas, viz., *Haploops setosa* and *Nymphon stræmii* excluding of course the foraminifera.

It will be interesting to learn if the same remarkable difference in the fauna on either side of the Wyville Thomson Ridge will be shown by more extended dredgings and trawlings during the present season in H.M.S. "Triton."

The dredgings on the ridge did not yield many animals, and these resemble rather those of the warm, than of the cold area.

The animals captured at the stations surrounding North Rona all belong to known British species.

What is the legitimate limit of the "British fauna"? Are the Farø Channel animals to be included in it? These are questions which have been often asked, and, although they appear to us unimportant, yet are not without interest.

When we regarded the marine fauna as having a depth limit, the question answered itself—the British fauna ended doubtless with the existence of the fauna. Now, since we know that the marine fauna has no depth limit, we must, if we wish a limit, fix an artificial one.

Temperature is the most important factor in the distribution of marine species. The mean annual temperature of the ocean and of the shallow water around coast-lines varies from about 29° Fahr. in the polar regions to about 75° Fahr. under the equator. This great inequality of temperature is the limiting cause of the distribution of marine species, both at the surface of the sea and in shallow water.

Pelagic species have a marked and limited distribution depending on temperature,—quite as much as species inhabiting the shore waters,—and this distribution can be traced on the bottom of the ocean in many instances.

By an examination of an oceanic deposit, it is possible to tell approximately its latitude from the character of the dead shells of surface organisms found in it. The depth from which the deposit came, and also its longitude, can in many instances be approximately determined by careful microscopic examination of the fragments, organic and inorganic, of which it is composed. While the surface of the ocean, like the surface of the land, has its climates, it is quite otherwise with the deep sea.

The mean temperature of the bottom of the ocean is about 35° Fahr., so that an enormous expanse of the sea-bottom, covering nearly three-fourths of the surface of the earth, is under circumstances where there is no bar to general diffusion, and the result is that this vast area, with a temperature say under 40° Fahr., admitting of free migration, is inhabited by a fauna whose most marked characteristic is extreme uniformity.

The temperature of 35° Fahr. rises in the polar regions towards the surface, and we should expect therefore that the shore and deep-

sea faunas would meet in these regions in comparatively shallow water.

Our deep-sea investigations give many examples which tend to corroborate this view.

In the Faroe Channel we have a mixture of abyssal, arctic, and modified British forms. Further investigations may show that a temperature limit can be drawn within which the British fauna should be restricted, but it is at the same time evident that this fauna is continuous, on the one hand, with the abyssal, and, on the other, with the arctic fauna in the Faroe Channel.

We desire to acknowledge our indebtedness to the many scientific men who have supplied us with information and furnished us with reports.

In the work of the exploration we were throughout assisted by Lieut. Hammond, R.N.

In the practical zoological work we received much assistance from Mr. Frederick Pearcey and Mr. James Chumley, assistants on the staff of the "Challenger" Expedition Commission.

JOHN MURRAY.

THOS. H. TIZARD.

"CHALLENGER" OFFICE, 32 QUEEN STREET,
EDINBURGH, *May 1882.*

Report on the FISHES. By Dr. A. Günther, F.R.S.

This Report was received by the late Sir C. Wyville Thomson in
November 1880.

The bathybial fish-fauna which surrounds the British Islands was hitherto almost unknown. Besides the stray specimens which now and then were found thrown ashore or floating on the surface, no further evidence of the existence of this fauna was obtained, except on two occasions, viz., on a dredging-excursion of Dr. Gwyn Jeffreys in 1867, from a depth of from 80 to 90 fathoms;* and during the cruise of H.M.S. "Porcupine" in 1869, from a depth of from 200 to 500 fathoms.†

Neither of these two contributions can compare as regards interest

* See *Ann. and Mag. Nat. Hist.*, 1867, vol. xx. p. 287.

† *Ibid.*, 1874, xiii. p. 138.

and number of specimens with the series obtained during the cruise of the "Knight Errant"; and it would seem as if now only the rich spoil, which I ventured to indicate in 1867 as likely to result from an exploration of the deep sea round the British Islands, were being gathered. Six out of the ten species obtained are new to the British fauna, and, of course, represent but a small fraction of the actual number of British deep-sea fishes. Much, therefore, remains to be done. The laws which govern the bathymetrical distribution of fishes are still obscure; and it is evident that a series of continued systematic observations, such as can be made in a limited oceanic district, like that round the British Islands, whose hydrographic conditions, with its surface and coast fauna, are so well known, is most likely to reveal the chain of facts which cannot be recognised in disjointed observations made at distant localities. Besides, there are not a few obscure points in the life history of our food-fishes which may well be expected to be cleared up by the deep-sea dredge; such are the unaccountable disappearance from certain parts of the coast of fishes like the haddock, and the change of habitat of many fishes according to the season, a change which evidently much more frequently takes place in a vertical than in a horizontal direction. It is therefore to be hoped that the present successful expedition will be followed by equally well conducted efforts.

The collection submitted to my examination contains a much greater proportion of arctic forms than of southern, and in this respect differs entirely from that made by Mr. Gwyn Jeffreys at a less depth. The only southern form is *Haloporphyrus lepidion* which we knew previously from the Mediterranean, Japan, and South Atlantic. Singularly, again, no trace of a *Trachypterus* or *Regalecus* was obtained; and we can account for their absence only by the supposition that it is difficult to enclose these long snake-like fishes in the dredge, and that young specimens, from their extreme delicacy of structure, are probably torn into fragments and lost long before the net reaches the surface. Some of the species had been previously obtained by the Scandinavian expeditions in similar latitudes towards the east. As all the species will be fully referred to or described in my report on "Challenger" deep sea fishes, only a few notes on them are appended here.

1. *Chimæra monstrosa*, L.—A young specimen was obtained at a

depth of 555 fathoms; therefore, this fish will have to be admitted in the fauna of the deep sea. Its horizontal distribution includes the northern and southern coasts of Europe, Japan, and the Cape of Good Hope.*

2. *Cottus thomsonii*, sp. n.—Hitherto one species only of this littoral genus was known from the deep sea, viz., *Cottus bathybius*, which was dredged on the "Challenger" expedition near Japan in a depth of 565 fathoms. The single specimen before us was obtained in 555 fathoms (Station 4), and is 7 inches long. It may be shortly characterised thus:—

The præopercular spines, like the remainder of the armature of the head, are short pointed tubercles covered by the skin. Four similar spines are placed in a quadrangle on the crown of the head, the quadrangle being much longer than broad. Eyes large, as long as the snout, their longitudinal diameter exceeding the width of the interorbital space. Vomerine teeth in two oblique bands separated in the middle; palatine teeth none. The first dorsal fin enveloped in skin, continuous with the second. Ventrals rather short, terminating at a considerable distance from the vent. Skin with scattered minute granules. Colourless (in spirits). D. $\frac{5}{17}$, A. 13, P. 22, V. 2.

3. *Cottunculus microps*, Collett.—This singularly shaped Cottoid is quite a recent discovery, a single very young specimen having been obtained by the Scandinavian explorers and described by Mr. Collett. Adult examples, up to 12 inches long, in a perfect state of preservation, are in the collection. Station 8, 540 fathoms.

4. *Liparis liparis*, L.—New to the deep-sea fauna. Station 8, 540 fathoms.

5. *Lycodes muræna*, Collett, and 6. *Lycodes pallidus*, Collett—both new to the British fauna, and only recently described. Station 8, 540 fathoms.

7. *Haloporphyrus lepidion*, Risso.—Specimens of this fish, which was originally known from Madeira and the Mediterranean, and met

* This specimen was 2 feet in length (caudal filament included). When taken from the trawl the pectoral and dorsal fins were covered with a green sheen on a velvety black ground, the sheen being more pronounced at the base of the fins than towards the tips. The back, tail, and head were light brown. The belly and long whip-like portion of the tail were white. There was a bluish colour about the mouth and gills. The eye had a beautiful golden appearance. A green sheen surrounded the pupil. J. M.

with by the "Challenger" in the Japanese Sea and South Atlantic at depths of 345 and 600 fathoms, seem to be quite common in the British district, having been obtained at Station 4 in 555 fathoms, and at Station 6 in 530 fathoms.

8. *Brosmius brosmæ*, Müll.—A large example in 530 fathoms (11th August 1880); new to the deep-sea fauna.

9. *Motella macrophthalmæ*, Stur.—Previously known from a depth of 80 fathoms; the specimens obtained on this occasion come from a depth of 540 fathoms; Station 8.

10. *Macrurus*, sp. n. (?).—Two young specimens from Station 4, 555 fathoms, which have lost the greater part of their scales, approach closely *M. trachyrhynchus*, and may possibly represent only the young state of this species. Their snout is conspicuously shorter than in a large specimen of the true *M. trachyrhynchus*, from the Mediterranean, but as this may be due to age, I hesitate to give an opinion, until I have had an opportunity of examining smaller specimens from the Mediterranean. New to the British fauna.

Report on the MOLLUSCA. By Dr. Gwyn Jeffreys, F.R.S.

This Report was received by the late Sir C. Wyville Thomson in November 1880.

Station 1; 305 fathoms.

Platydia anomioïdes, Scacchi and Philippi.

Astarte sulcata, Da Costa; var. *minor*.

Station 2; 375 fathoms.

Fusus islandicus, Chemnitz (young).

F. lachesis, Mörch.

Tritonium terebrale, M. Sars (MS.); not *F. terebralis*,

Gould, which is *F. spitzbergensis* of Reeve.

Pleurotoma declivis, Lovén.

Station 3; 53 fathoms.

Circe minima, Montagu.

Venus fasciata, Da Costa.

Tapes virgineus, Linné (young).

Tellina crassa, Gmelin.

Psammobia costulata, Turton.

Maetra solida, L. ; var. *elliptica*.
Saxicava rugosa, L. ; var. *arctica*.
Eulima polita, L.
Natica montacuti, (*montagui*) Forbes.
Aporrhais pes-pelecani, L.

Sounding ; 38 fathoms.

Venus fasciata, Da Costa.

Station 5 ; 515 fathoms.

Fusus sarsi, Jeffreys ; (young).
F. togatus, Mörch.
F. mœbii, Dunker and Metzger.

N.B.—*F. ebur* of Mörch was admitted by him to be only a worn specimen of a variety of *F. propinquus*, Alder.

Station 6 ; 530 fathoms.

Amussium hoskynsi, Forbes.
Pecten imbrifer, Lov.
P. mammillatus, M. Sars.
Aporrhais serresianus, Michaud.
Fusus fenestratus, Turton.
Buccinum fusiforme, Broderip.
F. berniciensis, King, var. *elegans*.
F. islandicus, Lov. ; not of Chemnitz.

Station 7 ; 530 fathoms.

Arca pectunculoides, Sc.
A. raridentata, S. V. Wood.
Leda lucida, Lov.
L. frigida, Torell.
Nucula tumidula, Malm.
N. pumila (Lov.), Asbjörnsen.
N. corbuloides, Seguenza.
Cardium minimum, Ph.
Næra striata, Jeffreys.
N. obesa, Lov.
Hela tenella, Jeffreys ; young.
Natica montacuti, Forbes ; young.
Aporrhais serresianus, Michaud ; young.

Cerithium metula, Lov.
Columbella costulata, Cantraine.
C. halizeti, Jeffreys.
Back. Synonym.
Cylichna alba, Brown.
C. ovata, Jeffreys.

Station 8 ; 540 fathoms.

Arca pectunculoides, Sc. ; var. *septentrionalis*.
Buccinum hydrophanum, Hancock ; var.
B. mörchi, Friele.
Fusus turritus, M. Sars.
 Not *F. propinquus*, Alder ; var.
F. lachesis, Mörch.
F. sabini, Gray.
F. stimpsoni, Mörch.
Mohnia alba, Friele.

I subjoin a list of what I consider the northern species of *Buccinum*. For their synonyms see the "Annals and Magazine of Natural History for December 1880" :—

1. *Buccinum glaciale*, Linné.
2. *B. undatum*, L.
3. *B. grænlandicum*, Chemnitz.

This is closely allied to *B. undatum* ; and both may be one and the same species.

4. *B. hydrophanum*, Hancock.
5. *B. humphreysianum*, Bennett.

Not *B. humphreysianum* of Möller, Lovén, Middendorff, M. Sars, Danielssen, or Malm.

6. *B. totteni*, Stimpson.
7. *B. tenue*, Gray.
8. *B. ciliatum*, Fabricius.

Report on the CRUSTACEA. By the Rev. A. M. Norman, Burnmoor Rectory, Fence Houses, Co. Durham.

This Report was received by the late Sir C. Wyville Thomson in November 1880.

Mr. Norman says :—"I send a list ; it is a very interesting one. No. 8 was a grand haul, the best I have ever examined from the North Atlantic. It leads off with a species (*Bythocaris Payeri*, Heller) discovered by the German Arctic Expedition. The second (*Hymenodora glacialis*, Bucholz) was discovered in the Austrian Arctic Expedition, and there follow several of the species of the Norwegian Expeditions. You will see that there are three or four things which I take to be new ; one of these, the *Nephropsis*, is not unlike *Nephrops norvegicus*, but the arms quite different, not angled, and hairy, and the eye rudimentary.

Station 1.

Munida rugosa, Fabr.

Station 3.

Stenorhynchus longirostris, Fabr.

Hyas coarctatus, Leach.

Ebalia tuberosa, Pennant.

Munida rugosa, Fabr.

Ligia oceanica (this must have been from Shore).

Eurydice truncata, Norman.

Scalpellum vulgare, Leach.

Station 4.

Munida tenuimana, G. O. Sars.

Nephropsis atlantica, n. sp.

Station 5.

Dorhynchus thomsoni, Norman.

Amathia carpenteri, Norman.

Munida tenuimana, G. O. Sars

Two or three Amphipods (small) to be examined.

Station 6.

Geryon tridens, Kröyer.

Munida tenuimana, G. O. Sars.

Station 7.

Amathia carpenteri, Norman.

Munida tenuimana, G. O. Sara.

Eurydice polydendrica, Norman and Stebbing (MS.).

Haploops setosa, Boeck.

Ampelisca compacta, n. sp.

One or two more Amphipods to be examined.

Station 8.

Bythocaris payeri, Heller.

Hymenodora glacialis, Bucholz.

Boreomysis insignis, G. O. Sara.

Diastylis Josephinae, G. O. Sara.

„ *longipes*, G. O. Sara.

Cyclaspis longicaudata, G. O. Sara.

Eurycope gigantea, G. O. Sara.

„ *cornuta*, G. O. Sara.

Anonyx lagena, Kröyer.

Atylus carinatus, Fabricius.

Eusirus cuspidatus, Kröyer.

Halirages elegans, n. sp.

Haploops setosa, Boeck.

Egina spinosissima, Stimpson.

Nephropsis atlantica, Norman, n. sp.

Carapace finely granulated and pubescent all over, with strongly marked transverse lines; rostrum rather longer than the peduncle of the upper antennæ, its extremity acute, its sides bearing two pairs of strong spines; a third pair of spines is situated at its base, and a fourth pair on the front of the carapace over the insertion of the exterior antennæ. The spines just described are the largest, but there are also on the central portion of the carapace two rows of about six spines each, of which the foremost is the largest, while the others are very small, these rows pass backward from the central portion of the base of the rostrum; there is another and strong spine on a line with and behind the spine which is situated on each side of the base of the rostrum.

Pleon having the segments furnished with a slight central keel dorsally; the epimera of the first segment not produced downwards, those of the four following segments, greatly produced downwards triangularly, and gradually attenuating, end in sharp spine-like points, the anterior margins of the epimera of the second segment furnished with a single acute anteaally directed spine; epimera of the sixth segment with two small spine-like points, one directed downwards, the other backwards over the insertion of the outer uropods; telson quadrate, the extremity truncated, bearing two divergent ridges which terminate at the distant corners in spine-like points; uropods gently rounded at their extremities, each with two raised ridges, one central, the other running along the outer margin and terminating in strong spines; there is also a spine on the upper surface of the basal joint.

Eyes minute, and apparently devoid of lenses, of a pink colour, lying close together and touching each other, being situated directly under the rostrum, by which they are entirely concealed, and resting on the upper antennæ.

Upper antennæ, which are furnished with two flagella as in allied genera, have the first and third joint subequal in length, and the middle joint about half their length; the flagella are about half as long again as the peduncle.

Lower antennæ are, in the specimen procured, imperfect, but the peduncle is short, equal in length to that of the upper antennæ; green gland with a conspicuous opening on the under side of the basal joint.

Chelipeds densely setose; with rounded joints, which present no appearance of angularity; the meros, which is the largest joint, does not quite reach the extremity of the rostrum; it bears a single spine at the extremity of the upper and outer margin, and another on the under surface; carpus furnished with three spines on the inner and one on the outer margin, and one on the under surface; hand unarmed, elongate, ovate, finger and thumb acute, with crenated inner margin, their tips crossing when closed.

The two following pairs of feet chelate, their coxæ furnished on the inner margin with large lobes, that of the third pair having a hook-shaped process on the outer side of the extremity of this lobe.

First pair of pleopods elongate, spatulate, porrected between the

bases of the pereopods, adpressed closely to the body, and reaching the coxæ of the third pair.

Length $3\frac{1}{2}$ inches. Length of chelipeds rather more than 2 inches.

“Knight Errant” August 10, 1880. Station 4; in 555 fathoms.

Mr. Wood Mason (*Journal Asiatic Society of Bengal*, vol. xiii. 1873; and *Ann. Nat. Hist.* ser. 4, vol. xii. 1873, p. 59), established the genus *Nephropsis* in 1873 for the reception of a small lobster-like crustacean which he procured in 260–300 fathoms off Ross Island, on the coast of the Andamans. The genus approaches very closely to *Nephrops*, but differs from it in the absence of the antennal scale of the lower antennæ. In 1880 Mr Spence Bate procured a second species, *Nephropsis cornubiensis*, off the Cornish Coast (*Report Brit. Assoc.*, 1880, p. 160), and mentioned that he had in his hands a third species taken during the “Challenger” Expedition in 700 fathoms, south of New Guinea, and a fourth, procured also by the “Challenger” in 800 fathoms off Bermuda, and remarked that “the resemblance of all four species is very close, and the distinction of one from the other is dependent chiefly upon the modified forms of more or less important parts.” In the same year Professor A. Milne Edwards described (*Ann. des Sci. Natur.*, vi. 9) *Nephropsis Agassizii* from 1500 meters, coast of Florida, but this description I have not seen; and almost at the same time Mr. S. I. Smith characterised (*Proc. National Museum, Washington*, vol. iii. p. 431) yet another form, *Nephropsis aculeatus*, which was taken off the coast of the United States in 100–126 fathoms. The foregoing description of *N. atlantica* was drawn up in November 1880, and the “Knight Errant” specimen was at the same time returned to Sir Wyville Thomson, and I have not since seen it. Comparing the description with that subsequently published by Mr. Smith, there is the strongest suspicion that they are the same species; but all the forms seem to be very closely allied, if indeed distinct. Mr. Smith describes the carapace of *N. aculeatus* as “showing no difference whatever” from *N. stewartii* except in having rather a longer rostrum. Now the spiny armature of *N. atlantica* is certainly different from that assigned to *N. stewartii*, and therefore I do not feel justified in assigning the “Knight Errant” specimen to *N. aculeatus*, though at the same time I very unwillingly give it a name.

Boreomysis nobilis, G. O. Sars.

Boreomysis nobilis, G. O. Sars, "Crustacea et Pycnogonida Nova in itinere 2do et 3tio Expeditionis Norvegicæ anno 1877 et 1878 collecta," *Archiv. for Matematik og Naturvidenskab*, 1880, p. 428.

Animal more or less mottled and suffused with red, younger specimens are paler in colour, but apparently the telson is always red. Rostrum horizontal, very acute, nearly as long as the eye when protracted. Antero-lateral corner of carapace produced into a triangular process projecting over the base of the inferior antennæ; hinder margin of carapace excavated in the centre, and there exposing the last segment of the pereion. Eyes rather flattened, broad, reaching slightly beyond the side of the carapace, having a small tubercle on the inner side of the peduncle and just below the well-developed dark-coloured eye itself. Upper antennæ having the second joint of the peduncle short, not half the length of the third, and not so patelliform as is usual in this genus. The lower antennæ have the scale much elongated, narrow, and gradually tapering, twice the length of the peduncle of the upper antennæ, its outer margin plain with a small spine at the apex; the apex slopes at once towards the inner margin and together with that margin is setose. Telson long, but not quite reaching the end of the inner uropods, which show no trace of an acoustic organ, and much shorter than the outer, excavated above, and cleft to about one-fifth of its length, its sides unarmed for half their length, but their distal half set with numerous (about 30) slender, closely-arranged, subequal spines, the cleft portion of the telson closely denticulated. Length about 65 millimetres.

Several specimens taken at Station 8, in 540 fathoms.

The above description was drawn up in 1880, when the specimens came into my hands. On comparison with the description published shortly afterwards by my friend Professor Sars, there can be no doubt of the identity of the "Knight Errant" example with the single male which was dredged by the Norwegian Expedition in 1878 in 459 fathoms, 79° 0' 59" N. lat., 5° 40' E. long. I may add to my original description that the tarsus of the legs is composed of three articulations, as in the type specimen of Sars.

Ampelisca compacta, Norman, n. sp.

Pleon not keeled, a very slight depression across the middle of the fifth segment, hind margin of that segment with a spine-like point, but not largely developed nor upturned. Upper antennæ exceeding the length of the peduncle of the lower by about a length equal to the last joint of that peduncle, flagellum consisting of ten articulations; lower antennæ much longer than the upper, and having the two last joints of the peduncle subequal to each other. Eyes apparently altogether absent. First two pairs of pereopods with the last joint about equal to the two preceding combined. The last pereopods have the basos with the posterior lobe well developed reaching to the end of the ischium, the lower margin truncate and slightly concave; ischium equal in length to the two following joints combined, meros short, carpus rather longer, manus not quite equal to the two preceding joints combined, dactylus half the length of manus; the lower joints are all flattened but simple (not produced downwards as in *A. lævigata*). First two pairs of uropods of the same length, subequal in length to the deeply cleft telson, and reaching to about one-fourth the length of the sparingly-ciliated branches of the last uropods; the outer margin of the outer branch of the second uropods bears two spines, and under a high power of the microscope is seen to be minutely crenulated. The entire animal has a rounded compact appearance, and is about 8 millimetres long.

A single specimen. Station 7; 530 fathoms.

Halirages elegans, Norman, n. sp.

Pereion and pleon not carinated, two last segments of the former and two first of the latter bearing a single central dorsal spine-like process, which is small on the first of these segments (and sometimes absent), but increases in size on each of the succeeding segments; fourth segment of pleon with a deep transverse sulcus. Lower and front angles of the head produced into an acute spine-like process; epimera of first and second pereion segments with serrated margins, the first also produced forwards into a sharp angle, rounded behind, the second rounded before and behind. Lower margin of the pleon segments not serrated, bearing rows of rather distant seta-like spines

a little within the borders, the second and third segments angled at the hinder corner, and the third also produced into a small spine-formed point, and the posterior margin not waved but finely crenated. Antennæ of both pairs very long, the upper pair as long as the entire animal, peduncles of both pairs remarkably round and smooth, peduncle of the upper pair reaching nearly to the end of the penultimate joint of that of the lower; the first joint large, round, and smooth, with two distal spines on the lower side; the second joint nearly as long as, but only half the thickness of, the first; the third very small. Peduncle of the lower antennæ having the two distal joints subequal in length. All the legs slenderly built, the two gnathopods small and slender, the hand shorter than the wrist, subquadrate, slightly widening from the base to the palm, which is only slightly oblique. Last uropods of great length, more than equal the combined length of the three posterior segments of the pleon, the peduncle not quite reaching to the end of the telson, rounded, smooth, with two distal spines above, branches narrow, round, smooth, margined with spinules, and about twice as long as the peduncle. Telson lanceolate, hollowed above, quite smooth, and not furnished with any spines, apex tridentate, the centre tooth large, the laterals small, the tridentate apex is formed by the telson itself (not by articulated spines).

Length 1 inch. Station 8, 540 fathoms.

This species comes very near to *Halirages quadridentatus*, G. O. Sars,* but differs from his description in the form of the epimera of the first segment of pereion, and in the third segment of pleon. Sars does not describe the telson, which is very characteristic.

Report on the PYCNOGONIDA. By Dr. P. P. C. Hoek.

From Station 3 there is one male *Pycnogonum littorale*, Ström, spec.

From Station 5 two specimens of *Nymphon strœmii*, Krøyer.

From Station 7 two specimens of the same species, and still ten other individuals were dredged at Station 8.

* "Prodromus descriptionis Crustaceorum et Pycnogonidarum, quæ in expeditione Norvegica, anno 1876, observavit G. O. Sars," *Archiv. for Matematik og Naturvidenskab*, 1876, p. 357.

The species, an extremely large quantity of which was obtained at Station 8, is the *Nymphon robustum*, Bell, the very same, of which Professor Wyville Thomson published a highly characteristic drawing in his *Depths of the Sea*, under the name of *N. abyssorum*, A. M. Norman.

I got large quantities of the same species from different dredging stations in the Barents Sea; in general the specimens from this locality are larger and stouter than those from the "Knight Errant." The same remark may be made with regard to the specimens of *N. stræmii*, dredged during the cruise of the "Knight Errant," Station 8, and those obtained by the Dutch schooner "Willem Barents" in higher northern latitudes. From the same station (8) a single specimen of *N. grossipes*, Oth. Fabr., and numerous *N. macronyz*, Prof. G. O. Sara, were obtained. The last named species is a very interesting one, which, till now, I knew only from the description of Prof. G. O. Sara. More than forty specimens I picked out from the three bottles with *N. robustum*.

As far as I know the cirriped on the *N. robustum* is new to science. It is a Scalpellum species, for which I propose the name, *Scalpellum nymphocola*.*

As for the large Pycnogonid, four specimens of which were dredged also at station 8, it is *Collossendeis proboscidea*, Sabine, spec., a species by no means rare in the cold area of higher northern latitudes. I will include these species in my Pycnogonid memoir; of *N. robustum*, Bell, *N. stræmii*, Krøyer, and *Collossendeis proboscidea*, Sabine, I prepared detailed descriptions for the narrative of the "W. Barents" cruise; so I will give only their names and a very short notice in my "Challenger" publication. (See Hoek Report Pycn. "Chall.," p. 94-99.)

Report on the POLYZOA. By Dr. Geo. Busk, F.R.S.

Station 1; 305 fathoms. A few fragments of rock, on which were minute colonies of

* A description of this species, with the necessary figures, will be given in my report on the Cirripedia of the Expedition of H.M.S. "Challenger."

1. *Lepralia granifera*, B. M. Cat.

? *Microporella impressa*, Audouin ; Hincks, in a highly calcified condition.

Station 2 ; 375 fathoms. Numerous pebbles and fragments of rock :—

1. *Lepralia (Alysidota) alderi*, Bk.2. „ *granifera*, B. M. Cat.3. „ *polita*, Norman.4. „ *dutertrei*, Aud.

Lep. woodiana, Bk.

Lep. dutertrei, Hincks.

5. *Alecto granulata*, B. M. Cat.

Stomatopora granulata, Hincks.

? 6. *Diastopora obelia*.? 7. *Discoporella hispida*, B. M. Cat.

Lichenopora hispida, Hincks.

Both the latter very small and much worn, so as to be scarcely recognisable.

Station 3 ; 53 fathoms.

1. *Cellepora ramulosa*, Linn.2. *Cellepora avicularis*, Hincks.3. *Eschara compressa*, Sowerb. (sp.).

Cellepora cervicornis, Fleming ; Couch ; Busk ; Sars ; Alder ; &c.

Eschara cervicornis, formâ.

Eschara, Smitt ; D'orb ; Hincks.

Millepora compressa, Sowerb.

Porella cervicornis, Gray.

Porella compressa, Gray ; Hincks.

4. *Bugula flabellata*, J. V. T. (sp.)

Flustra avicularis, Sow.

Flustra angustiloba, Lamk.

Avicularia flabellata, J. V. T.

Bugula flabellata, B. M. Cat. ; Hincks, &c.

Bugula avicularia, formâ, 2. *flabellata*, Smitt.

5. *Bugula plumosa*, Pallas (sp.)

Bicellaria plumosa, Blain N.

Bugula plumosa, B. M. Cat. ; Alder ; Heller ; Hincks, &c.

6. *Flustra foliacea*, Linn. (sp.)
Eschara foliacea, Linn. Ed. 10.
Flustra foliacea, Linn. Ed. 12; Solander; B. M. Cat.;
 Auctt.
7. *Retepora beaniana*, King.
Retepora cellulosa (pars) Anett.
Retepora beaniana, King; B. M. Cat.; Hincks, &c.
Retepora cellulosa, formâ.
beaniana, Smitt.
Eschara beaniana, Smitt. 1878.
8. *Salicornaria farciminoïdes*.
Sal. farciminoïdes, Solander; B. M. Cat.; Cuvier; Auctt.
Eschara and *Flustra fistulosa* (pars), Linn.
Cellaria salicornia, Lamx; Lamarck, &c.
Cellaria fistulosa, Searles Wood; Hincks; Smitt, &c.
9. *Lepralia unicornis* var. *ansata*, B. M. Cat.; Auctt.
Schizoporella unicornis, Hincks.
10. *Porella levis*, Fleming (sp.)
Cellepora levis, Fleming.
Eschara teres, Bk.
Eschara levis, Sars.
Porella levis (*Eschara* formâ), Smitt; Hincks.

The 17 species above enumerated include 13 Cheilostomata and 3 or 4 Cyclostomata. The latter are remarkable for their small size and strongly calcified condition; as were also some of the Lepralioid forms.

All are well-known northern forms, and none present any peculiarities worthy of remark, except that the two species of *Bugula* are represented by very luxuriant specimens. The condition also under which the specimens of *Porella levis* occurred was rather curious; the two or three fragments were, so to speak, enclosed in, and at first sight continuous with, the ramifications of *Cellepora ramulosa*, and were of the same diameter, so that at the first glance the growth appeared to be formed of two distinct kinds of cells.

All the species, it may be remarked, range as far south as the Mediterranean.

Report on the ANNELIDA. By Dr. McIntosh, F.R.S.

This Report was received by the late Sir C. Wyville Thomson in
November 1880.

Station 1.

Placostegus tridentatus, J. C. Fabr.

Station 3.

Lagisca propinqua, Mgn.

Evarne, n. sp.

Glycera capitata, Ersted.

Onuphis bilineata, Baird.

Lumbriconereis fragilis, O. F. M.

Ditrypa arietina, O. F. M.

Serpula vermicularis, L.

Station 4.

Empty chitinous tube, probably the same as one filled with ova
(molluscan ?) from Canada.

Station 5.

Evarne johnstoni, M'L.

Several Nemerteans (*Enopla* and *Anopla*).

Station 6.

Small *Nothria*, and empty muddy tubes probably pertaining to the
Ampharetidæ.

Station 7.

Aphrodita aculeata, L.

Lætmonice filicornis, Kbg.

Leanira hystrixis, Ehlers.

Maldane near *sarsi*, Mgn.

Ampharete arctica, Mgn.

Hydroides norvegica, Gunn.

Protula, fragt.

Station 8.

Eunoe equitis, n. sp.

Nephtys longisetosa, Erst.

Nothria hyperborea, Hansen.

Trophonia, n. sp.

Thelepus circinatus, Fabr.

Sabella, fragt.

Nemertes, n. sp.

Phascolosoma.

Station 10. †

Tomopteris onisciformis.

Report on the HOLOTHURIOIDEA. By Dr. Hjalmar Théel.

This Report was received by the late Sir C. Wyville Thomson in November 1880.

Lætmogone violacea, Théel (*Preliminary Report on the Holothuridae of H.M.S. "Challenger,"* vol. i.; *Bihang Till K. Sv. Vet. Akad. Handl.*, Bd. 5, No. 19, Stockholm, 1879, p. 11).

Station 4, 555 fathoms. Several hundred specimens.

Station 5, 515 fathoms. One specimen.

Station 6, 630 fathoms. One specimen.

It is a somewhat surprising and highly interesting fact that this beautiful animal should be found in abundance in a locality so far from Australia (Station 164, lat. 34° 8' S., long. 152° 0' E.) where the two specimens hitherto known were dredged up during the "Challenger" expedition, at a depth of 950 fathoms. Moreover, it is impossible to discover any characteristic by which these almost antipodal specimens may be distinguished one from the other.

Some species of *Elasipoda* vary a good deal in the number and size of the processes and pedicels; in *Lætmogone violacea* as well as in *Oncirophanta mutabilis*, Théel, and *Lætmogone wyville thomsoni*, Théel, this variation is so great that scarcely any one individual resembles another completely. Many forms of *Elasipoda* appear to congregate in very great numbers on the deep-sea bottoms, walking together in large flocks. During the "Challenger" expedition it was not uncommon to procure at the same time and in the same locality a great many individuals of the same species, sometimes a hundred or more; and this very summer Mr. Murray has found several hundred individuals of *Lætmogone violacea* living together in the same place.

The *Elasipoda* are essentially deep-sea forms. With few exceptions all hitherto discovered genera and species of this order belong to

the oceanic abysses.* Only *Elpidia glacialis*, Théel, has as yet been observed living at comparatively small and moderate depths, about 40 to 100 fathoms, in the Sea of Kara, but the same species was also obtained not far from Greenland, during a Swedish expedition, at a depth of 950 fathoms. The Norwegian Arctic dredging expedition also procured from great depths many specimens larger than those from the Sea of Kara; and the "Challenger" expedition brought home an individual, dredged at Station 160, lat. 42° 42' S., long. 134° 10' E., south of Australia, in a depth of 2600 fathoms. From this it is manifest that while *Elpidia glacialis* is able to exist at a great variety of depths, it is really a deep sea form.

Only two forms (*Ilyodæmon maculatus*, Théel, and *Orphnurgus asper*, Théel) are known to live at a depth less than 500 fathoms, and a few from 500 to 1000 fathoms; the remainder, about thirty species, are found at depths ranging from 1000 to 2900 fathoms. The order Elaspoda seems to be represented in all oceans, and the largest, most peculiar, and most characteristic forms prefer the greatest depths. The number of deep-sea dredgings being small in comparison with the large area of ocean, it is as yet almost impossible to arrive at any exact idea of the distribution of genera and species. As a matter of fact, however, the genus *Elpidia*, for instance, has a very wide distribution, its species having been observed at almost all parts of the sea, from the Arctic Ocean to lat. 60° 52' S., long. 80° 20' E. south of Kerguelen Islands, and not very far from the antarctic circle, as well as in more scattered localities around the world. As to the distribution of species it has already been mentioned that *Elpidia glacialis* and *Lætmogone violacea* appear to be very widely distributed, and *Oneirophanta mutabilis* has also been procured by the "Challenger" expedition at seven different stations around the world, but not in the Atlantic Ocean.

Echinocucumis typica, Sars (*Ofversigt af Norges Echinodermes* Christiania, 1861, pp. 102-108, pl. x. figs. 11-20, pl. xi. figs. 1-17), Station 7, 530 fathoms. Four specimens.

Thyone raphanus, Düb. and Koren (*Ofversigt af Skandinavien Echinodermes*; *Kongl. Sv. V. Akad. Handl.*, 1877, pp. 311-312, pl. xi. fig. 58-59, pl. v. figs. 49-55).

* As far as our present knowledge goes, no Elaspoda are found living at depths less than 40 fathoms.

Station 6, 530 fathoms. One specimen.

Station 7, 530 fathoms. Nine specimens.

All these individuals differ from the typical form described by Dübén and Koren in their small size, the largest being only about 15 mm. in length, and 10 mm. in breadth, and some other unimportant differences also exist. The pedicels being scattered over the whole body, seem to be more numerous along the three ventral ambulacra, forming there, more or less conspicuous rows. Pedicels with a few small arcuate spicula, and a small irregular terminal plate. Tentacles with larger and smaller, straight or arcuate spicula, the ends of which are enlarged and perforated. Anus with fine, small, elongated, perforated plates resembling teeth.

Stichopus (?) *tizardi*, nov.

Station 6, 530 fathoms. Two rather incomplete specimens, and some fragments.

Station 4, 555 fathoms. Some fragments.

In consequence of the fragmentary condition of the specimens which have been at our disposal, it has been quite impossible to obtain an exact idea of their form, or to fix the genus to which they belong. The viscera having been ejected it could not be ascertained whether respiratory organs were present or not. The bottle in which the specimens were stored contained also the posterior part of an intestine with two respiratory trees, and it seems probable that these organs belong to the larger specimen. As they bear some resemblance to *Stichopus* I propose, for the present at least, to refer them to that genus.

Body elongated, the length of the larger specimen being about 130 mm. Bivium with some small retractile processes arranged in a row around its foremost part, and with a few larger ones scattered on the back. Trivium with small retractile pedicels. It is impossible to state how the processes and pedicels are arranged on the larger specimen, but the fragments plainly show that the bivium is provided with tubercles or processes all round the body, and that the pedicels are disposed in rows on the bivium. Mouth anterior ventral; anus posterior, terminal, subdorsal. Tentacles twenty of almost equal size, their terminal part rather large, with some retractile processes. Integument very thick and soft, with two kinds of calcareous deposits; small G-shaped spicula; and other bodies representing the form of a

cross or star, composed of four long, straight arms with the ends more or less enlarged, flattened and pierced with one large and a few small holes; sometimes the enlarged ends of the arms are connected with one another, forming a more or less round, perforated plate; the centre of the cross always with a large and straight tower or steeple, directed outwards from the body of the animal, and composed of four long, straight, parallel columns, held together by three to seven transverse bands. The pedicels and processes with numerous rather large, more or less arcuate spinous spicula, and the former with a rudimental perforated terminal plate.

Only one pyriform sac, rather slender and cylindrical, the length being about 35 mm. The madreporic canal dorsal, very small, with numerous small spicula, curved in the form of a C, and resembling those of the integument. Each of the powerful longitudinal muscles is double. Genital tubes dichotomously branched, arranged in two rather large clusters, one on each side of the dorsal mesenterium, each cluster being again divided into from five to seven smaller ones. The respiratory trees (if they really belong to these animals) are two, undivided, almost of equal size, about 45 mm. in length, and bearing along their whole length a great many small processes or branches. Colour in alcohol light grey; terminal parts of the tentacles yellowish with some dark points.

Report on ECHINOIDEA. By Professor Alex. Agassiz.

I have examined the things and send you a list. There is nothing new, but I am very glad to have good specimens of *Phormosoma uranus* and *placenta*, which I had not seen, as well as good young specimens of *Echinocardium pennatifidum*, which are interesting.

| | | |
|---------------------------------------|-----------|----------|
| <i>Dorocidaris papillata</i> , A. Ag. | St. 1 | 305 fms. |
| <i>Porocidaris purpurata</i> , W. Th. | St. 7 | 530 " |
| <i>Phormosoma uranus</i> , W. Th. | St. 4 | 555 " |
| " <i>placenta</i> , W. Th. | St. 4 | 555 " |
| | and St. 2 | 530 " |
| <i>Echinus norvegicus</i> , D. & K. | St. 7 | 530 " |
| | St. 1 | 305 " |
| | St. 3 | 53 " |
| " <i>acutus</i> , Lamk. | St. 3 | 53 " |
| " <i>melo</i> , Lamk. | St. 3 | 53 " |
| <i>Echinocyamus pusillus</i> , Gray | St. 3 | 53 " |

| | | |
|--|--------------------------------------|----------|
| <i>Pourtalesia jeffreysii</i> , W. Th. | St. 8 | 540 fms. |
| <i>Spatangus purpurens</i> , Luke | St. 3 | 53 " |
| young (!) | St. 6 | 530 " |
| | (broken, possibly not the young) | |
| <i>Echinocardium flavescens</i> , A. Ag. | St. 3 | 53 "... |
| ,, <i>pennatifidum</i> , Norm. | St. 3 | 53 " |
| | with young specimens of the species. | |

ASTEROIDEA dredged during the Cruise of the "Knight Errant" in July and August 1880. By W. Percy Sladen, F.L.S., F.G.S.

The collection that forms the subject of the present report, although small numerically, is interesting in many respects. As might naturally be expected, the general facies of the whole is decidedly northern; and with the exception of two of the forms all have been previously recognised under similar conditions of habitat and association. Owing to the limited number of stations and the small number of starfishes obtained at each, I do not in the present instance feel justified in drawing from the study of this group of animals alone any definite generalisations upon the physical and faunatic conditions of the area surveyed. Of the five stations herein concerned, one is situated in the shallow water within the hundred fathom line, and all the forms there dredged are characteristic boreal and North British species; two stations occur in the "cold" area near to stations previously dredged by the "Porcupine,"—one being probably close to the most western extension of the area. The remaining two stations are in the "warm" area and near to the ridge that separates it from the cold area. One of the warm-area stations has furnished a very remarkable starfish, which constitutes the type of a new genus,—altogether distinct from any of its northern congeners; whilst from the second of these stations a recognised boreal species was dredged, which has not previously been found out of the cold area.

With the exception of the new form, each of the species enumerated has been previously taken in the cold area. Upon this fact, however, too much importance should not be placed. As our knowledge of the distribution and adaptability of starfish life increases, there seems much danger of confusing cold-area forms (previously so called) with frigid abyssal forms of far distant localities, which certainly cannot

be regarded as belonging to the same geographical or isothermal area. It is not improbable that, when the Asteroidea of the "Porcupine" and "Lightning" cruises have all been critically examined and the results tabulated, in connection with the additional information furnished by the "Challenger" and other expeditions, that some modifications may be necessary in the asterid fauna-lists of the respective areas. Every series of specimens therefore is of especial interest and adds further weight and importance to previous observations.

My hearty thanks are due to Mr. John Murray for the opportunity of examining this collection, as well as for much information.

I. List of the Species obtained.

1. *Archaster tenuispinus* (Düben and Koren), Sara.

Station 8. August 17, 1880. Lat. 60° 3' N., long. 5° 51' W. Depth, 540 fathoms; bottom temperature, 29°·2 Fahr.; surface temperature, 56°·5 Fahr.; ooza. Three examples.

All fully grown individuals, $R < 5r$; in the largest, $R = 73$ millim., $r = 16\cdot5$ millim. These specimens present many of the characters of *A. echinulatus*, Perrier, which is perhaps only a locational variety of the northern species,—at any rate a representative form.

2. *Archaster bifrons*, Wyville Thomson. (*Archaster bifrons*, Wyv. Thom. (1873), *The Depths of the Sea*, p. 122, figs. 17 and 74).

Station 7. Aug. 12, 1880. Lat. 59° 37' N., long. 7° 19' W. Depth, 530 fathoms. Three examples.

This elegant and well marked form was named by Sir Wyville Thomson in his account of the "Porcupine" cruise in *The Depths of the Sea*; and two admirable woodcuts are there given, unaccompanied, however, by any description. As no diagnosis of this species has yet been published, the following summary of details will not be out of place:—

Archaster bifrons.—Radii five, elongate, moderately broad at the base, tapering continuously to a finely pointed extremity. Inter-brachial angles widely rounded. Minor radial proportion 23·3 per cent., $R = 90$ millim., $r = 21$ millim. $R > 4\frac{1}{4}r$. Radii 25 millim. broad at the base.

Paxillæ of the dorsal area minute, crowded, bearing 20 to 25

spinelets,—5 or 6 in the midst of each crown more robust than the rest.

Marginal plates large and conspicuous. Supero-marginal series about as broad as high, 33 in number from the interbrachial angle to the extremity, covered with granules which become subconical in form on the lateral half of the plate. Each supero-marginal plate bears a single, moderately long, conical, pointed spinelet standing on the rounded angle of the plate and directed outward almost horizontally. Sometimes this spinelet may be reduplicated on two or three plates near the middle of the ray. Infero-marginal plates correspondent with the superior series and similar in every respect, covered with similar sub-conical granules, and each with a similar and equal sized spinelet directed horizontally. The supero-marginal spines diminish in size towards the interbrachial angle and towards the extremity; and also the infero-marginal spines, but in a less degree. The largest spines are consequently about midway on the ray. Adambulacral plates form a straight or very faintly festooned margin to the furrow. Ambulacral spines rather elongate, 10 in a lineal series on the furrow-margin of the plate, slightly compressed, not tapering, extremities rounded, the middle spines largest; the others diminishing by gradation to either end of the series, the outermost spine being small and setiform. External to this inner row stands a single large, conical, sharply pointed spinelet, nearly as large and robust as the marginal spines. A few minute setiform spinelets stand at the base on the outer portion of the plate.

Interbrachial areas large. The ventral plates are small, numerous, regularly quadrate, and are divided into lineal series or columns by furrows which extend from the adambulacral plates to the marginal plates,—the breadth of the columns at their inner extremity corresponding with that of the adambulacral plates, but contracting as they proceed outward, in consequence of the diminution of the size of the plates. The ventral plates are covered with papilliform granules or spinelets, and each of those in the angle bears a single, moderately robust, conical pointed spinelet springing from the midst.

Anus distinct. Madreporiform body obscure, hidden by paxillæ; probably situated in the midst of a circular area of more widely spaced paxillæ which occurs in one of the interradia, rather nearer the margin than midway.

Terminal (ocular) plate very minute. Sucker-feet pointed. No sucker disk.

3. *Astropecten andromeda*, Müller and Troschel. (*Astropecten christi*, Düben and Koren,* *Öfvers. K. Vet.-Akad. Förhandl.*, 1844, p. 113).

Station 7. Aug. 12, 1880. Lat. 59° 37' N., long. 7° 19' W. Depth, 530 fathoms. A single example.

Müller and Troschel† described their species as sometimes furnished with small single spinelets on the supero-marginal plates; but no trace whatever of such are to be found in the specimen under notice. In this respect I can confirm the observations of Sars,‡ and Danielssen and Koren,§ and also the description given by Düben and Koren.|| In the "Knight Errant" specimen all the spinulous or papilliform appendages of the actinal surface are invested with a thick membranous tissue which is often more or less united at their bases, and in some parts coalescent even at their extremities, which are joined by web-like and fibrillar extensions. The appearance thus produced is accurately enough expressed by Düben and Koren's "gelatinöst öfverdrag,"¶ and I have no doubt whatever as to the correctness of their description in this respect; although the character referred to has subsequently been called in question. Sars** states definitely that it did not occur in any of his specimens, and he considered that Düben and Koren had been deceived by the presence of foreign matter. Düben and Koren state that the character is not a constant one.

Remarks.—*Astropecten andromeda* has not previously been dredged out of the "cold" area. The present seems to be an instance of its occurrence within the limits of the "warm" area. It seems probable from this and other sources of information that some modifications will ultimately be required when drawing up a revision of the characteristic fauna-lists of the two areas.

* The date of the first publication of Düben and Koren's name was incorrectly cited by Dujardin and Hupé (*Hist. Nat. Zooph. Échinodermes*, p. 420) as 1834,—a mistake which has subsequently been copied, and has led to an erroneous priority being accorded to Düben and Koren's name. In 1846 Düben and Koren themselves acknowledged Müller and Troschel's claim.

† *System der Asteriden*, 1842, p. 129.

‡ *Oversigt af Norges Echinodermmer*, p. 30.

§ *Nyt Mag. f. Naturvidensk.*, 1877, bd. xxiii. 3, p. 66.

|| *Kongl. Vet.-Akad. Handl. för År 1844* (1846), p. 250.

¶ *Loc. cit.*, p. 251.

** *Loc. cit.*, p. 31.

4. *Luidia sarsii*, Düben and Koren.

Station 3. Aug. 3 and 4, 1880. Lat. 59° 12' N., long. 5° 57' W. Depth, 53 fathoms. Seven examples.

5. *Porania pulvillus* (O. F. Müller), Norman.

Station 3. Aug. 3 and 4, 1880. Lat. 59° 12' N., long. 5° 57' W. Depth, 53 fathoms. A single example.

6. *Mimaster tizardi*, gen. et sp. nov.

Station 4. Aug. 10, 1880. Lat. 59° 33' N., long. 7 14' W. Depth, 555 fathoms; bottom temperature, 45°·4 Fahr.; surface temperature, 57° Fahr.; mud. A single example.

Radii five, marginal contour stellato-pentagonal, interbrachial angles sub-acute, the radii tapering gradually to a fine extremity. The lesser radius is in the proportion of 45 per cent., $R = 120$ millim., $r = 54$ millim.; breadth of a ray at the base, 58 millim. Dorsal profile high and gibbous over the disk. Actinal surface convex.

Dorsal area covered with a great number of uniform small paxillæ, closely and equidistantly placed, presenting no definite order of arrangement. The paxillæ consist of a cylindrical pedicel nearly twice as high as broad, surmounted by a crown of 15 to 20 spinelets about equal in length to the pedicel, except where they have been abraded; and the spinelets radiate apart very slightly, which gives a compact appearance to the paxillæ. Papulæ in groups of 3 to 5 occur between neighbouring paxillæ.

Marginal plates, in ventral and dorsal series, small and sub-tubercular in appearance, 37 to 38 in each series between the interbrachial angle and the extremity of the ray. Each plate or boss is covered with a great number of small spinelets similar to those of the paxillæ, giving them a round, cushion-like appearance. The infero-marginal plates are the largest, transversely sub-oval in form,—the length increasing towards the interbrachial angle, and bear not less than 100 spinelets. The supero-marginal plates are smaller, usually round, and placed rather more aborally than the companion plate of the lower series, the pairs standing consequently slightly oblique. The ventral plates occupy a great space on the actinal surface, and extend up to the very extremity of the ray. Each plate bears a single paxilla, which is rather more robust than those on the dorsal surface, and carries rather fewer spinelets, which are somewhat longer and more widely expanded. In consequence of the size and arrangement

of the ventral plates, the ventral paxillæ are more widely spaced than the dorsal ones, and are disposed in regular lines which run from the adambulacral plate to the margin, the lines or columns being marked off by straight furrows or wrinkles in the membrane. As the paxillæ are equidistantly spaced in each of these transverse rows, equally regular and uniform longitudinal lines are also traceable along the ray. In the arm-angle 9 to 10 paxillæ stand in each transverse series, the same number being maintained until about the outer fifth of the furrow.

Each adambulacral plate stands on the furrow-margin as the terminal plate of one of the transverse series above mentioned; and carries a group of 15-20 spinelets resembling a compressed paxilla, only rather more robust than those on the ventral plates. Two of the spinelets (sometimes three) larger than the rest, slightly flattened and tapering to a point, stand at the margin of the furrow. The succeeding spinelets are less robust, and pass in gradation to the group of outermost spinelets which are about equal in size to those of the ventral paxillæ. The 5 or 6 innermost adambulacral plates have much larger spinelets than the others. About 75 adambulacral plates may be counted along the furrow.

The united mouth-plates form a sharp angle inwardly, and a large elongately ovoid, sub-tubercular swelling is developed on their superficies,—the whole surface being covered with spinelets arranged in somewhat similar series to the ambulacral spinelets, standing perpendicular, 7 to 8 along each side of the mouth angle. The aboral portion of each plate is occupied by a compressed paxilliform group, similar to those on the adambulacral plates

Madreporiform body undistinguishable.

Remarks.—The appearance of this magnificent starfish suggests in a remarkable way the association of the prominent external characters of a *Solaster*, a *Pentagonaster* and an *Asterina*. It is entirely distinct from its northern congeners and in structural formula cannot be referred to any genus at present known. Judging from description alone it perhaps resembles most nearly the genus *Radiaster*, recently established by M. Perrier* from a specimen obtained by the U.S. Coast Survey Steamer "Blake" in the dredgings in the Gulf of Mexico and the Caribbean Sea. That *Mimaster* is clearly distinct, however, from

* *Bull. Mus. Comp. Zool.*, Harvard, vol ix. no. 1, p. 17.

that form will be readily seen on comparing the summary given above with that of M. Perrier.

I have great pleasure in naming this interesting species after Captain Tizard, R.N., under whose command the "Knight Errant" cruise was conducted,—an officer to whom science is much indebted for many services and contributions, amongst the foremost of which may be mentioned the important hydrographic investigations on board H.M.S. "Challenger."

7. *Cribrella oculata* (Linck), Forbes.

Station 3. Aug. 3 and 4, 1880. Lat. $59^{\circ} 12' N.$, long. $5^{\circ} 57' W.$ Depth, 53 fathoms. A single example.

8. *Crossaster papposus* (Linck), Müller and Troschel.

Station 3. Aug. 3 and 4, 1880. Lat. $59^{\circ} 12' N.$, long. $5^{\circ} 57' W.$ Depth, 53 fathoms. Two examples.

One large specimen having thirteen rays, $R = 122$ millim., $r = 45$ millim.; and the other a small one with twelve rays.

9. *Crossaster papposus*, var. *septentrionalis*, n.

Station 2. July 29, 1880. Lat. $60^{\circ} 29' N.$, long. $8^{\circ} 19' W.$ Depth, 375 fathoms; bottom temperature, 31° Fahr.; surface temperature, 53° Fahr.; mud. A single example.

An interesting variety was dredged at Station 2 in 375 fathoms, which on account of its well-marked character I consider desirable to recognise by name,—a course further justified by its constancy over a considerable area of distribution. In proposing this step, however, I wish to state clearly that I do not regard the form as specifically distinct from *Crossaster papposus*. The form is ten rayed, and accords in this and other particulars with a number of examples taken at different stations during the "Porcupine" cruise. The chief characters are persistent throughout the whole series of specimens that I have examined; several, however, are present in an extreme degree in the specimen under notice, of which the following may be taken as a brief description:—

Rays ten, short, broad at the base, and sharply tapering, radial proportions = $R < 2 r$; $R = 35$ millim., $r = 18$ millim. Dorsal surface of the disk gibbous, sloping rather quickly at the base of the rays. Paxillæ small, numerous, closely crowded, with 10 to 21 spinelets, which are more or less divergent from the pedicel. 15 to 17 paxillæ may be counted in a median interradial line and about 10

across the base of a ray. Papulæ few, not more than 1 to 3 in a group.

Ambulacral spines: (1) furrow series, six on each plate near the mouth, five on the more outward plates, the aboral spine smallest; (2) transverse series composed of eight spines. The two spines nearest the furrow are placed more aborally than the rest, which gives the line of base of each transverse series an aboral curve at the furrow side. The middle spines are longest, the outermost smallest; all tapering to a fine point, robust at the base; no webbing apparent. Mouth-plates with robust mouth-spines, and a prominent series of 9 to 10 secondary superficial spinelets, larger than the marginal mouth-spines. Interbrachial areas covered with small paxillæ, and rather crowded.

Remarks.—On comparing with the above form a typical *Crossaster papposus* of the same diameter, it will be found that in the latter the rays, which are 11 to 13 in number, are less tapering and relatively longer, the proportion being $R > 2.5 r$. The dorsal area of the disk is very little higher than the rays. The paxillæ are larger, fewer, more widely spaced, and bear a greater number of spinelets, usually about 40, which are arranged much more compactly and give the paxillæ a more rounded appearance,—often resembling that of a well-worn brush, the central spinelets being longest. The papulæ are more numerous, 5 to 10 or more. Ambulacral spinelets three in the inner or furrow series,—a fourth very minute one, placed aborally, being present near the mouth. Transverse combs of five spinelets, those near the furrow series longest; line of base straight; webbing at the base more or less present. All the spinelets are more delicate in character than in the variety. Mouth-plates with delicate spines; secondary mouth-spines not more than two or three. Interbrachial areas quite naked or with only one or two small paxillæ.

This variety conforms in several respects with the admirable description given by Danielssen and Koren* of the form which they refer to the *Solaster affinis* of Brandt. The differences, however, are so marked that I cannot regard them as one and the same form; and in none of the specimens which I have examined either from the "Porcupine" or the "Knight Errant" dredgings can I recognise an identity with the specimens described by the eminent Norwegian

* *Nyt Mag. f. Naturvidensk.*, 1877, bd. xxiii. 3, p. 57.

naturalists. Judging from the description above cited, it seems to me that our variety occupies an intermediate position between the typical form of *Crossaster papposus* and the *Solaster affinis* of Danielssen and Koren; and thus appears to me to strengthen the opinion elsewhere expressed,* that the latter form is probably a local variation of the type of *C. papposus*.

10. *Asteracanthion rubens* (Linné), Müller and Troschel.

Station 3. August 3 and 4, 1880. Lat. 59° 12' N., long. 5° 57' W. Depth, 53 fathoms. Three examples; two of them being small.

The large specimen is remarkable for the elongation and attenuation of the radii, and for the comparative paucity and smallness of the dorsal spinelets. These are minute, conical, and almost hidden in the membrane. The margin of the dorsal area is bounded by a regular and prominent line of spinelets, and the median dorsal line is also more or less regular. The other spinelets are quite irregular in disposition and though moderately numerous are inconspicuous in consequence of their small size. The sides of the rays are deeper and more perpendicular than usual. Lateral spines, 2 or 3 in number, placed obliquely. No spines on the sides between these spines and the true dorsal series, and no spines between the lateral series and the ambulacral spines. Forciform pedicellariæ very numerous on the ambulacral spines, especially in the inner portion of the furrow, also on the sides of the ray; smaller and less numerous on the dorsal area. Forciform pedicellariæ comparatively scanty, a few at the base of the marginal dorsal spines, and a greater number at the base of the lateral spines; a few irregularly distributed over the dorsal area. This specimen in some respects simulates the habit of *A. glaciale* in a striking manner.

11. *Asteracanthion mülleri*, Sara.

Station 3. Aug. 3 and 4, 1880. Lat. 59° 12' N., long. 5° 57' W. Depth, 53 fathoms. A single example.

II. Station-Lists.

The following lists will show at a glance the association of the species at each of the stations.

* Duncan and Sladen, *A Memoir on the Echinodermata of the Arctic Sea to the West of Greenland*, London, 1881, p. 39.

Station 2. July 29, 1880. Lat. 60° 29' N., long. 8° 19' W.
Depth, 375 fathoms. Bottom temperature, 31° Fahr.; surface
temperature, 53° Fahr.; mud.

Crossaster papposus, var. *septentrionalis*.

Station 3. Aug. 3 and 4, 1880. Lat. 59° 12' N., long. 5° 57' W.
Depth, 53 fathoms; off the island of North Rona.

Luidia sarsii.

Crossaster papposus.

Porania pulvillus.

Asteracanthion rubens.

Cribrella oculata.

Asteracanthion milleri.

Station 4. Aug. 10, 1880. Lat. 59° 33' N., long. 7° 14' W.
Depth, 555 fathoms; bottom temperature, 45°·4 Fahr.; surface
temperature, 57° Fahr.; mud.

Mimaster tizardi.

Station 7. Aug. 12, 1880. Lat. 59° 37' N., long. 7° 19' W.
Depth, 530 fathoms.

Archaster bifrons.

Astropecten andromeda.

Station 8. Aug. 17, 1880. Lat. 60° 3' N., long. 5° 51' W.
Depth, 540 fathoms. Bottom temperature, 29°·2 Fahr.; surface
temperature, 56°·5 Fahr.; ooze.

Archaster tenuispinus.

Report on OPHIUROIDEA. By Professor Theodore Lyman.

I have examined the "Knight Errant" Ophiuroidea. They are
as follows:—

| | | |
|--|-------|----------|
| <i>Ophioglypha aurantiaca</i> , Vll. | St. 6 | 580 fms. |
| " <i>signata</i> , Vll. | St. 8 | 540 " |
| <i>Ophiactis abyssicola</i> , Ljn. | St. 2 | 375 " |
| | St. 7 | 580 " |
| <i>Ophioconia nigra</i> , Mull. & Tr. | St. 3 | 58 " |
| <i>Ophiopholis aculeata</i> , Gray | St. 8 | 58 " |
| <i>Ophiothrix pentaphyllum</i> , Ljn. | St. 8 | 58 " |
| <i>Ophioscolex glacialis</i> , Mull. & Tr. | St. 2 | 375 " |
| <i>Ophiacantha tridentata</i> , Ljn. | St. 5 | 515 " |

It is curious that they did not get things like *Ophiacantha spinulosa*,
and several common species of *Ophioglypha*, and that they did get
new things, viz., *Ophioglypha aurantiaca* and *O. signata*. The latter,
however, stands pretty near the common *O. affinis*.

Report on the SPONGES. By Professor Franz Eilhard Schulze.

Station No. 2, July 29, 1880; 275 fathoms.

(1) Two medium-sized specimens of *Tisiphonia agariciformis*, Wyville Thomson (*Depths of the Sea*, p. 74).

(2) An irregularly triangular flattened disc about 15 square centimetres in area and 2.5 mm. thick, flexible, and of the consistency of leather. One edge is irregularly torn, the two others are rounded off smoothly: the latter evidently represent the free margin in its normal condition. The surface on both sides exhibits a system of round pit-like depressions about 1 mm. broad, between which is left a level reticulate lattice-like network of trabeculæ, which also have a thickness of 1 mm. Large numbers of short siliceous spicules occur, pointed at one end and blunt at the other; they are united into a loose skeleton of tri- or quadri-lateral meshes by an extremely small amount of horny substance, and are all of the same form and size. Thus the sponge under notice is a *Reniera* (in the broad sense of the word). The species was hitherto unknown.

(3) A coarsely woven mass of siliceous spicules made up of long rod-like and abundant smaller quinque- and sex-radiate forms; it was probably derived from a *Holtenia*.

Station No. 3; 53 fathoms.

Tetilla Cranium, Müll.

Station No. 7; 530 fathoms. A packet of long tuft spicules from a Hexactinellid, most probably a *Holtenia*.

Station No. 8; 540 fathoms. Several examples of *Stylorkisa stipitata*, Oscar Schmidt (*Sponges of the Gulf of Mexico*, p. 79), a species identical with *Polymastia stipitata*, Carter (*Annals of Nat. Hist.*, 1876, ser. 4, vol. xviii. p. 393.)

Besides adults, young forms also occur, which exhibit a roundish head.

Report on the FORAMINIFERA. By Henry B. Brady, F.R.S.

This Report was received by the late Sir C. Wyville Thomson, in November 1880.

Sea-bottoms.—Specimens of the sea-bottom from five localities have been examined and the Foraminifera determined. Particulars

as to locality, physical conditions and the like, are given in the following summary. The letters A, B, C, D, E correspond to the headings of the columns in the distribution-table, and are otherwise used for reference.

- A. "STATION 1.—July 27; lat. 60° 4' N., long. 7° 37' W.; depth 305 fathoms; bottom temperature, 47·1° Fahr.; surface temperature, 54·8°."

Greyish-brown sandy mud, leaving but little residue after washing, and that chiefly hard silicious sand, with larger dark-coloured fragments. But few Foraminifera, principally of large coarse types such as *Anomalina coronata*, *Truncatulina refulgens*, and *Tr. lobatula* and *Uvigerina pygmaea*.

- B. "STATION 2.—July 29; lat. 60° 29' N., long. 8° 19' W.; depth, 375 fathoms; bottom temperature, 31·0° Fahr.; surface temperature, 53·0°."

Brownish sandy mud, with a good many small fragments of rock of darker colour. Foraminifera by no means abundant—the most conspicuous genera being *Globigerina*, *Polystomella*, *Nonionina*, and *Cassidulina*. One or two specimens of the interesting sessile species *Rupertia stabilis* were found in this gathering. A considerable proportion of the *Globigerinae* were of the small arctic variety, *Gl. borealis*.

- C. "STATION 4.—August 10; lat. 59° 33' N., long. 7° 14' W.; depth, 555 fathoms; bottom temperature, 45·4° Fahr.; surface temperature, 57·0°."

Grey *Globigerina*-ooze, leaving very little residue after washing. The residue composed almost entirely of the shells of Foraminifera, chiefly of *Globigerina bulloides* and *Gl. inflata*.

- D. "STATIONS 6 and 7.—August 12; lat. 59° 37' N., long. 7° 19' W.; depth, 530 fathoms; bottom temperature, 45·9° Fahr.; surface temperature, 56·6°."

Globigerina-ooze very rich in arenaceous types of Rhizopoda, notably *Astrorhiza*, *Rhabdammina*, and *Marsipella*, with occasional examples of *Saccamina* and *Storthosphæra*. Of the hyaline species, *Rotalia orbicularis*, by no

means a common form, alone requires notice—the specimens being not only plentiful but unusually fine.

E. "STATION 8.—August 17; lat. 60° 3' N., long. 5° 51' W.; depth, 540 fathoms; bottom temperature, 29·2° Fahr.; surface temperature, 56·5°."

Muddy sand. Of arenaceous Rhizopoda, *Reophax sabulosa* and *R. scorpiurus* are the most remarkable. The former is a large rare species, only previously known by specimens from one of the "Porcupine" stations. The latter is cosmopolitan, but in this particular dredging is particularly abundant. Of the calcareous types, *Cornuspira* claims attention from the gigantic size of some of the specimens, and *Lagena* from the long list of species found; *Pullenia sphaeroides* and *Cassidulina lævigata* are also prominent forms. A large proportion of the *Globigerinæ* are of the small northern thick-shelled variety.

Detailed lists of the Foraminifera from the several localities are furnished in the following table. It will be seen from the temperatures recorded in the foregoing summary that the columns headed A, C, and D represent the Rhizopod-fauna of a warm sea-bottom, B and E of a cold area.

A comparison of the Rhizopod-fauna of the cold sea-bottom, represented by column E, with that of the warmer area typified by C and D, suggests some interesting facts in connection with the distribution of species. The larger arenaceous types pertaining to the family *Astrorhizidæ*, such as *Astrorhiza*, *Saccamina*, *Storthosphaera*, *Rhabdammina*, *Jaculella*, *Marsipella*, and *Hyperammina*, are for the most part conspicuously absent from the colder portion of the channel, and appear to be partially replaced by the weaker forms of *Lituolidæ*. The genus *Bulimina* in its typical condition affects the warm area; whilst in the cold, the starved transition varieties which constitute the sub-genera *Bolivina* and *Virgulina* abound. The genus *Lagena* is represented in the cold region by a list of fifteen species; in the warm by only eight. The little thick-shelled *Globigerina borealis*, so far as we know, is confined to the cold area, and, as has been stated, the gigantic *Cornuspira striolata* is similarly limited in distribution. How far these facts may indicate general laws can only be determined by further investigation, and on the comparison of a larger series of soundings than are at present available.

| | A | B | C | D | E |
|---|---|---|---|-------|-------|
| <i>Biloculina ringens</i> (Lamk.) | x | | | x | |
| <i>depressa</i> , D'Orb. | | | | x | |
| <i>comata</i> , Brady | | | | x | |
| <i>elongata</i> , D'Orb. | | x | | x | |
| <i>Planispirina contraria</i> (D'Orb.) | | | | | x |
| <i>Miliolina seminulum</i> (Linn.) | x | x | | x | x |
| <i>trigonula</i> (Lamk.), var. | | | | x | |
| <i>tricarinata</i> (D'Orb.) | x | | | x | x |
| <i>celata</i> (Costa) | x | | x | x | |
| <i>Cornuspira striolata</i> , nov. | | | | | x |
| <i>carinata</i> (Costa) | | | | x | |
| <i>involvens</i> , Reuss | | | | x (†) | x (†) |
| <i>crassisepta</i> , nov. | | | | x | |
| <i>Pærammosphæra fusca</i> , F. E. Schulze | | | | | x |
| <i>Saccammina spherica</i> , M. Sars | | | | x | |
| <i>Astrophiza arenaria</i> , Norman | | | | x | |
| <i>Storthosphæra albidula</i> , F. E. Schulze | | | | x | |
| <i>Rhadamina abyssorum</i> , M. Sars | x | | | x | |
| <i>discreta</i> , Brady | | | | x | |
| <i>cornuta</i> , Brady | | | | x | |
| <i>Jaculella obtusa</i> , nov. | | | | x | |
| <i>Marsipella elongata</i> , Norman | | | | x | |
| <i>cylindrica</i> , nov. | | | | x | |
| <i>Hyperammina elongata</i> , Brady | | | | x | x |
| <i>ramosa</i> , Brady | | | | x | x |
| <i>Reophax difflugiformis</i> , Brady | | | x | x | x |
| <i>scorpiurus</i> , de Montfort | | | x | | x |
| <i>adunca</i> , nov. | | | | x | |
| <i>guttifera</i> , Brady | | | | | x |
| <i>sabulosa</i> , Brady | | | | | x |
| <i>Haplophragmium canariense</i> (D'Orb.) | | | | x | x |
| <i>subglobosum</i> (M. Sars) | | | | | x |
| <i>scilulum</i> , Brady | | | | x | |
| <i>simplex</i> , Reuss | | | | x | |
| <i>tenuimargo</i> , nov. | | | | x | |
| <i>Placopsilina vesicularis</i> , Brady | | | | | x |
| <i>Trochammina squamata</i> , P. & J. | | | | | x |
| <i>charoides</i> , J. & P. | | | | x | |
| <i>Webbina clavata</i> , J. & P. | | | | x | |
| <i>Cyclammina cancellata</i> , Brady | | | | x | |
| <i>Thurammina papillata</i> , Brady | | | | | x |
| <i>Textularia sagittula</i> , Defrance | x | | | | |
| <i>trochus</i> (D'Orb.) | | | | | x |
| <i>aspera</i> , nov. | | | | x | |
| <i>Verneuilina pygmaea</i> (Egger) | | | | x | |
| <i>Gaudryina pupoides</i> , D'Orb. | | | x | x | |
| <i>Valvulina fusca</i> (Will.) | | | | x | |
| <i>Bulimina marginata</i> , D'Orb. | | | x | x | |
| <i>pyrula</i> , D'Orb. | | | | x | |
| <i>subteres</i> , Brady | | | | x | x |
| <i>Virgulina Schreibersiana</i> , Czjzek | | | | | x |
| <i>squamosa</i> , D'Orb. | | | | x | x |
| <i>Bolivina punctata</i> , D'Orb. | | | | x | x |
| <i>dilatata</i> , Reuss | | | | x | x |
| <i>pygmaea</i> , Brady | | | | x | x |
| <i>canariensis</i> (Costa) | | | | | x |
| <i>Cassidulina levigata</i> , D'Orb. | x | x | x | x | x |
| <i>crassa</i> , D'Orb. | x | | x | x | x |
| <i>Lagena globosa</i> (Montagu) | x | | | | |
| <i>laevis</i> (Montagu) | | | | | x |
| <i>apiculata</i> , Reuss | | x | | | x |

| | A | B | D | C | E |
|---|---|---|---|---|---|
| <i>Lagena acuta</i> , (Reuss) | | | | x | x |
| <i>gracillima</i> (Seg.) | | x | | x | x |
| <i>marginata</i> , W. & J. | | | | x | x |
| <i>orbignyana</i> , Seg. | | | | x | x |
| <i>distoma</i> , P. & J. | | | | x | x |
| <i>striata</i> (D'Orb.) | | | | x | x |
| <i>semistriata</i> , Will. | | | | | x |
| <i>sulcata</i> (W. & J.) | | | | x | x |
| <i>pulchella</i> , Brady | | | | | x |
| <i>lineata</i> (Will.) | | | | | x |
| <i>melo</i> (D'Orb.) | | | | | x |
| <i>squamosa</i> (Montagu) | | x | x | x | x |
| <i>lagenoides</i> , Will. | | | | | x |
| <i>hispida</i> , Reuss | | | | | x |
| <i>Nodosaria</i> (G.) <i>laevigata</i> , D'Orb. | | | x | x | |
| (G.) <i>rotundata</i> , Reuss | | | | x | |
| <i>simplex</i> , Silv. | | | | x | |
| <i>scalaris</i> (Batsch.) | x | | x | x | x |
| (D.) <i>communis</i> , D'Orb. | | | x | | |
| (D.) <i>soluta</i> , Reuss | | | | | x |
| (D.) <i>pauperata</i> , D'Orb. | | | | | x |
| <i>Vaginulina linearis</i> (Montagu) | | x | | | x |
| <i>spinigera</i> , Brady | | | | x | |
| <i>Marginulina glabra</i> , D'Orb. | | | | | x |
| <i>costata</i> (Batsch.) | | | | | x |
| <i>Cristellaria rotulata</i> , Lamk. | x | | x | x | x |
| <i>cultrata</i> (de Montfort) | | | | x | |
| <i>reniformis</i> , D'Orb. | | | | x | |
| <i>Polymorphina lactea</i> (W. & J.) | x | | | x | x |
| <i>Uvigerina pygmaea</i> , D'Orb. | x | | x | x | |
| <i>angulosa</i> , Will. | x | x | x | | x |
| <i>Globigerina bulloides</i> , D'Orb. | x | x | x | x | x |
| <i>inflata</i> , D'Orb. | x | x | x | x | x |
| <i>bulloides</i> , var. <i>borealis</i> | x | x | x | x | x |
| (Orbulina) <i>universa</i> , D'Orb. | x | x | x | x | x |
| <i>Hastigerina pelagica</i> (D'Orb.) | | | x | x | |
| <i>Pullenia sphaeroides</i> (D'Orb.) | | | x | x | x |
| <i>quinqueloba</i> , Reuss | x | | x | x | |
| <i>Sphaeroidina bulloides</i> , D'Orb. | x | | | x | |
| <i>Spirillina vivipara</i> , Ehrenb. | | | | | x |
| <i>Patellina corrugata</i> , Will. | | | | | x |
| <i>Planorbulina ariminensis</i> (D'Orb.) | x | | | x | |
| (<i>Truncatulina</i>) <i>lobatula</i> | | | | | |
| (W. & J.) | x | x | x | x | x |
| (<i>Tr.</i>) <i>refulgens</i> (de Mont.) | x | x | | | |
| (<i>Tr.</i>) <i>variabilis</i> , D'Orb. | x | x | | | |
| (<i>Anomalina</i>) <i>coronata</i> , P. & J. | x | | | | |
| <i>Rupertia stabilis</i> , Wallich. | | x | | | |
| <i>Pulvinulina repanda</i> (F. & M.) | x | | | | |
| <i>karsteni</i> (Reuss) | x | x | | | |
| <i>menardii</i> (D'Orb.) | x | | | | x |
| <i>canariensis</i> (D'Orb.) | | x | x | | |
| <i>scitula</i> , nov. | | | x | x | x |
| <i>michelianiana</i> (D'Orb.) | x | | | x | x |
| <i>Rotalia orbicularis</i> , D'Orb. | | | x | x | x |
| <i>Nonionina stelligera</i> , D'Orb. | x | x | | | |
| <i>scapha</i> (F. & M.) | x | x | | | |
| <i>turgida</i> (Will.) | x | | x | x | x |
| <i>umbilicatula</i> (Montagu) | x | x | x | | x |
| <i>Polystomella striato-punctata</i> (F. & M.) | x | x | | x | x |
| <i>Operculina ammonioides</i> (Gron.) | | | x | x | |

The following notes refer to species mentioned in the foregoing table, which are either new to science or otherwise present points of interest :—

Planispirina contraria (*Biloculina contraria*, d'Orbigny).—Dr. Steinmann (*Neues Jahrb. für Min.*, 1881, vol. i. p. 37, pl. 2), describes in detail the structure of the shell in this species, and shows sufficient grounds for separating it from the genus *Biloculina*. In point of fact, it is an intermediate sub-type, more nearly resembling *Hauerina* than *Biloculina*, but differing from the former in two important particulars, namely, the alar extension of the chamber-walls over the lateral surfaces of the test, which imparts to the shell a laminated structure like that of a nummulite, and the simple arched orifice instead of a cribrate aperture. On the basis of the former of these characters Dr. Steinmann proposes for it the generic term *Nummoloculina*.

My friend, the Rev. A. M. Norman, placed in my hands, long ago, some specimens dredged in the Farøe Channel, which were in the collection of the late Edward Waller. These belong to a closely allied species, and have been regarded as somewhat anomalous *Hauerine*. More recently, Professor Seguenza of Messina has had the goodness to send me examples of his *Planispirina communis* (*Mem. R. Accad. Lincei*, 1879-80, vol. vi. p. 310, pl. xvii. fig. 18), and I find them to be quite indistinguishable from Mr. Waller's unnamed form; in both the laminated structure is even more apparent than in *Pl. contraria*. Under these circumstances Professor Seguenza's generic term takes precedence of the more appropriate one suggested by Dr. Steinmann. The "Challenger" species described as *Hauerina exigua* (*Quart. Jour. Mic. Sci.*, vol. xix. n. s. p. 267) must be referred to the same genus; and there is still another more aberrant modification amongst the "Challenger" gatherings, to which the MS. name *Pl. sigmoidea* has been applied.

Cornuspira striolata, nov., resembles the typical *C. foliacea* in general characters, but the last convolution widens rapidly, spreading out and imparting to the test a contour very similar to that of the wide "bonnet-shaped" varieties of *Peneroplis*. The specimens sometimes attain extraordinary dimensions, the largest hitherto found being one from Station E, which mea-

tures more than an inch in diameter (1·2 inch or 31 mm.); a second, somewhat thicker proportionately, measures ·45 inch, or nearly 12 mm. Both of these have a surface ornament of fine, raised, closely-set striæ, parallel to the direction of growth, not absolutely straight and continuous, but taking a slightly waved and irregular course.

Cornuspira involvens, Reuss.—The specimens from both localities are somewhat doubtful; they have fewer convolutions than usual, and it is just possible they may be the tubes of minute annelida.

Cornuspira crassisepta, nov.—Convolution very narrow and numerous, especially near the centre, as in *C. involvens*; but the peripheral edge is nearly square instead of rounded, and the spiral septal wall is thick, and marked externally by a raised limbate line. Diameter $\frac{1}{4}$ inch, or 0·56 mm.

This is the isomorph in the porcellaneous series, of a somewhat rare perforate form, *Spirillina limbata*.

Rhabdammina cornuta, Brady.—This is the species previously described under the name *Astrorhiza cornuta* (*Quart. Jour. Micr. Sci.*, vol. xix. n.s. p. 43, pl. iv. figs. 14, 15), but the structure of the test accords better with the firmly-cemented shell of *Rhabdammina* than with the thick, loose, sandy investment of *Astrorhiza*, and its position has been changed accordingly.

Jaculella obtusa, nov.—Test long, cylindrical, nearly straight, consisting of a tapering tube, commencing in a small bulbous chamber, and gradually increasing in size to the opposite extremity, which is broad and open. Texture coarsely arenaceous, hard and firmly cemented; exterior rough. Length, $\frac{1}{3}$ inch, or 8·0 mm.

It is possible that this may be only a variety of *Jaculella acuta*, from which it differs chiefly in having a small inflated primordial chamber instead of terminating in a point, and in its generally more slender contour. Of all arenaceous Foraminifera *Jaculella* appears to have the hardest and most firmly cemented test; at any rate, it is the one of which it is most difficult to obtain a satisfactory section by ordinary methods.

Mursipella cylindrica, nov.—Amongst the Arenacea found in the material from D., are a number of delicate cylindrical tubes, of

nearly even diameter, built up of short sponge-spicules laid side by side, and forming irregular, more or less interlacing tiers. The largest specimen is about a quarter of an inch (6 mm.) in length, and $\frac{1}{160}$ inch (0.17 mm.) in diameter, but such pieces can only be regarded as fragments of an organism that may be developed almost indefinitely. The species is manifestly closely related to *Marsipella elongata*, with which it is found associated. Similar fragments occur in one or more of the "Porcupine" dredgings, and less characteristic specimens at two of the "Challenger" stations.

Reophax difflugiformis, Brady.—There seemed a possibility that this species might turn out to be only the primordial chamber of *R. scorpiurus*, but as it exists in abundance in one of the dredgings (D) in which no specimen of the latter has been found, it is evident that it holds an independent position.

Reophax adunca, nov.—Test moniliform, consisting of a crooked line of inflated segments, irregular in size, but of nearly equal diameter. External constrictions between the segments comparatively slight; walls thin, rough externally. Length indefinite, specimens seldom found with either end entire; those which have been measured are about $\frac{1}{2}$ inch or 2 mm.

Reophax sabulosa.—This is the *Reophax rudis* of a previous paper (*Quart. Jour. Micr. Sci.*, vol. xxi. n. s. p. 49). The specific term *rudis* being preoccupied by a distinct form, figured by Costa as a *Nodosaria*, an alteration of name becomes necessary.

Haplophragmium tenuimargo, nov.—Test elongate, crosier-shaped, much compressed; lateral edges very thin. Spiral chambers few and small; linear segments about six in number, broad, slightly convex; septation obscure; aperture simple, irregular in form, terminal; texture coarse, surface extremely rough. Length of largest specimen, $\frac{1}{10}$ inch or 2.5 mm.

This is a somewhat rare species. Specimens have been met with at five of the "Challenger" stations in various parts of the world, at depths varying from 1000 to 3950 fathoms, but never more than one or two specimens from a locality.

Textularia aspera, nov.—An obscure few-chambered Textularian, with a loosely-made arenaceous test, not uncommon in some of

the "Porcupine" dredgings, and often found parasitic upon *Rhabdammina*, occurs in the material from Station D. In localities where it is abundant, some of the specimens generally present triserial or Verneuiline characters. As it does not appear to have been described, I have given it the provisional name, *T. aspera*.

Cristellaria reniformis, D'Orbigny. — Under this species are included a group of large, flat, more or less carinate *Cristellaria*, common at moderate depths in the North Atlantic, presenting every variety of contour from *Cristellaria compressa*, D'Orb., to *C. reniformis*, D'Orb. (*For. Foss. Vien.*, Pl. III. figs. 32, 33 and 41, 42).

Globigerina bulloides, var. *borealis*, nov.—In the fear of introducing unnecessary names, I have been unwilling to employ a distinctive term for the small thick-shelled *Globigerinae* common in cold areas, if not peculiar to them; and they have been treated hitherto as starved examples of the species to which they seemed most nearly related from a morphological point of view, namely, *Globigerina bulloides* and *Gl. Dutertrei*. They are, however, very uniform in character, and the more they are studied the more distinct and easily recognised they become. It seems desirable, therefore, that their peculiarities should be embodied in a specific, or at any rate in a varietal, definition.

The test is of smaller dimensions than *G. Dutertrei*, the longer diameter of fully-grown specimens being about 3 mm. (that of the D'Orbignian species is 5 mm.), and it has fewer chambers, almost invariably four in the final convolution. The shell-wall is relatively much thicker and the aperture less conspicuous, but the habit of growth in other respects is very similar. Compared with *Globigerina bulloides*, the shell is more compactly built, its segments are less inflated and globular, and it has no umbilical vestibule. Under the name of "*Globigerina bulloides*, arctic variety," it is figured in the *Ann. and Mag. Nat. Hist.* ser. 5, vol. i. pl. 21, fig. 10.

Pulvinulina scitula, nov.—A variety of *Pulvinulina canariensis*, differing from the typical form in its relatively small size and compact habit of growth. The margin is rounded instead of

sharp, and the peripheral ends of the chambers are only slightly convex instead of standing out prominently as in *P. canariensis*. Notwithstanding its small minute dimensions, it generally attracts attention by its glistening white appearance. Longer diameter, $\frac{1}{10}$ inch or 0.25 mm.

With one or two exceptions all these species, though some have been undescribed hitherto, occur in the material obtained on the "Challenger" and "Porcupine" expeditions, so that figures, as well as further details respecting their history and distribution, may be left until the publication of the "Challenger" report on Foraminifera. It may just be mentioned that the empty silicious tests of one of the *Phæodaria* (the form with Mr Murray's manuscript name *Challengeria nareei*) were found in the material from D and E.

Surface Forms.—There has not been time for the complete investigation of the gatherings made by the tow-net, and the following notes on the surface fauna are based upon the examination of about thirty mountings made by Mr Murray. As these are from material taken on nine different days, between July 27 and August 12, at various depths, from the actual surface down to 35 fathoms, and vary but little in the Foraminifera they contain, they are probably sufficiently representative.

The *Globigerinæ* are all referable to *Gl. bulloides*, *Gl. inflata*, and *Gl. (Orbulina) universa*; the specimens are small and thin-shelled, and those of *Globigerina* (proper) are non-spinous. The *Orbulinæ*, on the other hand, are sometimes armed with very short delicate spines. No specimens of *Globigerina borealis* occur in any of the surface mountings, and no *Pulvinulinæ*. The absence of the latter is in no way remarkable, for none of the species known to be pelagic are present in any considerable number in the dredged material; but that the small northern variety of *Globigerina*, which is tolerably abundant as a bottom species in three out of the five localities, should not be an equally prominent constituent of the surface fauna is a noteworthy fact.

Report on the Gas Contents of a number of Samples of Sea Water.
By Professor Dittmar, F.R.S.

The waters were left at my laboratory by Mr. Murray in the month of August.

In obedience to instructions received they were boiled out, the gases collected, measured, and analysed; care being taken to use the same methods as had served for corresponding work done in connection with the "Challenger" expedition.

The samples were contained in bottles of about one litre's capacity, provided with well-fitting glass stoppers. The bottles were almost full to the top; the empty air-space amounting to only 7 c.c. or thereabouts. The samples stood in my laboratory for some weeks before I received my orders as to what I should do to them; but they were carefully protected against direct sun-light, or elevation of temperature by other causes, and the stoppers never lifted before the contents were taken out to be worked up. Hence the dissolved gases are not likely to have changed much either qualitatively or quantitatively during the storage of the waters; the less so as the percentage of oxygen in the gas minus carbonic acid was in all cases found to be little different from what (according to my analyses of the "Challenger" water-gases) is generally met with in surface waters.

The boiling-out of the gases was effected by means of Jackobsen's apparatus, the flask of which held 740 c.c. of water. The flask in each case was charged by means of a long necked wide funnel going to the bottom of the flask; through this funnel water was run in until about 100 c.c. of water had run over the edge of the flask. This 100 c.c. of water, which was allowed to go to waste, could be assumed to include all that portion which was, to more than the absolutely unavoidable extent, affected by contact with the atmosphere of the laboratory. In regard to the rest of the work I may content myself with referring to my report on the "Challenger" gases.

Labels.

I. "Bottom Water No. 31; 11th August 1880. Depth, 515 fathoms."

II. "Bottom Water, No. 33; 17th August 1880. Depth, 540 fathoms."

III. "Bottom Water, No. 26; 4th August, 1880. Depth, 460 fathoms. Rona-Faroe."

IV. "Bottom Water; sounding No. 11; 28th July 1880. Depth, 270 fathoms."

V. "Bottom Water; 27th July 1880, Depth, 560 fathoms."

Supplementary label:—"This bottle was broken."

In the following statement of the results, V_0 means the volume in cubic centimetres (reduced to 0° C., and 760 millimetres, and absolute dryness), of the total gas extracted from one litre of water. vo means the volume in cubic centimetres of the nitrogen and oxygen contained in those V_0 c.c. of total gas, similarly reduced. So that $V_0 - vo$ represents the carbonic acid (in cubic centimetres and reduced as above) per litre of water.

| | I. | II. | III. | IV. | V. |
|---------------------------------|-------|-------|-------|--------|-------|
| V_0 , | 24·49 | 25·47 | 18·77 | 20·08 | 22·12 |
| vo , | 13·92 | 14·80 | 13·74 | 15·95 | 14·40 |
| Per cents. of CO_2 in V_0 , | 43·16 | 41·88 | 26·80 | 20·59 | 34·88 |
| Per cents. of O_2 in vo , . | 32·01 | 32·28 | 34·23 | 35·55* | 32·88 |

* This number is *very* high; possibly it may be infected with an unobserved error. Unfortunately there was not enough of material to repeat either the boiling out or the analysis of the gas resulting from the one boiling.

(Signed)

W. DITTMAR.

Note.—The percentages of CO_2 are rather high. The percentages of oxygen (in the gas freed from CO_2) are decidedly higher than those obtained for the "Challenger" waters from similar depths.

The high percentage of oxygen is owing probably to the relatively low values of the temperatures at which the waters originally absorbed their air, and the relative absence at their respective situations of decaying organic matter.

May 11, 1882.

W. D.

Rocks of North Rona collected in August 1880 on the North-east Spur of the Island. By Prof. A. Renard and John Murray.

1. Amphibolic rock with a more or less schistose structure, fine grained, breaking in elongated fragments following the plane in which the crystals of hornblende are arranged. It contains especially black brilliant hornblende with the cleavages of $124^{\circ} 30'$. Also quartz and some grains of feldspar.

2. A rolled fragment of sandstone (Cambrian?), red, fine grained, passing to arkose. This rock is essentially composed of fragments of quartz more or less rounded, of particles of hornblende, of epidote, of mica, and of more or less altered feldspar.

3. Gneiss composed of lamellæ of muscovite, plagioclase, orthoclase, and quartz.

4. Granitite containing plagioclase, orthoclase, quartz, and biotite.

5. Amphibolic rock, almost entirely formed of an aggregation of crystals of black hornblende, whose dimensions are from 0.5 to 1 centimetre, and show prismatic cleavage. Associated with the hornblende are granular quartz, lamellæ of biotite, and orthoclase.

7. Rolled pebbles of a clastic rock (Cambrian?) composed of fragments of quartz, more or less rounded, and red orthoclase.

8. Gneissic rock formed of quartz, orthoclase, lamellæ of biotite, and rather large crystals of hornblende.

2. Notice of the Solar Eclipse of the 17th May, with Remarks on the Calculation. By Mr. Edward Sang.

The eclipse of the 31st December 1880 was not seen here, and thus we lost the opportunity of comparing the computed with the observed times.

In the daily papers at that time expression was given to a feeling of dissatisfaction that any computation should have been added to that recorded in the *Nautical Almanac*. And therefore, while laying before the Society the results at which I have arrived in regard to the coming eclipse, it may be proper for me to explain how such an investigation comes to be needed.

The moon's place is given in the *Almanac* to the tenth part of a second of arc, which distance is passed over in about one-fifth part of a second of time. Now with a telescope of moderate power, say 50, we are able to note the instant of contact to within a second; and hence, in order to get the full advantage of our comparison, the calculations must be made at least to the nearest second.

The elements of the eclipse are only useful for a preliminary determination sufficiently near to give the limits within which the strict calculations must extend; and the local times given for our principal observatories are only to tenths of a minute; hence it is that a working astronomer, even though he be at one of these observatories, must find means for a more minute determination; while we who are elsewhere placed must, of necessity, make the calculation for ourselves. The impossibility of having the details so given in the *Almanac* as to suit every observer, is obvious.

The accompanying six figures show the appearance which the sun will have, as seen from Edinburgh, at intervals of ten minutes from 6^h 30^m till 7^h 20^m on the morning of Wednesday the 17th; and the times of the principal phases, civil reckoning, are

| | | |
|----------------|----|--|
| First Contact | at | 6 ^h 25 ^m 56 ^s |
| Greatest Phase | at | 6 52 58 |
| Last Contact | at | 7 20 53 |

At the middle of the eclipse 200" of the sun's diameter will be covered.

I have followed a method of computation differing somewhat from that usually adopted. It makes a considerable part of the work useful for all places, and avoids approximative formulæ.

The data given in the *Almanac* make it a very easy matter to decide on the limits within which the special calculations are to be made. In the present instance the times were taken at intervals of ten minutes from 18 20^m till 19^h 30^m Greenwich time.

The first step was to interpolate the sun's and moon's geocentric places, and to compute the moon's co-ordinates in relation to the earth's equator, to the meridian of a known observatory (Edinburgh), and to a plane perpendicular to these two. For this part of the work,

we need the moon's distance, which has to be computed back from the parallax. I venture to suggest that it would greatly facilitate and improve the computation of eclipses and occultations, to have the logarithm of the moon's distance printed in the *Almanac*.

The next step was to transpose the origin of co-ordinates from the earth's centre to the place of observation. This is done by the simple addition or subtraction, as the case may be, of the co-ordinates of the locality, in which the earth's oblateness and even the height above the sea-level may be taken into account.

Lastly, from these local co-ordinates we deduce the moon's apparent position, distance, semidiameter and parallaxes. Hence the sun's parallaxes and apparent position, the distance between the centres and the separation of the limbs; the item last named being that which determines the eclipse. These results, with their differences, are as under :—

| Gr. Time. | | Separation. | δ^1 | δ^2 | δ^3 |
|-----------|----|-------------|------------|------------|------------|
| h. | m. | " | " | " | " |
| 18 | 20 | - 92.7 | + 146.8 | " | " |
| | 30 | + 54.1 | + 98.7 | - 48.1 | - 4.5 |
| | 40 | + 152.8 | + 45.1 | - 53.6 | - 2.6 |
| | 50 | + 197.9 | - 11.1 | - 56.2 | + 3.0 |
| 19 | 00 | + 186.8 | - 64.3 | - 53.2 | + 6.7 |
| | 10 | + 122.5 | - 110.8 | - 46.5 | + 9.2 |
| | 20 | + 11.7 | - 148.1 | - 37.3 | |
| | 30 | - 136.4 | | | |

From this we see that the first contact will happen between 18^h 20^m and 18^h 30^m. Putting t for the time in minutes reckoned from the epoch 18^h 30^m, and using differences of the third order, the separation has the value,

$$-0.00916t^3 - .2405t + 12.3666t_2 + 54.1 = \text{sep}^n = 0'.$$

Following my own method of solution, published in 1829, the operation is :—

| | | | | |
|---------|--------------------|---------------------------------|---|---------------|
| - .0055 | - .4801 + .0220 | + 12.8667 + 1.9204 - 0440 | + 54.1000 - 49.4667 - 3.8408 + .0587 | 0. - 4. |
| - .0055 | - .4581 + 3 | + 14.2431 + 275 | + .8512 - .8546 - 8 | - 4. - .06 |
| | | | - .0042 | - 4.06 |

Hence the first contact will be at

$$18^h 30^m - 4^m 03^s.6 = 18^h 25^m 56^s.4.$$

The greatest phase will be between $18^h 50^m$ and 19^h . Putting t for the time in minutes from the epoch $18^h 50^m$, the value of the separation is expressed by

$$+ .00050t^3 - .2810t^2 + 1.6500t + 197.9 = \text{sep}^n,$$

which is to be a maximum. We might equate the derivative of this to zero, thus obtaining a quadratic equation, but it is much more convenient for us to retain the cubic form and to determine t so as to render the derivative zero, thus :—

| | | | | |
|---------|--------------------|-------------------------------|---|-------------|
| + .0030 | - .5620 + .0090 | + 1.6500 - 1.6860 + 135 | + 197.9000 + 4.9500 - 2.5290 + 135 | 0. 3. |
| + .0030 | - .5530 - 1 | - .0225 + 221 | + 200.3345 - 9 | 3. - .04 |
| | | - .0004 | + 200.3336 | 2.96 |

giving the time of the greatest phase

$$18^{\text{h}} 52^{\text{m}} 57^{\text{s}}. 6.$$

and the greatest eclipse 200".

By this very short operation, we have solved the quadratic and substituted the value of its root in the cubic equation.

Counting the time in minutes from 19^h 20^m, the equation for the last contact is

$$+ \cdot 00153t^3 - \cdot 1865t^2 - 13\cdot 0983t + 11\cdot 7 = \text{sep}^2 = 0.$$

| | | | | |
|--------|--------|-----------|-----------|-------|
| + 0092 | - 3730 | - 13 0983 | + 11 7000 | 0 |
| | + 83 | - 3357 | - 11 7885 | + 9 |
| | | + 87 | - 1510 | |
| | | | + 11 | |
| + 0092 | - 3747 | - 13 4303 | - 2384 | + 9 |
| | | + 66 | + 2417 | - 018 |
| | | | + 0033 | + 882 |

showing that the eclipse will end at

$$19^{\text{h}} 20^{\text{m}} 52^{\text{s}}. 9 \text{ Green. M. S. Time.}$$

Should favourable weather allow of a good observation, I shall compute the times for my own place, and submit the comparison to the Society.

3. Some Experiments on a New Secondary Cell.

By Mr. A. P. LAURIE, B.Sc.

Last summer I communicated a paper to the Society on an Iodine Cell. This cell consisted of a carbon and zinc rod immersed in solution of iodine, in iodide of potassium. I found that iodide of zinc was equally suitable to dissolve the iodine in, as mentioned in that paper. While experimenting with this cell, the idea occurred to me of using it as a secondary battery. When

the cell is exhausted, the whole of the iodine has combined with the zinc to form iodide of zinc. If an electric current is passed into this exhausted cell, the iodide of zinc is decomposed, zinc being deposited on the zinc plate, and iodine being set free at the carbon plate. The cell is now ready for use, and will give a steady current, having an EMF of 1.2 volts until the iodine is again combined with the zinc. I tried several experiments on this cell in Newcastle, with a view to testing its applicability to electric lighting as a storage battery.

In using a secondary battery for practical purposes, it is necessary to get a powerful battery of considerable storage into as small a space and weight as possible. The plates must therefore be brought close together. This makes it impossible to employ the usual methods for protecting the zinc plate by means of porous cells. A solution of iodine acts upon zinc to form zinc iodide, the rate of this action depending very much on the strength of the iodine solution. I directed my attention to finding out the amount of waste in the cell from this cause, and to finding out ways of checking it. I charged the cells with both battery and 'dynamo,' measuring the current put in and taken out on a voltmeter, or charging two cells and using one at once, the other some hours afterwards. I had great difficulty in getting results from these experiments, and was at first deceived by the small waste in a cell partially charged. I ultimately found that in a fully charged cell I lost about $\frac{3}{4}$ of the full charge in a few hours. This enormous loss was due to the closeness of the plates, the strength of the iodine solution, and the porosity of the zinc deposit. The cell was also hot from the charging and subsequent running down. The great rapidity of the loss up to a certain point prevented me from discovering it at first. I used every method I could devise for checking the diffusion of the iodine to the zinc plate. The carbon plate was covered with powdered carbon to make a large absorbent surface for the iodine. It was then wrapped in a double layer of parchment paper, and placed in a narrow zinc box forming the other pole of the cell. The space between the carbon and the zinc ($\frac{1}{4}$ inch) was stuffed with paper pulp from the paper works, which pulp had been steeped in iodide of zinc. All this was done to check the diffusion of the iodine but it was useless.

I have found paper pulp very useful in batteries which have to be carried about. It is capable of holding 80 per cent. of its weight of water, when not squeezed. It is soluble in strong iodide of zinc, forming a transparent jelly, and turns black in the iodine solution, as does the parchment paper. Iodide of zinc, if exposed to the air in presence of paper pulp, sets free iodine.

From the above summary of my attempts, it is evidently hopeless to expect a practical secondary cell, in which the active agent is in solution. I accordingly tried to find some method for storing the iodine on the carbon plate in an insoluble form. It is unnecessary here to mention the various substances I covered the carbon plate with, in the hope that the iodine would form with them an insoluble compound easily decomposable. The only substance among those which I tried that worked at all was starch. This took up a certain amount of iodine when spread over the carbon plate in a thick paste, and the cell when thus charged gave a current. These experiments were, however, brought to a conclusion by my devising the cell which I now propose to describe in the remainder of this paper.

Cuprous Chloride Cell.—In this cell chloride of zinc is used, both because of its cheapness and of the higher electromotive force it gives. Iodide of zinc may also be used. The uncharged cell consists of two copper plates immersed in a solution of chloride of zinc. By passing an electric current through it, the chloride of zinc is decomposed, zinc being deposited on the one copper plate and chlorine being separated at the other copper plate. The chlorine never appears in the free state; it combines with the copper to form cuprous chloride, an insoluble white precipitate. The cuprous chloride is held against the copper plate by a sheet of parchment paper. This cell is now charged, and will supply a current until all the zinc is reconverted into chloride of zinc, and the cuprous chloride is reduced to metallic copper. The action of the cell is quite simple. As soon as the circuit is completed, the usual electrolytic state is set up. The chlorine of the chloride of zinc nearest the zinc deposit combines with the zinc, and the zinc separated at the other plate combines with the chlorine of the cuprous chloride to form chloride of zinc. It is a case of action at a distance, as in Grove's gas battery.

What is curious about it, to my mind, is that an insoluble non-conductor should enter so readily into the action of the cell. It must be remembered that the zinc is never separated; it takes up the chlorine from the cuprous chloride without ever appearing as zinc. It is impossible that it should appear as zinc, and it is therefore curious that it should ever reduce the cuprous chloride. The reduction of the cuprous chloride proceeds from the copper plate outwards. This question of what insoluble substances will enter into the action of a battery, and why they do so, is one of great importance, if primary batteries are ever to be cheap sources of electricity.

This cell may also be used as a primary battery, one pole being a zinc plate and the other a copper plate surrounded by cuprous chloride. It has this great advantage as a primary battery, there is no waste from diffusion of one liquid into another, as in the Daniell cell. It is a one-fluid battery. With this advantage it has also the advantage of the Daniell cell, in being free from polarization, and in no gas being given off during its working.

I measured its electromotive force on a Thomson electrometer, using a Daniell cell as my standard. Calling the electromotive force of a Daniell one volt, the electromotive force of my cell is .75 volt. To return to the secondary cells. The first point I proceeded to investigate, was whether the cell lost its charge on standing. This would only take place in a properly constructed cell by the solution of the cuprous chloride in the chloride of zinc, and its diffusion to the zinc plate, where it would be reduced to metallic copper, chloride of zinc being formed, or by some local action at the zinc deposit, between it and the copper plate. This local action does exist to a very slight extent, the water itself or traces of other salts than chloride of zinc being the cause. Chloride of zinc itself cannot, of course, produce local action between zinc and copper. The other form of loss, namely, from the solution of the cuprous chloride, I investigated as follows:—I made up a small cell, by taking a copper and a zinc plate of about 4 square inches surface, with wires soldered to them, wrapping the copper plate in parchment paper, and tying it and the zinc plate together with thread, two slips of wood, about a $\frac{1}{4}$ inch thick, being put between them to keep them apart. This was then slipped into a small

beaker, containing chloride of zinc solution, and a current passed through the cell from a bichromate battery, the zinc being deposited on the zinc plate. The chloride of zinc used was the commercial chloride, and this sample contained little or no lead and no copper. This cell was charged for about three hours, and then left standing for twelve hours. At the end of that time I tested the $ZnCl_2$ solution. It gave a brown coloration with H_2S , but no precipitate. The zinc deposit was then dissolved in HCl , and some small black flakes were left insoluble in boiling dilute HCl . These flakes dissolved on adding a little chlorate of potash, and the solution thus prepared gave a blue coloration with ammonia, and a very small black precipitate with H_2S . There was evidently, therefore, copper in the zinc deposit, but it was only a trace. Inside the parchment paper there was plenty of cuprous chloride, which was pure white, the parchment paper itself was green. I made several experiments of this kind; sometimes I found more copper than at others. On these occasions the parchment paper was green, showing the presence of oxychloride, and therefore of cupric chloride. This was caused, I believe, by air bubbles under the parchment paper. Any copper found on the zinc plate is more likely to be due to this than to solution of the cuprous chloride. If it is at all soluble in chloride of zinc in the cold, it must be very slightly so. This loss from copper chloride diffusing cannot be more than 5 per cent. of the charge in forty-eight hours; it is more likely in a properly made cell to be 1 per cent. or 2 per cent. It is difficult to settle its exact amount.

With reference to the formation of oxychloride, I noticed one remarkable phenomenon which I cannot explain. If moist cuprous chloride is exposed to the air, oxychloride is formed; but if the moist cuprous chloride is wrapped in parchment paper, and the outer surface of the parchment paper exposed to the air, the oxidation seems to go on through the parchment paper, and in a few hours the outer surface of the parchment paper is covered with a green slime of copper salts, that have in some way penetrated it.

To test the working of this battery, I made up some primary cells with cuprous chloride and zinc plates. In these cells I foolishly used linen to wrap round the cuprous chloride paste, and

it came through in considerable quantities, thus causing a great deal of waste.

One of these cells was put on a voltmeter consisting of two copper plates, "both weighed," separated by two strips of wood tied together with string, and immersed in a beaker of CuSO_4 sol. This I found forms a very good voltmeter for rough purposes, and as the plates are very close together its resistance is low, which is of course important. By weighing both plates, and taking the mean, the results are fairly accurate. I used ordinary sheet copper, but no doubt electro-deposited copper would be better. I describe this form of voltmeter, because the form described in Wiedemann's *Galvanismus*, namely, a platinum crucible with a silver rod in the centre, is only of use in very special and small experiments. It is very expensive and troublesome to work with. In this experiment, then, I found that after the cell had run six hours, the difference between the weight of zinc dissolved and the equivalent weight of copper deposited represented a loss of 15 per cent. 85 per cent. of the zinc dissolved had been returned as deposited copper, notwithstanding that I had used linen, which caused considerable waste. I then measured the internal resistance of a cell of 28 square inches surface, and having a distance of $\frac{1}{4}$ inch between the plates, and found it to be .15 ohm. I have reduced the resistance very considerably below this in recent cells.

I also made up twelve primary cells of 28 square inches surface each, and used them to illuminate a small Swan lamp, measuring the current and the candle power.

These experiments also gave very satisfactory results.

When I began to charge one of these cells, however, measuring the current on a tangent galvanometer, I found to my astonishment, that the current, starting at the strength to be expected from the EMF of the external battery and the resistance of my cell, rapidly fell off, so that in a few seconds the current indicated an increase of resistance in the cell from a few tenths of an ohm to as much as thirty ohms. At this point the current would remain stationary. On now attaching the cell to the galvanometer a powerful current would flow from it, indicating that it had instantaneously returned to its normal internal resistance. At first I supposed that this was due to some polarization set up in the

cell greater than the legitimate electromotive force of the cell. But it is impossible to suppose so high an opposing electromotive force being set up as this explanation would require, and there is nothing in the chemical reactions of the cell to account for it. I have also observed a cell get very hot under the influence of a powerful current, no doubt on account of its great resistance. I set to work to remove this difficulty in the use of the cell as a secondary battery, both chemically and mechanically. To remove it mechanically I increased the surface of the copper plate by covering it with precipitated copper. This was a great improvement, the resistance accumulating with comparative slowness. I found that the nature of the precipitated copper had a great effect, and at last got the best results by the reduction of a paste of cuprous chloride covering the copper plate. I reduced it by replacing the other copper plate with a zinc plate, and running down the cell thus formed. A firm spongy surface of copper was thus formed, usually red in colour. A still further improvement was made by covering this copper surface with a sheet of copper gauze, the copper gauze being soldered by wires to the copper plate. The purpose of this gauze was to produce two surfaces of action, one on each side of the precipitated copper, also to steady the current flowing from the cell when it was charged, by preventing its internal resistance from changing so much as it would otherwise have done. I have curves showing the gradual improvement in charging capacity of the cell. These curves were plotted after each experiment. I attach great importance to this surface of wire gauze, both in the primary and in the secondary cell.

The way I propose to use it in the primary cell is as follows:— Let us suppose a primary cell consisting of a jar containing cuprous chloride, with a copper plate round the inside as the one pole, and with a small porous pot in the centre containing a zinc rod and chloride of zinc solution. The resistance of this cell would be considerable at first, and as the cuprous chloride was gradually reduced from the copper plate in towards the centre, leaving behind it copper, the resistance of the cell would become less, and in this way a gradually increasing current would be supplied. But if we had a cylinder of copper gauze surrounding the porous pot, and in metallic connection with the copper plate, it would form another

surface of action, and would keep down the resistance of the cell from the first.

I tried to reduce the accumulation of resistance chemically by introducing small quantities of various zinc salts. I found nitrate of zinc had a wonderful effect in preventing an accumulation of resistance though put into the cell in very small quantities. I suppose the nitric acid set free on the copper surface kept it clean from the skin of cuprous chloride, to which the accumulation of resistance is no doubt due. Unfortunately it seems to demoralise the cell. It is impossible to get the charge put into the cell properly and entirely returned. Why this should be I do not know. When I found the introduction of the nitrate of no practical use, I examined no further into its action. I have therefore had to be content with the improvement produced by the porous copper and the wire gauze. When the resistance has increased to such an extent as to cause a serious waste of the charging current, I consider the cell as fully charged. And I would here say, that in secondary batteries as at present designed, one of two things seems to be inevitable,—gas is given off, or resistance accumulates.

In the Planté cell the peroxide of lead formed is a conductor; consequently, when the surface exposed is nearly all oxidised, gas is given off the oxidised surface; to the modification of the Planté cell by M. Faure the same remarks apply. In my cell the substance formed is a non-conductor; no gas is given off, there is not even a smell of chlorine; but as the surface exposed is converted into cuprous chloride, resistance accumulates in the cell. These secondary batteries may simply be regarded as polarised plates, the amount of polarisation depending on the surface exposed. I am afraid, therefore, that it will be very difficult to store a large amount of energy in a cell of small surface and weight. The storage in the cells invented so far is miserably small, and mine is no better than the rest in this respect.

Another difficulty in this battery has been depositing the zinc successfully. It has a tendency to form bunches of crystals, which reach across the cell to the copper plate, and form metallic connection therewith. The charging current should not be too powerful, though a current of three or four times the EMF of the cell may be used, and it should be stopped when the resistance becomes

serious. I will state at the end of the paper at what resistance I usually stop charging. The zinc should have a smooth surface, with no edges to deposit on. It deposits best on a horizontal plate, as might be expected, and I have some reason to believe deposits better for having light excluded. This point would require careful investigation. It is very difficult to insulate any part of the zinc plate. The zinc appears in bunches, having come through invisible holes. The only effective insulation I have found is sheet gutta-percha.

The form of cell I most frequently use is a tray cell. Thin sheet copper is folded at the corners on a wooden mould into a shallow tray, with sides sloping outwards. The bottom of each tray has stamped in it a depression about $\frac{1}{8}$ inch deep, across which is soldered copper gauze. The sides of the tray are carefully insulated with gutta-percha, and the solder varnished or plated with copper. The shallow depression is filled with cuprous chloride paste, through the holes in the wire gauze, and is then covered with parchment paper. Each tray is kept apart from the tray beneath by gutta-percha supports, or by a piece of old fishing-net. The cuprous chloride is reduced by means of zinc plates inserted into the trays, and the battery is ready for use. The only objection to the trays is the gradual formation of bubbles of hydrogen, when a charged cell is left standing, from the slight local action on the zinc plate. These bubbles cannot escape very readily, but it seems sufficient to slightly incline the cells. The electromotive force of this cell I have already stated. The plates may be brought very close together, as very little water is sufficient to dissolve all the chloride of zinc required. The resistance is consequently very low, a primary cell of 1 square inch surface having a resistance of 1.2 ohm.

At the end of this paper I give a summary of one experiment with a primary cell, and of two experiments with a secondary cell. The storage of this cell for a given surface is very small. This is to be expected, from what I have already stated about the limited storage of secondary cells. With so small an EMF as mine, it is not possible to store much on a given surface. The materials of my cell are so light, however, that I can store about 30,000 ft. lbs. for every lb. weight of metal in the cell.

In the primary cells the current is usually pretty steady until

the cell is nearly exhausted, it then falls off rapidly. In the secondary cell it usually falls off from the beginning, or at any rate very soon after the cell begins to run down. This is due to increase of internal resistance from the using up of the cuprous chloride and the zinc. These cells usually run themselves out completely, leaving no zinc deposit.

To recapitulate the peculiarities of this cell. It is a one-fluid cell, and therefore does not suffer from diffusion.

Its internal resistance is very low. 1.2 ohm for 1 square inch surface. Its EMF is .75 volt.

It does not suffer from polarisation, nor does it give off any gas either during charging or running down.

When being charged it increases in internal resistance.

The experiments on the next page are selected from many, as being fairly favourable specimens of the action of the cell.

I have not said anything here on my views of the practical application of secondary cells to electric lighting, or of how I propose to use my cell. I hope to be able to lay a future paper before the Society on this subject. I should mention that this cell has been patented in my name as a secondary battery by Mr. Swan of Newcastle.

Primary tray cell, 6 sq. in. surface, weight = $\frac{1}{8}$ lb.*

Current varying from 3.5 to 5.5 Ampères.

1st minute, 4.2 Ampères.

45th minute, 4 Ampères, then rapidly falling.

Average for 45 min., 4 Ampères.

Work expended in circuit = 5950 ft. lbs.

Average internal resistance, 0.2 Ohm.

16 tray cells occupying 4" x 5" x 4", and weighing about 3 lbs., supported a small Swan lamp for 1 hour 10 minutes at 1 candle.

Secondary Tray Cells.

1st cell. Surface 7 sq. in., $\frac{3}{8}$ " between trays.

EMF of cell before use, 0.8 Volt.

After 12 minutes, current = 3.1 Ampères.

EMF = 0.7 Volt.

* By the "surface" is meant the surface of one plate, not of both together.

After 32 minutes, current = 2·2 Ampères.

EMF = 0·7 Volt.

After 52 minutes, current = 1·3 Ampères.

Work expended in circuit = 3560 ft. lbs.

2nd cell. Surface 7 sq. in.

After first minute, current = 0·4 Ampères.

After 30 minutes, current = 2·5 Ampères.

Work expended in circuit = 2880 ft. lbs.

Monday, 5th June 1882.

THE RIGHT HON. LORD MONCREIFF, President,
in the Chair.

The President read Obituary Notices of Mr. David Smith, Dr. William Lauder Lindsay, and Professor Benjamin Peirce, deceased Fellows of the Society.

OBITUARY NOTICES.

DAVID SMITH. By Mr. David Maclagan.

MR. DAVID SMITH was born 13th January 1803, and died 16th December 1880, in his 78th year. He was educated at the High School and University of Edinburgh, his native city.

Having resolved to adopt law as his profession, he joined the body of Writers to Her Majesty's Signet in 1826, and at a comparatively early period of his life acquired an outstanding position as a man of business. Large and important interests were committed to the charge of his partner, Mr. James Kinnear, and himself, involving increasingly from year to year much laborious care and watchfulness.

In the year 1858 he was offered, as affording by its more defined and systematic duties, some measure of relief from an overtaken life, the vacant appointment of principal officer of the North British Insurance Company; his wide general experience having included a practical acquaintance with the principles and manage-

ment of life assurance companies. He threw himself with characteristic energy into this new sphere of labour, and, under his guidance, the company, which had always held a high place among similar institutions, rose with rapid strides to a position of pre-eminence.

The labours of a crowded business life of half a century at last began to tell upon his health; and in the year 1880 he resigned his office, and retired from active business, receiving from a very wide circle in our city expressions of sympathy, respect, and gratitude.

While immersed, as might have been supposed, in purely professional work, Mr. Smith took an active and effective part in connection with a vast variety of matters affecting, in different relations, the interests of Edinburgh, and indeed of Scotland.

As a Justice of Peace and Deputy-Lieutenant of the city of Edinburgh, he identified himself with every movement fitted to further its prosperity and good government.

Educational questions had always a special place in his regard; and any movement designed to promote the advancement of the University, in the way of enlarged endowments or of extension of its range of teaching, received his steady support.

Philanthropic and benevolent institutions—notably the Royal Infirmary—secured much valuable service at his hands, while at the same time he was busy with ecclesiastical affairs in connection with the Established Church of Scotland, of which he was an office-bearer, and in the interests of which he was a much valued counsellor and an unwearied worker.

Our own Royal Society derived no small advantage from his tenure of the office of Treasurer during a long series of years.

In a variety of qualities, not always, and indeed not often found in combination, we have the secret of his power of discharging, with a large measure of effective success, the many and diversified duties which seemed to fall to him with a certain naturalness and propriety.

It was impossible not to be struck by the keen insight and rapidity of decision which characterised his examination of any subject brought before him. The matter being disposed of, it was dismissed and forgotten, and some new and quite different question or interest followed a like course with equal despatch and deter-

mination. That there were disadvantages attending this habit of mind is undoubtedly true; but, in the main, it enabled him to overtake an amount and range of work quite remarkable in its extent and variety.

His administrative talent was conspicuous; and in work which brought him in contact with large numbers of persons of diverging views and opinions, his genial presence and firm attitude often secured united action, and moderated with singular success in divided counsels.

His courtesy of manner, kindness of heart, and obviously earnest desire to be helpful, attracted towards him the confidence and affection of a wide circle of attached friends.

Broadly viewed, few more useful lives have been spent in the community of which he was a member, and still fewer have commanded for themselves so much influence and regard as to leave, as he has done, a vacant space in society, which it is not probable we shall soon or easily see adequately filled.

WILLIAM LAUDER LINDSAY. By Dr. W. C. M'Intosh, F.R.S.

Dr. WILLIAM LAUDER LINDSAY was born at Edinburgh on the 19th December 1829, and received his education at the High School. He had naturally strong tastes towards botany and geology, and had collected plants even before entering the University as a student of medicine in 1847. During his medical curriculum his botanical tendencies received a great impetus, as he himself records, from Professor Balfour, in whose classes for two summers he carried off high honours. Some of his beautiful dissections of grasses are still justly admired in the Museum in the Botanic Garden. After a career in which he distinguished himself as a zealous and industrious student, he graduated as Doctor of Medicine in 1852, his thesis being on the "Structure and Physiology of the Lichena." This essay and its illustrative preparations received the high commendation of the Medical Faculty. He soon after competed for the Conservatorship of the Museum of the Royal College of Surgeons, Edinburgh, but the late Professor Sanders obtained the post. He then became Resident Physician in the Cholera Hospital, Surgeon's Square, under the amiable and accomplished Dr. Warburton Begbie,

and while in this position his perseverance and acute powers of observation enabled him to make a series of interesting experiments on the communicability of cholera to the lower animals. These researches attracted considerable notice in the medical papers both at home and abroad.

Dr. Lindsay thereafter entered the Crichton Royal Asylum, Dumfries, as Assistant Physician, his chief being the able and genial Dr. W. A. F. Browne, the brother-in-law of his botanical patron. This seems to have been the turning-point in his career, as it is unlikely he would have left the arena of pure science if there had not been a paucity of suitable appointments in the botanical or other department. While doing duty in his new office in a manner that gained him much approbation, he received, at the instigation of the late Dr. Malcolm of Perth, the appointment of Resident Physician to Murray's Royal Asylum, Perth, at the end of 1854; and for a quarter of a century he laboured with unflagging zeal to promote the welfare of his patients and the interests of the institution, until failing health compelled him to resign at the end of 1879.

Few physicians in our country have been gifted with a pen so facile, an intellect so varied, and a perseverance so unbroken as that of Dr. Lauder Lindsay. The mere list of his literary and scientific publications would form a considerable pamphlet, the chief articles grouping themselves under the heads of Botany, Medicine, and General Literature. It must be remembered, also, that his scientific work was accomplished after his energies had been spent in continuous and responsible duty, and at a distance from scientific aid and encouragement. His medical writings, including his laborious work on *Pensions to Asylum Officers*, and the collection of incidents massed in his *Mind in the Lower Animals*, have already received notice in various Journals (e.g. the *Edinburgh Medical Journal* for January 1881), so that on the present occasion attention will be directed to his more strictly scientific labours.

Eager to add to existing botanical knowledge, he very early in his career, at the suggestion of Professor Balfour, chose the Lichens as a suitable subject for investigation, and soon after graduation he published a *Popular History of British Lichens*, illustrated by many plates. This little work received very favourable notice, and is still a useful guide on the subject. A series of structural and

other papers on the Lichens then followed, several being communicated to this Society. For one of these, viz., his Memoir on the Spermogones and Pycnides, the Neill Prize was awarded in 1859. His various papers were illustrated with plates drawn by himself, and though the nature of his subject did not admit of much artistic display, his representations were both accurate and well finished. His labours amongst the Lichens did much to place the study of that department on a scientific basis, and greatly extended our knowledge of their structure and economy.

In his early days a considerable traveller, he explored the mineralogical and geological features of the Hartz mountains, and made large collections. He also in subsequent years visited many other places on the Continent, besides Iceland and the Færoe Islands, America, and Egypt. Moreover, his health, which had never been robust, failing in 1861, he obtained a year's leave of absence, which he spent in visiting New Zealand and Australia, making extensive collections, and laying the foundation of many papers on the Botany and Geology of New Zealand. He also stimulated the colonists by a lecture, at Otago, on "The Place and Power of Natural History in Colonisation." In the same way his visits to Iceland and the Færoe Islands formed the basis of several botanical and geological papers, and subsequently enabled him to deal more easily with the Lichen-flora of Greenland.

In viewing the number and variety of Dr. Lindsay's botanical and geological communications, one is struck by the extraordinary industry that characterised him. His active mind was ever on the stretch, and his facile pen never failed to make the best use of the materials at his disposal. The field covered by his labours, however, was much too extensive for the production of work of equal value in every case, and the pressure on his time occasionally prevented the necessary consolidation of prolix articles. Taken all in all, however, his botanical labours do him infinite credit, and have greatly advanced the subject he took under his care. It will be long before the Lichens find so able and so accomplished a worker. He was, indeed, the Nylander of Scotland. In accordance with his instructions, his valuable collection of Lichens was presented by his trustees to the University of Edinburgh, and is now in the Museum in the Botanic Garden.

As a public official in the Perth Royal Asylum, his bearing and administration were admirable ; nor were his relations in private life less worthy of esteem. He placed the institution on a sound basis financially, in his early years, and reorganised every department ; while in his later years of office he greatly improved and beautified the internal arrangements of the various wards, and he did so with uncommon ingenuity and taste. Shrewd and acute to an extraordinary degree, he proved himself a most accomplished alienist-physician, kind and considerate to his patients, skilful in promoting their comfort and recovery, and an apt organiser of all the events that constantly take place in such institutions. His thorough medical training, and his natural penetration, made him always a safe and prudent adviser.

Originally of a slight build, his intense application to work caused his health to give way after his marriage in 1859, and even the improvement gained by the year's relief in 1861-62 gradually wore off on the active resumption of literary and official engagements. Indeed, for years before his death he was an invalid. Yet he bravely did his duty to the last, and kept a cheerful word for every one—even while he doubted if his strength would enable him to conclude his visit. Probably for the same reason he avoided society, solacing himself rather with his books and microscope. His health unfortunately showed no sign of improvement, and he had hardly been a year out of office when he succumbed to the increasing exhaustion on the 28th November 1880, at the comparatively early age of fifty-one. Much of the work his ardent mind sketched out for himself he left undone ; but he achieved enough to win a solid reputation, and to furnish a worthy example of what ability and application can do under difficulties.

PROFESSOR BENJAMIN PEIRCE. By Professor Simon Newcomb.

PROFESSOR PEIRCE was born at Salem, Massachusetts, April 4, 1809, and graduated at Harvard College in 1829. He made the acquaintance of Dr Nathaniel Bowditch, the translator of the *Mécanique Céleste*, and assisted him in getting his great work through the press. He spent two years after his graduation in teaching. He was appointed tutor in mathematics at Harvard

College in 1831, and professor in 1833. During the few years following he published a series of mathematical books covering the course then taught at the college from Algebra to Differential Equations. His elementary books were remarkable for their condensation. In the geometry, especially the short and terse and comprehensive forms of mathematical thought and expression, natural to the mathematician, were substituted for the minute demonstrations of Euclid. Free use was also made of infinitesimals. The volumes of geometry and the infinitesimal calculus were published under the title of *Curves, Functions, and Forces*. The subject of Forces, which was intended to cover mechanics, was, however, dropped from the series. The concluding portion of the second volume is devoted to the Differential Calculus, and is noteworthy for the brevity and conciseness of style, and the free use of operative symbols.

After the death of Bowditch in 1838, Peirce stood at the head of mathematical science in his country, as the leading one of the very few who had access to foreign journals. About 1842 he commenced, in connection with Professor Lovering, the publication of a serial under the title of the *Cambridge Miscellany of Mathematics and Physics*, of which, however, only a few numbers appeared. He took an active part in the foundation of the Harvard Observatory, the occasion being afforded by the great comet of 1843. The work which first extended Peirce's reputation, was his computation of the general perturbations of Uranus and Neptune. The formulæ to which he was led were published in the first volume of the *Proceedings of the American Academy*, but were accompanied by no description of his process. Subsequent investigations, however, showed them to have been remarkably accurate. In his views of the discrepancy between the mean distance of Neptune as predicted by Leverrier, and as deduced from observation, he was less fortunate, although, when due consideration is given to Leverrier's conclusions, there was much plausibility in the position taken by Peirce. As the subject has frequently been discussed without a due comprehension of all the circumstances, a brief review of them may be appropriate.

Leverrier, from his researches, found for the mean distance of the disturbing planet 36.1539, and a consequent period of 217 years.

He also announced that the limits of the mean distance which would satisfy the observed perturbations of Uranus were 35.04 and 37.90. He founded this conclusion on a supposed inadmissible increase of the outstanding differences between theory and observation, as the mean distance was diminished below 35. But when the planet was discovered its mean distance was found to be only 30; and yet the observations of Uranus were as well satisfied as by Leverrier's hypothetical planet. It was, therefore, an expression of Peirce's high confidence in the accuracy of Leverrier's conclusions that led him to announce that there were two solutions to the problem; the one being that found by Leverrier, and the other that corresponding to the actual case. He also sought to show a cause for the two solutions in a supposed discontinuity in the form of the perturbations, when the period was brought to the point at which five revolutions of Uranus would be equal to two of Neptune. As a matter of fact, however, it has been shown by Professor Adams that there was no such discontinuity in the actual perturbations during the limited period; from which it would follow that Leverrier must have made a mistake in tracing out the conclusions which would follow when the mean distance of the disturbing planet was diminished.

In 1849 the preparation of the *American Ephemeris and Nautical Almanac* was commenced at Cambridge, by Lieutenant C. H. Davis, and Peirce, in the capacity of consulting astronomer, took an active part in planning the work. It being especially desired that accurate tables should be employed in the new *Ephemeris*, Peirce made use of Airy's reduction of the Greenwich lunar observations, then recently published, to prepare new tables of the moon. He prepared the formula and plans for the table which were executed in the office of the *Ephemeris*. *Gould's Astronomical Journal* was commenced at this time, and Peirce contributed a number of short papers, the most important of which related to the theory of Saturn's rings. The suspicion had been expressed by Bond and others, that temporary divisions took place in the rings from time to time, thus showing that they could not be solid. Peirce showed that the equilibrium of a fluid ring was necessarily unstable, as well as that of a solid one, and therefore suggested that the equilibrium was preserved by the attraction of the satellites. The research, however, was

left in an unfinished state, but taken up some twelve years later in the first volume of the *Memoirs of the National Academy of Sciences*.

Among all of Peirce's contributions to science, that which he himself seemed to value most highly was his *Linear Associative Algebra*, which, however, was only published by lithographing and privately distributing a few copies. It essayed a general theory of the multiplication of units of different classes, subject to the law of association and distribution, but not of commutation.

In 1867 he was appointed Superintendent of the Coast Survey, to succeed Professor Bache; but finding administrative duties little to his taste, he resigned in 1874.

During the last few years of his life a tendency towards speculation, partly of a philosophic and partly of a cosmological character, which he had exhibited during most of his life, showed itself yet more strongly. He delivered before the Lowell Institute a course of lectures on Ideality in Science which have been published in book form, and afford an interesting view of the speculative operations of his mind.

The influence exercised by Peirce on the progress of mathematical science in his own country, is at least equal in importance with his scientific work. He was an ardent and enthusiastic friend, ever ready to encourage younger men and promote their work. He had an especial fondness for seeking out comparatively unknown men whose ability had been overlooked. As a teacher, he was very generally considered a failure. The general view he took was that it was useless for any one to study mathematics without a special aptitude for them; he therefore gave inapt pupils no encouragement, and made no attempt to bring his instruction within their comprehension. His extreme generality and terseness of expression, and his fondness for brevity of notation, sometimes made it difficult even for an expert to follow him; while a certain imaginative and poetic vein, in which his fundamental principles are laid down, was unsuited to most minds. The most characteristic as well as the most extensive of his works is his *System of Analytic Mechanics*. The exposition of dynamical concepts in the first forty pages is pleasant reading for one already acquainted with the subject, but that a student beginning the subject could understand it without a clearer distinction between definitions, axioms, and theorems seems hardly possible.

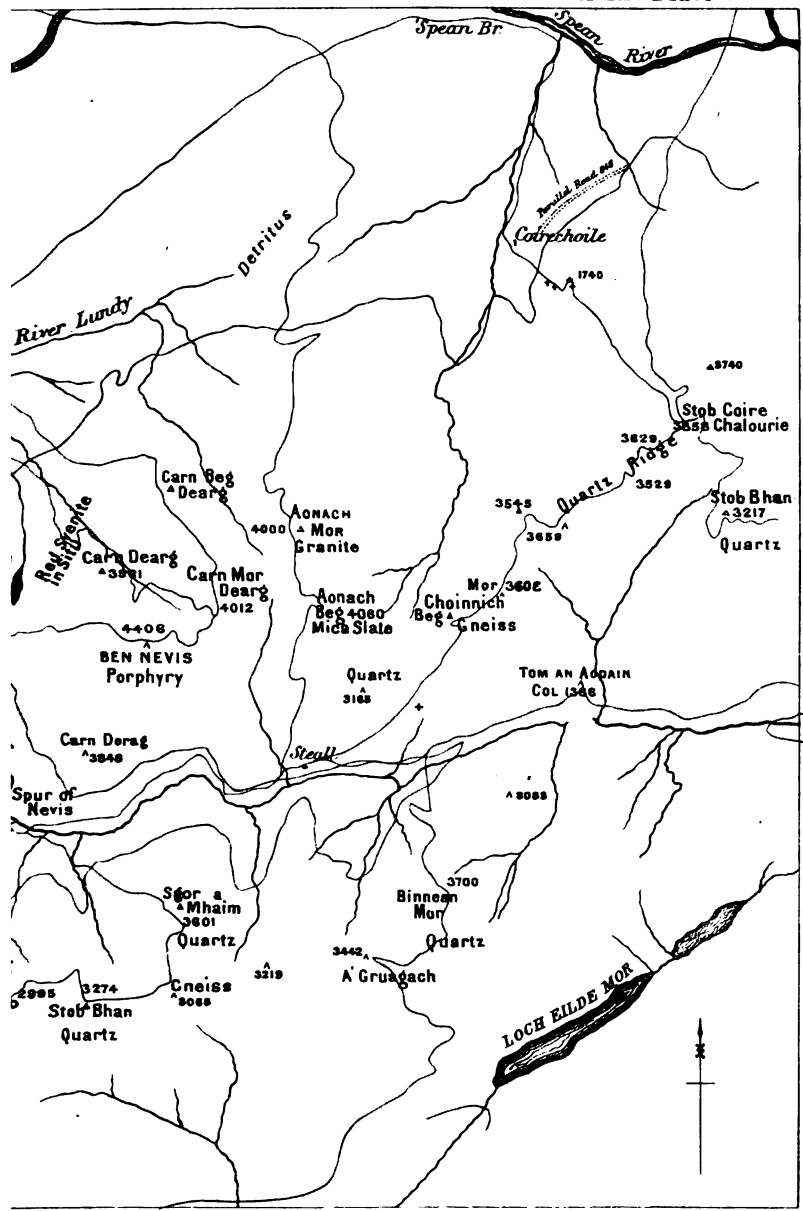

W. H. K. Johnston, Edinburgh

The President announced that the Council had awarded the Keith Prize, for the Biennial Period 1879-81, to Professor Chrystal, for his paper "On the Differential Telephone," published in the Society's *Transactions* for the Session 1879-80; and the Neill Prize, for the Triennial Period 1877-80, to Mr. John Murray, for his paper "On the Structure and Origin of Coral Reefs and Islands," communicated to the Society on 5th April 1880, and printed (in Abstract) in the *Proceedings* for that date.

The President read a letter from M. Dumas, perpetual Secretary of the Academy of Sciences, Paris, inviting the Fellows of the Society to subscribe to a Fund to be formed, in order to present to M. Pasteur a Medal, commemorative of his work and services. Professor Tait announced that the Council had replied to M. Dumas' letter, informing him that the Society has no funds which can be devoted to such a purpose, but that an opportunity would be given to individual Fellows of subscribing to the Medal to be offered to M. Pasteur.

The following Communications were read:—

1. On Mirage. Part II. By Professor Tait.
2. Report of the Boulder Committee, with Remarks by the Convener, Mr. Milne Home. (Plate V.)

The Convener being now no longer able to climb hills, or walk to any considerable distance, his own contribution of information to the Committee is, this year, exceedingly small.

I. CANTIRE.—LOCH TARBERT.

The only place visited by him during last autumn was East Loch Tarbert, Loch Fyne, at the suggestion of Mr. Alexander of Lochgilphead, whose services to the Convener during the two previous years were peculiarly valuable.

Having procured a horse, the Convener, under Mr. Alexander's guidance, rode up two-thirds of a hill, about two miles to the N.W. of East Loch Tarbert, on the property of Mr. Campbell of

Stonesfield. He omitted to record the name of the hill. The object was to examine a boulder bearing the name of "*Cappull-na-Cloiche*," meaning "The Mare of Stone," from its fanciful resemblance, in a misty day, to a mare feeding. The hill was found by aneroid to be 710 feet above the sea.

The summit of the hill is shown by the following diagram, not drawn to an exact scale:—

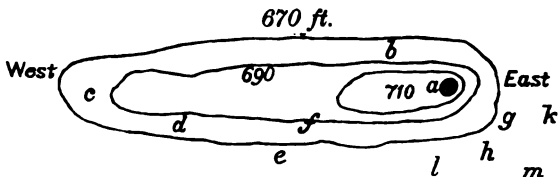

The length of the crest is about 60 yards in an east and west direction, along the contour line of 690 feet; and about 15 yards between N. and S. at *f*. The largest boulders are represented by the letters *a* to *m*.

The boulder with the name above mentioned (*a* in the diagram) stands on the very highest peak of the hill. It is composed of compact gneiss, whilst the rock of the hill is clay slate, with



numerous quartz veins. The height of the boulder is 8 feet, and its breadth or width each way, near the lower end, is 5 feet.

There are multitudes of boulders near the top of the hill,—chiefly on the S.E. side, *g*, *h*, *k*, *l*, *m*. The largest of these, *k*, is $14 \times 9 \times 8$

feet. There is only one boulder on the north side, viz, *b*, whose size is $9 \times 4 \times 4$ feet. They are all gneiss boulders.

As bearing on the question of transport, it is proper to mention that this hill stands by itself, in a sort of amphitheatre. There are no hills so high as it within a mile.

At about that distance towards the north, there is a range of hills somewhat higher,—with openings between, especially towards the west. On these hills, numerous boulders were descried through the telescope, and regret was felt at the inability to visit them,—especially as several were seen perched on ridges and peaks.

It seemed probable, that if there had been ice carrying boulders, floating on a sea from 800 to 1000 feet above the present sea-level and stranding on the hill, the position of the boulders on the hill and its sides might be accounted for.

In this district, with hills, none exceeding 1200 feet in height, local glaciers are not likely to have been formed; and if there had been such, they would have passed down the low grounds on each side of the hill along its base.

On his way back to Tarbert, the Convener passed a conical hill, on south, clad with smooth green pasture. On its N.W. slope, two large boulders were observed. But as the access to the hill was difficult, the Convener did not attempt to reach it.

The hills, both north and south of East Tarbert, are well covered by boulders, and would repay a special visit from any one interested in this subject. Even from the streets of the town, in a clear day, boulders can be seen along the ridges of the surrounding hills on the sky-line.

On the hills adjoining East Tarbert village, on the south, and at a height of from 280 to 300 feet above the sea, there are evident marks of some agent having swept through between the hills from west to east. The rocks are well rounded by friction; and on the east side of many rocky knolls, there are small boulders, and heaps of gravel, which look as if they had been protected by these knolls from a westerly debacle or current.

The Convener, when at Rothesay, walked along the course of the small stream which runs into the sea near the Queen's Hotel. In the lower part of its course, the stream cuts through beds of gravel, from 50 to 60 feet thick. In the upper part of its course he

came to a flat about 780 feet above the sea. He found there a number of boulders. The largest $4 \times 2 \times 2$ feet, had its longer axis pointing N.W. and S.E.

Mr. Alexander told the Convener of a large boulder, 9 or 10 feet high, on the Farm of Taynish, at the head of a small arm of the sea, on Loch Sweyn, about 4 miles south of Tayvalloch. It is surrounded by a cluster of smaller boulders. It lies on bare rock, which slopes down towards the west. It is about 50 feet above sea-level. On the east side of it, there is an old sea bank, which may have intercepted its transport farther eastward.

II. OCHIL HILLS.

The Convener has received a letter from James Johnstone, Esq., of Alva, referring to the south slopes of the Ochil Hills, mentioning that the boulders in Alva Glen and Silver Glen are mica schist. In Tillicoultry Glen, he says there used to be many granite boulders; but he thinks they have all been broken up for building purposes.

He adds, that as the rocks of the Ochils are here a species of trap, the boulders in question probably came from the Grampian Hills, *i.e.* from the N.W.

III. ORKNEYS—NORTH RONALDSHAY.

The Convener has received the following in answer to the circular sent out by the Committee during last winter:—

“In this island of North Ronaldshay, Orkney, of which I am proprietor, and the rocks of which consist of Old Red Sandstone flags, there are no boulders that I know of. I have, however, observed a mass of coarse conglomerate, like a rock which occurs to the S.W. at Heclabir, in the adjacent island of Sanday.* It had been built into a stone dyke, and was of a size too large for most men to carry. The surface was slightly worn, but not rounded like a beach stone. I have also often found smaller blocks of granite

* *Note by Convener.*—Sanday Island is 5 or 6 miles from Ronaldshay. Stromness is at the S.W. end of Pomona, and about 40 miles from Ronaldshay, with deep seas between, and several small islands. Stromness is the only locality in the Orkneys for granite and syenite. In Sanday, there is the remarkable granite boulder weighing about 9 tons, which is referred to in the Committee's Second Report, p. 168.

and syenite (which may have been transported from Stromness in the Island of Pomona, also to the S.W.); and also a stone resembling coarse jasper, scattered over waste parts of the island. These are often more than half buried in the ground, and most of the blocks are more angular than beach stones. Some of them have their surfaces flattened and smooth, and in one or two instances shining, as if ground and polished. The soil on which they are generally found, is clay, loam, or nearly pure clay of a red colour; and sections in making quarries show, that it contains in places rounded pebbles with here and there angular flints, much discoloured, and bits of mica schist mixed with quartz and other extraneous stones. This red clay extends over many acres, and varies from 1 to 4 or 5 feet in depth.

“WM. TRAILL of Woodwick.”

8th March 1882.

IV. SHETLAND.

1. *Parish of Lunnasting.*

In reference to the circular lately received asking for information about boulders, I beg to forward a few particulars respecting four. They are all in the parish of Lunnasting, on the estate of Lunna, and the property of Robert Bell, Esq., sheriff of Falkirk.

No. 1. Height 22 ft. 9 in.; length 36 ft.; breadth 25 ft.; shape, angular; direction of longest axis S.E. and N.W.; height above sea-level 150 to 200 ft.

No. 2. Height 19 ft.; length 34 ft.; breadth 14 ft.; angular; direction of longest axis N.E. and S.W.; height above sea-level 150 to 200 ft.

No. 3. Height 11 ft. 4 in.; length 8 ft. 7 in.; breadth 8 ft. 2 in.; angular; direction of longest axis S.E. and N.W.; height above sea 150 to 200 ft.

No. 4. Height 7 ft. 10 in.; length 8 ft. 7 in.; breadth 3 ft. 2 in.; wedge-shaped; direction of longest axis S.E. and N.W.; height above sea 300 to 400 ft.

Nos. 1, 2, and 3 stand all near each other in the northern part of the parish, and not far from the sea. Nos. 1 and 2 are separated only by a distance of 10 or 12 feet, the intervening space being

filled with large masses of stone which appear to have fallen from No. 2. No. 4 stands by itself, surrounded by deep moss, within a few yards of the highest point of a hill about four miles to the south of the other three. Its longest axis runs parallel to the face of the hill. It is known by the name of the "standing stone" of the south hill of Lunna.

No. 3 has no special designation.

Nos. 1 and 2 are known as "the stones of Stofas." "Stofas" is said to be a corruption of *stay fast*, and the legend accounting for the name is that it was given to the stones from the circumstance that they were originally two giants passing through Lunnassa, and converted into stone by some superior power who arrested their progress by pronouncing the words "stay fast."

All the above stones look something like pale granite.

GEO. CHRISTIE.

The Manse, Lunna, Lerwick, Shetland,

18th March 1882.

Note by Convener.—The stones of Steffis are referred to by the late Dr. Hibbert in his quarto volume on Shetland (published in 1822), p. 173, where also a diagram of them is given, and an intimation of his inability to say more about them than that they "were enormous detached masses, which do not seem to have undergone any very distant removal, since they repose on rocks of a similar kind." In a paper in the *Edinburgh Journal of Science* for 1831 (vol. iv. p. 88), written by Dr. Hibbert (as he observes) twelve years after his first visit, he offers an opinion, which he says he is now "disposed to pronounce with some degree of confidence." "These immense boulders (he says) are in an elevated situation upon a very narrow tongue of land, 3 or 4 miles in extent, which having jutted out into the ocean in a N.E. direction, would be opposed to the direct force of the diluvial wave. The extremity of the headland being much broken, an indication is thereby afforded of the site whence these stones have been *dislodged* and by diluvial currents *hurried along*. The distance (he adds) to which they have been detached cannot be estimated at more than a mile or two."

These remarks are interesting, as indicating Hibbert's opinion, after a second visit to the spot, that the "stones" had been disrupted by some tremendous agency moving in a direction from N.E. towards S.W. and carried to a distance of "a mile or two." When Hibbert wrote in the year 1831, he not unnaturally, for boulder transport, adopted the theory proposed by Sir James Hall of Dunglass in 1812, of oceanic waves sweeping across continents. It was not till many years after, that ice was suggested as a medium of transport.

Hibbert, after referring to these stones of Steffis as "immense boulders," "detached" and "hurried along" from the headland of Lunna, goes on (by way of confirming his opinion) to cite several other cases in the Shetlands of the transport of boulders, which are extremely interesting.

Thus, he says, that on the Island of Yell, there are "large fragments of Serpentine and Euphotide, which have evidently been drifted some miles, from the islands of Unst and Fetlar."

"On the summit of Roeness Hill, composed of red granite," there is an "immense quantity of boulders of a primary greenstone which appear to have been removed from a site 2 or 3 miles off, and to have been rolled in a S. or S. W. direction, up a gradual ascent of 3 or 4 miles."

"On the summit of Hilswick Ness, we meet with a surprising block, composed of granite, removed from a rock, the nearest site of which is about 2 miles to the N."

He had previously mentioned that, in the Island of Papa Stour, there are "numerous fragments of hornblende schist and actinolite schist"—"rocks which are nowhere to be met with in this archipelago, except at Hilswick Ness, a distance (when measured in a straight line across the Bay of St. Magnus) of at least 12 miles."

Dr. Heddle of St. Andrews informs the Convener, that he, some years ago, examined these "Stones," and formed an opinion that they had, by some natural agency of great power, been detached from a rocky cliff not far distant, and been moved in a direction towards E.S.E. They are a peculiar micaceous gneiss, containing nodules of white felspar.

These "Stones" are referred to in the Second Report of the Boulder Committee, p. 178.

2. Parish of Fair Isle.

The Rev. William Laurence, catechist and teacher, reports as follows:—

"There are no boulders above 10 tons, but there are several small ones of the pudding-stone description, quite different from the rocks *in situ*. There was one very remarkable large stone—a huge block of sandstone—quite similar to the "*Eday*"* sandstone, but it was blown up by gunpowder last year, for building purposes. There was nothing like it in the whole island.

"It and the other small ones are probably glacial deposits."

V. CAITHNESS.

The Rev. Hugh Mair sends the following answers to a circular from the Committee:—

"Boulder in Keiss parish; estate of Freswick; farm of Mr. Peter Gunn; proprietor, Wm. S. Thomson Sinclair, Esq.

* *Note by Convener.*—The Island of *Eday* is about 13 miles to the S.S.W. of *Fair Isle*. In the Geological Map of the Orkneys, lately published by Messrs. Peach and Horne (*Quart. Jour. of Lond. Geol. Society* for Nov. 1850), the rocks of "*Eday*" are represented as consisting of old red sandstone conglomerate. The geology of "*Fair Isle*" is not given by these gentlemen.

“Length 9 ft. ; breadth 5 ft. ; height 7 ft.

“Rounded, but rather broader at base.

“Longest axis W. by N. and E. by S., or W. and E.

“Different from any rock in locality ; none similar in locality so far as known.

“Conglomerate or pudding-stone of a most remarkably pronounced character.

“Popular name, “Greystone” ; no legend, save that it is called one of the Kirk stones,—origin of name unknown.

“200 ft. above sea-level ; and $\frac{1}{4}$ mile from sea on east coast.

“Marks the boundary between the old parishes of Wick and Canisbay, and between the lands of Nybster and Aukingill.

“I am sorry to say the answers refer to the stone *as it was*. Some utilitarian individuals blasted it ; and part has been carted away ; but three large portions remain. When whole, it must have been a most remarkable stone.”

Notes by Mr. Ralph Richardson (a member of the Committee) of a Visit by him to Strathnairn, in the Autumn of 1881.

I drove last August (1881) from Inverness *via* Druids Temple and General Wade's military road, to Strathnairn, crossing the River Nairn at Daviot, and proceeding down its right bank to the celebrated “*Tom Riach*” boulder, returning *via* Clava and Culloden Moor,—a distance of about 20 miles. Shortly after passing Craggie Burn, Strathnairn, I was struck with the number of boulders dotting eminences throughout the valley, and with the depth of sand which covered the hills,—the whole pointing to a period of submergence in Post-Pliocene times.

To make this still more evident, I may cite the interesting discovery last summer by Mr. James Fraser, C.E., Inverness, of Arctic marine shells at the height of 500 feet above the sea, at Drummore of Clava in this district, being the second highest discovery of the kind made in Scotland. Several of the shells discovered here being now only found in Arctic regions, the sea which once covered this district must have been of a decidedly glacial type.

I examined the section at Drummore, and found that it exhibited a considerable depth of sand, beneath which the shells occurred in a bed of blue clay. Similar shells in similar blue clay are found near the sea coast at Ardersier, Fort George, about 8 miles due north from Drummore of Clava, and at an elevation of about 50 feet. It is evident from the occurrence of these shells in two separate localities, that this part of Scotland had once been covered by a sea of a temperature similar to that now washing the coasts of Arctic America, Finmark, and Spitzbergen. I also inspected the two famous boulders of the district, both of them huge conglomerate blocks, "*Tom Riach*" (the stone of the grey hill), measuring 27 feet \times 22 feet \times 15 feet, near Croygorstan, and the "*Duke of Cumberland's stone*" on Culloden Moor.* Probably neither of these are far travelled, conglomerate rocks being found *in situ* in proximity to them. The valuable papers by Messrs. Thomas D. Wallace and James Fraser of Inverness, in volumes III. and IV. of the *Edinburgh Geological Society's Transactions*, treat fully of the Boulder phenomena and geology of this interesting district.

*List of Boulders in the Neighbourhood of Inverness, sent by
Mr. Wallace, High School, Inverness.*

1. Split conglomerate boulder, in the burn below Mid-Lairg Farm, in Upper Strathnairn.

2. *Clach-a-nid* (stone of the nest) lies on the N.E. shoulder of Meal-Mor, a hill 1207 feet high. The boulder is 950 feet above sea-level. It is composed of gneiss, and measures 28 \times 24 \times 14 feet.

3. *Brownie Stone*. A very large conglomerate boulder lying on the moor, half a mile north of Bunachton.

4. *Clach-na-h-ulaidh* (stone of the hidden treasure). A large block of gneiss, 12 \times 12 \times 5 feet, resting on the brink of a cliff of old red sandstone, overhanging the east bank of the Nairn River, a few yards from Nairnside House. It is about 40 feet above the river, and 400 feet above sea-level.

5. Gneiss boulder, measuring 6 \times 5 \times 4 feet, much rounded, lies

* The "*Tom Riach*" boulder is between 300 and 400 feet above the sea-level; and the "*Cumberland stone*" is 487 feet above the sea.

on limestone, interbedded with the old red sandstone, at Dalroy, on the Nairn. It is composed of ordinary gneiss.

6. Conglomerate boulder in a field, a little to the N.E. of "Tom Riach" boulder, measures 95 feet in circumference, and 35 feet in length. It lies about 350 feet above sea-level. Same kind of conglomerate as the "Tom Riach," which would show that it came from the S.W.

7. Conglomerate boulder (same as other), lies in the bed of the River Nairn, to the East of Daviot House. Measures about $6 \times 7 \times 8$ feet.

8. Four conglomerate boulders, same as last, on the moor, north of Nairnside School House, at a height of 590 feet above sea-level. One measures 14×8 feet, one 13×15 feet, one 9×9 feet, and one 9×8 feet. These may have come from west. They do not rest one upon the other.

9. In Cran-More Wood, Nairnside, there is one boulder measuring $9 \times 6 \times 3$ feet, which is stratified conglomerate, similar to that found at Fallie, about 5 miles to the west. This boulder lies at a height of 600 feet above sea-level. In the same wood there is a gneiss boulder, 5×6 feet, slightly rounded, and resting on old red sandstone.

10. Conglomerate boulder, on south shore of Loch Duntilchaig, opposite Achnabat, a few feet above the loch and 720 feet above sea-level. It measures $4 \times 5 \times 3$ feet. There are several others of the same rock lying along the shore of the loch. These can easily be identified with the rock on Dunchae, which is about a mile to the W. There is no other similar rock in the whole neighbourhood. It is composed not of rounded pebbles, but of thin pieces of rock.

11. Granite boulder on the west shoulder of Dalcromlin Hill, which lies S.W. by S. of Inverness. This boulder rests on conglomerate rock, 1200 feet above sea-level, and measures $5 \times 3 \times 3$ feet.

12. *Clach-an-abau* is a conglomerate boulder, lying in Petty Bay, to the E. of Inverness. It was moved by the tide. The waters round it had frozen, and thus served as a means of floating it. It is not large, perhaps about 4×3 feet. The underlying rock is old red sandstone.

13. Boulder of *Dirrymore* granite lies on the shore, a few feet above sea-level, to the E. of Kessock Ferry. *Dirrymore* lies N.W. by N. from Inverness. Boulders of this granite are found scattered over the shores of the Moray Firth as far east as Buckie. This boulder is lying on the gravel of the shore.

14. There are two boulders in Findhorn Bay; one of granite, measuring $4 \times 3 \times 3$ feet, and the other of gneiss, measuring $5 \times 3 \times 3$ feet.

15. The little burn to the west of Inches House, about $2\frac{1}{2}$ miles S. of Inverness, is full of boulders. One interesting group of three may be mentioned. They lie one against the other. The one to the west is granite and measures $7 \times 4 \times 2$ feet. The one in the middle is old red conglomerate and measures 6×3 feet. The one to the east is gneiss and measures 3×2 feet. They lie at a height of 200 feet above the sea-level.

16. There is a fine specimen of a striated stone, fixed in boulder clay, in the burn below Muckovie Quarry, about 3 miles S. of Inverness. The striæ when seen by me, when the stone was fixed in the clay on the bank of the stream, ran E. and W. It has now fallen from its original position.

17. *Porphyry Boulder*.—In wandering over Strathnairn and the district to the S.E. of Inverness, I was puzzled to know where the numerous specimens of porphyry could come from. While pursuing my investigation in the upper part of the Strath, I found the rock *in situ* between Loch Ruthven and Loch Duntilchaig. I have also, since that time, seen the same rock in other two places in Strathnairn, nearer the mouth of the river.

18. *Boulders of hornblende* are to be seen lying along the shore between Inverness and Culloden Station, as well as along the west shores of Loch Ness. There are two places on the west shore of Loch Ness, where hornblende rock is *in situ*. One of these, about two miles to the west of Loch End Inn, has been known to me for a number of years. The other, which is about two miles further to the west, was pointed out to me by Dr. Aitken, Medical Superintendent of the Inverness District Asylum, who discovered it.

19. One of the stones in the so-called Druidical circles at Stoneyfield, about one and a half miles E. of Inverness, is quite unlike anything I have seen within a radius of 20 miles of Inverness. I

have not been able exactly to identify this rock, but from descriptions in mineralogical books, I am of opinion that it is a diorite. The stone has every appearance of being waterworn and rounded, but whence it came I cannot say.

20. One of the stones in the "circle" at Culloden Railway Station is a serpentine. There is serpentine in Glenurquhart, which is about 12 or 14 miles W. from Inverness. I do not think the builders of these circles would have gone so far for building material.

21. A friend of mine in Glenurquhart tells me that there are granite boulders in that district, differing from all the granites surrounding the Glen. He is investigating the matter, and I expect to have exact information regarding them soon.

*Extracts by Convener from Notes supplied by Mr. William Morrison,
Secretary to Field Naturalists' Club, Dingwall, Ross-shire.*

1. On the south slope of Tulloch Hill, the following boulders occur:—

(1) At the height of 550 feet above sea, an irregularly rounded boulder of granite-gneiss, supposed to be one of those mentioned by Mr. John Campbell in *Frost and Fire*, vol. ii. p. 152, as consisting "of a peculiar kind of pink granite, resting on slate," and of which he gives a diagram at page 167.

Its girth is 29 feet; greatest length 11 feet; height 7 feet, and breadth 7 feet. Its major axis is N.N.W. and S.S.E., with sharpest end to E. The felspar in the boulder is pale red, and the mica so arranged as to produce a laminated appearance.

(2) About a quarter of a mile S.W. of No. 1, on Upper Docharty Farm, at 400 feet above sea, another boulder of same rock $8 \times 5 \times 5$ feet; and major axis N.N.W. and S.S.E., with sharp end to west.

(3) To N.W. of No. 1 boulder, at a height of 620 feet above sea, a flat block of mica schist, $11 \times 7 \times 2$ feet; major axis W. and E. The west end pointed, and appears as if scoured by running water.

The upper surface is scored by natural ruts, grooves, or striae, 2 and 3 inches broad, and from $\frac{1}{8}$ to $\frac{1}{4}$ inch deep. These run in a

direction from N.W. to S.E., and cross nearly at right angles the lines of lamination of the stone.

Over the upper surface of the boulder, there are about thirty-six artificial "cup markings." These marks are faint, where scorings are deepest and most frequent. The cup marks are well defined at the N.E. end of the upper surface of stone, and also at the S.W. end. One seen well marked at S.E. side, about half an inch from top surface.

(4) On Drynie Farm, S.W. of No. 3, at height of 600 feet above sea, a mica schist boulder $12 \times 8 \times 4$ feet; major axis N.N.W. and S.S.E.

On the surface of boulder there are six striations or groovings (not artificial), running N. and S.

There is one cup mark at south end.

(5) On Tulloch Hill, at 900 feet above sea, a boulder of same rock as No. 1 and 2, $8 \times 6 \times 4$ feet, with major axis N.W. and S.E.

The prevailing rock on Tulloch Hill is a bluish grey indurated sandstone shale.

Where the outcrop stands upon opposite side of valley, the strata (dipping south at angle of 45°) have been rubbed and smoothed on their north faces by some natural agency, in many lines bearing N.W. and S.E.

The prevailing soil on Tulloch Hill is a pale reddish till, derived possibly from the rocks of red sandstone and conglomerate, which exist towards the west.

To the north of Tulloch Hill a moor stretches to a uniform height of 1100 feet, on which are many smaller boulders similar to those on the southern slope of the hill. They occur also to the east of the hill, all the way down to the Cromarty Firth; and (as reported) even to the Black Isle. In most cases of the boulders having one axis longer than the other, the direction of the former is E. and W.

2. Thinking it probable that these Tulloch Hill boulders came from the westward, Mr. Morrison states that he lately set out, accompanied by a few friends, on an excursion in that direction.

At Garve (about eleven miles west of Dingwall), rock was found with surfaces rounded, smoothed, and striated; the striæ running E. and W.

The Strathgarve district is covered with multitudes of boulders

of granite and mica slate, chiefly the former. For miles along the Ullapool Road on to *Inchbae*, there are *torrents* of such blocks.

At *Achnaclerach*, there is a gigantic mass of the same kind of granite as the Tulloch Boulders, $25 \times 23 \times 12$ feet above ground, about seventy feet in girth, and weighing probably about seven hundred tons; evidently an erratic, the kind of granite composing it being different from the rock on which it rests.

Farther along the road towards *Inchbae*, several other boulders of the same kind, and not much less in size, were seen.

At *Inchbae Lodge*, the ground is much covered by these boulders.

At the confluence of the rivers *Glascarnoch* and *Strathvaich* near the schoolhouse, rock appears *in situ* identically the same as that of the Tulloch Hill boulders. The felspar of the rock has the same pink colour, and the mica is segregated in bands. The bed of *Strathvaik* river is entirely composed of the rock, and it appears to break naturally into huge cubical masses, among which the river rushes and foams violently.

In proceeding further west no boulders were to be seen. We seemed to have at length reached the parent rocks; for to the N. of *Garbad*, a place about a mile S.E. of *Inchbae Lodge*, no more boulders were met with.

The boulders in this district occupy the valley, through which the *Blackwater River* flows.

The *schoolhouse* above mentioned (about seven hundred feet above sea-level) is at or near the base of a hill called *Druim Buidhe*, 1080 feet above sea, which presents naked cliffs of granite rock facing W.N.W.

“We examined the pass of the *Bealach*, situated between *Big Wyvis* and *Little Wyvis*, which reaches to a height of about 1250 feet, and runs in a direction N.W. and S.E., to see if any granite or other boulders were lying there; but we found no travelled blocks. The *Bealach* itself is full of gigantic blocks of mica schist detached from the side of the pass.”

“It appeared to us, therefore, that the *Tulloch Hill* boulders had made a detour eastwards over the south shoulder of *Little Wyvis*, a hill which reaches to a height of 2497 feet. On the south side of the *Blackwater Valley*, the hills rise to the height of 1500 feet above the sea.”

Of course it is most improbable that the boulders on Tulloch Hill, at a height of about 1000 feet above the sea, could have been derived from the rocks forming the channel of the Black Water, at a height of only 500 feet above the sea. The parent rocks must have been at an elevation above that of the boulders. It only remains therefore to examine the adjoining hills, exceeding 1000 feet in height, to see whether they contain granite rocks of the same variety, or in the channel of the Black Water at Inchbae.

“I found granite boulders in large numbers, and of huge size, in the bed and on the banks of *Alt nan Cuirach*, four miles west of Tulloch Hill, and on move to E. conglomerate ridge, ending at *Cioch Mhor*. The river has washed out many of these boulders from the base of scours of yellow boulder clay of a depth of from 40 to 60 feet. These boulders were traced at heights from 1000 to 1200 feet above the sea from river bed at a spot due S. from Loch Glass. They probably came from Carn-Cuineag, through the opening occupied by Loch Glass. Both *Alt nan Cuirach* and the river *Glass*, of which the former is a tributary, cut all the way down to Evanton through deep cliffs of boulder clay, resting on hard sandstone strata dipping S.E. The granite boulders are imbedded at the very base of the clay deposits.”

[The Convener being struck with the account given of the striæ and cup marks on Boulder No. 3, wrote to Mr. Morrison, to ask whether any idea existed in his mind as to the possibility of the striæ having been formed after the cup marks had been formed. His answer, dated 24th April 1882, is—“The suggestion forced on the mind unquestionably is, that the cups were partially obliterated by the scoring agent, and hence were made before the natural striæ.”

If this suggestion is supported by further examination and study, it would indeed be a very marvellous discovery.

As Mr. John Campbell, in his *Frost and Fire*, refers to this district, the Convener gives the following extracts from his work:—

Page 149.—“Above the Inn at Garve, at about 600 feet, grooves on a rib of white quartz, turn with the glen. They do not point at Wyvis, or up into Strath Bran. They coast round a hillside, carefully avoiding the high hills, as rivers do at a lower level. They point S. 45° E.

“At the end of Loch Garve, beside the road, grooves on contorted

gneiss take another turn with the glen. At about 150 feet above the sea, the marks point N. 70° E., and aim at the shoulder of Wyvis, which bars the way. On this hill side are piles of drift.

“If Strath Bran held a glacier which flowed N. and E. towards Ben Wyvis, stones left by it ought to be blocks of white and grey quartz and gneiss, fragments of rocks in Strath Bran and near it. But there is no such collection of native drift here.”

Page 153.—“At 1000 feet up the side of Wyvis, the rock is laid bare in a small burn. It is a soft slate, dipping 10° south.”

“There are blocks of granite on the hill, and a moraine in the glen. But the granite is foreign.

“At 1650 feet is a conical hill *Cloch Mor*,—a lump of hard coarse conglomerate. The sides are scored, the steepest end is down stream towards the west. In the supposed “ice” are large blocks of mica schist, bits of grey quartz rock, and a big boulder of gneiss.

“At 3000 feet, the ground on a shoulder of Wyvis is smooth and flat, the rock shows in the edge of a deep corrie. It is a coarse gritty sandstone, which splits into thin flags. On this high shoulder are blocks of gneiss.”

Page 255.—“At 3000 feet on Beinn Wyvis, mica schist (boulders lie) upon slate.”]

In company with Mr. MacLean, factor for Ardross, Dr. Sutherland, Invergordon, and Mr. Joass, Dingwall, I visited Carn-Cuinneag (2744 feet) in Ardross. The hill has two peaks, from each of which enormous shoots of granite blocks have fallen, many of which weigh about 400 tons. In Strath Ruasdale we saw on roadside a block of granite 22 × 21 × 12 feet. Major axis N.W. and S.E., and weighing about 462 tons. We observed to the W. on the sky-line on the ridge forming west flank of *Glac-an-t-Seilich*, at 1600 feet above sea, a huge cubical block. Further to the W. on the sky-line, on ridge close by north end of Loch Glass, is to be seen an immense erratic block, cubical, said to be the largest in Ross-shire. Carn-Bhren to N.E. of Cuinneag, reported to be granite. These two hills of granite are probably part of the same belt, which to S.W. crops up at Strathvaich. The country to S.E. of this belt is full of boulders, chiefly granite. Many hills on their N.W. faces denuded and sown over with blocks.

The gravel of the road from Ardross to Diebidale is granitic. We observed under banks, washed by streams, beds of till yellowish red. The felspar of the Diebidale granite is generally paler than that of the Strathvaich granite, but many blocks were found, in which the felspar had same pale red appearance. The hill, Carn-Cuinneag, is entirely composed of granite. The saddle between the two peaks appears like a shingly beach; rounded stones of about 10 lbs. weight are seen packed on edge here and there in crevices, with longer axis of stones lying all in same direction. The east peak has shot down its fractured masses on the N.E. slope, whereas the west peak has sent its broken masses down on the N.W. side. Carn-an-Lochan (2000 feet) to N.E. of Carn-Cuinneag is also a hill of granite. Carn-Cuinneag being the highest hill in Easter Ross, commands a magnificent panoramic view of hills and deep glens to the N. and E., and hills rising on wide moors to S. and W. Many of these latter are rounded or dome-shaped and much denuded, hence the Gaelic name for such ("Creachan"), as may be seen by Ordnance Map, is frequent.

It was suggested that Carn-Bhren, said to be granite, Carn-an-Lochan, Carn-Cuinneag, all nearly in line N.E. to S.W., were but prominences in a belt of granite running S.W. to Strathvaich. To determine that point is to be our next work.

The road up Strath Ruasdale, and on through *Glac-an-t-Seilich* (Gaelic Glen of Willows—none, however, there now), passes through numbers of boulders chiefly on the north side of the road, and resting on slope of the valley. Many of them evidently were carried from Carn-Cuinneag without losing much of their angular form, others had their angles well rubbed off by the grinding action of some heavy agency passing over them. These rocks were probably rounded by their fellow boulders, for where accumulations of these boulders appear largest, granite gravel and sand are associated with them, indicating that these huge blocks struck against each other, and that the hammering and grinding produced the gravel and sand found in their neighbourhood.

The prevailing rock passed over on way to Carn-Cuinneag is quartzite, of hard, compact, and flaggy structure, some of it is flecked by ferric oxide. Indeed, in Strath Ruasdale is found so large a quantity of good hematite, that a Birmingham firm offered Ardross £2000 a year for the mining of one huge rock. Another

kind of rock prevailing to N. of Cuinneag is a hard blueish-grey quartzite (?), with a slabby structure.

Boulders were seen in the distance, perched on the sky-line of ridges to the west, of from 1600 to 2000 feet above sea.

W. MORRISON,

Secretary to Ross-shire Field Club.

Mr. Morrison, in sending the foregoing notes, writes to the Convener a letter (dated 8th May 1882) from which the following extracts are given, as they supply information of interest :—

“Carn-Cuinneag, in company with Mr. MacLean, factor for Ardross, Dr. Sutherland, Invergordon, and Mr. Joass, Dingwall, I visited on Saturday last. The weather unfortunately was extremely unpleasant; sleet and snow with driving mists prevented more thorough work being done. However, we satisfied ourselves as to the parent source of most of the travelled boulders in Easter Ross. Carn-Cuinneag and its lesser neighbours, Carn-Maine and Carn-an-Lochan, we saw were granitic. Carn-Bhren to the N.E., the keepers told us, is composed of the same rock as Cuinneag.

“The rock of the hills to the N. in the immediate proximity of Cuinneag was found to be of a flaggy or slabby structure. Under the microscope it shows grains of quartz. The appearance of the rock is uncommonly like limestone, but the acid test (hydrochloric) decided it was not limestone. I am not enough of a geologist to determine what this rock is. The description given in Rutley's *Petrology of Quartz-Trachyte* answers well to what I found the rock to be under the microscope. Carn-Cuinneag is a remarkable hill. Its two lugs (hence the Gaelic name) are pinnacles of granite; the slopes descending from these peaks are covered with immense numbers of huge oblong blocks to within a short distance of the base of the hill. On the N. and W. slopes are to be seen shoots of stones of all sizes besides.

“Kildermore to the S.E. is strewn over with boulders, evidently from the Diebidale hills.

“I shall report result of our investigation of the hypothetical belt, extending from Carn-Bhren over Carn-Cuinneag and on to Inchbae, where the granite or gneiss was found *in situ* at Druum Buidhe as reported before, when we get to work.

"The granite of Carn-Cuinneag, in the main, is like that of Inchbae. We saw blocks of pure granite of the Peterhead pattern on the slopes of Cuinneag, but the granite characteristic of this district is that which I have described in my previous reports. The summit of Carn-Cuinneag must have been splintered by some terrific agency, to account for the overthrow of such gigantic masses as are found on both sides (N.W. and S.E. sides) of the hill. The blocks descend in perfect cataracts on both these sides.

"If we had an experienced geologist with us, it would add very much to our pleasure in exploring these regions; but in lack of one queries from you for further information will do much to direct our observations.—Faithfully yours,

"WM. MORRISON."

Extracts from a Memoir by Professor Duns of the New College, Edinburgh (a member of the Committee), on the Surface Geology of Mid Lochaber, read in the Royal Society of Edinburgh on 6th February 1882.

"Boulders forming heaps or clusters are met with in the low grounds and also high up the sides of the mountains. Those in the low grounds contain sand and gravel; while in the heaps on the heights there are boulders alone. The explanation most likely is, that those in the upland slopes have had the sand and gravel washed away by heavy rains.

A typical boulder heap occurs near the foot of the S.W. slope of "*Meall an t' Suidhe*,"* on the farm of Ashantee. So far as examined, all the blocks composing it differ from the mica schist rock on which they lie. They consist of different sorts, as granites and porphyries. The blocks near the heap are also granites and porphyries. One is of immense size, 13 × 12 × 6 feet. A large piece has been broken off, in the line of cleavage, by another large boulder which had fallen against it, and been pushed partially over the part thus separated. To the N.W. of this heap, are other great clusters, which look like little hills.

* In English, "The hill for sitting on," in reference to the practice of travellers to the top of Ben Nevis resting on it.

The granites here are of various kinds, and frequently form boulders of great size. Some bear a close resemblance to the light red-coloured granite of Aberiachan, near Loch Ness.

Several of the heaps have a covering of peat. They lie in the course of a long line of single boulders referred to below.

Some large blocks are met with in association with many much smaller. Thus opposite to Lochy Bridge, at a height of 1500 feet, there is a porphyry boulder $7 \times 6 \times 5$ feet. The rest of the heap is made up of small granite blocks.

Not far from this heap, there are several boulders lying in line to the N.W. * * * *

Boulders which occur singly.

Near the old military road between Fort William and Stirling which leaves the drove road at the S.W. end of the former, there is a large boulder near the top of a hill, about 400 feet above the sea, and looking down on Loch Linnhe. Standing by this great stone, and looking to the N.E. in the direction of "*Meall an t' Suidhe*," one sees a series of boulders in line in the same direction, though the line is not so well marked as in some other cases. The boulder is a coarse grey granite, that next to it in the line is a fine felstone. Two others are quartzites, the rest are mainly of the rock of the hill,—mica schist—much rubbed and rounded. On the east of the road again, is a boulder of a fine-grained pinkish granite, with a close resemblance to the Aberiachan granite. * * * *

Coming now to the area lying N. of the River Nevis, including both low grounds and mountain slopes, granite, granitic porphyry, and porphyry blocks lie for the most part in a line of their own, while schists, micaceous gneiss, and some porphyrites, lie in either side of them.

The mica schists are nearest to the mountain; the granites and porphyries next, and the others lie between them and the River Nevis.

The line is a diagonal of the area referred to, running in a N.W. direction.

Looking from near Claggan Cottage along the steep slopes of *Meall an t' Suidhe*, granite boulders are seen lying on the mica schist rocks, where the side of the mountain slopes down so steeply as to make it a puzzle to understand how they can remain in position.

Some on the lowermost slopes and in the plain are of great size, and present distinct marks of polishing and well-defined striæ;—viz., (a) Syenite, $17 \times 5 \times 6$ feet, larger axis N.N.W. and S.S.E., with a deep conchoidal hollow at the broad end; (b) micaceous gneiss, $15 \times 9 \times 6$ feet; two other large boulders of the same mineral lie in front of this, one to the N.W., the other to the S.W. of the line.

On the north aspect of one of these blocks, are several round hollows, so very like the cup markings of the archæologist, that at first sight they seemed artificial; but in another block, a bit, having been noticed protruding from the surface, on being struck with the hammer, fell out, leaving the cup marking on the stone; (c) micaceous gneiss, $11 \times 7 \times 7$ feet; (d) mica schist (the rock *in situ*), 11×7 feet. * * * *

Slopes of Meall an t' Suidhe, from 100 up to 1500 feet.—On these, the size of the boulders and their “lie” to the horizon varies. (a) Porphyry, $7 \times 5 \times 4$ feet, angle of its site to horizon 35° , longer axis N.N.W. and S.S.E. This boulder is poised on an edge, which towards the mountain is 1 foot 7 inches broad, and towards the plain only 5 inches. (b) Porphyry (triangular shaped), $9 \times 7 \times 5$ feet, apex towards the hill, as if the point of the boulder had been violently driven into it, larger axis N.N.W. and S.S.E. On west side, a cup and ring mark. These oval or round marks are numerous, and occur chiefly on the N.W. side of the boulders;—angle of site to horizon 20° . (c) Micaceous gneiss, $13 \times 8 \times 13$ feet, angle to horizon 20° . The heavy end rests on the mountain. At the point which stands out from the face of the hill; the depth is only $3\frac{1}{2}$ feet; it lies mainly on three small rounded granite boulders, and is so poised as to suggest, that the slightest push would send it down the hill. * * * *

At a point 1060 feet above the sea-level, a considerable part of the surface has been laid bare, and the rock is distinctly striated, the direction of the striæ being apparently N.W. and S.W., but partly obliterated by cross-hatching. * * * *

On the area to the N. of the rounded crest above Suidhe lake, and to the W. of the great corrie between Ben Nevis and Carn Dearg, there is, (a) an enormous boulder of mica schist, lying on porphyry *in situ*; (b) large block of grey granite; (c) large block of porphyry.

These lie in a mass, associated with smaller boulders of mica schists, and stretching from this heap are two rows of boulders lying nearly direct W. The first block is grey granite, $7 \times 4 \times 6$ feet, angle of site to horizon 40° ; the others are grey granites, porphyries, and mica schists, their larger axis being N.N.W. and S.S.E.

The most noticeable feature is the "lie" of these blocks to the hills; they appear in long lines sometimes far apart, but there is no mistaking their place in the lines, which are W.N.W. and E.S.E. The larger axis varies so much, that from it no inference can be drawn."

Towards the conclusion of his paper, Professor Duns remarks that the gravels of the district consist mainly of rolled and water-worn fragments of granite, porphyry, quartz, mica schist, bits of arenaceous rock, and at one part of a mineral (malacolite) nowhere found massive in the locality. In the rare instances in which large boulders are met with in these gravel heaps, they are sub-angular blocks of the rocks of the immediate neighbourhood. The *erratics* occur on the heaps.

"On nearly all the mountain slopes, and even at the tops of some, blocks abound; many of enormous size and weight, for whose positions no explanation can be found in any of the forces at present existing in the locality.

The position of boulders in the plain may have as great significance as the position of those high up on the mountain. Thus, if a granite erratic be found at a height of 1000 feet, and one of the same rock in the low ground, at a height of 50 feet above the sea-level, in a place to which it could not have rolled, assuming the face of the country to have been the same as now, when the boulder on the high level was laid down, it will follow, either that one and the same force put them contemporaneously in their respective positions, or that the valleys, river courses, and little hills which now intervene between the high and the low blocks were formed since both were deposited. There is only one other alternative. Each may have been dropped by an agent, on which inequalities of surface could have no bearing.

A careful examination of the deposits within the area described, so far as they bear on Arctic conditions of climate

and a glacial surface, leads to the belief that the bulk of the phenomena may ultimately find their explanation in the recognition of two movements,—one outwards from Ben Nevis as a centre, the other a force travelling from the W. the N.W. or the N.N.W.”

Extracts by the Convener from Notes on Boulders and Striated Rocks situated to the W. of Fort William, by Colin Livingston, Teacher of Public School, Fort William.

The places mentioned by Mr. Livingston (Plate V.) are shown on the map reduced from the Ordnance Survey.

1. *Meall nan Cleireach*,* the height of which above the sea is 1651 feet, composed mostly of micaceous gneiss and clay slate. About 60 feet below the summit, is a boulder called “*Clach an Acrais*” † or the “Hunger stone” $8\frac{1}{2} \times 6 \times 3\frac{1}{2}$ feet. Its longer axis is N. 5° W., with heavy end to north, resting on clay slate. It bears from the summit of the hill N. 10° E. It might have come to its present position through Glen Nevis, or Glen More, or (but less probably) Glen Scaddle, on the W. side of Loch Linnhe.

A second boulder, $17 \times 6 \times 3$ feet, lies N.E. of the former at a distance of 24 yards. Its axis is N. 8° W., and about 70 feet below summit level of hill.

Both of these boulders are of mica schist with garnets. A third boulder $15 \times 7 \times 6\frac{1}{2}$ feet to the E. of the first mentioned, and distant about 40 yards, is mica schist without garnets.

These three boulders, being in sight of and near each other, are spoken of by Mr. Livingston as forming a triangle.

Mica schist with garnets is a rock not known in the neighbourhood. Dr. Heddle found it *in situ* on *Aonach Beg*, a hill to the E. of Ben Nevis, about 4060 feet above the sea, where it is open to Glen Spean and Glen More.

2. Other boulders with garnets occur at the following places:—

* Mr. Livingston explains that this word means “Hill of Clerks or Clergy,” implying that it belonged to the church.

† When the people at “Blar-mach-foldach” saw the sun over this boulder, viz., at 2 P.M., they went to dinner.

(1) A large mass about 200 yards above where the road from Fort William crosses the river *Abhainn Bheag*, $18 \times 10 \times 7$ feet.

(2) A similar block $11 \times 7 \times 5$ feet at a short distance.

A line connecting these bears almost on *Clach an Acras* boulder.

(3) A small boulder nearly in same line about a mile from Fort William to the W.

(4) At nearly same distance from Fort William on the E. side of the town a similar boulder of larger size on the hill face above Nevis Bridge.

If a glacier came down *Glen Spean* and along *Glen More* it might have brought the above boulders.

The idea of such a glacier is favoured by the existence of a remarkable *trainee* of boulders to the E. of *Blar-mach-foldach*,* partly above road on left, and partly on right at first house in township.

3. A more striking indication of ice movement in this direction is an immense collection of boulders on lower slopes of same hill, *Meall nan Cleireach*, called *Blar nan Cleireach*. The shoulder of the hill which projects so as to cause the bend of the river *Kiachnisk*, is littered with boulders. The boulders are mostly granite. There are also boulders of porphyry and mica schist. The largest in size are mica schist.

Most of these boulders are below the contour line of 800 feet. The following are the sizes of the largest mica schist boulders: $10 \times 8 \times 5\frac{1}{2}$ feet, $8 \times 7 \times 4$ feet, $10 \times 6 \times 3$ feet, $11 \times 4 \times 5\frac{1}{2}$ feet, $7 \times 5 \times 3\frac{1}{2}$ feet.

The granites are grey and purplish. The pink colour is owing to the predominance of felspar. In some, the felspar crystals are large, in some, small.

Of the boulders with large felspar crystals, one may be mentioned $10 \times 8 \times 3$ feet, one with small felspar crystals $8 \times 5 \times 4$ feet. Fine grained grey granite $4 \times 2 \times 5$ feet. There is one called "agglomerate," $7 \times 5 \times 3$ feet. Among this collection, there are one or two small quartzite boulders.

This large assemblage of boulders is on the N.E. shoulder of the hill. It could be reached by an arm of the *Glen More* glacier passing

* This Gaelic word means "Green spot, outlying, hospitable."

down over the col between *Achintore Hill* (940 feet) and *Bein Riabhach* (1300 feet), the watershed between which is from 400 to 450 feet, and by an arm of the Glen Nevis glacier through the transverse valley of the Riasgaig. *Achintore* hill has *strix* N. and S. at 590 feet.

Mr. Livingston observes that the lower boulders could hardly have come from the westward, as the only opening in that direction is the channel of the river *Kiachnish*.* To have come by it would imply their having crossed the supposed ice stream of Glen More, here flowing along the bed of the present Loch Linnhe.

4. Showing that ice has moved in this direction from Glen Nevis, we have on a ridge separating that glen from the valley of the Riasgaig—a feeder of the *Kiachnish*—the remarkable boulder called *Clach a Sgrogaidh* or “The tilted Stone” (1790 feet), between the summit of *Sgor Chalum* and *Glas Chreag*. This boulder is $10\frac{1}{2} \times 6\frac{1}{2} \times 9\frac{1}{2}$, axis W. 10° S. It is of compact mica schist, indurated, finely laminated with quartz veins, and contains chlorite and ilmenite. The rock on which it rests is of somewhat similar material, but differing considerably in structure, containing neither of the two latter minerals, which occur in Aonach Beg rock.

Within a few yards of it, and nearer the Glen Nevis edge of the ridge, is another boulder of the same kind of rock, $12 \times 7 \times 5$ feet.

Above these, on the shoulder of *Glas Chreag*, at a height of 1930 feet, *strix* occur, their direction being N. 20° W., apparently formed by an agent passing from Glen Nevis towards the glen of *Kiachnish*.

Proceeding further south along the skyline, a small angular perched block is seen at an elevation of 2170 feet, with its axis N. 25° E. It is quite angular, and might not have been carried far.

At about the same elevation, on the *Kiachnish* side of *Glas Chreag*, there are *ten* blocks all of considerable size, the two largest $7 \times 7 \times 4$ feet, and $7 \times 4 \times 4$ feet. They also are angular, and lie on the surface of detrital matter. They are open to *Glen More* and lower *Glen Nevis*, but more probably were brought from upper Glen Nevis by a glacier winding round the shoulder of the hill—*Glas Chreag*—through Glen Riasgaig. †

* This word means “Stream from a marsh.”

† *Note by Convener*.—It is difficult to understand how the supposed glacier could wind round the shoulder of the hill here referred to. The position of

5. In *Coire-a'-Mhiulinn*, farther round the shoulder of Glas Chreag, there is a large angular block $8 \times 6\frac{1}{2} \times 5$ feet. The rock is mica schist, indurated and thick bedded. It rests on native rock—mica schist also, but much softer and more fissile. Rock identical with it is found at the head of *Coire Riabhach*, which looks in to Glen Nevis.

6. Another feature of the locality is that while there are few or no boulders on the W. side of *Meall a' Chaoruinn*,* they are very numerous on the E. side, which is open to Glen Nevis through the glen of the Riasgaig.

Another large boulder of indurated micaceous schist occurs at the foot of *Meall an-t-Snidhe*, on the opposite side of *Glen Nevis* near its mouth.

7. On the east side of the streams forming the Riasgaig, at an elevation of 600 feet and under, there are boulders of the following sizes: grey granite $8 \times 6 \times 3$ feet, two granite boulders with pinkish felspar $15 \times 9 \times 9$ feet and $10 \times 6 \times 5$ feet, and smaller ones. They may have come from *Glen Nevis*, or *Glen More*.

8. Mr. Livingston, under the head of "General Conclusions," suggests that the boulders mentioned by him may have come by two glaciers, one descending Glen Nevis, the other Glen Spean and Glen More.

(1) With regard to the former, Mr. Livingston observes that from the confined nature of Glen Nevis in its upper part, and the height of the mountains enclosing it, the glacier would probably be of great depth, reaching to a high level. After passing the spur of Ben Nevis, opposite Achriabhach, the lower portion would turn to the right, but the upper and much larger portion would continue straight on, through *Glen Riasgaig* towards Linnhe Loch. Hence (he says) the accumulation of boulders upon *Blar nan Cleireach*.

As the boulders on *Meall nan Cleireach* are at a height of 1630 feet, *Clach a Sgrogaidh* at 1790, and *stricæ* at 1930, the glacier must have reached at least 2000 feet.

Mr. Livingston observes that a portion of the Glen More glacier may

the ten boulders on the surface of *dehrital matter*, seems rather to suggest the agency of water and floating ice.

* This name means "*Hill of Rowan trees*;" though there are none there now.

have united with the Glen Nevis glacier, and added to the boulders upon *Blar nan Cleireach*. He says that the general character of the boulders brought by the two glaciers differed. Granites of various kinds were brought down by the left flank of the Glen More glacier, and by the right flank of the Glen Nevis glacier. Mixed with these granites are occasional blocks of mica schist with garnets.

The left flank of the Glen Nevis glacier, he says, seems to have brought mica schists of various degrees of hardness, in some cases passing almost into quartzite. With these is mixed an occasional small block of true quartzite from *Sgor a Mhaim* and *Stob Bàn*.

Occasional blocks of porphyry are also met with. One or two fragments of actinolite, which is found *in situ* above Glen Nevis House, may also indicate the course of the *Glen Nevis* glacier. They were found on the road near Blarmachfaoldach.

On the left of the river Nevis, above Glen Nevis House, innumerable blocks, mainly of mica schist, occur. They have probably come partly from *Coire Riabhach*, partly from the shoulder of Ben Nevis above *Achriabhach*.

At the entrance into Glen Nevis, on the E. slope of the *Cow Hill*, above a small burial-ground, the stream called *Allt Eas an t-Slainein* cuts through detrital matter consisting mainly of granite boulders. It has long formed quite a quarry for building stone. One large granite block, found on the opposite side of the Nevis, furnished stone for the whole front of the Belford Hospital, Fort William.

On the right of the lower Nevis also, towards Inverlochy and Torlundy, there are immense mounds and ridges of detrital matter, the material of which, Mr. Livingston says, has "an imperfect stratification"—"such as might be produced if it fell from some height." He therefore supposes that the detritus was brought down by surface streams on the Glen Nevis glacier, and by others flowing on to that of Glen More.

He says there are also "remarkable lines, undoubted moraines, occupying great part of the area stretching towards Spean Bridge. One of these begins at the foot of the hill on the left of the Lundy, and may be traced almost continuously to *Blàr Odhar*, a distance of eight or nine miles. The part near Glen Nevis appears to have been formed by a glacier moving up in the direction of the Spean, while

the further part, and the three similar lines nearly parallel with it, have apparently been formed by a glacier descending the Spean valley."

*Extracts from Notes sent to the Convener by Dr. Heddle,
St. Andrews.*

1. On descending the west slope of East Lomond Hill, Fife, at a height of 1075 feet, overhanging Greenwalls, found a large number of dolerite blocks, from 4 to 7 feet in length, much rounded. They lay closely together on the brow of "a fall-over of the ground to the west."

About 40 vertical feet from the highest, and 20 from the lowest of the boulders, and at a distance of about 200 yards, a quarry of the same kind of dolerite was met with, in jointed pillars—the joints being somewhat open or loose.

"Concluded, that ice, sweeping from the west," had struck the west slope of the hill, where the dolerite rocks protruded, and pushed before it some of the loose pillars.

2. On descending Auchluiskey Hill (one of the Ochils), into Glenquay, at a height of 1025 feet, found a small red granite boulder weighing about half a cwt. The slope on which it lay faced W.N.W.

On ascending Benty Knowe, directly opposite, at height of 905 feet, found another red granite boulder, rather smaller. The rocks of the Ochils here are trap,—a "rotting clinkstone."

3. On ascending Benclench from the east, at a height of 2200 feet, found two boulders, each weighing about 4 tons, in a line with each other E. and W. One of the boulders is a variety of greywacke, which may be called "almond conglomerate," from its containing nodules of white quartz of the shape of almonds, but two to four times larger. Recognised the rock of this boulder to be the same as a rock at the foot of the north spur of Ben Lomond, mentioned in last year's Report, page 28, at a height of from 2230 to 2240 feet above the sea. The Rev. Mr. Peyton (who has frequently accompanied Professor Heddle in his excursions, and is a good geologist) mentioned having seen the same rock *in situ*, about 8 miles to the east of Ben Lomond.

The other boulder was of gneiss, laminated and convoluted in structure;—much resembling rocks *in situ* in the district of Loch Earn and Glen Falloch.

4. Walked in the Lewis from Stornoway to Tarbert, in Harris. The north part of the district, where not covered with peat, consists of glaciated rock, with ill-defined strise running in almost every direction except N. and S. The general flatness is the more remarkable as the strata are nearly vertical, so that their edges have been ground down by some agent passing over them.

This flat district of course terminated on the south at the base of the Harris Hills. One or two of these reach a height of about 2600 feet, and glaciers were no doubt formed in some of their valleys; but the levelling of the district to the north cannot be attributed to them.

The trench between the two Lochs Tarbert, where, in the previous year's Report, boulders were reported to have been seen, was again visited. There is evidence here of two independent glaciations. "In the main trench, there is evidence of ice rising on the hill sides to a great height, as if squeezed up, when moving through the pass from the west." In Glen Skeaudle, again, which joins the main valley at an obtuse angle, there is evidence of a small glacier, which pressed seaward to the west.

5. *Morvern*.—Walked for about ten days over the hills on the Glen Sanda property.

The shores of Loch Corry are much glaciated on both sides—in the same direction, namely towards the east.

A knoll or boss of red granite at the mouth of the loch attracts notice, from the way in which, on its W.N.W. side, the rocks on a slope reaching up to 150 feet were all rounded, smoothed, and scratched. The opposite, or S.E. side of the knoll, was rough and craggy.

On the north shore of Loch Corry, near its mouth, an angular block $27 \times 27 \times 10$ to 13 feet was observed; about 28 yards from it, a hollow in the rocks was discovered, which, in dimensions and shape, exactly fitted the boulder; this hollow was situated N.W. of the boulder. The boulder was about a foot lower in level than the hollow it came out from. A thick mass of floating ice was probably the transporting agent.

Several of the hills on this Glen Sanda property reach to a height of 1800 feet and more. They show glacial action to their very summits,—by the rounded surfaces of the rocks where hard. But



at one place a series of grey granite and red granite strata were seen to alternate thus :—the strata marked *g*, representing the soft grey granites, formed as it were

trenches between the red granite strata marked *r*. Most of the boulders on the hill slopes were grey granites.

6. From Stage House, on Loch Shiel, examined a valley leading to the west. Ascended double-peaked hill of Fraoch Bheinn, 2680 feet; on approaching each summit, found many blocks apparently torn from their natural beds, and carried very short distances eastward. In some of the belts of rock, sockets or hollows were observed, from which the blocks had been detached. These were from 20 to 40 feet below the east summit on its west side, and had manifestly been pushed up hill. These blocks weighed from about a ton to 10 tons. The top of the hill is pointed in a remarkable manner by a block of about 6 tons, "which is nearly turned up on end. It did not seem to have been moved more than a yard."

7. (1) *Fort-William District*.—In company with Mr. Livingston, went up Glen Finnan, at the head of Loch Shiel, then over a hill of 2419 feet (name unknown). Much glaciation in the col between

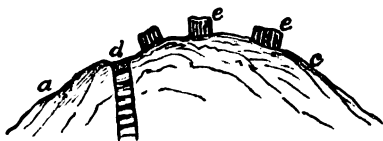

it and the east top of Sgoran-Coireachan (2718 feet), a hill of gneiss. A great white granite vein or dyke cuts right through the col running N.N.E. and S.S.W.

This dyke (8 to 10 feet thick) is a few feet below the summit-level of the col on the west side, thus :—*a e* being a transverse section of the col, *d* the granite dyke, and *e* blocks from the dyke, lying to the east of the dyke. The outcrop of the dyke was quite rounded; some of its blocks were found one-third of a mile to the east,—none to the west.

The summit of the hill (3136 feet) showed no glaciation. Ice, however, had gone over the col (2600 feet) between this hill, and that to the west (not named in the map).

From the 2500 feet contour line, to within almost 200 feet of the bottom of Glen Oban, there is one of the most tremendous scenes of glaciation probably to be seen in Scotland.

The sides of the glen abound in shallow corries, with large portions scooped out in some places, and smoothed over in others. There are precipices at many places rounded from top to bottom, some of them more than 100 feet in height. Local glaciers may have done the work.



Glen Oban, looking east.

The scooped-out parts of the Glen face the north, at right angles to the trench of Glen Oban.

The central parts of the Glen are nearly blocked by enormous masses of rock, fallen from a cliff on the north side, about 700 feet above.

At the mouth of Glen Oban, looking eastward, there are fine examples of perched blocks. These blocks in two cases rest on glaciated knolls or nobbs of rock, situated in the centre of the Glen, as shown in the foregoing rough sketch. These knolls are from 300 to 400 feet high, and cannot be climbed, their sides being so steep.

(2) Walked from Fort William to top of *Ben a Gueaig* (2017 feet) (to connect the traverse of a former year) along ridge to *Meall na*

Cleireach (1626 feet). Found near Corunanan House several small boulders of the same syenitic granite, which I found last year in a *trainee* on the top ridge of *Stob Choire a Chearchaill* on the north side of Linnhe Loch (*Seventh Boulder Report*, p. 36), and on *Bein Bhan* on the south side of the loch. The felspar was not so red in these boulders; no other difference.

Found on south spur of *Meall nan Cleireach* a boulder, $4 \times 6 \times 4$ feet, of a peculiar rock, which I learned afterwards had attracted much attention from Mr. Livingston and Professor Duns. The material of the boulder looks like a very vitreous hyaline quartz rock—the grains running into each other. The large amount of felspar in it, has cemented the grains of quartz. Many examples of this boulder were afterwards discovered. The parent rock I have never met with. I named it, for identification, after Mr. Livingston.

The ridge between *Bein na Gucaig* (2017 feet) and *Meall nan Cleireach* (1626 feet) consists of an igneous dyke, and is sprinkled with very small boulders, (1) of the red binary granite (felspar and quartz, almost a porphyry) of the hill *Mullach nan Coirean* (3077 feet) lying nearly due E., (2) of the above mentioned syenitic granite, (3) of the Livingston rock, (4) of a fine grained diorite, not found *in situ* by any of us, and (5) two small boulders of quartzite.

The top of *Meall na Cleireach* I found “intensely interesting.” Three boulders lay on its N.W. side about 20 feet below summit. They lie about 50 feet above the three which are mentioned in Mr. Livingston’s notes as forming the points of a triangle. The hill showed bare clay slate rocks on its W. side. Every other part had a thin cover of turf over it, and for about 50 feet down; from which point to the summit, but only on the N.E. side, there was a deep deposit of angular masses of rock, tossed in confusion as if rolled from off a glacier. They were thinly covered over with turf; but on clearing the turf off, the boulders were found to consist of micaceous gneiss and red granite.

On descending the hill towards the stream, and about 400 feet above it, I “came on a clump of three boulders.” Two of these are of interest; one $13 \times 4 \times 4$ feet being of *grey* granite with a little red felspar;—the other $5 \times 3 \times 2$ feet, a mass of matted fibres of

amianthus.* We afterwards found a similar rock (but far from identical) 3 miles N.E., near limestone, overhanging Glen Nevis.

(3) On following day, went up to *Mullach nan Coirean* (3077 feet). It forms a great round dome, all of red granite, tending to porphyry. On its summit there are several small angular blocks of pure white quartz rock, the nearest locality of which is the peak of *Stob Bhan*; others had been built into the cairn.

The ridge from this hill to *Stob Bhan* (3274) is one of exceeding interest. It is narrow, falling and rising five times, forming so many little hills.

In the second of the depressions, at an altitude of 2904 feet, the rock is of red syenitic granite, apparently the same as that of the boulders before mentioned on *Ben-a-Gucaig* and *Ben Bhan*, and also as forming a trainee on *Stob Coire Chearchaill*.

We afterwards found the same rock in abundance near the great precipice of *Ben Nevis*, at an altitude of 2200 feet.†

At another part of the ridge, the ground falls from 3004 feet to 2904 feet; and there "for about 100 yards, the ridge consisted of a bank of loose material." Whether a glacier, which had been pouring through, or rather sending a delta-branch through the hollow, showered down the heaps of stones which form the ridge, or whether it had been deposited by aqueous agency, may be matter of opinion. By going down the S. slope, and by peering over the precipices of the next height, so as to see the N. slope, we inferred that this bank was about 40 feet deep. It was quite "like the patch on the N.E. top of *Meall nan Cleireach*"; only, in addition to angular blocks, it contained much gravel and small rounded stones." Its ridge was broad enough for three persons to walk abreast. The heap is made up of many kinds of rock,—micaceous gneiss, *Livingston* rock, and quartzite being common. "I hope I have made it clear that the forementioned bank is the connecting ridge between the 3004 feet hill and the next hill (2995 feet). This last mentioned hill

* I found no other grey granite boulder on the S.W. of *Nevis*, though many on the N.E. The amianthus boulder may fairly be referred to the lime locality near *Glen Nevis*.

† This discovery of a rock *in situ*, identically the same as the rock composing boulders seen on *Stob Coire a' Chearchaill*, alters the opinion I had formed last year as to the direction from which these boulders had come.

rises out of the bank in plumb precipices of say 30 to 60 feet,—a deep-red burnt-like porphyry, rudely columnar.”

Stob Bhan (3274 feet) and *Sgor a Mhaim* (3601 feet) are both of them quartzite; but the connecting ridge was found to be in some places almost a clay slate.

(4) On following day, drove up Glen Nevis to *Achriabhach*, and from that walked up past *Steall*, and thereafter climbed the quartzite ridge to the N.E. The first half of the walk astonished me on account of the absence of boulders, in this part of Glen Nevis,—considering the thousands which lie at and about the mouth of the Glen. Above the narrow part of the glen at *Meall Cumhann* (2000 feet) the whole surface seemed swept clean. We saw only one boulder (micaceous schist) about a yard square. It lay on the S. side of *Sgòr-a-Choinnich Beg* (3108 feet) at an elevation of 1830 feet. We went, in an easterly direction, over seven other hills from 3600 to 3858 feet in height, and then descended the N.W. slopes of *Stob Coire Chalourie* to *Corrie Coilzie*. Until we came near this last named place, we saw no boulders. Between the heights of 1740 and 1260 feet on the N.W. slope, we came upon eight boulders lying rudely in a line, “as if part of a lateral moraine.” They were all much of one size, about $6 \times 6 \times 5$ feet; and they were of two kinds of rock only, viz., the Livingston rock, and a grey granite rather fine in grain;—the site of neither rock is known to me.*

(5) Another excursion was made with Mr. Livingston to *Craig Dhubb*, a hill near the mouth of Glen Roy. We found a number of huge boulders at 1780 feet, and extending to within 20 feet of summit, (which is about 2200 feet above sea). They lay on S. and S.S.E. side of hill. There was well-marked glaciation, with much rounding of rock-surfaces at 2050 feet, in a line N.N.W. and S.S.E.; and it seemed to us that the movement had been from the last point, but we had not time to satisfy ourselves on the point. All the boulders seen on this hill are of the same two rocks as those seen above Coire Choilzie (i.e., on the slopes of *Stob Coire Chalourie*, at the height of 1740 feet), over which we had passed two days previously.

* Professor Duns having read these notes, informs the Convener that boulders of the kind of rock here mentioned (Livingston rock), were observed by him on the slopes of *Meall an t Suidhe*, near the mouth of Glen Nevis.

“This hill should be thoroughly explored.” *

Professor Heddle in concluding his notes, states that—“Looking to what I saw on and of the ridge which forms the S. side of Glen Nevis;—the patch of matter on the N.E. side of the summit of *Meall nan Cleireach*;—the quartzite blocks on the summit of *Mullach nan Coirean*;—the red felspar syenite *in situ* to the E. of this;—a detrital bank at an altitude of 2904 feet;—and the quartzite and gneiss hills to the E.,—no doubt remains on my mind of there having been a glacier, which, sweeping down Glen Nevis, overtopped the hill of 3077 feet, on which, when decreasing in bulk, it may have left the quartz blocks; that when it dwindled somewhat more, it carried off blocks of the syenitic granite from somewhere near its 2904 feet locality; then, overflowing all the lesser heights to the W., crossing the Linnhe Loch, and sweeping into the directly opposing *Sroin a Chearcaill* glen, it was finally stopped by the precipice of *Stroin Coire Chobarcaill*, upon the ridge of which (2300 to 2500 feet) it left the boulders, as a kind of terminal moraine.” “That while still further dwindling, it laid down the detrital patch on the N.E. top of *Meall au Cleireach* (1580 to 1626 feet). Lastly when its bulk was no longer great enough to pass in a direct westerly course over 1600 feet hills, it was deflected by them into the N.W. bend of Glen Nevis.”

He is also of opinion that another great glacier, of nearly equal spread but lesser depth, may have been cradled in the gorges which lie between the lofty ridge of Aonach Beg and Aonach Mor, and the nearly equally lofty quartzite ridge which stretches from Sgor-Choinich Beg to Stob Coire Chalurie;—and that this glacier may have sent a tongue of ice northwards across the scoop of Lochaber. Before committing himself, however, to such a view, he would require many more days exploration of the district.

* [Note by Convener.—There is the greater reason for the more thorough exploration here suggested, because *Craig Dhu* has been examined by several other geologists,—Professor Nicol, Mr Jameson (Ellon), Mr Jolly (Inverness), and the Convener. The opinions formed by several of these, were that the agent which transported the boulders and glaciated the rocks on the hill came not from the eastward but from the westward. *Royal Society of Edinburgh Trans.*, vol. xxvii. p. 640.]

*Remarks by Mr. Milne Home, on presenting Report,
5th June 1882.*

As Convener of the Boulder Committee I now present the Eighth Annual Report.

I presume it is not expected that I am to read the Report, and that it will be sufficient if I describe verbally what appear to me the most interesting parts.

But before doing so, I beg to offer a few remarks of a general nature, explaining the objects for which the Committee was appointed, and the lines of inquiry pursued, as members will in this way be better able to see the bearings of the information contained in the Report.

These blocks of stone called boulders, so called probably from their generally rounded form, were first subjected to scientific observation and discussion, about seventy years ago, by a distinguished Fellow of this Society, whose portrait, as President, hangs on these walls—Sir James Hall of Dunglass. His Memoir on the subject was published in our *Transactions*, I think, about the year 1812. He was the first who realised the fact that most of these boulders, before reaching the sites now occupied by them, had travelled great distances; and having convinced himself, by a close study of the position of the boulders, that they had come from the westward, he suggested that there had been great inundations of the sea, whose waters swept fragments of rock across the country, subjecting them to enormous friction, and thus giving to them their rounded forms.

That theory was accepted for many years, until it was pointed out that boulders, similar in appearance to those in Scotland, and not less in magnitude, were to be seen travelling on the surface of glaciers, and, on reaching the lower extremities of these glaciers, were thrown down on localities remote from the rocks of which they were fragments. This view obtained great favour about the year 1840, having been advocated by the distinguished Swiss naturalist Agassiz, who, in company with the late Professor Buckland, visited the Highlands of Scotland, and declared that the transport of our Scotch boulders might be accounted for in that way.

At a later date, it became known that boulders, both numerous and large, were to be seen on icebergs and shore—ice floating in the Arctic Sea, and from which they were dropped when the icy rafts melted, or stranded on submarine rocks or sandbanks. To make this explanation possible for Great Britain, it implied the submergence of the land beneath the waters of an ocean many hundred feet above the present sea-level, and having a temperature greatly lower than that of our present British seas.

Whilst each of these theories has its supporters, all geologists are agreed on one point—that for the transport of our Scotch boulders, many being hundreds, some even thousands of tons in weight, in order to be carried many miles across a country, some agent of tremendous power has to be sought for, of whose existence and operations these boulders were witnesses. Could these boulders speak, what curious revelations would they not give out; or, could the mysterious markings on the surface of many of them, markings impressed whilst *in transitu*, be rightly interpreted, what important inferences as to the nature of the agent which carried them might not be obtained?

Another circumstance added to the interest of the inquiry. The events whose occurrence these boulders indicate must have been, in a geological sense, of recent occurrence. The boulders lie generally above all the rock-formations, and even above all the beds of clay, gravel, and sand, which form the surface of the country. They, therefore belong to a period subsequent to any of these geological deposits.

Such were some of the speculations current among geologists when, in the year 1871, this Society resolved to appoint a Committee to investigate the subject. Though our Society was, I believe, the first in Great Britain to take this step, other societies on the Continent had preceded us. Three years previously, Professor Favre of Geneva had organised a committee of inquiry for Switzerland, and at his instance the Geological Society of France took similar steps. I received several letters from the Professor, urging me to propose this inquiry also for Scotland. His communications having been made known to the Council of our Society, the result was the appointment of a Committee in April 1871.

In the autumn of that year, the British Association for the

Advancement of Science held its usual annual meeting, and it in like manner appointed a Boulder Committee for England.

For the first year or two of its existence, our Committee was occupied in procuring intelligence regarding boulders by circulars addressed to the parochial clergy and schoolmasters, and in our first two Reports, the information given was almost exclusively a statement merely of the localities of the boulders made known to us, their dimensions, and their altitude above sea-level. But latterly, the Committee, besides obtaining information on these points, has endeavoured to ascertain facts which seemed likely to throw light on the different theories of transport. Thus, almost the first question for eliciting information, in the event of the rock of a boulder differing in composition from all the rocks in the neighbourhood, was whether any other part of the country was known, where the same kind of rock prevailed? That being ascertained, How many miles must the boulder have travelled, to reach its site? In what direction by compass-bearings, did it travel? Had it to cross any valley *deeper* than its site? or to cross any range of hills *higher* than its site? or to cross any arm of the sea? If there were boulders perched on the summit or ridge of a hill at a great height, were there hills in the neighbourhood at a greater height, fit for being the birthplace of a glacier which might have brought the boulders?

These are examples of the inquiries which our Committee has latterly instituted, in order to obtain data for the solution of the problem. I by no means say or think that the data obtained are yet sufficient; but in the eight Reports supplied by the Committee, a large amount of information will be found which at all events clears up many points of interest.

I will now indicate verbally certain parts of the present year's Report.

During the past year materials have been contributed by twelve gentlemen, four of whom are members of the Committee.

1. The district regarding which most information has been obtained is a very important one. It is the district of which *Ben Nevis* is the highest point, and it comprises about 12 square miles. The *Ben* itself reaches to an altitude above the sea-level of 4406 feet; but within the limits of the district, there are many hills exceeding 2500 feet, and several exceeding 3000 feet.

The labour of climbing these hills to examine the boulders on them is much enhanced by proximity to the sea-level. Mountains in the interior of the country generally rise from an elevated plain, which, of course, lessens the ascent to their tops.

The boulders in this Ben Nevis district are described in notes by Professor Duns and Professor Heddle, two members of the Committee, and by Mr. Colin Livingston, teacher of Fort-William Public School.

Professor Heddle and Mr. Livingston having joined in the examination of the district, a map has been given to show the tracks followed by them; it also includes the localities mentioned in the notes by Professor Duns. (See Plate subjoined to Report.)

It will be seen from the notes by Professor Heddle and Mr. Livingston, that they think that most of the phenomena observed by them can best be explained by supposing that a glacier passed through Glen Nevis in a northerly and N.W. direction. It appears to the Convener that the facts most strongly favouring this view are the boulders, consisting of rocks (especially red syenite and quartz) identical in composition with rocks forming hills situated to the south of Ben Nevis, which reach to heights of about 3000 feet. Another fact relied on, is the occurrence in Glen Nevis of rocks smoothed and striated, which it is thought may be best accounted for by heavy bodies of ice passing down the glen. Some importance also is attached to "a detrital bank at an altitude of 2904 feet," forming "for about 100 yards, and about 40 feet deep, a ridge or bank of loose material, broad enough for three persons to walk upon abreast, and containing much gravel and small rounded stones." In regard to this "detrital bank," Professor Heddle remarks:—"Whether a glacier showered down the heaps of stones which form the ridge, or whether it had been deposited by aqueous agency, may be matter of opinion" ("Report," p. 35).

The Convener feels difficulty in accepting this glacier theory as being sufficient of itself to explain all the phenomena.

Then, when it is said that on the summit of *Mullach nan Correean* (at a height of 3077 feet)—which "forms a great round dome of red granite"—"there are several small angular blocks of pure white quartz rock, the nearest locality of which is the peak of *Stob Bhan*," at a height of 3274 feet above the sea, I ask, where could a glacier

have been formed, on which blocks could fall from *Stob Bhan*, to be carried to *Mullach nau Correan*?

The *detrital bank*, "containing mud, gravel, and small rounded stones" at a height of 2904 feet, 100 yards long and 40 feet deep, seems more like a submarine bank than a moraine, especially as at that height, any glacier generated about *Stob Bhan* could have had no opportunity of collecting sufficient debris to form a moraine of such dimensions.

The *striations* on the rocks of Ben Nevis do not necessarily imply glacier action, for striations have often been seen in localities, as in islands, where no glacier could have existed.

Professor Duns in his notes avoids adoption of any theory, but he mentions some facts which seem to suggest explanation. Thus, in noticing the "gravel heaps," he says, that the blocks which occur *in* them, are "subangular blocks of the immediate neighbourhood," and that the blocks which are *erratics*, occur *on* the gravel heaps; meaning apparently, that the gravel had been deposited first by one agency, and the erratics afterwards by another agency.

In referring to boulders occurring on "the mountain slopes," Professor Duns takes special notice of the remarkably precarious position of many large "granite boulders lying on mica schist rocks, where the side of the mountain slopes down so steeply as to make it a puzzle to understand, how they can remain in position" (pp. 23, 24).

It is also a puzzle to conceive what kind of agent it was which could set these boulders upon the steep slope of a hill so gently and exactly, as enabled the boulders to occupy positions of stability. One large porphyry boulder is mentioned with the "angle of its site to the horizon 35°" (page 23). Having been brought from a distance on a glacier or on floating ice, a boulder must in either case have fallen with such violence, as, by the reaction of concussion, to have slipped down any slope even though far from steep.

The only rational way, as it appears to me, of accounting for the position of these boulders is to suppose that the valleys became filled with detritus when the land was submerged, and that floating ice dropped boulders on the detritus. If the boulders were dropped near the side of a valley, the boulders, as the detritus was removed by rain and mountain streams, would slowly and gradually sink till

they reached the slope of the hill, and would then find a resting place.

This view is indicated by the following diagram, where A represents a boulder in detritus, and B the same boulder when the detritus was nearly all removed from the valley:—

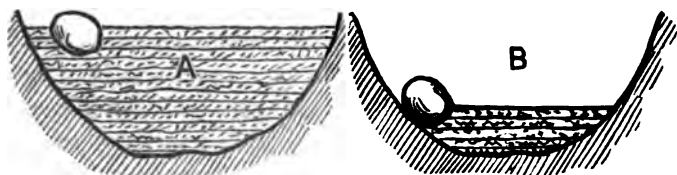

In the Seventh Report of the Committee I suggested this explanation of the position of two boulders lying on the steep side of a valley near Oban; and I now give these diagrams in further explanation of a difficulty which Professor Duns twice refers to in his notes.*

Another point brought out by Professor Duns is the arrangement of boulders in approximate *lines* or *rows*, of which several examples are given. He states that "they appear in long lines, some times far apart, but there is no mistaking their place in the lines which are W.N.W. and E.S.E." In another place he refers to "two rows of boulders being nearly direct west. The first block is grey granite, 7 x 4 x 6 feet, angle of site to horizon 40°, the others are grey granites, porphyries, and mica schists, their larger axis being N.N.W. and E.S.E."

Keeping in view the *trainées* of boulders mentioned by Dr. Heddle in last year's Report, as seen by him in Rannoch, it may be assumed that this arrangement of boulders is a feature requiring special attention, as probably indicative of the nature of the medium by which the boulders were brought to their present sites. I have no recollection of seeing in Switzerland, or hearing of boulders there, forming lines or rows after being projected from a glacier. But Arctic voyagers represent the sheets of ice formed along a rocky

* That all or most of the valleys were filled originally with detritus is evident, from the account given in Dr. Heddle's notes of a great bank of detritus found by him at a height of 2904 feet (page 35); and from the fact mentioned by Professor Duns, that one very large gneiss boulder (weighing about 100 tons) was found by him on a steep slope at a height of 1500 feet, resting mainly on three small rounded granite boulders (page 24).

shore as often covered by blocks of stone which have rolled off the land, and which, when floated away from the shore, drop their cargoes. These possibly may form rows on the sea-bottom, if the ice raft followed a straight track, or if an iceberg ploughed its way among the boulders when on the sea-bottom, and pushed them aside into approximately straight lines.

Professor Duns, whilst narrating the facts observed by him, has avoided theoretical speculation; but, after completing his record of facts, he concludes his notes by observing that "a careful examination of the deposits within the area described, so far as they bear on Arctic conditions of climate and a glacial surface, leads to the belief that the bulk of the phenomena may ultimately find their explanation in the recognition of two movements, one outwards from *Ben Nevis* as a centre, the other a force travelling from the W., the N.W., or the N.N.W." (page 23).

I presume from this remark that Professor Duns means that there have been two separate agencies, viz. (1) *glaciers* which filled the valleys and covered the mountain sides, and, after the land was submerged (2) *floating ice*, which came from the directions indicated by him.

If that view be correct, future observers in the Ben Nevis district, (and there is still an ample field there for further exploration), should endeavour to study what are the traces of each separate agency.

Whilst Dr. Heddle in his *Ben Nevis* excursions has seen mostly the traces of glacier action, he has elsewhere very clearly pointed out the evidence of a great and general movement over the country from a westerly direction. In the notes supplied for this Report he gives an example of blocks disrupted from a vein or dyke of white granite, in Glen Finnan, illustrated by a diagram (page 32), carried up hill and for about one-third of a mile to the eastward; and he has also pointed out, as lying on the Ochil Hills, boulders of dolerite, red granite, and almond conglomerate, which he has identified with rocks *in situ*, some of them twenty miles distant, situated to the westward (page 31).

2. Another district which has been well surveyed is that near Inverness, and chiefly to the S. and S.E. A list of no less than about twenty large boulders in that district has been supplied by Mr. Wallace, master of the High School of that town;

In the case of those which he has been able to identify with rocks *in situ*, he states that they have all come from some westerly point. Mr. Richardson, a member of our Committee, has visited many of the boulders in the list given by Mr. Wallace, and states in his notes (page 11) that he was "struck with the number of boulders dotting eminences, and with the depth of sand which covered the hills, the whole pointing to a period of submergence in Post Pliocene times." In corroboration of this view, he cites the discovery last summer by Mr. James Fraser, C.E., Inverness, of Arctic marine shells at the height of 500 feet above the sea, at Drummore of Clava in this district."

3. Notes have also come to the Committee from Mr. Wm. Morrison, secretary to the Dingwall Field Naturalists' Club. He has traced the boulders of granite and mica schist which abound on Tulloch Hill, to rocks situated on Ben Wyvis and Cairn Cunnraig, hills situated from ten to twenty miles to the W. and N.W.

Nothing has, however, been discovered, to show decidedly whether the transporting agent was glacier or floating ice, except the physical outline of the country, which is quite unfavourable to the generation or movement of a glacier.

Mr. Morrison suggested for consideration a curious question—Whether certain *artificial cup-markings* discovered by him on one of the Tulloch Hill boulders might not have been cut before the date of some natural *striæ* which occur on the boulder? His reason for suggesting the question being that "these cup marks were faint, where the scorings are deepest and most frequent."

He drew my attention to the circumstance, stating that it was a question interesting alike to geologists and archæologists, so I wrote to ask specially whether any idea was entertained by him as to the possibility of the *striæ* on the boulder having been formed after the cup marks had been formed. His answer was:—"The suggestion formed on the mind unquestionably is, that the cups were partially obliterated by the scoring agent, and hence were made before the natural *striæ*" (page 16).

If this suggestion is supported by further examination and study, it would indeed be a very marvellous discovery, supporting the idea that glacial agencies had been in operation since the arrival of human inhabitants in Easter Ross.

But is it quite certain that the cup marks are, as Mr. Morrison thinks they are, *artificial* ?

Professor Duns, in his notes on Ben Nevis, mentions that on one of the boulders mentioned by him, "are several round hollows, so very like the cup-markings of the archæologist, that at first sight they seem artificial. But in another block, a bit having been noticed protruding from the surface on being struck with the hammer, fell out, leaving the cup-marking on the stone" (page 21).

Might not the cup-markings on the Tulloch boulder be of the same nature as those on the Ben Nevis boulder, which at first deceived Professor Duns ?

4. Notices of some interest have been received regarding boulders in *North Ronaldshay*, Orkney, and from *Fair Isle* and *Lunna* in the Shetlands. Boulders on islands, which differ from the rocks of these islands, and can be identified with rocks of islands distant eight or ten miles, and separated by deep arms of the sea, are of extreme interest, because the theory of glaciers is quite inapplicable to them. Floating ice is the only possible solution, and if subject to the agency of tidal currents and varying winds, it will also explain why the directions of transport vary as they do in the Orkneys and Shetlands.

5. I have only now to allude to the small contribution which I have myself been able to supply for this year's Report. It is shown by a woodcut in the Report and by a coloured diagram on the wall. The boulders referred to in these, being a compact gneiss, whilst the rocks of the hill are clay slate, there can be no doubt that they are true erratics, and that they have come from the westward, as there are few gneiss rocks anywhere to the eastward, and they occur in abundance towards the west in Jura, Colonsay, Mull, and along the shores of Lochs Sweyn and Killesport.

The hill which bears these boulders, stands by itself, reaching to a height of 710 feet above sea-level. It is in a sort of amphitheatre formed by a range of hills both south and north, which reach to a height of from 1200 to 1500 feet, with openings towards both east and west. My conjecture, therefore, is that floating ice carrying boulders flowed in from the west, and, stranding on the hill, lodged there the boulders which now lie not only on the top, but on the south-east side of the hill.

There are several other facts mentioned in the Report, showing that through the gorge or kyle which lies between East and West Loch Tarbert a strong current must have passed, spreading boulders on each side of the gorge, striating rocks, and depositing detritus. The heaps of detritus are chiefly on the east, *i.e.*, the *lee* side of rocky knolls.

3. Supplement to the Eighth Report of the Boulder Committee.

Origin and Objects of the Committee appointed by the Royal Society of Edinburgh to obtain information regarding Boulders in Scotland.

The subject was brought before the Society by Mr. Milne Home in a paper referred to in the following Minute of Council, dated 21st April 1871 :—

“The Council, whilst authorising Mr. Milne Home’s paper “On the Conservation of Remarkable Boulders in Scotland,” to be read at an ordinary meeting of the Society, agree, in compliance with a suggestion in the paper, to express approval of its object, and of the scheme proposed for carrying it out.

“The Council nominate the following Fellows of the Society as a Committee to assist Mr. Milne Home in this matter.—Professor Christison, Professor Geikie, Professor Wyville Thomson, Rev. Thomas Brown, Captain White, R.E., Dr. Arthur Mitchell, Thomas Stevenson, C.E., Dr. Page, Professor Nicol (Aberdeen), Professor Young (Glasgow); Mr. Milne Home to be Convener. The Council agree to supply the Committee with copies of Mr. Milne Home’s paper, when printed in the *Proceedings* of the Society, if the Committee should wish to circulate it, with a view to create an interest in carrying out the scheme.”

(Signed) J. H. BALFOUR, *Secretary.*

The following extracts are made from Mr. Milne Home’s paper, read on 5th May 1871.

Among many geological questions which wait solution, there is probably none more interesting or perplexing than the agency by

which boulders or "blocs erratiques," as the French term them, have come to their present sites. I allude, not to blocks lying at the foot of some mountain crag from which they have fallen, but to blocks which have manifestly been transported great distances, after being detached from rocks of which they originally formed part.

That many of the large isolated blocks lying on our mountain sides and on our plains have come from a distance, and by some agency of tremendous power, is obvious even to an unscientific observer; and the perception of this truth by the popular mind has, in many cases, so invested these boulders with superstitious interest, that they have received names and suggested legends, which impute the transport of them to supernatural agents.

There are two circumstances which plainly indicate that these stones are strangers.

One is, that many of these blocks are in composition different from that of the rocks prevailing in or near the district where the blocks are situated, but similar to rocks in distant parts of the country.

The other is, that some blocks, whilst excessively hard,—so hard that it is difficult to break off a portion, are nevertheless round in form—a form evidently acquired by enormous friction—such friction as would result from being rolled or pushed a long way over a rough surface.

These round shaped blocks were the first to attract popular attention. The name given to them in Scotland of *boulders* has no doubt been suggested by their shape.

It is accordingly chiefly the rounded boulders which possess the traditionary names and legends by which many of them are known. Such names as *Carlin's Stane*, *Witch's Stane*, *Pech or Pict's Stone*, *Fingal's Putting Stone*, *Giant's Stone*, *Clach M'hor*, *Clachan-an-druid*, *Kirk-Stane*, *Pedlar's Stane*, *Thuggart Stane*, and *Devil's Putting Stane*, are all applicable to rounded blocks.

When the geologist turned *his* attention to the subject, it was soon discovered, that there were many blocks equally entitled to be called erratic, not round, but square shaped; and which, though discovered to belong probably to rocks at a great distance, yet showed signs of little or no attrition. Moreover, many of these angular or sharp-edged blocks were comparatively soft and loose in structure, so that they could not have been rolled or pushed for any considerable distance, without being broken or crushed.

On a minute inspection of erratic blocks, certain features were noticed which seemed to indicate the forces to which they had been subjected. Thus on many of them, deep scratches, ruts, and groovings were found, as if sharp pebbles or stones harder than themselves, had been squeezed against them under great pressure. It was also observed that, when a block had a long and a short axis, the longer axis was generally parallel with any well marked scratches or striæ on its surface; and, moreover, that the direction of these striæ frequently coincided with the direction of the parent rock.

These circumstances soon led geologists to speculate on the nature of the agencies which could have effected a transport.

After alluding to the different theories which had been suggested, to account for boulder transport, the paper proceeds as follows:—

It is not my intention to discuss these theories, or say which appears the most probable. I allude to them merely to indicate the tremendous character of the agencies, which it is found necessary to invoke for the solution of the problem,—agencies all implying a very different condition of things in Scotland, as regards configuration of surface and climate, from what now prevails. These phenomena are the more interesting, because, as most of the erratic blocks lie above all the rocks, and very frequently even above the beds of clay, gravel, and sand, which constitute the surface of the land we inhabit, they indicate probably the very last geological changes which occurred in this part of the earth's surface, and which there are some grounds for supposing, may even have occurred since this country was inhabited by man.

The basis on which geologists have been obliged to build their theories, it must be admitted, is sufficiently narrow. It consists merely of observations made casually by individuals, who have noticed certain appearances in districts which they happen to have visited; and, therefore, it is little to be wondered at, that more than half a century has been required for procuring the information, scanty as it is, which has been obtained.

What appears desirable for expediting the solution of the problem, is to discover and organise a staff of observers, for the purpose of discovering facts likely to throw light on the subject, and of making these facts known from time to time, both with a view to verification, and as a basis for further speculation.

It is probable that the numerous natural history societies and field clubs existing in Scotland, would be valuable agents in this investigation; and, moreover, that individual geologists might be induced to co-operate in their respective districts.

I hope no one will think that the object for which this investigation is now asked is not worthy of the trouble which it implies, and of the patronage which this Society is proposing to bestow on it. These erratic blocks bear the same relation to the history of our planet, as the ancient standing or memorial stones do to the history of the early races of man. These last-mentioned stones,—sometimes with sculpturing on them not yet understood,—sometimes arranged in circles or other regular forms not yet explained,—sometimes found in connection with sepulture, are beheld and studied with interest, or the gleams of light which they throw on the people who erected them; and popular indignation justly arises, when any of these prehistoric records are destroyed or mutilated. The great boulder stones to which I have been referring, would, if investigated and studied, in like manner cast light on the last tremendous agencies which have passed over whole regions of the earth. It is therefore important to have as many of these boulders as possible discovered and examined, and to have such of them preserved as seem worthy of study. I need not say how rapidly, during the last century, both classes of ancient stones have been disappearing; and therefore, if it be desirable to preserve the most remarkable boulders, the investigation which I advocate, cannot be too soon begun.

Alike in illustration and in recommendation of this suggestion, reference may be made to an investigation for the same object commenced two years ago in Switzerland, and in the adjoining parts of France. The design was twofold,—*First*, the conservation of remarkable boulders situated on the Jura and in Dauphiny; and *second*, the recording of their positions by maps, and of their characteristic features by schedules.

With this view a circular was drawn out, and issued by the Swiss Geological Commission, pointing out the scientific bearings of the subject, and invoking the co-operation not only of provincial societies, but also of municipal authorities, and of landed proprietors. A few extracts from the Swiss circular may not be inappropriate:—

“These erratic blocks are composed of granite, schist, or limestone;

but they rest on rocks of a different description. They are so remarkable by their number and size, that, from an early period, they attracted the attention of naturalists, and suggested scientific inquiries. It is, indeed, interesting to seek to comprehend how enormous masses, with from 40,000 to 50,000 cubic feet of contents, and weighing from 800 to 1000 tons, could be transported from the Alps from which they were evidently detached, to spots 40 and 50 leagues distant, crossing deep valleys, such as the lakes of Geneva, Neufchatel, Zurich, Constance, Lucerne, &c.

“This great problem has been discussed by numerous philosophers, both of Switzerland and of foreign countries.” Then follows a list of names, including those of our own Playfair, Lyell, Murchison, Forbes, Tyndall, and Ramsay.

“Unhappily” (the circular goes on to state), “during the last 100 or 150 years, these erratics have been broken up for building purposes, and even for road metal. Recently the work of destruction has gone on more rapidly, and, unless stopped, the result will be to obliterate all traces of one of the greatest facts in the natural history of our country.

“Though the destruction of these blocks is now advancing with great rapidity, there are still a number of very large specimens left, and these the Geological Commission is anxious to preserve.”

“The members of Archæological Societies are interested in the conservation of these blocks, for they often bear those curious sculpturings, to which much importance is now justly attached.”

The appeal thus made to various societies and to municipal authorities in Switzerland, was most successful; as in many cases the proprietors on whose lands the boulders were found, in order to ensure their preservation, gave a right of property in them to different natural history societies.

Professor Favre of Geneva, who was the first to institute the movement in Switzerland, next addressed a letter to the Geological Society of France, with the same object. A Committee was appointed to report on the subject; and from their report, which was adopted by the Society, the following extract may be given:—“Such is the object pursued vigorously in Switzerland with the co-operation of departments and of individuals. In a word, see what is going on near ourselves. Can we remain outside of, and

indifferent to, this scientific enterprise, especially when Mons. Favre has asked us to engage in the same work, and to undertake for our country what he is doing for his? We are bound to answer this appeal. The solution of the same questions ought to occupy us. These erratic phenomena abound everywhere in our district. The debris of rocks torn from the Alps cover the plain of Dauphiny, the plateau of the Dombes, the hills of Croix, Rousse, and Sainte-Foy. Already many geologists have studied these erratic phenomena in our neighbourhood, without being able to discover a solution. The truth, when we seek it, seems to fly from us, but we must persevere and pursue it till it is caught."

Professor Favre's efforts for the conservation and study of boulders were not confined to Switzerland and France. Having discovered that Scotland afforded an extensive field for inquiry, he sent to me a copy of the circulars which he had drawn out, and wrote several letters, from which the following passages may be quoted:—"Si vous pouvez organiser quelque chose de semblable en Ecosse, vous m'obligerez infiniment, en me tenant au courant."

In a subsequent letter, he says, "Permettez moi de vous renouveler la demande que je vous ai adressé, en vous priant de me tenir au courant de ce que vous ferez pour les blocs erratiques de l'Ecosse, et des resultats que vous obtiendrez."

I have given these details of the proceedings in Switzerland and France, and quoted these passages from Professor Favre's letters, in order both to add weight to my proposal, and show how we may proceed to attain it.

The disappearance of numerous camps, buildings, standing stones, and other objects of archaeological interest in all our counties, which every one now regrets, has been owing in a great measure to ignorance on the part of the proprietors and tenants on whose lands they were situated, of the value and even nature of these objects. But this work of destruction has been happily stopped, and chiefly by the interference and influence of our Society of Antiquaries. In like manner, the demolition of boulders which has been going on rapidly in Scotland, will, I hope, be arrested, when the proprietors and tenants on whose land they stand, are made aware of the interest they excite, and of what is being done to preserve them in other countries. Of course, it would only be certain boulders which it

would be desirable to preserve, boulders remarkable for size, or shape, or position, or for markings upon them; and when a report was made to the Committee of any boulder of this description, the Committee would judge whether an application should be made to the proprietor on whose lands it was situated, to spare the stone, so that it might be preserved for examination and study. I have little doubt that such an appeal would be attended to. Indeed, in the great majority of cases, a proprietor would be pleased to learn, that an object of scientific interest had been discovered on his estate, and would be glad to have it in his power to accede to any request in relation to it coming from a Committee of this Society.

The first step taken by the Committee was to send out about 700 circulars to parochial ministers in Scotch counties, containing queries, with the view—

1. Of ascertaining localities where boulders exceeding 50 tons in weight existed.
2. Of obtaining the dimensions of these boulders.
3. Of learning whether the rocks beneath and near these boulders, were the same as or different from the rock composing the boulders.
4. Of inquiring whether there existed any accumulations of sand or gravel in the form of mounds, or elongated embankments, above sea level.
5. Of ascertaining whether these boulders were known by any traditional name or legend.

These 700 circulars produced about 100 answers, containing much valuable information. But the Committee on considering the answers came to be of opinion, that they had acted injudiciously in asking information only regarding boulders exceeding 50 tons in weight.

They thereupon resolved to send out another circular containing the same queries as before, but extending to boulders of 20 tons and upwards in weight.

The Committee fearing that they might be considered troublesome, in again applying to ministers of parishes, addressed their second circular to parochial schoolmasters.

The answers received from them contained a very large amount of information.

The answers to both circulars were then carefully examined by

different members of Committee; and it was resolved to classify the information according to counties. The first report of the Committee was laid before a meeting of the Royal Society in April 1872. It gives in a condensed form, for counties (alphabetically arranged) and for parishes in each county, a list of boulders with particulars regarding the nature of the rock composing them, and other features of geological interest.

The first report also contains information of archaeological or traditional interest regarding some of the boulders. But in the reports of subsequent years, the information given is almost exclusively geological.

They include also occasional references to beds of gravel and sand, existing whether as mounds or in elongated embankments;—and with the view of considering whether they might be considered to be ancient moraines, and therefore indicative of local glaciers, or to be submarine banks, and in this last case, indicative of a submergence of the land.

The chief object of the Committee has been to collect facts, and not to announce conclusions. But it was also important to obtain data, bearing on the different theories of boulder transport. Thus in many cases the positions of boulders have been specially noted when these indicated the direction from which they probably came. In some cases their heights along the sea were specially noted when above the level of any possible glacier; or their positions on islands, where the existence of glaciers was most unlikely. So also, the smooth and rough sides of rocks, were studied and explained when they showed from what quarter the smoothing agent seemed to have passed over the rocks.

The Committee have now completed seven reports. These were laid before meetings of the Royal Society, and have been published in the Society's *Proceedings*. An eighth report is now in progress.

But a wish has been frequently expressed to have an index or an abstract of the information contained in all the reports. His Grace the Duke of Argyll, in his paper "On the Geology of the Highlands," read at the last Glasgow meeting of the British Association, whilst referring to the valuable information contained in the reports then published, expressed a hope that an abstract should be drawn out by

the Committee. The late Sir Robert Christison at almost every meeting reiterated the same wish.

The Convener of the Committee has made an attempt to carry out these suggestions, by gathering out of the seven reports already published, all the facts, applicable to the respective counties, in alphabetical order.

The compendium is such that any one wishing to learn something of the boulders in any particular county, or parish of that county (in so far as reported to the Committee), will be at once able to get that information.

But besides a topographical abstract merely to show where boulders of all kinds occur, one of perhaps greater interest might be formed, classifying boulders, under such heads as the following, and indicating the reports where they are noticed :—(1) Boulders of great size or weight :—(2) boulders perched on peaks or summits of hills ; (3) boulders at very high levels above the sea ; (4) boulders on islands remote from any mainland ; (5) boulder transport in so far as indicated by the ascertained direction of parent rock, or by the bearing of longer axis of boulders, or by the direction and depth of striæ on their surfaces.

Another heading in such an abstract, might be a reference to localities where great accumulations of sand and gravel occur, whether in the form of mounds, or embankments, or of horizontal terraces, and at various heights above the sea ; for notices of these occur in several of the reports.

PROCEEDINGS
OF THE
ROYAL SOCIETY OF EDINBURGH.

VOL. XI.

1881-82.

No. 112.

Monday, 19th June 1882.

THE RIGHT HON. LORD MONCREIFF, President,
in the Chair.

The Council having awarded the Keith Prize, for the Biennial Period 1879-81, to Professor Chrystal, for his paper "On the Differential Telephone," published in the Society's *Transactions* for the Session 1879-80, the Chairman presented the prize.

Professor Tait, in explaining the grounds of award, said that Professor Chrystal's paper was one of very high scientific interest and value, and contained much that was wholly original. But, what would be more readily understood by the majority of the Society, it was one which contained the description and theory of a new instrument destined undoubtedly to improve in a marked manner the measurement of electric capacities. Our means of measuring these have been, by this paper, raised from mere "rule of thumb" to real experimental accuracy. And the subject for measurement is one whose scientific and whose practical importance are every day becoming greater.

The Council having awarded the Neill Prize for the Triennial Period 1877-80, to Mr. John Murray, for his paper "On the Structure and Origin of Coral Reefs and Islands," communicated to the Society on April 5, 1880, and printed (in Abstract) in the *Proceedings* for that date, the Chairman presented the prize.

Mr. Buchan, in explaining the grounds of the award, said—
The Council has awarded to Mr. John Murray the Neill Prize for

the triennial period 1877-80, for his paper on "The Structure and Origin of Coral Reefs and Islands," which was communicated to the Society on April 5, 1880, and thereafter printed, in abstract, in the *Proceedings* of the Society.

One of the most remarkable results of the voyage of H.M.S. "Beagle," which was undertaken forty years ago, was the publication by Mr. Darwin of his book *On the Structure and Distribution of Coral Reefs*, in which he advanced a theory of their mode of formation which was at once universally accepted by scientific men, and may be stated to have been all but universally entertained till the publication of Mr. Murray's paper on Coral Reefs.

He had the good fortune, about the commencement of his scientific career, to serve as naturalist on board the "Challenger" during its voyage of discovery round the world. Among the new facts and ideas we owe to that celebrated expedition, and the skill with which it was conducted, those referring to the amount and distribution of oceanic life from the surface to a depth of about 100 fathoms, and the different chemical processes at work both at great depths and near the surface, must be named as among the more prominent.

The great merit of his paper consists in having brought these new facts and ideas to bear on the structure and origin of coral reefs. He has shown how the foundations for coral reefs have been prepared by the disintegration of volcanic islands and by the building up of submarine volcanoes by the deposition on their summits of sediments composed mainly of dead organisms. He has further shown that the food of the coral consists chiefly of the abundant oceanic life brought ceaselessly to them by the surface drift currents of the tropical regions; and that the extensive solvent action of sea-water, which so completely removes the carbonate of lime-shells at great depths of the ocean, holds no place at the shallow depths which form the habitat of the coral.

Without going further into details, it may here suffice to say that the theory of coral reefs propounded in Mr. Murray's paper renders it unnecessary to the geologist to assume, in explanation of some of the more difficult problems presented to him, the occurrence of great and repeated general subsidences which have formed one of the great difficulties of geology; and that from the general accept-

ance the theory is receiving from scientific men, particularly from those specialists whose domains in science it touches most nearly, it is already taking the place so long held by the ingenious and fascinating theory of Mr. Darwin.

The following Communications were read:—

1. On Mirage. Part III. By Professor Tait.
2. On a Red Resin from *Dracæna Cinnabarrî* (Balf. fil.) Socotra. By J. J. Dobbie, Assistant to the Professor of Chemistry, University of Glasgow; and G. G. Henderson, B.Sc. Communicated by Dr. Bayley Balfour.
3. On Voice-Effort and Rhythm. By the Rev. J. L. Blake. Communicated by Professor Crum Brown.

(*Abstract.*)

In this paper the author enunciates and illustrates the following propositions:—Speech is produced by distinctly separate jets of breath emitted under pressure; each such jet he names a monopressure. A monopressure may be used for the utterance of a single syllable, which may consist of a single vowel, or a vowel preceded or followed, or both, by consonants. In a monopressure the sound is weaker at the beginning and end, and stronger in the middle. The weak beginning, or the weak ending, of a monopressure, or both, may be used for the utterance of an unaccented syllable. There are thus four forms of a monopressure:—monosyllabic; dissyllabic, with the accent on the first; dissyllabic with the accent on the second; trissyllabic, with the accent on the second. These the author marks thus $\overset{1}{|}$, $\overset{1}{L}$, $\overset{1}{J}$, and $\overset{1}{\perp}$. A large number of examples is given. The following will indicate the use of the marks,— $\overset{1}{|}$ act, $\overset{1}{L}$ acting, $\overset{1}{J}$ react, $\overset{1}{\perp}$ reacting. The syllables (when there are more than one) of a monopressure need not, of course, all belong to one word; and many words require more than one monopressure for their utterance. Thus words of three syllables require two monopressures, unless the

accent is on the second. If the accent is on the first, they are of the forms $L \mid$; if on the last, of the forms $\mid J$. Examples— $\overset{L}{\underset{\mid}{a}}ccident$, $\overset{\mid}{\underset{\mid}{r}}ecollect$. The monosyllabic pressure in these words marks a secondary accent. A similar analysis is given of the pressures on words of four, five, six, seven, and eight syllables, with varied position of the primary and secondary accents. It is shown that not more than two unaccented syllables can occur together. A sentence may begin with three apparently unaccented syllables—for instance, "in the beginning;" but these words must have two pressures, one effecting the utterance of the words "in the" and the other sufficing for the word "beginning," the notations being $L \mid$. The amount of pressure in a monopressure can be varied. The author recognises three degrees corresponding to the accent, the secondary accent, and the accent by position.

The same sentence may be uttered in a great variety of ways, by varying the number and form of the monopressures. Children beginning to speak use a monopressure for each syllable. A proper distribution of the syllables to the monopressures and a proper regulation of the strength of the latter, so as to fit the meaning of each sentence, are essential elements of good speaking and reading. By means of examples from Shakespeare and Milton, the author shows how rhythm in verse depends upon the arrangement of the four forms of monopressure. He believes his theory and the notation founded on it may be successfully applied to instruction in pronunciation and rhythm, to textual criticism of Shakespeare, and to the decision of questions as to accentuation in Hebrew and Greek, and that it may lead to the economy of breath pressure and voice, and to an easy elocution which only an understanding of the mode in which voice is produced can help to perfect.

4. The Effect of Moisture on the Electric Discharge. By A. Macfarlane, M.A., D.Sc., and D. Rintoul, M.A.

(Preliminary Notice.)

In his recent lectures on Solar Physics,* Professor Stokes, while expounding his theory of the connection of magnetic disturbances, auroræ, and earth currents, says:—"We might not have tension enough to produce such a discharge (that is, a flash of lightning), the resistance to the passage of electricity from one portion of the air to another, which at any rate would be comparatively dry compared with what we have in warm latitudes, would prevent it by itself alone." Professor Stokes subsequently remarked in a letter to *Nature*:†—"These words, without actually asserting, seem to imply that the resistance to such a discharge through moist air would be less than through dry. My attention has been called by a friend to the fact that it has been found by experiment that moist air insulates as well as dry. I have not met with experiments tending to show whether the resistance to a *disruptive* discharge is the same or not in the two. Be that as it may, it does not affect what follows; for we know, as a fact, that thunderstorms are absent in high latitudes."

To the question here asked we have endeavoured to furnish an answer. The experimental method adopted was the same as that described in our paper on "The Effect of Flame on the Electric Discharge."‡ The spark was taken between two brass discs, each 4 inches in diameter, supported parallel to one another inside a receiver, after the manner described in former papers.§ The drying of the air was effected by first exhausting the moist air out of the receiver, and then allowing the air of the room to pass in slowly through one or more sulphuric acid tubes. In our first trials one drying tube was employed, but in the later trials two. Care was always taken that the air through which the discharge passed was at the atmospheric pressure. To obtain the humidity of the

* *Nature*, vol. xxiv. p. 615.

† Vol. xxv. p. 30.

‡ *Proc. R.S.E.*, 6th March 1882, p. 567.

§ *Phil. Mag.*, Dec. 1880.

air of the room, the readings of a dry and of a wet bulb thermometer were noted.

The following table gives the results of our different trials. The order of procedure is given in column sixth. A number of readings were first taken for the air of the room, then the receiver was exhausted to a pressure of 5 mm. or so, and the air subsequently allowed to enter slowly through the drying tube or tubes. When the state of the air was again changed, it was done by allowing the air to enter without passing through the drying tubes. The number entered in the seventh column is the mean of ten or six readings.

It will be seen that in the case of the great majority of the comparisons, the reading for the undried air is less than for the dried air, and that this is universally true in the case of the first comparison in each series. The diminution of the difference in the case of the subsequent comparisons of a series may be due to the fact, that to obtain undried air a second time, we allowed the air of the room to enter through the already dried passages of the air-pump.

The series observed on 26th May is the one in which the drying was most carefully performed; the conclusions which it supports are those which might be deduced from the other series taken collectively. In the case of this series, the individual observations are as follow :—

DIFFERENCE OF POTENTIAL.

| Reading. | First State. Undried. | Second State Dried. | Third State Undried. |
|----------|--------------------------|------------------------|-------------------------|
| 1st. | 240 | 258 | 253 |
| 2nd. | 242 | 270 | 262 |
| 3rd. | 241 | 283 | 258 |
| 4th. | 248 | 258 | 255 |
| 5th. | 250 | 257 | 255 |
| 6th. | 247 | 261 | 250 |
| Mean, | 245 | 265 | 255 |

RESULTS OF TRIALS.

| Date. | Thermometer. | | Pressure of Atmosphere. | Spark-length in Millimetres. | State of the Air. | Mean of Differences of Potential. | Percentage Ratio of Increment to Reading for Undried. |
|---------|--------------|------|-------------------------|------------------------------|-------------------|-----------------------------------|---|
| | Dry. | Wet. | | | | | |
| May 12. | 16·1 | 12 | ... | 6 | Undried. | 367 | 17 |
| " | ... | ... | ... | 6 | Dried. | 429 | |
| " | ... | ... | ... | 6 | Undried. | 415 | |
| May 15. | 16 | 11·8 | 755 mm. | 6 | Undried. | 400 | 8·5 |
| " | ... | ... | ... | 6 | Dried. | 434 | |
| May 18. | 16·8 | 13 | 755·4 | 3 | Undried. | 180 | 4·4 |
| " | ... | ... | ... | 3 | Dried. | 188 | |
| " | 18 | 14 | ... | 3 | Undried. | 191 | 4·2 |
| " | ... | ... | ... | 3 | Dried. | 199 | |
| " | 18·2 | 14·2 | ... | 5 | Dried. | 314 | 3·1 |
| " | ... | ... | ... | 5 | Undried. | 305 | |
| May 19. | 17·7 | 13·9 | 755·6 | 2 | Undried. | 140 | 5·0 |
| " | ... | ... | ... | 2 | Dried. | 147 | |
| " | ... | ... | ... | 4 | Dried. | 242 | 11 |
| " | ... | ... | ... | 4 | Undried. | 218 | |
| " | 18·8 | 15 | ... | 6 | Undried. | 365 | 0 |
| " | ... | ... | ... | 6 | Dried. | 358 | |
| " | ... | ... | ... | 6 | Undried. | 353 | |
| May 24. | 17·8 | 14·6 | 755·4 | 6 | Undried. | 348 | 16 |
| " | ... | ... | ... | 6 | Dried. | 406 | |
| May 25. | 19 | 15·8 | 755·9 | 1 | Undried. | 89 | 5·6 |
| " | ... | ... | ... | 1 | Dried. | 94 | |
| " | ... | ... | ... | 2 | Dried. | 151 | 1·4 |
| " | ... | ... | ... | 2 | Undried. | 149 | |
| " | ... | ... | ... | 3 | Undried. | 210 | 0 |
| " | ... | ... | ... | 3 | Dried. | 210 | |
| " | ... | ... | ... | 4 | Dried. | 254 | -3·1 |
| " | ... | ... | ... | 4 | Undried. | 262 | |
| May 26. | 19 | 15·6 | 755·7 | 4 | Undried. | 245 | 8·2 |
| " | ... | ... | ... | 4 | Dried. | 265 | |
| " | 20·4 | 16·7 | ... | 4 | Undried. | 255 | 3·9 |

Added 17th November.

The following series of observations was made on the 31st May. The readings for the undried state, with different spark-lengths, were first observed, the air was then dried once for all, and readings taken for the several spark-lengths. This method of comparison has the advantage of saving time in drying the air, but the disadvantage of requiring the distances of the plates to be readjusted. An error in this respect may account for the different result obtained in the comparison at 3 mm. Four readings were taken in each case. Wet bulb thermometer 16·8. Dry bulb thermometer 20·2.

| Spark-length in Millimetres. | State of the Air. | Mean of Differences of Potential. | State of the Air. | Mean of Differences of Potential. | Percentage Ratio of In- crement to Reading for Undried. |
|------------------------------------|----------------------|---|----------------------|---|---|
| 1 | Undried. | 67 | Dried. | 80 | 19·4 |
| 2 | „ | 119 | „ | 126 | 5·9 |
| 3 | „ | 168 | „ | 166 | -1·2 |
| 4 | „ | 222 | „ | 238 | 7·2 |
| 5 | „ | 280 | „ | 285 | 1·8 |
| 6 | „ | 339 | „ | 347 | 2·4 |

5. The Heats of Combination of the Metals with the Halogens. By A. P. Laurie and C. I. Burton. Communicated by Professor Crum Brown.

Professor Chrystal, in his article on "Electricity" in the *Encyclopaedia Britannica*, mentions the following formula of Sir William Thomson's, connecting the heats of combination in a voltaic cell with the EMF of the cell.

$$E = J e \theta.$$

(Where E = EMF of the cell; J = Joule's equivalent; e = amount of zinc, dissolved by unit current in unit time; θ = heat of combination of one grm. of the metal in the cell.)

This formula has been tested for the Daniell and other cells.

It occurred to me that it was peculiarly applicable to the cuprous

chloride cell and to the iodine cell recently described to the Society, on account of the simplicity of the reactions in both these cells, and that it could in this way be used as a simple method for the determination of the heats of combination of the metals with the halogens, by determining their electromotive forces, as the active elements in one or other of these cells. Mr. Burton and I accordingly set to work to investigate the matter.

In our first experiments we used an iodine cell and a cuprous iodide cell, the cuprous iodide being used in place of cuprous chloride.

The EMF of a cuprous iodide cell depends on the heat of combination of zinc with iodine minus the heat of combination of copper with iodine. The heat of combination of copper with iodine may be found by using copper as the positive metal in the iodine cell. Or we may determine the heat of combination of zinc with iodine directly in the iodine cell. The cuprous iodide cell, however, offers some advantages. The heat of combination of almost any metal with iodine can thus be measured.

The same method is applicable to chlorine and bromine compounds. The results obtained so far have been very satisfactory. Our numbers usually differ a little from the numbers found in calorimeter experiments. This discrepancy is to be expected, as the circumstances under which the combinations take place are so different in the two cases, and as we have not yet attempted any corrections.

The simplicity and rapidity of the method are sufficiently obvious, and it is particularly applicable to cases where only very small quantities of a metal can be obtained, and where the metal, when obtained, is too rare to be wasted in the calorimeter.

We hope to communicate to the Society the account of our experiments at a future meeting.

Monday, 3rd July 1882.

PROFESSOR DOUGLAS MACLAGAN, Vice-President, in
the Chair.

The Chairman read the following Notice as to the Government Grant of £4000 for scientific purposes, which has been prepared by Mr. John Murray, one of the Society's representatives on the Committee. He remarked that it is most desirable that this Notice should obtain wide circulation in Scotland, as there have hitherto been very few applications from this country.

"The Council have requested me to make a statement to the Fellows of the Society with respect to Scottish applications for grants from the Government Grant of £4000 for the promotion of scientific research.

"Our Society, it will be remembered, has two representatives on the Committee which has the distribution of these funds. If those Fellows who intend making application for grants from the funds will submit their applications to the Council of this Society before forwarding them to the Government Grant Committee, the Council will be glad to instruct their delegates to support the applications, should these, in the opinion of the Council, be deemed suitable.

"The same remark applies to those persons living in Scotland, and not Fellows of the Society, but who choose to submit their applications for the consideration of the Council previous to their transmission to the Government Grant Committee.

"In all cases it would be well that the delegates of the Society should be informed of the nature of the applications previous to the meeting of the Committee."

The following Communications were read:—

1. On the Kinetic Theory of Gases in relation to Dissociation.
By Professor Tait.

2. On the Change in the Peltier Effect due to Variation in Temperature. By Albert Campbell. Communicated by Dr. Knott.

The series of experiments here described had for their object the measurement of the variation in the Peltier effect due to change of temperature; they were made during the last six weeks. The arrangement which I used in these experiments was suggested by a form of apparatus used in Professor Tait's laboratory; the following is a description of it. A plate of sheet lead (say) is bent into the shape of an arch (Ω -shaped), and to its lower edges are soldered two plates of sheet-iron, to the opposite edges of which are soldered three or four copper wires proceeding to mercury-pools, which can be put into connection with a battery. In the trenches between the iron and lead are inserted the opposite ends of an iron-German silver thermopile of twelve to twenty junctions; these junctions are placed so that their points may nearly touch the junctions of the iron and lead plates, from which they are insulated by a thickness or two of thin paper. The whole is then wrapped tightly in cotton wool and pushed into a tin box, which is rolled round with flannel and placed in a larger tin box containing boiling water, an arrangement which gives a sufficiently uniform temperature in the inner box. The thermopile of iron and German silver wires has two advantages; first, these two metals give, for a given difference of temperature, a greater deflection than any other pair of easily obtainable metals; secondly, the deflection is very nearly proportional to the difference of temperatures.

The following is my method of working: I connect the thermopile with the galvanometer, turn on the battery current for thirty seconds (say), and note the galvanometer deflection at the end of this time; for the next thirty seconds the current is allowed to remain off, and at the end of this period the deflection is again noted; the current is then turned on for thirty seconds in the opposite direction, the deflection taken, the battery left off for another thirty seconds, the deflection again taken, and so on as at the beginning. This cycle of operations is gone through a number of times in order to get an average result.

If the deflections be A, a, B, b, C, c, D, d , and so on, then the average of $A, a - B, b - C, c - D$, &c., will be the measure of the Peltier effect.

The following tables give some of my results ; the first column gives the direction of the current and the period of time the current was kept on, and the other columns give the corresponding deflections :—

| I. Iron—Lead. | | | II. Iron—German Silver. | | III. Lead—Silver (Standard). | | IV. Iron—Zinc. | |
|------------------|--------|--------|-------------------------------|--------|------------------------------------|----------|-------------------|--------|
| Min. | 20° C. | 85° C. | 20° C. | 93° C. | 22°·5 C. | 98°·5 C. | 23°·3 C. | 99° C. |
| +½ | -70 | -82 | 100 | | 39 | 62 | 100 | 70 |
| off ½ | 0 | -2 | 65 | | 15 | 31 | 26 | 30 |
| -½ | 70 | 59 | -35 | -100 | -20 | -36 | -75 | -50 |
| off ½ | 0 | 0 | -30 | -60 | 3 | 4 | -20 | -3 |
| +½ | -72 | -79 | 70 | 60 | 38 | 61 | 90 | 76 |
| — | 0 | 0 | 44 | 40 | 15 | 28 | 25 | 36 |
| -½ | 70 | 69 | -47 | -90 | -30 | -43 | -105 | -43 |
| — | | 0 | -20 | -55 | -8 | -3 | -27 | -0 |
| +½ | | -77 | 70 | 50 | 27 | 64 | 82 | 72 |
| — | | -12 | 51 | — | 5 | 27 | 17 | 58 |
| -½ | | 58 | -45 | — | -40 | 45 | -104 | -26 |
| — | | -12 | -20 | +70 | -17 | -8 | -28 | +20 |
| +½ | | -72 | 80 | -45 | 19 | 57 | 81 | 101 |
| | | | 45 | | -2 | 22 | 18 | 62 |
| | | | -49 | | -45 | 52 | -105 | -22 |
| | | | | | -22 | 12 | | |
| | | | | | 15 | 58 | | |
| | | | | | -5 | 19 | | |
| | | | | | -46 | -47 | | |

I also tried Pb. brass with a one-cell Bunsen battery ; with my

galvanometer very sensitive, I failed to get any deflection; I have since found that the brass line lies very near the lead line, so that this result agrees with the diagram.

The following table (V.) gives the ratios of the Peltier effect at the lower temperature to that at the higher temperature for the various pairs of metals—1st, according to these experiments; 2nd, according to Professor Tait's thermo-electric diagram:—

| Metals. | Lower Temp. | Higher Temp. | Campbell. | Tait. |
|-----------------------------|-------------|--------------|-----------|-------|
| Fe-Pb..... | 20° C. | 85° C. | ·991 | 1·02 |
| Fe-Arg..... | 20° | 93° | ·86 | ·808 |
| Pb-Ag (<i>Standard</i>).. | 22°·5 | 98°·5 | ·582 | ·545 |
| Fe-Zn..... | 23°·8 | 99° | 1·48 | 1·86 |

It should be remarked that the battery used was not the same for all the pairs of metals; sometimes one Bunsen cell, sometimes three, were used. Hence these experiments give no means of comparing the Peltier effect for different pairs.

3. On the Lowering of the Maximum Density Point of Water by Pressure. By Professor D. H. Marshall, Professor C. Michie Smith, and R. T. Omond, Esq.

At the meeting of 17th April we gave an account of some experiments made at the request of Professor Tait on the lowering of the maximum density point of water by pressure. We called the notice we gave of these experiments at that time preliminary, because we were anxious to perform further experiments to satisfy ourselves thoroughly of the correctness of the important conclusions then arrived at. We desire now to state that we have repeated these experiments with some slight improvements in experimental details, and at different temperatures, and are glad to state to the Society that our further experiments quite bear out the conclusions previously arrived at. The following will suffice to show the nature of any day's experiment. [For description of the apparatus used, &c., see *ante*, p. 626.]

I. The galvanometer is adjusted, and its delicacy, that is the value of its scale-reading for one degree centigrade of difference of temperature of the thermo-electric junctions, tested.

II. A series of experiments are then made, each of the following nature:—The vessel of water containing one thermo-electric junction is subjected to a certain pressure, known and recorded. While under pressure, the junctions are put in connection with the galvanometer, and the deflection noted; we thus get the difference of temperature between the internal and external junctions. The actual temperature of the external junction is simultaneously read on a very delicate and accurate thermometer. Then the pressure is let off, and the heating or cooling of the water, as shown by the junction inside, observed on the galvanometer.

III. After a set of experiments made at pressures varying from 50 to 600 atmospheres, the galvanometer is again tested, and any small change allowed for in calculating out the results obtained.

In many experiments made on water between 0° and 4° cent., with pressures under 1 ton weight per square inch (150 atmospheres), we got a faint indication of cooling when the pressure was applied, but no appreciable change when it was let off. As the question of the change of the maximum density point is only attacked in an indirect manner in these experiments, we did not look for exact quantitative results. Thus, by comparing several days' experiments, we find that in order that water may neither heat nor cool when released from $1\frac{1}{2}$ tons per square inch pressure, it must have a temperature of from 0.2 to 0.5 degrees centigrade. But we do not regard ourselves as justified in stating that the maximum density point for water at this pressure lies within these narrow limits.

The diagram below gives our results in a convenient form. Horizontally we have the initial temperatures of the water under compression in degrees centigrade. Vertically the numbers represent tenths of a degree centigrade, and show the amount of cooling which takes place on release. Line I. is drawn through the various points obtained by letting off 1 ton per square inch pressure (150 atmospheres) at different initial temperatures, and noting the effect produced. Lines II., III., and IV. are similarly drawn for 2, 3, and 4 tons respectively.

From these curves it is evident that in the case of 4 tons pres-

sure, if the temperature of the water experimented on be 15° cent. to begin with, there is on release a cooling effect of about $0^{\circ}\cdot68$; while if the initial temperature be 0° cent., there is still a cooling effect of about $0^{\circ}\cdot15$, thus showing that the maximum density point of water under 4 tons pressure (600 atmospheres) does not lie between 0° and 15° cent., but is driven below the freezing point. Line I., however, crosses the axis at about $1^{\circ}\cdot5$. That is to say, we found that water which, when released from 1 ton pressure (150 atmospheres), cooled about $0^{\circ}\cdot13$ when its temperature was 15° , did

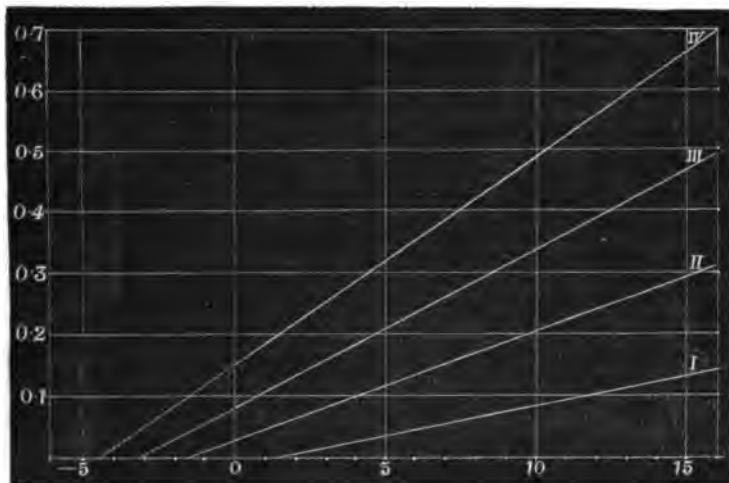

not change when its temperature lay between 1° and 2° , and at lower temperatures heated slightly on release.

Some of the discrepancies observed by us on different days may probably be explained by convection currents in the vessel of water, due to the change of the maximum density point under varying pressure, and by changes in the delicacy of the galvanometer. We mentioned in our previous notice how we were disturbed by the constant change in the magnetic field by the passing of carts, &c., on the street. We found that even the motion of the handle of the pump affected the galvanometer, and this was indeed the cause (till it was detected) of our taking double readings in many of our observations.

Some experiments we performed on salt water of the density of sea water, although quite in accordance with the received opinion

that salt water has no maximum density point, led us to suspect a maximum density point below zero centigrade. Thus, for 1 ton per square inch pressure, our experiments show that a line drawn as in the fresh water diagram above, would cross the axis at about -5° , that the corresponding 2 ton line would cross at $-8^{\circ}5$, the 3 ton line at -11° , and the 4 ton line at -13° . Whereas, the corresponding points in the fresh water diagram are $+1^{\circ}5$, $-1^{\circ}5$, -3° , and $-4^{\circ}2$ respectively. We found also that for equal initial temperatures the heating effect produced by a sudden increase of pressure was greater in salt than in fresh water. As the experiments with salt water were performed at temperatures nearly the same as those with the fresh water, they gave us greater confidence in the correctness of the conclusions we arrived at in the case of the latter.

Note, added July 21, 1882.

A careful consideration of the diagram on page 811 will show that if the rate of change of the maximum density point with pressure be uniform, as is assumed by Professor Tait in his note which follows, then when a line crosses the axis, that is, when there is neither heating nor cooling shown on a sudden release of a certain pressure, the water is at the temperature of the maximum density point for half the pressure that the line represents. The following example will make this clear:—Water at a temperature of $1^{\circ}5$ cent., when suddenly released from 1 ton on the square inch (150 atmospheres) pressure, is left at the same temperature after the release, as is shown by Line I. in the above diagram. This would at first sight seem to indicate that the maximum density point for water under 1 ton pressure is $1^{\circ}5$ cent. But if the temperature of the maximum density point is lowered by pressure, it must rise as the pressure falls off, and if the lowering is proportional to the pressure, it will rise uniformly. So, if in the example given above there is no final heating or cooling of the water, it shows that there must be first a cooling and then an equal heating; that is to say, that the maximum density point must be as much below $1^{\circ}5$ cent. at the beginning of the release of pressure, as it is above it at the end. Now we know that at the end it is $2^{\circ}5$ above $1^{\circ}5$ (viz., 4° cent.), therefore it must be $2^{\circ}5$ below $1^{\circ}5$ when the pressure begins to

fall off. That is to say, the maximum density point for water under 1 ton pressure is -1° cent.

This temperature is only given, of course, as an approximate one. The causes of error enumerated by Professor Tait in his note attached to this paper all affect it, and if the lowering of the maximum density point is not directly proportional to the pressure, it can only be regarded as a very rough approximation.

4. Note on the Preceding Paper. By Professor Tait.

If we assume the lowering of the temperature of maximum density to be proportional to the pressure, which is the simplest and most natural hypothesis, we may write

$$t_0' = t_0 - Bp,$$

where p is in tons-weight per square inch.

Now Thomson's thermodynamic result is of the form

$$\delta t = A(t - t_0')\delta p.$$

This becomes, with our assumption,

$$\delta t = A(t - t_0 + Bp)\delta p.$$

As the left-hand member is always very small, no sensible error will result from integrating on the assumption that t is constant on the right (except when the quantity in brackets is very small, and then the error is of no consequence). Integrating, therefore, on the approximate hypothesis that A and B may be treated as constants, we have for the whole change of temperature produced by a finite pressure p ,

$$\Delta t = A(t - t_0)p + \frac{1}{2}ABp^2.$$

I have found that all the four lines in the diagram given in the paper above can be represented, with a fair approach to accuracy, by the formula

$$y = 0.0095(t - 4)p + 0.017p^2,$$

where p has the values 1, 2, 3, 4, respectively. Hence, comparing with the theoretical formula, we have the values

$$A = 0.0095, \quad B = 3.6 \text{ C.}$$

B expresses the lowering of the maximum density point for each ton-weight of pressure per square inch.

It seems, however, that all the observations give considerably too small a change of temperature; for the part due to the first power of the pressure is from 30 to 40 per cent. less than that assigned by Thomson's formula and his numerical data. One obvious cause of this is the small quantity of water in the compression apparatus, compared with the large mass of metal in contact with it. This would tend to diminish all the results, whether heating or cooling; and the more so the more deliberately the experiments were performed. Another cause is the heating (by compression) of the *external* mercury in the pressure gauge. Thus the pressures are always overestimated; the more so the more rapidly the experiments are conducted. A third cause, which may also have some effect, is the time required by the thermo-electric junction to assume the exact temperature of the surrounding liquid.

Be this, however, as it may, the following table shows the nature of the agreement between the results of my original experiments (*ante*, p. 218) and the data derived from the present investigations. The gauge and the compression apparatus were the same as in my experiments of last year; the galvanometer, the thermo-electric junctions, and the observers were all different. The column MSO gives the whole heating or cooling effect at 15°·5 C., calculated for different pressures from the results of the investigation by Professor Marshall and his coadjutors. The column T contains the results of my direct experiments at that temperature.

| <i>p</i> (tons) | MSO | T | Thomson. |
|-----------------|----------|----------|----------|
| 1 | 0·131 C. | 0·139 C. | 0·177 C. |
| 2 | 0·294 | 0·311 | 0·355 |
| 3 | 0·465 | 0·516 | 0·533 |
| 4 | 0·665 | 0·750 | 0·711 |

It will be noticed that there is, again, a fair agreement; though the results are, as a rule, lower than those calculated from Thomson's formula. My own agree most nearly with Thomson's formula, probably because they were very rapidly conducted. As they stand, they give about 3° C. for the effect of 1 ton on the maximum density point. It is to be observed that if we could get the requisite corrections for conduction, and for compression of

mercury, their introduction would increase (as in fact is necessary) the constant A above, but would have comparatively little effect on the value of B, which is the quantity really sought.

5. Vocalisation and Articulation. By the Rev. J. L. Blake.
Communicated by Dr. Crum Brown.

(Abstract.)

In this paper the author discusses the mechanism of speech, and the character of the vowels and consonants which occur in the English language. He points out the importance of attending to the proper division of words into syllables, and of clearly articulating consonants. He shows how his theory of monopressures facilitates the correct reading of poetry.

BUSINESS.

Mr. Andrew Jameson and Mr. J. A. Wenley were balloted for and declared duly elected Fellows of the Society.

Monday, 17th July 1882.

PROFESSOR BALFOUR, Vice-President, in the Chair.

The following Communications were read :—

1. On the Order of Succession of Rocks in the North-West Highlands. By Professor Heddle.
2. On the Rotation of the Plane of Polarization by Quartz, and its relation to Wave-Length. By W. Peddie.
Communicated by Professor Tait.

The angular rotation of the plane of polarization of light-rays in

their passage through quartz is a function of the wave-length, and is roughly represented by the formula

$$\rho = \frac{A}{\lambda^2},$$

where A is a constant depending on the quartz. This formula is only approximate, however, and one object of the experiments described below was to ascertain how closely the rotation might be represented by three terms of the equation

$$\rho = \frac{A}{\lambda^2} + \frac{B}{\lambda^4} + \frac{C}{\lambda^6} + \dots$$

Another object was to test the amount of accuracy attainable by the exceedingly simple and direct method employed; and a third was to find how nearly the constants in the assumed formula agree with one another in different specimens of quartz.

A quartz plate 8.9 mm. in thickness was first used with ordinary Nicol's prisms, as polariser and analyser. The quartz plate was fixed immediately in front of the analysing prism. A beam of sunlight, having passed through the polariser and the quartz, proceeded through the upper half of the analyser. Another beam was reflected through the under half by a mirror placed between the polariser and the quartz. Both beams being then passed through a spectroscope, two spectra were obtained in juxtaposition, the Fraunhofer lines in the one exactly corresponding to those in the other. The upper one exhibited in addition the usual dark band caused by the rotatory action of the quartz upon the plane polarised ray.

The analyser being now moved round until the centre of the dark band coincided with a Fraunhofer line in the under spectrum, the angle recorded gave the total rotation for that ray, minus some multiple of π . That position of the analyser, for which all rays were extinguished when the quartz was withdrawn, was of course taken as the standard position from which all angular deviations were reckoned. The following results were obtained from observations with the rays D , E , b , F :—

| Ray. | Scale Readings. | | | | | | | | | | Mean. | Corresp. Rotation. | Total Rotation. |
|------|-----------------|---------|---------|---------|---------|---------|---------|---------|---------|---------|---------|--------------------|-----------------|
| D | 85° 20' | 85° 40' | 85° 12' | 85° 36' | 85° 30' | 85° 42' | 85° 12' | 85° 20' | 85° 28' | 85° 12' | 85° 25' | 14° 35' | 194° 35' |
| E | 35° 52' | 35° 52' | 35° 8' | 35° 48' | 34° 52' | 35° 18' | 35° 16' | 35° 14' | 35° 32' | | 35° 26' | 64° 34' | 244° 34' |
| b | 26° 0' | 26° 56' | 26° 20' | 26° 30' | 25° 16' | 25° 56' | 25° 54' | 25° 16' | 25° 10' | | 25° 55' | 74° 5' | 254° 5' |
| F | 10° 32' | 10° 44' | 10° 30' | 10° 36' | 10° 52' | 10° 24' | | | | | 10° 38' | 110° 36' | 290° 36' |

The angles recorded under the heading "Corresponding Rotation" are explained by the fact that the scale-reading 100° is taken as the standard of reckoning. The multiple of π to be added is easily obtained from the approximate formula $\frac{\rho_1}{\rho_2} = \frac{\lambda_2^2}{\lambda_1^2}$.

Hence, to the sixth power of the wave-length (rotations being expressed in minutes, and wave-lengths in fractions of an inch),

$$\rho(D) = 11675 = \frac{A}{5381} + \frac{B}{(5381)^2} + \frac{C}{(5381)^3}.$$

$$\rho(E) = 14674 = \frac{A}{4303} + \frac{B}{(4303)^2} + \frac{C}{(4303)^3}.$$

$$\rho(F) = 17436 = \frac{A}{3662} + \frac{B}{(3662)^2} + \frac{C}{(3662)^3}.$$

These equations give

$$A = 6661(10)^4, B = -4233(10)^7, C = 1180(10)^{11}.$$

Applying the formula

$$\rho = \frac{6661(10)^4}{\lambda^2} - \frac{4233(10)^7}{\lambda^4} + \frac{1180(10)^{11}}{\lambda^6}$$

to calculate the rotation for the ray *b*, where $\lambda = 0.00020367$, we get

$$\rho = 16069.6 - 2463.3 + 1656.9 = 15263.$$

The value obtained by direct observation, as given in the table above, is 15245.

With another specimen of quartz 70 mm. in length, the following results were got:—

| Ray. | Scale Reading. | Mean. | Angle. Corresp. | Total Rotation |
|------|--|-------|-----------------|----------------|
| D | 21°, 22°, 23½°, 21°, 21½°, 21°, 21°, 22°, 23°, 23° | 22° | 78° | 1515° |
| E | 126°, 126½°, 126°, 129°, 128°, 128°, 128½° | 128° | 126° | 1926° |
| b | 72°, 73°, 73½°, 72°, 73° | 72½° | 27½° | 2007½° |
| F | 129°, 129°, 131°, 129°, 129°, 129°, 130°, 130°, 129°, 129° | 129° | 151° | 2311° |

To find the multiple of π to be added to the measured rotation for the ray D, let $y =$ the ratio of the length of the long quartz to the length of the short, $\alpha_1 =$ the rotation for D in the short quartz, $\alpha_1' =$ the rotation for D in the long quartz above the nearest dark band in the less refrangible part of the spectrum, then,

$$\alpha_1 y = n\pi + \alpha_1'$$

Similarly for the ray E, $\alpha_2 y = n\pi + \alpha_2'$, where α_2' is equal to $2\pi + 128^\circ$. Combining the equations for the different rays,

$$y \Sigma \alpha^2 = n\pi \Sigma \alpha + \Sigma \alpha \alpha'$$

This equation gives $n = 8$. Hence

$$\rho(D) = 91080 = \frac{A}{\lambda_D^2} + \frac{B}{\lambda_D^4} + \frac{C}{\lambda_D^6},$$

$$\rho(E) = 115680 = \frac{A}{\lambda_E^2} + \frac{B}{\lambda_E^4} + \frac{C}{\lambda_E^6},$$

$$\rho(F) = 138660 = \frac{A}{\lambda_F^2} + \frac{B}{\lambda_F^4} + \frac{C}{\lambda_F^6}.$$

The values obtained for the constants are $A = 5289(10)^5$, $B = -4896(10)^8$, $C = 1509(10)^{12}$.

Using these values, $\rho(b) = 120200'$. The observed rotation is, 120450'. Reducing the constants to their value per mm., we get, for the short quartz,

$$A = 7485(10)^3, B = -4756(10)^6, C = 1326(10)^{10};$$

and for the long quartz,

$$A = 7557(10)^3, B = -6995(10)^6, C = 2156(10)^{10}.$$

3. On the Condition of Ammonium Salts when dissolved in Water. By W. W. J. Nicol, M.A., B.Sc. Part I.

When a salt, such as sodium chloride, which crystallises at ordinary temperatures without water of crystallisation, is dissolved in water, contraction takes place; that is, the specific gravity of the solution is greater than that calculated for a solution of that strength from the specific gravity of the salt in the solid state and that of water, by the formula—

$$\frac{100}{\frac{p}{d} + \frac{P}{D}} = \text{theoretical specific gravity of the solution.}$$

Where—

p = the percentage of salt in the solution.

d = the specific gravity of the solid salt.

P = the percentage of water.

D = the specific gravity of water at the temperature of observation.

The amount of this contraction varies greatly, being as much as 31·2 per cent. in the case of potassium sulphate, and only 2·5 per cent. in the case of potassium ferricyanide, when the salt dissolves in a nearly saturated solution, the volume of the solid salt being taken as 100.*

The above is the general rule, but it has been long known that ammonium chloride, when dissolved in water, expands instead of apparently contracting, consequently the specific gravity of its aqueous solution is always less than the theoretical. The amount of this expansion varies with the strength of the solution. Sorby (*loc. cit.*) states that when the solution contains 3 per cent. of the salt the expansion is 3·4 per cent., while near the point of saturation it is 15·8 per cent.

This apparent expansion of ammonium chloride has been observed by various experimenters, who all agree that it is the only known exception to the general rule. Table I. gives the numbers obtained by the more important of these, the theoretical specific gravity of

* Sorby, *Proc. Roy. Soc.*, xii. 544.

the solution, calculated from the number 1.53 = sp. gr. solid ammonium chloride, being given in the right-hand column.

TABLE I.

| Observer. | Per cent. | Observed sp. gr. | Theor. sp. gr. |
|--------------------------|-----------|------------------|----------------|
| Hassenfratz,* . . . | 19.3 | 1.0693 | 1.0718 |
| Michel et Krafft,† . . . | 24.7 | 1.0752 | 1.0935 |
| Schiff,‡ | 26.9 | 1.0767 | 1.1028 |
| Gerlach,§ | 26.3 | 1.0766 | 1.1002 |

Schiff (*loc. cit.*) says, that the fact already observed by Michel and Krafft—that ammonium chloride expands on dissolving in water is confirmed by his experiments, but is unable to offer any explanation of the cause of it. While Gerlach, writing in 1859, and again in 1862,|| after a long series of most careful experiments, extending over numerous salt solutions of various strengths, and with complete knowledge of the work done on the subject by Kremers, Schiff, Karsten, and others, has no hesitation in stating, that in the act of solution contraction takes place in the case of all anhydrous salts, with the single exception of ammonium chloride. Finally, Sorby (*loc. cit.*) found that, in the case of salts which produce contraction on solution in water, the effect of pressure is to increase the solubility, while with ammonium chloride the reverse is the case; pressure, as was to be expected, diminishing the solubility.

Not only is the specific gravity of solutions of Ammonium chloride abnormal, as shown above, but some of the other properties of the solution also show a variation from those to be expected from a consideration of the properties of solutions of potassium and sodium chlorides. For example, Quincke¶ has determined the cohesion or surface tension of solutions of ten chlorides, including ammonium chloride, by means of the method with capillary tubes and that with air bubbles. On comparing the results of experiment

* *Annales de Chimie*, xxviii. 298.

† *Ann. de Chim. et Phys.* [3], xli. 471.

‡ *Annalen der Chemie*, cix. 330.

§ *Spec. Gen. der Salzlösungen. Freiberg*, 1859, p. 11.

|| *Zeitschrift für Analyt. Chem.*, viii. 271.

¶ Pogg., *Annalen*, clx. p. 560.

with the numbers calculated,* he finds that there is satisfactory agreement except in the case of 2KCl , $2\text{NH}_4\text{Cl}$, and $\frac{1}{3}(\text{Fe}_2\text{Cl}_6)$. A small amount of free hydrochloric acid would account for these variations; and he admits its probable presence in the case of the ferric chloride solution, and believes that the ammonium chloride solution really contains free ammonia and hydrochloric acid. He cannot account for the irregularity in the case of potassium chloride, but it must be noted that it only makes its appearance when the solution experimented with is concentrated, and, in any case, the irregularity is small compared with that found for ammonium chloride solutions.

The coefficient of absorption for carbon dioxide is also abnormal in the case of ammonium chloride solution. Mackenzie† has determined it for solutions of various strengths of the six chlorides, KCl , NaCl , NH_4Cl , BaCl_2 , SrCl_2 , and CaCl_2 . The result of his experiments is, that whereas, in the case of strontium chloride, the coefficient of absorption lies between those of barium and calcium chlorides, as is the case with the molecular weights, that of ammonium chloride solution exceeds greatly those of potassium and sodium chlorides. I may note, in passing, a mistake that Mackenzie has made in his statement of results. He says (*loc. cit.*): *Für verschiedene Salzlösungen ist der Einfluss des Salzes verschieden, und zwar liegt die absorption beim Chlorkalium, wie sein Moleculargewicht zwischen der beim Chlornatrium und Chlorammonium, u. s. w.*" The absorption does really occupy that position, but not the molecular weight.

Further, the results obtained by Kittler,‡ in his experiments on the electromotive force of an element composed of two solutions and one metal point apparently to a similar irregularity in the behaviour of a solution of ammonium chloride, when compared with that of solutions of potassium and sodium chlorides; for when the element

* By the formulæ—

$$(1) \alpha = 7.35 \text{ mm.} + .1688 \eta.$$

$$(2) \alpha = 8.30 \text{ mm.} + .1870 \eta.$$

(1) Tube method; (2) air-bubble method; and η the number of equivalents of salt in 100 equivalents of water.

† Wiedemann's *Annalen*, i. 451.

‡ *Ibid.*, xv. 391, 410.

consists of copper, in a solution of copper sulphate and a solution of one of the three chlorides, KCl, NaCl, NH_4Cl , the order is NH_4Cl , KCl, NaCl; but when the element consists of copper in dilute sulphuric acid and a solution of one of these three chlorides, the position is regular. But, owing to Kittler's adherence to the old plan of regarding salt solutions from the percentage point of view, and his comparing in many cases only the concentrated solutions, it is impossible to state definitely that the above is true.

In the course of some experiments on the specific gravity of saline solutions, my attention was drawn to the divergence from the general rule in the case of ammonium chloride, and I made a series of experiments with the view of determining the cause of it. A portion of these form the contents of this paper.

In the first instance, determinations were made of the specific gravity of aqueous solutions of various strengths of the six salts formed by the union of potassium and sodium, with chlorine, bromine and iodine respectively. The mode of experiment was briefly as follows:—All the specific gravities were taken at 20°C . in a constant temperature bath (a modification of Dupré's) and referred to water at 20° as unity. Sprengel tubes were employed; these after filling were allowed to remain in the bath for ten minutes: after weighing, some of the liquid was poured into a weighed platinum dish, and the percentage of salt determined by evaporation. Three solutions of each salt were prepared, containing approximately 20, 15, and 10 per cent., and these were completely freed from air by boiling and allowing to cool *in vacuo*. In the case of the solid ammonium salts mentioned later, the specific gravity after crystallisation from alcohol, or a mixture of alcohol and water, was taken in paraffin by means of a special form of bottle; the error in experiment affecting the fourth decimal place only slightly.

My determinations correspond very closely with those of Gerlach, made at 15° by the hydrostatic method and corrected.

Table II. contains the results of these preliminary experiments compared with the specific gravity calculated from the most trustworthy determinations of the specific gravity of the solid salt.

TABLE II.

| A. | B. | C. | D. | E. |
|---------------|------------------------|-------------------------------|-------------------------------|----------------------------|
| NaCl 2·011 | 20·95 14·44 7·4 | 1·15711 1·10664 1·05339 | 1·12822 1·08108 1·03912 | ·03389 ·02556 ·01427 |
| KCl 1·977 | 19·5 14·98 7·44 | 1·13225 1·09954 1·04914 | 1·1067 1·0797 1·0382 | ·02555 ·01984 ·01094 |
| NaBr 3·014 | ... 14·92 11·57 | 1·14714 1·12478 1·09567 | 1· 1·1107 1·0838 | ... ·01408 ·01187 |
| KBr 2·681 | 22·04 14·37 8·96 | 1·17968 1·11817 1·06702 | 1·1604 1·0990 1·0596 | ·01928 ·01417 ·00742 |
| NaI 3·45 | 27·5 18·54 12·75 | 1·2649 1·16626 1·11138 | 1·2427 1·1517 1·0996 | ·0222 ·01456 ·01178 |
| KI 3·059 | 23·09 16·00 7·81 | 1·19977 1·12929 1·06127 | 1·1840 1·1207 1·0555 | ·01577 ·00859 ·00577 |

A = name of salt and specific gravity in the solid state.

B = percentage of salt in solution of specific gravity in C.

C = observed specific gravity of solution.

D = theoretical specific gravity.

E = C - D.

The following points are to be noted :—

1. That in each case the observed specific gravity is greater than the calculated, showing that contraction has taken place ;
2. That the difference C - D in E increases as the percentage of salt increases ; but,
3. That the first portions of salt added produce a relatively greater contraction than the subsequent portions.

Nothing more can be learned from the table in the above form. Experimenters are only just beginning to realise the fact that salt

solutions which contain the same percentage of different salts are *not* comparable. Before we can justly expect to be able to throw light on the subject of solution, we must be certain that the solutions which we compare together are *really* comparable. Kremers, * in the course of his numerous experiments on solution, and his deductions from them, compared solutions which contained, as he expressed it, 10, 20, 30 molecules of the salt (*Salzatomme*) to the 100 unit weights or unit volumes of water (*Gewichtseinheiten oder Volumeinheiten Wasser*): these numbers, as a reference to his papers will show, are too great, but for all that his solutions were to a certain extent comparable. The source of error which Kremers did not perceive, which indeed so far as I know has not hitherto been recognised, is the mutual attraction of the salt molecules for one another. If we wish to observe the results produced solely by the mutual action of the salt and the water, we must take care that our solutions are sufficiently dilute. As the solution becomes more concentrated, the observed specific gravity depends not only on the attraction of the salt for the water, but also on that of the salt molecules for one another.

With a view to testing the correctness of the above, I plotted the results given in Table II. cols. C. and D. The ordinates representing the specific gravity and the abscissæ the percentages; I thus obtained for each salt two curves approaching straight lines. Both turned upwards, but that expressing the observed specific gravity turned less than the other. The curvature in either case was so slight that it was impossible to draw with any approach to accuracy curves joining the various points; these were therefore joined by straight lines; from these lines the specific gravity for any percentage can be found with moderate exactness; but the difference between the observed and calculated specific gravities can be found with much greater accuracy, as the error affects both lines to very nearly the same extent. By the help of these lines, the actual and theoretical specific gravities were found for solutions containing 1, 2, 4, 6, and even 8 molecules of salt to 100 molecules of water. The differences between these are given in Table III.

* Pogg., *Annalen*, vols. xcii., xcvi., cxviii., &c.

TABLE III.

| 100M. H ₂ O | NaCl | KCl | NaBr | KBr | NaI | KI |
|------------------------|-------|-------|-------|-------|-------|-------|
| 1. m. salt. | ·0061 | ·0057 | ·0059 | ·0058 | ·0054 | ·0065 |
| 2. „ | ·0117 | ·0110 | ·0102 | ·0109 | ·0120 | |
| 4. „ | ·0209 | ·0191 | ... | ·0188 | ·0200 | |
| 6. „ | ·0280 | ·0261 | | | | |
| 8. „ | ·0388 | ·0288 | | | | |

These numbers, though not complete, show clearly that the amount of contraction (expressed by the difference between the actual and theoretical specific gravity), produced by dissolving any one of these six salts, in the proportion of one molecule to 100 molecules of water, is a number lying between ·005 and ·006. In the case of two molecules between ·01 and ·012, and that the amount of contraction produced by the addition of each successive molecule, is a steadily diminishing quantity. These points may help to explain the abnormal specific gravity of ammonium chloride solution.

Knowing that solutions of ammonium salts, *e.g.*, chloride, nitrate, and sulphate, became acid on boiling, it struck me that the explanation was to be found in a partial dissociation on solution in water. In order to ascertain whether the dissociation already observed at 100° was due to heat, or whether it actually existed at ordinary temperatures, pure dry air was drawn for three days through a solution of ammonium chloride rendered alkaline with ammonia. At the end of that time the solution was distinctly acid; but as this might be due to the formation of nitrous acid in small quantity, an alkaline solution of ammonium chloride was placed *in vacuo* over sulphuric acid, in less than twenty-four hours it was acid.

The next point to be determined was, whether this abnormal specific gravity was common to all ammonium salts, if so, then the explanation by dissociation would be confirmed. I tried solutions of ammonium, bromide, nitrate, iodide, and sulphate. The specific gravity of the two former was abnormal, that of the two last normal.

Table IV. gives the results of experiments with the solutions of

various strengths of the three salts, chloride, bromide, and iodide. It shows that in the case of the first two salts, solution is attended by increase of volume, but that when the last is dissolved contraction takes place as mentioned above.

TABLE IV.

| A. | B. | C. | D. | E. |
|-----------------------------|-------|---------|---------|---------|
| NH ₄ Cl 1·53 | 20·68 | 1·06003 | 1·07515 | +·01512 |
| | 14·84 | 1·04408 | 1·05219 | +·00811 |
| | 8·64 | 1·02603 | 1·02872 | +·00269 |
| NH ₄ Br 2·379 | 21·28 | 1·12976 | 1·1408 | +·01104 |
| | 15·81 | 1·09048 | 1·0978 | +·00692 |
| | 10·81 | 1·06265 | 1·0669 | +·00435 |
| NH ₄ I 2·464 | 18·58 | 1·12631 | 1·1241 | -·00221 |
| | 10·92 | 1·07118 | 1·0694 | -·00178 |
| | 6·71 | 1·0894 | 1·0881 | -·00180 |

The arrangement is the same as in Table II.

The question naturally arises, Why, if ammonium chloride and bromide dissociate to some extent on solution, does ammonium iodide remain intact, as these results seem to show? There is good reason to suppose that dissociation really takes place in this case also, for when these results are treated in the same way as those in Table II, it is found that when one molecule of ammonium iodide is dissolved in 100 molecules of water, the amount of contraction is ·0015. Now from Table III the amount of contraction in the case of a solution of that strength of one of the six salts there given is ·005—·006. Unless dissociation has taken place, I fail to see why ammonium iodide should not give the same amount of contraction.

While searching in Berthelot's *Chimie Mechanique* for some data that might explain this smaller amount of dissociation in the case of ammonium iodide, I found that the result of Berthelot's experiments on the thermal effect of diluting solutions of the sulphates, chlorides, and nitrates of potassium, sodium, and ammonium is, that we may conclude that these salts are not decomposed by water at the ordinary temperature, to an appreciable

extent. But he adds, that we must not lay too much stress on this conclusion; for if the decomposition of ammonium salts of strong acids is not to be detected by the thermometer, it is in consequence of its minuteness—for it really exists, and can be made evident by other proofs.

I hope soon to be able to bring forward other and more complete proofs of dissociation in the above salts, and also to extend my experiments to solutions of other ammonium salts.

4. On a Solar Calorimeter, and some Observations made with it in Upper Egypt. By Mr. J. Y. Buchanan.

(Abstract.)

The instrument consists of a Liebig's condenser mounted equatorially, so as to follow the sun by one motion. Projecting from the upper part of it, and enclosing the steam tube, is the boiler, which is a tube of half an inch diameter, where it receives the sun's rays, and widens out to 1 inch diameter in the steam space. This steam space or dome is formed by an inverted test tube, so that the operation can be easily watched. The tube is surrounded by a concave reflector made up of three conical surfaces of silvered copper. The diameter of the outer edge of the reflector is 13.5 inches, and its effective surface is almost exactly 1 square foot. The length of tube on which the rays were concentrated was 2 inches, and as its diameter was half an inch, its surface was 3.14 inches, therefore the thermal magnifying power of the combination was 46. These proportions were chosen in some doubt as to their suitability, but their choice was justified by the result. The amount of water actually in the focal portion of the boiler at any moment was 5 cubic centimetres; as the steam passed down through a central tube, and was condensed by the water rising outside of it to supply the place of what was evaporated in the boiler, the supply or feed to the boiler was effected practically at the temperature of ebullition. When, therefore, the instrument had been working for a few minutes, the whole of the effective radiant heat thrown upon the boiler was utilised in transforming water at 212° F. into steam of the same temperature. As the heat given out in the condensatio

of the steam was entirely absorbed by the water going to supply the boiler, and as this heat was sufficient to raise at least eight times the weight of water from the atmospheric temperature to that of ebullition, it will be seen that we are justified in assuming that the solar heat which penetrated the walls of the boiler was wholly utilised in making steam, and further, that loss by radiation was reduced to a minimum.

Immediately on presenting the mirror to the sun ebullition commenced, and it was kept going all the forenoon and the greater part of the afternoon, the position of the reflector being continually adjusted by hand. The distillate was collected in a graduated tube, and the time taken as every portion of 5 cc. was collected. The locality for experiment was that chosen by the eclipse observers,—on the banks of the Nile, close to the Egyptian town of Sohag, in latitude $26^{\circ} 30' N$. The instrument was very freely exposed to the sky, and was directly shone on by the sun from sunrise till 5 P.M., when it was obscured by a wood. As originally constructed the steam space was of metal, and was much too small, and, consequently, the results obtained in the first few days were vitiated by priming. When this had been thoroughly ascertained, the metal covering was removed and replaced by an inverted test tube, fitted tight with cork packing, the internal steam tube was also prolonged, so as to be well clear of the boiling water surface. The effect of this alteration was, by increasing the volume of the steam space, to eliminate altogether the danger of priming, and, by substituting glass for metal, to enable the operation to be constantly watched. The results obtained before this alteration have been rejected; those made on the 16th, 17th, and 18th May 1882, were subsequent to it, and were quite satisfactory. The results of these observations are condensed in the following table, which gives the amount of water distilled in an hour at different times :—

| Time. | | Grammes Water Distilled. | | |
|-------|----|--------------------------|-------|-------|
| From | To | 16th. | 17th. | 18th. |
| 9 | 10 | ... | ... | 78·1 |
| 10 | 11 | 58·8 | 70·25 | 82·4 |
| 11 | 12 | 69·5 | 69·7 | 82·8 |
| 2 | 3 | 73·2 | 65·5 | 71·6 |
| 3 | 4 | ... | 57·9 | 64·8 |

Taking the average performance on the 16th and 17th, which were comparatively cool, we find that 70 grammes, or 0·1542 lb. of water was distilled per hour, and on the 18th, a comparatively hot day, the amount was 81 grammes, or 0·1784 lb. per hour.

Setting aside cloud, the chief perturbing agent is wind. During the three days we were fortunate in having considerable varieties of weather. On the 16th, with a calm afternoon, the mean rate between two and three o'clock was 1·221, and on the 17th, when it was breezy, it was 1·087, or about 10 per cent. less. The breezes which occur on the Nile are cool from the north, and are variable in strength. On the three days mentioned the force was never greater than from 2 to 3, and what there was was always more or less gusty. We have seen that the mean rate between 2 and 3 P.M. on the 16th was 1·221, and the temperature of the air at 2 P.M. was 95° F.; while on the 18th the rate was 1·204, with a temperature of 105° at 2 P.M. On the latter day there was a fresh breeze in the afternoon, while on the former it was calm. If we consider that the lowering of the rate was wholly due to the wind, it appears that air of 105° F. in moderate motion cooled as much as stagnant air of 95° F. It is, however, impossible to be sure that some of the lowering may not be due to alteration in the absorptive power of the air.

The air was always excessively dry. At 2 P.M. the dry and wet bulb thermometers registered, on the 16th, 95° and 62·5°; on the 17th, 94° and 66·2°; and on the 18th, 105° and 68° F. Therefore the difference between the wet and dry bulbs ranged between

30° and 40° F. As an instance of the diurnal range of temperature, it may be mentioned that on the 18th, when at 2 P.M. the temperature was 105° F., just before sunrise it was only 59° F. On this day, therefore, we had an extreme range of temperature of 46° F., and a difference of 40° F. between the dry and wet bulbs themselves in the afternoon. The island of Teneriffe lies in very nearly the same latitude as Sohag; but in order to find a similar climate, it is necessary to ascend at least 6000 feet, and pass through the mass of clouds which always encircle the peak between the heights of 3000 and 5000 feet above the sea. The climate on the Nile in Upper Egypt is thus very peculiar. Looking to the height of the barometer and the day temperature, it is that of a tropical place at or near the level of the sea; looking to the range of temperature and the dryness of the air, it is quite Alpine.

On the morning of the 17th May the sun was totally eclipsed at 8.34 A.M.; at 8.51 the apparatus was exposed to the sun, but no boiling took place; at 8.58 the water began to "sing"; at 9.1 it boiled; at 9.3 it was boiling briskly, but it was not till 9.17 that the first drop of distillate fell into the receiver; by 9.19½ 1 cubic centimetre had passed, and between 9.21 and 9.29½ 5 c.c. passed.

The water did not begin to sing until 50 per cent. of the surface of the sun had been uncovered, a fact which supports the belief that there is a very great absorption of heat rays by the sun's atmosphere near the limbs. During totality the stars shone out brightly, and a comet appeared about a degree distant from the sun. The darkness was not so great but that I could read a rather closely graduated thermometer without difficulty. The fall of temperature during totality was only 1° F., and there was no wind or other atmospheric disturbance.

5. On the Heats of Combination of the Metals with the Halogens. By A. P. Laurie, B.Sc., and C. I. Burton.

At the last meeting of the Society a paper was communicated by us, describing a new method for determining the heats of combination of the metals with the halogens. The following paper is an account of our preliminary experiments mentioned in the former

paper. As these experiments were all made with modifications of the "iodine cell," or of the "cuprous iodide cell," we shall begin with a brief description of these two cells.

The iodine cell consists of a carbon rod and a zinc rod immersed in a solution of iodine in iodide of zinc. The cuprous iodide cell consists of a zinc plate and a copper plate immersed in a solution of iodide of zinc, the copper plate being covered with a paste of cuprous iodide, and then wrapped in parchment paper.

The E.M.Fs. of the cells were measured on a Thomson Quadrant Electrometer, the deflection corresponding to 1 volt, being found by measuring the deflection given by a Daniell cell. The Daniell cell was assumed to have an E.M.F. of 1.12 volts. This is not a strictly accurate assumption, but was sufficient for these preliminary experiments. The deflection given by the Daniell cell was measured at the beginning and end of each series of experiments. The zero of the instrument was usually noted after each deflection.

The formula used has been already mentioned. It is

$$\theta = \frac{E}{J_e}, \text{ or } \theta = \frac{E}{4.2 \times 10^7 \times e} \text{ (in C.G.S. units):}$$

e is equal to .003411 grm. for zinc.

On connecting an iodine cell as above described with the electrometer, zinc as the active metal gave a deflection of sixty divisions on the electrometer scale. (The deflection given by a Daniell cell was 52 divisions.)

Copper, as the positive metal, gave no deflection. This was due to the coating of iodide formed on it by the iodine solution. It seems under these circumstances to be in a similar state to negative iron.

We then constructed an iodine cell in the following manner:—

In the centre of a glass vessel containing a solution of an iodide is placed a porous pot, containing the iodine solution and the carbon rod. Closely surrounding the porous pot is a cylinder of perforated zinc with which the iodine combines as fast as it diffuses through the porous pot. In this way the iodide solution in the outer vessel is quite free from iodine.

Experiments with this cell give as an average of five experiments—Deflection with zinc, 63, in terms of the electrometer scale. As

already mentioned, the E.M.F. of zinc in the ordinary iodine cell is about 60.

The difference 3 is due to an E.M.F. set up between the iodine solution and the iodide of zinc solution.

The deflection with copper is 33.

Some experiments were then made with a cuprous iodide cell constructed in the manner already described. The following table contains the results:—

| Name of Metal. | E.M.F. in Iodine Cell. | Calculated E.M.F. in Cuprous Iodide Cell. | Found E.M.F. in Cuprous Iodide Cell. |
|-------------------|------------------------|---|--------------------------------------|
| Zinc, | 60·5 | 30 | 32 |
| Copper, | 30·5 | 0 | 0 |
| Silver, | 29 | -1·5 | 0 |
| Lead, | 39 | 8·5 | 10 |
| Tin, | 29 | ... | ... |
| Iron, | 31 | ·5 | 0 |

The second column of figures is found on the assumption that the E.M.F. of a metal in the cuprous iodide cell is its E.M.F. in the iodine cell, *minus* the E.M.F. of copper in the iodine cell.

Three has been subtracted from the numbers in the first column. The reason for doing this has been already explained. Taking 61·5 as the E.M.F. of zinc, which is the mean value, its heat of combination with iodine as calculated from the above formula is 924.

The number given by Naumann for the heat of combination of zinc with iodine in presence of water is 929.

Nearly all our other numbers agree approximately with those given in Naumann's *Thermochemie*.

The numbers, taken from Naumann's table, are the heats of combination of one gramme of the metals in presence of water. It will be seen that the value given for iron by Naumann does not show any agreement with our value. This is also the case with the chlorine and bromine compounds of iron.

| Reaction. | E. M. F. of Metal. | Heats of Combination, calculated from E. M. F. | Heats of Combination, from Naumann's Table.* |
|--|--------------------|--|--|
| $\text{Zn} + \text{I}_2 = \text{ZnI}_2$. . . | 1·324 volts. | 924 heat units. | 929 heat units. |
| $\text{Cu}_2 + \text{I}_2 = \text{Cu}_2\text{I}_2$. . . | ·657 „ | 235 „ | 256 „ |
| $\text{Ag}_2 + \text{I}_2 = \text{Ag}_2\text{I}_2$. . . | ·624 „ | 181 „ | 127 „ |
| $\text{Pb} + \text{I}_2 = \text{PbI}_2$. . . | ·861 „ | 189 „ | 191 „ |
| $\text{Fe} + \text{I}_2 = \text{FeI}_2$. . . | ·667 „ | 523 „ | 851 „ |

In order to test the effect of temperature on the E.M.F. of the cell, the E.M.F. of zinc in an iodine cell was measured when the cell was at 11° C., and when it was at 27° C. The E.M.F. in both cases was the same.

The deflection given by silver wire and silver electrolytically deposited from pure nitrate of silver is the same.

Iron wire with a blue tarnish on it gives a considerably less deflection than clean iron.

The E.M.F. given by alloys seemed to us to be of considerable interest. We supposed that they would give the E.M.F. of their most positive constituent. This, however, is not always the case. Solder gives a deflection of 40 (lead = 40, tin = 32), but brass gives the same deflection as copper, namely, 33. A confirmation of this is the fact that brass and copper give no E.M.F. in dilute sulphuric acid.

After having made these experiments with the iodine cell, we made a chlorine cell by filling the porous pot with a freshly prepared solution of chlorine. The results with the chlorine cell do not agree well with the results found in the cuprous chloride cell, and the heats of combination calculated from the electromotive forces in the chlorine cell must be regarded as very rough approximations. Two values are worth mentioning. The heat of combination of 1 gramme of zinc with chlorine, calculated from its E.M.F.

* At the time this paper was read we had not seen Naumann's *Thermochemie* (published 1882). The above values have therefore been inserted since then. They are much nearer our own than the values given in the older books.

in the chlorine cell, is 1578 heat units. The number given by Naumann is 1736 heat units. Naumann's value, with a correction which has not been made for the heat of solution of chlorine, is about 1660 heat units. The heat of formation of Cu_2Cl_2 from the E.M.F. of copper in the chlorine cell is 493 heat units. The number given by Naumann is 517 heat units.

We have made a few experiments with a bromine cell, but as we have not made any with a copper bromide cell, it is unnecessary to give them at present.

One experiment is mentioned in this paper, testing the influence of temperature on the E.M.F. of the iodine cell. This has become a matter of some importance. In a paper by Helmholtz, to which we referred in our last communication, it is shown that the difference of E.M.F. at different temperatures is possibly the measure of the work done in the cell which does not appear in the electric current.

In conclusion, the results derived from the iodine and cuprous iodide cell seem fairly satisfactory.

Probably the best way to test the accuracy of the method would be to run down an iodine cell in a calorimeter, and compare the heat evolved by the solution of a given weight of zinc with the value calculated from the electromotive force of the cell. We propose to make some experiments in this direction.

6. On the Nature of Solution. By Mr. W. L. Goodwin.
Communicated by Professor Crum Brown.

7. Diagnoses plantarum novarum et imperfecte descriptarum
Phanerogamarum Socotrensium, quas elaboravit Bayley
Balfour, Scientiæ Doctor et in Universitate Glasceuseni
rerum botanicarum regius professor. Pars Altera.

RUBIACEÆ.

58. *DIRICHLETIA VENULOSA*, *Balf. fl.*: frutex 10-pedalis; foliis oblongis v. oblongo-lanceolatis basi angustatis vix petiolatis acutis v. obtusis coriaceis margine revolutis, subtus venulis nigris perspicuis

nervoque medio sparse puberulo; seta media stipulari lateralibus triplolongiori; floribus brevissime pedicellatis; fructu glabro disco prominulo convexo, calycis limbo expanso foliaceo panduriformi nigro-venuloso nitido.

Socotra, in montibus Haggier. B.C.S. No. 320. Schweinf. No. 616 ex parte.

59. *DIRICHELETIA LANCEOLATA*, Balf. fl.: frutex parvus ramulis tomentosis; foliis lanceolatis v. elliptico-lanceolatis sessilibus v. subsessilibus vaginis amplis acutis coriaceis, supra subnitidis nervis puberulis, subtus pubescentibus; cuspidè media stipulari lateralibus triplolongiori; floribus breviter pedicellatis; fructu pubescente disco parum convexo, calycis limbo expanso elliptico acuto foliaceo coriaceo puberulo.

Socotra, in montibus Haggier infrequena. B.C.S. No. 422.

60. *DIRICHELETIA OBOVATA*, Balf. fl.: frutex 10-pedalis; foliis obovatis breviter petiolatis truncatis emarginatis sæpe mucronatis rarissime acutis crassiusculis coriaceis, supra nitidis, venulis ultimis inconspicuis, margine obscure ciliatis; seta media stipulari lateralibus duplolongioribus; floribus capillariter pedicellatis; fructu glabro disco plano, calycis limbo expanso membranaceo pellucido-punctulato venuloso nitido.

Socotra, frequens. B.C.S. Nos. 172, 592. Schweinf. No. 250.

PLACOPODA, Balf. fl.

Calycis tubus parvus, obconicus; limbi lobi 4, breves acut., æquales, persistentes, dentibus minutis fere obsoletis interjectis. Corolla tubulosa, tubo brevi intus piloso; limbi lobi 4, breves, triangulares, valvati. Stamina 4, infra faucem corollæ inserta, filamentis brevibus, subulatis; antheræ inclusæ, dorso affixæ, lineari-oblongæ, utrinque obtusæ. Discus tumidus, crenatus, glaber. Ovarium 2-loculare; stylus filiformis, exsertus, ramis 2 undique papillois; ovula in loculis pauca 2-3, in apice placentæ carnosæ columnaris a basi loculi adscendente sessilia. Fructus corneus, indehiscens compresso-campanulatus, parum bialatus, lateribus trinerviis nervis elevatis, 2-locularis, loculis 1-spermis. Semina verticalia, oblonga, obtusa, cylindracea, testa minute corrugata, albu-

mine carnosæ; cotyledones angustæ; radícula terea.—Suffrutices ramosi, ramulis 4-gonis, pubescentes proventu glabri. Folia parva, petiolata, subcrassa, ovali-oblonga, in ramulis brevissimis verticillatis fasciculata. Stipulæ minutissimæ. Flores in cymas umbellatas simplices terminales dispositi.

Genus monotypicum *Dirichletie* valde affine.

61. *P. VIBGATA*, *Balf. fl.*: species unica in campis crescens. B.C.S. No. 25. Schweinf. No. 476.

62. *HEDYOTIS STELLARIOIDES*, *Balf. fl.*: erecta annua tenuis, caule tetraquetro scabridulo; foliis remotis subsessilibus elliptico-oblongis v. trapeziformibus v. sublanceolatis acutis revolutis subciliatis; stipulis 2-3-dentatis; cymis terminalibus spurie abortu dichotomis; pedicellis filiformibus rigidis longis; floribus parvis albis; stylo integro capitato; fructu non-exserto capsulari pyriformi septicide ad basin bivalim fissente carpellis ventraliter dehiscentibus.

Socotra, apud clivos montium frequens. B.C.S. No. 313. Schweinf. No. 800.

63. *MUSSÆNDA CAPSULIFERA*, *Balf. fl.*: arbor parva ramis juvenilibus tetragonis pubescentibus; foliis oblongo-ellipticis v. obovatis acutis v. obtusis basi contractis subsessilibus coriaceis fere glabris; stipulis dentatis, floribus in rigidas erectas terminales cymas dispositis; calycis lobis æqualibus foliaceis linearibus; corolla elongata, limbis obcuneatis; fructu sicco loculicide dehiscente.

Socotra, in montibus Haggier. B.C.S. No. 550. Schweinf. No. 455.

64. *GAILLONIA (MICROSTEPHUS) TINCTORIA*, *Balf. fl.*: a collo radicis tortuose ramosa, ramis nigra, internodiis brevibus puberulis; foliis classis anguste spathulatis, sparse et brevissime puberulis; stipulis polymorphis; floribus solitariis axillaribus breviter pedicellatis; calyce 5-lobato, lobis 2 magnis, 2 minoribus, 1 mimino; corolla extus scabridula; stylo longe exserto.

Socotra, prope Gollonsir. B.C.S. No. 321.

65. *GAILLONIA PUBERULA*, *Balf. fl.*: suffrutex rigidus dichotome

ramosus puberulo-tomentosus internodiis elongatis ; foliis inferioribus lanceolatis v. oblanceolatis v. obovatis acutis v. obtusis revolutis sparse puberulis, superioribus linearibus ; stipulis polymorphis ; floribus axillaribus v. terminalibus solitariis v. in cymas trifloras dispositis ; calycis dentibus subæqualibus non-acrescentibus ; corolla extus pubescente ; staminibus sæpius inæqualibus ; stylo incluso ; fructu dentibus calycis coronato dense hirsuto.

Socotra, frequens. B.C.S. No. 155. Schweinf. No. 602.

66. *GAILLONIA (MICROSTEPHUS) THYMOIDES*, *Balf. fl.* : suffruticosa parva rigida dense dichotome ramosa, ramis strictis divaricatis scabrido-puberulis ; foliis petiolatis oblongo-ellipticis v. lanceolatis obtusis v. acutis revolutis scabro-puberulis, oppositis, sæpe in basin ramorum confertis ; stipulis heteromorphis ; floribus axillaribus solitariis brevissime pedicellatis ; calyce 5-lobato, lobis 3 magnis subulatis, 2 parvis hirsutis ; corolla extus puberula ; stylo exserto ; fructu hirsuto.

Socotra, frequens. B.C.S. No. 187. Schweinf. No. 254.

VALERIANACEÆ.

67. *VALERIANELLA AFFINIS*, *Balf. fl.* : herba pusilla tenuis sparse bipartim ramosa ; foliis inferioribus oblongo-ellipticis v. oblanceolatis obtusis obscure dentatis, superioribus sæpe linearibus remote acute-que dentatis v. interdum trifidis ; cymis paucifloris, bracteis scarioso-marginatis ; calyce rotato-campanulato herbaceo utrinque glabro reticulato-venuloso 6-fido, lobis uncinulatis inæqualibus ; capsulis calyci æquilongis puberulis antice obcuneatim sulcatis, in loculo fertili parum maximo lateraliter extenso, loculis sterilibus subteretibus.

Socotra, in montibus prope Gollonsir. B.C.S. No. 551.

COMPOSITÆ.

68. *VERNONIA COCKBURNIANA*, *Balf. fl.* : frutex plus minusve canescens ramis sæpe virgatis sed plurimis lateralibus abbreviatis ; foliis obovatis obtusis v. emarginatis integris remotis v. in apices ramorum contractorum fasciculatis ; capitulis majusculis 10-13-floris solitariis v. 2-3 in cymas in apices ramorum lateralium dispositis ; phyllariis multiseriatis obtusis ciliatis extus pubescentibus, interiori

bus persistentibus; achæniis 6–9-costatis intervallis sessili-glandulosis pilisque suffultis; pappo exteriori squamiformi brevi.

Socotra, frequens. B.C.S. No. 261. Schweinf. No. 513.

69. *PSIADIA SCHWEINFURTHII*, *Balf. fl.*: suffruticosa glaucescens non glutinosa; foliis lanceolatis petiolatis acutis integris v. supra obscure dentato-serratis glanduloso-puberulis crassiusculis; capitulis parvis copiose paniculato-corymbosis; phyllariis 5-seriatis exterioribus glanduloso-puberulis, internis glabris; stylis exsertis; achæniis pilis adscendentibus vestitis; pappi setis basi connatis.

Socotra, prope Kischen. Schweinf. No. 606.

70. *PLUCHEA GLUTINOSA*, *Balf. fl.*: suffruticosa glutinosa glabra: foliis oblanceolatis v. lanceolatis breviter petiolatis integris v. in parte superiore dentatis glanduloso-punctatis; capitulis multifloris parvis 3–4 sessilibus v. subsessilibus in apices ramorum multo v. pauci-ramosi terminalis v. pseudo-terminalis paniculati corymbi; phyllariis extimis squamiformibus apiculatis, intimis linearibus subecariosis; antheris obtusis; stylo indiviso; achæniis pilis adscendentibus vestitis; pappo squamiformi.

Socotra, in montibus. B.C.S. No. 616. Schweinf. No. 646.

71. *PLUCHEA AROMATICA*, *Balf. fl.*: fruticosa aromatica; foliis lanceolatis v. elliptico-oblongis acutis petiolatis integris v. in parte superiore obscure dentato-serratis ciliatis glanduloso-scabridis; capitulis longe pedunculatis multifloris terminalibus v. axillaribus solitariis rarius in cymam dispositis; phyllariis extimis brevissimis glandulosis apice reflexis, intimis angustissimis glabris; antheris acuminatis; stylo bifido, lobis complanatis; achæniis glabris; pappo squamiformi.

Socotra, in montibus Haggier supra Tamarida et Kischen. B.C.S. No. 465. Schweinf. No. 631.

72. *PLUCHEA OBOVATA*, *Balf. fl.*: fruticosa aromatica sæpe procumbens; foliis obovatis v. obcuneatis v. oblanceolatis sessilibus integris v. in parte superiore dentatis glabris glanduloso-punctatis; capitulis breviter pedunculatis multifloris terminalibus v. axillaribus solitariis v. in 2–3-capitatas cymas dispositis; phyllariis exterioribus

brevioribus glanduloso-lanato-puberulis erectis, interioribus angustissimis glabris ; antheris obtusis ; stylo bifido, lobis teretibus papillosis ; achæniis costis pilis adscendentibus vestitis ; pappo setiformi.

Socotra, in scopulis montium altiorum. B.C.S. No. 497. Schweinf. No. 764.

73. *HELICHRYSUM SPHEROCEPHALUM*, *Balf. fil.*: lignosum lanatum parvum a basi ramosum ramis diffusis compressis ; foliis 5-nerviis obovatis, basalibus breviter petiolatis, superioribus subsessilibus ; capitulis campanulatis 30-40-floris brevissime pedicellatis 20-25 in cymas globosas terminales solitarias glomeratis ; phyllariis multi-seriatis, interioribus in parte superiore niveo-petaloideis patentibus floribus longioribus glabris ; receptaculo nudo ; achæniis scabridulis.

Socotra, in montibus altissimis Haggier. B.C.S. No. 79. Schweinf. No. 629.

var. *sarmentosum*, *Balf. fil.* : quasi stoloniferum ; foliis majoribus angustioribus suboblanceolatis v. spathulatis ; capitulis 15-20-floris ; 50-60 in cymas $\frac{5}{8}$ poll. diam. glomeratis ; phyllariis interioribus floribus brevioribus.

Socotra, cum forma typica sed in locis nudis. B.C.S. No. 79 bis.

74. *HELICHRYSUM ARACHNOIDES*, *Balf. fil.* : annum parvulum ramosum plus minusve arachnoideo-lanatum ; foliis remotis ellipticis, inferioribus petiolatis, superioribus subsessilibus ; capitulis parvis 8-12-floris campanulatis brevissime pedicellatis 7-8 in cymas terminales (rarius axillares) congestas glomeratis ; phyllariis biseriatis, interioribus ad apicem niveis post anthesin patentibus ; receptaculo nudo ; achæniis scabriusculis.

Socotra, in montibus prope Gollonsir. B.C.S. No. 197.

75. *HELICHRYSUM ACICULARE*, *Balf. fil.* : suffruticosum ericæphylloideum procumbens v. cæspitosum glabrescens ; capitulis obconoideis 40-50-floris breviter pedicellatis 3-5 ad apices pedunculorum solitariorum axillarium longorum breviter lanatorum dispositis ; phyllariis glabris omnibus fulvo-stramineis ; receptaculo nudo ; achæniis puberulis.

Socotra, in summis montibus Haggier. B.C.S. No. 397. Schweinf. No. 561.

76. *HELICHRYSUM SUFFRUTICOSUM*, *Balf. fil.*: suffrutex plus minus glanduloso-pubescentis; foliis sessilibus, inferioribus cochleariformibus, superioribus panduriformibus; capitulis parvis campanulatis 20-floris pedicellatis in corymbas terminales dispositis; phyllariis glabris concoloribus fulvo-stramineis; receptaculo nudo; achæniis puberulis.

Socotra, in montibus Haggier. B.C.S. No. 406. Schweinf. No. 628.

77. *PULICARIA DIVERSIFOLIA*, *Balf. fil.*: herba scabrido-hirsuta ramis in capitula solitaria abeuntibus; foliis basalibus plerumque ab formis obcuneatis ad oblanceolatas basiue gradatim attenuatis interdum ellipticis v. oblongo-ellipticis basiue abrupte contractis, infra integris, supra grosse dentato-serratis v. crenatis, acutis v. obtusis, petiolo longo anguste alato subamplexicauli, caulibus angustioribus; capitulis hemisphæricis multifloris radiatis; phyllariis subæqualibus lineari-acuminatis glanduloso-hirsutis; achæniis 7-8-costatis hirsutis; pappo exteriori coroniformi, setis interioribus 10.

Socotra, in campis communis. B.C.S. Nos. 119, 600. Schweinf. No. 453.

78. *PULICARIA STEPHANOCARPA*, *Balf. fil.*: fruticosa tortuose ramosissima glaucescens; foliis crassis velutinis spathulatis v. cochleariformibus plus minusve 3-5-rotundato-lobatis persistentibus; capitulis homogamis solitariis axillaribus breviter pedunculatis; phyllariis exterioribus gradatim minoribus; antherarum caudis elongatis connatis simplicibus; achæniis angulatis 10-costatis corona setarum ad apicem sub pappo suffultis; pappo exteriori cupuliformi segmentis paleaceis, interioribus setis complanatis.

Nom. vern. Dheel

Socotra, in campis calcareis occidentalibus-et australibus abundans. B.C.S. No. 14. Schweinf. No. 252.

79. *PULICARIA VIERÆOIDES*, *Balf. fil.*: fruticosa cinerea habitu Vierææ; foliis obovatis crasse coriaceis glandulis instructis et arachnoideis; capitulis radiatis solitariis pseudo-terminalibus longe pedunculatis; phyllariis, pauciseriatis glanduloso-puberulis exterioribus

gradatim minoribus extimisque sæpe foliaceis magnis; antherarum caudis elongatis simplicibus connatis; achæniis subteretibus 10-costatis apice hirsutis; pappo exteriori cupuliformi paleaceo-lacero, interioribus setis complanatis.

Socotra, in montibus Haggier prope Tamarida. B.C.S. Nos. 402, 481.

80. *SENECIO (KLEINIA) SCOTTI, Balf. fl.*: perenna erecta glabra succulenta multo-ramosa, caulibus subteretibus; foliis remotis parvis linearibus; capitulis subcylindricis homogamis 6-8-floris ad extremitates ramorum solitariis v. 2-3 in cymas breviter pedunculatas aggregatis; phyllariis 5-6 linearibus cuspidatis floribus dimidio brevioribus; receptaculo nudo; achæniis subteretibus 10-costatis brevibus rigidis setulis intercostalibus; pappo corollæ vix æquilongo.

Socotra, in montibus Haggier prope Tamarida. B.C.S. No. 446.

81. *EURYOPS SOCOTRANUS, Balf. fl.*: suffrutex 3-pedalis glaber bipartim ramosus ramis cicatricosis; foliis sessilibus arcte trifidis, segmentis linearibus obtusis; pedunculis foliis vix æquilongis; phyllariis 8 connatis; achæniis hispidis.

Socotra, in montibus altissimis Haggier. B.C.S. No. 401. Schweinf. No. 673. Hunt. No. 11.

82. *DICOMA CANA, Balf. fl.*: prostrata cano-tomentosa lignosa; foliis linearibus obtusis sessilibus crassis persistentibus; capitulis solitariis pseudo-terminalibus subsessilibus paucifloris homogamis discoideis; phyllariis pallidis glabris, intimis membranaceis, exterioribus gradatim minoribus rigidis subulato-punctatis; receptaculo alveolato; achæniis dense setosis; pappi setis conformibus serrulato-barbellatis.

Socotra, in montibus prope Gollonsir. B.C.S. No. 757.

83. *LACTUCA RHYNCHOCARPA, Balf. fl.*: herba tenuis glabra depressa v. a basi ramosa caulibusque suberectis; foliis glaucis lyratopinnatipartitis, segmento terminali oblongo-acuto v. rotundato v. panduriformi subaculeato-dentato, segmentis inferioribus gradatim minoribus runcinatis, radicalibus breviter petiolatis subamplexicaulibus, caulinibus sessilibus; capitulis parvis 10-12-floris $\frac{2}{3}$ poll.

longis oppositifoliis in laxos pseudo-racemos dispositis ; phyllariis intimis ensiformibus obtusis post anthesin vix basi incrassatis, extimis parvis ovato-acutis ; achæniis vix compressis 4-gonis costis 1-2 in quoque facie conspicuis, infra angustatis, apice in rostrum longum abrupte productis ; pappi setis serrulatis.

Socotra, in campis. B.C.S. Nos. 217, 595. Schweinf. No. 398.

84. *LAOTUCA CRASSIFOLIA*, *Balf. fil.* : herba perenna glabra glauca valida divaricatim breviter ramosa ; foliis crassiusculis lyrato-pinnatifidis, segmento terminali oblongo-acuto v. obtuso calloso-dentato et sæpe inæqualiter lobato, lobis inferioribus irregulariter ad basin minoribus, radicalibus vix petiolatis amplexicaulibus, cauliniis sessilibus auriculatis ; capitulis 20-floris $\frac{1}{2}$ - $\frac{1}{2}$ poll. longis oppositifoliis in pseudo-racemos breves dispositis ; phyllariis intimis æqualibus linearibus marginatis, extimis paucis late ovatis minoribus ; achæniis basi truncatis in rostrum breve pallidum productis ; setis pappi scabridulis achæniis æquilongis.

Socotra, in campis. B.C.S. No. 595.

85. *PRENANTHES AMABILIS*, *Balf. fil.* : herba perennis cano-lanuginosa caule erecto in inflorescentiam abeunte ; foliis lyrato-runcinatis, lobo terminali rotundato v. acute lobato parte inferiore sæpe angustissimo, amplexicaulibus axillariter lanato-villosis membranaceis glabris ; capitulis longe pedunculatis 5-6-floris in laxe ramosas paniculas dispositis ; phyllariis intimis 5-6 linearibus acutis, exterioribus brevibus ; achæniis tetragonis truncatis basi angustatis pappo sordido setoso serrulato brevioribus.

Socotra, in montibus prope Gollonsir. B.C.S. No. 311.

86. *LAUNÆA CREPOIDES*, *Balf. fil.* : herba rosulata glabra perennis ; foliis spathulatis v. oblanceolatis basi longe attenuatis obtusis integris ; capitulis solitariis in apices scaporum longorum bracteolatorum v. in laxas 2-3-ramosas cymas dispositis ; phyllariis intimis 8 linearibus ; calyculi squamis paucis ovatis herbaceis ; styli lobis setulis nigris suffultis ; achæniis linearibus subfusiformibus multocostatis rugosis ; pappo exteriore lanoso-intricato, intimo setoso.

Socotra, in montibus non infrequens. B.C.S. No. 307. Schweinf. No. 570.

The Chairman read the following Review of the Session :—

In announcing the close of our Hundredth Session, I have to congratulate the Society on the gratifying fact that, though it has attained this advanced age, it shows no symptoms of decrepitude or senility.

But though the Society as an institution is prosperous and never dies, a retrospect on an occasion like this reminds us that the members of which it is composed are transitory—

Noctes atque dies patet atri janua Ditia.

Since the commencement of the session fifteen of our Fellows have passed away. Among these are included men of the highest rank in science, like Dr. Darwin, Sir Wyville Thomson, and Dr. Romney Robinson; illustrious physicians like Sir Robert Christison and Sir John Rose Cormack; and great surgeons like Professor Spence; eminent literary men like Dr. John Brown; great scholars like Dr. John Muir and Sheriff Hallard. The Society, besides, has lost a distinguished engineer in John Scott Russell, and a distinguished artist in Sir Daniel Macnee.

Many of these were regular attenders at our meetings. With most of them I was on familiar terms. It was our privilege to listen to the papers that they read in this place. How painful it is to me, how painful must it be for you, to miss in the course of a few months their thoughtful but cheerful countenances and their pleasant presence. But the services which men like these render to science and to this Society fortunately cease not with their lives. By their labours they have removed obstacles from the path of others in all time coming, and the inspiration of their example will stimulate their survivors to make similar efforts, which may be crowned with similar success.

On this occasion I cannot but remember what a long interval has elapsed since I joined the Society in 1835. I look back with pleasure on the forty-eight years during which I have attended your meetings; and the nineteen years during which I acted as General Secretary of the Society.

On looking back on what has been done by our members during

the session, I find that there have been twenty-five papers read on subjects connected with Natural Philosophy ; seven have dealt with Mathematical subjects ; nine relate to Geology ; seven are Chemical ; seven in the department of Natural History ; four in the department of Botany ; six relate to Physiology ; two relate to Mineralogy ; and two to Literature ; while Antiquities, Astronomy, and Meteorology have each had one paper devoted to them.

I think that those who have paid most attention to the work accomplished during the session that now comes to a close, will agree with me in holding that the papers that have been read, while fully equal, on the whole, to those of any previous session, show in some departments a marked and gratifying advance.

Donations to the Library of the Royal Society during
Session 1879-80.

I. TRANSACTIONS AND PROCEEDINGS OF LEARNED SOCIETIES,
ACADEMIES, &C.

Adelaide.—Transactions and Proceedings of the Adelaide Philosophical Society. 8vo. Vol. II., 1878-79; Vol. III., 1879-80.—*From the Society.*

American Association.—See United States.

Amsterdam.—Verhandelingen der Kon. Akademie van Wetenschappen. Afd. Natuurkunde, DL XX., XXI., 1880-81. Afd. Letterkunde, DL XIII., 1880. Verslagen en Mededeelingen, Natuurkunde, 2^o Rks., DL XV., XVI. Letterkunde, 2^o Rks., DL IX., 1880-81. Processen Verbaal, 1879-80. Jaarboek, 1880, 1881. Poemata Latina, 1880-81. Catalogus der Boeker der Akad.—*From the Academy.*

Flora Batava: Afbeelding en Beschrijving van Nederlandsche Gewassen. Voortgezet door F. W. Van Eeden. 249-258 Aflieveringen, 1881-82.—*From the King of Holland.*

Catalogus der Bibliotheek van het koninklijk Zoologisch Genootschap, Natura Artis Magistra. 8vo. Amsterdam, 1881.

Annapolis.—Annual Register of the United States Naval Academy. 1880-81. 8vo.—*From the Academy.*

Baltimore.—*Johns Hopkins University.*—The American Journal of Mathematics. Professor Sylvester (Editor-in-chief). Vols. III., IV. 1880-81.

The American Chemical Journal. Edited by Professor Remsen. Vols. II., III., IV. 1880-82.

The American Journal of Philology. Edited by Professor Gildersleeve. Vols. III., IV. 1881-82.

Studies from the Biological Laboratory of the Johns Hopkins University. Vol. II., Nos. 2, 3. March 1882.

Fourth and Fifth Annual Reports, 1879-80. Inauguration of President Gilmore, 1876.—*From the University.*

Basel.—Verhandlungen der Naturforschenden Gesellschaft. 7^{er} Theil, 1^{er} Hft. 1882. 8vo.—*From the Society.*

Batavia, The Observatory.—Observations made at the Magnetical and Meteorological Observatory at Batavia. Vol. IV. Jan. 1876 to Dec. 1878, pp. 1-320. Dr. Bergsma, Director. Vol. V., 1881.

Regens Waarnemingen in Nederlandsch Indie, 2^o en 3^o Jaarg. 1880-81. 8vo.—*From the Meteorological Observatory.*

The Batavian Society of Arts and Sciences.—Natuurkundig Tijdschrift voor Nederlandsch Indie uitgeven door de Kon. Natuurkundige Vereeniging. Deel XL. 1881. 8vo.

Tijdschrift voor Indische Taal-land-en Volkenkunde. Deel XXVII., 3, 4, 5, Afl. 1881-82. 8vo.

Tabel van Oud-en Nieuw-Indische Alphabetten. 1882. 8vo.

Verhandelingen van het Bataviaasch Genootschap van Kunsten en Wetenschappen. Deel XLI., 3^{de} Afl. Deel XLIII. 8vo.

Notulen, Deel XIX., 3, 4. 1881-82. Realia, 1632-1805, Erste Deel, 1882, 4to.—*From the Batavian Society of Arts and Sciences.*

Belfast.—Proceedings of the Natural History and Philosophical Society for 1880-81. 8vo.—*From the Society.*

- Berlin.**—Abhandlungen der Königlich Akademie der Wissenschaften. 1879, 1880, 1881. 4to.
 Monatsberichte der Kön. Akademie der Wissenschaften. Jun. 1880 to Dec. 1881. Sitzungsberichte, Nos. I to XXXVIII. 1882. 8vo.—*From the Academy.*
 Fortschritte der Physik im Jahre 1876. Dargestellt von der physikalischen Gesellschaft zu Berlin. 1^{te} Abtheil.—Physik, Akustik, Optik. 2^{te} Abtheil.—Wärmelehre, Electricitätslehre, Physik der Erde. 8vo. Berlin, 1880–81.—*From the Society.*
- Bern.**—20^e Lief. Der mechanische Contact von Gneiss und Kalk in Berner Oberland, 1880. 4to.
 Beiträge zur geologischen Karte der Schweiz, XIV^e Lief. 3^{te} Abth. Die Kantone Appenzell, St. Gallen, Glarus, und Schwyz. 1881. 4to.—*From the Commission Fédérale Géologique.*
 Mittheilungen der Naturforschenden Gesellschaft in Bern, 1880, 1881. Nos. 979–1029. 8vo.—*From the Society.*
- Birmingham.**—Proceedings of the Birmingham Philosophical Society, Vol. II., Pt. 2. 1881. 8vo.—*From the Society.*
- Bologna.**—Memorie dell' Accademia delle Scienze dell' Istituto di Bologna. Serie III. Tomo IX., Fasc. 3, 4, 1878. Tomo X. 1879. Indici Generali della terza Serie. Serie IV., Tom. I., II. 1880. 4to.
 Rendiconti, Anni Accademici, 1878–79. 1882.
 Accademia delle Scienze (Aperçu Historique)—*From the Academy.*
- Bombay.**—Archæological Survey of Western India. Nos. 2, 3, 4, 6, 7, 8. 1875–1879. 4to.—*From the Society.*
 Journal of the Bombay Branch of the Royal Magnetical Society, 1879–81.—*From the Society.*
 Magnetical and Meteorological Observations made at the Government Observatory, 1871 to 1878. 4to.—*From the Observatory.*
- Bonn.**—Verhandlungen des Naturhistorischen Vereines der Preussischen Rheinlande und Westfalens. 36^{er} Jahrg. 2^{te} Hälfte 1879. 37^{er} Jahrg. 1880. 38^{er} Jahrg. 1^{te} Hälfte 1881. Und Supplement: Die Käfer Westfalens von Fr. Westhoff. 1881. 8vo.
- Bordeaux.**—Mémoires de la Société des Sciences Physiques et Naturelles. 2^e Série. Tome IV. 1880–81. 4to.—*From the Society.*
 Bulletins de la Société de Géographie Commerciale. 1881–82. 8vo.—*From the Society.*
- Boston.**—Proceedings of the Boston Society of Natural History. Vol. XIX., Pts. III. and IV., 1878. Vol. XX., Pt. I., 1879; Pt. IV., 1880. Vol. XXI., Pt. I., 1881.
 Anniversary Memoirs of the Boston Society of Natural History. 1880. 4to.—*From the Society.*
 Proceedings of the American Academy of Arts and Sciences. Vol. XV., Pt. II., 1880. Vol. XVI., Pts. I., II., 1881.—*From the Academy.*
- Brera.**—See Milan.
- British Association for the Advancement of Science.**—Reports of the Fiftieth and Fifty-first Meetings (Swansea and York). 1880, 1881.
- Brunswick.**—Jahresbericht des Vereins für Naturwissenschaft, 1879–80. 1880–81. 8vo.—*From the Society.*
- Brussels.**—Annales de l'Observatoire Royal, Nouv. Sér. Annales Astronomiques. Tome III. 1880. 4to.—Annales Météorologiques. Tome I. 1881. 4to.—*From the Observatory.*
 Annuaire de l'Observatoire Royal. Années, 1880, 1881. 8vo.

- Brussels*.—Annales de la Société Scientifique de Bruxelles, 5^{me} Année, 1880-81. 8vo.—*From the Society*.
 Bulletin de l'Académie Royale des Sciences, des Lettres, et des Beaux-Arts de Belgique. Tomes XLIX., L., LI. 1880-82. 8vo.
 Mémoires de l'Académie Royale des Sciences, des Lettres, et des Beaux-Arts de Belgique. Tome XLIII. 4to.
 Mémoires Couronnés et Autres Mémoires publiés par l'Académie Royale des Sciences, &c., de Belgique. Tomes XXIX., XXX., XXXII. 1880-81. 8vo.
 Mémoires Couronnés et Mémoires des Savants Étrangers publiés par l'Académie Royale des Sciences, &c., de Belgique. Tomes XXXIX.-XLII. 1876-80.
 Biographie Nationale. Tomes VI., Pt. 2, 1878. VII., Pt. 1. 1880.
 Annuaire de l'Académie Royale. 1882. 8vo.—*From the Academy*.
Buenos-Ayres.—Description physique de la République Argentine, par le Dr. H. Burmeister. Tome III^{me}. Animaux Vertébrés 1^{re} ptie. Mammifères Vivants et Éteints. 1879. 8vo. Avec Atlas; fol. 2^{de} Livrais.
 Tom. V. Lépidoptères. 1^{re} ptie. 1880.
 Museo Publico. Vues Pittoresques de la République Argentine. 1881. Fol.
 Anales de la Oficina Meteorologica Argentina. Tom. II. Climas de Bahia Blanca y Corrientes. 1881. 4to.—*From the Government*.
Calcutta.—Proceedings of the Asiatic Society of Bengal, for 1880-81. 8vo.
 Journal of the Asiatic Society for 1880-81. 8vo.—*From the Society*.
 See Indian Government.
California.—Proceedings of the California Academy of Sciences. 6th June 1881.—*From the Academy*.
Cambridge (U.S.).—*Harvard College*.—Annual Reports of the Curator of the Museum of Comparative Zoology at Harvard College, 1879-80, and 1880-81.
 Bulletin of the Museum of Comparative Zoology at Harvard College. Vol. VI., No. 8, Letter. No. 4. On the Dredging Operations of the U.S. Coast Survey Sr. "Blake," during June and July 1880. By Professor Alexander Agassiz. No. 9. Description of Gravitating Trap. By C. D. Sigsbee, U.S.N. No. 10. On some points in the Structure of the Embryonic Zoëa. By Walter Faxon. 1880. No. 11. New Species of Selachians in the Museum Collection. By Samuel Garman. 1880. No. 12. Maturation, Fecundation, and Segmentation of *Limax Campetris*. By E. L. Mark. 1881.—Vol. VII. Geology of the Iron and Copper Districts of Lake Superior. By M. E. Wadsworth. 1880.—Vol. VIII., No. 1. Études préliminaires sur les Crustacés. Par M. Alph. Milne-Edwards. 1880. No. 2. Preliminary Report on the Echini. By Alexander Agassiz. 1880. No. 3. New and Little Known Reptiles and Fishes in the Museum Collections. By Samuel Garman. 1881. No. 4. List of Dredging Stations. No. 5. Report on the Cephalopoda. By A. E. Verrill. 1880. No. 6. Stomach and Genital Organs of Astrophytidæ. By Theodore Lyman. 1881. No. 7. Report on the Acalephæ. By J. Walter Fewkes. 1880. No. 8. Studies of the Jelly-fishes of Narragansett Bay. By J. Walter Fewkes. No. 9. List of Mammals collected by Dr. Edward Palmer in North-Eastern Mexico, with Field Notes. By J. A.

- Allen. 1880. No. 10. The Trilobite: New and Old Evidence relating to its Organisation. By C. D. Walcott. 8vo. No. 11. Report on the Selachians. By Samuel Garman. No. 12. Report on the Pycnogonida. By Edmund B. Wilson. 1880. No. 13. On some Crustacean Deformities. By Walter Faxon. 1879. No. 14. The Devonian Insects of New Brunswick. By Dr. H. A. Hagen. 1880.—Vol. IX., No. 1. Description des Espèces nouvelles d'Astéries. Par Prof. E. Perrier. No. 2. Preliminary Report on the Mollusca. By W. H. Dall. No. 3. Prof. Alex. Agassiz on Explorations at Tortugas. No. 4. Preliminary Report on the Comatulæ. By P. H. Carpenter. No. 5. The Species of the Genus *Partula*. By Dr. Hartman. No. 6. Bibliography. 1. Crustacea. By W. Faxon. 1882. No. 7. Surface Fauna of the Gulf-Stream. By A. Agassiz. No. 8. The Acalephæ of East Coast of New England. By J. W. Fewkes. 1882.—Vol. X., No. 1.—Results of Dredging on the East Coast of the United States.—Report on the Crustacea. By S. J. Smith. 1882. 8vo.
- Cambridge (U.S.)*—Memoirs of the Museum of Comparative Zoology at Harvard College. Vol. VI., No. 1. The Auriferous Gravels of the Sierra Nevada of California. By J. D. Whitney. 1880. 4to.—Vol. VII., No. 2, Pt. 1. The Climatic Changes of later Geological Times: a Discussion based on Observations made in the Cordilleras of North America. By J. D. Whitney. Pts. 1, 2. 1880, 1882. 4to.—Vol. VIII., No. 1. The Immature State of the Odonata. Pt. 2. Sub-family *Æschnina*. By Louis Cabot. Camb., 1881. 4to.—*From the Museum.*
- Catalogue of 618 Stars observed at the Astronomical Observatory of Harvard College during the years 1871–2, 1874, and 1875. By Prof. W. A. Rogers.
- Annals of the Astronomical Observatory at Harvard College. Vol. XII. Observations made with the Meridian Circle during 1874–5. By Professor W. A. Rogers. 1880. 4to.—Vol. XIII., Pt. 1. Micrometric Measurements. 1882. 4to.
- Thirty-fifth and Thirty-sixth Annual Reports of the Director of the Astronomical Observatory of Harvard College. By E. C. Pickering. 1881. 8vo.—*From the Observatory.*
- Canada.*—Geological Survey of Canada. Report of Progress, 1878–79, and 1879–80; with vol. of Maps. 8vo.—*From the Government of the Dominion.*
- Cape of Good Hope.*—Catalogue of 12,441 Stars for the Epoch 1880, from Observations made during 1871–79. By E. J. Stone, F.R.S. 4to.
- The Cape Catalogue of Stars deduced from Observations made at the Royal Observatory, 1834–40. By E. J. Stone, F.R.S. 1878. 8vo.
- A Determination of the Solar Parallax, from Observations of Mars made at the Island of Ascension in 1877. By David Gill, LL D. 1881. 4to.—*From Cape Town Observatory.*
- Catania.*—Atti dell' Accademia Gioenia di Scienze Naturali Ser. 3^{ma}. Tom. XI., XII., XIII., XIV., XV., XVI. 1877–82. 4to.
- Ceylon Government.*—The Lepidoptera of Ceylon. Parts 1–5. By F. Moore, F.Z.S. 1880–82. 4to.—*From the Government.*
- Cherbourg.*—Mémoires de la Société Nationale des Sciences Naturelles et Mathématiques. Tomes XXII., XXIII. 1879–81. 8vo.
- Chicago.*—Annual Reports of the Board of Directors of the Chicago Astronomical Society and of the Dearborn Observatory. 1880–82. 8vo.—*From the Observatory.*

- Christiania*.—Den Norske Nordhavs-Expedition. 1876-78.
 Chemi. 1. Om Luften i Søvandet. 2. Om Kulyren i Søvandet.
 3. Om Saltholdigheden af Vandet i det Norske Nordhav. Af
 H. Tornøe. 1880. Fol.
 Zoologi. Fiske, ved Robert Collett. 1880. Fol.
 Gephyrea ved D. C. Danielssen og Johan Koren. 1881. Fol.
 Holothurioidea, ved D. C. Danielssen og Johan Koren. 1882. Fol.
 Annelida, ved G. Armauer Hansen. 1882. Fol.
 Astronomiske Observationer, af H. Mohn.
 Magnetiske Observationer, af C. Wille.
 Geografi og Naturhistorie, af H. Mohn.
 Historisk Beretning: Apparaterne, af C. Wille.
 Archiv for Matematik og Naturvidenskab. Udgivet af Sophus
 Lie, Worm Müller, og G. O. Sars, 3^e Bind, Tillaegshefte. 4^e Bind
 5^e Bind. 1878-80. 8vo.
 Forhandlinger i Videnskabs-Selskabet. 1878-80. 8vo.
 Carcinologiske Bidrag til Norges Fauna, af G. O. Sars. I. Mono-
 graphi over Norges Mysider. 3^e Hft. 1879. 4to.
 Publication der Norwegischen Commission der Europäischen
 Gradmessung. Geodätische Arbeiten Hft. 1-3. 1880-82. 4to.
 Vandstands Observationer: Udgivet af den Norske Gradmaalings-
 kommission. Hft. 1. 1872-79. 4to.—*From the Norwegian
 Government.*
- Cincinnati*.—The Journal of the Cincinnati Society of Natural History.
 Vols. III., IV., V., 1880-82.—*From the Society.*
- Connecticut*.—Transactions of the Connecticut Academy of Arts and
 Sciences. Vol. IV., Pt. II. Vol. V. 1882. 8vo.
- Copenhagen*.—Mémoires de l'Académie Royale de Copenhague. 5^{me} Série.
 Classe des Sciences. Vol. XII., No. 6. Spolia Atlantica: Bidrag
 til Kundskab om Formforandringer hos Fiske under deres
 Vaext og Udvikling, særligt hos nogle af Atlanterhavets Højsø-
 fiske. Af Dr. Chr. Lütken. 1880. 4to.—6^{me} Série. Vol. I., No.
 1. Undersøgelser over Lysets Brydning i Dampe og tilsvarende
 Vaedsker. Af K. Prytz. 1880. 4to. No. 2. Studier over
 Decapodernes Slaegtskabsforhold. Af J. E. V. Boas. 1880.
 4to. No. 3. Sepidiarium og Idiosepius, to nye Slaegter af
 Sepiernes Familie. Af Japetus Steenstrup. 1881. No. 4.
 Stormen over Nord-og Mellem-Europa af 12^{de}-14^{de} November,
 1872. Af Prof. A. Colding. 1881.—Vol. II., No. 1. Familien
 Podostomaceæ. Af Dr. E. Warming. 1881. No. 2. Om Metal-
 lernes Ledningsevne for Varme og Electricitet. 1881. No. 5.
 Om en Fossil Zebra-Form fra Brasiliens Campos med to Arter
 af Slaegten Hippidion, af Dr. Boas.
 Oversigt over det Kongelige Danske Videnskabernes Selskabs
 Forhandlinger i Aaret 1880, Nos. 2, 3; 1881, 1882, No. 1.—
From the Academy.
- Cordoba* (*Republica Argentina*).—Boletin de la Academia Nacional de
 Ciencias de la Republica Argentina. Tomo III. Entrega, 1,
 2, 3. 1879. 8vo.
 Resultados de la Oficina Meteorologica Argentina. Tomo II.
 Climas de Bahía Blanca y Corrientes. 4to. 1881.
 Resultados del Observatorio Nacional Argentino. Vol. II. Ob-
 servaciones del Año 1872. 4to.—*From the Argentine Government.*
- Cornwall*.—Transactions of the Royal Geological Society of Cornwall.
 Vol. X., Part 3. Jan. 1881-82.—*From the Society.*
- Dantzic*.—Schriften der Naturforschenden Gesellschaft. Bd. IV. 1876-78.
 Bd. V. 1879-82.—*From the Society.*

- Dublin*.—Proceedings (Science). Series II. Vol. III., Nos. 5–8. 1880–82.
 Proceedings (Polite Literature and Antiquities). Series II. Vol. II., Nos. 2, 3. 1880–81. *From the Academy*.
 Transactions of the Royal Irish Academy. Vol. XXVIII. Science. 4to.
 I. On Chemical Equilibrium. By Dr. Tarleton. 1880.
 II. On a New Sponge with supposed Heteromorphic Zooids. By Dr. Perceval Wright. 1881.
 III. On *Blodgettia Confervoides* of Harvey. By Dr. Perceval Wright. 1881.
 IV. On New Unicellular Algae, living on *Rhizoclonium Casparii*. By Dr. Perceval Wright. 1881.
 V. On the Periods of the First Class of Hyper-Elliptic Integrals. By W. R. W. Roberts. 1881.
 VI. New Researches on Sun-heat and Terrestrial Radiation, and on Geological Climates. By Rev. S. Haughton, M.D. Parts 1, 2. 1881. 4to.
 VII. Extension of Theory of Screws to the Dynamics of any Material System. By Rob. S. Ball, LL.D.
 VIII. On some hitherto undescribed Compounds of Selenium. By C. A. Cameron, M.D., and E. W. Davy, M.D.
 IX. Dynamics of a Rigid System moving in Elliptic Space. By R. S. Ball, LL.D.
 X. On some Deductions from M'Culloch's Lectures on Rotation. By F. A. Tarleton, LL.D.
 Polite Literature and Antiquities. No. IV. Ogham Inscriptions. By Sir S. Ferguson. 1881. 4to.—*From the Academy*.
 The Scientific Proceedings of the Royal Dublin Society. (New Series.) Vol. II., Part 7, 1880. Vol. III., Parts 1–6, 1881.
 The Scientific Transactions of the Royal Dublin Society:—Vol. I., No. 13. On the possibility of originating Wave Disturbances in the Ether by means of Electric Force. By G. F. Fitzgerald. 1880. No. 14. Explorations in the Bone Cave of Ballynamtra. By G. H. Kinahan and R. J. Usher. 1880.
 Journal of the Royal Geological Society of Ireland. Vol. XVI., Part 1. 1881.—*From the Society*.
Dunsink (Dublin).—Astronomical Observations and Researches made at Dunsink. 4th Part. 1882.—*From the Observatory*.
Edinburgh.—Transactions of the Royal Scottish Society of Arts. Vol. X., Parts 3, 4. 1881–82. 8vo.—*From the Society*.
 Annual Reports of the Council of the Royal Scottish Academy of Painting, Sculpture, and Architecture. 1879–82.—*From the Academy*.
 Highland and Agricultural Society of Scotland's Transactions. 4th Series. Vol. XIII., 1881. Vol. XIV., 1882.—*From Society*.
 Transactions and Proceedings of the Botanical Society. Vol. XIV., Part 1. 1881. 8vo.—*From the Society*.
 Transactions of the Edinburgh Geological Society. Vol. IV., Part 1. Session 1881–81. 8vo.—*From the Society*.
 Journal of the Scottish Meteorological Society. With Tables for Half-Year ending 30th June 1877. Nos. LX.—LXIII., 1879–80. Nos. LXIV.—LXIX., 1881. 8vo.—*From the Society*.
 Proceedings of the Royal Physical Society. Session 1879–80. 8vo.
 Monthly and Quarterly Returns of the Births, Deaths, and Marriages registered in Scotland. July 1879 to July 1882.
 Ninth Decennial Census of the Population of Scotland (1881), with Report. Vol. I. Edin. 1882. Fol.—*From the Registrar-General*.

Edinburgh.—*Edinburgh University Calendar for Sessions 1880–81, 1881–82, 1882–83.* 8vo.—*From the University.*

Geological Survey of Scotland. One-Inch Scale.—Maps of Kirkcudbright (No. 5), of Dumfries and Kirkcudbright (No. 6), of Kelso (No. 25), of Glasgow (No. 30), of Benholm (No. 57a). Six-Inch Scale.—Map of County of Linlithgow (No. 8), of County of Perth (Nos. 133, 134, 135, 139, 140, 141, 142, 143). Horizontal Section of Scotland—Muirkirk Coal Fields. Vertical Section of Scotland—Muirkirk and Douglas Coal Fields. Vertical Section of Scotland—Rutherglen and Carlisle Coal Fields. Explanation of Sheet 31, embracing parts of Stirlingshire, Lanarkshire, and Linlithgowshire.—*From the Survey.*

Ekatherinebourg.—Bulletin de la Société Ouralienne d'Amateurs des Sciences Naturelles. Tomes V., VI., VII., Livr. 1, 2. 1880–82 (In Russian and French).—*From the Society.*

Erlangen University.—The following Inaugural Dissertations:—

Alafberg (C. Eugen). Ueber die angeborne Verwachsung der Finger.—Amon (H.). Zur Pathologischen Anatomie der Soliden Ovarientumoren.—Andreas (H. C.). Ueber die bei der Nitrirung von Ortho- und Paraazophenetol entstehenden Nitrokörper und deren Derivate.—Bacharach (J.). Schnittpunktsysteme algebraischer Curven.—Baist (Gottfried). Alter und Textueberlieferung der Schriften Don Juan Manuela.—Becker (Dr. Carl). Ein Fall von Hospitalbrand in der Privatpraxis.—Bernhuber (F.). Ueber Carcinom und Sarcom am Uteruskörper.—Beutner (F.). Ein Fall von Doppelmissbildung (Thoracopagus tetrabrachius).—Böhmer (C. H.). Ueber Diazophenole.—Börner (C.). Ein Beitrag zur Pathogenese der Pericarditis.—Bostroem (E.). Das Endothelcarcinom: Ein Beitrag zur Histogenese des Carcinoms.—Bredenkamp (C. J.). Vaticinium quod de Immanuele edidit Jesaias (VII. 1, IX. 6) explicatum.—Brock (J.). Versuch einer Phylogenie der dibranchiaten Cephalopoden.—Buchner (W.). Die Einwirkung des Alcohols auf die Magenverdauung.—Crämer (F.). Zur Pathogenese der febrilen Albuminurie.—Dietrich (O.). Ueber die Wiederholungen in den altfranzösischen Chansons de Geste.—Ebert (A.). De M. Cornelii Frontonis Syntaxi.—Franz (C.). Ueber künstliche Athmung.—Γεωργιος (Ανδρέας Πάπα). Πραγματεία περί των ρηματικων επιθετων τεο, τεα, τη, τεον, &c., παρ̄ επτα και εικοσι ποιηταις και πεζοις συγγραφεισιν.—Γεωργοπουλος (Γ. Δ.). Περί του γαμου των αρχαιων Ελληνων.—Goes (W.). Einfluss der antiseptischen Wundbehandlung auf die Therapie der Hernien.—Grimm (F.). Slickstoffausscheidung in pathologischen Zuständen.—Hauser (G.). Physiologische u. histologische Untersuchungen über das Geruchsorgan der Insekten.—Heim (L.). Die Veränderungen im Magen nach Vergiftung mit Arsenik.—Heimbs (M.). Acute Miliartuberculose des puerperalen Uterus unter den Symptomen eines Puerperalfiebers.—Hallbauer (O.). Life and Works of George Farquhar.—Hellmuth (K.). Zur Casuistik der Missbildungen: Ein Fall von congenitalen Radiusdefect und von Dicephalus dibrachius tripus.—Hensolt (L.). Temperatur-Minimum und Maximum für die Ergrünung einiger Culturpflanzen.—Hoffman (J.). De Pseudoapuleiano Libro de Mundo.—Johannides (Dr. D. P.). Die gefässlose Stelle der menschlichen Retina, und deren Verwerthung zur Bestimmung

der Ausdehnung der Macula lutea.—Καρικουλα (A.). Περὶ ἀρχῆς καὶ χρήσεως τοῦ Στεφανοῦ παρατοῦ Ἑλλήσιν.—Kietz (A.). Zur Lehre von der Verdauung im Magen.—Kiesselbach (W.). Zur normalen u. pathologischen Anatomie des Schläfebeins.—Kirchner (V. M.). Sulfotoluid u. einige Derivate.—Köberlin (H.). Verhalten der Cervix Uteri während der Schwangerschaft.—Kraemer (O.). Ein Fall von tabetischer Affection beider Hüftgelenke.—Francke (G.). Ueber Hesperidin und Bergapten.—Kreuzmann (H.). Ueber Messung Schwangerer als diagnostisches Hilfsmittel.—Leist (J.). Zur Lehre vom Fötus sanguinolentus.—Libieratos (E.). Alterthümer von der Insel Kephallenia.—Macher (H.). Electrotherapeutische Erfahrungen bei Augenaffectionen.—Menzel (E.). Die Privatklage nach dem Reichsstrafprozessrechte.—Mangelsdorff (M.). Zur Casuistik der Balkendefecte.—Mittenzwey (O.). Äthylirten Ortho- und Paraamidophenole.—Mocattelli (R.). Das Vorkommen von Zucker und Gallenfarbstoff im menschlichen Harn.—Mühle (F.). Ein Fall von Anus praeternaturalis.—Nissen (C.). Angeborene Difformitäten des Kniegelenkes.—Panhoff (W.). Die physiologischen Wirkungen des Methylenchlorid.—Πολιτος (N. Γ.). Δημῶδες μετεωρολογικὰ Μῦθοι.—Preuss (S.). De Bimembris dissoluti Usu.—Rinck (L.). Enthält die Grundluft Ammoniak?—Schiller (Dr. A.). Der chinesische Thee und seine Verfälschungen.—Schilling (Dr. F.). Zur Ätiologie des Akuten Gelenkrheumatismus.—Schoeman (O.). Die Wirkung des Physostigmins auf die Pupille.—Schoeman (R.). Werth der Fleischsolution bei der Behandlung des einfachen Magengeschwürs.—Schröter (H.). Die Giftwirkungen der Benzarsäure des Arseniks und der Arsensäure.—Schwarz (Dr. F.). Jod, ein Specificum gegen croupöse Pneumonie.—Siemienski (J. J. v.). Ueber einige Phenanthrenderivate.—Soltmann (H.). Der Infinitiv mit der Präposition à im Altfranzösischen.—Steiner (M.). Giebt es habituelles Absterben der Frucht ohne Syphilis?—Salger (Dr. C.). Einfluss der Ventilation auf die CO₂-Menge im Boden.—Sassmann (E.). Ein Fall von interstitieller Schwangerschaft.—Schillfarth (Dr. H.). Von der Magenerweiterung und ihrer mechanischen Behandlung.—Schwarz (Dr. A.). Ueber Conglutinatio Orificii Uteri externi.—Stich (J.). De Polybii dicendi genere.—Tillmann (H.). De Dativo verbis passivis Linguae Latinae subjecto, qui vocatur Græcus.—Toeniessen (G.). Ueber Blutkörperchenzählung beim gesunden u. kranken Menschen.—Veraguth (C.). Veränderungen des Lungenepithels bei künstlich hervorgerufenen pneumonischen Prozessen.—Vogel (P.). Ueber die Curven vierter Ordnung vom Geschlechte eins.—Winter (J.). Die metrische Reconstruction der Plautinischen Cantica.—Zingerle (W.). Ueber Raoul de Houdenc und seine Werke.—Zeitler (F. X.). Ueber die Menge des von Pyrogallol in alkalischer Lösung absorbirten Sauerstoffes, und ueber den Sauerstoffgehalt des Wassers.—From the University.

Essex Institute.—See Salem.

Frankfurt-a-M.—Abhandlungen herausgegeben von der Senckenbergischen Naturforschenden Gesellschaft. Bd. XII., Hfte. 1 to 4. 1880–81. 4to.

Bericht über die Senckenbergische Naturforschende Gesellschaft. Bde. für 1879–80, 1880–81. 8vo.—From the Society.

- Geneva*.—Mémoires de la Société de Physique et d'Histoire Naturelle de Genève. Tome XXVII., Pts. 1, 2. 1880-81.—*From the Society.*
- Genoa*.—Annali del Museo Civico di Storia Naturale. II Marchese G. Doria, Direttore. Vol. XV., 1879-80. Vol. XVI., 1880-81. Vol. XVII., 1881. Ragni dell' Austro-Malesia et del Capo York, per T. Thorell. 8vo.—*From the Museum.*
- Glasgow*.—Proceedings of the Philosophical Society of Glasgow. Vol. XI., No. 2. Vol. XII. Vol. XIII., No. 2. 1878-82.—*From the Society.*
Transactions of the Geological Society of Glasgow. Vol. VI., Part 2. 8vo.—*From the Society.*
- Göttingen*.—Abhandlungen der Königl. Gesellschaft der Wissenschaften. Bde. XXVI. XXVII. XXVIII. 1880-81.
Nachrichten von der K. Gesellschaft der Wissenschaften und der Georg-Augusts-Universität, aus dem Jahre 1880-81. 8vo.—*From the Society.*—*From the University.*
- Graz*.—Mittheilungen des Naturwissenschaftlichen Vereines für Steiermark. Jahrg. 1881. 8vo.—*From the Society.*
- Greenwich*.—Spectroscopic and Photographic Results. 1880, 1881 (Royal Observatory, Greenwich). 4to.
Astronomical, Magnetical, and Meteorological Observations, 1878, 1879, 1880. 4to.
Observations of the Transit of Venus, 1874, Dec. 8, made under the authority of the British Government, and Reduction of the Observations. 4to. 1882.—*From the Observatory.*
- Hague (The)*.—Commission Géodésique Néerlandaise. 1. Détermination à Utrecht de l'Azimut d'Amersfoort par J. A. C. Oudemans. 4to. 1881.—*From the Commission.*
- Haarlem*.—Archives Néerlandaises des Sciences Exactes et Naturelles, publiées par la Société Hollandaise de Harlem. Tomes XVI., XVII. 1881-82. 8vo.—*From the Society.*
Archives du Musée Teyler. Serie II. 1^{re} Pt. 1881.
Teyler's Godgeleerd Genootschap. N. Serie, Tiende Deel, Stuk 1, 2. 1882.—*From the Museum.*
- Halifax*.—Proceedings and Transactions of the Nova Scotian Institute of Natural Science. Vol. II., 1866-70; Vol. III., 1870-74; Vol. IV., 1875-78; Vol. V., Parts 1-3, 1880-81.—*From Institute.*
- Halle*.—Nova Acta Academiae Caesareae Leopoldino-Caroliniae Germanicae Naturae Curiosorum. Tom. XLI-XLIII. 1879-82.
Leopoldina, amtliches Organ der K. Leopold-Carolinisch-Deutschen Akademie der Naturforscher. Hft. XVI., XVII. 1880-81. 4to.—*From the Academy.*
Abhandlungen der Naturforschenden Gesellschaft. Bd. XV. 1881. 4to.
Bericht über die Sitzungen der Naturforschenden Gesellschaft. 1880-81. 8vo.—*From the Society.*
- Helsingfors*.—Öfversigt af Finska Vetenskaps-Societens Förhandlingar. Vol. XXII. 1879-80. 8vo.
Observations Météorologiques, publiées par la Société des Sciences de Finlande. Années, 1879. 8vo.
Bidrag til Kännedom af Finlands Natur och Folk, utgifna af Finska Vetenskaps-Societeten. Haft. 33, 34, 35. 1880-81. 8vo.
- Indian Government, Calcutta*.—Records of the Geological Survey of India. Vol. XII., Part 4, 1879; Vol. XIII., Parts 1, 2, 3, 4, 1880; Vol. XIV., Parts 1, 3, 4, 1881.
Memoirs of the Geological Survey of India.—Vol. XV., Part 2. Griesbach (C. L.). Geology of the Ramkola and Tatapani Coalfields. 1880.—Vol. XVI., Part. 2. Nellore portion of

- Carnatic. Part 3. Upper Gondwanas of Godavari District. 1880. 8vo.—Vol. XVII., Part 1. Blandford (W. J.). Geology of Western Sind. 1879. Part 2. Wynne (A. B.). Trans-Indus Extension of the Punjab Salt Range. 1880.—Vol. XVIII. Part 1. Bolan Pass. Part 2. Districts of Manbhūm and Singhbhum. Part 3. Pranhita-Godavari Valley. 1881.
- Indian Government, Calcutta.*—Palæontologia Indica. Series X. Vol. I., Part 4. Supplement to Crania of Ruminants. By R. Lydeker. 1880. 4to. Part 5. Siwalik and Narbada Proboecidia. By R. Lydeker. 1880. 4to.—Series XIII. Productus—Limestone Fossils. 2. Pisces—Cephalopoda, Supplement. Gasteropoda. 1880. 4to.—Series II. Vol. I. Fossil Flora of the Gondwana System. Vol. I. 1880. Fol.—Series II., XI., XII. Fossil Flora of the Gondwana System. Vol. III. 2. Flora of the Damuda and Panchet Divisions. Parts 1, 3. 1880–81. Fol.—Series XI. Parts 1, 2. Jurassic Flora of Kach. Flora of Jabalpur Group.—Series XII. Gondwana System, 1st Supplement. Flora of Talchir-Karharbari Beda. 1881. Fol.—Series XIII. 1. Productus—Limestone Fossils, 3. Pelecypoda. 1881.—Series XIV. Vol. I. Fossil Echinodea (of Western Sind). By P. Martin Duncan, F.R.S., and W. Percy Sladen, F.L.S. 1882.
- A Manual of the Geology of India. Part 3. Economic Geology. By V. Ball, M.A. Calcutta, 1881. 8vo.
- The Indian Antiquary: A Journal of Oriental Research. 1880–82.
- The Flora of British India. By Sir J. D. Hooker, M.D. Part 8. 1880.
- Account of the Operations of the Great Trigonometrical Survey of India. Vol. VI.
- The Triangulation of the South-East Quadrilateral, including the Great Arc Section 18° to 24° , the East Coast Series, the Calcutta and Bider Series, &c. 1880. 4to.—From *Indian Government*.
- Jena.*—Denkschriften der Medicinisch-Naturwissenschaftlichen Gesellschaft:—
- Band I., 1^{te} Abth. System der Acraspeden, mit Atlas, von Ernst Haeckel.
- Sitzungsberichte der Jenaischen Gesellschaft für Medicin und Naturwissenschaft für 1881. 8vo.
- Jenaische Zeitschrift für Naturwissenschaft, herausgeben von der Medicinisch-Naturwissenschaftlichen Gesellschaft zu Jena. Bd. XV. 1882. 8vo.—From *the Society*.
- Kasan.*—Isvestia i Ouchenuia Sapiski Imperatorskago Kasanakago Universiteta. 1880. Nos. 1–6. 8vo.—From *the University*.
- Kew.*—Kew Observatory Report for 1881. 8vo.
- Kiel.*—Vierter Bericht der Commission zur wissenschaftlichen Untersuchung der deutschen Meere für die Jahre 1877, bis 1881. Abtheil 1. 1882. Fol.—From *the Commission*.
- Schriften, der Universität zu Kiel. Bd. XXVI., XXVII. 1878–80. 4to.—From *the University*.
- Becker (H.). Die Herniotomien der Kieler Klinik 1877–80.—Benthin (O.). Resection des Fussgelenks. 1880.—Bertheau (H.). Zur Lehre von der Inhalationstuberculose. 1880.—Bock (C.). De Metris Horatii lyricis. 1880.—Beckendahl (A.). Bewegungen des M. Tensor Tympani nach Beobachtungen beim Hunde. 1880.—Bötjer (W.). Die Antisepsis in der Geburtshilfe. 1880.—Burchard (J. L.). Zur Lehre vom Erfüllungsorte. 1880.—Bültmann (W.). Zum Erfolge der Iredectomie bei Glaucoma Simplex. 1880.—Cosack (J.). Deri-

- vata der Toluidine. 1880.—Düvelius (J.). Entzündungen der Bursa trochanterica. 1880.—Fritz (R.). Die Resektion des Ellenbogengelenks, nebst Fälle. 1868–80.—Goetz (E.). Das Homotropin in der Augenheilkunde. 1880.—Grothe (O.). Ueber Metajodorthonitro und Amido Benzoesäuren, sowie über Nitrobenzylcyanide u. Paranitrophenylessigsäure. 1880.—Hansen (M.). De Tropis et Figuris apud Tibullum. 1881.—Haas (H.). De Herodis Attici Oratione *περι πολιτειας*. 1880.—Heinemann (J.). Die Krystallinischen Geschiebe Schleswig-Holsteins. 1879.—Hennings (P.). Statistik u. Aetiologie der amyloiden Entartung. 1879.—Henrici (C.). Trepanation bei Gehirnbräunen. 1880.—Hecksteden (E.). Zur Lehre vom Echinokokkus. 1881.—Lorck (A.). Hermann von Salza. Sein Itinerar. 1880.—Luebbert (G.). De Amnestia anno CCCCIII. a. Chr. n. ab Atheniensibus decreta. 1881.—Mayer (G.). Ueber einige künstliche u. natürliche Alkaloide. 1879.—Peters (J.). Ueber Natron salicylicum beim Diabetes mellitus. 1880.—Peterson (Gul.), Quaestiones de Historia Gentium Atticarum. 1880.—Peterson (H.). Magenresektion zur Heilung einer Magenbauchwandfistel. 1880.—Puls (A.). Lautlehre der Lieder Muscatblüt's. 1881.—Rheder (B.). Die subpleuralen Echy-mosen beim Erstickungstode. 1880.—Schrader (A.). Englisch-relativpronomen der sprache Chaucer's. 1880.—Schall (C.). Einwirkung von Tetrachlorkohlenstoff auf die drei Isomeren Kresole und Oxydation der daraus entstehenden Oxytoluylsäuren zu Oxyphthalsäuren. 1881.—Thaden (C. v.). Das Senile Staphylo-m. 1880.—Thiessen (J. H.). Die Legende von Kisgotamī. 1880.—*From the University.*
- Lausanne.*—Bulletin de la Société Vaudoise des Sciences Naturelles. 2^de Série. Vols. XVII., XVIII. 1881–82. 8vo.
- Leeds.*—Philosophical and Literary Society. 60th Report. 1880–82.
- Leipzig.*—Berichte über die Verhandlungen der Königl. Sächsischen Gesellschaft der Wissenschaften. Math. Phys. Classe. 1880. 8vo.
- Abhandlungen der Math.-Physischen Classe. Bd. XII., Nos. 5, 6. 1880. 4to.
- Preisschriften gekrönt u. herausgegeben von der Fürstlich Jablonowski'schen Gesellschaft. No. 15. Die Historisch-National-ökonomische Section. Die Griechischen Wörter im Latein. 1882. 8vo.
- Sitzungsberichte der Naturforschenden Gesellschaft. 1879, 1880, Nos. 1, 2.—*From the Society.*
- Lille.*—Société Géologique du Nord. Annales VII., 1879–80; VIII., 1880–81.—*From the Society.*
- Liverpool.*—Proceedings of the Literary and Philosophical Society. Vols. XXXIII., XXXIV. 1878–80. 8vo.—*From the Society.*
- Lisbon.*—Memorias da Academia Real das Sciencias. Classe de Sciencias Moraes, Politicas e Bellas-Lettas. Nova Serie, Tomo V., Parte 1. 4to. Classe de Sciencias Mathematicas, Physicas, e Naturaes. Nova Serie, Tomo V., Parte 2, 1878. 4to. Tomo VI., Parte 1, 1881.
- Sessão Publica da Academia Real das Sciencias, em 9 Junho 1880.
- Jornal de Sciencias Mathematicas, Physicas e Naturaes publicado da Academia. Nos. 27, 28, 29. 1880. 8vo.
- Conferencias na Academia acerca dos Descobrimentos e Coloniações dos Portuguezes na Africa. 1880. 8vo.

- Lisbon*.—Demostheneas. A Oração da Coroa. Versão e Estudo sobre a Civilização da Grecia. Por J. M. Latino Coelho. 2^a Edição. 1880. 8vo.
- Don Pedro Calderon de la Barca: Rapido Esboço da sua Vida e Escriptos. Per José Silvestre Ribeiro. 1881. 8vo.
- William Shakespeare—Hamlet. Tradução de Bulhão Pato. 1879. 8vo.
- Flora dos Lusíadas. Pelo Conde de Ficalho. 1880. 8vo.
- Vida e Viagens de Fernão de Magalhães por Diego de Barros Arana. Tradução do Hespanhol de F. de Magalhães Villas-Boas. 1881. 8vo.
- Historia dos Etabecimentos Scientificos Litterarios e Artisticos de Portugal. Tom. VIII, IX.
- Elementos de Histologia Geral e Histophysiologia. Por E. A. Motta. 1880. 8vo.—*From the Lisbon Academy.*
- London*.—Proceedings of the Society of Antiquaries. Vol. VIII., Nos 4, 5. 1880.
- Archæologia; or Miscellaneous Tracts relating to Antiquity. Vol. XLVI., Part 2; XLVII., Part 1. 1881–82. 4to.—*From Society.*
- Journal of the Anthropological Institute of Great Britain and Ireland. Vol. XI. 1881–82. 8vo.—*From the Institute.*
- Journal of the Society of Arts. 1879–82. 8vo.—*From the Society.*
- Nautical Almanac and Astronomical Ephemeris for the Years 1884, 1885, 1886.—*From the Lords of the Admiralty.*
- Monthly Notices of the Royal Astronomical Society. Vol. XLI. 1880–82. 8vo.—Memoirs of the Royal Astronomical Society, Vols. XLV., XLVI. 1880–81. 4to.—*From the Society.*
- Report of the Scientific Results of the Exploring Voyage of H.M.S. "Challenger," 1873–76. 4to.—Narrative, Vol. II. 1882.
- Zoology. Vol. I. Report on the Brachiopoda. By T. Davidson, F.R.S.—The Pennatulida. By A. v. Kölliker.—The Ostracoda. By G. S. Brady, M.D.—The Bones of Cetacea. By Professor W. Turner, F.R.S.S.L & E.—The Development of Green Turtle. By W. K. Parker, F.R.S.—The Shore Fishes. By A. Günther, M.D.—Vol. II., 1881. Hydroid, Alcyonarian, and Madreporarian Corals. By H. N. Moseley, F.R.S.—The Birds. By Dr. P. L. Sclater, F.R.S.—Vol. III., 1881. The Echinoidea. By Alexander Agassiz.—The Pycnogonida. By Dr. P. P. C. Hoek.—Vol. IV., 1882. Anatomy of the Petrels. By W. A. Forbes, F.L.S.—The Deep-Sea Medusæ. By Professor Ernest Hæckel, M.D.—The Holothurioidea. By H. Théel.—Vol. V., 1882. The Ophiuroidea. By T. Lyman.—Anatomy of the Thylacine, Cuscus, and Phascogale, and Muscles and Nerves of the Mammalian Pes. By Dr. D. J. Cunningham.—*From the Lords of the Treasury.*
- Journal of the Chemical Society. 1880–82. 8vo.—*From the Society.*
- Transactions of the Clinical Society of London. Vols. XIII., XIV., XV. 1880–82.—*From the Society.*
- Minutes of Proceedings of the Institution of Civil Engineers, Vols. LXIV.–LXX. 1880–82. 8vo.—*From the Society.*
- Institution of Mechanical Engineers, Proceedings and Catalogue. No. 2, 1881–82.—*From the Institution.*
- Proceedings of the Royal Geographical Society. New Series. Vol. III., 1880–81; Vol. IV., 1882. Journal of the Royal Geographical Society. New Series. Vol. XLIX., 1879; Vol. L., 1880. 8vo.—*From the Society.*

- London.*—Abstracts of Proceedings of the Geological Society of London. 1880-82.
- Quarterly Journal of the Geological Society. Vols. XXXVII., XXXVIII. 1881-82. Catalogue of the Library of the Geological Society of London. Lond. 1881. 8vo.—*From the Society.*
- Proceedings of the Geologists' Association. Vols. VI., VII. 1880-82.—*From the Association.*
- Journal of the East Indian Association. Vols. XIII., XIV. 1880-82. 8vo.
- Report of the Kew Committee for the year 1880.
- Journal of the Linnean Society, 1881-82.
- The Transactions of the Linnean Society. Second Series. Zoology. Vol. II., Parts 2, 3, 4. 1881-82. 4to.
- The Transactions of the Linnean Society. Second Series. Botany. Vol. I., Part 8, 1880; Vol. II., Parts 1, 2, 1881.—*From the Society.*
- Transactions of the Royal Society of Literature. Second Series. Vol. XII., Parts 2, 3. 1880. 8vo.—*From the Society.*
- Proceedings of the London Mathematical Society. Vols. XI., XII., XIII. 1880-82.—*From the Society.*
- Medical and Chirurgical Transactions published by the Royal Medical and Chirurgical Society. Second Series. Vols. XLV., XLVI. 1880-81. 8vo.
- Proceedings of the Royal Medical and Chirurgical Society. Vol. IX., Nos. 1-4. 1881-82.—*From the Society.*
- Quarterly Journal of the Meteorological Society. Vol. VII., Nos. 37-41. Vol. VIII., Nos. 42, 43. 1880-82. 8vo.
- Index to Publications of the English Meteorological Society, 1839-81.
- The History of English Meteorological Societies, 1823-80. The President's Address at the Meeting, 19th Jan. 1881.
- The Meteorological Record: Monthly Results of Observations made at the Stations of the Meteorological Society. Nos. 1, 2, 3, 4, 5. 1881-82.
- Report of the Meteorological Council to the Royal Society for the years ending 31st March 1880 and 31st March 1881.
- Meteorological Observations at Stations of the Second Order for the year 1879. 4to.
- Quarterly Weather Report of the Meteorological Office. New Series. Part 1, Jan. to Mar. 1876. Official, No. 33.
- Hints to Meteorological Observers, with Instructions for taking Observations, and Tables for their Reduction. By William Marriott. Lond. 1881. 8vo.
- Report of International Meteorological Committee Meeting at Berne. Official, No. 14. 1880, 1881. 8vo.
- The Meteorological Record; Monthly Results of Observations at Stations of the Meteorological Society for Quarter ending June 30, 1881. Nos. 2, 3. 8vo.
- Contributions to our Knowledge of the Meteorology of the Arctic Regions. Pt. 3. 1882. 4to.
- Report on the Storm of October 13-14, 1881.
- Report on the Gales in the Ocean adjacent to Cape of Good Hope. By Captain H. Toynbee. 1882. 4to.—*From the Meteorological Society.*
- Journal of the Royal Microscopical Society, containing its Transactions and Proceedings. New Series. Vols. I., II. 1881-82. 8vo.—*From the Society.*

- London.*—Statistical Report of the Health of the Navy for 1879–80.—
From the Lords Commissioners of the Admiralty.
 The Mineralogical Magazine and Journal of the Mineralogical
 Society of Great Britain and Ireland. Vol. III., No. 18. Vol.
 IV., No. 19. 1880–81.—*From the Society.*
 British Museum—Illustrations of Typical Specimens of *Lepidoptera*
heterocera in the Collection of the British Museum. Part V.
 By Arthur Gardiner Butler. Lond., 1881. 4to.
 — Catalogue of Passeriformes or Perching Birds in the British
 Museum. (Cichlomorphæ, Pt. II., Turdidæ.) By Henry Seebohm.
 1881. 8vo.
 — Catalogue of the Passeriformes. Cichlomorphæ, Pt. III.,
 containing the First Portion of the Family Timelidæ (Babbling
 Thrushes). By R. B. Sharpe. 1881. 8vo.
 — Catalogue of the *Batrachia salientia* (*S. caudata*), in the
 Collection of the British Museum. By G. A. Boulenger, 2nd
 Edition. London, 1882. 8vo.
 — List of Hymenoptera with Figures, &c., in the British
 Museum. Vol. I. Tenthredinidæ and Siricidæ. By W. F. Kirby.
 1882. 8vo.—*From the Trustees of the British Museum.*
 Transactions of the Pathological Society of London. Vols. XXXI.,
 1880; XXXII., 1881. 8vo.—*From the Society.*
 Philosophical Transactions of the Royal Society. Vols.
 CLXXI., Pts. 2, 3; CLXXII., 1880–81; CLXXIII., Pt. 1,
 1880–81.
 Proceedings of the Royal Society. Vol. XXXI., Nos. 206–211;
 Vol. XXXII.; Vol. XXXIII. 1879–82.
 Catalogue of Scientific Books in the Library of the Royal Society.
 1881. 8vo.—*From the Royal Society.*
 Proceedings of the Royal Institution of Great Britain. Vol. IX.,
 Parts 3, 4, 5. 1880–81. Catalogue, Vol. II.—*From the Institu-*
tion.
 Journal of the Statistical Society. Vols. XLIII., Parts 3, 4;
 XLIV., XLV., Parts 1, 2. 1880–82.—*From the Society.*
 Transactions of the Zoological Society of London. Vol. XI., Pts.
 3–7, 1881–82. 4to. Proceedings for the years 1881–82, and
 Index, 1871–80.—*From the Society.*
- Lund.*—Acta Universitatis Lundensis.—Philosophi, Språkvetenskap och
 Historia. Tom. XIV.–XVII. 1877–1881.
 Matematik och Naturvetenskap. Tom. XIV.–XVII. 1877–1881.
 Theologi. Om Nadens Ordning i dess inre Sammanhang. Af Otto
 Ahnfelt. 1880–81.
 Festskrift till Kgl. Universitet i Köpenhamn från Kgl. Caroliniska
 Universitet i Lund, Clarus Saga: Clari Fabella, Islandice et
 Latine. Juraformationen på Bornholm. 1879. 4to.
 Minneskrift udgifven af Kongl. Fysiographiska Sällskapet, 1878.
- Lyons.*—Mémoires de l'Académie des Sciences, Belles-Lettres et Arts.
 Classe des Sciences, Tomes XXIII; XXV^{me}. Classe des Lettres,
 Tomes XIX., XX., 1879–82.—*From the Academy.*
 Annales de la Société d'Agriculture, Histoire Naturelle, et Arts
 Utiles. 5^{me} Série, Tomes II., III., 1879. Tome III., 1880.
 8vo.—*From the Society.*
 Nouvelles Remarques sur la Réforme de la Nomenclature Botanique.
 Par le Dr Saint-Lager. Lyons, 1881. 8vo.
 Annales de la Société Botanique VIII^{me} Année, No. 1. 1881. 8vo.
 Musée Guimet. Annales, Tom. 1–3. 1880–81. Revue de
 l'Histoire des Religions. Tomes 1–4. 1880–81. 8vo.

- Madras.**—Report of a Tour in the Cuddapah and North Arcot Districts in 1879. By Charles Benson. Fol.
The Madras Journal of Literature and Science for 1879-80. 8vo.
- Madrid.**—Memorias de la Comision Geologica de España Provincia de Salamanca. 1880. 8vo.
Boletin de la Comision del Mapa Geologico de España. Tomo VII. Cuadernos 1, 2. 1880.—*From the Commission.*
Provincia de Cordoba. Islas de Tenerife, Ibiza, Formentera. Provincia di Oviedo. Tomo VIII. Provincia de Granada. Hundimientos en la Cuenca de Tremp. El Marmol de los Pireneos. 1881. 2. Guadajara, Islas de Luzon y Cuba. 1881.
- Manchester.**—Transactions of the Manchester Geological Society. Vol. XVI. 1880-81.—*From the Society.*
Literary and Philosophical Society. Memoirs, 3rd Series, Vol. VI., 1879. Proceedings, Vols. XVI.-XIX. 1877-80.
- Marseilles.**—Bulletin de la Société Scientifique Industrielle. Tomes I., II., III., IV., V., VI., VII., VIII. 1872-80.—*From the Society.*
- Milan.**—Reale Istituto di Scienze e Lettere. Memorie : Classe di Lettere e Scienze Morali e Politiche. Vol. XIII., Fasc. 5, 1880. Vol. XIV., Fasc. 1, 2. 1880-81. 4to. Rendiconti. Vol. XII. 1879.—*From the Institute.*
Atti della Società Italiana di Scienze Naturali. Vol. XXII., 1879-80. Vol. XXIII., 1880. 8vo.—*From the Society.*
Pubblicazioni del Reale Osservatorio di Brera in Milano. VII., Pt. 1. Osservazioni di Stelle Cadenti. 1868-70. XV. Sull' Umidità Atmosferica nel Clima di Milano. Risultati di 35 Anni di Osservazioni, (1845-79) calcolati da G. V. Schiaparelli XIX. Determinazione della Latitudine di Brera e di Parma. 1881. 4to. XX. Osservazioni Meteorologiche Orarie durante l'anno 1880, Da Celso Fornioni 1882. XXI. Determinazione della Differenza di Longitudine del Campidoglio in Roma et di Brera. 1881. 4to.—*From the Observatory.*
Atti della Società Crittogamologica Italiana. Vol. III., Disp. 1. 1881. 8vo.—*From the Society.*
- Modena.**—Memorie della Regia Accademia di Scienze Lettere ed Arti. Tom. XIX., XX. 1879-82. 4to.—*From the Academy.*
Annuario della Società dei Naturalisti. Anno XIV. (1880-81), Disp. 4.—*From the Society.*
- Montpellier.**—Académie des Sciences et Lettres de Montpellier : Mémoires de la Section des Sciences. Tome IX., Fasc. 3, 1879. Tome X., Fasc. 1, 1881.—Section des Lettres. Tome VI., Fasc. 4, 1878-79.—Section de Médecine. Tome V. 1877-79.—*From Academy.*
- Moscow.**—Annales de l'Observatoire de Moscou. Vol. VII., Livr. 1. Recherches sur les Queues des Comètes, par Th. Bredichin. 2. Sur le Coefficient thermométrique de la Réfraction. Par A. Socoloff. 3. Observations de Jupiter en 1879. Par J. Kortazzi. Parallaxes de quelques Étoiles. Par G. Schweizer.—*From the Observatory.*
Bulletin de la Société Impériale des Naturalistes de Moscou. Nos. 1, 2. Années 1880-81. 8vo.—*From the Society.*
Nouveaux Mémoires de la Société Impériale des Naturalistes de Moscou. Tome XIV., Livr. 2.
Bulletins de la Société Impériale des Amis d'Histoire Naturelle, d'Anthropologie, et d'Ethnographie. Tomes XXVI., Livr. 2, 3, 1880. XXXII., Livr. 2, 1880. XXXIII., Livr. 1, 1880. XXXIV., Livr. 2, 1882. XXXV., Livr. 3, 4, 1880-82. XXXVII., No. 2, 1880; Livr. 1, 2, 1881. XXXVIII., Livr. 3,

1880. XXXIX., Livr. 1, 1880. XLI., Livr. 1, 1881. XLII., 1881.—*From the Society.*
- Munich.**—Abhandlungen der k. Bayerischen Akademie der Wissenschaften Mathematisch-Physikalische Classe, Bde. XIII., Abtheil. 3, 1880. Bd. XIV., 1880.—Philosophisch-Philologische Classe, Bd. XV., 1^o Abtheil., 1880. Bd. XVI., 1 and 2^o Abtheil., 1881–82.—Historische Classe, Bd. XV., Abtheil. 1, 2, 3, 1880. Bd. XVI., 1881.
- Sitzungsberichte der Mathematisch-Physikalischen Classe der k. B. Akademie der Wissenschaften. 1881–82.—Der Philosophisch-Philol. und Historischen Classe, 1881–82. Bd. I., Hefte 4, 5, 1880. Bd. II., Hefte 1 to 5, 1881.
- Das Haus Wittelsbach und seine Bedeutung in der Deutschen Geschichte, von J. v. Döllinger. 1880. 4to.
- Die Pflege der Geschichte durch die Wittelsbacher. Verfasst von Dr. Ludwig Rockinger. 4to.
- Ueber dem Geologischen Bau der Libyschen Wüste. Festrede von Dr. Karl A. Zittel. 1880. 4to.
- Ignatius von Loyola an der Römischen Curie. Festrede von August von Druffel. 1879. 4to.
- Catalogus Codicum Latinorum Bibliothecæ Regiæ Monacensis. Tomi II., Pars IV. 1881. 8vo.—*From the Academy.*
- Naples.**—Atti della R. Accademia delle Scienze Fisiche e Matematiche. Vols. VII., VIII. 1878–79. 4to.
- Rendiconti della R. Accademia. Anni XV.–XVIII. 1876–79. 4to.—*From the Academy.*
- Mittheilungen aus der Zoologischen Station zu Neapel, Bde. II.–III. 1880–82. 8vo.—*From the Station.*
- Neuchatel.**—Bulletin de la Société des Sciences Naturelles de Neuchatel. Tome XII., Cahiers 1, 2, 3. 1880–82.—*From the Society.*
- New York.**—Bulletin of the American Museum of Natural History. Nos. 1, 2, 3. 1882. 8vo.—*From the Museum.*
- Nijmegen.**—Nederlandsch Kruidkundig Archief.—Verslagen en Mededeelingen der Nederlandsche Botanische Vereeniging. 2^e Serie, 3^e Deel, 3^e, 4^e Stuk. 1881.—*From the Society.*
- Norwich.**—Transactions of the Norfolk and Norwich Naturalists' Society, for 1880–82. Vol. III., Pts. 2, 3.—*From the Society.*
- Oberpfalz und Regensburg.**—Verhandlungen des historischen Vereines. Bde. XXXIV. to XXXVI. 1879–80. 8vo.—*From the Society.*
- Oxford.**—Results of Astronomical Observations at the Radcliffe Observatory in 1876–79. Vol. XXXVII. 8vo.—*From the Observatory.*
- Palermo.**—Hortus Botanicus Panormitanus, Auctore Augustino Todaro, Direttore. Tom. II., Fasc. 3. 1882. Fol.—*From the Director.*
- Paris.**—Comptes Rendus des Séances de l'Académie des Sciences. Sept. 1880 to Dec. 1882. 4to.
- Oeuvres complètes d'Augustin Cauchy, publiées sous la direction scientifique de l'Académie des Sciences. 1^{re} Sér. Tome I.
- Comptes Rendus de l'Académie des Inscriptions et Belles-Lettres. 1881–82.
- Mémoires de l'Académie des Inscriptions et Belles-Lettres. Tomes XXIX^e., XXX^e.. 1879–81.—*From the Academies.*
- Annales de l'École Normale Supérieure. Tome XL. 1882.
- Annales des Mines. Tomes XVIII., XIX., XX. 1880–81. 8^{me} Série. Tome I. 1882.—*From the French Government.*
- Bulletins des Séances de la Société Nationale d'Agriculture de France. 1880–82. 8vo.—*From the Society.*
- Bulletin Hebdomadaire de l'Association Scientifique de France. Nos. 68–146. Juillet 1881.—*From the Association.*

- Paris.—Bulletins de la Société de Géographie. Juillet 1880 to Octobre 1881-82. Comptes Rendus, 1882.—*From the Society.*
- Société Géologique de France.—Bulletins. 2^e Série, Tomes V.-XII. Tomes XIV.-XVIII. Tomes XX.-XXIX. 3^e Série. Tomes I.-X. 1847-1882.—Mémoires, 3^e Série. Tomes I.-II. 1887-82.—*From the Society.*
- Annales Hydrographiques. 1881-82.—*From French Government.*
- Annales de l'Observatoire de Paris. Observations, les Tomes pour 1870-78. 4to.—Mémoires, Tomes XVI. 1882. 4to.
- Rapport Annuel sur l'État de l'Observatoire de Paris par M. le Contre-Amiral Mouchez pour l'Année, 1880.—*From Observatory.*
- Journal de l'École Polytechnique. Tome XXVIII., 1879; XXIX. 1880; XXXI., 1881.—*From the School.*
- Bulletins de la Société Mathématique de France. Tomes IX., X. 1880-82. 8vo.—*From the Society.*
- Les Mondes. Revue Hebdomadaire des Sciences. Par M. l'Abbé Moigno. Tome LV., Nos. 7, 8, 9, 10. 1881.
- Muséum d'Histoire Naturelle. Rapports Annuels de MM. les Professeurs et Chefs de Service. 1879-80.—*From the Museum.*
- Nouvelles Archives du Muséum d'Histoire Naturelle. 2^{me} Série.—Tome III., 1^{er} Fasc. Étude sur la Faune Ichthyologique de l'Ogooué. Par H. E. Sauvage. Revision des Garidiées du Muséum d'Histoire Naturelle. Par M. Victor Bertin.—Recherches sur les Écureils Africains. Par M. Huet. 1880. 4to.—2^{me} Fasc. Recherches d'Ostéologie comparée sur une Race de Bœufs en Senegambie. Par le Dr. Rochebrune. 1880. Recherches sur la Maturation de quelques Plantes Herbacées. Par M. M. Dehérain et E. Bréal. Quelques Remarques au sujet des Plaqueminiens. Par Ch. Naudin. Recherches Stratigraphiques et Paléontologiques sur les Tables marines de Pierrefitte. Par M. M. Meunier et Lambert. Revision des Ophidiens Fossiles. Par le Dr. Rochebrune.—Observations de Température pendant les Années Météorologiques 1878-79. Par MM. E. et H. Becquerel. 4to.—Tome IV., 1^{er} Fasc. De l'Anatomie des Tissus appliquée à la Classification des Plantes. Par M. Julien Vesque.—Revision des Donacidiées du Muséum d'Histoire Naturelle. Par M. Victor Bertin.—Recherches sur la Faune Ichthyologique de l'Asie et Description d'Espèces Nouvelles de l'Indo-Chine. Par M. H. E. Sauvage. 4to.—Revision des Clématites du Groupe des Tubuleuses. Par M. J. Decaisne.—Flore des Isles du Cap-Vert. Par M. de Rochebrune.—Documents Anthropologiques recueillis en Cafrerie. Par M. E. T. Hamy.—Observations faites pendant 1879-80, avec les Thermomètres Électriques. Par MM. E. et H. Becquerel.—*From the Museum.*
- Journal de l'École Polytechnique. Tome XXIX. Paris, 1880. 4to.
- Publications du Dépôt de la Marine, 1881, 1882.
- Philadelphia.—Proceedings of the American Philosophical Society for Promoting Useful Knowledge. Nos. 105-109. 1880-81. 8vo.—Transactions. New Series, Vol. XV., Pt. 3. 1881.—*From the Society.*
- Proceedings of the Academy of Natural Sciences for 1880-81.—*From the Academy.*
- Journal of the Academy of Natural Sciences. Vol. VIII., Pt. 4. 1874-81. 4to.
- Pisa.—Il Nuovo Cimento. 3^{ma} Serie. Tom. VIII., 1880-81. Tom. IX., 1881.—*From the Editor*

- Poulkova.**—*Librorum in Bibliotheca Speculæ Pulcovenis cententorum Catalogus Systematicus.* Pars 2^{da}. 1880. 8vo.
 Nicolai-Hauptsternwarte. Jahresbericht für 1878–79 und 1879–81. 8vo.
 Observations de Poulkova, publiées par Otto Struve. Vol. XI. 1879. Fol.—*From the Observatory.*
- Prague.**—Astronomische, Magnetische, and Meteorologische Beobachtungen an der K. K. Sternwarte zu Prag, in 1881.—*From the Observatory.*
- Quebec.**—Transactions of the Literary and Historical Society of Quebec. Sessions of 1880–81, 1881–82. 8vo.—*From the Society.*
- Rhineland and Westphalia.**—Verhandlungen des Naturhistorischen Vereines der preussischen Rheinlande u. Westfalens. 1880–81.
 Rio de Janeiro.—Bulletin Astronomique et Météorologique de l'Observatoire Impériale. Nos. 1–6, 1881; Nos. 1–9, 1882. 4to.
 Instrucções para observar a Passagem de Venus pelo disco do Sol em 5–6 Dezembro de 1882. 1882. 4to.—*From the Observatory.*
- Rome.**—Atti della R. Accademia dei Lincei. Transunti, Vola. V., VI. 1881–82.
 Memorie. Classe di Scienze Fis., Mat., e Nat. Serie II. Vola. V., VI., VII. 1880. Serie III. Vola. VI., VII., VIII. 1881–82.—Classe di Scienze Morali, Storiche e Philol. Vola. IV., V., VI. 1881–82.
 Osservazioni astronomiche e fisiche del Pianeta Marte di G. V. Schiaparelli. 1881. 8vo.—*From the Academy Dei Lincei.*
 Memorie della Società degli Spettroscopisti Italiani. Vola. IX., X., XI. 1880–81–82. 8vo.—*From the Society.*
- Roorkee.**—Roorkee Hydraulic Experiments. By Capt. Allan Cunningham, R.E. Vol. I., Text. Vol. II., Tables. Vol. III., Plates. 1880–81.
- Shanghai.**—Journal of the North China Branch of the Royal Asiatic Society. New Series. Vola. XV., XVI. 1880–82.
- Saint Louis.**—Contributions to the Archæology of Missouri, by the Archæological Section of the St. Louis Academy of Science. Part 1, Pottery. 1880. 4to.
 Transactions of the Academy of Science. Vol. IV. No. 2. 1882. 8vo.—*From the Academy.*
- St. Petersburg.**—Bulletins de l'Académie Impériale des Sciences de St. Pétersbourg. Tomes XXVII., 1881; XXVIII., 1882.
 Mémoires de l'Académie Impériale des Sciences:—Tome XXVII., No. 5. Die Foraminifern des Russischen Kohlenkalks. Von Val. v. Möller. 1879. 4to. No. 6. Studien über die Spongien des Russischen Reiches, mit besonderer Berücksichtigung der Spongien-Fauna des Baikal-Sees. Von Dr. W. Dybowski. 1880. 4to. No. 7. Der erste Fund einer Leiche von Rhinoceros Merckii. Von Dr. Leop. v. Schrenck. No. 8. Pflanzen-Geographische Betrachtungen über die Familie der Chenopodiaceen. Von Al. Bunge. 1880. 4to. No. 9. Ueber den anomalen Canalis Basilaris Medianus des Os Occipitale beim Menschen. Von Dr. Wenzel Gruber. No. 10. Nachträge zur Jura-Flora Sibiriens. Von Dr. Oswald Heer. No. 11. Études sur le Mouvement Relatif des deux Étoiles du Système de 61 Cygni. Par O. Struve. 1880. 4to. No. 12. Ein Cycclus Fundamentalbarometrischer Höhenbestimmungen auf dem Armenischen Hochlande. Von H. Abich. No. 13. Ueber die Entwicklungsgeschichte der Keimblätter, und des Wolff'schen

Ganges in Hühnerlei. Von J. Dansky und J. Kostenitsch. 1880. No. 14. Die Spermatogenese bei den Säugethieren. Von E. Meyer. 1880.—Tome XXVIII., No. 1. Über das Bonpo-Sutra. Von A. Schiefner. 4to. No. 3. Theori der Magnetischen Dämpfer. Von O. Chwolson. 1880. No. 4. Untersuchungen über die Pflanzenathmung. Von J. Borodin. 1^{te} Abh. 1881. No. 5. Die Jura-Ablagerungen an der oberen Wolga. Von S. Nikitin. 1881. No. 6. Zur Theorie der Enke'schen Cometen. Von O. Bachlund. 1881. No. 7. Die Handbücher des Geistlichen Rechts aus der Zeiten des Byzantinischen Reiches und der Türkischen Herrschaft. Von E. Z. von Lingenthal. 1881. No. 8. Studien über die Fossilen Reptilien Russlands. Von W. Kiprijanoff. 1 Th. Ichthyosaurus König. 1881. 4to. No. 9. Anatomie des Darmkanals. Von A. Tarenetzky. 1881. 4to.—Tome XXIX., No. 1. Einblikke in das Ferghana-Thal Von A. von Middendorff. No. 2. Neue Integrations-Wege. Von Prof. P. Helmling. 1881. No. 3. De Coriaria, Ilice, et Monochasmate, Bungea et Cymbaria. 1881. No. 4. Ueber die thermische Ausdehnung des Meerwassers. Von R. Lenz. 1881.—Tome XXX., No. 1. Revision der Ostbaltischen Silurischen Trilobiten, nebst Uebersicht des Ostbaltischen Silurgebiets. Von F. Schmidt. 1881. No. 2. Sur l'Oxyde de Sodium Anhydre. Par N. Beketoff. 1882. No. 3. Das Magnetische Ungewitter von 30 Jan. bis 1 Feb. 1881. Von H. Wild. 4to. No. 5. Wanderblöcke und Diluvialgebilde Russlands. Von G. von Helmersen. 1882. 4to.

St. Petersburg.—Tableau Général Alphabétique des Matières contenues dans les Publications de l'Académie Impériale des Sciences de St. Pétersbourg. Supplement 1. Publications depuis 1871, jusqu'à November, 1881. 1882. 8vo.—*From Academy.*

Comptes-Rendus de la Commission Impériale Archéologique pour l'Année. 1880. 4to., avec Atlas, folio.—*From the Commission.*

Journal Russkago Phisico-Chimicheskago Obtschestva. Tom. XIII., XIV. 1881-82. 8vo.—*From the Society.*

Bulletin de la Commission Polaire Internationale. Hfte, 1, 2, 3. 1881-82. Fol.—*From the Commission.*

Annalen des Physicalischen Central-Observatoriums. Jahrg. 1878-81.

Repertorium für Meteorologie, herausgegeben von der Kaiserlichen Akademie der Wissenschaften. Bd. VII., Heftet 1, 2. 1880. 4to.

Die Temperatur-Verhältnisse des Russischen Reiches, von H. Wild, Supplementband zum Repertorium für Meteorologie und Atlas. 1881. Fol.—*From the Central Observatory.*

Salem.—Essex Institute Historical Collections. Vols. XVI.-XVIII. 1880-82.

Bulletin of the Essex Institute. Vols. XI.-XIII.—*From Institute.*

Stockholm.—Astronomiska Jakttagelser. Bd. 1-5. 1878-81. 8vo.

Öfversigt af Kong. Vetenskaps Akademiens Förhandlingar. Bd. XXXIV., 1877; XXXV., 1878; XXXVI., 1879; XXXVII., 1880. 8vo.

Handlingar. Ny Följd. Bd. XIV., 2, 1876; XV., 1877; XVI., 1878; XVII., 1879.

Bihang till Kong. Svenska Vetenskaps-Akademiens Handlingar. Bd. IV., 1, 2, 1875-76; Bd. V., 1, 2, 1877-78. 8vo.

Minnesteckningar öfver Carlander, Hallenberg, Carl von Linné, Bjerken, Sundeval, Ångström.—*From the Academy.*

- Stuttgart*.—Jahreshefte des Vereins für vaterländische Naturkunde in Württemberg, 37^{ter} Jahrg. 1881, 38^{ter} Jahrg. 1882.
- Switzerland*.—Nouveaux Mémoires de la Société Helvétique des Sciences Naturelles. Band XXVIII., Liv. 1. 1881. 4to.—*From Society*.
- Europäische Gradmessung. Das Schweizerische Dreiecknetz, herausgegeben von der Schweizerischen Geodätischen Commission. Bd. 1. Zürich. 4to.—*From the Commission*.
- Verhandlungen der Schweizerischen Naturforschenden Gesellschaft, 1879–80, 1880–81. 8vo.—*From the Society*.
- Sydney*.—The Proceedings of the Linnean Society of New South Wales, Vols. I.–VII., Parts 1, 2. 1876–1882.—*From the Society*.
- Transactions and Proceedings of the Royal Society of New South Wales. Vols. XIII., XIV. 1879–81. 8vo.—*From the Society*.
- Annual Reports of the Department of Mines for 1878, 1879, with Maps. 1879. 4to.
- Australian Museum. Catalogue of the Australian Stalk- and Sessile-Eyed Crustacea. By William A. Haswell, M.A. Sydney, 1882. 8vo.—*From the Museum*.
- Toronto*.—The Canadian Journal and Proceedings of the Canadian Institute. New Series. Vol. I., Parts 1, 2. 1880.—*From the Institute*.
- Trieste*.—Bolletino della Società Adriatica di Scienze Naturali. Vol. VI., 1881; Vol. VII., 1882.—*From the Society*.
- Tromsö*.—Tromsö Museum Aarshefter. Nos. 3, 4. 1880–81.—*From the Museum*.
- Turin*.—Memorie della Reale Accademia delle Scienze di Torino. Serie Seconda, Tom. XXXII., 1880. 4to. XXXIII., 1881. Ornitologia della Papuasias e delle Molucche, di Tommaso Salvadori. 4to.
- Atti della R. Accademia delle Scienze di Torino. Vol. XV. 1879–80; Vol. XVI., Disp. 6, 7.—*From the Academy*.
- Bolletino dell'Osservatorio della Regia Università di Torino. Anni XIV., XV., XVI. 1879–1881.—*From the University*.
- Effemeridi del Sole, della Luna, e dei Principali Pianeti per l'anno 1882, del Prof. Angelo Charrier. Torino, 1880. 8vo.
- United States, Salem*.—Proceedings of the American Association for the Advancement of Science, 28th Meeting, held at Boston, August 1880. 8vo.—*From the Association*.
- Upsala*.—Bulletin Météorologique Mensuel de l'Observatoire de l'Université d'Upsal. Vol. VIII., Année 1876; Vols. XI., XII., Années 1879, 1880, 1881. 4to.—*From the Observatory*.
- Nova Acta Regiæ Societatis Scientiarum Upsaliensis. Ser. 3^a. Vol. X., 1879; Vol. XI., Fasc. 1, 1881.—*From the Society*.
- Utrecht*.—Verslag van het Verhandelde in de Provinciaal Utrechtsch Genootschap van Kunsten en Wetenschappen, 1879, 1880, 1881. Aanteekeningen van het Provinciaal Utrechtsch Genootschap. 1879–82.—*From the Society*.
- Het Klooster te Windesheim. Door J. G. R. Acquoy, 3^e Deel. 1880. 8vo.
- De Polybii Fontibus et Auctoritate Dissertatio. Scripsit J. M. J. Valetton. 1879. 8vo.
- Het Leven en de Verdiensten van Petrus Camper. Door C. E. Daniels, Med. Doct.
- Het Leven van M. Nicolaas C. Witzten. 1641–1717. Door J. F. Gebhard. 2 vols., 1881. 8vo.
- De Nederlandsche Scheikundigen van het laatst der vorige Eeuw. Door Dr. Van der Horn van den Bos. 1881. 4to.

- Utrecht.*—*Commentatio de Ajacis Sophoclei Authentia et Integritate.*
Scripsit J. van Leeuwen. 1881. 8vo.
Geschiedenis van de Kerspelkirk van St. Jacob te Utrecht. Door
M. Th. H. F. van Riemsdijk. 1882. Fol.
- Venice.*—*Atti del Reale Istituto Veneto di Scienze, Lettere ed Arti.*
Tomo 4^{to}, 1877-78; Tomo 5^{to}, Disp. 1-10, 1878-79; Tomo VI.,
Disp. 1-10, 1879-80; Tomo VII., Disp. 1-9, 1880-81.—*From*
the Institute.
Monographia Stratigraphica e Palaeontologica del Lias nelle Pro-
vincie Venete, del Professor Torquato Taramelli. Venezia, 1880.
Fol.
- Victoria.*—*Transactions and Proceedings of the Royal Society of Victoria.*
Vols. XVII., XVIII. 1881-82.—*From the Society.*
Statistical Register and Australian Statistics for the years 1879-80,
1880-81, with a Report by the Government Statist.
Victorian Year-book for 1879-80. 8vo.—*From the Victorian*
Government.
- Vienna.*—*Denkschriften der K. Akademie der Wissenschaften. Math.-*
Naturwissenschaftliche Classe. Bd. II., Lief. 1, 2, 3, 1849-50;
Bd. III., Lief. 1, 2, 3, 1850; Bd. IV., Lief. 1, 2, 1851; Bd. V.,
Lief. 1, 2, mit Tafeln, 1851-52; Bd. XV., 1857; Bd. XVI.,
1857-58; Bd. XL., Bd. XLI., Bd. XLII., 1880; Bd. XLIII.,
1881; Bd. XLIV., 1882.—*Philosophisch-historische Classe.* Bd.
II., Lief. 1, 2, 1849; Bd. III., 1858-51; Bd. IV., 1851; Bd.
V., 1852-53; Bd. XXI., 1871-72; Bd. XXX., 1879; Bd. XXXI.,
1881; Bd. XXXIII., 1882.
Sitzungsberichte der Mathemat.-Naturwissenschaftlichen Classe.
1^{te} Abtheil. Bde. LXXXIX.-LXXXV., 1879-80; 2^{te} Abtheil.,
Bde. LXXXI.-LXXXIV., 1880-82; 3^{te} Abtheil. Bd. LXXX-
LXXXIV., 1880-82.—*Philosoph.-Historische Classe.* Bde.
XCIV.-XCIX., 1879-82.
Almanach der K. Akademie der Wissenschaften für 1880.—*From*
the Academy.
Zeitschrift der Oesterreichischen Gesellschaft für Meteorologie.
Bd. XIV. September 1880-82.—*From the Society.*
Jahrbücher der K. K. Central Anstalt für Meteorologie und
Erdmagnetismus, Jahrg., Neue Folge; Bde. XV., XVI., XVII.
1878-1881. 4to.—*From the Institute.*
Verhandlungen der K. K. Geologischen Reichsanstalt. 1879-82.
Abhandlungen der K. K. Geologischen Reichsanstalt. 1880-82.
4to.
Die Gasteropoden der Meeres-Ablagerungen der ersten und zweiten
Miocänen Mediterran-Stufe in der Oesterreichisch-Ungarischen
Monarchie, von R. Hoernes und M. Auinger. 1880. Fol.
Neue und wenig bekannte Conchylien aus dem Ostgalizischen
Miocän von Dr. V. Hilber. 1882. Fol.
Die Cephalopoden der Mediterranen Triasprovinz. Von Dr. E.
Mojsisovics von Mojsvar. 1882. Fol.
Jahrbücher der K. K. Geologischen Anstalt. Jahrg. 1880; Bd.
XXXI., 1881; Bd. XXXII., 1882.—*From the Institute.*
Verhandlungen der K. K. Zoologisch-Botanischen Gesellschaft.
Bd. XXX. 1881-82.—*From the Society.*
- Warwick.*—*Proceedings of the Warwickshire and Archæologists' Field*
Club. 1879-81. 8vo.
- Washington.*—*Bureau of Navigation, Navy Department, Astronomical*
Papers. Vol. I., Part I. Table of Eclipses, 1879. Part II.
Transformation of Hansen's Lunar Theory. 1880. 4to. Part

III. Velocity of Light. 1880. 4to. Part V. On Gauss's Method of Computing Secular Perturbations. 1881. 4to.

- Washington*.—United States Naval Observatory.—Washington Observations for 1876, Appendix III. Reports on the Total Solar Eclipse of July 29, 1878, and January 11, 1880. 4to.—United States Coast Survey. Vols. for 1858 and 1877. 4to.—Observations of Double Stars made at the United States Naval Observatory. By Asaph Hall. 1881. 4to.—Astronomical and Meteorological Observations made during the years 1876 and 1877. Vols. XXIII., XXIV. 4to.
- Signal Service Office—War Department.—Report of the Chief Signal Officer, General W. B. Hazen, for 1879. 8vo.
- Professional Papers of the Signal Service:—No. 1. Total Eclipse of the Sun, July 1878. 4to.—No. 2. Isothermal Lines of the United States, 1871–80. 4to.—No. 3. Chronological List of Auroras, 1870–79.—No. 4. Tornadoes of May 29 and 30, 1879.—No. 5. Construction and Maintenance of Time-Balls.—No. 6. Reduction of Air-Pressure to Sea-Level at Stations west of Mississippi River. 1880.—No. 7. Report on the Character of Six Hundred Tornadoes. By Sergeant J. P. Finley. 1882. 4to.
- First Annual Report of the Bureau of Ethnology to the Secretary of the Smithsonian Institution, 1879–80. By J. W. Powell, Director. 1881. 8vo.
- First Annual Report of the United States Geological Survey. 1880. 8vo.
- Report of the United States Surveys west of the One Hundredth Meridian, in charge of Lieutenant G. M. Wheeler.—Vol. II. Astronomy and Barometric Hypsometry. 1877. 4to.—Vol. III. Geology (Nevada, Utah, California, Arizona, New Mexico, Colorado). 1875. 4to.—Vol. IV. Palæontology. 1877. 4to.—Vol. V. Zoology. 1875. 4to.—Vol. VI. Botany (Nevada, Utah, Colorado, New Mexico, and Arizona). 4to.—Vol. VII. Archaeology. 1879. 4to.
- United States Geographical and Geological Survey of the Rocky Mountain Region (J. W. Powell in charge). Report on the Geology of the High Plateaus of Utah, with Atlas. By Captain C. E. Dutton. Washington, 1880. 4to.
- Bulletin of the United States Geological and Geographical Survey of the Territories. Vol. V., No. 4, 1880; Vol. VI., Nos. 1, 2, 1881.
- Report of the Superintendent of the United States Coast and Geodetic Survey during the Years 1858 and 1878. 4to.
- Bulletin of the United States Geological and Geographical Survey of the Territories. Vol. VI. No. 3. Bibliography of Cetacea and Sirenia. By Joel Asaph Allen. 1882. 8vo.
- Smithsonian Miscellaneous Collections. Vols. XVIII–XXI. 1880–81. 8vo.
- Smithsonian Contributions to Knowledge. Vol. XXIII. 4to. 1881.—Lucernariae and their Allies. By H. J. Clark.—The Geology of Lower Louisiana, &c. By Dr. E. W. Hilgard.—On the Internal Structure of the Earth considered as affecting the Phenomena of Precession and Nutation. By J. G. Barnard.—A Classification and Synopsis of the Trochilidæ. By D. G. Elliot, F.R.S.E.—Fever: A Study in Morbid and Normal Physiology. By Dr. H. C. Wood.
- Smithsonian Reports for 1879, 1880. 8vo.

- Washington*.—Bulletin of the United States National Museum. Part 2, 1875; Part 3, 1876; Part 7, 1877. 8vo.
 Proceedings of the United States National Museum. Vol. I., 1878; Vol. II., 1879; Vol. III., 1880. Nos. 1-27.
 Bulletin of the Philosophical Society of Washington. Vols. I., II., III. 1874-1880. 8vo.
- Wellington*.—Transactions and Proceedings of the New Zealand Institute. Vols. XIII., XIV. 1881.—*From the Institute*.
 Fifteenth and Sixteenth Annual Reports of the Colonial Museum and Laboratory. 1880-82. 8vo.
 Reports of Geological Explorations (New Zealand) during 1874-76, 1876-77, 1878-79, 1879-80, with Maps and Sections. 8vo.—*From the New Zealand Institute*.
 Manual of the Birds of New Zealand. By Walter L. Buller, F.R.S. 1882. 8vo.
 Manual of the New Zealand Coleoptera. By Captain Thomas Brown. 1880. 8vo.
 Palaeontology of New Zealand. Part IV. Corals and Bryozoa of the Neozoic Period. By Rev. J. E. T. Woods. 1880. 8vo.
 Manual of the Birds of New Zealand. By Dr. Walter L. Buller, C.M.G. 1882. 8vo.
 New Zealand Thermal Springs District. Rotorna.—*From the Government Survey, Dr. Hector, Director*.
 Meteorological Report for 1880, including Returns for 1877-78-79. 8vo.
- Zurich*.—Vierteljahrsschrift der Naturforschenden Gesellschaft in Zürich. 24^{er} Jahrg. 1879, 25^{er} Jahrg. 1880.—*From the Society*.
 Schweizerische Meteorologische Beobachtungen. 15^{er} Jahrg. 1878; 6^{te}, 7^{te} Lief., 16^{er} Jahrg. 1879; 5^{te} Lief. 17^{er} Jahrg. 1880; 18^{er} Jahrg., 1-4, 1881.—*From the Swiss Meteorological Observatory*.

II. FROM AUTHORS. 1880-82.

- Abernethy (James), F.R.S.E. Address on taking the Chair as President of the Institution of Civil Engineers, 11th Jan. 1881. 8vo.
- Balfour (Professor John Hutton), F.R.S.E. Sketch of the Life of Professor J. H. Balfour, read at a Meeting of the Carson H. Pillans Club in 1876. Edinburgh. 4to.
- Ballard (Robert). The Solution of the Pyramid Problem; or Pyramid Discoveries, with a New Theory as to their Ancient Use. New York, 1882. 8vo.
- Beddoe (John), M.D., F.R.S. The Progress of Public Health in our own Times. Presidential Address (Brit. Med. Association). Bristol, 1879. 8vo.
- Address on Health; A Paper read at the Meeting of the Social Science Congress in Edinburgh, 1880. 8vo.
- Bellati (E. M.). See Naccari (A.).
- Blackie (Professor John Stuart), F.R.S.E. Homer and the Iliad. Edinburgh, 1866. 4 vols., 8vo.
- On Beauty. Three Discourses delivered in the University of Edinburgh. With an Exposition of the Doctrine of the Beautiful according to Plato. Edinburgh, 1858. 8vo.
- Buchan (Alexander), M.A., F.R.S.E. The Weather and Health of London. London, 1881. 8vo.
- Burnham (S. W.), F.R.A.S. Quadruple Stars. London, 1881. 8vo.

- Chambers (F.). Brief Sketch of the Meteorology of the Bombay Presidency in 1879. 8vo.
- Abnormal Variations of Barometric Pressure in the Tropics and their relation to Sun-spots, Rainfall, and Famines. 1880. Fol.
- Chelini (Domenico). In memoriam Dominici Chelini: *Collectanea Mathematica, nunc primum edita curâ et studio L. Cremona et E. Beltrami.* Mediolani, 1881. 8vo.
- Clark (Latimer). Mr. Latimer Clark: Sketch of his Life and Work. By H. T. Humphreys. Dublin, 1881. 8vo.
- Darwin (Charles). Note sur Charles Darwin. Par M. De Quatrefages. Paris, 1882. 4to.
- Daubrée (M. le Professeur). *Études Synthétiques de Géologie Expérimentale.* 2^{me} partie. Paris, 1879. 8vo.
- Examen des Matériaux provenant des Forts Vitifiés de Craig Phadrick, près Inverness (Écosse) et de Hartmannswillerkopf (Haute-Alsace). Paris, 1881. 8vo.
- Examen Minéralogique et Chimique de Matériaux provenant de quelques Forts vitifiés de la France; Conclusions qui en résultent. Paris, 1881. 8vo.
- Denny (W.), F.R.S.E. On Local Education in Naval Architecture. London, 1881. 4to.
- The Economical Advantages of Steel Shipbuilding. Edinburgh, 1881. 8vo.
- On Cooking and Heating by Gas. Dumbarton, 1881. 8vo.
- On the Speed and Carrying of Screw Steamers. Greenock, 1882. 8vo.
- Fayrer (Sir Joseph), M.D. Rainfall and Climate of India. London, 1881. 8vo.
- Fievez (Ch.). Note sur l'Analyse de la Lumière de la Comète (b), de 1881. Bruxelles, 1881. 8vo.
- Recherches sur l'Élargissement des Raies spectrales de l'Hydrogène. Bruxelles, 1881. 8vo.
- Fleming (Sandford). The Adoption of a Prime Meridian to be common to all Nations. The Establishment of Standard Meridians for the Regulation of Time. London, 1881. 8vo.
- Gamgee (Sampson), F.R.S.E. The Influence of Vivisection on Human Surgery. London, 1882. 8vo.
- Guccia (M. J.) de Palerme. Sur une Classe de Surfaces représentables, Point sur Point, sur un Plan. Paris, 1880. 8vo.
- Haan (D. Brerens de). Sur le Role de nos Ingénieurs Hollandais dans l'Emploi des Lignes de Niveau.
- Hallard (Frederick), Sheriff-Substitute of Midlothian. A few Words on the Law and Legislation of the Past Year. Edinburgh, 1880. 8vo.
- Harkness (William). On the Relative Accuracy of Different Methods of Determining the Solar Parallax. Washington, 1881. 8vo.
- Herman (Otto). Sprache und Wissenschaft. Budapest, 1881. 8vo.
- Hevelius. The Illustrated Account given by Hevelius in his "Machina Celestia" of the Method of Mounting his Telescopes and Erecting an Observatory. By C. Leeson Prince, F.R.A.S. 1882. 8vo.—From C. L. Prince, F.R.A.S.
- Hildebrandsson (H. H.). Marche des Isothermes au Printemps dans le Nord de l'Europe. 1880. 4to.
- Hinde (George Jennings), F.G.S. Fossil Sponge Spicules from the Upper Chalk, found in the Interior of a single Flint-stone from Horstead in Norfolk, Munich, 1880. 8vo.
- Honeyman (Rev. D.). Nova Scotian Geology—Digby and Yarmouth Counties. 1880. 8vo.

- Hull (Edward), LL.D., F.R.S. On the Geological Structure of the Northern Highlands of Scotland. Dublin, 1880. 8vo.
- Kolliker (A.). Neber die Lage der weiblichen Enneren Geschlechtsorgane. 1881. 4to.
- Loomis (M. Elias). Mémoires de Météorologie Dynamique. Traduits de l'Anglais, par M. H. Brocard. Paris, 1880. 8vo.—*From M. l'Abbé Moigno.*
- M'Cosh (John), M.D. Grand Tours in many Lands: a Poem. Lond., 1881. 8vo.
- Macdonald (Richard Hayes). Notes preparatory to a Biography of Richard Hayes Macdonald of San Francisco, California. By his eldest child, Frank V. Macdonald. Vol. I. Cambridge, 1881. 4to.—*From F. V. Macdonald, Esq.*
- Macfie (R. A.), F.R.S.E., of Dreghorn. Cries in a Crisis. 1881. ——— Literary Copyright. 1881. 8vo.
- Massey (Gerald). A Preface to, with Extracts from A Book of the Beginnings. Lond., 1880. 8vo.
- Mexican Publications. Anales del Museo Nacional de Mexico. Tomo 1. 1877. Fol.—Boletin de la Sociedad de Geografia y Estadistica de la Republica Mexicana. Tercera Epoca, Tomo I. 1873. 8vo.—*From Patrick Geddes, Esq., F.R.S.E.*
- Moore (F.). The Lepidoptera of Ceylon. Part 1. 1880. 4to.
- Murray (John), F.R.S.E., and Staff-Commander Tizard, R.N. Exploration of the Faroe Channel during the Summer of 1880, in H.M.S. "Knight-Errant." Edin. 1882. 8vo.
- Nacari (A.) e Bellati (E. M.). Sul Riscaldamento dei Corpi Isolanti solidi e liquidi in causa di successive Polarizzazioni Elettrostatiche. Torino, 1882. 8vo.
——— Sui Fenomeni Termici prodotti dalla Scintilla d'Induzione. Torino, 1882. 8vo.
- Nicholson (Professor H. Alleyne), F.R.S.E., and Etheridge (Robert) Jun. A Monograph of the Silurian Fossils of the Girvan District in Ayrshire, with Special Reference to those contained in the "Gray Collection." Fasc. III. 1880. 8vo.—*From Robert Gray, Esq., F.R.S.E.*
——— On the Structure and Affinities of the Genus Monticulipora and its Sub-Genera, with Critical Descriptions of Illustrative Species. Edin. 1881. 8vo.
- Oppelt (Gustave). Navigation Aérienne, par les Ballons. Bruxelles, 1882. 8vo.
- Pettersen (Karl). Lofoten og Vesteraalen. 1880. 8vo.
- Ponton (Mungo), W.S., F.R.S.E. The Beginning: Its When and How. Lond. 1871. 8vo.
——— Glimpses of the Future Life, with an Appendix on the Probable Law of Increase of the Human Race. Lond. 1873. 8vo.
——— Songs of the Soul: Philosophical, Moral, and Devotional, 2nd edition. Bristol, 1877. 8vo.
——— The Freedom of the Truth. London. 8vo.
——— Instructive Rhymes of Olden Times. Bristol. 8vo.—*From Mrs. Ponton.*
- Phlogaitis (Th. N.). Φλογαίτις (Θεόδωρος Ν.) Εγχειριδιον Συνταγματικου Δικαιου. Αθηνησι, 1879. 8vo.
- Pole (William), F.R.S.E., LL.D. A Study of the Problem of Aerial Navigation as affected by recent Mechanical Improvements. London, 1882. 8vo.
- Price (John), Mem. Inst. M.E. On Iron and Steel as Constructive Materials for Ships. Lond. 1881. 8vo.

- Reade (T. Mellard). *The Glacial Beds of the Clyde and Forth.* 1880. 8vo.
- Retzius (Gustaf). *Das Gehörorgan der Wirbelthiere, morphologisch-histologische Studien. I. Das Gehörorgan der Fische und Amphibien, mit 35 Taf.* Stockholm, 1881. Fol.
- Rutherford (William), Professor, F.R.S.E. *An Experimental Research on the Physiological Action of Drugs on the Secretion of Bile.* Edin. 1879. 4to.
- Sadler (John). *The Flowering of Yucca gloriosa in the Royal Botanic Garden.* Edin. 1879. 4to.
- *Report of the Temperatures during the Winter of 1879–80 at the Royal Botanic Garden, Edinburgh, and the Effects of the same on Open-Air Vegetation.* 1881. 8vo.
- Saint Lager (Le Dr.). *Nouvelles Remarques sur la Nomenclature Botanique.* Paris, 1881. 8vo.
- Scheffler (Dr. Hermann). *Die Naturgesetze, und ihr Zusammenhang mit den Prinzipien der abstrakten Wissenschaften.* 4^{te} Theil. 1881. 8vo.
- *Das Wesen der Elektrizität, des Galvanismus, und Magnetismus.* 2^{te} supplement zum 2^{ten} Theile der Naturgesetze. Leipz. 1882. 8vo.
- Slafter (Rev. E. F.). *History and Causes of the Incorrect Latitudes as recorded in the Journals of the Early Navigators relating to the Atlantic Coast of North America, 1535–1740.* Boston, 1882. 8vo.
- Smith (John Alexander), M.D., F.R.S.E. *Note on the Horn of a Rhinoceros, stated to have been found in a Marl Pit in Forfarshire.* 4to.
- *Notes on Mediæval "Kitchen Middens," recently discovered in the Monastery and the Nunnery on the Island of Iona.*
- *Notice of the Remains of the Great Auk, or Gare-Fowl (*Alca impennis*, Linn.), found in Caithness; with Notes of its Occurrence in Scotland and of its Early History.* 4to.
- *Additional Notes to the above Notice of the Remains of the Great Auk.* 4to.
- Smyth (Professor C. Piazzi), Astronomer-Royal for Scotland, F.R.S.E. *Madeira Meteorologic.* Edinburgh, 1882. 4to.
- *Madeira Spectroscopic: being a Revision of 21 Places in the Red Half of the Solar Visible Spectrum, with a Rutherford Diffraction Grating.* Edinburgh, 1882. 4to.
- Stevenson (Thomas), F.R.S.E., F.G.S., Mem. Inst. C.E. *Lighthouse Construction and Illumination.* 1881. 8vo.
- Tilden (William A.). *Introduction to the Study of Chemical Philosophy. The Principles of Theoretical and Systematic Chemistry.* 2nd ed. London, 1880. 12mo.
- Tizard (Staff-Commander) and Murray (John). *Exploration of the Faroe Channel.*—See Murray (John).
- Tweeddale (Arthur, 9th Marquis of), F.R.S.E. *The Ornithological Works of Arthur, 9th Marquis of Tweeddale.* Reprinted from the Originals by the desire of his Widow. Edited and Revised by his Nephew, R. G. Wardlaw Ramsay, with a Biographical Sketch of the Author, by William Howard Russell, LL.D. London, 1881. 4to.
- Whipple (G. M.), F.R.A.S. *On the Rate at which Barometric Changes traverse the British Isles.* London, 1880. 8vo.
- Wulff (Ludwig). *Ueber die scheinbare Tetartoëdrie der Alaune.* 1880. 8vo.

INDEX.

- Absorption of Sea-Water, by John Aitken, 637.
- Adamantine Carbon or Diamond: Its Preparation, by Dr. R. S. Marsden, 20.
- Addresses:—
- Introductory Address (Session 1880-81), by the Right Hon. Lord Moncreiff, 136.
- Address on the Island of Socotra, by Professor I. Bayley Balfour, 245.
- Address on Closing the Session 1880-81, by Sir Alexander Grant, Bart., 293.
- Address by David Milne Home, on presenting the Makdougall-Brisbane Prize to Professor Piazza Smyth, Astronomer-Royal for Scotland, 362.
- Address on the Historic Evidence for the Destruction of Pompeii and Herculaneum, by Dr. Cazenove, 421.
- Address by Professor Tait, on presenting the Keith Prize to Professor Chrystal, 797.
- Address by Mr. Buchan, on presenting the Neill Prize to Mr. John Murray, 797.
- Address on Closing the Session 1881-82, by Professor J. H. Balfour, 843.
- Agassiz (Professor A.), Report on the Echinoidea of the Faroe Channel, 697.
- Aitchison (Dr. J. E. Tierney) elected a Fellow of the Society, 233.
- Aitken (Dr. A. P.), and Hamilton (Prof. D. J.), Report on Louping-ill and Braxy, 615.
- Aitken (John) on Dust, Fogs, and Clouds, 14, 122.
- Aitken (J.) on the Colour of the Mediterranean and other Waters, 472.
- on the Absorption of Sea-Water, 637.
- Algebra of Relationship, by Dr. Alexander Macfarlane. Part II., 5; Part III., 162.
- Ammonium Salts, their Condition when dissolved in Water, by W. W. J. Nicol, 819.
- Amoeboid Movements, by John B. Haycraft, 29.
- Ampelidea Socotrenses*, 506.
- Ampelisca compacta*, New Species of Crustacean, 688.
- Anacardiaceæ Socotrenses*, 507.
- Anglin (A. H.), M.A., M.R.I.A. elected a Fellow of the Society, 133.
- on the Expansion of Rational Fractions, 162.
- Annelida of the Faroe Channel, by Dr. M'Intosh, F.R.S., 693.
- Anurella, a Sub-Family or Section of the *Molgulidæ anuræ*, 233; Anurella and Molgula, in classifying the "Challenger" species, considered as one genus, 234.
- Arrangement.—Additional Note on a Problem of Arrangement, by Thomas Muir, A.M., 187.
- Article, the Definite, in Greek, by Professor Blackie, 622.
- Articulation, by the Rev. J. L. Blake, 815.
- Ascopera, a New Genus of the *Molgulidæ*, 234.
- *gigantea*, new species, 238.
- *pedunculata*, new species, 239.
- Asteroidea of the Faroe Channel, by W. P. Sladen, F.L.S., 698.
- Atmospheric Electricity, by Professor C. Michie Smith, 613.

- Atmospheric Refraction, Professor Vince's Two Cases of, 581.
- Atomicity (Chemical), by William Durham, 231.
- Avicennia officinalis*, by Dr. Joseph Bancroft, 456.
- Bacillus anthracis* resembles the Bacillus of Braxy, 621.
- Balaenoptera borealis* or *laticeps*, by Professor Turner, 515; its Spine, 519; its Skull, 523; its Pectoral Limb, 526.
- Balfour (Professor I. Bayley), Address on the Island of Socotra, 245.
- Diagnoses Plantarum Novarum et imperfecte descriptarum Socotrensium, Fungorum, Algarum, Lichenum, 456, 498.
- Diagnoses Plantarum Novarum et imperfecte descriptarum Phanerogamarum Socotrensium, 834.
- Balfour (Dr. J. H.) contributes Obituary Notice of Dr. P. D. Handy-side, 329.
- Address on Closing the Session 1881-82, 843.
- Ballengeich Boulder, 266.
- Bancroft (Dr. Joseph) on Respiration in the Roots of *Avicennia officinalis* 456.
- Barnes (Dr. Henry) elected a Fellow of the Society, 514.
- Baryta (Caustic), its action on Acid Sulphate of Tetra-Benzyl-Phosphonium, 48.
- Battery (Iodine), by A. P. Laurie, 230.
- Beddard (Frank E.), B.A., and Geddes (Patrick), on the Histology of the Pedicellariæ and the Muscles in *Echinus sphæra* (Forbes), 88.
- on the Anatomy of the Nervous System of the Pond Snails Planorbis and Lymnæus, 576.
- on the Anatomy and Histology of *Pleurochaeta Moseleyi*, 629.
- Ben Nevis.—The Application of the Rocks of Ben Nevis to Ornamental Art, 365.
- Berry (Walter), Danish Consul-General, elected a Fellow of the Society, 233.
- Betaines.—On Phosphorus Betaines, by Professor E. A. Letts, 40.
- Bismutho-hypobismuthic Oxide, 566.
- Bismuth, an Oxycyanide of, and a New Oxide of, by M. M. Pattison Muir, 557.
- Blackie (Professor J. S.) on the Definite Article in Greek, with special reference to the Revised Version of the New Testament, 622.
- Blake (Rev. J. L.) on Voice-Effort and Rhythm, 798.
- on Vocalisation and Articulation, 815.
- Blood-Corpuscles.—Some Physical Experiments bearing upon the Circulation of the Blood-Corpuscles, by Professor D. J. Hamilton, 370.
- Blyth (Professor James), Note on an Electric Sonometer, 28.
- on a Simple Form of Selenium Cell, 119.
- on the Cause of Sounds produced in the Microphone Receiver, 206.
- on the Action of the Microphone, 622.
- Bolteninæ, a Sub-Family of the Cynthiadæ, 58.
- Boltenia elegans*, new species, 80.
- *legumen*, 81.
- *pachydermatina*, new species, 81.
- Boreomysis nobilis*, 687.
- Boulders.—Seventh Report of the Boulder Committee, 246; Eighth Report of the Boulder Committee, 748.
- Bourget (Lake of), the Colour of its Waters, 478.
- Brady (H. B.), Report on the Foraminifera of the Farøe Channel, 708.
- Braxy, Report on, 615, 620.
- Brotherston on the Cause of Sheep Disease, 616.
- Brown (Professor Crum) on Chemical Nomenclature and Notation, 211.
- proposes an amendment to Law XIV., that the words *December to July* be substituted for the words *November to June*, 421.
- on a Case of Dyspeptic Vertigo, 594.
- Brown (J. A. Harvie) of Dunipace elected a Fellow of the Society, 133.
- Buchan (A.) M.A. Address on presenting the Neill Prize to John Murray, 797.
- Buchanan (George): His Treatise "De Jure Regni apud Scotos" in connection with the Dawn of the Constitutional Principle, by Lord Moncreiff, 137; Short Biography of, 138.
- Buchanan (J. Y.), on a Solar Calorimeter, and some Observations made with it in Upper Egypt, 827.

- Buchanan (J. Y.) on the Oxidation of Ferrous Salts, 191.
- Buchanan (T. R.), M.P., elected a Fellow of the Society, 637.
- Burseraea Socotrenses*, 605.
- Burton (C. J.) and Laurie (A. P.), the Heats of Combination of the Metals with the Halogens, 804, 830.
- Burton (John Hill), LL.D., D.C.L., F.R.S.E., Obituary Notice of, by J. Gordon, assistant librarian, 324.
- Busk (Dr. G.), Report on the Polyzoa of the Faroe Channel, 690.
- Calicicæ Socotrenses*, 457.
- Calorimeter, a Solar, by J. Y. Buchanan, 827.
- Cameron (A. J. D.), elected a Fellow of the Society, 233.
- Campbell (Albert), Change in the Peltier effect due to Variation in Temperature, 807.
- Candle-power of Swan's Lamp, by A. Jamieson, 615.
- Canna: Its Leaf-bed, by Professor Heddle, 630.
- Capparidæ Socotrenses*, 501.
- Carbon (Adamantine) or Diamond: Its Preparation, by Dr. R. S. Marsden, 20.
- Its State in Iron and Steel: a New Hypothesis of the Hardening of Iron and Steel, by Dr. R. Sydney Marsden, 368.
- Carboniferous Rocks of the South of Scotland, by Archibald Geikie, F.R.S., 598; The Crustacea and Scorpions of, by B. N. Peach, 603.
- Caryophyllæ Socotrenses*, 501.
- Cay (W. Dyce), Memb. Inst. C.E., elected a Fellow of the Society, 598.
- Cayley (Professor), His Theorem regarding a Bordered Skew Determinant, by Thomas Muir, M.A., 187.
- Cazenove (Rev. Dr.) delivers an Address on the Historic Evidence for the Destruction of Pompeii and Herculaneum, 421.
- Cells.—Yellow Cells of Radiolarians and Cœlenterates, 877.
- The Vegetable Cell, by J. M. Macfarlane, 576.
- Channel between Scotland and the Faroe Islands: Its Physical and Biological Conditions, 238, 638, 720.
- Chase (Pliny Earle), His $\frac{\pi^n}{32}$ Series represents Professor George Forbes' Hypothetical Planets, 93.
- Chemical Affinity and Atomicity, by William Durham, 231.
- Chemical Nomenclature and Notation, by Professor Crum Brown, 211.
- Chloroacetic Acid: Its action on Triethylphosphine, 41.
- Christie (Rev. George), Report as to Boulders in Lunnasting, 747.
- Christison (Sir Robert), Bart., Hon. V.-P., on the Application of the Rocks of Ben Nevis to Ornamental Art, 365.
- The loss sustained by the Society through his Death adverted to, 421.
- Chrystal (Professor), Remarks on Dielectric Strength, 487.
- awarded the Keith Prize for 1879-81, 748; the Prize presented, 797.
- Cist discovered at Parkhill, Aberdeenshire, 405.
- Clouds.—On Dust, Fogs, and Clouds, by John Aitken, 14.
- Coats (Sir Peter) elected a Fellow of the Society, 361.
- Cockburn (Charles), Fungi et Algae in Socotra, 456.
- Cœlenterates and Radiolarians—their Yellow Cells, 377.
- Collemæ Socotrenses*, 457.
- Collie (N.), and Professor Letts, on the Action of Haloid Compounds of Hydrocarbon Radicals on Phosphide of Sodium, and on the Salts of Tetra-benzyl-phosphonium, 46.
- Comenic Acid, by D. B. Dott, 241.
- Como, the Lake of; the Colour of its Waters, 477.
- Compositæ Socotrenses*, 837.
- Compression, Temperature Changes caused by, 51.
- Constitutional Principle, the Rise of, by Lord Moncreiff, p. 136.
- Cooke (Dr M. C.), Diagnoses Fungorum Novorum in Insula Socotra, 456.
- Cornuspira crassisepta*, 714.
- *involvens*, 714.
- *striolata*, 718.
- Council for Session 1880-81, 1; for Session 1881-82, 324.
- Crassulacæ Socotrenses*, 512.
- Cristellaria reniformis*, 716.
- Cruciferæ Socotrenses*, 500.
- Crooked Stone Boulder, 268.
- Crystallization of Silica from Fused Metals, by Dr. R. Sydney Marsden, 37.
- Ctenicella, a Genus of the Molgulidæ, 233, 234.
- Cubic (Symbolic).—A Particular Case of the Symbolic Cubic, by Dr. Gustav Plarr, 342.

- Oucurbitaceæ Socotrenses*, 518.
 Culeolus, New Genus of the Cynthi-
 adæ, 82.
 ——— *Moseleyi*, new species, 87.
 ——— *Murrayi*, new species, 88.
 ——— *perlucidus*, new species, 86.
 ——— *recumbens*, new species, 85.
 ——— *Suhmi*, new species, 86.
 ——— *Wyville-Thomsoni*, new species,
 84.
 Cumming (Rev. John), D. D., Obituary
 Notice of, by the Rev. Professor
 Flint, 328.
 Cynthia, a Genus of the Cynthiadæ,
 57.
 ——— *arenosa*, new species, 59.
 ——— *cerebriformis*, new species, 57.
 ——— *complanata*, new species, 62.
 ——— *irregularis*, new species, 60.
 ——— *fissa*, new species, 58.
 ——— *formosa*, new species, 58.
 ——— *hispida*, new species, 61.
 ——— *pallida*, Heller, 60.
 Cynthina, a Sub-family of the Cyn-
 thiadæ, 58.
 Determinants.—Transformations con-
 necting General Determinants with
 Continuants, by Thomas Muir and
 Professor Chrystal, 135.
 ——— Mr Thomas Muir on Professor
 Cayley's Theorem regarding a
 Bordered Skew Determinant, 187;
 Law of Extensible Minors in Deter-
 minants, 187.
 Dickie (Dr. G.), Diagnoses Algarum
 Novarum Socotrensiæ, 456.
 Dielectric Strength, by Professor
 Chrystal, 487.
 Dimethyl-thetine, 41.
Dirichletic Socotrenses, 834.
 Dittmar (Professor), Report on Gas
 Contents of Water of Faroe
 Channel, 718.
 Dixon (J. A.) elected a Fellow of the
 Society, 622.
 Dobbie (Dr. J. J.), M.A., and G. C.
 Henderson, B.Sc., on the Forma-
 tion of Serpentine from Dolomite,
 606.
 ——— on a Red Resin from *Dracæna*
Cinnabari, Socotra, 798.
 Dobbin (Dr. Leonard) elected a Fellow
 of the Society, 202.
 Donations of Books from Scientific
 and Literary Societies, and from
 Authors, 845.
 Dott (D. B.) elected a Fellow of the
 Society, 421.
 ——— Comenic Acid 241.
 ——— Meconic Acid, 88.
Dracæna Cinnabari, Socotra, 798.
 Duns (Professor), The Surface Geology
 of Mid-Lochaber, 483.
 ——— on Boulders at Mid-Lochaber,
 761.
 Durham (William), Note on Chemical
 Affinity and Atomicity, by William
 Durham, 231.
 Dust, Fogs, and Clouds, by John
 Aitken, 14; If there was no dust,
 there would be no fogs, no clouds,
 and probably no rain, 15; Dust-
 motes may be removed by heat, and
 yet the air may produce clouds, 16;
 Part II., 122.
 Dust-Particles form the Nucleus on
 which Vapour Condenses, 15. 45.
 Dyspeptic Vertigo, A Case of, by
 Professor Crum Brown, 594.
 Earthquake of 28th November, 1880,
 in Scotland and Ireland, by Charles
 Alexander Stevenson, 176.
 Earth's Rotation, Thermodynamic
 Acceleration of, by Sir William
 Thomson, 397.
 Echinoidea of the Faroe Channel, by
 Professor A. Agassiz, 697.
Echinus sphaera (Forbes), The Muscles
 in, by Patrick Geddes, F.R.S.E., and
 F. E. Beddard, B.A., F.R.S.E., 88.
 Eclipse (Solar) of 31st December 1880,
 by Edward Sang, 18.
 ——— of 17th May 1882, with
 Remarks on the Calculation, by
 Edward Sang, 720.
 Eigg: Its Pitchstone-Porphry River,
 by Professor Heddle, 632.
 Electricity (Atmospheric), by Prof. C.
 Michie Smith, 613.
 Electric Conductivity, Effects of Strain
 on, 135.
 Electric Discharge Through Colza Oil,
 by Dr. Alex. Macfarlane, 293.
 Electric Discharge, The Effect of
 Flame on, and the Effect of Mois-
 ture on, by Dr. A. Macfarlane and
 D. Rintoul, 567, 801.
 Electric Sonometer, by Prof. James
 Blyth, 28.
 Equidistant Multiples of Irrational
 Quantities, by E. Sang, 2.
 Eoscorpius, a Genus of Scorpion, 245.
 Eskdale, Carboniferous Rocks of, by
 Archibald Geikie, F.R.S. 600; Ad-
 ditional Fossil Fishes of, by Dr. R.
 H. Traquair, 603; Fossil Plants of,
 by R. Kidston, 603.
 Ethyl-chlorate of Triethyl-phosphorus-
 betaine, 42.
 ——— Action of Oxide of Silver on, 43.

- Ethyl-chlorate of Triethyl-phosphorus-betaine, Action of Heat on, 44.**
- Eugyra Kerguelensis*, new species, 237.
- Euplectella : Its Structure, 2.**
- Everett (Professor), Letter to Professor Tait on Mirage, 358 ; Note on Mirage, 361.**
- Faroe Islands.—On the Physical and Biological Conditions of the Channel between Scotland and the Faroe Islands, by Sir Wyville Thomson, 233.**
- Faroe Channel.—Exploration of, by Staff-Commander Tizard and John Murray, in the "Knight-Errant," 638 ; I. Introduction, 638 ; II. Origin and Objects of the "Knight-Errant" Investigations, 640 ; III. Narrative of the Cruise, 644 ; IV. Results, 648 ; Wyville Thomson's Ridge, 648 ; Temperature, 652 ; Surface Dredging, 654, 657 ; Its Minerals, Animals, &c., 658 ; On the Plateau surrounding North Rona and Sulisker, 657 ; Soundings, Dredgings, and Trawlings in the Warm Area, 660 ; Description of the Muddy Deposit, 662 ; List of the Animals taken in the Warm Area, 665 ; Dredgings and Trawlings in the Cold Area, 666 ; Its Minerals, &c., 669 ; List of the Animals taken in the Cold Area, 670 ; Soundings, Dredgings, and Trawlings on the Ridge, Minerals and Organisms, 671 ; List of the Animals taken on the Ridge, 673 ; Report on the Fishes, by Dr. A. Günther, F.R.S., 677 ; Report on the Mollusca, by Dr. Gwyn Jeffreys, F.R.S., 680 ; Report on the Crustacea, by Rev. A. M. Norman, 683 ; Report on the Pycnogonida, by Dr. P. P. C. Hoek, 689 ; Report on the Polyzoa, by Dr. G. Busk, F.R.S., 690 ; Report on the Annelida, by Dr. M'Intosh, F.R.S., 693 ; Report on the Holothuriodea, by Dr. Hjalmar Theel, 694 ; Report on the Echinoidea, by Professor A. Agassiz, 697 ; Report on the Asteroidea, by W. Percy Sladen, F.L.S., 698 ; Report on the Ophiuroidea, by Professor Theodore Lyman, 707 ; Report on the Foraminifera, by H. B. Brady, 708 ; Report on the Gas Contents of Sea Water, by Professor Dittmar, 718 ; Rocks of North Rona, by Professor A. Renard and John Murray, 720.**
- Ferguson (William), of Kinmundy, on a Cist discovered at Parkhill, Aberdeenshire, 405.**
- Ferrous Salts, The Oxidation of, by J. Y. Buchanan, 191.**
- Fishes of the Faroe Channel, by Dr. A. Günther, F.R.S., 677.**
- Flint (The Rev. Professor) Contributes Obituary Notice of the Rev. John Cumming, 328.**
- Focus of Object Glass, Easy Method for Determining the Position of, 50.**
- Fogs.—On Dust, Fogs, and Clouds, by John Aitken, 14.**
- More Perfect Combustion will remove the Pea-Soup character of Town Fogs, 13.
- Foraminifera of the Faroe Channel, by A. B. Brady, F.R.S., 708.**
- Forbes (Prof. George), Additional Note on an Ultra-Neptunian Planet, 89.**
- Simple and Accurate Method of Determining the Longitude of a Place by a Single Observer, without measuring Time, 167.
- Fossil Fishes of Eskdale and Liddedale, by Dr. R. H. Traquair, 603.**
- Fossil Plants of Eskdale and Liddedale, by Robert Kidston, 603 ; of Canonbie, 604.**
- Fraser (Professor T. R.), contributes Obituary Notice of Professor Sanders, 333.**
- Fungi.—Diagnoses Fungorum Novorum in Insula Socotra, a Bayley Balfour, C. Cockburn et A. Scott, lectorum, 456.**
- Galvanic Polarization, by Professor Helmholtz, 202.**
- Gases : Their Compression by High Pressures, by Prof. Tait, 293.**
- Geddes (Patrick) and Beddard (F. E.), on the Histology of the Pedicellariæ and the Muscles of *Echinus sphaera* (Forbes), 88.**
- on the Classification of Statistics, and its Results, 295.
- on the Nature and Functions of the Yellow Cells of Radiolarians and Cœlenterates, 377.
- Geikie (Archibald), F.R.S., on the Carboniferous Rocks of the South of Scotland, 598.**
- Geneva, The Lake of.—The Colour of its Waters, 477, 478.**
- Glass.—Crushing of Glass by Pressure, by Prof. Tait, 204.**
- Globigerina bulloides*, 716.**
- Goodwin (W. L.), on the Nature of Solution, 834.**

- Gordon (James), contributes Obituary Notice of Dr. John Hill Burton, F.R.S.E., 324.
- Government Grant for Scientific purposes, Statement by John Murray concerning, 806.
- Grant (Sir Alexander), His Address on Closing the Session 1880-81.
- Graphidæa Sootrensens*, 465.
- Gray (Thomas), elected a Fellow of the Society, 14.
- on the Effect of Permanent Elongation on the Specific Resistance of Wires, 33.
- Grove (The Hon. Justice), elected a British Honorary Fellow, 95.
- Günther (Dr. A.), F.R.S., Report on the Fishes of the Faroe Channel, 677.
- Halirages elegans*, New Species of Crustacean, 688.
- Hallard (Sheriff), contributes an Obituary Notice of Maurice Lothian, 99.
- Halogens.—Heats of Combination of the Metals with the Halogens, by A. P. Laurie and C. J. Burton, 804, 830.
- Haloid Compounds of Hydrocarbon Radicals: Their action on Phosphide of Sodium, and on Salts of Tetra-benzyl-phosphonium, by Prof. Letts and N. Collie, 46.
- Hamilton (Prof. D. J.), M.B., elected a Fellow of the Society, 202.
- Some Physical Experiments bearing upon the Circulation of the Blood-Corpuscles, 370.
- and Aitken (Dr. A. P.), Report on Louping-ill and Braxy, 615.
- Handyside (Dr. P. D.), F.R.S.E., Obituary Notice of, by Dr. J. H. Balfour, 329.
- Haplophragmium tenuimargo*, 715.
- Harrington (James), His Oceana, in connection with the Dawn of the Constitutional Principle, 159.
- Haycraft (Professor John B.) on Certain Movements exhibited by Low Forms of Animal Life, and termed Amœboid, 29.
- on the Walls of Hepatic Cells, 131
- Heat.—Heat Waves: Effects of Temperature-changes of Specific Heat and Conductivity on the Propagation of Plane Heat Waves, by Professor Tait, 126.
- Simple Method of Showing the Diminution of Surface Tension in Water by Heat, by Professor Tait, 131.
- Heat.—Its Action on Thioformanilid, 199.
- Note on the Heating produced by Compression, by Professor Tait, 217.
- Heats of Combination of the Metals with the Halogens, by A. P. Laurie and C. J. Burton, 804, 830.
- Heddle (Professor Forster), Notes on Boulders in Dumfriesshire and the Highlands, 268.
- Chapters on the Mineralogy of Scotland (chap. vii.), 549.
- Geological Notes—Leaf-bed in Canna, 630.
- The Pitchstone Porphyry River of the Scuir of Eigg, 632.
- A Supposed Organism from the Marble of Sutherland, 634.
- Notes on Boulders in Fife, the Lewis, and the Fort-William District, 772.
- on the Order of Succession of Rocks in the North-West Highlands, 815.
- Henderson (G. G.) B.Sc., and Dr. J. J. Dobbie, on the Formation of Serpentine from Dolomite, 606.
- on a Red Resin from *Dracæna Cinnabari*, Socotra, 798.
- Hepatic Cells: Their Cell-Walls, by Professor J. B. Haycraft, 131.
- Herculaneum and Pompeii: The Historic Evidence for their Destruction, by the Rev. Dr. Cazenove, 421. See *Pompeii*.
- Helmholtz (Professor) on Galvanic Polarization, 202.
- Herdman (Dr. W. A.), elected a Fellow of the Society, 133.
- Preliminary Report on the Tunicata of the Challenger Expedition: Part III. Cynthiadae, 52; Part IV. Molgulidae, 233.
- Highland and Agricultural Society.— Report of their Committee on the Sheep Diseases known as Louping-ill and Braxy, 615.
- Hoek (Dr. P. F. C.), Report on the Pycnogonida of the Faroe Channel, 689.
- Holothurioidæ of the Faroe Channel, by Dr. H. Theel, 694.
- Home (D. Milne), LL.D., His Address on presenting the Makdougall-Brisbane Prize to Professor Piazzi Smyth, 362.
- Remarks on presenting the 7th Boulder Report: Inquiry as to Whence and How Boulders have come to their present positions, 286, 293.

- Home (D. Milne), LL.D., Remarks on presenting the Eighth Boulder Report, 778.
 — Objects for which the Boulder Committee was appointed, and lines of inquiry pursued, 778, 787.
- Horne (John), elected a Fellow of the Society, 175.
- Hydrocarbon Radicals, Haloid Compounds of, 46.
- Hydrochlorate of Triethyl-phosphorus-betaine, 44.
- Hypericaceæ Scotrenses*, 502.
- Ilmenites, 549.
- Inglis (J. W.), elected a Fellow of the Society, 637.
- Iodine Battery, by A. P. Laurie, 230.
- Iron.—On the State of Carbon in Iron and Steel, by Dr. R. Sydney Marsden, 368.
 — The Dimensions of Cast-Iron at various Temperatures, with more especial reference to the Phenomena of the Solid floating on the Molten Metal, by W. J. Millar, 549.
- Irrational Quantities, Equidistant Multiples of, by E. Sang, 2.
- Iserines, 549.
- Jaculella obtusa*, 714.
- Jamieson (Andrew), Recent Tests of Swan's Lamp for Fall of Resistance, 615.
 — elected a Fellow of the Society, 815.
- Jamieson (Dr. Fife), Notes on the Bones in a Cist discovered at Park-hill, 405.
- Jamieson (Thomas F.) on Boulders in Aberdeenshire and Perthshire, 282.
- Jeffreys (Dr. Gwyn), F.R.S., Report on the Mollusca of the Faroe Channel, 630.
- Jets (Liquid).—Effects of Rotation in Liquid Jets, 94.
- Keith Prize (1879-81) presented to Professor Chrystal for his Paper on the Differential Telephone, 797.
- Key (Thomas), F.R.S.E., Obituary Notice of, 95.
- Kinetic Theory of Gases in relation to Dissociation, 806.
- Kinetics, A Singular Problem in, 173.
- Knox (Thomas), Obituary Notice of, 103.
- Lago Maggiore, The Colour of its Waters, 477.
- Lassell (Dr. William), Obituary Notice of, 97.
- Laurence (Rev. William), Report as to Boulders in Fair Isle, 749.
- Laurie (A. P.), B.Sc., on an Iodine Battery, 230.
 — Some Experiments on a New Secondary Cell, 724.
 — and C. J. Burton, on the Heats of Combination of the Metals with the Halogens, 804, 830.
- Law XIV. amended.—The words *December to July* to be substituted for the words *November to June*, 421; and, when there are five Mondays in January, the Meetings shall be held on the third and fifth Mondays of that month, 567.
- Lawson (Robert), M.B., elected a Fellow of the Society, 133.
- Leaf-bed in Canna, 630.
- Lecanoracæ Scotrenses*, 460.
- Lecideæ Scotrenses*, 462.
- Leguminosæ Scotrenses*, 508.
- Leslie (Alexander), Memb. Inst. C.E., elected a Fellow of the Society, 514.
- Letts (Professor E. A.) on Phosphorus Betaines, 40.
 — On the Action of Haloid Compounds of Hydrocarbon Radicals on Phosphide of Sodium and on the Salts of Tetra-benzyl-phosphonium, 46.
- Leucocytes.—Conclusions as to their Nature and Movements, 376.
- Liddesdale, Carboniferous Rocks of, by Archibald Geikie, F.R.S., 600; Additional Fossil Fishes of, by Dr. R. H. Traquair, 603; Fossil Plants of, by R. Kidston, 603.
- Light.—Nature of Vibrations in Common Light, by Professor Tait, 419.
- Lindsay (Dr. William Lauder), Obituary Notice of, 736.
- Livingston (Colin), Notes on Boulders and Striated Rocks at Fort-William, 765.
- Livingston (Josiah), elected a Fellow of the Society, 622.
- Liversidge (Professor A.) on Stilbite from Kerguelen's Island, 117.
- Lochaber, *see* Mid-Lochaber, 483.
- Loch Lomond: The Colour of its Waters, 479.
- Longitude, Simple and Accurate Method of Determining, 117.
- Longitude, Determination of, without a Chronometer, 293.
- Lothian (Maurice), Obituary Notice of, 99.
- Louping-ill: Report on, 615.

- Loven (Professor Sven), elected a Foreign Honorary Fellow, 94.
- Lowering of the Maximum Density Point of Water by Pressure, 626, 809.
- Lyman (Professor Theodore), Report on the Ophiuroidea of the Faroe Channel, 707.
- Lymnæus: Its Anatomy, by F. E. Beddard, B.A., 576.
- Lynghya scabrosa*, 456.
- Lythraceæ Socotrenses*, 512.
- Macfarlane (Dr. Alex.), Algebra of Relationship, Part II., 5.
- Algebra of Relationship, Part III., 162; the Number of Genus Relationships of the 11th Order, 165; the Order-Index, 167; the Degree-Index, 165.
- On Morgan's Systems of Consanguinity and Affinity, 245.
- Electric Discharge through Colza Oil, 293.
- and D. Rintoul, on the Effect of Flame on the Electric Discharge, 567.
- and D. Rintoul, on the Effect of Moisture on the Electric Discharge, 801.
- Macfarlane (J. M.), B.Sc., on the Vegetable Cell, 576.
- Macintosh (Dr. W. C.), Note on a Phoronis dredged in H.M.S. "Challenger," 211.
- M'Intosh (Professor W. Carmichael), Report on the Annelida of the Faroe Channel, 693.
- Contributes an Obituary Notice of Dr. William Lauder Lindsay, 736.
- Mackay (J. S.), M.A., elected a Fellow of the Society, 514.
- Maclagan (David), F.R.S.E., contributes an Obituary Notice of David Smith, late Treasurer, 734.
- (Professor) contributes Obituary Notice of Dr. Andrew Wood, 338.
- M'Neill (Donald), Notes on the Boulders of Colonsay, 264.
- Madeira.—On some Points in its Meteorology, by the Astronomer-Royal for Scotland, 629.
- Mair (Rev. Hugh), Report as to Boulders at Keiss, 749.
- Makdougall-Brisbane Prize for the period 1879-80, awarded to Professor Piazzi Smyth, Astronomer-Royal for Scotland, 361.
- Malvaceæ Socotrenses*, 503.
- Manganese: Its Action on Steel, by Dr. R. S. Marsden, 566.
- Marsden (Dr. R. Sydney) on the Crystallisation of Silica from Fused Metals, 37.
- on the Manner in which Silicon, Phosphorus, Manganese, and other elements exert their influence upon Steel, 566.
- on the Preparation of Adamantine Carbon or Diamond, 20.
- on the State of Carbon in Iron and Steel; a New Hypothesis of the Hardening of Steel, 368.
- Marshall (Professor D. H.) elected a Fellow of the Society, 622.
- On the Lowering of the Maximum Density Point of Water by Pressure, 626, 809.
- Marsipella cylindrica*, 714.
- Martite, 549.
- Mazonia: A Genus of Scorpion, 245.
- Meconates of Lead, 34; of Silver, 34.
- Meconic Acid, not proved to be Tri-basic, 33.
- Mediterranean: Its Colour, by John Aitken, 472.
- Menispermaceæ Socotrenses*, 500.
- Menzies (Dr.), Determination of Longitude without a Chronometer, 293.
- Mesoplodon bidens* (Sowerby's Whale), by Professor Turner, 443; Table of Cranial Measurements, 449; Spinal Column, 451; Dorsal Vertebrae, &c., 452-55.
- Metals, Heats of Combination of, with the Halogens, 804, 830.
- Microcosmus (Heller), a Genus of the Cynthiæ described, 54.
- *polymorphus* (Heller), 55.
- *propinquus*, new species, 55.
- Microphone.—On the Cause of Sounds produced in the Microphone Receiver, by Prof. James Blyth, 206.
- Its Action, by Professor James Blyth, 622.
- Microhamnion breviararticulatum*, 456.
- Mid-Lochaber: Its Surface Geology, by Professor Duns, 483.
- Millar (W. J.) on the Dimensions of Cast Iron at various Temperatures, with more especial reference to the Phenomena of the Solid Floating on the Molten Metal, 549.
- Milton (John), His "Defensio pro Populo Anglicano," in connection with the Dawn of the Constitutional Principle, 155.
- Minding's Theorem, by G. Plarr, 528.
- Mineralogy of Scotland, Chapter VII., by Professor Heddlie, 549; Pailomelane, Turgite, and Martite, 549; Ilmenites and Iserines, 549.

- Mirage, by Professor Tait, 354; Part II., 743; Part III., 798.
- Moisture, its effect on the Electric Discharge, 801.
- Molgulide, a family of the Tunicata, divided into four genera—Anurella, Molgula, Ctenicella, and Eugyra, 233.
- Molgula, a Genus of the Tunicata.
 ——— *gigantea*, 234.
 ——— *gregaria*, 234.
 ——— *pedunculata*, new species, 234.
 ——— *horrida*, new species, 235.
 ——— *Forbesi*, new species, 236.
 ——— *pyriformis*, new species, 236.
- Mollusca of the Faroe Channel, by Dr. Gwyn Jeffreys, F.R.S., 680.
- Moncreiff (The Right Hon. Lord), President, His Introductory Address, 2, 136.
 ——— Receives the Thanks of the Society for his Address, 2.
 ——— Contributes an Obituary Notice of Lord Ormidale, 107.
- Morgan's System of Consanguinity and Affinity, 245.
- Morrison (William), Report as to Boulders in Ross-shire, 754.
- Moscow.—The Imperial Society of Naturalists of Moscow invite the Royal Society to the Celebration of the Fiftieth Anniversary of the Graduation of Dr. Charles Renard, 567.
- Muir (M. M. Pattison), M.A., on an Oxycyanide, and a New Oxide, of Bismuth, 557.
- Muir (Thomas), M.A., on Professor Cayley's Theorem regarding a Bordered Skew Determinant, 187; the Law of Extensible Minors in Determinants, 187; Additional Note on a Problem of Arrangement, 187.
 ——— On a Class of Permanent Symmetric Functions, 409.
 ——— and Professor Chrystal on some Transformations connecting General Determinants with Continuants, 135.
- Müller (Dr. J.), Diagnoses Lichenum Socotrensius Novorum, 457.
- Murray (John) and Staff-Commander Tizard, Exploration of the Faroe Channel during the Summer of 1880 in the "Knight-Errant," 638.
 ——— Rocks of North Rona, Faroe, 720.
 ——— awarded the Neill Prize for 1877-80, 743; Prize presented, 797.
 ——— his Statement with respect to Applications for the Government Grant of £4000, 806.
- Muscles of the Mammalian Foot, 162.
- Neill Prize (1877-80) presented to Mr. John Murray for his Paper on the Structure and Origin of Coral Reefs and Islands, 797.
- Nephropsis Atlantica*, New Species of Crustacean, 684.
- Newcomb (Professor Simon) elected a Foreign Honorary Fellow, 94.
 ——— Contributes an Obituary Notice of Professor Benjamin Peirce, 739.
- Nicholson (Prof. H. Alleyne) on the Structure of the Skeleton of *Tubipora musica*, and on the Relation of the Genus *Tubipora* to *Syringopora*, 219.
- Nicol (W. W. J.), the Action of Heat on Thioformanilid, 199.
 ——— Condition of Ammonium Salts when dissolved in Water, 819.
- Norman (Rev. A. M.), Report on the Crustacea of the Faroe Channel, 683.
- Numbers, Theory of, by Professor Tait, 245.
- Obituary Notices of—
 Burton (Dr. John Hill), 324.
 Cumming (Dr. John), 328.
 Handyside (Dr. P. D.), 329.
 Key (Thomas), 95.
 Knox (Thomas), 103.
 Lassell (Dr. William), 97.
 Lindsay (Dr. William Lauder), 736.
 Lothian (Maurice), 99.
 Ormidale (The Honourable Lord), 107.
 Peirce (Professor Benjamin), 739.
 Ponton (Mungo), 100.
 Sanders (Professor), 333.
 Sharpey (Professor William), 110.
 Smith (David), Treasurer, 734.
 Wood (Dr. Andrew), 333.
- Object-Glass.—Easy Method for Determining the Position of its Principal Focus, 50.
- Office-Bearers for Session 1880-81, 1; for Session 1881-82, 324.
- Omond (R. T.) on the Lowering of the Maximum Density Point of Water by Pressure, 626, 809.
- Omphalarieæ Socotrenses*, 457.
- Ophiuroidea of the Faroe Channel, by Professor Theodore Lyman, 707.
- Ormidale (Lord), Obituary Notice of, 107.
- Oxidation of Ferrous Salts, by J. Y. Buchanan, 191.
- Oxide (A New) of Bismuth, by M. M. Pattison Muir, M.A., 557.
- Oxycyanide of Bismuth, by M. M. Pattison Muir, M.A., 557, 562.

- Paleoniscidae: Their Structure, by Dr. R. H. Traquair, 217.
- Parmeliæ Socotrenses*, 458.
- Pasteur Medal, Invitation to subscribe for, 743.
- Peach (B. Neeve) elected a Fellow of the Society, 175.
- Some New Species of Fossil Scorpions, with a Review of the Genera *Eoscorpius* and *Mazonia*, 245.
- Crustacea and Scorpions of the Carboniferous Rocks of the Scottish Border, 603.
- Peddie (W.), Rotation of the Plane of Polarisation by Quartz, and its relation to wave-lengths, 816.
- Pedicellariæ: Their Histology, by Patrick Geddes, F.R.S.E., and F. E. Beddard, B.A., 88.
- Peirce (Professor Benjamin), Obituary Notice of, 739.
- Peltier Effect due to Variation in Temperature, by Albert Campbell, 807.
- Permanent Symmetric Functions, 409; Symmetric Functions distinguished from Alternating Functions; Determinants may be placed under the class of Alternating Functions, 409; Products of Permanents and Determinants of the n^{th} Order, 411.
- Phoronis. — Note on a Phoronis Dredged in H.M.S. "Challenger," by Dr. W. C. Macintosh, 211.
- Phosphate of Sodium, 46.
- Phosphorus: Its Action on Steel, by Dr. R. S. Marsden, 566.
- Phosphorus Betaines, by Prof. E. A. Letts, 40.
- Physcia Socotrenses*, 459.
- Pitchstone-Porphry River of the Scuir of Eigg, 632.
- Placodius Socotrenses*, 459.
- Placopoda Socot.*, 835.
- Plane of Polarisation, Rotation of, by Quartz, 816.
- Planispirina contraria*, 713.
- Planorbis: Its Anatomy, by F. E. Beddard, B.A., 576.
- Plantamour (Professor Emile) elected a Foreign Honorary Fellow, 94.
- Plarr (Dr. Gustav) on a Particular Case of the Symbolic Cubic, 342.
- on Minding's Theorem, 528.
- Platysomide: Their Structure, by Dr. R. H. Traquair, 217.
- Pleurochaeta Moseleyi*, The Anatomy and Histology of, by F. E. Beddard, B.A., 629.
- Polarisation (Galvanic), by Professor Helmholtz, 202.
- Polarisation, Rotation of the Plane of, 816.
- Polycarpa, Heller, a Genus of the Cynthiadae.
- *irregularis*, new species, 72.
- *longisiphonica*, new species, 77.
- *minuta*, new species, 78.
- *molguloides*, new species, 76.
- *pedata*, new species, 71.
- *pilella*, new species, 73.
- *quadrata*, new species, 78.
- *radicatus*, new species, 75.
- *rigida*, new species, 76.
- *sulcata*, new species, 73.
- *tinctor* (Quoy and Guinard), 74.
- *viridis*, new species, 74.
- Polyzoa of the Faroe Channel, by Dr. G. Busk, 690.
- Pompeii and Herculaneum—Historic Evidence of their Destruction: An Address by Rev. Dr. Cazenove, 421; Evidence of Martial, 425; Evidence of Plutarch, 426; Evidence of Statius, 427; Evidence of Tacitus, 430; Evidence of Josephus, 432; Evidence of Suetonius, 433; Evidence of the Younger Pliny, 433; Evidence of Dion Cassius, 437; Evidence of Marcus Aurelius, 441.
- Ponton (Mungo), W.S., Obituary Notice of, 100.
- Pressure.—Crushing of Glass by Pressure, by Professor Tait, 204.
- on the Average Pressure due to Impulse of Vortex Rings on a Solid, by Sir William Thomson, 204.
- on the Compression of Gases by High Pressures, 293.
- Pressure-Errors of the "Challenger" Thermometers, by Prof. Tait, 199.
- Note on the Heating produced by Compression, 217.
- Prizes. — The Makdougall - Brisbane Prize for the Biennial Period 1879-81 awarded to Professor Piazzi Smyth, Astronomer-Royal for Scotland, 361.
- Keith Prize for 1879-81 awarded to Professor Chrystal, 743.
- Neill Prize for 1877-80 awarded to John Murray, 743.
- Pryde (Dr. David) elected a Fellow of the Society, 637.
- Pseudopodium: How produced, 31.
- Psilomelana, 549.
- Psora Socotrenses*, 460.
- Pulvinulina scitula*, 716.
- Pycnogonida of the Faroe Channel, 689.
- Pyrenulus Socotrenses*, 471.

- Quaternions. — On Quaternion Integration, by Professor Tait, 293.
- Radiolarians and Oolenterates: Their Yellow Cells, 377.
- Ramalina Socotrenses*, 458.
- Rational Fractions, The Expansion of, 162.
- Ratray (Dr. James Clerk) elected a Fellow of the Society, 421.
- Refraction. — Professor Vince's Two Cases of Unusual Atmospheric Refraction, 581.
- Relationship, The Algebra of, 162; Number of Genus Relationships of the n^{th} Order, 165.
- Renard (Prof. A.) and John Murray, Rocks of North Rona, Faroe, 720.
- Reophax distugiformis*, 715.
— *aduncz*, 715.
— *sabulosa*, 715.
- Resedaceae Socotrenses*, 501.
- Resistance of Wires, 33.
- Rhabdammina cornuta*, 714.
- Rhythm, by the Rev. J. L. Blake, 798.
- Richardson (Ralph), F.R.S.E., Note on a Boulder at Loch Skene, 281.
— Report as to Boulders at Strathnairn, 750.
- Rintoul (D.) and Dr. A. Macfarlane on the Effect of Flame on the Electric Discharge, 567.
— on the Effect of Moisture on the Electric Discharge, 801.
- Robinson (The Rev. Dr. T. R.) contributes an Obituary Notice of Dr. William Lassell, 97.
- Roccellex Socotrenses*, 458.
- Rocks, Order of Succession of, in the North-West Highlands, 815.
- Rogerson (John Johnston), A.B., elected a Fellow of the Society, 238.
- Rona (Faroe).—Rocks of North Rona, by Professor A. Renard and John Murray, 720.
- Rosebery (The Right Hon. the Earl of) elected a Fellow of the Society, 233; admitted, 421.
- Rotating Mass of Fluid, Figures of Equilibrium of, by Sir William Thomson, 610.
- Rotation in Liquid Jets, by Professor Tait, 94.
- Rotation of the Plane of Polarisation by Quartz, and its relation to Wave-Length, by W. Peddie, 816.
- Rubiaceae Socotrenses*, 834.
- Rumble (Thomas Wm.), Memb. Inst. C.E., elected a Fellow of the Society, 133.
- Rutaceae Socotrenses*, 505.
- Rutherford (Samuel), His Treatise "Lex Rex" in connection with the Dawn of the Constitutional Principle, by Lord Moncreiff, 151.
- Salmasius (Joannes), His "Defensio Regia pro Carolo Primo," in connection with the Dawn of the Constitutional Principle, by Lord Moncreiff, 153.
- Salmon (Rev. Professor George) elected a British Honorary Fellow, 95.
- Sanders (Professor W. R.), Obituary Notice of, 833.
- Sanderson (James, Dep. Inspector-Gen. of Hospitals) contributes an Obituary Notice of Thomas Key, 95.
- Sang (Edward), on Equidifferent Multiples of Irrational Quantities, 2.
— on the Solar Eclipses of 31st December 1880, 18.
— Notice of the Solar Eclipses of the 17th May 1882, with Remarks on the Calculation, 720.
— Notice of an Easy Method for Determining the Position of the Principal Focus of an Object Glass, 50.
— Moves an Addition to Law XIV. "That when there are five Mondays in January, meetings shall be held on the 3rd and 5th Mondays of that month," 421; His Motion Adopted, and Law XIV. Amended accordingly, 567.
— A Critical Examination of Two Cases of Unusual Atmospheric Refraction, described by Professor Vince, 581.
- Sapindaceae Socotrenses*, 507.
- Schultze (Dr. F. E.) on the Structure of Euplectella, 2.
- Schweinfurth (Dr.), *Lichenas Socotrenses*, 457.
- Scorpions, New Fossil, by B. N. Peach, 245.
- Scott (Alexander), Fungi et Algae in Insula Socotra, 456.
- Sea Water: Its Absorption, by John Aitken, 637.
— Gas Contents of Water of Faroe Channel, by Prof. Dittmar, 718.
- Secondary Cell.—Some Experiments on a New Secondary Cell, by A. P. Lawrie, B.Sc., 724.
- Selenium Cell, A Simple Form of, by Professor James Blyth, 119.
- Serpentine: Its Formation from Dolomite, by Dr. J. J. Dobbie, and G. G. Henderson, B.Sc., 606.

- Shand (The Hon. Lord) contributes an Obituary Notice of Thomas Knox, 108.
- Sharpey (Prof. William), Obituary Notice of, 110.
- Sheep Diseases, known as Louping-ill and Braxy, 615.
- Silica : Its Crystallization from Fused Metals, by Dr. R. Sydney Marsden, 37.
- Silicon : Its Action on Steel, by Dr. R. S. Marsden, 566.
- Sladen (W. P.), F.L.S., Report on the Asteroidæ of the Faroe Channel, 698.
- Smith (Professor C. Michie) elected a Fellow of the Society, 622.
- Notes on Atmospheric Electricity, 613.
- On the Lowering of the Maximum Density Point of Water by Pressure, 626, 809.
- Smith (David), late Treasurer, Obituary Notice of, 734.
- Smyth (Professor Piazzi), Astronomer-Royal for Scotland, awarded the Makdongall-Brisbane Prize for the Period 1879-80, 361.
- on some Points in the Meteorology of Madeira, 629.
- Snails (Pond), Their Nervous System, by F. E. Beddard, B.A., 576.
- Socotra, Island of, by Professor I. Bayley Balfour, 245.
- Diagnoses Plantarum Novarum et Imperfectæ descriptarum Socotrensium, 456, 498, 834.
- Solar Calorimeter, and some Observations made with it in Upper Egypt, 827.
- Solar Eclipse of 31st December 1880, by Edward Sang, 18.
- Solar Eclipse of 18th May 1882, by Edward Sang, 720.
- Solution—its Nature, by W. L. Goodwin, 834.
- Sonometer (Electric), by Prof. James Blyth, 28.
- Sorley (James) elected a Fellow of the Society, 598.
- Sowerby's Whale (*Mesoplodon bidens*), by Professor Turner, 443.
- Space-Loxi, by Professor Tait, 187.
- Sprague (T. B.), Mathematical Note, title only, 000.
- Statistics : Their Classification, by Patrick Geddes, F.R.S.E., 295.
- Steam shows Impure and Dusty State of Atmosphere, 15.
- Steel.—On the State of Carbon in Iron and Steel, by Dr. R. Sydney Marsden, 868.
- Steel.—On the Influence of Silicon, Phosphorus, and Manganese on, by Dr. R. S. Marsden, 566.
- Steenstrup (Professor Johannes Iapetus Smith) elected a Foreign Honorary Fellow, 95.
- Sterculiaceæ Socotrenses*, 503.
- Sterium retirugum*, a New Fungus, 456.
- Stevenson (Charles Alexander), B.Sc., The Earthquake of 28th November 1880 in Scotland and Ireland, 176.
- Stilbite from Kerguelen's Island, by Professor A. Liversidge, 117.
- Storm : Its Motion in an Easterly Direction only possible as a Circular Atmospheric Wave, by Robert Tennent, 209.
- Styela bythia*, new species, 63.
- *clava*, new species, 70.
- *convexa*, new species, 69.
- *exigua*, new species, 68.
- *flava*, new species, 64.
- *glans*, new species, 65.
- *grandis*, new species, 67.
- *gyroca*, Heller, 67.
- *lactea*, new species, 68.
- *Macleay*, a genus of the Cynthiadæ, 62.
- *oblonga*, new species, 65.
- *squamosa*, new species, 66.
- Styelinae, a Sub-family of the Cynthiadæ, 53.
- Sulphate of Triethyl-phosphorusbetaine, 45.
- Sulphur, when burned, a Fog-producer, 13.
- Surface Tension.—Method of showing Diminution of Surface Tension in Water by Heat, by Professor Tait, 131.
- Sutherland Marble, A supposed Organism from, by Professor Heddle, 634.
- Swan's Lamp, Recent Tests of, by A. Jamieson, 615.
- Sydney (Algernon), His "Treatise on Government," in connection with the Dawn of the Constitutional Principle, by Lord Moncreiff, 160.
- Symbolic Cubic, A Particular Case of, by Dr. Gustav Plarr, 342.
- Symmetric Functions.—On a Class of Permanent Symmetric Functions, by Thomas Muir, 409.
- Syringopora.—The Structure and Relation of the Genus Tubipora to Syringopora, by Dr. H. Alleyne Nicholson, 219.

- Tait (Professor P. G.), Note on the Temperature Changes due to Compression, 51, 217.
- on some Effects of Rotation in Liquid Jets, 94.
- Note on the Influence of Temperature-Change of Conductivity on the Conduction of Heat in Solids, 94.
- Note on Thermal Conductivity, and on the Effects of Temperature-Changes of Specific Heat and Conductivity on the Propagation of Plane Heat Waves, 126.
- Simple Method of Showing the Diminution of Surface Tension in Water by Heat, 131.
- Note on a Singular Problem in Kinetics, 173.
- on some Space-Loci, 197.
- on the Pressure-Errors of the "Challenger" Thermometers, 199.
- on the Crushing of Glass by Pressure, 204.
- Note on a Proposition in the Theory of Numbers, 245.
- on the Compression of Gases by High Pressures, 293.
- on Quaternion Integration, 293.
- on Mirage (Abstract), 354; Part II., 743; Part III., 798.
- Optical Notes (1) on a Singular Phenomenon produced by some Old Window-Panes, 418; (2) On the Nature of the Vibrations in Common Light, 419.
- His Address on Presenting the Keith Prize to Professor Chrystal, 797.
- Kinetic Theory of Gases in relation to Dissociation, 806.
- Note on the Lowering of the Maximum Density Point of Water by Pressure, 813.
- Tennent (Robert) on the Motion of a Storm in an Easterly Direction being only possible as a Circular Atmospheric Wave, 209.
- Tetra-Benzyl-Phosphonium, 46; Chloride of, 47; Acid Sulphate of, 48; Hydrate of, 49.
- Textularia aspera*, 715.
- Trameles Socotrana*, a New Fungus, 456.
- Theel (Dr. Hjalmar), Report on the Holothurioidea of the Faroe Channel, 694.
- Thermal Conductivity, by Professor Tait, 126.
- Thermo-Dynamic Acceleration of the Earth's Rotation, by Sir William Thomson, 396.
- Thermometers. — Pressure-Errors of the "Challenger" Thermometers, by Professor Tait, 199.
- Thioformanilid, The Action of Heat on, by W. W. J. Nicol, 199.
- Thomson (Dr. Allen) contributes an Obituary Notice of Dr. William Sharpey, 110.
- (William), M.A., B.Sc., elected a Fellow of the Society, 598.
- (Sir William), Hon. Vice-President, Effect of Moistening with Water the opposed Metallic Surfaces in a Volta-Condenser, and of substituting a Water Arc for a Metallic Arc in the Determining Contact, 135.
- on Vortex Sponge, 135.
- on the Average Pressure due to Impulse of Vortex-Rings on a Solid, 204.
- on the Thermo-Dynamic Acceleration of the Earth's Rotation, 396.
- on the Figures of Equilibrium of a Rotating Mass of Fluid, 610.
- Tiliacea Socotrenses*, 504.
- Tizard (Staff-Commander) and John Murray, Exploration of the Faroe Channel, during the Summer of 1880, in the "Knight Errant," 638.
- Todd (D. P.), Letter as to his Search for a Trans-Neptunian Planet, 91.
- Traill (William), Report as to Boulders in North Ronaldshay, 746.
- Traquair (Dr. R. H.), Additional Researches on the Structure of the Palæoniscidæ and Platysomidæ, 217.
- Additional Fossil Fishes of Eskdale and Liddesdale, 603.
- Triethyl-phosphine, 41.
- phosphorus-betaine, Ethylchlorate of, 42; Ethyl-bromate and Ethyl-iodate of, 43; Action of Heat on Compounds of, 43; Hydrochlorate of, 43; Sulphate of, 45.
- methyl-phosphonium, 45.
- Tubipora musica*: The Structure of its Skeleton, and the Relation of the genus *Tubipora* to *Syringopora*, by Dr. H. Alleyne Nicholson, 219.
- Tunicata of the "Challenger" Expedition, by Dr. W. A. Herdman. Part III. Cynthiadae, 52; Part IV. Molgulidae, 233.
- Turgite, 549.
- Turner (Professor) on a Specimen of Sowerby's Whale (*Mesoplodon bidens*), captured in Shetland, 443.
- on a Specimen of *Balaenoptera borealis* or *laticeps*, captured in the Firth of Forth, 515.

- Ultra-Neptunian Planet, by Professor George Forbes, 89.
- Umbellifera Socotrenses*, 518.
- Valerianacea Socotrenses*, 837.
- Vapour always Condenses in the Atmosphere on a Solid Nucleus, 15.
- Verrucariae Socotrenses*, 471.
- Vertigo, A Case of, by Professor Crum Brown, 594.
- Vibrations in Common Light, by Professor Tait, 419.
- Vince (Professor), His Two Cases of Unusual Atmospheric Refraction, by Edward Sang, 581.
- Vocalisation and Articulation, by the Rev. J. L. Blake, 815.
- Voice-Effort and Rhythm, by the Rev. J. L. Blake, 798.
- Vortex-Rings.—On the Average Pressure due to Impulse of Vortex-Rings on a Solid, by Sir William Thomson, 204.
- Vortex-Sponge, by Sir William Thomson, 185.
- Wallace.—Report as to Boulders near Inverness, 751.
- Water, Colour of, by John Aitken, 472.
- the Lowering of its Maximum Density-Point by Pressure, by Professor D. H. Marshall, C. M. Smith, and R. T. Omond, 626, 809.
- Wenley (J. A.), elected a Fellow of the Society, 815.
- Whitehead (Walter) elected a Fellow of the Society, 133.
- Wires.—Effect of Elongation on Resistance of Wires, by T. Gray, 33.
- Wise (Dr. T. A.) re-elected a Fellow of the Society, 14.
- Witch's Stone Boulder, 266.
- Witkowski (M. August), Effects of Strain on Electric Conductivity, 135.
- Wood (Dr. Andrew), F.R.S.E., Obituary Notice of, 338.
- Wyville Thomson Ridge in the Faroe Channel, 648.
- Young (Andrew) elected a Fellow of the Society, 361.
- Young (F. W.) elected a Fellow of the Society, 637.
- Young (Thomas Graham) elected a Fellow of the Society 598.

| | PAGE |
|--|------|
| On a Case of Dyspeptic Vertigo. By Professor CRUM BROWN, | 594 |

Monday, 20th March 1882.

| | |
|---|-----|
| Note on the Carboniferous Rocks of the South of Scotland. By ARCHIBALD GEIKIE, F.R.S., | 598 |
| Additional Contributions to our Knowledge of the Fossil Fishes of Eskdale and Liddesdale. By Dr. R. H. TRAQUAIR, | 603 |
| Further Researches among the Crustacea and Scorpions of the Carboniferous Rocks of the Scottish Border. By Mr. B. N. PEACH, | 603 |
| Report on the Fossil Plants collected by the Geological Survey of Scotland in Eskdale and Liddesdale. By ROBERT KIDSTON, F.R.P.S., | 603 |
| On the Formation of Serpentine from Dolomite. By J. J. DOBBIE, M.A., D.Sc., Assistant to the Professor of Chemistry, Uni- versity of Glasgow, and G. G. HENDERSON, B.Sc., | 606 |

Monday, 3d April 1882.

| | |
|--|-----|
| On a Rotating Mass of Fluid. By Sir WILLIAM THOMSON, | 610 |
| Notes on Atmospheric Electricity. By Prof. C. MICHIE SMITH, | 613 |
| Recent Test of Swan's Lamp for fall of Resistance, with increase of Electromotive Force, and Ratio of Candle-power to work expended. By Mr. A. JAMIESON. Communicated by Pro- fessor CHRYSAL, | 615 |
| Communication of Preliminary Observations made by the Com- mittee appointed by the Highland and Agricultural Society to investigate the Nature and Causes of the Sheep Diseases known as Louping-ill and Braxy, | 615 |

Monday, 17th April 1882.

| | |
|---|---|
| On the Definite Article in Greek, with special reference to the Re- vised Version of the New Testament. By Prof. BLACKIE, | 6 |
| On the Action of the Microphone. By Prof. JAMES BLYTH, M.A., | 6 |
| Experiments to Determine the Lowering of the Maximum Density Point of Water by Pressure. By Professor D. H. MARSHALL, Professor C. MICHIE SMITH, and Mr. R. T. OSOND, | 6 |

Monday, 1st May 1882.

| | |
|--|--|
| On some Points in the Meteorology of Maderia, both Absolute Comparative. By the ASTRONOMER-ROYAL for SCOTLAND | |
| On the Anatomy and Histology of <i>Pleurocheta Moseleyi</i> . E. BEDDARD, B.A., New College, Oxford, | |
| Geological Notes. By Professor HEDDLE, | |
| Note on the Absorption of Sea Water. By Mr. JOHN AITKEN, | |

Monday, 15th May 1882.

| | |
|---|--|
| Exploration of the Faroe Channel, during the Summer of H.M.'s hired ship "Knight Errant." By Staff-Co TIZARD, R.N., and Mr JOHN MURRAY, with Reports. (Plate VI.), | |
| Notice of the Solar Eclipse of the 17th May, with Re- Calculation. By Mr. EDWARD SANG, | |
| Some Experiments on a New Secondary Cell. LAURIE, B.Sc., | |

Monday, 5th June 1882.

| | |
|--|-----|
| Obituary Notices of Mr. David Smith, Dr. William Lindsay, and Professor Benjamin Peirce, | 775 |
| On Mirage. Part II. By Professor TAIT, | 773 |
| Report of the Boulder Committee, with Remarks by the Convener, Mr. MILNE HOME. (Plates IV, V), | 773 |
| Supplement to the Eighth Report of the Boulder Committee, | 787 |

Monday, 19th June 1882.

| | |
|--|-----|
| On Mirage. Part III. By Professor TAIT, | 795 |
| On a Red Resin from <i>Dracaena Cumulari</i> (Balf. fil.) Socotra. By Messrs. J. J. DOBBIE, Assistant to the Professor of Chemistry, University of Glasgow; and G. G. HENDERSON, B.Sc. Communicated by Dr. BAYLEY BALFOUR, | 799 |
| On Voice-Effort and Rhythm. By the Rev. J. L. BLAKE. Communicated by Professor CRUM BROWN, | 799 |
| The Effect of Moisture on the Electric Discharge. By A. MACFARLANE, M.A., D.Sc., and D. RINTOUL, M.A., | 801 |
| The Heats of Combination of the Metals with the Halogens. By Messrs. A. P. LAURIE and C. I. BURTON. Communicated by Professor CRUM BROWN, | 804 |

Monday, 3rd July 1882.

| | |
|---|-----|
| On the Kinetic Theory of Gases in relation to Dissociation. By Professor TAIT, | 806 |
| On the Change in the Peltier Effect due to Variation in Temperature. By Mr. ALBERT CAMPBELL. Communicated by Dr. KNOTT, | 807 |
| On the Lowering of the Maximum Density Point of Water by Pressure. By Professor D. H. MARSHALL, Professor C. MICHIE SMITH, and Mr. R. T. OMOND, | 809 |
| Note on the Preceding Paper. By Professor TAIT, | 813 |
| Articulation and Articulation. By the Rev. J. L. BLAKE. Communicated by Dr. CRUM BROWN, | 815 |

Monday, 17th July 1882.

| | |
|--|-----|
| Order of Succession of Rocks in the North-West Highlands. By Professor HEDDLE, | 815 |
| Rotation of the Plane of Polarization by Quartz, and its Relation to Wave-Length. By Mr. W. J. PEBBLE. Communicated by Professor TAIT, | 815 |
| Stability of Ammonium Salts when dissolved in Water. By Mr. J. NICOL, M.A., B.Sc. Part I., | 819 |
| Calorimeter, and some Observations made with it in Egypt. By Mr. J. Y. BUCHANAN, | 827 |
| Heats of Combination of the Metals with the Halogens. By Messrs. A. P. LAURIE, B.Sc., and C. I. BURTON, | 830 |
| On the Solution of Salts. By Mr. W. L. GOODWIN. Communicated by Professor CRUM BROWN, | 834 |

Phanerogamorum novarum et imperfecte descriptarum Phanerogamorum Socotrensium, quas elaboravit BAYLEY BALFOUR, et in Universitate Glasguensi rerum botanicarum Professor. Pars altera,

3 2044 106 279 821

Date Due

~~FEB 1974~~

