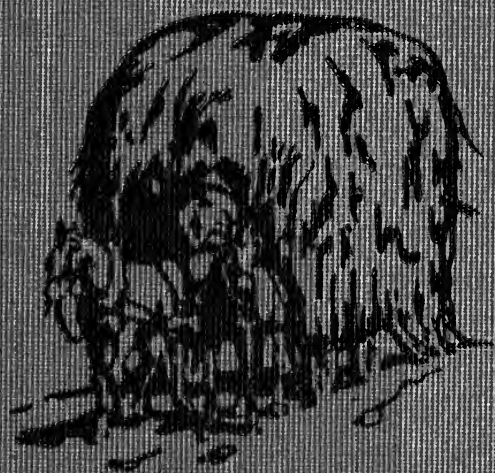


# PRODUCTIVE FARMING



KARY C. DAVIS

From the collection of the

o P<sup>z n</sup>re<sup>m</sup>inger<sup>a</sup>  
v L<sup>t</sup>ibrary<sup>p</sup>

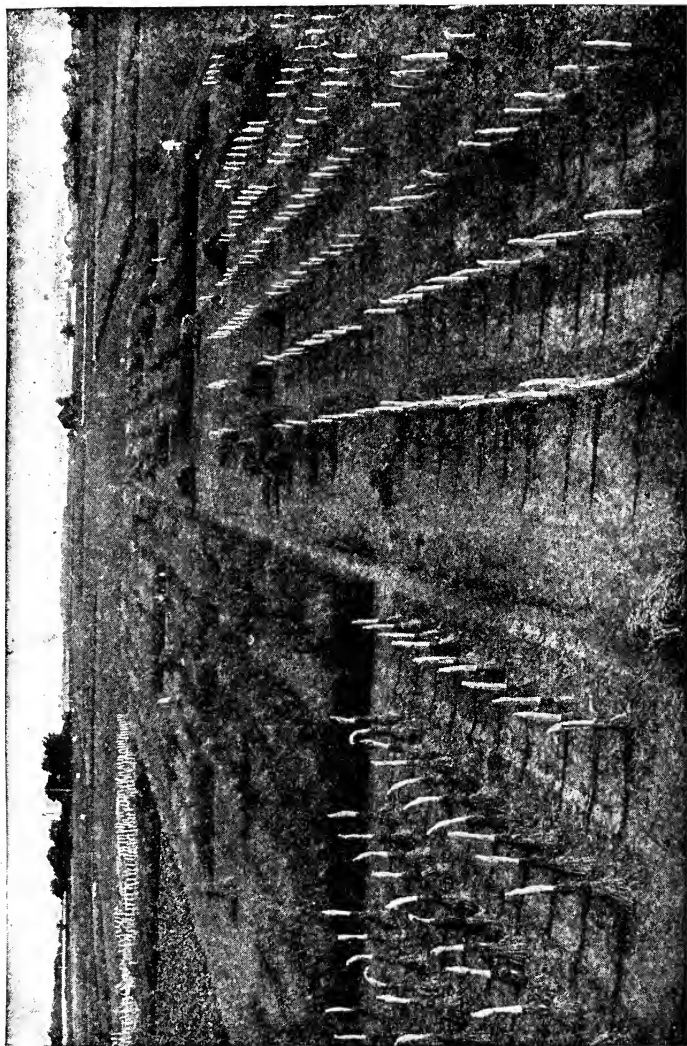
San Francisco, California  
2006

Dr. J. L. ... (led)

(over)







View at Minnesota Experiment Station. Improving varieties of wheat and other small grains. Tying up the grain to prevent shelling and loss by sparrows.

# PRODUCTIVE FARMING

BY

KARY CADMUS DAVIS, PH.D. (Cornell Univ.)

PROFESSOR OF AGRICULTURE, KNAPP SCHOOL OF COUNTRY LIFE, GEORGE PEABODY  
COLLEGE FOR TEACHERS; FORMERLY PROFESSOR OF AGRONOMY, NEW JERSEY  
COLLEGE OF AGRICULTURE (RUTGERS); INSTRUCTOR IN AGRICULTURE, UNI-  
VERSITY OF VIRGINIA SUMMER SCHOOL; PROFESSOR OF HORTICULTURE,  
WEST VIRGINIA UNIVERSITY; PRINCIPAL, DUNN COUNTY (WIS.)  
SCHOOL OF AGRICULTURE; DEAN, STATE SCHOOL OF AGRICUL-  
TURE, CANTON N. Y.; CONDUCTOR MANY SUMMER TRAINING  
SCHOOLS; INSTRUCTOR IN FARMERS' INSTITUTES

FIFTH EDITION, REVISED AND ENLARGED



PHILADELPHIA AND LONDON  
J. B. LIPPINCOTT COMPANY

COPYRIGHT, 1911  
BY J. B. LIPPINCOTT COMPANY

---

COPYRIGHT, 1912  
BY J. B. LIPPINCOTT COMPANY

---

COPYRIGHT, 1917  
BY J. B. LIPPINCOTT COMPANY

---

COPYRIGHT, 1920  
BY J. B. LIPPINCOTT COMPANY

---

COPYRIGHT, 1922  
BY J. B. LIPPINCOTT COMPANY

PRINTED BY J. B. LIPPINCOTT COMPANY  
AT THE WASHINGTON SQUARE PRESS'  
PHILADELPHIA, U. S. A.



## PREFACE

THIS book is intended to suit the needs of rural schools of all kinds, and graded village and city schools chiefly below high-school rank. It is believed that many high-schools wanting a less advanced course in agriculture than is offered in more difficult books will find this text helpful. It is hoped that farmers and others pursuing a short course, a reading-circle course, a correspondence course, or a home-reading course will find this volume of value. Such persons should read the exercises but probably omit the trial of some of them.

In the preparation of this book the writer has been aided very materially by a number of people. The ever-present memory of the boys and girls with whom the writer has associated as a schoolmate or as teacher in the rural schools and graded schools has been an inspiration and help in preparing every lesson to be studied by other such boys and girls. The many teachers of both rural and graded schools who have criticized the lessons as they have been presented by the writer have spurred him on to do his best in the making of this book. It is to such teachers and such boys and girls that this book should be dedicated, for they have been in the writer's mind every moment of the time.

Special acknowledgment is due to a number of persons who have helped in the preparation of the whole book or of special chapters. Professor Dick J. Crosby, Specialist in Agricultural Education of the United States Department of Agriculture, has read the first manuscript of the whole book and parts of the second draft. His suggestions and help have been so valuable that his name should go on the title page if he would allow it. He has read the proofs, and

through him many photographs have been supplied by the Department of Agriculture. Cuts made from those photographs are marked "A. E." of agricultural education.

In like manner, Frederick C. Minkler, Professor of Animal Husbandry of the New Jersey College of Agriculture, has read the manuscript and proofs of several chapters on Animal Production, Animal Breeding, Horses, Cattle, Sheep, and Swine. Other Professors of the same institution have read the manuscript and proofs of a number of other chapters: Dr. Jacob G. Lipman, Director of the Agricultural Experiment Station, the five chapters on Soils and their Improvement; Professor Harry R. Lewis, Head of the Poultry and Dairy Departments, the chapters on Poultry Management and Cattle Products; Dr. John B. Smith, State Entomologist, the chapters on Insects and Bee-keeping; Professor Maurice A. Blake, Head of the Horticulture Department, the chapter on Fruit Production; Dr. Byron D. Halsted, Botanist and Plant Pathologist, the first chapter and the chapter on Plant Diseases and Spraying; Walter W. Shute, Instructor in Forage Crops, the chapters on Field Crops and on Alfalfa; Arthur J. Farley, of the Horticulture Department, the Sections on Spraying and the Tables of Insecticides and Fungicides; Dr. Myron T. Scudder, Headmaster of the Rutgers Preparatory School and Professor of the Science of Teaching in Rutgers College, has read manuscripts and proofs of the Introduction and the chapter on The Business of Farming. Mrs. Kary C. Davis has read and criticized the whole manuscript and corrected the proofs. She has made nearly all of the pen-and-ink drawings in the book. To all of these and others, including many farmers and teachers whose names do not appear, the author is greatly indebted for material aid and encouragement.

Photographs besides those already mentioned have been kindly furnished by the Agronomist and the Dairy Division of the United States Department of Agriculture. These

are marked under illustrations: "An. I." for Animal Industry, and "Pl. I." for Plant Industry. Credits are given with the name of the station to those furnished by State Experiment Stations: "Kans.," "W. Va.," "Wis.," "N. J.," "Minn.," "Maine," "Cornell." Professors Harry R. Lewis and Maurice A. Blake kindly supplied a number of photographs; animal photographs were also given by F. Warren Sumner, of Elizabeth, N. J., the White Wyandotte Hen; Thos. Wyckoff, Orchard Lake, Mich., the Rambouillet Ram; *Cornell Countryman*, the Dorsets; Chas. Leet, Mantua, Ohio, Southdown Ewe; R. C. Parsons, Grand Ledge, Mich., Oxford Ram; A. T. Gamber, Wakeman, O., American Merino. Cuts have been loaned by the author and the J. B. Lippincott Co. from John B. Smith's "Insect Friends and Enemies," and "Economic Entomology."

The author will be glad to receive suggestions and corrections from teachers and others regarding any mistakes in the book.

---

THE chapter on Cotton was added in the second edition. The third edition included a number of changes in the Appendix tables to bring the matter up to date. Suggestions to Teachers for additional exercises and projects were added to the Appendix. Changes and many additions were made through the text in both the third and fourth editions. Much of the new Part V was added in the fourth edition. The present Chapters XVI and XXXI were added. A Southern Edition was issued in 1919. In the fifth edition 1922, the Swine Chapter (XXVI) was rewritten, enlarged and adapted to home project methods; Chapters on Sheep, and Poultry were likewise much improved by the addition of matter on projects, debates, contests and fresh references.



# CONTENTS

## INTRODUCTION.—THE TEACHING OF AGRICULTURE

### PART I.—PLANT PRODUCTION

I.	STRUCTURE AND PHYSIOLOGY OF PLANTS .....	8
II.	PLANT IMPROVEMENT—GOOD SEED .....	22
III.	PROPAGATION OF PLANTS WITHOUT SEEDS .....	35
IV.	HOW SOILS ARE FORMED .....	44
V.	KINDS OF SOILS—THEIR CHARACTERISTICS .....	52
VI.	SOIL MOISTURE .....	60
VII.	LAND DRAINAGE .....	67
VIII.	SOIL IMPROVEMENT .....	71
IX.	SYSTEMS OF CROPPING .....	88
X.	FARM CROPS .....	97
XI.	ALFALFA .....	111
XII.	COTTON PRODUCTION .....	117
XIII.	CORN .....	133
XIV.	SMALL GRAINS .....	154
XV.	POTATOES .....	162
XVI.	TOBACCO FOR MARKET .....	175
XVII.	THE PRINCIPLES OF FORESTRY .....	178
XVIII.	GARDENING .....	191
XIX.	FRUIT PRODUCTION .....	206
XX.	INSECTS .....	220
XXI.	DISEASES OF PLANTS—SPRAYING .....	246

### PART II.—ANIMAL PRODUCTION

XXII.	IMPROVEMENT OF ANIMALS .....	259
XXIII.	HORSES .....	262

XXIV.	CATTLE.....	279
XXV.	SHEEP.....	293
XXVI.	SWINE.....	300
XXVII.	POULTRY MANAGEMENT.....	305
XXVIII.	BEE-KEEPING.....	321
XXIX.	FEEDS AND FEEDING.....	327

## PART III.—ANIMAL PRODUCTS

XXX.	CATTLE PRODUCTS.....	344
------	----------------------	-----

## PART IV.—FARM MANAGEMENT

XXXI.	THE BUSINESS OF FARMING.....	360
-------	------------------------------	-----

## FARM MECHANICS

XXXII.	ROAD CONSTRUCTION AND MAINTENANCE.....	371
XXXIII.	WORK WITH ROPE.....	376
XXXIV.	REPAIR OF FARM EQUIPMENT—HANDY DEVICES.....	385
XXXV.	POWER ON THE FARM.....	391

## PART V.—APPENDIX—REFERENCE TABLES

I.	REFERENCE BOOKS.....	i
II.	LIST OF EXPERIMENT STATIONS.....	iii
III.	INSECTICIDES AND FUNGICIDES.....	v
IV.	QUANTITY OF SEED PER ACRE AND LEGAL WEIGHTS.....	ix
V.	SAMPLE PEDIGREE OF PURE BRED CATTLE.....	x
VI.	RULES.....	xi
VII.	FERTILIZER FORMULAS.....	xii
VIII.	AVERAGE DIGESTIBILITY OF FEEDS AND THEIR FER- TILITY.....	xv
IX.	FEEDING STANDARDS.....	xvi
X.	AVERAGE COMPOSITION OF FARM MANURES.....	xvii
XI.	DISTANCES APART FOR PLANTING FRUIT.....	xvii
XII.	USUAL DISTANCES APART FOR PLANTING VEGETABLES.....	xviii
XIII.	SUGGESTIONS TO TEACHERS FOR ADDITIONAL EXER- CISES AND PROJECTS.....	xix
	INDEX.....	xxix

# PRODUCTIVE FARMING

## INTRODUCTION

### THE TEACHING OF AGRICULTURE

*at*  
*here*

THE demand for the teaching of agriculture in the public schools is growing stronger all the time. In many States of the Union and several provinces of Canada the subject has been introduced into schools very generally. Not only has the subject been taken up in the high-schools, but also in special schools started for the avowed purpose of teaching agriculture, manual training, and domestic economy.

This is in response to the very general demand for more practical instruction. The feeling exists that the schools have been doing work too remote from real life; and that where the work has touched the life at all, it has been the city side or the commercial side rather than the productive side and the industrial side of life. Such training tends to lead all, or nearly all, young people away from rather than toward the industrial and productive callings. The census reports indicate that this tendency has aided in building up the cities and actually decreasing the population in many of the rural districts.

The interest in rural life should be kept up by the training received in country schools, and in all schools. A proper conception of the opportunities afforded in the country should be in the minds of all young people—whether they live in cities or in the country. The productive wealth of the nation is from the country, not from the city. This wealth should be used to improve rural life rather than city

life. All young people should learn of the opportunities for health, independence, happiness, and wealth afforded by the country. Those living in the country often fail to realize their blessings. They rush in dangerous numbers to the cities, until every legitimate city occupation is overcrowded. Hosts of them are left to seek livelihoods by devices and means that are at least not elevating.

The comforts and conveniences enjoyed by a few in the cities are very alluring to the young ambitious mind. Why not show that things better than these are in the country—and that many of these same comforts may be enjoyed by rural communities.

**Suggestions to Teachers.**—The teaching of agriculture is most easily done by taking up those subjects nearest at hand. Teach the lines of agriculture that will be most valuable in your community. If in a gardening section the special garden crops will be most interesting; in a dairy section study dairy breeds, the testing of milk, the dairy products; in the corn belt the class will delight in the study of corn improvement, the testing of seed corn, and the judging of corn by score cards.

There are certain chapters in this book which are fundamental and cannot be omitted. For example, Chapter I is necessary to the proper understanding of other plant studies. However, there are certain other chapters which may be taken independently at a time of year which suits the subject. The chapter on Forage Crops and perhaps others may well be used as reading lessons and then studied more in detail later.

**How to Begin.**—Enter heartily into the new subject without hesitation. Teach the newest things in agriculture. It will be easier for you to teach these than to teach the topics more familiar to the class. This is particularly so if the pupils are from farms. The field is so broad no one can know it all. Teach the facts which you know best and



which are newest to the class: the making of spray mixtures; the prevention of certain plant diseases; the raising and use of special crops which should be grown, as, perhaps, alfalfa, or certain clovers; the green-soiling methods of feeding; use of catch crops and cover crops; the saving of soil moisture. The best United States Farmers' Bulletins will help you along these newer lines and will give you new points on the old themes. Why? It is because the U. S. Department of Agriculture and fifty or more agricultural experiment stations are finding out new things in agriculture all the time.

**Farmers' Bulletins.**—References to United States Farmers' Bulletins are given at the close of the chapters. A complete list of Farmers' Bulletins can be had by writing to the Secretary of Agriculture, Washington, D. C. Besides those listed at the close of the chapters, there are others that will be helpful in schools. Write for them. They are free to schools.

Make pasteboard holders for the Bulletins. Put labels on these so that a simple classification will be possible. Label them similar to the chapters in this book.

**How to Use the Bulletins.**—Teachers will find the United States Farmers' Bulletins very useful. Let us illustrate. No. 1233, "Tomatoes for Canning," is full of suggestions for teachers and others. It tells what to do and how to do it. The pictures are simple and plain. Most of the Bulletins are well illustrated and plainly written. Each of these Bulletins has a special use in teaching some definite subject. Have advanced pupils use the Bulletins as extra work, or as supplementary reading.

**Time Saved.**—If the objection is raised that there is no room in the schedule—no time—for a new subject because there are already too many subjects to teach, answer by saying there is always room for a subject that will hold the pupils' interest. Such subjects, if practical, are the best in the school course.

**Arranging the Schedule.**—A “sliding schedule” may be made to admit agriculture without reducing the recitation time for other subjects, thus: First plan—On Mondays let agriculture take the place of the first morning recitation period; on Tuesdays, the second period; on Wednesdays, the third period, and so on through the week. Another plan would be to have agriculture three times a week, alternating with some three other subjects,—each of them being given four times a week. Another time-saving plan to use in the smaller rural schools is to combine several of the upper classes into one class when teaching a new subject like agriculture.

**Correlation.**—It is, indeed, a very good plan to correlate the work in agriculture with other subjects in school. The other subjects will be made far more interesting to most of the pupils if agriculture is made the center of interest around which to group these other subjects.

School English is made more interesting by having pupils read and write and speak on those themes which are close to human life. Language comes forth spontaneously when the pupils have something real to tell or to write about. New words in this book or in the Bulletins should be woven into the spelling and language work.

A few arithmetical problems have been suggested in this book. These will serve to show that much of the arithmetic work of the school can be founded on agriculture or enriched by it.

One of the best ways to study local geography is to study the soils of the neighborhood (Fig. 1). Trips may be taken by the class to near-by places where examples of erosion are shown, or the action of ancient glaciers, or the cropping out of ledges of sedimentary rocks. Study soil-depths, soil-textures, and soil improvement. Take samples of soils and subsoils. The study of the ways in which soils are being formed all about the neighborhood is real geography.

All this should be done not solely for the sake of agriculture, but for the sake of more interest in other subjects when the agricultural matter is introduced. There is as much or more cultural value in the teaching of a practical subject as in teaching any other subject in the school course.



FIG. 1.—Studying soils and potting plants. Graded school work in Virginia.

**Use the Exercises.**—The practical exercises offered in this book are simple and can be performed by pupils themselves with a little guidance. Pupils will be willing to supply the necessary articles in most cases. The exercises add much to the interest and also to the value of the work. The work should be directly with things, handling them, reasoning from them. Use also the exercises given in United States Farmers' Bulletins 428, 586, 606, 609, 617.

Suit the subject considered to the season so far as convenient. Seed testing is a good exercise for early spring. School garden work will come later. Do not fail to provide window boxes. The pupils will do the work gladly, and in the spring season fill them with germinating seeds and growing plants.

Teachers will find that agriculture will add a new interest to the whole school work. Exhibits of the school garden pro-

ducts may be made at the school in the fall. Prizes may be offered for the best products grown by the pupils in the home gardens. Money to buy prizes may be raised by charging an admission fee when the exhibit is made. If the exhibit is small, supplement it with a suitable program.

**A Community Center.**—The public affairs of the community should center about the school much of the time during the school year.

The teacher may appoint committees to arrange the details of many events to be held at the school or at other near-by places in the name of the school. Hold corn exhibits in the fall or early winter and let students and others enter into corn-judging contests. Apple shows and vegetable shows may be held at separate times or in connection with the corn show. Poultry shows and dairy-product shows may be possible in some places.

Premium lists should be issued to the pupils to take home, or they may be published in local papers. Award cards may be issued in lieu of premiums; but the merchants or neighbors may be called upon to contribute suitable articles to be used as prizes. Get county agents and agricultural high school teachers to do the judging.

**Boys' and Girls' Clubs.**—The school should be the center for the organization of boys' corn clubs, or alfalfa clubs, or experimental clubs. Girls' clubs may be organized. They may follow nature study, or home gardening, or sewing, or basketry. Let the work of all these clubs be shown at the school on stated occasions. Read *Farmers' Bulletin 562*.

Special school exercises of an appropriate nature should be given on arbor day, bird day, corn day, alfalfa day, and other special days. Always have the patrons of the school present on these occasions. Make the school building the attractive center for the people of the community. The newer lines of education will connect with the life of the community at every point.

Let school holidays and perhaps other days be filled with historical or agricultural or other pageants suitable to the season; have appropriate contests, school games, and good sports. Let there be recreational diversion for old and young. Appoint committees to coöperate in preparing for these occasions.

*Problems*  
**Problems.**—A few problems here will be suggestive and serve as sample problems to be placed on the board for pupils, from time to time.

1. Calculate the number of cabbages on an acre if they are set as close as shown in Appendix, Table XII, allowing for one-fourth loss.

2. If cabbage worms destroy one-third of the above result, and the good heads bring 5 cents per head, what is the income for the acre?

3. What would be the money value of the heads destroyed by cabbage worms?

4. If a boy working at \$1 per day can dust three acres of cabbage plants a day and keep off the worms, what is the profit for his day's work, if the material costs 90 cents?

5. A man has 500 young apple trees attacked by woolly aphid insects, which he wishes to spray with kerosene emulsion to save the trees. If six gallons of the stock solution given in Appendix, Table III, are required (diluted with ten parts water), calculate the cost of materials at present local prices for soap and kerosene.

6. If the use of the sprayers is worth \$1 and the labor can be done by two men in a day and a quarter, what is the total cost of the spraying job?

7. If a pair of bluebirds, in seeking food for their young in the nest, gather 120 worms from an old orchard each day, and each worm is thereby prevented from doing five cents' worth of damage to fruit, calculate the value of these birds in one nesting season of sixteen days.

8. A solitary wasp collected for her brood thirty-eight apple worms, and thus prevented each of these worms from maturing and laying 200 eggs, each of which would have caused an apple to be wormy. Consider the apples each worth two cents more when not affected with the worms. What is the value to man of this solitary wasp?

9. A toad ate ten cutworms each night and thus saved a like number of tomato plants in my garden. What do you consider is a fair value of a tomato plant in cost and labor after it is set in the garden? What is the value of this toad in three weeks?

**References.**—U. S. Farmer's Bulletins 586 and 606, on Collection and Preservation of Material for Study of Agriculture.

# PART I.

## PLANT PRODUCTION

---

### CHAPTER I.

#### STRUCTURE AND PHYSIOLOGY OF PLANTS.

THE plants produced in field and garden form the food for man and nourishment for his live stock. Parts of plants are useful in the arts, as their oils for paint, their fibers for clothing, and their wood for buildings and fuel.

The parts of farm plants are broadly considered to be made up of (1) root, (2) stem, (3) leaf, (4) flower, and (5) seed.

**Roots of plants** are for three purposes: to hold the plant in place or prevent its blowing away; to take nourishment and moisture from the soil; and to serve as storage places for plant food.

In growing into the soil the tip of the root forces its way among the soil particles. For this reason there is a **root cap** or covering over the tip to prevent injury. The growth takes place a little back of the tip cap, or covering, at the end of the fine roots.

**Root-hairs** are formed on the fibrous roots a little distance from the tips. These are of fine growth, giving a plush or velvety surface to the root. The surface of all these fine hairs is very thin and is much greater in area than the surface of the roots. This allows moisture from the soil to pass through into the plant more easily.

**EXERCISE.**—*To Show Root-hairs.*—Plant a few kernels of corn in moist sand or soil in a bottle with wide mouth.

Wrap some black or dark paper around the body of the bottle to exclude the light. Roots seek darkness. Keep the soil moist and in a warm room for a week or so. The growth of the young roots will then have reached the inside surface of the glass. Notice their very fine, plush-like appearance (Figs. 2a and b). Notice also which grow in length faster during the first two weeks, the roots or the tops of the young corn plants.

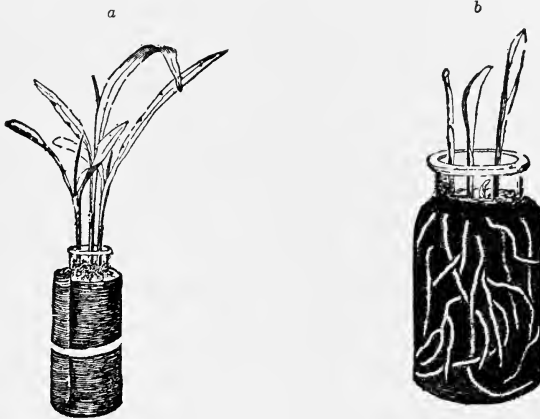


FIG. 2a.—Corn grown in a bottle of soil. The dark paper around it excludes the light, so the roots may be studied by removing the paper.

FIG. 2b.—Corn grown as in Fig. 2a, showing fibrous roots and root-hairs for absorbing moisture.

**EXERCISE.**—*Root-hairs on Seedlings*—Sprout some seeds of squash or beans in folds of moist blotters between two plates until the roots are two or three inches long. Examine for root-hairs on these by holding them against a dark cloth or paper.

**Stems** of plants have several uses: They support the leaves and hold them up to the air and light. They serve as storehouses for the saving of starch, sugar, and other forms of nourishment for the future use of the plant. They are the channels of circulation of plant sap and the transfer of plant food from root to leaf and from leaf to root.

**EXERCISE.**—*Sap Channels in Stems.*—Put the stems of fresh plants into water colored with red ink. After a few hours cut off the stems and notice the stained places on the cut surface. Use for this exercise some woody stems, as willow, and others like celery or rhubarb, golden-rod, corn, tall grass, or other convenient plants.

The different ways in which the stems of various plants hold the leaves up to the light and air are interesting. Vines do this by climbing upon objects which they may find near them. Trees have rigid stems which hold the leaves high in the air. Those growing in dense forest clumps are taller and more slender than those growing in open places where there is plenty of light. This is also true of corn-stalks planted close or far apart.

The leaves of the plant have much work to do. They secure substances from the air, chiefly carbon dioxide, and change it into forms of food that will build up the plant or produce growth. The leaves also permit the escape of water from the plant into the air. Water is taken up by the roots, not by the leaves. There are large amounts of water given off by the leaves during the growth of the plants.

**EXERCISE.**—*Plants Absorb Moisture.*—Get the material shown in Fig. 3a. After the corn or other plant is a few inches high, start the experiment. Have the water line marked on the lard pails one inch above the bottom of the pots. Each day fill the water up to the mark, and record the amount required for each pail in two weeks. If the one with the growing plant requires the most, where has the extra water gone to?

**EXERCISE.**—*Moisture from Leaves.*—Arrange an experiment as shown in Fig. 3b. The moisture which escapes from the leaves will partly be condensed on the inside of the inverted glass, and may be seen in fine mist or drops.

**Leaf Structure.**—Fig. 4 shows the cut edge of a leaf. Between the upper and lower surfaces of the leaf there are



many soft plant cells. These cells have very thin walls and are bathed by air. The air cavities are shown at A in the figure. All the cells shown with dark grains in the figure contain the green coloring matter of the leaf. This is called *chlorophyl* (klo-ro-fil). The use of this will be spoken of later.

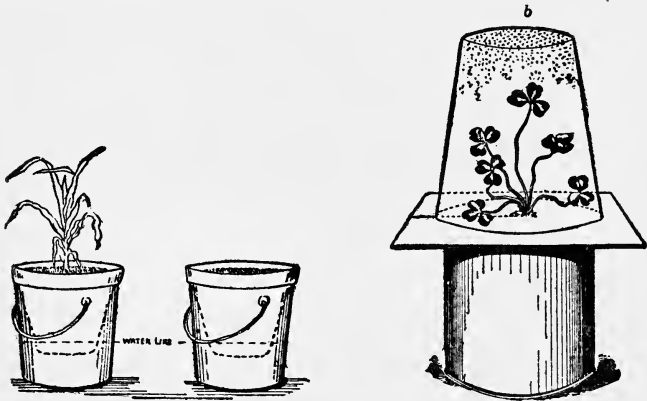


FIG. 3a.—Growing plants absorb moisture from the soil. Two flower-pots with equal amounts of the same kind of soil are set in lard pails having water up to the line shown. Corn is growing only in the left one. (Agricultural Education.)

FIG. 3b.—Evaporation of water from leaves. The condensed moisture shows in the upper part of the glass inverted over the growing plant. (Agricultural Education.)

**EXERCISE.—*Skin of Leaf.***—Break a leaf partly in two in such a manner as to peel the surface away from the inner cells. This surface layer of cells is clear and contains no chlorophyl, as shown in Fig. 4. The outer layer of cells is so thin and clear that sunlight may pass through and reach the green cells of the inner part of the leaf.

**Air Openings.**—Air may enter the leaf through small openings, chiefly on the under side. One of these openings is marked S in Fig. 4. These are called *stomates*, the word meaning “mouths.” There are great numbers of the stomates on the under surface of leaves. They may be opened or closed according to the condition of the weather. This is done by the action of a pair of cells at the opening called

*guard-cells*. The stomates are partly closed in dry weather. This keeps moisture from passing too freely out of the leaves into the air. ✕

**Plants Get Food from Air.**—Growing plants take much of the substance which produces growth directly from the air. They use the carbon dioxide from the air which is given off to the air by the breathing of animals and by the burning and decay of wood. This plant-food from the air furnishes about ninety-five per cent of the dry weight of plants. It is through the leaves that this form of food is taken. The

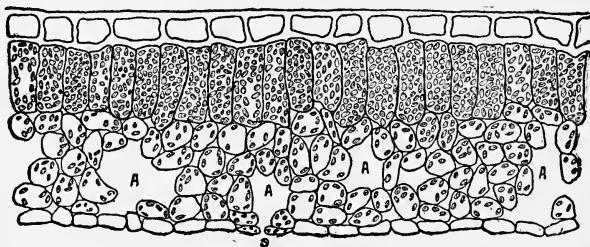


FIG. 4.—Cross section of leaf. The inner cells contain chlorophyl; those near the under side are loose to allow the free passage of air (A). Many breathing pores are in the under skin. One shows at S.

breathing pores on the surface of green leaves allow the air to come in contact with the soft cells of the inner tissue (Fig. 4).

**Sunlight aids the plant** in changing the carbon dioxide into starch or other organic food. Only those plants which contain the green coloring matter, chlorophyl, are able to use the carbon dioxide from the air and change it in this way. Mushrooms grow in the dark, and have no chlorophyl. Their food is not taken from the air nor from the real soil, but from the partly decomposed matter in the soil.

**EXERCISE.**—*Need of Sunlight.*—Place a board, box, or other object over the green grass of a lawn and let it remain for several days. Notice that the color is soon gone from the leaves. In time the grass would be killed. Celery is

*blanched* by excluding the light from the stems. Why does a covering of straw or other thick mulch in a strawberry patch prevent the growth of weeds? What harm comes from the accidental covering with soil of young corn plants by the cultivator?

EXERCISE.—*Leaves Seek Light.*—Set some growing plants in the window for a few hours and notice that the leaves turn toward the light. Turn the plants around and see how long it takes for the leaves to face the light again.

EXERCISE.—*To Show Presence of Starch.*—Crack a few kernels of wheat or corn and treat them with a few drops of *iodine*. The change of color which follows is a proof of the presence of starch. This was stored in the seed for its future use. Starch turns blue when treated with iodine. The same trial made with potato, corn-pith, pith of tree twigs, and many seeds, will show the presence of starch.

**Balance in Nature.**—Animals use large quantities of oxygen from the air and return carbon dioxide to the air. Plants make use of the waste which animals breathe off. The plants break up this gas, retaining the carbon and giving off the oxygen. A small amount of oxygen is also used by plants. The carbon retained by the leaves and the water which the plants obtain from the soil are combined to form organic matter. This is chiefly starch at first, but it may be readily changed to sugar or other forms suitable for storage. In sugar-beets and sugar-cane the storage matter is largely sugar.

Tissue for new growth of the plant may be formed either from stored plant-food or from newly-formed plant-food that has not been taken to any storage place in the plant.

EXERCISE.—*Balance of Life in an Aquarium.*—Make an aquarium in a large fruit-jar or other glass vessel, as shown in Fig. 5. Very clear sand is used in the bottom. The plants are started from pieces of water plants commonly growing in ponds or lakes. The animals may be water insects of

several kinds—polliwogs, water snails, and small fish. Set the aquarium in a very light place. When the plants begin to grow, they will give off oxygen to the water. The animals will breathe the oxygen from the water. A little careful

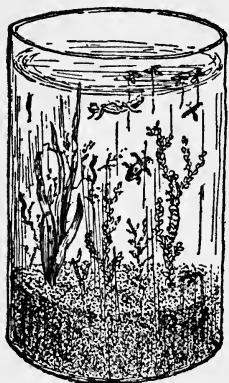


FIG. 5.—A sunlight aquarium. The plants furnish oxygen and the animals use it. The animals produce carbon dioxide and the plants use it.

observation will tell whether there are too many animals in the aquarium or not. If the fishes come to the surface to breathe a great deal, some of them should be taken out. Snails and polliwogs are scavengers and will eat the waste matter gathering on the inside of the glass and on the plants. Do not let the pupils feed the fishes too much. This will spoil the water for the fishes.

**How Plants Get Water.**—The moisture from the soil is the only water taken in by farm crops. This enters through the thin covering of the root-hairs growing on the fibrous roots. The absorbing surface is very great and large quantities of liquid are taken up. It is estimated that several hundred tons of water or liquid food are taken up by a corn crop to produce one ton of dry fodder.

**Osmosis** is the name of the process by which liquid food is taken into the plant through the roots. A little of the acid or other cell sap in the roots passes into the soil at the same time. There is a sort of trading of two liquids through the surface membrane of the root-hairs. A very little of the denser liquid of the plant is sent out in exchange for a large quantity of soil water.

Osmosis may be defined as the exchange of two different liquids through a thin membrane which separates them. Two liquids separated by a membrane will pass through it and mingle with each other. Soil water will thus reach and

minge with the contents of root-hairs. The thin liquid passes more rapidly. Osmosis may be well illustrated in a number of ways.

**EXERCISES.**—*Osmosis with Potato.*—Take a wilted potato tuber and cut it into slices about one-fourth inch thick. Place a few slices in water. Do they become more rigid in an hour or so? Is water taken into the cells? Place a few slices in strong salt water. Should they become wilted because of the water drawn from them into the brine? The potato sap is naturally denser than water, but not so dense as the salt water.

**EXERCISE.**—*Osmosis with an Egg.*—In the small end of an egg make a hole a little larger than a pin head. Over this hole fasten a short piece of glass tubing. Melted paraffin or wax will fasten it well. At the large end of the egg chip away a bit of the shell. Place it with the large end down in the wide mouth of a bottle which is full of water (Fig. 6). Watch later and if liquid be seen to rise in the tube, give its source. Can water make its way through the thin membrane? This membrane shows no pores even under the microscope.

**Plant-food from Soil.**—If plants take about ninety-five per cent of their food from the air there is left only about five per cent to be obtained from the soil. The plant-food from soils must be in soluble form, and is taken in with the soil water. When plant-food is soluble it can pass through the membrane of the fine root-hairs growing on the roots of plants. It produces in the plant the part of the tissue which is called the ash or mineral matter.



FIG. 6.—Osmosis with an egg over a bottle of water. If egg liquid and the water exchange places through the membrane of the egg, which moves the faster? Why does fluid rise in tube?

**PROBLEM.**—One hundred pounds of cured corn fodder contain 58 pounds of dry matter, 2.9 pounds of which are from the soil and the remainder from the air. What per cent of the dry matter is from each source?

**EXERCISE.**—*Mineral Matter in Plants.*—Burn a piece of very dry wood on a stove shovel in the stove, to save all the ashes on the shovel. If the dry wood be weighed first and the ashes be weighed afterward the exact proportion can be determined. The ash represents nearly all of the mineral matter in the wood. This part comes from the soil and the remainder chiefly from the air. This exercise shows how small a part of the plant's food is from the soil; but this part is very necessary. Our farm crops could not live without the ash or mineral matter which they obtain from the soil.

**Other Needs of the Plant.**—We have already seen that most plants need light to make use of the food which they get from the air. Light is not necessary for the germination of seeds in the soil. The leaves of the young plant soon seek the light by growing toward the surface of the soil.

The need of moisture has also been considered.

Other needs of the plants are a proper amount of warmth and a supply of air.

Light, heat, moisture, and air are all needed by growing crops.

**Temperatures.**—Certain degrees of warmth are necessary for the best growth of plants and the sprouting of seeds. Very few seeds will sprout if colder than 40 degrees F. or warmer than 115°. Wheat will not sprout below 41° and prefers a warmth of 60° or 70°. Corn needs more heat; even 48° is too cold for it and soil as warm as 70° or even 90° suits it better. Seeds that sprout in cool soil may be planted in earliest spring time; while those which require more heat must be planted later.

**Air and Oxygen.**—Not only must the leaves and stems of plants have free access to air, but the roots of our farm

crops must be in soils supplied with oxygen. If there is too much standing water in a field the air is excluded from the soil and crops do not thrive. The leaves of plants turn yellowish and show an unhealthy condition if the soil is not supplied with air. This may be noticed in the wet parts of a cornfield. If the soil is well drained, the surplus water gets away and air is drawn into the soil.

**EXERCISE.**—*Need of Air for Germination.*—Put a dozen or more beans or kernels of corn in a bottle nearly full of water. In another bottle place a dozen of the same kind, thoroughly wet but not submerged in water. Cover both bottles loosely to prevent loss of water. Put both in a warm place and watch results for a week or so. The water in the first bottle excludes the air from the seeds. If they do not sprout it will be for want of air. When crops are planted in low, wet places in fields do the seeds refuse to grow for lack of air?

**EXERCISE.**—*Need of Air in Soil.*—Two cans of soil may be planted alike with the beans or corn. Have one can watertight at the bottom, and the other with plenty of holes through the bottom for drainage. When the plants have grown a few inches high fill the undrained can with water to the top of the soil. Notice the effect on the plants in that can. Compare with the others having air and moisture both in the soil.

**Purpose of Flowers.**—The main aim of life for all plants is to produce seed. To do this a flower must be formed. The form and structure of flowers are quite variable, as seen when the strawberry is compared with the lady-slipper and the apple.

A perfect flower has two different kinds of essential organs, the *pistils* and the *stamens*. The stamens bear pollen, which is carried to, or falls upon, the pistil. This fertilizes the pistil and enables it to produce the seed. The seed or seeds of most plants are borne in the lower part of

the pistil called the ovary, as shown in Fig. 8. The other parts of a perfect flower are shown in that figure.

**Imperfect Flowers.**—The flowers of many plants are not perfect. Some of them bear the stamens only and others the pistils. In the cucumber, musk-melon, and others, the stamens and the pistils are in different flowers on the same plant. In any case where the flowers are not perfect, the



FIG. 7.—Strawberry blossoms. Those on the left are of varieties each having both stamens and pistils. Those on the right have only pistils. Varieties which have only pistils must be grown near perfect varieties so the pollen may be carried to them at the blossoming time. (Experiment Station, N. J.)

pollen must be carried by some means to the flowers having the pistils; otherwise seed could not be formed.

**How Pollen is Carried.**—The pollen of corn and many grasses is very light and dry and is carried by the wind. Some of it falls upon the pistils and grows, thus helping to form seed. The pollen of most fruits and vegetables is rather sticky and heavy and is carried by insects. Bees and other insects visit the blossoms in search of nectar to make honey. As they go from flower to flower even among the perfect blossoms, **much** pollen is distributed where it is needed. These insects are attracted to flowers by the bright showy colors of the petals of the flower, and by their fragrance. Showy petals and fragrant blossoms are not found on corn,



grains, and grasses, because their pollen is borne by the wind.

**Cross Pollination.**—Plants are said to be cross pollinated when the pollen is taken from one to another by some means. Many of our fruit trees bear much more and better fruit when they are cross pollinated. A number of varieties of apples, pears, peaches, and plums will not bear fruit if grown by themselves. They produce abundant fruit when pollinated by other varieties of the same class that blossom at the same time. For this reason it is of much benefit to have plenty of bees in the orchard at work gathering their supply of honey during the blossoming season. The owner of a large orchard should have a yard of beehives. The work of the bees gives him a larger crop of fruit as well as a crop of honey.

**EXERCISE.**—*Parts of a Flower.*—The members of the class should examine a few large, simple flowers and learn to name the parts shown in Fig. 8. United States Farmers' Bulletin 408 will be helpful in this exercise.

**EXERCISE.**—*Pollination of Corn.*—Have students or others bring to school ears of corn on which some of the kernels failed to develop. This shows the result of poor pollination. Perhaps a hot wind injured the *silks*, or pistils, before the pollen was received. Other ears may be shown which have sugar-corn kernels mixed with field corn, or have white kernels among the yellow. These prove that pollen was carried from other corn plants. Should two different kinds of corn be planted close together if it is desirable to keep the varieties pure?

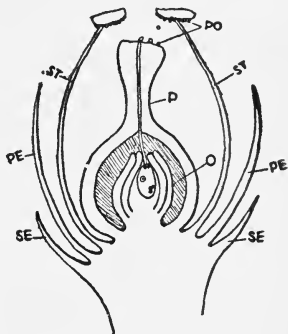


FIG. 8.—Diagram of cross section of a flower. P, pistil; o, ovary with young seed receiving the pollen growth; st, stamens; po, pollen scattering from stamen to pistil; PE, petals; SE, sepals.

**Purpose of Seeds.**—A true seed bears within its coats a minute plant called the germ. Its purpose is to develop into a new plant like the parent plant. Some nourishment is stored in the seed for the use of the young plant when it begins to grow. This store of nourishment in the bean is in the two seed leaves or thickened halves of the bean. In the corn kernel a store of starchy matter is found about the germ.

**EXERCISE.**—*Study of Seeds.*—Soak some large lima beans and some kernels of corn for a few days. Let each member of the class find the little plant inside the bean coats; and the long oval germ of the corn imbedded in the store of starchy matter. Other large seeds may be soaked and studied closely.

**Duration of Life.**—With respect to their length of life most farm plants are divided into three groups: *annuals*, *biennials*, and *perennials*.

Annual plants are illustrated by corn, oats, beans, and peas. They germinate, grow, blossom, bear seed, and die within one year. No part lives over to the next year but the seed.

Biennials are not so numerous among farm crops. Examples are beets, carrots, parsnip, onions, and cabbage. They germinate, grow, and store a large supply of nourishment the first year. The second year they use up this store of nourishment, send up a flower stalk, produce flowers and seeds, and then die. Only the seeds live over.

Perennials include many of the grasses, alfalfa, trees, shrubs, and many others. They germinate and grow for some time without bearing blossoms and seeds. When old enough they begin blossoming and bearing fruit. This may continue year after year for several or many years. The peach tree bears some fruit the second or third year and dies after ten or fifteen years. The apple tree does not bear so young but lives much longer.

REVIEW.

1. Name the five parts of a plant.
2. What two purposes have roots?
3. What is the use of the root cap?
4. Describe the location and appearance of root hairs.
5. Give several purposes of plant stems.
6. What are the uses of leaves?
7. Draw and describe the structure of the leaf, showing the air cavities and the stomates.
8. What food do plants get from the air? What do they make from this?
9. What plants use sunlight? How does it help them?
10. Tell of the balance in nature in the production and use of carbon dioxide and of oxygen.
11. Tell how the oxygen supply is produced and used in an aquarium in the window.
12. How do field crops get their water?
13. What is osmosis?
14. Give one or two examples of osmosis.
15. How much of the food of plants comes from the air, and how much from the soil?
16. From what source is the ash or mineral matter derived? The starch?
17. Mention four climatic needs of the growing crop.
18. Tell of suitable temperatures for the sprouting of corn and of wheat.
19. What is the effect of no air in the soil, for germinating seeds and for growing crops?
20. Tell of the purpose of flowers.
21. Name the two essential organs of a perfect flower, and give the use of each
22. What are the two chief ways by which pollen is carried?
23. Give two ways in which flowers attract bees and other insects.
24. What is cross pollination? Of what benefit is it in orchards?
25. Why should fruit growers keep bees?
26. What is the purpose of the germ in a seed?
27. Where is the storage matter in the bean? In the corn kernel?
28. Give the life cycle of an annual.
29. Describe the work each year of the biennial plant.
30. Define a perennial. Give examples.

References.—United States Farmers' Bulletins: 382, Seed Adulteration; 884, Saving Seed. Applied Economic Botany, by Cook (Lippincott).



## CHAPTER II.

## PLANT IMPROVEMENT—GOOD SEED.

ONE of the best ways to improve our crops on the farms or in the gardens is to select good seeds for planting. It is a law of nature that "like produces like."

**Seed Selection.**—Careful selection year by year will gradually improve any crop. The seeds should be healthy in every respect, free from impurities, large and heavy for its kind, and taken from the best plants. We may save seeds from those plants in the garden that show the qualities which we want. The same care should be exercised in the selection of seed wheat, oats, rye, and other field crops. In the case of corn and potatoes it is possible to select seed in the field from the best individual plants or hills, but in the case of small grains this method would not be practicable. With these grains we should follow some good method of grading to secure good, large, plump kernels; such have the best characters (Fig. 9).

**Sifting and Fanning Grain.**—Sieves are very useful for separating the poor seed from the good. Meshes of just the proper size are used to screen the large and let the small fall through the sieve. The practice of winnowing the grain, used in olden times, is now replaced by the use of fanning mills. Fanning devices are usually found in threshing machines to separate the chaff, lighter seeds, and trash from the heavier grains. All seeds to be sown should be cleaned and re-cleaned until they are pure and of the best quality. (See exercise with large and small radish seeds, page 26.)

Wheat and other small grains have been less improved by selection than corn because the kernels are handled less, and being smaller less attention is given to their individual

characters when being harvested. The smaller grains are now receiving the attention of a few experiment stations, and valuable improvements are being made.

**Choosing from the Best.**—With garden plants such as squashes, melons and tomatoes we should not only choose good specimens from which to save seed, but we should select those specimens from plants that yield large crops of good fruits. This selection can be done more carefully by the grower himself than it can by any wholesale methods where large quantities are carelessly saved from large areas. When

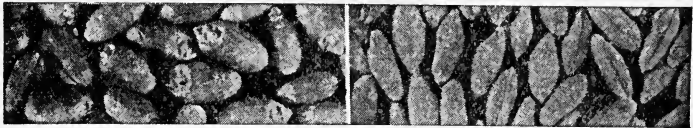


FIG. 9.—Good plump wheat at the left; a poor type of wheat at the right, with narrow shrivelled kernels. (Experiment Station, Kans.)

a few desirable individual plants are found, they can be rapidly multiplied.

**The Ear-Row Method.**—The best ear of corn from the best bearing stalk may be saved for seed and planted in a row by itself. This corn may produce many good stalks with ears as good or better than the one we began with. If the corn of each ear is grown in a separate row we can compare the yields of these rows and select the next seed accordingly. These best ears should be grown in a separate field where the wind cannot carry pollen to it from other cornfields.

**The Hill-Row Method.**—Potatoes should be grown from those found on the best individual plants. If the potatoes from two plants or hills weigh about the same they may be planted in separate rows. The best row will next furnish the hills for seed-potatoes.

**Bud Selection.**—Peaches, plums, apples, grapes, and some other fruits are propagated by the use of buds, grafts,

cuttings, and divisions of the plants. The buds or other parts are taken from the best plants of the preferred varieties. Their seed, if used, would not come true to kind.

**EXERCISE.**—*Looking for Weed Seed.*—Let each pupil have a half teaspoonful of clover or other common farm seeds. Spread them on a sheet of white paper. Let the seed be examined without the aid of lenses first. The weeds that are known should be put to one corner of the paper which is labeled “known weeds.” In another place put the unknown weeds; and in another the dirt, grit, sticks, and other

FIG. 10.

FIG. 11.



FIG. 10.—Teacher showing the class how to examine a seed sample.  
 FIG. 11.—Seeds on the thumb, magnified through a reading glass.

dead matter; in another the shriveled seed of the kind you have present. Single seeds are removed by use of a moist pencil point or similar object. When the study is completed, count or estimate the lots of each kind to determine the per cent of each.

**EXERCISE.**—*Another Way of Looking at Seeds.*—Moisten the first joint of the thumb of the left hand and dip it into the seed to be studied. One layer of seed will cover the moist surface. With a lens or reading glass in the right hand the seed may be carefully examined for impurities (Figs. 10 and 11).

**EXERCISE.—Identifying Weed Seeds.**—The figures in U. S. Farmers' Bulletins 260 and 382 will help to determine the names of the weed seeds not known by the pupils. Let students cut out the figures and paste them on a card for quick reference. If the school has a collection of weed seeds in small bottles (Fig. 15), they may now be used to help identify the unknown seeds.

**EXERCISE.—To Compare Good and Poor Lots of Grass Seeds.**—Take a piece of clean window glass and wet it with water. Spread on it a thin layer of blue-grass or of red-top seeds. Hold the glass between you and the bright light. Notice how many of the glumes or husks are hollow. Compare in this way a good sample with a poor one. Note the difference in the amount of chaff.

**Seed Analysis.**—The methods of studying seeds outlined in two preceding exercises may be called seed analysis. The sieves mentioned before may also be used in analyzing a sample of seed as well as in aiding in the cleaning of large quantities.

**Seed Testing.**—Another way to detect impurities in seeds is by sprouting a sample of the seed and then observing the differences in character of growth; they may differ in the shape or number of seed leaves, or in manner of coming out of the seed coats.

Another reason for seed testing is to determine the vitality or germinating power of the sample.

There are several advantages of knowing the vitality:

1. It will save us buying poor seed if we test a sample before buying.
2. If the test is low we will not use the seed at all, even if we own it.
3. If it is as good as we can get we will plant enough more seed than usual to allow for the reduced vitality.
4. Thus knowing how much to plant, will save us the time, labor, and expense of replanting a crop after the first planting shows a poor stand.

5. The first planting being made with good seed will give us a good even stand at the proper season, instead of too late.

6. This means a better harvest and good return for labor expended in cultivation through the season.

**Methods of Testing Seeds.**—When seeds are to be tested they must be given proper moisture, warmth, and air; these must not change much during the test. A warm living room is about right if the moisture is held close about the seeds.

A common way is to take two lots of one hundred seeds each; these are planted in a shallow box of moist sand.

Another good way to test seeds is to place them in pans or deep plates between wet blotters or layers of wet cloth (Fig. 12). The plates are placed one above another as high as desired. A label is made for each lot of seeds by using pencil and paper, thus:

Date—February 10.

Number of seeds.....	100
Kind.....	Red clover
Number sprouted.....	90
Per cent of good seed.....	90

Folds of wet cloth may be made. A lot of seeds with its label is placed in each fold. This is carefully placed in a covered pan in a warm place. If a hundred seeds are taken each time, the per cent of germination is more exactly expressed.

**EXERCISE.—*Test Seeds.***—Have grains and garden seeds brought to school. Have them counted, labeled, and tested by each method described here. Winter and early spring are good times to make such trials with seeds.

**EXERCISE.—*Size of Seeds.***—From a large package of radish seeds, select 100 of the largest, and another 100 of the smallest. Make sprouting tests of these two lots, by planting them in a shallow box of moist sand or soil. Keep them in separate rooms, and label them. Does the result show that gardeners should select large seeds? Could this be done with sieves?



**Buy the Best.**—It seldom pays to buy cheap seeds. The age, size, weight, purity, and vitality should be determined when buying. Protect seeds from mice, insects, and moisture.

**Cheap seeds** are sometimes mixed with better seeds if the two kinds look much alike. Old seeds which have nearly lost their life are sometimes made fresh looking by using fumes of sulfur. These are then mixed with good seeds and sold. Such mixtures are called adulterations.

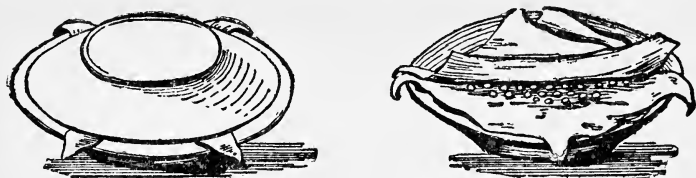


FIG. 12.—A convenient home apparatus for testing seeds. The seeds are germinated between wet cloths or blotters. The plates help to hold the moisture (Agricultural Education.)

Immature seeds are those not fully ripened; such seed cannot sprout well. To sprout under ordinary field conditions, the seed must be fully matured.

#### SECTION ON WEEDS

**The Weed Nuisance.**—One of the greatest hindrances to good farming is the presence of weeds in the fields. Weed seed is in the soil, in the grain, grass seed, and nearly all farm seeds (Figs. 13a and b). There are thirty or more undesirable weeds to be found in clover seed and alfalfa seed. The grass seed is too often full of bad weed seed. There is no place on the farm where weeds are a greater enemy to our success than in the grass fields. It is harder to get rid of them there than from the fields where we are doing some tilling. But most of the weeds found in the pastures and hay-fields have been sown there or near there by some farmer, at some time in the past. Some weed seeds are sown from fence rows by the wind.

**Examining for Impurities.**—Weed seeds and other impurities can usually be seen with a common reading glass or pocket microscope. The proper thing to do is to examine seeds before buying them, and avoid spending money for weed seeds to sow on the farm. At least let us look at the seed before sowing it (Fig. 14).

**Weeds** have been briefly defined as “plants out of place.” This is a satisfactory meaning of the term, for many plants that are grown for the uses of man are objectionable when



FIG. 13a.—Hay-field filled in late summer with wild carrots or Queen Anne's lace.

FIG. 13b.—Hay-field “taken” by dandelions.

found among other crops. Rose bushes sprouting in a cornfield are called weeds. Likewise corn in a rose garden is considered as a weed. *Noxious weeds*, however, are those plants which are very frequently found in fields, or gardens, or other undesirable places.

**Classification.**—Weeds may be grouped, according to the length of life, into annuals, biennials, and perennials.

**Annual weeds** bear blossoms and seeds the first year and then die entirely. This group includes many of our most abundant weeds, such as rough pigweed, lamb's-quar-

ter, Russian tumbleweed, the large sunflower, horseweed or fleabane, ragweed, Spanish needles, buffalo bur, purslane, cocklebur, corn cockle, mustard, chickweed, and field dodder.

The annual weeds are more commonly found in with annual crops such as grain, corn, potatoes, and garden annuals; this is chiefly because the weed seeds sown each year by the plants find ready lodgment in the freshly plowed or cultivated fields and gardens.

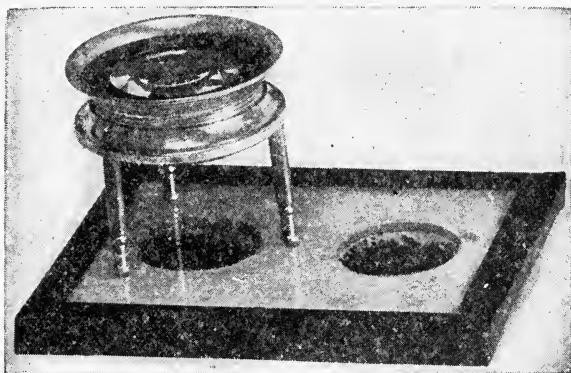


FIG. 14.—Seeds mounted in holes in heavy pasteboard between two pieces of glass held with paper binding. A tripod lens used for seed study. (Agricultural Education.)

One of the easiest ways to get rid of a bad field of annual weeds is to rotate the crops by thickly seeding the field to clover or grasses. Annual weeds are seldom found in such fields, particularly after the first cutting of the hay.

**Biennial weeds** are those plants which live two years, the first year making a vigorous growth and storing some nourishment, but bearing no blossoms nor seeds until the second summer. There are not many common kinds of weeds in this group. Burdock, teasel, bull thistle, wild carrot (Fig. 13a) and parsnip are common biennial weeds.

**Perennial weeds** live several years and bear blossoms

and seeds each year. The roots or underground parts live over from year to year, and usually new leaves and stems are sent up from the old roots in the spring. Such weeds are most commonly found in pastures, hay-fields, lawns, roadsides, and fence rows. They grow in places where their roots may live undisturbed in the soil from year to year. Because of this we may conclude that rotation of crops will help destroy them. When a hay-field is plowed and harrowed for corn, nearly all kinds of perennial weeds are killed.

**Examples of perennials** are: Canada thistle, quack-couch grass, Johnson grass, curled or yellow dock, smart-

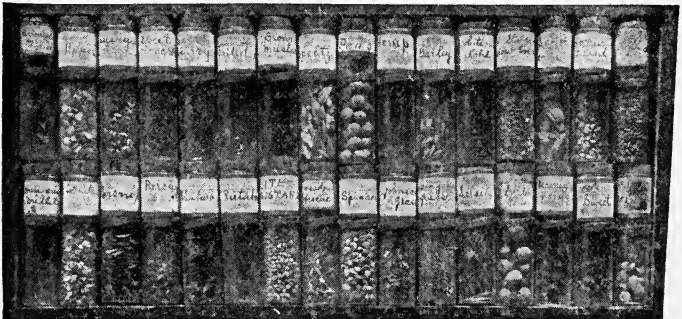


FIG. 15.—Seed samples in wooden case, bottles held in place with shoestring. (Agricultural Education.)

weed, dandelion (Fig. 13*b*), golden hawkweed, milk-weed, nut sedge, ox-eye daisy, rib-grass plantain, wide-leaved plantain, red field sorrel, toad flax, white and purple fall aster, wild garlic, chicory.

**Persistent Weeds.**—Among the perennial weeds those which are most troublesome are either provided with (1) a rapid means of spreading, or (2) a fleshy root or bulb. Those with runners which take root at the joints are seen in some grasses, as Bermuda grass, and the trailing white clover, and the running buttercup. Some have underground running rootstocks that send up new shoots at the joints, as Johnson

grass, quack or couch grass, red field sorrel, Canada thistle, and toad flax. Examples of bad weeds with fleshy underground parts are: wild onions, garlic, curled or yellow dock, dandelion, and many others.

**Fighting Bad Perennial Weeds.**—There are several methods of fighting bad perennial weeds such as those mentioned in the preceding paragraph.

1. In most cases the best method of fighting persistent weeds is to practice very frequent tillage to prevent exposure of the green leaves to the sunlight. This method is economical when there is a crop on the land which is benefited by frequent tillage, as corn, cotton, and garden crops.

2. In some cases a dense growth of grain, millet, alfalfa, or other close-growing crop may be effective in choking down or smothering the weeds

3. Smothering of small patches of weeds is sometimes accomplished by means of straw stacks placed over them. Tar paper may be used in some cases.

4. Sheep in pastures will crop down many weeds and keep them under control. Hogs confined in small areas will root out many bad kinds of weeds and completely destroy them. In small poultry yards weeds are kept in complete subjection by fowls eating off their tops closely.

5. Frequent mowing of pastures, meadows, and yards will aid materially in checking certain kinds of bad weeds. It makes the grass grow better and retards asters, chicory, plantains, hawkweed, dock, and many others.

6. Chemicals are sometimes used on the crowns and roots of weeds in yards, walks, roads, or where only a few weeds have started. Chemicals used for this are salt, copper sulfate, iron sulfate, kerosene, carbolic acid, and others. Salt on the bad weeds in pastures often causes the cattle and sheep to eat them down to get the salt.

**Spraying Weeds.**—Annual weeds, such as wild mustard, corn cockle, and others that are bad in grain fields are

often controlled by spraying with iron sulfate before the grain begins to send up its stems. The principle involved in this method is this: The leaves of most grain crops and grasses are naturally protected by a coating of wax or "bloom" which keeps off the chemical and prevents their injury. The weeds when young are tender and not thus protected. Hence the chemical may be made strong enough to kill many kinds of weeds without killing grasses or grain crops.

**EXERCISE.—Collecting Weed Specimens.**—In the fall of the year a collection of weeds should be made by the student. One set of the specimens should be kept at the school. They may be dried by spreading out the plants between large folded newspapers. Put the pile of papers and plants on the floor; place over them a board and stone or other heavy object. This pressure will drive the moisture from the plants into the papers. Change the papers from day to day until the plants feel quite dry. They may then be fastened to sheets of paper or cardboard eleven by seventeen inches. Find the names of the weeds from any one who knows them, group them into annuals, biennials, and perennials. U. S. Farmers' Bulletin 28 will be of much help in the study of weeds.

**EXERCISE.—Seed Collection.**—Let the pupils bring to school in the fall such weed seeds as they can find upon the known weeds. These may be carried in small papers or old envelopes on which the name of the plant is written. These may be transferred to small bottles as in Fig. 15, or to holes in a seed board made like the one shown in Fig. 14. A collection of farm and garden seeds should also be made for the school to use.

**Common Weeds.**—An alphabetical list of some bad weeds, with useful information regarding them is given in the table. (A = annual, B = biennial, P = perennial.) (Adapted from H. R. Cox, U. S. Department Agriculture.)

Description of Common Weeds.

Common name, botanical name, and duration of life.	Color, size, and arrangement of flowers.	Method of seed distribution; vegetative propagation of the perennials.	Place of growth and products injured.
Bindweed, field bindweed ( <i>Convolvulus</i> ), P.	White or pink; 1 inch; solitary.	Grain and flax seeds; creeping roots.	Rich moist soils; grain and hoed crops.
Bull nettle, horse nettle ( <i>Solanum carolinense</i> ), P.	Purple; 1 inch; solitary.	Plants rolled by wind; running roots.	Everywhere; grain and hoed crops, pastures.
Chess, cheat ( <i>Bromus secalinus</i> ), A.	Green; spikelets in panicles.	Grain seed, especially wheat.	Everywhere; grain fields.
Chickweed, common chickweed ( <i>Alsine media</i> ), A.	White; $\frac{1}{8}$ inch; cymes.	In crop seeds; has a long seeding period.	Meadows, lawns; winter crops.
Cocklebur, clotbur ( <i>Xanthium americanum</i> ), A.	Green; $\frac{1}{4}$ inch; head.	Carried by animals.	Cultivated fields and waste places; hoed crops and wool.
Crab-grass ( <i>Syntherisma sanguinale</i> ), A.	Green; spikes...	Clover and grass seed, hay, animals.	Cultivated fields, gardens, lawns; hoed crops.
Daisy, oxeye daisy ( <i>Chrysanthemum leucanthemum</i> ), P.	White with yellow center; 1 inch; heads.	Clover seed, hay; woody, rather short rootstocks, but largely by seed.	Pastures, meadows, roadsides; hay, pasturage.
Dandelion ( <i>Taraxacum officinale</i> ), P.	Yellow; $1\frac{1}{2}$ inch; head.	Wind; taproot, which spreads but little.	Lawns, meadows, waste places; hay and lawns.
Dock, yellow dock, sour dock ( <i>Rumex crispus</i> ), P.	Green; $\frac{1}{4}$ inch; panicle.	Hay and straw, clover and grass seed; taproot, which spreads but little.	Hay, small grain, and hoed crops.
Fleabane, horseweed ( <i>Erigeron canadensis</i> ), A.	White; $\frac{1}{4}$ inch; heads in cymes.	Hay, grass and clover seeds.	Meadows, pastures and grain fields.
Foftail, yellow foftail, pigeon grass ( <i>Chaetochloa glauca</i> ), A.	Green; spikes...	Animals, hay, grain, and grass seeds.	Land cultivated in early part of season; young grass and clover seedlings.
Lamb's-quarters, pigweed ( <i>Chenopodium album</i> ), A.	Green; very small; panicle.	Grain and grass seed.	Grain fields and hoed crops.
Lettuce, prickly lettuce ( <i>Lactuca virosa</i> ), A.	Yellow; $\frac{1}{2}$ inch; heads in panicles.	Wind.....	Everywhere; all crops.
Pigweed, redroot, careless weed ( <i>Amaranthus retroflexus</i> ), A.	Green; quite small; spikes in panicles.	In grain and grass seeds; plants blown by wind.	Plowed land; hoed crops.
Plantain, buckthorn, rib-grass ( <i>Plantago lanceolata</i> ), P.	White; $\frac{1}{8}$ inch; spike.	Hay, clover and grass seed; spreads but slowly from a crown.	Everywhere; meadows, pastures, and lawns.
Poison ivy, poison oak ( <i>Rhus toxicodendron</i> ), P.	Greenish white; $\frac{1}{2}$ inch; panicles.	Does not spread fast by seeds; running rootstocks.	Moist rich land, along fences; poisonous by contact.
Purslane, pusley ( <i>Portulaca oleracea</i> ), A.	Yellow; $\frac{1}{4}$ inch; solitary.	Implements; has a long seeding period.	Rich cultivated land, gardens; hoed crops.
Ragweed, smaller ragweed ( <i>Ambrosia elattor</i> ), A.	Yellow; $\frac{1}{4}$ inch; small heads on spikes.	Wind carrying matured plants; in grain and red-clover seeds.	Everywhere; grain stubble; hoed crops, grass seeding.
Sorrel, sheep sorrel, horse sorrel ( <i>Rumex acetosella</i> ), P.	Red; $\frac{1}{4}$ inch; panicles.	In clover seed; creeping roots.	Meadows and pastures.

## REVIEW.

1. Tell of the value of sifting and fanning grain which is to be used for seed.
2. From which plants in a garden should the gardener save seeds?
3. Describe the ear-row method of improving corn.
4. Describe the hill-row method of improving seed potatoes.
5. Tell why weeds are so prevalent and give a remedy.
6. Why should farm seeds be examined before they are purchased or sown?
7. Tell how to analyze a sample of clover seed.
8. Tell how to mount a sample of grass seed to study its value.
9. Give a number of advantages from knowing the vitality of seeds.
10. Describe the plate method of seed testing.
11. Describe some other good method of testing seeds.
12. Tell of some ways in which seeds are sometimes adulterated.
13. What are immature seeds? Why not plant such?
14. Tell how seeds should be stored.
15. What are noxious weeds?
16. What are annuals? biennials? perennials?
17. Where are annual weeds most commonly found?
18. In what places are perennials most commonly found?
19. Name several annual weeds.
20. Name several common biennial weeds.
21. Name all the perennial weeds you can.
22. Name some of the most persistent weeds.
23. How are they propagated?
24. Name several methods of fighting bad weeds.
25. When and with what are weeds sometimes sprayed?
26. Of what value is a collection of weed specimens in school?
27. Why should every one know the common weeds?
28. Would a collection of seeds properly labeled be of use in school? Why?

References.—U. S. Farmers' Bulletins: 382, Adulteration of Forage Plant Seeds; 428, Testing Farm Seeds; 660, Weeds; 884, Saving Seeds; 434, 646, 676, Seed Production; 948, Rag-doll Tester.





## CHAPTER III.

## PROPAGATION OF PLANTS WITHOUT SEEDS.

**The Raising of Fruit Trees.**—Plants propagate themselves naturally either by seeds or by buds. One or both of these natural methods is used by the farmer for all plants and crops. Very few fruits “come true” from seed because the seeds are formed by cross-pollination. The pollen is carried by insects and wind from other varieties. For this reason the nurserymen, who produce the young fruit trees or bushes, must avoid the use of seeds. With such fruits seeds may be used in an effort to secure new varieties, or to produce stocks on which to grow the improved varieties; but the standard sorts are multiplied by some form of bud propagation, such as grafting, true budding, layering, and making cuttings.

**Propagation of Apples.**—One common method for the production of young apple trees involves the use of grafting. It is called the root-grafting process.

First.—Seeds from cider-presses are planted in garden rows and the young trees cultivated for one summer to get the greatest growth possible. These trees would probably never bear good apples if they were allowed to reach maturity, but they serve admirably as the *stocks* on which to grow good trees. They are taken up roots and all, in the fall, tied in bundles of one hundred each, and well stored in moistened sawdust in a very cold cellar.

Second.—Well-matured shoots of one-year wood are cut for *scions* from the tops of good specimens of apple trees of the varieties we may wish to propagate. These are properly labelled, tied in bundles, and stored in the same manner as the seedling trees. This is done in late fall.

Third.—The actual work of grafting the tops of the desired varieties onto the roots of the young seedlings is to be done during the winter months. This work is done in the cool cellar and the little grafted trees are then tied into bundles and stored until warm spring weather.

Fourth.—The little trees are set in good rich garden soil, deep enough to cover the union or grafted point well. The top of the plant with a bud or two will be above the surface of the ground. The dirt should be well tramped around the grafts.

**Details of Root-grafting.**—The tops are cut from the young seedling trees and destroyed. The top-shoots from good trees are inserted upon the roots in their place. The new tops are called scions. They may be only a few inches long and contain from three to six buds. The roots may be either used entire for each new tree; or they may be cut into pieces four to six inches long, and a graft made on each piece.



FIG. 16.—Steps in root-grafting of apples. A, the small root tongue cut; B, the scion with tongue cut; C, the two in place ready to tie with waxed cotton.

**Whip or Tongue Graft.**—The kind of graft or union to make for apple root grafts is the one that is known by nurserymen as the tongue or whip graft. This is shown in Fig. 16; A represents the upper end of the piece of root cut so that there is a tongue ready to slip beneath a similar tongue made in the scion, shown at B. As soon as cut they are slipped together very firmly, as shown

at C. Now a piece of waxed knitting cotton is wrapped about the grafted portion to hold the parts snugly together.

It is necessary to have the root and scion of the same diameter or nearly so. The *cambium*, or growing layer, is

just beneath the bark of each. If the cambium of the scion is in perfect contact with the cambium of the root, growth is likely to take place, otherwise they will probably not live.

**EXERCISE.—*Root-grafting.***—Let the students have some practice in making root-grafts. Until the method is well learned, it is best to use willow or any other convenient switches to represent the roots and scions of apples. The second lesson may be with the real apple roots and apple scions. These may be secured in the neighborhood or from any nurseryman. For this exercise and the exercise in budding any wide thin-bladed pocket knives will do if better ones are not available. Have them very sharp.

**EXERCISE.—*Making Grafting Wax.***—Melt together in a tin can or pail one pound of rosin, one-half pound of beeswax or paraffin, and four ounces of tallow; when well melted and mixed allow the mass to cool a little and then pour it into a pail of cold water. Let one or two pupils rub tallow on their hands, work and pull the mass, as they would pull candy, until it is of a light yellow color; make it into rolls and lay on a sheet of greased wrapping paper to harden.

**EXERCISE.—*Waxing Cotton for Grafting.***—While the wax is melted, in the preceding exercise, put into it for a few moments a ball of No. 18 or No. 20 knitting cotton. Remove it and let it cool on a sheet of greased paper. Pieces of this six or eight inches long will be used to wrap around each root-graft and may be used in the budding exercises.

**Budding Apple Trees.**—New apple trees of the preferred varieties may be propagated by budding. This method is now quite common among nurserymen. The young seedling trees for stocks are grown in good soil for one season, or until August, from seeds sown the preceding spring.

**Scions or bud sticks** are taken from the new growth on trees we wish to propagate. This is done in August or early September. The leaves are all clipped off leaving about one-half inch of each leaf stem on the twig to serve as bud

handles. The budding is done immediately. One bud from the budding stick is inserted just under the bark of the little seedling tree a few inches above the ground. How to insert the bud will be described under "Budding Peaches."

The little seedling is not disturbed in this method of propagating apple trees. The roots are left growing in the soil. The new bud becomes united to the surrounding tissues that fall. All the top above the bud is pruned away (Fig. 17) just as soon as the new bud starts growth in spring, and all the natural buds of the seedling stock are rubbed off. Then the new bud makes a vigorous growth and is soon developed into the new tree top.

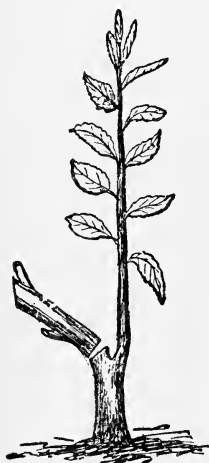


FIG. 17.—Method of pruning a budded tree after the new shoot starts.

Another method is to insert the buds of the desired varieties in the little seedling trees the following spring. In this case the scions are taken when dormant and stored in a cold cellar until about June. This method is quite common in some sections, particularly where the hot, dry weather of August would be injurious.

After one season's growth the most vigorous budded or root-grafted trees are ready to transplant to the orchard. They are then called one-year old trees. Many apple growers prefer to leave them in the nursery one more year, and always select two-year-old trees for the setting out of new apple orchards.

**Budding Peaches and Plums.**—Improved varieties of peaches and plums are propagated by budding.

Stocks for this purpose are usually started from pits of native or seedling peaches and plums. Special kinds of stocks, however, are desired for a few particular varieties of plums.

The pits of peaches and plums are hard to start into growth, the shell is too hard for the germ to burst through. They must be frozen over winter or cracked by hand. Frequently layers of peach pits are covered with a little sand in shallow boxes. This is called *stratifying* the pits. These are left exposed to the weather over winter. The action of the frost should crack them. In spring they are to be planted in rows three feet apart in rich garden soil. They are given thorough tillage until August, when they are to be budded.

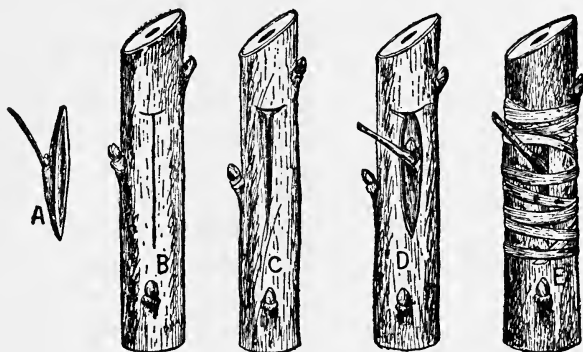


FIG. 18.—Method of budding a young fruit tree. A, the bud and surrounding parts cut from a good variety; B, the T-shaped cut in bark of tree to be budded; C, the same rolled back ready to receive the good bud; D, the good bud set in place under bark; E, the bud and bark tied securely in place with waxed knitting cotton or with raffia fiber.

Peach and plum scions or budding sticks are cut from the new growth on the trees of the desired varieties. The leaves are trimmed off, but stems are left near each bud to aid in handling when the bud is removed from the scion. The buds are inserted on the stocks right away. The operator must get down close to the ground to do the work properly. The top of the seedling stock is cut away early the following spring before the buds swell. This forces all the sap of the root system to the new bud and the growth will be rapid. One-year-old trees of peach and plum varieties

should be transplanted to the orchard. If left in the nursery rows longer than for one year's growth from the bud, they are likely to become misshapen or overgrown and will be undesirable trees for the orchard.

**How Budding is Done.**—A good, healthy bud is cut from the scion with the bark surrounding it in the form of a shield (Fig. 18, A). A cut is now made through the bark of the stock, in the form of a letter T, shown at B; this is preferably done on the north side of the stock to avoid the hot sun.



FIG. 19.—Cleft-grafting a fruit tree. The tree is severely cut back and good scions are grafted on. The boys are top-working the tree.

Turn back the edges of the bark as shown at C. Insert the bud into its new home just under the bark as shown at D. The top of the shield must be as low as the top of the T. Tie the bark down tightly over the edges of the shield as at E; waxed knitting cotton, No. 18 or 20, may be used for this, as it will not grow into the bark and stop circulation; raffia fiber is also good for this purpose.

**EXERCISE.**—*Practice in Budding.*—Twigs from willow

trees may be placed in water in a warm room in the winter and the bark well loosened in a few days. Use these to practise the method of budding just described.

**Top-working of Trees.**—Tree tops may be changed from one variety to another. If an apple tree bears poor fruit it may be changed to bear good apples. This is done by top-working, as it is called. Many branches are cut off the poor tree, and in their places may be inserted new buds or grafted new scions of the variety desired (Fig. 19). This

work is often done in June with scions held dormant in the cellar; or it may be done in August with scions of the current year's growth. Top-working is accomplished by one of three methods: budding, or tongue-grafting, or cleft-grafting. The first two methods have been described. *Cleft-grafting* is now less commonly used. (For a description of this method reference is made to U. S. Farmers' Bulletins 157 and 408.)

**Tip-layering.**—This is the most common way of propagating black raspberries. The soil is cultivated at both sides of the raspberry row, and in late July or August the tips of the long canes, or stems, are bent to the ground and slightly covered with soil (Fig. 20a). They will send down roots and



FIG. 20a.—Tip-layering. The young plant has taken root.

FIG. 20b.—Vine-layering. The young plants are ready to be cut apart.

develop new plants. The canes are cut loose from the young plants, which may then be transplanted to a new garden.

**Vine-layering.**—Several kinds of vines, including certain varieties of grapes, are propagated by layering (Fig. 20b). A shallow furrow is made and a vine is laid in it and parts of it covered with soil with other parts exposed to the light. Shoots will start up and roots will be formed. The new plants may be cut apart with a spade; they are then ready to transplant to desired places.

**Mound-layering.**—This is used for the propagation of gooseberries, quinces, and many ornamental shrubs. The earth is mounded up around the lower branches, which will then send new roots into the soil (Fig. 21). The following

fall or spring the plants may be dug; the branches with their new roots will form new plants; then they are cut away from the parent plant.

**Division of Plants.**—Some plants naturally form roots from the lowest parts or send up new shoots near the parent

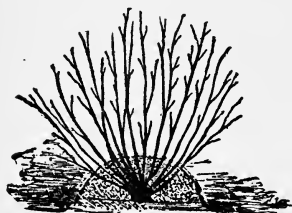


FIG. 21.—Mound-layering. The soil is mounded among the shoots, and new roots will be formed.

stalks. After the plant is dug it becomes an easy matter to pull or cut the parent plant into a number of smaller plants. This method of propagation is used in multiplying purple lilac, rhubarb, asparagus, and many shrubs and herbs.

**Cuttings.**—There are a few fruit plants and many others

that can be propagated by cuttings. Currants, gooseberries, and several kinds of grapes may be multiplied by cuttings of the ripe wood. Blackberries are propagated by root-cuttings,—pieces of the roots dropped in a furrow and entirely covered. Many kinds of houseplants will grow from *slips* or cuttings of *green wood*; these are sometimes called soft-wood cuttings.

Cuttings of ripe wood, six inches or more in length, should be taken in the fall after the leaves have dropped. They are cut from the newest growth, and the strongest shoots are selected (Fig. 22).

When tied into bundles they should be properly labelled and stored in damp sawdust in a cold cellar. In late spring they are set in deep furrows in rich garden soil with one



FIG. 22.—Four forms of grape-vine cuttings. A, single eye or single bud; B, two buds; C, heel cutting; D, mallet cutting.



or two buds showing above ground. The soil must be pressed firmly about them (Fig. 23). In the case of grape cuttings one bud only is left projecting above the surface of the soil.

EXERCISE.—*Starting Slips at Home or at School.*—In a shallow box of moist, clean sand, plant a number of cuttings of several house-plants. Keep the box in a warm room and water the soil frequently. These slips are made by taking a few inches of the healthy shoots and removing a large portion of the older leaves. For this exercise many forms of winter house-plants may be tried—begonia, carnation, geranium, fuchsia.

After the slips have formed roots in the sand, they may be transplanted to rich soil in well-drained pots or boxes.



FIG. 23.—Cutting of red currants, showing depth for planting, allowing one or two buds to protrude.

REVIEW.

1. What are the two general plans by which plants naturally propagate themselves?
2. Name four forms of bud propagation used by nurserymen.
3. Describe the starting of stocks for the budding or grafting of young apple trees.
4. Tell when to take scions and how to store them for winter root-grafting.
5. When are root-grafts set out? and how?
6. Describe the details of root-grafting.
7. What is the cambium layer? Where is it?
8. Tell how to make grafting wax and how to wax knitting cotton.
9. What are used for stocks and for scions in the budding of young apple trees?
10. At what two times of year is apple budding done?
11. Tell how peach and plum stocks are started.
12. When are peach scions cut from the trees? When is the budding usually done?
13. What is the purpose of top-working old trees?
14. How is this done?

15. Describe tip-layering of black raspberries.
16. Describe vine-layering for grapes.
17. What is mound-layering?
18. Describe the cutting, storing, and planting of grape or currant cuttings.
19. What plants may be propagated by soft-wood cuttings?

Reference.—U. S. Farmers' Bulletin 157, The Propagation of Plants.

---

## CHAPTER IV.

### HOW SOILS ARE FORMED.

THE soil is one of those common things most of us think very little about. We see it every day, we walk on it, we eat and wear its products, but we very seldom give it a thought. It may even surprise some of us to know that we get from the soil not only our food, our houses and our clothing, but that all animal life comes indirectly from the soil. For every living thing comes originally from two primary sources, the air and the soil. All elements or substances found in plants or animals are from either the soil or the air.

The foods which plants secure from the air are too abundant to ever become exhausted by large farm crops. No human efforts are required to make them available to plants, except for the securing of nitrogen from air, when inoculation with certain bacteria may be necessary. The foods taken from the soil on the other hand are much less available, and the ability of plants to secure them may depend very largely on the efforts of the farmer. It is necessary for the farmer first of all to study his soil to see how he can make its plant-food most available.

**What Soil is.**—That part of the earth's surface which can be tilled, and in which plants grow, is called soil. It is the loose, highly decomposed layer of mineral matter result-

ing, primarily, from rock decay, which furnishes food and foothold for plant and animal life.

**Soil Builders.**—Soil is derived from two main classes of substances; rock and organic matter. Rocks crumble into fine particles. They are gradually being changed into soil. Plants and animals decay to form the organic matter or humus in the soil. The humus present in our fields is chiefly of vegetable origin.

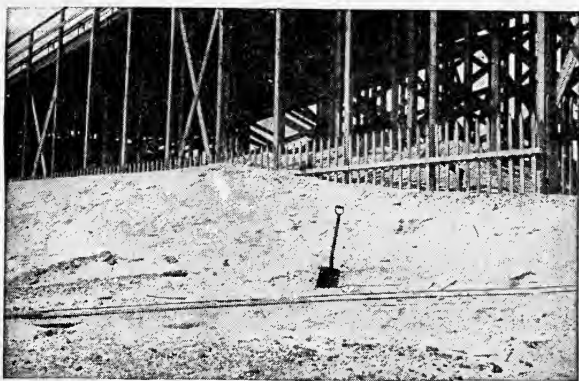


FIG. 24.—A high bank of wind-blown soil. Notice where it has nearly covered the fence. (Plant Industry.)

**How Soils are Formed.**—Certain forces are constantly at work changing rock into soil and making soil particles finer. These forces are: (1) air; (2) water; (3) temperature; (4) plants; (5) burrowing animals; and (6) minute plant and animal organisms. These forces act both physically and chemically.

**EXERCISE.**—*Soil Forming.*—Find places near the school or at home where any of the agencies mentioned are at work forming soil. Tell of the places and what you have seen. Can you find places where water has carried soil? How are the little gulleys formed in hillsides? Where is the soil carried to?

**The Action of Air and Temperature Changes.**—The action of the air and the changes in temperature, which together we call weathering, is of many kinds. The heat of the sun causes the rock to expand. As all of the substances which make up a rock do not expand the same amount, the rock breaks and the particles flake off the surface. In regions where the soil is not protected by vegetation the wind becomes an important soil former (Fig. 24). The particles of soil are caught up by the wind and hurled against rocks and against cliffs, and grind the surface of the rocks and undermine the cliffs. This

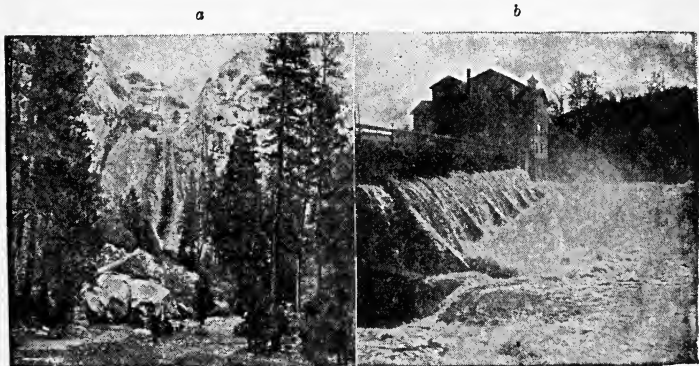


FIG. 25a.—A little stream falling many feet will wear away the hardest rock. The fine particles help to make up the soil. (Plant Industry.)

FIG. 25b.—A muddy water-fall. Soil is carried by swift current to the low land.

little agent does a really large work. Then there is a chemical action of the air, in which certain substances in the air, as oxygen and carbonic acid, unite with certain substances in the rock and cause it to decompose. Such an action of the air is termed oxidation and is a slow burning or decay.

A good example of weathering may be observed in the rapid crumbling of shale on exposure to the air. In such cases the air, temperature, and water each play an important part.

**EXERCISE.** — *The Action of Air on Iron.* — A familiar

illustration of oxidation is seen when iron is exposed to the air; the red rust that forms is an oxide of iron—a substance very different from the iron itself. To test for ourselves the action of air on iron we may take a piece of bright iron or steel, as the blade of a knife. Cover one end with linseed oil or wagon grease, and leave the other end exposed to the action of rain and air for a few days. Notice the effect on the exposed part. What lesson on the care of plows and other farm tools may we learn from this?



FIG. 26.—A broad valley of rich alluvial soil. This soil at some time was chiefly part of the surrounding hills. (Plant Industry.)

**Water** is the most powerful agent in decomposing or breaking down rock (Fig. 25a). Its action, especially in dissolving rocks, is very important. Nearly all rocks are more or less affected by this action, and some, as limestone, are easily affected.

Water breaks up rock by freezing. Most rocks contain cracks or openings into which the water readily flows; when the water freezes, it expands and forces the rock apart. Solid rock is thus gradually broken to pieces by the freezing

and thawing of water in it. This force is especially active in cold climates.

**EXERCISE.**—*To Show the Action of Freezing Water.*—Fill a small bottle with water and place it where the water will freeze. The bottle will probably be broken by the expansion due to the change in temperature.

Water also makes the rock particles finer. After rains the flowing of water grinds the fragments together. The force of running water is continually wearing them smaller (Fig. 25*b*). The finest particles are first carried away by the water to valleys below (Figs. 26 and 27).

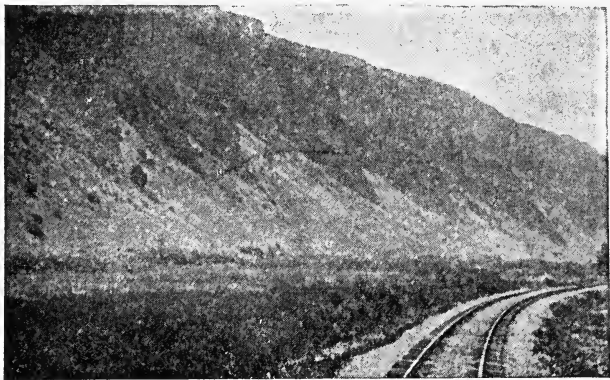


FIG. 27.—A rocky hill changing into soil. The soil is gradually carried to the valley by rains and mountain streams. (Plant Industry.)

Water in the form of glacial ice, carrying sand and boulders frozen into the under side, wears down the rocks over which it passes and carries the material with it (Fig. 28).

The effects of plants in the rotting of rocks are of two kinds: (1) The roots grow into the crevices found in rocks. This in time forces the rock particles apart (Fig. 29). Roots of trees often lift large rocks and cause them to crack by their own weight. This aids the rocks to crumble into soil grains. (2) When the plants decay acids are formed,

that help the water to soften or dissolve the rocks. Every one has seen rocks covered with lichens and mosses. When these are taken away one can often see where the rocks have been eaten into by the small plants, due to the action described. As this process of growth and decay continues for ages, the soil is gradually improved until it will produce plants useful to man.

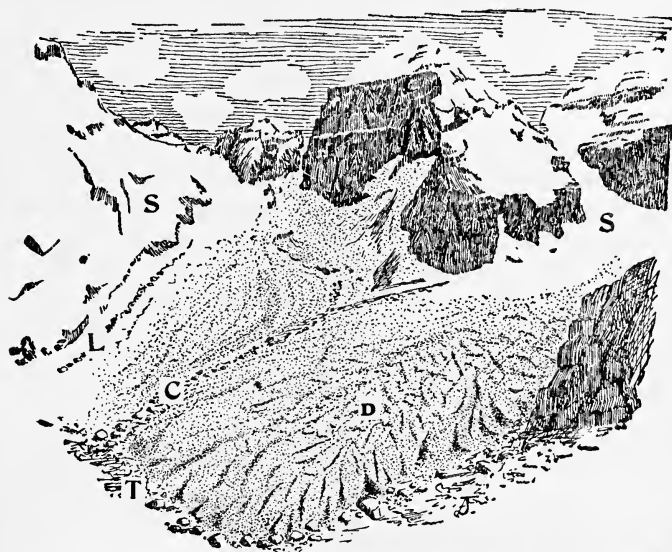


FIG. 28.—View of Victoria glacier, several miles in length. S, mountain snow; D, dirt and broken rock carried by the moving snow and ice; L, broken rock where the moving glacier rubs the bank or side of the valley; C, central line of dirt and rocks brought by the edges of two moving streams of ice and snow; T, terminus or end of the glacier where the sun melts the snow and leaves the rock and soil. The finest soil is carried by running water to the broad field farther down the valley.

**How Animals Help.**—Burrowing animals, such as the ground squirrel and the prairie dog, earthworms and insects living in the ground, as well as rabbits, gophers, and wolves, aid in preparing the soil for the growth of plants. They often burrow deep into the ground; the openings aid in free movement of air and water, and roots can enter the soil more

easily. The animals also drag into their homes nesting materials and other vegetable matter. When this decays it aids in forming fertile soil.

**How Soils are Moved.**—The same forces that form soil also carry it away. Soil is almost constantly moving from high lands to low lands. It is deepest in the valley, and thinnest at the top of the hill. Great furrows are formed in the hillsides after heavy rains.

The swollen and muddy streams carry the soil to lower parts of the land. When rivers overflow, they always leave a deposit of soil which was carried by the water.

**Transported soil** is any soil moved from the place where it was formed. It is described by different names or terms, depending on the means by which it was transported; and these different means of transportation leave the soil in very different condition as regards its general nature and appearance and use for growing crops.

Go out into a plowed field after a heavy rain and see

where little gulleys have been worn. Follow one of these and see how much soil was carried by the water that ran off. Notice the size of the particles that were carried.

Soil deposited by water is called *alluvial*. It is found in valleys and river-beds, beds of old lakes, ponds and marshes. (Fig. 26.)

Soil deposited from ice is called *drift soil*. It has been formed by the action of *glaciers*, which are large bodies of

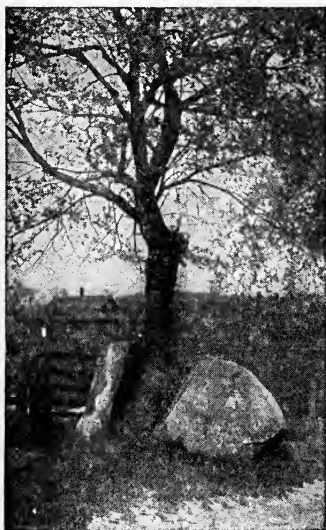


FIG. 29.—A large rock split by the growth of a tree near Lansing, Mich.



ice moving like rivers, carrying quantities of earth and rocks. The results of ancient glacial action are found in many places. Rocks with deep scratches show the wearing and grinding effects of the moving masses of ice. Drift or glacial soil is easily recognized by the presence of rounded rocks or boulders. It is usually fertile because of the variety of mineral substances brought from far and near. Much drift soil is found throughout the northern states and Canada, east of the Rocky Mountains.

Two other kinds of transported soil should be studied. One, known as *colluvial* soil, occurs on mountain slopes and steep hillsides, and is the mixed mass of soil and rocks brought down by avalanches and landslides. Such soil is not generally in condition to grow good crops. The other, known as *wind-drifted* or *aeolian* soil, is found in arid or semi-arid regions, that is, in places where there is very little rain-fall and the soil is dry, and there is little vegetation to hold the soil. This soil is carried by the winds and is deposited in dunes or drifts like snow. These dunes sometimes cover cultivated fields, forests, and even villages. As this soil is shifting, plants frequently do not have an opportunity to grow and hold it. (Fig. 24.)

## REVIEW.

1. What is soil?
2. From what is soil made?
3. Name four forces which are making soil.
4. How does the air help to make soil?
5. Tell of the influences of temperature in crumbling rocks.
6. Tell of the ways in which water helps to crumble rocks.
7. Tell where and when you have seen running water carrying fine soil or mud.
8. In what kinds of places is this mud deposited?
9. Do plants help to form soil? How?
10. In what ways do animals help to make soil useful?
11. What is transported soil?
12. Describe the several kinds, and tell where they are likely to be found.



## CHAPTER V.

**KINDS OF SOILS—THEIR CHARACTERISTICS.**

SOILS used in the production of crops are of many kinds. Some of these differ widely from each other in their physical nature and in their ability to produce good return to the owner. It is the purpose of this chapter to point out the characteristics of the most important types of soil.

**Kinds of Soil.**—Soil may be divided into four natural classes—sandy, loamy, clayey, and peaty—according to the proportion of sand, clay, and vegetable matter which it contains. Between these groups or classes we may have very many others, depending on the combinations of these types and the sizes of the soil particles.

A loam is a soil intermediate between sand and clay.

A marly soil is a combination of clay and fine lime material.

Silt is a soil whose particles are slightly larger than clay particles but finer than sand.

We should mention also limestone soils. These result from the crumbling of limestone (Fig. 30).

**Sandy Soil.**—Sand is formed from sandstone. It does not produce large crops, for it is poor in plant-food and moisture. A soil made of sand only would need to be changed a great deal to be of any use in farming, as it would produce no crops in its natural condition. Soil with much sand in it is light and open and allows the entrance of air, and it can absorb and hold little moisture. Sandy soil is so loosely held together that water and air pass through it readily. Crops on such land become parched if the weather is hot and dry.

This type of soil dries quickly even when the season is wet. Then large crops may be grown better on sandy soil

than on clay, if enough plant food is provided. Compact and sticky soils produce poor crops in wet seasons. The farmer finds it easy to plow and cultivate a sandy field. It is adapted to quick-growing crops, such as early vegetables; and sweet potatoes do well on such a soil. It may be cultivated without injury when wet. When it lies over clay under-soil or subsoil it may have a high degree of fertility.

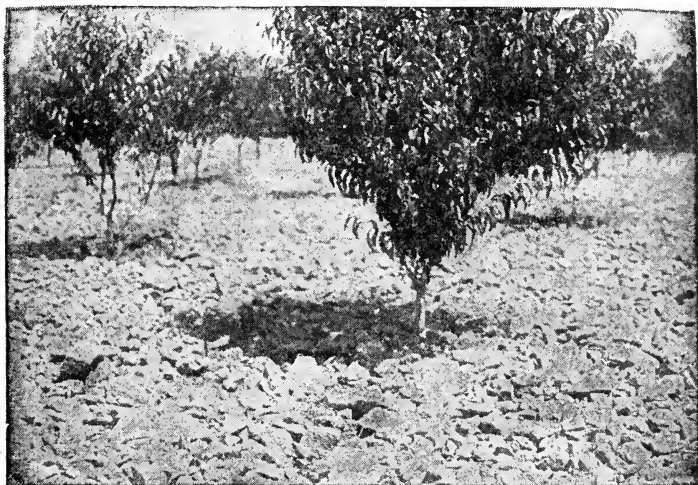


FIG. 30.—Peach trees in rocky soil. After the soil is plowed, the rains soon wash the fine soil away through the top of the rocks and leave the surface as shown in the picture. The roots of trees are in the finer parts of the soil and the growth is good. (Experiment Station, N. J.)

**Clay Soil.**—Clay soil is much more finely divided than sand. When wet it is plastic and sticky. The latter property makes it useful for making bricks and tiles. Some farm soils are largely clay; but clay alone does not make a good farm soil and its plant-food is not readily available.

Soil composed of as much as forty per cent of clay may be good farm soil, and may be well adapted to the growth of grains and grasses. It should not have over fifty per cent of clay present. The finely divided particles of clay adhere

so closely as to make the access and circulation of air, heat, and moisture difficult; the soil is, therefore, cold and heavy. It is hard to work, and, unless well drained, crops are likely to suffer both in wet and in dry seasons; in wet seasons because the moisture and air do not pass through it readily and the surplus water does not drain away, and in dry seasons because the land becomes so hard as to prevent the growth of roots, and the small amount of moisture in the soil is not available to plants because it does not readily circulate.

**Clay and Sandy Soil Compared.**—Clay soil is almost the opposite of sandy soil, in many respects. Grains and larger masses of sand do not stick together; if wet and moulded in the hand, they will soon fall apart. Clay may be moulded into any shape, and is sometimes used for making pottery because the particles stick together when moist. Sand, being open and porous, quickly loses moisture and plant-food. Clay is so compact that it retains moisture and plant-food. Sand admits heated air and soon becomes dry and warm; clay admits air more slowly and remains wet and cold. Because of these differences which make sandy soil easy to work and clay soil hard to work, sandy soil is said to be *light* and clay soil *heavy*, while in weight a quart cup full of sandy soil is really heavier than the same amount of clay soil. Both are valuable farm soils when supplied with enough plant-food and vegetable mould, or humus.

**EXERCISE.**—*To Show the Difference between Sand and Clay.*—Use rather pure sand and pure clay. Make a wet ball of each the size of a hen's egg. Place the two wet masses on a board to dry. When dry, examine and note the differences. Which ball dried more quickly? Which is harder to work when dry?

**EXERCISE.**—*To Compare the Water-holding Power of Sand, Clay, and Loam.*—In three boxes about the size of cigar boxes place respectively some sand, clay, and black

foam, which we have learned is intermediate between sand and clay. Wet all of them equally. Place the boxes in the free air or sun and allow them to dry. Which soil loses its moisture first? Which last?

**Peat or vegetable matter** makes up a large part of some soils, particularly in low places. The vegetable matter may be more or less decayed, and is often called peat. It is found in bogs and marshes and other wet places. When the peat has nearly all decomposed it is called *muck*. If peat and muck soils are well drained and are supplied with enough lime, they are very productive. They are often used for such market-garden crops as cabbage, onions, celery, and cauliflower.

**Humus.**—Partly decayed vegetable matter in soil is called humus. It has a blackish color. In newly cleared farm soil it is derived from the dead roots and leaves of a former vegetation. Leaf mould found in forests is largely humus. On farms it is secured by plowing under waste materials such as weeds, stubble, roots, vines, and leaves. Farm manure is valuable for this purpose. Special crops are often grown to be plowed under, and when so used are called *green manure*. When these rot in the soil, humus is formed.

Humus is very useful in all soils. It improves a sandy soil because it increases its power to take and hold moisture, supplies it with plant-food, and thus increases its productivity. It will absorb and retain more moisture than any other part of the soil. It improves clay soil by loosening it, thus helping the circulation of air and moisture. It is less likely to clod and crust. Humus is the main immediate source of nitrogen, so necessary in the growth of all farm crops. In the formation of humus other plant-foods are set free,—but best of all is its improvement of the structure or texture of the soil, resulting in better drainage, better ventilation, and deeper root growth.

**Lime in Soil.**—When lime is found in soil it is usually in the form of particles of limestone or marble, but it may be

in solution in the soil water. It is a valuable substance in soil. It furnishes the important plant-food, calcium. Limestone crumbles or dissolves easily and helps to make available other plant-foods in the soil. The lime aids in the decay of vegetable matter and in the formation of nitrates from decaying vegetable matter. It improves the physical condition of soil; its presence helps to make heavy clay soil loose and more easily worked and to facilitate the passage of water and air through it. In small quantities it improves sandy soil by causing the particles to adhere more closely to each other, and consequently, to hold moisture better. It prevents harm from acids and certain other poisonous compounds in soil. It lessens the injury from certain plant diseases that are transmitted through the soil. Soil containing an abundance of lime is usually of good character. It is easy to work and should be well adapted to grains and fruits.

While lime is very valuable in the soil, it is possible for it to become harmful. Too much of it in sandy soil or gravelly soil is more harmful than in clay soils. It may cause other plant-foods to be liberated faster than they can be used by the crop, and they will be wasted. It may cause the vegetable matter or humus to decay too fast; it may reduce the yield of certain crops, as cranberries, and watermelons which prefer acid soil.

A **loam** is a soil consisting of a mixture of sand and clay and containing humus. If two-thirds of the mixture is sand it is called a sandy loam. If one-half of the soil is clay it is called a heavy clay loam. Soils between these two extremes are called loams or medium loams. When gravel or coarse sand and lime are present in considerable amounts, we have gravelly or limy loam. Loam soil is the best for most farm purposes. Sand, clay, and humus are improved as they become mixed together.

Medium loams are the best soils for farming if there is a large amount of humus present. The farmer says, "they

work up well." They are usually not too wet nor too dry. They do not bake and crack so badly as the heavy clay soils do. Clods are less likely to form. They hold moisture better than light sandy soils. Corn, cotton, potatoes, fruits, vegetables, grains, and grasses all do well on the medium loams.

**Texture of Soil.**—The texture of soil is determined by the size and shape of the particles of which it is composed and the way in which these particles are grouped in kernels or crumbs or larger masses. The texture determines to a large

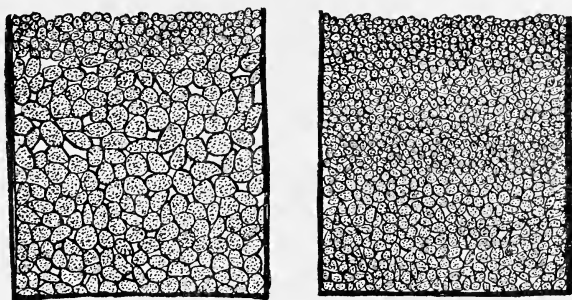


Fig. 31.—Soils of different texture. The coarse or open texture may be improved by tillage and by packing with roller or plunker.

extent the agricultural value of soil (Fig. 31). It is a factor to consider when studying the composition of soil, as it determines largely the capacity of soil to retain such foods as may become available for plants.

Soil such as sand is *open in texture* and freely admits water, which quickly passes downward, carrying soil fertility with it. Open soil is more likely to lose its plant food than a soil that is fairly *close in texture*. Clay loams, in retaining water, also retain their plant-food better. We call them close in texture. An open texture also allows too rapid decay of vegetable matter. On the other hand, a very compact soil such as clay is undesirable. When there is rain it puddles, and neither air nor water can enter and circulate.

When it dries it becomes very hard and unworkable. A good farm soil should be between these two conditions,—open enough to permit the proper entrance and movement of air and water, and yet compact enough to prevent the washing out of plant-food.

**Farm Soil.**—The best farm soil does not belong strictly to any of these classes already described, but is one which is a mixture of sand, clay, and humus in certain proportions. With reference to the proportions of sand and clay present, the useful farm and garden soils may be divided into three general classes,—sandy loam, medium loam, and clay loam

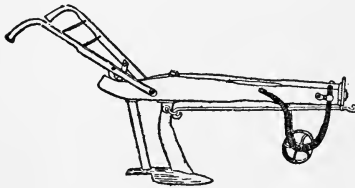


FIG. 32.—A subsoil plow has a long shank. It is used in the bottom of furrows behind a turning plow where the subsoil is too compact. It stirs the subsoil but does not bring it to the surface.

(Fig. 31). A perfect soil is one whose physical nature and chemical composition make it best adapted for the purpose or crop intended. It contains just enough sand to enable it to absorb air and moisture in proper amounts and to make it warm and easily

worked. It contains enough clay to keep it from getting too warm and to prevent too rapid loss of water. Lime must be present to perform its several duties. Humus is there to control the amounts of moisture and air, to furnish nitrogen, and to help produce valuable chemical changes in the soil. There are a few other conditions necessary to provide sufficient plant-food.

Perfect soils are hard to find. They are also hard to make in any of the known ways of soil-improvement. We usually can make slight improvements in the soil found in nature. Since this is true we must select crops for the farm which are best adapted to the soil found there.

The subsoil lies under the soil, which generally occupies the surface six to twelve inches. There are several differ-



ences between soil and subsoil: The soil is usually darker in color because it contains more organic or vegetable matter. It is more easily worked and less compact than the subsoil (Fig. 32). Air and moisture usually circulate in the surface soil better, and its plant-food is more available. The subsoil serves as a storehouse for moisture and with some plants is penetrated by the roots. Its character materially affects the crops grown on the soil. When the underlying rocks have rotted they make the subsoil. When the subsoils have rotted they are more of the nature of the surface soil.



FIG. 33.—Teachers and students taking soil samples and studying soil.  
(Agricultural Education.)

**Names of Soils.**—In the following list the soils are arranged with reference to the fine and coarse particles they contain: Clay, heavy clay loam, clay loam, loam, sandy loam, light sandy loam, fine sand, medium sand, coarse sand, gravel.

The list omits peat and other organic matter. If humus is present in these they are usually of a dark color or black. Lime also darkens the color of soils in presence of vegetable matter. Otherwise the color will vary a great deal.

**EXERCISE.**—*To Show Kinds of Soil and Subsoil.*—Have pupils bring to school in small boxes or tin cans samples of different kinds of soil and subsoil of the neighborhood (Fig. 33). The pupils should classify and name these. Much benefit may come by discussing the relative value of these types of soil and subsoil.

### REVIEW.

1. Name as many different kinds of soil as you can.
2. How many of these have you seen? Where?
3. What kind of rock forms sand when crumbled?
4. In what ways is clay soil better than sandy soil?
5. In what ways is sandy soil better than clay soil?
6. Name several ways in which lime or limy substances are helpful to soil.
7. What is humus?
8. How does humus improve sandy soil? How does it improve clay soil?
9. Describe a good farm soil.
10. How may the subsoil differ from the surface soil?

**References.**—Physical Geographies will be helpful in the further study of the topics taken up in the chapters on Soils. Let the most advanced pupils in the class read the chapters on soil movement in a good Physical Geography and report to the class.

## CHAPTER VI.

### SOIL MOISTURE.

**Water in Soils.**—Many soils contain too much or too little water. The water in soils may be in three conditions: (a) *Free* water, or that which would flow into a hole dug for a post or telephone pole. (b) *Capillary* water, or that which tends to fill the small spaces between fine particles of soil, as the oil of a lamp fills the spaces in the wick above the free oil in the lamp. This is called also *coarse film* or simply *film* moisture. (c) *Fine film* water, or that which clings to the surface of each small bit of soil even when it is as dry as road dust. This is called also *hygroscopic moisture*. If too much

water is present, proper drainage may help; if too little, by adding water or by adding vegetable matter and barn manure, to aid the soil in retaining water, the crops will be improved. Soils with good texture are seldom too wet or too dry. The average rainfall of a certain region may be enough, but the best growth is impossible if the rain is not well distributed through the growing season.

**EXERCISE.** — *Three Conditions of Water in Soils.* — Fill a glass jar or drinking glass with some fine sand or other loose soil and pour in water until half full of free water. Above the free water the soil will become wet with capillary water. By stirring the top soil it will become dust like or some dust may be spread on top. The dust, though perfectly dry in appearance, is supplied with fine film water.

Just after heavy rainfalls the free water is close to the surface, and falls lower at drier times.

**Capillary Moisture.** — Capillary water clings to the surfaces of the soil particles and cannot be seen as free water can. When a soil has all the capillary water it will hold, its presence can be felt with the fingers. The color is darker than the same soil when dried in the air.

Take a pound of soil fresh from the garden and spread it out on a paper to dry. The next day weigh it and determine how much capillary moisture it has lost.

**Fine Film or Hygroscopic Moisture.** — Dry dust from a road contains a very fine film of moisture on each soil grain. This is too fine to be seen. Put some road dust in the bottom of a glass tube or vial and heat it gently. Moisture will be seen collecting in the top of the tube. This was held in the form of fine films on the soil grains before they were heated.

**Capillary Moisture Most Useful.** — The roots of plants take up capillary moisture. This in turn is supplied from the bed of free water deeper in the soil. Farm crops cannot make direct use of free water. Plants need air in the soil about the roots. Free water would exclude the soil-air, and

also prevent the rise of temperature. Fine film moisture probably does not aid plants in their growth, but will help to maintain life at the time of great drought. Slow-growing plants, such as those found in deserts, may be kept alive by the presence of fine film moisture.

**Soil Moisture Used by Plants.**—Plants use moisture while growing. One ton of a dry corn crop may use up 300 to 600 tons of soil moisture during its growth. The moisture while in the soil dissolves plant-food which it finds there. The plants take up this food in the water they drink through the roots. This all passes up to the leaves of the plant and the surplus water is lost by evaporation into the air.

**How Capillary Moisture Moves.**—When grains of soil are wet with capillary moisture, each grain is covered all over with a thin layer of water. Deep down in the soil near where the free water is found the layers of water around the grains are quite thick. Higher up, the films are less thick. The films about the grains are as thin as the films of soap bubbles. The grains next to the air become as dry as the air itself.

But the moisture is constantly moving from the lower depths toward the surface. The power by which this movement takes place is called capillary action. It is in the same way that oil will rise in the wick of a lamp.

The moisture moves upward in fine-grained soils such as clay more readily than in coarse sand. The openings between soil grains are called *pore spaces*. If these are rather large the capillary movement of water is slow. Packing the soil grains closer together, as with a roller, will greatly increase the rise of water in the soil. This is often done when small grain or grass seeds are sown, to hasten the sprouting of the seeds.

**Water Holding Power of Soils.**—One hundred pounds of each of the following soils, when saturated, held the following amounts of water in capillary form:

Sand . . . . .	held	25 pounds moisture
Heavy clay . . . . .	held	50 pounds moisture
Cultivated loam . . . . .	held	52 pounds moisture
Black garden loam . . . . .	held	81 pounds moisture
Humus . . . . .	held	190 pounds moisture

EXERCISE.—*Absorbing Rainfall.*—Arrange an apparatus as shown in Fig. 34. Use gravel, sand, loam, clay, and peat, or other soils of the region. Pour water on all of these, keeping the soil covered. With watch or clock note time required in each case for the water to begin dripping through

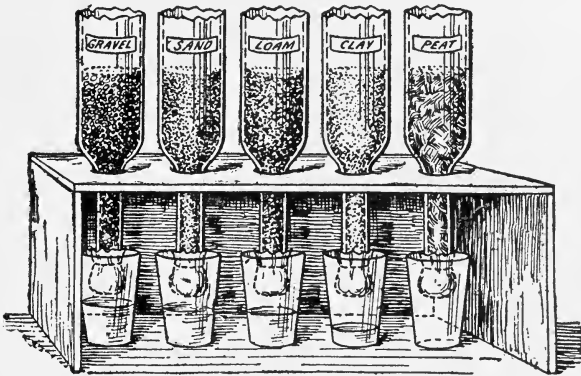


FIG. 34.—Apparatus to show the rate of taking in rain water by five different soils. Cloth tied around the mouth of the bottles prevents the soil from washing through. (Agricultural Education.)

into the glass below. Which kind of soil will take in rainfall most rapidly? Which has the closest texture? What becomes of most of the rain water falling on a compact soil during a heavy rain?

EXERCISE.—*To Illustrate Capillarity.*—Place one end of an old loose cloth in a cup of water and leave the other end outside. In a short time the whole cloth may become wet by capillarity. The water moves along in the fine meshes of cloth. Oil is drawn up in a lamp through the wick by the force of capillarity.

**EXERCISE.** — *To Show Capillarity in Soils.* — Tie cloth over the large ends of lamp chimneys and fill with different kinds of dry soils, as shown in Fig. 35. Set them in a dish of water. The water will rise in the soils by capillarity. Does it rise higher in the finer soils such as clay and loam? Moisture rises quickly but not so high in coarse land.

**Increasing Soil Moisture.**—Since humus holds so much capillary water, the farmer has one sure way to increase the water-holding power of any soil. The addition of green manure and barn manure will cause humus to form in the soil. Large quantities of humus will hold more moisture in

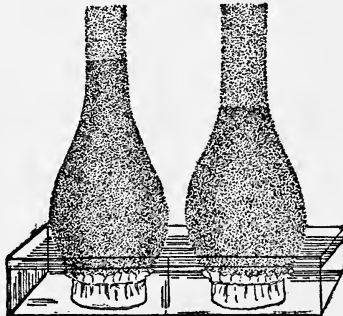


FIG. 35.—Water rises higher by capillarity through fine soils than in coarse soil.

the capillary form and thus encourage the growth of larger crops. Deep plowing will increase the depth of the water reservoir. Harrowing and cultivating will help, because the more a soil is stirred the less water it will lose by evaporation. Furthermore, rains sink into a loose surface better than into a hard compact one. Underdrainage of soils will increase this power to hold capillary moisture, because the volume of soil above the free water level is made greater.

**How to Save Soil Moisture.**—Spaces between soil grains serve as very crooked small tubes to conduct the lower soil water toward the surface. Harrowing and cultivating the

surface of the soil will break the connection of the spaces or pores with each other. If this capillary connection is broken near the surface the moisture will be checked in its upward movement and be held near the roots.

The covering of fine soil produced by a harrow or cultivator is called a *dust mulch* or fine soil mulch (Figs. 36a and b). The chief purpose of the dust mulch is to save moisture. As growing plants use a very large amount of water, it is wise for the farmer to keep a fine soil mulch on the fields all the

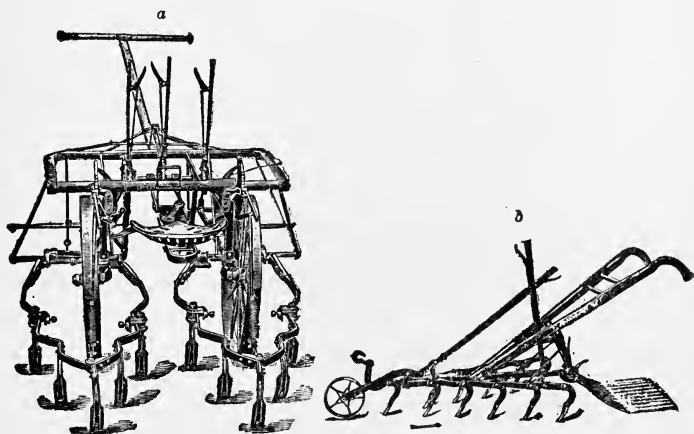


FIG. 36a.—A ten-shovel sulky cultivator. This form of machine leaves a fine soil surface which helps to save moisture.

FIG. 36b.—A one-horse walking cultivator with many small shovels and a smooth rake behind. The fine soil mulch produced is the best means of preventing evaporation of the moisture.

growing season. If the tubes and pores through which the water passes are undisturbed the water will escape rapidly into the air. If, on the other hand, these tubes are broken by tillage, evaporation is checked.

EXERCISE.—*Effect of Mulch.*—When the ground is dry place an old cloth or carpet or a bunch of hay on the ground. In a day or so the ground under this mulch will become moist by drawing water up from beneath, while the ground around the mulch may remain quite dry. A covering of

fine soil made with a rake, called a *dust mulch*, will have the same effect in keeping garden soils moist during dry

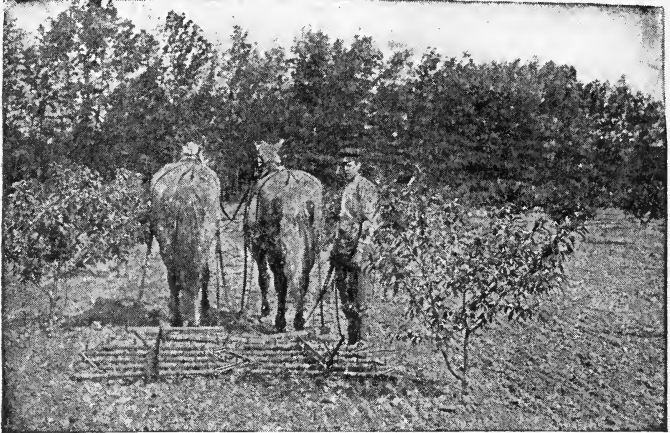


FIG. 37.—Spike-toothed harrow, producing a dust mulch in a peach orchard. (Experiment Station, N. J.)

weather. A dust mulch can be made with a fine-toothed harrow or weeder over a large field very rapidly (Fig. 37).

## REVIEW.

1. Name the three forms of water in soils.
  2. Which form is most useful to growing plants?
  3. How can we determine the amount of capillary water in a soil sample?
  4. How does free water in soil help the farmer?
  5. Under what circumstances is the free water harmful?
  6. What becomes of the moisture taken up by a growing crop?
  7. Describe the movement of capillary moisture in soils?
  8. What are pore spaces in soils?
  9. What kinds of soil have the largest pores?
  10. In what soils is the capillary movement of moisture most rapid?
- What is the effect of rolling the loose soils?
11. What soils hold the most capillary moisture?
  12. What kind holds the least?
  13. Suppose humus soil and sandy soil were mixed, what would be the effect on their moisture-holding powers?
  14. What is a dust mulch? How made?
  15. What is the effect of a dust mulch?

Reference.—Dry Farming, by Widtsoe.



## CHAPTER VII.

### LAND DRAINAGE.

**ALL** good farm land should be well drained. In some cases it is naturally drained because of the loose or open character of the subsoil. In other places we find the surface so sloping that much of the rainfall is carried away on the surface or near the surface. There are special cases where some form of artificial drain should be used.

**What Drainage Does.**—In soils where water stands too close to the surface, drainage will help in several ways. We, therefore, use draining ditches or drain pipes for the following reasons:

1. To remove surplus water.
2. To admit air to soil and roots.
3. To deepen feeding area for roots.
4. To reduce suffering at time of drought.
5. To aid tillage.
6. To increase chemical action.
7. To raise the soil temperature.

Soil which has been well drained is improved, not only by the removal of water from it, but because the more rapid passage of water through the soil carries the air and warmth to lower levels, which are important factors in making plant-food soluble, and thus increasing the power of plants to secure food.

On too many farms we find half-developed crops grown year after year upon land which would be able the yield large returns if properly drained.

**Methods of Drainage.**—There are two general methods of draining land: first, by open ditches, which may have either straight banks or sloping banks; second, by underdrains or

covered drains, which may be composed either of tile (Fig. 38) or of broken stone, gravel, boulders, etc. Surface or open ditches are cheaper to start with, but are not so good as others. They do not give as good results, and are in the way.

**Effect on Roots.**—Deep drainage increases the room for plant-roots. The roots of most farm crops will not grow down into any free water which may be standing in the sub-soil. If drains carry away such water the roots may go into the deeper soil to get plant-food (Fig. 39, D).



FIG. 38.—Ready to lay the six-inch drain tiles.

This reduces suffering at time of drought, because the roots are then so deep in the soil that the drying of the surface does not harm them. They get their moisture from lower depths and from a larger volume of soil.

On the other hand, if the free water is allowed to remain near the surface during the spring of the year (Fig. 39, F), very shallow root systems are formed. Later, in July, when a drought comes, the free water settles to a great depth too quickly for the roots to follow. The shallow roots are then surrounded by the dry soil near the surface and growth is stopped (Fig. 39, W).

**How Drainage Warms the Soil.**—Drainage lowers the water in soils. As the water goes downward, the air from above is drawn into the soil. In warm weather the air will thus warm the soil, increase chemical action, and aid in the growth of soil bacteria. Plant growth is thus hastened.

**Drains Ventilates the Soil.**—This not only warms the soil but also gives it the necessary oxygen and removes the harmful gases.

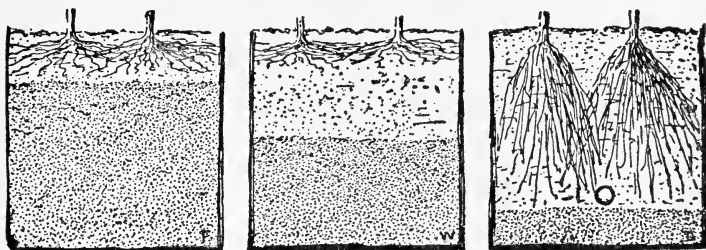


FIG. 39.— Drainage deepens the feeding area for roots and reduces the suffering at time of drought. The view at the left shows free water just under the roots. When drought comes the roots are left so near the surface as to let them dry very badly. See centre view. The view at the right shows the deep root system allowed by tile-drainage.

**Where Drainage is Needed.**—There are several kinds of places where it would be wise to put in artificial drains of some kind:—

1. Flat lands which are too wet because of the overflow of streams at time of heavy floods.
2. Bogs and marsh lands which hold the free water too near the surface most of the summer season.
3. Large, flat areas having clay subsoils.
4. Depressions in hillsides which hold the water coming from the land above.
5. Fields which are to be flooded at certain times for special crops, such as rice and cranberries.

**Principles of Underdrainage.**—The value of underdrains depends upon the free passage of water through them.

They should always lead to the lowest portion of the field. They must be gradually sloped to secure an even flow of water in them. A fall of two feet in one thousand will be enough for the flow of water if the tile pipes are laid carefully. The main drain should always occupy the lowest part of the field, and the others may lead the water to the main.



FIG. 40.—Laying drain tiles and testing the depth by measurement from level grade stakes.

The distance of drains from each other and the depth below the surface are governed by the character of the land. On light, open soils, they should be deeper and farther apart; on heavy land they should be nearer to the surface and closer together. The mouth of the drain should be well protected, and kept free and open.

**Drain Tile.**—The best underdrains are made by laying drain tile pipes in the bottom of the ditches. These are then covered with soil.

The tile pipes should be very strong and hard, so they will not rot in the soil. They should be smooth inside to avoid clogging. The ends should be clean cut so they will fit together closely. A very common length for each piece is twelve inches, but sometimes they are longer than this.

The joints are open but are usually covered with sods, rocks, broken tile or other material to help keep out the fine soil. Sections of drain pipe are placed as close together as possible and the openings are very small (Fig. 40).

Water enters drain-pipes at the joints. The pipes carry away only the free water and the capillary moisture is left in the soil for the use of plants. If the pipes should lead through a drier soil, the water would there flow from the pipes into the soil.

### REVIEW.

1. Give several ways in which drainage may help the soil.
2. Give two methods of draining land.
3. How does drainage warm the soil in the spring?
4. How does drainage reduce suffering at time of drought?
5. Give five kinds of places where drainage is needed.
6. Give several points to be observed in making underdrains.
7. What does distance between lines of tile depend upon?
8. What things help to determine the depth at which to lay drains.
9. Describe good drain tiles.
10. How does water enter a line of tile?

References—U. S. Farmers' Bulletins: 805, 815, 1131, Tile Drainage; 1234, Gullies; 997, Terracing. Ark. Sta. Bul.; 104, Drainage.

---

## CHAPTER VIII.

### SOIL IMPROVEMENT.

THE farmer should do what he can to improve soils, as natural causes work too slowly. The depletion of a poor soil may be due to the natural causes. Fields that are on hillsides may be badly washed and gullied by running water

from rains. Such bad effects can usually be remedied by the application of practical methods. The aim should be to bring the soil into suitable condition for the production of large crops.

**Kinds of Improvement.**—The improvement may be in several regards:

1. In its physical condition.
2. In its chemical make-up and food-yielding power.
3. In its moisture-holding power.
4. In its germ life or bacteria.



FIG. 41.—Plowing under a crop of green manure to add humus to the soil.

Tillage is one of the commonest ways to put soil in proper physical condition to yield good crops. There are two main types of tillage: Deep tillage, as with a plow (Fig. 41), and shallow tillage, as with harrows and cultivators (Figs. 37 and 42).

**Objects of Plowing.**—The primary object of plowing a field is to make a good seed bed by crumbling the soil and

making it fine. As the furrow slice slides along the curved surface of a polished mouldboard, the particles are caused to slide upon each other. Take the leaves of a book between your thumb and finger when the edges are nearly even. Bend them, and see that they all slide a little and the edges are no longer even. Thus, in plowing, the particles of soil tend to slide upon each other and the crumbling is accomplished. Other objects of plowing include:

1. The covering of wild plants and burying of stubble, stalks, vines, and other wastes.

2. The unlocking of plant-food in the soil by exposing the particles to new conditions of heat, light, moisture, and air.

3. The deepening of the water reservoir and making the moisture conditions more perfect.

4. Loosening of the soil to allow of better shallow tillage.

Plowing not only pulverizes and loosens the soil; it may also warm and dry wet soil; it may deepen the surface soil and increase the feeding area for roots; it admits air and increases the weathering; it deepens the water reservoir.

**Plows.**—Walking plows are best for rough and stony fields. Riding plows have wheels, and are called *sulky* plows. These are much more common in sections where the fields are large, level, and free from stones and stumps.

Gang plows are those which have two or more plows attached to the same frame and turn several furrows at a

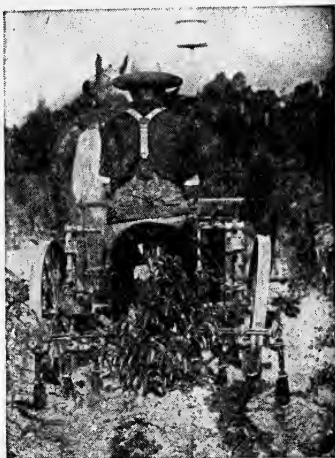


FIG. 42.—Cultivating young peach trees. Frequent tillage makes the soil yield its fertility to growing plants. (Experiment Station, N. J.)

time (Fig. 43). The two-plow gang is usually drawn by horse power, but larger gangs are frequently drawn by steam or gasoline traction engines.

**Forms of Mouldboards.**—Plows have three main forms of mouldboards, suited to the different purposes of the farm.

The mouldboard for turning over sod is long from the front point to the rear, is very oblique, and has a very slight curve. The rear of the mouldboard turns the slice more nearly upside down than the other forms.

The mouldboard for stubble ground is extremely different from that of the sod plow, being very short, steep, and much curved. It bends the furrow slice abruptly and causes it to crumble, leaving it somewhat on edge.

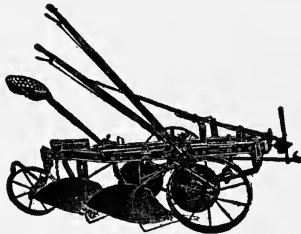


FIG. 43.—Modern gang plow, turning two furrows at a time.

The general purpose mouldboard is medium in form between the other two extremes, and is useful where much litter and manure are to be plowed under.

**Fall Plowing.**—When a field is plowed in the fall it gives more time for the rotting of barnyard manure and other forms of vegetable matter turned under by the plow. The farmer usually has more time in the fall, and the plows may be kept going until the soil is frozen. Heavy soils plowed in the fall are greatly improved and made mellow by alternate freezing and thawing during winter. Many forms of injurious insects are destroyed in the upturned soil during the winter. The moisture conditions are better and the crops



will suffer less from drought than if the soil were not plowed until late spring.

There is one strong argument against late fall plowing: It prevents the growth of a winter cover crop on the field. The very light soils are greatly benefited by winter cover crops. In regions where the climate is dry, winter cover crops are used to prevent the blowing of soils. In hilly regions where heavy winter rains are common, cover crops are necessary to prevent washing or erosion.

**Depth of Plowing.**—For most crops deep plowing gives better results than shallow plowing. A very good general rule for humid climates would be to always plow the soil as deep as the dark surface soil, being careful to not bring too much of the subsoil to the surface. When vegetable matter is plowed under each year, the plowing can extend to a greater depth each time.

**Shallow tillage** includes the cultivating and harrowing of soils. There are several objects in view—the preparation of a seed bed, the killing of weeds, and the saving of moisture. (Figs. 36*a* and *b*, 37 and 42.)

**Preventing Weeds.**—Before crops are planted in the spring, the soil should be so frequently tilled as to prevent the starting of weeds; that is, to kill the little sprouts before they show above ground. On fields of corn, potatoes, cotton, and other crops in rows, the tillage should also be very frequent and shallow—thus killing the little sprouts of weeds and checking the loss of soil moisture. If weeds are allowed to grow they take from the soil quite as much plant-food and moisture as the cultivated plants.

**Green Crops as Manures.**—Crops are frequently grown with the intention of turning them under before they become mature. Such are called green manures. They add vegetable matter to the soil in a form to decay quickly. This produces humus and liberates considerable plant-food in a form ready for crops to use. Both physical and chemical benefits thus

arise from the use of green manures. Red and crimson clover, cow peas, vetch, rye, and buckwheat are commonly used as green manures, but any other crops may be grown for this purpose. Those plants which belong to the *legume*, or clover, family are among the best for this purpose, because they gather nitrogen from the air and leave it available for the use of other crops. The benefits of this family of plants will be discussed more fully in the chapters on Farm Crops and Alfalfa.

**Benefits Enumerated.**—By the careful use of green manures, soils may be benefited in several ways:

1. Food is brought from great depths by the roots and when turned under is left near the surface.

2. Such food is left in a form suitable for other plants to easily make use of it, because the green manure will decay quickly.

3. The decaying matter becomes humus and has many beneficial effects, already studied.

4. Chemical action in the soil is promoted.

5. Small organisms, bacteria helpful to the soil, are multiplied more rapidly.

**Planning for Green Manures.**—It requires some planning ahead to be most successful in securing crops suitable as green manures. Certain crops, such as rye and crimson clover, may be sown in the late summer or fall after the season's crop is off. These may be plowed under in the spring as green manure before the next season's crop is put in. Cow peas or buckwheat may be used to produce a good heavy green manure crop by letting it use the last half of the summer after a crop of small grain has been removed from the field.

**Care in Their Use.**—When too heavy crops of rye or clover are plowed under at one time, there are apt to be bad results. This is chiefly due to the formation of acids in the soil which make it sour. Such bad effects are not noticed

when there is plenty of lime in the soil. Lime should be applied to the soil when heavy crops are plowed under. Heavy applications of green manure also have a drying effect upon the soil, and there may then be more suffering at time of drought.

**Benefits of Lime.**—In another chapter the character of limestone soils was discussed. (Pages 53–54.) It is a good practice to spread lime on soils for certain crops just as fertilizer is applied. The benefits derived from the addition of lime to soils are here enumerated:

It aids decay of vegetable matter.

It helps liberate plant-foods in the soils.

It hastens the growth of bacteria in the soil.

The heavy clay soils are made more open, porous, and more easily tilled; moisture and air move more freely; the soil will then become warmer in early spring.

The light sandy soils are made more compact, and hold moisture better.

Lime acts upon acids in soils and destroys the sourness; this is a benefit for nearly all farm crops.

It is a direct plant-food for alfalfa and some other members of the clover family.

**EXERCISE.** — *Slaking Lime.* — Expose a small lump of burned lime, called quick-lime, on a board or paper, for a day or more. Does it crumble to powder? This powder is then called air-slaked lime. A second lump of quick-lime may be placed in a dish and wet with a very little water from time to time until it heats and crumbles. When burned lime is used on soil, it should be air-slaked before spreading. A little water added to it will hasten the slaking.

**EXERCISE.** — *To Study Lime-water.* — Slake some fresh lime the size of a baseball by pouring water over it very slowly until it crumbles. Then cover it well with water and stir. After it is allowed to settle, pour off the clear water. Put in a strip of red litmus paper and note the result.

Put in a strip of blue litmus paper and see the result. Why is it not affected? Draw off a glassful of the lime-water and, after taking a deep breath and holding it for awhile, force the air from the lungs into it through a straw or tube. The milky color resulting shows that there is a union of the lime-water with the carbon dioxide in the breath, and a new substance is formed. If some of the clear lime-water is left open to the air for some time, a white crust will be formed on the top of it in the same way.

**EXERCISE.**—*To Show an Important Plant-food in Ashes.*—Pour a few quarts of water into a pan of wood ashes and allow it to stand for fifteen minutes. Drain the water out through a loosely woven cloth. Examine the liquid to detect the lye or potash in it. It is soft and slippery to the touch. Place some red litmus paper in the liquid. Note the change in color. This is because the potash is what we call an *alkali*.

**EXERCISE.**—*Wood Ashes and Sour Soil.*—Bog soils are often sour and show an acid reaction with litmus paper. Make some soil sour by wetting it with vinegar. See if it turns litmus paper red. Then wet it with “lye water” obtained by letting wood ashes stand in a vessel of water. Test with litmus paper. This time how should it change? Sour (or acid) soils may be made “sweet” or neutral by spreading wood ashes on them. Fresh or well-stored wood ashes contain both potash and lime, which have several benefits besides correcting acidity of soils.

**EXERCISE.**—*Lime and Sour Soil.*—Take a sample of sour soil which you have prepared as in the last exercise. Sweeten (or neutralize) it by the application of lime-water prepared by slaking lime in water. Lime is very helpful to bog soils and other soils too rich in humus.

**Barnyard Manure.**—The use of barnyard manure on farm and garden soils is one of the best ways of improving them. Its benefits are of several kinds. It is a direct food

for plants because of the three fertilizing elements which it contains, *nitrogen*, *phosphoric acid*, and *potash*. These are the three elements of plant-food of greatest value to plants. Another benefit is from the vegetable matter contained in the manure, which is a great source of humus. This helps to put the soil into better physical condition and makes a better home for soil bacteria. The decay of the vegetable matter sets up certain chemical changes which are of benefit to the soils and crops.

**Value of Manure.**—The value of barnyard manure depends on several conditions:

- 1 The age and kind of animals.
- 2 The kind and amount of feed they eat.
- 3 The amount and kind of litter or bedding used.
- 4 The care of the manure after it is made.
- 5 The age of the manure.

When compared with the market prices of commercial fertilizers the average value of manure from the barn of a horse or mule in a year is estimated at \$43; a cow, \$38; a hog, \$25; a sheep, \$4. To get these values the manure must be used to the best advantage.

When equal weights of manure are considered the values from the different kinds of farm stock would usually be in this order: Poultry, sheep, pigs, horses, cows.

**Loss in Manures.**—Manures are liable to lose their value during storage from two direct causes:

First, *heating*, when left in heaps in the barnyard or in the field. This results in the loss of nitrogen. Manure must not be allowed to get hot from its own fermentation.

Second, *leaching*, when left where water can wash it. This may take away much of the valuable plant-food. When manure is allowed to leach the most valuable parts are lost first.

Extremes in moisture and temperature should not be allowed if manure is to be saved. There is very little loss

if the heap is kept wet enough to prevent heating, and kept dry enough to prevent water from passing through it.

Under the average conditions where manure is allowed to stand in the barnyard for three months or more, the loss is from one-third to one-half of the plant-food in it (Fig. 44).

**Care of Manures.**—A good way to save manure is to store it under cover—sheltered from rain and direct sunshine.

There is less heating of manure when it is packed very hard, because the air is kept away. One plan of keeping it well packed is to have a shed or covered barnyard with a

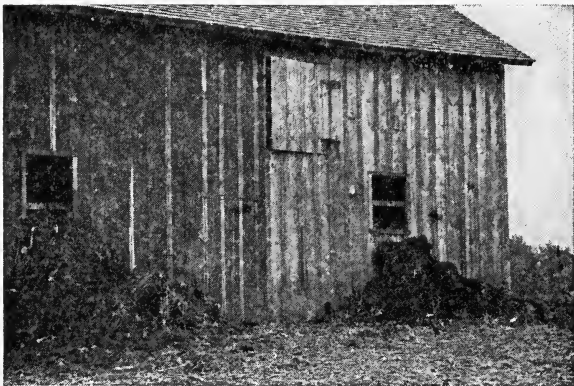


FIG. 44.—A poor way to store barnyard manure, even when the ground is level. The barn is badly rotted by this method. (Animal Industry.)

cement floor, on which the manure from the barn is spread daily. Stock are allowed to tramp this down all winter, and it is hauled to the fields in the spring.

**Spreading Directly on Fields.**—Barnyard manure is used to the best advantage when it is spread directly on the fields regularly, every day or every week. In northern and central states where many animals are stabled during the winter, a large amount of manure is allowed to pile up about the buildings and waste rapidly. It should be spread on the fields, where it is to be used, as fast as it is made (Figs. 45 and 46).

This saves the manure best. Labor is cheaper in winter; snows may allow the use of sleds for hauling; the least amount of labor is required in placing the manure from the stalls on a sled or wagon to be taken to the field. The manure should be spread when carried to the field, and not left in heaps to leach.

The practice followed in some sections of putting the manure in piles in the field should be stopped. That is an old-fashioned way which requires more labor. It makes the grain or other crop uneven in growth and uneven in ripening. It does not make the best use of the plant-food in the manure.

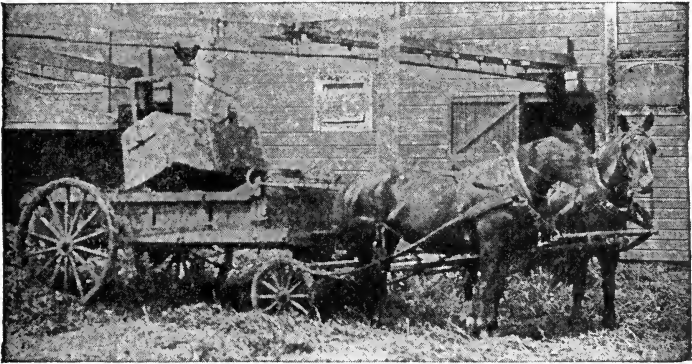


FIG. 45.—The modern manure spreader in the barnyard. A litter carrier which runs on an overhead track is used to take the manure from the barn. The figure shows the carrier in position of emptying into the spreader-box. The team is hitched on and the load is spread in a field as shown in another figure.

**Using Barnyard Manure.**—Three points should be considered in the use of barnyard manure. First, it is rich in nitrogen and has some of the other elements. Second, it is well supplied with bacteria which are very helpful to the soil. Third, it supplies the soil with humus.

The manure of the farm should be spread on the highest parts of each field, because they are usually the poorest soils and some of the fertility naturally washes down toward the lower soils.

A light dressing of manure on each field every year is better than very heavy applications less frequently. This is particularly true if the soils are light. Large applications of manure are saved better by heavy soils than by light soils.

Fresh manure has a forcing effect on the crops. If large amounts of fresh manure be applied to light soils there is danger of the plants suffering from drought in dry seasons; the soil may be made too open and loose by too much fresh manure at one time. Soils containing much clay will not suffer from larger amounts of fresh manure.



FIG. 46.—A manure spreader at work. This machine can be regulated to spread the manure thick or thin on the field. The spreader makes the best use of the manure, saves labor, and produces the most uniform crop.

Some root crops, such as potatoes, may be injured by the use of fresh manure. Scab disease may become worse. On fields where such crops are to be grown a large amount of manure may be used one year before the root crop is planted.

**Composts.**—For gardens, flower-beds, and greenhouses, it is sometimes a good thing to rot the manure before it is used. How to do this without wasting its plant-food is a problem which many farmers do not understand. The use of a compost heap serves the purpose very well.

A good compost heap is made by spreading a layer of barnyard manure, then a layer of tough sods from a meadow, or a layer of leaves, on each of these two layers is sprinkled



some lime or wood ashes. The layers are repeated until the manure is all in the compost. The moisture from rains prevents the compost heap from rotting too fast and becoming too hot. The sod layers save much of the plant-food which would otherwise leach out.

Rotting manure in a compost heap will kill the weed seeds; it will reduce the bulk of the manure; it helps to unlock the plant-food in the manure; it destroys the injurious effect which fresh manure has on such crops as potatoes. Whether to make such a compost of the manure will be determined by the uses for which it is intended.

**Feeding Plants.**—Those forms of plant-food which contain nitrogen, potash, phosphoric acid, or lime are considered most precious on any farm. Soils are apt to become weak in these foods. Many such compounds readily dissolve in water and are lost from the soil at times of heavy rain by leaching or washing away. They may be absent from other causes. There are few if any other plant-foods which need cause the farmer much concern. The others are usually abundant enough.

**Commercial fertilizers** containing nitrogen or phosphoric acid or potash—or all three of these—are purchased in great abundance in the Eastern and Southern States and for special crops elsewhere. These are applied to the soils for the direct feeding of crops. It is estimated that over eight million tons of such fertilizers are used in the United States each year. These cost the farmers over two hundred million dollars. As a rule they have no beneficial effect in improving the soil itself, as do the barnyard and the green manures. A commercial fertilizer is valuable in proportion to the amount and kind of these three plant-foods contained in it.

**Nitrogen** is the most important element of such fertilizers, because soils are more often in need of it, and it is the most costly. When it is in a soluble form for plants to use, it is apt to be lost from many kinds of soils, unless cover

crops are used. There are several sources of the nitrogen purchased for fertilizers. Nitrogen is derived from animal or vegetable matter as in meat scraps, dried blood, and cottonseed meal. It is also abundant in sulphate of ammonia and nitrate of soda purchased by fertilizer manufacturers.

In the nitrate form it is more quickly useful to the crops, and should be applied to the soil after the plants have started growth. Some of the other forms in which nitrogen is used are very slow in changing to forms available to plants; some of these are hair, leather scraps, garbage tankage, and others. It is very important for the farmer to know the source of the nitrogen in the fertilizer he is buying. For this reason it is becoming a common practice in some sections for farmers to buy the fertilizer materials separately and mix them on the farm.

**Phosphoric acid** is contained in substances in combination with lime and other materials. Such combinations are called phosphates. Ground bone is one of the chief sources of phosphoric acid in fertilizers. If this is ground very fine it will rot gradually and liberate food useful to growing crops. Animal bone contains on an average four per cent of nitrogen and twenty per cent of phosphoric acid.

Bone tankage is a by-product from slaughter-houses, made up of various wastes that have been thrown in a tank and the grease extracted. Its value varies considerably according to the amount of meat or of bone in it.

Phosphate rock has been obtained some time from a number of deposits in South Carolina, Florida, and Tennessee. Recent discoveries of it have been made in Utah, Idaho, and Wyoming.

The rock is used in two ways: (1) It is ground very fine and applied to soils, yielding its phosphoric acid to plants very gradually. This form is sometimes called *floats*. (2) The ground phosphate rock is treated with sulfuric acid

before it is used on the soil. This makes the phosphoric acid more quickly available for the use of growing plants. In this form it is called *superphosphate*, or *acid phosphate*, which is a soluble phosphate; this may contain from fourteen to twenty per cent of phosphoric acid. Superphosphates may also be made from bone and bone tankage.

**EXERCISE.**—*To Study Phosphorus.*—Roll the head of a match between the moistened fingers. The white fumes are caused by the phosphorus in the match uniting with the oxygen in the air. They are called phosphoric acid. This is a form of the plant-food we have been studying.

**Potash** is the third essential element in commercial fertilizers, and is not so generally required. It is often needed on soils that have been farmed for a long time and also on sandy soils and peaty soils. It is derived from wood ashes to a limited extent. The largest source is in the form of mineral salts from the Strassfurt Mines of Europe. The chief names given to these salts are car-nall-ite, kain-it, and syl-vin-it. These may be ground fine and used on the soil; but they are more commonly refined or concentrated before being shipped to this country. The two concentrated forms of potash salts are the (1) muriate of potash, containing fifty per cent of actual potash, and (2) the sulfate of potash, containing forty-eight per cent of actual potash. In all of the forms potash is soluble in water, and is easily absorbed by plants.

**Value of Fertilizers.**—In buying commercial fertilizers the purchaser should remember that the agricultural value is based not upon the brand but more upon kind and form of the elements and upon their proportion in the mixture. Many farmers are inclined to buy fertilizers that have a low price per ton. These are invariably more expensive sources of plant-food elements than those more highly concentrated, because of the necessity of diluting the mixtures with "make-weight" or low-grade materials. High-grade

fertilizers, those that contain good forms of plant-food, cannot be made from cheap materials, and if they contain high percentages of the elements they cannot be sold for a low price (Fig. 47). The price per ton, whether high or low, is not a safe guide as to the effect that a fertilizer may have upon the crop production. This is measured by the kind and form of the materials used in the mixture.

EXERCISE.—*Dissolving Nitrate of Soda.*—Put one-half teaspoonful of nitrate of soda in a glass of water and stir



FIG. 47.—The large square *A* represents a ton of low-grade fertilizer (formula 2% nitrogen, 8% phosphoric acid, 2% potash). The valuable part is represented by the dark square in the corner. The shaded area shows what is called filler, which does no good to the soil.

The large square *B* represents a ton of high-grade fertilizer. The valuable part is what is shown by the white square in the corner. Some filler is always present. It is represented by shaded area.

until dissolved. Plants must have their food in the soil dissolved before they can use it. Would this nitrate dissolve in the rain?

EXERCISE.—*Collection of Fertilizers.*—Let the pupils aid the teacher in making a collection of all the different fertilizers to be found at the dealers or which can be secured by mail. Put these in bottles with suitable labels. Keep them for future study.

EXERCISE.—*Solubility of Phosphates.*—Put a very little phosphate rock which is ground fine in a glass of water and see if it will dissolve. Do the same with a little ground bone in another glass. Pour in a little clear lime-water. If there were any phosphate dissolved this would cause a

white cloudy appearance. If bone and phosphate rock were in the soil, would they be dissolved by rain?

**EXERCISE.**—*Dissolving Superphosphates.*—Put a very little superphosphate (or acid phosphate) from a fertilizer sack in a glass of water and stir. Does any of it dissolve? Add a little clear lime-water. It should make a white cloudy appearance, showing that some of the material has dissolved. This would mean that plants could use this form of fertilizer.

**Problems.**—1. If nitrate of soda is 16 per cent nitrogen, how many pounds of nitrogen in a ton of it?

2. If sulphate of ammonia is 20 per cent nitrogen, how much of it would be required to supply a 12-acre field with 240 pounds of nitrogen?

3. When available phosphoric acid is valued at 5 cents per pound, what should be the cost per ton of mineral superphosphate which is 14 per cent available? What should it cost per ton if it is 20 per cent available?

4. A shipment of sulphate of potash contained 48 per cent potash, which should sell at 5 cents per pound of potash. What will be the selling price per ton of this fertilizer?

## REVIEW.

1. Give four kinds of improvement for soils.
2. Give two kinds of tillage and the implements used for each.
3. Give all the objects of plowing.
4. Describe the different forms of mouldboards and the special use of each form.
5. What is a gang plow?
6. Give several reasons for fall-plowing.
7. Give a general rule governing the depth to plow.
8. Describe a system of preventing weeds by shallow tillage.
9. Give the benefits derived from green manures.
10. What care should be exercised in the use of green manures?
11. Give the effects of lime on light soils. On heavy soils.
12. Give five other effects of lime.
13. Give five things which influence the value of barnyard manure.
14. What are the two main causes of loss in stored manures? How great is the loss usually?
15. Describe two good ways of storing manure.

16. By what plan is manure used to the best advantage?
  17. Describe the making of a compost. Of what use is it?
  18. What three important plant-foods are found in commercial fertilizers? Which is the most important?
  19. Name five or more substances from which nitrogen is derived.
  20. Give three sources of phosphoric acid.
  21. What crops are grown in your section for green manure?
- References.—U. S. Farmers' Bulletins: 716, 745, 761, 921, 924, 931, 967, 978, 986, 1142, 1143, 1148, 1153, 1163. Ark. Sta. Bul. 11, Sterilizer; Ark. Ext. Circ.: 97, 134, 149, Fertility.  
See pages xxix to xxxii.

---

## CHAPTER IX.



### SYSTEMS OF CROPPING.

By rotation of crops is meant the succession of different crops, in contrast with the bad practice of having the same kind of crop grow year after year on the same field without any cover crop intervening.

**Special and General Farming.**—In many of the Eastern States special farming is more profitable than general farming. The raising of dairy produce, poultry products, hay, and seed-corn are some of the distinct lines of special farming. In the South, cotton, cane, corn, and tobacco are among the special crops. In the Northwest and Middle West grain is the only crop on many farms.

General farming is practised in nearly all parts of the country. In such cases it is found much easier to carry out good systems of rotation.

**Why We Rotate Crops.**—There are a number of advantages gained when crops are raised in rotation.

1. Some crops have deep roots; others shallow roots. The growth of a variety of crops on a certain field will prevent it from being exhausted so soon.

2. Grain crops and many others take all their nitrogen from the soil; but leguminous crops, such as the clovers, peas and beans, gather much nitrogen from the air in the soil. Their growth will increase the store of nitrogen in the soil. A rotation of crops which includes the legumes will help to keep up the nitrogen supply in the soil.

3. Crops put waste matter into the soil through their roots. This often acts as a poison to the kind of plants that put it there. It may not be a poison to other kinds of crops which follow in the rotation.

4. Soils should be covered with growing crops as much of the time as possible. This guards against loss of soil by washing and leaching. It is possible to keep the soil thus protected if we have a rotation of crops; but it is usually not possible if but one crop is grown.

5. Insect enemies and diseases of plants are liable to be worse when one crop is grown continuously. Rotation of crops is often a perfect remedy against these enemies.

6. There is more continuous work for men and horses, because a rotation of crops distributes the labor throughout the season. Horses and men should be given steady employment if possible. It is not profitable to keep horses idle too long at a time, as when only one crop is raised.

7. Rotations always require a variety of soil treatment, as plowing the ground at different times of year. This is better than always following the same tillage at the same season of the year. We can best control the soil moisture by proper tillage at the right season.

8. Rotation of crops helps to keep weeds in check. Many weeds which thrive in a hayfield will be kept down by a culture crop, as corn, cotton, or potatoes; while certain other weeds, which are bad in a cornfield, may be killed by growth of grain or grass.

9. More sources of income are found on those farms where rotations are practised. There is also less danger of financial

loss in seasons when certain crops are failures. The other crops grown on the fields of the farm may not fail.

**Chief Needs of Rotations.**—The needs of rotation are fairly well understood by most farmers. There is greatest need when crops are suffering from particular weeds, bad insect pests or diseases, or when the soil is becoming exhausted. However, rotation of crops should always be practised.

**EXERCISE.**—*One Benefit of Rotation of Crops.*—Have students dig out a few plants of different kinds of crops, such as clover and timothy. They should study the root systems and compare the deep-feeding roots with the shallow-feeding ones. Shallow roots use the surface soil; deep roots, such as clover, will bring up food from the subsoil. This will help to make plain one value of rotation of crops.

**Bare Fallow.**—It is now considered bad practice to allow ground to remain bare for any great length of time between one crop and the next. It is sometimes a good plan to do this for a few weeks providing the soil is kept pulverized on top by the use of a harrow once a week or soon after each rain. This practice of bare fallowing will cause the sprouting of weed seeds and the harrow teeth will kill the young sprouts. The soil moisture is also saved by the mulch of fine soil on top of the field.

**Catch Crops.**—In place of fallowing has come the use of *catch crops*. In this method the ground is kept covered with a growing crop of some kind as much of the year as possible. For example, after a grain crop has been removed, a crop of cow peas, soy beans, millet, sorghum, or some other quick-growing crop is seeded. Crimson clover (Fig. 48) and winter vetch are often mixed with winter grain and sown in the cornfield in July, so they will be ready to occupy the field as soon as the crop is taken off. These three plants all live through the winter. This winter cover crop is also used after removing other crops such as early potatoes.

**How They Help the Farmer.**—Catch crops or cover crops may be useful in several ways:



1. They help to hold soil from washing away by heavy rains.
2. Their roots are helpful to unlock plant-food in the soil.
3. When members of the clover family of plants, called legumes, are used, they gather nitrogen from the air and add it to the soil for future crops.

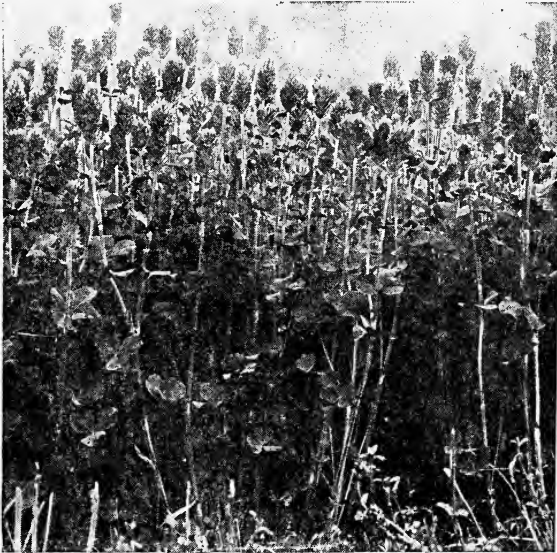


FIG. 48.—Crimson (or scarlet) clover. This is a hardy legume, chiefly used as a winter cover crop. It is sown in fields of corn, cotton, or other crops and in orchards in July or August. It will improve the soil while growing until the following spring. It may then be cut for hay or may be plowed under for green manure.

4. They check the growth of bad weeds.
5. They furnish pasture, hay or other valuable stock feed.
6. If plowed under as green manure, they produce humus in the soil, and quickly give to the soil the plant-food they have been using.
7. When grown among fruit trees and shrubs they check late growth of the trees and temper the effect of winter freezing.

**Cover Crops in Orchards.**—In young orchards winter rye is sown in early fall. This crop is turned under in spring and soy beans or cow peas are sown in June, to be turned under in time for sowing rye. These add humus and keep a cover on the orchard soil; the cow peas or soy beans add nitrogen, and much plant-food is unlocked by all of them for the young trees to use in their growth.

**A Few Rotations.**—Examples of rotations with catch crops and cover crops may be of interest:

1. Oats and common red clover may be sown in the early spring. When the crop of oats is harvested the clover will occupy the ground quickly. It forms a good cover on the field that winter, and will produce one or two cuttings of hay the next summer. The stubble may be plowed under for corn the following spring. In the cornfield in July we can sow a cover crop of crimson clover, winter vetch, and rye for a winter cover crop. This is to be plowed under the next spring as green manure. This three-year rotation is thus outlined:

*Oats; Red clover; Corn with winter cover crop.*

2. Early potatoes may be followed with a winter cover crop. This cover crop is plowed under in the spring and early potatoes again planted. This and the next are called one-year rotations.

3. Corn is sometimes planted on a field year after year if a winter cover crop is put on each time.

4. Winter wheat is sown in September, and the crop cut in July. After the stubble is plowed in, a good summer catch crop of cow peas or of soy beans may be grown in six, eight, or ten weeks. Then the catch crop may be harvested for hay or it may be plowed under as green manure. This is done in time to prepare the field for winter grain again.

**A Rotation for Dairy Farms.**—A very good four-year rotation followed by a number of dairymen is about as follows:

The farm has four fields, A, B, C, and D. This year, field A is seeded to oats and red clover with a little timothy and blue grass in it. After the oats are cut off the growth of clover comes on and may be pastured a little in September. Next year the clover will be cut twice for hay. The third year the field will be well filled with the grasses and some clover and the stock will use it all for pasture. This will be plowed for the next year's corn crop. Fields B, C, and D each follow the same rotation, but each is just a year behind the other, thus:

	A		B
1st year.....	Grain and seeding		Clover hay
2d year.....	Clover hay		Pasture
3d year.....	Pasture		Corn
4th year.....	Corn		Grain and seeding
	C		D
1st year.....	Pasture		Corn
2d year.....	Corn		Grain and seeding
3d year.....	Grain and seeding		Clover hay
4th year.....	Clover hay		Pasture

**Details of the Rotation.**—The four fields are each about the same size and the corn area may be reduced by using part of that field for the summer green-feed each time. In this four-year rotation system two of the fields are plowed and prepared for planting each year, one for spring grain and one for field corn. In case winter grain is used instead of spring grain, the corn is removed as soon as possible after cutting.

Quick rotations give us better clover for the dairy herd than when the fields are kept in hay for several years. It is better for the dairyman to produce hay that is all clover than it is to let the clover all disappear because the field is kept too many years in hay. Timothy hay or the "mixed" red-top and timothy are very poor milk producers. Clover is more than twice as valuable for milk cows.

In this four-year rotation a small permanent pasture may be used also; but let it be well kept up and never used too

long at a time. If the other four fields are fenced, the field that is growing up to timothy and blue grass will make the best pasture.

During the winter and early spring the stable manure may be spread on the field that is to be plowed up next for corn.

This rather rapid rotation of crops keeps up the fertility of the soil well. It allows the use of clover often on each field, and clover manure is one of the richest forms of manure for the soil.

Pasturing a field one season in four is no small factor in keeping up its fertility; but some commercial fertilizer, in the form of acid phosphate and potash, may be used to supply the loss of mineral constituents. Some of this fertilizer may be applied when corn is planted and some when the grain is sown. Lime should be applied to the field where clover is to grow next.

In all rotations where common red clover follows small grain, it is usually seeded in the growing grain in early spring or with the spring seeding of grain.

**An Alfalfa Rotation.**—On dairy farms where alfalfa is extensively grown, some systematic rotation may be adopted. It is advisable to plow up the alfalfa field as soon as it becomes rather weedy. This gives a chance to take advantage of the fertility which it has been gathering for us.

As soon as the June cutting has been taken off, the ground is quickly prepared for corn to be used for fodder. The next spring oat-and-pea mixture is sown, and as soon as the crop is off the stubble is turned under. The harrow is used once a week until the middle of August; then lime is applied and alfalfa is seeded, using about thirty pounds to the acre. Inoculation at this time is unnecessary. We have thus taken from the field a crop of fodder corn and one of oats-and-peas, between two crops of alfalfa.

**EXERCISE.**—*Rotation Courses.*—Let pupils report on the rotations followed at home or in the farming neighbor-

hoods where they are best acquainted. They may tell whether they could be improved or not. Some of them should be written on the blackboard and discussed as to the tillage required, effects on weeds, and other points.

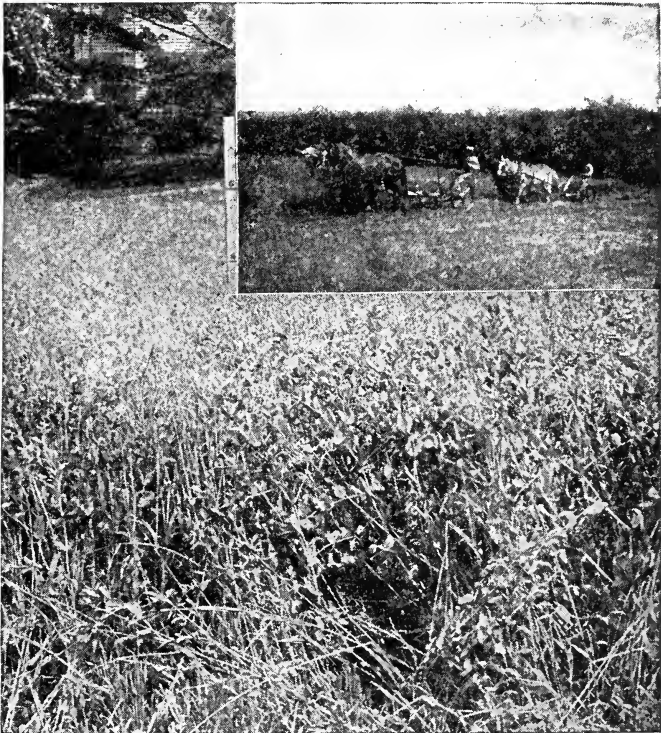


FIG. 49.—Oats and peas sown in early spring, ready to cut for use as green feed or for making hay by the middle of June. Corn may be grown on the same ground in the same season. Harvesting the oats and peas shown in the upper figure. The stubble may be plowed or disked and the field quickly planted to corn. (Experiment Station, N. J.)

**Succession Cropping.**—This is the growing of one crop after another on the same land in the same season. For example, radish, lettuce, tomatoes. Let the pupils tell what plans of cropping they have seen in use either in gardens

or in fields. This may arouse much valuable discussion. (Figs. 49, 50.)

**Companion Cropping.**—This is a form of double cropping. What crops may be grown in fields together? Have you seen



FIG. 50.—Corn grown for forage after the spring crop of oats and peas shown in Fig. 49. (Experiment Station, N. J.)

corn and squashes grown together? All the pupils should think over the crops that may grow together as companion crops. Early onions with late celery are an example in the garden. Early dwarf peas and tomatoes may be grown together.

## REVIEW.



1. Give examples of special lines of farming in your section of the country.
2. Give several reasons for the rotation of crops.
3. Why do we want crops of the legume family in a rotation series?
4. Can you tell how rotation of crops will help to keep down insect enemies and diseases of plants?
5. Explain why you think the sixth advantage from rotation of crops is a good one.
6. Name some weeds often found in hayfields or pastures which would not thrive in a cultivated cornfield.
7. Give one benefit of a bare fallow.
8. In what condition should soil be kept during a bare fallow period of a few weeks?
9. Tell the difference between a bare fallow system and a catch crop system.

10. Give examples of summer catch crops.
11. Give examples of plants used as winter cover crops.
12. Give several uses of catch crops and cover crops.
13. Should such crops be used in young orchards or in old ones?
14. How do they benefit the soil and trees?
15. Give an example of a three-year rotation of crops.
16. Tell when each of these crops is planted and harvested.
17. Give an example of a rotation system where potatoes are the special crop desired.
18. Repeat the four-year rotation given in the book for dairy farms.
19. Describe a good rotation where alfalfa is grown.
20. What is succession cropping? Give examples.
21. What is companion cropping? Give examples.

References.—U. S. Farmers' Bulletins: 1148, 1153, Cowpeas; 931 973, Soybeans; 515, 967, Vetches; 579, 646, 1142, Crimson Clover. Ark. Ext. Circ. 99, System.

---

## CHAPTER X.

### FARM CROPS.

**Classification of Crops.**—Field crops are those which are most commonly grown in fields; they are sometimes also grown in gardens. Those usually found in gardens only are called *horticultural* crops; these include all fruits and flowers and most vegetables.

Crops of all kinds may also be classified according to the following six groups:

1. *Forage and Fiber Crops.*—These include grasses, clovers, and alfalfa, used for green forage, for hay, or for pasture; and cotton, flax, and hemp, used for fiber.

2. *Cereal Crops.*—The grains are called cereals. These include corn, wheat, oats, barley, rye and emmer.

3. *Tuber Crops.*—White or Irish potatoes are true tubers; sweet potatoes are usually also classified with tubers, but strictly speaking they are believed to be roots.

4. *Root Crops* include many that are used for stock feed, such as mangels, field beets, beets, turnips, carrots.

5. *Market-garden Crops.*—Here we find cabbage, cauliflower, celery, onions, lettuce, radish, table beets, melons, and many others.

6. *Fruit Crops*.—These may be grouped as (a) stone fruits, such as peach, plum, and cherry; (b) pome fruits, such as apple, pear, and quince; (c) small fruits, such as strawberries, grapes, currants, gooseberries, raspberries, and blackberries; (d) citrus fruits, such as orange, lemon, pomelo or grape fruit, and lime fruit.

7. *Timber Crops*, or products of the forest.

#### FORAGE CROPS.

**The Soiling System.**—One thing that the dairy farmer needs to keep in mind is the succession of green forage for use during the summer months when the weather is dry and the pastures are short. Crops grown to be cut and fed green to stock are called *soiling crops*. Such a system of feeding is called the *soiling system*. A better name would be the green-feed system. The soiling system used on any farm may be either (1) entire soiling, when green feed is provided for the whole season, or (2) partial soiling, where it is used in combination with pastures.

The need for preparation in advance is very great on all dairy farms in this climate. The weather statistics show that we always have least rainfall in midsummer. There is certain to be enough drought each summer to cause a great shrinkage in the milk flow from herds fed on pastures.

Just when the drought will come depends somewhat upon the locality and also the season. Frequently it is in July. Dairymen, however, prepare themselves to take care of the herd regardless of the dates when the dry weather comes.

In a single county alone each summer there are thousands of dollars lost by the dairymen, due to the lack of green feed during the dry, hot days. In some localities the shrinkage of milk-flow is forty per cent in two weeks' time. In other cases the loss is about twenty-five per cent in the same time. Who is the loser at such a time? Is it the dairy farmer, or is it the buyer? Surely the farmer gets nothing for the milk which his cows fail to produce. He stands the



heaviest loss. Some cows of the herds run so low at the dry pasture season that they cannot be brought back to their normal flow when the fall rains come. They are often carried into winter as mere strippers, at a dead loss to their owners.

The farmer can lay out his fields and plan the seeding so as to have some green feed to give the cows at any time when the dry weather comes on. He cannot hope to have such green forage ready at any time it is needed for the cows unless he plans for it in advance. First, he should make a list of the crops which would suit his purposes and his other farm plans. Second, he should decide what areas of each of these crops will be needed for the number of cows in the herd, providing for plenty. If there is any left over it may be used for hay or fodder.

**Soiling Crops.**—Here is a suggestive list: Wheat or rye mixed with crimson clover or winter vetch, sown in the corn-field in July, to be cut when the grain begins to head out or when in full blossom.

Oats and Canada field peas sown in early spring, to be cut as the peas begin to blossom.

Spring vetch with oats or barley, sown at the same time as oats-and-peas or a little later.

Crimson clover sown in corn in July or August, ready to cut in May.

Red clover sown last season may be fed green in June if needed.

Timothy and other grasses may be cut early and some fed green to the cows.

Alfalfa, where grown, will furnish green feed from May to October.

Millets sown in early June may be fed six or eight weeks later as green forage.

Cow peas or soy beans sown in June or July will supply a long succession of green feed, at dates six to ten weeks from the seeding time.

Flint corn, sweet corn, dent corn, and kaffir (Fig. 58), sown broadcast or drilled in rows, will begin to furnish feed as early as July 15th or August 1st. This will last until fall frosts come.

After these soiling crops are gone the dairy farmer may use root crops, such as mangels, to furnish succulence for the dairy in late fall and early winter, if ensilage is not available.

**Oats and Peas.**—The benefits derived from using this mixture as a crop each year on the farm are very great. As forage this mixture is very good because of the high content of protein.

The ground should be plowed and harrowed early and the seed drilled in as early as the weather will permit. Do not be afraid of a little freezing weather afterward. Two bushels of Canada field peas and one bushel of oats will seed an acre. A bushel and a half of each may be used.

**For Green Feed.**—Begin to cut the crop for green feed just as the first pea blossoms are showing. This first field will furnish green feed for the dairy herd for ten or fifteen days, depending on the weather.

For a herd of twenty-five or thirty cows, it is well to allow two acres for each sowing of oats-and-peas, and make three sowings—one as soon as the soil can be worked; the next two weeks later; and the last about three weeks later than the second sowing. The yields should be ten or twelve tons of green feed per acre.

**A Good Hay.**—The areas mentioned for each of these sowings may leave a little each time to be cured for hay. Those dairy feeders who are already familiar with the good feeding qualities of hay made from oats-and-peas will be sure to make the areas large enough to leave plenty of the crop to be cured for winter use. In cutting it for hay it must not be allowed to get too ripe. If the peas are hard the cows do not like them so well. The cured hay is nearly equal to good clover hay as winter roughage.

When farmers get a larger crop of hay from this mixture than they can from common grasses, they should not depend upon timothy and red top so much in dairy sections. Aside from the yield, we must remember also that the quality of the hay is much better than timothy, for it contains two or three times as much protein or milk-producing substance.

There is always a greater yield of oats per acre because of the presence of the Canada peas. A field sown with three bushels per acre, half peas and half oats, will yield more oats than if the sowing were all oats. This is because the peas gather nitrogen for the two, getting it from the air.

**A Good Grain Mixture.**—If the crop should be ripened and threshed, the grain may be all ground together. This produces an excellent balanced grain ration for the dairy cow. Why should dairymen not produce more of their own grain at home in this very way? Oats alone seldom pay for the cost of raising them in the East, but when raised in this mixture they will pay well, providing we have a mill near by where the grinding can be done. Swine and poultry thrive on this grain mixture.

**Forage for Midsummer.**—The foregoing are chiefly very early crops. Other special crops may be grown which will be ready to feed to stock at a time near midsummer when pastures are apt to be too dry to give the stock enough feed. Some such crops were mentioned in the earlier part of this chapter. As we have already seen, this system of green feeding is called the *soiling system*. Now let us consider the matter of growing such forage crops as will be ready to feed green during the dry season. We can then combine the *pasture system* with the *soiling system*—called *partial soiling*.

**Corn for Green Forage.**—Early sweet corn may be ready for July use. The ears may be used for market and the forage fed to stock. Early flint corn would come along just after it. Next the dent field corn would be fit to use. This would last until frost.

Several plantings of sweet and dent corn may be made through May and June, the later plantings being ready later. It is best to not use these early plantings of corn before they are in the roasting-ear or milk stage. In that condition corn has a good supply of nourishment, but it grows richer as it grows older.



FIG. 51.—Black-hulled white kaffir, much grown in dry climates to use in place of corn. (Experiment Station, Kans.)

**Substitutes for Corn.**—Kaffir (Fig. 51) and sorghum are both good substitutes for field corn and have the advantage of being suitable to feed green at almost any stage in their growth, because they are a little more fibrous. Both sorghum and kaffir make rapid growth in warm weather on good soil.

**The Legume Family.**—This is a family of plants of great value to agriculture. The legume family is often called the

clover or pea family, after prominent members of the group. Other common plants included in it are beans, lentils, locust trees, alfalfa, vetches, lupins, cow peas, and soy beans.

The growth of characteristic one-sided blossoms and the formation of seed in a pod are distinguishing features of the members of this family.

They have power, under proper conditions, of taking free nitrogen from the air for their own use in growing. They have nodules on their roots which are the homes of special kinds of helpful bacteria. It is when these bacteria are present that the plants can use the nitrogen from the air. None but members of this family are thus able to use the free nitrogen. But when the stubble and roots of the legumes decay they leave nitrogen in the soil in a form which other kinds of crops can use. As nitrogen is the most expensive element in purchased fertilizers, farmers should use members of this family often in the rotation courses to secure nitrogen in the soil for all crops. (Page 87.)

**EXERCISE.**—*To Become Acquainted with Some Legumes.*—The members of the class should bring samples of different clovers, alfalfa, vetch (wild pea), beans, peas, or other legumes. If possible, examine the pods of seed in the heads of clover and on other plants. Note also the one-sided appearance of the blossoms on all of them. The clover heads are composed of many blossoms.

**EXERCISE.**—*Nodules on Clover Roots.*—Have some of the older pupils dig up roots of clover, alfalfa, or other legumes. Wash them and find the nodules or lumps, the size of a pin-head or larger. These are the homes of many bacteria which aid the clover plants in getting nitrogen. Save the best samples obtained in this exercise by placing them in a bottle of water with a small amount (2 per cent) of formalin added to it. (See Figs. 52 and 55a.)

**Legumes for Summer Forage.**—Farmers should give some attention to the growing of several legume crops and

mixed crops for use when pastures are dry in summer, and also for winter forage.

There are two summer, or hot weather, legumes which should always find a place in the rotations on a dairy farm. Cow peas (Fig. 53) and soy beans have both been tried so often that their use is no longer an experiment.

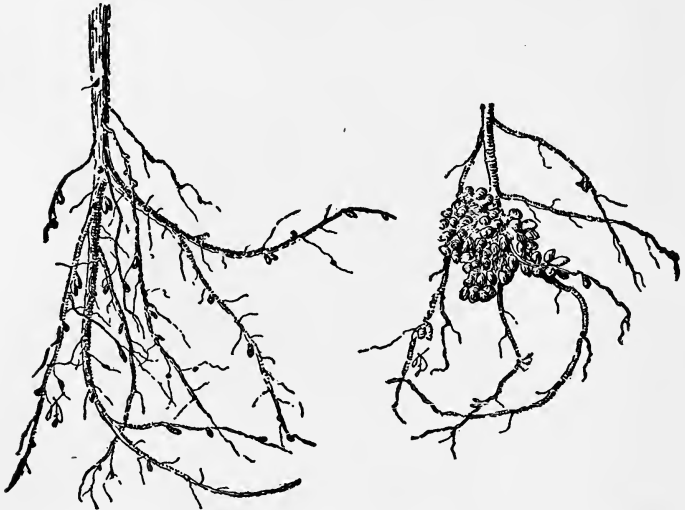


FIG. 52.—Alsike-clover roots (on left) and garden-pea roots (on right). Useful bacteria live in these nodules and enable the plants to use nitrogen from the air which they otherwise could not do.

They have many advantages: Quick, dense growth if sown in warm weather; a big supply of green forage to feed when pastures are dry; very good for hay if cut and cured in dry weather; ten to twelve per cent of *protein* in the cured crop; a very high content of protein in the ripened seed, especially of soy beans; a big supply of nitrogen and green manure for the improvement of the soil if the crop is turned under, or even if the stubble and roots only are worked in; and the deep roots are a great physical help in most soils.

In a warm spring it is safe to sow cow peas early in June, and the quick-growing varieties will be ready to begin feeding green by the middle of July. Six or seven pecks of seed per acre are sown. By a succession of sowings of two or three



FIG. 53.—Cow peas grown in hot weather in eight weeks. They produce good green feed or green manure. (Experiment Station, N. J.)

varieties we can give the cows fresh green forage every day from early July until frost time.

**Cow=Pea Mixtures.**—A larger yield to the acre can be produced by mixing cow peas or soy beans with other crops. We must choose a crop that does best in the hot weather,

such as barnyard millet, pearl millet, sorghum, kaffir, or even common field corn. These all serve as nurse crops and allow the use of taller climbing varieties of cow peas. Under most conditions the mixtures are better for the dairy farmer than the cow peas alone. The mixtures usually cure better if any is left to cut for hay. Splendid winter forage is thus produced.

**The True Clovers.**—The most important clovers of the Northern States are white or Dutch clover, red clover, alsike or Swedish clover, and crimson or scarlet clover. The clovers are the most popular forage plants of the legume family.

*White clover* is a low trailing perennial plant with white blossom heads. It is too low to be useful for hay, but is abundantly grown in pastures.

*Red clover* is more commonly grown for hay in the North and East than any other legume. It lives about two years. There are two varieties—the common or medium and the mammoth or sapling clover. The latter is coarser and taller and blossoms later. They are both often mixed with timothy for hay purposes. Red clover, if grown alone, will usually produce two crops of hay the year after sowing. The second growth may be saved for seed production, as the bumble-bees, which carry the pollen from blossom to blossom, are more abundant during the latter part of the summer.

*Alsike clover* is more slender and shorter than red clover. It is a short-lived perennial, but it re-seeds itself in the field somewhat. The blossoms are shorter and smaller, so that common honey-bees will work in them and carry the pollen. Thus seeds may be formed in the first crop in June. The hay made from alsike clover is finer and better, but the yield is lighter than red clover. These two clovers are often mixed together and with timothy for hay.

*Crimson clover* is an annual plant which is hardy enough to live over winter as far north as the fortieth parallel of



latitude or farther north where soils are favorable (Fig. 48). It is chiefly used as a winter cover crop after early potatoes or sown in cornfields in July to grow until spring. The following spring it may be plowed under as a green manure or it may be pastured or used for green forage.

**Methods of Starting Clover.**—There are three methods of starting red clover.

Probably the most common way is to sow the seed in early spring in a field of grain sown the fall before; or with spring grain sown at the same time. After the grain is off in summer the clover soon begins to show.

Second, red clover is often given a better start by seeding alone in August or early September, just as for the summer seeding of timothy alone. This plan has the advantage of an extra plowing of the ground after the early crop has been harvested. Weeds are removed and weed-seed sprouted and killed. Lime is applied to a better purpose at that time after the fine seed bed is prepared.

A third way is to seed the red clover in the cornfield in August just as crimson clover often is seeded with the last cultivation of the corn. After the corn is cut a stubble cutter is used so the field may be in suitable condition for the use of the mower next season. This rotation and method of seeding is less common, and for several reasons less desirable.

Too many farmers allow their hayfields to stand three or more years. In such cases the clover plants die and other grasses, such as timothy and red top, and weeds fill the field. This is a bad mistake if dairy feed is wanted. Too often dairymen are trying to get milk from the feeding of timothy hay. Such grasses usually make only one good cutting a year, with a little aftermath. The clovers are twice as rich in protein, and two good cuttings may be made. Furthermore, quicker rotations are better for the soil.

**When to Cut for Hay.**—Red clover for hay should be cut early. Do not wait until its heads are a third brown. A

better time is when the heads are just beginning to turn brown. This will make hay which has more protein in it and the cows like it better if it is cut early.

**Permanent Pastures.**—A permanent pasture is a field which is used as a pasture each summer and does not enter into any systematic rotation. In some instances the field is used for such a pasture because of the rough surface making it untillable. It may be too steep or hilly, or too stony, or have too many stumps, or be too low and wet for cultivated crops. In some of these places pastures may be very good if properly maintained.



FIG. 54.—Dump hay-rake used in raking hay into windrows. (Plant Industry.)

In still other instances we find permanent pastures on the very best soil and over tillable areas.

**Good Pasture Plants.**—Low white clover, Kentucky blue grass, and timothy are the most popular and best plants for pastures where the climate is moist and cool. There are many other grasses which we often find growing with these, such as red top, meadow fescue, orchard grass, and Canada blue grass. A variety of grasses is best because of the different kinds of seasons, and variations in soils. For example,

shallow-rooted plants like wet soils better than the deeper-rooted plants do; some stand drought better than others; some kinds require more lime in the soil than others.

**Bad Conditions in Pastures.**—Too often the permanent pasture is a field of weeds with very little grass to be found most of the summer. The conditions grow worse each year. Little feed is supplied to the cows pasturing there; milk is made bitter and given other bad flavors by garlic, wild onions, and other weeds, eaten by the animals. The number of acres used for the pasture often fools the dairyman into the thought that the cows get plenty of feed from it if they want it. Here is where the trouble begins. The cows do get a fair amount of grass for a while in June. But the change comes; the dry weather strikes it; the grasses are shallow rooted; the result is dead grass. The blossom and seeding time for early grasses comes; this also means death.

**How to Keep Good Pastures.**—The pasture should be filled with good stands of mixed grasses. The farmer should maintain the pasturage to the best of his ability. Certain amendments or improvements are needed from time to time—such as fertilizing, liming, re-seeding, harrowing, mowing, and using a few sheep in the pasture with the cows.

**Fertilizers and manures**, particularly nitrate of soda, may be spread a few weeks before the stock are turned on to the pastures in the spring.

**Lime** should be applied to low meadow land every year or two. Clovers, blue grass, and timothy do much better after the liming.

**Re-seeding** is a good practice. More seed should be sown wherever the grasses are not so thick as they should be. A good time for this is very early in the spring. The thicker we make the grass the less room there is for weeds.

**Harrowing** is quite possible on many parts of most pastures. A number of harrowings each spring will pay well.

**Mowing** the pasture twice each year will help to check

the growth of weeds and will prevent many of them from seeding. It also helps the growth of all grasses. The cutting should be made high, as a low cutting destroys too much of the valuable leaf growth of the lower grasses. In a pasture, the tall weeds and tall grasses that have sent up seed stalks should be mown down. The cows do not like them because they are old and fibrous.

**Sheep** may be used in a very rough pasture along with cows to help keep down the weeds. They have a liking for many kinds of weeds and keep them eaten close to the ground. Too many sheep will eat the grasses so close that cows cannot get enough.

### REVIEW.

1. What do you understand by system or lack of system referred to on the first page of this chapter?
2. After making a farm map, tell whether you think there are too many fields or too few.
3. Eastern farms usually have many more fields than Western farms. Tell of the advantages if any in each case.
4. What are the advantages of having a farm map?
5. What is the soiling system?
6. What are soiling crops?
7. What are some advantages of summer soiling for dairy cows?
8. Why is there need for it in connection with the pasture system?
9. Name some of the crops for spring and early summer soiling.
10. Name some better suited to growth in hot summer.
11. Mention three uses of oats-and-peas.
12. At what stage should this crop be cut to cure for hay?
13. When may soy beans and cow peas be sown?
14. What are some reasons in their favor?
15. Give a list of common plants belonging to the legume family.
16. Give two characteristics of this family.
17. How does the growth of legumes in a field aid the soil?
18. Why should a farmer use legumes in a rotation with other crops?
19. What does the absence of nodules from the roots of clover tell the farmer?
20. Name four kinds of clover and give the length of life of each.
21. What is the chief use of white clover?
22. Which two clovers are most commonly cut for hay?
23. Tell of the two varieties of red clover.
24. What bees pollinate red clover? What bees pollinate alsike clover?
25. Of what special use is crimson clover?
26. Which of the three methods described for starting red clover is considered the best?

27. At what stage should red clover be cut for hay?
28. In what kinds of fields are permanent pastures often found?
29. Name the plants to be grown in the best pastures.
30. Mention some of the bad conditions associated with permanent pastures.
31. Tell of five things to help maintain permanent pastures.

**References.**—U. S. Farmers' Bulletins: 289, 969, Beans; 962, Velvet Beans; 886, 931, 973, Soybeans; 660, Weeds; 797, 820, 836, 1005; Sweet Clover; 677, Market Hay, 535, 567, 568, Sugar Beets; 669, Flax; 676, Clover Seed; 724, Sorghum Grain; 690, Field Pea; 693, Bur Clover; 726, Natal Grass; 730, Button Clover; 455, 579, 971, 1142, 1151, Clovers.

---

## CHAPTER XI.

### ALFALFA.

**ALFALFA** is the best milk-producing crop we can grow. It may be used either for green feed or for hay, but in the East it is best not to pasture it. It is so rich in protein that a ton of the dry hay is equal to a ton of bran for dairy cows. It produces heavy yields; the farmer may expect from four to five or even six or seven tons of cured hay each season from an acre.

**Alfalfa as Green Feed.**—As a green feed there is nothing that will excel it. Alfalfa reproduces itself frequently and constantly throughout the summer, by a quick new growth each time it is cut. A good stand of alfalfa on four or five acres will supply all the green feed needed for a herd of twenty-five cows from the latter part of May until the middle of September. A little is cut at a time so as to keep it always rather fresh for the cows. By the time the entire field is thus fed off, the side of the field first cut is again ready for cutting.

**A Soil Improver.**—There is one more strong argument in favor of alfalfa growing, viz., it is a soil improver. The roots reach down deep and recover lost minerals such as potash and phosphoric acid. The plant is a great feeder on nitrogen

from the air. The store of nitrogen in the roots and stubble, when plowed under, will help produce large corn or other crops on that field afterwards.

**Sprouting Weed Seeds.**—An early field of oats-and-peas should be grown in the spring and the stubble plowed under in June or as soon as the crop is all off. The ground is harrowed about once a week until the middle of August. This makes a good alfalfa seed bed; it controls the soil moisture, and also causes the weeds to sprout and be killed by the harrow. Now if we select alfalfa seed that is free from weed seed, we will have very little or no trouble from weeds in the alfalfa field later on. The seed should be examined with a good reading glass before sowing.

**Inoculation of Soils.**—As alfalfa requires its own bacteria in the soil where it is growing, the grower should get four or five hundred pounds of soil from the nearest alfalfa field and spread it on each acre of the new field. Do this when the sun is not shining so the bacteria will not be killed. It should be harrowed in immediately. These germs in the new soil will be ready to help the young plants as soon as they start to grow (see figure 55a). New alfalfa fields require inoculation before sowing the seed, except in a few parts of the country where certain wild legumes like sweet clover have used the same kind of bacteria.

**Liming the Field.**—Alfalfa is a great lover of lime. It is best to plow the field and apply at least a ton of fine lime to each acre not long before seeding. If some lime was put on that field in early spring before the oats-and-peas so much the better.

**The Seeding of Alfalfa.**—We should be all ready to do the alfalfa seeding by the time the first August rains moisten the ground enough to sprout seeds well.

Half a bushel of seed, or thirty pounds, is abundant for one acre. Half of it can be sown the long way of the field and then the last half put in cross-wise of that. In sections

where alfalfa is seeded in the spring, it is sown very early, and often with oats.

**Good Drainage.**—The field selected for alfalfa should be well drained and no water should stand near the surface. The roots naturally run down very deep (Fig. 55a), and they cannot stand free water at all. A field rich enough and well enough drained to produce good corn or oats will do for alfalfa. A small application of fertilizer will help to start the crop off well.

a

b



FIG. 55a.—Nodules or tubercles on alfalfa, showing the characteristic location on fine fibrous roots.

FIG. 55b.—First growth of alfalfa. Three feet tall. Note the leafy character and fine quality of hay it will make.

**Cut Four Times a Year.**—Do not cut the crop the first fall but allow it to stand until the next May or June before the first cutting is made. That season and each following year the crop should be cut four times (Fig. 56). There are two signs to follow in deciding when to cut any growth of alfalfa. First, never let it get too far along in the blossom stage. Cut it when the blossoms are just showing a little over the field. The second indication of the cutting stage is the slight starting of the buds on the sides of the stems at the surface of the ground. The new growth starting from those buds means that the crop must be cut and removed

very quickly, otherwise the new growth would be much injured. If, at any time, a yellow appearance or any spots on the leaves should be seen, the crop should be cut. The last cutting should be made in September so as to give time for a new growth to start before winter sets in. This will help to prevent winter injury.



FIG. 56.—A. Hay-caps are often used in curing the first cuttings of alfalfa in humid climates. (Experiment Station, N. J.)  
B. Loading alfalfa by hand power.

**Curing Alfalfa Hay.**—It is sometimes quite difficult to cure the earliest cutting because of the rains late in May and early in June. Alfalfa is very much injured if wet by rain after it is cut. We must keep it dry during the curing process (Fig. 56, A). The sap in the stems does not do so much injury; so it may be put in the barn with more of its own



moisture than almost any other hay crop. If allowed to get too dry before hauling in it will lose many leaves, and



**FIG. 57.**—Push power sweep rake used in taking hay to a stack in the field. (Plant Industry.)

they are the best part of the crop. With a little care alfalfa can be cured in perfect condition, because the time required for curing is not long (Figs. 57, 58).



**FIG. 58.**—Hay-stacking machine. The hay is taken from the sweep rake (Fig. 57) and lifted to the stack by horse-power. Notice the horses at the end of the rope. (Plant Industry.)

**Eleven Alfalfa Rules.**—For the sake of brevity let us summarize the chief points in alfalfa management. The following eleven rules are quite comprehensive:

1. *Lime the soil* by applying about one ton of lime per acre just before sowing the seed.

2. *Inoculate* the new alfalfa field by spreading and harrowing in about five hundred pounds per acre of good soil from an old alfalfa field when the sun is not shining.

3. Have the soil as *free from weed seed* as possible by using a bare fallow for a few weeks before seeding.

4. Be sure that the alfalfa seed is perfectly *pure* and free from weed seeds.

5. Use *plenty of seed*, about thirty pounds per acre, sowing it both length-wise and cross-wise of the field.

6. Use good *fertile soil* and apply some high-grade fertilizer about the time of sowing the seed.

7. Always select a *well-drained field* for alfalfa.

8. *Cut the crop often*—about four times a year, beginning with the spring following the August sowing.

9. *Cure the hay carefully* to avoid shattering of the leaves and to avoid its getting wet with rain.

10. Do *not* use the field for *pasture*, particularly while it is young.

11. Harrow stubble after cutting.

## REVIEW.

1. Give several arguments in favor of growing alfalfa.

2. Tell of the use of alfalfa as a green dairy feed.

3. In what ways does alfalfa improve the soil where it is grown?

4. Give three benefits of a few weeks of bare fallowing before the August seeding of alfalfa.

5. Tell how a new alfalfa field may be inoculated with the bacteria which the plants need.

6. How much lime should be spread, and when?

7. Give time, amount, and manner of seeding alfalfa.

8. Which is better for alfalfa, upland or lowland? Why?

9. Tell of two things which indicate when to cut alfalfa for hay.

10. Tell one difficulty in curing alfalfa hay; and mention one advantage over other kinds of hay, in its curing.

11. Give briefly the points covered by the eleven alfalfa rules.

References.—U. S. Farmers' Bulletins: 339, 757, 865, 1021, Alfalfa; 636, 944, 982, 1185, Alfalfa Insects; 838, 943, 956, 977, 987, 1009, 1049, Haymaking. Ark. Ext. Circ. 91, Stacking; 137, Alfalfa.

## CHAPTER XII.

## COTTON PRODUCTION.

THE cotton plant was cultivated in the Old World in the earliest historic times. It probably originated in India or China. The ancients of India wove the fiber into very good cloth. Alexander the Great introduced the plant into Europe. Cotton was also grown by the natives of Mexico and South America before the discovery of the New World by Columbus.

To Virginia belongs the credit of first starting the cultivation of cotton in the American Colonies. This was in 1621. After that it rapidly became a leading money crop of the farmers of the South. The labor of removing the lint from the seeds greatly reduced the profit from this crop for many years. It was a day's labor to separate the seeds from one pound of cotton. But in 1792 the cotton gin was invented by Eli Whitney. This machine, as improved later, greatly increased the profits of cotton raising.

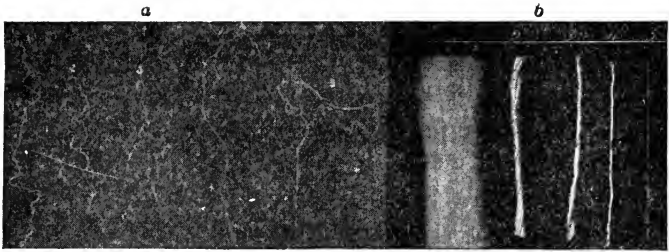
**Importance of the American Cotton Crop.**—Cotton is far the most important fiber crop of the world. Twelve Southern States now supply more than two-thirds of the cotton of the world. All nations make clothing from American cotton. We sell more cotton to other countries than all other agricultural products combined.

Other countries producing large amounts of cotton are British India, Egypt, Russia, China, Brazil, Mexico, Peru, Turkey and Persia. But all of these combined produce only one-half as much cotton as is grown in the United States.

The ten leading States in the production of cotton are in the following order: Texas, Georgia, Mississippi, Alabama, South Carolina, Arkansas, Oklahoma, North Carolina, Louisiana and Tennessee.

**Uses of Cotton.**—The fibers of the commonest cotton are only about one inch long, but they become very much

twisted as they ripen (Fig. 59a). This twist causes them to cling together well to form thread when put through the spinning process (Fig. 59b). The thread may then be woven



Courtesy of Johnson & Johnson.

FIG. 59a.—Individual fibers of long-staple or Sea Island cotton. The lengths of the five are about equal. The ripest are very kinky. (After Brooks.)

FIG. 59b.—Slivers or hanks of cotton in different steps of making thread or yarn. The factory names are: 1, drawing hank; 2, slubbing hank; 3, intermediate hank; 4, roving hank; 5, yarn or thread.

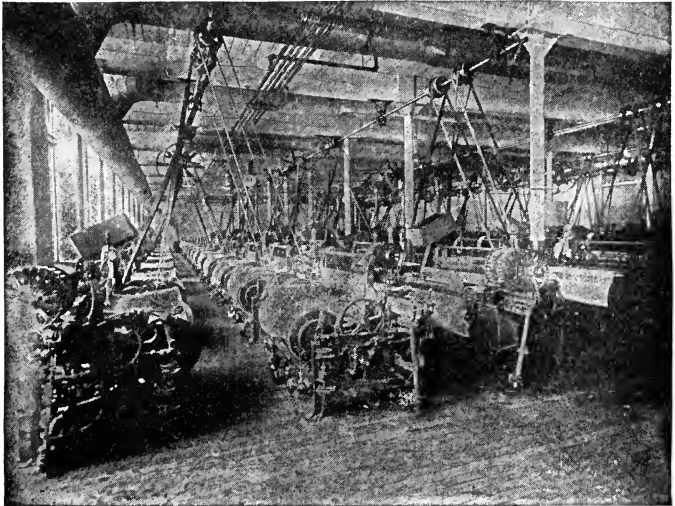


FIG. 60.—Modern looms, all weaving white cotton cloth. One person can operate twelve to sixteen such looms at a time. Each machine makes seven square yards of cloth per hour, using 3,024 yards of yarn to each yard of cloth.

into cloth (Fig. 60), or formed into rope. The longest fibers of lint are desirable for use in making sewing thread, and in mixing with the shorter fibers in certain grades of cloth.

**Exercise.**—Examine the fibers of cotton from a cotton boll or from a roll of cotton. Notice how minute they are when seen separately. Try twisting a few of the fibers together to form a thread. Pull them along as you twist them and they will gather up more fibers from the pile of cotton.

**The Cotton's Relatives.**—The cotton plant belongs to the same family of plants as the hollyhocks, okra, althea, mallow weed, and many others. The group is called the mallow family.

**Types of Cotton.**—There are several different types or kinds of cotton. Those grown in the United States are all annual, that is, they are all killed by freezing in the fall; but in tropical countries they live for many years. Even here the plants sprout up from the old root after a mild winter.

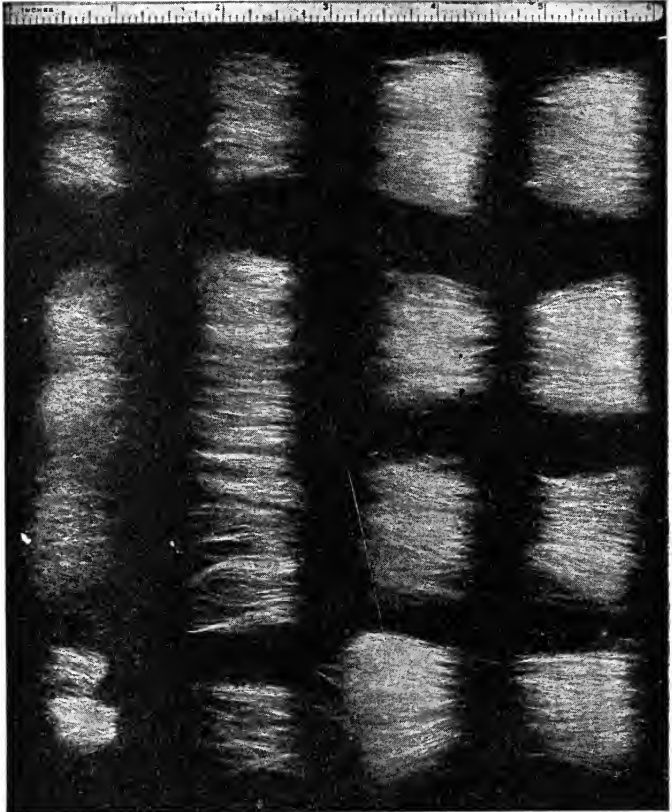
Cotton grown in this country is chiefly of three kinds: (1) Common or Short-staple upland cotton, (2) Long-staple upland cotton, and (3) Sea Island cotton (Fig. 59a). Important kinds grown elsewhere are (1) India cotton, with very short staple, (2) true Peruvian or Egyptian cotton, with long staple, usually brownish in color.

**American Upland Cotton.**—As shown above, the upland cotton is of two kinds, short-staple and long-staple. Together these make up all of the American cotton crop, except the Sea Island cotton, grown in small amounts, chiefly near the Atlantic and Gulf coasts.

Short-staple differs from long-staple cotton in length of the lint which surrounds the seeds. Short-staple is from  $\frac{3}{4}$  to  $1\frac{1}{8}$  inches long (Fig. 61), and long-staple is usually  $1\frac{1}{4}$  to  $1\frac{1}{2}$  inches long. These varieties may also differ in other ways. The long-staple plants are taller, later in maturing and have slender, pointed bolls, with less lint. But the long-staple sells for a higher price.

**Sea Island Cotton.**—This gets its name from the fact that it originated in the West India Islands. It grows well on the islands and mainland within one hundred miles of the coast. Georgia, South Carolina and Florida are increas-

ing the growth of the Sea Island cotton. The price of this type of cotton is high because of the great value of such long fibers in making spool cotton for sewing. This plant grows rather taller than upland cotton, has long, flexible branches;



Courtesy of Johnson & Johnson, New Brunswick, N. J.

FIG. 61.—Four grades of lint, showing length of fiber, from samples of short-staple upland cotton. The relative amounts are also indicated by the masses in the photograph.

the leaves are more deeply lobed; the flowers are yellow instead of white when freshly opened; the staple is longer, and the seeds are free from lint after ginning.

**Improvement of Cotton.**—Cotton growers are able to improve their crops very greatly by the proper selection of varieties and selection of seed from heavy yielding plants.

As usually grown here the plant is either erect or bushy and varies in height from three to eight feet. The length and arrangement of branches are indications of *earliness* and *productiveness*. Cotton itself has other desirable qualities, such as *strength of lint*, *fineness*, and *uniformity of color*. Improvement of cotton is best accomplished by selecting seed from plants with such desirable qualities.

The yields of cotton may be greatly increased by proper fertilizers, good rotations, early planting, securing a good stand of plants and frequent tillage.

**Selecting Seed.**—The grower should select the seed just before or during the second picking, and avoid planting seed from later pickings. Select bolls from thrifty plants with compact growth of branches. The branches should have short nodes or joints and be abundantly supplied with bolls. Always select the largest bolls with long fiber. Avoid picking for seed from any unhealthy plants. Avoid also those bolls where the cotton tends to fall to the ground, as such are not “storm proof.”

If a grower is to purchase cotton seed for planting, he should select such varieties as will best resist disease. Varieties of upland cotton most abundantly planted are Peterkin, Truitt and Russell. In Texas, where the boll-worm and boll-weevil insects are present, Triumph is commonly grown. Other productive varieties suited to special soils or seasons are: King, Cook, Cleveland, Toole, and Layton. The Alabama Experiment Station reports over 200 varieties of cotton grown there.

It is usually best for growers to select their own seed for planting. In every field the plants vary through all degrees from very good to very poor. By carefully selecting as above suggested the next crop can be greatly improved.

**Range of Cotton.**—Cotton needs a long growing season, with six or more months of warm growing weather free from frosts. This condition is found chiefly south of latitude 37°.

It is desirable to have an abundant rainfall evenly distributed through the growing season, but with plenty of sunshine at least during the ripening months.

**Soil.**—Cotton prefers a medium loam, but will thrive in almost any good farm soil if the conditions of temperature and rainfall are favorable. The soil should be deep, as the plant has a tap root and is a deep feeder. If there be a clay subsoil it should be down about two feet from the surface. Good drainage is important, but there should be enough humus present to cause the soil to hold moisture well. When cotton is grown each year on the same field it is well to grow some crop for green manure between the rows of cotton, to be plowed under in the fall or the next spring. Such crops might be cow peas, peanuts, or soy beans. As legumes to grow all winter in the cotton field it is well to use crimson clover, and winter vetch, which may be sown in the cotton field in early fall, or just after the fall plowing (Fig. 48).

On poor sandy soil the rust disease of cotton is worse than on loams or heavy soils. If the soil is too rich, as along some rivers, the cotton plants grow large and coarse without developing much cotton.

**Preparation of Soils.**—Unless there is a winter cover crop growing in the field, it is best to plow the soil for cotton in the fall. This helps to get rid of the boll-worm and boll-weevil, sprouts the waste cotton seed in time to be killed by freezing, and the old stalks are turned under in time to decay and form humus.

When cotton was grown on the field the preceding year, the disposal of the stalks and litter is a serious difficulty. Sometimes they are pulled and burned, but this is bad practice. It is better to beat the stalks to pieces on a frosty day, or drag them down with a heavy iron bar, or cut them to pieces with a stalk cutter made for the purpose. After they are broken or cut to pieces they may be readily plowed under.

The plowing should be thorough and complete, and the deeper the better if no bad soil is brought to the surface by



so doing. If this broadcast plowing is done in the fall, the soil may be plowed up into ridges or beds in the spring ready for planting. The best cotton growers are rapidly adopting this plan of "double preparation" of the soil—first plowing and then ridging. A crop of green manure may be grown on the land after the fall plowing. This is particularly desirable if the soil is very light. Small grains, winter vetch or crimson clover may be used.

The ridges may be formed in spring either with a turning plow or with a disk-harrow if the field has been first plowed in the fall. The plan of forming low ridges or beds with the disk-harrow is better, more rapid and less expensive.

The rows for planting are marked off with a shovel plow and commercial fertilizer is usually distributed in this row. Simple drills are also in use which form the furrow, spread the fertilizer and then draw some soil over it.

**Fertilizers for Cotton.**—The crop of cotton itself is not hard on the soil if the cotton seeds or their equivalent be returned to the field. The cotton seed is fed to stock and the stable manure is returned to the field without much loss in fertility. If the seed is sold, the grower should buy enough fertilizer to take its place. For every 100 pounds of cotton seed sold a return should be made of 3 pounds nitrogen, 1 pound phosphoric acid and 1¼ pounds potash. In addition to this a liberal allowance should be made for losses from the soil by washing and leaching. If green manures are used by growing legumes, the nitrogen supply will be kept up and humus will be formed. Most cotton soils have an abundance of potash; but they respond readily to increased applications of phosphoric acid, increasing the yield of bolls and lint, and forcing earlier ripening. Too much nitrogen may cause a rank, "weedy" growth with little cotton. Too much potash delays the ripening of the crop.

**Planting.**—The distance between cotton rows is 3½ to 4 feet, and 12 to 18 inches are allowed between plants in the row. Allow about 1 to 1½ bushels of seed per acre to insure

a good stand of plants. Planting begins about two weeks later than the date of the last killing frost. March 10th or 15th is often the time for beginning the planting near the Gulf coast; April 1st to 10th near the central latitude of the cotton belt; and early May in the northern limits of cotton growing.

There are several forms of cotton planters which are not expensive. A good machine will drop the seed uniformly in a small furrow and cover it with an inch or two of soil.

**Exercise.**—Let some member of the class write to the U. S. Weather Bureau, at Washington, and get a table or report which will show the dates for the last spring frosts for a number of years past. From this report let the class determine the best date for beginning the planting of cotton.

**Cultivation.**—A weeder or light harrow should be used over the field before planting and also after planting. This broadcast tillage will prevent small weeds from getting started ahead of the cotton plants and will also prevent the soil from becoming crusted. A weeder<sup>o</sup> should also be used over the young cotton plants just before the thinning process begins. This may not be advisable if the stand is thin or the ground very stony or otherwise rough. Thinning of the plants is usually necessary. This is done by chopping out the surplus plants with heavy hoes. It is a good practice to cultivate the individual rows, setting the shovels to throw the soil away from the plants, just before the thinning or chopping begins. Subsequent cultivation should move the soil back toward the plants. The cultivation should be frequent and shallow. It is continued until about time for picking to begin. When the plants completely shade the soil, a crust is not apt to form and further cultivation is not so necessary.

**Harvesting.**—Although several machines have been invented for harvesting cotton, none have come into general use, and the cotton crop is picked by hand. It is the most expensive part of cotton production (Fig. 62). The price paid to pickers varies from 40 to 80 cents per hundred pounds

of seed cotton, or about six to twelve dollars per bale of 500 pounds of cotton. A picker can readily average 200 pounds of seed cotton per day. The fields have to be gone over several times as the bolls do not all ripen at once. The harvesting of cotton runs through September, October and November, and should be finished before December.

The most productive fields will grow more than two bales per acre, and many more fields exceed one bale per acre,



Courtesy of Johnson & Johnson, New Brunswick, N. J.

FIG. 62.—A typical cotton-picking scene.

but in spite of these high yields the average for the cotton belt is only 200 pounds or two-fifths of a bale per acre.

On the United States "demonstration" farms in South Carolina the recent average yield per acre was nearly 600 pounds, while on similar farms in that State the average was less than half as much. The yield in Louisiana, due to the United States "demonstration" methods, was increased from 380 up to 760 pounds per acre. These facts show the value of studying and using better methods in cotton production.

**Problem.**—A man increased his cotton yield from 200 up to 800 pounds per acre by selecting seed properly. The extra cost for such work may be estimated at 75 cents per acre. If he grows 22 acres of cotton, what is his profit due to seed selection, the selling price being 10 cents per

pound? (Consider the extra work of picking and ginning as balanced by the increased seed yield.)

**Preparation for Market.**—A public ginnery is usually found in any section where cotton is raised. The seed cotton is hauled from the field to the cotton gin. The suction pipes lift it from the wagons and take it to the gin stand, where it is taken over fine-toothed revolving circular saws. These saws separate the lint from the seeds, which are kept from passing along over the revolving saws by means of long stationary teeth or combs. The seeds may be stored in a seed room of the ginnery or may be returned directly to the grower's wagon. The white lint (Fig. 63) is carried by the machine into a large hydraulic press, where it is covered with coarse bagging and bound by iron bands into bales of about 500 pounds each (Fig. 64).

Baled cotton is too often exposed for months without shelter from the weather. This may darken and weaken the outer layers and reduce the selling price of it all.

Most cotton intended for shipment a long distance is put through a compressor to reduce the size of the bales.

**Market Grades of Cotton.**—The price paid for cotton at any time is governed by the grade or quality. The grade is determined by samples taken from the bales. When a grower sells his cotton, the buyer usually does the grading. The seven principal market grades of cotton in order of value are: (1) fair; (2) middle fair; (3) good middling; (4) middling; (5) low middling; (6) good ordinary; and (7) ordinary. There are sub-divisions of these principal grades which are designated by prefixing such terms as "strict," "fully," or "barely." Most of our American cotton is poorer than middling fair, and grades as high or higher than middling.

**By-products of Cotton.**—The chief by-product of the cotton crop is cottonseed. This is now used for several purposes. The hulls are removed by machinery. Oil is extracted from the kernels by cooking and pressing. Cotton oil is used in making salad oils, cottolene, oleomargarine,



Courtesy Johnson & Johnson.

FIG. 63.—Inside view of ginnery, showing sheet of loose cotton lint as it comes from the cotton gin, just before baling.



Photo. by Russell, Anniston, Ala. Courtesy Johnson & Johnson.

FIG. 64.—A local cotton market in Alabama, showing common form of bales. The cotton is too often thus exposed to weather without shelter for several months.

soaps, and other articles. The remaining part of the seed after pressing out the oil is ground into cottonseed meal and used for stock feed, particularly for dairy cows. (See composition in Appendix Table VIII.) It is also used as a fertilizer as it is so rich in nitrogen. The hulls are also used for stock feed and fertilizer.

In ginning the cotton for one bale, nearly 1000 pounds of seed are obtained. This amount of seed at the oil mill will produce about the following numbers of pounds: Oil 150; cottonseed hulls 400; cottonseed meal 375; linters, trash, and dirt 75.

The fibers of the stems and branches of the cotton plant are sometimes used in the manufacture of coarse grades of bagging.

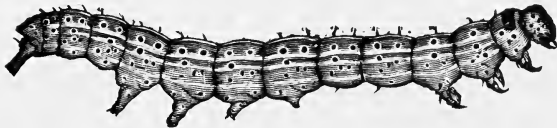
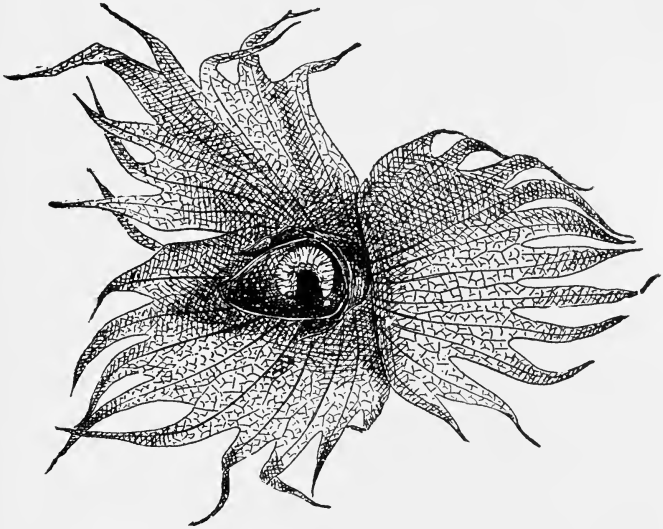
**Diseases of Cotton.**—Cotton wilt, cotton rust and cotton root-knot are the most common diseases likely to affect the crop if it is grown year after year on the same soil. If a good rotation of crops is kept up as with corn, wheat, and legumes, there is little danger from disease.

**Insect Enemies.**—The cotton plant is not seriously affected with insects except in the squares and bolls. Two insects do most of this damage, the boll-weevil and the boll-worm.

The Mexican boll-weevil has now spread over the southeastern and central parts of Texas, much of Louisiana and the adjacent portions of Mississippi, Arkansas and Oklahoma. The area is increasing rapidly. In those sections only such farmers as practice the best methods of cotton culture are able to continue raising the crop successfully. As this insect spreads over the cotton belt it causes much change in the methods of growing the crop.

When the insect appears in early summer, it first attacks the buds and the flower leaves, called "squares" (Fig. 65a). These soon fall to the ground. The earliest buds may escape the injury and develop bolls and cotton.

There are several methods of preventing damage from boll-weevil:



Smith's Economic Entomology.

FIG. 65a.—Cotton square, showing boll-weevil in position. Natural size.  
(After Hunter.)

FIG. 65b.—Cotton-worm from side and above.

1. By forcing the cotton crop to early maturity much of the loss due to weevils is overcome. The grower should

*force his crop to set many bolls before weevils are abundant.* Only the late buds will then receive the attack of the enemy.

Forcing is done in several ways:

- (a) Prepare the soil thoroughly and early.
- (b) Plant early and use enough seed for a good stand of plants.
- (c) Cultivate often during the growing season.
- (d) Grow varieties which set bolls early.
- (e) Select seed from early fruiting plants.
- (f) Apply phosphoric acid fertilizer liberally.

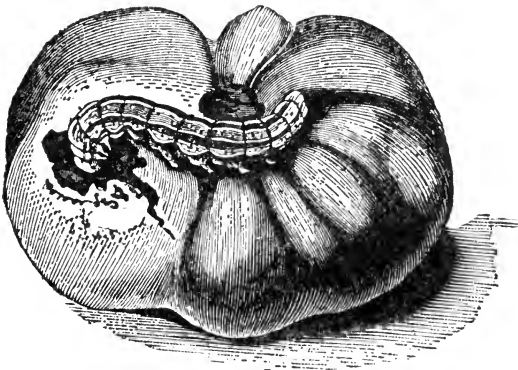
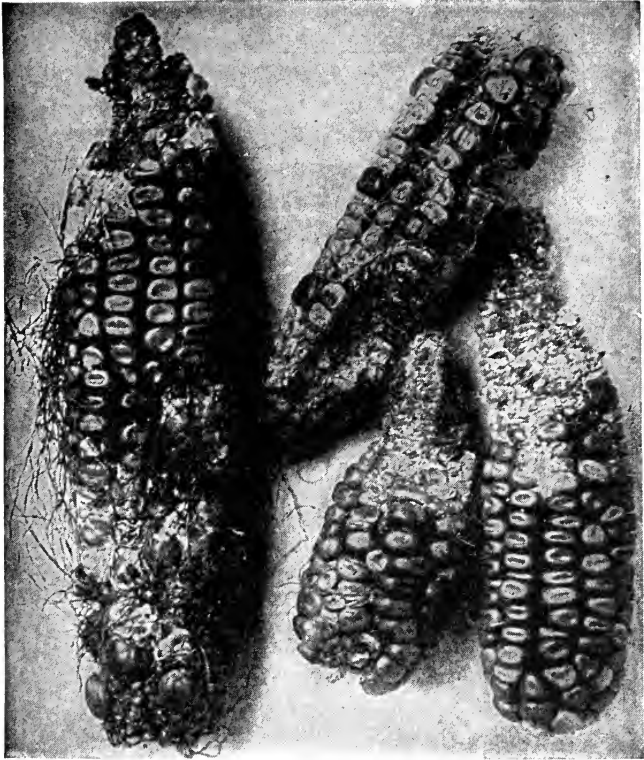
2. Pick the cotton crop as early as may be, and immediately destroy the entire field of plants for the purpose of starving the weevils several weeks before cold weather drives them into winter quarters under trash. The prompt destruction of the plants after harvest may be done in either of two ways: (a) cattle may be turned into the field in such numbers as to eat all leaves and young growth, after which the stalks are promptly cut up and plowed under well. (b) The stalks may be pulled and burned.

3. Poisoning the early spring weevils on the growing tips of cotton plants is sometimes tried. For this purpose arsenate of lead is applied in the form of powder at the rate of  $2\frac{1}{2}$  pounds per acre. This must be done before the appearance of the first squares.

4. Buds and squares which fall to the ground from the attacks of weevils should be caused to wilt very soon and thus prevent the further development of the insects which would soon form another brood. The wilting may be hastened by planting the rows far enough apart to let sunshine in freely. The wilting is also increased by dragging the buds and squares to the open sunlight of the "middle." This is done by the use of a special chain cultivator devised for the purpose.

**The boll-worm** (Fig. 65*b*) does not confine its attention to cotton, but prefers young corn and tomatoes (Fig. 66). It is the same insect which we call the corn "ear-worm."





Smith's Economic Entomology.

FIG. 66.—Work of cotton-worm or corn ear-worm, on corn and tomato.

After the nearby corn crops have passed the tender stage of the ears the future broods attack the squares and bolls of the cotton field.

The best remedies are based upon this habit of the insects:

1. Produce an early crop by the methods already suggested. Thus the cotton crop will be too far advanced to be injured when the attacks of the boll-worms begin.

2. Use corn as a trap crop by planting at several different times, either near the cotton field or alternating three rows with every thirty rows of cotton. As the corn passes the tender stage it may be fed to cows, and the young insects thus destroyed (Fig. 66).

3. Plow the fields in the fall to destroy the winter quarters of boll-worms.

### REVIEW.

1. Tell something of the early history of cotton growing.
2. How did the invention of the cotton gin help the cotton industry of the world?
3. Name the leading cotton growing States of America.
4. In what ways are the other States of the Union interested in this great crop?
5. What fraction of the world's crop do we produce?
6. What other countries are important cotton producers?
7. What three types of cotton do we grow?
8. Describe the best climate and best soil for cotton.
9. Give some reasons for plowing cotton fields in the fall.
10. Give other steps in the preparation of soil for cotton planting.
11. Tell of the uses of a weeder on a cotton field.
12. Give distances and methods of planting cotton.
13. Tell all you can about the picking of cotton.
14. How does a cotton gin pick the lint from the seeds?
15. Mention the seven principal market grades of cotton; which three are most commonly produced here?
16. Mention several uses of the different by-products of cotton.
17. What is the best remedy for the cotton diseases mentioned?
18. Where is the Mexican boll-weevil now most destructive?
19. Mention four ways of combating this insect.
20. Mention six ways of forcing an early cotton crop.

**References.**—United States Farmers' Bulletins: 577, 764, 775, 787, 802, 1015, Cotton; 501, 555, 831, 890, 1098, 1187, 1262, Cotton Enemies. Ark. Sta. Bul. 3181, Corn and Cotton; 15, Grading; 44, 49, 166, Varieties; 153, Spacing; 173, Diseases. Ark. Ext. Circ. 84, Club Manual; 92, Marketing.

## CHAPTER XIII

## CORN.

WHEN America was first explored the natives were growing this crop, hence the name Indian corn. The plant was not known in the Old World before that. It has been much improved by breeding and selection since that time.

**Importance.**—It is far the most important field crop now grown in the United States. In money value it is more than double our wheat crop or cotton crop, in the average year. In number of bushels corn is approximately four times as large as any other grain crop of America. Probably three-fourths of the world's corn is grown in the United States. Although the crop is grown to some extent in every state of the Union, the seven "corn belt" states grow from one-half to two-thirds of the crop. These states are Illinois, Iowa, Nebraska, Missouri, Kansas, Indiana, and Ohio.

**The Corn Crop.**—Corn is king and alfalfa is queen. These two crops go together very well. On dairy farms, where these two crops are raised for the stock, we find very little outside feed is purchased. They cut down the feed bills enormously. Too few farmers in the dairy sections are trying alfalfa; and too many farmers are not doing their best even in the corn fields.

Winter is the time to make plans for the corn crop for the following spring. If the seed is not on hand it should be secured and tested for its germinating powers. Winter is a good time to plan the fields and decide how much corn ground will be used for production of green forage, how much for ensilage, if any, and how much for winter fodder and ears.

**Types of Corn.**—The four main types of corn raised in America are pop corn, sweet corn, flint corn, and dent corn. The last two are both spoken of as field corn.

*Flint Corn* has a hard kernel which is short and rounded, with no dent in the top. There are only a few rows of kernels on the cob, eight rows being quite common. Flint corn matures quickly and is often grown where the warm season is short. There are several colors and a number of varieties (Fig. 67, Nos. 4, 10, 12, 14).

*Dent Corn* has a longer kernel with a dent in the crown or top. The ears are large and the yield per acre is greater than with any other type. The many varieties or breeds of

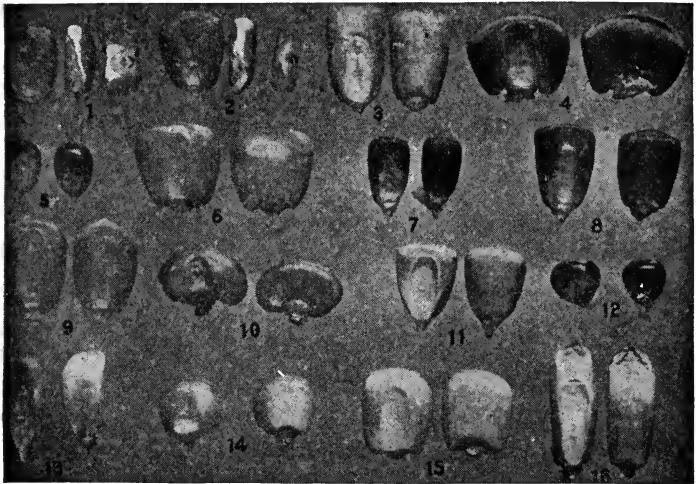


FIG. 67.—Corn kernels of different shapes. Number 3 is one of the best. (Agricultural Education.)

dent corn vary in color, length of season for ripening, shape of kernel, size, shape, and length of ear, character of stalks, and in other ways. White and yellow are the commonest colors. The people in certain sections prefer white varieties, while in others the yellow corn is grown entirely. Corn does not vary in quality because of its color, but when white or yellow meal is preferred in certain markets the millers will buy corn of that color only.

**EXERCISE.**—*Kinds of Corn.*—Have some of the best

samples of the different types of corn brought to school by pupils. The ears should be wrapped in paper to prevent shelling. These may be compared and studied by use of a score card. Save the ears for future use in corn testing.

**Rules for Selecting or Judging Corn.**—Seed corn should always be purchased on the cob if possible. Then we can tell whether the ears are of the type we want, or not. Too often the shelled corn we get comes from ears we would not try to grow if we saw them.

The following explanation of points should be used in selecting corn for seed, and also in judging corn at exhibits.

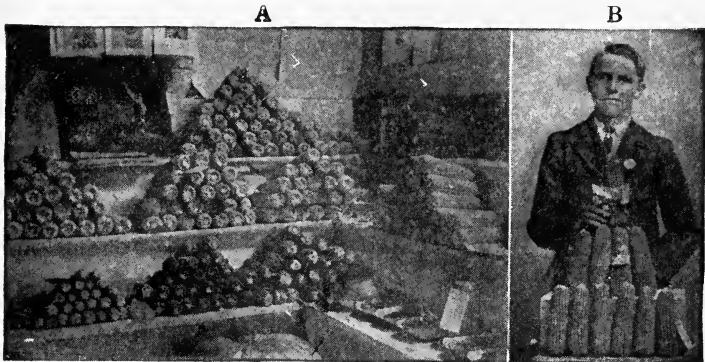


FIG. 68.—A. Exhibit of Boys' Experiment Club in Nebraska. (Agricultural Education.) B. Prize-winning corn and the boy who grew it. (O. B. Martin.)

The corn exhibits may be held at school each winter and the score card used by the students and the judges. Ten ears of corn will constitute a sample.

1. *Trueness to Type or Breed Characteristics.*—All the ears selected should possess similar or like characteristics, and should be true to the variety which they represent (Fig. 68). Two representative kernels should be taken from each ear and placed germ side up in front of the ear and studied in connection with type in the ear.

2. *Shape of Ear.*—In shape the ears should conform to variety type. Each ear should be full and strong in the cen-

tral portion and not taper too rapidly toward the tip. This is indicative of strong constitution and good yield (Fig. 69).

3. *Purity of Ear; (a) Grain.*—In color the kernels should be true to variety and free from mixture. Difference in shade of color, as light or dark red, white or cream color, must be scored according to variety characteristics. *(b) Cob.*—An ear of white corn should have a white cob; yellow corn should have a red cob; if mixed, mark it zero. A mixture reduces the value of the corn for seed purposes, indicates lack of purity.

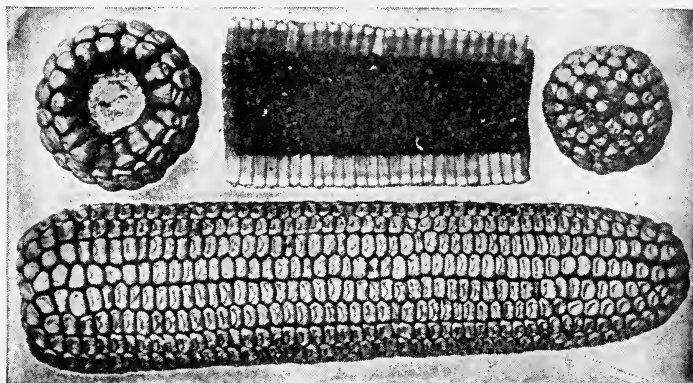


FIG. 69.—Good seed corn. The upper ear shows good even rows with very narrow spaces between rows and between kernels. The tips of the cob should be covered with corn. There is a good deep impression and small stem shown at the left. The kernels are deep as compared with the size of the cob, as shown. (U. S. Farmers' Bulletin 229.)

and tends toward a too wide variation in time of maturity, size, and shape of kernels (Fig. 70).

4. *Vitality or Seed Condition.*—Corn should be in good market condition; show good constitution, and be capable of producing plants of strong, vigorous growth and heavy yield. All indications of freezing or other injury from exposure and all evidences of immaturity show poor vitality. Corn with adhering chaff, or a black tip, caused by the tip cap adhering to the cob, is not in good condition.

5. *Tips* (Fig. 69) should be regular, uniform, and properly proportioned with the body of the ear. The rows should

be well carried out and the kernels conform closely to those in the main body of the ear in shape and size. The proportion to tip covered or filled must be considered. Long pointed tips as well as enlarged or double tips are objectionable.

6. *Butts*.—The rows of kernels (Fig. 69) should extend in regular order over the butt, leaving a deep depression when the stem is removed. Opened and swelled butts, depressed and flat butts with flattened glazed kernels are objectionable.

7. *Kernels*.—(a) The kernels should be uniform in size and shape, making it possible so to grade the corn as to secure

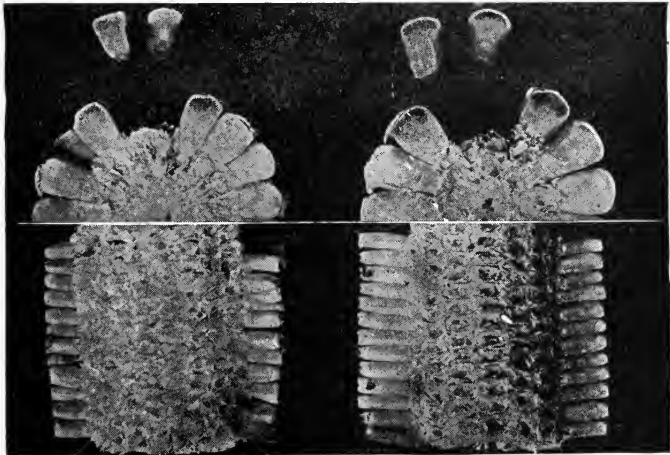


FIG. 70.—Large cob on the left with small layer of corn, Small cob on the right with deep layer of corn.

even dropping by the planting machine. This is essential to securing a good stand. Not only should the kernels be uniform on the individual ear but they should be uniform with all the ears selected. (b) The *shape of kernels* should be such that their edges touch from tip to crown (see Fig. 67, 3). The tip portion of the kernel is rich in protein and oil, and hence of high feeding value. Kernels with large germs insure strong, vigorous growth as well as richness in quality of kernel. Germs should be large, showing strength and high feeding value (Figs. 71, 72).

8. *Length of Ear.*—The length of the ear varies according to variety, type and the characteristics sought by the individual farmer. Uniformity of length is to be sought in a sample, and a sample having even length of ears should score higher than one that varies, even if it is within the limits (Fig. 73). The usual length of ears for the northern section for dent corn is 7 to 9 inches; central section,  $8\frac{1}{2}$  to  $9\frac{1}{2}$  inches; south-

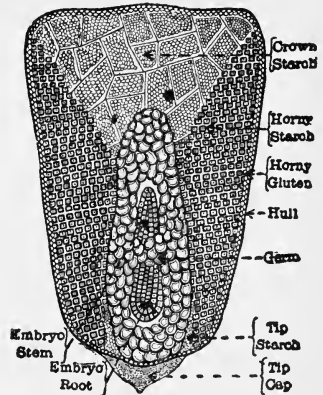
Fig. 71.



Fig. 71.—Sections and surface views of kernels of corn. The three on the right show large germs and have much protein, those on the left small germs and less protein. (Agricultural Education.)

Fig. 72.—Diagram of a section of corn kernel, enlarged, showing the locations of starch, embryo, horny part rich in protein, and the protein layer under the hull. In kernels where the germ is large and the horny part is large toward the tip there is much protein. Such corn makes the best feed and should be selected when choosing seed corn.

Fig. 72.



ern section, 10 to 12 inches. Very long ears are objectionable, as they usually have poor butts and tips, shallow kernels and hence less corn on the cob. Some varieties produce several small ears on each stalk.

9. *Circumference of Ear.*—The circumference of the ear should be in symmetry with its length. An ear too great in circumference for its length is generally slow in maturing, and too frequently results in soft corn. Dimensions for the north-



ern section for dent corn are  $6\frac{1}{2}$  to 7 inches in circumference; central section,  $6\frac{3}{4}$  to  $7\frac{1}{4}$  inches; southern section, 7 to 8 inches. Measure the circumference at one-third the distance from the butt to the tip of the ear.

10. (a) *Furrows Between Rows*.—The furrows between the rows of kernels should be of sufficient size to allow the corn to dry readily, but not so large as to lose in proportion of corn to cob. (b) *Space Between Tips of Kernels at Cob*.—This is very

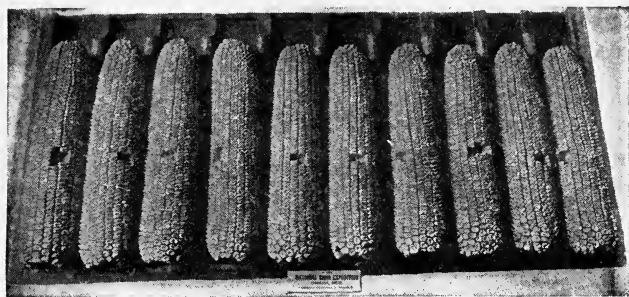


FIG. 73.—Finest corn in the world. These ten ears won a thousand-dollar prize at Omaha in 1908. (Agricultural Education.)

objectionable, as it indicates immaturity, poor constitution, and poor feeding value.

11. *Proportion of Corn to Cob*.—Depth of kernels, size of cob, maturity, furrows and space at cob all affect the proportion. The corn may be selected and judged by those features. But if scales are available the proportion of corn is determined by weight. In determining the proportion of corn to cob, weigh and shell an average ear in the sample. Weigh cob and subtract from weight of ear. This will give weight of corn; divide weight of corn by total weight of ear, which will give per cent of corn. Per cent of corn should be from 86 to 87. For each per cent short of standard, a cut of one and one-half points should be made.

## SCORE CARD FOR CORN JUDGING.

	Perfect Score.
1. Trueness to Type or Breed Characteristics . . . . .	10
2. Shape of Ear . . . . .	10
3. Purity of Ear. (a) Grain . . . . .	5
(b) Cob . . . . .	5
4. Vitality or Seed Conditions . . . . .	15
5. Tips . . . . .	5
6. Butts . . . . .	5
7. Kernels. (a) Uniformity . . . . .	5
(b) Shape . . . . .	10
8. Length of Ear . . . . .	5
9. Circumference of Ear . . . . .	5
10. (a) Furrows Between Rows . . . . .	5
(b) Space Between Tips of Kernels at Cob . . . . .	5
11. Proportion of Corn to Cob . . . . .	10
Total Points . . . . .	100

**Testing Seed Corn.**—No farmer can afford to use corn for seed which is not the best he can get. It should be carefully selected along the lines laid down in the rules given in this chapter. Then it should be subjected to a germination test of the individual ears. Any method that will enable a corn grower to know the percentage of germination of each individual ear of corn can be used to make the test. If you test five kernels taken from different parts of an ear of corn and two of them do not germinate and three do, it is a pretty good indication that sixty per cent of the kernels of the ear will grow and forty per cent will not. This means that four hundred out of a possible one thousand kernels of that ear will fail if planted in the field. The farmer using such corn for seed would get only a sixty per cent stand, which means a very poor crop. He would waste two days out of every five spent in cultivating such a field, because two-fifths of the field would be bare ground.

**How to Test.**—The ears of corn may be tested as clearly shown in Fig. 74. First arrange a germination box; any shallow flat box will do; place in it some clean wet sand or wet sawdust to a depth of about one inch (Fig. 75).

Mark off squares two by two inches with a black lead pencil on white cloth; number these squares 1, 2, 3, etc.; wet the cloth and spread it over the wet sawdust so the numbers are in plain view. Next number all the ears of corn by using

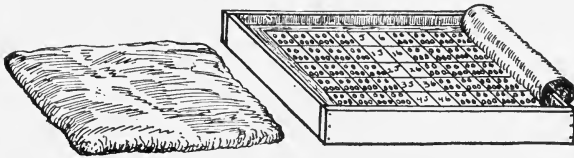


FIG. 74.—A box tester for seed corn. Upon muslin cloth squares are drawn and numbered. On each square are laid five kernels from an ear of the same number. When the tester is filled, the sawdust shown at the left is placed to keep the grain moist.

little squares of paper, which are held to the butt end of the ears with small nails pushed through the numbered papers and then into the cobs. Now take five kernels from different parts of each ear, not using any from near the tip nor butt.

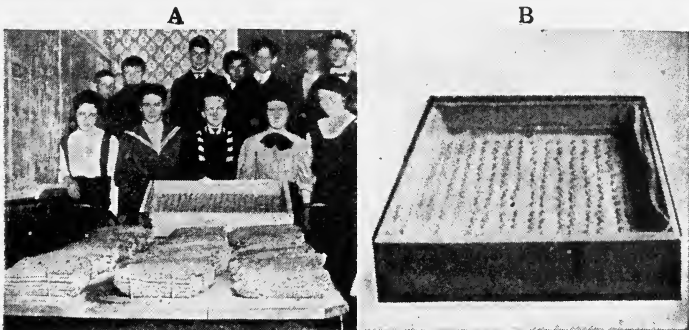


FIG. 75.—A. Testing individual ears of seed corn by the moist cloth method. The tray is ready to be covered with another wet cloth and moist sawdust. B. The tray of corn shown in Fig. A.

Put the five kernels from the first ear on the first square of cloth, and so on for the rest of the ears (Fig. 75). It is well to place the germ sides upward so the sprouts will show well afterwards. Cover the kernels with a plain wet cloth and

spread over it a layer of wet sawdust. Keep the box in a warm room for two weeks or less, keeping it damp all the time.

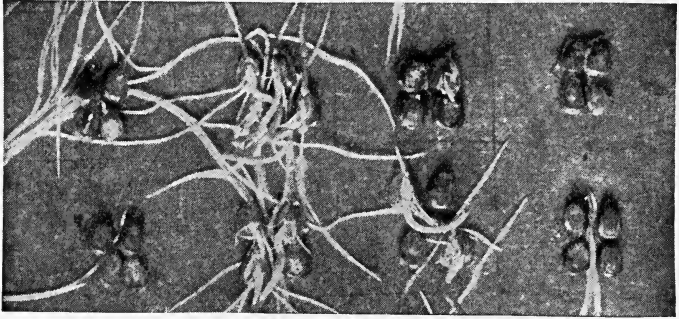


FIG. 76.—Germination test of corn, showing healthy and weak germination. (Agricultural Education.)

**The Results.**—Raise the top cloth and thus remove the upper layer of sawdust. Look over the germination cloth and see what ears fail to give a perfect result. These should be removed and not used for seed (Fig. 76).

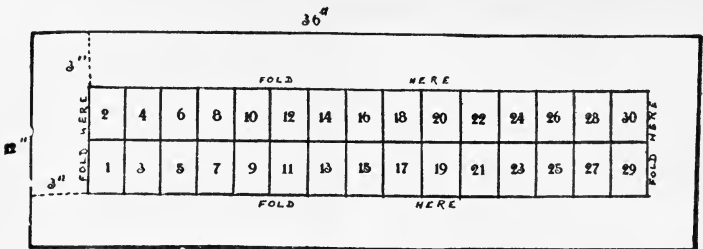


FIG. 76a.—Rag doll tester for individual ears.

**Rag Doll Tester.**—One of the simplest methods of testing corn, or seed of any kind, is to roll it in wet cloth and keep it damp until it has time to germinate.

The individual ears should be numbered before the test. Take a piece of cloth, say 12 by 36 inches. Mark it off in the manner shown in the diagram (Fig. 76a), using a soft black pencil. Take five kernels at random from the first ear to place on space numbered 1. Continue this for the thirty ears

Do not use kernels from the butts and tips of the ears. Fold the cloth edges over the corn to hold it in place. Lay your pencil across the end and roll the cloth up carefully. Put a rubber or string around it and the "doll" is made. In farm practice a number of cloths may be used so as to test enough seed for large fields. The thirty ears on one cloth might be enough for two acres.

Soak the "dolls" in water for about one day. Then remove from the water and place in a covered jar to keep them moist a few days until germination takes place.

Then unroll carefully and examine and decide what ears are low in germination. Write down the percentages for list of numbered ears in your note-book. Then locate and discard the ears that are not good for planting.

#### CORN CULTURE.

**Soil and Fertilizers.**—It hardly pays to try to grow much corn on poor soil. There may be other crops, such as cowpeas or oats, that would thrive on poor soil better than corn. Rather rich medium or heavy loam is admirably adapted to corn growing. If moisture conditions are favorable corn may be grown on a wide variety of soils. The lighter soils may become too dry in the summer, and the undrained muck soils may remain wet and cold in the early part of the growing season. The latter soils may produce heavy growths of stalks and leaves, but fail to mature much sound grain.

Barnyard manure should be applied to uplands for the best growth of corn, as organic matter and nitrogen are very beneficial for the crop. Heavy soils are much improved by plowing under green manure crops and barnyard manure.

**Preparing the Soil.**—The best corn growers insist on the early plowing of the ground for corn, unless it was fall plowed. It should be plowed a month or six weeks before the date of planting. If the ground was in sod, the disc harrow may be used soon after the plow. During the balance of the time the

smoothing harrow should be used every ten days or soon after each heavy rain. This is to prevent the crusting of the ground and the loss of moisture. Each harrowing of the ground helps to keep the moisture in the soil where it will be ready for the roots of the corn next summer when the dry weather sets in.

In regions where the soil is heavy the field should be well stirred up again just before planting, using a spring-tooth harrow, disc harrow or a pulverizer set very deep.



FIG. 77.—Corn planted at different depths to show time required for sprouting and vigor after sprouting. (Agricultural Education.)

**Methods of Planting.**—Corn is usually planted either by hand-power planters or horse-power planters. The depth to plant varies with the quality and moisture of the soil. In a moist clay loam one inch is deep enough; but in a dry, sandy soil three or four inches is better.

**EXERCISE.**—*Depth to Plant Corn.*—Plant corn at several different depths in two kinds of soil, one rather dry and sandy, the other heavy and rather moist

(Fig. 77). These should be in two separate bottles or boxes. In each case, note the time required for the young plants to reach the surface.

**Distances for Planting.**—There are three ways of planting for three different purposes.

If we plan to cut the crop for green forage, to feed in summer when pastures become dry and short, we should drill the corn in rows so the stalks will stand three or four inches apart all along the rows. This plan will produce an immense tonnage of green feed for summer use, but the yield of ears will be light. (See Chap. X.) A southern white variety would be good for this purpose.

If we want the crop to cut in September for winter fodder or ensilage it is well to have the stalks about a foot apart in the

rows. This will result in the greatest total yield of nutrients in the stalks and ears. A good variety for this purpose would be one which would ripen in the region where planted.

The third plan is to have the stalks stand three in a hill and hills three feet apart in the row, with rows four feet apart or a little less. This is the plan followed in the great corn region of the middle West. Usually the hills are in rows both ways for greater ease of cultivation. The so-called hill plan or check-row plan gives the greatest yields of ear corn. These are not real hills, as corn should not be hilled up. There are good local varieties in different sections. These usually prove better for the locality than any other from a distance.

**Planting Dates.**—It is not entirely safe to go by the calendar in deciding when to plant corn. If the soil is prepared early and thoroughly so that the warm air can enter it, the time of planting may be hastened. The crop should not be planted until after the last killing frost is past.

The Year Book of the United States Department of Agriculture gives the following dates for three regions:

Gulf States, March 15 to May 10, and April 5 most general.

Central States, Virginia to Kansas, April 15 to May 25, and May 1 most general.

Northern States, New York to Minnesota, May 10 to June 1, and May 20 most general.

**Tillage.**—As soon as the seed is planted we can use the smoothing harrow and continue to use it after each heavy rain as soon as the soil loses its sticky character. Have no fear of injuring the little corn plants except in the early morning when the plants are too full of moisture, or in very stony fields. If this system of harrowing the corn after it is up is followed, there will be very few weeds to be seen in the field. It is much faster work to harrow the field, taking several rows at a time, than it is to use the cultivator, one row at a time.

When the corn is high enough so the cross-bars of the harrow tend to break off the plants, use a weeder or a fine-toothed cultivator a number of times to keep a fine soil-

mulch on the field. If the weather conditions should be such as to keep the cultivator out of the field too long at a time, the ground will form a crust. Then it will be necessary to make the cultivator teeth go deep enough to break up and pulverize the crust. But when no crust is formed always keep the shovels or teeth quite shallow (Fig. 78).



FIG. 78.—Corn plants half grown, showing the root system. Many small fibrous feeding roots are only a few inches under ground between the rows of corn. Deep cultivation is likely to destroy many of them.

#### Harvesting Seed Corn.—

It pays the farmer well to select his own seed corn. This is best done in the fall, just before frost and before harvesting the main crop. Such ears are selected as have the characters described in the rules given, pages 133–137. Pick out the ones that are most mature; they will be hanging downward. Take them from stalks which bear two or more good ears.

**Storing Seed Corn.**—As soon as the ears are selected and gathered the husks should be entirely removed from them. Store the ears where the moisture will dry out well before winter, and where mice will not attack them. A good way is to tie the ears with cord in such a way that they will not touch each other and suspend each lot from a hook in the ceiling where mice will not bother the corn. Corn may be stored on sheets of finely woven wire netting which is tacked to the bare rafters or joists of a dry room, as a shop or attic. If there are vertical posts in the room, headless nails may be driven part way into the posts; and then the large ends of the ears are slipped over the nails (Fig. 79).

**Harvesting the Main Crop.**—To secure the best return from the corn crop the harvesting should include not only the ears but also the stalks. This should be done as soon as



the ears are nearly ripe, after the kernels are hard. With most all field corn grown in the northern states the growth continues until about the time of the first fall frosts.

There are several plans in use in various sections for the harvesting of the corn crop.

1. The farmer can more nearly secure the entire value of the corn crop by cutting the whole stalks just at the proper time and putting it in the silo. The stalks and ears are run through a cutting machine (Fig. 80), and the finely cut forage is blown or taken by a carrier into a silo. This is called *ensilage*. For the making of good ensilage the corn crop should be well matured, the kernels glazed and well-dented, and the husks partially dried.

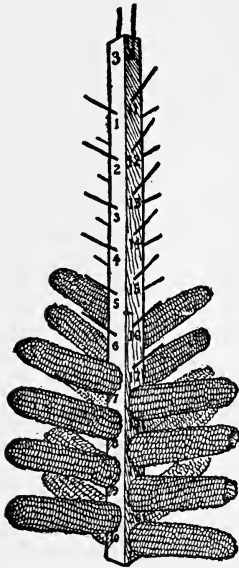


FIG. 79.—Corn-drying rack.

2. In all dairy sections the stalks are usually saved and fed after the ears are removed. This is called *stover*. First the whole crop is cut, by hand or by machines, and put into shocks. This should be done before the leaves become brown and the stalks dry. The shocks are tied very tightly near the top to avoid weathering. Later the ears are husked from

the shock, and the stover is tied in large bundles and stored under shelter. The husked ears are first put in piles on the ground and then hauled to the crib.

3. Husking and shredding machines are often used in some sections. The corn fodder from the shocks, after it is well cured, is run through a machine which husks and snaps off the ears and shreds the stalks. This is one of the best ways to use the whole crop after it is cured.

4. Stripping the blades of corn before the ears are harvested is quite common in some parts of the South. The labor is too great to compensate for the crop of forage thus secured.

5. Topping is a name given to the practice, in some localities, of cutting the stalks just above the ears. This is as much labor as to cut and shock the whole crop.



FIG. 80.—Silo filling. This silo is made from wooden staves and steel hoops, a structure common in the Eastern States. The ears and stalks are cut fine and carried up into the silo by the endless chain.

6. In some sections the ears are husked from the standing stalks late in fall or in winter. This is done by driving through the field with a wagon having a large box, into which the ears of corn are thrown by the men doing the husking. The stalks are wasted, but cattle are sometimes allowed to “pick over” the field and eat the ears that were skipped. A considerable amount of fodder is also eaten by the stock.

7. In some southern sections where the attacks of the grain weevils are bad, it has become the practice to jerk the ears and store them unhusked. The work required to jerk the corn and afterwards husk it is greater than husking from the standing stalks. But most of the jerked corn is fed to stock without husking.

**Ensilage Most Economical.**—The entire feeding value of the corn crop is best saved in silos. The ears, stalks, and leaves, cut up very fine at harvest time, are saved for the feeding of stock in winter or in the dry season of the summer. The product is called silage or ensilage. (See chapter on feeds and feeding.)

**Silos** are often made of staves with steel or wooden hoops. Some are made by standing up studding in the form of a circle and then nailing two layers of half-inch lumber bent around inside, with tar-paper between the layers.

Masonry silos may be made of (1) concrete reinforced with steel rods; (2) brick with reinforcing bands; (3) stone; (4) hollow tile blocks with reinforcing rods or wires.

Metal silos are found in some sections.

In dry climates silos are entirely below ground, and in other regions they are often placed about six feet in the ground and the masonry wall extends one or two feet above the surface for protection of the wooden superstructure.

Silos should be round in form to prevent the silage from spoiling in the corners. The silage is thoroughly tramped, particularly at the edges, at filling time to make it to settle well.

Roofs may or may not be used as desired in cold climates having much snowfall. Rainfall is usually considered beneficial, and water is often run into the silo at filling time if the crop is rather mature.

The capacity of silos increases more with the depth than with the area of the surface. This is because the silage is packed so closely in very deep silos. The following table,

adapted from King, shows the number of tons of mature silage in round silos of different diameters and depths:

*Approximate Capacity of Silos.*

Depth of silo, feet	Inside diameter of silo, feet						
	10	12	14	15	16	18	20
25	36	52	70	81	90	116	143
26	38	55	74	85	97	123	152
27	40	58	78	90	103	130	160
28	42	61	83	95	108	137	169
29	45	64	88	100	114	144	178
30	47	68	93	105	119	151	187
31	49	70	96	110	125	158	195
32	51	73	101	115	131	166	205
36	64	105	130	139	155	190	235
40	75	121	150	165	180	228	279

**Storing the Ears.**—Corn should be stored in a crib with slatted sides to allow the air to circulate freely. The roof should be broad, and rain proof, to keep the corn entirely free from external moisture. Corn should be kept on the cob, at least until it is thoroughly dry, to prevent heating and molding. It is best to protect the crib of corn from mice, rats, and sparrows. For this purpose the floor and sides of the crib are sometimes covered with galvanized wire netting of about one-fourth-inch mesh.

**Storing the Stover.**—Corn stalks intended for feed should not be exposed for a long time to the weather. Corn thus exposed loses much of its feeding value. It is much better to put it under shelter in barns or in sheds. The corn stalks should be thoroughly dried before storing for winter. If the fall weather be very damp, much care must be exercised to prevent the stover from heating in the sheds. When corn stover has been shredded, it is sometimes stored in layers alternating with dry straw.

#### CORN CLUBS

Much interest has been aroused in the improvement of varieties of corn, and in the increased production per acre, through the boys' corn clubs.

**New Standard for Corn.**—In sections of the United

States where the average yield has been comparatively small for many years, the boys have set an entirely new high standard in corn yields per acre. For instance, in Alabama, one boy grew 232.7 bushels per acre in 1913, whereas the average yield for corn in the United States is 30 bushels per acre. These noticeable and startling improvements were made by



Fig. 81.—A prize-winning field of corn in Virginia and the boy who grew it. He used the correct methods. (O. B. Martin, Plant Industry.)

the selection of improved seed, followed by careful and persistent tillage.

**Value of Clubs.**—Other boys, encouraged by such results, are led to exert their best efforts to do as well as this Alabama lad did. By belonging to a club the boys are spurred to greater activities because of wholesome competition. This is a good thing. If farmers could feel some of the same thrilling interest in their work—if all farming had some of the spice of competition in it—there would be fewer run-down farms, fewer tenant farmers, less farming for a bare living, and more and better crop production, as well as happier, more contented people on the farms of our country.

**Organization of Clubs.**—If it is desired to organize a Corn Club in your school or neighborhood, confer with the County Demonstration, or Farm Bureau Agent. Get him to assist in perfecting the plans. If there is a district or state club leader, consult him also. Your state agricultural college will be glad to help, or the United States Department of Agriculture will furnish printed matter telling how to pro-



FIG. 82.—The same boy as in Fig. 81 in his neighbor's field the same day. Compare the cornfields. (O. B. Martin, Plant Industry.)

ceed with the organization. Generally the younger pupils are organized in separate clubs from the older ones.

The basis of club work is usually estimated on (1) the greatest yield per acre; (2) greatest profit on investment; (3) best ten ears shown; (4) report and story of work done.

**Report blanks** are furnished free by the United States Department of Agriculture, and every club should obtain them so as to make its work uniform.

**Keeping Notes.**—Every member of the club should keep careful notes of his work, his expenses, and all interesting items in connection with raising his crop. He should be able to give in his report at the end of the season the exact amount of hand labor, horse labor, seed, fertilizer, and everything else expended on his crop, as well as the exact yield and the value of it.

If he can select a considerable quantity of extra fine corn from his crop, carefully preserve it through the winter, test it in the spring, and sell it at a fancy price for seed, he will be doing a good stroke of business and may be able to start a bank account or pay his way at an agricultural college.

**Corn Festival.**—In the corn belt or in any section where there is much interest shown in the raising of improved varieties of corn, a corn festival makes an interesting get-together event for the neighborhood.

At this time the corn club may have its exhibit and listen to the final reports of its members. Prizes to be awarded for the best crops should be given at this time. There should be ribbons for those doing extra well, and honorable mention for others. All should be encouraged as much as possible.

Many corn contests are to be arranged for this corn festival, such as corn picking in the field, corn husking, corn judging and others.

Methods of selecting, curing, and caring for seed corn, also seed testing, should be discussed.

The girls, for their share of the entertainment, may furnish corn bread and other dishes made of corn for the picnic dinner.

Some pupil should give the history of corn, and some one else should read a paper on the uses of corn—both its direct uses and its by-products.

Parents should enter into this heartily with their children, and should not be slow in welcoming new methods nor be afraid to adopt the new ideas. It is not "good business" to hold onto an old farm practice when a better one is at hand and may be used.

## REVIEW.

1. Briefly describe the preparation of soil for corn planting.
2. Give directions for the planting of corn for summer green feed.
3. Give distances for planting corn used as winter forage or silage.
4. What is meant by "hill" corn? What is its chief use?
5. Name four types of corn grown in America.
6. Describe dent corn.
7. Describe flint corn.
8. Tell when to select corn for seed.

9. Describe the best shape of ears of field corn.
10. What things indicate purity of corn?
11. Give the points which indicate vitality, besides the test.
12. Describe good tips and butts of ears of corn.
13. Why should the kernels be uniform in shape?
14. Describe the best shape and give the reasons.
15. Why should ears of corn for seed be uniform in length and circumference?
16. Why do we object to deep furrows between rows and open spaces between the tips of the kernels at the cob?
17. Name five things which aid in determining the proportion of corn to cob.
18. Give two things to be considered when storing seed corn.
19. Give three good ways of storing seed corn.
20. Give a good reason for the individual ear method of testing corn.
21. Describe a seed testing cloth and box for that purpose.
22. How would you keep the ears from being mixed during the testing time?
23. Tell how to select the kernels that are to be put into the tester.
24. What use may be made of the ears which do not show perfect germination?
25. Mention several methods of harvesting the main crop of corn.
26. What types of silos are found in your district?
27. What corn club work is carried on in your district?

References.—United States Farmers' Bulletins; 537, 773, 992, 1149, 1175, Corn Growing; 553, 554, Pop Corn; 739, 872, 875, 891, 915, 950, 1025, 1029, 1046, on Corn Insects; 1124, 1176, on Diseases. Ark. Ext. Circ. 124, Corn Club Manual.

---

## CHAPTER XIV.

### SMALL GRAINS.

**Wheat.**—Wheat is probably the oldest grain used by man. It is more extensively grown and used than any other human food except perhaps rice. When flour is made from it the by-products are now extensively used to feed animals. In America the newer lands in some portions of the West produce the largest crops of wheat, but the grain is grown somewhat in all sections.

**Types of Wheat.**—As a general rule, the drier regions of the middle West produce hard winter wheat or hard spring wheat, best for flour; the humid climates produce soft wheats.



Varieties are also classified by the heads, as bearded and beardless or smooth (Fig. 83). As to color of grain they may be (1) white or yellowish, and (2) red varieties.

**Soil.**—The heavy clay loams are best for wheat growing but medium loams are also used. Heavy soils are cool and hold their moisture better than lighter soils. The kernels will not develop fully, or “fill,” if the soil is too light.

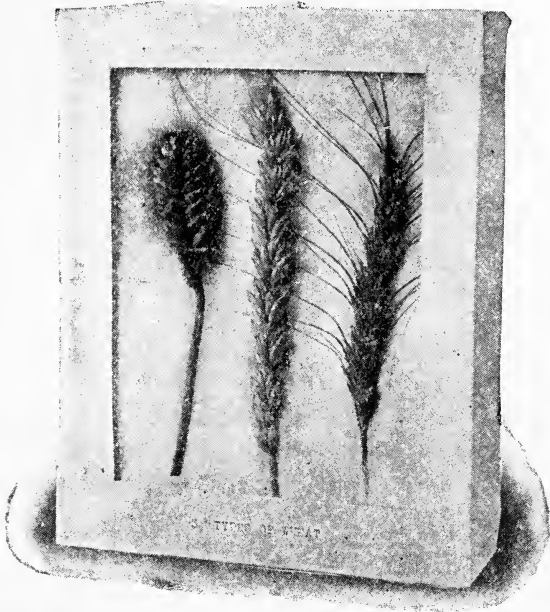


FIG. 83.—Three types of wheat mounted under glass on cotton. Bearded wheat on the right; the others are smooth; square-head wheat on left.

**Preparation and Planting.**—The soil is usually plowed in the early fall, whether it be for winter or for spring wheat. It is important that the bottom soil be well packed down before the grain is sown. For fall seeding the ground may be rolled and then harrowed again to secure the desired condition of seed bed.

The time to plant varies considerably in different sections. In Canada and the northern tier of States the spring wheats are usually used and are sown as early in the spring as the soil can be prepared. Winter wheat is more common in the other States and is sown early enough in the fall to let the young plants make a good growth before winter.

*A grain drill* is usually used for the sowing of wheat. This gives a better stand than broadcasting or sowing by hand, as the seed is evenly distributed and well covered. The amount of seed per acre varies—according to soil, quality of seed and manner of seeding—from one and a half to three bushels.

*Heavy seed wheat* should always be selected for seeding. The plump, full kernels will give much better results than slender shrunken seed (Fig. 9). The legal weight in all States is sixty pounds per bushel. That used for seed should weigh this much or more if possible.

**Harvesting.**—Wheat is ripe when the kernels have passed the dough or soft stage. The kernels should be examined before the cutting is made. Cut before there is danger of the grain shattering out of the head.

Much progress has been made in the improvement of machines used for harvesting grain. The cutting and binding into bundles is done with a self-binder (Fig. 84). Then the grain is put into small shocks of about a dozen bundles. Here it remains in the field for a week or two to “cure.” It is then ready to thresh or to put in stacks.

In the driest regions of the West the grain is *headed* and threshed immediately. Heading is cutting the stems just below the grain heads with special machines made for that method of harvesting.

**Oats.**—Oats grow farther north than corn or wheat. They like a cool moist climate, and have been grown in the cooler parts of the Old World for centuries. They are now produced in Canada and most of the States of the Union.

Oats make one of the best feeds for horses, and when ground are used for other farm stock. Oatmeal in the form of rolled oats forms a good human food. Oat straw is better for stock than the straw of other cereals.

**Soil.**—Oats will grow on soils that are rather too poor for wheat, but they thrive best on the richer soils. Heavier crops of grain are produced if the soil is heavy. The crop responds well to good applications of fertilizer, if too much nitrogen is not used. Too much nitrogen in the soil produces tall growth and little grain.



FIG. 84.—A modern grain harvester. All small grains are cut and bound into bundles by this machine. The tying part of the machine is one of the greatest inventions of modern times.

**Preparation.**—Good plowing and harrowing are advisable before the crop is sown. The lower soil of the seed bed should be well packed down if the plowing is done only a short time before seeding. In some sections the soil is merely stirred with a disc harrow instead of plowing. This custom prevails in the middle West, when oats are sown the next year after corn. A more thorough preparation if the soil is heavy usually gives larger yields.

**Seeding** is done in very early spring throughout the Northern States and Canada. In the South oats are started in the fall. The seeding may be either broadcast or with grain

**drills.** Two or three bushels of seed are used per acre, according to fertility and method of seeding. Very heavy seed should be selected. Thirty-two pounds is the legal weight of a bushel of oats in all States except Virginia, New Jersey, Idaho, and Maryland. The grain selected for seed should be as heavy as thirty-eight or forty pounds per bushel.

**Harvesting.**—There is a little less danger of the oats shattering from the heads when cut than there is with wheat; but in general the same condition of maturity should be secured. The grain is cut and bound with self-binders and then placed in shocks, where it is left for several weeks to thoroughly dry out before threshing.

**Barley.**—There are several types or varieties of barley grown in America, which may be grouped as two-row, four-row, and six-row; the numbers referring to the rows of grain on the heads. The two-row barley is more common in Europe and the six-row more common in America. Most all varieties have hulls on the grain, but hullless varieties are sometimes grown.

Barley adapts itself to a wide range of climate, as the time required for maturing a crop is very short. It is found wherever any of the other cereals are grown.

**Soil and Its Preparation.**—Barley thrives best on well-drained, rich, sandy loam. The soil is prepared as for oats and the times for seeding in different sections is about the same. ✕

**Rye.**—Rye is less used for bread making than wheat in America, but in some parts of the Old World the reverse is the case. The flour there is cheaper, as it is much darker than wheat flour. Rye grows somewhat taller than wheat and thus produces more straw. The straw has a commercial value for packing purposes.

**Culture.**—Rye will grow in any region adapted to wheat raising, and is grown even farther north than wheat. It does

fairly well on poor soils, but the rich loams are better for the crop. When the crop is wanted for grain and for straw the methods of culture are practically the same as for wheat.

Rye is often sown in summer to serve as a winter cover crop, and the green growth is plowed under in spring to serve as green manure in the improvement of soils.

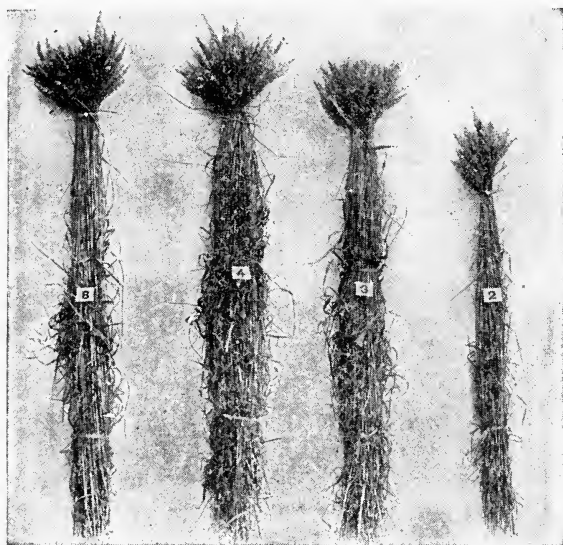


FIG. 85.—A good way to tie up small grains and grasses for exhibits. No. 2 had no fertilizer, No. 3 had poorly kept manure, 4 fresh manure, 8 nitrate of soda.

**Flax.**—This crop is grown in the northern States and in Canada chiefly for its seed. In the Old World, and somewhat in America, it is also grown for its fibre. The smooth, brown seeds furnish two products: linseed oil is used in painting because it dries so well; after the oil is extracted by pressure the remainder is ground into meal for use in feeding livestock. Linseed meal is rich in protein and is highly prized for feeding calves. It often forms a part of many stock feeds.

Flax has been grown for many centuries for the fibre

which it yields. The best qualities are used in weaving the finest linen fabrics, and the dark, coarse fibres, called tow, are used for heavy cloth bagging and for twine.

The leading States in the growth of flax seed are North Dakota, South Dakota, and Minnesota; but Argentina produces more seed than any other country of the world. About four-fifths of the flax fibre of the world is grown in Russia.

**Growing the Crop.**—The plant is an annual with purple blossoms. It is not related to the cereal grains. It is sown in the spring, new land being preferred for its growth. Prairie sod land is often selected for growing the crop. It is best to “break” it in the fall and disk it the next spring.

Three pecks of seed to the acre will produce a good stand if put in with a grain drill. If a fibre crop is desired two or three times as much seed is planted so the plants will not branch so much and the fibre will not be so coarse.

No culture is required and little attention is given the crop until harvest time.

**Harvesting Flax.**—The grain crop is usually harvested by use of a grain binder, and the threshing and cleaning is done with a common threshing machine. Yields vary from eight to fifteen bushels per acre.

The fibre crop is usually pulled by hand, as much of the best fibre is in the tap roots and lower part of the stems. The plants are tied in bundles and placed in shocks for a short time before delivery to the fibre works. Growers sometimes strip off the heads before selling the stems.

The crop grown for fibre is chiefly of a different variety from that grown for seed. It must be entirely free from weeds.

**To obtain flax fibre** from the plants, the bast or inner “bark” must be separated from the inner pith and other parts of the stem. To do this the bundles are spread out for the retting process in the rain and weather for several weeks.

Next the breaking process breaks the straw into very short joints and removes some refuse material. The scutching process then follows. This is beating with paddles or combing the fibre through revolving rollers and then through comb-like rods. When thoroughly cleaned and sorted it may be baled or may be spun into thread and woven into cloth.

**Flax for fibre** is a paying crop to grow where hand labor is cheap; but it is because of the scarcity of such labor that flax is so little grown in America.

**EXERCISE.—Samples of Grains.**—Let pupils bring from their homes or from their stores small samples of wheat, rye, oats and barley. There may be poor and good samples in the collection. These may be placed in bottles with suitable labels. Extra fine samples may be secured by the teacher for a school collection at local fairs or other expositions.

**EXERCISE.—Heads of Grains.**—Make a collection for the school of all the forms of heads of the different kinds of grain that are grown near by. Preserve these in a bed of cotton in shallow pasteboard boxes with glass over them, secured by binding strips (Fig. 83). A method of preparing samples for school fairs is shown in figure 85.

## REVIEW.

1. Tell what you can of the different types of wheat.
2. Tell of the preparation of the soil and times for drilling in wheat.
3. What is the legal weight of wheat? Why should seed wheat be heavier, if possible?
4. Describe the appearance of good seed wheat.
5. What is a self-binder? What is a header? What is a thresher?
6. What are the chief uses for oats?
7. Give directions for the seeding of oats.
8. Name three types of barley. Which is most grown in America?

**References.**—U. S. Farmers' Bulletins: 395, 420, 436, 892, 1119, Oats; 968, Barley; 756, 894, Rye; 669, 785, Flax; 596, 678, 769, 833, 885, 895, 1103, Growing Wheat; 680, 732, 827, 1168, Varieties of Wheat; 1058, Barberry; 991, Thrashing; 673, 1086, 1092, 1141, 1195, 1212, Rice. Ark. Sta. Bul. 43, Smuts; 121, Varieties.

## CHAPTER XV.

POTATOES. 

## IRISH POTATOES.

THE origin of the Irish potato has been traced to South America. From thence it was brought to North America, and from here was taken to Europe by the early explorers. It was called Irish potato because it was so extensively grown in Ireland after its introduction into Europe.

**Importance.**—It is now one of the most important crops of the world and is so universally grown that no one section can claim to raise the majority of the world's crop. The United States in reality produces a small portion of the world's crop.

Not only is the Irish potato used very extensively as human food; it is also fed to animals, used for the manufacture of starch, and also largely for the making of alcohol.

Every State in the Union raises potatoes to some extent. Those States which produce the bulk of the crop grown in this country are, in the order of the amount grown, New York, Michigan, Wisconsin, Maine, Pennsylvania, Minnesota, Ohio, Iowa, Illinois, California, Colorado, New Jersey, Washington, Indiana, Nebraska.

In 1913 the United States produced 331,526,000 bushels of potatoes, valued at \$227,903,000.

**Greatest Production.**—It will be noticed that the States named in the paragraph above are all northern States. The reason that the leading potato-producing States are all in the northern part of this country is that the Irish potato thrives better in the cooler soils and climates.

**Southern Potatoes.**—While the South produces many thousands of bushels of potatoes annually, they are mostly the early crop, planted even as early as December in Florida, and of course harvested correspondingly early. These southern potatoes supply the early markets, both North and South. They will not keep long. Thus the South must



depend for its winter supply on its late potato crop, or on those grown in the North. The combined yields per acre of the two plantings in the South will hardly equal the one crop grown each season in northern States.

**Northern Potatoes.**—The North raises but one crop, and this is planted in the spring after all severe frost is over. It then requires the whole season to mature and is harvested before the ground freezes in the fall. These potatoes, which have grown through the long season and are well matured, are of good keeping quality. They do not sprout so readily as the more rapidly matured potatoes of the South. It is for this reason that the southern States get most of their seed potatoes from the North.

**Types.**—There are chiefly two types, viz., early potatoes and late potatoes. These differ chiefly in the time required to mature the crop from the time of planting. Early varieties are planted as soon as the ground can be worked in spring and are harvested as soon as possible for early market. Late varieties are planted late in May or early in June and are left in the ground to full maturity and are then sold or stored for winter.

**Soil.**—The best soil for the potato is a rich, sandy loam, well drained and well supplied with vegetable matter. A soil heavier than this may be used if it is improved by green manuring and drainage. The lighter soils should be greatly enriched by the addition of green manures and fertilizers. Potatoes should be alternated or rotated with other crops on the field, not continuously grown on the same land.

Barnyard manure for potato fields should be well rotted or may be applied to the soil for the preceding crop, such as corn. Commercial fertilizers are commonly applied at the time the potatoes are planted.

**Need of Moisture.**—Irish potatoes require a large supply of capillary moisture. For every pound of potatoes harvested the plant will have used nearly five hundred pounds

of water taken from the soil during the growing season. The grower therefore finds it necessary to conserve the soil moisture by thorough tillage at the proper times, and by the maintenance of dust mulch or straw mulch. The soil should be deep, black, and full of vegetable matter to aid in holding moisture.

**Green Manure.**—A green manure to plow under in the early spring may be started in the field of corn or other crop the preceding summer. Sow the seed in July or early August, using a mixture of rye, winter vetch and crimson clover. These plants will serve as a winter cover crop and when plowed under will quickly decay and form humus.

**Fertilizers for Potatoes.**—In States east of the Mississippi Valley it is usually found advisable to fertilize the soil for potatoes when grown for market. Barnyard manure is usually applied to the field a year before the potatoes are to be grown there. Green manure or grass sod may be turned under the spring that the potatoes are to be planted; but it should be worked well by disking after the plowing. Fresh manure from horse stables applied the same year that the crop is planted tends to cause the scab disease to develop badly.

Commercial fertilizers for potatoes are usually applied at planting time and are drilled in the rows after part of the soil has been drawn over the seed potatoes. The fertilizer should not actually touch them. A fertilizer that is rich in potash is desirable for potatoes. A complete mixture may contain these percentages: 2 to 3 of nitrogen, 4 to 6 of phosphate, 8 to 10 of potash. See Appendix Table VII for ingredients to use for these mixtures.

**Plowing** should be done in the spring not long before the potatoes are to be planted. It must be deep and thorough as the potatoes require a loose bed for growth. The newly plowed ground must not be packed with a roller, but should be smoothed with a common harrow.

**Cutting Seed.**—The seed pieces are cut in many different ways, with one or two eyes to a piece being the most common.

Experiments have shown that cutting the tubers into quarters will give larger crop yields (Fig. 86).

**Saving Seed Potatoes.**—When seed potatoes are very expensive, as is often the case at planting time, there is a strong temptation to cut the pieces very small with only one or two “eyes” or buds on each piece.

As the buds are abundant and strong at one end, and scarce and weak at the other, it is often best to cut off the eye end for planting and use the remainder for cooking (Fig. 86a). Much is saved and a better stand is secured in the field. Large tubers may be cut into pieces, of about two ounces each.

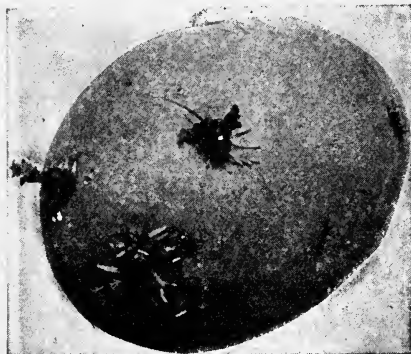


FIG. 86.—Seed potatoes may be sprouted in bright sunlight before planting. Vigorous green sprouts will thus be developed. These will greatly strengthen the growth after planting.

**Varieties.**—Irish potatoes vary in color of skin and flesh, texture of flesh, depth of eyes, smoothness of skin, shape, size, earliness,

keeping qualities, cooking qualities, and in other ways. As to time required to mature the crop, growers commonly classify the varieties as early, medium, and late.

The **early varieties** are most desirable for summer market and are not so good for storing as the others. They are sold as soon as harvested so as to obtain the best prices. Good early varieties are Early Rose, Peachblow, Early Ohio, Red Triumph, White Triumph, and Irish Cobbler.

**Later varieties** yield more than the early ones and are usually left in the ground until thoroughly matured. They will, therefore, keep better in storage.

Green Mountain and American Giant are heavy yielding varieties of the medium season.

Carman No. 3 and Rural New Yorker are late varieties that resist disease fairly well. Other late varieties that are popular because of good quality and heavy yielding are Burbank and Sir Walter Raleigh.



FIG. 86a.—The eye end of the potato is best for seed. The stem end may be saved for food if desired. Never cut across the eye end as shown at the left.

**Seed Selection.**—For the best crop it is well to select seed potatoes of the form and character desired in the crop. The following score card will serve as a guide in selecting potatoes either for seed or for exhibition:

Size.....	20
Too large, cut 2	
Too small, cut 12	
Not even, cut 6	
Appearance.....	60
Not bright, cut 10	
Dirty, cut 10	
Scabby or wormy, cut 40	
Shape.....	10
Quality.....	10
Unsound, cut 5	
Brittle or spongy, cut 5	
Total.....	100

It is not wise to plant small potatoes because they are cheap. It is well, if possible, to select seed from heavy-yielding plants, as this is certain to help increase the yield.

**Seed potatoes from northern States** are shipped to growers in the middle and southern latitudes for the sake of increasing the yield and hastening the growth of the crop. This practice of "importing" seed from farther north is not always necessary for the middle latitudes, but should be continued in the South where the tubers do not ripen well.

**Planting.**—Early potatoes may be planted as early in the spring as the soil can be prepared. Late potatoes should be planted in May or early June. The crop suffers when dry weather comes on. The time of planting should be planned to bring the time when the tubers are forming at a period when the rainfall is usually good.

There are several good methods of planting potatoes; these vary according to climate and soil. In wet or heavy soil they may be planted only three inches deep; in the lighter soils or when the weather is hot and dry the tubers may be planted as deep as six inches.

In large fields, potatoes are usually planted by the use of machine planters. There are several types of these machines. The best ones open the furrow in the plowed field, drop the seed potatoes at regular intervals, cover them with soil, and distribute commercial fertilizer as desired.

**Two crops a year** are usually grown in States south of the Ohio River. It is best to not grow the second crop on the same field where the first was dug. Rotation is better.

**The first crop** is planted in February or March or as early as the ground can be prepared. This crop usually suffers very little from dry weather and is more productive than the late crop. The harvest is in May, June or July, depending upon the latitude.

**The second, or late crop** is planted about June or July, and if protected from blight disease may continue growing until winter, say about the first of December. Frost does not injure the crop. For the second crop, seed potatoes chiefly from the northern States are held over in cold storage for the midsummer planting.

Mulching the second crop with straw or similar material is practiced in many places. This is to save the soil moisture and to give the growing tubers a cooler condition. The crop is planted in the usual way, or perhaps a little shallower. Then the straw is spread over the field a few inches deep. If the

ground is mellow no tillage is given, at least until the vines are half grown. In some cases no tillage whatever is required.

**Early varieties** should be planted for the second crop of potatoes. Lookout Mountain, Green Mountain, Irish Cobbler, Early White Triumph, and Red Triumph are popular for both plantings in the South.

**Distances for Planting Potatoes** vary somewhat in dif-



FIG. 87.—Digging potatoes by use of a machine and four horses. Men, women and children sometimes pick up the potatoes after the machine.

ferent potato districts. Very commonly the rows are three feet apart and the seed-pieces are twelve or eighteen inches apart in the rows. Ten bushels of seed potatoes are required to plant an acre, at distances one and a half by three feet, if the pieces weigh one ounce each.

**Cultivation.**—After the planting is done the field should be harrowed. After this frequent shallow cultivations are made until the vines are so large that they shade the soil well. A light ridging of the soil towards the rows at the time of the last cultivation is usually practiced, the purpose being to prevent the new tubers from growing out of the ground.

**Insect Pests and Diseases.**—Farmers have lost many acres of Irish potatoes through the ravages of insects or plant diseases which they did not know how to combat. But through the experiments made at the State experiment stations, farmers are now able to control both insects and plant diseases.

**Potato beetles and flea beetles** are kept in check by spraying or dusting the plants with poisons. For example, one part of Paris green is mixed with 20 to 40 parts of powdered lime, air-slaked. It is put into a burlap sack and shaken over the potato plants in early morning while the dew is on them. This work should be started in early spring when the adult potato beetles are coming out of their winter hiding places to lay their eggs on the potato leaves. Killing old ones early will prevent much damage by young ones a little later. See the insect chapter for the life history of potato beetles.

**Spraying potato fields** is a little more expensive than the dusting method, but is usually the more desirable for several reasons: (1) the poisoning can be done more thoroughly; (2) the poison when applied wet will stay on the plants longer and may not need repeating so often; (3) the spraying work may proceed in fields all day, while dusting can be done only while the dew remains in early morning; (4) when spraying for beetles the farmer may also add Bordeaux mixture, and thus prevent the blight disease, at the same time.

**The spray solution** for beetles alone should contain arsenate of lead or Paris green. If the latter is used a little lime is added to make the spray cling well and to prevent damage to the leaves by free arsenic. Use one-fourth to one pound of Paris green and one pound lime to 40 or 50 gallons of water (or Bordeaux). Keep well stirred while spraying.

For spraying with arsenate of lead, mix two to three pounds of the arsenate in paste form with 40 or 50 gallons of water or Bordeaux (see Appendix, Table III).

**Potato blight** is often as serious an enemy of the main crop as the beetles. In one sense it is more serious because of the fact that when it makes a start in a field nothing can stop it and the whole crop is likely to become affected. Prevention spraying is the only practical remedy. Bordeaux mixture is used for this. Apply it as early as you would begin to

fight the beetles. Plan to fight them both at each spraying, by combining the poison with the Bordeaux. See preceding paragraphs.

Two kinds of potato blight affect the crop, namely early blight and late blight. They both turn the vines brown and gradually kill them. They are both effectually prevented by using Bordeaux in advance of the disease, say every time that poison is needed to kill potato beetles or flea beetles.

The early blight is much less destructive in most States than the late blight. Growers do not always find it practical to spray to prevent early blight. But as Bordeaux mixture is not expensive and if the work of spraying for beetles is done early, it is advisable to use both the poison and the Bordeaux together.

Late blight is usually very common. Most unsprayed crops are affected by it. The vines die too soon; the yield is much reduced; the tubers ripen prematurely; and the potatoes will not keep in storage so well. The so-called "centre rot" and "end rot" of the tubers at harvest time and later, are results of the attacks of late blight. It was this potato blight which caused the terrible famine in Ireland in 1846.

There is no excuse for not preventing this disease by spraying with Bordeaux mixture while spraying with poison to fight the beetles. (See Appendix, Table III, for making Bordeaux mixture.)

**Potato Scab Disease.**—This is a serious trouble in nearly all potato-growing districts. If all seed potatoes are given a preventive treatment before planting, the soil will be kept free from the disease and the crop will not be affected.

Before cutting the tubers, soak them for two hours in a solution of one pint full strength formalin in thirty-two gallons of water. Applications of fresh lime or fresh manure both tend to increase the scab disease in the soil. These should both be avoided when potatoes are planted.

**Harvesting.**—Large potato fields are usually dug by use



of machines drawn by horses (Fig. 87). One of the smaller forms is shown in Fig. 87a. Larger machines elevate the tubers, shake off the dirt, and drop them on the ground. They are drawn by three or four horses. Small garden patches are dug by hand tools.

**Weights and Yields.**—The legal weight of a bushel of potatoes is sixty pounds, except in Pennsylvania and Virginia, where the weight is fifty-six pounds. The yields are often two hundred and fifty bushels or more per acre, but

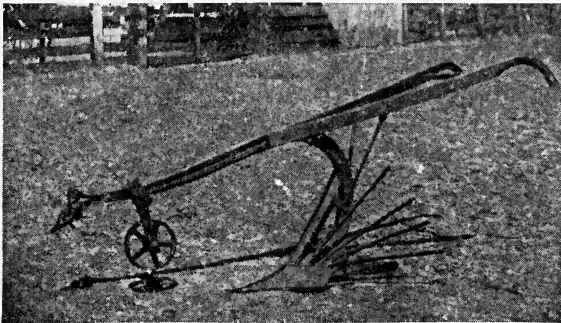


FIG. 87a.—An inexpensive potato digger to be drawn by one or two horses.  
(Plant Industry.)

the average is about one hundred bushels per acre. The value of the crop in the United States each year is about \$100,000,000.

#### SWEET POTATOES.

The sweet potato is grown to a limited extent in nearly all the northern States, but the best qualities and largest quantities are produced in the southern States. The plant is of tropical origin.

**Soil.**—Sweet potatoes thrive best on a rather sandy loam which does not contain too much of organic matter. Soils that are too poor for the production of most other farm crops may suit sweet potatoes very well.

**Starting the Plants.**—New plants are started in early

spring from seed potatoes. The whole potatoes are planted in fine, rich sandy loam in hot-beds (Figs. 88, 89). These may be heated either by manure or by fuel. The temperature at first is kept at 80° or 85° F. Before the plants are pulled from this bed to be transplanted to the field the temperature is gradually lowered to 60° F. The growth in the hot-bed requires about six weeks.

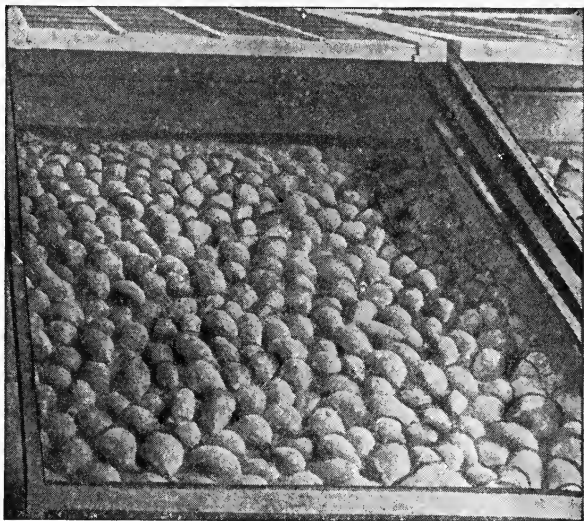


FIG. 88.—Sweet potatoes in a hot-bed ready to be covered. They will produce young plants for field planting. (Experiment Station, N. J.)

**In the Field.**—The soil is prepared as for corn—the surface being left smooth and even. In some places the farmers ridge the field and set the plants on the ridges. Others practice the level culture. Planting in the field should be done when the soil is moist enough to produce a rapid growth after setting the young plants. Where level culture is practiced the plants are often set two or two and one-half feet each way. Where ridges are made the rows are often three and one-half feet apart and the plants fourteen to eighteen

inches apart in the rows, requiring over 8000 plants per acre. The plants are set in the ground by hand, by tongs, or by large machine planters.

**Cultivation** is simple and does not last long as the vines soon cover the ground. Large weeds are usually pulled by hand or cut with hoes.

**Harvesting** is done before cold weather. The vines must be cut loose from the hills before they are frozen to prevent injury of the crop. There are special plows, similar to Fig. 87, for digging sweet potatoes. Small areas are often dug with spading forks.

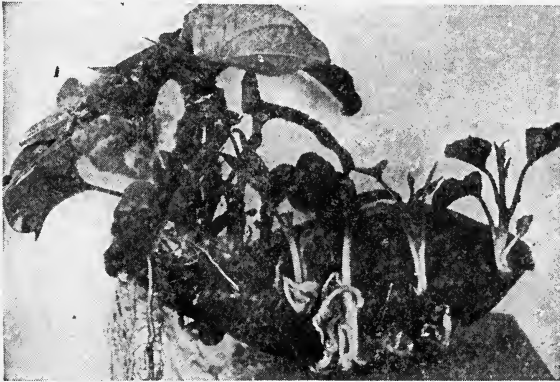


FIG. 89.—A single sweet potato from the hot-bed, showing many young sprouts. Note the difference in the size of young plants. (Experiment Station, N. J.)

**Storage** is necessary if the crop is not sold immediately. Special pits and heated buildings are constructed for storing sweet potatoes. The roots must be handled with the greatest care to avoid bruising them if they are to be stored. When first put into storage they go through a “sweating” or curing process; this requires a temperature of 85° or 90° F. After that the temperature is kept at 55° to 65° F. A great deal of ventilation is required to keep the place perfectly dry.

**EXERCISE.—Yield and Value.**—Find out the usual yield per acre of Irish potatoes in your vicinity, and then estimate how many acres of land it would take to raise the number of bushels produced in the United States in 1913. Would this acreage entirely cover any of the smaller States? What was the value of the yield per bushel that year? What per acre?

### REVIEW.



1. Where was the Irish potato first found?
2. How did it come to be called the Irish potato?
3. Learn if you can who is said to have carried it from North America to Europe.
4. What States grow the heaviest crops of potatoes?
5. Compare potato growing in different sections of the United States, as to planting dates, keeping qualities, and in other ways.
6. What kinds of soil are best suited to potato growing?
7. Why do potatoes need so much moisture?
8. Name some of the best varieties for seed.
9. Find out what kinds are grown in your vicinity. Learn which yield the heaviest crops.
10. Tell of the times for planting early and late potatoes.
11. Give depth for planting; also distances.
12. Give directions for treating seed potatoes to keep the scab disease out of the soil.
13. What is the legal weight per bushel of potatoes in your State?
14. What fertilizers do farmers use for potatoes in your locality?
15. What green manures help the potato crop?
16. Give directions for plowing potatoes.
17. Give directions for selecting and preparing seed potatoes for planting.
18. Where and how are two crops grown in one year?
19. How should a field of potatoes be cared for after planting?
20. What insects attack the potato fields?
21. Have any plant diseases ever destroyed potatoes in your neighborhood?
22. How may insects and diseases be controlled at the same time?
23. In what climates and on what soils are sweet potatoes grown?
24. Describe the starting of sweet potato plants for a large field.
25. Tell how sweet potatoes are stored for winter.

**References.**—U. S. Farmers' Bulletins: 970, 999, 1020, 1059, Sweet Potatoes; 533, 753, 847, 953, 1050, 1064, 1091, 1190, 1205, Irish Potatoes; 868, Spraying; 940, 1225, Insects. Ark. Sta. Bul. 30, Fall Potatoes; 167, Mosaic of Sweet Potatoes. Ark. Ext. Circ. 90, 122, Sweet Potatoes; 114, Irish Potatoes.

## CHAPTER XVI.

## TOBACCO FOR MARKET.

TOBACCO crops were grown in Virginia by white men, as early as 1612. Before that time Indians had been growing it for their own use. The United States now produces over a billion pounds annually, which is fully a third of the world's production. When sold as low as ten cents a pound the money value is enormous.

The crop is grown commercially in all the humid parts of the country, particularly in the Eastern States. The leading States in order of production are Kentucky, North Carolina, Virginia, Ohio, Tennessee, Wisconsin, Pennsylvania, South Carolina, and Connecticut.

Tobacco is of several types or classes which are much influenced by local soil and climatic conditions. Each section is usually devoted to the growing of one type, as cigar wrapper or binder, cigar filler, pipe tobacco, and plug tobacco. Manufacturing types include all but cigar types and export types.

**The plant** is an annual which grows very large and rank, with an erect, simple stem. The large, simple leaves from this stem are of commercial value. They have a biting or pungent flavor and aroma and contain from one-half to two and one-half per cent of nicotine in mild tobacco, and as much as eight per cent in the lower grades. The seeds of the plant are abundant and very small. Only a few plants are allowed to form seed with which to start the next crop.

**The soil** should be deep, rich, and well drained, but sandy enough to be easily warmed and ventilated. The plant is very exhaustive to the nitrogen, phosphate, and potash, and these plant foods should be supplied by the use of manures and fertilizers. The plowing should be nearly a foot deep, and the surface is then disked and harrowed until well pulverized.

**Seeding** is in cold-frames in the South and in hot beds in the North. The soil for the bed is often made sterile by burning some brush over it just before the time of planting. Seeds are sown after the soil is in fine condition. For a bed 10 by 50 feet use about one ounce of seed, or one tablespoonful. This may furnish plants enough for about five acres, when transplanted. Cover the seeds lightly by tramping, rolling or raking. Cloth may be used to cover the beds, but glass is used in the cold regions. About six weeks should be allowed for the growth in beds.

**Transplanting** is not done until all danger of frost is over and the field soil is warm and mellow. The rows are placed three to four feet apart and the plants a little closer in the rows; or they may be in rows both ways for ease of tillage. The transplanting may be either by hand or by machine as with early cabbage plants (Fig. 89a).



FIG. 89a.—Press the soil well around the newly set plant. (Dunham Co.)

**Care.**—The crop is given very clean culture during its growth. The large horn-worms, if abundant, must be killed by spraying with a poison, arsenate of lead or Paris green; but if not abundant they are picked off by hand. When the plants are large the suckers are removed, and the tops are cut to prevent flowering and seeding. Priming is the removal of the lower leaves which are apt to be injured by the soil.

**Harvesting** begins when the leaves are ripe enough to cure. The skilful grower determines this by the color and the "feel" when folded in the fingers. Usually the whole plant is cut near the ground and the stem split to slip on a lath, after wilting. The laths, each with several plants hanging from it, are hauled to the barns or sheds and hung in open tiers for curing. In some sections and with some types of

tobacco, the leaves are gathered separately as they ripen.

**Curing** is of three main types: (1) air curing in well-ventilated buildings; (2) open fire curing in closer barns with fires on the floor after the plants have yellowed a few days; (3) flue curing in tight barns with furnaces and flues. The last method requires most skill but least time, and smaller buildings may be used.

**Stripping and sorting** is done after curing at a time when the leaves are moist enough to be handled without loss. Grades depend upon length of leaf, injury, texture, color, and curing. It can then be tied into hanks and bulked. It is now ready to be stored for future marketing.

**Varieties** for dark tobacco are Yellow Mammoth, Pryors, and Orinocos, with their many derivatives. These are usually fire-cured. White Burley is the leading air-cured variety.

## REVIEW.

1. Compare tobacco as a money crop with some other crops of the United States.
2. Mention the different classes of tobacco.
3. Describe the starting of the crop.
4. Tell what you can of the field care.
5. What are the two methods of harvesting?
6. Outline three methods of curing.

References to Bulletins on Tobacco.—United States Farmers' Bulletins: 416, 523, 571, 595, 846, 867. Kentucky Station bulletins 129 and 139.

## CHAPTER XVII.

## THE PRINCIPLES OF FORESTRY.

FOREST products in America are not as generally considered a part of the permanent resources of the farm as they should be. The chief products are lumber, posts, poles, railroad ties, and fuel. Thus far lumber, ties, and poles have been obtained mainly from native forests. These are rapidly becoming exhausted. In the prairie States firewood and posts are obtained from plantings made by man (Fig. 89b), but elsewhere chiefly from the native woods.



FIG. 89b.—Tree seeds of many kinds may be planted in fields and gardens. The seedlings are cultivated for one year and then transplanted to wood-lots and shelter-belts (U. S. D. A.)

Forestry should become a systematic part of many farms in all the prairie States as well as in the States where timber was originally found.

Tree planting is naturally considered under two heads: (1) Prairie planting may be for ornament, windbreaks, shelter-belts, and wood-lots or groves for wood, posts and



lumber. (2) Forest planting, which is primarily for the revenue to be derived from the sale of wood and lumber.

It is a special problem in the management of each individual farm to decide just what planting should be done. The Forestry Service of the United States Department of Agriculture offers to give practical assistance to tree planters in deciding these questions. Circular 22 of that service should be read in this connection. Careful study should be given to the planting of trees under some good system, as a forest is the most permanent thing that can be planted on a farm.

**Need of Forest Planting.**—Forests are necessary to the highest material development of any country. The climatic influences are very beneficial. It is desirable in behalf of the public welfare to plant trees in great number. This is true both on the treeless plains and also on the sites of destroyed forests. To be of most public benefit the planting should be well distributed over the region. All will share the benefits and all should join in planting the trees.

**Forest Influences.**—Growing trees conserve moisture, modify climatic extremes, and purify the air. Careful observation shows that large trees growing in a grove affect climatic and soil conditions in several ways:

1. During the day the ground under the trees is protected from the sun's rays and is therefore cooler than soil not protected. The air circulating over this cool soil tends to cool the air in the immediate vicinity on sunny days.

2. At night the trees retard the loss of heat from the ground under them. This tends to equalize the temperature of not only the soil and air under the tree but that in the near vicinity. The soil and air are kept cooler by day and warmer by night. This equalizing of temperature is noticeable during short periods of very hot or very cold weather. Gardens growing near trees are sometimes uninjured by fall frosts which kill tender plants in other gardens.

3. The drying out of soil is also prevented by the mulch of leaves and twigs which fall to the ground under the trees. Trees and leaves check the flow of water over the land, thus preventing the washing away of good soil. The soil is not so badly beaten down by heavy rains. The water soaks into the soil better and the flow-off is very gradual.

4. By breaking the force of the wind trees will aid in retaining moisture in the surface soil near the trees. The evaporation decreases as the wind is checked. Water is also held better in the soil shaded by the trees. A large amount of water which the trees give off from their leaves is drawn from the subsoil, without drawing on the water of the surface soil. This moisture from the leaves increases the amount in the surrounding air. Trees which have the roots near the surface, as the elm and red maple, take up so much water near the surface as to make it unwise to try to grow crops near them.

5. The destructive force of severe winds is often prevented by trees. Tornadoes may be prevented or made of little effect by large groups of trees. Certain crops may be grown when protected by shelter-belts of trees that could not otherwise be grown on the prairie. These shelters from high winds prevent the blowing of soils. They lessen the severity of cold winter winds both for stock and for people.

**How Trees Influence Water Supply.**—The proper distribution of water upon the land is the most important factor in the growing of crops. In the natural course of the seasons we have both floods and droughts. The proper holding of the water from flood-time to drought is best accomplished by the growth of trees and the protection of natural forests.

Rain falling upon forested areas flows away slowly. Springs and streams are kept constantly supplied from the water of such areas.

Instead of the waters of the rainy season producing heavy floods and causing much destruction along the courses of

streams the water is greatly retarded and no flood is experienced. The water from heavy rains is held back by the carpet of leaves on the soil beneath the trees, by the roots in the soil, and by the decaying matter from former years.

In sections where the forests have been cut off for the use of man, the streams frequently go dry during the summer. Water power of mills and factories is thus cut off; the water supply for homes, villages, and cities is reduced to the danger point. Navigation of the larger streams is checked or stopped for a while. Many wells are without drinking water because the level of the soil water is deeper than the wells.

The growth of forests would correct the difficulty of water supply in many parts of the country. The United States Government has reserved large areas of mountainous and hilly land for the purpose of preserving the natural forests and maintaining the flow of the larger streams in those sections.

**Forest Planting on the Farm.**—The wood-lot or forest plantation on a farm where the land is all tillable should usually be in the form of a wide shelter-belt. If there be rough land on the farm not suitable for the more common crops, groves may be maintained on this to good advantage. On land too stony or too steep for use of other crops some kinds of trees will grow well. The location of such groves is to be determined by natural conditions.

The location of the wide shelter-belts will be influenced by several things. These trees may affect the air drainage of near-by orchards; the wind currents will be controlled; and the humidity of the air about the home will be influenced.

Such trees should be far enough from the buildings and roadways to not cause the drifting of snows which would be in the way. The shelter-belt should be about six rods wide, made up of a number of lines or rows of trees with the smaller kinds on the side toward the prevailing wind. This will deflect the wind currents upward and prevent their bad effects.

Make the belts of trees several rods wide, because single rows of trees or narrow belts are less profitable when we consider the relative amount of land used.

Shelter-belts should be planted on the side of the prevailing winds. In some places this is on the southwest side of the group of farm buildings to protect the premises from hottest winds of summer. The coldest winds of winter will be checked by planting trees along the north and northwest. Probably the planting of belts along the north and west sides would be best in most cases.

In prairie countries and in dry climates the shelter-belts should be used to protect fields of crops from both the blasting winds of summer and the storms of winter.

**Kinds of Trees.**—There has always been a tendency in the prairie States to plant trees that would grow quickly. These are not the best kinds because, as a rule, they are short-lived and the plantation is soon gone. The more permanent kinds of trees should be chosen.

The revenue to be derived from the sale of fuel, posts, poles, and lumber should be considered in the choice of varieties. Chestnut groves have often paid a good return for their cost in the nuts produced for market. Walnut is a slower growing wood than cottonwood, but when mature will return a much larger income for each year of its growth. Trees with deep root systems should be chosen if the trees are to grow near other crops, as the surface soil will not be dried out so fast. Such trees would be walnut, hickory, hardy catalpa, chestnut, locust, and others. All of these have valuable woods.

**Propagation of Forest Trees.**—Nearly all kinds of forest trees are propagated by seeds. Willows and a few others are easily increased by cuttings.

The seeds for planting should be mature and as freshly gathered as possible. It is quite difficult to germinate some tree seeds that are very old and dry.

The nuts of black walnut, hickory, chestnut, and others, and the pits of the plum, peach, and cherry should be either spread between layers of moist sand or planted in the fall where they are to grow. They should not be allowed to dry out after ripening. The larger nuts may be planted while doing shallow plowing, by dropping them in a furrow and covering them with the next furrow slice.

The deep root system formed by most of the true nut-bearing trees makes them difficult to transplant, even when young.



FIG. 90.—Lattice supported on poles. Such a structure gives alternate light and shade in growing forest seedlings, tobacco, ginseng, and a few other plants. (Plant Industry.)

Seeds that ripen in spring and early summer should be planted within a few weeks, as they live but a short time. The American elm, soft maple, and cottonwood are examples of this group, but the red elm is an exception, as the seeds will not sprout until the next spring.

Seeds of trees that ripen in the fall, except the evergreens, may be planted either the same fall or the following spring. If planted in the fall they should be covered with a leaf mulch and also protected from squirrels and other animals.

The cone-bearing trees, including the pine, spruce, tamarack, and white cedar are started from seed sown in the

spring under partial shade. This partial shade may be made by a lattice work supported on poles (Fig. 90). Rather sandy soil is best for the starting of these seeds, which are planted very shallow. They may be sown either broadcast or thickly in drills with the rows close together.

Before young trees of any of the kinds become too crowded in the seed beds they should be transplanted. If they are too small to be used in the forest plantation they are put in rows far enough apart to cultivate in a forest nursery. It is a very common practice to keep young trees in the forest nursery for one or more years.



FIG. 91.—Young maple-tree seedling showing the first seed-leaves still clinging.

EXERCISE.—*Starting Tree Seeds.*—Collect from the woods, or buy from a seed store, seeds of ash, birch, hard maple, and box elder. Plant them in a window box in loose black soil, covering them to a depth of about one inch. Moisten the soil from time to time and observe the time required for germination of each kind. Note the methods they have of coming out of the soil. How many seed-leaves have they? (Fig. 91.)

**Distances Apart for Trees.**—The Forest Service recommends that in a wood-lot or forest plantation most trees be set four feet apart each way. It is the aim to get the soil shaded by the trees as soon as possible, and to use all the space for tree growth after the first year. The first year a low-growing crop requiring cultivation may be planted in the rows with the young trees. Potatoes may be used for this purpose one season only.

Another plan followed in some forest planting is to plant the trees two feet apart in the rows with eight feet between the rows. In this plan the space between rows may be used for other cultivated crops for several years. The trees can

be cultivated for a much longer period than where they are only four feet apart.

**Mixed plantings** are made by setting alternate rows of two or three varieties. There are a number of advantages derived from the mixing of the trees instead of planting only one kind (Fig. 92):



FIG. 92.—A shelter-belt of mixed hard woods. This form of fence will protect the forest from grazing stock. (Plant Industry.)

1. There is less danger of total loss from drought, insects, and diseases.

2. Rapid-growing trees may temporarily fill the area while the slower and more permanent ones are becoming large enough.

3. Tender kinds, such as Scotch pine, do much better when partially protected by more hardy trees.

4. Mixed plantings are more beautiful and interesting.

5. Birds are attracted by the greater variety of food and shelter.

6. The ground is usually better shaded by mixed planting. Tall trees with thin foliage, such as maple and birch, may be

FIG. 93.

FIG. 94.

FIG. 94a.



FIG. 93.—A pine tree growing in an open place, holding the leaves out to the light.

FIG. 94.—Pines and other trees grown in a dense forest, which is now mostly cleared away.

FIG. 94a.—Sugar maple tree yields sap in early spring.

alternated with those which have dense foliage and can endure shade well, such as spruce and beech.

**EXERCISE.**—*Distance Apart and Shape.*—In a wood-lot or other place where trees are growing close together, notice the distance from the ground to the first side limbs that are beneath the shade of other trees (Fig. 94). Compare these with trees of the same kind growing in open places. In a dense forest the side limbs are shaded from the light and



may soon die and drop off. Those in the open grow large because of the light all about them (Fig. 93). Which would produce clear lumber and which would be knotty?

EXERCISE.—*Rings of Wood.*—Have some one bring to school a circular section cut across the end of a tree trunk,



FIG. 95.—Method of mounting wood samples for study. (Agricultural Education.)

showing the rings of wood. Each ring represents one season of growth. Count them. Are some wider than others? Are the wide rings indications of favorable or of unfavorable seasons of growth? Notice the dark heart-wood in the center and the light colored sap-wood near the bark. Figure 95 represents a good method of saving samples for future study.

**Planting the Trees.**—When wood-lots and wide shelter-belts are to be planted, the ground should be prepared by plowing and harrowing, unless it is too rough or stony. The trees from the seed bed or forest nursery are transplanted to their new location when of suitable size. The size depends upon the kind and size of those with which they are to be planted. Evergreens may be transplanted whenever new shoots are not growing, but late spring is probably the best time. Early spring is best for other trees and shrubs.

When very small seedlings are to be planted in great numbers, a small but deep opening is made by thrusting a narrow spade into the plowed soil and moving the handle back and forth. The spade is removed and the little tree roots pushed to the bottom of the hole. The soil is then pressed in about the roots and at the same time the little tree is lifted to make it of proper depth. This plan of planting is very rapid.

*Larger Trees* must be planted with more care. The holes should be larger and deeper than the trees seem to require. Prune all broken or bruised roots. Prune off some of the top, to somewhat balance the reduced root surface. Place loose rich soil in the bottom to come in contact with the roots. The tree should be a little deeper in the ground than it was before. Fill the hole with the best soil and tramp it in well, but leave a layer of rather loose soil on the surface.

**EXERCISE.**—*Arbor Day Planting.*—Plan for the planting of trees and shrubs on the school grounds on Arbor Day and other spring days. Have the places for planting each shrub or tree determined in advance. Study the principles laid down in the reference bulletins and in this book, to make the school grounds very beautiful.

**Ornamental Planting.**—One of the best plans for the planting of trees on Eastern farms, and indeed everywhere, is to place them where they will lend a degree of beauty to the farm home. The appearance of the surroundings may

be wonderfully improved by planting in suitable places a number of well chosen kinds of trees.

**Care and Management.**—The farm wood-lot should be managed in such a way as to produce regular harvests of fuel, lumber, posts, and railroad ties, through a long series of years. Advancing prices of these materials make the wood-lot a very profitable part of the farm.

In the proper management of the wood-lot there are a number of principles to be applied. Some of the most important are given here:

1. In cutting the crop take those trees that are ripe, not the young or middle-aged ones.
2. Save the small seedlings and saplings to renew the forest when the old trees are harvested.
3. Take out the badly shaped and diseased trees and those of inferior kind. Such are called weeds, and may be used for fuel.
4. Leave good specimens that are old enough to bear good crops of seed. These will naturally re-seed the wood-lot and keep it supplied with young growth.
5. Usually the wood-lot should not be used as a pasture. This destroys the young trees and the future life of the forest. The leaf mulch is never good in a pasture.
6. The stand of trees left at any time must be neither too thin nor too thick, as this affects the shape of the trees (Figs. 93, 94).
7. Some kinds that send up shoots from the stumps, called *coppice growth*, must be thinned to avoid crowding. Catalpa, chestnut, locust, mulberry, osage orange, and others send up rapidly-growing coppice from the stumps.
8. Trees damaged by storms should be harvested before insects and diseases attack them, as these often spread to healthier trees.
9. Always pile up and burn the waste brush after each harvest. This will check the spread of insects, and reduce the danger from fire.

10. Post up legal notices furnished by the State authorities to warn all campers and hunters against forest fires.

11. Replant belts destroyed by fire or storm.

**EXERCISE.**—*Kinds of Trees.*—Collect twigs of the evergreens and other trees and have pupils name them for the class. They may learn the names at home or elsewhere if none in the class know them. Students should learn what ones are most valued for posts, for lumber, and other uses.

### REVIEW.

1. What are some of the common uses to be derived from the farm wood-lot?

2. In what way is a forest of public benefit?

3. Tell of the influence of a grove of trees on the temperature of the soil.

4. How does a forest control soil moisture?

5. Why should homes be protected by trees?

6. How are streams affected when forests are cut off?

7. How does a forest help to prevent a flood?

8. On what sides of the farmstead should shelter-belts be grown?

9. What width is suggested for these shelter-belts? Why is one row of trees not the best?

10. What things must be considered in deciding what trees to plant?

11. What tree seeds must be planted or put in moist sand in the fall?

12. Which are planted in early summer?

13. Tell when and how to start seeds of the cone-bearing trees.

14. Give distances apart for planting trees in the wood-lot, and compare the two plans given.

15. Mention several advantages of mixed planting.

16. How does the distance apart affect the shape of trees?

17. Tell how to plant small seedlings in the wood-lot.

18. Describe the planting of a larger tree.

19. How are wood-lots naturally re-seeded?

20. What are forest weeds? What should be done with them?

21. Why not use the wood-lot as a pasture?

22. Mention one way of preventing forest insects and diseases.

23. Mention two ways to help prevent forest fires.

**References.**—United States Farmers' Bulletins: 516, Maple Sirup and Sugar; 622, Basket Willow Culture; 700, Pecan Culture; 715, Woodlot Products; 744, Preservative Treatment of FarmTimbers; 788, The Windbreak as a Farm Asset.

## CHAPTER XVIII.

## GARDENING.

IN the broad sense the word *horticulture* is used to include fruit growing, vegetable growing, the production of flowers, ornamental trees and shrubs, and the uses of these in beautiful landscape effects about lands and buildings. We have already considered the subject of fruit growing.

**Vegetable Gardening.**—The growing of vegetables has been given the name *olericulture*. Farmers may grow vegetables either for home use or for market.

Gardening is always a special line of farming, and may be called intensive agriculture. Large returns are secured from small areas. Several hundred dollars per acre may be expected from a good market garden.

**Elements of Success.**—To be very successful in growing good vegetables several conditions are required:

1. The soil must be rich and well drained.
2. It must be supplied with plenty of humus to retain moisture. It should be manured heavily.
3. Sandy loam is necessary if vegetables are to be ready for early market.
4. The soil should be plowed deep and the most thorough tillage of crops practiced.
5. The best methods for the prevention of weeds must be practiced. Never allow weeds to scatter seed or spread by other means in the garden.
6. Select good varieties for the table and market, and have the products ready for all seasons.
7. Prepare produce attractively for market.
8. Gather the best seeds from the best plants for future planting; or if seeds are purchased, get the best possible.

**Planning the Garden.**—The best plan for planting the

garden is to have the crops in long rows, not in "beds." Have the rows run the longest way of the garden, preferably north and south (Fig. 96), and have the garden long enough so that a horse may be used both in plowing the soil and in cultivating the crops.

Plant the rows far enough apart to allow the use of a cultivator drawn by horse power. See Table XII in the Appendix. Much more profit may be gained from a garden cultivated by horse power. Too much hand weeding and



FIG. 96.—School gardening in California with the long rows instead of small beds. Irrigation water is just flowing in the center of the garden from the portable flume or trough along the edge of the garden. (Agricultural Education.)

hoeing is irksome and is too often neglected. Hand labor is always more expensive than horse labor in the garden.

The perennials or permanent crops, such as asparagus, rhubarb, horse-radish and many of the sweet herbs, should be planted along one side of the garden near the bush fruits. They will then be out of the way when plowing the rest of the garden (Fig. 97).

**Time of Planting.**—Some plants used in the garden are very tender and must not be planted in the open garden in spring until all danger of frost is over. Others are quite hardy and may be planted as early as the soil can be prepared. The following lists may be referred to by beginners:

**Hardy vegetables** which will endure a frost after sprouting in the spring:

asparagus	endive	parsnip
beets	horse-radish	peas
cabbage	kale	radish
carrot	lettuce	rhubarb
cauliflower	onions	salsify
celery	parsley	spinach
cress	potato	turnip

Late and early plantings of several of these may be made.

**Injured by Frost.**—These vegetables will be injured by a slight frost. They should be planted after all danger of it is over:

beans of all kinds	muskmelon	squash
corn	okra	sweet potato
cucumber	pepper	tomato
egg-plant	pumpkin	watermelon

There are several of this group that should be started earlier than the last spring frost. The seed may be planted in hot-beds or in window-boxes in the home or school. Egg-plant, pepper, tomato and sweet potato are usually thus started in early spring.

**Planting Seed.**—Such large seeds as corn, beans, peas, squash, pumpkin, and melons may be covered with two inches or more of soil. Small seeds must be planted very shallow. If the soil be rather damp or heavy the planting should be shallower than in light, dry soil. When seeds are planted the soils should be pressed firmly down upon them, so that the soil moisture will soften the seed and cause it to sprout. For seeds planted in hills it is well to walk on the covered seeds. After the packing is done with the foot or with a roller, the rake should be drawn lightly over the top to leave a loose soil mulch. This saves the moisture by preventing its escape into the air.

**Setting Garden Plants.**—Those garden plants which are started indoors for protection should be strong, healthy plants when set in the garden after the weather is settled.

Care must be exercised in setting the plants in the garden. Avoid the hot sun, and if possible do the work in the evening. Save all the root of the young plant, but a little pruning of the leaf surface may be made.

Make the hole in the mellow garden soil deep enough to avoid doubling the root. A dibber is used in the planting.

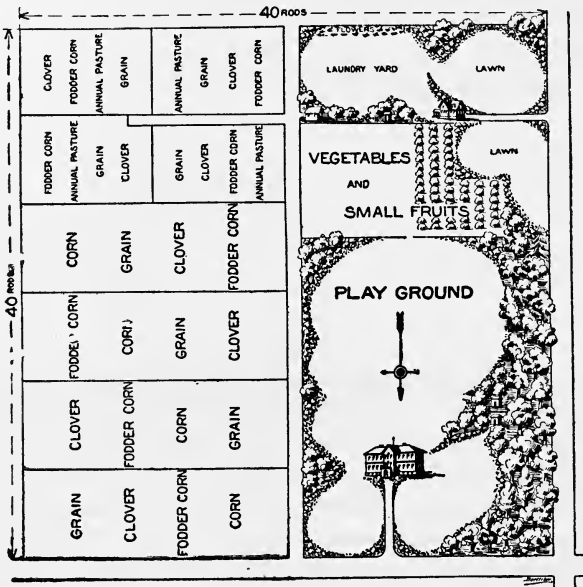


FIG. 97.—Plan of ten-acre farm-school. The rotation of crops is to be changed to suit each locality. (Agricultural Education.)

Set the plant a little deeper than it grew before. Water, if necessary, before filling in all the dirt. Fill in around the roots and plant with the very finest soil. Press this down well, but leave a little quite loose on top.

**Hot-bed or Cold-frame.**—For the starting of early vegetables a hot-bed is of great aid. Plants may be grown in it to be set in the garden later. Early crops of lettuce and



radish may be grown during late winter. Make a tight frame of boards, perhaps six by nine feet, or to suit the size of the glass (Fig. 98). This should be about two feet deep on the north side and six or eight inches less on the south side. This gives a slope to the window sash to catch the rays of the sun.

The hot-bed should have in the bottom ten inches of firmly tramped horse manure that has begun to heat a little. Cover this with five or six inches of rich garden soil.



FIG. 95.—A back-yard hot-bed. These sashes were made for this special purpose with lap glasses to shed off water.

The cold-frame is made in the same way but does not have the heating manure in the bottom to warm the soil. It is usually placed on the south side of a building or high fence to secure the best effects from the sun's heat.

Care must be exercised not to let the temperature in these frames vary too much. On cold nights, carpets or blankets may be thrown over the glass. When the sun is very hot, the glass is raised a little or taken off to let out the surplus moisture and hot air (Fig. 99).

**Double Cropping.**—Market gardeners often raise two or more crops on the same ground in a season. This is called double cropping.

If the crops follow one after another it is *succession-cropping*. Such crops must mature quickly. Early peas or radish or lettuce may be followed by tomatoes, late cabbage or celery.

If the crops are grown together in the garden for all or part of their time the system is called *companion-cropping*. One of these crops matures early and the other is started between the rows before the first crop is harvested (Fig. 100). An example would be early onions with cabbage. With some vegetables both the crops may be drilled in the row



FIG. 99.—A market gardener's hot-beds for the forcing of early vegetables and starting plants for the open ground. (Plant Industry.)

together, as when radishes and beets are planted. The radishes are harvested by the time the beets need the room. Early and late celery may be grown together. When the first crop is sold the late crop is ready to use all the space.

**Storing Vegetables.**—Vegetables of several kinds may be stored for winter use. Onions should be well dried before storing. They are to be handled without bruising, and are spread in single layers on open shelves in a dry place where they will not freeze.

Celery and cabbage may be transplanted to a cold cellar before the ground freezes. Keep the soil moist about the roots and they will keep all winter.

Beets, turnips, and similar root crops may be covered with dry dirt in a cellar box. This will keep them from drying too much.

Tomato vines may be pulled up before heavy frost and suspended from the ceiling in a cellar or cool room. As the green tomatoes ripen they may be wrapped in paper and kept several weeks. Hubbard squashes, pumpkins and watermelons need to be handled without bruising and kept in a dry, cold cellar. By storing vegetables for late fall and



FIG. 100.—Harvest in the spring-time, from the school garden. (Agricultural Education.)

winter use, and starting a hot-bed for late winter and early spring use, we can supplement the summer garden and have vegetables for home use all the year.

**EXERCISE.**—*Frost and Rainfall.*—Write to the Weather Bureau, at Washington, and get the summary of the weather record for your section. Find the dates when the late spring frosts and the early fall frosts occur. Look up, also, the annual rainfall and see how many inches of this rain falls in the summer months. It is good practice for the members of the class to keep records of frosts in fall and spring. The time of planting garden vegetables may be governed by these records.

**School Gardening.**—The principles already given for vegetable gardening at home may be used in the school garden. Let the rows be long, and each student may have

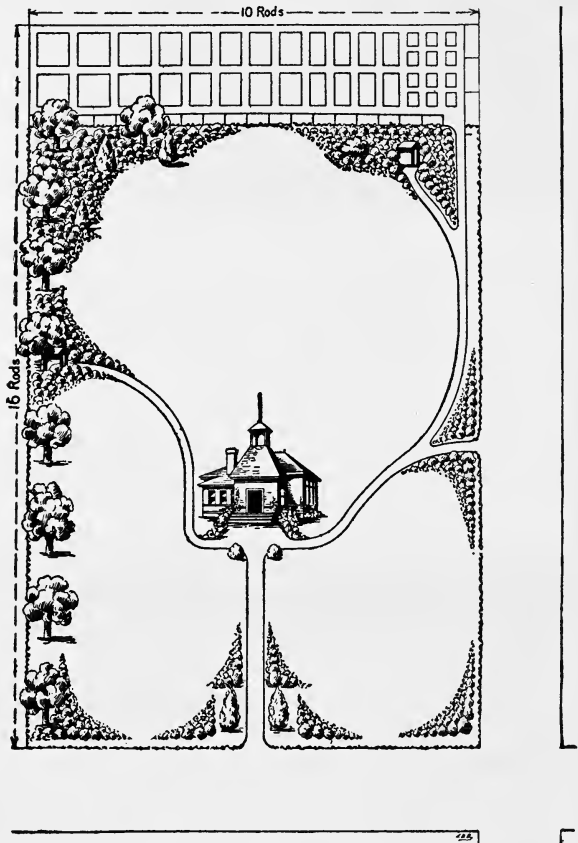


FIG. 101.—Planting plan for a one-acre school-yard, with school garden plots at the rear. The trees and shrubs are not scattered over the lawns and playground. (Agricultural Education.)

a whole row or a section across several rows instead of a small bed. In this way the students can learn to garden as at home. They may use the drill and wheel hoe if the school can afford these implements.

*The place* for the school garden should be handy to the school but not necessarily on the land owned by the school. Do not let its location interfere with the school play-ground. See the location in Figs. 97 and 101.

The garden need not be very large, but let the size be whatever is available and make the best use of it.

**Equipment and Seeds.**—Under most circumstances a fence will be required. A neat woven wire fence will keep out chickens and dogs as well as larger animals.

The school need not own the plow and horse tools. The horse work will be done by volunteers or by those paid for doing it. The school may own several good hand rakes and dibbers, a few hoes, a few spades, lines and stakes for marking the rows, and some sprinklers for watering. Seeds may be purchased in small packages, and schools may also get seeds for school gardening by writing to the Bureau of Plant Industry, United States Department of Agriculture, Washington, D. C.

**EXERCISE.**—*Making a Hot-bed.*—Allow the larger boys to make a hot-bed according to directions in this chapter. (See Fig. 98.) Probably most of the materials may be brought by students. Two small sashes may be held together by two strips of wood along the edges. When it is all made, put in the manure and soil, and when the bed has become warm plant lettuce and radish seeds. It is well to keep a thermometer inside as a guide in governing the temperature.

**What to Plant.**—One plan to follow in the spring work in the school garden is to plant such crops as will give results before school closes for the vacation (Fig. 102).

Some of the quickest crops for spring use are lettuce, radish, early peas, onion sets, spinach, early carrots, and in some cases there might be time to grow very early potatoes.

The plants that could be left growing in the school garden through the summer vacation would be late potatoes, tomatoes, squashes, egg-plants, late beans, late cabbages,

late onions, late beets, turnips, and celery. These should be taken care of by some one living near who is appointed for the purpose. The summer garden is too often neglected. Rhubarb and asparagus may be planted in spring, and when well established will be a good feature of the spring garden.

The fall season is not a bad time to start a school garden. At that season we may start vegetables that will live over winter, such as kale, winter onions, spinach, and others. The cold-frame may be used to store over winter plants that were started in the warm fall weather. Lettuce, cabbage, and



FIG. 102.—Children's garden, Red Wing, Minn. (Agricultural Education.)

cauliflower may be kept over and get an early start the following spring.

The hot-bed may be used in the fall to produce quick crops of lettuce and radishes.

Fruits and flowers should also be used a great deal in the school garden. Select those which will bear the blossoms and fruit at a time when the school is in session. Early strawberries may be used if school is not closed too early. Plant the permanent crops at one side of the garden to allow free use of the plow in preparing for annual planting. (See Fig. 97.)

**Garden Experiments.**—The school garden in both city and country should be a place to experiment. Something

should be learned besides how plants grow. Such experiments as some of the following may be tried even in window boxes, or plant trays (Fig. 103):

Determine the influence of depth of planting as suggested by Fig. 77. But try it in the garden as well as in the school-room.

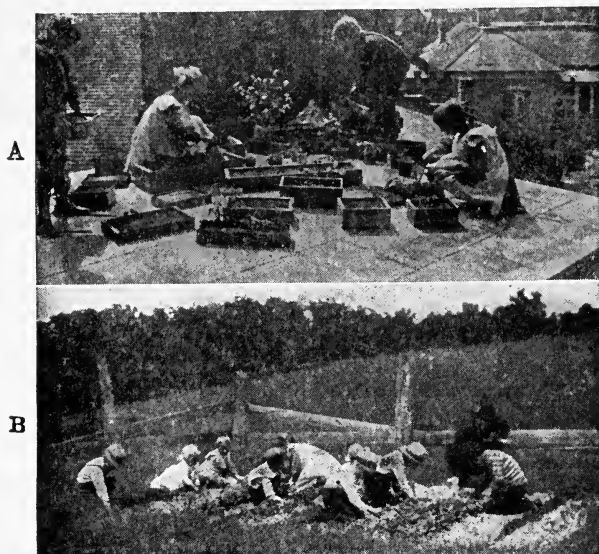


FIG. 103.—A. The roof garden made by children. The city is a place where many experiments may be tried.  
B. School garden work; a lesson in thinning plants. (Agricultural Education.)

Compare two parts of a row with and without dust-mulch methods.

Try potatoes by the “level culture” and the “hilling up” methods.

Grow crops that are not commonly raised in the section; perhaps some new legumes, as alfalfa, cow peas, soy beans, or vetch.

The effects of certain fertilizers or of lime may be tried

on certain rows and other rows next to them left untreated. In like manner the effects of spraying may be tested.

Many soil experiments may be tried in the garden. Test the soil with litmus paper for acids. Test the temperature of the soil in spring and fall.

Cover a square foot with black material, as charcoal, and another square with lime. Then test the soil again to see if the sun heats one soil more than the other. Which?

Compare the packing, baking, and crusting effects of sandy soil and clay soil.

Germination tests may be made to show the benefits of pressing the soil against planted seeds; to show the effect of too much water, which excludes the air; to determine the length of time for sprouting of seeds of different size, as large and small radish seed, or the tip kernels and middle kernels of an ear of corn.

**Use of Products.**—If there be suitable products from the school garden let them first be used for making up an exhibit at school. Later they may be sold to get money for the garden expenses.

**School Garden Plots at Home.**—Much of the summer gardening may be done at home by the students. Parents should be requested to set aside a stated area for use of the pupils at their homes. On this plot they may grow the crops desired for school exhibits. Corn and other crops may be grown in home plots better than at school during vacation. Let fertilizer experiments, culture trials, and spraying be conducted by the students on the home plots. Suitable bulletins and leaflets may be obtained outlining contests to be carried on during the vacation. The products may be shown at school in the fall.

**Ornamental Gardening.**—The appropriate use of trees, shrubs, vines, greensward, or grass plots, and flowering plants to adorn a place is sometimes called *landscape gardening*. Too little thought is given to this by the average



person. The school grounds and the home grounds too often show no ornamental planting.

**Principles of Planting.**—There should be a lawn on which green grass is growing thriftily, but which is well trimmed. This should cover most of the area.

The trees and shrubs should not be planted in rows nor scattered at random over this greensward. They should be in groups, masses, borders, and corners (Fig. 104). Large trees may be in rows along roads or streets.

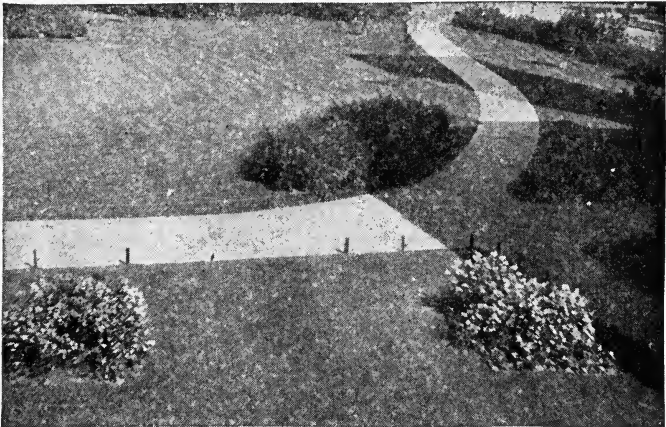


FIG. 104.—Arrangement of shrubs at the bays and angles of the walks to give a pleasing picture.

Shrubs may fringe curved walks and driveways, but are more satisfactory if massed in the angles or curves of the driveways. Let them form the footing about the foundations of buildings—hiding the naked feet of the structure.

Masses of shrubs and trees or vines on trellises should hide any unsightly structures from view (Fig. 105).

Let all the planting assume grace and natural curvature of outline. Do not prune the evergreens and shrubs to

assume grotesque and artificial forms. Such were the fashions of ornamental gardening many years ago.

The lower branches of evergreens and shrubs should be left near the ground and carry the pleasing effect of blending the foliage with the greensward (Fig. 106).

Vines may be used about porches and on trellises over the corners and in the angles of buildings. They remedy the angular effects and lend a softening beauty to the rugged structure.

*The School Grounds* should come in for their full share of attention in the study of ornamental planting. Dr. L. H.



Fig. 105.—Vines are here used to cover a glaring white stone building. The mass of trees at the left is used to hide low buildings.

Bailey has described the conditions on the average rural school grounds as “bare, harsh, cheerless, immodest.” These are some reasons assigned for children disliking the school.

Let a change be made. Have plans made before the opening of spring.

**EXERCISE.**—*Plans for Planting.*—Make a sketch of the grounds showing the permanent structures, well, fences, and any trees now growing. Add to this the proposed plantings for the spring. Indicate these by lines such as are used in Figs. 97 and 101. Use United States Farmers’ Bulletins 185 and 248 to aid in making the plans. The former will suggest what plants to use. Students may supply these from home,

or they may be obtained from the native woods or from nurseries.

*Planting* may be done on any suitable days in early spring. Protect the roots of trees well before they are planted. The easiest way is to make a little trench, put the

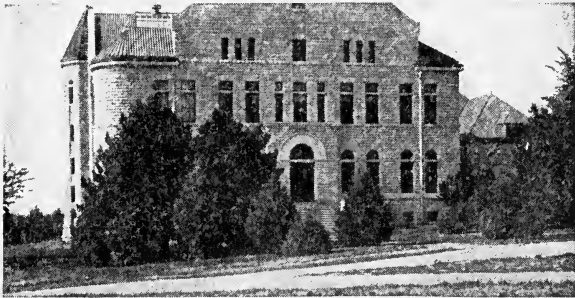


FIG. 106.—Evergreens may be planted in close masses and also as single specimens.

roots in these and cover with dirt until the permanent places are ready. Evergreens need to be handled with the greatest care, because they are constantly losing moisture through the leaves. The soil should not be removed from the roots at all while being transplanted. They may be set into small boxes while being carried, or the soil may be kept on by wrapping with old carpet or sacking.

## REVIEW.

1. What is horticulture? Olericulture?
2. Give several elements of success in growing good vegetables.
3. Describe a good plan for the vegetable garden.
4. Name ten garden plants that can stand some frost.
5. Name ten that are injured by frost.
6. Give directions for depth of planting seeds in heavy and light soils.
7. Tell how to set out tomatoes and other garden plants.
8. What is a hot-bed? A cold-frame?
9. In what two ways is a hot-bed heated?
10. What are the uses of a hot-bed?
11. What is succession-cropping? Give examples.
12. What is companion-cropping? Give examples.

13. Tell how to store for winter use some of the common vegetables.
14. What is the best kind of fence for the school garden?
15. What are some of the best vegetables for the spring garden?
16. What ones may be planted in spring for fall use?
17. What ones may be started in fall and live over winter?

**References.**—United States Farmers' Bulletins: 218, School Garden; 232, Okra; 254, Cucumbers; 289, Beans; 354, Onion Culture; 434, Onion Seed and Sets. 642, 1233, Tomatoes; 707, Cantaloupes; 1253, 1255, Peas; 856, 934, 937, 1044, 1242, Home Gardening. Ark. Sta. Bul. 21, Tomato Diseases; 46, Storage. Ark. Ext. Circ.: 107, Cantaloupes; 110, Garden Clubs; 113, Tomatoes; 127, Watermelons; 140, Home Gardens.

See pages xxiv and xxxiii.

---

## CHAPTER XIX.

### FRUIT PRODUCTION.

**THERE** is an active interest in the growing of good fruit. Almost every farmer is interested in the subject. He may grow it for his own use if not for market. Fruit may be considered among the luxuries of the table. As the people become more prosperous they call for more such luxuries. Thus the demand for fruit of the best quality is increasing.

**The Orchard.**—The production of fruit naturally involves more time than the growth of most farm crops. For this reason more care must be exercised to have the best conditions possible from the very beginning.

**The Orchard Site.**—Exposure, soil, and air-drainage are all-important considerations. If the orchard is somewhat above the surrounding land, the cold air of frosty spring nights can drain away. Thus the early blossoms may be saved from injury. Strong westerly winds are often injurious to trees and, therefore, an easterly or northeasterly slope is preferred. If a south slope were chosen this might cause more movement of sap in winter or very early spring. We should avoid forcing the spring growth too early.

Heavy soils are well suited to the growth of apples and pears; while the lighter soils are better for peaches, American plums and grapes.

The propagation of fruit trees at home and in nurseries has been described. (See Chap. III.)

**When to Plant Fruit Trees.**—The age of a fruit tree is counted from the time of its first spring growth after budding or grafting.

Peach and plum trees are usually transplanted to the orchard after one season's growth in the nursery. They are then called yearling trees.

Apple trees for orchard planting may be either one or two years old. Some orchardists prefer the younger trees, while others want them older.

The planting may be done in late fall or early spring, the latter being preferred.

**Setting Orchard Trees.**—As much fibrous root should be preserved as possible. The roots should be kept from the wind and sun to prevent drying out. As soon as delivered at the orchard, heel them in. That means to cover the roots with soil in a temporary trench.

The holes should be large and some of the best loose dirt thrown in the bottom before the tree is placed in it. The roots are to be straightened out, not bent. Pack the richest dirt well, but leave a mulch of loose soil on top to prevent evaporation of soil moisture.

In dry weather and in dry climates it is well to haul water in barrels or tanks and water each tree soon after it is set. The loose soil is to be put on after the water has soaked into the soil.

**Principles of Pruning.**—The pruning of trees is very essential in securing the best results in fruit growing. Various parts naturally crowd each other; the fruit is smaller as a result of this. Twigs or branches become diseased and should be cut out. Limbs may break in the wind and should

be sawed off smoothly so the wounds may heal quickly. In spite of these conditions we find many old orchards that are neglected and never pruned.

**Young Trees.**—When a young orchard is set out the roots should be examined and any broken or split surface made smooth with a sharp knife. The straggling or extra long roots should be cut back. The tops should be cut back to a suitable height. With a one-year-old tree this may cause the formation of side branches to make the future *head* of

FIG. 107.



FIG. 108.



FIG. 107.—Peach tree headed too high.

FIG. 108.—Low-headed peach tree at pruning time.

the tree. It is best to head trees low enough so they will be within easy reach of pickers. Compare Figs. 107, 108. Fig. 109 shows the relative position of the young twigs that will become the future main branches: (A) represents the position of these on an imaginary circle drawn around the tree. Here there are three branches; perhaps four would do as well. These should be at different heights on the main stem (B), to avoid splitting away from each other when there is a heavy wind or load of fruit.

**Annual Pruning.**—As the trees grow older it is well to cut back a part of the new growth each year to induce proper

branching of the long shoots. This will induce the formation of fruit buds, fruit spurs and future fruit crops lower down on the branches, and the support will be better.

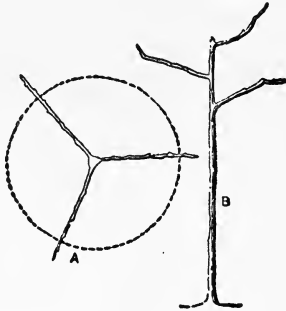


FIG. 109.—A shows the choice limbs which extend in different directions from the main axis; others are cut away. B shows the same limb of the mature tree. If they are the same height they will be split off too easily by wind when loaded with fruit

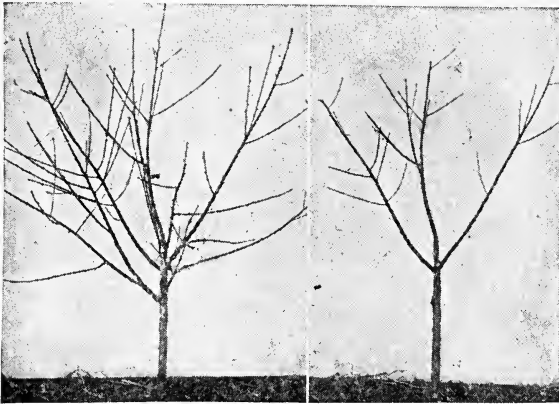


FIG. 110.—Yearling peach tree, before and after pruning.

Cut out some side twigs where they strike across through the tree top. Prune where they are too thick; such pruning is equivalent to thinning the fruit, making it larger. Let in the sunlight. Cut out all dead or diseased or broken parts. Prune where branches rub together. (Fig. 110.)

**Care in Pruning.**—Avoid cutting very large branches if several smaller cuts will accomplish the same result. Large wounds are apt to lead to internal decay.

Leave the cut surfaces as smooth as possible. If a saw is ever used, the wound should be smoothed with a knife.

Cut side limbs as close to the main stems as possible. Never leave stubs (Fig. 111).

Cover the exposed tissues of the larger cut surfaces with paint or grafting wax to prevent weathering and decay.

**Time to Prune.**—Pruning by pinching off small shoots and disbudding can be practised to very good advantage in

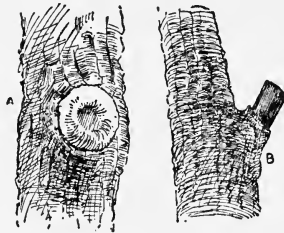


FIG. 111.—Side limbs should be cut very close to the main stem, so the place may heal over and get “well.” A was properly pruned; B was pruned too far out.

the summer time (Fig. 112). The main pruning, however, is done in very early spring before the sap begins to flow. Some plants, such as grape vines, will bleed or lose much sap if pruned too late in the spring.

**EXERCISE.—Fruit Buds.**—Twigs bearing both fruit buds and leaf buds may be selected from the different kinds of fruit trees in the neighborhood. Compare these and learn to recognize fruit buds on trees in winter (Fig. 113).

**EXERCISE.—Pruning.**—A small tree or upright branch from the woodlot may be cut and brought to school. Let pupils first mark with chalk what limbs and twigs should be taken off. Then have the pruning done in accordance with the lesson taught in Fig. 109. Either sharp knives or special pruning shears (Fig. 114) may be used in this exercise.



**Culture.**—The young orchard should be kept growing rapidly. Considerable organic matter and nitrogen in the soil will help produce this early growth. To obtain these materials the best fruit growers sow cover crops in the orchard each year, to be plowed under in the spring. If these crops are composed partly of legumes, such as crimson clover and



FIG. 112.—Young peach tree, summer pruned by pinching off small shoots.

winter vetch, they will gather the nitrogen for the young trees to use. After the cover crop or green manure is plowed under in spring the ground is kept well harrowed until mid-summer (Fig. 115); then the cover crop is again sown. One influence of the fall cover crop is to check late fall growth, especially in peach trees, and cause the season's growth to harden up for winter.

The first year or two some orchardists grow a crop for market between the trees. In such cases this crop should have clean culture until July or August. Fall cultivation is not desirable, as the young shoots are more apt to winter-



FIG. 113.—Fruit buds and spurs of four common fruit trees, apple and pear at left, plum and cherry at right.

kill if kept growing too late. For economy of space peaches are frequently used as *fillers* or temporary trees, in rows between apple trees. The peach trees come into bearing by the third or fourth summer and may be past their prime by the time the apple trees are large enough to fill the space between rows. The peach trees are then cut out. Where

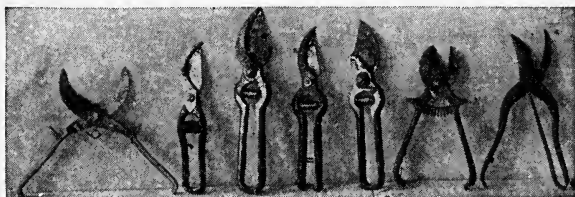


FIG. 114.—Several forms of hand pruning shears.

fillers are used, the permanent trees should be set from thirty to forty feet apart, according to variety and soil.

**Varieties.**—Choose varieties carefully. There are many good varieties to choose from, in all kinds of fruit. Select those which are known to do well in your own climate and on similar soils. Prof. M. A. Blake, of the New Jersey

Experiment Station, names the following varieties of peaches in order of ripening as a suitable list from which to choose: Carman, Hiley, Champion, Belle of Georgia, Elberta, Fox Seedling, Edgemont Beauty, Iron Mountain, and Krummel October.

Varieties of apples are classified as summer, fall, and winter, according to the season when they are in prime con-



FIG. 115.—Cultivating an orchard with a disk harrow. Where the land is level enough to prevent bad washing of the soil, orchards should be cultivated throughout the first half of each summer. Plows and disk harrows may be used in early spring. These are followed by spike-toothed harrows or light cultivators.

dition of maturity. Good varieties may be chosen from the following lists:

<i>Summer</i>	<i>Fall</i>	<i>Winter</i>
Yellow Transparent	Wealthy	Tompkins King
Williams Early Red	Twenty Ounce	Baldwin
Duchess of Oldenburg	McIntosh Red	Rome Beauty
Maiden Blush	Grimes Golden	York Imperial
Gravenstein	Jonathan	Stayman Winesap

The above is merely a suggestive list. The planter is to be governed in his choice of varieties by the results of other growers about him in his vicinity. Only one or two varieties of each season should be grown for market purposes.

**EXERCISE.**—*Studying Apples.*—In the fall or winter let students each bring to school good type specimens of apples. Let each tell the names of the apples he brings. The collection may be studied and the varieties compared so the students will learn to know many of them. At noon or recess on the last day of this study let the apples be cut into sections so that they may be sampled as to flavor, texture, and value.

**Strawberries.**—One of the best fruits for home use, as well as for market, is the strawberry. There are not many difficulties in growing this crop successfully. Probably the



FIG. 116.—The hedge-row system of raising strawberries. The straw mulch is kept between the rows until after picking time.

greatest difficulty is in harvesting the crop after it is grown. Strawberries thrive best in a very rich black sandy loam.

**Two Methods of Planting.**—There are several methods of planting strawberries. Two are here described, (1) the hedge-row system and (2) the matted-row system. In either system the plants may be set in the early spring, or in August if the weather is favorable. *In the hedge row system* (Fig. 116) the rows are three feet apart and the plants are set two feet apart in the rows. The runners, which all strawberries send out, are kept cut off with a hoe or wheel cutter; except that about three runners are placed and allowed to take root between each two plants, making the plants about six

inches apart in the row. Frequent cultivation is practised throughout the first season and the blossoms are picked off to prevent any fruit from forming. About December first a clean mulch of straw or other clean litter is spread over the soil and vines to a depth of two or three inches. In spring this mulch is parted just a little over the rows to let the green leaves come through, and the mulch remains on the soil between the rows until the crop of fruit is all picked. Then the plants are mown and the mulch and tops raked and burned. This destroys the diseases and insects. Thorough cultivation is given until late fall and a mulch is again put on as before. After two or three crops are obtained, the plants are plowed under.

*In the matted row system* of planting, the plants are set three and one-half or four feet apart and the plants about two feet apart in the row. Cultivation is given the first year, but many of the runners sent out by the plants are allowed to "take root" and form new plants in the middles or aisles within about one foot on each side of the mother plants. A mulch should be applied for winter, but it is again removed in the spring. After the crop is picked each year the weeds are pulled by hand from the wide matted row of plants formed by the runners. The narrow strips are cultivated as before. When two crops are obtained the vines should be plowed under.

**Comparison of the Two Systems.**—The hedge-row system requires more vigilant care to prevent runners from taking root, and an equal amount of horse power cultivation is given to the plants. But there is very little hand weeding necessary, as in the matted row. The mulch kept on the soil through the berry-forming months keeps the fruit cleaner; it keeps down weeds, and conserves the soil moisture. In the hedge-row system the berries are larger and cleaner; the yield of marketable fruit is greater, and the work of picking is less.

**Varieties.**—The many varieties of strawberries are grouped under two heads (Fig. 117), (a) Those with *perfect* blossoms, bearing both stamens and pistils, and able to produce fruit without the aid of pollen from other plants; (b) *Imperfect varieties*, those which have no stamens to bear pollen, having pistils only; these must get their pollen from other perfect varieties near them. *Perfect varieties* may be planted alone. Imperfect varieties must grow by the side of or near perfect ones which blossom at the same time. The pollen is carried from one blossom to another by bees and other insects.

For the choice of varieties and methods of growing strawberries reference is made to U. S. Farmers' Bulletin 198.



FIG. 117.—Flowers of strawberry, pistillate on left and perfect on right.

**Other Small Fruits.**—In addition to the fruits which have just been described, the home fruit garden should contain such fruits as grapes, black and red raspberries, blackberries, currants, and perhaps gooseberries. These are all so easily grown that very little special training is necessary for any one to produce enough fruit for home use. The site for the home fruit garden should be chosen not far from the residence. The soil may then be enriched and put in good tilth.

**Pruning Small Fruits.**—The beginner has greatest difficulty in questions of pruning. When the plants are being set out, all broken or decayed roots should be trimmed off; smooth-cut surfaces only should come next to the soil. The top should be cut back somewhat in proportion to the reduc-

tion of the root area in transplanting. This maintains the proper balance of root and top in the next season's growth.

**Grapes** need very little of the old wood left for the following season's growth of vines and crop of fruit. The fruit is annually borne on shoots of the same season's growth (Fig. 118). Better grapes are obtained by cutting away considerable of the old wood each winter.

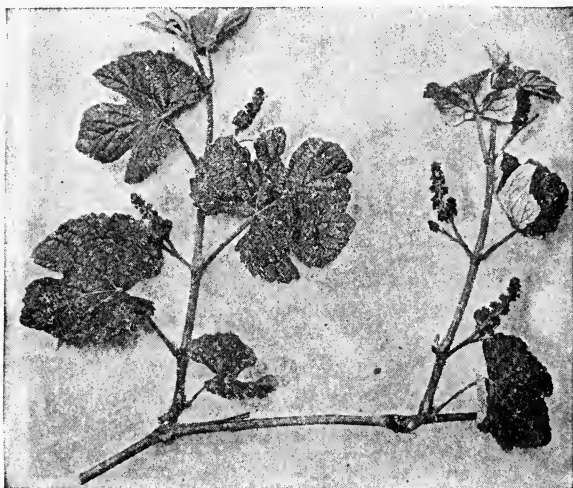


FIG. 118.—The grape-vine showing blossom clusters on the new shoots.

**Raspberries and Blackberries** both bear their blossoms and berries on the end of new shoots. These shoots come from the last year's canes. In summer, after the crop is picked, cut out all of the old canes, and either head back or cut away entirely many of the young canes. This heavy pruning induces the growth of new canes from the crowns. These will bear the fruit branches next season.

**Currants and Gooseberries** should not be pruned so much each year. The fruit is borne on both old and new wood, and only the very oldest parts need to be cut out.

**The Fruit Crop.**—When good fruit has been grown it should never be handled carelessly. Never shake apples, peaches, or other kinds of fruit to the ground. Pick the crop



**FIG. 119.**—Picking apples from ladders with sacks hanging from shoulders. The fruit is not bruised.



**FIG. 120.**—A. A good way to pack the best peaches for market. The crates each hold six half-peck baskets, and are called Georgia carriers.  
B. Sorting apples. For marketing they are packed in tight boxes and barrels.

carefully, handling it almost as carefully as eggs. Bruised spots are the first to decay (Fig. 119).

Pack the perishable kinds of fruit—grapes, berries, peaches, plums, and cherries—in suitable form for immediate



sale in the markets (Fig. 120, A). Peaches, plums, apples, and pears should be graded according to size, color, and other market features. More money is thus secured for the whole crop. When large and small apples are sold in the same barrel or box they bring only the price of small apples (Fig. 120). Grading machines are in use for sorting peaches or plums into several sizes; but the hand method is most common. Study the figures showing methods of picking, sorting, packing, and marketing.

Summer apples keep only a short time and must be marketed soon after they are ripe. Late fall and winter apples are often stored for sale or use later in the winter. A good method is to pack them in closed barrels and store in a cold cellar at a temperature just a little above freezing. When exposed to dry cellar air they shrivel badly.

### REVIEW.

1. Give reasons for pruning trees.
2. Tell what side limbs to save in pruning young trees just set in the orchard.
3. What annual pruning should be done in the orchard?
4. Give several rules to observe in careful pruning.
5. Describe a good orchard site.
6. Describe good culture methods for young orchards.
7. What are *fillers* in an apple orchard? Tell how used.
8. Name several varieties of peaches. How many of these have you seen?
9. Name some good summer apples. Fall. Winter. How many varieties do you know at sight?
10. Describe the hedge-row system of growing strawberries.
11. Describe the matted-row system.

References.—U. S. Farmers' Bulletins: 727, Home Fruit Garden; 181, Pruning; 471, Grapes; 482, Pears; 492, Enemies of Apple; 492, 852, 938, 1080, 1160, 1204, Apple; 917, 918, 1266, Peaches; 643, Blackberries; 1026, 1027, 1028, Strawberries; 670, Field Mice; 685, Persimmons; 696, Citrus Fruits; 702, Rabbits; 710, Bridge Grafting; 728, Dewberry 763, Barkbeetles; 1128, Aphids. Ark. Sta. Bul.: 20, 42, 109, 123, 134, 141, 149, Orchards; 174, Grapes. Ark. Ext. Circ. 104, Strawberries; 95, 146, Orchards.

See pages xlii and xliii.

## CHAPTER XX.

## INSECTS.

FARMERS, market gardeners, and fruit growers have their enemies to combat. Their crops and animals are attacked by numerous species of insects. It is estimated that hundreds of millions of dollars are lost by the American farmers annually from this cause. Fruit that is infested or deformed by insects will bring much lower prices than first-class fruit.

**Structure.**—Insects are six-legged animals with the body made up of segments or covered with a series of rings. There are two pairs of wings, except that flies and mosquitoes have only one pair, and in a few species of all orders the wings are undeveloped or are entirely wanting, as in the case of the bedbug. All insects in the adult stage have the body divided into three parts: the *head*, the *thorax*, and the *abdomen*. The head bears the *mouth parts*, the *antennæ* or feelers, and the *eyes*. The thorax, or chest, bears the *wings* and three pairs of *legs*. See Fig. 122d.

Many insects have enormous powers of flight, as in the cases of the dragon fly and the honey bee. The Rocky Mountain locust is a migrating insect and probably flies a hundred miles or more at a single flight. Some of the larger beetles seldom fly very far at a time.

**How Insects Feed.**—The mouth parts of insects are of two kinds: those fitted for *biting*, as in grasshoppers and beetles, and those suited for *sucking* the food, as in mosquitoes, bedbugs, bees, butterflies, and others.

Those with biting mouth parts have two pairs of jaws with which they cut and chew their food (Fig. 138). They consume the entire substance on which they feed, as bark, leaves, fruit, flowers, or other tissues (Fig. 121). Such insects, when found on the outside of plants, may be killed by the

application of some poisonous material to the plants on which they feed, as when we put poison on potato vines to kill the potato beetles. When biting insects such as bark beetles and tree borers feed in protected places it is impossible to apply the poison, and some other remedy must be found if possible. To decide what remedy to use we must first know the kind of mouth parts and the feeding habits of the insects.

Insects with sucking mouth parts usually live upon the sap of plants or the blood of animals; a few of them, such as bees, butterflies, and moths, largely feed upon the nectar of flowers. The stone-fly and a few others get most of their

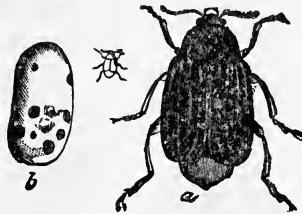


FIG. 121.—Bean-weevil, natural size and enlarged, and a much infested bean. (From Smith's "Insect Friends and Enemies.")

food when in the *larva* or youngest stage and have no true mouth parts when they come to the adult stage. Such insects live only a short time in the *adult* stage, their chief purpose being to lay eggs for the next brood; when this is done they soon die.

The larva form of the butterfly has a biting mouth, while the adult has a sucking mouth. This is also true of flies and mosquitoes.

As sucking insects get their food from the inside and not outside the objects on which they feed, we cannot poison them. We must resort to more difficult methods of fighting them.

*Contact insecticides* are substances which will kill insects by coming into contact with them or by covering their bodies.

The manner in which these insecticides kill is interesting. Insects breathe through pores or openings in the body—not through noses or mouths. When any material clogs these breathing pores the result is death. Suitable materials for this purpose are oils and powders. The oils may be mixed with other materials to prevent any damage to the plants on which the insects live. Kerosene emulsion and the miscible oils are so diluted that no damage will result to the trees or other plants.

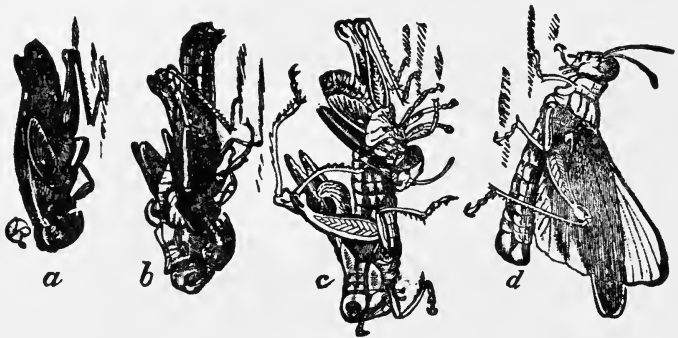


FIG. 122.—Moulting of a grasshopper: *a* nymph ready to change; *b* the skin split along the back and the adult emerging; *c* continues the process, and at *d* the insect is drying out. (From Smith's "Insect Friends and Enemies.")

It must be remembered that these contact insecticides really smother the insects and must necessarily be applied when the insects are present. They should not be applied in advance, as poisons may be, to prevent the attacks of the insects.

**How Insects Grow.**—The skin or outside coat of insects becomes very hard and will not stretch. When a growing insect has become so large as to entirely fill this coat, a new, soft coat forms underneath and the old one is shed. This process of shedding the coat is called *moulting* (Fig. 122). The skin is *moulted* several times during the life of the insect, and each time the insect becomes larger or changes in other

respects. The chief changes with many insects occur in the last two moults. As insects have no bones or inside skeleton it is usually considered that the outside skin is really a *skeleton*. In this sense they may be said to have an outside skeleton. Muscles of the insect are attached to this skeleton; and sometimes the texture is very hard and horn-like.

**Complete and Incomplete Changes.**—All insects may be classified on the basis of the amount of change occurring in their structure during the last two moults. (1) Those making the least change in structure and appearance during the last two moults are said to have *incomplete changes*. Examples of this are the true bugs and the grasshoppers. (2) Those making very great changes in structure and outside appearance at the times of the last two moults are said to have *complete changes*; this is seen in the wasps, bees, butterflies, moths, beetles, flies, and mosquitoes.

**Four Stages in the Life.**—Insects with complete changes may be said to have four stages in their lives: (1) Egg stage, (2) larva stage, (3) pupa stage, (4) adult stage (Fig. 123).

*The larva* is the growing stage. It is during this stage that most of the eating is done; and with some insects enough is eaten during this stage to last them through the other stages of life. Some forms of larva will consume several times their own weight of food in a single day.

*The pupa* is the resting or sleeping stage for many insects. The larva has enclosed itself in a case of some kind; sometimes it spins a silken covering called a *cocoon*, as in the case of the silk worm and others. During this quiet resting stage the insects go through a great many changes. The digestive organs are very much changed; wings are grown and ready to unfold; legs are present instead of mere claws or pads; compound eyes are developed; often a very different mouth is formed; antennæ or feelers are grown upon the head. The pupa stage sometimes lasts over winter, and in other insects or other broods it may last only a few weeks.

The adult emerges from the pupa case with the new set of organs just mentioned. It does not look like the larva that formed the pupa case about itself, and yet it is the same individual. When a butterfly comes from its pupa it crawls upon some object, as a plant stem, where its folded wings may

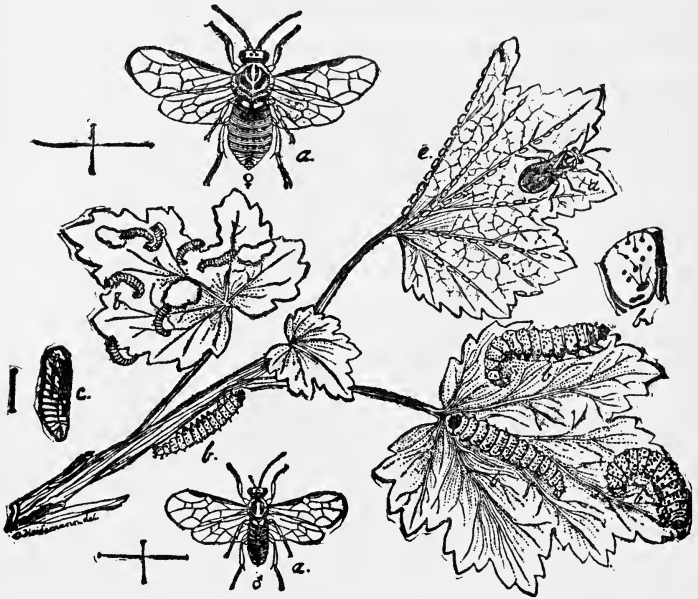


FIG. 123.—The currant worm: *a*, adults; *b*, larvæ in various stages of development; *c*, pupa; *e*, eggs along veins on leaf. (From Smith's "Insect Friends and Enemies.")

hang downward. The wings gradually unfold or "grow" and in about twenty or thirty minutes they may be of full size and firm enough to use in carrying the insect in the air. The adult never moults and never grows any larger.

*Special names* are given to some forms of larvæ. The larvæ of butterflies and moths are called *caterpillars*. The larva of a beetle is called a *grub*. A *maggot* is the larval form of the fly. Mosquito *wrigglers* are really the larvæ.

*Nymph* is a name given to the larval stage of dragon flies, stone flies, grasshoppers, and some others having incomplete life changes.

EXERCISE.—*Collecting Caterpillars*.—Late in fall let pupils bring to school caterpillars or other larvæ of several kinds which they may find. Let these be placed in boxes with wire or cloth gauze tied over them. Place in the bottom of the box some soil and insert in this some of the twigs with leaves for the larvæ to feed upon. If the caterpillars are found on plants, that will indicate what food they prefer. If they form pupa cases in the cage, these may be kept in a cool place until the warm weather of spring brings them out. Or they may be induced to transform to the adult stage by bringing them into a warm room for a few weeks in February or March.

EXERCISE.—*Collecting Cocoons*.—Cocoons and pupa may be collected during the winter months and brought to school, where the transformations may be watched.

EXERCISE.—*Making Glass Cages for Insects*.—Let the pupils bring a few tin cans or six-inch flower pots, some large glass chimneys, such as lamp or lantern chimneys, and cloth netting. Damp soil may be kept in the pots and the chimneys placed over them with gauze tied on the top of the chimneys (Fig. 124). The cages may be used at school for insects that are to be observed by the pupils. Suitable plants may be kept fresh by inserting the stems in a small bottle of water inside the cage.

**Insect Enemies of Man.**—Among the many kinds of insects there are those that are beneficial and others that are injurious. Some of the injurious insects are found attacking man himself; others his prepared food and clothing; and others harass the domestic animals, or attack the crops in the field, garden, or orchard.

**Mosquitoes.**—Mosquitoes are not only troublesome pests; they are worse than that, because they are carriers

of the germs of human diseases. *Malaria* is spread by mosquitoes, and in no other way. These malaria organisms are taken into the system of the mosquito with the blood sucked from diseased people. In the mosquito's body certain

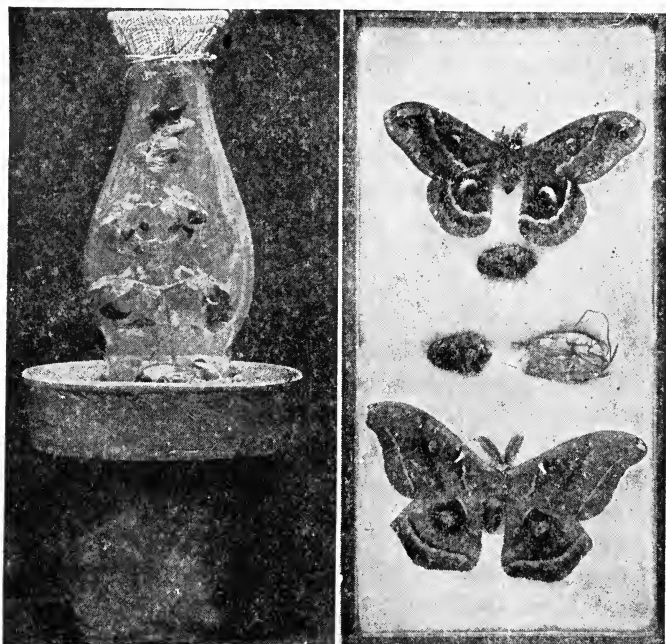


FIG. 124.—A. An insect breeding cage, easily made. (Agricultural Education.)  
B. Moth and pupa cases mounted on cotton under glass. Male cecropia moth above, male polyphemus moth below. (U. S. Office of Experiment Stations).

changes take place in the life of the organisms which can take place nowhere else. If the mosquitoes were exterminated the organisms of malaria could not thrive. When a mosquito attacks a well person some of the germs of malaria are apt to be forced into the blood of the person by the sucking mouth parts of the insect. Thus every new case of malaria is started.



The remedy is easy to understand. If the ponds or pools of standing water are taken care of, the malarial mosquitoes will not be able to find suitable breeding places. These stagnant waters may be drained away, or covered with crude oil, or fish may be kept in them to feed upon the wrigglers. Barrels and other vessels of water must be emptied or covered with oil. Houses should be screened to keep out mosquitoes. It is believed that the malarial mosquitoes are never active during the day when the sun is shining.

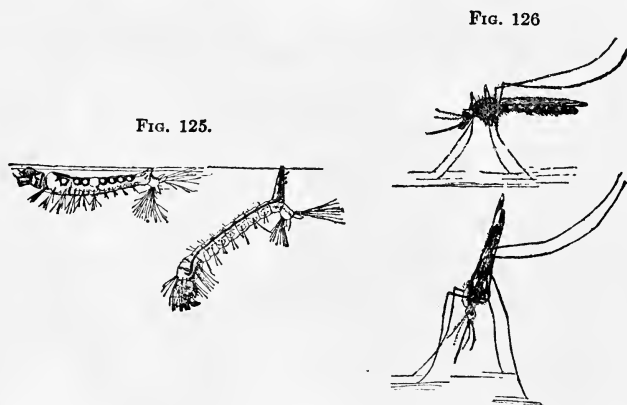


FIG. 125.

FIG. 126

FIG. 125.—Malarial mosquito wriggler at left, common at right. (Div. Ent., U. S. Dept. Agric.)

FIG. 126.—Malarial mosquito below, common above. (Div. Ent., U. S. Dept. Agric.)

It is not difficult to distinguish the malarial mosquitoes from the other common forms. The position of the wrigglers in the water when at rest is parallel to the surface of the water, while the resting position of the common mosquito wriggler is nearly perpendicular to the surface of the water (Fig. 125). When the adult malarial mosquito is attacking a person the body is nearly perpendicular to the surface attacked; while with the common mosquito it is nearly level with the surface (Fig. 126).

*Yellow fever* is also spread by mosquitoes of a particular

group (Fig. 127). This is a common form in the South. The bodies of the insects are striped with bands of black and white. By removing the breeding places of these insects the yellow fever disease has at times been stamped out in New Orleans and elsewhere.

**EXERCISE.**—*To Study Mosquito Wrigglers.*—Put a glass of water from a rain barrel, with a few wrigglers in it, on a window sill. Cover it with a sheet of wire gauze to catch any that transform. Observe the breathing tubes that are held up to the surface of the water when the wrigglers are at rest.

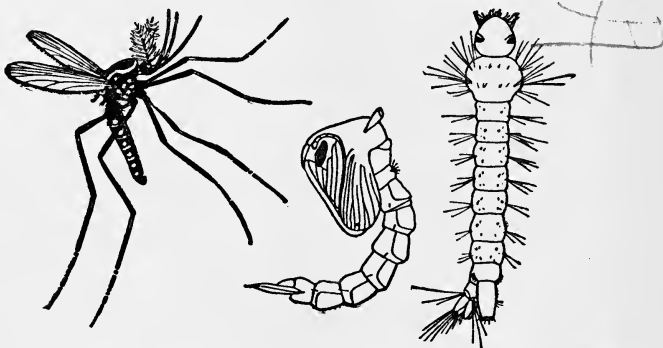


FIG. 127.—The yellow-fever mosquito, larva, pupa, adult. (From Smith's "Insect Friends and Enemies.")

**Flies.**—The eggs of flies are laid in moist masses of decaying refuse, such as manure, dead animals, slop, and many kinds of garbage. When the eggs hatch the maggots use those materials as food and grow rapidly. Then they cover themselves with a leather-like pupa case, from which they emerge in a few days as adult flies (Fig. 128). The time required for the eggs to develop into adult flies is only a few days. A few of the adult flies live over winter and these are the ones that start the first broods when warm weather returns. By the end of the summer the number of flies has increased enormously.

*Diseases of man* are carried on the feet and mouth parts of house flies (Fig. 129). The swarms of flies seeking suitable places to lay their eggs visit all kinds of filthy places. Again

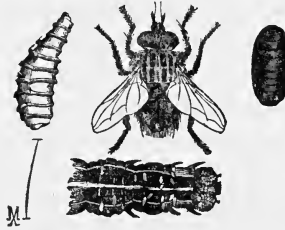


FIG. 128.—A Tachinid fly: its eggs on body of caterpillar, larva and pupa. (From Smith's "Insect Friends and Enemies.")

these same flies visit the kitchens and dining rooms in search of food. Germs of disease, as well as others, are carried from the filthy places to the food over which they crawl. House flies may well be called typhoid flies.

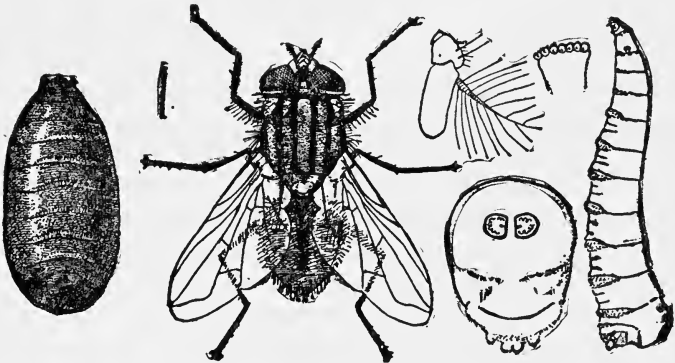


FIG. 129.—The house fly: larva with details at right, pupa case at left. (From Smith's "Insect Friends and Enemies.")

*Two good remedies* are easy to apply. (1) Clean up the near-by garbage heaps and filthy places where flies could breed. Sprinkle diluted carbolic acid all about such places

frequently. This will help to keep flies away from there and will kill many of the germs of typhoid fever and other diseases which might be there. (2) Screen the kitchen and dining-room well to keep all flies away from the human food.

**The Clothes Moth.**—These insects lay their eggs in stored furs, woollen clothing, and other such places. The young eat the garments or materials in which they find themselves, thus doing much damage (Fig. 130). The adult moths do no damage except to start new broods of young. There are several remedies. Probably the best is to keep the adult

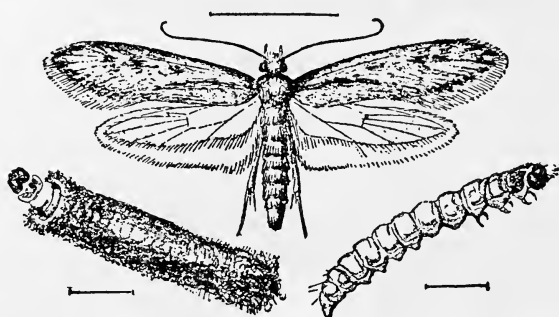


FIG. 130.—A clothes moth, with its caterpillar in and out of case. (From Smith "Insect Friends and Enemies.")

moths away from the stored materials by keeping these articles securely closed up in tight boxes or moth-proof bags, in which there is some odor not agreeable to the moths. Such odors are tar, camphor, naphtha, tobacco, and red cedar. Moth-proof bags may be made of new muslin, sewed well and closely tied after articles are put in. Clothes moths have no taste for cotton goods. Articles will be well protected from moths if kept in a trunk in cold storage. The low temperature prevents the development of the insects.

**Grain Moths.**—The adult grain moth is seen flying about homes or places where corn or other grain has been stored. Its habits and its size cause it to be mistaken for the adult

clothes moth. The eggs are laid on corn and the small grains. The larva eats its way into the kernels, and emerges only when it has transformed to the adult stage. When these insects are in great numbers they do much damage.

*Stored grain* may be treated by evaporating a dish of *bisulphide of carbon* on top of the bin of grain. The fumes settle into the crevices and kill the insects (see Appendix). The bins should be made as close or air-tight as possible during this treatment. Corn in open cribs is seldom troubled with grain moths, except in warm climates, as the cold of winter checks their breeding.

**Chinch Bug.**—This is a showy insect, in spite of the fact that it is less than one-fifth of an inch long, the body being nearly black and the wings white. The chinch bug is a true bug, with a sucking mouth, and has a continuous growing stage from the egg to the adult form. The insects attack wheat, corn, and other grains and grasses, sucking the sap and often destroying the crop or reducing the yield. It lives over winter in the adult stage. A single female can lay several hundred eggs which soon hatch and the numbers become very great by midsummer. After a wheat crop is killed or has ripened they hunt for other succulent crops, such as corn. As only the adults can fly, the greatest numbers have to migrate to the next field by crawling. Efforts have been successfully made to stop their march from one field to another by plowing deep furrows in which tar, kerosene, or other materials may be used to destroy the insects. It is also well to practise rotation of crops, and to plow the fields in fall in places where the chinch bugs are abundant.

**Potato Beetles.**—The Colorado, or ten-lined, potato beetle is known well by all who raise potatoes (Fig. 131). It passes the winter in the pupa stage, and the adult, appearing in spring, lays clusters of yellow eggs on the under side of potato leaves early in the season. These hatch into small, soft, red grubs which eat the leaves. The best remedies

are sprays of poison on the growing crop. Paris green or arsenate of lead is mixed with water or with Bordeaux (bor-dō') mixture and sprayed on the vines two or three times at intervals of a few weeks. The Bordeaux mixture (see Appendix) is used with the poison on potatoes for several reasons. It prevents the injury to leaves by the strong poisons. It holds the poison on the plants longer. It helps to prevent the early and the late blight diseases of potatoes.



FIG. 131.—Colorado potato beetle: a, egg; b, larvæ; c, pupa; d, adult beetles. (From Smith's "Insect Friends and Enemies.")

**The Codling-moth or Apple Worm.**—The worst insect enemy to apple growing is the codling-moth, the larva of which is the apple worm. The markets of the cities do not want wormy apples. The insect which thus destroys the apple crop is shown in Fig. 132. The larva spins a nest or case in the crevices about the trunk of the tree where it lives over winter. The adult emerges in warm spring weather, and lays eggs in the blossom end of the little apple just after the petals fall from the tree (see Fig. 150 C). The larva eats its way into the fruit and feeds about the center. When

fully fed, it crawls out and lets itself down to the ground by a silken thread. Later a second brood may appear, to attack the fall and winter varieties of apples, the eggs being laid on the outside of the half-grown fruits.

*The best remedies* for the apple worm are poison sprays. These may be applied along with other sprays to prevent such diseases as apple-scab and apple-rust. Three pounds of arsenate of lead are mixed with fifty gallons of the other

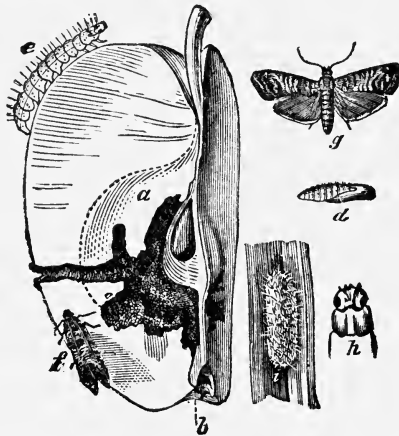


FIG. 132.—Codling-moth and its work: *a*, the injury done; *b*, place where egg was laid; *c*, larva; *d*, pupa; *i* cocoon; *f*, *g* adults. (From Smith's "Insect Friends and Enemies.")

spray material and sprayed on the tree in the form of a fine mist just after the petals fall. The other spray material may be either lime-sulfur or Bordeaux mixture. The calyx cup of the apple should be open when the poison is applied. This condition is seen in Fig. 150 C, and the calyx after it has closed is shown in Fig. 150 D.

**The Curculio of Plums and Peaches.**—This is the insect which makes certain stone-fruits wormy. The peach, plum, cherry, apricot, and others are often attacked by it. This insect is a true beetle, but it has the jaws at the end of a

long snout or beak (Fig. 133). When the fruit is very small the adult beetle cuts a crescent-shaped opening in the skin with its jaws, and lays an egg in it. A grub-like larva hatches from this and burrows into the fruit, eating its way to the seed. This attack is likely to cause the peaches or plums to fall to the ground. When the larva is fully fed it leaves the fruit and forms its pupa in the ground.

Apples, pears, and peaches are frequently bitten by the adult curculio and the wounds thus formed may make the fruit become deformed, as in Fig. 134.

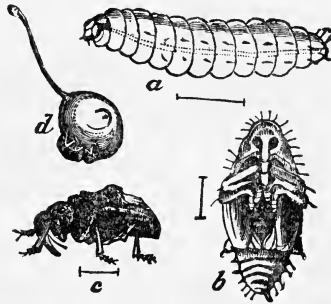


FIG. 133.—Plum-curculio: *a*, larva; *b*, pupa; *c*, adult; *d*, beetle at work on a young plum, showing a crescent mark. (From Smith's "Economic Entomology.")

It is difficult to poison the larva because it is inside the fruit. The adult insect may be poisoned by spraying while it is feeding upon buds and young leaves in the orchard before laying the eggs. Another time to poison the adult is when the fruit is being eaten to make a place for the eggs. Hogs, sheep, and poultry in the orchard, during the time the early fruits are falling, will destroy many of the curculio larvæ. This will probably reduce the injury next season. Some fruit growers spread sheets or other receptacles under the trees and jar the trees to shake off the beetles before they lay their eggs. They lie quiet after being jarred off and are easily gathered up and destroyed. This should be done very



early in the morning and repeated every day or two for about two weeks just before the eggs are laid.

**Peach Tree Borer.**—This insect does more injury throughout the plum and peach growing districts than any other insect. The adult is a beautiful moth, resembling a wasp in

FIG. 134.

FIG. 135.

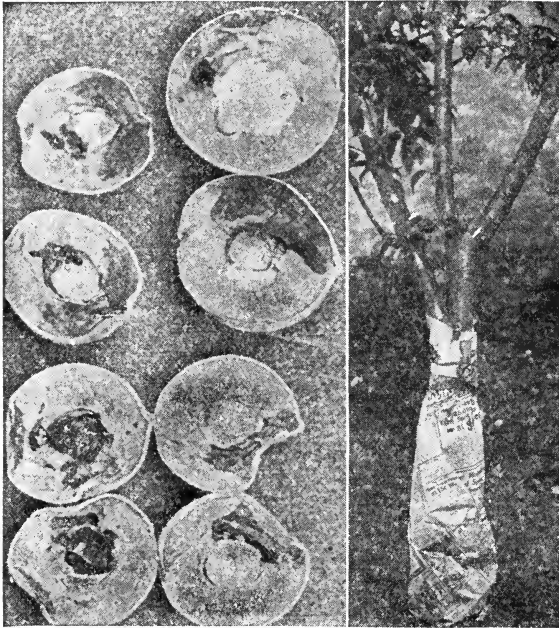


FIG. 134.—Peaches injured by curculio.

FIG. 135.—Trunk of peach tree showing a method of keeping away peach borers. (Experiment Station, N. J.)

appearance. The eggs are laid during the summer upon the bark near the surface of the ground. The little borer or grub begins eating under the bark of the trunk and becomes nearly three-fourths of an inch long by fall. A gummy formation indicates the presence of the borer. The watchful grower will also find saw-dust-like borings escaping in some

places near the surface of the ground. Very frequently the insects work in the sap wood just below the surface of the ground.

Washing the trunks with lime-sulfur in the spring and summer is tried by many growers. It will probably protect the orchard from a large per cent of the borers. The more common and more certain remedy is to dig into the trees for borers in September or October and again in April or May. This is done by digging the dirt from the trunks of

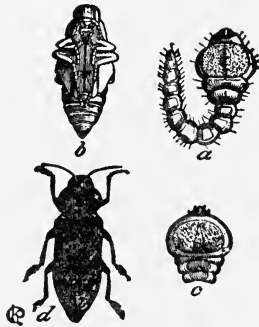


FIG. 136.—The flat-head apple-borer: *a*, larva; *b*, pupa; *d*, adult.  
(From Smith's "Economic Entomology.")

the trees a few inches below the ground level. After a few days dig with a knife or wire for the borers under the bark wherever the gum or borings may be seen.

Grafting wax may be rubbed over these wounds, and the dirt thrown back and heaped up around the tree. Heaping up the dirt will cause the next brood to work a little higher where they can be more easily discovered.

**Apple Tree Borers.**—There are two kinds of beetles that attack the trunk of the apple tree and eat in the wood: the flat-headed and the round-headed borer. Their work is similar, but the grubs and beetles are quite different, as shown in Figs. 136, 137. The flat-headed borer attacks a

great many trees besides apple trees. The round-headed borer is a serious enemy of the apple and quince and is sometimes found in pear trees. The grubs of these borers live in the tree trunk about three years and then change to the pupa stage a few weeks before emerging as adults.

The best remedy is to keep the adults from laying their eggs on the trunks. This is done by tying tar paper or wire gauze about the trunks. The bottom of the material should be slightly in the ground and the top securely tied to prevent the beetles from crawling in. These protectors



FIG. 137.—Round-head apple-borer: *a*, larva; *b*, pupa; *c*, adult. (From Smith's "Economic Entomology.")

should be renewed before the egg-laying season of June and July. Above these screens the trees should be whitewashed or sprayed with lime-sulfur.

**The San Jose Scale.**—These insects were probably introduced into this country from China and were first found in America near the city of San Jose (Hō-sā'), California.

This insect is probably the worst enemy of fruit trees. It has sucking mouth parts, and not only sucks the sap from leaves and fruit but also from the more tender branches.

The breeding season of the insect lasts throughout the warm summer months, being checked only by frost. Large

numbers of young are produced by a single insect, each one of which in turn begins to produce young in five or six weeks from birth. It is thus seen that where healthy insects of this species are not killed before the warm weather begins, the numbers may be so great by fall as to destroy or seriously threaten the trees of the vicinity.

These scale insects thrive not only on orchard and nursery fruit trees, but are also found on hedges, some kinds of shade trees, and roadside shrubs. This makes it difficult to totally destroy the pest in any section where it has become firmly established.

**Remedies.**—As this pest does not eat the tissues of the plant, poisonous sprays are not effective. The covering with which the insect naturally protects itself makes it a very difficult enemy to fight. A few good spray materials have now been found. *Soluble oil* is on the market under different trade names; in these the oil and water are caused to mix readily by use of certain chemicals.

*Lime-sulfur* sprays are very successful in combating the San Jose scale. One application is made in winter or early spring before the buds of the trees begin to swell. Another application is sometimes made in June or July when the young, tender insects are abundant. This summer spray is made very weak to avoid danger to the leaves.

The early spring spraying and also the summer spraying will be very valuable as a means of combating several diseases such as peach scab and apple scab, and brown rot of peaches. Thus the fighting of the San Jose scale is not, in itself, a very serious problem for the fruit grower.

**EXERCISE.**—*Insect Specimens.*—Let pupils bring to school at any time insects which are injurious to plants in the home garden or elsewhere. The leaflets issued by the Bureau of Entomology at Washington will be helpful in the study of the insects thus collected.

**EXERCISE.**—*Preserving Specimens.*—Insect specimens

may be killed by placing them in poison bottles for a few hours. These bottles should have wide mouths and good corks. A piece of cyanide of potassium, which is such a deadly poison that even breathing its fumes will kill insects and other animals, may be fastened in the bottle by pouring over it some wet plaster-of-Paris. A piece of the poison as large as a hickory-nut is enough for a four-ounce bottle. Let the plaster dry and then cork up the bottle. After insects have been killed they may be pinned into a cigar box, in the bottom of which has been fastened a sheet of thick corru-

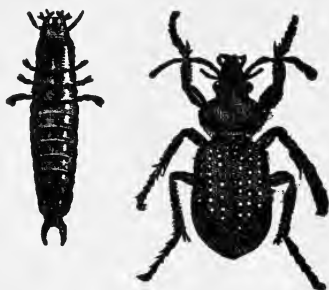


FIG. 138.—A caterpillar-hunting ground beetle and its larva. (From Smith's "Insect Friends and Enemies.")

gated paste-board. A good way of preserving large butterflies, moths, and other large insects is shown in Fig. 124 B.

**Beneficial Insects.**—Not all insects are harmful. There are indeed a great many groups that are beneficial in one way or another. The silk worm produces a product worth many millions of dollars annually in the commerce of the world. Honey bees store large quantities of honey used as human food, and also carry pollen from blossom to blossom, thus increasing the crops of fruit. The ground beetle (Fig. 138), tiger beetle, and some other insects prey upon other injurious insects and thus act as a balance in Nature's forces for the control of the enemies of man. The spotted lady-beetle (Fig. 139) destroys many thousands of the San Jose scale insects.

There are certain parasitic insects living on the more injurious forms and this aids materially in the control of insect pests. (See Figs. 140, 141.)

**EXERCISE.**—*Parasites of Insects.*—In the breeding cages or in the boxes where cocoons are kept, watch carefully for the indications of parasites. Some of them may be similar to one or more figures in this chapter.

**Toads as Insect Destroyers.**—The common toad, found in the garden, lives almost entirely upon insects. He eats enormous numbers, most of which are of the harmful kinds.

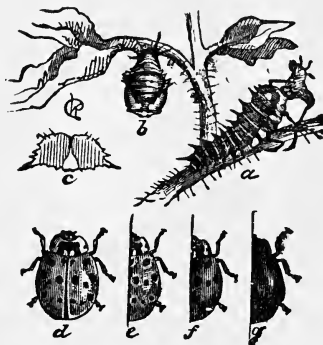


FIG. 139.—15-spotted lady-beetle: *a*, larva; *b*, pupa; *d-g*, adult varieties. (From Smith's "Insect Friends and Enemies.")

Toads have no harmful habits. They should be protected because of the good they do. A single full-grown toad will do several dollars' worth of good in a garden each season.

#### BIRDS AND THEIR VALUE TO AGRICULTURE.

Birds are one of the most effective means of retaining the so-called "balance in Nature." That is, it may be seen that in certain seasons, or in places where insects are unusually destructive, more birds than usual will be found, busily eating up the insects. Or if the weed crop is very abundant the

birds will congregate in larger numbers to feast upon the seeds.

**Food Habits of Birds.**—Through the Biological Survey of the United States Department of Agriculture, the food habits of very many species of birds have been studied and published, so that farmers, and everyone else for that matter, may know exactly to what extent we are indebted to the

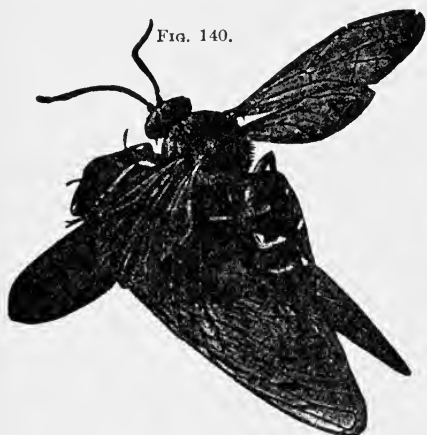


FIG. 140.



FIG. 141.

FIG. 140.—Digger-wasp carrying a cicada to its home.

FIG. 141.—Sphinx caterpillar covered with cocoons of parasites. (From Smith' "Insect Friends and Enemies.")

birds for their help in keeping down the numbers of destructive insects and the weed pests that would soon literally take the country, were it not for the activities of the birds.

Through the studies made in the Biological Survey, which have covered a long period of years, it has been determined that very few species of birds can actually be called harmful to the interests of man.

**Harmful Birds.**—Three hawks—Cooper's hawk, the sharpshinned hawk, and the goshawk—are the three that commit the most depredations against chicken yards, and

kill many other useful birds. These three should be learned and killed on sight.

**Other Hawks**, including the red tailed hawk, red shouldered hawk, marsh hawk, Mississippi kite, Swainson's hawk, American rough-legged hawk, sparrow hawk and broad winged hawk, are all very useful, as their diet consists mainly of rats, mice, and other small creatures that are very destructive to grain crops. Owls are also included in this list with the useful hawks. It is said that hawks work by day and owls by night, so that these birds work for the farmer twenty-four hours every day. Nothing could be more friendly and helpful than that. Farmers in turn can do no less than protect these birds.

**Some Robin Arithmetic.**—The following paragraphs are quoted from William Rittenhouse: "A pair of robins eat two worms or insects every minute, all summer long, and also raise one or two broods of young robins to do the same.

"We count that the robin starts to look for the early worm at five o'clock in the morning and keeps up his search until five in the afternoon, that makes twelve hours, or seven hundred and twenty minutes—1,440 worms a day for the pair of birds. For at least four months the robins stay with us. Robins live about fifteen summers if their enemies—usually men or boys with guns—let them alone to do their work. So in one lifetime a pair of robins could destroy 2,592,000 bugs and worms.

"Worms and insects when not interfered with, increase at a frightful rate. One pair of potato bugs, if unmolested, will increase to 55,000,000 in a single season. But one bird in a minute, can gobble up one of these parent bugs, and thus prevent the 55,000,000 from ever existing. To keep down insect life is the robin's great occupation, and its foraging begins early in the spring. Thus it destroys the early bugs which, if let alone, would lay countless eggs and prepare endless trouble for the farmer later on.



"A pair of robins are the farmer's private detectives. They guard his trees twelve hours a day. Yet some farmers object because robins eat cherries. It would pay every farmer to plant a group of cherry trees for the robins, in order to gain a band of industrious helpers all summer."

It is not alone the robins that are valuable to agricultural interests. The following is a partial list of birds that are friends to man:

All sparrows except the English; all swallows; siskin; killdeer; flicker; nighthawk; grackle; pheasant; quail; grosbeak; bluebird; nut-hatch; bluejay; thrushes; wren; catbird; warbler; meadow lark; blackbirds; oriole; cardinal; mocking bird; chickadee; all woodpeckers, and many more.

**What Birds Eat.**—United States Farmers' Bulletin 755, "Common Birds of Southeastern United States in Relation to Agriculture," gives a list of 66 birds which are known enemies of the cotton boll-weevil. It also says that 128 kinds of birds eat wireworms, an enemy of corn. 55 species destroy billbugs, another corn pest; 43 kinds feed upon army worms; 24 kinds eat chinch bugs; 25 kinds are especially fond of the large clover leaf hoppers. The small clover leaf weevils furnish food for 74 species of birds. And so on through the long list of insect enemies of farmers, gardeners and fruit raisers.

It is estimated that insects damage and destroy about \$700,000,000 of crops annually in the United States. Probably no one has estimated or could estimate the saving to agriculture by birds feeding on insects and weed seeds.

**Amount of Seeds Eaten.**—If those birds which eat mainly weed seeds, each consume one-half ounce of seeds daily, it is easily estimated that in a large agricultural State, such as Illinois or Iowa, the annual food supply of these birds would amount to hundreds of tons of weed seeds.

**Methods of Encouraging Birds.**—Plant shrubbery for nesting places. Dense patches of brambles make good hid-

ing places, where birds may be safe from stray cats and dogs. Plant berry-producing shrubs and vines for food. Spice bush, barberry, mulberry, blackberry, hackberry, and thorn-apple are good. Also many others.

**Make bird houses** out of tin cans or boxes and place them where the birds will not be afraid to nest in them. Protect the trees in which nests are found, with sticky flypaper to keep off stray cats.

Feed the birds in winter and furnish them drinking places in summer.

**Bird Enemies.**—Probably the worst enemies of birds are stray cats, bird dogs, hunters, and thoughtless boys. The cats should be killed. The dogs should either be kept tied or killed. The boys should be taught to love and protect the birds instead of robbing their nests and shooting the birds. Hunters should be controlled by better laws.

**Laws protecting birds** should be more stringent. When farmers become fully aroused to the importance of birds in relation to agricultural interests, they will see to it that hunting is prohibited, and that all seasons are "closed" for all game birds. They should be protected and encouraged in every way possible, as they are among the farmer's best friends and are one of the greatest assets to the successful raising of crops.

Among the worst enemies of birds are bird dogs. They are bred for hunting birds and do it instinctively, so cannot be blamed. The people who keep them and allow them to run at large are the ones at fault. They are also the ones who suffer most, perhaps, as a dog will naturally roam about his master's place first, and destroy the nests of the birds which he can reach.

The following birds nest on, or near, the ground: bobolink; meadow lark; chewink; quail; pheasant; prairie chicken; Harris sparrow; lark sparrow; white throated sparrow; tree sparrow; red winged blackbird, and veery. Their nests are

very liable to be broken up by prowling bird dogs, or worthless curs, which eat the eggs.

Hunters often shoot useful birds merely for the sake of killing something. Of course all the game birds which are bagged by hunters are a direct loss to the farmers, as they have just that many less friends who would help them in destroying insect and weed enemies.

**EXERCISE.**—Count the number of cats in your school district. Estimate the loss to the farmers if each cat destroys five nests each year for five years.

Let each pupil make a bird house and put it up in the school yard or at home.

Report on watering places for birds in the locality, either natural or artificial. Suggest schemes for watering the birds.

Have pupils observe the habits of birds and report on such things as feeding, watering, nest building materials, and nesting locations.

One bird dog was known to have destroyed 21 quails' nests on one farm in one season. If each nest averaged 15 eggs, how large a flock of quails were destroyed by that one worthless dog? Each quail would have eaten at least 100 potato bugs and at least that number of many other kinds of insects in one day. Figure out how many insects these quails might have destroyed in one season, if they had all lived. Which do you think would have been the most valuable to the farmer, the quails or the dog?

### REVIEW.

1. Describe the structure of insects, as to body, wings, legs, and parts on the head.
2. Tell of the two kinds of mouth parts of insects.
3. Why cannot insects that have sucking mouth parts be poisoned?  
How are they usually controlled?
4. Tell what you can about the skeleton of an insect.
5. Tell how insects grow.
6. Tell what is meant by the terms complete change and incomplete change in the development of insects.
7. Name the four stages in the life of insects having complete change.

8. Tell what you can about the larval stage.
9. Tell what you can about the pupal stage.
10. To what forms of larvæ do these terms apply: caterpillar, grub, maggot, wriggler, nymph?
11. Tell how mosquitoes develop malaria and impart it to man.
12. Tell two differences between malarial mosquitoes and others.
13. Tell of three more ways of preventing the spread of human diseases by mosquitoes.
14. Tell how mosquito wrigglers breathe.
15. Describe the life development of the house fly.
16. How do flies spread typhoid and other human diseases?
17. What are the remedies to be used against the fly?
18. Tell how to prevent damage from clothes moths.
19. Describe the damage done by grain moths.
20. In what ways are chinch bugs injurious?
21. What are the different means of control?
22. How are potato beetles controlled?
23. Describe the life and work of the coddling-moth.
24. Tell at just what time to spray to fight the spring brood. Why?
25. What injury is done by the curculio beetles?
26. What are some of the ways of fighting it?
27. Tell how the peach tree borer may be found.
28. What are the remedies for this insect?
29. Name two kinds of apple treeborers and tell what harm they do.
30. Why is it so difficult to control the San Jose scale?
31. What two materials are used to spray the scale? When used?
32. Name some groups of beneficial insects and tell of their benefits.
33. How do birds help farmers?
34. How have we learned what birds are our friends?

**References.**—U. S. Farmers' Bulletins: 595, 799, 926, Important Insecticides; 650 and 723, Scale insects; 657, Chinch Bug; 662, Apple Tent Caterpillar; 668, Vine Borer; 675, Apple Tree Borer; 691, Grasshoppers; 701, Bagworm; 708, Leopard moth; 739, Cutworms; 725, 733, on Wireworms; 721, Rose Chafer; 731, Army Worm; 1185, Alfalfa Weevil. On household pests: 627, 658, 699, 1037, 1101 and 740; 755, Birds; 766, Cabbage Worm; 1246 Peach Borers Ark. Sta. Bul. 107, 177, Scale; 185, Strawberry insects. Ark. Ext. Circ. 143, Spray Calender.

---

## CHAPTER XXI.

### DISEASES OF PLANTS—SPRAYING.

**Diseases of Plants.**—There are many diseases which attack plants grown in field, garden and orchard. These are mainly: (1) Those produced by fungous growth of minute plants, on tissues of useful plants, examples of which are rust on leaves and smut on grain. (2) Those produced by bacteria,

as in the case of pear blight and peach yellows. (3) Those due to poor drainage or poor soil or unfavorable climate; these would not be contagious.

**Prevention of Plant Diseases.**—The spores or organisms from which the fungous diseases develop may be killed by special spray materials. These should be killed before they get into the leaves or other parts of the plants. Spraying is a means of preventing disease rather than curing it. The spray materials are made just strong enough to kill the disease germs and weak enough not to harm the useful plants that are sprayed. (See Appendix for formulas of spray mixtures.)

**EXERCISE.**—*Studying Plant Diseases.*—Specimens of various diseases found on fruits, vegetables, trees, and other plants may be brought to school. Let the pupil name all of these possible. If there are any that seem to be serious diseases in the neighborhood at the time they may be reported or specimens sent to the State Agricultural Experiment Station of the State. Ask that Station for special bulletins telling how to control the particular disease.

**Brown Rot of Peaches.**—This disease causes decay of the fruit and the blighting of the twigs of peaches, plums, and cherries. Fig. 142 shows the rot on peaches. The trouble with peaches is confined almost exclusively to the early varieties. After the rotted fruits have become dry they cling to the trees, and thus hold the spores over until the next year. Remove all such dried fruits from the trees in the winter. The sprayings made to control San Jose scale will help to keep this disease in check.

**Peach Scab or Black Spot.**—This disease gives the fruit a sooty appearance, because of the presence of grayish black spots. The scab may become so bad as to cause the fruits to crack open. It is thought that this disease is worse in orchards where the air-drainage or ventilation is poor. Spray with the self-boiled lime-sulfur mixture, given in the

Appendix as the 8—8—50 formula, just after the blossom calyx is shed from the young fruits (Fig. 143). Repeat this spray once or twice at intervals of three weeks.

**Peach Leaf Curl.**—In early spring, when this disease occurs, the leaves become thickened, curled, and distorted (Fig. 144). The diseased leaves turn brown and fall off. The loss of leaves from this cause may be very severe in the worst cases. The spraying for scale insects will usually keep the leaf curl within control.



FIG. 142.—Brown-rot disease of the peach. Fresh fruit above, last year's fruit clinging to twigs. (Experiment Station, N. J.)

**Peach Yellows.**—The exact cause of this disease is not yet definitely known, although a great deal of study has been given to it. The real cause may be due to some form of bacteria, as the disease is very contagious in the peach orchard. In the earlier stages of the disease the leaves on some shoots are very abundant and small. Fig. 145 shows the appearance in spring. Wiry shoots are sent out from the main branches. The leaves may even become yellowish-green in color, and quite sticky. In advanced stages of *yellows* the fruit appears ripe much ahead of its time; the

skin and flesh are spotted and blotched with red, the flavor being bitter or insipid. The best remedy is to cut out the diseased tree as soon as detected, and burn it. Disinfect instruments used to help prevent spread to healthy trees.

**Little-Peach.**—This disease of the peach is somewhat like yellows, the leaves becoming yellowish-green and dropping as in yellows. But there is one important difference. Instead of appearing ripe too early, the fruits remain very small and are green much too long. (See Fig. 146.) The diseased trees should be burned as in the case of yellows.

**Apple Scab.**—This disease of the apple is very bad in nearly all regions where the crop is grown for market. It is very similar to the scab disease found on pears. It attacks both leaves and fruit. This disease appears at blossom time and soon after, causing large numbers of the small apples to drop from the tree. The fruits that cling on may become affected and will be small, irregular, rough, and blotched. Irregular, roughened, brown

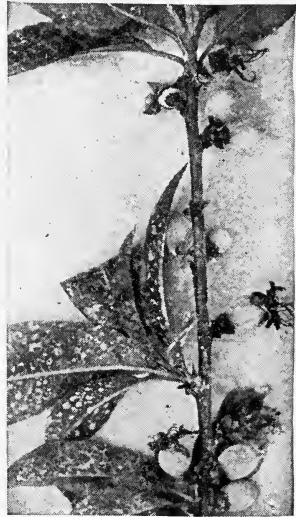


FIG. 143.—Time for first summer spray on peach and plum, as the calyx is being shed from young fruit. (Experiment Station, N. J.)

spots, more or less running together, are formed on the surface of the apple. The roughened or scabby area may cover all one side of the apple and even cause it to crack. It is from this scabby appearance that the disease takes its common name. The disease on the leaves causes sooty spots on the under side. Later these leaves become yellow and drop from the tree, in severe cases taking most of the leaves from the tree.

This disease is prevented by spraying in early spring before the buds swell, with lime-sulfur preparation. This is repeated with a weaker solution just before the blossom buds open, and again just after the petals of the blossoms fall to the ground.



FIG. 144.—Leaf-curl disease. Healthy twig on right, the disease prevented by lime-sulfur spray. (Experiment Station, N. J.)

**EXERCISE.**—*Studying Apple Scab.*—Have some one bring to school a few samples of scabby apples from the grocery store or home orchard. The class should all become familiar with the ways in which the fruit is affected by the scab.

**Apple Rust.**—Leaves attacked by apple rust appear as though covered in blotches by a heavy coat of iron rust. The whole under surface may present a rusty appearance (Fig. 147). The trouble may spread to tender twigs and even to



the fruits in some cases. The life of this disease is interesting, and a knowledge of it leads to the proper remedy.

The apple rust fungus lives a portion of its life upon the apple tree or the quince tree, as already described, but it appears in a very different form upon red cedar trees that may be growing near the orchard. The growth on the cedar tree is popularly known as *cedar apple*. These cedar apples in spring appear as large masses of yellow or orange-colored



FIG. 145.—Twigs of peach in spring-time. Two at right affected with "yellows," healthy twigs at left. (Experiment Station, N. J.)

jelly clinging to the branches of the cedar tree; in winter they are small, brown or purple galls. These enlarge next spring. It is from these cedar apples that the disease spreads to the orchard.

If this disease is very prevalent in the orchard, it may be best to remove the cedar trees near the orchard. This would greatly check or stamp out the disease. Spraying as for apple scab will perhaps aid a little in checking the apple rust, but is not a complete remedy.

**EXERCISE.**—*Cedar Apples.*—In the fall or winter students may find specimens of the winter form of the cedar apple, above described, on the cedar trees near apple orchards. If these are found use the specimens to illustrate the lesson on apple disease.

**Potato Scab.**—On the surface of Irish potatoes in the winter time may be found scabby-looking spots or areas caused by the potato scab fungus. The disease when very bad produces deep depressions or pits in the surface of the



FIG. 146.—Disease called "little-peach." Healthy fruit above.  
(Experiment Station, N. J.)

tubers. The crop yield may be greatly reduced by the attacks of this disease. The spread of the disease may be in several ways:

1. The germs of potato scab will grow more rapidly when there has been a heavy application of fresh *stable manure* to the field just before the potatoes are planted. It is better to manure the field one year in advance if possible, or to use some well-rotted manure.

2. When *lime* is applied to the soil the disease will likely be worse on the potato crop. Green manure plowed under in preparing the field for potatoes will help to counteract this action of the lime.

3. *Soils* from which a very scabby crop of potatoes has

been harvested recently will probably cause the next crop to be diseased in like manner. Rotation of crops is, therefore, advisable. Do not use beets and other root crops in this rotation, as the scab disease also attacks them.

4. *Seed potatoes* are usually more or less scabby or have the germs of the disease upon them. If these are planted without treatment the disease will likely be introduced into the soil.

*The treatment of seed potatoes* to prevent the planting of scab disease is now a very cheap and simple process. The



FIG. 147.—Apple rust on leaf and twig.

seed potatoes are soaked for two hours in a solution of formalin. This solution is made by mixing one pint of the strongest formalin in thirty-two gallons of water. This kills the disease germs but does no harm to the potatoes. The liquid may be used for several sacks of potatoes.

**EXERCISE.**—*Showing Potato Scab.*—Specimens of Irish potatoes having the scab disease should be brought to school and shown to all the students.

**Grain Smut.**—In fields of grain, when it is in head, may be often seen a black powder which clings to the husks of the grain (Fig. 148). This black powder is the fruit of a disease growing inside of the grain stalks. The disease is

called grain smut, for it causes the black appearance, like stove soot, on the heads of grain. Oats and barley are often very badly injured by this disease.

Any farmer can prevent his grain from having the disease by a very simple and cheap process. The seed should be



FIG. 148.—Loose smut of oats mounted on cotton under glass. (A. E.)

treated in a liquid before it is planted. The liquid used is formalin and water. If into a common barrel are poured twenty gallons of water and then one half-pint of strong formalin is thoroughly mixed with it, the liquid will be ready for use. The seed grain is placed in a loose sack and then lowered into the barrel of liquid; after about ten minutes all of the black smut or spores in the seed will be killed. The sack is then raised up and allowed to drain for a few minutes. The wet seed is then spread out to dry before it is planted. This drying may be done on a clean barn floor, in a wagon-box, or on a cloth stack-cover spread

on the ground. The seed should be spread out thin enough so that it will dry before it begins to sprout.

The same liquid may be used for many sacks of seed, so that the cost of treating enough seed for a large field is not great.

**EXERCISE.**—*Treating Oats for Smut.*—It is suggested that

the pupils bring some oats in a sack, and treat them in a pail of water with a little formalin in it.

**EXERCISE.**—*Showing Grain Smut.*—Perhaps sample heads of diseased grain can be brought to school. If so, preserve them as shown in Fig. 148. Some one should bring samples of corn smut disease to show to the class. Corn smut is not prevented by the formalin treatment.

**EXERCISE.**—*Treating Seed Potatoes.*—The pupils may bring a pail and a few potatoes from home. A half-ounce (four teaspoonfuls) of formalin should be added to one gallon



FIG. 149.—Spraying orchard trees in early spring, for scale insects, with barrel pump. (Experiment Station, N. J.)

of water. Soak the potatoes in this mixture for two hours. Urge the pupils to tell of the method at their homes.

**Spraying.**—Under ordinary conditions a bearing apple orchard should be sprayed at least three times each spring and perhaps once in summer.

The first spraying is to be made before the buds swell in very early spring (Fig. 149). This is to prevent scab and similar diseases and to kill the San Jose scale insects. For this spraying it is well to use either soluble oil at the rate of one gallon of the oil to fifteen gallons of water, or to use the

lime-sulfur solution. Commercial concentrated lime-sulfur is diluted at the rate of one gallon to nine of water.

The second spraying is made just before the blossom opens

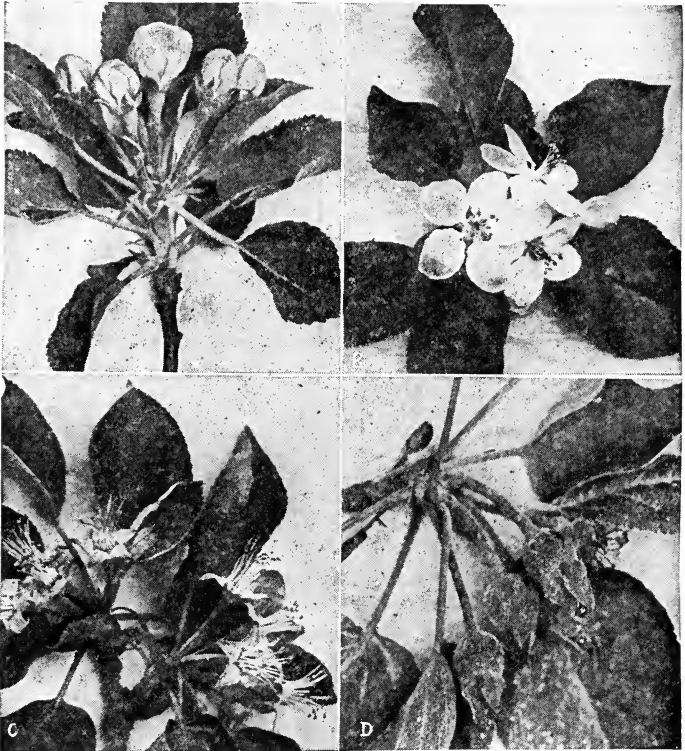


FIG. 150.—A. Too soon to spray for apple worm or codling-moth. Spray for apple scab at this stage or before.

B. Apples in full bloom. Spraying now would poison the honey bees.

C. Petals just fallen; just the right time to spray for apple worm. Poison will fall in the calyx cup of the blossom and kill the worm as soon as hatched.

D. Too late to spray for apple worm. The calyx is closed and apples turned down. (Experiment Station, N. J.)

(Fig. 150, A). It is to control apple scab disease and to kill all leaf-eating insects. This time use one and one-half gallons of strong lime-sulfur solution and three pounds of arsenate

of lead to fifty gallons of water. This will accomplish the two purposes at the same time.

The third spring spraying is made just after the petals fall from the blossoms. Its chief purpose is to control the codling-moth. It also aids in preventing the trouble from apple scab. As there are two purposes, use the combined sprays as in the second spring spraying. Study Figs. 150 A, B, C, D together.

For the control of codling-moth on fall and winter varieties of apples, a midsummer spraying is advisable. For this



FIG. 151.—Summer spraying by school students. (Agricultural Education.)

use two pounds of arsenate of lead to fifty gallons of water.

**Principles of Spraying.**—Always select, if possible, a bright clear day without much wind for all kinds of spraying.

Do the work carefully and thoroughly. Let all parts of the plants be touched with the spray materials.

Use special nozzles which throw the materials into fine mists. Learn of the latest and best nozzles and spraying apparatus by writing to the Agricultural Experiment Station of the State. Always consider what are the special purposes of the particular spraying, and use the proper materials for those purposes.

An insecticide is to be used for insects, and a fungicide used for the plant diseases. These may be combined into one spray material.

Weaker sprays are necessary on plants when the leaves are on; stronger sprays when the trees are dormant.

Lime-sulfur is used both as a winter spray and as a summer spray, but the strength must be made to suit the condition of the trees or other plants. It is a fungicide and also a special insecticide for the control of scale insects.

Soluble oils are for winter use only and are especially for scale insects.

Bordeaux mixture alone is a fungicide and, in different strengths, may be used either when the trees are dormant or when in leaf.

Paris green and arsenate of lead are two of the most common insect poison materials. They may be used in combination with lime-sulfur and also with Bordeaux mixture. (See spray formulas in the Appendix.)

### REVIEW.

1. What are the three main causes of plant diseases?
2. Name two fungous diseases of the apple.
3. Name five diseases of the peach.
4. Describe peach yellows and tell of the best remedy.
5. Tell how to prevent apple scab.
6. Tell of the relation of cedar apples to the rust disease of apples.
7. Give four causes of potato scab and the remedy for each.
8. Describe the treatment of seed potatoes to prevent the planting of scab disease.
9. Describe the treatment of oats to prevent smut disease.
10. Give the objects for each of the three spring sprayings of apple trees.
11. Give the material to use at each time.
12. Give all the principles of spraying that you can.

References.—U. S. Farmers' Bulletins: 648, Root Knot; 938, Bitter-rot; 618, 1053, Leaf-spot; 1056, Pear enemies; 1213, 930, Smut; 1041, Eelworm; 1058, Rust; 1224, Wheat scab; 1226, Take-all of Wheat; 856 925, Garden diseases. Ark. Sta. Bul. 28, Fumigation.



## PART II.

# ANIMAL PRODUCTION

---

### CHAPTER XXII.

### IMPROVEMENT OF ANIMALS.

IN man's efforts to secure for his use the best types of live stock or farm animals he has produced the various breeds of horses, cattle, sheep, swine, and poultry. He has intelligently selected those animals which showed a tendency to produce the desired qualities. The correct principles of breeding have been applied, somewhat as an art and sometimes also as a science. It is important that we have animals suited to a definite purpose, rather than for several or all purposes. Men want horses for draft and for speed; some cows for milk, others for beef; some sheep for wool, others for mutton; some swine for bacon and lean meat, others for lard; some hens for eggs, others for meat.

**A Breed.**—A group of animals which have special characteristics of habit, color, and form is called a breed. They have a tendency to transmit such characteristics without much change to their offspring. The best breed to keep is always the one best suited to the desired purpose. There are so many breeds that one may be chosen for each particular need.

**Laws of Breeding.**—There are several laws of nature which govern in a large measure the maintenance of good breeds and the improvement of live stock.

The law of *heredity* is one of these. It means that animals inherit from their ancestors certain forms, characteristics, qualities, habits, and tendencies. These may be either desirable or undesirable and are frequently both. That "like produces like" is as true with animals as with plants. If

this law were an absolute one, man would find it impossible to make any improvements in his animals by careful selection.

*Variation* among farm animals is a natural tendency for them to differ from each other and from their parents. No two calves in the barn are alike. The pigs in a litter may look alike when young, but the attendant can soon point out differences. This tendency to vary allows stockmen to select the desired types and produce, in time, the animals desired for special purposes.

**EXERCISE.**—*Variation Among Animals.*—Let pupils tell of variations in color or other marked characters among pure-bred stock such as cattle, poultry, or swine. Care should be used to bring out the law of variation.

*Reversion* is the tendency for young animals to exhibit characters of distant ancestors, which their own parents did not possess.

Sometimes there are characters present in certain individual animals which are not like any of the animals of the breed. Such cases are called *mutations* or *sports*. Such very odd or different characters are not always transmitted by animals to their offspring. When such new characters are given to the offspring they may become fixed and give rise to a new line or strain of animals in a breed. The hornless or *polled* Shorthorn cattle and the *polled* Hereford cattle were first started from sports. Now the hornless character of those strains has become fixed. The groups may even be considered as distinct breeds.

**Pure-Bred Animals.**—These are animals which have been bred along a certain line or within the bounds of the breed for many generations. The vulgar term *full-blood* should not be used to express purity of blood in an animal. The term *thoroughbred* is also incorrectly used in this connection. This name belongs to a breed of race-horses which originated in England.

*Grades* are animals which are not pure bred but are part

**native.** A *high grade* animal is one which is more than half pure bred. *Native stock* are those in which there is no certain, traceable blood of any special breed. They may be a mixture of several breeds. They are often called "Scrubs."

*Cross-bred* animals are the result of crossing two pure-bred animals of different breeds, as a Holstein-Jersey cross in cattle, or a Plymouth Rock-Cochin cross in poultry.

**Pedigrees.**—These are statements of the lineage or ancestors of animals. Records are kept of all the animals of the pure breeds, if the owners care to register them. Owners of stock of a certain breed form an Association, the officers of which establish herd books in which records are kept of the animals and their offspring owned by the members. (See the sample Holstein pedigree in the Appendix.)

**EXERCISE.**—*Stock Pedigrees.*—Some pupils in the school may be able to bring to the teacher a written or printed pedigree of farm animals owned by some one in the neighborhood. The value of such a complete record may then be made clear to the class, because of its local application.

**Bad Effects of Crossing.**—It is far too common a practice for farmers to cross the stock of two breeds. Where a herd is graded up toward one breed, as Jerseys, they are then crossed with Holsteins or Shorthorns, the hope being to increase the quantity of milk. The result is usually a disappointment and the practice is a bad one. When there are so many good breeds of each kind of farm animals it is unwise to try to blend them by doing such crossing. Instead of a blending effect, the stockman often gets the extreme characteristics emphasized by close contrast in one individual. For example, the head, hairy feet and legs, and large hoofs of the Clydesdale are sometimes found on the slender body of a race-horse. The more extreme the crosses or the greater the difference in type between the breeds used in the cross, the greater will be the number of failures. The successful crosses are few. Occasionally the bad effects of a cross do

not show until the second generation. Then the disappointment of the owner is emphasized, and the time lost in his failure is greater.

**Keeping Pure Breeds.**—All stock breeders should keep pure-bred animals. Each breed has been produced because the animals are the best for some particular purpose. The breeder should determine what his purpose is and then choose the proper pure breed for that purpose. The animals of that breed are sure to be more satisfactory than any cross breeds or grades. Pure-bred animals have fixed characteristics and may be expected to come *true to type*. The superior qualities of the parents will be found in the offspring. The profit derived from pure-bred animals is usually much greater than from natives or from grades.

### REVIEW.

1. What is meant by special purpose animals? Give examples.
2. How have these been developed?
3. What is meant by a breed? Which is always the best one?
4. What is heredity? What is variation?
5. What benefits arise from the law of variation?
6. What is meant by reversion?
7. What are mutations or sports? What use is made of them in forming new breeds?
8. Define grades and natives.
9. What is a pedigree?
10. Why should farmers not cross the pure breeds of farm animals?
11. Give reasons for breeders keeping pure-bred animals instead of native stock, or scrubs.

---

## CHAPTER XXIII.

### HORSES.

**THERE** were no horses in America at the time of the discovery by Columbus. All horses that are now found here are imported or are offspring of imported stock. Some horses were brought by Columbus on his second voyage, others were brought by Cortez, by DeSoto, and by French, Dutch, and English settlers. The wild ponies of the Southwest. called

Texas ponies, are probably descendants of horses abandoned by DeSoto.

Most of the pure breeds of horses found here at the present time have originated in the Old World; but America has established a distinct breed of saddle horses and trotters, and a carriage breed is being developed.

**Types of Horses.**—There are several types of horses: (1) Those for heavy work are called the *draft type*. (2) Those of light build, for quick action, are called the *light horse type*. (3) There are many that would not fall into either of these two extreme types, but would be somewhat intermediate between them. Such horses may be grouped into a third type, sometimes called *dual-purpose* or *general-purpose* horses. The descriptive points of the draft horse and the light horse are given in the score cards at the end of this chapter.

**Pure Breeds of Horses.**—The pure breeds of horses may be grouped as follows: draft breeds, coach breeds, light breeds, and pony breeds. The market types of horses, whether they be pure-bred or not, may be classified as draft, coach, roadster, saddle, and pony.

*The draft breeds* are all large, heavy horses, ranging in weight from thirteen hundred to two thousand pounds. They are well built for heavy teaming. The leading breeds of the draft group are Clydesdale, Percheron, English Shire, Suffolk Punch, and Belgian.

*Coach Horses.*—The heavy carriage or coach breeds include the large, active, stylish *coach horses*, such as the Hackney, German and French coach, the Cleveland Bay or Yorkshire coach.

*Light horse breeds* include the Thoroughbred, the American trotting horse, and the American saddle horse

*Pony breeds* are the Welsh, the Shetland, and Exmoor. These differ considerably in size, habits, and other special characters. Besides these pony breeds there are several

pony types which have not been kept pure in their breeding. Among these may be mentioned the broncho of the Western plains, the Indian pony of the Northwest, and the Mexican or Indian mustang of the Southwest.

**Percherons** (Fig. 152).—This is a French breed of draft horses, identical with or nearly the same as the French and the Norman draft horses. Percherons are gray or black when

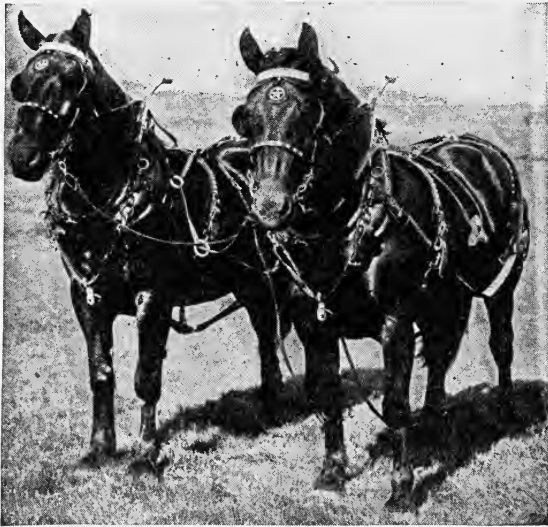


FIG. 152.—Black Percherons in harness. Large, gentle draft horses; well suited to use on farms.

young, becoming lighter in color with age. The dark colors are preferred, and are more common. Dapple grays of this breed are much admired. The body is compact, short, and thick; the head is of moderate size; the legs are rather short and very muscular, with short hair. The feet are smaller than in the Clydes. Percherons are very easily managed and become very gentle. Little, if any, "breaking" is necessary. They are much used on the farms of the middle West and

Northwest. Grades of this breed are used in great numbers in city dray work in America.

**Clydesdales.**—This (Fig. 153) heavy draft breed dates back to its origin in Scotland two hundred years ago. The general color is bay or brown, but sorrels and blacks may be found among the Clydes. Usually there are some white markings on the legs and a strip of white in the face. The

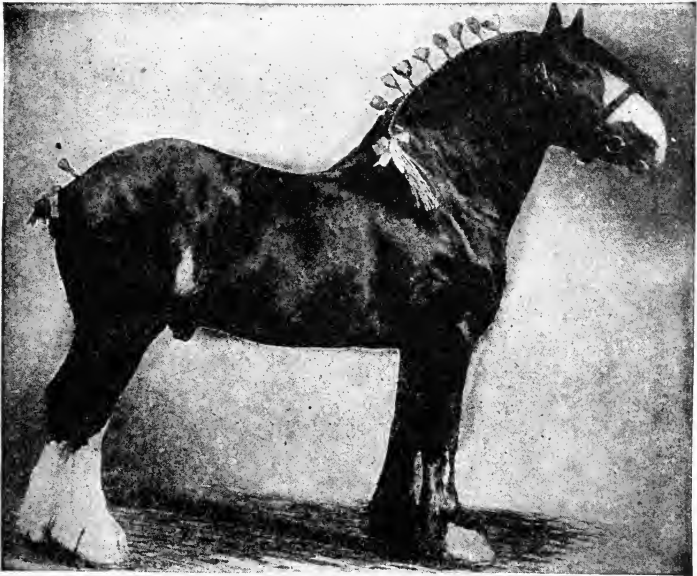


FIG. 153.—Pure-bred Clydesdale horse. Heavy draft type. (U. S. D. A.)

form of the body is long, smooth, and symmetrical. The height is often sixteen or seventeen hands. (Four inches is called a *hand* by horsemen.) The thick, stout legs are heavily fringed below the knees and hocks with long, shaggy hair. The Clydes are well suited for heavy farm work, because of their strength, rapid walking gait, and gentle disposition.

**English Shires.**—There are no very marked differences between the Scotch Clydesdale and the English Shire horses.

The colors and markings and the form are much the same in the two breeds. The English Shire is heavier, more compact and the legs shorter. They are not so common in America as their Scotch ancestors.

**Suffolk Punch.**—This is another English breed of draft horses. The color is chestnut. They are rotund in build and are seldom so large and heavy as the Percherons. The shoulders, neck and legs are of the true draft type. As yet this is not a common breed in America.



FIG. 154.—Fancy driving team, French coach breed. (Experiment Station, N. J.)

**Belgian Horse.**—This is probably the heaviest of our draft breeds. The body is more blocky, the breast wider, and the neck thicker than in either the Percherons or the Clydesdales. The color is roan, brown or bay. The breed has not come into very popular use in America.

**Coach Horses Described.**—The Cleveland Bay is the oldest or most distinctive breed among the coach horses. The color is bay; feet and legs dark, mane and tail black. They are tall, being sixteen to seventeen hands; weight 1100 to 1300 pounds.

The coach or cab horses used in cities are large, active, and stylish, and are highly valued for heavy harness duty and for general driving. They are required to haul medium



loads and to travel at a moderate trot. The French coach (Fig. 154), the German coach, and the Hackney all serve these purposes very well. The German coach horses are less used in America than the others, probably because of their greater weight. The French coach is bay, chestnut or black; and the German coach brown, bay or black.

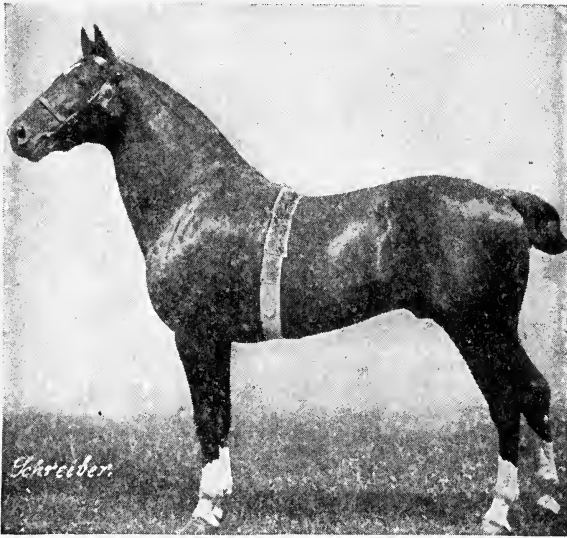


FIG. 155.—Champion Hackney stallion "Oxford."

The Hackney (Fig. 155) is used to grade up the native horses for coach purposes. He is much liked because of his striking and pleasing appearance and good temper. His action is very good, though not so quick as the trotter. The color is brown, chestnut, roan or gray, with some white markings.

**Thoroughbred.**—The English race horse or Thoroughbred is the oldest of all pure breeds of horses, being a descendant of the Arabian stock of Asia. The American Thoroughbred found commonly in Kentucky and Tennessee is from the

English breed. This breed is not excelled for speed and endurance. No other horse approaches the Thoroughbred in beauty, intelligence, and courage (Fig. 156).

**American Trotter.**—This (Fig. 157) is just becoming well recognized as a distinct breed of light horses. They have much of the Thoroughbred or English race horse blood in them. Their special characters are much the same. The trotting gait has been more highly developed in the new breed, and they are destined to become the most popular light carriage horses of the future (Fig. 158).

**American Saddle Horse.**—This horse (Fig. 159) has been called the Kentucky saddle horse. The South had much to do with the building up of this new breed. The blood in the breed traces back to the English Thoroughbred and the Canadian pacer. The best animals of the American saddle horse are quick in action, developing some speed if desired, and showing good style. They also have a variety of gaits suitable to the pleasure of their riders. Besides the walk, trot, and canter of other horses, they also develop the running-walk, the slow pace, the fox trot, and single-foot.

**The Mule.**—A mule is a cross between a true donkey and a horse. The donkey is a native of Asia. Mules are raised in every part of the country, but particularly in the South. They are of several types, chiefly differing in size. Large mules are extensively used for all farm purposes.

In the large mule markets of St. Louis, Chicago, Kansas City, Louisville, and New Orleans mules are classified somewhat according to height, weight, and soundness. Those sold as *plantation or farm mules* are 16 to 16½ hands high; next in order of size are the *lumber or logging mules, railroad mules, levee or dock mules, and mine mules*. The common thought regarding mules is that they are treacherous and apt to kick; this is not true, at least not more so than horses. They are usually very faithful and reliable. They are quick in movement and have wonderful endurance.

HORSE 8

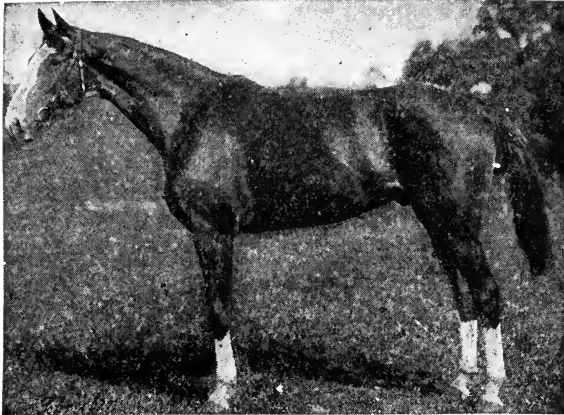


FIG. 156.—A Thoroughbred, "Oponia," the true racing type.

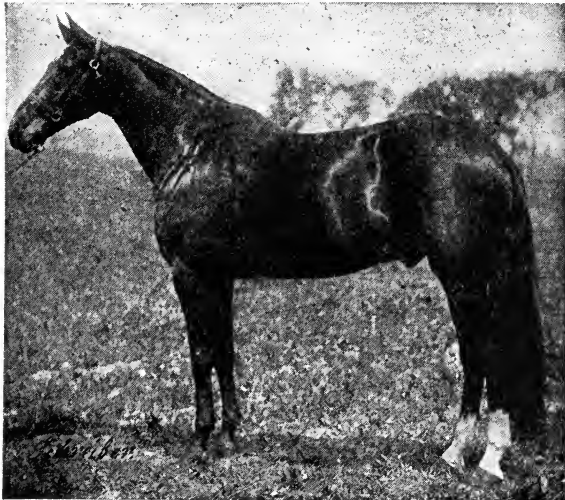
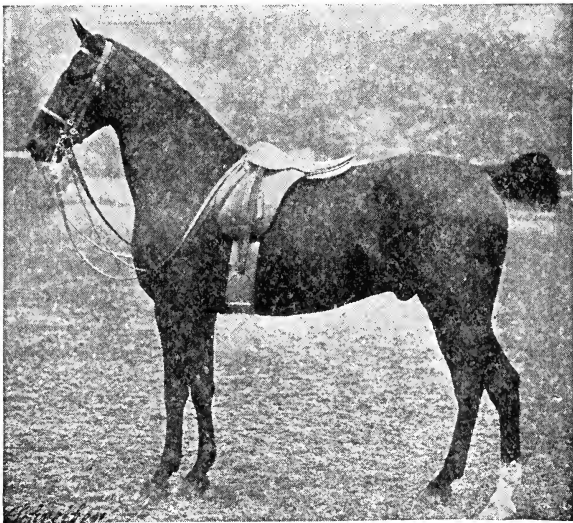


FIG. 157.—American trotter, "George G."



**FIG. 158.**—Pure-bred Morgan. The Morgans were formerly classed as a family of trotters; now they are bred as a distinct style.



**FIG. 159.**—Champion saddle horse, "Confidence."

**Care and Management of Horses.**—Much skill is required to care for horses in the best way. The appetite, condition and spirit of the horse must be watched. Regularity should be exercised in the matter of feed and water.

The horse should be groomed and the coat kept in a healthy, sleek condition.

Examine the shoulders of working animals and protect them against any suspected soreness. Such parts should be bathed with water and the cause of the soreness removed.

Some one who would recognize the defects should examine the teeth for sharp points and for decaying places. Swollen gums may be looked for if a horse refuses to eat corn.

The feet of the horse should be carefully examined, particularly if lameness is detected. The hoofs should be trimmed when overgrown. The shoes should be regularly changed and always suited to the kind of work to be performed.

Plenty of exercise must always be given to horses. The amount of grain in the feed should be reduced when the labor is lightened. The proper balance between the amount of exercise and feed should be maintained.

The farm horse at light work may be given 6 to 10 pounds of oats and 7 to 10 pounds of hay daily. At medium work he should have 10 pounds of oats and 12 pounds of hay. When doing heavy work the amount should be increased to 12 or 13 pounds of oats and 12 or 13 pounds of hay daily.

**Inspecting Horses.**—Horses are often unsound in one or more respects. They must not be considered sound if they have any physical defects or blemishes. A person intending to buy should always examine the animal thoroughly.

**Examining in Barn.**—While a horse is in his stall he may show some of his acquired vices. Cribbing, or biting the stall, wind sucking, kicking the stall and persistent pawing

are easily detected. Have him stand over to the other side of the stall; he may have string-halt and, if so, may be unable to lift the foot on the affected side. Look for the halter-pulling habit.

**Inspection Out of Doors.**—Out in the yard, examine every part of the head, legs, feet, and body for diseases and defects. Go all over one side and then the other, being careful to overlook nothing. Look for colds or similar troubles about the nose, and swellings about the lower jaw and throat. Examine the mouth for bad teeth. The mouth may show signs of a harsh bit. The eye should be free from bad discharges, and must be sensitive to light. Feel the top of the head for sores or swelling or any unusual tenderness which would make him hard to bridle. The withers and back may show scars of old running sores. Look for signs of collar boils on the shoulders. Scars on the knees may indicate a stumbling habit. Watch closely for enlargements, wind-puffs, or other defects of the front legs. Feel for ring-bones, bunches or scars near the hoofs and just above them. Feel the cartilages at the back of the hoof on both inner and outer sides; if hard they are called *side bones*, and will cause lameness. The hoof should be of proper shape, size and color, free from cracks, and the foot not contracted at the heel. The frog in the center of the sole should be elastic.

The hind leg and foot can usually be examined without danger by having some one hold up the front foot on the same side of the body. Look for signs which indicate a kicking habit. The hocks are important and the two should be compared in detecting curby hocks, soft or bog-spavin, and bone-spavin. Compare the right and left legs below the hocks in looking for ring-bones, scratches, cracks or any defects of the hoof and foot. Walk, trot, and gallop the horse and watch closely to detect any irregularity in gait, due to lameness or bad habits. Heaves and other

difficult breathing may be noticed when the horse is exercised vigorously.

**EXERCISE.**—*Unsoundness in Horses.*—Let pupils examine a horse for unsoundness. If a horse is brought to the school yard by some one, the class may assemble about the horse after studying the above lesson on “Inspecting Horses” (Fig. 160).

**EXERCISE.**—*Height and Other Measures.*—With an ordinary tape line, measure the perpendicular distance from the



FIG. 160.—Small boys examining a horse for unsoundness at the school. (Agricultural Education.)

top of the withers to the ground. How many hands high is the horse? Compare the length of the head, from tip of nose to poll or crown, with the length of back from the withers to the hips. Two different horses may be compared as to width of hips, width of breast, girth, length of leg, and other corresponding parts which indicate symmetry.

**EXERCISE.**—*Age of Horses.*—Let some pupils put on the blackboard the diagrams of the incisors of the horse to show

how age is indicated by the teeth. Such diagrams may be copied from a cyclopedia or from references mentioned in the Appendix of this book.

**EXERCISE.**—*Horse Judging.*—A number of lessons should be given in the judging of horses. Light and heavy types

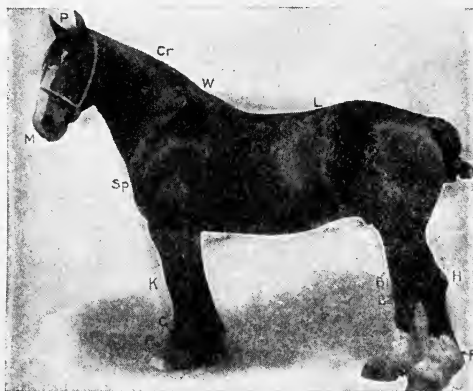


FIG. 161.—A good draft type, explaining points. P, poll; Cr, crest; W, withers; L, loin; H, hock; B1, bone-spavin; B2, bog-spavin; P, pastern; F, fetlock; C, cannon; K, knee; Sp, shoulder point; M, muzzle.

may be used at different times. Several different breeds may be studied in this way. The following score cards are to be used for this purpose. A sheet of lined paper may be used by students to keep scores on—one line being used for each of the numbers down the left side. Learn the names of parts from Fig. 161.



## STUDENT'S SCORE CARD FOR DRAFT HORSES.

	Perfect Score.	Student's Score.
1. AGE.....		
GENERAL APPEARANCE.		
2. HEIGHT.....		
3. WEIGHT, over 1500 lbs. score according to age.....	4	
4. FORM, broad, massive, low set, proportioned...	4	
5. QUALITY, bone clean, yet indicating sufficient substance; tendons distinct; skin and hair fine.....	4	
6. TEMPERAMENT, energetic, good disposition.....	4	
HEAD AND NECK.		
7. HEAD, lean, medium size.....	1	
8. MUZZLE, fine; nostrils large, lips thin, even.....	1	
9. EYES, full, bright, clear, large.....	1	
10. FOREHEAD, broad, full.....	1	
11. EARS, medium size, well carried.....	1	
12. NECK, muscled; crest high; throat fine; windpipe large.....	1	
FOREQUARTERS.		
13. SHOULDERS, sloping, smooth, snug, extending into back.....	3	
14. ARM, short, thrown forward.....	1	
15. FOREARM, heavily muscled, long, wide.....	2	
16. KNEES, wide, clean cut, straight, deep, strongly supported.....	2	
17. CANNONS, short, lean, wide, sinews large, set back.....	2	
18. FETLOCKS, wide, straight, strong.....	1	
19. PASTERNS, sloping, lengthy, strong.....	3	
20. FEET, large, even size, straight; horn dense; dark color; sole concave; bars strong; frog large, elastic; heel wide, high, one-half length of toe.....	8	
21. LEGS, viewed in front, a perpendicular line from the point of the shoulder should fall upon the center of the knee, pastern and foot...	3	
BODY.		
22. CHEST, deep, wide, low, large girth.....	2	
23. RIBS, long, close, sprung.....	2	
24. BACK, straight, short, broad.....	2	
25. LOIN, wide, short, thick, straight.....	2	
26. UNDERLINE, flank low.....	1	

## STUDENT'S SCORE CARD FOR DRAFT HORSES.—Continued.

	Perfect Score.	Student's Score.
<b>HINDQUARTERS.</b>		
27. HIPS, smooth, wide .....	2	
28. CROUP, long, wide, muscular .....	2	
29. TAIL, attached high, well carried .....	1	
30. THIGHS, muscular .....	3	
31. QUARTERS, deep, heavily muscled .....	2	
32. GASKINS OR LOWER THIGHS, wide, muscled ...	2	
33. HOCKS, clean cut, wide, straight .....	8	
34. CANNONS, short, wide; sinews large, set back ...	2	
35. FETLOCKS, wide, straight, strong .....	1	
36. PASTERNS, sloping, strong, lengthy .....	2	
37. FEET, large, even size; straight; horn dense, dark color; sole concave; bars strong; frog large, elastic; heel wide, high, one-half length of toe .....	6	
38. LEGS, viewed from behind, a perpendicular line from the central point of each quarter should fall upon the center of all the joints and foot .....	3	
<b>ACTION.</b>		
39. WALK, smooth, quick, long, balanced .....	6	
40. TROT, rapid, straight, regular .....	4	
Total .....	100	

## STUDENT'S SCORE CARD FOR LIGHT HORSES.

	Perfect Score.	Student's Score.
1. AGE .....		
<b>GENERAL APPEARANCE.</b>		
2. WEIGHT .....		
3. HEIGHT .....		
4. FORM, symmetrical, smooth, stylish .....	4	
5. QUALITY, bone clean, fine, yet indicating sufficient substance; tendons defined; hair and skin fine .....	4	
6. TEMPERAMENT, active, good disposition .....	4	

## STUDENT'S SCORE CARD FOR LIGHT HORSES.—Continued.

	Perfect Score.	Student's Score.
<b>HEAD AND NECK.</b>		
7. HEAD, lean, straight.....	1	
8. MUZZLE, fine; nostrils large; lips thin, even....	1	
9. EYES, full, bright, clear, large.....	1	
10. FOREHEAD, broad, full.....	1	
11. EARS, medium size, pointed, well carried, and not far apart.....	1	
12. NECK, muscled; crest high; throat fine; wind-pipe large.....	1	
<b>FOREQUARTERS.</b>		
13. SHOULDERS, long, smooth, with muscle oblique, extending into back and muscled at withers..	3	
14. ARM, short, thrown forward.....	1	
15. FOREARM, muscled, long, wide.....	2	
16. KNEES, clean, wide, straight, deep, strongly supported.....	2	
17. CANNONS, short, wide, sinews large, set back...	2	
18. FETLOCKS, wide, straight.....	1	
19. PASTERNS, strong, angle with ground 45°.....	3	
20. FEET, medium, even size, straight, horn dense; frog large, elastic, bars strong; sole concave; heel wide, high.....	7	
21. LEGS, viewed in front, a perpendicular line from the point of the shoulder should fall upon the center of the knee, pastern and foot.....	3	
<b>BODY.</b>		
22. CHEST, deep, low, large girth.....	2	
23. RIBS, long, sprung, close.....	2	
24. BACK, straight, short, broad, muscled.....	2	
25. LOIN, wide, short, thick.....	2	
26. UNDERLINE, long; flank rather low.....	1	
<b>HINDQUARTERS.</b>		
27. HIPS, smooth, wide, level.....	2	
28. CROUP, long, wide, muscular.....	2	
29. TAIL, attached high, well carried.....	1	
30. THIGHS, long, muscular, spread, open angles...	2	
31. QUARTERS, heavily muscled, deep.....	2	
32. GASKINS OR LOWER THIGHS, long, wide, muscular.....	2	
33. HOCKS, clearly defined; wide, straight.....	5	
34. CANNONS, short, wide; sinews large, set back...	2	
35. FETLOCKS, wide, straight.....	1	
36. PASTERNS, strong, sloping.....	2	

## STUDENT'S SCORE CARD FOR LIGHT HORSES.—Continued.

	Perfect Score.	Student's Score.
37. FEET, medium, even size; straight; horn dense; frog large, elastic; bars strong; sole concave; heel wide, high.....	5	
38. LEGS, viewed from behind, a perpendicular line from the central point of each quarter should fall upon the center of all the joints and foot.....	3	
ACTION.		
39. WALK, elastic, quick, balanced.....	5	
40. TROT, rapid, straight, regular, high.....	15	
Total.....	100	

## REVIEW.

1. Mention the market classes of horses.
2. What are the four groups of pure breeds of horses?
3. Name five draft breeds.
4. Name four coach breeds.
5. Name three light horse breeds, and three pony breeds.
6. Tell all you can of the Percherons. What other two breeds are nearly like them?
7. Describe the Clydes and English Shires.
8. Tell what you can of the Suffolk Punch; also the Belgian Draft.
9. Describe the coach horse type.
10. Which are the oldest pure-bred horses? What can you say of them?
11. Give the origin of the American trotter, and American saddle horse.
12. What is a mule? Where are they chiefly raised?
13. Why should a buyer examine a horse for soundness?
14. For what things should he look when the horse is in the stall?
15. What defects may be found about the nose, mouth, eyes, and head?
16. What faults may be looked for on the fore and hind legs?
17. Give five characteristic features of a good draft horse.
18. Give five in contrast with these for the light horse type.

References.—U. S. Farmers' Bulletins: 619, Draft breeds; 667, Colts; 779, How to Select a Sound Horse; 952, Light breeds; 1030, Feeding; 1093, Tractor influence; 1097, Stable Fly; 1146, Dourine. Ark. Ext. Circ. 117, Judging Livestock.

## CHAPTER XXIV.

## CATTLE.

THE improved breeds of cattle of to-day were developed from the native types found in Western Europe, chiefly in Great Britain. There are many named breeds, but only a few have gained a prominent place among stockmen. The most important are classified as (1) beef breeds, (2) dual-purpose or general-purpose breeds, (3) dairy breeds. Grade animals of the pure breeds may be obtained by the use of pure bred males of the breed desired. Good high grades always give better results than scrubs or natives, either for milk or for beef.

**Beef Breeds.**—These are raised not for milk but for meat. They are in some rare cases so highly specialized that the mothers, though well fed, fail to give enough milk for their calves. None of the beef breeds except the Shorthorn gives milk enough to be considered profitable for dairy use.

Beef animals should have deep, plump, compact bodies, well covered with flesh, giving them a blocky appearance; the back is broad; the legs are short, straight, and well-placed; all quarters are quite thick; the neck is short and thick. The whole appearance is that of meat-production.

The chief distinctive beef breeds are: (1) Shorthorn, including Polled Durham, (2) Hereford, (3) Aberdeen Angus, and (4) Galloway.

*Shorthorns* originated in northeastern England and were first introduced into America in 1783. They are now very popular cattle. In their general type most of the families of the breed conform closely to the beef type (Fig. 162); but that branch known as the Bates family of Shorthorns are so much inclined toward the dairy type as to be classed as general-purpose animals. The name was given them

because of their short horns in contrast with the long-horned cattle of England. The names Durham, Teeswater, and Holderness were local names given them in those localities where they were bred.

The Polled Durhams are a hornless branch or family of the Shorthorn breed; the term "polled" means hornless. Their hornless character is their only difference from the Shorthorns. Cows of the breed weigh 1400 pounds or more. The colors vary much more than in any of the other breeds of cattle. The prevailing colors are red, white, and roan.



FIG. 162.—Beef type of shorthorn, white and roan. (An. I)

*Herefords* (Fig. 163) originated in Herefordshire, England, and were first brought to this country by Henry Clay in 1817. The breed is old and well established. In color these cattle are red with white faces and some white markings along the back, under line and sometimes on the feet and tail. The *Herefords* (pronounced *Her-fords*) are shorter legged, more blocky and a little heavier than the *Shorthorns*. They are well suited to grazing and fatten easily on the grassy plains of the West. There they have been extensively mixed with the native cattle, the grade *Herefords* making good beef cattle.

As already mentioned in another chapter, there is now

a branch of this breed without horns, the Polled Herefords. The hornless character in cattle is always to be desired: there is then no necessity for dehorning. Horned cattle often do each other, or their keepers, considerable harm, in the feed-lot or cattle car.

*Aberdeen Angus* cattle originated chiefly in the county of Aberdeen and the district of Angus, in the northeastern part of Scotland. Local names for them are Polled Angus and "Doddies," both names referring to their natural hornless character. They are black, sleek, short-legged, plump

FIG. 163.

FIG. 164.

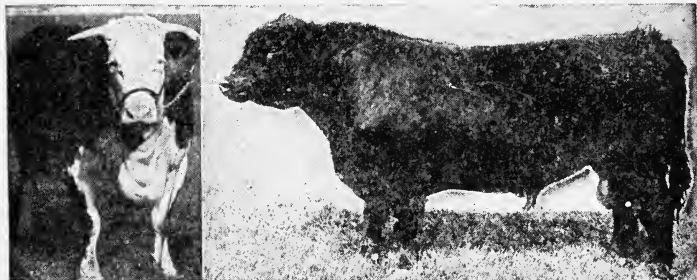


FIG. 163.—A. Hereford cow, of the heavy beef type; color red and white, FIG. 164.—Galloway bull, black, hornless with shaggy coat. Beef type. (Kans.)

cattle, a little smaller than the Shorthorns. Their disposition is very quiet and gentle, and they fatten easily, either on good blue grass pastures, or in close feeding quarters of the corn-belt. The beef is of the very best quality, and the fattened animals bring the highest market prices (Fig. 165).

*Galloway* cattle are also from Scotland, but from the rough districts of the southwestern part of the country. Like the Angus cattle, the Galloway is black and hornless and has very short legs. But a marked difference in appearance is due to the shaggy or curly hair (Fig. 164). The hair is so long and curly that the cured skins are used for making rugs, robes, and overcoats. These cattle can subsist on the poorest

roughage or pasture, but respond rather too slowly to good feeding. The cuts of beef of the Galloway carcass are of good quality and the animals sell in the Chicago markets at prices next to those paid for Angus cattle. Galloway cows are very light milkers, but usually supply enough to raise their own calves.

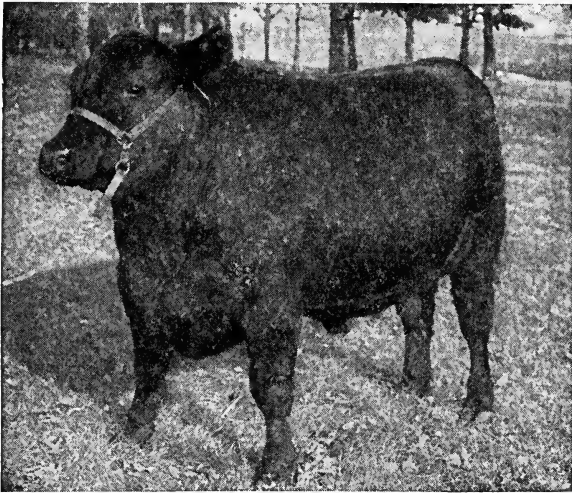


FIG. 165.—A product of good breeding. Aberdeen Angus calf, two years old, black, weight 1624 pounds. Champion of the baby-beef type. (Minn.)

These cattle are hardy because of the climate from which they came. Because of this hardy character they are used in the Northwestern States where the winters are severe. Galloway cows have been crossed with the American buffalo, the name *Catalo* being given to the hybrid offspring. No special benefit has yet been derived from this cross.

**Dual-Purpose Breeds.**—Cattle of these breeds serve two purposes, giving milk and producing meat, but do each only fairly well. They may properly be called general-purpose animals. The type of body is not so lean and angular



as in the true dairy breeds, nor so blocky and heavy as in the beef type. A few of them are heavy and incline a little toward the production of beef rather than milk, and others are heavier milkers and have more of the dairy conformation; for example, the Devons and also the Red Polled breeds have both types. Dual-purpose breeds are quite popular with general farmers because they are fair milkers and the male calves are heavy enough to be sold for veal. Special farmers do not use the dual-purpose breeds very much. They want the best beef breeds if their special line is beef production; or special dairy breeds are kept for the production of milk, cream, and butter.

The leading dual-purpose breeds in America are: Devon, Red Polled, Brown Swiss, the Bates family of Shorthorns, and usually the Polled Durhams.

*Devon Cattle.*—These originated in England centuries ago, and were brought to America in Colonial times. They are red with an occasional marking of white on the udder. The horns of the cow are long and slender and curved upward. As suggested above they are of two types. The plump, trim animals are better for beef, although smaller than those of the dairy type. Those of the beef type fatten fairly well and the meat is of good quality. As milk producers, Devon cows rank very well, the milk being nearly as rich as Jersey milk. These cattle are usually much smaller than Shorthorns.

*Red Polled.*—This (Fig. 166) is another English breed of red cattle. They are always polled, are larger than the Devons, and often have some white markings on the under parts. Solid red is most common. This is probably the best of the strictly dual-purpose breeds; the cows when dry will fatten easily, and the steers are good beef animals. The males will weigh from 1800 to 2200 pounds when mature and fat. The cows give a good flow of rich milk, but have very large teats and badly shaped udders. The two types of cattle found in this breed make it difficult for breeders to

always secure the special type of calves which they prefer. Dairymen keeping this breed will often be disappointed by the frequent recurrence of the beef form.

*Brown Swiss* cattle have been bred for centuries in Switzerland. They were first brought to this country in 1869, and are not yet given wide distribution. The color is dark



FIG. 166.—Red-polled cows. one of the dual-purpose breeds. (An. I.)

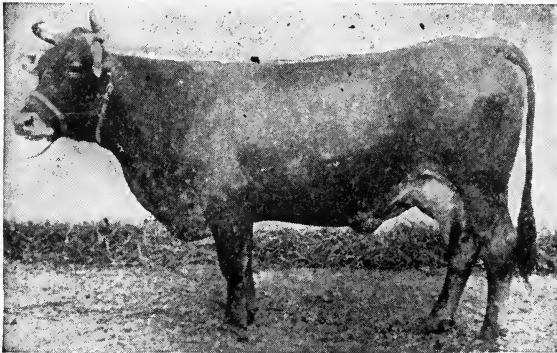


FIG. 167.—Brown Swiss cow, of the dual-purpose type.

mouse to light brown, with more or less of gray along the back line and under parts. The udder is usually white. The tongue and nose are dark or black, the hoofs black, the horns white at the base and dark at the tip. In form these cattle are more blocky than the Red Polled cattle (Fig. 167). The neck and head are large and heavy. Brown Swiss cows yield rather large quantities of milk. It is not very rich in butter fat. The climate and surroundings from which these

cattle come make them well suited to foraging for themselves, but when given good treatment and proper feed they respond well.

**Dairy Breeds.**—There are several special dairy breeds, the chief purpose of which is the production of milk. They are little suited to beef production (Fig. 168). The form is lean and angular, inclined to the wedge shape as viewed from the front, side, and top. The full description of the dairy type is given in the score card at the end of this chapter. (See also Figs. 169–171.)



FIG. 168.—Products of the dairy. One Jersey calf at the left, next a Guernsey, Ayrshire in the middle, and two Holsteins on the right.

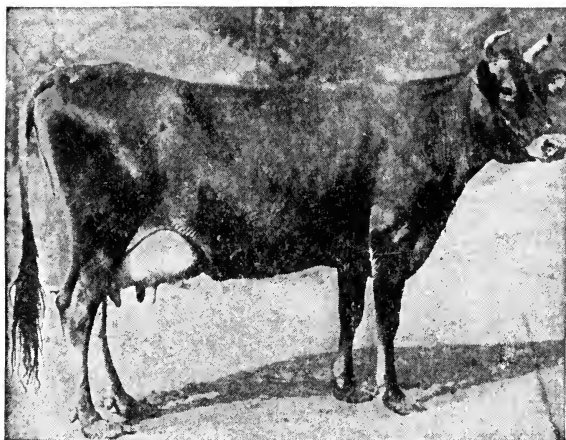
The chief dairy breeds in America are: (1) The Jerseys for butter; (2) the Guernseys for good quality of cream; (3) the Holsteins, or Holstein-Friesians, for market milk; (4) the Ayrshires for cheese, home milk and infant feeding. Less common dairy breeds are: The Dutch Belted Cattle of Holland, black with wide white belts; and the French Canadian of the province of Quebec, resembling black Jerseys.

*The Jersey breed* originated on a small island by that name in the channel group of islands in the English Channel. No cattle can be taken to that island except for slaughter within twenty-four hours, because of laws made for the purpose of keeping the breed pure. This is the most popular of the dairy breeds in America because of the richness of

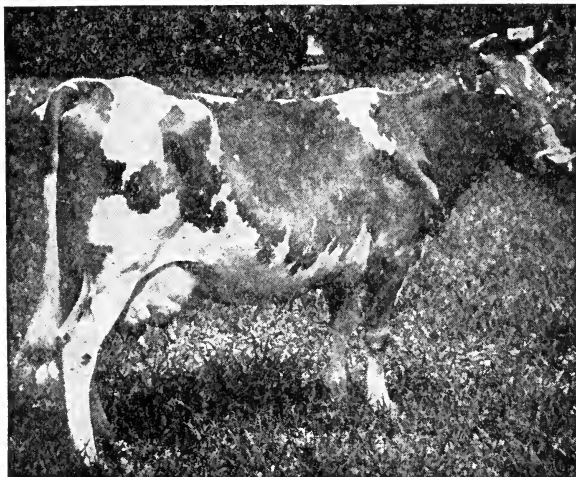
the milk. The cows are famous for the large quantities of butter which they produce, many of them yielding from fourteen to seventeen pounds of butter in a week. "Loretta D," shown in Fig. 169, produced 330 pounds of butter in 120 days. The Jersey is smaller than any of the other dairy breeds used in this country. The general color is squirrel gray and fawn color. White markings sometimes appear, and considerable grayish shading is seen about the mouth and eyes. The nose is usually black or dark colored. The tongue and switch may be either black or white.

*Guernseys* also have for their native home one of the small islands in the English Channel. They were first brought to America in 1818. The cattle are much like the Jerseys in their milk and butter yields. The cream is much smoother than that of the Jerseys, as the fat particles are not so coarse. The cream and butter of the Guernsey are well supplied with their own natural coloring matter. The cows are a little larger than Jerseys and more rugged in appearance (Fig. 170). The general colors are red-and-white or fawn-and-white. The nose should be flesh-colored, never black. The popularity of the breed is rapidly increasing, and even the grades command a high price in the butter-making sections.

*The Holstein-Friesians* are usually called merely Holsteins (Hol-stines). The longer name is derived from the names of two provinces in Holland, the native home of the breed, where it has been kept pure for many centuries. They are much larger than the Jerseys and are black-and-white in color (Fig. 171). They are the heaviest milk producers of all the cattle. The milk is of fair quality but not rich in fat. One of the best records for milk and butter produced by a Holstein cow was made by "Colantha 4th's Johanna," 27,432 pounds of milk and 1164 pounds of butter in one year. Among dairymen who sell milk in the markets of the large cities this breed is very popular. In cheese-making districts of Wisconsin and elsewhere this breed is much used. The fat particles are very fine and hence the cream does



**FIG. 169.**—Jersey cow, "Loretta D." She has won prizes as the champion cow of the world in producing milk and butter. (Animal Industry.)



**FIG. 170.**—Pure-bred Guernsey cow, an ideal dairy type. (Experiment Station, N. J.)

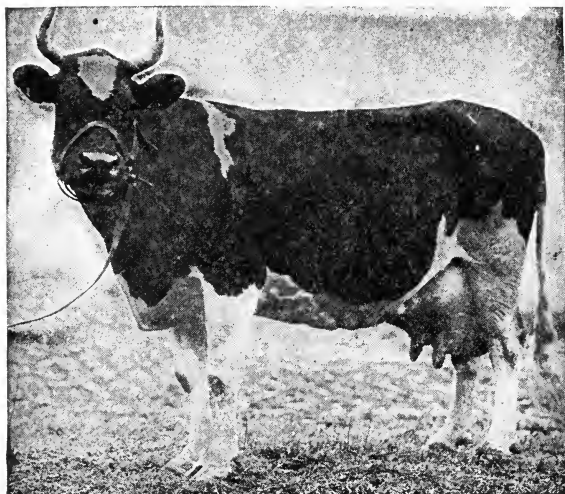


FIG. 171.—Grade Holstein cow. Notice the udder and milk-vein showing under the body. (Experiment Station, N. J.)

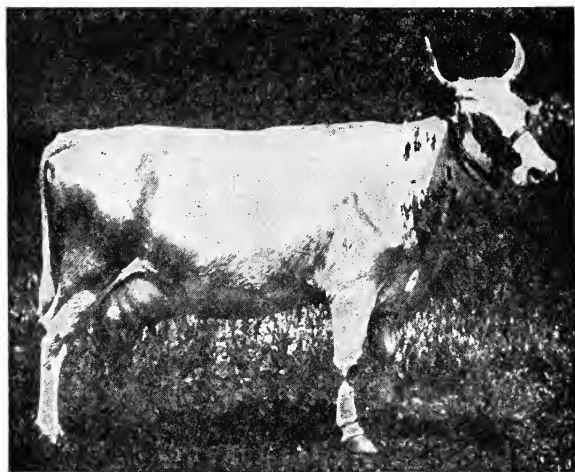


FIG. 172.—Pure-bred Ayrshire cow (Experiment Station, N. J.)

not rise quickly. This makes it suitable milk to use in the ordinary city delivery.

*Ayrshire* cattle are natives of the county of Ayr in Scotland. They are smaller than the Holsteins but much larger



FIG. 173.—School-boys and young farmers studying a Hereford. (Agricultural Education.)

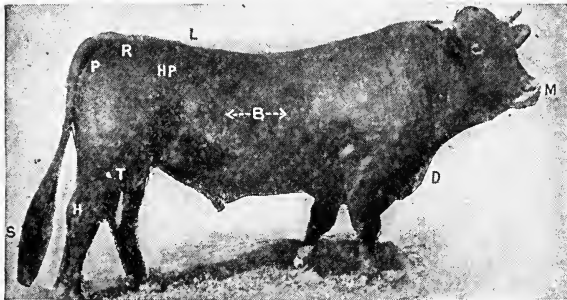


FIG. 174.—Points of cattle shown on a Brown Swiss bull. M, muzzle; D, dewlap; B, barrel; L, loin; HP, hip or hook; R, rump; P, pin bone; T, thigh; H, hock; S, switch.

than the Jerseys. In form the Ayrshires are somewhat plump and less angular than any of the other dairy breeds (Fig. 172). The calves are very good for veal. The milk-producing properties of Ayrshires are very much like the Holsteins, the yields being large and the milk not so rich in fat as the Jerseys. The milk has much total solid matter in it, thus

making its food value very high. It is valuable for cheese making. The colors among Ayrshires are red, brown and white, these colors often being mixed. The breed is much more common in Quebec, Ontario, New England, and New York than in other parts of the country.

EXERCISE.—*Breeds of Cattle.*—The breeds of cattle that are most used in any section are the ones that should be studied most. The class may be taken to near-by places for this purpose, or the animals may be brought to sheds or barns nearer by for the purpose of class study (Fig. 173).

EXERCISE.—*Beef and Dairy Types.*—It is important that students learn well the beef and the dairy type. The animals to be used for this purpose need not be pure in breed. Type specimens may usually be found without difficulty and should be brought to the school, or the class may go where the animals are found. The following score cards should be studied and used in the judging exercise. The names of the parts are shown in Fig. 174.

## REVIEW.

1. For what two purposes are cattle raised? What three classes of breeds are used for these purposes?
2. Describe the beef form of animals.
3. Name four beef breeds and tell what country each is from.
4. Give the chief colors of each of the four beef breeds. Which are hornless?
5. Name them in order of their relative size.
6. Which one is used most on the Western grass plains? Why?
7. Which is the most hardy and cold-loving?
8. Give some reasons for raising dual-purpose breeds.
9. Why should special farmers not raise them?
10. Describe the dairy type of animal.
11. Name four dairy breeds and give the special use of each.

References.—U. S. Farmers' Bulletins: 206, Milk Fever; 498, 569 and 639, 1057, Texas Fever; 612, 893 Breeds; 666, Foot-and-Mouth Disease; 724, 743, 777, 812, 873, 1073, 1179, 1218, 1229, Feeding; 784, 790, 909, 954, 1017, 1018, 1069, Diseases; 949, Dehorning and Castration; 1066, Age; 993, Bull Associations; 1135, Beef Calf. Ark. Sta. Bul. 96, 106, 136, on Diseases. Ark. Ext. Circ. 82, Beef Calf Clubs.



STUDENT'S SCORE CARD—DAIRY COW.

	Perfect Score.	Student's Score.
<b>GENERAL APPEARANCE.</b>		
1. WEIGHT, estimated..... lbs.....		
actual..... lbs.....		
2. FORM, wedge shaped as viewed from front, side and top.....	5	
3. QUALITY, hair fine, soft; skin mellow, loose, medium thickness, secretion yellow; bone clean.....	8	
4. CONSTITUTION, vigorous, not inclined to beefiness.....	8	
<b>HEAD AND NECK.</b>		
5. MUZZLE, clean cut; mouth large; nostrils large..	1	
6. EYES, large, bright.....	1	
7. FACE, long, lean, quiet expression.....	1	
8. FOREHEAD, broad, slightly dished.....	1	
9. EARS, medium size; yellow inside, fine texture..	1	
10. NECK, fine, medium length; throat clean; light dewlap.....	2	
<b>FORE AND HIND QUARTERS.</b>		
11. WITHERS, lean, thin.....	2	
12. SHOULDERS, light, oblique.....	2	
13. HIPS, far apart; level between hooks.....	2	
14. RUMP, long, wide.....	2	
15. PIN-BONES OR THURLS, high, wide apart.....	1	
16. THIGHS, thin, long.....	2	
17. LEGS, straight, short; shank fine.....	1	
18. TAIL, long, slim; fine switch.....	1	
<b>BODY.</b>		
19. CHEST, deep, low; girth large.....	8	
20. RIBS, broad, well sprung, long, wide apart.....	5	
21. BACK, lean, straight.....	3	
22. LOIN, broad, level.....	2	
23. FLANK, moderately low.....	1	
<b>MILK-SECRETING ORGANS.</b>		
24. UDDER, long, attached high and full behind, extending far in front and full; quarters even.....	15	
25. UDDER, capacious, flexible, with loose pliable skin covered with short fine hair.....	15	
26. TEATS, large, evenly placed.....	4	
27. MILK VEINS, large, tortuous, large milk wells..	6	
Total.....	100	

## STUDENT'S SCORE CARD—BEEF CATTLE.

	Perfect Score.	Student's Score.
GENERAL APPEARANCE.		
1. WEIGHT, estimated . . . . . lbs. . . . . according to age . . . . .	6	
2. FORM, straight top-line and under-line; deep, broad, low, set stylish . . . . .	10	
3. QUALITY, firm handling; hair fine; pliable skin; dense bone; evenly fleshed . . . . .	8	
4. TEMPERAMENT, quiet . . . . .	5	
HEAD AND NECK.		
5. MUZZLE, mouth large; lips thin; nostrils large . .	1	
6. EYES, large, clear, placid . . . . .	1	
7. FACE, short; quiet expression . . . . .	1	
8. FOREHEAD, broad, full . . . . .	1	
9. EARS, medium size, fine texture . . . . .	1	
10. NECK, thick, short; throat clean . . . . .	2	
FOREQUARTERS.		
11. SHOULDER VEIN, full . . . . .	3	
12. SHOULDER, covered with flesh, compact on top; snug . . . . .	4	
13. BRISKET, advanced, breast wide . . . . .	2	
14. DEWLAP, skin not too loose and drooping . . . . .	1	
15. LEGS, straight, short; arm full; shank fine, smooth . . . . .	3	
BODY.		
16. CHEST, full, deep, wide; girth large; crops full . .	8	
17. RIBS, long, arched, thickly fleshed . . . . .	8	
18. BACK, broad, straight . . . . .	8	
19. LOIN, thick, broad . . . . .	6	
20. FLANK, full, even with under-line . . . . .	4	
HINDQUARTERS.		
21. HIPS, smoothly covered; distance apart in pro- portion with other parts . . . . .	4	
22. RUMP, long, even, wide, tail head smooth, not patchy . . . . .	5	
23. PIN-BONES, not prominent, far apart . . . . .	3	
24. THIGHS, full, deep, wide . . . . .	3	
25. LEGS, straight, short, shank fine, smooth . . . . .	2	
Total . . . . .	100	

## CHAPTER XXV.

## SHEEP RAISING.



SHEEP have two main uses, the production of mutton and the production of wool. In ancient times shepherds also kept them for their milk. For these two present purposes there are now a number of breeds of sheep.

**Types.**—Those which produce the most and best mutton are blocky in form and correspond closely in outline to the beef type in cattle. Sheep that naturally have a lean, angular frame, like a good dairy type of cow, are of the type best suited for wool production.

**Breeds Classified.**—Many of the common breeds of sheep are used both for wool and mutton. They are, therefore, usually grouped according to the length or fineness of wool, as: *fine* or short wooled; *medium* wooled; and *coarse* or longed wooled. The medium and the coarse wooled sheep comprise the mutton breeds.

**Coarse Wooled Breeds.**—The coarse or long-wooled sheep include the Leicester (Les-ter), Lincoln, and Cotswold. They all originated in England.

*The Cotswolds* (Fig. 175) are much more common in America than the others of the coarse wooled group. They are larger than most other sheep, the males attaining a weight of 250 pounds or more. The meat from the lambs is of fair quality. They have no horns; the face is always white. The locks of crimped wool are often twelve inches in length. The fleece or annual shearing from a Cotswold will average ten pounds of rather coarse wool with long staple or fiber.

*The Leicesters* are of much the same type as the Cotswold;

but the head is without wool, the fleece is not in curly locks, and the frame is not so large. They are also hornless.

*The Lincolns* exceed the Cotswolds in size, the males sometimes weighing 350 or 400 pounds (Fig. 176). They are hornless, have white faces with a little wool on the head. The fleece of the body hangs in curly locks, and the staple is longer than in any other breed; they shear about fifteen pounds to a fleece.

**Medium Wooled Sheep.**—This group is much more popular than either of the others because of their general-purpose character, and their lambs mature sooner than those of the larger breeds. The most common breeds of this type in America would be named in about the following order: Shropshire, Southdown, Hampshire, Oxford, Cheviot, and Dorset. These are all natives of England, and are hornless except the last or occasionally the Cheviot males. They have brown or black faces, ears, and legs, except the Dorsets and Cheviots, which have white markings. All of these breeds have wool on the faces except the Cheviots, which are woolled only to the ears. Shropshires, Southdowns, and Cheviots increase in numbers rapidly, as twin lambs are very common.

The Southdowns (Fig. 177) are the smallest breed named in this group. The Shropshires, Cheviots, and Dorsets come next in size and weight. The Hampshires have larger frames and are a little heavier, but the Oxfords stand at the head of the list in size and weight (Fig. 178).

The fleeces of the Shropshire (Fig. 179), Oxford, and Dorset are all of good weight and the wool of excellent quality. These three and the Cheviots produce very good mutton, but the Southdown meat is popularly considered the best.

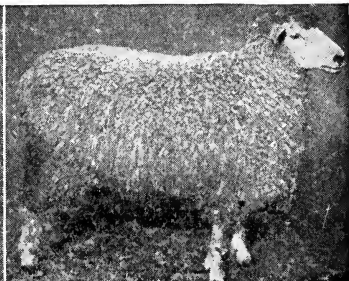
Cheviot sheep are the best grazers, having been well trained to this in their native land—the Cheviot hills, between England and Scotland.

The Dorset breed (Figs. 180, 181) is much used for the production of early or winter lambs for the city markets.

**FIG. 175.**

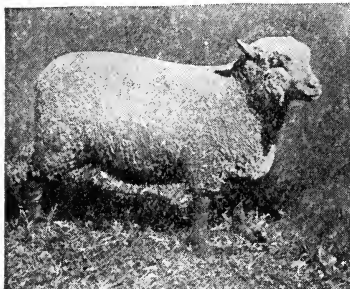


**FIG. 176.**



**FIG. 175.**—Cotswold ewe, one of the longer or coarse-wooled breeds.  
**FIG. 176.**—Lincoln ewe, a coarse-wooled type.

**FIG. 177.**



**FIG. 178.**



**FIG. 177.**—Champion Southdown ewe, one of the most popular of the medium woolled breeds.

**FIG. 178.**—Oxford ram. These have the longest wool of the medium breeds.

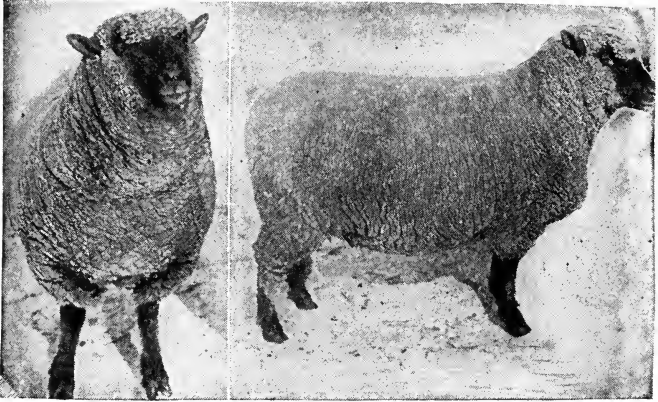


FIG. 179.—Prize-winning Shropshire wether one year old.  
(Experiment Station, Wis.)

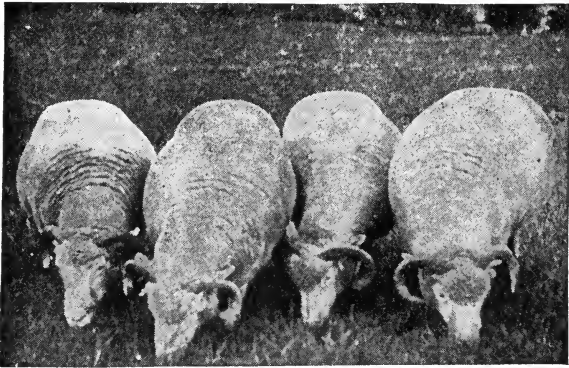


FIG. 180.—Dorset sheep making mutton on pasture, a horned breed of the medium wool type. (From *Cornell Countryman*.)

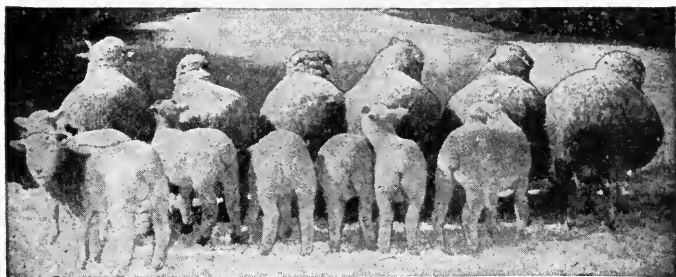


FIG. 181.—Dorset ewes and their winter lambs. This is a good breed for the production of winter or "hot-house" lambs.

FIG. 182.



FIG. 183.

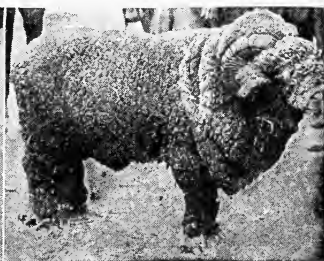


FIG. 182.—American Merino ram, "Perfection." Note the wrinkles all over him except on the back.

FIG. 183.—Rambouillet or French Merino of the fine woolled type.



FIG. 184.—A lesson in judging sheep. (U. S. Dept. of Agr.)



The "hot-house" lamb industry, as this is called, is a growing and special line of the sheep industry in America.

**Fine Wooled Sheep.**—This is the Merino group. Their wool is very fine in quality and the fleeces much heavier than in the other breeds. There is an oil secreted by the skin which makes the wool very oily; this is called the *yolk*. The oil catches much dust, which always gives the sheep a dirty appearance. The sheep are quite small in size and lack the plump form found in the mutton breeds. The mutton is not of good quality, and none but the largest are used for this purpose.

There are three breeds of Merinos found in America. They are all descendants of the original Spanish blood. These are (1) American Merino; (2) Rambouillet (Ram-boo-yá) or French Merino; (3) Delaine Merino. The males have spiral horns and the females are without horns.

In all of these the fine wool covers the body and legs down to the feet; but the nose and ears are usually free from wool. The American Merino (Fig. 182) is the smallest and has deep wrinkles or folds all over the body except on the back. The Delaine is less wrinkled and is somewhat larger. The Rambouillet (Fig. 183) is much the largest of the group, with no folds at all except sometimes on the neck and breast.

The Merinos are all hardy and good grazers. Their grades are used for grazing in large flocks on the Western plains.

**Care of Sheep.**—Sheep naturally live in mountainous and hilly regions, where they get their living by feeding on grasses and native plants of all kinds. There is now greater profit from the raising of sheep in those sections where the country is too rough for the raising of cultivated crops. Sheep make good use of the land that would otherwise be wasted. This is true to a greater degree with sheep and Angora goats than with any other domestic animals. Sheep are naturally kept in flocks, the Merinos in very large

flocks and the mutton breeds in smaller numbers. The handling of very large numbers of any breed in a single flock requires considerable experience. It is better to begin with small flocks.

Winter quarters for sheep should not be very warm. The animals have their own coats and will suffer if housed too closely. It is highly important that they be kept perfectly dry in every respect. Protective shelter from rain and snow to keep the coats dry, and good drainage in the sheds and lots to keep the feet dry, are essential to success.

During the winter the flocks should be divided so that all will have equal opportunity at the feed trough and racks. Not over twenty-five or fifty in a single flock should be the rule. When the numbers are large they may be sorted into such groups as: first, wether lambs; second, ewe lambs; third, shearling ewes; and fourth, breeding ewes.

The winter feed for sheep should include plenty of roughage, such as clover hay, cut corn fodder, and oat straw. They are very fond of root crops, and plenty of sugar beets, mangles, or turnips should be provided.

Great care and constant attention are required by the shepherd when lambing time comes. New-born lambs must not become chilled. Some ewes fail to own their lambs and must be held for the young to draw the milk. These and many other points require the immediate attention of a good shepherd.

**EXERCISE.**—*Samples of Wool.*—Typical samples of wool may be brought by pupils or obtained from noted breeders through the mail. These should be fastened with thread to cards and labelled with the name of the breed. Let students point out the difference in wool while studying the breeds of sheep.

**EXERCISE.**—*Breeds of Sheep.*—Pupils should be given an opportunity to become familiar with all the breeds or the types of sheep kept in the section where the school is

located. Typical specimens may be brought to the school; or the students may go where the sheep are kept (Fig. 184). Score cards for fine woolled sheep and for mutton sheep may be used in judging such sheep. Write to the Agricultural College of your State for such score cards. (See address in the Appendix.)

**Projects With Sheep.**—1. A lamb feeding project is well suited to young people studying agriculture. Lamb clubs may be formed to add more interest. The project should start with six or more spring lambs, preferably wethers, to be fed for mutton. This project may continue for several months and should include pasture period, fattening period, marketing, treatment for disease, keeping records of weights at beginning and end, all costs, income, and profit. The story of the project should be written at the close.

2. Ewe lambs raised and kept for breeding will form another good home project. These should be high grade or pure bred lambs.

3. A few good ewes of breeding age may be selected to start a project to continue for a year. Include all feeding and care of adults and lambs, prevention of disease, selection of breeders and feeders among the lambs, and keeping records such as those suggested in project No. 1.

**Sheep Debates.**—Resolved, that there should be more profit in one year from a sheep project with 25 ewes than from a swine project beginning with 5 sows; or a dairy project beginning with four good milk cows. Labor, feed, cost, interest, and income to be considered. In preparing for the debate make lists of these items and all arguments on both sides of the question.

Pure bred vs. scrub grades. Coarse wool vs. medium wool breeds. Warm houses vs. open houses. Early lambs vs. late lambs.

## QUESTIONS

1. What are the two main uses for sheep?
2. What are the three classes of sheep? Which two of these are used for mutton.
3. Describe the Cotswolds.
4. Compare the Leicesters and Lincolns with these in every way that you can.
5. Name five breeds of the medium woolled sheep.
6. Give the chief differences between these five breeds.
7. Which breed is used for the winter lamb industry?
8. Describe the Merino breeds and tell their differences.
9. For what kinds of places are sheep best suited?
10. Describe best winter quarters for sheep.
11. Why should the flock be separated into small numbers in winter?

**References.**—Write to your congressman for several copies each of the following U. S. Farmers' Bulletins on sheep raising: 713, 798, 810, 840, 929, 1051, 1150, 1155, 1172, 1179, 1181, 1199, 1229, 1268. Ark. Sta. Bul. 16, Goats.



## CHAPTER XXVI.

## SWINE PRODUCTION.

**Swine Raising.**—Before deciding to be a swine specialist one should do several things: (1) Make a study of the different breeds. (2) Study the best methods of care, management, and marketing. (3) Gain some experience in growing swine by beginning with a few.

Hogs are most abundant in the Corn Belt of America because they produce a home "market" for the corn grown on the farms. They may be produced with as great profit in the East and South, particularly where markets and pastures are good. Plenty of pasturage is essential to profitable swine growing.

The common practise, in some sections, of keeping pigs in small pens or dry lots without green feed, is seldom profitable. Mud and filth make them a menace to human health; the pigs are apt to become diseased; their growth is slow; and the feed given them is often largely wasted.

Where pigs are kept for the purpose of consuming substances that would otherwise go to waste, they may be kept in hurdle pens easily moved to clean fresh grass. Light, movable pens are sometimes used in keeping pigs on vacant lots in villages. These are frequently moved to clean grass and no objectionable odor is produced.

The use of pigs to consume by-products or wastes, is quite common in all sections. Undigested corn or other grain in cattle feed lots; gleanings from stubble fields; skim milk, whey and buttermilk; tankage and other slaughterhouse wastes; weeds; small potatoes and other garden by-products; kitchen refuse—these are all turned into cash value when consumed by growing pigs. When such by-products are used

to good advantage the profits are greatest. This may be the reason why more swine are raised in the United States than any other class of livestock except cattle.

**When to Buy Breeding Stock.**—Do not hesitate about going into the swine business just because prices of market pigs happen to be low. That may be the very best reason for increasing your numbers, for others are apt to be dropping out and rising prices will be the result. Periods of high prices always follow periods of low prices.

**Keep Good Swine.**—It is from the wild forms of the Old World that the improved breeds of swine have been developed. The changes wrought have been truly wonderful. The time required for the pig to mature has been reduced more than one-half. The tendency to become very fat, which is so well marked in some breeds, is not found in wild hogs. Domestic pigs are usually quiet, not wild and ferocious.

To obtain the best results in swine management, it is necessary to keep pure bred or high grade swine. They are more prolific, fatten easier, mature at an earlier age, and are larger than the scrubs.

**Which Type of Swine.**—There are a number of breeds of swine but only a few have become very popular in America. They are of two types first, *lard* or *fat type*; and second, the *bacon* or *lean type*. The form of the body in the fat type is compact, deep, broad, and low, with short back and deep, fat sides; the neck is short and thick; head small; hams and shoulders large.

The bacon type has long legs, long neck, coarse head, narrow back, long and deep sides, in many respects the very opposite of the fat type. Bacon swine are kept for their fine, lean cuts of bacon. The demand for this type is not so great in the United States as in England, because the fat type is better suited to corn feeding.

**Which Breed of the Fat Type.**—The most popular breeds of swine in America, of the fat type, are Poland China,

Duroc-Jersey, Chester White, Hampshire, Berkshire, and Spotted Poland China. Others of less prominence are Cheshire, Victoria, Small Yorkshire, Essex, and Suffolk.

America has produced very few new breeds of horses, cattle or sheep, but a number of good breeds of swine have been developed here. Swine from Europe are not so well suited to the use of American field corn as to the grains of their own country. Many of the English breeds are of the bacon type and will not thrive so well on corn. The Berkshire is the only very popular English breed in this country. The Poland China originated in Ohio, the Chester White in Chester County, Pennsylvania, and the Duroc-Jersey in New Jersey.

The Poland China (Fig. 185) and the Berkshire are both black with some white markings on the face, legs, or other parts. The Chester White and the strain called Ohio Improved Chester (O. I. C.) are white in color. The Duroc-Jersey is red or some modification of that color. These are all large in size and the pigs mature early. The Berkshire has erect ears and a dished face; in the others the ears are drooping. The Duroc-Jersey is liked throughout the country because of the large litters of pigs.

The white breeds of swine are not much used in the South and Southwest because of the greater danger of skin diseases in hot, sunny climates. (See U. S. Farmers' Bulletin 765 Breeds of Swine.)

**Which Breed of the Bacon Type.**—The Large Yorkshire (Fig. 187), Tamworth (Fig. 186), and Hampshire are the leading breeds of the bacon type of swine. The last mentioned originated in Kentucky and the others in England. The Large Yorkshire is white, the Tamworth red, and the Hampshire black with a wide white belt.

**How to Begin Swine Raising.**—The beginner should start on a small scale. Losses from too large numbers may be serious and cause discouragement. There are several safe ways of beginning.

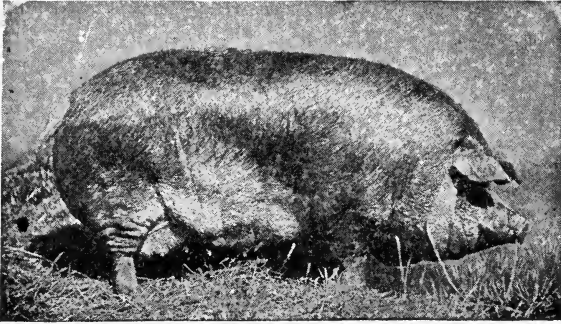


FIG. 185.—The lard type, a Poland China sow. Color, black with white markings.

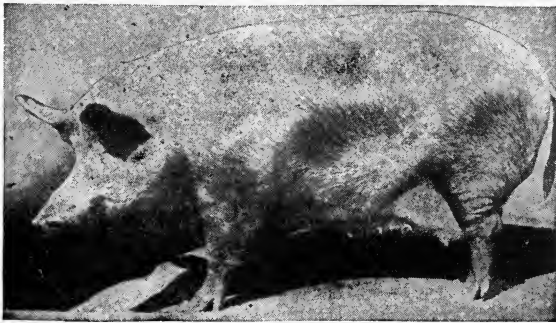


FIG. 186.—A Tamworth sow, red, representing the bacon type.



FIG. 187.—Students judging large Yorkshire swine. The bacon type.  
(U. S. Office of Experiment Stations).

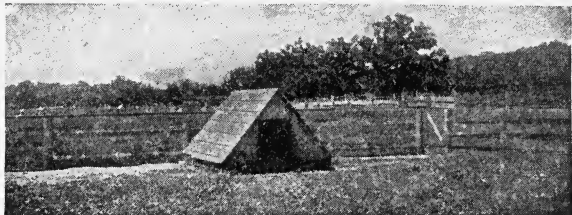


FIG. 188.—A form of brood house for sow and pigs. Easily removed  
to a clean place to prevent disease.



1. For boys and girls, one of the least expensive methods is to secure female pigs of weaning age, called gilts. Experience in feeding and earing for these is gained before they are of breeding age. They may be mated with a pure bred boar when at an age of eight months or so. When they farrow three months and twenty days later it should occur in the mild weather of spring or fall so that most of the pigs may be raised.

2. A good way to start is to buy one or two good young sows safely in pig. The type and quality of the sows may be well judged at this age and it is not necessary to secure a boar the first season. The returns come sooner than in plan No. 1. The inferior females in the litter may be culled and sold with the males as soon as heavy enough. This leaves the best gilts and their mothers for the future breeding stock.

3. A plan which gives quick returns is to buy male (or barrow) pigs of weaning age to be kept as feeders only. When these are sold for pork the money may be used for the purchase of breeding stock by plan No. 1 or plan No. 2.

4. Probably the poorest and most expensive plan for beginning is to buy a sow with her litter of pigs. Of course the qualities of the sow may be well judged at this time, and the pigs may sell for enough to justify the purchase.

**Scopes of Swine Projects.**—Young people planning home projects with swine, to be pursued during the years they are in school, may choose one of the preceding plans. Let each project continue for a year or more if possible. Manage the enterprise in such a way as to make it beneficial to the student in both training and income. The first cost of any such project is the greatest difficulty to overcome. When once started the project should continue long enough to get the income from at least two litters of pigs, if conditions will permit. One fall litter and one spring litter can be developed within one year if plan No. 2 is chosen for starting.

**Selecting Breeding Stock.**—After deciding which of the two types of swine to raise, and which breed to keep, the breeder of swine should use good judgment in selecting the foundation stock.

*The sow* should be typical of her breed, whether pure or high-grade. She should be of good breeding form with rather long body capable of producing and supporting a good udder. The heart girth, measured just back of the fore legs, should be large. She should be vigorous and hearty, not puny nor dainty. Not too thin nor yet too fat. She should be well

developed before mating at eight months of age or more. Do not buy a stunted sow. If a bred sow is chosen select one that will farrow in fall or spring, as extreme heat of summer and cold of winter are objectionable in raising young pigs. If an old sow is selected, she should not have been rebred until several weeks after her preceding litter was weaned. The number of pigs she raised before may be a good indication of her qualities as a mother. Count the number of well developed mammary glands. A sow that raised a good-sized first litter is preferred to one that raised only a few.

*The Boar.*—In choosing a boar to which to mate sows consider the following points:

(1) Use a pure-bred if possible; (2) one of the same type and breed as the sows; (3) well developed for his age and not under eight months of age; (4) one having the breed characteristics; (5) strong in any points in which the sow is weak; (6) one not used too much; (7) not too fat, nor too thin; (8) one having plenty of exercise.

**Care of the Breeding Stock.**—**Good Quarters** are essential to success with sows and young pigs. A good type of movable house is shown in figure 188. If this type of house is adopted make one for each sow and have a lot fenced off for each. The cost is low and it may be easily made. It should either face the South in winter, or the window in the back may be turned to the South if the door is kept closed. Move the house to clean ground when needed. A rail or shelf, about eight inches from the base, is constructed around the inside along the walls. This allows the young pigs to find a place of safety when the sow is about to lie down. She cannot kill them by crowding them against the wall. In cold climates a floor is needed in the winter house, but in warm weather no floor is necessary.

**Pastures.**—Provide plenty of pasturage for all times when there is no snow covering it. Not only should the owner provide lots where the pigs may run, but he should plan ahead and have crops planted that will make green growth at all times of the year.

In some lots have permanent grasses and clovers growing in their seasons. In others have Dwarf Essex Rape or turnips for spring and fall seasons. Have small grains growing for winter greens, and also winter vetch and crimson clover in regions where they will thrive. Provide fresh green growth for the hot, dry weeks of summer, using thickly sown kafir, sorghum, Sudan, cowpeas, soybeans, and sweet corn. Have some good shade in the pasture for protection in hot weather.

Pastures not only provide the green succulence necessary for the health and growth of pigs, but the necessary exercise, the protein for the ration, and much of the mineral matter. Pigs on pasture will make more rapid growth and cheaper gains than any others. They are healthier and have better frame-work because of good pasturage.

**Care at Farrowing Time.**—Try to provide quarters for the sow where she will be very comfortable, neither too cold nor too hot. Provide bedding that is easily moved, as cut-up straw, chaff free from dust, or wood shavings from a planing mill. Avoid long tangled straw that would entrap the pigs and cause them to be mashed. Keep her bed clean at all times. Have the quarters dry and free from drafts of air.

Before farrowing time the sow should have bran mashes made with skim milk or butter milk. Some tankage may well be mixed with it. She must have plenty of mineral matter to eat as given in this chapter. With such feed she will not only be in good health but she is less likely to eat her young pigs. Continue to use such feeds after farrowing also.

Make the sows gentle by scratching, rubbing, talking kindly, and petting when among them. No rough treatment should ever be allowed. Watch sows closely at farrowing time and help pigs and mother if needed. Sows that have had proper feed and exercise seldom have trouble at this time. Do not interfere if the sow is quiet and the pigs seem strong.

If the place is cold and the pigs seem weak, they may be placed in a nest box lined with warm carpet, containing a hot water bottle, and all covered with a blanket. Place the pigs in this drying nest until dry and ready to nurse. A drink of the mother's warm milk very soon after birth, is important. Strong pigs need no help to get this, but the weak ones may need your help at first. If a pig seems dead when he comes,

promptly wipe out his nostrils and mouth; pull the tongue forward, press a time or two on his ribs to induce breathing. Try blowing air into his lungs. He should revive in a moment, if at all.

When pigs are about a day old look for needle teeth at fore corners of each jaw. If they are prominent remove them with a pair of pliers to prevent them from causing sores in their own mouths and from injuring their mother and other pigs.

**Feeding the Sow and Litter.**—If good pasturage is provided, the sow and litter should be fed a wet mash of wheat middlings, gluten meal, or similar meal rich in protein. This should be made into a thin mash by mixing with butter-milk, skim milk, whey or warm water. It need not soak for more than a few hours. Corn is not a good feed for a sow and her litter. It is too rich in starchy matter, called carbohydrate. When the pigs are a few weeks of age they should be able to eat wet mash and drink milk from a trough. Provide a place for them to have a trough of their own and give them skim milk with a little middlings and meal added to it. Such a pig creep may be made in one corner of the lot. This feeding will help them and save the mother. Runts of the litter will thus have a better chance than before. This plan will gradually make pigs so independent of their mother that weaning has very little effect on them or their mother. If weather will not permit them to feed on pasture, supply them with turnips or other roots.

**Water.**—Running water, or other good fresh water should be provided, besides the slop furnished them. Do not depend on stagnant pools of water for your swine if you expect them to be thrifty.

**Mineral Matter.**—It is well to supply legumes, bran and other feeds rich in mineral matter, for growing swine; but in addition to such feeds, they should be supplied with a good mixture of such materials as the following, for the minerals they contain:

Plenty of charcoal, soft coal dust, and wood ashes; small amounts of common salt, saltpeter, sulfur, and air slaked lime. Secure as many of these as possible, mix them together and keep them under shelter where the pigs have constant access to them.

The bones and other tissues of the body require much mineral matter for their development. The owner should not fail in providing these cheap materials for the pig's growth. Pastures are not so badly rooted by pigs supplied with minerals.

**Four Feeding Periods.**—The life of a spring pig may be conveniently considered as divided into four feeding periods of six or eight weeks each:

(1) The *milk period*, during which time a large part of his growth is from his mother's milk, but some sloppy feed may be added. (2) the *wet mash* period, when the feed is mostly given in the wet form and plenty of skim milk is supplied to him. The ground feeds, such as middlings, gluten, and other feeds rich in protein are used in the wet mash, (see feed table in Appendix), and some sliced roots and clover pasture are provided. (3) The *pasture* period, when the clovers and grasses produce the greatest growth. A little wet mash is fed at the first part of this period and a little dry grain toward the last. (4) The *corn* period, or fattening stage. It is well to use some succulent feed in addition to the corn, but it is not best to give a wide range on pasture at this time.

**Fattening.**—If this four-period plan of feeding is followed for early spring pigs they can be sold at the best price without carrying them over winter. During this fattening period, when it occurs in the fall, the swine may be allowed to "hog off" a corn crop. This saves labor of gathering the crop and of feeding the hogs.

Self-feeding hoppers are sometimes used by owners of swine, particularly in regions outside the corn belt. The swine may be allowed to balance their own rations by having different kinds of feed in different bins of the hoppers.

The cost of producing a pound of live weight is much less for growing pigs than for those which have reached maturity. For this reason the farmer finds it more profitable to sell his market pigs before they are a year old. Those to be sold as fat hogs should not be fed through two winters. In most

markets the price per pound is best if they do not exceed 225 or 250 pounds live weight.

**Protection from Disease and Parasites.**—*Lice.*—Parasites must be killed or prevented if swine are to be thrifty. Lice are best controlled by liberal use of crude oil. Sacks wet with crude oil may be tied around posts where swine will rub on them. Sprinkle oil on shoats when they are feeding close together. They will rub it on each other. It may be necessary to catch the individuals and rub the oil on their under parts. Do this thoroughly with an oily cloth.

*Worms.*—Pigs are subject to several kinds of intestinal worms, kidney worms, and lung worms. They are seldom serious if the quarters for feeding, wallowing and sleeping are changed often or otherwise kept clean. Pigs are not naturally filth-loving and their owner should aid in keeping them clean. Ponds where they wallow should be changed from time to time, or they may be covered with crude oil to hold parasites in check. Eggs from the droppings of hogs may be swallowed by pigs eating in filthy places or sucking from filthy udders. In every way try to keep troughs and feeding floors free from all filth. Use common disinfectants freely after cleaning.

**Several diseases** are commonly found to attack swine. Tuberculosis is spread to pigs from cows, chiefly through the milk. Scours, indigestion, sore mouth, pneumonia, etc., are not uncommon. Probably hog cholera is the most serious disease of swine.

**Hog Cholera.**—Swine production is much hampered by the disease known as cholera. This is very contagious. It spreads from place to place in several ways, as by running streams, by buzzards, crows, dogs and other animals, and on the shoes of men. Care must be taken to prevent the disease from spreading in any way. Swine may be vaccinated to prevent cholera. This method is used by most owners. The plan most commonly followed is to inject anti-cholera serum

into the tissues of the body, and at the same time to inject in a different place a little dose of virus. When this is done by someone who understands all details, it should make the pigs immune to cholera. Doses of serum and virus vary with the weight of pigs. Ask county agents or other authorities to show methods and give advice regarding treatment to prevent hog cholera. (Farmers' Bulletin 834).

**Pig Project Problems.**—A pig club boy started with two pure bred gilts which he bought from a neighbor at eight dollars each, at weaning time, May 15. Each weighed 30 pounds and was 60 days old. He made a movable pen of eight ft. strips of 1 by 3 inch lumber and four corner posts each  $3\frac{3}{4}$  feet high of 2 by 4 inch lumber, costing two cents per board foot. Some barrel staves for palings were given him. Find the cost of the pen allowing 10 cents for nails and 50 cents for the boy's labor.

Answer \$11.12.

2. Using a scale of  $\frac{1}{4}$  inch to a foot, draw a plan of one side of the pen showing two corner posts, top and bottom strips of 1 by 3, and the staves nailed to these strips.

3. Calculate the cost of feeding, watering, moving the pen to fresh grass, and other care of the two pigs for the 90 days of this boy's ownership, allowing 25 minutes per day at 10 cents per hour; 400 pounds of feed averaging \$1.40 per hundred; 25 cents for mineral matter; 120 gallons of skim milk valued at 8 cents per gallon.

Answer \$19.20.

4. The combined weight of the pigs was then 300 pounds. What was the gain for each per day for the 90 days?

Answer  $1\frac{1}{2}$  lbs.

5. What was the average cost per pound of gain for the first 90 days? (see result in problem 3). What was the cost per day?

Answer 8 cents.  $21\frac{1}{2}$  cents.

6. At the same rate of cost per pound of gain, what will they have cost the boy when they are 12 months of age if they then weigh 600 pounds? Include cost of pigs and pen. Two A-shaped houses were built in the fall at a cost of \$25 each, one-tenth of which should be charged to each gilt.

Answer \$65.32.

7. One of the gilts was taken to the County Fair in the fall at a cost of \$3, but won a prize of \$10. Deduct this net income from the result in problem 6.

Answer \$58.32.

8. Litters of 9 and 11 pigs farrowed March 15 were all raised. Allowing \$60 for feed, labor, etc., since the time mentioned in problems 6 and 7, what was the average cost per pig at weaning time, May 14? (Charging all to the 20 pigs).

Answer \$5.92.

9. Twelve male pigs were then sold for an average of \$7.50, but the registration of the 20 pigs and membership in the swine association cost \$20. \$1.00 was spent for advertising, and \$6.00 for anti-cholera inoculation. Compare with the cost found in problem 8, and find the net cost of the 8 gilts and 2 sows.

Answer \$55.32.

10. He then sold 4 of the registered and inoculated gilts for \$12 each. What must he get for each of the mother sows to clear \$80, on the year's project, besides the 4 gilts he keeps?

Answer \$43.66.

### PROJECTS, EXERCISES, TRIPS, AND SURVEYS

1. **Swine Surveys.**—Let each member of the class make one or more sets of questions, similar to the following, leaving room for answers, and have them filled in at home and at neighboring places. Have all returned the second day and count up in class the results from most of the points. Keep this report and the papers for further swine study and for aid in making arithmetic problems.

(1) Name. (2) Size of swine pasture and crops in them. (3) Size of swine lot. (4) Kind of hog houses. (5) No. of pure bred sows. (6) What breed. (7) No. grade sows. (8) No. and name of sire. (9) No. pigs raised per year. (10) Does owner register them? (11) At what ages are they sold? (12) Prices. (13) Age or weight when sold or killed for meat. (14) Is meat cured and smoked? (15) What feeds for sows with pigs. (16) Feeds for fattening. (17) Cost per pound. (18) Treatment for lice. (19) For worms. (20) For cholera. (21) Deaths and causes in past year. (22) Kinds of wallows. (23) Provision for mineral matter. (24) Provision for watering.

2. Students should report in class from time to time any local swine practices by farmers, as new pasture seeding, sizes of new litters, weighing and gains in weight, new houses, making of feed-hoppers, hogging off crops, inoculation, oiling wallows, treatment for lice, new purchases, prices at sales, weights and methods at butchering time.

3. **Judging of swine** to aid in selection of animals may be done with animals brought to the school by farmers, or the class may go to neighboring farms toward the end of the school day. Or the county agent, a vocational teacher or some good swine raiser may take them to suitable farms, fairs, sales, etc.

4. **Methods and management** may be studied in such ways as suggested in No. 3. Suitable times for special studies at particular farms may be learned through members of the class (see No. 2).

5. **Inoculation and Other Treatments.**—Arrange for the county agent or some other qualified person to demonstrate to the class how to inoculate pigs against hog cholera, treat them for worms and lice, mark them for identification in registration, nip off needle teeth of day old pigs.

6. **Registration.**—Students should practise making applications for registration of pure bred pigs. Blanks for this can be obtained by writing to the secretary of the association for the breed of swine. Ask the county agent for the address.

7. **Advertising.**—Students in language class may practise writing brief advertisements of pure bred pigs for sale.

8. **Pig projects** should be started at home by members of the class. Let several of the plans suggested in this chapter be followed by different members. Practise at school the various steps suggested in the preceding group of problems.

9. **Swine Feeding Projects.**—Very good pig feeding projects may be conducted by boys and girls during the summer vacation. Select good grade weanling pigs from litters in the region. Have them all barrows if possible and of rather uniform size and type. They should be started on wet mash (see period No. 2 in preceding topic). Give them plenty of good pasture or have it ready for them very soon. Follow



the suggestions for feeding and try to make them reach a weight of 250 to 300 pounds live weight at six or seven months of age. If possible weigh them once a week. Perhaps they may be fattened at the end of the period by hogging off a crop of corn and soybeans. Keep records of all items of cost—including feed, labor, rent for pasture, housing, etc. Watch market prices for different weights and prepare to sell to best advantage possible. Join coöperative shipping association if one is formed and let it help in marketing. Get prices frequently from local buyers. Calculate the total expense, the total income and the net profit or loss.

10. **Preparing pigs for show** may be practised by members of the class having swine of suitable ages in their home projects. Study premium lists and select the best swine. Feed to condition them.

11. **Making pens and houses** may be a part of the home projects. Students should practise making things at school which will help them in their home projects,—pig creeps, troughs, self-feeders, mineral bins, shipping crates, etc.

12. **Records of home projects** should be kept by students. These should be brought to school and used in the arithmetic class. Let them be criticised by pupils and teacher and then used in problem work.

**Swine Debates.**—Discussions and debates may be held in class on such points as the following: That it does not pay to keep pigs, intended for market or for slaughter, beyond six or eight months of age. Pure bred swine vs. scrub swine. Movable houses vs. stationary houses. Pasture system vs. dry lot system of growing young swine. Two litters a year vs. one litter a year. Fat type vs. bacon type. That lice and worms do more harm than hog cholera for the American swine industry.

**Swine Contests.**—Students should contest and try to excell in weights of market pigs at six months of age; in best daily gains with pigs; in percentage of points in pig clubs; in greater profit with pigs; in showing pigs at community fairs and other fairs; in judging swine at fairs, sales, and on farms; in writing best project stories; in describing the breeds of swine; in planning continuous pasture systems.

**References.**—Write to your congressman for several copies each of the following U. S. Farmers' Bulletins on swine: 438, 614, 780, 781, 834, 874, 951, 966, 985, 1018, 1085, 1186, 1229. Use these in assigning topics, in project studies, and in reading classes. Ark. Sta. Bul. 2, Handbook; 45, 128, 142, Fattening; 181, Helps. Ark. Ext. Circ. 69, Houses; 101, 125; Pig Clubs; 189, Feeder Pigs.

## QUESTIONS

1. Why is swine raising so popular in the corn belt?
2. Compare the pasture method with the dry lot method of raising swine. (Debate)
3. Of what advantage is a movable pigpen to a village owner?
4. What forms of waste may pigs use?
5. What are the advantages of keeping good swine instead of scrubs?
6. Describe and contrast the two types of swine.

7. Name the four most common breeds of the fat type and give colors.

8. Name three breeds of the bacon type and give their colors.

9. Describe the first mentioned (least expensive) plan of starting with swine.

10. Give second plan and its advantages.

11. Give plan No. 3, for quick returns.

12. What is the chief objection to the fourth plan?

13. Which of the four plans of starting have you known to be used? Which will you follow? Why?

14. Which plan did the boy use in the project on which the ten problems are based? Describe this project.

15. Which plan will allow for two litters from one mother in a one-year project? Explain such a project.

16. Give the important points in selecting a good brood sow.

17. Describe one or more good hog houses you know or about which you have read.

18. What pasture crops are grown in your region?

19. Give points on the care of sow and litter at farrowing time.

20. How should a sow and pigs be fed? What is a pig creep?

21. What forms of mineral matter should be supplied to swine?

22. What is hogging-off a crop? Describe how it is managed.

23. What is a self-feeder? Give its advantages.

24. Tell how to control lice with crude oil.

25. What diseases or parasites of swine are known in your region? What remedies are used for each?

26. Describe a successful swine project of your own or of someone you know.

## CHAPTER XXVII.

## POULTRY MANAGEMENT.

THE term Poultry commonly includes chickens, ducks, geese, and turkeys; but may also refer to guineas, pigeons, pheasants and peafowls. The keeping of poultry by farmers is usually only incidental to other lines of farming. But in some sections, particularly near large cities, poultry raising is extensively carried on as a special line of farming.

The value of poultry and eggs produced annually on American farms is about two-thirds of a billion dollars. In their values they exceed all other live stock except horses and cattle. Poultry products equal the value of the combined mine products of gold, silver, iron, and coal. When considering the value of poultry on the farm the farmer should remember the great food value of the eggs and meat, the large number of injurious insects destroyed, and the ease with which they may be fed, often living almost entirely on products that would otherwise be wasted.

The production of improved breeds of poultry has received much attention by poultrymen. This is particularly true of chickens. There are many divisions of this specialty, such as the production of eggs in winter, raising early broilers, the raising of fancy birds for shows, the raising of ducks, geese or turkeys.

**Varieties of Chickens.**—There are more than one hundred varieties of chickens. These may be grouped according to their purposes into four classes: (1) Egg breeds, (2) meat breeds, (3) general-purpose breeds, and (4) ornamental breeds.

**Egg Breeds.**—These are of light weight. They mature

and begin laying very young. They include all the Leghorns (Fig. 189), Minorcas (Fig. 190), and Spanish, of the *Mediterranean class*, and also the less common Red Caps of the *English class*. The eggs of these egg breeds are usually white.

**EXERCISE.—Egg Records.**—The records from small or large flocks of chickens near by may be collected. The pupils may find a wide difference among them. Have the causes of the difference explained by pupils if the conditions can be learned. Save the records to use in arithmetic class.

**Meat Breeds.**—The very heavy breeds of the *Asiatic class* are very slow-maturing fowls. The Cochins, Brahmas (Fig. 191), and Langshans belong to this group. They all have feathers on the shank, or lower part of the leg. The Dorkings and Indian Games are also called meat breeds. The heavy meat breeds are not noted for their egg-laying, but the meat is excellent. They are good sitters, but clumsy as mothers.

**General-Purpose Breeds.**—All varieties of the *American class* belong here. This includes the Plymouth Rocks (Figs. 192 and 193), Wyandottes (Fig. 194), Javas, Dominiques, Rhode Island Reds, and Buckeyes. The Orpingtons from England and the Houdons from France are also included in this group. General-purpose breeds are medium in weight and they vary a great deal as to their egg and meat-producing qualities. They mature much younger than the meat breeds, but not so early as the egg breeds. They are good sitters and mothers.

**Ornamental Breeds.**—These are used for show purposes, and include the Bantams, Games (except Indian Games), Polish, Frizzles, Silkies, and other less common classes. The Houdons are sometimes considered as ornamentals, because of their large crests. All breeds of poultry, regardless of class, are bred quite commonly for show purposes.



FIG. 189.—Single-comb white Leghorn hen, one of the best of the egg-laying breeds.

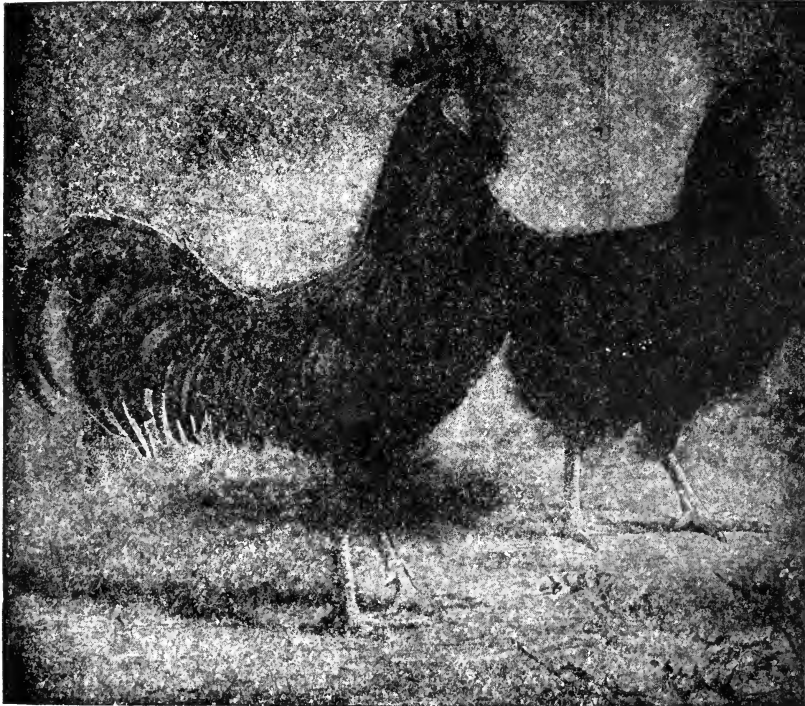


FIG. 190.—Black Minorca pair, an egg-laying breed producing the largest white eggs.

FIG. 191.

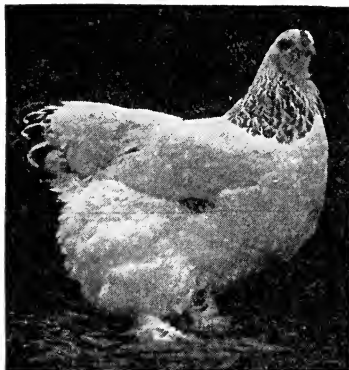


FIG. 192.

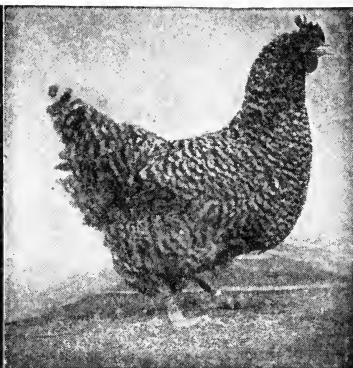


FIG. 191.—Light Brahma hen, one of the most popular of heavy fowls.  
FIG. 192.—Barred Plymouth Rock hen, the most popular of the general-purpose type.

FIG 193.

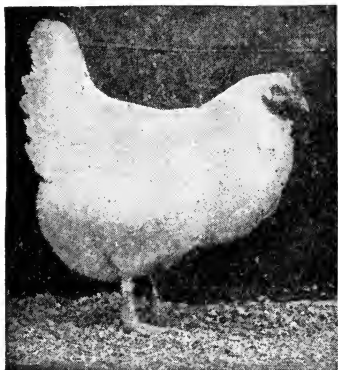


FIG. 194.

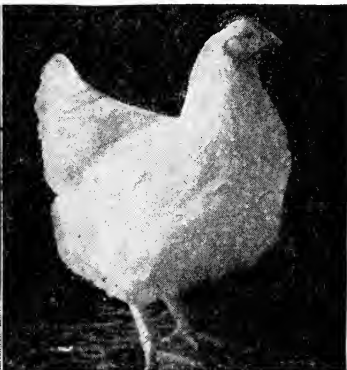


FIG. 193.—White Plymouth Rock hen, a general-purpose breed.  
FIG. 194.—Prize-winning white Wyandotte hen.

**What Variety to Keep.**—It is very important to keep varieties best suited to the purposes desired. For large numbers of eggs poultrymen use the egg breeds, and use them while young. The first year is their best egg-laying year. For table use, keep the meat breeds. Within the varieties there are certain strains or families which are better than others because they have been selected with reference to a special purpose.

**EXERCISE.**—*Study of Varieties.*—Let the pupils who have seen pure-bred chickens describe them to the class. If some are now keeping any of the pure breeds, have them weigh some of them and report weights to the class. Compare these with the standard weights given in the United States Farmers' Bulletins 806, 898, 1050 and 1221.

**Housing.**—Chickens should have special places made for them to roost and to lay eggs. It is very bad practice to allow them to use buildings and places intended for other purposes.

The poultry house may be very simple and inexpensive (Figs. 195, 196, 197). It should be dry and comfortable in winter, free from drafts of air, but with plenty of fresh air and direct sunshine. Many poultry raisers now use light-weight muslin stretched on wood frames in the south side of their poultry houses. The frames are hinged in place at the top and are kept open every day except when the weather is stormy. In many of these houses no glass windows are used. In others the south side is part glass and part muslin. The curtains prevent any strong drafts of air at night and in stormy weather. In houses with too little ventilation the fowls will suffer more from extremely cold weather than in those with muslin curtains.

Artificial heat in a poultry house is not advisable, except for brooder chicks. Winter feathers are so warm that artificial heat often leads to some form of sickness. The better

plan is to build the houses with low ceilings over the roosts so that the chickens will sleep warm because of their own heat (Figs. 198 and 199). Extra curtains may be placed in front of the roosts for use on cold nights. The sides and roof of the house should be well built to keep out drafts of air and rain. Chickens thrive in houses that are cool and dry better than in those which are damp and warm.

**Location of Poultry House.**—This is very important. Select a high spot to put the chicken house on. Natural drainage away from the building will help in keeping the ground dry and free from disease. Sandy or gravelly soil is better than clay for the same reason. A place gently sloping to the south is best. Where natural slopes are not found the surface drainage may be provided by grading the ground with the use of horses and scrapers. This should be done before the house is built.

*Wind Breaks* should be provided on the north and west sides. They are sometimes composed of evergreens or other trees planted very near together. Tight board fences may be built. Where the house is placed on the south side of larger farm buildings the worst winds are kept away.

**Inside the House.**—If the house faces the south, with the muslin windows on that side, then the roosts should be along the north side of the room. Place all the roosts on a level with each other, or nearly so. Have a board platform built six inches below the roosts to keep the floor clean and make more room for litter and for the fowls to scratch. The nests may also be placed under this platform if the room is small.

The roosts, nests, and platform should be so made as to be easily cleaned. These as well as the inside walls should be covered with lime white-wash, containing some disinfectant renewed from time to time.

*Dust Boxes.*—Chickens love to wallow in dust. This helps to keep them free from mites and lice. Dust boxes



should be provided, particularly in winter time. These may be filled with a sifted mixture of ashes and dry soil. Place the boxes in sunny places.

*Feed Troughs and Hoppers.*—These should be used only for the ground feeds, whether wet or dry. For wet mash the troughs are best; but for dry, ground feeds, called *dry mash*, the self-feeding hoppers are used. Make the feed boxes in such a way as to prevent the fowls from getting into the feed to scratch. The whole grain should be fed in deep litter. This will induce the chickens to do more scratching, and keep them strong and healthy.

*Self-Feeding* hoppers are made so as to allow the fowls to eat near the bottom. As fast as the feed is used up more of it runs down from above. These are called *dry mash hoppers* (Fig. 200).

*Grit Boxes.*—Boxes for grit, charcoal, and oyster shell may be fastened to the walls above the litter, for use at all times.

*Drinking Fountains.*—These should be placed a foot above the floor for grown chickens. This helps to keep the water clean. A simple water fountain can be made thus: A gallon pail or can or jar without a top is used (Fig. 201). Make a nail hole on one side one-half inch from the top. Fill with clean water. Place over it a flat pan somewhat larger than the mouth of the vessel used. Then suddenly invert the fountain, and place it on a low box in the poultry room. As the water is used out of the pan more will flow down until it is gone. Care should be taken to wash it well each day, and to keep it well supplied with clean water. All chickens require much water to drink.

**Feeding Systems.**—Much discussion has been carried on by poultry raisers as to the feeding systems to be followed. Some are most successful with the wet-mash system of feed-

ing fowls. This system consists in feeding wet ground feed once or twice a day and dry grains at other times.

Recently a number of poultrymen have adopted a plan known as the dry-mash system of feeding. A dry mash is made by mixing a number of finely ground feeds together. This is kept in a self-feeding hopper or feeding fountain at all times. Besides this dry mash one or two feeds of mixed whole grains are given in the deep litter on the floor. The heat-producing feed, as whole corn, is fed in the evening, during cold weather.

**EXERCISE.**—*Feeding Dry Mash.*—If possible, to make a trial in winter, let one or more persons near by try the dry mash, fed by the hopper method. They may report results to the teacher or to the school.

**Feeding for Winter Eggs.**—The feed for egg production, as well as for forcing the growth of young broilers, should be very rich in protein. Below are given several different rations in use on egg farms:

*Dry Mash No. 1.*—100 pounds wheat bran, 100 pounds wheat middlings, 100 pounds alfalfa meal, 75 pounds good beef meal.

This is given as a dry mash. Whole wheat or a mixture of wheat and oats is thrown in the litter every morning; and whole corn or cracked corn in the evening, just before roosting time. Shell, grit, and charcoal are kept in separate boxes.

*Dry Mash No. 2.*—100 pounds cornmeal, 100 pounds beef meal, 100 pounds alfalfa meal, 5 pounds oyster shell, 3 pounds grit, 3 pounds charcoal.

This mash is fed in the open hoppers and kept supplied constantly. Two grain feeds are given in the litter each day to get the fowls to exercise. This is a mixture of one part **oats**, two parts cracked corn, and three parts wheat.

*Wet mashes* are very commonly fed to chickens of all ages.

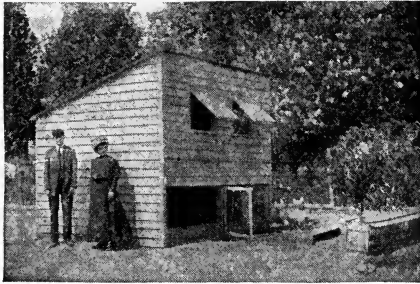


FIG. 195.—A colony house two stories high for laying hens. The nests and scratching litter are on the ground.

FIG. 196.

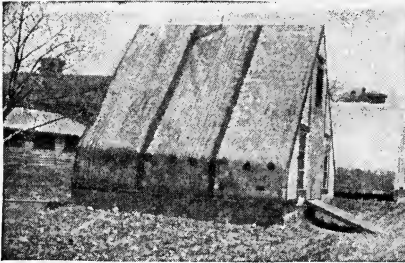


FIG. 197.

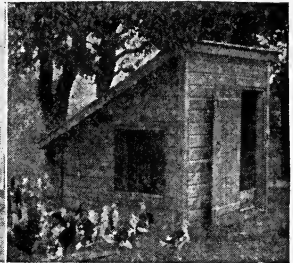


FIG. 196.—Movable chick brooder house heated by gasoline.  
FIG. 197.—Brooder house for raising incubator chicks. The Houdon chicks have been raised in this house.

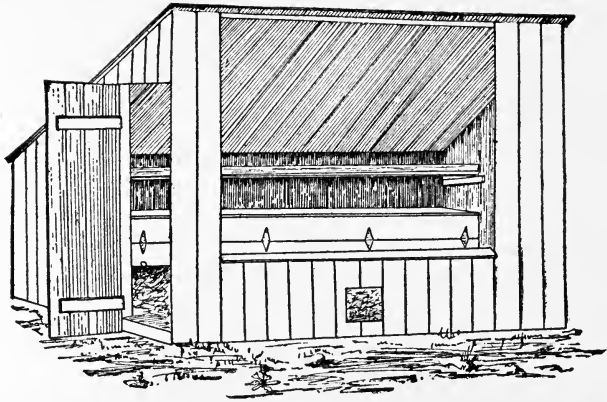


FIG. 198.—Open-front colony house for poultry, ready for a muslin screen in large window. Through the window may be seen the roosts, platform, and nests. Hens enter nests from the dark side at back. The hinged board allows the easy removal of eggs.

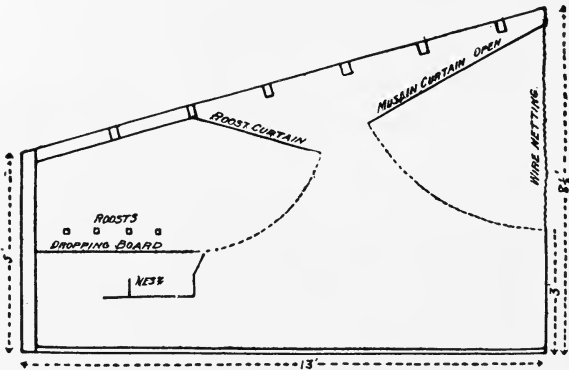


FIG. 199.—Sectional view of shed-roof poultry house, shown in Fig. 198, having a muslin curtain in front instead of glass.

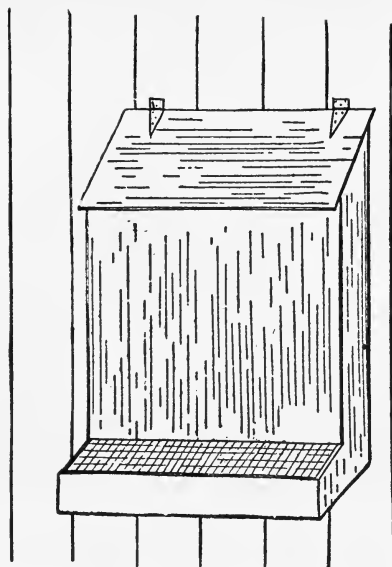


FIG. 200.—Dry-mash hopper. The wire screen over the lower opening prevents the waste of feed.

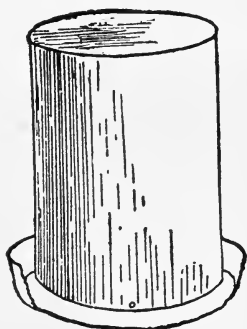


FIG. 201.—A simple drinking fountain for poultry, easily cleaned each time before filling.

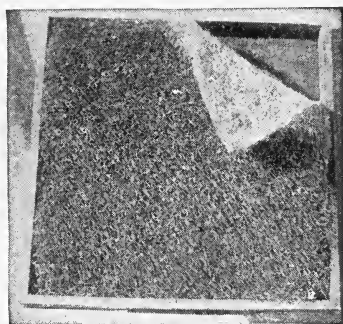


FIG. 202.—Sprouted oats as winter green feed for hens. The oats are wet and put in a shallow tray in a warm room for about ten days. (Maine.)

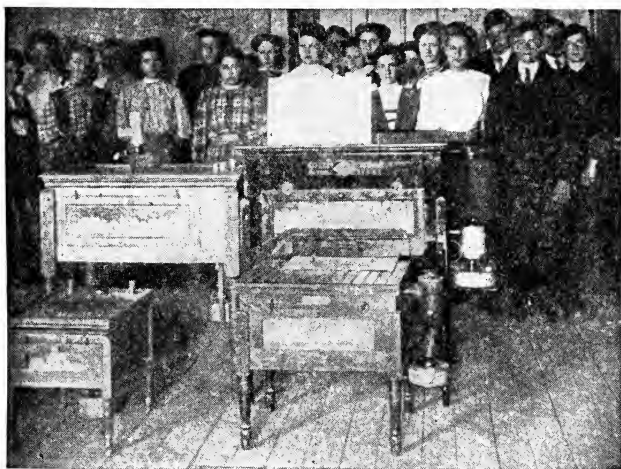


FIG. 203.—Practical operation of incubators in a school-room.  
(Agricultural Education.)

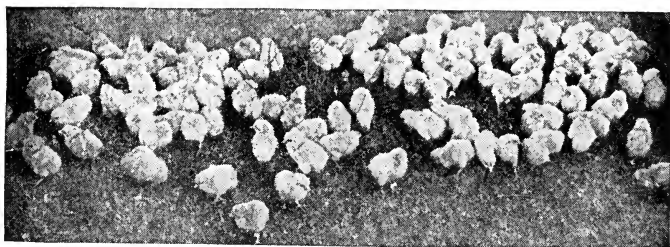


FIG. 204.—A hundred white Leghorn chicks from an incubator. (Cornell.)



FIG. 205.—A good way to prepare eggs for market. Each dozen is uniform in size and color and packed in the dozen-size carton of pasteboard. The crate is painted and labelled with the owner's name. (H. R. Lewis.)

They are very effective as forcing feeds, but the careless use of them tends to produce disease of various forms. The two mixtures given here may be slightly changed to suit different conditions.

*Wet Mash No. 1.*—One hundred pounds each of ground oats, ground corn, ground barley, and bran.

*Wet Mash No. 2.*—Equal parts by weight of ground corn, bran, ground oats, and cut clover or cut alfalfa.

These are each supplemented with grain, fed in the litter; and grit, shell, and charcoal in boxes. Meat scraps are usually given separate from the wet mash.

**EXERCISE.**—*Poultry Rations.*—All the pupils who have poultry at home should tell of the daily system of feeding and watering, and of the rations fed. Men or women who are successful poultry raisers may be invited to tell the school their plans of feeding and other practical points.

**Succulent Feed.**—Chickens should have plenty of succulent green feed, if possible. The best forms of this in winter are cabbage, turnips, and beets; as substitutes, clover and alfalfa hay may be fed wet or dry, either whole or cut fine. Growing rye or other winter crops furnish green feed in late fall and early spring. Oats may be sprouted in flat boxes in a warm room and fed to the fowls daily (Fig. 202).

**Care of Poultry.**—Poultry raising is an art most easily acquired by practice combined with a study of the principles underlying it.

The health of the fowls must be guarded. They must be kept free from vermin. Brush crude oil (petroleum) on the roosts once a week through the warm weather. Spray this oil on the walls and in the nest boxes. The conditions and effects of moulting must be understood. Hatching with hens and with machines and the raising of young chicks must be learned by practise. Many helpful suggestions along these lines are given in United States Farmers' Bulletin 585.

**EXERCISE.**—*Running an Incubator.*—(Fig. 203).—In the spring time, when the school-room does not get too cool at night, run an incubator in the school-room. One may be borrowed for the purpose, or the pupils may earn money enough to buy one and supply the eggs and kerosene. Follow directions carefully. Appoint certain pupils to attend the incubator each day. Make a record form on large paper or cardboard on the wall. Let this show each morning and evening: (1) the temperature, (2) whether regulator is open or shut, (3) condition of lamp, (4) who filled and trimmed the lamp, (5) who turned the eggs. The chicks hatched may be cared for at school for two weeks or taken to one of the homes when one day old (Fig. 204). United States Farmers' Bulletin 624 will be helpful. Either of the two types of outdoor brooders shown in Figs. 196 and 197 can be made by boys at home.

**EXERCISE.**—*Color of Yolk.*—When the grain fed to hens is chiefly oats the yolks are much lighter colored than when they are fed corn, particularly yellow corn. Let this difference in color of yolk be shown at school by having eggs brought from flocks fed in these ways.

**EXERCISE.**—*Packing Eggs.*—Let pupils tell of the different ways they have seen eggs packed for market. Some can tell of the ways they come from stores. Should the eggs be washed, if dirty, before marketing? Should they be sorted by size as apples usually are? Do you know of any markets where the prices are higher for white-shelled eggs, or higher for brown-shelled eggs? (See the method of packing shown in Fig. 205).

**EXERCISE.**—*Weight of Eggs.*—Weigh a dozen large eggs and get the average weight in ounces. Weigh a dozen small eggs and get the average weight. How many of the large eggs does it require to weigh a pound, and how many small



ones? Eggs are usually sold by the dozen, but in some places by the pound. Which way is fairer?

**EXERCISE.**—*Drinking Fountain.*—Have some one make a drinking fountain like the one described and figured, and show how it works (Fig. 201).

**EXERCISE.**—*Testing Eggs.*—Let some form of tester be used in testing eggs brought from homes or from a store. Eggs are usually *candled* in some stores to detect any not suitable for human food. This is done thus: Put a candle or stronger light in a dark box; have an oval hole a little smaller than an egg in one side, even with the light; let that part of the room where the testing is to be done be darkened somewhat. Hold an egg over the hole and look for any dark or clouded parts in the contents. Other forms of egg testers are in use. The eggs in an incubator are usually tested the sixth or seventh day to see if a live, growing germ is present.

**EXERCISE.**—*Preserving Eggs.*—Let some of the pupils preserve a few dozen fresh eggs. April or May is a good time to preserve them for winter use. The eggs may be kept at home and the report of the trial made to the class a few months later. Directions: Scald out a stone jar with boiling water. Prepare a solution, using water that has been first boiled and then cooled to ordinary temperature. To each six quarts of water add one pint of *water-glass* purchased at a drug store. Select clean (not washed) fresh eggs, and place them in the jar. Pour the liquid over the eggs covering them more than an inch above the top ones. Keep them in a dark, cool, dry cellar. Sterile eggs keep best.

**Problems.**—A flock containing 28 pullets laid 1600 eggs in January, February and March—

1. What was the average number of eggs from each.
2. What was the average number of eggs from the flock for each of the 90 days?

3. If 400 of the eggs were laid in January and sold at an average price of 36 cents a dozen, what was the income for January?

4. If they laid 500 eggs in February worth 30 cents a dozen, what was the income for the month?

5. They laid 700 eggs in March which were sold at 18 cents a dozen. What was the amount of the month's sales?

6. Find the total income from the 28 pullets for the three months.

7. Find the average income from each hen for the three months.

**Poultry Projects.**—A number of different types of home projects are pursued by boys and girls in America. These are the most common:

1. Start with a few setting of eggs of some pure breed and hens to hatch them; brood the chicks; cull them; fatten and market the culls; develop the breeders and layers; continue to one year from starting time. Keep all records carefully, and write an account of the project.

2. Start with a good lot of eggs and incubator and continue as in No. 1.

3. Start with a good lot of baby chicks and continue for one year or less.

4. Start with eight to fifteen pullets and a cockerel. Produce eggs, hatch, brood, and raise the chicks; cull, feed and market males. Develop breeders for next season. This may be continued for as many years as desired and should increase in the number of layers each year.

5. Short time projects may run for a few months, only, in the production of eggs or broilers, or fries for profit.

6. Feeding projects may be completed in a few weeks and may include chickens of any desired age. Crate fattening is a good type of feeding project.

**Poultry Debates.**—The following topics are suggested for discussion or debate: That poultry husbandry is more profitable than any other line of animal industry. Egg farming vs. poultry meat production—broilers, fries, roasters, capons. Egg breeds vs. general purpose breeds. That community egg circles should be established. That one or two breeds for a county are better than many breeds. Pure bred vs. grades or scrubs.

## REVIEW

1. Tell what you can of the importance of the poultry industry in this country.
2. Give a list of the special egg-laying breeds of chickens. How many colors of these have you heard of?
3. Give a list of the special meat breeds.
4. What is meant by general-purpose breeds? For what are they used? Name them.
5. Describe a good location for a poultry house.
6. Why should chickens have a house of their own?
7. Tell of the plan for muslin windows for poultry houses. Why are they used?
8. Mention some of the requirements of a good poultry house.
9. Why not use artificial heat in poultry houses?
10. Tell of some good wind-breaks for the poultry house.
11. Describe, or draw on paper, the inside arrangement of the poultry house.
12. Why are dust baths necessary for hens?
13. Describe a good drinking fountain for chickens.
14. What do poultry raisers mean by wet mash and dry mash?
15. Why should some grain be thrown into the litter every day?
16. Describe a daily ration for laying hens. (1) Wet system. (2) Dry system.
17. What feeds will supply succulence in winter?
18. Tell how to destroy vermin on roosts and in nests.

**References.**—Write to your congressman for several copies of each of the following U. S. Farmers' Bulletins, and use them in making assignments of the topics, in project studies, and in reading classes: 287, 528, 574, 585, 624, 656, 682, 684, 697, 767, 791, 801, 806, 830, 849, 858, 889, 898, 957, 1018, 1040, 1052, 1066, 1070, 1105, 1106, 1107, 1108, 1109, 1110, 1111, 1112, 1113, 1114, 1115, 1116, 1200, 1221. Ark. Sta. Bul. 163; Ext. Circ. 106.

## CHAPTER XXVIII.

## BEE-KEEPING.

WHEN the subject of pollination of fruit trees was discussed two purposes of bee-keeping were mentioned. The production of honey and the pollination of fruit blossoms are both sources of profit on the farm. A fairly good average yield from a colony of bees each season is forty pounds of extracted honey or twenty-five pounds of comb honey. When honey is extracted from the combs the bees are not

required to build new combs and much of their time is saved for honey-making.

There are very few bee-keepers who make this the only source of their income. It is usually combined with other lines of farming. Bees are kept in both city and country. The flowers, or bee-pastures, from which bees secure their nectar, must not be too far from the hives of the bees. Bees frequently go two or three miles in search of nectar, but their main supply should be much nearer.

**Breeds.**—The wild honey bees are of the black or *German* variety, brought by early settlers to this country. This breed is also kept by a few farmers. The chief objection to bees of this breed is that they are very cross and easily excited. A number of other breeds have been brought to America.

*Italian* bees are now much more in use than any other breed. These bees are easily managed, and are good defenders of their hives. They are good honey gatherers. Italian bees are easily recognized by the three yellow bands across the body behind the wings. They are more difficult to keep over winter than some of the other kinds. Hybrid bees are commonly found in American bee yards. Many of these have been formed by Italian bees crossing with other breeds.

*Cyprian* bees are the best honey gatherers, but they have bad tempers and their management is difficult.

*Carniolan* bees are very quiet. They are the largest of all our breeds of bees, and have great wing power. As honey gatherers they are among the best. They multiply in the hives quite rapidly and much time is spent in swarming to divide the colony.

*Caucasian* bees are very gentle, good workers, and defend their hives well. They swarm rather too often if kept in small hives.

*Syrian* bees are much like the Cyprians in temper, and they are not as thrifty workers.

**The Colony.**—Bees in a colony are of three kinds, *workers*, *drones*, and *queens*. The workers number from 30,000 to 40,000 in a colony at the beginning of the gathering season. These do all the work of the colony; they are really females, but never lay eggs. There are only a few hundred drones or male bees, and only one queen. The queen bee lays all the eggs to produce new colonies.

**The Life of Bees.**—The workers, acting as nurse bees, place the eggs, laid by the queen, in the bottom of the wax-cells. The larva hatches from the egg in about three days and is fed with pollen and honey by the nurse bees. In five days the pupa stage is reached. It rests as a pupa for thirteen days, when the mature insect appears. Twenty-one days are thus used in the development of worker bees. Queens are produced in a little less time, and drones require twenty-four days. The first duty of the young workers is to act as nurses. But in about two weeks they begin gathering honey. Workers usually wear their wings out and die in less than one season. Queens live several years. The drones are nearly all killed and thrown out in the fall or before the winter is over. The life of the colony is kept up by young bees.

**Honey-Making.**—Worker-bees visit flowers, suck the nectar, and store it in honey sacks in their bodies. They fly to the hive and deposit the nectar in wax cells, made by other workers. Some of the workers dry out the nectar by producing a breeze with their wings over the cells. Study the structure of the worker-bee as shown in Fig. 206.

White clover, alsike clover, alfalfa, basswood, locust, fruit trees, buckwheat, and golden-rod are among the best plants for the production of nectar. There are hundreds of plants grown for other purposes which are used by bees in the making of honey.

**Hives.**—A good beehive is in the form of a box with a removable bottom and top (Fig. 207). The bottom projects to form an entrance platform. A small slot is made in the

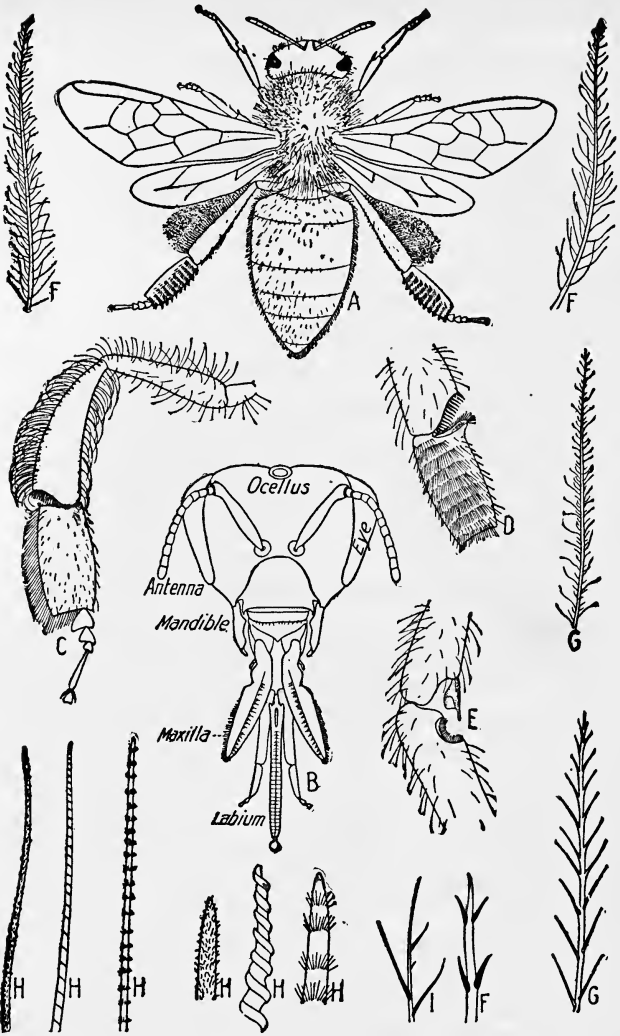


FIG. 206.—Bee structures: a, worker-bee, pollen loaded; b, mouth parts of a long-tongued bee; c, hind leg of bee showing pollen carrier; d, wax cutter and curry-comb of 1st joint of hind leg; e, antenna-cleaner of fore leg; f, hair of bumble-bee; g, h, i, hairs of three different kinds of bees. (From Smith's "Insect Friends and Enemies.")

front just above the floor for the entrance of bees. Frames are hung inside the box, and are supplied with honeycomb. These combs will become filled with honey and young bee-bread. Then another box called a *super* is placed above the first one. If comb honey is wanted for use or for market, the super is supplied with small frames to hold one pound each. If liquid, or extracted, honey is wanted the frames in the super are much larger. From these the honey is removed without destroying the cells.

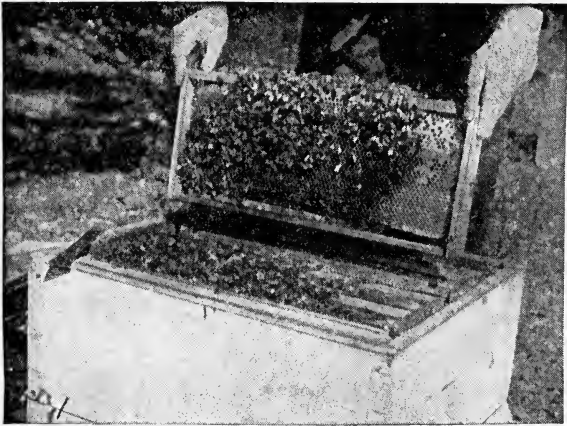


FIG. 207.—Typical beehive. (From "The A, B, C of Bee Culture," A. I. Root Company.)

**Swarming.**—In early summer the hives of bees usually become overcrowded with bees, because of the young broods maturing. This brings on the desire to *swarm*. One queen goes out with the swarm, usually leaving a queen cell in the old hive from which a young queen emerges in a few days. The swarm usually gathers on some object, as a tree near by. If an empty hive is ready the queen and most of the bees can be taken while quiet and placed near the entrance to the hive or in the hive. The colony will then adopt this as

its new home. It is important that hives be watched closely at the season when most of the swarming is done. This will help to prevent loss of swarms. Many swarms are lost each year by not knowing when the queen and bees leave the hive. One way of preventing loss in this way is to keep the wings of the queen clipped so that she cannot fly away. This is a common practice among bee-keepers.

**Winter Care.**—Bees should be protected during severe winter weather. They may be placed in sheds or dry cellars, or in houses built for the purpose. They must not be kept too warm, but sudden change in temperature is bad for the bees. Hives are sometimes made double and the space between the walls is filled with sawdust or other material. The hives are sometimes covered with straw, carpet or other means of protection. The door is left open so that bees may exercise on warm days.

**EXERCISE.**—*Bee Studies.*—Students may tell what plants they have seen bees visiting for honey. Also what methods they know to prevent the stinging of bees; how hiving of swarms is done; and what means of protection are used in winter by local bee-keepers.

## REVIEW


1. Name the several breeds or races of bees.
2. Which one is most in use in America? What are its characteristics?
3. What three kinds of bees are in a colony? About how many of each kind?
4. Describe the development of the young honey bee.
5. Describe the making of honey.
6. Tell how a beehive is made.
7. What is the *super*? What is it for?
8. Why do bees swarm? When is this most common?
9. Tell of the need for winter care of bees.

**References.**—U. S. Farmers' Bulletins: 975, 1084, Bee Diseases; 447, Bees; 1039, Comb Honey; 653 Honey and Its Use, 695, 1012, 1014, Wintering; 1198, Swarm Control; 961, Transferring; 1215, 1216, 1222, Bee pastures. Ark. Sta. Bul. 170.



## CHAPTER XXIX.

## FEEDS AND FEEDING.



THE nourishment and development of animals is more complicated than the growth of plants. Their growth is from the use of substances ready formed in plants, or which have been derived from them. These are transformed into flesh and bone.

**Composition of Animals.**—The animal body is composed of substances derived directly or indirectly from plants. It may be divided into two classes of products, water and dry matter.

Water ordinarily is more than one-half of the total weight of the live animal and is necessary for the proper nourishment of the body. Pure fresh water should be supplied freely to all animals.

The dry or solid matter of an animal's body is made up of several different substances, called tissues, as fat, muscle, bone and others. The chief substances which enter into these are fat, protein, horny matter and mineral matter.

**EXERCISE.**—*Water in Flesh.*—Heat a small piece of fresh lean beef or other meat in a long glass test tube. Notice the water which rises and collects on the cooler parts of the vessel. If delicate scales or balances are in the school, the meat may be weighed before and after heating. Thus the weight of water driven off may be determined.

**EXERCISE.**—*To Get Dry Matter.*—Place a few small pieces of air-dry wood of any kind in a glass test-tube or bottle over a flame or on a hot stove. The moisture will escape from the wood and condense on the cooler parts of the glass above the wood where it can be seen. After a time only the dry matter will remain in the bottom of the glass. If the wood be weighed before and after drying, the per cent of dry matter may be determined.

**Essentials in Animal Feeds.**—As the animal body consists of several classes of substances, it demands similar classes from the feeds consumed. The substances in animal feeds are: (1) Protein, (2) carbohydrates, (3) fats, (4) mineral salts.

**Protein.**—The protein of a feed includes vegetable albumen, fibrin, and other substances similar to the protein of the animal body. The term albumenoids was formerly used to designate this class of substances when contained in feed or in animal tissues.

The different kinds of protein substances vary somewhat in their composition. They are all rich in nitrogen, and are quite uniform in their value in feeds. They are the most important of the compounds in feed, and are indispensable, as they are the sole direct source of the protein in the bodies of all domestic animals. The chief forms in which protein is found in the animal's body are: *albumen*, *fibrin*, and *casein*. These differ widely in appearance but agree in containing about the same percentage of nitrogen. Gluten is abundant in wheat. Albumen is well represented by the white of an egg. Fibrin is seen in the white solid of coagulated blood remaining after the red color is washed out. Casein is the basis of cheese.

**EXERCISE.**—*Protein in Wheat.*—Make some stiff dough of wheat flour. Wash the dough in cold water to remove the starch. The remainder will become very elastic. It is made up chiefly of that kind of protein called gluten. The "gum" formed from chewing wheat is also chiefly gluten.

**EXERCISE.**—*Study of Protein.*—Examine some of the other substances mentioned, and let pupils become familiar with the different forms of protein. Have present the white of egg, both raw and cooked. American cheese or cottage cheese, or both, may be put into small bottles with a weak solution of formalin to preserve them for future use in illustrating that form of protein called casein.

**Carbohydrates.**—Plant fiber, sugar and starch are the most important of the carbohydrates. They are of about the same composition, containing carbon, hydrogen, and oxygen only, no nitrogen being present.

The cell wall or structural part of a plant is called *cellulose*. Where great strength is needed, the cell walls become thick and hard as in trees. There is little cellulose in seeds. It is found in greater proportions in ripe hay, straw, and corn fodder. Paper is now chiefly made from the cellulose or fiber of wood. Flax fiber and cotton are good examples of nearly pure cellulose. Pure fiber has very little color, odor, or taste.

**EXERCISE.**—*Cellulose.*—Make wet paper balls of as many different kinds of paper as you have in school. The water will remove starch and other substances and leave the pure fiber or cellulose. Brown paste-board may be used to illustrate the fiber in straw of small grains. Fiber of flax is found in linen paper and linen cloth. Most soft white paper is made of wood fiber.

*Starch* is stored by nearly all kinds of plants. It is a very abundant substance. Small grains, corn, and the dry matter of root crops are especially rich in this substance. Potatoes and corn furnish most of the pure starch in the commerce of America. Because of its abundance and ease of digestion, starch is one of the most important feeds. It is readily converted into glucose, or grape sugar, by treatment with acids. The glucose syrups are largely derived from the starch of corn.

**EXERCISE.**—*Showing Starch.*—Cut open kernels of corn, wheat, rye, and other common grains. Examine the white powder. This is nearly pure starch.

*Sugars* are closely related to starch. There are three kinds: cane sugar, milk sugar, and grape or fruit sugar. These are very much alike in composition. All resemble each other in their properties. Cane sugar is the common sugar

of commerce. It is derived from the stems of sugar-cane and from the sugar-beet. Milk sugar is from the milk of the cow and other animals. Grape or fruit sugar is abundant in honey and sweet fruits and occurs in the juices of many plants.

Sugars are easily digested, as they are all readily soluble in water. When animals eat sugar beets and sorghum fodder the sugar is used directly as feed. Sugar is a very important feed and although it occurs only in small quantities in ordinary feeds, it is formed in large quantities from starch during digestion.

*Fat.*—The fat in animals agrees closely in composition with that contained in plants. Fat exists in some seeds, as flax and cotton, in such quantities as to make them valuable as sources of oil, for feed and other uses. Most of the oil is pressed out before the remainder of the seed is used for feed.

*EXERCISE.*—*To Show Presence of Oil.*—Get seeds of flax, cotton, sunflower, or castor bean. Crush them and rub between the fingers to detect the oil. It has been stored there by plants for future use of the young plant sprouting from the seed.

*Mineral Matter* is what remains of plants after they have been burned; it is the ash. Some plants, as alfalfa, are rich in mineral matter. In ordinary fodders there is usually enough to supply the needs of the animal body. Common salt is fed separately. Hogs are fed with ashes and charcoal from wood and cobs, to supply them with more mineral matter. They even get much mineral matter from the soil itself.

*Analysis of Feeds.*—The State laws of most States authorize the agricultural experiment stations to take samples of feeds offered for sale within the State and make analyses of them. The reports of these analyses usually show the per cent of total dry matter and water, and the per cents of

protein, carbohydrates, fat, and mineral matter (Fig. 208). Such reports are very valuable to all stock feeders, as the figures indicate as clearly as is possible the feeding value of each kind analyzed. Those feeds, rich or poor in any one ingredient, as protein, may be easily compared in the published tables. (See Appendix.)

**Feeds Changed Into Animal Tissues.**—The object of feeding is to furnish material for supporting life, and for building up the animal body and the securing of some prod-



FIG. 208.—The bottle at the right represents 100 ounces of shelled corn. The five bottles at the left represent the chemical composition of this corn as determined by analysis. The elements are as follows: starch, 80.35 ounces; protein, 10.92 ounces; oil, 4.70 ounces; fiber, 2.60 ounces; ash, 1.43 ounces.

uct, as milk from cows, eggs from hens, wool from sheep. Each of the four classes of compounds of the feed is of special use in the process. Any one alone, as starch or fat, is unable to completely nourish the body and maintain life.

Animals are incapable of making very great changes in these feed compounds. Each is changed into similar animal products in the living animal by a series of processes called digestion, circulation, respiration, secretion, and assimilation.

**Loss in These Processes.**—In these five processes of life, digestion in particular, the substances contained in the

feed are not all changed into animal products. Some of the feed is used to maintain or carry on the digestion. There is always a loss. Any material capable of building up tissue or of replacing this loss, in whole or in part, is valuable as feed for the animal.

**Nutrients.**—Any single compound, like protein or fat, is called a nutrient. All feeds must contain nutrients. They must be palatable, so stock will like them. They should be largely digestible. Some of the feed each day must possess enough bulk to properly fill or distend the digestive organs.

**Roughage and Concentrates.**—It is common to divide all animal feeds into two classes: coarse fodders or roughage, and concentrated feeds. By *roughage* is meant such bulky feeds as hay, cornstalks, straw, and green fodders.

*Concentrated feeds* are the more highly nourishing materials with less bulk. Ground or whole grains, peas, bran, middlings, and other mill products are concentrates.

**Hay.**—Those forms of hay produced from the true grasses, as orchard grass, red top and timothy, are rich in carbohydrates and indigestible fiber, but contain very little protein. Hay made from alfalfa and clover is nearly as bulky, but much richer in protein than the others.

The value of any hay depends upon the kind or variety, the condition at time of cutting, and the success in curing.

**Corn Stalks and Straw.**—These are very bulky forms of roughage and are so rich in fiber that they are harder to digest than good hay. The nutritive matter that first existed in the growing crop has passed into the seeds, which have been removed. This leaves the straw poorer in both protein and carbohydrates. Corn grown for fodder, if the ears are not to be removed, should be cut as soon as the grain is well glazed. Racks for feeding corn fodder and straw are shown in Fig. 211.

**Green Forage Crops.**—The growing of crops for green forage has been discussed in another chapter. Such feeds are

watery in character. They contain, however, the same nutrients as the hay made from them, if no loss occurs in making the hay. Their weight when green makes them difficult to handle. This disadvantage is balanced by the saving of all nutrients. Green fodders are more succulent and are liked better by stock. They are more easily digested than dry fodders, and contain more protein because of being cut at an earlier stage of growth.

Grasses, growing corn, alfalfa, and other fodders when cut and fed green to stock are called *soiling crops*, as stated in Chapter X. Many of the best stock feeders are using such green feeds a great deal. It saves much in the way of pasture room. Several times as many cows can be fed from a certain field as could pasture well on it. The pasture system is too common to need any description.

**Ensilage.**—Silos are made of various building materials, such as wood, brick, stone, and concrete (Figs. 80 and 209). They are made air tight and will preserve fodder corn or other green feed in such condition as to retain most of the succulent qualities of the original product. Such feed is called ensilage. It is highly valued on dairy farms, where succulence in the daily feed is very important. Corn stalks with the ears still attached are cut when the grain is well glazed. The whole crop is run through a revolving cutter and the small pieces and leaves thrown or blown into the top of the tall silo (Fig. 209). The silos are usually round and are twelve to twenty feet in diameter. The depth is from twenty to forty feet. Small doors along one side allow the ensilage to be taken out easily during the winter months, or whenever it is being fed.

**Root Crops.**—Mangels and beets are grown especially for cows, turnips for hogs and sheep, carrots for horses. But these and other root crops may be used for all kinds of farm animals. They are valuable as feed particularly when the

other feed used is in the dry form. They all contain much water and are very succulent. Stock usually like them, and they are very digestible. The effect upon the animal system is very good.

**Concentrates from Grains.**—Many of the concentrates in use are made from the grains of the cereals. The various products which they furnish are suited for all kinds of farm



**FIG. 209.**—A modern brick silo near end of dairy barn. The cutter and pipe through which cut corn is blown are in place to begin filling silo.

animals. They are easily digested and nearly all are rich in the three groups of feed compounds, protein, carbohydrates, and fats.

*Corn* makes up more than half of the concentrate feeds used for animals in America. It is largely used for fattening hogs and beef animals, and for the feeding of work animals. It is rich in carbohydrates and oil, but contains very little mineral matter and less protein than the small grains. **It** is used in fattening stock.



*Oats* are commonly used as horse feed, particularly in the North. They are richer in protein than corn. For this reason they make better feed for horses than corn where timothy hay is used as roughage.

**By-Products and Mill Feeds.**—Millers make flour from wheat, rye, barley, and buckwheat, and meal from corn and oats. Breakfast foods are made from all of these. In the making of these products for human use there are many parts of the grains not used; such are called *by-products*. They are all carefully saved and sold for the feeding of animals. Bran and middlings are common examples of these.

There are also by-products from the manufacture of starch, glucose, sugar, beverages, oils, and even from the dressing and curing of meats.

The term *mill feeds* may include also the ground grains, either mixed or singly. Corn, oats, and rye are often used in the ground form for stock.

**Bran.**—The outer coats of wheat, removed in making flour, are called bran. Much of the protein of the grain is just beneath the outer coats or coverings of the grain and is kept with the bran during the milling process. There is a higher per cent of protein in wheat bran than in the wheat itself. The bran from corn is of little value and is seldom sold.

**Wheat Middlings.**—The by-product from wheat called middlings is better than bran in its total amount of nutrients. It has as much protein, and is richer in starch. There is less fiber in middlings and this makes it better for hogs. *Shorts* is another name given to middlings. Sometimes mill sweepings and finely ground wastes are mixed with middlings and sold under the name of shorts.

**Gluten Meal.**—When starch and glucose syrups are made from corn the by-product or remainder of the grain is ground up and sold under such names as gluten feed and gluten meal. It has in it the protein, the oil, and the bran. It is

very high in protein and is mixed with other concentrates for the feeding of dairy cows.

**Brewers' Grains.**—These are the by-products from breweries and contain both the bran and the germs of barley. When dried and mixed with other concentrates they are very suitable for dairy cows. They are somewhat richer in protein than wheat bran. Brewers' grains are sometimes fed while very wet. Cows like them in this condition if the grains are not allowed to spoil, which they are likely to do in warm weather.

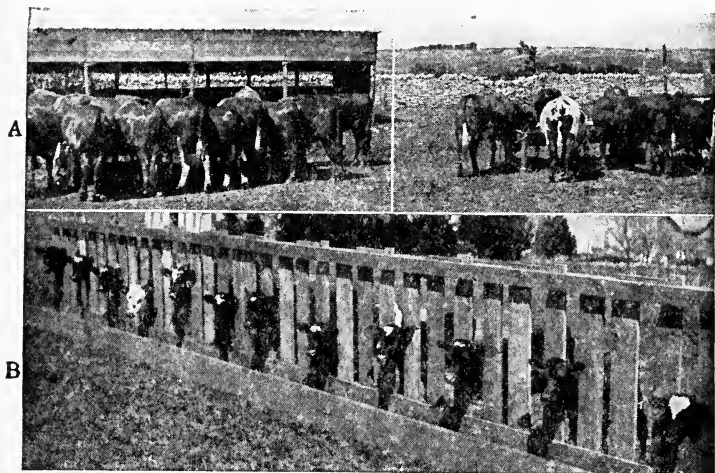
**Beet Pulp.**—After sugar is extracted from sugar-beets the shredded pulp is dried and shipped to all parts of the country for use as stock feed. It should be again wet and soaked for a few hours before feeding. Dairymen are now feeding beet pulp quite extensively as a winter succulence, substituting it wholly or in part for ensilage. Its chief nutrient is carbohydrate, there being little protein.

**Cottonseed Meal.**—Cottonseed meal is one of the richest of the concentrates produced from plants for stock feed. It is the chief by-product from the cottonseed in the manufacture of cottonseed oil. The hulls are usually first removed and the oil pressed out of the cottonseed. The remaining feed is ground into the form of meal, and fed to stock with grains or other concentrated feeds and with fodders. Cottonseed meal is very rich in protein and has more fat than most of the other grains. In feeding it to stock much care must be exercised, as when fed too heavily there is sometimes a poisonous effect.

**Linseed Meal.**—This is frequently called *oil-meal* in the North, as cottonseed meal is less common there. It is a by-product from the manufacture of oil from flaxseed. The oil is chiefly used for paint. The meal is of two kinds, called old process and new process. In the old process the oil is pressed from the flaxseed and the remaining part is broken into small pieces or ground into meal for feed. In the new

process the oil is more completely removed by the use of gasoline or ether. The difference in their feeding values is very slight, as both are rich in protein and show very little waste matter.

**EXERCISE.**—*Samples of By-Products.*—Get from local dealers a collection of samples of all the concentrated feeds they have. Put these in small bottles and label them. Write to the manufacturers for samples of the cottonseed products,



**FIG. 210.**—A. Beef cattle are fattened with corn, fed in large, flat troughs. (Experiment Station, Kans.)

B. Calves in pasture. They are temporarily put in stanchions when fed with skim milk and ground feed. (Experiment Station, Kans.)

corn products, and the linseed products. Local dealers will give you the addresses or get the samples for you. Get the names of feeds from the Appendix in making up the list for the school collection of samples.

**The Principles of Stock Feeding.**—The feeding of animals to obtain the best results is one of the most difficult problems of the farmer or stockman. It involves a knowledge of the feeds used, how to properly balance the nutrients in the daily

feed, the best ways of feeding these (Figs. 210 and 211), the needs of each class of animals, and a study of individual differences between animals of the same kind.

**Digestibility.**—There are several factors which influence the digestibility of feeds. (1) The less fiber present the easier they are to digest. (2) Concentrated feeds digest more perfectly than others. (3) Soft seed coats allow seeds to digest better than those with hard shells, if swallowed whole. (4) Digestion is aided by the grinding and crushing of feeds. (5) The early cutting of fodder and hay will aid. (6) If well cured and stored the feeds are more completely digested. (7) The kind or breed of animal using the feed has an influence. (8) Likewise the individuality and age of the animal have their influence.

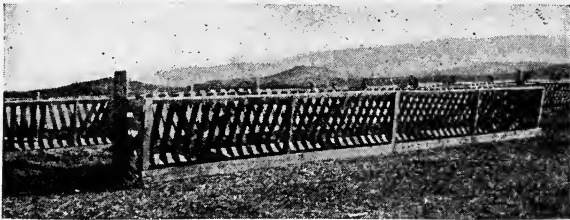


FIG. 211.—Outdoor feed-racks used for feeding flocks on the range.

**Relation of Feed to Purpose.**—We have already learned that we must feed not only to maintain the weight and heat of the animal, but also to produce certain animal products or work. There are many kinds of products. The kind and amount of feed must be suited to the special purpose. The feeds must be rich in protein when the products desired contain much protein. Milk, eggs, lean meat, and wool are such products. The animal cannot produce anything containing protein without the use of protein in the feed.

When the purposes are to build up fat or merely to maintain the body heat and weight, very little protein is required in the feed. If too much protein is fed to an

animal when not yielding some protein-bearing product, much of it is wasted, and a portion of it may be transformed into fat. In the simple maintenance of life, carbohydrates and fat are largely fed. They produce the necessary heat and energy for such a purpose. For this reason much roughage is fed to animals not at work in the winter time. Timothy hay, straw and stalks, with perhaps a little corn grain, are enough for the simple maintenance of cattle and horses. For a gain in fat these same feeds are used in larger quantities. Very little protein is then needed.

In the building of bone, muscle, and other animal tissues, as in the growth of young animals, considerable amounts of protein and mineral matter are used by the body. It is then necessary to use in the daily ration those feeds that have been mentioned as being rich in protein.

**Feeding Young Animals.**—When a stockman desires a profit from the increase in the gain in weight he will feed young animals instead of old ones. Their natural growth is a factor in his favor. Young animals bring better prices in the markets. The thoughtful farmer will fatten lambs and pigs rather than old sheep and hogs. The practice of fattening *baby beef* is now more common than the old way of keeping beef cattle for several years.

**Feeding Standards.**—Scientific men have carefully figured the exact amounts of each nutrient required by the animal's body. The results of their work are called *feeding standards*. Wolff and Lehmann are two German experimenters who have published standards for stockmen to follow. There are fixed standards for each kind of animal and for each purpose of feeding. For example, a thousand-pound cow giving twenty-two pounds (about eleven quarts) of milk daily is to be given such an amount of feed as to equal 29 pounds of dry matter, 2.5 protein, 14.1 carbohydrates and fat combined. The feeding standards commonly used are given in the Appendix. In order to obtain the proper amounts of each of the nutrients

to meet the standards it is often necessary for the farmer to sell some grain, such as corn, and to purchase others of different composition.

**Balanced Rations.**—When the nutrients are in the proper amounts to meet the requirements of the feeding standard the ration is said to be a *balanced ration*. If they are not in the right proportion it is called *unbalanced*. Very few natural feeds conform closely to the standards given for the various purposes of feeding. They must be combined with other feeds in such a way as to balance the daily ration.

**Nutritive Ratios.**—The amount of protein in any feed compared with the other nutrients is called the *nutritive ratio*. For example, there are about three pounds of protein and six of other nutrients in one hundred pounds of skim milk. Dividing the six by three ( $6 \div 3 = 2$ ) the ratio is found to be two. It is expressed thus—1:2. The nutritive ratios are given in the feeding table in the Appendix.

In calculating these ratios the fat is not added directly to the carbohydrates, but it is first multiplied by two and one-fourth and then added. This is done for the reason that fat in any feed is two and one-fourth times as valuable as carbohydrate in the producing of heat and fat.

To make this clear, the ratio for alfalfa hay may be figured. The digestible nutrients in one hundred pounds of alfalfa are: 1.2 pounds of fat, 39.6 pounds of carbohydrates, and 11 pounds of protein.

$$1.2 \times 2\frac{1}{4} = 2.7 \text{ (fat equivalent to c.h.)}$$

$$2.7 + 39.6 = 42.3 \text{ (total nutrients not protein).}$$

$$42.3 \div 11 = 3.84 \text{ (ratio, expressed 1:3.84).}$$

**Comparison of Clover with the Standard.**—Red clover hay is very nearly a balanced feed for dairy cows giving twenty-two pounds of milk daily. It comes as near the feeding standard for such a purpose as any one feed can without mixing with other feeds. Feeding a great amount of any

one feed is not advisable, as all animals want a little variety.

	Dry Matter	Protein	C. H. and Fat	Nutritive Ratio
Standard for 1000-lb. cow giving 22 lbs. milk.....	29.	2.5	14.1	1:5.6
Nutrients in 35 lbs. red clover hay.....	29.64	2.38	13.86	1:5.8

Thirty-five pounds of clover hay give a little too much dry matter and not quite enough of either class of nutrients. The ratio is a little too wide. A ratio that is greater than that given in the standard is said to be too wide; if too small it is too narrow. Alfalfa hay has too narrow a ratio (1:3.8) for dairy cows when fed alone. Corn with cobs (1:15.1) is too wide for this purpose. The two can be combined in such a way as to make a ration very close to the standard, as shown below:

	Dry Matter	Protein	C. H. and Fat	Nutritive Ratio
21 lbs. alfalfa hay.....	19.65	2.46	9.05	
10 lbs. corn-and-cob meal	8.49	.44	6.55	
	<hr/>	<hr/>	<hr/>	
Total.....	28.14	2.90	15.70	1:5.41
Standard.....	29.	2.5	14.1	1:5.56

It will be seen that if the dairyman feeds twenty-one pounds of alfalfa hay and ten pounds of corn-and-cob meal the ration is close to the standard; both columns of nutrients are a little too high, but the dry matter is a little under the standard. It should be remembered that these two feeds are both easily produced on the farm and no money is then paid out for feed.

**What Stock Like.**—It is necessary that a feeder select or provide feeds that are liked by the stock. If certain feeds are not palatable to the animals, the best results are not secured. It is also necessary to avoid too much indigestible matter. The coarser forms of roughage, such as corn fodder, should be run through a cutter, and the hard grains are liked better when they are ground. Animals which chew their cud, called ruminating animals, as the cow and sheep, like more roughage than hogs. All animals like a change

of feed, and a little variety in the ration. It should be changed gradually and not all at once.

**EXERCISE.**—*Palatability of Feeds.*—Let the older pupils report as to which of the following feeds are liked best by stock: clover, alfalfa or timothy hay by cows; turnips or carrots by horses; bright clean corn or mouldy corn by horses.

**Problems.**—1. What is the cost of protein per pound in clover hay containing 6 per cent protein when the hay is valued at \$10 per ton?

2. What is the cost of protein in timothy hay containing 3 per cent protein when the hay is worth \$18 per ton?

3. Which hay is better for dairy cows?

**Buying Feeds.**—A farmer often finds it very advisable to sell some of the wheat or other grain and buy instead mill feeds and other by-products. It is well to select those mill feeds which are rich in protein to mix with the farm roughage and corn. This will make it easier to balance the rations for the different kinds of stock.

Some roughage may be sold or exchanged for the desired concentrates. Timothy hay brings a good price in the markets, but is very poor form of roughage hay to keep on the farm to feed to dairy cows. Clover hay is far better for cows and yet the market price is much lower.

In deciding which feeds to purchase it is well to decide the cost per pound of protein contained in each feed considered.

**Problem.**—Figure the cost per pound of protein in each of the following concentrates when the prices per ton are as follows: Cottonseed meal, \$33; linseed meal, old process, \$32; brewers' grains, dry, \$27; wheat bran, \$25; wheat middlings, \$30; cornmeal, \$32. (See the protein contents Table of Feeds in the Appendix.)

**Fertilizing value** of feeds is a thing to be considered in all feeds. When farmers buy feeds they may well consider that they are buying fertility for the farm. It is usually better to buy mill feeds for farm stock than to buy commercial fertilizers. Such feeds are often rich in available organic



nitrogen; and the minerals, phosphate and potash, are more or less abundant. How much of this fertility reaches the soil will always depend upon the care and use of the manure from the barns

### REVIEW

1. Of what is the solid part of an animal's body composed?
2. Tell about how much of the body is water.
3. Name three or four common forms of protein.
4. Give the four classes of nutrients needed by animals, besides water.
5. Name some of the common feeds rich in protein.
6. What substances are included by the group termed "carbohydrates?"
7. Name some feeds rich in starch.
8. Mention three different kinds of sugar and the sources of each.
9. Name the five animal processes necessary in changing feed to animal tissue.
10. Give examples of feeds classed as roughage.
11. Give several examples of feeds classed as concentrates.
12. Give some examples of crops suitable for being fed green in summer when pastures are poor.
13. Name three feeds suitable for winter succulence.
14. How is ensilage made? What is a silo?
15. Tell what you can about bran; middlings.
16. Discuss the character of gluten meal. From what is it made?
17. Tell how cottonseed meal is made.
18. Distinguish between "old process" and "new process" oil meal. Which is richer in oil?
19. Tell what things influence the digestibility of feeds.
20. Give two objects of feeding.
21. What is the sole source of an animal's protein?
22. Name the classes of nutrients that may cause the formation of fat in the animal body.
23. Why is it more profitable to feed young animals than old ones if we are to sell them by weight?
24. Give the weights of the several nutrients for a 1000-pound cow giving milk.
25. Of what use are feeding standards?
26. What is meant by a nutritive ratio of 1 to 6?
27. Give the meaning of wide ratio and of narrow ratio.
28. Why use feeds which animals crave, rather than feeds they dislike?
29. Why do farmers need to buy mill feeds to use with farm feeds?
30. Why is it better to buy mill feeds than it is to buy commercial fertilizers?

References.—U. S. Farmers' Bulletins on Feeding: 578, 655, 724, 743, 777, 873, 906, 972, 1030, 1133, 1179, 1218, 1229. Ark. Sta. Bul. 108, Cottonseed Poisoning; 164, Silage; 184, Vitamines.



## PART III.

### ANIMAL PRODUCTS.

---

#### CHAPTER XXX.

#### CATTLE PRODUCTS.

THE most important products from cattle are beef, veal, milk, cream, butter, and cheese. Other minor products and by-products are skim milk, buttermilk, whey, hides for leather, hair for plaster, hoofs and horns for glue, blood and bones and other parts for fertilizers. Small useful articles, as buttons, knife handles, and others are made from bones and horns.

**Cuts of Beef.**—The beef type of cattle bring the highest prices per pound. This is true when sold either by live weight or as dressed meat. This type also gives a higher percentage of dressed beef than the carcass of the dairy animal. The carcass of the beef animal has a better percentage of weight in the high-priced cuts of meat than the others. The quality of meat is far better in an animal bred for beef than in a dairy cow. Figure 212 gives the names of the different cuts of beef as used by butchers and buyers. The retail prices given are relative, not actual.

**Products of the Dairy.**—In the wild or primitive condition cows gave milk only for their calves. They have since acquired the character of giving much more than that, and now milk has become a standard article of food for man.

**Milk as Food.**—Milk is one of the most perfect forms of food used by human beings. It is easily digested and contains the nutrients in proper proportion to supply the needs of the body.

In 100 pounds of milk these parts are in about this proportion:

Water.....	87.	pounds
Fat.....	4.	pounds
Casein and albumen (protein).....	3.3	pounds
Sugar (carbohydrates).....	5.	pounds
Mineral matter.....	0.7	pounds
Total.....	100.	pounds

*Fats in Milk* are of several kinds, which fall into three groups: (1) The *volatile* or easily evaporated fats. (2) The fats that are in *liquid* form at ordinary temperature.

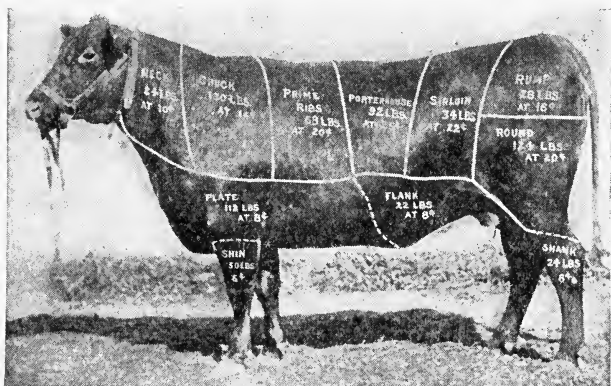


FIG. 212.—The cuts of a beef animal, giving the relative prices and weights.

(3) The fats that are in *solid* form at ordinary temperature. Some of the volatile fats may be allowed to escape by airing the milk or cream. If they are not thus removed they soon break up into forms which give bitter flavors to the milk or cream. The airing process should be done in a clean room where the air is pure and free from dust.

The fats in milk are lighter than the other parts and readily rise to the top; but in so doing they take with them certain other parts which compose the cream.

*Casein* is the chief protein in milk. It is the important ingredient found in cheese, which is familiar to all. There

is always a little albumen present. It is similar to the white of raw egg. The casein is the main tissue-forming part of the milk when used as food.

*Milk sugar* is the heat-producing part of milk when used as food. When milk sours it is due to the action of bacteria which changes the sugar into an acid, called *lactic acid*.

*The mineral matter* in milk is made up of the same minerals required by the bones and other body tissues. They are very beneficial when milk is used as human food. When milk is pasteurized by heating, it loses much of the mineral value and is no longer a suitable food for growing children. The bones are apt to be too soft when such milk is used regularly.

**Composition Varies Naturally.**—The milk from dairy animals varies in its composition from several causes. The main factors are given below:

1. Breed of animal; as Jerseys have more fat in the milk than Holsteins.

2. Period of lactation; the milk being richer in fat just before a cow dries up.

3. Different parts of same milking; the first is poor in fat, the last is rich.

4. Kinds of feed; this influences quantity of milk chiefly; but the character of butter fat is influenced by feed; for example, cottonseed meal makes the fat harder than does linseed meal.

**EXERCISE.**—*Difference in Milk.*—Have one of the pupils or a farmer save in two separate bottles some of the first of the morning's milking and some of the strippings from the same cow. One-fourth pint of each will be enough. These two bottles may be kept in a cool place for a day until the cream has all risen. The difference will then be shown by measuring the thickness of the layer of cream in each bottle. It is not a bad plan to use the first pint of each milking for pigs or calves instead of for human food.

**EXERCISE.**—*Bad Flavor in Milk.*—Some farmer's son may be able to tell the class some of his own experience in getting bitter milk when cows have been in weedy pastures when the grass is poor.

Cabbages, wet brewers' grains, and spoiled ensilage may flavor the milk if fed only a few hours before milking. To avoid such bad effects from those feeds, if used at all, they should be fed to the cows when their udders are empty, just after milking.

**EXERCISE.**—*Composition of Milk.*—Prepare a set of bottles containing the proper amounts of different materials to show approximately the composition of one pint of milk. Preserve these with a few drops of formalin in each. Use the following:

14 oz. water in a pint bottle.

$\frac{1}{2}$  oz. melted butter in  $\frac{1}{2}$  oz. vial.

$\frac{1}{2}$  oz. cheese (protein) in  $\frac{1}{2}$  oz. vial.

$\frac{7}{8}$  oz. milk sugar in 1 oz. bottle.

$\frac{1}{8}$  oz. salt (mineral matter) in smallest vial.

These should be neatly labelled and kept for future reference. The set will resemble Figure 208.

**Difficulty in Obtaining Pure Milk.**—Healthy milk cows naturally produce a pure product, but much of the milk used for food is not as pure as it should be. There are many chances for the milk to become dirty or infested with bacteria before it is used. Careless and improper methods in barns or on the part of those who handle the milk before and after it reaches the home are the chief causes of impure milk. Milk may be kept pure and free from harmful contamination. Poor and unclean milk should not be used for food.

**Bacteria in Milk.**—The bacteria in milk are classed as either good or bad. Those which cause milk to sour are useful when the milk or cream is to be used for making butter or cheese. There are many bad forms of bacteria

which will produce bad flavors in milk and its products. Milk is a substance very favorable to the rapid development of both classes of bacteria. These multiply very rapidly if the milk is kept warm. There are many ways in which bacteria find their way into milk. Some of these are from the coats or hairs of the cows, from the dirty hands and clothing of milkers, from flies that fall in, from dirty pails, cans, strainers, bottles or other utensils, from dust or other impurities in the air of barns, milk-rooms, and homes (Fig. 213).

FIG. 213 A.

FIG. 213 B.

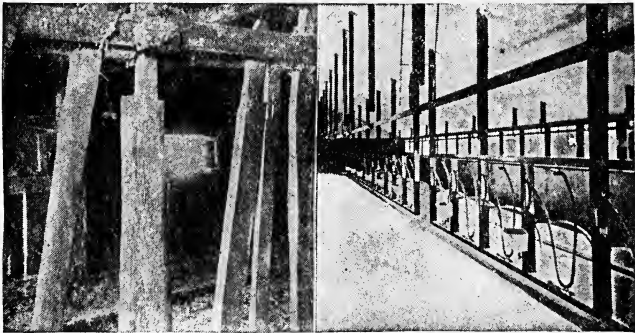


FIG. 213A.—Dark. Bad construction. Difficult to keep clean.

FIG. 213 B.—Good construction. Smooth floor, walls, and ceiling, plenty of light, easy to keep clean. (Animal Industry.)

**Pure Milk.**—Milk of a healthy cow contains no germs while forming in the udder. They get into the milk in the ways mentioned in the last paragraph. By pure milk is meant the properly-handled product of healthy cows.

To keep dirt and bacteria out of the milk the barns should be kept clean. This is made possible only by having the floors, walls, and ceilings smooth and tight (Fig. 214).

Direct sunlight through large south windows will help to destroy many bacteria in barns (Fig. 214).

The air must be free from dust at the time of milking. Feeding should be done after milking instead of before.

The barn should be properly ventilated to remove bad odors, bad air, dust particles, and bacteria. The ventilation must be ample and yet free from drafts of air. There are two good systems in use. One consists of muslin cloth screens placed in several of the open windows. The other is the King ventilation system, which draws the foul air out from near the floor, through a long shaft or chimney (Fig. 215). This is the best system for winter ventilation of buildings.

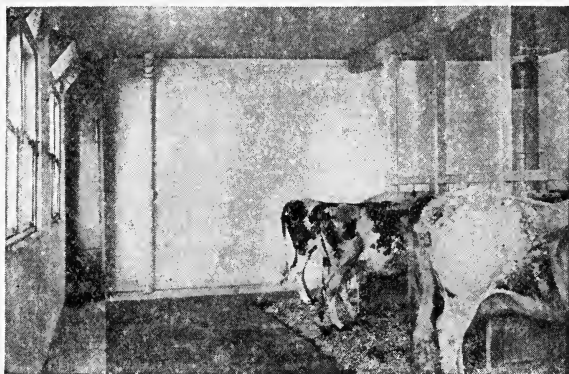


FIG. 214.—A small but clean dairy barn. (Animal Industry.)

The cows must be clean if pure milk is to be produced for food. Milk always becomes dirty if the cows are dirty. The udders and surrounding parts should be washed if filthy; and the dust and loose hairs must be removed just before milking, by the use of a damp cloth.

The milker must be healthy, and must have clean hands and clean clothes.

Milk pails should have small tops because they catch less dirt. The pails with good hoods shown in Fig. 216 will keep out the most dirt.

All milk utensils must be washed well and then always

scalded thoroughly with boiling water to kill the bacteria. This is called sterilizing them.

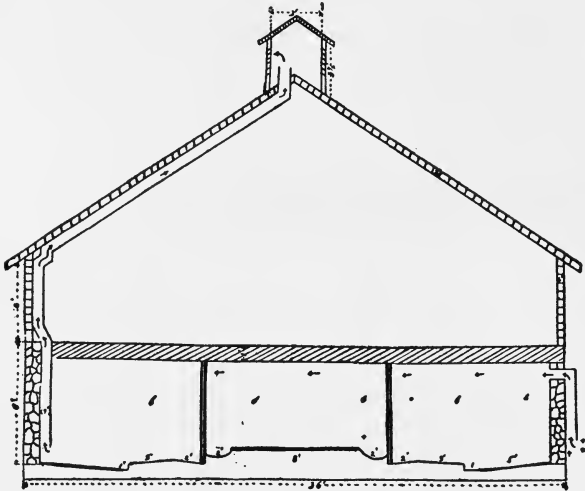


FIG. 215.—King system of ventilation for dairy barns. The air outlet should start near the floor and extend through the roof. The inlet for air into the stable is near the ceiling, but should start outside well above the ground. Windows are for light, not for ventilation, when the King system is in use.

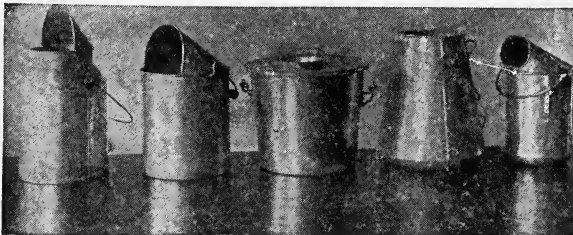


FIG. 216.—Five styles of milk pails, intended to reduce the amount of dirt in milk which falls in from cows and from milkers. Which do you consider the best form for this purpose?

**Cooling and Airing.**—As soon as milk is drawn from the udder it should be taken to a clean place and thoroughly aired and cooled. The temperature should be lowered quickly



to 50° F. or below. This will check the multiplication of bacteria that would spoil the milk (Figs. 217, 218).

**EXERCISE.**—*Temperature and Souring.*—Get two bottles of milk, both fresh. Set one in a cool place where it will not quite freeze. Set the other in a warm room. Notice the difference in time it will take to sour the two bottles of milk. These samples may be tasted for sourness and also tested with blue litmus paper.

FIG. 217.



FIG. 218.



FIG. 217.—Milk bottles with crushed ice in shipping box.  
FIG. 218.—Delivery of milk to city houses.

**Bottling Milk and Cream.**—Milk and cream to be delivered directly to the users should be put into sterilized bottles, which are kept covered and cold until the milk is used in the home. The old way of delivering milk from cans which were opened in the streets to take out the milk for each customer, allowed dust and all kinds of city bacteria to get into the milk. Simple machines are used by which milk and cream may be put into bottles very rapidly with little handling (Fig. 219).

**Special Forms of Market Milk.**—There are laws or certain regulations in many places which require that milk shall be of a certain quality or standard.

*Legal* milk usually contains three per cent of fat and not less than twelve per cent of total solids, which includes everything but the water. This is the most common form of milk delivered to consumers, and to butter and cheese factories.

Milk is also *standardized* by certain producers of milk for special markets. A certain dairyman may produce milk for his customers which will always have any desired percentage of butter fat. This is done by mixing rich milk or cream with poor milk in such amounts as to give the desired results.

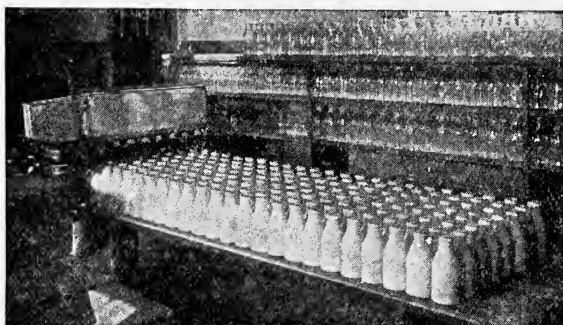


FIG. 219.—Milk bottled for the retail market. The machine at the left fills eight bottles at once and is then moved to the next row.

*Certified milk* is that which meets the requirements of milk commissioners, as to purity and safety. The barns, milk-rooms, methods of handling and delivering are all inspected by experts, and certificates are issued to all dairymen who meet the requirements of the milk commissioner.

*Condensed milk* is now extensively canned and shipped for use in many places. Much of the water is removed by evaporation. Sometimes sugar is added. It will keep a long time while sealed, and is used by armies in the field, on board ships at sea, in mining camps, and is becoming more popular in cities.

*Powdered milk* is a newer and less common form of market milk. Some of the fat is usually first removed, and then the

milk is evaporated to dryness without burning. Before being used it is mixed with water.

*Modified milk* is prepared for use of infants and invalids, by increasing or decreasing one or more of the parts of the milk, to suit special cases.

*Fermented milk and ripened milk* are made from skim milk or from whole milk. The proper bacteria are added to cause the souring and thickening of the milk, as cream is ripened for churning. When ready for use it is somewhat similar to buttermilk.

**Creaming.**—There are three common methods of obtaining the cream from milk. (1) The shallow pan method is the oldest and most common. (2) The deep can method is sometimes used when much milk is to be handled. The large cans of milk are kept in cold water until the cream rises. The skim milk is drawn off through a faucet at the bottom. (3) The modern centrifugal bowl separator is the only quick way of removing the cream from milk (Figs. 220, 221). In all types of these machines the milk flows into a rapidly whirling metal bowl. The speed is very great, and the skim milk, being heavier, is thrown to the outer edge and runs out. The cream overflows near the centre of the bowl.

**Ripening Cream for Churning.**—As soon as cream is separated from the milk it must be cooled and kept cold until about twelve hours before it is to be churned into butter. It is then warmed to a temperature at which the bacteria will grow to make it sour. This may be 60° to 75° F. It will sour faster when warmer, but will not make so good butter. At churning time the temperature should be about 58° in the summer and 60° or 62° in the winter. Ripened cream should be slightly sour to the taste and pour as a thick, smooth, glossy liquid, free from lumps or curds. When ready to churn, it should be poured through a strainer to remove any curds that might be present.

**Steps in Churning.**—1. Put the cream into the churn and add a little vegetable butter-color.

2. Operate the churn steadily and slowly to cause the globules to be affected by the dashing movement.

3. Stop the churning when the granules are the size of large grains of wheat or peas.

4. Strain the buttermilk out, leaving the butter in the churn as loose and open as possible.

FIG. 220.

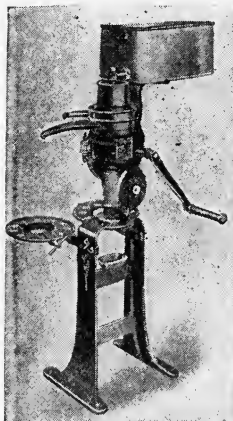


FIG. 221.



FIG. 220.—A modern hand separator. Cream separators of small size are used on dairy farms where cream or butter is sold.

FIG. 221.—School pupils learning to operate a cream separator. (A. E.)

5. Wash the butter with cold water twice, by pouring it on and draining it off. Use as much cold water each time as half the amount of the buttermilk.

6. Sprinkle over the loose butter enough salt to suit the taste. One ounce of salt to a pound of butter suits the usual market.

7. Work the butter in large masses, but not enough to give it a smeared or greasy appearance.

8. Mold or pack to suit the market requirements, as in pound molds covered with parchment paper.

**Cheese.**—Whole milk cheese is very nutritious as a food and the use of it has greatly increased in recent years. It is rich in both casein and fat. There are many kinds of cheese sold in the markets, but the steps in making the various kinds are similar. These steps are: (1) The coagulation of the casein, with or without a special material, called rennet; (2) the removal of the whey; (3) salting; (4) pressing; and (5) ripening.

**Dairy Records.**—Records should be kept of the milk produced by each cow so that the owner may know which ones are paying best. The profits from each cow cannot be determined unless a record is kept of the daily flow of milk. If the milk is used for making butter or cheese, the records should then also show the richness of the milk from each cow. The milk of each cow should be frequently weighed and a sample of it tested for butter fat. If the weighing is done one day each week, for three weeks of the month, an approximate record of the amount of milk given each month may be easily determined. It is better to weigh the milk each time just after it is drawn from each cow. Samples for testing should be taken after the milk is poured into another vessel, as this mixes the milk, and a truer sample is obtained. The samples are easily preserved, until time for testing, by the use of special poison tablets made for the purpose. Cows which do not yield good profits should not be kept. Many do not pay their board.

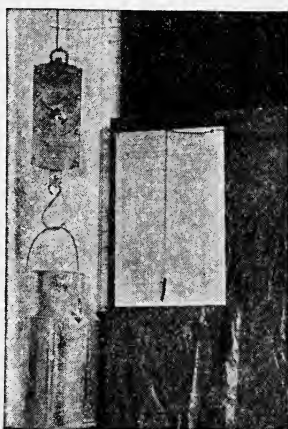
Keeping the dairy record is made easy by having a good spring balance hanging near the record sheet in the barn (Fig. 222).

**The Babcock Test.**—The method of testing milk for determining the amount of fat was devised by Dr. S. M. Babcock, of the Wisconsin Experiment Station. It is very simple and gives accurate results. A set of the apparatus used in this test is shown in Fig. 223.

**EXERCISE.**—*Testing Milk and Cream.*—Some one near the school, who has a Babcock test outfit, may be invited

to bring it before the class and give a lesson in testing samples of milk and cream. Or perhaps it will be as well for the class to take a trip to a near-by creamery and observe the operation. If possible the school should own an outfit. The students could then test samples of milk from the cows of the neighborhood.

**EXERCISE.—*Skim Milk and Buttermilk.***—Samples of skim milk from two or more separators should be tested to deter-



**FIG. 222.**—The weight of each cow's milk is written on the record sheet.

mine which one removes the cream the best. If buttermilk is tested, this will tell how well the churning has removed the butter.

**Principles of the Babcock Test.**—The testing of milk by this method is founded on the fact that very strong acid will dissolve all the substances in the milk except the butter fat. The particles of fat are thus set free from the rest. As the fat is the lightest part of the milk, it will rise to the top. This takes place in a few minutes if the bottles of milk are placed in a whirling machine (centrifugal). In other words, the heavier parts of the milk are thrown to the bottom.

In making the test a definite, or measured, amount of milk is put into a bottle with a long, narrow neck and just enough acid is mixed with this to set free the fat. After the fat is brought to the top by the whirling force, some hot water is added to fill the bottle up to the neck. A second whirling brings the fat above this water. A little water is again added to float the fat up even with the scale on the neck of the bottle. The third whirling gathers all the fat together in the neck of the bottle so that the length of the column of

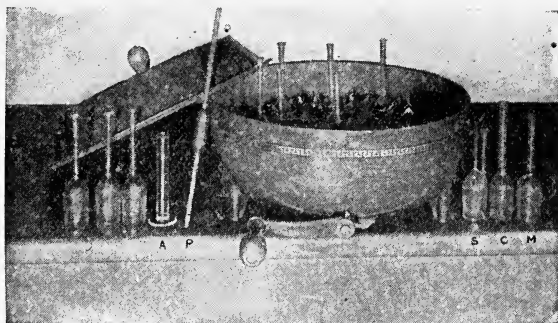


FIG. 223.—Glass-ware and machine for making Babcock test for butter fat in milk, cream, and skim milk. (Experiment Station, Wis.)

the fat may be read on the scale. The neck must have been correctly scaled, to give the result in percentage of the amount of milk first put into the bottle. Thus if the fat fills four full spaces of the neck of the bottle, the milk is four per cent fat.

**Details of the Test.**—*Sampling.*—Shake or otherwise mix the samples to be tested just before beginning the work. It must not be hot nor very cold. Measure out 17.6 cc. (cubic centimeters) by drawing milk into the long pipette (Fig. 223, P), just up to the mark. Suck the milk into the pipette with the mouth; put a finger over the top and let enough drip out until the top is exactly even with the mark.

Let this milk flow gently down the long neck into the test bottle, M. Do not spill any. Blow in the last drop. The steps thus far are the most particular and should be practised with water a few times or until the work can be done well. Always make the test in duplicate to avoid error, using two bottles.

*Adding the Acid* must be done carefully. Be ready to wash up any spilled acid quickly, as its burns are serious. Use water freely and add soap or soda if needed. The acid is measured up to the 17.5 cc. mark, in the little cylinder or acid measure, A. Pour it into the milk sample in the test bottle, holding the bottle in a slanting position to let the acid pass by the outgoing air.

Mixing the milk and acid is now done by holding the bottle by the neck and giving it a circular motion for a few minutes. Do not point the mouth towards yourself nor any one else. Mix until the contents are dark colored throughout. The action of the acid makes it very hot.

*Whirling.*—Place the test bottles in the whirling machine in pairs, directly opposite each other, to perfectly balance the machine. The speed to run the machine depends on its diameter and is usually marked on the machine. Run it five minutes. Stop and add hot water to fill each test bottle up to the bottom of the neck. Whirl two minutes. Add hot water to bring the top of the fat nearly to the top of the scale (graduation) on the neck. Whirl one minute. During all the whirling and the reading the test bottles must be kept hot by putting hot water into the machine under the bottles.

*Reading the Result.*—Take the bottle by the top of the neck and hold the scale level with the eye. Read the marks at the extreme top and bottom of the fat. The difference between these is the percentage of fat in the sample. For example, if the bottom reads 3.2 and the top reads 7.4 the percentage of butter fat would be the difference, or 4.2.



This percentage, 4.2, of fat in the milk would mean that there are 4.2 pounds of fat in 100 pounds of milk. The glassware must be kept clean so that the test and the reading will be accurate.

*Skim Milk and Buttermilk* are tested in special bottles having double necks (S, Fig. 223).

*Cream* is tested in bottles with extra large necks (C), because there is so much fat in it. The sample taken is weighed instead of measured.

### REVIEW.

1. Give two reasons why the beef type of animals is preferable for beef.
2. Name three of the highest priced cuts of meat.
3. Why is milk considered a complete food for young animals?
4. Tell what you can of the composition of butter fat.
5. What is meant by volatile fat?
6. Why should volatile fats be allowed to escape from milk when freshly drawn from the cow?
7. What per cent of average milk is water? Name the other substances in the order of their greatest abundance.
8. What are the usual differences in composition of milk drawn at different times?
9. At which part of the milk period is milk the richest?
10. Tell of the influence of feed on the character of butter fat in milk.
11. Tell of the different effects of good and bad bacteria in milk.
12. How can clean methods in barns help to keep bacteria out of milk?
13. Mention six ways in which bacteria may get into milk.
14. Describe the King system of taking foul air out of the barn.
15. What are the best forms of milk pails?
16. Tell how to sterilize milk utensils.
17. Describe the conditions for ripening milk.
18. Give the steps in making good butter.
19. Why should dairymen keep records of individual cows?
20. How is this done? Why should the milk of each cow be tested?
21. Of what use is the Babcock test outfit?

References.—U. S. Farmers' Bulletins: 623, Ice; 748, Dairy Sterilizer, 850, 960, 1191, Cheese; 876, Butter Making; 930, Parcel post; 976, Cooling; 1019, Straining; 1207, Uses of Milk; 1214, Dairy Houses. Ark. Ext. Circ. 109, Canning Beef; 64, Steam Makers.

## PART IV.

### FARM MANAGEMENT.

---

#### CHAPTER XXXI.

#### THE BUSINESS OF FARMING.

**Changes in Farming.**—Young men and, indeed, older people who live in the city of to-day scarcely realize the great change that is taking place in American country life and the farmer's business. In fact, so many new principles are being introduced that persons who have been off the farm only a few years have no idea of the modern ways of doing things by up-to-date methods. To be sure, there are some things which have not changed, but there have been radical changes along the lines which concern and affect the financial side of the business.

**Some Causes.**—Most of these changes have been brought about through the instruction along advanced lines given by State agricultural colleges; by the farmers' institutes; in bulletins from the State experiment stations and the United States Department of Agriculture, and, as a corollary of all this, the improvement of farm papers and magazines. The United States Government does more to advance the interests of agriculture than is done for other lines of education by the four largest universities in America. Many legislative changes have been made tending toward the improvement of the rural classes. The increase in American export trade has done much to advance the price of farm produce.

As prices for land advance and competition increases, it becomes necessary to adopt the most modern methods of

farming in order that the profits may be reaped from smaller areas. The invention of machinery has played an important part in the introduction of new methods.

*The results* of these changes are only just beginning to be realized. Many may think that fewer people will be needed upon the farms. The very opposite is true. But instead of the farmer of the future being an uneducated person, he is coming to be well prepared for his new calling.

**The Best Men Needed.**—The farm demands men who are prepared for their chosen work. Men with the best brains are wanted on the farm. The time is rapidly drawing near when no occupation can be found which will demand a better preparation than farming. A wide knowledge of science; a thorough understanding of basic principles of plant and animal life; a constant acquaintance with the world's market quotations and how to interpret them; a clear insight into reasons underlying all farm operations; a close attention to all details of the business; a steadiness in all matters pertaining to the operations of the farm; courage to act, and act quickly, at the proper time; good physical strength and power of endurance;—these are some of the qualities demanded of the farmer by the farm of tomorrow. Already we hear the call for such men.

**Some Contrasts.**—Take a ride across any agricultural section of America in the fall and you will find many of the cornfields remain uncut. Some few farmers have learned that the corn stalks contain forty per cent of the crop, and are careful to utilize it.

A certain man was seen applying barn-yard manure to recently drained swamp land when already the place was too full of unrotted vegetable matter to produce its best crops; his neighbors spread manure on the poorer soils of the uplands.

Many dairymen are keeping dairy cows which do not pay more than five dollars each over the cost of keeping them

each year; while others clear fifty dollars or more a year from each cow above the cost of feed and labor.

Farmer "A" will be deluded by the false belief that the creamery separators will kill germs of tuberculosis and thus prevent that disease from spreading from one herd to others in the neighborhood. "B" will investigate the matter, and if neighboring cattle are thought to have the disease he will promptly stop taking skim milk from the butter factory. He will retain his own herd's pure skim milk on his place and sell cream only.

**System in Farming.**—In all parts of the country farmers need to put more business and system into their farming. Too little system is the chief cause of failure in many instances. On farms that are successful more system could be introduced with profit. No other calling of man could withstand the lack of system which is often found in farming.

**Mapping the Farm.**—Begin by mapping out the farm. It is not necessary to employ a surveyor. First make a rough sketch of the outline of the fields as they now exist. State the area of each field or division as nearly as possible. With this sketch as a basis to work from, then measure the real length of each line represented on the chart. A man and a boy with a tape line fifty or one hundred feet long will be able to measure all the lines in a few hours. Write the lengths on the chart.

Now you are ready make a corrected map. With a foot rule or yard measure, a large sheet of paper and a pencil, you can make a map with true proportions very easily. Previous work in map drawing will aid in getting directions of lines. Of course a scale must be established, say one inch on the map to five hundred feet on the land. After the map is drawn it will be easier to calculate the true area of each field.

**Planning the Crops.**—On each division or field we should next write the name of the crop or crops which that field produced last year, as "Oats followed by clover." Then

establish the rotation that each field is to follow for several years. Several rotations of crops are suggested in the chapter on Systems of Cropping. Let each field on the map be marked with the main crops it is to grow for several years.

Dairy farms will be planned to produce plenty of green and dry forage, as well as some root crops, grain, and corn. During the long winter evenings a farmer and his family should sketch the farm and plan the special crops for the following season on each field.

**EXERCISE.—Mapping School Grounds.**—Let the whole class, or those who have the most time to spare from other work, measure the school grounds and make maps of it on large paper. Each line should be marked with the length it represents on the ground. The scale on a map is always given for a map in a geography. Let the scale for this map be as large as the paper will accommodate. Try one inch to four feet for a very small place, or one inch to 100 feet for a large place. Figure 101 suggests a good plan for school grounds with a school garden.

**Elements of Business Success.**—Farmers should keep records and accounts. This is one of the commonest reasons for the great success of certain farmers as compared with others who seem to farm by the same methods. The farmer who keeps clear and simple accounts always knows his business, and can stop the losses that occur. He should keep records of all agreements with men and thus avoid many disputes or law suits. Records regarding crops or stock will help to bring about the best financial results.

A memorandum book should be kept in which are written the dates of the first killing frosts each fall; the dates of the opening of fruit buds in spring; the dates of bad spring freezes; the birth of all kinds of live stock; the dates when each field is sown and harvested; and many other important events of the year.



**Keeping Farm Accounts.**—All farm accounts should be so simple as to require very little time in keeping them. They should also be easily referred to, and give the desired information in a few moments. What is known as a *single entry* system is easy to understand and requires little time. When a calf is sold for cash the entry is made on that date in the cash account, "Calf sold, \$10.00."

The "*Column System*" is still more simple, but requires a special ruling for the purpose. Any book with a number of money columns will be easily adapted to farm purposes.

FIG. 224.—The column system of keeping farm accounts.

The pages are wide and the names of accounts are written at the tops of the narrow columns. The left-hand page is for the sales and receipts, and the right for expenses or purchases. The photograph of the open page is shown in Fig. 224. Down both sides the dates are written or printed, one line being used for each day of the month. The two pages show all the business of one month. Each department of the business is given an item column and a money column.

A similar book with other names for the columns should be used in keeping the household expenses. The columns could be headed: **Furnishings, Wearing Apparel, Food,**

Personal Expenses, Repairs, Education and Church, Reading, Sundries, and others.

**EXERCISE.**—*Using the Column System.*—Let students rule a sheet of paper for the column system, following the plan shown in Fig. 224. Then make ten or more appropriate entries, as practice work. Girls in the class may rule a sheet for a household page, using the headings suggested.

*Field records* are very valuable to show the cost of producing any crop. To keep a cornfield record, a page of a book, having two money columns at the right side, is used. Books with such rulings are called “journals” and are for sale by stationers. Write in the record of the manuring, plowing, harrowing, seeding, planting, cultivating, and harvesting. The amounts for such items are estimated at so much per day for man and team, and are written in the first, or left-hand, money column. Credit records are written on the same page later in the year. The items may include green corn fodder, cured fodder, and ripe corn. The amounts for these will go into the right-hand money column. At the end of the year add the amounts in each column; the difference will show the profit (or loss) from the field.

**EXERCISE.**—*Making a Field Record.*—A page of paper should be ruled by each student like a “journal,” with two money columns at the right and a date column at the left. Make the probable entries for one year for some familiar crop. Suitable amounts for the items may be estimated after talking with a good farmer.

*The Accounts to Keep* on any farm will depend upon the special lines of farming that are followed. Some or all of the following accounts would be included: *Cash, grocery, labor, horses, dairy, hogs, poultry, fruit, potatoes,* and others.

**The Farmer a Salesman.**—A farmer usually has produce of some kind to sell. He should advertise that fact in a number of useful ways:

The produce itself should be put up in the very best form

so as to catch the eye of the consumer. This idea is used in the egg case and the fruit case shown in Figs. 205 and 120, A.

The farm from which the produce comes should be attractive and pleasing in appearance, as to its fields, buildings, fences, and lawns. This also adds real value to the place itself.

The farmer, his team, and wagon must be neat and presentable when making deliveries of goods. These help to sell future products. Dairymen wear white uniforms. The work clothes should be kept at home. The commercial traveling salesman does not wear a factory suit.

The farm should have an attractive name. This name should be printed neatly on letterheads, envelopes, shipping cards; and on cases, crates, and baskets in which produce is sold.

The farm name should be made prominent on articles exhibited at agricultural fairs or in advertisements in local newspapers.

Bulletin boards bearing the name of the farm, and announcing the kinds of produce for sale, should be placed at the nearest approach of the public road.

An inventory should be a part of the records of every farm. It is made up of two lists: (1) the things the farmer owns, and (2) the debts or liabilities of the farmer. The list of property is usually made in the winter, about January 1st. It should include the land itself; the different buildings; the several kinds of live stock, with their numbers, breeds, and ages; the machines; the hay, grain, apples, potatoes, and other stored products; household goods. Making the inventory list is always easier after the first year, as many of the articles will be merely transferred to the new lists and their values corrected.

EXERCISE.—*Value of Property*.—The whole class working together should make up a list of the articles which probably



would be found on some supposed place in the country. Let the complete list be made first, and the values may be added later. Students may learn the approximate values of different articles by asking older people at home or elsewhere.

**EXERCISE.**—*Making an Inventory.*—Let each pupil make an inventory of his father's property, and after the total value of the property has been estimated let him find the necessary net income in order to realize 5 per cent on the investment. Many different problems may be based on this exercise.

**Value of the Farm.**—There are many things to consider when determining the value of a farm. The surface and drainage, the soil, the size as suited to the type of farming, the shapes and sizes of the fenced fields, the kind of improvements, the neighbors (whether they are in the same lines of farming or not), the distance to good markets, and the kind of roads. Before buying a farm a man would also think of the climate, source of drinking water, healthfulness, churches, schools, mail service, telephone, and taxes. He might well estimate the cost of securing modern conveniences in the home, including a water-pressure system and house drainage.

**Need for better management** in farming is easily seen on a majority of the farms in all sections of America. There are many losses to be checked: (1) better planning of the work to economize time of men and teams; (2) the utilizing of waste forage of the farms; (3) the plowing and washing of soil through failure to use winter cover crops, (4) loss of soil moisture by improper tillage methods; (5) the bad waste of barnyard manure; (6) failure to save farm seeds for future planting; (7) bad seed that is purchased; (8) spread of weeds on the farm through seeding of weeds in pastures, in fence rows, on roadsides; and by fowl seeds purchased; (9) bad rotations; (10) run-down pastures; (11) badly arranged fields; (12) exposure and neglect of machinery and buildings; (13)

poorly culled flocks and herds as breeding stock; (14) ravages of insect pests due to destruction of birds; (15) plant diseases not kept in control; (16) loss of animals that are improperly treated; (17) bad ventilation of buildings; (18) bad feeding methods.

**Modern agricultural teachings** will greatly reduce these losses on our farms if the farmer himself will learn and apply them. There are good and inexpensive remedies for all the foregoing losses and wastes. The time has come when farmers, especially the younger ones, are willing and anxious to apply the best methods in their farm practices. As these methods are introduced farm wastes will gradually disappear.

#### GETTING STARTED ON THE FARM.

Young men and women desiring to enter farming as a means to a livelihood are usually confronted with the problem of how to get started. Where is the capital to come from? Shall we rent? Shall we "go in debt" for the land and equipment? Or shall we work for wages until enough is earned with which to buy a place?

**A Stepping Stone.**—In many instances other callings are used as stepping stones to farming. Teaching, mercantile business, and other pursuits are often followed with the hope of getting enough capital to start into farming. This plan often results in failure in two ways: (1) attention to such pursuits trains the mind away from farming and usually all interest in modern agriculture is lost; (2) money is saved so slowly by most people that a farm cannot be acquired free from debt.

**The renting plan** often furnishes the best means of getting started. By careful management and forethought in all details of the business money can be saved faster by the intelligent young man while operating a farm on shares than while teaching or clerking or managing a business in the city.

It is true that many share renters never "get ahead," but bright young people with some knowledge of modern agriculture must remember the numerous opportunities to gain where the average renter loses.

**Going in debt** at the outset for part of the cost of the farm and equipment is usually justifiable. The most prosperous farmers in the best agricultural States are usually the heaviest borrowers.

The operation of the national farm loan associations has reduced interest rates to farmers, has made the terms easier, and eliminated commissions. The borrower can either join such an association, or he may secure similar terms from other agencies. It is therefore easier than ever before for young farmers, or others with little capital, to borrow money and make a better start in the farming business.

**Choice of a Farm.**—There are many things to be considered in the choice of a farm: (1) topography or surface; (2) suitability of soil for the crops to be grown; (3) location of buildings with reference to fields; (4) shape of fields; (5) prosperity of community; (6) nearness and character of neighbors; (7) farm improvements; (8) water supply; (9) roads; (10) markets; (11) church; (12) school; (13) granges, unions or coöperative associations; (14) taxes; (15) labor supply.

Probably no farm will ever be found that will suit the most critical in all these details; yet all these and other points should be considered when a farm is selected. The farm should be thought of as a home as well as a place of business.

**EXERCISES.**—1. *Classifying Farms.*—Make a list of ten to twenty farms in your neighborhood. Classify them as to the chief business of each—dairying, swine raising, grain farming, and others.

2. Opposite the name of each write the numbers of the

kinds of losses enumerated in this chapter, so far as they have applied or do apply to each.

3. Note what variations in crop rotations are found in the neighborhood. Give reasons for these variations.

4. Find out how many farms in your section have names such as "Meadow Brook Farm," "The Heights," "Alfalfa Acres," or others. Of what value to a farm is a name? How should a farmer advertise?

5. Estimate the value of some farm with which you are very familiar.

### REVIEW.

1. In what ways is farming different now from what it was fifty years ago?

2. What has brought about these changes?

3. What kind of men make the best farmers, educated or uneducated?

4. Do farmers in your section map their farms and plan their work ahead?

5. Why should a farmer keep accounts?

6. What accounts should he keep?

7. What is a field record and of what value is it?

8. How may a farmer get the best prices for his products?

9. Why should a farmer make an inventory?

10. Name several poor or really bad methods generally practiced on farms.

11. How may a young man, or any man without money, acquire a farm of his own?

12. How would you choose a farm?

13. What bad management is found in your section?

14. Suggest methods of improvement.

15. Is there a federal farm loan association in your region?

16. What farmers whom you know keep accounts?

**References.**—United States Farmers' Bulletins: 505, Benefits of Improved Roads; 511, Farm Bookkeeping; 572, System of Farm Cost Accounting; 614, Efficient Farm System for Corn Belt; 745, Waste Land and Wasted Land on Farms; 782, Use of a Diary for Farm Accounts; also 964, 987, 989, 1008, 1042, 1139, 1146, 1182, 1204, 1210, 1232, 1266, 1271. Ark. Ext. Circ. 93, Farm Surveys.

# FARM MECHANICS.

---

## CHAPTER XXXII.

### ROAD CONSTRUCTION AND MAINTENANCE.

THE value and importance of good roads is so great that there are national, state and local highway associations, formed for the agitation, promotion, location, and even the building of good roads. The almost universal use of automobiles and trucks has been the greatest factor in making the need for good roads one of the liveliest issues of the day. Especially do we find much discussion of roads in the farm papers.

Good roads in a community are a sign of prosperity, and prosperity is one result of good roads. The two seem to go together. The ancient Romans, who built the famous road known as the Appian Way, were wealthy people. While they had no automobiles to drive over this paved highway, still they knew they could haul loads, with their cumbersome, wooden-wheeled carts drawn by cattle, much more cheaply and easily over a good road than over a poor one.

The same fact exists to-day. If a farmer has anything to haul to market he can do it with a greater saving of time and energy, and with less wear and tear on his vehicle, if the road be a good one.

**United States Highways.**—Of the two million two hundred thousand miles of roads in the United States, the two hundred thousand, or a very small per cent, are classed as improved roads. So it is quickly apparent that the vast majority of people in this country are wasting much time and energy in getting about from place to place over poor roads.

This should not be so. The situation should be exactly reversed, because the majority of people in the United States

are farmers, and if they have bad roads to contend with during the large portion of the year—or during any portion—they are often isolated and lonely. They are cut off from communication with neighbors. Children cannot attend school regularly. Rural mail carriers are often forced to abandon their trips. Profits are lost on produce that should be marketed, but cannot be hauled.

**Reasons for Good Roads.**—The success of consolidated schools, rural delivery of mail, rural churches, and the question of hauling produce to market are probably the most important things from the point of view of the farmer. But good roads may mean quite as much to city dwellers, as they depend upon farm produce which is often hauled to the city markets. If not actually hauled to the city where consumed, it is somewhere hauled to the train which takes it to the city. In the peach-growing districts of New Jersey heavy loads of peaches are started at night and hauled by wagon to the large city markets, thirty or forty miles distant. This would not be possible except for the fine macadam roads.

**Kinds of Roads.**—Improved roads are of various kinds, one type generally being found in a certain section of the country.

In California, for example, there is much **concrete** road. One may travel for hundreds of miles on roads which are made exactly like the cement sidewalks now so familiar in all towns and cities.

In Tennessee, and in other limestone regions, the roads are **macadam**, or “stone roads.” Many miles of the famous “Dixie Highway” are thus constructed.

In regions where **gravel** is abundant it is used as the basis of the road improvement.

Hundreds of miles of roads are graded and drained, then are covered with clay loam free from vegetation. In Georgia, Florida and elsewhere such are called **top-soil** roads. When well dragged and rolled they are very durable.

**Earth Roads.**—But as those two million miles of unimproved roads, before mentioned, are earth roads, and as they mostly need improvement, it will be best to consider what may be done with them, and how it may be done well and at a reasonable cost.

In some sections the roads need to be straightened to cut out dangerous curves or to shorten them. In many instances steep grades need to be remedied before the road is made permanent.

**Construction of Roads.**—The top of the road, or contour, should be slightly curved, to give good surface drainage, as shown in figure 225. At every point in the road this should be the same, as unevenness makes the road rough and may allow water to stand on it. A good road grader, pulled by several horses or a tractor, and followed by a heavy road

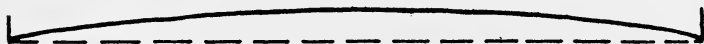


FIG. 225.—Showing proper curvature of finished roadway so as to insure good drainage.

roller, will put a road into such good shape that it can easily be cared for and kept in the best condition with the road drag.

**Proper Grade.**—To make hauling of heavy loads the easiest possible, the grade should not be more than six feet in each hundred. Where the grade is steeper than this an effort should be made to equalize the differences by grading down the hills and filling in the lower places with the earth so obtained.

**Maintenance.**—The roads, like the vehicles which pass over them, require constant care and maintenance to keep them in the best condition. One of the best methods to accomplish this is the use of the road drag. Either a split-log drag (Fig. 226) or a drag similarly constructed of plank, is very effective in keeping a hard, smooth surface on earth roads. The road drag should be used after each heavy rain as soon as the soil ceases to be sticky. This will eliminate

ruts and deep cutting of roadbeds, with consequent clods and humps.

**Drainage** is also important. The rules for drainage must depend upon the lay of the land. Naturally a road through a flat, low country must have deeper ditches beside it than in a high or rolling location. Culverts and small bridges may be made of concrete, and should be large enough to take care of the greatest amount of water that ever falls in that region.

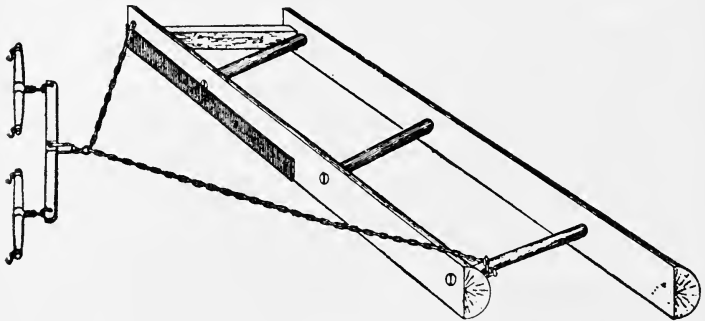


FIG. 226.—Road drag for surfacing roads after heavy rains.

**Shade Objectionable.**—Too much shade on a road prevents its drying out after a wet spell. Dense clumps of trees bordering the road should be thinned. Hedges should be trimmed. Sunlight is as important to good roads as to good crops.

**Wide Tires.**—If farmers can be persuaded to use wide-tired wagons for hauling heavy loads the roads may be more easily kept in repair. In some States any farmer who will use such a wagon may have a certain per cent of his road tax refunded.

**EXERCISES.**—1. Make a map of the roads in your neighborhood. Determine if they could be improved at any point by change of grade, or change in location. Also how they could be made better by drainage.



2. Determine the number of miles of road in your school district. What per cent of it is good? What per cent is bad? How much is simply fair? Is any of it positively impassable at any time of the year?

3. Try to find out, by actual experiment or inquiry, how much it would cost to keep a mile of average road in your community in good condition for a year with a road drag. From this estimate what the cost would be to keep all the roads in your school district in good condition. From these estimates try to decide whether it would be a paying proposition for each farmer to care for the section of road which borders his own property.

4. What highway organizations are in your State and county? What road officers do you have, and what are their duties? What road taxes are paid by your district? What vehicles are specially taxed, and how much? For what is this money used?

5. Let the students do something to beautify the roads in their district. Get unsightly things out of the roadsides. Plant trees that will eventually be a joy to travellers, and the pride of the neighborhood. Plant vines on roadside fences. Plant an occasional fruit tree. In many foreign countries fruit trees are planted by the roadsides and the fruit may be picked by passing travellers. Roses and other flowering shrubs would not be out of place beside the public roads.

6. Glass, wire, tin cans, rocks, sticks and other obstructions should be removed from roads by pupils. Let reports on this work be made until much interest is aroused and good habits are formed.

## REVIEW.

1. How many miles of roads are there in the United States? What percentage are improved roads?
2. Why should roads be improved?
3. What kinds of improved roads have you seen? Describe them.

4. Tell what you can of road construction.
5. How are good roads maintained?
6. Why should roads be drained?
7. What effect do narrow and wide tires have on roads?
8. What have you done to beautify the roadways in your neighborhood?

References.—U. S. Farmers' Bulletins on Roads: Nos. 311, 505, 597.

---

## CHAPTER XXXIII.

### WORK WITH ROPE.

STUDENTS of both city and country will find much value and interest in learning to tie a few useful knots and to splice ropes. For a farmer the methods of tying and mending rope are of great value. The knowledge may be the means of saving a crop of hay, saving animals from injury, or even saving human life. A few of the most common hitches, knots, and splices are here shown.

**How Ropes and Cables are Made.**—Cotton or hemp fibres of various grades are used in making ropes. Fibres are spun to the right hand to make yarn; yarns are twisted to the left to form strands. Three strands twisted to the right are used to make a common rope or hawser. If three hawsers or ropes are twisted together to the left they form a cable. The reversal of spinning or twisting aids in keeping the rope or cable from unwinding. The strength of any rope depends upon its fibres, yarns, and strands lying closely together so they cannot slip.

**Square Knot.**—This is the knot that should be used most commonly in tying cords together, as in tying up packages. The knot will not slip and yet it is easily untied. Tie a

common first knot and then cross the ends and tie again so as to bring each of the two ends back along its own rope body, as shown in figure 227, A. Practice until learned well.

**Granny Knot.**—This is started as in the square knot, but the last half is reversed so that the ends will not lie along

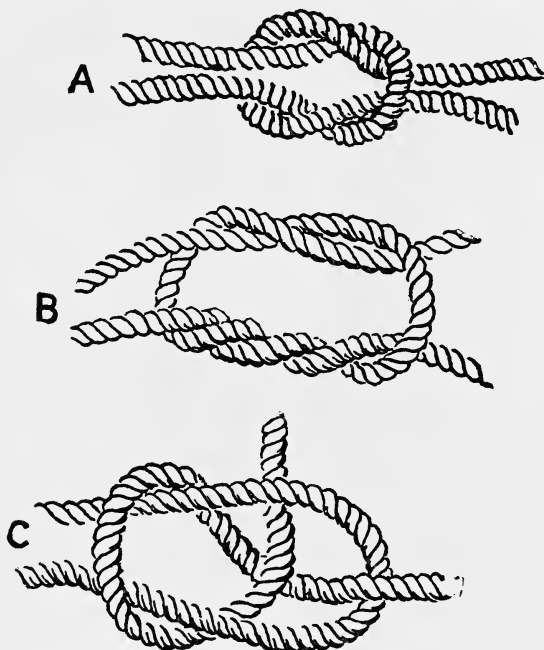


FIG. 227.—A, square knot; B, surgeon's knot; C, weaver's knot.

their own rope bodies. This knot is insecure, and should seldom be used.

**Surgeon's Knot.**—The first part is like the first part of the square knot except that the ropes are put around each other twice instead of only once. The finish is like the finish of the square knot. The surgeon's knot has the advantage

of having the first step hold itself while the last step is being completed (Fig. 227, *B*).

**Weaver's Knot.**—This knot, when finished, differs from the square knot by having the end of the right-hand rope laid across between its rope body and the two lines of the left-hand rope, as shown in figure 227, *C*. The procedure is usually somewhat different. First, make the "bight" with

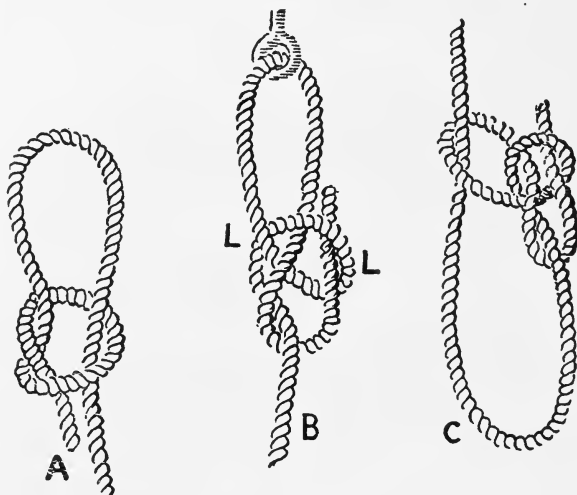


FIG. 228.—*A*, slip knot; *B*, bowline; *C*, running bowline.

the rope in the left hand. Then put the right-hand rope through this "bight" far enough to wrap it over and bring the end through and across between the two ropes as shown. Then draw the rope tight. Practice this many times as it is a good knot for many uses.

**Slip Knot.**—This is an easy knot to tie if figure 228, *A* is examined closely. It is used in tying ropes or halter reins to hitching posts, and many other purposes.

**Bowline.**—(1) Make a loop or turn in the body of the rope some distance from the end, as shown at *L* in figure 228,

*B.* (2) After putting the end through a ring or around a post pass the end through the loop *L.* (3) Pass the end around the body of the rope and bring it back through the loop as shown. When drawn tight the bowline knot is completed. This should be practiced until you can do it with your eyes shut, as it is one of the most valuable knots for logging work, for picketing or tying stock, for use by contractors and builders, as well as others. When the cut is inverted you have what may be called an overhand bowline.

**Running Bowline.**—This is a lasso or slip-knot bowline,

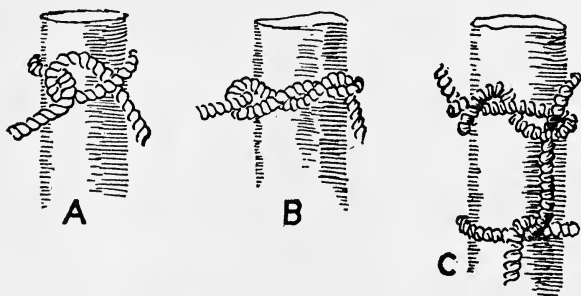


FIG. 229.—*A*, half hitch; *B*, timber hitch; *C*, timber hitch and half hitch.

made by having the body of the rope in place of the ring or post mentioned in (2) of the preceding description. See figure 228, *C.*

**Half Hitch.**—This simple hitch, shown in figure 229, *A*, is often used in connection with other knots and hitches. It may also be used alone as shown in the figure.

**Timber Hitch.**—While this is a simple and quick hitch, it is much more secure than the half hitch. It is used by loggers and builders, hence its name. The end is wrapped around the rope one or more times. In this respect it differs from the half hitch, where the end is merely tucked under. Compare *A* and *B*, figure 229.

**Timber Hitch and Half Hitch.**—This is a combination

of the two preceding—the timber hitch usually being made first and the half hitch afterwards. The half hitch may be repeated several times if desired. This is not uncommon when large bundles or bales are being tied up. This combined hitch is useful for handling long timbers and long pipes. See figure 229, C.

**Clove Hitch.**—This may be formed either in the middle of the rope or near the end. Practice making the hitch as shown in figure 230. This is the sailor's method. The clove

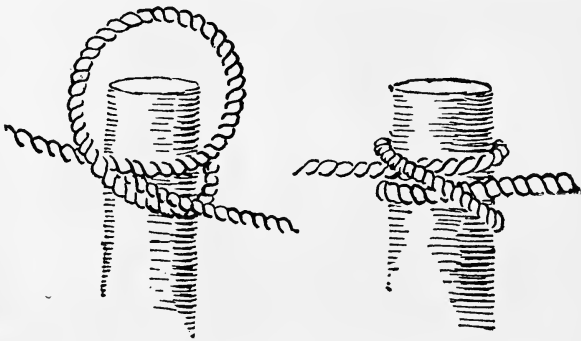


FIG. 230.—Clove hitch, sailor method.

hitch is the most useful hitch. It is very convenient, simple, and secure for guy ropes, tent ropes, etc.

**Short Splice.**—Two ropes may be quickly spliced together by the short splice method. About three inches from each of the ends to be spliced together is required for a quarter-inch rope; six inches for half-inch rope, etc. As all the strands are intertwined at one place, this method makes the rope twice as large at this place. This makes it unsuitable for use with a pulley. If a spliced rope is needed for use through a pulley the long splice should be used.

**Method of Short Splice.**—First, unlay the strands of both ends that are to be spliced. Butt the ends of the rope

together as shown at 1, figure 231. Pair the six strands so that each strand pointing to your right is adjacent to a strand beyond it, pointing to your left.

Tie a first (overhand) knot with each pair, as shown at 2. Then continue to wrap each strand around its mate in both directions until the ends are nearly used up. In doing this wrapping, keep the strands tightly twisted, as when the rope was first made. The wrapping should take the direc-

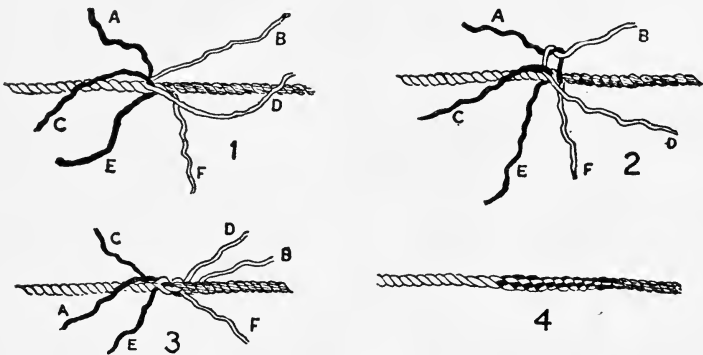


FIG. 231.—Short splice, showing four stages in the operation 1. The six strands of the two ropes arranged in pairs, A-B, C-D, E-F. 2. A-B tied with first overhand knot. 3. Each of the three pairs tied with first step of surgeon's knot. 4. Completed splice.

tion of the natural twist of the rope. Trim off all surplus ends, as shown at 4.

**The Long Splice.**—This method of splicing ropes together leaves them of the same diameter they were before, yet as strong as if made in one piece. The method is good to use for well ropes, hay ropes, and others that are used with pulleys. For each quarter-inch of diameter allow about nine inches on each of the two ends to be spliced together. For one-inch rope we would use about three feet from each end.

Unlay one strand from each end the required distance.

Bring the ropes together at this point, as shown at 1, figure 232. Hold the ropes at this point with the left hand. Unlay strand *B* from the right-hand rope, and lay strand *A* snugly in its place, working to some distance to the right, as shown in 2.

Now unlay the other two pairs of strands and mate them

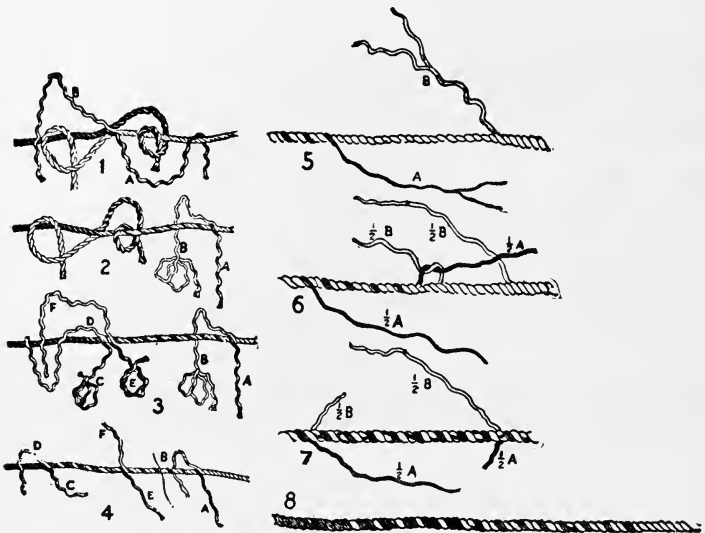


FIG. 232.—Eight stages or steps in the long splice. (First four stages after H. W. Riley.)

with each other exactly as shown in the third stage, 3, lettered *C-D* and *E-F*. Unlay strand *C* and place *D* in its place, working toward the left some distance, as shown in view 4. Trim all the long strands to make them as short as the shortest, somewhat as shown in 4.

The remainder of the splice is practically alike for each of the three pairs. Let us, therefore, consider the pair *A-B* only. Unlay *B* about three inches (for quarter-inch rope), without following with *A*. See stage 5. Now split each



strand of *A* and *B*, and twist a half strand of each firmly and lay these in the vacant channel until they meet midway. Tie these together with a common overhand knot (stage 6,) and draw snugly. This part of the rope is now to be made full size by wrapping these half strands continuously around each other until they meet the points of division, stage 7. The four half strands may then be trimmed close to the rope. When the pairs *C-D* and *E-F*

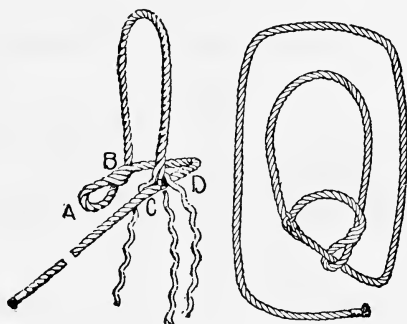


FIG. 233.—Rope halter. Construction at left. Finished halter at right. (After H. W. Riley.)

are finished in much the same way, the rope will have the appearance shown in stage 8. Note that the pair *A-B* was carried to the right to work; the pair *C-D* was carried to the left to work; so the pair *E-F* will have to finish in the center (see 4). To do this the strands *E* and *F* will each be unlaidd a half distance before splitting the strands.

A four-strand rope would be spliced in the same way as this three-strand rope except that four finishing places would need to be planned by the operator.

**Rope Halter.**—It is often of great value to be able to make a good rope halter quickly. A study of figure 233 will enable an ingenious person, who has spliced ropes, to make a

good rope halter of any size desired. Practice will aid much in making the work more perfect.

Form the halter over the knee while sitting down, so as to get reasonable dimensions. First decide where the eye, *A*, is to be made. At *B* raise the top strand of the rope and pass the short end of the rope through it toward the left. Then raise the top strand of the short end at *A* and pass the long end through it towards the right. Unlay the short end to *C* and pass the middle strand under the outer strand of the main rope at *D*. Raise the next strand of the main rope and pass the lower end through it. Now complete the splice by continuously passing each of the three strands around its mate in the rope. The long end of the rope is then run through the eye of the halter.

### REVIEW.

1. How would you manage a new rope to avoid kinks?
2. How many of the knots and hitches can you make from memory?
3. Have you learned any others not here given? What are they?
4. What are the advantages of the short splice?
5. When would it be advisable to make the long splice?
6. What knots do you consider the most useful?

**References.**—Cornell Reading Course Bulletin, Vol. 1, No. 8, Knots, Hitches and Splices; Iowa Extension Bulletin 24, Rope and its Uses; Minnesota Bulletin 136, Rope and Its Use on the Farm.

## CHAPTER XXXIV.

## REPAIR OF FARM EQUIPMENT—HANDY DEVICES.

ON modern farms the machinery is too often out of repair at the time it is needed for farm work. One of the best elements in good management is to have the equipment in good condition at all times. The equipment includes not only the

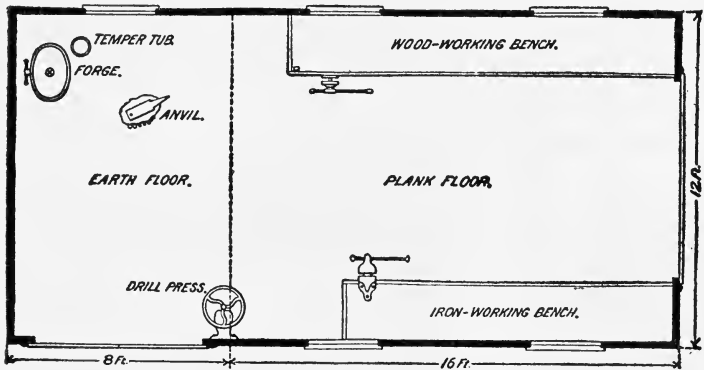


FIG. 234.—Floor plan of workshop. (U.S.D.A.)

buildings, fences, field machinery, but also the garden tools, dairy utensils, and other small articles. We should also include a shop, tools and materials with which to repair the farm equipment.

The elements in the care of equipment are:

1. Keep machinery housed when not in use.
2. Keep machines, buildings, gates, and similar equipment painted.
3. Oil machine bearings when placed in storage as well as when in use.
4. Constant attention to repairs of all kinds of equipment.

**Repair Work on the Farm.**—A farm shop may not be necessary if there is a good repair shop near by. But usually a room or small building where all the hand tools of the farm can be housed is a great asset on any farm. Here should be



FIG. 235—This three-horse evener is easily constructed by attaching a single-tree and a two-horse evener to a new triple-tree divided as shown.  
FIG. 236—One of the best forms of a three-horse evener.

found the grindstone, work benches, vise, a few of the most important wood-working tools, a few pipe tools, other iron-working tools, drill press, harness mending tools, etc. Perhaps a forge and anvil may be in an adjoining room as shown in figure 234. Paints and machine oil may be kept in the opposite end of the building.

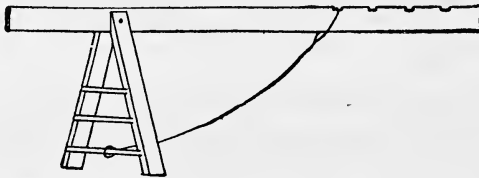


FIG. 237.—Lifting lever for wagon rack or bed. It saves heavy lifting and requires only one person.

**Plan of the Farm Shop.**—It is important that there be a place for every tool and that the shop be kept in neat order. If not it will soon look like a junk room. Figure 234 shows a good plan arrangement. Let the carpentry tools be hung over the wood-working bench. It is a good plan to paint an outline of each tool on the wall where that tool is to hang. Then they are easily kept in place, and if any are missing the fact is easily noticed. Boxes containing bolts, screws,

nails, staples, rivets, hinges, and fittings should be on shelves and should be plainly labeled.

**Time for Repairing.**—Boys on the farm should be taught to use the tools and to do careful work with them. This is of great value in keeping them interested in the repair work of the farm.

Much of the repair work of the field machinery may be done on rainy days, during the winter, or at midday in hot

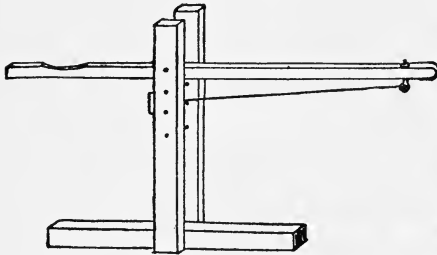


FIG. 238.—A simple wagon jack is a very useful device on any farm.

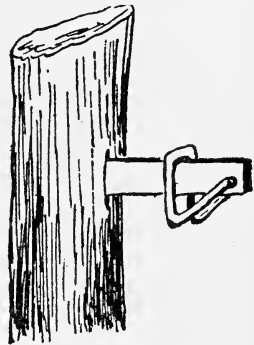


FIG. 239.—A simple but old-fashioned gate latch that many a boy could make.

summer weather. Let all machines be looked over before they are to be needed, as at haying or harvest time. Never wait until the machine is needed before seeing that it is in perfect repair.

**Handy devices** for use in the home and on the farm should be made in the farm shop when time will permit. A few suggestions for such devices are shown in figures 235-244.

**Three-Horse Eveners.**—It is often desired to hitch three horses together in pulling heavy machinery or doing hard plowing. Two plans for three-horse eveners are shown in figures 235 and 236.

**Hay Rack Lifter.**—This man-saver is worth a place on many farms. It is made of a height to suit the height of the wagon. Its construction is simple, as shown in figure 237. To use it, raise the long end of the lever until the short end will go under the hay rack or wagon box to be lifted. By lowering the long lever the lifting is easy. The wire may be slipped to one of the notches to hold the weight. One end of

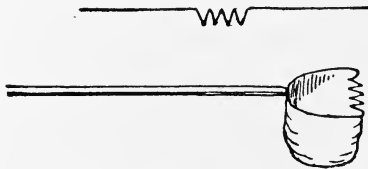


FIG. 240.—A home-made bag for picking the highest fruit from trees. It saves shaking and bruising the fruit.



FIG. 241.—A monkey wrench and round file may serve as a pipe wrench.



FIG. 242.—A simple garden marker for light garden soil.

the rack or bed is thus lifted at a time to some height. Many farmers suspend the racks or beds under a shed. With this plan one man with little effort may remove the heaviest rack alone.

A **wagon jack** is one of the handiest devices on a farm. Make the lever four to six feet long. Make several holes so the height may be adjusted to the vehicle when the spindles are to be greased. The rod may be of heavy wire. The block on the left (Fig. 238) is movable and holds the rod and lever when desired.

An **automatic gate latch**, such as shown in figure 239, is one

of the oldest and simplest ways of being sure that a gate is latched when it closes. Usually the gates of a farm should swing in such a way that they will close by their own weight. Then this latch will hold them.

A **long-handled fruit picking bag** may be made at home. A heavy wire may be bent as shown in figure 240. The ends are then thrust into a long, stout bamboo pole. The bag is small. Its chief use is for picking such fruits as apples when out of reach of the picking ladders. Never shake fruit off the trees.

A **pipe wrench** may be improvised by placing a round file (rat-tail file) with the pipe in the jaws of a common wrench, as shown in figure 241. It will serve the purpose if the strain is not very great.

A **garden marker** for two rows may be made as shown in figure 242. If the soil is light and loose, a horse may not be needed.

**Large fly traps** such as that shown in figure 243 are useful in dairy barns, piggeries, and other places where flies are abundant. Banana peels or other attractive bait may be placed under the bottom hole. The central cone of screen wire has a half-inch hole at the top through which the flies enter the main trap. When well filled with flies they may be killed with boiling water. They are then removed at a small opening made at the bottom edge by removing a single tack.

A **chick creep** for feeding young chickens is shown in figure 244. A space of two inches is left at the bottom by

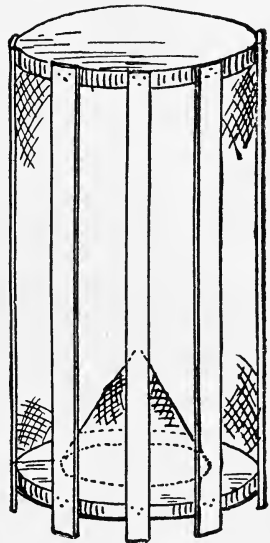


FIG. 243.—A home-made fly trap.

making the four corner posts longer than the side boards. The frame may be made of a size to suit the width of the poultry wire to be used on top. When little chicks are fed in here the large fowls cannot bother them.

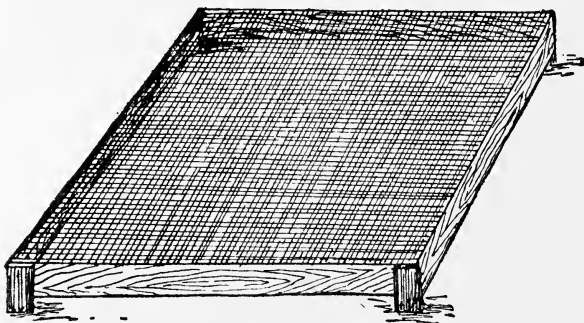


FIG. 244.—A protective screen for feeding young chicks in yards where larger fowls are kept.

## REVIEW.

1. Give a list of things to be done in the care of farm equipment.
2. What places have you seen that have farm workshops?
3. Give a list of their repair equipment.
4. What are the most essential tools for the repair shop?
5. Make a list of the simple, handy farm devices which you have seen or learned about.

**References.**—U. S. Farmers' Bulletins: 474, Use of Paints; 744 Preserving Timbers; 813, Farm Weirs; 825 and 855, Silos; 828, Farm Reservoirs; 842, Protection Against Lightning; 927, Farm Home Conveniences; 941, Water Systems for Farm Homes; 943, 956, 987, 991, 992, 1009, 1036, 1049, Haying and Harvesting Machinery; 946, 947, Care and Repair of Implements; 966, Hog-breeding Crate; 997, Terracing. Ark. Sta. Bul. 186, Tractors.



## CHAPTER XXXV.

## POWER ON THE FARM.

ANIMAL power, wind, and water power have long been in use on farms for various purposes. Many of the well-equipped farms of to-day use gas engines to operate many kinds of farm machinery. Electric power is coming into more general use. It is used as stationary power in running small machines and in producing light.

**Using Gas Engines.**—The widespread knowledge of the use of gas engines makes it possible to find many men and boys who are fairly competent to operate them.

Their use as stationary engines first became popular, but soon after they came to be extensively used in running automobiles, motor trucks and farm tractors.

**Motor Trucks.**—It is not an uncommon sight to find both heavy and light motor trucks in use on farms in regions where roads are good. They are most common in the vicinity of the best city markets. This is doubtless due to the fact that one of their chief uses is in marketing farm produce. Farmers thus haul to market baled hay, threshed grain, potatoes, garden truck, fruit, livestock, milk, etc. Trucks are used in hauling mill feeds, commercial fertilizers and other forms of merchandise out to farms.

Large motor trucks are more economical to operate than small ones, when full loads are taken. This is because one operator can do more work in a day with a large motor truck.

Coöperative and private motor truck routes are maintained in a number of rural districts. See Farmers' Bulletin 1032.

**Plowing With Gas Tractors.**—The chief use of the gas tractor on modern farms is for plowing. Usually the owner does not hope to save money by getting his plowing done at a less price per acre. One man does more plowing in a very

short time; it can be done in very hot weather without injury to draft animals; double cropping is thus often accomplished; one man can farm more acres; hired help is not so necessary; more hours in the day are likely to be used.

One of the disadvantages of the tractor in some sections, is the difficulty in using it when the soil is rather wet, if it is naturally heavy soil. Spring work may be delayed while waiting for wet parts of a field to become dry enough to use a heavy tractor. This difficulty is less serious with cater-

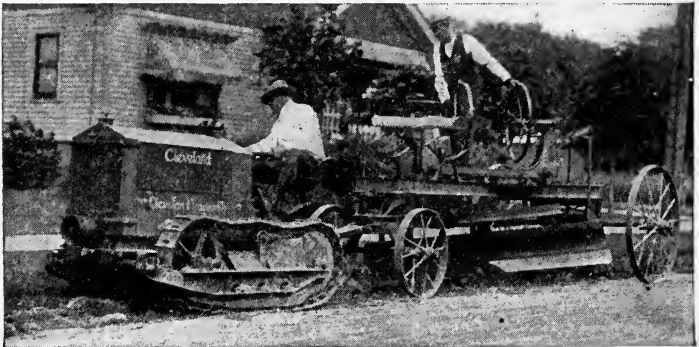


FIG. 245.—Opening road drains with scraper and tractor. (Cleveland Tractor Co.)

pillar tractors. The moisture can be rapidly reduced by harrowing the field with a team before plowing.

**Sizes of Tractors for Plowing.**—The very large tractors, pulling six to twelve or more breaker bottoms, were once used on the northwestern plains, but these are now seldom found. Those pulling two, three, four or five are far more popular. The two- or three-plow sizes are most rapidly coming into favor. The original investment is less; the cost of operation is low; the loss of time from troubles is less serious; and the small-sized tractor is more suitable for many other farm operations.

**Cost of Plowing With Tractors.**—There are a number of elements or factors to be considered in calculating the cost

of tractor work: fuel, oil, grease repairs, depreciation, man labor, and interest on money invested.

In some investigations it has been found that two and one-half to three and one-half gallons of fuel is an average amount consumed in plowing one acre. This amount varies with the operator, kind of fuel (gasoline or kerosene) depth of plowing, kind and condition of soil, sharpness and adjustment of plows, and underloading or overloading of the tractor.

—The quantity of lubricating oil per acre may be figured



FIG. 243.—A caterpillar tractor drawing a wagon and hay loader. (Cleveland Tractor Co.)

at three-fifths of a quart, and the cup grease at about one pound per day or about one cent per acre.

Ten to twenty cents per acre should be allowed for repairs. Depreciation should be calculated at from thirty to forty cents per acre. At four dollars per day for an operator the cost per acre for the two-plow to four-plow outfits is about sixty-five cents down to thirty-seven cents.

The interest on the investment cannot be calculated on the acre basis unless it is known how many acres will be plowed each year. It should be counted at about seventy-five cents to one dollar per acre if the tractor is used for plowing say forty-five to sixty days in each year, with no other work to its credit.

**Tractors for Pulling Other Implements.**—Farm tractors are frequently used for pulling disk harrows, soil packers, hay wagons (Fig. 246), moving threshing machines, grain binders (Fig. 251), mowers, manure spreaders (Fig. 249), and other implements. They are easily hitched to any implement to be drawn on the farm. They are useful in hauling heavy loads of lumber, logs, commercial fertilizer, grain, etc. They are sometimes used in pulling stumps,

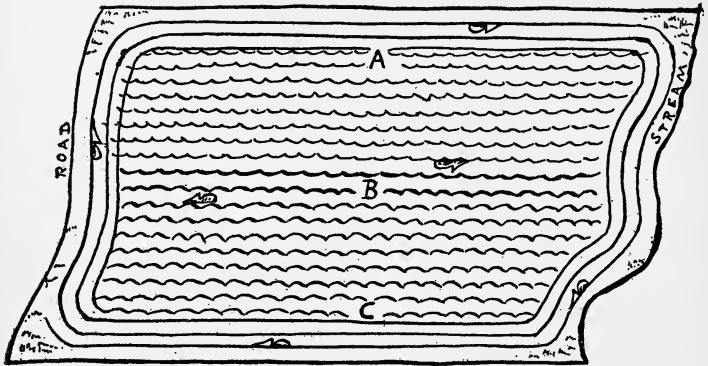


FIG. 247.—Plan for laying out an irregular field for tractor plowing. Throw the furrows toward the center, B; then plow around the field throwing the furrows from the edges. The corners may be finished with a team if necessary.

hauling rock, and otherwise clearing land. They may be useful in road work by pulling scrapers, road graders, (Fig. 245), scarifiers, and in hauling road materials.

**Operating Stationary Machinery.**—Since small-sized farm tractors have come into general use they are much used for belt work in operating stationary machines of many kinds. Other gas engines are also much used for such purposes.

Heavy lines of farm work for such power to do are: Threshing grain (Fig. 252), shredding and husking corn, baling hay and straw (Fig. 248), cutting fodder and filling silos (Fig. 250), crushing rock for roads and fields, elevating corn and grain.

Lighter kinds of work are: Shelling corn, grinding grain, grinding tools, sawing wood, operating lighting systems, pumping water, running milking machines, washing clothes, churning butter, running cream separators and vacuum cleaners.

**Operation of Gas Engines.**—Only a careful and experienced operator can handle a tractor or other gas engine properly. Experience should be gained under a good instructor for a few days. Careful preparation is important. Instruc-



FIG. 248.—Baling hay with tractor to drive the baler. (International Harvester Co.)

tion books and trouble charts should be read a number of times until the operator becomes expert.

Ignorant, careless workmen and boys should not be trusted with such engines without thorough training. One of the objections to owning a tractor is the inability to find a competent operator. This is the chief cause of failure in cases where tractors have proved to be unprofitable.

**Four Essentials in Operation.**—The four most important requirements in the successful operation of a gas engine are: (1) Proper mixture of the gas with air; (2) perfect compression by the piston; (3) ample spark (called ignition); (4) correct valve action.

**The mixture of gas and air** is obtained through a carburetor

retor which allows the suction of the piston to draw in both fuel gas and enough air with each stroke. The temperature greatly influences the amount of fuel gas and so more fuel is usually supplied during the first few strokes when the engine is starting and becoming warm.

Abundant moisture in the air also slightly affects the mixture and some little adjustment may improve the mixture when the weather is unusually wet or dry. The beginner should usually let the carburetor mixture alone after the engine is running and is fairly warm. He should know



FIG. 249.—Tractor used in hauling manure spreader. (Tennessee Power Farming Review.)

that the carburetor is extremely sensitive and that a very slight change in its adjustment is very effective in changing the mixture.

The amount of unburned fuel which appears as black smoke from the exhaust pipe is usually controlled by having a proper mixture. One part of fuel gas to four parts of air is a very *rich* mixture and may produce considerable smoke under ordinary temperature and moisture. One part to twelve or fourteen is called a very *lean* mixture and would have too little power for an engine at work.

**Good compression** is necessary so that the full power of the fuel will be obtained. Piston rings are placed around the

piston so that it will not allow gas to leak past it. If well lubricated the rings will spring closely against the cylinder

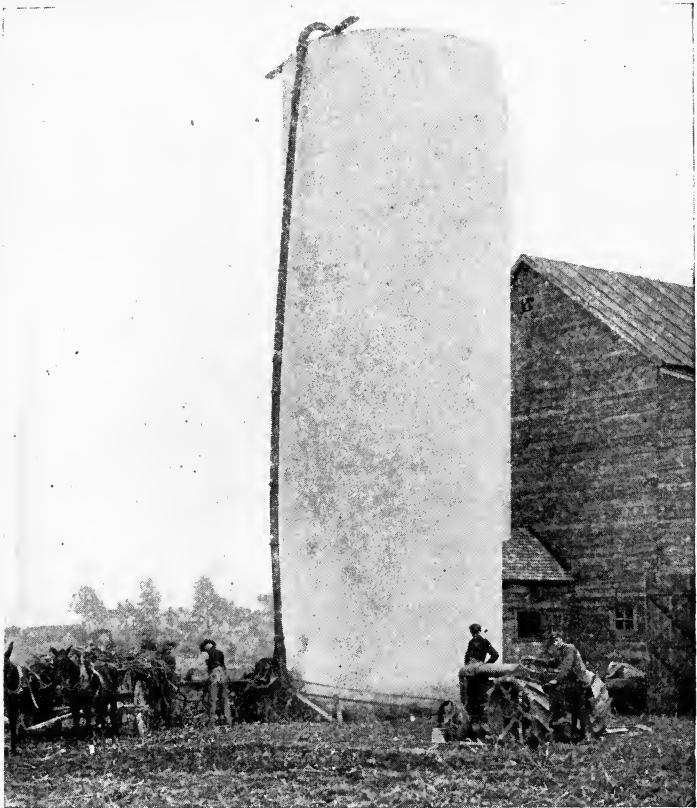


FIG. 250.—Tractor running a silage cutter and blowing the cut corn into a very high concrete silo. (Tennessee Power Farming Review.)

and prevent leaks. They will become worn and should then be replaced with new ones.

**Spark System.**—This is often called the ignition system. By it the compressed gas in the cylinder is lighted and caused to explode. This explosion throws the piston toward the

opposite end of the cylinder. This performs the work. If the spark fails the power fails. The firing or lighting of the gas is now usually done, in American engines, by means of an electric spark from a spark coil which receives its current either from a battery or from a magneto (dynamo).

**The make-and-break** method uses a simple coil and low tension current. The circuit is closed and opened at the proper time, automatically, by a device for that purpose. This plan is common on stationary engines.

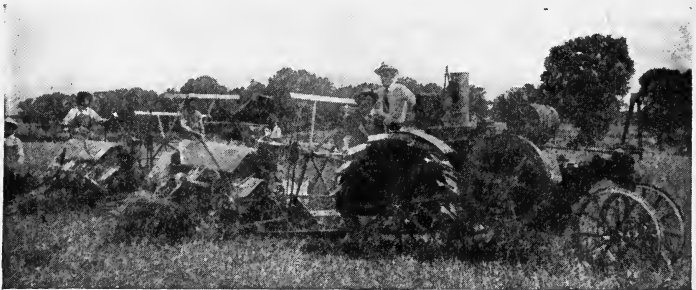


FIG. 251.—Tractor used in harvesting oats with two self-binders. (International Harvester Co.)

**The jump-spark system** uses a high tension induction coil, and the current when interrupted will jump a small gap of a spark plug. This spark ignites the compressed gas in the cylinder. There are no movable parts within the cylinder as in the other system. The jump-spark may usually be controlled by changing the time of the circuit breaker. This is called advancing or retarding the spark.

**Proper valve action** is essentially the careful timing of the valves which open to let the gases into the cylinder and close it for the power stroke. Exhaust valves open just before the end of the expansion stroke to let the burned gases escape. Inlet valves are self-timing on many stationary engines, as the suction stroke of the piston opens them.

Directions for the regulation of the valves of each engine



should be closely followed. If gummy oil or carbon collects on the valves they should be cleaned to prevent leaks of gas.

**Engine Troubles.**—The chief engine troubles are associated with one or more of the four essentials which have just been considered. The operator should learn to reason regarding each of these and determine the probable cause of any trouble. Get United States Farmers' Bulletin 1013 and check over the trouble chart for gas engines.

A common trouble comes from the use of too little oil in lubricating the engine. The rings of the piston are apt to



FIG. 252.—Threshing wheat with the power of a tractor. (Cleveland Tractor Co.)

get dry and stick; this causes trouble with the compression. Too much oil in the cylinder will cause carbon deposit, as shown by blue smoke from the exhaust pipe. This causes over-heating and loss of power. Oil of proper quality should be used. If the machine is one which supplies oil from the crank case this should be cleaned out occasionally.

**Starting Troubles.**—It is more common to find troubles in starting an engine than at any other time. When it is impossible to get a single explosion, trouble is likely to be in the mixture. The fuel may be flooded into the cylinder, in which case the supply should be cut off and the cylinder emptied by a few revolutions of the crank. The supply of gas may be too low or too cold. Usually the mixture will

need to be changed by continual trial until an explosion is obtained. In cold weather a little hot water on the carburetor to warm it, will aid in the formation of gas from the fuel.

Engines which burn kerosene or other oil are usually started with a small supply of gasoline until enough heat is generated to readily vaporize the fuel oil.

**Spark troubles** in make-and-break engines may arise from the current source failing, or to a bad connection of the wires. This trouble can be tested by opening and closing the circuit by hand. Watch for a good spark.

When trouble is suspected in the jump-spark system it should be tested by removing the spark plug and laying it on the cylinder. Then operate the circuit breaker by hand and watch for a spark. If a good spark is not seen, the trouble may be in the source of the current, in the wire connections, in the insulation being wet or worn, or in a dirty spark plug.

**Electric Power on Farms.**—As the scarcity of coal becomes more apparent the use of electricity, generated by water power, will become more common. Electricity from this source or from coal, is now most common on farms that are near cities that are supplied with electricity. All belt-driven machines may be operated by electric motors.

**Electric motors** are expensive to purchase, but they have a number of advantages, viz., easy to operate, always ready, no power wasted, clean and compact.

**Electric Lights.**—Farms wired for electric power can be easily lighted even without operating their own generators. Electric lights in homes, barns and elsewhere, are less troublesome, less dangerous, more efficient, and more convenient than the usual kerosene lamps and lanterns.

**Farm Dams and Water Power.**—There are thousands of farms which have water power in their own streams. In many places farmers have harnessed this water power by building dams and running water wheels. The water wheels are sometimes used directly to operate the belt-driven

machines of the farm. In other cases they are made to drive dynamos and generate current for all uses on the farm.

This is often a very handy source of power for the farm and too often is not realized by the owner.

**Hydraulic Ram.**—Where two or more feet of fall can be secured within a hundred feet or so from a spring, it is usually possible to place a hydraulic ram. This is a very inexpensive device for forcing water to the house or other farm buildings.

If water from a spring is thus forced to a small tank for house purposes, much labor is saved forever. The ram operates with little or no wear and without the use of oil. It is almost everlasting.

A steady water supply of this kind makes it possible to install a hot water tank in the kitchen and equip a modern bathroom.

The constant overflow of water from the house tank may run to a dairy trough, then to a stock trough, then to a hog wallow, then to a garden for irrigating purposes.

**Windmills.**—In many parts of the country windmills are used for pumping water and for other light work. The wind is variable in power and uncertain, and as a source for the farm power it is not often used for operating belt machines. This uncertainty and unsteadiness is usually not serious in the pumping of water because a storage tank is easily supplied. Large tanks are often built on the windmill tower.

Windmills are easy to maintain and manage. Children and women can throw them into gear, and a man or boy can climb up to oil them.

**Animal Power.**—No power has yet been devised which is more convenient than horses and mules for direct draft of farm machinery. Tractor engines are only partly displacing them for this purpose. The corners of fields can hardly be plowed, harrowed, etc., without the use of animals. For cultivation of truck crops, gardens, and similar purposes, horse power is probably the best.

Animal power is often used on *sweeps* for operating balers, grinders, and some other machines. Such power has long been used on *tread mills* for operating belt machines for such work as sawing wood, grinding, threshing, etc. Bulls, calves, sheep, and heavy dogs are used on tread mills for light work—cream separation, churning, milking, washing clothes, pumping water, etc.

EXERCISE.—The students should visit one or more farms having a tractor, motor truck or stationary engine. If possible, study belting systems, uses of power, parts of engines, troubles, etc. At some places study lighting systems, other forms of power, etc.

### REVIEW.

1. For what work are motor trucks used by farmers in your region?
2. What sizes of motor trucks have you seen?
3. Give the advantages of using tractors for plowing.
4. What are the disadvantages?
5. Discuss the sizes of tractors for farm work.
6. What are the factors which enter into the cost of plowing with tractors?
7. What is the average fuel cost per acre?
8. What things cause this to vary?
9. How much grease and oil are required?
10. What is the cost of repairs? What should be allowed for depreciation?
11. Give some examples of cost of tractors and plows, and figure the necessary annual interest charge.
12. What other farm implements are sometimes drawn by tractors in your region?
13. What other lines of farm work are done by tractors?
14. Ask some farmer the necessary horse power for operating each of the belt machines on farms.
15. Discuss the need of competent operators for tractors.
16. What are the four chief essentials in operation of gas engines?
17. What is the carburetor? Discuss its uses.
18. What does the black smoke from the exhaust indicate? Blue smoke?
19. Tell of the importance of good compression.
20. What sources of current are used for ignition of gas engines?
21. Describe the make-and-break system, and tell how to test it.
22. Describe the jump-spark system and tell how to test it.
23. Discuss the importance of proper valve action.
24. What engine troubles have you observed?
25. What engine troubles are most common?
26. For what work may electric motors be used on farms?

27. Give the advantages of electric lights over kerosene lamps in the dairy; in the barn; in the farm home.

28. Tell what you can of the uses of water power on farms, with examples, if possible.

29. Describe the advantages and use of a hydraulic ram.

30. Tell what you can of the work of windmills.

31. Tell what you can of some unusual uses of animal power on the farm.

**References.**—U. S. Farmers' Bulletins: 813, Farm Wiers; 866 Windmills for Irrigation; 996, Steam Sterilization; 719, 963, 1004, 1013, 1035, Gas Tractor; 1023, Cutting Firewood; 1032, A Motor Truck Route; 1045, Laying Out Fields for Tractor Plowing; 946, 947, 1036, Care and Repair of Farm Implements; 943, 956, 987, 1009, 1049, On Hay Machinery; 991, Threshing Machines; 992, Corn Cutting Machinery; 941, Water Systems for Farm Homes.



## PART V.

### APPENDIX—REFERENCE TABLES.

---

#### TABLE I.

#### REFERENCE BOOKS.

THE school library should be supplied with a set of all available United States Farmers' Bulletins and the printed index to the same; a set of the State Experiment Station bulletins; the Yearbooks of the United States Department of Agriculture; the circulars of the United States Bureau of Entomology; the volumes on animal diseases issued by the United States Bureau of Animal Industry. Get as many of the following reference books as the library funds will warrant: Select first those which may be used as supplementary readers in your school.

##### *Soils.*

Soil Physics and Management—*Mosier and Gustafson*, J. B. Lippincott Co., Philadelphia.

Irrigation and Drainage—*F. H. King*, Macmillan Company.

Manures and Fertilizers—*Wheeler*, Macmillan Co.

##### *Farm Crops.*

Field Crops—*Wilson & Warburton*, Webb Pub. Co.

Forage and Fiber Crops—*Thos. F. Hunt*, Orange Judd Company.

Productive Farm Crops—*Montgomery*, J. B. Lippincott Co.

Clovers—*Thos. Shaw*, Orange Judd Company, New York.

Forage Crops—*Piper*, Macmillan Co.

Alfalfa—*Coburn*, Orange Judd Co.

Corn—*Bowman and Crossley*, Pub. by Authors, Ames, Iowa.

*Horticulture.*

- Productive Orchardng—*Sears*, J. B. Lippincott Co.  
 The Principles of Fruit Growing—*L. H. Bailey*, Macmillan Co.  
 The Pruning Book—*L. H. Bailey*, Macmillan Company, New York.  
 Productive Vegetable Growing—*Lloyd*, J. B. Lippincott Co.  
 Manual of Gardening—*L. H. Bailey*, Macmillan Co., New York.  
 Bush Fruits—*F. W. Card*, Macmillan Company, New York.  
 American Apple Orchard—*F. A. Waugh*, Orange Judd Company.  
 School and Home Gardening—*Davis*, J. B. Lippincott Co.

*Animal Husbandry.*

- Judging Live Stock—*J. A. Craig*, Kenyon Printing Company, Des Moines, Iowa.  
 Types and Breeds of Farm Animals—*C. S. Plumb*, Ginn & Co., Boston.  
 Feeds and Feeding—*Henry & Morrison*, Published by the Authors, Madison, Wis.  
 Productive Poultry Husbandry—*Lewis*, J. B. Lippincott Co.  
 Productive Swine Husbandry—*Day*, J. B. Lippincott Co.  
 Productive Horse Husbandry—*Gay*, J. B. Lippincott Co.  
 Common Diseases of Farm Animals—*Craig*, J. B. Lippincott Co.  
 Productive Feeding of Farm Animals—*Woll*, J. B. Lippincott Co.

*Dairying.*

- Productive Dairying—*Washburn*, J. B. Lippincott Co.  
 The Business of Dairying—*C. B. Lane*, Orange Judd Company.  
 First Lessons in Dairying—*Van Norman*, Orange Judd Co.

*Bees and Insects.*

- Economic Entomology—*J. B. Smith*, Lippincott Co., Philadelphia.  
 Insect Life—*J. H. Comstock*, D. Appleton & Company, New York.  
 Productive Bee Keeping—*Pellett*, J. B. Lippincott Co.

*Cyclopedias.*

- Standard Cyclopedia of Horticulture, 6 vols.—*L. H. Bailey*, Macmillan Company, New York.  
 Cyclopedia of American Agriculture, 4 Vols.—*L. H. Bailey*, Macmillan Company, New York.  
 Farmers' Cyclopedia of Agriculture—*Wilcox and Smith*, Orange Judd Company, New York.



*General.*

- Agriculture and Life—*Cromwell*, J. B. Lippincott Co.  
 Among Country Schools—*O. J. Kern*, Ginn & Co., New York.  
 Farm Arithmetic—*Burkett & Swartzel*, Orange Judd Co.  
 Productive Plant Husbandry—*Davis*, J. B. Lippincott Co.  
 Bacteria in Relation to Country Life—*Lipman*, Macmillan Co.  
 Physics of Agriculture—*F. H. King*, published by the Author,  
 Madison, Wis.  
 Agricultural Engineering—*Davidson*, Webb Pub. Co.  
 How to Choose a Farm—*T. F. Hunt*, Macmillan Co., New York,  
 N. Y.  
 Farm Management—*Boss*, Webb Pub. Co.  
 Our Trees: How to Know Them—*Emerson and Weed*, J. B. Lippin-  
 cott Co., Philadelphia.  
 Lights of the Farmer, *Snyder*, J. B. Lippincott Co.  
 Farm Management, *Wheeler*, Macmillan Co.  
 Co-operation in Agriculture, *Powell*, Macmillan Co.  
 Rural Improvement, *Waugh*, Orange Judd Co.  
 Farm Management, *Card*, Doubleday, Page & Co., Garden City,  
 New York.

---

TABLE II.

LIST OF EXPERIMENT STATIONS.

THE list of agricultural experiment stations follows. Mail may be addressed to the director of the station or merely to the station, as for instance—Agricultural Experiment Station, Wooster, Ohio.

Write to the State agricultural experiment station of your State for the bulletins, and for information regarding any farm subject: feeds, fertilizers, sprays, diseases, insects, implements, live stock, crops, etc.

**Alabama—**

- College Station: *Auburn*.  
 Canebrake Station: *Uniontown*.  
 Tuskegee Station: *Tuskegee*.

**Alaska—***Sitka*.

- Arizona—***Tucson*.  
**Arkansas—***Fayetteville*.  
**California—***Berkeley*.

- Colorado**—*Fort Collins*.  
**Connecticut**—  
     State Station: *New Haven*.  
     Storrs Station: *Storrs*.  
**Delaware**—*Newark*.  
**Florida**—*Gainesville*.  
**Georgia**—*Experiment*.  
**Guam**—*Island of Guam*.  
**Hawaii**—*Honolulu*.  
**Idaho**—*Moscow*.  
**Illinois**—*Urbana*.  
**Indiana**—*Lafayette*.  
**Iowa**—*Ames*.  
**Kansas**—*Manhattan*.  
**Kentucky**—*Lexington*.  
**Louisiana**—  
     State Station: *Baton Rouge*.  
     Sugar Station: *New Orleans*.  
     North La. Station: *Calhoun*.  
**Maine**—*Orono*.  
**Maryland**—*College Park*.  
**Massachusetts**—*Amherst*.  
**Michigan**—*East Lansing*.  
**Minnesota**—*University Farm,*  
     *St. Paul*.  
**Mississippi**—*Agricultural College*.  
**Missouri**—  
     College Station: *Columbia*.  
     Fruit Station: *Mountain Grove*.  
**Montana**—*Bozeman*.  
**Nebraska**—*Lincoln*.  
**Nevada**—*Reno*.  
**New Hampshire**—*Durham*.  
**New Jersey**—*New Brunswick*.  
**New Mexico**—*Agricultural College*.  
**New York**—  
     State Station: *Geneva*.  
     Cornell Station: *Ithaca*.  
**North Carolina**—  
     State Station: *Raleigh*.  
     College Station: *West Raleigh*.  
**North Dakota**—*Agricultural Col-*  
     *lege*.  
**Ohio**—*Wooster*.  
**Oklahoma**—*Stillwater*.  
**Oregon**—*Corvallis*.  
**Pennsylvania**—*State College*.  
**Porto Rico**—*Mayaguez*.  
**Rhode Island**—*Kingston*.  
**South Carolina**—*Clemson College*.  
**South Dakota**—*Brookings*.  
**Tennessee**—*Knoxville*.  
**Texas**—*College Station*.  
**Utah**—*Logan*.  
**Vermont**—*Burlington*.  
**Virginia**—*Blacksburg*.  
**Washington**—*Pullman*.  
**West Virginia**—*Morgantown*.  
**Wisconsin**—*Madison*.  
**Wyoming**—*Laramie*.

In Canada write to Agricultural College at Guelph, Winnipeg,  
 or St. Anne de Bellevue. Dominion Department of Agriculture,  
 Ottawa.

TABLE III.

INSECTICIDES AND FUNGICIDES.

FOR BITING INSECTS—*Poisons.*

1. **Arsenate of Lead—**

Arsenate of lead.....	2 to 3 pounds
Water, or Bordeaux, or lime-sulfur.....	50 gallons

Many experiments have shown that well-made arsenate of lead is much the safest of all available arsenical poisons. Arsenate of lead is to be found on the market both as a powder and as a putty-like paste, which latter must be worked free in water before it is added to the lime-sulfur mixture or to Bordeaux mixture. The paste form of the poison is largely used at the rate of 2 or 3 pounds to each 50 gallons of the liquid and is added to it after it has been well worked free in water. As there are numerous brands of arsenate of lead upon the market, the grower should be careful to purchase from reliable firms.

2. **Wet Paris Green—**

Paris green.....	$\frac{1}{4}$ pound
Lime.....	$\frac{1}{2}$ pound
Water.....	50 gallons

If the above amount of Paris green is to be used with 50 gallons of Bordeaux mixture the half pound of lime would be omitted.

3. **Dry Paris Green—**

Paris green.....	1 pound
Powdered lime.....	20 pounds

FOR SUCKING INSECTS

4. **Kerosene Emulsion—**

Strong hard soap, shaved fine.....	$\frac{1}{2}$ pound
Water.....	1 gallon
Kerosene or crude petroleum.....	2 gallons

Dissolve the soap in the water by boiling and immediately add it boiling hot, away from the fire, to the oil. The whole mixture is then agitated violently while hot. After five minutes' agitation the emulsion should be perfect, and the mixture will have increased from one-third to one-half in bulk and assume the consistency of cream. Well made, the emulsion will keep indefinitely and should be diluted only as wanted for use.

*How to Use the Emulsion.*—During the growing period of summer, for most plant lice and other soft-bodied insects, dilute the emulsion with 15 parts of water; for the red spider and other plant-mites, the same, with the addition of 1 ounce of flowers of sulfur to the gallon; for scale insects, the larger plant-bugs, and larvæ, dilute with from 7 to 10 parts of water. Apply with spray pump. The greatest dilution noted gives 4 per cent of oil and the lesser dilutions approximately 6 and 8 per cent.

#### FOR WEEVILS IN CORN, BEANS, ETC.

5. **Bi-sulfide of Carbon.**—One teaspoonful liquid bi-sulfide of carbon to each two cubic feet of tightly closed air space. The fumes settle downward in the space. Keep all flames away from the materials.

6. **Bordeaux Mixture.**—Used as a fungicide to prevent diseases of plants.

Copper sulfate (bluestone).....	5 pounds
Unslaked lime.....	5 pounds
Water.....	50 gallons

This is called the 5-5-50 formula commonly used on apple trees in spring and summer.

Dissolve the copper sulfate at the rate of 1 pound to one gallon of water. Slake the lime carefully until it is of a creamy consistency, add water to make one gallon per pound of lime. These two are called stock solutions and may be kept covered until needed.

To make the Bordeaux mixture, dilute each as much as convenient before pouring them together. Pour the two diluted solutions at the same time into a third vessel. Strain it through a cloth before using it as a spray. Paris green or arsenate of lead may be mixed with this to prevent diseases and to poison insects at the same time, as on potatoes, tomatoes, and fruit trees.

7. **Lime-Sulfur** (chiefly to kill San José scale and prevent disease).—

*Old Formula (without salt)*—

Powdered flowers of sulfur .....	15 pounds
Burned lime.....	15 to 20 pounds
Water.....	50 gallons

Wet the sulfur and slake the lime. Add these to 10 gallons of boiling water. Boil for 40 to 60 minutes or until well dissolved. Then water is added to make 50 gallons. This is for winter use on orchards, and is used while warm.

*Concentrated Lime-Sulfur*—

Powdered sulfur .....	30 pounds
Burned lime.....	15 pounds
Water.....	15 gallons

Add the wet sulfur and the lime, after starting it to slaking, to 15 gallons of boiling water, and boil until dissolved. This may be kept in a closed vessel until wanted. A layer of oil on the top of the liquid will keep away the air sufficiently. This is diluted with about 9 times its volume of water for winter use on apple trees. The rule for dilution requires that the specific gravity of the liquid be found. Divide the decimal part of this number by three hundredths (.03) and the quotient will tell the number of times to dilute the liquid. For example, if the specific gravity equals 1.27, divide .27 by .03, giving 9. Then dilute the liquid with 9 times its volume of water for winter use. As a summer spray on apples and potato vines it should be diluted with 3 times as much water as for winter use.

The boiling of lime-sulfur is done in an open kettle with fire beneath, or in a barrel or tank with steam escaping from a pipe in the bottom of the liquid.

*Commercial Lime-Sulfur.*—A number of commercial preparations of lime-sulfur are sold. Each is supposed to be of about the strength given in the above formula for “Concentrated Lime-Sulfur.” The strength and the directions for dilution should be obtained with the liquid. As a general rule it is diluted with 9 times its volume of water for winter use.

*Self-Boiled Lime-Sulfur*—

Fresh burned lime .....	8 pounds
Powdered sulfur .....	8 pounds
Water .....	50 gallons

The lime should be placed in a barrel and enough water poured on to almost cover it. As soon as the lime begins to slake the sulfur should be added, after first running it through a sieve to break up the lumps, if any are present. The mixture should be constantly stirred and more water (3 or 4 gallons) added as needed to form at first a thick paste and then gradually a thin paste. The lime will supply enough heat to boil the mixture several minutes. As soon as the lime is well slaked, water should be added to cool the mixture and prevent further cooking. It is then ready to be strained into the spray tank, diluted, and applied. It is used in the above strength, 8-8-50, as a summer spray on peaches, plums, and cherries.

*Powdered Lime-Sulfur.*—A commercial form of powdered lime-sulfur is now on the market. It is to be mixed with water for winter spraying and may take the place of the commercial liquid as it is somewhat cheaper.

TABLE IV.

QUANTITY OF SEED PER ACRE, AND LEGAL WEIGHTS.

Name of seed.	Amount per acre.	Lbs. per bu. usually.
Alfalfa.....	30 lbs.	60
Barley.....	8-10 pks.	48 <sup>1</sup>
Beans.....	3- 6 pks.	60
Blue grass, alone.....	20-25 lbs.	14
Buckwheat.....	3- 5 pks.	48 <sup>2</sup>
Clover, alone.....	10-15 lbs.	60 <sup>3</sup>
Corn, shelled, checkrow.....	6- 8 qts.	56 <sup>5</sup>
Corn, for ensilage.....	10 qts.	
Cotton, Upland.....	4- 8 pks.	32 <sup>4</sup>
Cowpeas.....	4- 6 pks.	60 <sup>5</sup>
Flaxseed.....	2- 4 pks.	56 <sup>5</sup>
Mangels.....	5- 8 lbs.	
Millet.....	1- 3 pks.	50 <sup>5</sup>
Oats.....	2- 3 bu.	32 <sup>5</sup>
Oats and Canada peas.....	5- 6 pks. each	
Onions.....	5- 6 lbs.	52-57 <sup>5</sup>
Peas, field.....		60
Potato.....	6-18 bu.	60 <sup>5</sup>
Potatoes, sweet, bedded.....	1½- 3 bu.	46-60
Rice, rough.....	1- 3 bu.	43-45
Rye.....	3- 8 pks.	56 <sup>5</sup>
Soybeans.....	4- 6 pks.	60 <sup>5</sup>
Timothy.....	10-20 lbs.	45 <sup>5</sup>
Timothy and clover mixture.....	10-12 lbs. each	
Turnips or rape.....	3- 5 lbs.	
Vetch and grain mixture.....	4- 5 pks. each	
Vetch, Augusta.....	3- 4 pks.	60 <sup>5</sup>
Wheat.....	6- 9 pks.	60

<sup>1</sup> Pennsylvania 47 varies in a few States from 45 to 50.

<sup>2</sup> Varies in different States from 42 to 56.

<sup>3</sup> New Jersey 64.

<sup>4</sup> Varies 28 to 33½.

<sup>5</sup> A few exceptions.

**Problems.**—1. At the present market prices for the seeds of six of the crops sown in your section, calculate the cost of seed for ten acres of each.

2. Find the legal weights for seeds that are shown in this table to vary, and note the standard for your State.

**TABLE V.**  
**SAMPLE PEDIGREE OF PURE BRED CATTLE—RAVENSWOOD FARM.**

**Pedigree of the Pure Bred Holstein Friesian Bull**

**DUTCHLAND SIR ABBEKERK COLANTHA**

<p><b>Dutchland</b>  <b>Sir Abbekerk Colantha</b>                  No. 56603 H.-F. H.-B.                  Born January 21, 1909                  Owned by  <b>Wm. Bayard Blackwell</b></p>	<p><b>Colantha Johanna Lad</b>                  No. 32481 H.-F. H.-B.</p>	<p><b>Sarcastic Lad</b>.....                  No. 194 A. R. S.</p>	<p><b>Maurice Bonheur</b>                  No. 22394 H.-F. H.-B.</p>
<p><b>Tidy Abbekerk De Kol.</b>                  No. 2758 A. R. O.</p>	<p><b>Sir Pietertje Inka De Kol</b>                  No. 30571 H.-F. H.-B.</p>	<p><b>Sir Pietertje Josephine Mechthilde</b>                  No. 21412 H.-F. H.-B.</p>	<p><b>Pietertje 3d's Albina</b>                  No. 1230 A. R. O.</p>
			<p><b>Tidy of Dowine</b>                  No. 4076 H.-F. H.-B.</p>

H.-F. H.-B. refers to the Holstein-Friesian Herd-Book. A. R. O. means advanced registry, official, for cows making high records. A. R. S. means advanced registry, standard, for sires with four daughters having A. R. O.



## TABLE VI.

## RULES.

## CUBIC MEASURE FOR THE FARMER.

231 cubic inches make one liquid gallon.

2,150.4 cubic inches make one bushel.

The standard bushel of the United States is cylindrical, 8 in. deep and  $18\frac{1}{2}$  in. diameter.

$1\frac{1}{4}$  cubic feet are allowed for one bushel of shelled corn or grain. Multiply the cubic feet in a bin by  $\frac{4}{5}$  to get the number of bushels.

$2\frac{1}{4}$  cubic feet are allowed for one bushel of corn on the cob. 2 measured bushels of cob corn equals one of shelled.

A crate 10 x 11 x 20 inches inside is used for a bushel of onions, potatoes, or other vegetables.

A ton of hay on a wagon rack measures about 512 cubic feet.

A ton of newly stored hay, settled two weeks, measures  $7\frac{1}{2}$  feet cube, or about 422 cu. ft.

A ton of hay in stack, settled 30 to 60 days, is about 7 feet cube, or 343 to 380 cu. ft.

After hay has settled several months it measures 270 cubic feet to the ton.

## MEASURING LAND.

One acre of land measures 160 square rods, or 4,840 square yards, or 43,560 square feet.

When the length of a field is known in rods, the width to take to make one acre is found when the given length is divided into 160. For example, if a corn field is 40 rods long, an acre of it will be four rods wide ( $160 \div 40 = 4$ ).

TABLE VII.  
FERTILIZER FORMULAS.

THE object in the preparation of fertilizer formulas is to show the kinds and amounts of materials to use. Any one formula is not the best for all conditions; these vary as widely as the soils and different methods of management.

*Field Corn.*

Ground Bone.....	250 lbs.
Acid Phosphate.....	500 lbs.
Muriate of Potash.....	250 lbs.

*Composition.*—Nitrogen, 1 per cent; Phosphoric Acid (available), 7 per cent; Phosphoric Acid (total), 12 per cent; Potash, 12.5 per cent.

Application, 200 to 300 pounds per acre on manured soils; 300 to 500 on medium soils without manure. For forage corn or ensilage, the nitrogen should be increased.

*Oats.*

Nitrate of Soda.....	150 lbs.
Tankage.....	200 lbs.
Acid Phosphate.....	600 lbs.
Muriate of Potash.....	50 lbs.

*Composition.*—Nitrogen, 3.5 per cent; Phosphoric Acid (available), 8 per cent; Phosphoric Acid (total), 10 per cent; Potash, 2.5 per cent.

Application on good soils, 200 to 300 pounds per acre; 300 to 500 pounds per acre on medium soils without manure.

*Wheat.*

Dried Blood.....	150 lbs.
Tankage.....	100 lbs.
Acid Phosphate.....	700 lbs.
Muriate of Potash.....	50 lbs.

*Composition.*—Nitrogen, 2.5 per cent; Phosphoric Acid (available), 9 per cent; Phosphoric Acid (total), 10 per cent; Potash, 2.5 per cent.

Application on good soils, 200 to 300 pounds per acre. On medium soils, without manure, 300 to 500 pounds per acre.

*Early Potatoes.*

Nitrate of Soda.....	100 lbs.
Sulfate of Ammonia.....	100 lbs.
Tankage.....	100 lbs.
Acid Phosphate.....	500 lbs.
Sulfate or Muriate of Potash.....	200 lbs.

*Composition.*—Nitrogen, 4 per cent; Phosphoric Acid (available), 6 per cent; Phosphoric Acid (total), 8 per cent; Potash (actual), 10 per cent.

Application may range from 800 to 1200 pounds per acre.

*Sweet Potatoes.*

Tankage.....	300 lbs.
Dried Blood.....	100 lbs.
Acid Phosphate.....	400 lbs.
Muriate of Potash.....	200 lbs.

*Composition.*—Nitrogen, 2.5 per cent; Phosphoric Acid (available), 5.5 per cent; Phosphoric Acid (total), 9 per cent; Potash, 10 per cent.

Application per acre, from 500 to 800 pounds.

*Early Tomatoes and Market Garden Crops.*

Nitrate of Soda.....	250 lbs.
Ground Bone.....	100 lbs.
Acid Phosphate.....	550 lbs.
Muriate of Potash.....	100 lbs.

*Composition.*—Nitrogen, 4 per cent; Phosphoric Acid (available), 7 per cent; Phosphoric Acid (total), 9 per cent; Potash, 5 per cent.

Application per acre, 800 pounds.

*Timothy Hay, Top Dressing.*

Nitrate of Soda.....	500 lbs.
Ground Bone.....	200 lbs.
Acid Phosphate.....	200 lbs.
Muriate of Potash.....	100 lbs.

*Composition.*—Nitrogen, 8 per cent; Phosphoric Acid (available), 3 per cent; Phosphoric Acid (total), 6.5 per cent; Potash, 5 per cent.

Application, 200 to 300 pounds per acre.

*Fruits and Berries.*

Ground Bone.....	250 lbs.
Acid Phosphate.....	450 lbs.
Muriate of Potash.....	300 lbs.

*Composition.*—Nitrogen, 1 per cent; Phosphoric Acid (available), 5.5 per cent; Phosphoric Acid (total), 10.5 per cent; Potash, 15 per cent.

For medium or good soils, the application of this formula to the large fruits need not begin until the trees come in bearing, after which an annual application of from 300 to 500 pounds per acre will furnish an abundance of the mineral elements. For berries, this formula may be applied at the rate of 400 to 600 pounds per acre previous to setting the plants, and annually thereafter.

**Fertilizer Equivalents.**—The nitrogen in 1 pound nitrate of soda is about the same as in  $2\frac{1}{4}$  pounds cottonseed meal; 1 pound sulfate of ammonia =  $1\frac{1}{3}$  pounds nitrate of soda; 1 pound dried blood =  $1\frac{4}{5}$  pounds cottonseed meal; 1 pound nitrate of soda =  $1\frac{1}{4}$  pounds dried blood.

TABLE VIII.  
AVERAGE DIGESTIBILITY OF FEEDS AND THEIR  
FERTILITY.<sup>1</sup>

Name of feed	Dry matter in 100 lbs.	Digestible parts in 100 lbs.		Fertility in 1000 lbs.		
		Protein	Carbohy- drates (+fat ×2.25)	Nitro- gen (N)	Phos- phoric acid (P <sub>2</sub> O <sub>5</sub> )	Potash (K <sub>2</sub> O)
Alfalfa, green.....	28.2	3.6	13.0	7.7	1.3	5.6
Alfalfa, hay.....	93.6	11.7	43.1	26.1	6.1	17.9
Alsike (in bloom), green....	25.2	2.6	12.5	6.2	1.1	2.0
Beets, sugar.....	13.5	1.3	10.0	2.9	0.8	3.7
Brewers' grains (dried).....	91.3	20.0	45.7	40.0	16.1	2.0
Canada pea meal.....	89.5	16.8	53.3	32.3	8.2	9.9
Cotton seed meal.....	93.0	37.6	43.0	72.5	30.4	15.8
Corn ensilage.....	26.4	1.4	15.7	4.3	1.1	3.7
Corn fodder, green.....	20.7	1.0	12.8	2.9	1.1	3.9
Cornmeal (all).....	85.0	6.7	72.2	14.7	6.3	4.7
Corn stalks with ears.....	57.8	2.5	37.3	7.2	5.4	8.9
Corn stalks without ears....	59.5	1.4	32.7	6.1	3.8	10.9
Corn and cob meal.....	84.9	4.4	66.5	13.6	5.7	4.7
Cow peas, green.....	16.4	1.8	9.1	3.8	1.3	4.6
Crimson clover, hay.....	90.4	10.5	37.6	24.3	4.0	13.1
Dried beet pulp.....	91.6	4.1	65.1	12.9	2.2	3.1
Gluten meal.....	90.5	29.7	56.2	54.8	3.3	0.5
Kentucky blue grass, hay....	86.0	4.4	41.8	12.5	4.0	15.7
Linseed meal (old process)....	90.2	30.2	47.5	54.2	16.6	13.7
Malt sprouts.....	90.5	20.3	49.1	42.1	17.4	19.9
Mangels.....	9.1	1.0	5.9	2.2	0.9	3.8
Oats.....	89.6	10.7	58.7	18.2	7.8	4.8
Oat forage, in bloom, green...	25.0	1.1	13.5	2.6	1.3	3.8
Oat straw.....	90.8	1.3	41.3	5.8	3.0	17.7
Peas and oats, green.....	20.3	1.8	11.1	3.8	1.5	5.0
Red clover, green.....	29.2	2.9	16.4	7.0	1.5	4.8
Red clover, hay.....	84.7	7.1	41.8	19.7	5.5	18.7
Red top, hay.....	91.1	4.8	49.1	12.6	3.6	10.2
Ruta-bagas.....	11.4	1.0	8.5	1.9	1.2	4.9
Rye.....	91.3	9.5	72.1	18.1	8.6	5.8
Timothy, green.....	38.4	1.5	21.2	5.0	2.6	7.6
Timothy, hay.....	86.8	2.8	45.3	9.4	3.3	14.2
Wheat.....	89.5	8.8	70.8	19.0	5.5	8.7
Wheat bran (winter).....	88.5	12.1	43.4	25.1	26.9	15.2
Wheat middlings.....	88.8	13.0	55.8	27.0	26.3	15.3

In quarts the dry feeds to make a pound would be: gluten meal 0.8, linseed meal 0.9, cottonseed meal, pea meal, cornmeal each 0.7, wheat 0.5, rye 0.6, oats 1, wheat middlings 1.3, bran 2, malt sprouts 1.7, brewers' grains 1.7.

<sup>1</sup> Chiefly adapted from W. A. Henry's "Feeds and Feeding."

TABLE IX.  
FEEDING STANDARDS.

(Wolff-Lehmann)

POUNDS PER DAY PER 1000 POUNDS LIVE WEIGHT.

Animal	Total dry matter	Protein	Carbo-hydrates (+fat ×2.25)	Nutritive ratio	
Horse, at light work.....	20.0	1.5	10.4	1 : 7.0	
Horse, at medium work.....	24.0	2.0	12.3	1 : 6.2	
Horse, at hard work.....	26.0	2.5	15.1	1 : 6.0	
Cattle, fattening, first period.....	30.0	2.5	16.1	1 : 6.5	
Cattle, fattening, second period...	30.0	3.0	16.0	1 : 5.4	
Cattle, fattening, third period.....	26.0	2.7	16.5	1 : 6.2	
Milk cows, 11 lbs. milk daily.....	25.0	1.6	10.7	1 : 6.7	
Milk cows, 16.5 lbs. milk daily....	27.0	2.0	11.9	1 : 5.4	
Milk cows, 22 lbs. milk daily.....	29.0	2.5	14.1	1 : 5.7	
Milk cows, 27.5 lbs. milk daily....	32.0	3.3	14.8	1 : 4.5	
Lambs, 60 to 75 lbs., 2-4 months..	25.0	3.2	15.6	1 : 4.9	
Sheep, fine wool.....	23.0	1.5	12.7	1 : 8.5	
Sheep, fattening, first period.....	30.0	3.0	16.1	1 : 5.4	
Sheep, fattening, second period....	28.0	3.5	15.8	1 : 4.5	
Swine:					
2- 5 mos. 50-100 lbs.....	40.0	6.5	27.3	1 : 4.0	
5- 8 mos. 150-200 lbs.....	30.0	3.8	20.9	1 : 5.5	
8-12 mos. 200-250 lbs.....	26.0	3.0	17.5	1 : 5.8	
Swine, fattening, first period.....	36.0	4.5	26.5	1 : 5.9	
Swine, fattening, second period....	32.0	4.0	25.1	1 : 6.3	
Swine, fattening, third period.....	25.0	2.7	19.9	1 : 7.0	
<b>GROWING CATTLE—DAIRY BREEDS.</b>					
Age, months.	Average live weight, per head.				
2- 3.....	150 pounds.....	23.0	4.0	17.0	1 : 4.5
3- 6.....	300 pounds.....	24.0	3.0	15.0	1 : 5.1
6-12.....	500 pounds.....	27.0	2.0	13.6	1 : 6.8
12-18.....	700 pounds.....	26.0	1.8	13.4	1 : 7.5
18-24.....	900 pounds.....	26.0	1.5	12.6	1 : 8.5

**TABLE X.**  
**AVERAGE COMPOSITION OF FARM MANURES.**

Farm manures	Pounds per thousand			Value per year 1000 lbs. live weight	Value per ton of manure <sup>1</sup>
	Nitrogen	Total phosphoric acid	Potash		
Cow manure (fresh).....	3.4	1.6	4.0	\$39.00	\$1.91
Horse manure (fresh) .....	5.8	2.8	5.3	42.00	3.13
Sheep manure (fresh) .....	8.3	2.3	6.7	46.00	4.20
Hog manure (fresh).....	4.5	1.9	6.0	80.00	2.56
Hen droppings (fresh).....	16.3	15.4	8.5		9.12
Mixed stable manure.....	5.0	2.6	6.3		2.88

<sup>1</sup> Considering nitrogen at 20 cents, phosphoric acid at 6 cents, and potash at 4½ cents per pound.

**TABLE XI.**  
**DISTANCES APART FOR PLANTING FRUIT.**

(If planted in rows each way the distances usually range in feet about as given here.)

Fruit trees.	Small fruits.
Apples .....	Blackberries.....
Apricots.....	Cranberries .....
Cherries.....	Currants.....
Oranges .....	Gooseberries.....
Peaches .....	Grapes.....
Pears .....	Raspberries, black.....
Pears, dwarf.....	Raspberries, red .....
Plums.....	Strawberries, hedge row ..
Quinces .....	Strawberries, matted row .

TABLE XII.  
USUAL DISTANCES APART FOR PLANTING  
VEGETABLES.

Vegetables	Rows, feet apart	Distance in rows, feet	Plants per acre
Asparagus .....	3-4	1-2	
Beans, bush and pole .....	2-4	1	
Beet, early.....	1½-2	drills	
Beet, stock, sugar.....	1½-2	thin drills	
Cabbage, early .....	2-2½	1½-2	8712-14520
Cabbage, late.....	3	3	4840
Carrot .....	1½-2	drills	
Cauliflower.....	2-2½	1½-2	8712-14520
Corn, sweet .....	3-3½	1-2	
Celery .....	3-4	½-1	10890-29040
Cucumber and melons.....	4-6	4-6	
Egg plant.....	3	3	4840
Lettuce, curly .....	1-2	thin drills	
Lettuce, head.....	1½	½	58080
Onion .....	1½-2	drills	
Parsley .....	1-2	drills	
Peas.....	1-3	drills	
Pepper.....	2½	1½	11616
Potato.....	2½-3	1-1½	
Radish.....	1-1½	drills	
Rhubarb.....	4	2-4	2722-5445
Salsify .....	1½-2	drills	
Spinach.....	1-1½	drills	
Squash and pumpkin.....	6-8	6-8	
Sweet potato.....	3-4	2	5445-7260
Turnip.....	1½-2	drills	
Tomato.....	3-4	3-4	2722-4840



## TABLE XIII.

**SUGGESTIONS TO TEACHERS FOR ADDITIONAL EXERCISES AND PROJECTS.**

THE following projects and field and laboratory exercises will be suggestive to those who wish to further supplement the text. These are arranged according to the numbers of the chapters to which they are most closely related. They may be taken up in connection with their corresponding chapters if desired.

## CHAPTER I.—PHYSIOLOGY OF PLANTS.

1. Tie a piece of bologna skin over the top of a long glass funnel tube from a chemical laboratory. Fill the bowl of the funnel with dense sugar syrup. Place it with the membrane beneath the surface in a glass of water. Then support the tube in some way and observe the osmosis of the two liquids. With a piece of rubber tubing splice on more glass tubing and see how high you can conduct the liquid before the action stops.

## CHAPTER II.—PLANT IMPROVEMENT.—WEEDS.

1. Make a study of a fanning mill at a dealer's or at some farm. Study the sieves and the fan. Try the machine with a quantity of uncleaned seeds and note its work.

2. Let home projects be started in the ear-row method of improving corn, and in the hill-row method of increasing the yield of potatoes.

3. Make a list of bad weeds observed at your home farm or elsewhere, seen in the following places: (1) roadsides and fence rows; (2) in grain fields; (3) in cultivated fields; (4) in hay fields; (5) in pastures.

4. Make a list of the ways you have seen for storing seeds over winter.

## CHAPTER III.—PLANT PROPAGATION.

1. Pupils may start home projects in the growing of nursery trees of apple, peach, and plum trees and also grape vines.
2. Bush fruits may be propagated at home for sale to others.

## CHAPTER V.—KINDS OF SOIL.

1. In regions where soil is quite variable, students should make lists of trees or other plants which thrive best on the different types of soil.
2. Trials of special crops may be made on different types of soil to show the value of each for certain purposes.

## CHAPTER VI.—SOIL MOISTURE.

1. Home projects should be started to show the effects of good and bad methods of tillage in preparing the soil and caring for some culture crops, say corn, potatoes, tomatoes, and others.

## CHAPTER VII.—LAND DRAINAGE.

1. Let root systems be studied to prove that drainage deepens the root systems, and reduces injury from drought.
2. In springtime test the fact that drainage warms the soil. Use a thermometer or observe the early growth of plants on both drained and undrained places.
3. Home or neighborhood projects in tile drainage may be planned, surveyed, and the cost estimated.

## CHAPTER VIII.—SOIL IMPROVEMENT.

1. Study the different types of plows, harrows, cultivators and other tillage machinery at a dealers or on farms.
2. List all the farms in the community that grow green manure crops. What crops are grown? Do they all find it beneficial?
3. What farms use lime for soil improvement? What

kinds are used? Which kinds are preferred? For what crops is the liming done? Does it help them? Let pupils make surveys to obtain answers to these questions.

4. Make a survey regarding the care, management, and uses of barnyard manure.

5. Make a similar survey regarding use of commercial fertilizers—kinds, grades, prices, for what crops, benefits, home mixing, ingredients purchased.

6. Start home projects to prove the benefits of liming, use of barnyard manure, commercial fertilizers.

#### CHAPTER IX.—SYSTEMS OF CROPPING.

1. Make a survey to determine what rotations in cropping are practiced in the community. What are the best ones?

2. Long projects in crop rotations, may be started in connection with those in the preceding chapter.

#### CHAPTER X.—FARM CROPS.

1. Determine how many of the different classes of crops enumerated at the first of this chapter are grown in the community. Which are important crops? which minor crops?

2. What farmers are using the soiling crop system, wholly or partially, in the summer season?

3. Start projects with pigs, cows, or calves, to compare the expense and value of soiling systems and pastures, and perhaps summer silage.

4. Start projects in the growth of crops that should be encouraged in the region.

5. Start projects in pasture improvement using methods suggested at the last of the chapter.

#### CHAPTER XI.—ALFALFA.

1. Let pupils make surveys among the farmers to determine how many of the alfalfa rules are followed.

2. Start alfalfa projects to bring out the most important

ones of these—liming, inoculation, frequent cutting. Include also the harrowing of stubble after cutting to keep down weeds and conserve moisture.

#### CHAPTER XII.—COTTON PRODUCTION.

1. In cotton sections, students should make surveys showing varieties grown, soil preparation, tillage methods, damage from insects and diseases, time of picking, yields, methods of marketing, and cropping systems.

2. Cotton growing projects may be started with records to be kept along all of these lines and including the cost of the crop. The combating of the boll-weevil and other enemies should be planned in these projects.

#### CHAPTER XIII.—CORN.

1. Corn growing projects, when started, should be planned to include all the essential points in growing the crop. Records of time, cost, yield, etc., should be kept.

#### CHAPTER XIV.—SMALL GRAINS.

1. Mount all the different types of grain obtainable, using the methods described in this chapter.

2. Let some pupils grow rice, flax, or any other grain crops that are not well known in the region. Have students study these.

#### CHAPTER XV.—POTATOES.

1. Let pupils combine in making a survey of the community on Irish potatoes or sweet potatoes or both. Determine varieties, soil maintenance, preparation of soil, planting rotations, cost of crops, methods of combating insects and diseases, yields, methods of marketing, storage, etc.

2. Home projects with a small area of either of these crops should be started. Let competitions be started in yield, quality, and cost.

## CHAPTER XVI.—TOBACCO FOR MARKET.

1. If tobacco is a market crop of the region, divide the list of growers among the pupils and make a survey to determine methods of preparing soil, starting plants, transplanting, tillage, fighting insects and diseases, suckering and topping, harvesting, curing, sorting, packing, storing, marketing, etc.

## CHAPTER XVII.—FORESTRY.

1. Let pupils see how many of the forest influences mentioned can be discovered in the region.

2. Study the trees of the region and make a list of all. Learn to know them at sight.

3. Home projects may be conducted with forest tree nurseries.

## CHAPTER XVIII.—GARDENING.

1. Several plans for home gardens should be drawn by each student. These may be compared and discussed.

2. A garden survey of the region may be made to determine a number of points: (1) How nearly the home is supplied with winter and summer vegetables; (2) what crops are grown for market; (3) what crops are not grown that should be grown; (4) manuring or other fertilizing practiced; (5) succession cropping plans; (6) companion cropping plans; (7) leading varieties of the main crops; (8) methods used in preventing damage from insects and diseases; (9) methods of harvesting; (10) methods of marketing; (11) methods of curing, drying, and storing; (12) what seeds are saved for future planting, and how.

3. There are many home garden projects that can be pursued by both boys and girls.

## CHAPTER XIX.—FRUIT PRODUCTION.

1. Practice pruning of orchard trees for a few growers.

2. Make a survey of the varieties of fruits that succeed well in the region.

3. Have exercises in grading and packing fruit.
4. Study methods of storing and of marketing as practiced in the region.

## CHAPTER XX.—INSECTS.

1. Observe and report damage from insect enemies.
2. Report examples of birds feeding their young on insect larvæ.
3. Report damage to birds' nests by cats, dogs, and other enemies of our bird friends.

## CHAPTER XXI.—DISEASES OF PLANTS.

1. Make up a number of the spray mixtures and use them on nearby trees as needed.
2. By means of a rapid survey calculate the loss from each of the worst plant diseases of the region.

## CHAPTER XXII.—IMPROVEMENT OF ANIMALS.

1. Report observations of the bad effects of crossing.
2. Report examples of the money values of pure bred stock as compared to scrubs.
3. Have pupils bring in examples of variation in poultry, pigs, etc.

## CHAPTER XXIII.—HORSES.

1. Students should visit the stables of a veterinarian in a group. He will be glad to show cases of sickness or injury of horses in his care. He can show you specimens and give lessons on teeth, horses' feet, etc.
2. Get a good horseman in the district to demonstrate with light and heavy horses the good and poor points of each individual.

## CHAPTER XXIV.—CATTLE.

1. Students should be taken to a farm where beef cattle are found. Practice picking the best and the poorest for the type, both as feeding for beef or as breeding animals.

2. Similar trips should be taken for the study of dairy animals.

3. Make a list of all the breeds of cattle in the region, either grade or pure-bred. Determine for what purpose they are each kept.

4. If possible arrange with some parents or with some bank to finance home projects in calf raising.

#### CHAPTER XXV—SHEEP.

1. Ascertain by a student survey what breeds of sheep are found in the region. Let comparisons of these be made.

2. Make a list of all the families in the district that keep dogs, and the number for each family. How many of these are known to worry or to kill sheep? Does this influence the sheep industry?

3. Sheep feeding experiments may be started as home projects.

#### CHAPTER XXVI—SWINE.

1. Enumerate the number of swine of each breed represented in the district. Which are most popular? Which make the most rapid gains in weight up to six months of age? Or which ones reach the weight of 100 pounds first?

2. Home projects in management and feeding of pigs should be started if possible. Establish competitions among the members of a pig club for the district.

#### CHAPTER XXVII—POULTRY MANAGEMENT.

1. Start contests in the hatching of chicks at home by the natural method or by incubators.

2. Let students draw plans for the construction of chick brooders and then make them at home or at school.

3. Contests may be started in the preservation of eggs.

4. A poultry exhibit and fair may be held at one of the homes or at school if a suitable place is available. This may be on Saturday. Contests in judging may be conducted in this connection.

## CHAPTER XXVIII—BEE-KEEPING.

1. Make a census of all the colonies in the district. What is the honey output of each place for one season?
2. If only a few bees are found in the district calculate the loss to the district, supposing that each farmer could easily keep twenty-five colonies.
3. Ascertain the returns from comb honey and from extracted honey. Compare these methods in yields and money value. Which is most followed in the district? Why?
4. Make a list of the chief honey plants in the district—early, medium, and late.

## CHAPTER XXIX—FEEDS AND FEEDING.

1. Make up a complete list of stock feeds grown in the district. Classify them as concentrates, roughage, root crops, and others. Determine if possible what quantity of each is raised, and their market values.
2. What kinds and amounts of concentrates and hay are purchased from town by feeders in the district? What is the cause of this? Is there any good reason for the purchase of feeds that could be raised on the farms?
3. Make a list of the pasture crops grown in the district.

## CHAPTER XXX—CATTLE PRODUCTS.

1. Home projects in the weighing, sampling, and testing of milk should be carried on by students.
2. Let students compare the methods of churning they have observed at home and elsewhere with those given in this chapter. Give reasons for differences.
3. If cream separators are found in the district, let students inquire regarding their success or failure; then see if they can aid in solving the troubles if any are found?



## CHAPTER XXXI—THE BUSINESS OF FARMING.

1. Make a survey of the farms in the district to determine to what extent the losses mentioned in this chapter are found.
2. Make a list of farms where careful accounts of cost of production are kept. Why do not all keep such accounts?
3. Make a list of young men who have left their farms in the last few years and those who are now considering doing so. What reasons can be assigned for this?

## ROAD CONSTRUCTION AND MECHANICS.

1. Determine the kinds and amount of private work done by farmers or others to help maintain or improve the public roads along their places. How many use road drags on their own roads?
2. Make a list of farms in the district where there are convenient and suitable rooms or buildings for use as workshops.
3. Make a survey to determine how many large field machines are bought each year in the district; also how long these last on the farms. Get some data regarding the cost of repairs for these machines.
4. Boys should carry on home projects in the painting, repair, and maintenance of the farm machinery for several months.
5. Exercises should be conducted in the over-hauling of farm engines; installing of belt machines and power; using concrete on the farm; structure of gates, poultry houses, feeding, etc.



# INDEX

- Abbreviations, Preface, v  
Aberdeen Angus, 281, 282  
Accounts, keeping, 364  
    to keep, 365  
Adults of insects, 221, 223, 224  
Æolian soil, 51  
Agricultural experiment station, iv  
Agriculture, teaching of, 1  
Air for germination, 17  
    forming soil, 45, 46  
    in soil, 17  
Airing milk, 350  
Alfalfa as green feed, 111  
    a soil improver, 111  
    a chapter on, 111  
    curing of, 114  
    cutting, 113, 116  
    for soiling, 99  
    inoculation for, 112, 116  
    in rotation, 94  
    loading, 114  
    raking, 115  
    rotts with nodules, 113  
    rules for, 115  
    seeding, 112, 116  
    stacking, 115  
Alluvial soil, 47, 50  
American Merinos, 295, Fig. 182  
    saddle horse, 268, 270  
    trotter, 268, 269  
Ammonia, sulfate of, 84  
Analysis of feeds, 330  
Animal production, section on, 259  
    products, section on, 344  
Animals as soil formers, 45, 50  
    composition of, 327  
    improvement of, 259  
Antennæ of insects, 220  
Annual defined, 20  
    weeds, 28  
Appendages of insects, 220  
Appendix tables, i  
Apple borer, flat head, 235  
    round head, 237  
    budding, 37  
    root grafts, 36  
    rust, 250, 251, 253  
    scab, 249, 250  
        and rust, 233  
    spraying for, 256, 257, 258  
    scions, 35, 37  
    stocks, 35  
    varieties 213  
    worm, 232, 233  
Apples picked from ladders, 218  
    propagation of, 35  
    studying, 214  
Aquarium, 13, 14  
Arbor Day planting, 188  
Arithmetical problems, see *Problems*  
Arsenate of lead, 258, 394  
Ashes and sour soil, 78  
    plant food in, 78  
Ayrshire cattle, 288, 289  
Babcock test, 355  
    principles of, 356, 357  
    outfit, 357  
Bacon type of swine, 299, 300  
Bacteria in milk, 347  
Bailey, Dr. L. H., quoted, 204  
Balance in Nature, 13  
Balanced rations, 340  
Barley, 158  
Barn, a clean, 348, 349  
    bad construction of, 348  
    good construction of, 348  
    manures, value of, xviii  
Barns, ventilation of, 349, 350  
Barnyard manure, see *Manure*  
Bean weevil, 221  
Bee colony, 323  
    hives, 323, 325  
    -keeping, chapter on, 321  
    studies, 326  
    structure, 324  
Beef breeds, 279  
    cattle, fattening, 337  
    cuts of, 344, 345  
Bees and insects carry pollen, 18,  
    19  
    life of, 323  
    winter care of, 326  
Beet pulp, 336  
Belgian horse, 266  
Beneficial insects, 239  
Berkshire swine, 299, 300  
Berries, fertilizer for, xiv  
Biennial defined, 20  
    weeds, 29  
Birds as insect eaters, 240  
    beneficial hawks, 242  
    chapter on, 240  
    encouraging, 243  
    enemies of, 244  
    food habits of, 241  
    food of, 243  
    harmful, 241  
    houses, 244  
    laws protecting, 244  
    seeds eaten by, 243  
Bi-sulfide of carbon, 231, 395  
Biting insects, 220  
    sprays for, 394  
Black Minorca pair, 307  
    spot of peach, 247  
Blackberries, 216, 217  
Blake's, Prof. M. A., list of peaches,  
    212  
Blossoms, see *Flower*  
Bone, ground, 84  
Books, reference, 60, i

- Bordeaux mixture, 233, 258, v, vi  
 Bottling milk and cream, 351  
 Boys' and girls' clubs, 6  
 Brahma hen, 308  
 Bran, 335  
 Breed, defined, 259  
 Breeding, laws of, 259  
 Breeds, beef, 279  
   keeping pure, 259  
   of bees, 322  
   of horses, 263  
   sheep, 293, 294, 296  
   swine, 301, 302, 304  
 Brewers' grains, 336  
 Brooder houses, Fig. 196  
 Brown rot of peach, 247, 248  
   Swiss cattle, 284, 285  
 Budding apple trees, 37  
   peaches and plums, 38, 39, 40  
   sticks, 37, 39  
 Bud selection, 23  
 Buds, fruit, 210, 212  
 Bulletins, Farmers', how to secure  
   3, 390  
   how to use, 3  
   referred to, see end of  
   each chapter  
 Bushel measure, xi  
 Business of farming, 360  
   success, elements of, 363  
 Buttermilk, 353, 354, 356, 359  
 Butts of corn, 137  
 Buying feeds, 342  
 By-products and mill feeds, 335,  
   337  
  
 Cab horses, 266  
 Cables, how made, 376  
 Calf feeding, 337  
 California, school gardening in, 192  
 Calves, dairy, 285  
   feed for, xvi  
 Cambium layer of wood, 36  
 Capillary moisture, 60-64  
   experiment, 64  
 Carbohydrates, 329  
   and fat in feeds, xv  
 Carbon bi-sulphide, 231, x  
   dioxide, 13, 14  
   in plants, 13, 14  
 Carniolan bees, 322  
 Casein of milk, 345  
 Catalo hybrid cattle, 282  
 Catch crops, 90, 91  
 Caterpillar-hunting beetle, 239  
 Caterpillars, 224, 225  
 Cattle, chapter on, 279  
   feed for, xvi  
   judging, 289, 290  
   points of, shown, 289  
   products, chapter on, 344  
   types of, 279  
 Caucasian bees, 322  
 Cedar apple, 251, 252  
 Cellulose, 329  
 Cereal crops, 97  
 Certified milk, 352  
 Changes in insects, 223  
 Cheese-making, 355  
  
 Chester white swine, 201, 302  
 Cheviot sheep, 294, 295, 296  
 Chick creep, 388  
 Chicken houses, 313, Figs. 195,  
   199  
   inside of, 314  
   location of, 314  
   plan for, Fig. 199  
   varieties, Figs. 189-194  
   to keep, 313  
 Chickens, varieties of, 311-313  
 Chinch bug, 231  
 Chlorophyl, 11, 12  
 Cholera, hog, 306  
 Churning, steps in, 354  
 Cicada captured, 241  
 Clayey soil, 52, 53, 54, 58, 59, 63  
 Cleaning seed, 22  
 Cleveland Bay horses, 266  
 Clothes moth, 230  
 Clover, alsike, 106  
   compared with standard, 340,  
   341  
   crimson, 91, 106  
   for soiling, 99  
   in rotation, 92, 93  
   methods of starting, 107  
   nodules, 103, 104  
   red, 106  
   when to cut, 107  
   white, 106  
 Clubs, corn, 151, 152  
 Clydesdales, 265  
 Coach horses described, 266  
 Coarse woolled sheep, 293  
 Cob of corn, 139  
 Cocoon, 223, 225  
 Codling-moth, 232, 233  
   spraying for, 256, 257,  
   258  
 Cold frame, 194, 195, 196  
 Colluvial soil, 51  
 Colony of bees, 323  
 Column system of accounts, 364,  
   365  
 Commercial fertilizers, 82  
 Community centre, 6  
 Composition of animals, 327  
   corn, 331  
   feeds, xvi  
   fertilizers, xii, xiv  
   manures, xvii  
   milk, 345, 346, 347  
 Composts of manure, 82, 83  
 Concentrated feeds, 332, 334-336  
 Concrete roads, 372  
 Condensed milk, 352  
 Contests, swine, 309  
 Contrasts in farming, 361  
 Cooling milk, 350  
 Copper sulfate, x  
 Coppice growth of trees, 189  
 Corn after oats and peas, 96  
   as feed, 334  
   butts, 137  
   chapter on, 133  
   clubs, 150, 151, 152  
   cob, 135  
   composition of, 331  
   crop, 133

- Corn culture, 143  
 distances for planting, 144  
 -drying rack, 147  
 ensilage most economical, 149  
 fertilizer for, xii  
 festival, 153  
 finest in the world, 139  
 for forage, 96  
 for soiling, 100, 101  
 germs, weak and healthy, 142  
 grain, 135  
 harvesting, 146, 147, 148, 149  
 importance of, 133  
 in rotation, 92, 93  
 in United States, 133  
 keeping notes, 152  
 kernels, 134, 137  
 methods of planting, 144  
 new standard for, 150, 151  
 origin of, 133  
 planting, 144  
   dates for, 145  
   pollination of, 19  
   preparation of soil for, 143  
   proportion of, to cob, 139  
   report blanks, 152  
   root system, 146  
   rules for selecting and judg-  
   ing, 135  
   score card, 140  
   silks, 19  
   silos, 149  
   size of ears, 137, 138  
   soil and fertilizers, 143  
   stalks as feed, 332  
   storing, 146, 150  
   testing, 140, 141  
   tillage, 145  
   tips, 136  
   types of, 133, 134, 135  
   vitality of, 136
- Cornbelt States, 133
- Correlation of subjects, 4
- Cotswolds, 293, 294
- Cotton, chapter on, 117  
 cultivation, 124  
 diseases, 128  
 fertilizers, 123  
 fibres, 118, 120  
 gin, 126, 127  
 harvesting, 124  
 importance of, 117  
 improvement of, 121  
 insects, 128-132  
 market grades of, 126  
 planting, 123  
 problem, 125  
 range of, 121  
 relatives of, 119  
 Sea Island, 119  
 selecting, 121  
 soil, 122  
 types, 119  
 upland, 119  
 uses, 117
- Cottonseed meal, 336
- Cover crop for orchards, 211
- Cow peas, 92, 99, 104  
 mixtures, 105
- Creaming, methods of, 353
- Cream, ripening, 353  
 separators, 354  
 testing, 359
- Cropping, companion, 96, 196  
 double, 96, 195  
 succession, 95, 196  
 systems of, 88, 89
- Crop, the fruit, 218
- Crops, catch, 90, 91  
 classification of, 97  
 cover, in orchard, 92  
 planting, 362  
 rotation of, 88, 89, 194  
 soiling, 99
- Cross-bred animals, 261
- Crossing, bad effects of, 361
- Cultivating, effects of, 64, 65  
 peach trees, 73
- Cultivation of potatoes, 168  
 sweet potatoes, 173
- Cultivators illustrated, 65
- Culture of corn, 143  
 orchards, 211, 213
- Curculio of plums and peaches, 233, 234  
 injuries of, 235
- Currant worms, 224
- Currants, 216, 217
- Cutting seed potatoes, 166
- Cuttings, kinds of, 42, 43
- Cyprian bees, 322
- Dairy breeds, 285, 289  
 calves, 285  
   farm rotations, 92  
   products, 344  
   records, 355, 356
- Debates, 209, 297, 320
- Delaine Merinos, 295
- Dent corn, 133, 134
- Depth of planting seed, 193
- Devon cattle, 283
- Digestibility, influence on, 338  
 of feeds, xv
- Diseases of man, 229  
 plants, chapter on, 246
- Distances for planting fruits,  
 406  
 trees, 184, 185  
 vegetables, xviii
- Division of plants, 42
- Dorset sheep, 294, Figs. 180, 181
- Draft horses, 263, 266
- Drainage, chapter on, 67  
 defects of, 64, 68, 69  
 for alfalfa, 113, 116  
 methods of, 67  
 warms the soil, 69  
 where needed, 69
- Drains, reasons for, 67  
 ventilate the soil, 69
- Drain tiles, 68, 70, 71
- Drift soil, 50, 51
- Drill, grain, 156
- Drinking fountains, 315, 319, Fig. 201
- Dry mashes for chickens, 316  
 matter shown, 327  
 in feeds, xv
- Dual-purpose cattle, 282, 283, 284  
 horses, 263
- Durham, see *Shorthorn*

- Duroc-Jersey swine, 300  
 Dust boxes for hens, 314  
   Mulch, 65, 66
- Ear-row method, 23  
 Earth roads, 373  
 Egg breeds, 311  
   packing, 318  
   problems, 319  
   records, 312  
   testing, 319
- Eggs, preserving, 319  
   weight of, 318  
   yolk of, 318
- Electric lights, 400  
   motors, 400  
   power on farms, 400
- Engine troubles, 399  
 English shire horses, 265  
 Ensilage, 147, 148, 333  
 Essentials in feeds, 328  
 Evergreens, how to use, 204, 205  
 Exercise, frequent in all chapters,  
   see special topics, xix  
   referred to, 5
- Experiment stations, list of, iii,  
 iv
- Experiment for school gardens, 200,  
 201, 202
- Eyes of insects, 220
- Fallow, bare, 90  
 Fanning grain, 22  
 Farm accounts, 364, 365  
   choice in buying, 369  
   crops, chapter on, 97, xxi  
   equipment, repair of, 383  
   forest planting, 181, 182  
   getting started on, 368  
   going in debt, 369  
   management, section on, 360  
   mapping the, 362  
   need for better managements  
     367  
   renting plan, 368  
   school, plan of, 194  
   stepping stone, a, 368  
   the value of, 367
- Farmer, a salesman, 365  
 Farmers' bulletins, see *Bulletins*  
 Farming, best men needed in, 361  
   causes for changes in, 360  
   changes in, 360  
   contrasts, 361  
   results of changes in, 361  
   special and general, 88  
   system in, 362
- Fat in feeds, 330  
 Fats in milk, 345
- Feed, equivalents in quarts, 404  
   for pigs, 304, 305  
   related to purpose, 338  
   succulent, 317  
   troughs for poultry, 315
- Feeding beef cattle, 337  
   for winter eggs, 316  
   of insects, 220  
   plants, 83  
   principles of, 337  
   standards, 339, xvi
- Feeding, systems for poultry, 316, 317  
   young animals, 339
- Feeds, analysis of, 330  
   and feeding, 327, xxvi  
   buying, 342  
   change to tissue, 331  
   digestibility, table of, xv  
   essentials in, 328  
   fertility in, xv  
   list of, xv
- Fermented milk, 353  
 Fertility in feeds, table of, xv
- Fertilizer equivalents, xiv  
   formulas, xii, xiv  
   in feeds, 342
- Fertilizers, collection of, 80  
   commercial, 83-87  
   for corn, 143  
   for pastures, 109  
   for special crops, xii, xiv  
   high grade, 85, 86  
   low grade, 85, 86  
   problems on, 87  
   value of, 85
- Fibre crops, 97  
 Field records, 365  
 Fillers in orchards, 212  
 Film moisture in soils, 60, 61  
 Fine woolled sheep, 295  
 Flax, fibre, 159, 160, 161  
   growing, 160  
   harvesting, 160  
   where grown, 160
- Flies carry disease, 229  
   life of, 228, 229  
   remedies for, 229, 230  
   trap for, 387
- Flight of insects, 220  
 Flint corn, 100, 101, 133  
 Floats, 84  
 Flowers, imperfect, 18  
   of strawberry, 18  
   parts of, 19  
   perfect, 17  
   pollination of, 18, 19  
   purpose of, 17
- Food value of milk, 345  
 Forage crops, 97, 98  
   for midsummer, 101
- Forest care and management, 189  
   influences, 179, 180, 181  
   planting, 178-182  
   trees, distances, 184, 186  
   mixed plantings, 185  
   nurseries, 183  
   propagation of, 182  
   shade, 183
- Forestry, chapter on, 178, xxiii  
 Formalin for grain, 254  
   potatoes, 253
- Fountains, drinking, 313, 315  
 Free water in soils, 60, 61, 62  
 French coach horses, 266, 267  
   Merinos, 297
- Frost and rainfall, 197  
   vegetables injured by, 193
- Fruit buds, 210, 212  
   crop, care of, 218  
   crops, 98  
   fertilizer for, 403

- Fruit** planting, distances for, xvii  
     production, chapter on, 206, xxiii  
     trees, raising of, 35  
**Fruits**, small, 216  
**Full-blood**, see *Pure-bred*  
**Fungicides**, 258, v  
  
**Gallon** measure, xii  
**Galloway** cattle, 281  
**Gang** plow, 74  
**Garden** crops, 97  
     fertilizer for, 402  
     marker, 387  
     planning, 191, 192  
     plants, setting, 193, 194  
**Gardening**, chapter on, 191, xxiii  
     landscape, 202  
     ornamental, 202  
     school, 198-202  
     success in, 191  
     vegetable, 191  
**Gas** engine, carburetor, 395  
     compression, 396  
     mixtures, 395  
     operation, 395  
     spark system, 397, 400  
     troubles, 399  
     valves, 398  
     injuries, 399  
     starting, 399  
**Gate** latch, 387  
**German** coach horses, 267  
     black bees, 322  
**General-purpose** chickens, 312  
     horses, 263  
**Ginseng**, shelter for, 183  
**Glaciers** as soil formers, 49, 50  
**Gluten** meal, 335  
**Good** roads, 371  
**Gooseberries**, 216, 217  
**Grades** defined, 260  
     high, 261  
**Grafting**, cleft, 40, 41  
     wax, making, 37  
**Grain**, drill, 156  
     heads of, 161  
     moth, 230, 231  
     remedy for, 231  
     samples of, 159  
     sifting and fanning, 22  
     small, 154  
     smut, 253, 254, 255  
**Grapes**, 216, 217  
**Grass** seed, good and poor, 25  
**Grasses** for soiling, 99  
**Gravel**, 59, 63  
**Green** crops as manures, 75  
     forage crops, 332  
     manure, 56  
         benefits of, 76  
         for potatoes, 164  
         planning for, 76  
         plowing under, 72  
         use of, 76  
**Grit** boxes, 313  
**Ground** beetle, 239  
**Grub** of beetle, 224  
**Guard** cells, 12  
**Guernseys**, 286, 287  
  
**Hackney** horses, 267  
**Halter**, rope, 382  
**Hampshire** sheep, 294  
     swine, 302  
     Hardy vegetables, 193  
**Harrowing**, effect of, 64, 65  
     pastures, 109  
**Harrow**, spike-toothed, 66  
**Harvesting** corn, 145, 146, 147  
     grain, 156, 157, 158  
     potatoes, 170, 171  
     sweet potatoes, 173  
**Hawks**, 241, 242  
**Hay** as feed, 332  
     caps for alfalfa, 114  
     fertilizers for, xv  
     in rotation, 93  
     measure of, xi  
**Hayrack** lifter, 385  
**Hay-stacking** machine, 115  
**Heading**, see *Pruning*  
**Hedge-row** system, 214, 215  
**Henry**, W. A., credit given, xvi  
**Heredity**, law of, 259  
**Herefords**, 280, 281, 289  
**Highways** in United States, 371  
**Hill-row** method, 214, 215  
**Hives**, 323, 325  
**Hog** cholera, 306  
**Holstein-Friesians**, 286, 288  
**Holstein**, pedigree of, x  
**Home** plot for school garden, 202  
**Honey-bees**, 239  
     poisoning, 256  
     -making, 323  
**Hoppers** for chickens, 315, 316  
**Horses**, age of, 273  
     care of, 271  
     chapter on, 262, xxiv  
     examining in barn, 271, 272  
     feed for, xvi  
     inspecting, 271, 272  
     judging, 274  
     measurements of, 273  
     origin of, in America, 262  
     points of, shown, 274  
     pure breeds of, 263  
     types of, 263  
     unsoundness of, 273  
**Horticultural** crops, 97  
**Horticulture** defined, 191  
**Hot-bed**, 194, 195, 196, 199  
     for sweet potatoes, 172  
     plants from, 173  
**Houdon** chicks, Fig. 197  
**House** fly, 332, 333  
     for chickens, 314, Fig. 198  
     for pigs, Fig. 188  
**Humus**, 55, 58, 59, 63  
**Husking** and shredding machines, 147  
**Hydraulic** ram, 401  
**Hydrosopic** moisture, 60, 61  
  
**Improvement**, kinds of 72  
     of animals, 259, xxiv  
     of soils, 71, xx  
**Impurities** of seeds, 28  
**Incubator**, running an, 317, 318  
**Inoculation** of soils, 112

- Insecticides, 220, 221, 258, v  
 Insects, beneficial, 239  
   breathing of, 222  
   cages for, 225, 226  
   changes of, 223  
   chapter on, 220, xxiv  
   enemies, 225  
   feeding of, 220  
   growth of, 222, 223  
   moulting of, 222  
   mounting of, 226  
   skeleton of, 223  
   specimens of, 238  
   structure of, 220  
 Inventory, an, 366, 367  
 Iodine test for starch, 13  
 Irrigation of the garden, 192  
 Italian bees, 322
- Jersey cattle, 285, 287  
 Journal ruling for records, 365  
 Judging corn, rules for, 134, 139  
   cattle, 291, 292  
   horses, 275, 277  
   sheep, Fig. 184  
   swine, 308, Fig. 187
- Kaffir for soiling, 100, 102  
 Keeping farm accounts, 364, 365  
 Kernels of corn, 134, 137  
 Kerosine emulsion, 222, v, vi  
 Kinds of forest trees, 182, 183, 189  
   190  
 King system of ventilation, 349  
   350
- Ladders used in picking fruit, 218  
 Lady-beetle, 239, 240  
 Lambs, winter or hot-house, 192  
 Land drainage, chapter on, 67, xx  
   measuring, xi  
 Landscape gardening, 202  
 Lard type of swine, 299, Fig. 185  
 Larva of insects, 221, 223, 224  
 Lattice shade for nurseries, 183  
 Laws of breeding, 259  
   protecting birds, 244  
 Layering, tip, mound, vine, 41  
 Leaf curl of peach, 248, 250  
   skin of, 11  
   structure, 10  
 Lean type of swine, 299, Fig. 185  
 Leaves, chlorophyl in, 11  
   moisture from, 10, 11  
   of plants, 10  
   openings in, 11  
   stomates in, 11, 12  
 Legal milk, 352  
   weights of grain, ix  
 Leghorn hen, Fig. 189  
 Legumes defined, 192, 103  
   gather nitrogen, 103  
   learning, 103  
 Leicester sheep, 293  
 Lens, use of, in examining seeds, 24  
 Life, duration of, 20  
   of insects, 223  
 Light horses, 263, 267, 268  
   see *Sunlight*  
 Lime and sour soil, 78
- Lime and scab, 252  
   benefits of, 77  
   for pastures, 109  
 Lime in soil, 55, 58, 59  
   slacking, 77  
   -sulfur, 247, 250, 256, 258  
     forms of, vii, viii  
     water, 77  
 Liming for alfalfa, 112, 116  
 Lincoln sheep, 294  
 Linseed meal, 336  
 Little-peach diseases, 249, 252  
 Loam, 52, 54, 56, 58, 59, 63  
 Loose smut of oats, 254  
 Loss from feeds, 331
- Macadam roads, 372  
 Maggot of fly, 234  
 Malaria mosquitoes, 226, 227  
 Manure and scab, 235  
   care of, 80  
   composition of, xviii  
   composts, 82  
   for pastures, 109  
   green, 55, 72, 75, 76  
   heating of, 79  
   leaching of, 79  
   loss in, 79  
   spreading, 80, 81, 82  
   using, 81  
   value of, 78, 79  
 Mapping the farm, 362  
   school grounds, 363  
 Market, fruit ready for, 218  
   garden crops, 97  
   milk, form of, 351, 352  
 Marl, 52  
 Masses of trees and shrubs, 203  
   204, 205  
 Matted row system, 214, 215  
 Measure, cubic, and land, xi  
   of a pound of feed, xv  
 Meat breeds of chickens, 306, 308  
 Men needed in farming, 361  
 Merino sheep, 295, Fig. 182  
 Metamorphosis, see *Changes*  
 Middlings of wheat, 335  
 Milk as food, 344  
   bacteria in, 347  
   bad flavor in, 347  
   composition of, 345  
   fats in, 345  
   minerals in, 346  
   pails, 349, 350  
   pure, 348  
   showing difference in, 346  
   sugar in, 346  
   varies naturally, 346  
 Millets for soiling, 99  
 Mill feeds, 335  
 Mineral matter, 330  
   in milk, 346  
   plants, 16  
 Mixed planting, reasons for, 185  
 Modern agricultural teachings, 368  
 Modified milk, 353  
 Moisture increasing in soil, 64  
   saving in soil, 64, 65  
   used by plants, 62



- Morgan horse, 270  
 Mosquitoes, 224, 225  
   malaria, 226, 227  
   yellow fever, 227, 228  
 Moth, clothes, 230  
   grain, 230, 231  
 Motor trucks, 391  
 Mouldboards, forms of, 74  
 Moulting of insects, 222  
 Mouth parts of insects, 220  
 Movement of moisture, 62  
 Mowing pastures, 109, 110  
 Muck, 55  
 Mulch, effect of, 65  
   dust, 65  
 Mules, classes of, 268  
 Mutations defined, 260  
  
 Native stock, 261  
 Nitrate of soda, 84, 86, xii, xiv  
 Nitrogen, xii, xiv  
   fertilizers, 83  
   in feeds, xv  
   manures, xvii  
 Nodules on legumes, 103, 104  
   studying, 113  
 Nozzles for spraying, 357  
 Nutrients, 332  
 Nutritive ratios, 340  
 Nymph stage of insects, 225  
  
 Oat smut, treatment, 254, 255  
 Oats, 156, 157, 158  
   and grain for soiling, 101  
   hay, 100  
   for peas, 99, 100  
   in rotation, 95  
   as feed, 335  
   fertilizers for, xii  
   in rotation, 92, 93  
 Oil meal, 336  
   presence of, 330  
 Olericulture defined, 191  
 Ornamental chickens, 311, 312  
   gardening, 202, 203  
   planting, 188  
 Orchard cover crops, 92, 211  
   culture, 211, 213  
   site and soils, 206, 207  
   trees, pruning, 207, 208  
   setting, 207  
   when to plant, 207  
 Osmosis defined, 14  
   use of, 14  
   with egg, 15  
   with potato, 15  
 Owls, 342  
 Oxford sheep, 294, Fig. 178  
 Oxygen in plants, 13, 14  
   and air, 16, 17  
  
 Pageants, 7  
 Palatability of feed, 341, 342  
 Parasites of insects, 240  
 Paris green, 258, v  
 Pasture, in rotation, 93  
   plants, 108  
   system, 101  
 Pastures, bad conditions in, 109  
   how to keep, 109, 110  
  
 Pastures, permanent, 108  
 Peach culture, 211  
   leaf curl, 248, 250  
   scab, 247  
   tree borer, 235  
  
 Peach varieties, 212, 213  
   yellows, 247, 248, 251  
 Peaches injured by curculio, 235  
 Pea root nodules, 104  
 Peaty soil, 52, 55, 59, 63  
 Pedigree, sample, x  
 Pedigrees, 261  
 Percherons, 264  
 Perennial weeds, 30  
 Perennials defined, 20  
   place for, in garden, 192  
 Perfect strawberries, 216  
 Permanent pastures, 108  
 Phosphate rock, 84  
 Phosphoric acid, xii, xiv  
   in fertilizers, 84, 85  
   in feeds, xv  
   in manures, xvii  
 Phosphorus, study of, 85  
 Picking and packing fruit, 218  
   bag for fruit, 387  
 Pig management, 308  
 Pipe wrench, 387  
 Pistillate strawberries, 216  
 Plan for farm school, 194  
   school grounds, 198  
 Planting crops, 362  
 Plans for planting shrubs, 204, 205  
 Plant diseases, 246, 247  
   prevention of, 247  
   studying, 247  
   food in soils, 15, 58, 59  
   improvement, chapter on, 22  
   xix  
 Planting corn, 144  
   experiment, 144  
   distances for fruits, xviii  
   vegetables, xviii  
   mixed, for trees, 185  
   ornamentals, directions for, 205  
   potatoes, 167  
   principles of, 203  
   time of, 192  
   trees, 179, 180, 181  
   methods of, 181, 188  
   need of, 179, 181  
   on the farm, 181  
   vegetables, 193  
 Plants and moistures, 10, 11  
   as soil formers, 45, 48  
   breathing of, 12  
   division of, 42  
   feeding of, 83  
   flowers of, 8, 17  
   for pasture, 108  
   get food from air, 12  
   leaves of, 8, 10  
   mineral matter in, 10, 11, 14  
   needs of, 16  
   parts of, 8  
   per acre for vegetables, xviii  
   roots of, 8,  
   stems of, 8, 9  
   water used by, 62

- Plowing, depth of, 64, 75  
   fall, 74  
   for potatoes, 164  
   objects of, 72, 73  
   with tractors, 391  
 Plows, form of, 73, 74  
   gang, 74  
 Plum curculio, 233, 234  
 Plymouth Rock hen, 312, Fig. 193  
 Poison for insects, 394  
 Poland China swine, 300, Fig. 185  
 Polled Angus, 281  
   cattle, origin of, 260  
   Durhams, 280  
 Pollen, how carried, 18  
 Pollination, cross, 19  
   of corn, 19  
   self, 19  
 Pony breeds, 263  
 Pore spaces in soil, 62  
 Potash, xii, xiii  
   fertilizers, 85  
   in feeds, xiv  
   manures, xvi  
   muriate of, 85  
   sulfate of, 85  
 Potato beetle, 231, 232  
   diggers, 171  
   harvesting, 170, 171  
   scab, 252, 253  
 Potatoes, chapter on, 162, xxii  
   blight, 169, 170  
   cultivation of, 168  
   diseases, 169, 170  
   fertilizer for, 164  
   crops, 167  
   importance, 160  
   insects, 168, 169  
   Irish, 162  
   origin and types, 162, 163  
   planting, 167, 168  
   plowing, 164  
   score card, 166  
   second crop, 167  
   seed, 164, 165, 166  
   soil, 163  
   spraying, 169  
   treatment for scab, 255  
   varieties, 165, 166, 168  
   weights and yields, 171  
 Poultry, care of, 317  
   chapter on, 311, xxv  
   projects, 320  
   rations, 315, 316  
 Powdered milk, 352  
 Power animal, 401  
   electric, 400  
   on the farm, 391  
   water, 400  
   wind, 401  
 Principles of planting, 203  
   of spraying, 257, 258  
 Problems, 7, 16, 307, 319  
   arithmetical, 4  
   feeds, 342  
   fertilizers, 87  
   on eggs, 320  
 Products of cattle, listed, 344  
 Projects, xix, 297, 308, 320  
   the dairy, 344  
 Propagation of forest trees, 182,  
   183, 184  
   plants, 35, xx  
 Property, value of, 366  
 Protein, 328  
   in feeds, xvi  
 Pruning a budded tree, 38  
   annual, 208  
 Pruning, care in, 210  
   choice in, 209  
   currants and gooseberries, 217  
   grapes, 217  
   high and low, 208  
   illustrated, 208-211  
   instruments, 210, 212  
   methods of, 209, 210  
   practice in, 210  
   principles of, 207  
   raspberries and blackberries,  
   217  
 Pruning small fruits, 216  
   time for, 210  
   young trees, 208  
 Pupa stage, 223  
 Pure-bred animals, 260  
   milk, difficulty in obtaining, 347  
   how to get, 348  
 Purity of corn, 136  
 Quantity of seeds for crops, ix  
 Questions, review, see end of each  
   chapter  
 Rag doll corn tester, 142  
 Rainfall, absorbing, 63  
   and frost, 197  
 Rambouillet sheep, 297  
 Raspberries, 216, 217  
 Rations balanced, 340  
 Records for dairy cows, 355, 356  
   of fields, 365  
 Red polled cattle, 283, 284  
 Reference books, i  
   tables, appendix, i  
   to books, 60  
 References to bulletins, see *Bulletins*  
 Remedies for codling-moth, 233  
   curculio, 234  
   flies, 229  
   grain moth, 231  
   mosquitoes, 227  
   potato scab, 252, 253  
   scale, 238  
 Reversion defined, 260  
 Review questions, see end of each  
   chapter  
 Rings of wood, 187  
 Ripened milk and cream, 353  
 Roads, concrete, 372  
   construction of, 373, xxvii  
   drainage of, 374  
   drag for, 373  
   earth, 373  
   grade of, 373  
   gravel, 372  
   importance of, 371  
   kinds of, 372  
   maintenance, 373  
   mechanics, 371

- Roads, reasons for, 372  
 Robin arithmetic, 242  
 Roof garden, 201  
 Root crops, 97, 333  
   for dairy cows, 100  
   grafting, 36, 37  
   hairs, 8, 9  
   system of corn, 146  
 Roots, effects of drainage on, 68  
   for chickens, 213  
   of plants, 8  
 Rope, halter, 382  
   hitches, 378, 379  
   how made, 376  
   knots, 376, 377, 378  
   splices, long, 381  
   short, 380  
 Rotation courses, 94  
   of crops, benefit of, 90  
   need of, 90  
   reasons for, 88  
   for dairy farms, 92  
 Rotations, a few, 92  
   quick, 93  
 Roughage, 332  
 Rows of kernels on corn, 139  
 Rules for alfalfa growing, 131, 132  
   corn judging, 134, 139  
   farmers, xi  
 Rust of apple, 205, 251  
 Rye, 158, 159  
 Saddle horse, 268, 270  
 Salesman, the farmer a, 365  
 Sampling milk to test, 357  
 Sandy soil, 52, 54, 59, 63  
 San Jose scale 237, 238  
 Scab of apples, 249, 250  
   potato, 252, 253  
 Scale, San Jose, 237, 238  
 Schedule for placing agriculture, 4  
 School gardening, 198, 202  
   equipment, 199  
   experiments, 200, 201  
   in California, 192  
   place for, 199  
   plots, 198, 202  
   products of, 202  
   suggestions for, 199, 200  
   grounds described, 204  
   mapping of, 363  
   needs of, 204  
   plans for, 198  
 Scions for apples, 35, 37  
   peaches and plums, 39  
 Score card for cattle, 291, 292  
   corn, 140  
   horse, 275, 277  
 Scrub, see *Native Stock*  
 Seed analysis, 25  
   cheap, 27  
   collection, 27  
   corn, harvesting, 145  
   storing, 145, 147  
   depth of planting, 193  
   for crops, quantity, 367  
   good, chapter on, 22  
   immature, 27  
   impurities, examining for, 28  
   potatoes, cutting, 166  
 Seed treating, 253  
   samples of, 30  
   selection, 22, 23  
   testing, 25  
   what to buy, 27  
   wheat, 156  
 Seedling alfalfa, 112, 116  
   oats, 157  
   pastures, 109  
 Seeds, forest tree, 182, 183, 184  
   mounted, 29  
   purpose of, 20  
   structure of, 20  
   study of, 20  
 Selecting corn, rules for, 134, 139  
 Separators, hand, 354  
 Shallow tillage, 75  
 Sheep, care of, 295  
   chapter on, 293, xxv  
   feed for, 406  
   projects, 297  
   to kill weeds, 110  
   types of, 293  
 Shelter belts, 180, 181, 182, 185  
 Shire, English, 265  
 Shorthorns, 279, 280  
 Shorts, 335  
 Shropshire, 294, Fig. 179  
 Shrubs, masses of, 203  
 Sifting, grain, 22  
 Silage, see *Ensilage*  
 Silk worm, 239  
 Silo, capacity of, 149  
   filling, 148, 334  
   masonry, 149  
   metal, 149  
   stave, 149  
   underground, 149  
 Silt, 52  
 Site for orchards, 206  
 Skim milk, 356, 359  
 Slips, see *Cuttings*  
 Small fruits, to grow, 207  
   grains, chapter of, 154, xx  
 Soil, agencies in forming, 45  
   and fertilizers of, 154  
   builders, 45  
   clayey, 52, 53, 54, 59, 63  
   defined, 44  
   farm, 58  
   for barley, 158  
   improvement, chapter on, 71,  
   xx  
   kinds of, chapter on, 52, xx  
   loamy, see *Loam*  
   moisture, chapter on, 60, xx  
   names of, 59  
   oats, 157  
   packing of, 62  
   perfect, 58  
   plant-food form, 15  
   potatoes, 163  
   preparation for corn, 143  
   rocky, 53  
   sampling, 59, 60  
   sandy, 52, 54, 59, 63  
   texture of, 57  
   transported, 50, 51  
   warmed by drainage, 69  
   wind-blown, 45, 51

- Soiling crops, 98, 99, 333  
 entire, 98  
 for the dairy, 98  
 partial, 98, 101  
 system, 98
- Soils, characteristics, chapter on, 52  
 how formed, chapter on, 44  
 inoculation of, 112  
 water-holding power, 62, 63  
 in, 60, 63
- Soluble oil, 238
- Sorting and grading fruit, 218, 219
- Souring of milk, 351, 353
- Southdown sheep, 294, Fig. 177
- Soy beans, 92, 99, 104
- Spark system, 397
- Specimens, preserving, 238, 239
- Sphinx caterpillar, 241
- Sports defined, 260
- Spray mixtures, v  
 time to, 249, 255, 256, 257
- Spraying, 246, 250, 255, 258  
 orchards, 255, 257  
 principles, 257
- Standardized milk, 352
- Standards of feeding, 339, 362
- Starch, 329  
 in plants, 13
- State experiment stations, iii
- Stems of plants, 9  
 relation of light, 10  
 sap in, 10
- Steps in churning, 354  
 cheese-making, 355
- Stock feeding, 337
- Stocks for apples, 35  
 peaches, 38, 39
- Stomates, 11, 12
- Storage of sweet potatoes, 173
- Stored grain, treatment of, 231
- Storing corn, 147, 151, 152  
 vegetables, 196
- Stover corn, 147, 152
- Stratifying peach seeds, 39
- Straw as feed, 332
- Strawberries, 214, 215, 216  
 flowers of, 216  
 methods of planting, 214  
 varieties of, 216
- Structure and physiology of plants  
 chapter on, 8
- Subjects in school, 4, 5
- Subsoil and plow, 58
- Success, elements of, 363  
 in gardening, 191
- Succulent feed, 316
- Sucking insects, 220, 221  
 sprays for, v
- Suffolk Punch, 266
- Sugar in milk, 346  
 plants, 13
- Sugars, 329, 330
- Suggestions to teachers, 2, xix
- Sunlight aids plants, 12, 13
- Super for hives, 325
- Superphosphate, 85, 87
- Surveys, swine, 308
- Swarming of bees, 325
- Sweeps, 402
- Sweet corn, 100, 101, 102  
 potatoes, 171, 172, 173  
 cultivation, 173  
 fertilizer for, xiii  
 harvesting, 173  
 hot-bed, 173  
 soil for, 171  
 storage, 173
- Swine, chapter on, 298, xxv  
 contests and debates, 309  
 feed for, xvi
- Swine, four stages in life of, 305  
 mineral for, 304  
 types of, 299
- Syrian bees, 322
- System in farming, 362
- Systems, cropping, 88, xxi
- Tables, consult Appendix, :
- Tachinid fly, 229
- Tamworth swine, 300, Fig. 186
- Tankage, 84
- Teachers, suggestions to, 2
- Temperature and souring, 350, 351  
 in soil farming, 45, 46
- Temperatures, 16
- Tender vegetables, 193
- Tester for ear method, 141
- Testing milk and cream, 355, 359  
 results, 142  
 seed corn, 140
- Thinning plants, lessons in, 201
- Thorax of insects, 220
- Thoroughbred, 260, 267, 269
- Three-horse eveners, 385
- Tillage, 72, 75  
 of corn, 145
- Timber crops, 98
- Time to prune, 210
- Tips of corn, 136
- Toads destroy insects, 240
- Tobacco, care of, 176, xxiii  
 curing, 177  
 harvesting, 176  
 nicotine in, 175  
 seeding, 176  
 soil for, 175  
 sorting, 177  
 transplanting, 176  
 types, 175  
 varieties, 177  
 where grown, 175
- Tomatoes, fertilizer for, xiii
- Tongue graft, 36
- Tractors, for belt machine, 394  
 for implements, 392, 394, 396  
 plowing with, 391  
 sizes of, 392
- Tread mills, 402
- Treatment of seed potatoes, 253
- Tree planting, 179, 188  
 Arbor Day, 188  
 seeds, 182, 183, 184
- Trees and water supply, 180, 181  
 kinds of, 182, 190  
 raising of, 35  
 shape of, 180  
 top-working, 40
- Tripe, swine, 308
- Trotter, American, 268, 269

- Tuber crops, 97  
 Type of corn, 135  
 Types of cattle, 279  
   horses, 263  
   wheat, 154, 155  
 Typhoid flies, 229  
  
 Underdrainage, effects of, 64  
   principles of, 69  
 Unsoundness in horses, 273  
  
 Value of manures, xvii  
   poultry, 311  
   the farm, 367  
 Variation among animals, 260  
   in milk, causes of, 346  
   laws of, 260  
 Varieties of chickens, 306, 309  
   fruit, 316, 317  
 Vegetable gardening, 191, 197  
   matter in soil, 55  
 Vegetables, hardy and tender, 193  
   planting distances for, xviii  
 Ventilation by drainage, 69  
   of barns, 349, 350  
 Vetch, 99  
 Vines on buildings, 204  
   vitality of seed corn, 136  
  
 Wagon jack, 387  
 Wasp with cica da, 241  
 Water, capillary, 60-64  
   free in soils, 60, 61  
   in flesh, 327  
   plants, 14  
   soils, 60, 63  
 Water in soil formation, 46, 47, 48  
   influenced by trees, 180, 181  
 Wax for grafting, 37  
 Waxing cotton for grafting, 37  
 Weathering of rocks, 46  
  
 Weed nuisance, 27  
   seeds, identifying, 25  
     sprouting, 112, 116  
 Weeds classified, 28, 32, xix  
   collecting, 38  
   common, table of, 33  
   defined, 28  
 Weeds, fighting perennial, 31  
   persistent, 30  
   preventing, 75  
   spraying, 31  
 Weevils, treatment for, vi  
 Weights of seeds, ix  
 Wet mashes for chickens, 316  
 Wheat, 154, 155, 156  
   fertilizer for, xii  
   good and poor, 23  
   harvesting, 156  
   heavy seed, 156  
   in rotation, 92, 93  
   planting, 155  
   soil for, 155  
   types of, 154, 155  
 Whip grafting, 36  
 Wind-breaks, 180, 181, 182  
   for poultry, 311  
 Windmills, 401  
 Wings of insects, 314  
 Wood lot, 179, 181, 189  
   mounted samples, 187  
   rings of, 187  
 Wool, samples of, 296  
   yolk of, 295  
 Wrigglers of mosquitoes, 224, 226  
   227  
 Wyandotte hen, Fig. 194  
  
 Yellow fever mosquitoes, 227, 228  
 Yellows of peach, 247, 248, 251  
 Yorkshire, large, 300  
 Young animals, feeding, 339

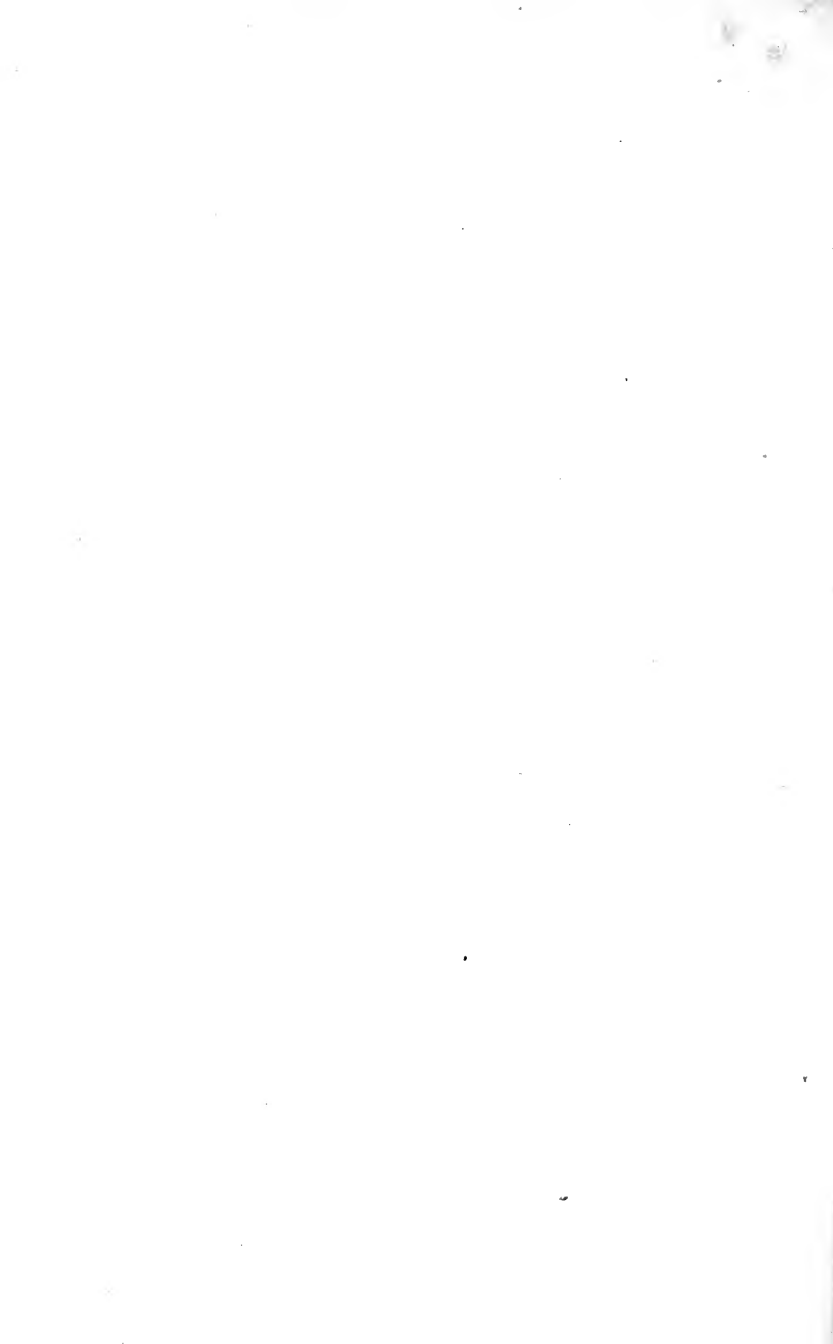












Take Back your heart  
I missed you  
Love + R + you

