



This is a digital copy of a book that was preserved for generations on library shelves before it was carefully scanned by Google as part of a project to make the world's books discoverable online.

It has survived long enough for the copyright to expire and the book to enter the public domain. A public domain book is one that was never subject to copyright or whose legal copyright term has expired. Whether a book is in the public domain may vary country to country. Public domain books are our gateways to the past, representing a wealth of history, culture and knowledge that's often difficult to discover.

Marks, notations and other marginalia present in the original volume will appear in this file - a reminder of this book's long journey from the publisher to a library and finally to you.

Usage guidelines

Google is proud to partner with libraries to digitize public domain materials and make them widely accessible. Public domain books belong to the public and we are merely their custodians. Nevertheless, this work is expensive, so in order to keep providing this resource, we have taken steps to prevent abuse by commercial parties, including placing technical restrictions on automated querying.

We also ask that you:

- + *Make non-commercial use of the files* We designed Google Book Search for use by individuals, and we request that you use these files for personal, non-commercial purposes.
- + *Refrain from automated querying* Do not send automated queries of any sort to Google's system: If you are conducting research on machine translation, optical character recognition or other areas where access to a large amount of text is helpful, please contact us. We encourage the use of public domain materials for these purposes and may be able to help.
- + *Maintain attribution* The Google "watermark" you see on each file is essential for informing people about this project and helping them find additional materials through Google Book Search. Please do not remove it.
- + *Keep it legal* Whatever your use, remember that you are responsible for ensuring that what you are doing is legal. Do not assume that just because we believe a book is in the public domain for users in the United States, that the work is also in the public domain for users in other countries. Whether a book is still in copyright varies from country to country, and we can't offer guidance on whether any specific use of any specific book is allowed. Please do not assume that a book's appearance in Google Book Search means it can be used in any manner anywhere in the world. Copyright infringement liability can be quite severe.

About Google Book Search

Google's mission is to organize the world's information and to make it universally accessible and useful. Google Book Search helps readers discover the world's books while helping authors and publishers reach new audiences. You can search through the full text of this book on the web at <http://books.google.com/>

PRODUCTIVE
PLANT HUSBANDRY

KARY C. DAVIS

WARM-UP TEXT SLIDES



EX LIBRIS

AGRIC. DEPT.



LIPPINCOTT'S
FARM LIFE TEXT SERIES

EDITED BY
KARY C. DAVIS, PH.D. (CORNELL)

PRODUCTIVE PLANT HUSBANDRY

LIPPINCOTT'S FARM MANUALS

Edited by K. C. DAVIS, Ph.D.

PRODUCTIVE SWINE HUSBANDRY

By GEORGE E. DAY, B.S.A.

PROF. OF ANIMAL HUSBANDRY, ONTARIO AGRICULTURAL COLLEGE, CANADA.
96 illustrations. xiii + 363 pages. \$1.75 net.

PRODUCTIVE POULTRY HUSBANDRY

By HARRY R. LEWIS, B.S.

POULTRY HUSBANDRYMAN, NEW JERSEY AGRICULTURAL
EXPERIMENT STATION.
330 illustrations. xxi + 536 pages. \$2.00 net.

PRODUCTIVE HORSE HUSBANDRY

By CARL W. GAY, B.S.A.

PROF. ANIMAL HUSBANDRY, CHAIRMAN ANIMAL HUSBANDRY SECTION,
DEPARTMENT OF AGRICULTURE,
UNIVERSITY OF MINNESOTA.
176 illustrations. xvi + 331 pages. \$1.75 net.

PRODUCTIVE ORCHARDING

By FRED C. SEARS, M.S.

PROF. OF POMOLOGY, MASSACHUSETTS AGRICULTURAL COLLEGE.
157 illustrations. xiv + 314 pages. \$1.75 net.

PRODUCTIVE VEGETABLE GROWING

By JOHN W. LLOYD, M.S.A.

PROF. OF OLERICULTURE, UNIVERSITY OF ILLINOIS.
194 illustrations. xiii + 339 pages. \$1.75 net.

PRODUCTIVE FEEDING OF FARM ANIMALS

By F. W. WOLL, Ph.D.

PROF. OF ANIMAL NUTRITION, UNIVERSITY OF CALIFORNIA.
106 illustrations. xii + 375 pages. \$1.75 net.

COMMON DISEASES OF FARM ANIMALS

By R. A. CRAIG, D.V.M.

PROF. VETERINARY SCIENCE, PURDUE UNIVERSITY.
124 illustrations. xii + 334 pages. \$1.75 net.

PRODUCTIVE FARM CROPS

By E. G. MONTGOMERY, M.A.

PROF. OF FARM CROPS, CORNELL UNIVERSITY.
204 illustrations. xix + 501 pages. \$1.75 net.

PRODUCTIVE BEE KEEPING

By FRANK C. PELLETT

STATE APIARIST OF IOWA.
135 illustrations. xiv + 302 pages. \$1.75 net.

PRODUCTIVE DAIRYING

By R. M. WASHBURN

PROF. OF DAIRY HUSBANDRY, UNIVERSITY OF MINNESOTA.
132 illustrations. xii + 393 pages. \$1.75 net.

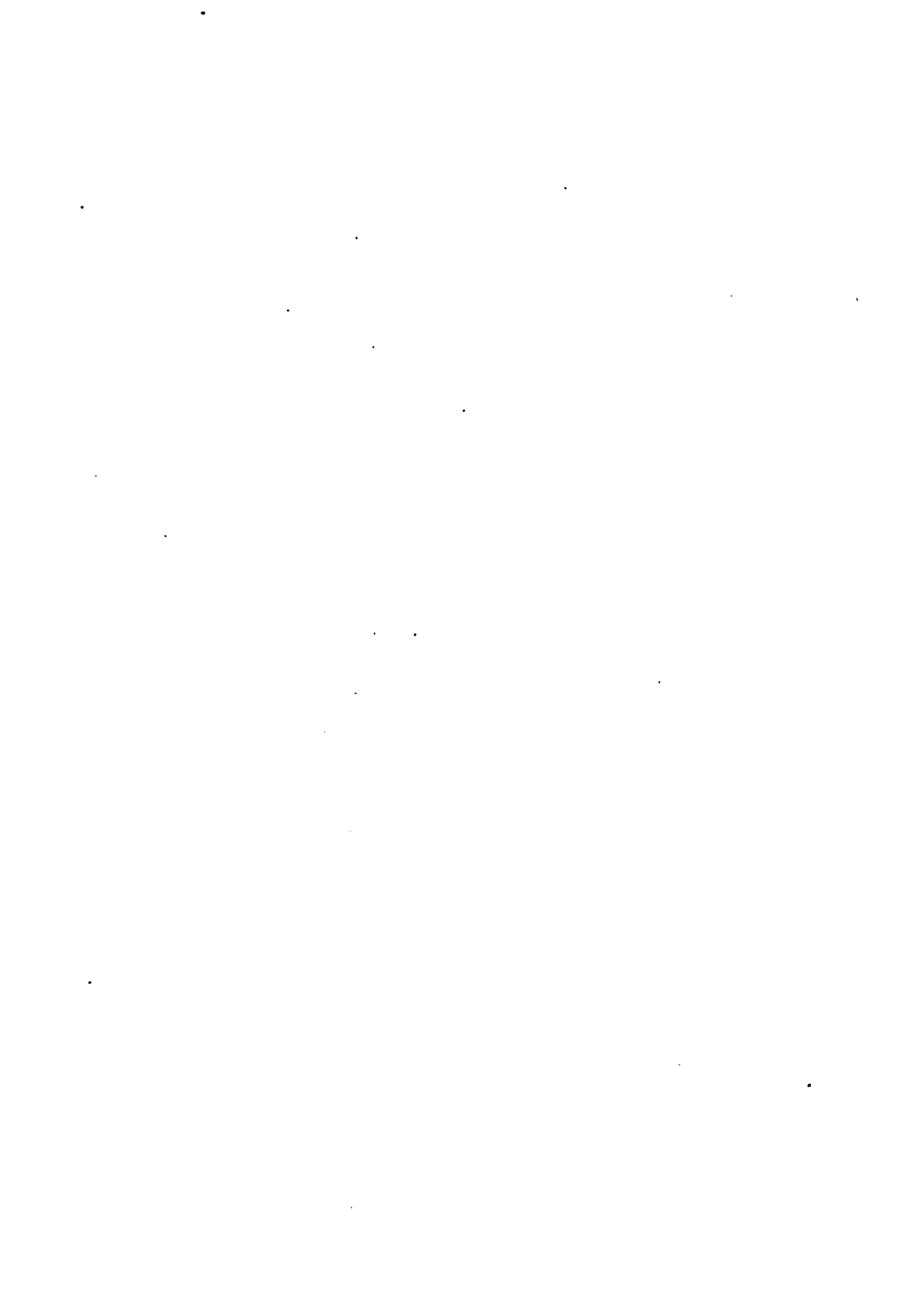

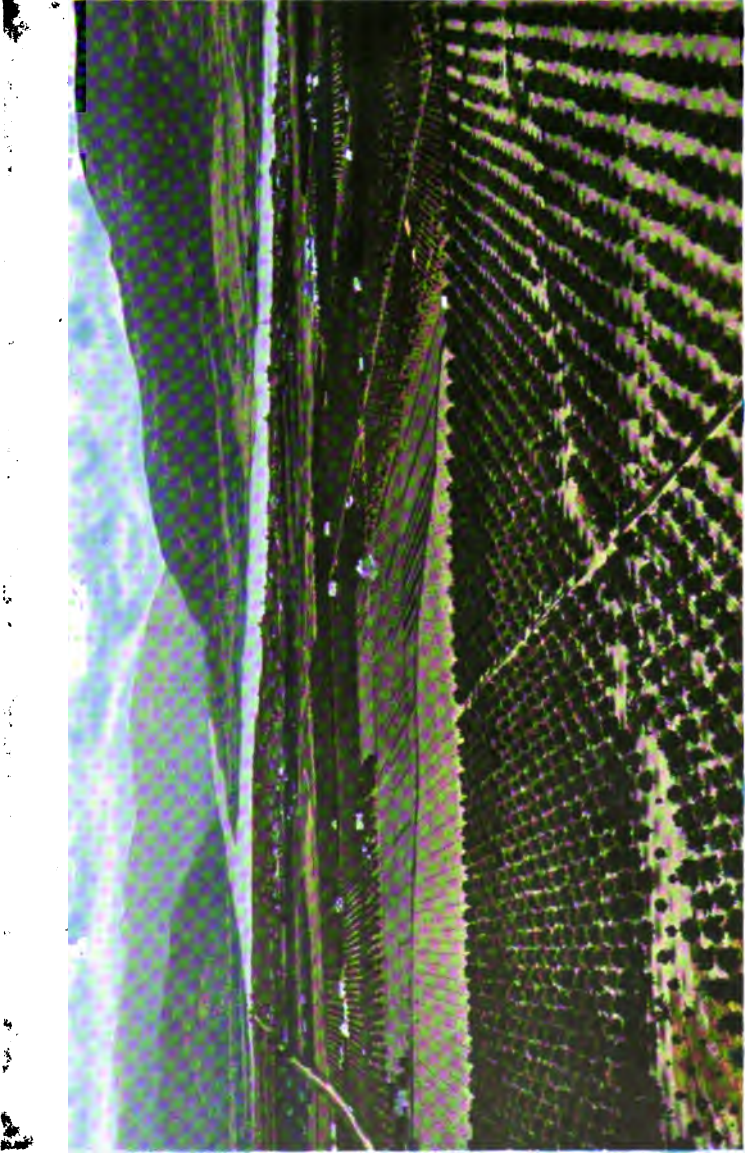

INTENSIVE FRUIT GROWING IN A WESTERN IRRIGATED SECTION. ALMOST EVERY FARMER IS AN ORCHARDIST.

FARM LIFE TEXT SERIES

EDITED BY K. C. DAVIS, PH.D. (CORNELL)

PRODUCTIVE PLANT HUSBANDRY

A TEXT-BOOK FOR HIGH SCHOOLS

INCLUDING PLANT PROPAGATION, PLANT
BREEDING, SOILS, FIELD CROPS, GARDEN-
ING, FRUIT GROWING, FORESTRY, INSECTS,
PLANT DISEASES, AND FARM MANAGEMENT

BY

KARY CADMUS DAVIS, PH.D. (CORNELL)

PROFESSOR OF AGRICULTURE, KNAPP SCHOOL OF COUNTRY LIFE, GEORGE PEABODY COLLEGE
FOR TEACHERS, NASHVILLE, TENNESSEE; AUTHOR OF PRODUCTIVE FARMING;
EDITOR OF LIPPINCOTT'S FARM MANUAL SERIES, ETC.

312 ILLUSTRATIONS



PHILADELPHIA & LONDON
J. B. LIPPINCOTT COMPANY

1917
-2-

AGRIC. DEPT.
1917

COPYRIGHT, 1917
BY J. B. LIPPINCOTT COMPANY

THE WASHINGTON SQUARE PRESS
PHILADELPHIA

*Electrotyped and Printed by J. B. Lippincott Company
The Washington Square Press, Philadelphia, U. S. A.*

PREFACE

A GLANCE at the table of contents will show that this book treats, first, the subject of plant life and growth, and methods of improving plants. A preliminary study of botany is not essential to the understanding of these lessons. Soils and their improvement and maintenance are next considered. The treatments of the various farm crops, including fruits, vegetables, field crops and forestry, are given in much more detail than in texts which attempt to include also the study of livestock. The latter is omitted from this book except as it enters into the discussion of the principles of farm management, the business of farming, or the principles of breeding. The enemies of crops—weeds, insects, and diseases—are considered somewhat fully. Much emphasis is laid upon the improvement of the home and the community.

The field and laboratory exercises at the close of each of the chapters are given so fully that it is believed they will be easily understood and may be readily followed.

The time allowed to complete the studies and the exercises in the book should be one school year. In many instances there are more exercises in field and laboratory work, suggested at the ends of the chapters, than can be performed by all students. A good plan may be to divide the exercises among the students. In other cases the materials may not be available in the particular region, but similar exercises will naturally suggest themselves. The different sections of the country have been in the writer's mind while preparing the text and suggesting the exercises.

More than 4,600 high schools are giving courses in agriculture. The courses offered vary from one-half to four years of agricultural work. In addition to these regular high schools there are many agricultural schools offering much more agriculture, and also giving courses in manual training for boys and home economics for girls. At the present day there is a tendency to formulate more systematic courses in the agriculture offered by high schools. In the past, too many have started with a one-year course of general agriculture and then later tried to change it by adding one, two, or three years of agricultural work. Students continuing under such a plan found that the first year of work

had covered much of the matter taken up in the following years. Such duplication is discouraging to the student, and less real progress is made in the instruction.

This book, including the study of soils and plant husbandry, offers a solution for this difficulty.

The book has had its origin in the discussions and plans formulated by the agricultural teachers of accredited high schools in conferences beginning in 1914. These conferences for southern states have been held and reports formulated in coöperation with the United States Department of Agriculture.

A decided effort has been made to get away from the one-year plan for the starting of the high school course in agriculture. There has also been a feeling that high school students should not be required to purchase too many separate text-books for each year of the high school course.

The plan, somewhat modified, would be:

High schools offering only one year of agriculture, should give—

A year of plant husbandry (with a view to adding a second year of animal husbandry later).

High schools offering two years of agriculture should give: *First year:* Plant Husbandry. *Second year:* Animal Husbandry (including Poultry).

High schools offering three years of agriculture should give: *First year:* Plant Husbandry. *Second year:* Animal Husbandry (including Poultry). *Third year:* Farm Mechanics and Engineering (half year). Farm Management and Accounting (half year).

High schools offering four years of agriculture should give: *First year:* Plant Husbandry. *Second year:* Animal Husbandry (including Poultry). *Third year:* Farm Mechanics and Engineering (half year). Farm Management and Accounting (half year). *Fourth year:* Dairying, or Poultry (half year). Feeds and Feeding, or Special Fruit Growing (half year).

Electives from the following may be substituted in the third year of three-year high schools, and in the last two years of four-year high schools: $\frac{1}{4}$ unit each of Fruit Growing, Vegetable Gardening, or Improvement of Home Grounds; $\frac{1}{2}$ unit each of Dairying, Animal Husbandry (Feeding), or Field Crops; $\frac{1}{4}$ unit each of Insects or Forestry.

In the high school curriculum the science work to be taken parallel with the agricultural course, should be of a practical nature. The biology should include additional studies in economic insects, birds, bacteria in relation to country life, and the main types of plant diseases. Physics or chemistry, or perhaps both of these sciences, can be given a strong practical trend.

This plan may or may not be preceded by agricultural lessons in the grades below the high school, but such an elementary course covering the whole field in a very brief way, would be helpful, and is recommended. Some Nature lessons in the grades may also be given, and these should have a practical and perhaps an agricultural trend.

In some instances it may be found advisable to reduce the

work offered in this book to one-half year. Such might be the case while adjusting the high school course to the new plan. If this be attempted it could be accomplished by omitting certain chapters which seem of least value in the particular locality. Some of the exercises suggested at the ends of chapters could then also be omitted if necessary.

The supplementary reading, offered by the references at the ends of the chapters, may be done wholly or in part, to suit the special needs of the course pursued.

The school equipment for laboratory work may be very simple, or it may be very elaborate, to suit the funds of the school. For example, in the study of soils, tin cans, lamp chimneys, and soil boxes may be used in place of expensive brass cylinders and similar apparatus.

Land for use in teaching high school agriculture is always helpful. It maintains the interest of students, makes the lessons more concrete, and inspires confidence in the work, among patrons. Large areas are not usually to be recommended, except for special agricultural schools. Plots may be either rented or owned. On them should be grown such crops as should be more grown in the community. Demonstrations in soil treatment, as liming, fertilizing, or subsoiling, may be carried on. Variety tests are valuable. Cultural methods may be shown.

Home projects suggested at the close of a number of these chapters will give valuable farm practice. Credit for such work should be given. It is as valuable as, and perhaps more so than, the school work itself. Of course the home gardens, club work, and home projects should always be under the guidance of the instructor. Satisfactory reports of the work should be made; and inspection of the progress of the work will be necessary from time to time.

Criticisms of the plan and subject matter of the book will be gladly received by the author.

K. C. DAVIS

NASHVILLE, TENN., April, 1917

ACKNOWLEDGMENTS

Credit should be given here to many who have aided the author in preparing this text book. Particular thanks are due to Mr. C. H. Lane, Chief Specialist in Agricultural Education, United States Department of Agriculture, whose suggestions regarding arrangement and content of subject matter have largely been followed. Mrs. Kary C. Davis has read and criticised the manuscript, made a number of the pen drawings, read the proofs and aided in a number of ways.

Thanks for the use of photographs or cuts are due John W. Lloyd, author of *Productive Vegetable Growing*; E. G. Montgomery, author of *Productive Field Crops*; A. D. Cromwell, author of *Agriculture and Life*; Alva Snyder, author of *Fights of the Farmer*; F. C. Pellett, author of *Productive Bee-Keeping*; F. W. Woll, author of *Productive Feeding of Farm Animals*; M. A. Blake, Horticulturist, New Jersey Station; Office of Illustrations, United States Department of Agriculture.

Credit for the illustrations furnished by these, as well as by others, is given under illustrations.

CONTENTS

	PAGE
I. PLANT LIFE.....	1
II. FLOWERS—SEED PRODUCTION.....	13
III. PRINCIPLES OF BREEDING.....	22
IV. APPLICATION OF PRINCIPLES TO FARM CROPS.....	34
V. FARM AND GARDEN SEED.....	44
VI. PROPAGATION OF PLANTS BY DIVISION.....	55
VII. SOILS AND THEIR USES.....	69
VIII. WATER IN SOILS.....	81
IX. CONSERVATION AND IMPROVEMENT OF SOILS.....	94
X. DRAINAGE AND IRRIGATION.....	126
XI. CROP ROTATIONS.....	137
XII. FORAGE CROPS—GRASSES.....	149
XIII. LEGUMINOUS CROPS.....	165
XIV. CORN.....	187
XV. SMALL GRAINS.....	205
XVI. POTATOES.....	224
XVII. SUGAR BEETS AND OTHER ROOT CROPS.....	239
XVIII. VEGETABLE GARDENING.....	254
XIX. THE CULTURE OF VEGETABLES.....	263
XX. COTTON GROWING.....	286
XXI. MINOR FIBRE CROPS.....	302
XXII. SUGAR CANE.....	314
XXIII. FRUIT GROWING.....	320
XXIV. SMALL FRUITS.....	337
XXV. PRODUCTS OF THE FOREST AND WOOD LOT.....	348
XXVI. TOBACCO.....	366
XXVII. WEEDS.....	372
XXVIII. ECONOMIC INSECTS.....	390
XXIX. PLANT DISEASES.....	409
XXX. METHODS OF CONTROLLING INSECTS AND PLANT DISEASES.....	417
XXXI. THE BUSINESS OF FARMING.....	434
XXXII. THE RURAL COMMUNITY.....	444



ILLUSTRATIONS

FIG.		PAGE
	Intensive Fruit Growing in a Western Irrigated Section... <i>Frontispiece</i>	
1.	Germinating Oats and Barley.....	2
2.	A Seedling Maple Tree.....	4
3.	A Self-balanced Aquarium.....	5
4.	A Section of Green Leaf Under Microscope.....	7
5.	Osmosis with a Bladder Membrane.....	9
6.	The Poppy Flower.....	13
7.	Ear of Corn in Full Silk.....	14
8.	Cross-section of Head of Wild Sunflower.....	15
9.	Ear of Corn from Isolated Corn Stalks.....	16
10.	Violet Showing Cleistogamic Flowers.....	17
11.	Larkspur Flowers.....	18
12.	The Honey Bee.....	19
13.	The Pistil of the Peanut Blossom.....	19
14.	Base of Peanut Plant.....	19
15.	Tobacco Flowers and Seed.....	20
16.	Seedling Carnations Showing Slight Variation.....	23
17.	Vegetable Trial Grounds.....	25
18.	Breeding Plants to Resist Root Disease.....	26
19.	The Modern Chrysanthemum.....	27
20.	Methods of Emasculation of Tobacco Flowers.....	28
21.	Methods of Wheat Breeding.....	29
22.	Tobacco Field Showing Bagged Plants.....	30
23.	Strong and Weak Tuber Units.....	35
24.	Potato Harvest.....	35
25.	Wheat Breeding in Minnesota.....	36
26.	Methods of Breeding Wheat.....	36
27.	Wheat Crossed with Pollen from Rye.....	37
28.	Variable Types of Johnson County Corn.....	38
29.	Prize Winning White Dent Corn.....	38
30.	Variation in the Apex of Heads of Timothy.....	40
31.	Variation in Thickness of Heads of Timothy.....	40
32.	Variation in Length of Heads of Timothy.....	41
33.	Potato Seed Cases.....	42
34.	Potato Seedlings.....	42
35.	Potato Seedlings Showing Variations.....	42
36.	Lens.....	44
37.	Preserving Seed Samples.....	45
38.	Student's Collection of Seeds.....	45
39.	School Set of Economic Seeds.....	46
40.	An Inexpensive Fanning Mill.....	46
41.	Map Showing Sources of Vegetable and Flower Seeds in United States.....	51
42.	Chief Districts for Grass and Forage Seeds.....	52
43.	A Single Sweet Potato Showing Sprouts.....	55
44.	A Field of Young Bulbs.....	57
45.	Mother Hyacinth Bulbs.....	57
46.	An Excellent Crop of Young Bulblets.....	58
47.	Tip Layering.....	59

48. Vine Layering.....	59
49. Mound Layering.....	59
50. Making Hard Wood Cuttings.....	60
51. Methods of Making Hardwood Cuttings.....	61
52. Methods of Placing Hardwood Cuttings in a Trench.....	61
53. Three Steps in the Budding Operation.....	62
54. The Growing of the Young Shoot.....	63
55. Sweet Cherry Trees During Their First Season's Growth.....	64
56. Apples are Commonly Propagated by Root Grafting.....	65
57. Students Setting Out Rooting Grafts in Garden Rows.....	66
58. A Quiet Lily-pond.....	70
59. A Soy Bean Nitrogen Factory.....	72
60. When Eroding Fields are Neglected.....	74
61. Hillsides.....	75
62. Hillsides May be Terraced to Prevent Erosion.....	76
63. Moisture Conservation Methods for Wheat.....	82
64. Moisture Conservation Methods for Corn.....	83
65. Common Lamp Chimneys as Soil Containers.....	84
66. Placing Dynamite and Fuse in Drill Hole.....	86
67. The Acme Harrow is a Good Clod Crusher.....	88
68. The Weeder.....	89
69. Ridging the Soil.....	90
70. Tractor with Wheels of the "Caterpillar" Type.....	96
71. The Disk Harrow.....	97
72. Loosening the Subsoil With Dynamite.....	97
73. A Spring Tooth Harrow.....	98
74. The Common Spike Tooth Harrow.....	99
75. Plowing Under a Green Manure Crop of Rye.....	101
76. Diagram Showing Comparative Manurial Values of Feeding Stuffs.....	104
77. Manure Left in Piles in Barnyard.....	105
78. Liming the Soil.....	109
79. Equivalents in the Different Forms of Lime.....	112
80. Lime May be Spread With a Manure Spreader.....	113
81. The Spreading of Lime or Fertilizer.....	113
82. Diagram Showing the Mixture of Fertilizers.....	114
83. Glade Land in a Mountainous Region.....	127
84. Students Surveying for Drainage Lines.....	128
85. Students Placing Tile in Ditch for Land Drainage.....	129
86. Diagram of Acreage of Crops Irrigated in 1909.....	130
87. A Dam of Wood and Earth.....	131
88. Elephant Butte Dam, Messilla Valley, N. M.....	132
89. A Dredge Digging a Ditch for Irrigating an Extensive Area.....	133
90. Irrigation of Wheat by Open Furrow Method.....	134
91. Peanuts.....	139
92. Just Right for Hay Making.....	140
93. Diagram Showing Rotation of Crops.....	143
94. Another Plan for a School Farm.....	143
95. A Ten-acre School Farm Showing the Building Facing South.....	144
96. A School Farm Plan in Which School Building Faces West.....	144
97. Tall Meadow Oat Grass.....	152
98. Hay Demonstration in South Carolina.....	153
99. Types of Grain Sorghums.....	153
100. Kafir Corn.....	154
101. Timothy.....	155
102. Kentucky Blue-Grass and Canada Blue-Grass.....	156

103. Redtop is Well Suited to Low, Sour Soils	157
104. Orchard Grass	157
105. Smooth Brome-grass	158
106. Common Millet	159
107. Sudan Grass	160
108. A Crop of Mixed Timothy and Clover	161
109. The Side Delivery Hay Rake	161
110. The Hay Loader	162
111. Baling Straw With Engine-driven Press	162
112. Young Plant of Red Clover	166
113. Hulling Red Clover Seed	167
114. White Clover	168
115. Crimson Clover	169
116. The Crown Root and Nodules of Alfalfa Plant	170
117. Early Rather Than Late Fall Sowing of Alfalfa	171
118. The Seeds of Dodder	172
119. Dodder is a Parasite Weed	173
120. The First Cutting of Alfalfa	174
121. Alfalfa in Virginia	174
122. Making the Fourth Cutting of Alfalfa	174
123. Stacking Alfalfa in South Carolina	175
124. It Pays to Use Hay Caps in a Moist Climate	175
125. Cowpeas Grown in a Peach Orchard	176
126. The Soy Bean Plant	178
127. Vetch Plants	179
128. The Tall Sweet Clover of the White Variety	181
129. Two Types of Peanuts	182
130. Map of Corn Distribution, 1909	188
131. One Hundred Sixty-seven Bushels of B. C. White Corn	189
132. The Six Main Types of Corn	190
133. Riding Cultivators With Small Shovels	192
134. The Root System of Corn Plants	193
135. The Corn Husker and Shredder	194
136. On a Florida Farm at Silo-filling Time	195
137. Corn Harvester that Cuts and Ties the Crop	196
138. Seed Corn Ready to Hang Up	197
139. Seed Corn May be Hung on Cards	197
140. Racks for Drying Corn	197
141. Students Should Have Practice in the Use of the Score Card	198
142. Corn Judging Exercise	199
143. Removing the Kernels to Study Their Character	199
144. A Ten-ear Sample of Prize-winning Corn	199
145. Poor Shoe-peg Kernels	200
146. Good Seed Corn	201
147. The Embryo of Corn	201
148. Bread Wheats and Club Wheat	206
149. Map Showing What Types of Wheat are Common	207
150. Wide Grain Drill Drawn by Four Heavy Horses	208
151. Harvesting Grain With Modern Self-binder	209
152. A Montana Field	209
153. Grain Was Formerly Cut With a Cradle	210
154. The Modern Thrasher	210
155. A "Blue Sky" Granary	211
156. Shocks of Oats	212
157. Photograph Showing Heads of Barley	213

158. Cross-section of Flax-seed.	218
159. The Swelling Test.	219
160. Digestible Components in Common Feeds.	220
161. Tubers Sprouted in Strong Light and in Darkness.	227
162. This Type of Planter Requires Two Men to Operate It.	228
163. Horse-drawn Potato Diggers.	229
164. Potato Harvest.	230
165. Simple Potato Digger with Several Tines Instead of a Moldboard.	230
166. Bedding Sweet Potatoes.	232
167. Sweet Potato Plants.	233
168. Short Stems and Many Leaves.	233
169. Sweet Potato Bed.	234
170. The Long Form of Sugar Beet Root.	240
171. Students Harvesting Sugar Beets.	241
172. Half Sugar Mangels.	243
173. Carrots for Stock Feeding.	247
174. Rutabagas of the Bloodsdale Variety.	249
175. Dwarf Essex Rape.	250
176. A Thrifty Plant of Kohlrabi.	252
177. Farmer's Home Vegetable Garden.	255
178. Even North Dakota Gardeners Stake Their Tomato Vines.	256
179. The Construction, Use, and Management of a Hotbed.	258
180. The Transplanting Machine.	260
181. Head of Cauliflower.	267
182. A Typical Head.	267
183. Celery.	269
184. Bush-lima Beans in a Young Peach Orchard.	275
185. Okra or "Gumbo" Much Grown in the South.	277
186. Tomato Plants.	281
187. Saving Tomato Plants from Frost.	282
188. Sweet Peppers.	283
189. Flowers of the Cotton Plant.	287
190. Stages in the Development of Cotton Boll.	288
191. A Typical Cotton Plant.	289
192. Two-row Riding Cultivators at Work.	292
193. Upland Cotton in Mississippi.	293
194. A Typical Cotton-gin House.	294
195. Interior View of Gin.	295
196. Cotton Attacked by Boll-weevil Larvæ.	296
197. Fiber Flax in Michigan.	304
198. Flax Brake.	304
199. Flax Hackles.	305
200. Harvesting Hemp.	307
201. Hemp Fiber.	308
202. Abaca (Manila Hemp) Plants.	309
203. Henequin Ten-year-old Plants.	309
204. The Sisal Plant.	310
205. Sisal Fiber Drying.	310
206. The Ramie Grown from Perennial Rootstocks.	311
207. Jute is Sown Broadcast in India.	311
208. Stripped Sugar Cane.	315
209. Cutting the Cane Crop.	316
210. An Up-to-date Cane Harvester.	317
211. Interior of a Sugar Cane Mill.	318
212. When Trees Are First Received.	321

ILLUSTRATIONS

xv

213. Young Peach Trees.....	321
214. Pruning of Orchard Trees in Winter.....	322
215. Summer Pruning of Fruit Trees.....	322
216. When Trees are Small.....	323
217. Clean Culture in Apple Orchard.....	324
218. The Cutaway Disk Harrow.....	324
219. Cutaway Disk Harrow at Work.....	324
220. When Fruit is Growing.....	329
221. When the Fruit is Thinned.....	329
222. At Harvest Time.....	331
223. Marketing the Best Grades of Peaches.....	332
224. The Very Choicest Peaches.....	332
225. Nectarines and Choice Japanese Plums.....	332
226. Making Crates for Peaches.....	334
227. A Storeroom for Fruit Awaiting Shipment.....	334
228. Blackberry Bushes.....	338
229. When Blackberries Ripen.....	339
230. A Twig of the Downing Gooseberry.....	340
231. The Cherry Currant.....	341
232. Pruning Grapevines.....	341
233. The Grapevine Should be Well Supported.....	342
234. Strawberry Blossoms.....	344
235. Strawberries are Often Grown in the Narrow Row.....	345
236. The Straw Mulch.....	345
237. The Matted Rows of Strawberries.....	346
238. Students Studying Methods of Growing Strawberries.....	346
239. A Mountain Lake.....	349
240. A Sturdy Old White Pine Tree Too Crooked for Lumber.....	349
241. The Hemlock.....	350
242. White Spruce.....	350
243. Black Spruce.....	350
244. Cone of Norway Spruce.....	351
245. A Log-jam in a Small Stream.....	352
246. Land Skinned.....	353
247. Pruning and Tree Surgery.....	356
248. The Raising of Seedling Trees.....	357
249. A Well-managed Wood Lot.....	358
250. Buckets Catching Maple Sap.....	359
251. The Making of Maple Syrup.....	360
252. Commercial Hickories.....	362
253. Hickory Nuts.....	363
254. "The Opening of a Chestnut Bur".....	364
255. Tobacco Planter at Work.....	368
256. Tobacco in Maryland.....	368
257. Wagon Rack of Tobacco.....	369
258. Interior of Tobacco Barn.....	369
259. Tennessee Tobacco Barn.....	370
260. Hay-field in Late Summer.....	373
261. The Wild Aster.....	373
262. The Mullein Plant.....	374
263. Wide-leaved Plantain.....	375
264. Chicory.....	375
265. Young Plants of Sudan and Johnson Grass.....	379
266. The Wet Thumb Will Pick Up Seeds.....	385
267. One of the Quickest Ways of Examining Seeds.....	385

268. Noxious Weed Seeds Found in Farm Seeds (No. 1)	386
269. Noxious Weed Seeds Found in Farm Seeds (No. 2)	387
270. Enlarged Lapping Organ at Tip of Fly's Mouth	391
271. Foot of the House Fly	391
272. The "Rocky Mountain" Locust	393
273. The American Grasshopper	393
274. Chinch-bugs	394
275. The San Jose Scale	394
276. Round-head Apple Tree Borer	395
277. Apple Wood	395
278. Pea-weevil	395
279. A Male and Female of the White Cabbage Butterfly	396
280. Grain Moth	396
281. Hessian-fly	397
282. Bite of Curculio Insect Causes Deformed Growth	402
283. Injury to Peaches	403
284. Inside of Young Peach	403
285. Breeding Cages for Insects	407
286. Potato Tubers Attacked by Scab	410
287. Oats Attacked by Smut Disease	412
288. Monilia (Brown Rot) of Peach	414
289. Peach Leaf-curl Disease	415
290. The Black-knot Disease	415
291. Fifteen-spotted Lady-beetle	417
292. Quails and Their Relatives	417
293. A Spray Pump Operated by Hand	420
294. Bordeaux Mixture	425
295. Four-row Sprayer Operated by Chain Gear on Axle	426
296. Spraying Shade Trees	427
297. Spraying Accessories	428
298. Spraying With Gas Engine	429
299. Spraying Outfit	429
300. Types of Spray Pumps	430
301. Map of 100-acre Farm Badly Planned	439
302. Farm of the Preceding Figure Replanned	439
303. The Neighborhood Meeting	445
304. Field Meeting	446
305. A Community Meeting of Colored Farmers	446
306. Drag Made From Two Pieces of Plank	448
307. One Bale of Cotton Heavy Load on Bad Roads	449
308. Ten or More Bales of Cotton Carted on Good Road	449
309. A Septic Tank	450
310. Hydro-pneumatic Pressure System	451
311. A Bleak-looking Farm House	452
312. The Same Home Later	452

PRODUCTIVE PLANT HUSBANDRY

CHAPTER I

PLANT LIFE

Whatsoever a man soweth, that shall he also reap.—*Bible*.

ALL animals used by man are dependent upon plant life. Man himself is directly or indirectly dependent upon it. Plant life either furnishes food for man directly or the nourishment necessary for the production of the animal food he eats. Plants also furnish much of the fiber used by man in industrial arts, and for his clothing. Likewise they furnish much of the building material and fuel used by him.

Man is interested in the soil chiefly because of the crops which it may be made to produce. His chief interest is, therefore, in plants—not in soil.

Agriculture is the science and art of producing plants and animals and their products for the benefit of man. It is the oldest and most important occupation known because it is fundamental to all other occupations of man. Indeed no civilization can exist long without agriculture.

The Cycle of Plant Life.—The plants used by man are nearly all very complex in their structure, and their physiology is as interesting as it is important. The study may begin with the germination of the seed. The little plant soon develops a stem from which will spring both roots and leaves. The complexity of the young plant is rapidly multiplied. Later on buds are formed, then flowers and seeds. In time the plant may die and the species survive only through the remaining seeds.

Germination.—The conditions for germination of any given kind of seeds are: proper amount of moisture, warmth, and air. Light is not necessary during this stage of growth (Fig. 1).

Of these conditions for growth, moisture and warmth are the ones most essential for consideration, as air is usually present.

Moisture.—Most farm and garden seeds rapidly absorb water when placed in contact with moist soil. The rate at which water will be taken up depends on the nature of the seed coat; the temperature of the soil and seed; the amount of water present; and the completeness of the contact.

The seed coat itself may be of such a character as to retard the absorption of water. Such seeds are better protected against germination at improper seasons than are other seeds with soft coats. Even the seed itself may contain much oily matter which helps to preserve it a long time. Such will not absorb water so



FIG. 1.—Germinating oats, on left, and barley, on right. Note that oats has three temporary roots and barley six. The plush-like root hairs are abundantly shown. (Productive Farm Crops.)

readily, and usually their germination is slower. For these reasons some kinds of seeds should be soaked a few hours before planting.

Many seeds will not germinate until the temperature of the soil is nearly equal to that of warm spring air.

Water must not be so abundant in the soil as to exclude the air. If this be so germination of most kinds of seeds will be prevented and the seeds will rot instead of germinating. Such a condition is commonly found in wet soils in early spring. The replanting of corn is perhaps as often due to this trouble as to the lack of sufficient warmth. Neither should the soil be too dry.

If there is not enough moisture to cause the seeds to take up water rapidly they will remain dormant for a long time in the soil. As many seeds are planted very shallow, and as the top layer of soil is usually drier than that farther down, their germination is often very slow. It may be hastened by increasing the moisture in some way. This may be done by watering the seed bed or by firming the soil.

If the moist soil be pressed firmly against the seeds water will be absorbed and germination take place sooner than if the soil is left very loose. It is for this reason that seed beds are rolled. The gardener may tramp upon the row of seeds after he has planted it.

Warmth.—The needs for proper temperature for germination are usually well understood by the farmer or gardener. It is possible for him to control the temperature of the soil to a very great extent. Harrowing will warm the soil by letting in warm air. Rolling in the spring cools it by increasing the evaporation. He also knows that certain kinds of seed will start when the soil is comparatively cool, while others must not be planted until later when the air and soil have become very warm. Oats will not sprout well at a temperature below 40 degrees F., and prefer a temperature of 60 degrees or more. Corn needs about 50, and will do better if the soil is as warm as 80 or 90 degrees.

Air and Oxygen.—Air is usually present in soils in sufficient abundance to allow seeds to germinate properly. This is particularly true of coarse or sandy soils. In heavy clay there may be enough water present to exclude the air. If the air be kept out because the soil is puddled or too firmly packed when wet, germination is not likely to take place. Seeds differ a great deal in this matter. Flax for example does not require so much air for germination as wheat or corn. It is partly because of these differences in seeds that the cultural methods are found to vary so widely. The student may prove the need of air for germination by placing seeds of any kind in a bottle of water to see if they will germinate. They should be compared with others placed in proper conditions of moisture, warmth and air.

What Germination Is.—When seeds begin to germinate the store of plant food in them is changed into a form suitable for circulation (Fig. 2). As moisture is absorbed and oxygen taken in, carbon dioxide is given off. During these changes the tissues of the embryonic plant contained in the seed begin to grow. Soon a stem is formed which turns its growing joint downward and away from the

light. As this young stem extends in length it either forces the first seed leaves upward and toward the light or raises the seed itself.

If the seed is in the ground the lengthening of the young stem may either push the young leaves up out of the ground, or push the remainder of the seed into the air. This is called *sprouting*. The seed leaves are called cotyledons, and the young growing stem is called the hypocotyl. The next leaves formed, and which appear in the growth after or above the seed leaves, form the plumule. This is the terminal bud of the young plant.

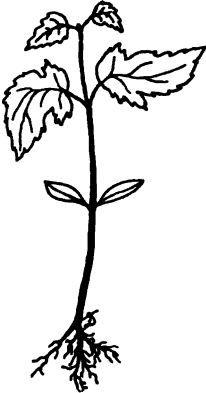

FIG. 2.—A seedling maple tree showing the pair of seed-leaves (cotyledons) still clinging. These have furnished much of the nourishment for the early growth of the plant. When these drop off the other leaves must supply all the carbon dioxide from the air and the roots will supply the necessary mineral matter from the soil.

Depth of Planting.—Seeds differ in the character of growth of the hypocotyl. In the field and garden pea, for example, the two halves of the seed, called cotyledons, are usually not forced above the ground. In the germination of melons, squash, beans and others they are lifted through the surface of the ground into the air.

Because of these differences in seeds the depth of planting must be varied. Those seeds which push the cotyledons out of the ground should not be planted so deep and care must be exercised to avoid the soil becoming crusty at that time. Those which leave the cotyledons in the ground may use their energy in forcing the ascending stem and leaf cluster through a firmer layer of soil. Peas are usually planted much deeper than beans.

Depth of planting is somewhat in proportion to the size and vigor of the seed. The character and amount of moisture in the soil also help to govern the depth of planting. For any given kind of seed, plant deeper in warm weather and in light soils. Plant shallower in wet weather and in heavy soils.

THE LEAVES

Green Color.—As soon as the plant appears above ground light causes it to assume a green color. This is because the protoplasm or life fluid of the plant produces a substance called chlorophyll. Its purpose is to enable the plant to make use of sunlight. The higher forms of plants contain chlorophyll, and are able to

use carbon dioxide from the air because of its presence. Lower forms of plants, such as mushrooms and other saprophytes, as well as parasitic plants, do not contain chlorophyll. They must get their food already prepared for assimilation.

Starch Forming.—Plants containing no chlorophyll are unable to break up carbon dioxide to form starch for their own nourishment. Fungi which attack growing plants have no chlorophyll in their tissues. They use the starch made by the host plant. The formation of starch is performed only by plants which contain chlorophyll. The starch is manufactured in the presence of sunlight from carbon dioxide and water taken into the tissues.

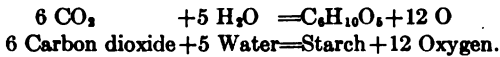

Office of Leaves.—When the young plant began its growth a store of nourishment in the seed supplied the energy necessary to cause the plant to burst the seed coats and perhaps to sprout above the soil. The leaves formed near the surface of the ground must then supply nourishment to the young plant. From this time on the growing plant receives a large proportion of its nourishment from the air through the leaves. There are breathing pores in the surface of the leaves through which air may come in contact with the soft cells within.

In the making of starch, carbon dioxide is taken in through the pores (or stomates) of the leaves where it comes in contact with water taken up by the young plant. Here, through the



FIG. 3.—A self-balanced aquarium. When placed in a window the plants in the aquarium give off oxygen, which the animals use. The animals produce the necessary carbon dioxide for the plants, which live principally on it.

influence of sunlight and the work of the cell fluid, called protoplasm, if chlorophyll is there, starch will be formed. Oxygen is given off in the process of making starch (Fig. 3). Starch is the staple food of the plant. Thus the leaves acquire from the air and develop much of the substance of which plant tissues are formed.

Breathing.—The work of acquiring the materials and manufacturing starch is related to digestion. Leaves also perform a function which is related to breathing in animals. The breathing process is carried on through the surface of the leaves both day and night. It is exactly analogous to the breathing in animals. In this process the plant uses the oxygen from the air and gives off carbon dioxide to the air. But in the daytime, when the sun is shining, the leaves are carrying on the digestive process more rapidly than they are breathing. The net result of the two lines of work is that the plants really give off more oxygen than they take up and they use up more carbon dioxide than they exhale. In the dark the starch-forming process ceases, but breathing continues. Those plants in the house breathe out carbon dioxide at night just as people do.

The object of the breathing in plants is similar to that in animals. Because of this work of the leaves they may properly be called the "lungs" of the plant.

Leaf Structure.—A fresh green leaf may not be very thick, but it is composed of a number of layers of cells. Those inside are very soft with very thin walls. These contain the live cell fluid, called protoplasm, in which is the green chlorophyll. Among these soft cells, called parenchyma, there are spaces for air (Fig. 4).

Outside of the soft cells, that is on the upper and lower surface of the leaf, there are layers of cells called epidermis, corresponding to skin. These epidermal cells do not contain any green coloring matter. They are transparent, and the green chlorophyll from the inner walls shows through, giving the leaf a green appearance. Sunlight shines through the epidermis during the starch-making process.

Stomates.—Numerous small openings are found in the epidermis of the leaves. In many kinds of leaves they are more abundant on the under surface. It is estimated that about 150,000 to the square inch exist on the under side of an apple leaf. These openings, called stomates or mouths, are for the purpose of breathing and the taking in of carbon dioxide for the making of starch.

Guard-cells.—These little openings in the epidermis of the leaves are guarded by special cells, called “guard-cells.” They differ from the other cells in appearance by being of a different shape and containing a little chlorophyll. They are long and slender, but curve so that two of them surround each opening. The pair may be said to form the lips of the little mouths in the leaves. They are sensitive to moisture and heat. They are called guard-cells because they control the size of the openings. When the weather is favorable they leave the mouths open, but when the weather is dry and hot they close the mouths to help prevent the evaporation of water from the inner parts of the leaf (Fig. 4,S).

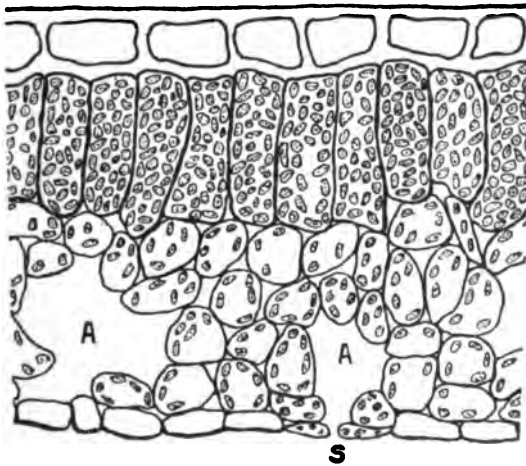

FIG. 4.—A section of green leaf under the microscope, showing air spaces (A, A), a breathing pore at S, epidermal (skin) cells at the top and bottom, palisade cells below the upper skin, and the loose cells just below these. Chlorophyll grains are seen in all but the epidermis.

Leaves in Their Relation to Light.—Probably the chief office of the leaves of the plant is to manufacture starch from carbon dioxide and water in the presence of sunlight. The leaves on a plant are therefore arranged in such a way as to gather as much light as possible. Many different plans or devices to accomplish this end are found among plants. The leaves of the corn plant turn their broad surface toward the light and curve over to catch as much as possible. The under leaves of many plants may wither and drop off when younger leaves from above have completely shaded them. Leaves on vines climbing on a wall often spread out

in such a way as to avoid shading each other too much. Thus the plant secures all the light possible. Trees in dense woods grow tall in search of light. There is little need for them to produce side branches, because the sun would not reach them.

If rows of corn or garden crops are planted east and west each plant will receive more light during the young growing stage than otherwise. Of course if the distance between plants in the rows is the same as the distance between rows the direction will make no difference.

THE ROOTS

Young plants soon after germination produce rootlets at the lower end of the hypocotyl.

Purpose of Roots.—Besides holding the plant in place, the roots gather moisture and plant food from the soil. Indeed all or nearly all of the moisture taken in by plants must enter through the roots. The food gathered by the roots must be dissolved in the water of the soil.

The amount of water required by growing plants is difficult to comprehend. Many of our field crops may require 500 times as much water as dry matter during their growth. Thus a ton of mature dry corn fodder may have required 500 tons of water from the soil where it grew. If this amount of corn is grown to maturity in 125 days, then four tons of the soil water would be the average amount taken in by the ton of corn each day. It is for this reason that much attention must be given to the matter of soil moisture for our growing crops.

How Water is Acquired by Plants.—When the water in the soil is distributed in films through the grains, the roots of the plant must be finely divided and come in close contact with these films to obtain the water. The fibrous roots of half-grown plants in the garden may reach from one row to the next. Some are at considerable depth, and others near the surface.

Root-hairs.—For the purpose of greater increase in the surface of fibrous roots, numerous root-hairs are produced on the surface, particularly on the younger growth, but not at the growing tip. When the root-hairs are examined closely they give the appearance of fine white plush, as each is very short and the mass is dense and soft. The walls of this fine growth are very thin and water can be taken in readily. A study of root-hairs can easily be made by germinating pumpkin or other large seeds on moist cloth, and allowing the growth to continue for a few days.

Osmosis.—Liquids pass through cell walls and other membranes by a trading process called osmosis. It is a force or process almost as universal as gravitation itself. Among the cells of all living creatures exchange of liquids is taking place by an osmotic process. It may be defined as an exchange of liquids or gases of different density, through a membrane.

Tie a piece of bladder from a butcher shop very tightly over the mouth of a funnel tube (Fig. 5). Fill the funnel either before or after with a very strong sugar syrup as dense as it can be made when it is hot. Then support the funnel as shown in the figure in a vessel of water. The liquids will immediately begin to exchange places through the membrane. The greatest movement of the liquids is always toward the denser. But both liquids will pass through the membrane to some extent. There is an exchange going on. After a few hours some sugar may be proved to be in the outer vessel. The rise of liquid in the funnel tube will prove that much of the water from the outer vessel has gone into the funnel through the membrane. If conditions are favorable more glass tubes may be fastened with a piece of rubber at the top of the funnel and the water will come to a height of several feet.

It is by this process that water is forced through the cells of the plant to the height of the leaves.

Exchange at the Root Surface.—Growing plants must have in them sap which is denser than the moisture found in the films about the grains of soil. If the soil water were very heavily saturated with plant food in solution, and if the sap in the roots were not so dense, the plant would have to give off more water to the soil than it would absorb. This would cause the plant to wilt.

This may be illustrated by putting a fresh plant of lettuce with its roots and lower part in a glass containing a dense syrup;



FIG. 5.—Osmosis with a bladder membrane tied on mouth of funnel tube. After the bladder is tied in place, the tube is filled with thick syrup or other strong solution. Water is in the large bottle. As the osmosis takes place the liquid may ascend the tube many feet if it is extended high enough.

wilting will take place in a short time. Compare it with a similar plant placed in fresh water at the same time.

Water must be supplied to the soil to make the density of the soil water less than that of the sap in the roots. When conditions are thus favorable growth may follow. During the normal process the plants give off a very little liquid to the soil in exchange for a large quantity of very dilute liquid made up of a large quantity of water and a very slight trace of plant food in solution. The liquid given off by plants at the roots usually has an acid reaction and is sometimes useful in dissolving lime, phosphates and other minerals in the soil. It thus becomes changed in its character and when diluted may be later taken up by the roots.

In certain other cases where the soil conditions are unfavorable the liquid thrown out by roots may remain in the soil, and until it is changed has a poisonous effect upon the plant. The action of air and water during the process of tillage will help to remove or change this poisonous substance. This makes the soil again suitable for plant growth.

THE PLANT AND THE SEASONS

In the temperate climates of the globe the change of season during the year is so regular that plant growth has adjusted itself to the extremes of winter and summer. In the more northern parts of the temperate zone the changes are more pronounced than in the extreme south.

Examples of the preparation for winter are found among all plants in the ripening of fruits and seeds in the fall. Woody plants and other perennials form buds and some means of protection, as the formation of scales, waxy or downy growth, lenticel or corky growth on the leaf scars near the buds.

In early fall while leaves are still upon the trees examine twigs of various fruit trees, such as apple, peach, and plum. Study the protective coats found on the buds. See if any of the leaves will snap off readily, indicating the formation of a natural separation from the twig which will leave a leaf scar. If this study is made in the winter the protection of the buds may be shown even better and leaf scars may show corky growth. The surfaces of young twigs will show more protection. The green color is then destroyed and breathing pores are filled with corky growth.

The orchardist understands the need of checking the growth of his fruit trees in early fall by the growth of a cover crop to use

up the surplus soil moisture. This checking of the growth of the trees will allow the plant to better protect itself from winter killing.

Plants store up food for the early spring development. Examples of these are found in all seeds and fruits, in the stems of plants and in underground parts. The stored parts of plants may form food for animals and man. This is illustrated in beets and in other root crops, in corn, wheat, oats and other grains. The sap from sorghum cane is used for making syrups because of the sugar stored there by the plant.

FIELD AND LABORATORY EXERCISES

1. **Sugar and Starch.**—Test the stems of corn or sorghum for sugar and starch. The same test may be made with twigs and buds of the apple or other woody plants. Starch may be detected by a drop of iodine on the cut surface. The color will change to blue or purple if starch is present. Sugar may be detected in beets, sorghum stems and other tissues by the use of a little copper sulfate solution on the cut surfaces. In a few moments rinse this off. Then heat the tissue on a glass slip over a flame after adding a few drops of very strong potassium hydroxide. If sugar is present a blue coloration will gradually appear in the liquid.

2. **Test for Oil.**—Examine the seeds of a castor-oil plant, flax, cottonseed, soy beans, peanut or others for oil. In soft seeds the presence of the oil may be detected by pressing it between two layers of paper or between the fingers. If a chemical test is desired use henna root dissolved in alcohol. This solution is called alcanin. Drops of oil or fat will be stained red by alcanin.

3. **Examining Starch.**—If a high power microscope is available a useful study may be made of the different kinds of starch found in seeds. Compare the grains of such seeds as rice, wheat and corn with those of the potato tuber. Then examine a few samples of flour to see if more than one kind of starch is present. It is not an uncommon thing to find some corn starch present in wheat flour. What is the probable source of the grains found in laundry starch?

4. **Moisture and Germination.**—Students should carefully read over exercises showing the effect of moisture on germination, warmth influencing germination and the necessity of air in germination. Exercises of this character are outlined in the writer's book on School and Home Gardening. If this or similar exercises have not been performed by the students, they should be taken up in connection with this chapter.

5. **Sprouting at Different Depths.**—An exercise on depth of planting is outlined in "Productive Farming." This may be repeated.

6. **The Effect of Sunlight** in producing green color in leaves should be tried. A simple way to prove the effect of sunlight in producing green color is shown by placing a light board over a plot of grass for a few days. Then notice the bleached appearance of the grass leaves.

7. **Window Aquarium.**—In connection with the paragraph on plants, the student should start a self-balanced aquarium by putting into a two-quart glass jar or gallon jar a little clean sand and gravel. Then a supply of water plants from stagnant pools, such as algae, duck weed, *Nigella* and others; then a few water insects and a few minnows, and place the glass jar in direct sunlight, as in a south window. See description of such an aquarium in School and Home Gardening (Fig. 3).

8. **Structure of Leaves.**—If compound microscopes are available in the school, the students should make cross sections of leaf structures and study the tissues, stomates and guard cells.

9. **Leaves Seek the Light.**—Have some house plants growing in the window and note the leaves turn toward the sunlight. Turn the plants around half way, and note the length of the time required to change the direction of the leaves toward the light again.

10. **Root Hairs.**—Plant corn, beans and other large seeds in bottles of sand or soil. Wrap each bottle with black paper, or otherwise shut out the light. After the roots are well formed, remove the covering and study the root hairs and root systems which can be seen through the glass bottles. Of what use is the black paper?

11. **Osmosis Through Egg Membrane.**—In addition to the exercise suggested to show osmosis with a piece of bladder over a funnel tube, try also the exercise describing osmosis with an egg detailed in Productive Farming.

QUESTIONS

1. Give the conditions for germination of plants.
2. How are each of these conditions provided in out-door germination?
3. Give some cases of difference in depth of planting seeds.
4. Of what value is the green color in leaves?
5. What important product is manufactured in leaves exposed to sunlight?
6. Describe the breathing of plants, and give the leaf structure which provides for this.
7. Give some examples you have observed of the struggle of leaves to get sufficient light.
8. Enumerate the purposes of roots.
9. Describe the structure and state the use of root hairs.
10. Define osmosis and state its relation to plant life.
11. Describe an experiment by which osmotic action is demonstrated.
12. In what ways do woody plants prepare for winter? How do others prepare for winter?

References.—U. S. Farmers' Bulletins: 157, "The Propagation of Plants; 586, Collection and Preservation of Plant Material for Use in the Study of Agriculture.

CHAPTER II

FLOWERS.—SEED PRODUCTION

The soil receives in its bosom the seed scattered broadcast upon it, softened and broken up; she first keeps it concealed therein; next, when it has been warmed by the heat and by close pressure, she splits it open and draws from it the greenery of the blade.—CICERO.

NEARLY all plants used by man for farm and garden crops produce flowers and seeds. The sole purpose of the flowers of plants is to produce seeds.

The Flower.—A perfect flower contains the essential organs necessary for the production of seeds. These are the stamens,



FIG. 6.—The poppy flower shows a large pistil in the center to bear the seeds; around this are the numerous stamens surrounded by the bright petals. (U. S. D. A.)

bearing pollen, and one or more pistils bearing ovules which may develop into seeds (Fig. 6). Other organs are sometimes present in the flower. These consist of petals and sepals sometimes called the floral envelope. The purpose of the floral envelope may be to protect the flower from cold in the early stages of its opening,

to attract insects by the color and perhaps to form a case for nectar, which will reward insects for their visits.

If the flower does not contain both of the essential organs—stamens and pistils—it is called an imperfect flower (Fig. 7). In such cases the other set of organs is found in other flowers on



FIG. 7.—Ear of corn in full silk and ready to be pollinized. There is one silk from each kernel and each must receive a pollen grain, from some corn tassel, which sends a thread-like growth the entire length of the silk. (Productive Farm Crops.)

the same plant as in corn, or on other individual plants, as in poplars. Monoecious plants, as corn, are those in which the staminate flowers and pistillate flowers are both on the same plant. Dioecious plants are those in which the staminate and the pistillate flowers are on different plants, as in the cottonwood and poplar trees.

Flowers may be borne singly as in case of the poppy (Fig. 6), in heads as in the sunflower (Figs. 8 and 12), in spikes (Fig. 11) and in many other forms of clusters.

Pollination.—In perfect flowers the pollen may fall directly upon the pistil. The pollen grains may then develop a long, thread-like growth which reaches the ovules within the base of the pistil. When the pollen growth reaches the ovule a fusion of the two takes place. This may be termed the fertilization of the ovules. Seed cannot properly develop until such fertilization takes place. Flowers which pollinize their own pistils are probably not so common among the cultivated plants as in wild ones. Self-pollin-

ating is impossible among plants which have imperfect flowers. Other conditions or structures may make cross-pollinating necessary (Fig. 9). Self-pollination is sometimes compulsory, as in hidden flowers of the violets, blossoming under ground (Fig. 10).

Cross-Pollinating.—Any plan or structure which requires that the pollen be carried from one flower to another will enforce cross-pollination. Certain perfect flowers may have their pistils and stamens mature at different times. If the pollen is not "ripe" or ready to be distributed at the time the pistil is ready to receive the pollen, then pollen must come, if at all, from some other flower where it is more mature. Again, if the pollen is ripe before



FIG. 8.—Cross-section of head of wild sunflower showing the individual flowers in different stages of development. Note the curled stigmas at the left. (U. S. D. A.)

or after the pistil in that flower, then the pollen can be useful only in some other flower where the pistils are in the right condition.

The structure may also be an important factor in causing cross-pollination. In drooping flowers the pistils may be shorter than the stamens so that the pollen will fall away from, instead of toward, the pistil. In erect flowers the pistil may be longer than the stamens so that the pollen cannot fall directly upon the stigma or receiving surface of the pistil.

In certain varieties of fruits, as in the apple, it has been found that perfect flowers may be self-sterile. The pollen falling upon the pistil of the same flower will not grow so well as pollen received on the same stigma surface from other varieties of apples. It is for this reason that two or more varieties of apples are frequently



FIG. 9.—Ear of corn from isolated corn stalks, showing approximate amount of self-pollination. (U. S. D. A.)



FIG. 10.—Violet showing cleistogamic flowers blooming under ground. The seed pods projecting up above ground in order to spread seed. (U. S. D. A.)

planted near together in the same orchard. The same is sometimes true in such other fruits as pears, plums, peaches and strawberries.

Wind Pollinating.—Usually pollen is carried either by wind or by insects. Flowers in which the wind is the chief force to aid in cross-pollinating have certain characteristics. Usually the pollen is light and dry. The flowers themselves are inconspicuous as to color, but may be placed where the wind can easily strike them. There is no odor or nectar present. Examples of the class are corn, grasses and grains.

Insect Pollinating.—Many of our cultivated plants are dependent upon the work of insects in transporting the pollen from one flower or plant to another. Bees, flies and other insects aid greatly in this work. Flowers which are dependent upon insects to carry the pollen have some or all of the following characteristics: (a) Sticky, heavy pollen. (b) Showy flowers. (c) Fragrance and nectar (Fig. 11). (d) Sometimes special structures to accommodate the insects. An example of the special structure is found in sweet pea blossoms.

When the insect alights upon the limb of the flower the pollen

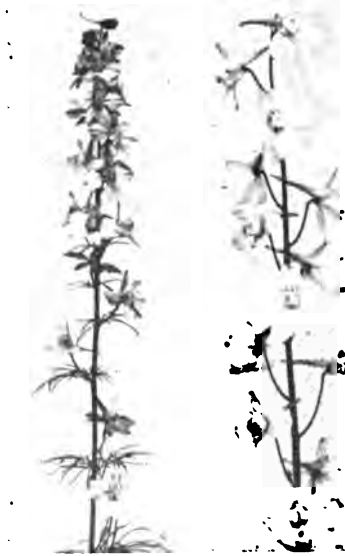

FIG. 11.—Larkspur flowers bear nectar in the deep "spur," to attract insects. The latter carry pollen from flower to flower, and they are "cross-pollinated." (U. S. D. A.)

is brushed from the coat of the insect by the stigma surface. As the insect leaves the flower other pollen is scattered by the stamens upon the coat of the insect to be carried to other flowers (Fig. 12).

Growth of Seeds.—After pollination takes place the ovules usually develop rapidly and mature seed may be formed in a very short time. The period elapsing from the time the timothy field is in blossom until the seed is ripe is only a few weeks. This is noticeable also in wheat and other small grains. During this



FIG. 12.—The honey bee gathers honey only from those flowers which are open and ready to receive or distribute pollen. (F. C. Pellett.)



FIG. 13.—When the pistil of the peanut blossom receives its pollen its stem greatly elongates downward and pushes the end into the soil. Here the pod develops into the mature peanut. (U. S. D. A.)

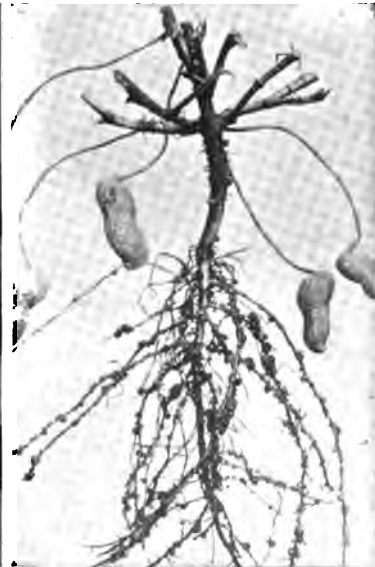

FIG. 14.—Base of peanut plant, showing seeds, roots and nodules. (U. S. D. A.)

development much of the nourishment of the plant is taken to the seeds by the process of circulation through the stems. Note the peculiar action in the case of the peanut (Figs. 13 and 14).

This is a very critical period in the life of the plant or crop. The moisture conditions must be as nearly perfect as possible. The yield of the crop of seed, as of wheat, is largely dependent upon the development during this period. If conditions are



FIG. 15.—Tobacco flowers and seed in different stages of development from left to right. Note the abundance of seed from one case. (U. S. D. A.)

unfavorable the mature seed may be shriveled and poor and the resulting crop be very light.

Purpose of Seeds.—In nature seeds are formed for the purpose of reproducing the species at a later time and in other places. Distribution is accomplished largely through seeds (Fig. 15). Annual plants live through winter in the form of seeds only.

The length of time which seeds may live is dependent upon several things: (1) The nature of the storage matter in the seed. If much oil is present the seeds may be less subject to weather conditions because they do not absorb moisture readily. (2) The

seed coat or the seed case may be resistant to moisture. (3) The place of storage of seed if very dry or very cold may hold the life of the seed much longer. Grains sowed in very dry soil in an arid region may live for several months without germinating. When the next rain comes germination may follow quickly. Stories are often told of seed being found in cases with Egyptian mummies, which would germinate after many centuries. These stories are not duly authenticated, but such conditions would be very favorable because of the absence of moisture.

FIELD AND LABORATORY EXERCISES

1. **Study the flowers** of different plants, and find some provided with pistils, some with stamens and others with both organs.

2. **Determine** what the effect would be of having only pistillate plants in a strawberry bed.

3. **Study pollen** of various flowers. This may be done with or without a compound microscope. Decide whether the supply of pollen is abundant or scarce with various cultivated plants that may be available. Determine what flowers have light, dry pollen, which could be scattered by the wind, and what ones have waxy or sticky pollen which would be carried chiefly by insects.

4. **From Pistil to Seed.**—If possible, examine a certain kind of plant, for example, peas or beans, in the different stages of development of the seeds (Figs. 13, 14 and 15). Begin with the first pollination and early development of the embryonic seeds, and trace them toward maturity.

5. **Parts of Seeds.**—Study the parts of mature seeds, including those with two seed leaves, as the bean, and including those of the monocotyledonous type, as corn. The seeds are more easily examined if they have been soaked a few hours in advance.

QUESTIONS

1. What are the organs of a flower essential for the production of seed?
2. Of what use is the floral envelope?
3. How may imperfect flowers produce seed?
4. Describe the pollination and fertilization of a perfect flower. Of the corn plant. Of a pistillate strawberry.
5. What are the characteristics of wind-pollinated flowers?
6. Give the characteristics of flowers pollinated by means of insects.
7. Mention the conditions which influence the longevity of seeds.

References.—United States Farmers' Bulletin 195, Annual Flowering Plants. Cornell Bulletins: 320 and 342, Sweet Pea Studies, III and IV.

CHAPTER III

PRINCIPLES OF PLANT BREEDING

The vast possibilities of plant breeding can hardly be estimated . . . They are not for one year nor for our own time and race, but they are beneficent legacies for every man, woman, or child who shall ever inhabit the earth.

—LUTHER BURBANK.

BREEDING of cultivated plants or domestic animals is their systematic raising or reproduction under the direction of the expert for the purpose of securing improved forms. The object may be to increase the profits or merely for scientific experiment. When desirable traits or characters are noticeable in certain individuals or types, a trial may be made to determine whether or not those points will be reproduced or perhaps intensified in the offspring.

Heredity.—This is one of the laws of nature which governs the work in scientific breeding. The law of heredity is that all plants and animals inherit from their ancestors certain characteristics, forms, qualities, etc. "Like produces like," or "similar produces similar," are true of both plants and animals. The undesirable characteristics are just as certain to be transmitted as the more desirable ones. The law is not absolute. It is subject to some variation due to environment or other causes.

Variation.—There is a natural tendency in nature for all creatures to differ from each other and from their parents. It may almost be said that no two trees in a nursery row are exactly alike, or that no two plants in a bed of seedlings are alike (Fig. 16). This tendency of varying from each other and from their parents is even more noticeable among animals. It allows the scientific breeder to select the desired types and produce from them, in time, those valuable for special purposes.

Mutation or extreme sudden variations from the type are sometimes noticeable. These may be called "sports." It is believed by some scientists, De Vries and others, that the extreme characteristics of mutation or sports may be transmitted to succeeding generations. Others believe that plants do not have the power to transmit these. It is certain that the offspring often revert to the original type. The breeders of plants and animals



FIG. 16.—Seedling carnations showing slight variation. New varieties are developed from seed and are then kept pure by propagation by cuttings. (U. S. D. A.)

often try to make use of such sports in the establishment of new types better suited to the uses of man, and perhaps better suited to the environment. The object of using such sports, when it is found possible to do so, is that much time is gained in establishing new types. Certain it is that successful results have been attained through their use, in breeding both animals and plants.

Reversion.—This is the tendency found among both plants and animals for the offspring to exhibit characteristics of different ancestors which the more immediate ancestors did not show. The tendency to reversion is usually detrimental to the progress of the work of the scientific breeder. It brings results contrary to his expectation and perhaps contrary to his ideals.

Environment.—The principle of selection is the one most commonly used by the scientific breeder. It is believed by many scientific breeders that environment or surroundings of the individual, is a vital cause of variation. There is no doubt that environment has a vital influence upon the results obtained from the growth of certain farm crops or certain domestic animals. Seeds that are of the same origin, planted on different farms, may produce very different yields. Just as fertilizer and tillage may influence the development of a crop, so may feed and other environment influence the development of animals. A litter of pigs if divided into equal lots at weaning time may show variations in their growth during the next few months, due to difference in feed or other conditions. Differences would likewise be noticed if we plant all the beans borne by one bean-stalk.

To what extent these differences, due to environment, will be inherited by the offspring is a matter of contention among scientists. Most modern breeders act upon the principle that extremes of variation, due to environment, do influence the offspring to some extent.

Prepotency.—The power of individual animals or plants to impress certain characteristics upon their offspring is called prepotency. Use is made of this in scientific breeding. Characters thus fixed may be spoken of as dominant characters. But prepotency means more than dominance of character, for certain individuals have the power of fixing many of their characteristics upon their offspring.

Selection.—The breeder of plants or animals must carefully practice selection; indeed his greatest skill must be exercised along this line (Fig. 17). After the several lines of variation in any type

have been discovered it is necessary that he should make a wise selection among them to attain the results desired.

In nature selection is going on constantly, but less carefully. The struggle for existence in a dense bed of seedlings of field plants causes some natural selection. The most thrifty individuals will reach light and air above the others and soon dwarf or kill the weaker. In an arid region a thorny cactus has prevailed over the spineless kinds because animals do not molest the former. Volumes are filled with such examples of natural selection.

Selection by man is more rapid than in nature. It is an im-



FIG. 17.—Vegetable trial grounds, Potomac river flats near Washington. Varieties and new strains are here tested by the United States Department of Agriculture. Many large seed companies test new varieties of vegetables and flowers in this way. (U. S. D. A.)

provement upon nature by the application of the intellect of man to natural laws. Certain valuable results may be attained within a few generations which might require centuries if left to nature (Fig. 18). Under natural conditions certain valuable types might be entirely submerged, but under the guidance of the breeder they may be protected and established as fixed types.

To be successful through the medium of selection the breeder of plants or animals should keep in mind the following elements: (1) He should keep his ideals or aims clearly in mind. (2) He should know the laws of nature governing variation. (3) He

should be familiar with the pedigree or history of the types he is using. (4) He may have occasion to depart from the fixed rules or principles of breeding and should then be wise in his judgment. (5) It is usually best that he should keep in mind the economic aspect of the results.

Adaptation to Surroundings.—The student will understand that natural conditions are the most important influences involved



FIG. 18.—Breeding plants to resist root disease. Diseased and resistant tobacco plants in field under cloth. (U. S. D. A.)

in variation and selection, whether selection be by nature or by man. De Candolle studied the influences of climate upon plants and reached conclusions which are very valuable in agricultural practice. Plants suited to a moist climate are usually not thrifty in an arid region. Corn grown in a warm climate, as in Mexico, will not mature its seed in a region several hundred miles farther north. The orchardist well knows that he must select the varieties of apples, peaches, plums or other fruits which are adapted to his

climate. Seedsmen may find it necessary when securing enough seeds to supply the demand to buy many lots grown in very different climates. The purchasers may not know where the seeds were grown. The results are often disastrous. Examples of this are common among garden seeds. It is also true of several field crops, such as alfalfa, cow peas, Canada peas, corn, special varieties of wheat and others. Dealers should keep records of



FIG. 19.—The modern chrysanthemum is a triumph in plant breeding—the blending of two distinct species, both resembling the common or oxeye daisy. (U. S. D. A.)

where seeds are grown. The purchaser should know the source of the seed before using it. Adaptation to surroundings not only refers to climate but also to the character of soil, fertility, season of growth, tillage and other environment. The gardener who saves seeds from his own garden has all of these elements within his own control.

Crossing.—This is the result of breeding two fixed types of plants or two pure bred animals of different breeds. The Light Brahma may be crossed with the Black Langshan or the Plymouth



FIG. 20.—Methods of emasculation of tobacco flowers—instruments and method of preparing flowers for crossing. The central flower has had the anthers removed. The pistil may now be pollinated with pollen from another plant. Note the protection by means of paper bags in figure 22. (U. S. D. A.)

Rock with the hope of securing a type suited to some particular purpose which the breeder has in view, as a strain particularly suited to a special meat market. Pop corn will cross with sweet corn; a white variety of corn may be crossed with a yellow variety. The offspring from such crossing may be called *hybrids*.

The effect of crossing extreme types, as when the oxeeye daisy is crossed with a chrysanthemum with very different characteristics, is to cause extreme variations in the offspring and future generations. The parental types are said to be broken. When extreme variations are thus started the breeder is able to make selections which may more nearly suit the ideals for which he is



FIG. 21.—Methods of wheat breeding. The stamens must be removed before natural pollination takes place. After artificially pollinating the flowers, the operator covers the head of wheat with a bag and labels it. (U. S. D. A.)

striving. It was in this way that the modern chrysanthemum was produced (Fig. 19).

The crossing may be within closer relationship and may have as its purpose the blending of characteristics of the parents, and an effort to establish or fix one characteristic and cause others to depart.

Artificial Pollinating.—Among plants, crossing is accomplished through artificial pollinating of the flowers. The pollen from one parent may be placed upon the stigma surface of the pistil in the other with successful results. This is done by careful hand manipulation. The stamens must be removed to prevent other pollen from reaching the pistil (Fig. 20). Then the flower must be protected until the stamen surface is mature enough to receive pollen. Then pollen from the desired parent may be brought by means of a very fine, soft brush, or feather, and carefully dusted upon the stigma surface. Again this flower must be covered to keep away all other pollen.

Stamens from the flower to be worked upon may be removed with a pair of fine pointed scissors (Fig. 21). Care must be exercised to not injure the pistil. This work must be done before the pistil is ready to receive the pollen.

Such flowers may be protected from receiving outside pollen by tying a paper bag over the stem supporting the blossom (Fig. 22). Natural development will take place within the paper



FIG. 22.—Tobacco field showing bagged plants in seed breeding plots. (U. S. D. A.)

bag. After the pollen growth has reached the ovules in the pistil there is no longer any danger of outside pollination. Then the bag may be removed.

During the cross-pollinating of flowers it is necessary to place labels on the stems. This should indicate both the staminate and pistillate parents. Records should also be kept of all such crossing. Numbers or letters may be used to designate the different parents. These are often written above and below a horizontal line, the staminate number being above the line and the pistillate below, thus:

325

157

The study of flowers and their cross-pollination may be carried on during the winter by placing several branches from fruit trees in a jar of water in a warm room for several days before the study is made. If the conditions be favorable the blossoms will develop in a week or two. Let the several steps mentioned in the above paragraph be tried on these flowers.

Testing for Purity of Type.—When a new strain of plants or animals has been formed, through crossing or otherwise, the

breeder may not know whether the characteristics found in this strain are permanent or not. If the type be pure the characteristics will be perpetuated in future generations; but if it is a mixed type the succeeding generations will be variable. It is always necessary for him to establish the purity by actual trial through one or more generations.

Mendel's Law of Heredity.—When the minute growth of pollen unites with the ovule in the pistil a union is formed which develops into a new individual. This seed will produce a plant with certain characteristics. If the pollen is from a yellow variety of corn and the pistil is on a white variety, the seed produced will be either yellow or white, not both colors. The corn grown from this seed, if no other crossing be allowed, will be one-fourth pure white, one-fourth pure yellow, and two-fourths (one-half) will appear as yellow but will produce both white and yellow offspring in the next generation. The proportion in the first generation is $\frac{1}{4}Y + \frac{2}{4}YW + \frac{1}{4}W$ (if Y = yellow and W = white).

In the following generations the one-fourth pure yellow will produce yellow without mixture; the pure white will produce pure white without mixture, but the mixed (or hybrid) two-fourths will produce either yellow or white corn in the same proportions as before, breaking up in each generation, thus:

First Generation	Second Generation	Third Generation	Fourth Generation	Fifth Generation	
Y(hybrid)	$\left\{ \begin{array}{l} 1/4 \text{ Y (pure)} \\ 2/4 \text{ Y (hybrid)} \\ 1/4 \text{ W (pure)} \end{array} \right.$	$\left\{ \begin{array}{l} \text{Y (pure)} \\ 1/4 \text{ Y (pure)} \end{array} \right.$	$\left\{ \begin{array}{l} \text{Y (pure)} \\ \text{Y (pure)} \\ 1/4 \text{ Y (pure)} \end{array} \right.$	$\left\{ \begin{array}{l} \text{Y (pure)} \\ \text{Y (pure)} \\ \text{Y (pure)} \\ 1/4 \text{ Y (pure)} \\ 2/4 \text{ Y (hybrid)} \\ 1/4 \text{ W (pure)} \end{array} \right.$	
		$\left\{ \begin{array}{l} 2/4 \text{ Y (hybrid)} \\ 1/4 \text{ W (pure)} \end{array} \right.$	$\left\{ \begin{array}{l} 2/4 \text{ Y (hybrid)} \\ 1/4 \text{ W (pure)} \\ \text{W (pure)} \end{array} \right.$	$\left\{ \begin{array}{l} 2/4 \text{ Y (hybrid)} \\ 1/4 \text{ W (pure)} \\ \text{W (pure)} \\ \text{W (pure)} \end{array} \right.$	$\left\{ \begin{array}{l} \text{Y (pure)} \\ \text{Y (pure)} \\ \text{Y (pure)} \\ 1/4 \text{ Y (pure)} \\ 2/4 \text{ Y (hybrid)} \\ 1/4 \text{ W (pure)} \\ \text{W (pure)} \\ \text{W (pure)} \\ \text{W (pure)} \end{array} \right.$
		$\left\{ \begin{array}{l} \text{Y (pure)} \\ 1/4 \text{ Y (pure)} \end{array} \right.$	$\left\{ \begin{array}{l} \text{Y (pure)} \\ 1/4 \text{ Y (pure)} \end{array} \right.$	$\left\{ \begin{array}{l} \text{Y (pure)} \\ \text{Y (pure)} \\ 1/4 \text{ Y (pure)} \end{array} \right.$	$\left\{ \begin{array}{l} \text{Y (pure)} \\ \text{Y (pure)} \\ \text{Y (pure)} \\ 1/4 \text{ Y (pure)} \\ 2/4 \text{ Y (hybrid)} \\ 1/4 \text{ W (pure)} \end{array} \right.$
		$\left\{ \begin{array}{l} \text{Y (pure)} \\ 1/4 \text{ Y (pure)} \end{array} \right.$	$\left\{ \begin{array}{l} \text{Y (pure)} \\ 1/4 \text{ Y (pure)} \end{array} \right.$	$\left\{ \begin{array}{l} \text{Y (pure)} \\ \text{Y (pure)} \\ 1/4 \text{ Y (pure)} \end{array} \right.$	$\left\{ \begin{array}{l} \text{Y (pure)} \\ \text{Y (pure)} \\ \text{Y (pure)} \\ 1/4 \text{ Y (pure)} \\ 2/4 \text{ Y (hybrid)} \\ 1/4 \text{ W (pure)} \end{array} \right.$

The net results, expressed in fractions of the first hybrids, would be in the three generations:

$$3/8 \text{ Y (pure)} + 2/8 \text{ Y (hybrids)} + 3/8 \text{ W (pure)}.$$

The law which covers these results, when individuals with such different characters are crossed, was first discovered by the Abbot of Bunn, named G. J. Mendel, who published his result prior to 1865. Similar results have been attained by other experimenters in recent years. Mendel experimented with garden peas and contrasted them in such characters as color of blossom,

length of stem and wrinkled or smooth seed. In nearly all cases where large numbers of individuals are used in the experiments results similar to those experienced in the formulas are obtained.

In such experiments it is necessary to consider unit characters only in contrast with each other. When two characters are contrasted one may prevail over the other and is then said to be a dominant character, and the other over which it prevails is a recessive character. White color in any blossom or plant, as in white corn, is recessive in contrast with any other color. A light color is recessive in contrast with a dark color. Mendel found that in peas round seed was a dominant character and wrinkled seed a recessive character. In wheat the beardless character is dominant over bearded heads. In cotton the long staple is dominant over short staple.

If D represents the dominant character and R the recessive, the result in the first generations after the cross would be expressed thus: $\frac{1}{4}D + \frac{2}{4}DR + \frac{1}{4}R$. The breaking up of the hybrids in succeeding generations would follow the formulas given in the table.

Pedigrees are records of lineage or ancestry. It has been very common to keep such record for pure-bred animals. As scientific breeding of plants becomes more common it becomes necessary to keep their records in pedigree form. "Pedigree corn" or "pedigree wheat" are strains having a recorded history or ancestry. The terms are sometimes used for farm seeds when the record is very incomplete so far as individuals in the lineage are concerned.

It must be remembered that a pedigree is no guarantee of quality; but that will depend upon the value of the individuals in the lineage. Stock breeders' associations are formed for each breed of animals for the purpose of keeping such records. They establish and maintain certain rules governing the records.

Animals' pedigrees are much more exact than those of plants. This is because the breeder learns to know the individuals better, the numbers are fewer, and the cost for the raising of each individual to maturity is greater. The action of wind and insects in the pollination of plants is difficult to control. Whenever a good strain of plants is established it can be named and this name may be the only record necessary. Such is the case with plants that are readily propagated by grafts, buds, cuttings or other asexual means. The type once fixed may never have the danger of being mixed with other strains, as might be the case if seeds were used. The Grimes Golden apple, for example, was established by chance.

No record of its history is known. The individual tree producing the desired fruit was named. From this grafts and buds have been its only means of propagation. The same is true of many other fruits and vegetables.

FIELD AND LABORATORY EXERCISES

1. **Effects of Environment.**—Bring to the laboratory weeds or other plants that have been growing in dense clusters, and, to compare with these, the same kinds of plants grown in open spaces. What differences are noticeable? What is the influence of the environment shown here? Why do trees grow tall?

2. **Take two boxes** of growing corn, each a few inches high, that have grown under the same conditions of environment. Place one of these in a warm room in a light window. Place the other in a cool room with less light. Note the difference in growth during the next week. Let all conditions of moisture, air and plant food be maintained as before. What influences of environment are here shown?

3. **The value of selection** may be studied in a group of tomato plants, some of which are affected with blight. Select plants which seem to be strong and vigorous in spite of the presence of the disease. If tomato plants are not available for this, use alfalfa or any other plants where a disease exists.

4. **Variations among plants** should be examined, and a full list of their variations may be made. Why are some taller than others? Why do some have small and others slender stems? Why are some darker in color than others? Why are some more leafy than others? Would it be possible to establish an ideal for the kind of plants you are studying and select those which most nearly approach that ideal?

5. **Each student** should determine, if possible, five or more examples of adaptation to surroundings among plants which he may observe in window boxes, gardens, along roads or on farms.

6. **Hybridizing.**—Students will understand the possibility of hybridizing much better if they practice cross-pollinating among a number of flowers. Let the pollen from red corn be placed on the silks of white corn. Or any other similar plants or crops may be used in the exercise.

7. **Testing Mendel's Law.**—A good home project would be to take some one line of plants, as white or yellow corn and test so far as possible the working of Mendel's law. This can be carried at least to the second generation.

QUESTIONS

1. Define and illustrate what is meant by heredity in plant breeding.
2. Of what value is variation to one who is trying to improve a certain type of plant?
3. What is the meaning of mutation? Give examples of this.
4. Define and illustrate reversion.
5. Illustrate what we mean by the environment of plants.
6. Explain how variation and selection are used together in the improvement of plants.
7. Give the elements which a plant breeder must always keep in mind.
8. Define and illustrate the term "cross" among plants.
9. Describe one method of artificial pollination and state its use.
10. On the blackboard, or on a sheet of paper, give a bracket outline of results of crossing according to Mendel's law.
11. What are pedigrees? What is meant by pedigree corn?

Reference.—Cornell Reading-Courses No. 38, Principles and Methods of Plant Breeding.

CHAPTER IV

APPLICATION OF PRINCIPLES TO FARM CROPS

Still will the seeds, though chosen with toilsome pains,
Degenerate, if man's industrious hand
Cull not each year the largest and the best.—VERGIL.

THE principles of breeding have only recently been applied to field crops. Some more or less careful selection has been exercised for many years. Man has searched the world over for natural varieties and strains, but in many cases has failed to keep them pure or to improve them by continued selection. Crossing, breaking the types and establishing new varieties is now much more common among scientific breeders of plants. The New York College of Agriculture is establishing a new strain of timothy. The Minnesota Station and the Kansas Station have established new and valuable strains of wheat. Many scientific breeders have worked upon corn. It is an easy subject to work upon, and gives striking results. Cotton and tobacco have been improved and valuable varieties of each established by the work of several southern states. Experiment stations have done much to improve the yield and quality of Irish potatoes (Figs. 23 and 24). Sugar beets were greatly improved by careful selection during the Napoleonic wars. Prizes were offered by Napoleon for any variety yielding a high percentage content of sugar. Commercial plant breeding is successfully conducted on seed farms in America and in Europe.

Self-Pollinated Plants.—The methods employed in the improvement of wheat, oats and other self-pollinated plants are very different from those used where the pollen may be carried from one plant to another. The chief work in the breeding of wheat or oats is to study the yield of individual plants. The seed from different plants is kept intact by covering the heads with cloth, as shown in figure 25. This keeps the birds away and prevents the shelling of the seed. The plants yielding the most and best seed are kept separate from the others. The seed may be planted in separate rows or plots without danger of mixing with the others. The yield of individual plants or rows is again recorded. By such careful selection the improvement may go on for many generations (see Fig. 26).

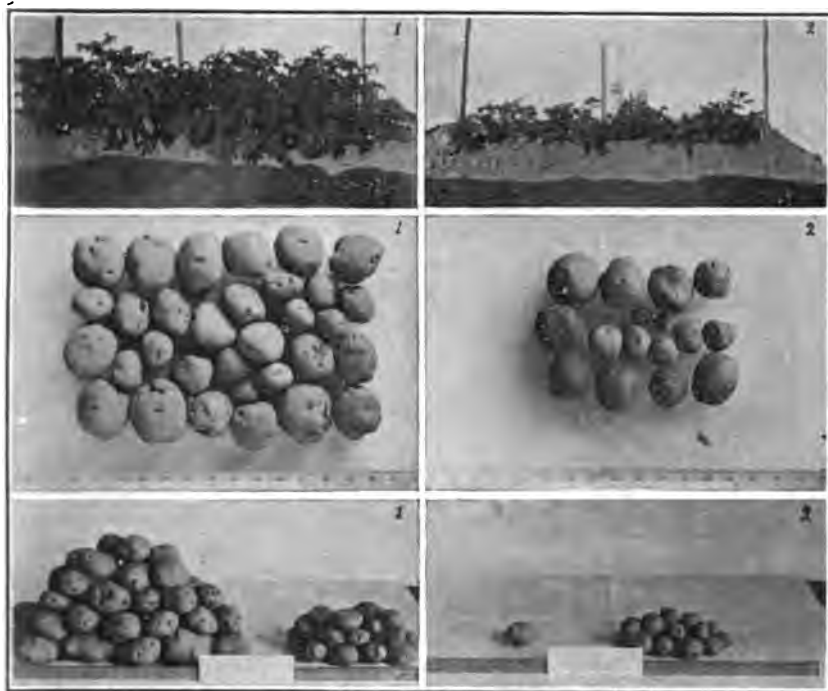

FIG. 23.—Strong tuber units on left, 1, 1, 1. Weak units on right, 2, 2, 2. The lower figures show the small ones sorted from the others in each lot. (U. S. D. A.)



FIG. 24.—Potato harvest, showing variation in yields from individual tubers. (U. S. D. A.)



FIG. 25.—Wheat breeding in Minnesota. Each trial plot is easily kept pure because the plant does not cross-pollinate, but the ripening seed must be kept from shattering and also protected from sparrows by tying the heads as shown. Accurate tests are then possible. (Minnesota Station.)

Cross-Pollinated Plants.—The problem of improving plants belonging to this group is much more difficult. There is always the danger that they will be mixed with other seeds or individuals through the distribution of pollen by wind and insects. Corn, cotton, timothy and rye are important farm crops belonging to this group. Little can be done by the ordinary farmer in improving such crops. The careful breeder devoting his entire time to the

work may succeed in establishing improved varieties.

Note the great effect of extreme crosses as shown in figure 27.

Corn Breeding.—The corn plant bears the pollen in the tassel and the pistils are located on the young ear. The ovule is attached



FIG. 26.—The methods involved in breeding wheat are very tedious. After the flowers are artificially cross-pollinated they are protected with bags and properly labeled and records are kept of both parents so the pedigree of all the seeds will be known. (U. S. D. A.)

to the center, which becomes the cob. Each ovule has its own silk (Fig. 6). In other words, each grain of corn has its own silk extending to the upper end of the ear, where it may be readily pollinated by the action of the wind. Examples are often found in ears in which a number of the kernels did not develop. This may have been due to the silks being eaten off by insects, or because pollen failed to grow on the stigma surface of the silk (Fig. 8).

There are several methods by which the corn grower can improve his variety of corn without great difficulty.



FIG. 27.—Wheat (left) crossed with pollen from rye (right). The three central heads are average results of this cross. (U. S. D. A.)

1. Go through the windward or westerly side of the field just before the pollen begins to scatter and cut off the tassels from every stalk which does not promise a thrifty growth and a good ear. The tassels may be thrown upon the ground or used for feed. By this method the poorest stalks in the field will not become the parents of the seed corn for future crops.

2. Just before the pollen scatters cut all the tassels from every alternate row. This is to enforce cross-pollinating to some

extent. The seed corn should be selected from the rows which were detasseled. This seed corn will have received its pollen from other plants and not from itself.

3. Select seed corn before the main crop is harvested. This

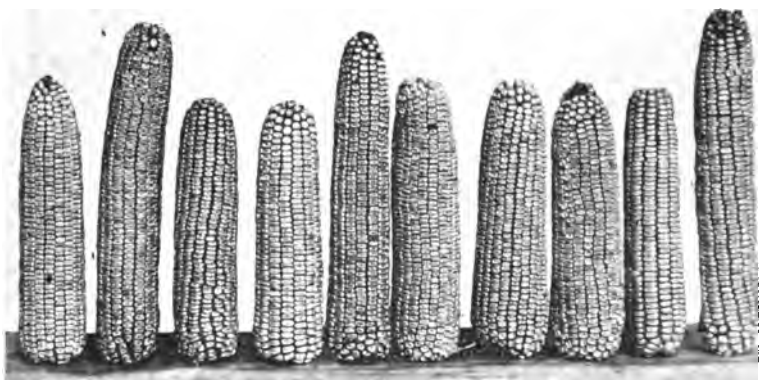

FIG. 28.—Variable types of Johnson county corn, showing the need of close selection at the time of saving seed corn. Compare with figure 29 to see the possibilities of careful selection. (U. S. D. A.)

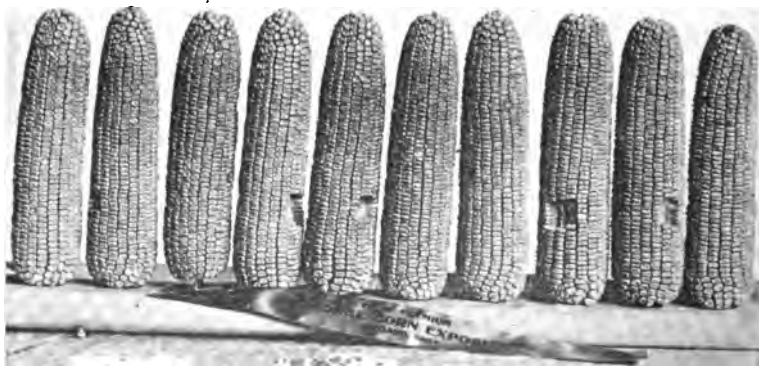

FIG. 29.—Prize-winning white dent corn of the Johnson county variety. Study the uniformity of the ears. (U. S. D. A.)

should be done in the field after the corn is reasonably mature. Select the ears which are drooping and otherwise show maturity. Take ears only from stalks showing a heavy yield. Attention may also be given to all of the good points of the ears and the kernels mentioned in the score card. Compare figures 28 and 29.

4. Select plenty of seed corn so that future sorting may be done after a more careful study of such characters as depth of kernel, size of cob and others which indicate heavy yield.

5. Ears from heavy yielding stalks should be especially marked. These may be planted in separate rows and the hill-row method of improvement followed if desired. More careful breeders will follow such a method. Yields from the separate rows are recorded and the best ears of the best rows are again saved for future seed corn.

6. Individual ears should always be tested for germinating power before planting time. (See Productive Farming, Corn Chapter.) By this process the strains of corn with weakest germ are eliminated.

Cotton.—It is more difficult to improve cotton by preventing cross-pollination. The pistils and stamens are borne in the same flowers. The work consists chiefly of selection. There are a number of points to be considered in the selection of cotton. The plant should have good shape with rather short nodes, and an abundant supply of blossoms and bolls. The crop should mature somewhat uniformly and with the proper consideration of earliness. There should be a large number of bolls of desired size. Select plants which show resistance to cotton diseases, wilt, rust and rot. Plants vary in the storm resistance of the bolls. The selection should be done with a view to increasing the length of the lint, and make it more uniform, as well as to increase its yield and earliness.

Selection of cotton seed may be done at either the first or second picking. A skilled workman should first go through the field and pick the seed from the best plants. At the cotton gin is a poor place to select cotton seed. Much of the seed obtained at such a place may be light or immature or from very poor plants. After carefully selecting cotton seed in the field the grower should have a separate field in which to grow it. From this future selections may be made, and thus the yield and quality may be increased annually. The grower who establishes a "seed patch" and yearly selects the best from the best in that seed patch is on the right road to improvement of his crop. After the first year or two the whole farm will show marked improvement in the yield of cotton.

Tobacco is usually cross-pollinated, but may be self-pollinated. Self-pollination may be enforced by covering the center cluster

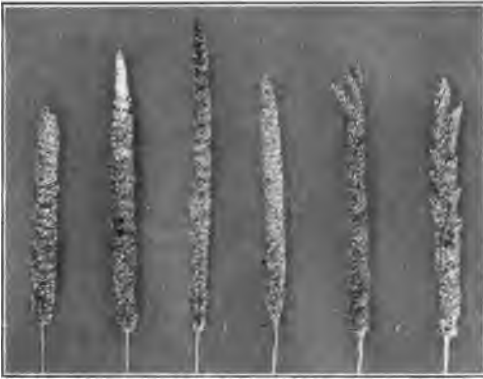

FIG. 30.—Variation in the apex of heads of timothy. (Cornell.)

of flower buds with paper bags. Seed thus formed will produce plants which are more vigorous and productive, and are also more uniform. Much attention should be given to the improvement of varieties by selection. For example, if a certain variety is used as cigar wrapper the qualities desired for that purpose will serve

as a guide in selecting the plants from which to save the seed.

Oats.—As the flowers of this plant are self-pollinated there is no danger of poor varieties mixing with better ones. Improvement is therefore easily carried on. Save the best heads showing greatest yield. In certain varieties it is well to eliminate the beards by selection. Uniformity in height and size of heads, plumpness of grain, ability to harvest without shattering are all desirable characters. Much can be done to prevent disease by selecting seed from plants which resist the attacks of smut and rust.

Timothy.—Under careful selection timothy will show wide differences in the length and diameter of heads, the quantity of seed produced, the height and leafiness of the growth, and the number of stalks from a single root. In improving the strains the seed from individual heads may be kept separate and planted in separate rows or clumps, where the plants will not be pollinated by inferior strains. The work thus far indicates that



FIG. 31.—Variation in thickness of heads of timothy. (Cornell.)

strains much superior to those in common use will be established. The natural variations in timothy are shown in figures 30, 31 and 32.

Potatoes.—The hill-row method of improving the quality and yields of potatoes is very successful. Record is kept of heavy-yielding hills (Figs. 23 and 24). Yields are also kept separate and planted in individual rows or sections of rows, each being properly labeled by stakes. Records are kept of the yields of each and the best are again selected. Those which prove most inferior are eliminated. Marked differences have been found.

New varieties of potatoes are established through the use of seeds which are produced in seed-balls (Fig. 33), but this should not be commonly practiced. Improvement in quality and yield by selection of tubers gives far better results. Variations in seedling potatoes are seen by comparing figures 34 and 35.

Sweet Potatoes.—The work of improving sweet potatoes is similar to that with white potatoes. They are both chiefly propagated by asexual methods. In both attention may be given to disease resistant qualities of the vines and tubers. Size of the tubers, neither too large nor too small, should be considered in both of these crops.

Sugar Cane.—The Louisiana Sugar Station has conducted a series of experiments in the improvement of sugar cane. As the crop is usually grown by planting the buds or joints, and not by planting the seeds, the work is chiefly that of selection. Plants grown from seed show a wider variation than those grown from buds. New and improved varieties of sugar cane are started from seed. After improved strains are established by planting seed from the best canes the cutting method of propagation is followed and little deterioration in quality will follow. Qualities to be considered in improving sugar cane are the total yield of cane and the percentage of sugar.

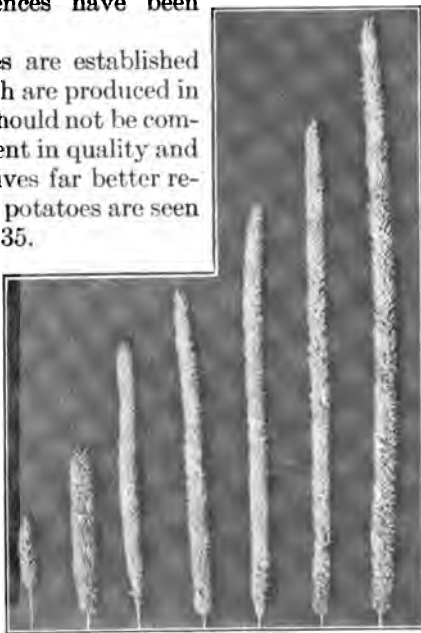

FIG. 32.—Variation in length of heads of timothy. (Cornell.)

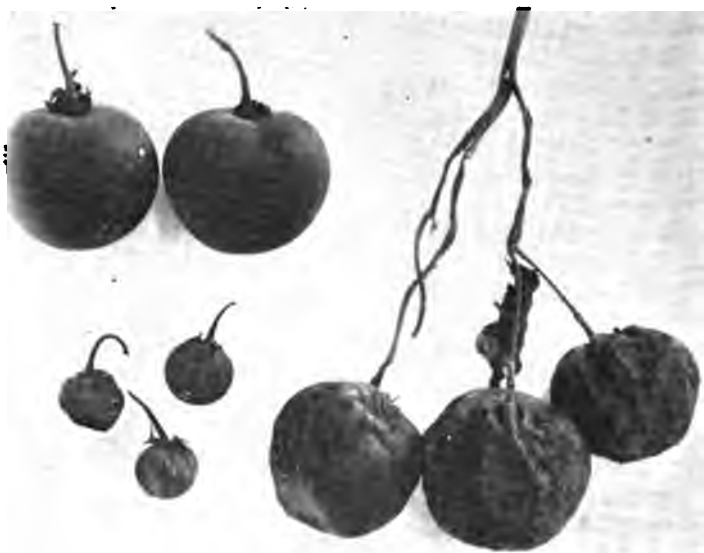

FIG. 33.—Potato seed cases. New varieties of Irish potatoes are developed by planting the true seeds and then selecting the most desirable forms for propagation. See other figures showing variation in seedling potatoes. (U. S. D. A.)

FIG. 34



FIG. 34.—Potato seedlings, of the short form desired for market; this would be the form to propagate. It might have distinctive characters in texture, soundness, season, etc., to entitle it to a new varietal name. (U. S. D. A.)

FIG. 35.



FIG. 35.—Potato seedlings, showing variations to the extremely long form. (U. S. D. A.)

FIELD AND LABORATORY EXERCISES

1. The flower structures of wheat, oats and rye may be studied. Which ones of these seem to require self-pollination, and which ones will allow of cross-pollination? How can new varieties be bred from grains which naturally self-pollinate?
2. **Safe Distances between Varieties of Corn.**—Determine, if possible, how far corn pollen may be scattered by the wind. Shake a tassel of corn bearing ripe pollen and see if any of the pollen can be detected ten feet away. If the wind were strong, what could limit the distance which the pollen might be carried?
3. **Why Kernels Fail to Develop.**—Just before pollinating, a young ear of corn may be selected and with a knife cut the silks around the middle line of the ear without injuring the cob. Study the effect of such treatment upon the future development of the kernels on the lower half of the cob. What would be the effect of worms or other enemies injuring part of the silks of corn before pollinating time?
4. **Value of Good Cotton Seed.**—A good home project with cotton is to plant seed which has been well selected from ideal cotton plants, as described in this chapter, and other seed taken at the gin from unselected stock. Compare the growth and development of the two lots.
5. **Try Heavy Seed.**—Plant two lots of any one kind of farm seeds, one lot in each case being heavy, well developed seed, and the other being light, or chaffy. Try wheat, oats, rye, radishes or other available kinds.
6. **Improving Yields of Potatoes.**—If possible, a home project in the hill-row method of growing Irish potatoes should be carried out by students.

QUESTIONS

1. How many plants which are self-pollinated be improved by the plant breeder?
2. What methods must he use with cross-pollinated plants?
3. Describe each of the ways by which the corn grower may improve his variety of corn.
4. What are the methods used with corn? With tobacco?
5. Why do self-pollinated plants have more stable varieties? Explain this with reference to oats.
6. How are potatoes improved by the hill-row method?

Reference.—Improvement of Cotton Seed by Selection, Year Book, U. S. Dept. Agr., 1902, pp. 363-386.

CHAPTER V

FARM AND GARDEN SEED

Good tilth brings seeds,
Ill tulture, weeds.

TUPPER.

IMPURITIES are frequently found in farm and garden seeds. Weeds are disseminated through this channel. The problem of obtaining pure seeds, true to name, and free from weed seeds, is one of the most serious things to be considered in good agricultural practice.

How Impurities are Detected.—Weed seeds can usually be detected by means of a good hand lens or reading glass (Fig. 36).



FIG. 36.—Such a lens is inexpensive yet efficient in helping to detect weed seeds in any seed sample. Each student and each grower should use a simple lens of some kind.

The trueness to name can best be determined by growing the seeds. Some of this kind of impurity can be detected soon after sprouting time. But differences between closely related varieties can seldom be detected by growth until the development of stems and leaves and perhaps not until flowers are formed. This may require too much time to be of use to the grower before planting the main crop.

Experts who make special study of seeds are frequently able to detect mixture of varieties of seeds or to discover improper naming of varieties.

Students may compare seeds found in samples with other labeled samples, as in figures 37, 38 and 39.

Seed Analysis.—A number of states have laws authorizing the employment of such seed experts to examine samples of seeds for prospective planters and also for dealers. Laboratories are established either at State Experiment Stations or State Departments of Agriculture for the analysis of seed samples. The work of such laboratories is chiefly along the following lines:

1. Examination for impurities by means of microscopes, sieves, fanning devices (Fig. 40), and scales.

2. The percentage of weed seeds and the names of the different weeds, particularly the most injurious.

3. The detection of foreign, inert matter, such as sand, chips, pulp, chaff or other similar impurities.



FIG. 37.—A method of preserving seed samples in small bottles. This collection shows a mixed sample at the left to be compared with pure sample in the other bottles. The case is made by students. (U. S. D. A.)



FIG. 38.—Student's collection of seeds—all valuable kinds except the Johnson grass. Such a collection may include all economic seeds.

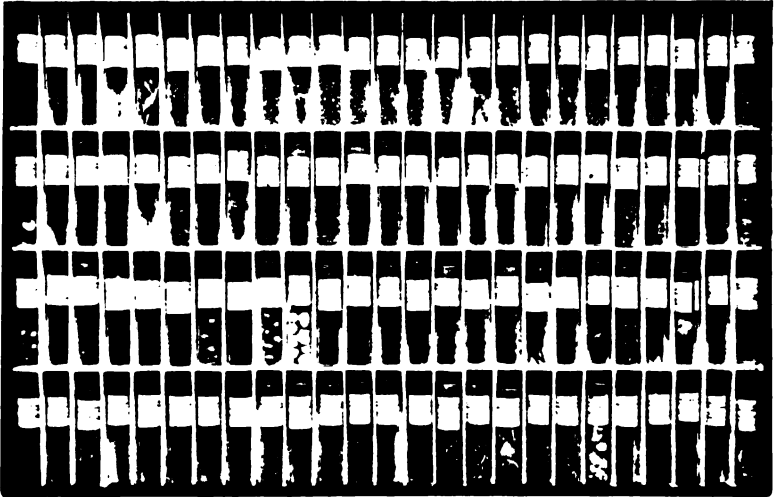

FIG. 39.—School set of one hundred economic seeds supplied by the United States Department of Agriculture, for cost of case, bottles, corks, and labels.

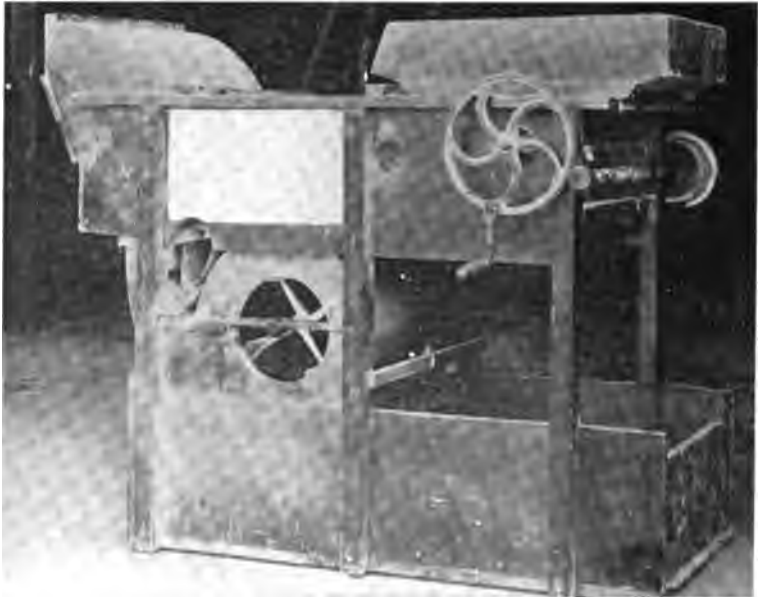

FIG. 40.—An inexpensive fanning mill should be used to reclean farm seeds before planting. Light seeds, chaff and other trash are blown out by the fan. Sieves should be used of suitable size to separate the seeds of different sizes. (U. S. D. A.)

4. Identification of crop seeds and the determination of the admixture of inferior varieties. For example, winter and spring vetch may be detected by the expert from the appearance of the seeds. If the sample is sold as winter vetch it would be very detrimental in most climates to have spring vetch mixed with it or substituted for it. Germination tests are made in the seed laboratories to help determine the trueness to name, as well as to help determine certain kinds of weed seed. Seed incubators, where the temperature is maintained at any degree desired, may be used for this purpose.

5. Tests are made for vitality of seed.

6. The age of seed is detected so far as possible by different methods for different kinds of seeds.

Reports from Seed Laboratories.—Reports by the seed analyst are made to the person or firm requesting the analysis. Such reports may give the percentage of weed seeds and name the most injurious kinds present; the amount of inert matter; trueness to name; the percentage of germination; and the probable freshness, maturity, and other points regarding the seed.

The laws of some states require the publication of the results of all samples examined. The laws may require that the details of such analysis accompany each lot of seed sold by dealers.

The benefits to be derived from such laws are clearly apparent. Dealers are in this way able to state on authority the exact worth of their seeds. Planters are able to avoid lots of seeds which are not up to the desired standard in every respect. Poor lots of seed are thus thrown out or put through a cleaning process. Distribution of weeds through the planting of weedy seed is reduced to a minimum. State seed analysts are in charge of laboratories to accomplish these purposes in a number of the states.

Seed Testing at Home.—Whether there be a public seed analyst in your state or not, it frequently pays to test seeds at home. Samples tested by the public analyst may not be true samples, or there may be more work than he can do because of insufficient help in his laboratory.

There is a great deal of poor seed sold upon the market. Many seasons it is practically impossible for dealers or planters to secure seeds of certain kinds with high percentage of germination. This may be due to drought, late spring, early fall, ravages of insects, plant diseases or other causes. Each planter should know from his own test the exact germinating power of all seeds he has to use.

Reasons for Testing.—Attention is called to impurities in seeds during the testing operation. Foreign inert matter is then more easily detected. The vitality or germinating power of the seeds can be determined in no better way.

Why Know the Germinating Power.—The grower who knows the germinating power of seeds before sowing time may be able to save the money which he would otherwise throw away in buying poor lots of seed.

He will save the time and labor expended in planting seeds which will not grow.

He will save the labor necessary for re-planting those parts of the field where there would be a poor stand of the crop.

He will save something in the amount of seed used in planting the field.

A poor and uneven stand of the crop is avoided if seed with strong and even germination is planted at the beginning.

He will have a more uniform and evenly maturing crop at harvest time. This means a better paying crop.

Testing of Seed Corn.—A seed analyst can never give the grower the information desired regarding the germinating power of corn. The grower should know the percentage of germination for the kernels on each ear of corn. A wide variation is found among the ears in any lot of seed corn. Probably no two rows in a field are of the same degree of maturity. After test of each ear is made those showing poor germination may be discarded entirely, and used for stock feed. As each ear may contain from 700 to 1000 kernels the removal of such a number with low germinating power is important and very easy.

Methods of Testing Ear Corn.—Number the ears of corn on small cards or bits of paper by thrusting a slender nail through the paper and into the large end of the cob. Arrange all the ears of seed corn in some systematic way on shelves or in racks or by suspending them as shown in the chapter on corn.

The Rag Doll Method of testing ear corn is described as follows by the Illinois Station:

“In preparing to make this test, secure sheeting of a good quality and tear into strips from eight to ten inches wide and three to five feet long. Where these are to be used very much it is well to hem the edges, as otherwise the ravelings sometimes disarrange the kernels in unrolling. Each cloth should then be marked with a heavy pencil, first lengthwise in the middle and then crosswise, making squares about three inches wide.

“Moisten one of these cloths and lay it out on a board of convenient size in front of the ears which are to be tested. Remove six kernels from ear No. 1 and place in the square No. 1 in the upper left-hand corner of the cloth. Take six kernels from ear No. 2 and place in square No. 2. When the cloth has been filled begin at the upper end with ears 1, 2, etc., and roll the cloth up. Since the cloth is moistened the kernels will not likely push out of place. If a small irregular-shaped piece of wood or some other substance is used as a core in rolling, a more uniform germination may be secured. When the rolling of the cloth has been finished, tie a string rather loosely about the middle of the roll; or, better still, use a rubber band. Number this roll No. 1. Then proceed with roll No. 2 in the same way. As many rolls may be used as are necessary to contain the corn. From 20 to 50 ears can be tested in each roll, depending upon the length.

“After the rolls have been filled they should be placed in a bucket of water, where they may remain for from 2 to 18 hours, depending upon the preference of the operator. At the end of this time pour off the water and turn the bucket upside-down over the rolls—or a common box may be used for this purpose. Small pieces of wood should be laid under the rolls and one edge of the pail should be lifted from one-half to one inch in order to give sufficient ventilation. Some have left the pail in an upright position, placing a few sticks or corn cobs in the bottom of the pail to insure proper drainage, and then packing a moist, coarse cloth over the rolls to prevent excessive drying. Cover the pail with a kettle lid. At the end of five days the kernels should be ready to read.

“Depending upon the arrangement of the ears, select, first, either roll No. 1 or the last roll filled. This cloth will be unrolled in front of the ears which are represented. Examine all kernels carefully.”

After the test is made the ears showing low germination should be removed from the others. Those with about 80 per cent of germination may be kept in reserve for use only if there are not enough with perfect seed.

Testing Smaller Farm and Garden Seeds.—There are several good methods by which farm and garden seeds may be tested.

1. The seeds may be planted in trays or boxes of soil. These should be well watered and kept in a warm room and away from mice. A record of each lot should be placed on a label in the soil

at the edge of the box. This should show the number of seeds planted, the kind and the date.

2. One hundred seeds of each lot may be placed on wet blotters with a paper label for each. The blotters may be piled upon each other as high as desired and placed inside a moist jar or other vessel. This should be loosely closed to retard the evaporation and yet allow some air to enter.

3. Use a modification of the rag doll method, placing a label with each lot of seeds as the cloth is rolled up.

4. The plate method is often used. Blotters or cloth are used to help retain the moisture, as the seeds must be kept uniformly moist as well as warm during the germination.

Other methods can be easily devised to suit the particular needs or conditions in any school or home.

Obtaining Good Seed.—Careful gardeners find it profitable to save seeds of their own growing. This is the most satisfactory way of improving the special strains or varieties which they wish to grow. For example, if a tomato grower finds certain plants bearing tomatoes which most nearly meet his market conditions he should save seeds from those plants. The admixture of seed from other inferior fruits will not pay.

In the wholesale methods of obtaining tomato seeds for sale to dealers no such careful selection can be made. It may be that such lots of seeds are taken from the fruits which matured late in the season after market prices for tomatoes had dropped below the profitable point. Crops grown from such late-matured seeds would be less likely to be ready for the early markets when the prices are best. Tomatoes vary greatly in the proportion of flesh and core. In the wholesale methods of obtaining tomato seeds for market such variations within varieties cannot be taken into consideration.

Similar reasons can be found for the home selection of seed for other garden and field crops.

Limits.—There are certain garden crops which will not mature seeds well in the climates where the crops themselves are profitably grown for market. For example, this is the case in some localities where onions, cauliflower and sugar beets are grown.

Home Grown Seeds should be thoroughly and carefully dried as soon as they are mature. They may then be placed in envelopes or other receptacles and properly labeled. Special descriptions may be desirable in certain cases. These envelopes or containers

away the lighter parts. Records are given in the Bible of the use of this method by the ancients. Modern hand fanning mills are inexpensive and should be used more commonly than they are for the removal of chaff from grass or the removal of light weed seeds from the heavier seeds of the desired crop.

The use of sieve and fan methods are often combined and machines are devised for sifting and fanning out at the same time. A lot of wheat or oats, for example, may be easily improved and the best selected by running it through such a machine a few times. Small seeds are sifted out and light seeds perhaps containing smut are blown farther than the others and may be removed.

Seed Cleaners.—There should be a seed cleaner either on every farm which produces seed for sale, or for home use in every neighborhood. In the latter case, the machine may be owned by several farmers in the community. If owned by one, he may do seed cleaning for other people at a stated compensation, or he may rent the machine to others at so much per day.

There are several types of machines used for cleaning seed. The most satisfactory among these have provisions for both sifting and fanning. The large kinds of seed are separated from the small by the sieves. During the same process the heavy seeds are separated from the light seed or chaffy ingredients by the fanning (Fig. 40.) It is surprising how uniform a lot of seed may be.

Storage of Grains and Seeds.—Conditions for the saving of garden seeds have already been given in this chapter. Larger quantities of farm seeds should be stored in mouse-proof bins in well-sheltered buildings. There is always danger of attacks by weevils and grain moths. These enemies are commonly found in the warmer climates. Beans, peas, cow peas, soy beans and others are frequently attacked by bean weevils. In some cases the eggs are laid before the crop is stored. As soon as they begin to hatch the whole mass of seed should be treated with carbon bisulfide. This may be done in a bin by placing the liquid in an open vessel above the grain. Evaporation takes place quickly and the fumes settle through the mass of seeds. Sheets or canvas should be spread over the bins, or if possible the bins should be made more nearly air tight during the treatment. This should be repeated in a few weeks after more of the larvæ have hatched. The process is inexpensive and may be used with corn, grain or

seeds of any kind without injury. Care should be taken not to breathe the fumes nor to have any fire present, as the fumes are very inflammable. Have tight bins and use one ounce of carbon bisulfide to each ten cubic feet of space.

FIELD AND LABORATORY EXERCISES

1. The six lines of work of seed laboratories, as mentioned in this chapter, should be made the subject of laboratory practice. Samples of seed for this purpose may be obtained from dealers.

2. The state law regarding seed inspection should be studied and the percentages mentioned for some of the amounts of weed seed allowable under the law should be compared with samples that may be available.

3. Different methods of testing seeds should be practiced in the laboratory or at home. Try the rag doll method for seed corn. Use the blotter method, the seed box method and others. Which methods seem most suitable for large seeds, and which for small seeds? Which methods seem to give conditions most nearly like the field or garden?

4. Samples of spoiled grain, spoiled corn or other seeds injured by improper storage should be obtained. Let the conditions of storage in each case be described and the better methods compared with these.

QUESTIONS

1. Explain the operation of state laws regarding seed analysis and give the work done by state seed laboratories.
2. Of what use are the reports from seed laboratories?
3. Give the advantages of seed testing at home.
4. Why should the grower know the germinating power of seeds before planting?
5. Describe the "rag doll" method of testing seed corn.
6. Give some methods of testing smaller farm and garden seeds.
7. How can the grower obtain good seed through testing methods?
8. Give the advantages of home-grown seeds.
9. Give the methods and principles involved in the cleaning of a lot of seeds.
10. What are the precautions to be taken in the storage of grains and seeds?

References.—U. S. Farmers' Bulletins.—111, The Farmer's Interest in Good Seed. 194, Alfalfa Seed. 229, The Production of Good Seed Corn. 253, The Germination of Seed Corn. 260, Seed of Red Clover and Its Impurities. 286, The Advantages of Planting Heavy Cotton Seed. 306, Dodder in Relation to Farm Seeds. 382, The Adulteration of Forage-plant Seed. 415, Seed Corn. 428, Testing Farm Seeds. 434, The Home Production of Onion Seeds and Sets. 495, Alfalfa Seed Production. 646, Crimson Clover: Seed Production. Circ. 96, U. S. Office of Exp. Sta., How to Test Seed Corn in School.

CHAPTER VI

PROPAGATION OF PLANTS BY DIVISION

All are but parts of one stupendous whole,
Whose body Nature is, and God the soul.—POPE.

METHODS of propagation of plants may be grouped into two classes, sexual and asexual. The first includes propagation by spores and by seeds. Spores are produced by mushrooms, by parasitic fungi and by some others of economic importance. Seeds are produced by practically all classes of farm and garden plants.



FIG. 43.—A single sweet potato from the hot-bed, showing many young sprouts. When the largest shoots are about twelve inches high they may be pulled and set in the fields.

The method of seed formation is sexual, involving both stamens and pistils, as described in Chapter II.

Many such plants are multiplied by means of stems, leaves or roots. This is without sex, and is called asexual. The propagation is accomplished by a division of the parent plant in some form. Examples of division are by roots, underground stems, tubers, bulbs, runners, cuttings, layers, buds and grafts.

Root Propagation.—The sweet potato is a true root. The store of plant food is abundant. Buds may start under the epidermis at any point, and many plants are started from a single root (Fig. 43).

The blackberry is commonly propagated by means of cuttings from the roots, seeds being used chiefly for the starting of new varieties. Roots about one-fourth inch in diameter are taken up in the fall and cut into two-inch lengths. These are kept in wet sand or sawdust in a cool cellar until spring, when they may be planted in shallow furrows and covered with about two inches of soil. They are sometimes started in hot-beds in very early spring and transplanted to the permanent garden about six weeks later.

Difference Between Roots and Stems.—The technical difference between a root and a stem is that a root does not bear true buds, at least the buds are not arranged in systematic order as they are upon stems. There are no scales or modified leaves about the "buds" on roots as there are on stems. True buds are often only upon stems. They contain rudimentary leaves for future growth.

Divisions of Crowns.—True buds are found at the crown of the root stem. This is true of many woody plants and herbaceous perennials. Such plants may be readily multiplied by division of the crowns in such a manner that some of the buds remain attached to each part of the roots after the division is made. Thus a lilæ bush may be divided into a number of plants. Many of the perennial flowers are propagated in this manner; for example, dicentra, delphinium, columbine, perennial phlox, golden-glow and peonie. Division of roots may be accomplished best when the plant is dormant, as in late fall or early spring. This is one of the easiest methods of multiplying plants. It is used in the propagation of hundreds of different shrubs, such as roses, currants, gooseberries, altheas, wygelia and spirea.

Rootstocks, or underground stems, creep near the surface of the ground and may be partly out of the ground at different places. They are supplied with buds, and at many of these new stems may be sent upward and roots sent downward. Thus new plants may be propagated by division at any point. This is a common method of propagation among many of the grasses, such as blue grass and quack grass. White clover spreads extensively in this way.

Tubers and Bulbs.—Tubers are commonly used in the propagation of white potatoes, dahlias and a few others. True buds are often found upon the tubers. These are sometimes called "eyes."

Many bulbs are multiplied in the moist climates of western Washington (Fig. 44) and western Europe. The Dutch bulbs are

perhaps most commonly found in American markets. A common method is to slit the bud in sections running vertically through the center (Fig. 45). Each piece then develops a number of small buds (Fig. 46) which in time grow to a size large enough to be used



FIG. 44.—A field of young bulbs being grown to marketable size; in the moist climate of Bellingham, Washington. (U. S. D. A.)

commercially. Examples are hyacinth, crocus and Chinese lily.

Scaly bulbs are more easily divided. Bulbs may start from the base of a scale and form new plants. A number of lilies are propagated in this way.



FIG. 45.—Mother hyacinth bulbs. Those on left are scored, on right scooped, to cause them to develop bulblets. (U. S. D. A.)

The bulbs of canna are similar to the true tubers. They are divided in the crown by merely breaking apart at the natural divisions.

Runners.—Horizontal stems are developed by some plants for the purpose of propagation. Such runners are above ground

and take root at any or all of the nodes, wherever they may come in contact with the ground. Bermuda grass spreads rapidly by means of runners. This plant becomes a bad weed in fields of corn or cotton because the runners take root so readily when the soil is moist. The grass apparently suffers from drought quickly, but does not really die. As soon as rains begin the brown runners revive, turn green, and send up new leaves.

The wild Buffalo grass of the arid regions also spreads by means of runners.



FIG. 46.—An excellent crop of young bulbets started from the wounds of the mother bulb. (U. S. D. A.)

The strawberry is seldom propagated in any other way than by runners, except when new varieties are desired. It is after the crop of berries is harvested that the runners make their most vigorous growth. If the weather is favorable strong plants may be formed at the first joint of the runners. After this the runners should be cut off to prevent secondary plants from starting. In this way the strongest strawberry plants may be obtained. The ground should be kept well tilled to conserve the moisture and encourage the rooting of runners. The young plants may be transplanted in August or September to their new location, or this may be done in early spring. Plants which are desired for use in hot beds or indoor growth during the winter may be started in pots or cans by plunging these in the soil near the open garden before the runners take root.

Layers.—There are three types of layering: *Tip layering* is a common method of multiplying the black raspberry (Fig. 47).

The tips of the canes are bent over and pegged or otherwise held to the ground. Usually the tip is recurved and perhaps slightly broken a few inches from the top, and this wounded point is brought in contact with the loose soil. If this is done immediately after the crop of berries is harvested the new plants will be well started in time to transplant them the following fall if desired. After rooting takes place the canes of the parent plants may be cut loose from the young plants by the use of long-handled hedge shears or a sharp spade.

Vine layering is practiced with certain varieties of grapes and with such other plants as certain kinds of roses, Virginia creeper and viburnum (Fig. 48). It is possible to use the method with almost any shrub. The vine is laid down in a furrow and covered at several points with soil. With some vines, rooting will take

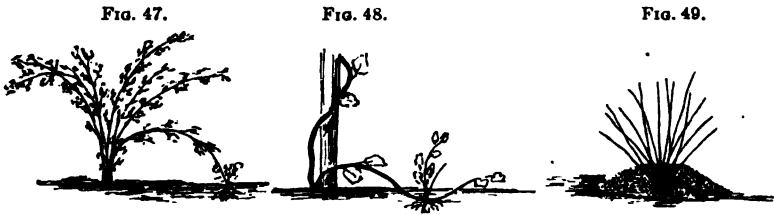

FIG. 47.—Tip layering as practiced with black cap raspberries and many other shrubs.
 FIG. 48.—Vine layering as practiced with ampelopsis, grape, and many other vines.
 FIG. 49.—Mound layering as practiced with the gooseberry, quince, lilac, and some others.

place more readily if a wound has been made at the point of contact with the soil.

Mound layering.—Many shrubs, such as the gooseberry and sometimes the quince, may be propagated by this method (Fig. 49). A mound of loose earth is formed among the branches above the crown. When roots have formed in this mound the plant may be taken up and divided by cutting the branches apart. Each will have its own roots, thus forming a separate plant.

Cuttings.—Many house plants are started by means of cuttings made from either the green stems or the leaves or both. This is a method familiar to many, because it is practiced in so many homes. Begonia, geranium, fuchsia, spiderwort and numerous others are thus propagated. The condition most favorable for the starting of green cuttings is to have very clean sharp sand partially shaded from the sun by means of newspapers or very fine covering to retard evaporation. The room should be warm.

Hardwood cuttings are used in propagating several varieties of grapes, currants, some hardy roses, and many ornamental shrubs (Fig. 50). Willows and poplars are so quickly rooted that they are recommended for practice by students.

Grape vine cuttings are taken in the fall after the leaves are



FIG. 50.—Making hardwood cuttings from shrubs. With some shrubs cuttings may be taken in mid-summer and set in rows in the garden. Others must be taken in their dormant condition in fall, winter, or spring, as the ripe buds will start better. (U. S. D. A)

off. They are cut in such length as to leave one or two buds on each piece (see figure 51 for four types of cuttings). They are tied in bunches properly labeled, and stored in wet sand or sawdust in a cool cellar until spring. During this time callouses form on the cut surfaces. They are set in the open garden or vineyard about planting time. One bud should be left at the surface of the

ground or just above it, packing the soil well about the base of the cutting to cause the roots to start promptly (Fig. 52). Young plants may be thus started in the garden or nursery row and left for one season. They are transplanted to the vineyard a year or two later.

Buds are used in the propagation of peaches, plums, pears, apples and many ornamental trees and shrubs by a process called budding or bud-grafting. The most common form of budding, in the propagation of fruit trees, is that known as shield-budding (Fig. 53). Other forms of budding are sometimes used.

Plate-budding, in which a rectangular plate bearing the bud is made to fit into an incision in the bark of like shape and size is sometimes used in propagating olive trees.

H-budding is a modification of this in which a flap of bark is left both above and below the center of the opening on the stock; those cover the bud at the ends when it is inserted.



FIG. 51.—Methods of making four types of hardwood cuttings. From left to right: mallet cutting, heel cutting, single-eye cutting, two-bud cutting.



FIG. 52.—Method of placing hardwood cutting in a trench. The soil is now to be filled in and tramped firmly against the cuttings, leaving one bud projecting above the surface.

Ring- or annular-budding may be used in propagating magnolia and hickory trees, which have very thick bark. A ring of bark is removed entirely from the stock and in its place is put a piece with its good bud, to fit the ring closely.

If this be modified by removing only a part of the ring it is called veneer-budding.

Shield-budding is so named because of the shape of the bark removed with the bud which is to be inserted in the stock. The name T-budding is also given to this method because of the T-shaped cut which is made in the stock before inserting the new bud (Fig. 53). This method of budding is the most rapid and for this reason has become the method in most common use.

Shoots of the current season's growth are cut from good varieties, as seen in figure 50. The plump buds from these should be

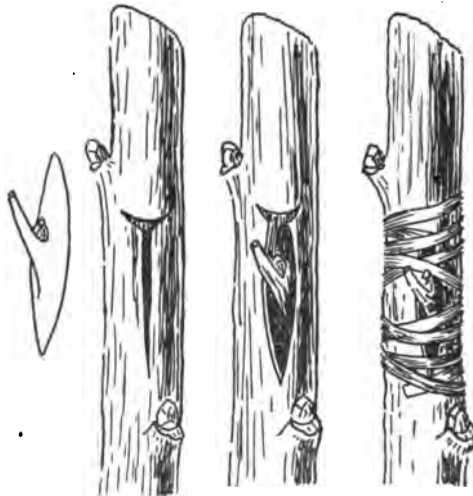

FIG. 53.—Three steps in the budding operation. The shield-shaped "bud" at the left is from the good variety desired. The stem on which it is placed is the "stock." The buds inserted in stocks in August or September start growth next spring.

inserted, without delay, into the growing stocks. The leaves are trimmed from the shoots, leaving a portion of each leaf-stem, with which to handle the bud. The shoots are then wrapped in moist paper or cloth to keep them fresh until all are used.

Stocks used in budding fruit trees are usually grown from seed. Apples and pears are usually not budded until the second summer, if grown in a northern climate. The stocks for peaches and plums are more commonly budded the first season of their growth from seed—August or September in the north, and June or July in the south. When June budding is practiced the buds to be used may be taken during the dormant season, stored in wet sawdust or sand in a cool cellar or in cold storage until budding time.

The operation is very simple and much skill can be attained by practice. The shield-shaped bark with bud is cut by slanting the cut about a quarter of an inch above or below the bud and letting the blade pass behind the bud and complete the shield about a quarter of an inch past the bud. Very little of the wood of the shoot should be cut. The knife used should be very sharp and the blade very thin. The bark of the stock is cut in the form of a T a few inches above ground. The angles of bark are rolled back to admit the shield with bud. The latter is pushed well down to the base of the cut and until the entire shield is within the bark and adjacent to the wood of the stock. The angles of the bark will cover the edges of the shield. The stock is then wrapped with waxed knitting cotton, or raffia fiber, to hold the bud snugly in place until it has united to the stock. The wrapping is cut on the opposite side of the stock soon after growth starts, to prevent strangulation or other injury.

Buds set in late summer should not start growth until the following spring. Then all the stock is pruned away above the bud (Fig. 54). This will force all the sap into the expanding leaves of the bud, and the growth should be very rapid (Fig. 55). When buds are set in spring or early summer more attention must be exercised in pruning away the leafy growth of the stock, as it should not all be cut off at one time for fear of checking the growth of the stock which had started before the bud united with it.

Top-working with Buds is frequently practiced because the wound formed by the union is not so bad as in some forms of grafting. This is described under the head of grafting.

Grafts are used in the propagation of many fruits as well as for many ornamental trees and shrubs. Grafting differs from true budding in that there is a piece of the twig inserted upon the stock and not merely a bud. This piece is called the *scion* (or *cion*). It may have either one or more buds, as desired. Scions are taken, from the kinds which we desire to propagate, in the fall after the leaves are off. They are stored in moist sand or sawdust in a cold cellar until used.



FIG. 54.—When the young shoot starts a vigorous growth in spring the superfluous part of the stock is pruned off.

The stocks for young nursery trees are grown from seeds, started in beds or rooms early in the spring. Conditions for their rapid growth should be made as favorable as possible. After they have made one season's growth they are usually taken up.

For root grafting, the seedlings are dug in the fall, tied in bundles and stored carefully in a cellar for winter use. But if they are to be grafted at or near the crown they are reset in open rows to be worked the second season.



FIG. 55.—Sweet cherry trees during their first season's growth in the nursery—Windsor on the right, Lambert on the left. The former variety usually develops a few branches the first season as indicated, but most other sweet varieties grow the first season without branching as is the case here with the Lambert. (U. S. D. A.)

Whip or Tongue Grafting is one of the most common methods employed. It is used extensively in root-grafting of apple trees (Fig. 56). The work may be done in a cellar during the winter season. The process is only slightly more difficult than that of budding. The tops are cut from the seedlings and destroyed. The roots and scions must be protected from the air to keep them moist during the process.

Make long sloping cuts across the lower end of the scion and the upper part of the root. This should be done with a very sharp knife. Then make secondary cuts forming tongues on each piece,

as shown in the figure. Push the pieces together firmly. If the root and scion are of the same size the cambium layers just beneath the bark will be in contact. This is essential to future union. The graft is now ready to be tied. This is usually done with moist raffia fiber or with No. 18 knitting cotton which has been dipped in melted grafting wax. The scions used for this purpose should be very thrifty twigs, and should bear from one to several buds each. The roots are usually cut into pieces varying in length from four to six inches. Some nurseries prefer to have the entire seedling root used. Such grafts are then called "whole-root" in distinction with "piece-root" grafts.

As the grafts are made they are kept moist and tied in bunches of from 25 to 100, with a label for each. These are stored in moist sawdust or sand and are held until spring. About corn-planting time they are set in nursery rows (Fig. 57) from six to twelve inches apart. The distance between rows should allow of cultivation and is usually from three to four feet, depending upon the soil. The depth should be such as to leave one or more buds exposed to the air. The ground should be pressed firmly about the graft to cause it to produce fibrous roots immediately. The young trees should be well cultivated the first season, and care given to the removal of any sprouts ascending from the roots below the point of union. After one or two years the young trees may be transplanted to the orchard.

Top-Working of Fruit Trees is a more common practice than formerly. There are several reasons for top-working. (1) The tree may be in bearing and the fruit be of an undesirable kind, either because the trees



FIG. 56.—Apples are commonly propagated by root grafting. The twig (scion), the root (stock) are shown slipped together and ready to tie with waxed cotton.

were improperly named or because the fruit does not suit the market. (2) The orchardist may desire to try some new variety on a tree of bearing age and bring it to fruitage more quickly than if it were worked on young stock. (3) The grower may wish to introduce into a block of trees in his orchard a few rows of any desired variety for the purpose of aiding in the cross-pollination of the trees.

Top-working is done chiefly by three methods: cleft grafting, tongue grafting, and budding. Still other methods are occasionally found but are less common; for example, side grafting consists in inserting a wedge-shaped scion beneath a very large stem or trunk.

Cleft grafting was formerly the most common method of top-



FIG. 57.—Students setting out rooting grafts in garden rows. Note the completed row at the right. (New Jersey Station.)

working orchard trees. Limbs varying in size from one-half to two inches in diameter are cut square across with a saw. With a chisel or special grafting cleaver, the end is split to receive two scions bearing the buds of the desired variety. The scions are cut in a wedge-shape form, one being inserted near the cambium layer at one edge, and one at the other, of the split stem. The scions should be slightly beveled to make them fit the stock most perfectly at the cambium layer and bark. The wounded surfaces are then thoroughly covered with grafting wax to protect them from the weather. This operation may be performed at any time during the early part of the growing season, dormant scions being used.

Tongue grafting is used in the top-working of trees, but must be practiced on smaller branches of the stocks. The wound formed by this method is not so great and the union is more apt to become perfect. In order to completely change the bearing tree from one variety to another by this method it is necessary to insert a much greater number of scions than would be necessary by the cleft grafting process.

Budding is used in top-working by inserting the buds either on large or small branches. Budding is coming into more general use for this purpose.

Pruning is essential after top-working of a large tree. The buds or scions which have been inserted must be protected in their struggle for growth. Competing branches near them must be pruned away after the new buds have produced leaves. Common sense and good judgment are the chief guides in this matter. There is always great struggle in a tree top among the different branches. The owner must aid the ones he wishes to develop and cut away the others.

Double Working.—Growers sometimes practice what is called double working of stocks. Young root grafts, for example, may be grown in the nursery row one year or more and then may be again budded or grafted at a height of from one to three feet above ground. This may be done either before or after the trees are transplanted to the orchard. This second operation would seem to be unnecessary, but may be required for one of the following reasons: (1) The young trees may be of bad shape, and the buds inserted may be for the purpose of lowering the first main branches. (2) The grower may have been unable to secure from a nursery the variety he desired, and so planted in his orchard an inferior variety. He will then change the variety by budding or grafting with the desired kind. (3) He may have a special strain or variety of his own well suited to that soil and other environments. By inserting the scions or buds himself upon young trees that have started growth in the orchard he can be more certain of securing fruit of his special variety.

FIELD AND LABORATORY EXERCISES

1. **Root Cuttings.**—Make cuttings of roots of blackberry. Plant these in favorable conditions and watch their growth.

2. **Compare Roots with Stems.**—Take the roots of any convenient shrub and compare them with the stems, or if possible with underground stems from the same plant. Note the buds and the stalks near the buds which form the nodes on underground stems called rootstalks. Note the absence of such nodes on roots.

3. **Division of Roots.**—Take groups of tuberoses, asparagus, golden glow or any other convenient plant in the garden which has a supply of buds near the crown. Divide the clump into separate plants, and plant them separately.

4. **Types of Bulbs.**—Compare bulbs of different kinds and determine which ones are more scaly than others, and which ones you would call firm or solid bulbs. In any one variety, as tulips or hyacinths, select those bulbs which would produce the best growth. What are the points you see in this selection?

5. **Purpose of Plant Runners.**—Examine the runners of strawberry, trailing buttercup, Bermuda grass and others that are propagated naturally by runners. From what points are the roots sent into the soil? At what points do the new shoots start up? What plants seem to be largest—those near the parent plant or those farther away? Why is there a difference?

6. **Layering.**—Make tip layers of raspberry plants, and vine layers of grape vines.

7. **Cuttings.**—Make cuttings of various woody shrubs found in the yard or along the roadside. Determine what trees will grow from cuttings if taken at the proper size. Use also cuttings of grape, English ivy, geranium, begonia, and others.

8. **The Practice of Budding.**—Students should practice budding. The operation may be learned by practicing on willows or other twigs which have stood in water in a warm room for a few days. This loosens the bark and makes the operation more like the real conditions found in the peach orchard in September. Buds of any kind may be used for practice, but at the right season the buds of good varieties of peaches should be inserted on stalks of seedling peaches. Use the method called shield budding in this work.

9. **Practice the cleft graft on twigs brought into the laboratory.** Then let the work be done with some good scions of apple trees grafted on the limbs of trees out of doors.

10. **Learn to make the tongue or whip graft, and secure a supply of seedling apple roots from a nearby nursery.** The expense of securing these may be covered by the sale of the grafts made from them. Cut off the tops of these young seedlings and graft on to the old scions from good varieties of apples which may be secured in the vicinity. Store the products in moist sawdust or sand in cool cellars until about corn-planting time. These should then be set in rows in the garden at proper distances for cultivation. Set the grafts so that only one bud projects above the ground.

QUESTIONS

1. Give examples of propagation by means of roots.
2. What are the technical differences between the root and stem?
3. Describe the division of crowns and give examples.
4. How are root stalks used in the multiplication of plants?
5. Describe the different kinds of tubers and bulbs.
6. What plants have runners? Tell how runners multiply the plants.
7. Describe the multiplication of black raspberries through tip layering.
8. Describe vine layering.
9. Explain how mound layering is done, and how it increases the number of plants.
10. Give examples of plants multiplied by green or soft-wood cuttings.
11. Mention several plants propagated by hard-wood cuttings.
12. Describe the budding by shield-bud method. Apply this to the peach.
13. Why is top-working with buds better than top grafting? Apply this to the apple.
14. Describe and illustrate the whip or tongue graft.
15. What special pruning should follow after top-working of an apple tree?

References.—U. S. Farmers' Bulletins: 157, The Propagation of Plants. 471, Grape Propagation, Pruning and Training.

CHAPTER VII

SOILS AND THEIR USES

Whoever will be perfect in the science of agriculture must be well acquainted with the qualities of soils and plants, and must not be ignorant of the various climates, so that he may know what is agreeable and what is repugnant to each.—COLUMELLA.

ALL elements or substances found in plants or animals are from either the soil or the air. Plants are produced from the soil and air; animals, in turn, secure their food from plants. The grower of field and garden crops is interested directly in soils; and the stock raiser is only slightly less interested in them. Both must know what kinds of soil are best for their special lines of farming.

What the Soil Really Is.—Soil has often been defined as the surface part of the earth in which crops may grow; but this gives us very little idea of its real nature. To understand it better let us follow the suggestion of I. P. Roberts and put a sample of good black soil to different tests. It will usually be found to contain insect life and other animal life in different forms. The bacteria present are not only abundant but are of too many kinds to be all known by the bacteriologist. Seeds and spores are usually present in countless numbers. The dark color is chiefly due to the presence of decayed organic matter—the result of both animal and vegetable matter which has begun decay soon after death. Much moisture is there and with it different chemicals in suspension. Oxygen, nitrogen and other gases constitute the air of the soil. The greatest bulk is probably made up of particles of clay and sand which have resulted from the disintegration of rocks through the long ages past.

In the study of soil formation through the crumbling of rocks of different kinds, a student must not lose sight of the real nature of soil and the multitude of organisms and substances in it.

The best farm soil is made up of a proper mixture of sand, clay, and decaying organic matter called humus, in just the right proportions. With it must be plenty of moisture in the best form. It must be in such physical condition as to allow the proper degree of ventilation for the supply of oxygen and the removal of injurious gases, and to supply heat at the proper seasons. It must have an abundant supply of useful bacteria and similar organisms.

Enough lime must be present to help produce valuable chemical changes in the soil. Plant food of various kinds must be present. This may be either in solution or in particles to become valuable at a later time.

Such an ideal soil is one which every good gardener or farmer will strive to produce and maintain. The methods of soil improvement discussed in Chapter IX are used by man in his efforts to produce or maintain such ideal soils.

Organic matter in the decayed or decaying form in the soil is called humus. The amount of it present in a given soil is to a very great extent the measure of the value of that soil. It determines its moisture-holding powers, the amount and activity of the bacteria present, and the condition of the soil with respect to



FIG. 58.—A quiet lily-pond where the feeding stream is depositing its heavy load of soil. As the soil fills in more plants will grow, until the place becomes a level field, suitable for growing crops.

ventilation and drainage. Humus is also one of the chief sources of nitrogen and other plant food.

Under natural conditions humus is produced in soils by the death and decay of insects, worms, grasses, leaves, twigs and trunks of trees, and other natural growth (Fig. 58). As these substances decay they are readily incorporated with the soil through the action of water and other natural agencies.

A sample of soil from the woods is usually black because of the humus present. Such soil is phenomenally rich. Under agricultural conditions the grower tries to imitate nature in the production of such qualities in farm soils.

There are other forces in nature, such as erosion and the blowing by wind, which tend to remove the surface layer of the earth

from a given area, and with it humus is taken. Because of the erosion, or wearing away by water, the surface layer of black soil is not so deep in a humid region as in regions of less rainfall. In arid regions the decayed organic matter which has accumulated for centuries makes the black layer of surface soil much deeper. The decayed matter will penetrate more deeply into a loose, open soil because of better ventilation. Root growth is deeper and the decay of such roots will form humus at a great depth. These conditions help explain the fact that in the arid regions the black layer of soils may be several feet deep, while it may be only a few inches deep in a more humid region, particularly if the conditions are favorable for erosion.

Live Organisms in Soil.—A good soil contains much life. It may almost be said to be alive with bacteria, molds and other organisms. They are so abundant in kind that specialists frequently discover new ones. Their work is only half understood by soil bacteriologists, and farmers are only just beginning to believe in their benefits. They attack the tissues of the dead plants and hasten their decay; the plant-food is thus rendered available to crops. Certain bacteria bring on chemical changes which result in making nitrogen available for plants. Other kinds produce other series of changes. There exists among soil bacteria a specialized division of labor.

If the sample of soil be baked in a hot oven until well heated through, the bacteria and other organisms will probably all be killed. Such a soil would then be much less productive, and if no bacteria were allowed to enter such a lot of soil, its productivity in the growing of crops would soon be reduced to a minimum. If a little soil containing a number of kinds of bacteria were added the whole mass would again become thoroughly alive with them. Under favorable conditions the process of reproduction of bacteria by division is very rapid. The process of division takes place within a few minutes. Simple calculation will demonstrate the great number which may be produced in a single day from a small beginning. It is estimated that a small handful of good soil may contain as many as a billion or more micro-organisms.

Soil Inoculation.—The process of adding certain desirable bacteria to a soil for any particular purpose is called "soil inoculation." It is well known that certain bacteria enable alfalfa to acquire nitrogen from the air. A different kind enters into partnership with the roots of red clover. Still other kinds help other

members of the clover family to accomplish the same purpose. Each of these makes its host plant more thrifty and productive. See the nodules on the roots of soy bean in figure 59. These are full of bacteria. The farmer is thus enabled to introduce into any field the bacteria which will be most helpful to the member of the legume family which he wishes to grow. If alfalfa, for example, has never been grown upon a certain field, the most suitable bacteria for this crop may



FIG. 59.—A soy bean nitrogen factory. The free nitrogen of the air is changed by the bacteria in the root nodules into forms that are used by the plant for making protein. (Productive Feeding.)

be introduced by spreading upon the field a few hundred pounds per acre of soil from an old alfalfa field. This should be done under favorable conditions, as when the sun is not shining. The top dressing of soil is harrowed in to mix it with the other soil. The rapid multiplication will soon thoroughly inoculate the whole mass, resulting in great benefit to the alfalfa crop as soon as it begins to grow.

Pure cultures are sometimes used for inoculation of soils. Bacteria for this purpose may be grown under favorable conditions in laboratories and applied to the field in different ways. The seed to be sown may be treated with water containing bacteria or some soil may be so treated and spread upon the field. The cost of such pure cultures is so great that the natural soil

method first mentioned is usually preferred.

Air in Soils.—The presence of living organisms in the soil requires ventilation not only for their own existence, but in order that they may accomplish the work which they do. Bacteria which change nitrogen into nitrates could not do so without the presence of oxygen. It has long been observed that air is necessary for the germination of seeds and for the growth of roots of farm and garden crops.

Air is able to circulate or move among the soil particles, if the soil is in good physical condition. For the best growth of crops the soil must allow the entrance of fresh air to supply oxygen. A fresh supply of atmospheric nitrogen to be worked upon by nitrogen-fixing bacteria is brought into the soil through the ventilating process. Air which has once been used must be removed; thus an excess of carbon dioxide may be liberated from the soil by ventilation.

There are a number of forces constantly active which tend to aid the movements of air in soils. Each change of temperature is helpful. Some days the air is heavy and other days it is light. These changes will condense or expand the soil air. The action of wind, particularly on a hillside, has a strong influence. As rain water enters the soil it may not only carry air in solution but also draw air downward through the openings left behind it. Underdrains may take away surplus soil water and leave pores to be filled with air. Ventilation often follows the channels left by decaying roots.

If a field becomes hard and dry the crust may be broken by a cultivator, harrow or other implement. This will allow air, as well as rain water, to enter more readily. Deep tillage will also greatly increase the amount of air space in the soil and aid in its ventilation.

Soil Grains.—The finest particles of those portions of the soil formed from rocks are called clay. The next finer are called silt, and those coarser than silt are fine sand or coarse sand. Gravel may also be present in the soil. These particles of rock are larger than sand and are usually not considered a part of the soil at all. Following are the sizes of such soil particles as are used in soil analyses (mm. indicates millimeters in diameter):

Clay	0.005	to 0.0001 mm.
Silt	0.05	to 0.005 mm.
Very fine sand	0.1	to 0.05 mm.
Fine sand	0.25	to 0.1 mm.
Medium sand	0.5	to 0.25 mm.
Coarse sand	1	to 0.5 mm.
Fine gravel	2	to 1 mm.

Disintegration of Rocks.—There a number of forces or agencies that work in nature tending to disintegrate both large and small rocks and make them into finer particles which may finally become useful in helping to form soils. Among these agencies commonly seen about us are the action of running water; the freez-

ing of water; the work of air; the action of the sun and heat; the action of growing roots; the agency of plants; the work of earth-worms, insects and burrowing animals. The action of the ancient ice sheets called glaciers had a mighty influence in grinding the rock of the northern part of this continent. No other single influence has been so great.

Soil Movements.—The ancient glaciers not only ground up rocks but moved them from place to place. Much soil was carried by the moving ice. Soils became mixed. The surface contour was greatly changed. High places were ground off and moved



FIG. 60.—When eroding fields are neglected the soil is carried away to the streams below—a barren waste is the result. (Fights of the Farmer.)

away. Valleys were filled and at melting-points moraines were formed. These were sometimes in the form of hills, long ridges, or occasionally served as dams across valleys. Water was impounded in the form of lakes. The long chains of lakes of Minnesota, New York, Canada and elsewhere were thus formed.

Running water has ever been a mighty force in the movement of soil (Fig. 60). Very heavy rain may form streams which carry with them large quantities of clay and silt. In regions where the natural streams are muddy much movement of soil has taken place. In regions where the streams are clear less soil is being carried.

In the hilly sections farmers are compelled to face the problems of soil erosion. The natural efforts of running water to carry away the surface soils of fields should be prevented so far as possible (Figs. 61 and 62). This is done by the use of cover crops on fields; by the use of the steep hillsides for wood lots; by terracing cultivated fields; by plowing and cultivating along level lines at right angles to the slopes, instead of up and down the slopes.

Wind is a mighty force in the movement of soils, particularly in dry climates or during dry seasons in the humid climates. Crops are sometimes blown out by the roots. Hills may be removed in a single day and others as quickly constructed. The influence of



FIG. 61.—Hillsides may often be prevented from erosion by throwing up furrow-slices to form dams or "balks" along the meandering contour lines of the hill. Water follows these so slowly that no erosion occurs. (Fights of the Farmer.)

the wind is greatest upon such soils as do not retain moisture readily and those which do not have much binding material. For just these reasons sandy soils are more frequently blown by winds than clayey soils. To prevent the blowing away of the surface soil fields should be kept well covered with a growing crop, particularly in dry seasons when the danger is greatest. Sheltered belts of growing timber will be helpful. Such are strongly recommended for use in the prairie states. The addition of humus to soils will cause them to hold moisture better and thus prevent blowing. When fields are plowed late in the fall they may be left rough and thus be less damaged by plowing than when harrowed.

Soils Classified.—Many kinds of soil are in use by man in the

production of crops. They may be classified according to fineness into sandy, loamy, and clayey soils, according to the proportions of sand, silt, and clay present. This classification is based entirely upon the size of the inert particles present. A sandy soil is coarse, loose and open. A clayey soil contains much silt and clay, and is therefore very fine, close, and compact. Loams are intermediate between these two extremes.

If the soil particles are formed from the crumbling of limestone



FIG. 62.—Hillside may be terraced for each row of orchard trees—to prevent erosion. (F. A. Waugh.)

they may be designated as limestone soils. They usually have the characteristics of clay loams, but are darker in color. Peaty soils are those which contain a very great proportion of vegetable matter in a more or less perfect state of preservation. They may be formed in bogs where the presence of water prevents decay. On exposure to air the decay may be very rapid. The color is usually black or dark brown.

In like manner, other soils may be given special names referring to special characters which they exhibit.

According to fineness of the rock particles present, common soils may be arranged as follows: clay, heavy clay loam, clay loam, loam, sandy loam, light sandy loam, fine sand, medium sand, coarse sand, gravel (P. 73).

Special Use of Sandy Loam.—Sandy soils are usually poor in plant food as compared with clayey loams. Because of their loose, open texture they do not hold water well. Air passes through them readily and, if the weather is dry, crops will suffer for want of moisture on such soils sooner than on those containing more clay. Because of their loose, open texture sandy soils are quicker to warm in spring by the entrance of warm air. This makes them well adapted for use in the growing of early spring vegetables. Market gardeners find such soils most profitable. In wet seasons sandy soils are much to be preferred for general farming, as crops do not suffer so much from heavy rains. Their drainage is natural and they dry out quickly. They seldom become cloddy, even if plowed during wet weather.

Heavy Clay Loams.—When clay soils are wet they are sticky and likely to become cloddy if plowed before they are sufficiently dry. It is difficult to keep such soils in proper condition. They are well adapted to the growth of grains and grasses, and are used for general farming, hay and grazing. They are very properly called "cold soils," because moisture and air do not pass through them readily. In dry seasons general crops may suffer less than on sandy soils, but if much clay be present the surface is likely to become baked and crusty. This is very detrimental to the best growth of crops. Great care must be exercised to keep the surface in proper condition by tillage. Because of the difficulty in plowing clay soils, and because of their sticky condition, they are spoken of as "heavy soils" in contrast with sandy soils, which are called "light." Clay soils with much gummy substance are often called gumbo.

Limestone Soils.—Soils derived from limestone contain the important plant food calcium. Lime is usually considered a valuable asset in soils. It improves the physical condition of both heavy and light soils. It aids in the decay of vegetable matter and in the liberation of plant food from it. It neutralizes acids and certain other poisonous substances in soil. The texture of limestone soils is usually very good. They are easy to work and usually well adapted to general crops and fruits.

Lime may be added to soils in a caustic condition in such

quantities as to liberate plant food too readily. Sandy soils are more likely to suffer under such treatment than clay soils. The liberated plant food may be lost from the sandy soils more readily than from clay soils. If the lime be in a carbonate form the liberation of plant food and the rotting of vegetable matter is slower and the growing crop may use the food as fast as it is liberated. There are a few special crops, such as cranberries, watermelons, and others, which prefer acid soils. These do not thrive on soils where much lime is present.

Four Great Soil Types.—There are a number of special soil types which have been studied and mapped by the Bureau of Soils and which are well known in the sections where they occur.

Four of these occur abundantly in the Central States.

1. **Fargo clay loam** is the principal soil in the Red River Valley. Similar soil is found in a few other ancient lake basins, in North and South Dakota and in Minnesota. These are all formed of glacial sediment. The soil is deep, and rich in humus. The color is dark brown and the texture that of a clay loam. Particularly because of the climatic conditions these soils are abundantly used for the growing of spring wheat, barley and oats. Flax was formerly much grown.

2. **Marshall silt loam** covers an extensive area from central and western Indiana through northern Missouri, southern Iowa, eastern Kansas and west beyond the center of Nebraska. In this extensive area it is the most common type of soil found. The soil is well supplied with humus, is very deep and varies in color from brown to black. It is a loose, silty loam and is easily tilled. It is the best corn soil of any extended area. It is the best soil for this purpose in the great corn belt.

3. **Carrington loam** is the prevailing soil over the northern region between the Missouri and Mississippi Rivers, including the eastern portions of North and South Dakota, outside of the Red River Valley, southern Minnesota, and northern Iowa. This loam is of glacial origin. It is loose, deep and usually dark or black in color. The soil is well suited to the growing of corn where the climate will permit. Spring wheat is the most important crop of the region; others are flax, barley, oats, winter wheat and hay.

4. **Miami clay loam** was the natural forest soil of southern Michigan, eastern Indiana, and western Ohio, with limited areas in Iowa and in Wisconsin. The soil is of glacial origin and is of a heavy clay or silty texture. It varies in color from dark brown to

yellowish or grayish in color. The surface soil varies from eight to twelve inches in depth. The area is adapted to general farm crops, with hay taking the lead. Permanent pastures are very successful and the associated industries of dairying and stock raising are extensively carried on. The chief grains grown are winter wheat, corn and oats.

Special Crop Soils.—A number of soils occupying much smaller areas than the four just described have been studied with reference to crop adaptation. Some of these are well suited to special crops. The soils of the Portsmouth series are adapted to small fruits and somewhat used for late truck. The soils of the Porter series in the Blue Ridge section are used for apple growing. The Norfolk fine sand, of the Atlantic coastal plain, is best suited to the production of early truck crops. The Wabash clay loam of the Mississippi delta is specially suited to the growing of sugar cane. Crowley loams of Louisiana and Arkansas are well adapted to rice-growing. The Clyde soils, of southern Michigan, are used for such special crops as celery, onions, and sugar beets. The Dunkirk series of soils of the lower Great Lakes are used for orchards, vineyards, and general farm crops.

FIELD AND LABORATORY EXERCISES

1. **Field and Weed Seeds in Soil.**—Try to prove that there are live seeds in chance samples of garden soil. Put the soil in favorable condition for germination, keeping the moisture and temperature favorable, and see if any seeds germinate.

2. **Germs in Soils.**—Examine a sample of garden soil for organic life by testing the presence of mold germs. This may be done by taking two samples of the same soil in two cans. Place one of these samples in an oven for half an hour to kill all spores or other life present. Then in each can place a piece of freshly toasted bread or freshly baked biscuit. Moisten these with water that has been boiled and cooled. Cover both cans alike to exclude mold from the air. Set them on a shelf and await developments. In which one does mold develop first? The bread in this case serves as food on which the mold can grow.

3. **Bacteria and Growth.**—Sterilize two samples of soil as in the above exercise. In each plant wheat and moisten both with water which has been boiled and cooled and is free from bacteria. Compare the growth in the two lots of soil.

4. **Bacteria Cultures.**—If conditions are favorable for making bacteria cultures, test samples of garden soil by making cultures from them.

5. **Soil inoculation** may be illustrated by taking two flower pots which are filled with the same kind of soil. Sterilize both of these in the oven. Into one of them introduce a culture of clover bacteria by taking a few ounces of soil where clover is growing thriftily. Stir it into a pot. Then plant clover, using the same number of seeds for each pot. Compare the clover for the next six or eight weeks, taking care to keep the moisture conditions and temperature favorable for clover.

6. **The above exercise** may be varied by using an artificial culture for clover obtained from the United States Department of Agriculture.

7. Test the value of air in soils by growing two lots of corn in two pots, one under favorable conditions of reasonably loose soil, and the other using heavy clay soil which has been puddled by mixing when very wet and the air has been almost entirely driven out. The air may be excluded by keeping the clay soil very wet. In wet seasons such adverse conditions are often found in low spots of corn or cotton fields.

8. Soil Collection.—Make collections of all the types of soils available. Classify these and put the proper labels on them.

9. Soil Grains.—If microscopes are available, study the soil grains of clay, silt and fine sand. Compare them as to size and as to their tendency to cling together.

10. Soil Analysis.—We may analyze a sample of soil in a crude way by placing, say, ten grams or $\frac{1}{4}$ oz. in a bottle of water. Pour off all the water into another bottle, or drain it off with a glass siphon, leaving the coarsest sediment in the bottom of the first bottle. Shake the second bottle a few times and allow it to stand for thirty seconds and draw off the water into a third bottle, leaving a finer sediment in bottle Number 2. Continue this separation of the soil until nothing but the finest clay is left in the water. If we wish to determine the exact amount of soil of each degree of fineness, the water from each may be evaporated, and the grains may be carefully weighed. Compare this with the table showing the sizes of soil particles given in this chapter.

11. Comparative Study of Soils.—Obtain several samples of soil from different fields. Rub a bit of each sample between the thumb and finger and decide as nearly as possible which sample contains the most clay and which the most sand. Which seems to contain the most organic matter. For this purpose the fingers should be wet as each sample is examined.

12. Soil Types.—The school should provide itself with samples of soil of each of the great soil types. A bulletin describing the soil types of America may be obtained from the Bureau of Soils, United States Department of Agriculture. Send for samples of these soils by writing to friends or prominent teachers who live in each of these soil areas. The samples may then be used for comparative study and in contrast with the soils in the vicinity of the school.

QUESTIONS

1. Describe what soil really is.
2. What are the advantages of organic matter in the soil?
3. What are the effects of bacteria in soils?
4. Describe an exercise to show the difference between a sterilized and an unsterilized spot of soil.
5. Describe the method of soil inoculation. What other methods are there?
6. Of what importance is air in soils?
7. Give some idea of the range in size of different soil grains.
8. Name the kinds of grains in order of size.
9. What are the agencies at work in the movement of soil?
10. What are some of the special uses of sandy soils and sandy loam?
11. Give the special adaptations of heavy clay loams.
12. What family of plants is best adapted to limestone soils?
13. Tell briefly what you can of the Fargo clay loam.
14. Where is Marshall silt loam found? What crops are suited to this region?
15. Tell what you can of Carrington loam and its uses.
16. Tell what you can of Miami clay loam and its uses.

References.—U. S. Farmers' Bulletins: 245, Renovation of Worn-out Soils. 257, Soil Fertility. 494, Lawns and Lawn Soils. Soil Laboratory Manual, Eastman & Davis, J. B. Lippincott Co., Philadelphia. Soils, Their Properties and Management, Lyons, Fippin and Buckman, The Macmillan Co., N. Y. Soil Physics and Management, Mosier and Gustafson, J. B. Lippincott Co.

CHAPTER VIII

WATER IN SOILS

It is difficult to comprehend the importance of water in soils. Not only must the water be present in the right amount, but the condition in which it exists during the growth of plants affects their development. The annual rainfall in any region may be abundant for the growing of crops if it were distributed evenly throughout the growing season. It is found that in many sections of this country the greatest rainfall is during the dormant season, and much of the growing season is without sufficient rain. Long dry periods are frequent during the summer when plants are in greatest need of water to maintain their rapid growth.

Water Required During the Growing Season.—Much of the rain which falls during winter or when there are no plants growing upon the fields may be lost by running off or percolating to great depths. Much less of the rain which falls during the spring and summer, when growing plants occupy the field, will be lost.

By a number of trials King showed that the average amount of water used by various crops during their growth, to produce one ton of dry matter, was as follows: Oats, 504 tons, or nearly 40 inches; Barley, 464 tons, or nearly 21 inches; Clover, 576 tons, or 22 inches; Potatoes, 385 tons, or nearly 24 inches; average of these four crops, 482 tons, or 27 inches. The number of inches of rainfall is not proportional to the tons of water for a ton of dry matter, because of the variation in yield in these crops.

Average Annual Rainfall.—The average annual rainfall in the humid sections of this country is much greater than this average. The Pacific Coast of Oregon and Washington has fifty to sixty inches of rainfall annually. This amount is also found in the southeastern states, along the coast from Louisiana to Virginia. It exceeds forty inches throughout the eastern states as far west as southeastern Kansas, Oklahoma and eastern Texas. In most of the region west of Minnesota and the western third of Nebraska, Kansas and Texas the annual rainfall is twenty inches or less. As we go westward this amount is seldom exceeded in any locality until we reach the central lines of Oregon and Washington, and the western line of Nevada.

Wheat requires a little less water than the other small grains. It has been shown by King that if the rainfall be well distributed through the growing season twelve inches is sufficient to produce a heavy yield of wheat. Wheat is grown in some regions where the rainfall is too light for a number of other field crops. Note the management illustrated in figure 63.

The most important lesson, however, to be learned in the study of crop requirements is the fact that the rainfall is not evenly distributed and that regions with twenty or thirty inches of annual rainfall will not produce good yields of wheat, or corresponding yields of other crops. So much of the rain comes at a season when it is lost instead of being used by crops. A part of



FIG. 63.—Moisture conservation methods as practiced in some sections of the arid regions. Winter wheat continuous cropping on right, alternate crop and fallow on left. Note the comparative yields. (U. S. D. A.)

the rainfall may be saved over till the growing season by fall plowing, as shown in figure 64. It is more important to know the amount of rainfall during the growing season than to know the total annual rainfall, but even here we may be misled by the figures, as much of the rain which comes during the early spring or summer may be lost in streams or by percolation through loose, open soils.

Three Conditions of Soil Water.—The water which soils contain may be: (1) free water, (2) capillary or heavy film water, (3) hygroscopic or fine film moisture.

Free water is that which can be plainly seen as water when the soil is handled, or when openings are made as for post holes or wells. When the soil is saturated with such water, field crops

cannot make use of it. Its presence excludes the air so that most farm crops cannot thrive until the surplus water is removed. An abundance of free water may wash out valuable plant food in solution.

If the free water stands at a level in the soil of say two feet below the surface, such level is called the free water table in the soil. In practically all field conditions the free water table is constantly moving. After a period of heavy rains it may be near the surface and during dry weather may recede to a great depth. In regions where wells are shallow the depth of the water table is practically that of the surface of the water in the wells. In the



FIG. 64.—Moisture conservation methods. Spring and fall plowing in Colorado for corn. Note the heavier growth on left due to fall plowing. (U. S. D. A.)

spring after the heaviest rains have ceased it is a good plan to determine the depth of the free water table. This may be done by digging holes a few feet deep as if for the setting of fence posts.

The Benefits of Free Water.—Probably the greatest benefit of free water to the growing crop comes from the replenishing of other forms of water in the soil from it. As the capillary water is used up by plants, more is supplied from the soil below the water table, if the distance is not too great. A secondary advantage sometimes exists by the free water washing away injurious substances in the soil. This is apparent where the soil contains alkali, as in some of the arid regions.

Capillary Water.—Above the free water table in the soils and in surface soils after rains, the capillary water may exist in large quantities. Each of the many grains of soil has surrounding it a film of moisture. These films about the grains are thick enough to allow the moisture to readily move from moister to drier parts. This process is called capillary movement. It may be illustrated by the oil of a lamp moving upward through the wick to the flame. A soft cloth placed with one end in a vessel of water and the other end outside may draw the water out of the vessel. The cloth over the edge of the vessel cannot be said to contain free water, because it is so finely spread out in films over the fibers of the cloth.

An ounce of sandy soil contains about sixty billion particles

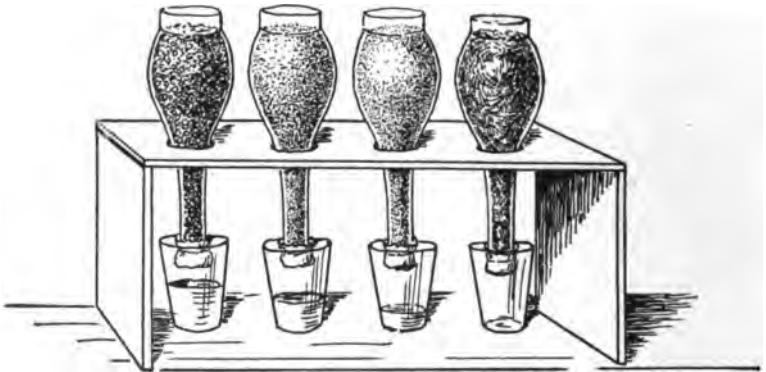

FIG. 65.—Common lamp chimneys with cloth tied on to prevent the escape of soil samples placed in them. This may be used to show the rate at which different soils will take up rain water and their relative power of retaining water for use of crops. From left to right they may contain coarse sand, loam, clay, and humus soil.

and an ounce of clay loam contains about four hundred billion particles. It is possible for a comparatively large amount of water to be held in soils when we consider that the number of particles is so great. The amount of capillary water which a soil may hold depends somewhat upon the size and number of grains in it. A clay soil will always hold much more capillary water than a sandy soil, because of the greater number of particles in it (Fig. 65).

The capillary film of water may readily move from soil grain to root surface and root-hairs. It is in this condition chiefly that plants make use of soil water. Free water must first be changed to the capillary condition before field crops can use it. Capillary water contains the plant food for roots to absorb. Soils wet with

capillary water may contain air in the intervening spaces. This allows the constant work of bacteria and other soil organisms. This condition is affected by tillage. If the soil be puddled by plowing it when it is too wet the particles may be pressed so firmly together that much air is excluded. If conditions are favorable at the time, the operation of plowing or harrowing will allow more air to enter.

Hygroscopic Moisture.—This may be termed fine film moisture. The film about the soil grains is so thin that it does not move by capillary action from one part to another, and from the grains to the root surface. If a sample of air-dry soil which has the appearance of dust be heated in a test tube over a flame, moisture will be seen to collect above the dust on the sides of the tube. This water had existed in the form of hygroscopic moisture on the soil grains. It is thus seen that water in such fine films can be caused to move from place to place through the action of heat. Air in the soil may become saturated with such moisture when the soil is very warm. At night, as the surface cools, this soil air may deposit some of its moisture upon the cold grains near the surface.

Hygroscopic moisture is of value to the plants by keeping the plant food in solution during dry weather. It helps to maintain the life of plants in arid regions, and during dry seasons in humid regions. If the amount of soil moisture be reduced to this condition the plants cannot thrive. Its presence in the soil will cause the soil to take up water more readily when rains occur. A soil which is absolutely dry will not take up water quickly. As soon as each particle has a thin film about it this may be increased through capillary action as soon as water is supplied.

Movements of Soil Water.—Free water moves downward through soils by the force of gravity. For this reason it is sometimes called gravitational water. The process may be called percolation. When such water carries with it certain plant food, or other ingredients in solution, these substances are said to be carried away through the pores by "leaching."

It is evident, from what has already been said, that capillary water moves by capillary action. This may be in any direction in the soil. It is natural, however, to think of it as being chiefly upward or laterally. But it may be downward also, as when a light rain occurs upon a rather dry field, the water near or at the surface is distributed among the soil grains below, through the capillary process.

The process by which hygroscopic moisture moves is called thermal movement. This is because the internal evaporation and condensation of such moisture in the soil is due to the difference in heat. More heat causes evaporation and less heat causes condensation from the soil air.

Water-holding Power of Soils.—No reference is here intended to the capacity of a soil for free water. The only form of water that is valuable to plants is that in capillary condition. The more capillary water a soil can hold the better it can produce crops.



FIG. 66.—Placing dynamite and fuse in a drill hole two feet deep. The explosion loosens the subsoil for the roots of trees and other plants. They find the moisture conditions much better after such treatment. (New Jersey Station.)

It is therefore highly important that a farmer or gardener should endeavor to increase the capacity of his soils for holding capillary water. This he can do in a number of ways:

1. Deep tillage will greatly increase the air space and allow the soil to hold more capillary moisture (Fig. 66). Portions of the soil which are not stirred by the plow become so closely packed together that the capacity for capillary films is greatly reduced. Soil grains gather together in compound particles, and if this condition is prevalent in any soil the result may be that of having very coarse particles. Coarse soils hold less moisture. Tillage,

which breaks up the compound particles, pulverizes the clods, and breaks up the solid or packed masses, will allow the soil to hold more moisture. The modern deep-tillage machines which stir the soil to a depth of 12 or perhaps 24 inches are among the most successful machines for the deepening of the "water reservoir." Heavy clay soils become very compact below the level of ordinary plowing. The use of subsoil plows will loosen the soil and subsoil to a greater depth and if done when the soil is not too wet will deepen the root bed and otherwise increase the moisture capacity of the field.

2. Humus in soils increases their water-holding capacity. We have seen that clay soils will hold much more capillary moisture than sandy soils. A rich, black soil containing an abundance of well-rotted organic matter will hold four or five times as much moisture as a heavy clay soil, if both are in well-drained vessels where the free water may fall away. The amount of humus in any soil is largely within the control of the owner. It may be readily increased by plowing under barnyard manure, straw, vines, weeds and other farm wastes, green manure and special crops grown for the purpose. The best systems of farming are those in which suitable rotations are established whereby certain crops are grown during the rotation to be plowed under for this purpose. Sods, resulting from the growth of grasses for hay or pasture, will produce much humus in the soil when plowed under.

3. Underdrainage has its effect upon the amount of water available to plants. If the free water table be near the surface roots can feed to only a shallow depth. If the water table be lowered by underdrainage the soil space above the deep water table will be suitable for the growth of roots. The amount of capillary water which the roots may obtain is thus greatly increased. If by any natural or artificial means the water table is lowered to a very great depth the free water will not readily replenish the capillary moisture as fast as it is used up by roots.

4. In the soils of arid regions perhaps no free water table can be found at certain seasons of the year. The soil a few feet below the surface may be drier than that above it. The problem of increasing the capacity of the soil in such cases is chiefly that mentioned in paragraphs 1 and 2; but if the soil be very open and porous the moisture during the rainy season will penetrate to great depths and be lost from use of the crops which are soon to be planted. If such loose soils are firmly packed by the use of

very heavy packers, rain water will be prevented from percolating so readily and much of the rainfall may thus be held among soil particles within a few inches or a few feet of the surface. Such management of arid soils is known as "sub-surface packing." The packers used for this purpose are heavy rolls of some form with a rough surface. Three main types are in use: Some have a number of heavy cast wheels with fluted rims; some have a number of heavy cast wheels with V-shaped rims; some have ribbed surfaces made with iron pipes or bars.

CONSERVATION OF MOISTURE

Since much of the rain water which falls in a given region is lost by surface run-off, or by evaporation, and by rapid percola-



FIG. 67.—The Acme harrow is a good clod crusher. When the soil surface becomes pulverized the moisture is conserved.

tion; and since there is much suffering from droughts, even in humid regions, it is essential that every practical means be used to save the moisture which falls during wet seasons. Among the sources of loss of moisture which are largely within the control of the farm manager, are: (1) evaporation through baked and crusty soils; (2) run-off is increased by bad management; (3) the growth of weeds; (4) reduction of the humus content of soils; (5) failure to loosen packed soils; (6) failure to pack loose soils; (7) failure to check winds.

Dust Mulch.—Evaporation of soil moisture, particularly during the hot, growing season of the year, is one of the greatest losses of the farm. The modern methods in vogue in semi-arid regions tend to prevent this loss. They are just as applicable to humid regions during the growing season, because of the droughts which usually occur. If the surface soil be kept loose so that the capillary contact of the particles is broken, the loss through surface evaporation is greatly reduced. Such a condition of the surface soil is spoken of as a dust mulch. It can be readily produced by the use of a harrow. The surface soil may be easily kept in this fine broken condition before crops are sown, by the frequent use of a harrow (Figs. 67, 68). In the so-called hoed crops, such as corn, cotton,



FIG. 68.—The weeder will produce a fine dust mulch and conserve moisture in the soil. (Bateman Mfg. Co.)

potatoes, tobacco and others, a fine-tooth cultivator may be used to stir the soil very frequently and thus prevent the formation of a crust.

The student should understand that a crust formed upon the surface of soils, by drying rapidly after heavy rains have packed the particles together, is very detrimental to the growth of all crops. Such a crust causes very rapid evaporation of soil moisture. The particles are so close together that the capillary climb of water is direct and rapid. As soon as the ground begins to dry enough to allow the use of a harrow or light cultivator these implements should be used. The farmer who allows a crust to form on any field loses water which the crop will need later. The same

operation which prevents the formation of the crust and stops evaporation will also be effective in causing the water to penetrate a little deeper into the soil where it may be saved for use of the crop during dry weather. It may thus be seen that if the harrow or cultivator be used at the proper time it accomplishes two important purposes in the saving of soil moisture.

Ridging up the surface causes it to lose water more rapidly because the exposure to the air is much greater (Fig. 69).

Cover Crops.—If hillsides are constantly clothed with growing crops there will be less soil erosion. The water and the soil which would both be wasted are held by such cover crops. The roots of



FIG. 69.—The practice of ridging the soil, for certain crops, tends to make it lose water more rapidly than if the planting is in the level surface. (New Jersey Station.)

the cover crop allow water to enter the soil more readily. The soil will thus take up much more water and take it more quickly than if the ground were bare. This drinking in of the water is made more rapid also by the mellow condition of the surface soil. A cover crop prevents the surface from baking or becoming crusty. During a heavy rain the soil is not packed by the heavy patter of rain drops, because of the protection given to the surface by the growing cover.

The most important time for having a cover crop upon any hillside field is during the rainy season. The use of winter cover crops which are started in late summer, before the main crops are harvested, is practiced in modern farm management, and should

be emulated. Small grains, such as winter wheat and winter rye for the north, and winter oats for the south, serve well the purpose of a winter cover. These small grains may have mixed with them for this purpose such legumes as may be suited to the section where they are used. Crimson clover and winter vetch do well in the middle and southern states. Seed for such winter cover crops may be mixed and sown between the rows of corn, cotton, tobacco, sugar cane and other cultivated crops. As soon as the main crop is harvested the growth of the cover crop becomes more vigorous and a fine cover for winter conditions is produced.

Besides these benefits of cover crops there are several other uses discussed in Chapter IX.

Adding Humus.—The presence of humus in all kinds of soils improves them in a number of ways. We have already seen that humus increases the water-holding capacity of both clay and sandy soil. Soils containing a large proportion of humus will receive the rain water more readily than those containing little humus. If the rain falls rapidly this characteristic of soils is very important. Much surface run-off is thereby prevented.

As soils containing little humus will absorb much less water, they soon become saturated by continuous rains. If other rains follow upon this condition the soil is either washed away in masses or rivulets will be formed, cutting gullies down the hillsides, and torrents of water may rush to the valleys, bearing with them much valuable plant food and soil materials. The addition of humus to the soil tends to prevent all of this, as much more water will be held by the soil and washing will not take place until the soil becomes saturated. Methods of adding humus have been mentioned in Chapter VII.

Wind Breaks and Shelter Belts.—In all climates wind causes much loss of soil moisture. Water which is once taken into the soil should not be allowed to escape by evaporation from the surface, if it can be prevented. One method of reducing surface evaporation is by using wind breaks or more extensive shelter belts. In a level region the influence of such a barrier will be effective for a distance of ten or twelve times the height of the wind break. Within this area the evaporation of water will be greatly reduced because of protection from rapidly moving air. Crops in this area will suffer less from drought because of such protection.

A number of crops will thrive better when they are not disturbed by wind, and the presence of an abundance of soil mois-

ture makes them all the more thrifty. Truck crops, orchards and other fruit plantations usually thrive better under such protection.

One objection which is often raised to the growing of wind breaks near fields or crops is the drying effect of the trees on the soil very near them. This is sometimes prevented by digging a trench two or three feet deep between the trees and the growing crop. This should be a few feet from the tree trunks. Surface roots are thus cut and prevented from drawing moisture from the soil beyond the ditch. The roots of trees will send out many fibrous branches where they have been cut, and it will require several years for them to draw moisture from a distance beyond the ditch. Of course the ditch is not left open. It may be reopened every five or six years and closed immediately. By this method the roots of the growing wind break are turned and the moisture is conserved for the use of the money crop.

In prairie countries the wind break may be made wide enough to produce a crop of its own. Such may be made wide shelter belts and produce timber for posts, poles, lumber and fuel. It is believed that such shelter belts will be profitable in themselves, aside from the benefits they give to the adjacent cultivated fields.

FIELD AND LABORATORY EXERCISES

1. **Distribution of Rainfall.**—Obtain weather reports covering your region and find the average annual rainfall. In what months does most of the rain occur? What are the dry months for your section? What years in the last ten have been considered wet years and what ones were dry years? If the hot, dry months are during the growing season, what is the conclusion regarding the need of saving moisture in the soil?

2. **Depth of Water Table.**—During the wet season of the year dig a post hole in the field or yard and determine, if possible, the depth of free water. Protect the post hole from being filled up by placing a board or flat stone over it. From time to time examine and see if the free water has disappeared or has reappeared during the changes of weather.

3. **Capillary Action of Soils.**—Compare two samples of soil in their capillary action. Use sand for one and clay for the other. Place them in two lamp chimneys, with a cloth tied at the bottom of each to hold the soil. Place both at the same time in a dish of water and note the rise of water in each. Is this water climbing in the soil capillary water, free water or hygroscopic water?

4. **Moisture in Dust.**—Take a sample of dry road dust. Put it in a test tube. Place a little wad of paper in the mouth of the tube to partially exclude the air, and heat the sample over a flame. Note the moisture which collects near the top of the tube because it is the coolest part. Such moisture when found in dry road dust or other dry soil is called hygroscopic moisture. The films on the soil grains are finer than in capillary moisture.

5. **Percolation in Different Soils.**—Place a sample of clay and a sample of sand packed alike in two lamp chimneys of the same size, and having cloth tied under each to hold the soil. Set them in a dry pan, and pour water in

the top of each equally, and keep a good supply of water in the top of each. In which soil is the downward movement of the water most rapid?

6. **Water-holding Power of Soils.**—In the above exercise, the amount of water poured into each may be measured, and the pouring may be continued until each lot of soil has taken up all the water it will hold; that is, until all the soil is wet and the surplus water begins to run through at the bottom. The water-holding capacity of the two samples may then be compared.

7. The above exercise may be varied by weighing the two samples of soil while dry, before any water is poured on. Then weigh the samples after each is thoroughly saturated with water. Compare the weights and calculate the percentage in each case.

8. The effect of a mulch may be studied by placing a layer of straw or carpet over dry soil in the garden. The next day remove this straw or other mulch and compare the soil which has been thus covered, with that around it.

9. Take two deep boxes of soil, say six to ten inches in depth. The soil should be alike in each and should be moistened well when the exercise is started. Weigh each. Leave the soil loose by scratching with a kitchen fork over the surface in one of the boxes. Pack the surface of the soil in the other box with a brick or block of wood so that a crusty surface may be formed. From day to day for about a week compare the evaporation by weighing the two samples.

10. **Organic Matter Aids in Holding Water.** Test the water-holding capacity of organic matter when added to garden soils. To one sample of soil add half its volume of black humus soil from a peat bog or from a compost heap. This is to be compared with another sample of soil without the added humus. Put them in lamp chimneys and weigh each. Pour in water from above until saturated. Reweigh and determine the percentage in each case. This will prove the immense water-holding capacity of humus and organic matter.

QUESTIONS

1. Tell of the quantities of water required by plants during the growing season.
2. What is the average annual rainfall of your region? How much of this falls during the months of crop growth?
3. Explain how crops can be grown when so little rain falls during the growing season.
4. What are the three conditions of soil water?
5. What is free water? How can it be detected in soils?
6. Of what use is free water in soils?
7. What is the direct use of capillary water?
8. Tell how hygroscopic moisture may be detected in soil which is apparently very dry.
9. Tell how water in each of the three conditions is moved from place to place in the soil. Explain for each condition.
10. Explain the different ways by which a grower can increase the capacity of his soil for holding capillary water.
11. What are the chief sources of loss of moisture from soils?
12. What do you mean by dust mulch? Of what use is it?
13. What relation have cover crops to the moisture-holding power of soils?
14. How and to what extent does humus aid in the holding of moisture?
15. Explain the effects of wind breaks.

Reference.—U. S. Farmers' Bulletin 266, Management of Soils to Conserve Moisture.

CHAPTER IX

CONSERVATION AND IMPROVEMENT OF SOIL

Better farming, better business, better living.—ROOSEVELT.

REGIONS that were naturally forested, but have since been cleared by man, have been found to rapidly deteriorate in their ability to produce crops. When first cleared they were spoken of as virgin soils, and were usually very productive.

Prairie soils were also much more productive when first used by man than after he had made use of them for a number of years. Statistics show a great decrease in the yields of wheat, corn, cotton and other staple crops in the older systems of American agriculture. These facts seem to indicate that the systems as followed by man have failed to give enough attention to the conservation of the soil. The effort of the farmer in the newer sections of the country has been to get from the soil as much of its fertility as possible by raising large crops on the land until it would no longer give him profitable returns. He then abandoned the land, or left it to others who were not so familiar with its condition, and moved westward or southward to newer regions. The reaction has now set in. Some men from the west are returning eastward. Those in the middle states have realized the temporary nature of the methods originally followed and are rapidly changing them to more permanent methods. The term "permanent agriculture" is now often used in the vocabulary of the best farmers in all parts of the country. Conservation of the soil is recommended by all and few are left to doubt the teachings of the leading advocates of soil conservation. The actual practice of these teachings is coming more and more to be a reality in American farming.

Soil Maintenance.—As crops are removed from the soil, fertility must be returned. Conditions which reduce the humus or bacteria content must be remedied immediately. Activities in the soil must be kept up. Chemical changes which are so rapid in a virgin soil must not be allowed to decrease because of misuse by man. As many of the soils used by man in all sections have already been reduced to a much poorer condition than they were when he first began to crop them, the problems with which he is now confronted are those of improvement rather than conserva-

tion. The man who buys a "worn out" farm will endeavor first to bring the soil to the condition which will make it as good as, or better than, it was before it was first used for farming.

The principles of soil improvement are numerous, but they may be chiefly grouped under the following headings: better tillage; the frequent use of green crops as manure; more frequent use of barnyard manure, and more attention to its proper management; drainage of heavy soils, even where the land is not too wet; irrigation not only in arid regions but in humid climates; intelligent use of commercial fertilizers. All of these are considered in this chapter with the exception of drainage and irrigation. For the latter see the next chapter.

BETTER TILLAGE

Plowing of the land is the most expensive operation of farming. The actual cost in labor, time and equipment for plowing the fields of a given farm is so great that the operation is readily neglected. Many fields which would be improved by plowing once or perhaps twice a year are often put under a system of crop rotation whereby the plowing may not be necessary more than once in three or four years. A farm manager who is endeavoring to improve his soils should study the benefits of plowing and other forms of tillage. If he finds that more frequent plowing would greatly benefit the soil he should if possible adopt a system of cropping which will give a return in money, as well as in improved condition of the field, for the extra labor expended. If the soil be light the cost of an extra plowing in a year is not so great as for heavy soils. The owners of light soils often find it profitable to plow twice a year—once for the turning under of the stubble or other remains of the main crop, and once for turning under the green manure crops between the seasons of the main crops. In such cases the increased money returns come from the increased yields of the main crop because of the presence of the green manure. The cost of deep plowing is sometimes reduced by the use of a tractor (Fig. 70).

Reference has already been made to the importance of plowing soils very deep. Deep tillage has its limits. The importance of emphasizing deep tillage arises from the fact that many of the "run down" farms of America are plowed entirely too shallow. In determining the depth for plowing a field this is a good rule to follow: Turn up very little of the subsoil each time the surface

is plowed; gradually deepen the soil by increasing the depth of tillage each time. By this method a little of the subsoil is very gradually incorporated with the surface, and the depth of tillage is increased without detriment. Too much of the subsoil turned up at one time might be injurious, particularly if it be sour or contain matter poisonous to plants. It has been said that a man with a forty-acre field which was usually plowed to a depth of six inches can double the yields by gradually doubling the depth of tillage. Thus, when he is able to plow the field regularly to a depth of twelve inches he will have in effect an eighty-acre field. In fact the management of the forty-acre field, taken as a whole, will be much less expensive than if he really had eighty-



FIG. 70.—This tractor has wheels of the "caterpillar" type and may be used on rather rough land without difficulty. Tractors give enough power to allow very deep tillage of soils. Farming thus becomes both more intensive and more extensive.

acres plowed to the original depth of six inches. If organic matter be added from time to time during this process of deepening the soil, the increased depth may be attained much more rapidly.

Disk plows and disk harrows (Fig. 71), have greatly improved the method of tillage. Heavy soils turned with the original mold board plows are usually not sufficiently crumbled and mixed during the process. If the plowed field be thoroughly disked the tenacious particles are thoroughly crumbled and mixed.

The effects of tillage may be either physical or chemical. Proper tillage also includes the conditions for soil bacteria. The moisture-holding effects of tillage have already been considered. Dynamiting the soil is for moisture effects and is seldom practiced except for the planting of trees (Fig. 72).



FIG. 71.—The disk harrow may be made to stir the soil deeper than other harrows. The clods are destroyed and the surface will be made finer, thus aiding in the saving of moisture. (I. H. Co.)



FIG. 72.—Loosening the subsoil with dynamite aids in the conservation of moisture. It is practiced before setting orchards more than for other crops. (New Jersey Station.)

Chemical changes are often much increased by tillage. The more rapidly chemical changes are going on in the soil the more rapidly plant food is liberated, as most of the changes tend to liberate plant food, or make it available for use by plants.

The stirring of soil by plows or other implements exposes new surfaces to the sun, air and other weather influences (Fig. 73). Obnoxious gases, such as carbon dioxide, may readily escape. Nitrogen and oxygen may become combined with chemicals in the soil. Particles of lime, phosphorus, or other valuable materials may be brought in contact with each other and with other acids,



FIG. 73.—A spring-tooth harrow is well suited to such a rough soil as this. No other harrow would do good work among the rocks. (New Jersey Station.)

alkalies or other compounds, resulting in changes which are usually beneficial.

Plowing is often the best means of incorporating new materials with the soil, such as green manure, barnyard manure and others. The subsequent actions of these are of a chemical nature, and will of course improve the soil chemically as well as physically.

The physical changes in soils produced by tillage are of several kinds. The plow loosens and shears the soil. As the common mold board bends the furrow-slice the particles are moved among each other and past each other so that each comes in contact with new parts. A field plowed with a very abrupt mold board "shears" the soil more than a long mold board with gradual slope. The latter is more commonly used in turning over sod.

The surface of a plowed field is a few inches higher than before it was plowed. This difference is due to the looseness of the particles and the added pore space among the grains. These pores are first filled with air. As snows melt, or as rains fall upon such a field, much of the pore space may be filled with water. The use of the harrow (Fig. 74) and the roller will repack the surface to some extent.

Heavy soils are often plowed in late fall, particularly in the middle and northern states. This has a marked physical effect upon such soils. The weathering of under-soil thus exposed on the surface is beneficial and the effect may be readily observed by



FIG. 74.—The common spike-tooth harrow is sometimes called a drag harrow. It is one of the best implements for smoothing the surface of the soil and producing a dust mulch to save the soil moisture. (New Jersey Station.)

any one. Fall plowing may be practiced on any soils in any climate for the purpose of destroying certain forms of injurious insect life, by exposing the hibernating forms of the destructive insects to winter weather and to attacks of winter birds. Fields which have been plowed in the fall can be prepared for crops early in the spring. On level fields, not subject to erosion, winter moisture may be conserved best by fall plowing. The field may be harrowed before spring winds cause the ground to become crusty. This harrowing will allow the air to enter and the temperature is made warmer.

Late fall plowing cannot well be practiced where it is important to have a winter cover crop growing. The farm manager must

use judgment in deciding whether to plow a field in the fall or to have it protected with a cover crop. He must consider the character of soil, slope, insect enemies, the possibilities regarding time and labor, and perhaps other special matters which bear upon these points.

Packing Loose Soil.—Soils which are plowed in the spring, only a short time before the planting of the crop, may be so loose as to prevent the capillary rise of water to the seeds or to the roots of the crop after it begins growth. To correct this difficulty it is necessary to bring the surface soil in contact with the soil below the furrow-slice. This may be done by packing the soil with a plank drag or roller. If the latter is used the soil should be left with a loose, broken surface to prevent too rapid evaporation. The harrow may follow the roller, unless the roller is of a type which leaves a roughened surface. Packing may sometimes be accomplished by the use of a common spike-tooth harrow with the teeth sloping backward.

Sandy soils or other loose soils may be greatly improved by packing. (See Chapter VII.)

GREEN MANURING

This term applies to the growth of crops not intended as money crops, but intended to be plowed under to benefit the soil. They are not always turned under in their green state, but may improve the soil nearly or quite as much if they die before being plowed under.

Green Manure from Cover Crops.—A double purpose is very often accomplished in this operation. (1) The crop, while growing, serves the purpose of a cover crop. (2) It may be used as green manure to improve the soil.

The other purposes of cover crops should here be mentioned:

(a) Erosion of soil is checked or prevented; this is particularly helpful on hillsides.

(b) When grown in orchards they prevent the frequent freezing and thawing of tree roots and thus avoid much winter injury.

(c) If grown in late summer and fall in orchards they check the growth of the trees, so that the wood may become more mature before winter.

(d) They conserve plant food and moisture which would otherwise be wasted.

(e) The preparation of soil for them, as well as the growth of cover crops, will tend to check the growth of weeds.

Improvement Due to Green Manuring.—1. Probably the chief benefit following the use of green manure is the addition of humus. This is often the most satisfactory way of adding humus to the soil, particularly on farms where there are only a few animals. During the decay of the green crop a number of changes take place which are in themselves directly beneficial.

2. During the growth of the green manure crop its roots gather



FIG. 75.—Plowing under a green manure crop of rye, which was sown the fall before. (Productive Farm Crops.)

plant food which might otherwise be wasted, or not be available for use of other crops. This accumulation of plant food in roots, stems and leaves becomes quickly available after the crop begins to decay, and helps the crop which is to follow. The growth of such green manure crops at off-seasons, when the main crops are not occupying the soil, conserves much plant food which would otherwise be lost by leaching or in some other way. Such losses cannot be prevented by any other practical method. The rapidity with which plant food is liberated from the green manure crop after decay begins will depend upon the temperature of the soil

and the amount of moisture present. It may also depend somewhat upon the character of the stems and growth and the maturity of the crop. If a large quantity of green manure be plowed under at any one time the decay may be very slow indeed. The best plan is to plow under a moderate growth each time, rather than a heavy growth. If the soil be well packed after the crop is plowed in, decay will take place more quickly.

Under favorable conditions green manure plowed under in the spring will liberate an abundance of plant food for the growing crop the same season (Fig. 75).

3. If all or a part of the plants forming the green manure crop belong to the legume family a supply of nitrogen will be gathered from the soil and be changed to the form of nitrates for the use of money crops. This is usually the cheapest way to supply nitrogen to any soil. Commercial forms of nitrogen are becoming much more expensive year by year. The gardener or farm manager will find much profit in growing leguminous crops to supply nitrogen to the soil for the production of market crops. Not only is there a saving of money, which would be expended for commercial nitrogen, but the results are more satisfactory. Larger crops are produced when the equal amounts of nitrogen are compared.

4. Many chemical changes take place in the soil during the growth and decay of the green manure crop. Comparatively inert particles are acted upon. The soil as a whole is in better condition for the future crop.

5. The soil is a better medium for the growth and multiplication of beneficial bacteria of many kinds. Indeed the soil is made into an active, live mass instead of an inert, soggy, dead clay or sand.

The above five benefits arising from the use of well-planted systems of green manure are not in any sense theoretical. They have all been proved to exist in a very practical way, with the result that the best farm managers have formulated some regular system of green manuring as a part of the annual maintenance of the farm.

Planning Ahead.—Any one intending to have crops ready to be plowed under for the frequent or yearly improvement of soils will find it necessary to make definite plans for the succession or rotation of crops on each field. In many southern states, for example, corn or cotton is grown annually on the same field as

the money crop. The fertility is chiefly kept up by the growth of crimson clover, which is sowed between the rows of the main crop in July or August, if moisture conditions are favorable. The crop grows throughout the fall and winter and is plowed under in spring as early as desired to prepare the ground for the main crop. An annual rotation is thus established.

In the potato-growing sections farther north a similar annual rotation is sometimes practiced. If crimson clover is not hardy a mixture of winter vetch and rye may be used. In a slower rotation coarse heavy sod, as timothy and clover, may be plowed under every three or four years. In regions where spring grain is grown a winter cover crop is sometimes grown after corn and plowed under in the spring before the grain is sowed. After small grain has been harvested a quick-growing crop, such as cow peas, soy beans, or buckwheat, will produce a supply of green manure, to be turned under either in late fall or the following spring.

USE OF MANURES

Barnyard Manure.—In all parts of the country where livestock is kept, barnyard manure is one of the chief assets. The benefits arising from the use of barnyard manure for farm and garden crops have long been recognized. Near cities of all sizes farmers make use of the manure from the stables. It is often shipped long distances and sold at prices far above its actual value. The value of course should not be under-estimated, but prices, including the cost of hauling, are sometimes found to be as high as three dollars or more per ton, and this for inferior grades.

Humus is always added to the soil by the use of barnyard manure. The amount of humus derived from it depends upon the kind of litter used for bedding of the stock.

Barnyard manure acts as a direct plant food for crops. Under the most favorable conditions nitrogen is added more abundantly than other fertilizer ingredients, but some phosphoric acid and potash are always present. These are the three plant foods most needed by growing crops. The benefits arising from the decay of barnyard manure in soil are similar to those found in the decay of green manure. An average 1000 pounds of fresh manure from a horse stable contains about six pounds of nitrogen, three pounds of phosphoric acid and five pounds of potash, if the value of these elements is taken from market prices of chemical fertilizers. On this basis the manure from a 1000 pound horse has a value of

nearly \$30.00 a year. This value, however, does not include the humus produced, but merely the three chemical plant foods mentioned.

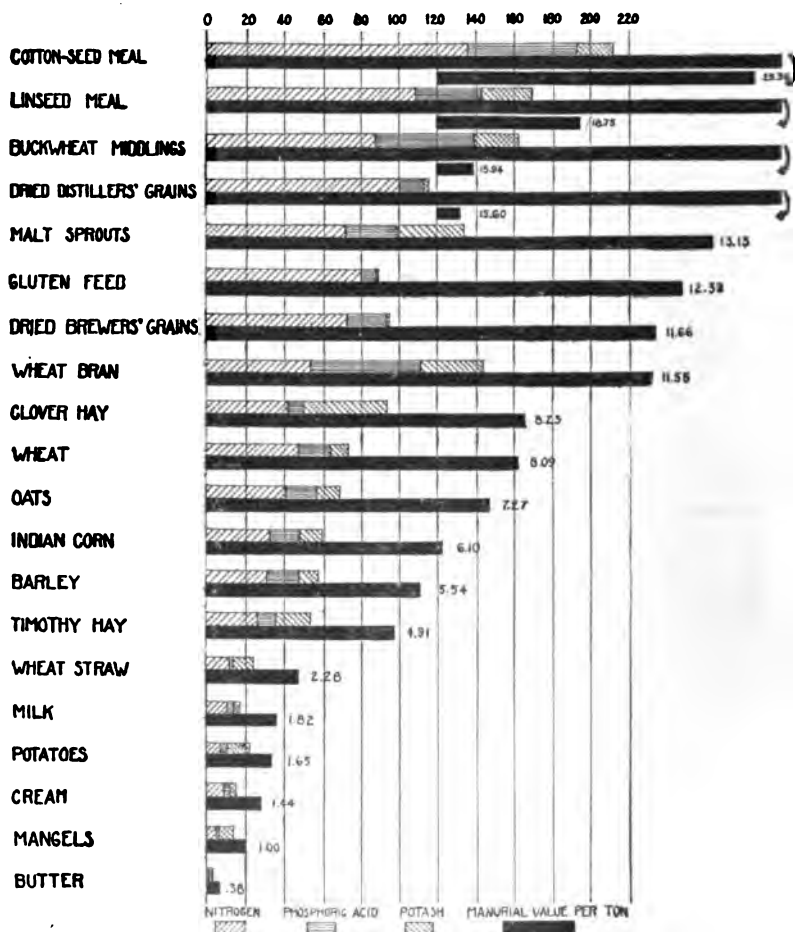

FIG. 76.—Comparative manurial values of feeding stuffs. The actual prices given are based on the commercial prices of fertilizers: nitrogen 15 cents, phosphoric acid 4 cents, and potash 4 cents per pound. (Productive Feeding.)

If equal weights of manure from the different kinds of farm animals are considered, the relative values would be arranged from poorest to best in this order: cattle, horses, swine, sheep

and poultry. There are a number of other conditions which help to determine the real value of barnyard manure: the age of the animals; kind of bedding used; whether the feed contains much or little grain or other concentrates (Fig. 76); the age of the manure and the care of it after it is made.

Care of Manure.—On farms where much manure is produced improper care of the manure is frequently a very serious farm loss. This is chiefly from two causes: heating and leaching. When manure accumulates in large heaps in the barnyard the chemical action and the work of anaërobic bacteria cause the



FIG. 77.—When manure is left in piles in the barnyard the water may wash away the richest part. Some pond or stream of water usually receives the drainage of the barnyard, and the loss is very great. (U. S. D. A.)

manure to heat or “fire fang.” This results in loss of nitrogen and much of the organic matter is burned out.

When manure is left in open barnyards or, worse yet, is left under the eaves where large quantities of water will fall upon it, the loss from leaching and washing is a serious one. As the manure leaches the most valuable parts of the plant food are lost first (Fig. 77).

Because of such losses as these it may be estimated that fully one-half of the value of barnyard manure produced on American farms is wasted. Under good management at least four-fifths of all of the crops fed to stock, or used in the barn for litter, should

such a cover, and having it well spread and thoroughly tramped. They sometimes spread the manure from stalls in such covered barnyards where stock during exercise will tramp it down.

Rotted manure is often needed for special lines of gardening and for some farm crops. To produce well rotted manure, without serious loss, requires good management. The manure should be spread so well that the heat will not become too great. The top of the pile should be left flat, or slightly hollow, so that rain water will enter the mass and help prevent heating. If the amount of rain be too great, loss will occur by leaching. This loss may be reduced by a cover of straw or other material to shed off surface rain.

Composts are often made by gardeners for the purpose of preparing well rotted manure for use in their work. A good plan is to make the pile of manure with alternate layers of heavy sod. Leaves raked from lawns may be used in addition to, or as a substitute for, the sods. Lime, wood ashes, land plaster, and rock phosphate are also valuable materials to add to the compost heap. The tops should be kept rather flat to allow the entrance of rain, particularly during the summer.

Some of the benefits to be derived from rotting manure are: Weed seeds are killed; the manure is not so bulky; its heating effect is reduced and there is less injury to certain plants; it is not so likely to produce potato scab or other injurious diseases; it is much more suitable for use in flower beds, green house beds and for potted plants; and the plant food in the manure is made more quickly available.

USING LIME

Liming of soil is the direct application of lime to soils. This treatment is usually very beneficial, and within certain limits is exceedingly profitable. The uses of lime on soil are of several kinds: Light, sandy soils are affected in such a manner as to make them more compact and are thus more retentive of moisture and plant food.

Heavy clay soils are also affected physically. They become more open and more easily tilled. They allow air and moisture to move more freely, with the result that they are more easily warmed in early spring.

Any soils containing acid are neutralized by the use of lime. Soils may become acid, or sour, by the use of barnyard manure,

green manure and by the action of certain chemical fertilizers. Few farm crops thrive in sour soils. The action of lime is therefore beneficial to all such crops.

For clover, alfalfa and most other members of the legume family, lime seems to act as a direct plant food, supplying a material actually used in the growth of the plant (Fig. 78).

When lime is applied after the plowing under of green manures or other vegetable matter, decay takes place much more rapidly.

The presence of lime in the soil makes conditions more favorable for the rapid development and growth of bacteria. This is particularly true of those forms of bacteria which aid legumes in acquiring nitrogen from the air. It is doubtless also helpful to other kinds of soil organisms.



FIG. 78.—Liming the soil improves the growth of leguminous crops. The large yield was from the limed plot. The other was unlimed. (U. S. D. A.)

Its general action upon sand, clay and organic matter helps in the liberation of plant food in all soils. This may in some cases be more rapid than the growing crop can use the food thus liberated. If some form of lime is applied, the action of which is not too rapid, the growing crop may use the liberated food without appreciable loss.

The combined use of green manure, or other vegetable matter, with the application of lime, causes the most favorable action in soils for the production of large crops. Much activity is set up within the soil, making the conditions most favorable. By the use of lime the soil will produce much larger crops of alfalfa, clover and other legumes. These in turn have their beneficial effects upon the soil, and make it possible for the owner to carry the soil improvement to the utmost limit. It is often found that the

application of lime is the first step in the building up of a worn-out soil. The owner must remember that other methods of improvement must accompany this treatment.

The need of lime on a field is often indicated when clover will not grow. Sourness in the soil may be detected by the presence of certain weeds, such as sheep-sorrel. It may also be detected by the use of litmus paper, as described in one of the exercises. If the need of lime is doubted by the owner, a small strip instead of the whole field may be treated. This trial may be made upon a field used for clover or almost any other field crop. If marked improvement is shown the owner can easily draw his conclusions.

Forms of Lime.—There are several forms of lime in common use. Some understanding of each of these should be had before lime is applied. *Ground limestone* is perhaps the most common form used by farmers, particularly in regions where the distance for shipment is not very great. Limestone grinders are in use near stone quarries in all parts of the country. From such grinders the products vary in fineness from a fine powder to a coarse granular state. Commercially the fineness is indicated by the sieves through which the ground stone will pass. That which passes through a sieve of fifty or sixty meshes to the inch will contain some material which is as coarse as this and much more that is a great deal finer. The coarse products used for agricultural purposes should be fine enough to go through an eight-mesh sieve. Ground lime as coarse as this can be produced without artificial drying of the stone, but the finest grades must be artificially dried, thus greatly multiplying the cost of production.

Ground limestone is chiefly composed of carbonate of lime or calcium carbonate (CaCO_3).

Burned lime is extensively used for agricultural purposes. It is prepared in lime-kilns by burning under such conditions as to produce great heat without much moisture or air. The carbonate of lime is broken up by the heat into two compounds; calcium oxide and carbon dioxide, thus $\text{CaCO}_3 = \text{CaO} + \text{CO}_2$.

The carbon dioxide is driven off into the air and the calcium oxide exists in a form which is sometimes called stone lime, or caustic lime or quick lime. It is this form of lime which is used in making mortar for masonry or plaster. Because of the driving off of the carbon dioxide the weight is reduced nearly one-half. This must be taken into consideration when deciding upon the qualities of lime to be applied to the soils.

Hydrated Lime.—Another form of lime less commonly used for agricultural purposes is called hydrated lime. It is formed from burned lime which has taken up some water and usually some carbon dioxide has also been acquired by it. It is shipped either in bulk or in bags, and is usually much more expensive than the other forms of lime. Its composition is expressed by the mixture of the compounds CaH_2O_2 and CaCO_3 .

The pure hydrated lime or calcium hydrate would be formed by the addition of water to caustic lime:

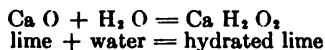

When water is added to the lime the weight is increased about one-third, as fifty-six pounds of lime take up eighteen pounds of water, making seventy-four pounds of hydrated lime. In this amount there is forty pounds of calcium, both before and after combining with water.

Air-slaked lime is usually mixed with some hydrated lime, even when sold under its own name. If it were pure its composition would be the same as pure limestone. It is formed by the slaking of lime with only a small amount of water. A part of the lime takes up water as shown in the preceding paragraph, and as it becomes exposed to the air it takes up carbon dioxide, and the water is displaced. If the influence of the water is not considered the real effect is shown thus:

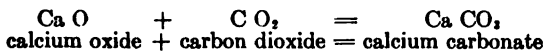

This action is the reverse of that which is produced when limestone is burned in kilns. The weight increases less than once as fifty-six pounds of caustic lime takes up forty-four pounds of carbon dioxide, forming one hundred pounds of air-slaked lime. There is no more calcium than before it was slaked.

Other forms of lime are upon the market under different names, such as "limeoid," "agricultural lime," "land lime," and many others. They may be made from various sources, some from wastes about grinders, others from wastes about kilns, or from places where builders' lime is handled in large quantities and may become damaged. These miscellaneous lime products are not standardized, but are sold in the powdered or ground form. Such a product is usually of no greater value to the farmer than the same weight of ground limestone.

Ashes, if made from hard wood and well stored to prevent leaching, contain, besides about four per cent of potash, a good supply of lime. This may be calculated at the rate of about thirty-three per cent of calcium carbonate, or 600 to 700 pounds to the ton. Marl is found in many parts of America in deposits accessible for agricultural purposes. It is rich in lime of a form well suited for agricultural purposes. The richness of the particular deposit should be determined, as the compositions vary widely. It may sometimes be found to contain ninety per cent of calcium carbonate.

Action of Different Kinds.—The most active forms of lime in the soil are the quick lime or calcium oxide, and the hydrate. Carbonated lime in the form of ground limestone acts more slowly. The former burn out the humus from soils more rapidly than pul-



FIG. 79.—Equivalents in the different forms of lime when applied to soil.

verized limestone. They are more effective in causing the decay of organic matter and the unlocking of plant food from the soil. Their effects upon the soil are not so permanent. Pulverized limestone acts slowly in the unlocking of plant food and in causing the decay of organic matter and humus. Its effect upon the soil lasts for several years. The lasting effects are determined somewhat by the fineness of the powder. The finest forms are used up more quickly because they are more rapid in their action. Coarser forms act slower and last longer.

Just what form of lime to apply to the soil depends upon several soil conditions, besides the question of which is most available for purchase. If a heavy supply of organic matter has been plowed under and a rapidly growing crop, such as cabbage or other truck crop, is to occupy the field immediately, quick lime, or calcium

oxide, may be used to best advantage. Plant food should not be unlocked more rapidly than the growing crop will use it, otherwise wastes will result. If a field is well supplied with humus and more permanent forms of field crops, such as hay, grain, corn, or



FIG. 80.—Lime may be spread with a manure spreader; if a wooden hood is placed over the beater the dust will not be so badly blown by the wind. (U. S. D. A.)

cotton, are being grown, it is then better to use ground limestone.

Rate of Application.—From what has just been said it is evident that light applications of quick lime, or calcium oxide, should be made (1000 pounds to the acre), and this every year or two.



FIG. 81.—The spreading of lime or fertilizer with a machine of this type gives an even distribution. (Ohio Station).

Heavy applications of pulverized limestone may be used (Fig. 79). Applications of one or two tons to the acre may be used once in four or five years. The use of lime on soil should be adapted to the crop rotation used on the farm. If a three-year rotation is used with clover as one crop in that rotation, it is well to apply

the lime just before the growth of clover, as it will benefit this crop and clover will prevent loss of lime itself. If the rotation be long or short the lime may still be applied once in the rotation course. The form and amount of lime to use will depend somewhat upon the length of the rotation course.

In determining the quantity of lime to apply to a field the actual amount of calcium in the form to be used should be considered, remembering that other ingredients, such as water and

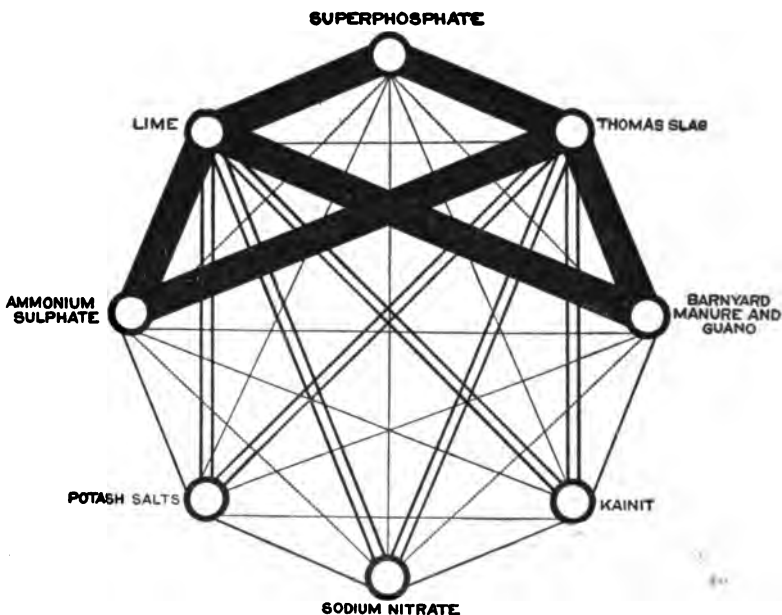

FIG. 82.—This diagram shows what fertilizers may be mixed before they are applied. Those that cannot be mixed before applying may be spread on the field separately if desired. Ingredients joined by black bands should not be mixed. Those joined by light lines may be mixed. Those joined by two lines should be applied separately. (U. S. D. A.)

carbon dioxide, add much weight, but do not add more calcium.

Methods of Liming.—It is a very disagreeable task to spread lime on a field when the wind is blowing. This is particularly true of hydrated and air-slaked lime. Compare figures 80 and 81. Quick lime, or calcium oxide, should always be air slaked by leaving it in a pile long enough to accomplish the purpose.

A little water is usually added to hasten the process, if rains do not occur. Some low, box form of fertilizer spreader or special

lime spreader may be used in applying lime to the field. Bags or old grain sacks may be allowed to drag back of the delivery tubes at the surface of the ground to prevent much of the disagreeable cloud of dust for the driver and team. Pulverized limestone is not caustic and is usually not so dusty. It can also be hauled directly from the car to the field and requires no extra handling. Burned lime must be handled twice to accomplish the slaking and spreading.

Lime is usually spread on top of the plowed field, and should rarely be plowed under. Its tendency is to work downward through the soil too rapidly. Quick lime, or calcium oxide, should not be applied long in advance of the time when it is to be used. Pulverized limestone may be hauled at any time when teams are not busy, as its loss upon the field is much slower.

COMMERCIAL FERTILIZERS

It is sometimes said in reference to rich humus soils of the western prairie states that "They do not need commercial fertilizers." This might also have been said regarding the newly cleared lands of the timber states farther east. But after soils have been used by man for a generation or more they deteriorate in the actual amount of available plant food. Analyses of old soils usually show an abundant supply of potash and phosphate, but little of them in available forms. The amount of potash and phosphate is usually greater in heavy soils containing much clay or silt. The nitrogen may have almost entirely disappeared unless some system has been used for its special maintenance.

Because of the deterioration of soils in long use for farming purposes, it has usually been found very profitable to resort to the use of commercial fertilizers. The greatest profit from their use is usually found in the growing of special crops, such as truck crops, cotton, tobacco and potatoes. Indeed when a farmer is making a specialty of any particular crop he usually finds it very profitable to use fertilizers. American farmers are using at the rate of between 200 and 300 million dollars' worth annually.

In one form or another commercial fertilizers contain nitrogen or phosphoric acid or potash—perhaps two or all three of them. These are applied to the soils at the time the crops actually need them for the purpose of directly feeding and stimulating the crops. As a general rule they should not be used with the hope of permanently improving the soil itself, except when they are used to

stimulate the growth of a green manure crop which will itself be more permanent in its effects. Any commercial fertilizer is available in proportion to the amount and kind of the three plant foods which it contains.

Commercial fertilizers are inspected by nearly all states for the purpose of keeping up their standards, food content, availability, and to protect legitimate business from fraudulent sales. The laws of some states require that the sources of the three ingredients be published by manufacturers. By this means the user may know more regarding the availability of the plant food he is buying.

Nitrogen is the most expensive as well as the most important element in commercial fertilizers. It usually costs three or four times as much per pound as the other ingredients. Because of this great cost the nitrogen must be carefully conserved by applying it at a time when it can be readily taken up by plants, particularly if it is all or nearly all in an available form.

Nitrogen is derived from several sources: meat scraps, dried blood, tankage, fish, cottonseed meal and such minerals as sulfate of ammonia, nitrate of soda, and calcium cyanamid. Nitrogen in the first four forms is sometimes called organic nitrogen.

Nitrogen from dried blood is usually more quickly available for the use of plants than from other forms of organic nitrogen. It may contain from ten to fifteen per cent of nitrogen, but may be as low as five or six per cent. When the price is satisfactory this is a very suitable form in which to purchase nitrogen as plant food. The danger is that the price per pound will be too great when compared with other forms of nitrogen. Some phosphoric acid is found in samples of dried blood. This is greater when meat scraps have been added.

Tankage is the waste from the slaughter of animals in the packing houses. It varies widely in composition and the analysis should always be known before a purchase is made. If much meat scraps be used it may be rich in nitrogen and phosphoric acid. The presence of ground bone in it increases the phosphoric acid. Tankage is usually slow in its availability for plant growth.

Fish is often a source of fertilizer ingredients. Waste fish products from seine fishing along sea coasts are ground up and used for fertilizer. They usually contain, besides a good supply of nitrogen, some phosphoric acid. The price of these ingredients in this form is usually high in spite of the fact that they are not quickly available for plant growth.

Cottonseed may contain six to seven per cent of nitrogen. It is used extensively as a source of nitrogen in the South. The nitrogen in this form is not as quickly available as in dried blood. The price of cottonseed meal has greatly advanced since its merits for stock feed have been discovered. It is now found to be better economy to use it for feeding stock and then use the manure as a fertilizer.

Sulfate of ammonia is produced in the manufacture of coke and illuminating gas. It usually contains about twenty per cent. of nitrogen. The nitrogen in it is not all quickly available, as that found in sodium nitrate. A part of it may be taken up directly by some plants. Because of its acid nature it should be used in a system of farming where lime is practiced. Use of it without lime tends to make the soil sour. The cost in this form usually compares favorably with that from nitrate of soda.

Nitrate of soda is usually considered the very best form in which to purchase nitrogen, if the grower wishes the nitrogen to be immediately available. Since this salt dissolves in soil moisture or rain water, it must be used by the plants or much of it may be lost by leaching. For this reason it is well to make several small applications at different times during the early part of the growing season. Nitrate of soda is imported from Chili and other western countries of South America, where it is mined from extensive beds. It is usually received in American ports in the somewhat purified form, containing about fifteen per cent. of nitrogen. In comparing the cost of nitrogen from different sources, the market price of nitrate of soda is usually taken as the standard for comparison.

Calcium cyanamid is a new form of nitrogenous fertilizer, containing much lime. Because of the presence of these two valuable ingredients it is given various commercial names, such as "lime-nitrogen," or "nitrolime." It was first made in Norway and Germany, but it is now made extensively in Italy, the United States and elsewhere. It may be produced in any locality where electric power is not too expensive. It is a dark gray powder, having a composition of $\text{Ca}(\text{CN})_2$. On exposure to air or moisture, or in the presence of steam it decomposes into ammonia and calcium carbonate, thus

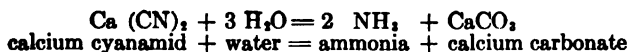

It compares favorably as a fertilizer with sulfate of ammonia, but is still thought to be somewhat injurious to very young plants, if the above mentioned change has not all taken place. One of

the greatest difficulties in the use of this material is its tendency to lose ammonia, because of this change in composition. It is sometimes mixed with a little dry peat to help hold the ammonia. It does not tend to make soils acid, but acts in the very opposite way because of the great amount of lime present.

Our greatest interest in the production of calcium cyanamid lies in the fact that its production is unlimited. The products from which it is made, atmospheric nitrogen, carbon and lime, are inexhaustible. The danger that other sources of nitrogen for fertilizing purposes will soon become exhausted, or nearly so, has been the great fear of all mankind. But man can always make use of leguminous crops in farm rotations and thus acquire nitrogen from the air.

Phosphoric Acid.—There are two main sources of phosphoric acid: (1) animal substances; (2) phosphate rock.

Animal bone is the chief source of phosphoric acid. It was much used as a fertilizer before rock phosphate was known to be available for this purpose. Indeed bone phosphate is considered so valuable that much of the rock phosphate is sold as bone. This is due to a false belief that the bone is better than the rock form. A good sample of raw bone meal contains about four per cent of nitrogen and twenty to twenty-five per cent of phosphoric acid, but samples poorer in both of these ingredients are often used. To make the phosphoric acid in bone more readily available it is put through a steaming process. "Steam bone" is sold on the market, containing as much as twenty-five or thirty per cent of phosphoric acid. During the process of boiling or steaming the nitrogen content is usually reduced to almost nothing. But the phosphoric acid is made more available.

Rock phosphate is obtained from a number of deposits in South Carolina, Florida, Tennessee, Utah, Wyoming, and Idaho. The rock as quarried from the earth is used in two ways: (1) In a form called "floats." In this condition the natural rock is ground very fine and applied to soils, yielding phosphoric acid very slowly to plants. It may be applied only once in three or four years, but the applications are very heavy; perhaps a thousand pounds or more per acre at a time. (2) The rock may be ground and afterward treated with strong sulfuric acid to change the composition from calcium phosphate to acid phosphate. The sulfuric acid takes from the natural rock a part or all of its calcium, forming calcium sulfate or land plaster, which remains mixed with the phosphoric acid. The resulting mixture is sold under the

names of superphosphate or acid phosphate. This form of phosphate is chiefly soluble and is quickly available to plants. It may contain from fourteen to twenty per cent of phosphoric acid.

Superphosphates (acid phosphates) are sometimes, though rarely, made from bone, and bone tankage, by treating them with sulfuric acid. The change which takes place when rock phosphate is treated with sulfuric acid is here shown:

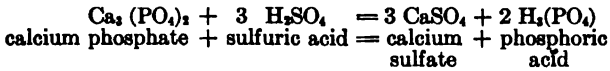

If all of the calcium is not removed from the original rock by the sulfuric acid the resulting phosphate may be represented by the formula



Basic slag, sometimes called Thomas slag, is a by-product of the manufacture of steel from ores containing much phosphorus. The amount of phosphoric acid present varies widely, seventeen or eighteen per cent being commonly found. Its availability for plant growth is usually slow. In the older methods of manufacture this product contained much lime, but in the more recent methods very little lime is left in the slag.

Potash is not so generally needed as phosphoric acid and nitrogen, but a little is often combined with the other ingredients in commercial fertilizers. It is particularly valuable on sandy soils, on soils containing an abundance of humus and other soils that have been used many years. We have already seen that it may be derived to a limited extent from unleached hard wood ashes. The chief commercial sources, however, are certain mineral salts from mines in Germany. The natural material exists in the mines in the form of kainit, sylvinit and other less common forms. From these salts two chief products are made by a process of separation and purification: (1) Sulfate of potash containing about 48 per cent of actual potash, K_2O . (2) Muriate of potash containing about 50 per cent of actual potash. Both of these forms are soluble in water and are easily absorbed by plants.

Muriate of potash is slightly cheaper than the sulfate and is recommended for use when potash is required for such staple crops as cotton, potatoes, tobacco and others. It is usually considered the better form to use if the soil is light and sandy.

Sulfate of potash is perhaps more commonly used than it otherwise would be, because of its physical condition, which

renders it more easily mixed with other fertilizer ingredients. It is more expensive than the muriate. Some farmers have a notion that it improves the quality of potatoes and tobacco. This belief has not been well established experimentally.

Kainit is one of the crude mined products and contains about twelve per cent of potash (K_2O). It is used to a limited extent, particularly near eastern ports where the cost for shipment is not too excessive for such a low grade of fertilizer.

The Use of Fertilizers.—There are several ways of determining what fertilizers to use on each field for each crop. The actual requirements of any given crop should be known. Tables showing the composition of different crops will tell in a very definite way the amount of nitrogen, phosphoric acid and potash removed from the soil during its growth. If a wheat crop, for example, is grown, and the straw used for litter and returned to the field, the amount of plant food actually taken from the field and not returned is represented in the composition of wheat grain which may have been sold from that field. When the yield is known the amount of plant food removed may be easily calculated. (See tables in Chapter XII).

Other indications of the amount of fertilizer to use are found by, (1) analyzing the soil, (2) plot method of trial; (3) the observation of growth and yield of the crop itself through a series of years.

Soil Analysis.—In some states it is a common mistake to put too much dependence upon analyses of soils made by State Experiment Stations and employed chemists. Such analyses are valuable only as indicating the total amount of plant food of each of the three or four main ingredients, but they do not indicate how much of each of these is available for growth of plants. If the analysis shows a superabundance of any or all of these elements in a certain field, it may be a fair guide to the owner, when considered in connection with what he knows regarding its yielding ability. But the analysis as an independent fact does not tell him definitely what fertilizers to use. If, however, one of the ingredients is shown by the analysis to be very deficient he will know that such deficiency must be supplied. The range in composition of surface soils is so great that analysis serves as a guide in detecting the great reduction of any one element.

Plot Trial.—A manager of a large farm should determine the needs of each field by actual trials on small plots. For small grains, grasses, corn and cotton, use small strips about one rod

wide across the field. Each trial strip or plot should have a distinct treatment and one should be left unfertilized as a check plot for comparison with the others. In fertilizing a crop of wheat one strip may be fertilized with a given amount of acid phosphate, another with rock phosphate (floats). Another may have one of these fertilizers with the addition of some muriate of potash, and perhaps another with a little nitrogen added. Still another may have a supply of lime with or without the other fertilizers. It is often well to compare the chemical fertilizers with barnyard manure. This can easily be done by applying manure alone to one, and manure with lime to another plot.

During the growth, and as the crop matures, the farmer may determine well which treatment has benefited the crop most. It may not be profitable for the farmer to make actual weights of the yields, but that may be left to State Experiment Stations. In most states the soils vary so widely in their characteristics that it is important that the soil on each farm be tested in such a manner. The farmer who does such work will improve his method more rapidly than by simply studying the results in some other part of the state.

Buying Fertilizers.—There are several different problems involved in the purchase of commercial fertilizers. Since laws have been passed controlling their sale some of the difficulties have been overcome. In most states it is still impossible to determine the source of ingredients from which the nitrogen, phosphoric acid and potash are derived. A number of the state laws require that the source of the phosphoric acid and the potash be indicated, but few if any of them require that the source of the nitrogen content be published. Fortunately changes in state laws regarding this are gradually being made. At present comparatively few buyers know the real nature of the numerous preparations which are offered for sale every year under special brand names. These names are not permanent or do not represent an unchangeable composition in the fertilizer sold under the name. Usually the name is meaningless, if not actually misleading. "Brown's Truck Grower" may not be suited to all truck growers, and indeed may be very badly suited to certain soil conditions and special truck crops.

The analysis is usually required by law to be printed upon the tag or upon the bag containing the fertilizer. This analysis should be studied very closely by a man who has power to eliminate the non-essentials, as much is usually added which tends to

confuse the ordinary buyer. For example, the following is a common statement of analysis:

<i>Analysis</i>		Per cent
Nitrogen.....	0.85 to	1.10
Equal to ammonia.....	1.03 to	2.00
Soluble phosphoric acid.....	6.50 to	7.50
Reverted.....	2.00 to	3.00
Available.....	8.50 to	10.50
Insoluble.....	1.50 to	3.00
Total.....	9.00 to	13.00
Potash (actual).....	1.00 to	1.50
Equal to sulfate of potash.....	2.00 to	3.00

The minimum or first column only is guaranteed by the seller under the law. As there are only three ingredients in the table which are to be used by plants, the other six lines are superfluous. The buyer should be interested only in the following three facts:

Nitrogen.....	0.85
Available phosphoric acid.....	8.50
Potash.....	1.00

This shows the need of eliminating from the analysis all but the essentials. The insoluble portions of the phosphoric acid should not be considered. Two thousand pounds or one ton of this fertilizer would contain only seventeen pounds of nitrogen, one hundred and seventy pounds of phosphoric acid and twenty pounds of potash. This would be called a very low grade of fertilizer, and contains much material which should not be handled in an effort to fertilize the soil. Freight has to be paid upon it and much hauling is required for material which is valueless. When ready-mixed fertilizers are purchased those containing much valuable plant food should be used. After eliminating the non-essentials in the analysis the actual valuation may be determined by multiplying the number of pounds of nitrogen in the ton by twenty (cents); the number of pounds of phosphoric acid by six (cents) and the number of pounds of potash by six (cents). Adding these three values will give the real value of a ton of the fertilizer. In the above example the nitrogen is worth \$3.40; the phosphoric acid \$10.20 and the potash \$1.20, giving a total value for the ton of \$14.80. As prices fluctuate the pound values for these ingredients may be changed, but fertilizers of different grades should always be compared on an equal basis.

Fertilizer formulas are often indicated on tags and fertilizer bags. They express the ingredients in the sample, expressed in

percentage or pounds per hundred. In the above analysis slightly simplified, one is the total nitrogen; nine is the total phosphoric acid and one is the total potash in each hundred pounds of the mixture. This would be expressed 1:9:1. A higher grade fertilizer might be 3:10:4. To determine the money value of a ton when the analysis is given, a verification should be made in the formula itself, and the figures for the available constituents must be substituted for the total constituents, so far as known. The analysis will usually show this at least for the phosphoric acid. If a 3:10:4 formula is corrected to read 3:9:4, then the ton value is determined by multiplying each of these by twenty (the number of hundred weight in a ton), and then multiply each by the average market value per pound. That is multiplying the nitrogen content by twenty, the available phosphoric acid by six and the potash by six. The sixty pounds of nitrogen in a ton equals \$12; the one hundred and eighty pounds of phosphoric acid is valued at \$10.80, and the hundred pounds of potash equals \$6.00, making a total of \$28.80.

Home Mixing.—It has long been the custom in European countries, such as Germany and England, to practice the home mixing of commercial fertilizers. American farmers have probably not understood so well the scientific principles involved in fertilizing the soils, and there is comparatively much less home mixing in America. Those farmers who practice it are able to save in several ways: (1) They are able to secure the raw materials which they know to be well suited to their own soils and crops. (2) They are able to avoid the use of such low grade materials or fill-in materials which are, in effect, of little or no benefit to the soils. (3) They are able to save on the cost of freight and the amount of material hauled for the same amount of plant food. (4) They are able to save much in actual cost of each year's production.

There is no secret about mixing. The amount of material suitable to use in various home-mixed fertilizers for different crops is published by a number of experiment stations. Figure 82 indicates what ingredients may be mixed before they are applied and those which should not be thus mixed.

FIELD AND LABORATORY EXERCISES

1. **Depth of Plowing.**—When plowing is being done in the vicinity, or at home, have a ruler handy to take several measurements of the depth of the furrow on the landbar side. This will help to gain a correct impression of the depth of plowing at sight. In the bottom of the furrow, dig with a spade and

determine the depth of the surface soil. If the surface soil is not all being turned up, find if possible why the plowing is not made deeper.

2. Have one part of the field plowed extra deep and the remainder plowed as usual. Then compare the yield after the crop is grown. Young people not having an opportunity to carry out this exercise on their own places may induce some farmer or gardener to conduct the experiment under their guidance.

3. **Fall or Spring Plowing.**—Compare the yields of crops, or fields plowed in the fall, and those not plowed until the following spring.

4. Study the effects of rolling by having one part of a grain field rolled after seeding, and the other part not rolled. In which plot does the grain sprout first? Which has the more rapid growth later on?

5. **Effect of Green Manure.**—Compare the yield of grain or corn on two plots, one of which has been supplied with green manure turned under and the other having no green manure. This exercise is more valuable if the green manure consists of the crimson clover or other legume crops. A comparison may also be made between crimson clover and rye as green manures.

6. **Testing Barnyard Manures.**—On two plots test the value of spreading manure fresh from the barn on the field instead of allowing it to remain in a heap in the yard for some time. Test one plot with fresh manure from the stalls and the other plot with a like amount of manure which has stood under the eaves of the barn for six months or so. Corn may be grown on these plots, and yields recorded.

7. The value of rock phosphate as an absorbent in stables may be shown by manuring two plots. On one use manure in which the rock phosphate has been used as an absorbent, and on the other use the manure without this. The result should show the first season on corn or cotton.

8. **Forms of Lime.**—Test the caustic effects of the three main forms of lime: freshly burned lime, hydrated or slacked lime, and ground limestone. Use litmus paper in the test. Also wash a small quantity of each of these materials and determine the alkalinity of the water resulting therefrom. Which would be more quickly available in the soil? Which is the most caustic? Which would remain in the soil a longer time?

9. Slack some fresh lime in a pile after having determined its volume in advance. After the air slacking is entirely finished, determine the volume again. How much increase do you find?

10. Take a pound of freshly burned lime. Let it gradually air slack, and then again determine its weight. How do you account for the change in weight?

11. **Potash from Ashes.**—Put a few pounds of wood ashes in a tin can provided with holes in the bottom. Fill with water and allow it to leach through. Catch the leachings and test for alkalinity. Feel of the liquid and see if it feels slippery to the fingers.

12. **Fertilizer Samples.**—Make collection of samples of fertilizers in glass bottles. Obtain all kinds in the market, including materials from which mixed fertilizers are made, and also the mixtures themselves. Label each with the name and composition.

13. **Solubility of Certain Fertilizers.**—Test the solubility of sulfate of ammonia, nitrate of soda, and the several potash salts.

14. Study Phosphorus as suggested in a high school chemistry. Carefully handle the material, as it is very combustible. If a piece of phosphorus is exposed to the air for a few minutes, the white fumes produced when dissolved in water, are the same as pure phosphoric acid in fertilizers.

15. **Availability of Phosphoric Acid.**—Put samples of rock phosphate, phosphoric acid and ground bone each in separate test tubes or bottles to determine their solubility. Whether any of the material is dissolved or not may be determined by pouring in a little clear lime water. If there be any soluble phosphate present there will be a white cloudy appearance. Which one of

these would be available first in the soil, and which would remain longest without being leached out?

16. **Effects of Fertilizers.**—Make pot trials with different fertilizers as suggested in this chapter. This work may be done either on farms or nearby places, or in the home gardens and farms of students, if not at the school itself.

QUESTIONS

1. Explain what is meant by the problem of soil maintenance.
2. What are the chief features of soil improvement?
3. What are the ways by which tillage may improve soils?
4. What are the chemical changes wrought by good tillage?
5. What are the physical changes?
6. Explain the different lines of improvement due to green manuring.
7. In what ways do live stock aid in soil maintenance and soil improvement?
8. Give directions regarding the care of manure.
9. Explain the use of rock phosphate as a preservative in manure.
10. Compare the different kinds of litter for use in stables.
11. What is the use of a covered barnyard, so far as manure is concerned?
12. Describe how to make a compost for garden use.
13. Enumerate the benefits from liming of soils.
14. Explain why green manuring and liming should be combined in farm practice.
15. What are the different forms of lime? Which ones of these forms are cheapest in your locality? Give approximate prices for each form.
16. What are the comparative weights of the different forms of lime? Which form has the most calcium in a ton?
17. Describe how to handle freshly burned lime in applying it to a field without injuring the soil or plants.
18. To what extent are hard wood ashes valuable in the liming of soils?
19. Give directions to aid in choosing the kind of lime to be applied to a certain farm.
20. What are some of the common rates of application?
21. What are the three essential elements in commercial fertilizers?
22. What is the advantage of state inspection of commercial fertilizers?
23. Give some of the sources from which nitrogen is obtained by fertilizer companies. Discuss the relative values of these.
24. How is calcium cyanamid made, and what valuable ingredients does it contain?
25. State the difference between phosphoric acid and rock phosphates.
26. Which of these is more permanent and which is most active?
27. Give methods of determining how much fertilizer to use on a certain field.
28. Give the advantages of home mixing of fertilizers.
29. Take a fertilizer tag which gives the analysis of the mixture and reduce the statement to its simplest form.

References.—United States Farmer Bulletins: 44, Commercial Fertilizers; 77, The Liming of Soils; 88, Alkali Lands; 192, Barnyard Manure; 222, Home Mixing of Fertilizers; 245, Renovation of Worn-out Soils; 257, Soil Fertility; 259, Uses of Commercial Fertilizers; 278, Leguminous Crops for Green Manuring; 326, Building up a Run-down Cotton Plantation; 327, The Conservation of Natural Resources; 342, Conservation of Soil Resources; 398, Farm Practice in the Use of Commercial Fertilizers; 406, Soil Conservation; 421, Control of Blowing Soils; 446, The Choice of Crops for Alkali Land.

Introduction to the Principles of Soil Fertility, Cornell Reading-Courses, Soil Series No. 1 revised. The maintenance of Fertility, Ohio Exp. Sta., Buls. 182, 183. The Fertility of the Land, Roberts. Improving Acid Soils, N. J. Exp. Sta. Circ. 54. Crops and Methods for Soil Improvement, Agee, The Macmillan Co., N. Y.

CHAPTER X

DRAINAGE AND IRRIGATION

Till taught by pain, men really know not what good water's worth.—
BYRON.

THESE two special methods of soil improvement are closely associated with each other in many places. In regions which are irrigated throughout the entire growing season with an abundance of water, it is often found advisable to remove surplus water by underdrainage. This would not be necessary if the soil and subsoil are open and very porous; but is found advisable if the subsoil is very heavy and compact. In regions where the soil contains considerable black alkali with a superabundance of sodium carbonate or similar salts, the effect of irrigation water may be to dissolve the alkali salt which is deposited at the surface during the process of evaporation. This is very injurious to plants. If such fields be underdrained much of the surplus salt will be washed into the drains and thus be removed from the soil entirely. A combined drainage and irrigation system is the best plan by which to improve such alkali soils.

The student should understand that alkali as used in this agricultural sense is not a true alkali in a chemical sense. It is really a surplus salt which has an injurious effect, by "supersaturating" the soil water, which causes plants to wilt because of reversing the osmotic action in the roots.

DRAINAGE

It is often thought that drainage is needed only in places where there is too much water. There are millions of acres of marsh land requiring drainage for the removal of surplus water. But there are also a number of other places which should be drained.

Where Drainage Will Help.—Soils which warm up too slowly in the spring may be improved by underdrainage. There are often limited areas where water stands near the surface, but is not exposed to view; these are improved by lowering the water table. Drainage is desirable in places where the water is abundant in the early part of the season, but where plants actually suffer from drought later in the summer. The effect of drainage in such

instances is to allow the roots to penetrate the soil much deeper at all times and thus prevent suffering during the dry season.

Where an annual overflow of water occurs along streams its prompt removal through some system of drainage is essential to the best production of crops. Most farm crops would be smothered when the water is allowed to stand on the field for many days at a time. Underdrains would prevent much damage.

There are often areas on mountain sides or hillsides where water from above enters the ground and appears again at the surface or near the surface. The crops may there suffer from too much water, even though the area is much elevated and drainage seems natural (Fig. 83). Such paradoxical cases are frequently



FIG. 83.—Glade land in a mountainous region which was much improved by drainage. After being both drained and limed it is very productive.

found and are caused by the peculiar underground formation which brings seepage water toward the surface. This water is not abundant enough in any one stream to be called a spring, but in reality numerous springs cause the condition. The remedy is to place a line of underdrainage along the upper side of the area to gather the seepage water and conduct it away.

Limited low areas within the boundaries of a single farm are often found where the surrounding high land drains the surface water into them. Usually the soil in such places is very rich. Drainage will permanently improve them by making the soil available for crop use each season.

Large areas of flat land which may be so set as to be commonly called marshes are often capable of improvement by an extensive

system of drainage. Miles of acres of this type of land have been improved by some system of coöperation among land owners and by the work of state drainage officials who are sometimes authorized under certain conditions to drain the land and assess the cost in the form of a tax against the owners.

Value of Drained Land.—Usually any area requiring drainage is rich in plant food. The very conditions which make drainage desirable have brought to the areas an abundance of plant food and organic matter during past ages. When soils are very rich and conditions may be made favorable for the production of enormous crops of high money value, by simply draining them, the results of drainage may be very profitable. The amount of profit which may result from the drainage of land is dependent upon the kind



FIG. 84.—Students may have practice in surveying for drainage lines.

of crops which the owner may desire to grow and the facilities for marketing such crops. Very often the soil after being drained is well suited to the growth of market garden crops, such as cauliflower, celery, spinach, onions and cabbage. If the railroad or other facilities for marketing such valuable crops are favorable, the money expended in draining the land will be amply repaid. On the other hand, if the area is to be used for a general farm crop, and if the cost of drainage per acre is found by calculation to be very great, the project would probably not be a profitable one.

Profits from Drainage.—Several things must be considered in determining the cost of draining a given area. This should always be determined as closely as possible before the work is undertaken. By the use of the carpenter's level or an inexpensive farm level (Fig. 84), any one can determine whether or not drainage is possible. In doing this the distance for each line of drain may be

measured. The outlet of the main drain must first be determined. The length and number of lateral drains running to the main drain should also be determined. If tile drains are to be used the cost of material, as well as an estimated cost of digging and closing ditches, and the cost of placing the tile, is easily determined.

After thus estimating the elements of cost for any drainage project it is wise to estimate the increased price of land resulting therefrom. This should be measured by its probable crop-producing ability, and should not be based upon speculative land values. Usually when such calculations are made in advance the profits from any drainage project are great enough to fully warrant the cost. The increased price of land is so great, and the cost of drainage so small, that results are usually very favorable.



FIG. 85.—Students placing tile in ditch for land drainage.

Kinds of Drains.—There are two main types of artificial drainage in use: (1) Underdrainage; (2) open ditches. These two methods may be combined in the same project. The main drain may be an open ditch with lateral underdrains leading to it. This is most desirable where the quantity of water to be carried by the main may be very great during the rainy season.

In small drainage projects it is usually best to use underdrains (Fig. 85). This type has several advantages over the open system: (1) No area of land is wasted if the drains are covered. (2) There is no waste time and labor of man and teams in farm work because of open ditches. (3) There are no strips left for the growth of weeds. (4) The cost of repair is reduced. (5) The results in actual removal of soil water are better.

Effects of Drainage.—When underdrains are properly installed the benefits resulting from drainage are of several kinds. We usually think of the removal of surplus water as the chief advantage; but other results are as important. The feeding area for roots is deepened. Instead of the roots remaining near the surface during the wet season they may extend to a much greater depth at all times. This results in less damage during the hot, dry weather of midsummer. Underdrains cause the upward movement of surplus water. This often prevents surface washing and will aid in drawing air into the soil. As the water moves downward air must follow. In the spring the entrance of

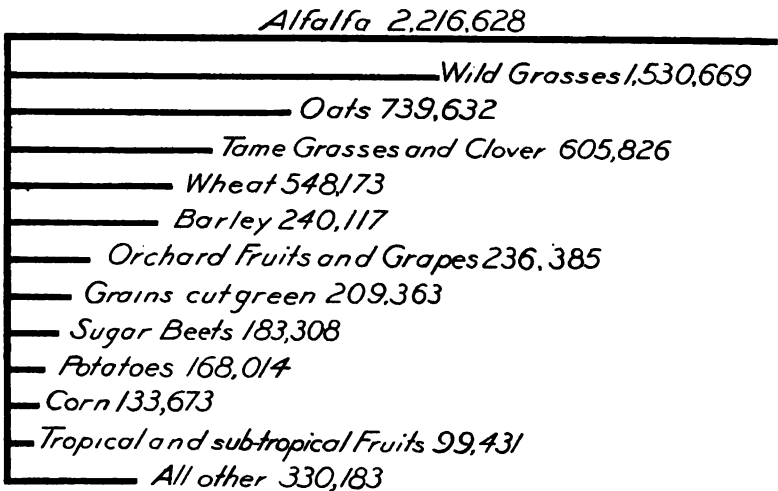

FIG. 86.—Acreage of crops irrigated in 1909 total 7,241,561 acres.

air by this means has a beneficial effect in warming the soil. Crops may be started much earlier and the growth be more rapid. Such conditions favor the growth of market garden crops, early potatoes and fruits which are to mature in time for the best market prices. A corollary to all of these effects of drainage is an increase in bacteria and chemical action in the soil and subsoil. This increase is due chiefly to the admission of oxygen and nitrogen among particles of soil which have not been sufficiently supplied with air. Underdrains ventilate the soil by admitting oxygen and nitrogen and by removing carbon dioxide. Much of the surplus carbon dioxide may be dissolved in soil water which is carried downward to the drains.

IRRIGATION

This name is given to a number of different methods of supplying water to soils used for agricultural purposes. Every one is familiar with the needs for irrigation in regions having low annual rainfall. The purpose is to supply water at a time when the growing crops most need it, thus securing increased yields sufficient to give ample returns for the cost of irrigation. Not only is irrigation needed in arid regions, but it is often found profitable even where the annual rainfall is abundant. This is because water may be artificially supplied during dry, hot weather when the rainfall is not enough to produce maximum crops. Recent trials made on light soils in the east have shown that yields of



FIG. 87.—A dam of wood and earth erected by private capital to irrigate land to be sold to users. The water "shares" go with the land.

potatoes and truck crops can be increased many fold and that the profit from such irrigation is very great.

About twelve million acres of land are irrigated in the United States. This is only a small fraction of the arid region which could be improved by irrigation. There is also a very extensive area which can never be profitably irrigated because of the difficulty and enormous expense of conducting water to the land.

The United States Government has under construction a number of irrigation projects which will irrigate many thousands of acres (Fig. 86). As soon as the land watered by this means becomes available for use it may be sold to actual users and the money reinvested in other irrigation projects. Extensive areas

have also been irrigated by grants of land made by the national government to individual states. The states or companies chartered by them have installed irrigation systems and thus reclaimed several million acres of arid land which was otherwise useless for the growing of crops. Individual owners have irrigated small areas in all parts of the country.

Irrigation Systems.—In large irrigation projects water is stored in large reservoirs formed by the building of dams across either deep gorges or shallow cuts made by streams. Some of the



FIG. 88.—Elephant Butte dam, Messila Valley, New Mexico, completed May 13, 1916. It is one of the largest re-enforced concrete dams of the United States Reclamation Service. In these projects the land is sold in small tracts to actual settlers only. (Courtesy Country Gentleman.)

largest and highest dams in the world are found in these projects. The Arrowrock dam in Idaho is the highest dam in the world, being 349 feet high. The Roosevelt dam in Arizona has a total height of 290 feet. Another government dam at Elephant Butte, New Mexico, has a total height of 300 feet (Fig. 88). This dam forms the largest artificial reservoir in the world, excepting the Gatun Lake on the Isthmus of Panama. The Elephant Butte dam is capable of storing 2,627,700 acre-feet of water and will create an artificial lake of over 40,000 acres which is, however, mostly worthless land.

Before such projects can be safely undertaken it is always necessary to determine the annual stream flow through a series of years. The supply of water for the project can thus be accurately determined and the investment of money in the project is well founded. For many years the United States Government has gauged the stream flow in many parts of the country for the purpose of determining the water supply. The information thus recorded may be useful at any time that a project is contemplated.

Canals are built to conduct the water from storage reservoirs to the upper side of the area to be irrigated. Smaller canals or



FIG. 89.—A dredge digging a ditch for irrigating an extensive area. (U. S. D. A.)

divisions are used to carry the water to different parts, and canal systems may ramify the whole area (Fig. 89).

Water from Dry Streams.—Another plan of supplying water for irrigation is to pump water from large wells in the beds of submerged streams. The water from such wells is supplied to the canals, by which it is conducted to the areas within reach. A noted project using this system is near Garden City, Kansas, where water is pumped from the apparently dry bed of the Arkansas River.

In humid climates water may be obtained from streams, wells and springs. It may be pumped to small storage reservoirs or

directly into irrigation ditches. It may be forced by the pump directly through pipes to the fields.

Methods of Applying Water.—Water may be applied to fields where crops and orchards are growing in several different ways. One of the most common methods is to conduct the water along shallow ditches and let it flow from them into furrows which run along the rows of the growing crop. In the fields of clover, alfalfa or other sowed crops the furrow system is also sometimes used (Fig. 90), but has the objection of leaving bare strips where the crop has been killed by the furrow. For such sowed crops the method known as flooding is more commonly used. The field when laid out may be levelled if necessary, so that water flowing in at one side will spread somewhat evenly through the surface without washing the soil or damaging the growing crop.



FIG. 90.—Irrigation of wheat as seen here is practiced only where the water rights are low. The method here in use is known as the "open furrow method." (U. S. D. A.)

Subirrigation is sometimes practiced by laying tile deep enough in the ground to avoid damage when plowing. Irrigation water is allowed to flow into the main, which is slightly higher than the laterals, and water is thus conducted to the whole garden or field. This system is applicable only to small areas. It has the advantage of not wetting the surface and thus puddling the soil or causing it to bake. Such difficulties are sometimes found in other systems of irrigation.

Overhead pipes, placed on posts high enough to allow the work of men and teams under them, are used to supply water directly to truck crops. Each line of pipe running across the field is connected with the head pipe, supplying water to all the lines. The

delivery pipes are supplied with numerous openings through which the water flows upon the field. By turning the line of pipe with a lever the direction of the small streams of water is changed so that the water may be more conveniently and evenly distributed over the surface. The delivery pipes are close enough together so that the water from two parallel pipes may reach all of the area between them.

FIELD AND LABORATORY EXERCISES

1. **Make a farm level** by securing two elbow joints of $\frac{3}{4}$ -inch pipe on the ends of a piece of $\frac{3}{4}$ -inch pipe 2 feet long. When the elbows are securely on, they should both point upward when the pipe is on the table. Then in the upper openings of the two elbows insert a piece of glass tubing about $\frac{1}{4}$ inch in diameter and 4 inches long. This may be done with perforated rubber corks or in some convenient method. Color some water with a little black ink and fill the "level" until the water stands level half way up in the glass tubes. This "level" is permanently level whenever it is resting on a table or box in the field where it is being used. One may sight across the top of the liquid in the two glasses and this line of sight will be in the level plane of operation in laying out drainage systems.

2. **Another device for use in running levels** is made by driving two four-penny finish nails in the two ends of a carpenter's level which is about 2 feet or thirty inches in length. Have the nails stand at equal heights above the wood. When the spirit in the level reads correctly, the operator may sight across the top of the two nails, and this line of sight will be in the level plane. Both of these devices are reasonably accurate for preliminary surveys.

3. **Make a sighting pole** by selecting a large piece of wood about 1x2 inches and 12 feet long. Carefully mark this off with a soft black pencil at intervals of one foot. Number these by pasting on a prominent number above each of the marks. The figures for this may be cut from a large calendar. This pole may be held by the pole-man, who will carry a foot ruler in his hand for use in determining the exact height of the pole where the line of sight of the instrument-man strikes the pole. For longer distances the pole-man may point to the line of sight with a pencil covered with a handkerchief and when the true point on the pole has been found, the height above the nearest foot mark is measured with a ruler and the reading recorded.

4. **Running Levels.**—With the above instruments, students should practice running levels, taking the readings at intervals 100 feet apart along a road or along other lines selected for practice. From the data thus obtained, make drawings showing the amount of rise and fall along the surface of the ground, indicating the distances at each point below a stated line above called the datum line.

5. The above exercise should be repeated in a field where drainage might be worth considering. From the data obtained calculate the amount of fall possible along the line of operation. It is safe to assume that the head or upper end of the line of trial drainage should be two feet under the surface of the ground, and should not come closer to the surface than that at any point, except near the mouth, where the water is to empty.

6. **Outflow from Drains.**—If drain tiles are in use in the vicinity, the outlets should be examined at intervals of say every eight hours after a heavy rainfall. The records should be taken each time. Make notes of the gradual increase and decrease in the outflow. What do these indicate with reference to the efficiency of the drainage in that particular case?

7. **Cost of Drainage.**—Study the structure and make notes regarding the items of cost of a complete drainage system in a field where the project is either completed or being contemplated.

8. **An overhead irrigation system**, if one is in use in the vicinity, should be studied by the students and the structure of the nozzles, the location of valves and other details should be well understood. Make a drawing of the pipe lines and indicate the distances apart, the size of pipe, the length of each line. Show location, direction and size of the supply pipe.

9. **Testing Effect of Irrigation.**—If possible, on two plots grow one crop having all conditions for growth the same, except the supply of water. Let one plot be irrigated and the other supplied only with natural rainfall. Calculate the increased yield due to irrigation and compare this with the cost of the water supply. Credit the net increase to the cost of the irrigation plant.

QUESTIONS

1. Give the advantages of drainage.
2. Tell what kinds of places are likely to need drainage.
3. How much increase in value often accompanies drainage?
4. How can an owner figure the profits to be derived from drainage?
5. Give the advantages of underdrains as compared with open drains.
6. Give some idea of the area of land under irrigation in the United States. How much more needs irrigation?
7. Describe the reservoir plan of water storage and irrigation.
8. Describe the methods of applying the water to the field.

References.—United States Farmers' Bulletins: 138, Irrigation in Field and Garden; 158, How to Build Small Irrigation Ditches; 187, Drainage of Farm Lands; 263, Practical Information for Beginners in Irrigation; 266, Management of Soils to Conserve Moisture; 371, Drainage of Irrigated Lands; 373, Irrigation of Alfalfa; 392, Irrigation of Sugar Beets; 394, The Use of Windmills in Irrigation in the Semi-arid West; 399, Irrigation of Grain; 404, Irrigation of Orchards; 524, Tile Drainage on the Farm; 698, Trenching Machinery used for the Construction of Trenches for Tile Drains.

CHAPTER XI

CROP ROTATIONS

A field becomes exhausted by constant tillage.—OVID.

THE production of crops may be divided into two classes. (1) The general crop production when a number of kinds of crops are produced. (2) Special farming or special crop production, when attention is given chiefly to one or perhaps two money crops. Specialized farming is more and more coming to be the practice in America. Many farmers in New York state, as well as elsewhere, produce timothy hay as their only money crop. In the West alfalfa is now frequently found to be the only money crop. In the South the money crop on different farms may be cotton or sugar cane or tobacco. In parts of Louisiana and Arkansas rice is sometimes the only crop raised for sale. In the northwest and middle west wheat or other small grain is sometimes the only crop on many farms. Potato growing is an example of special farming in many parts of the country. Other examples of this kind are orcharding, or market gardening, or raising of sweet potatoes, or sugar beet growing.

Specialized farming may extend beyond the production of crops and is illustrated in poultry raising or more specialized egg farming, or swine farming, or the production and sale of dairy products, or the raising of mules, or the production of some pure breed of livestock. Where livestock farming is involved the operations on the farm are usually less specialized. The management and feeding of livestock usually involve the production of a wide range of farm crops.

Whether the system of farming carried on by any manager is classified as special or as general farming it is advisable, and usually necessary, that he should adopt suitable systems of rotation. In general farming, where several crops are grown, it is easier to establish a suitable plan for their rotation. When only one or two crops are produced it is not so easy to profitably plan a rotation course, but this may be accomplished by the growing of cover crops, green manure crops, and catch crops between the regular seasons when the main crops are produced.

Management Required.—By rotation of crops is meant the order or arrangement of their succession. On a given field the plan is made to have one crop follow another for the purpose of securing certain definite beneficial results. This is in contrast with the plan of having the same kind of crop grown on the same field for several seasons, with no other crop intervening.

One of the most important elements in good farm management is to have a good system of rotation established for each field. The plan should always have for its foundation good scientific reasons which are applicable to the particular case in hand. The rotation should suit the soil, the kinds of crops grown, and also take into consideration the market conditions and money return from the business.

Many good systems of rotation are in use. No one can hope to specify any definite rotation which would best suit all conditions. Each farm manager must become thoroughly acquainted with the underlying principles or reasons, and then make use of them in formulating the rotation course for each field.

Take, for example, a dairyman in Wisconsin, who has his farm divided into four fields and has on each of these fields a four-year rotation.

The first year field A has corn; field B has oats, followed by clover just starting; field C has clover with timothy; field D is chiefly timothy with some clover and is used for growing pasture for that year.

The second year field A is sowed to oats, with clover and timothy seed as B was the year before; field B is now used for clover hay; field C is used for pasture and D is growing corn. Thus each year the rotation is pushed back one and the cycle is complete in four years. The four fields are approximately the same in size.

It must not be supposed that this identical plan can be followed even by all dairy farmers.

Underlying Principles.—There are a number of fundamental reasons which are applicable in special cases. These should all be borne well in mind by the owner or manager when he is planning any rotation course.

- 1 Some crops gather nitrogen from the air and add it to the soil, while others exhaust it or rob this element from the soil. If a rotation be adopted whereby the use of nitrogen-gathering crops of the legume family are used once or perhaps oftener in the rota-

tion, money is saved which would otherwise need to be used in the purchase of nitrogen in the form of manure or commercial fertilizer. The growth of legumes may be so planned as to actually increase the store of nitrogen in the soil. The growth of a legume with a non-legume is shown in figures 91 and 92.

2. Crops differ widely in their root systems. Some have very shallow roots, as timothy and other grasses; while others have deep roots, as alfalfa and clover. The growth of crops varying in



FIG. 91.—Peanuts may be grown between the rows of corn as far north as Nebraska and New Jersey. (Fights of the Farmer.)

this respect on a certain field will make better use of the fertility, and the plant food will not be exhausted so soon.

3. Cover crops should be grown in the winter and usually in other seasons after the main crops have been harvested. These cover crops prevent the loss of soil and plant food by washing and leaching. In a well-planned rotation a growing crop can be kept on the field practically all the time. When but one crop is grown the soil is often poorly protected. This does not apply, however, where the single crop is grass or alfalfa.

4. Diversification of crops means a variety of soil treatment, as fertilizing, liming, plowing and cultivating at different times of the year. Such a variety of treatment is usually better than following the same tillage at the same season each year. By suitable planning soil moisture may be conserved by proper tillage at the right season.

5. Weeds are better kept in check. Annual weeds are seldom injurious in hay fields. Most perennial weeds are less common in



FIG. 92.—Just right for hay making. Canada field peas and oats, when grown together, are used for hay if cut when the peas are in blossom. They may be allowed to ripen and the seeds threshed out together and ground for feed. When growing the peas are improvers of the soil because they gather nitrogen from the air. The crop may be followed with timothy or with alfalfa sown in August.

grain fields and cultivated crops. Rotation therefore tends to choke out each type of weeds. The growth of a cultivated crop will help to destroy perennial weeds, and the growth of a perennial crop will help to destroy annual weeds.

6. Injurious matter in the soil exuded by roots during their growth are somewhat poisonous to the one kind of plants. By rotation this material may be used up or changed by the action of plants of a different kind.

7. Certain crops are often badly affected with special kinds of

injurious insects. By the growth of different plants the next year these insects may be destroyed or caused to leave for want of their special kind of food. The wheat midge is not injurious in a corn field. The clover maggot does not affect the cotton crop. The cotton boll weevil is not injurious to other crops.

8. Plant diseases are often kept in control by rotation. For example, club root of cabbage lives over in the soil and would affect subsequent crops if cabbage is grown continuously. It may also affect closely related crops, but it will not attack potatoes, corn and many other crops. Similar affections living over in the soil may be injurious to the roots of beets and raspberries. If these plants be grown together or in succession the rotation must be planned to destroy such diseases.

9. Rotation may require a greater diversity of farming. This in turn results in more sources of income than where one crop only is produced for market. Some income is more certain when several market crops are produced. If one crop fails the others may not. If the market be poor for one it may be good for the others.

10. If rotation brings about more diversified farming it will give more continuous work for men and teams, because the work will be distributed more evenly throughout the year. One of the great losses on many farms arises from the fact that man and horse are not steadily employed in profitable work. In the one-crop system much loss arises from this source.

One-year Rotations.—The farm may produce only one kind of market crop. This is true in many lines of special farming. Rotations are still possible. Cotton may be grown year after year on the same field. The objections to this may be chiefly overcome by establishing an annual rotation; that is, by the use of a winter cover crop grown during the late summer, fall, and winter and turned under in the spring as green manure, perhaps a few weeks before cotton is planted. The winter cover crop may be sown in the late summer or early fall between the rows of cotton. An extra cultivation may be necessary to make the conditions favorable for the seed. Some cotton growers use crimson clover for this purpose. Much the same effect may be secured by the growth of peanuts, cow peas, soy beans or other summer crops between the rows of cotton or between the rows of corn. The ground thus receives a different treatment and nitrogen is accumulated by the legumes to supply nitrogen for the growth of cotton.

Similar annual rotations may be adopted for other cultivated crops, such as corn, potatoes, sweet potatoes and market garden crops. If the winter cover crop cannot be grown between the rows of the main crop it may in some cases be started after the main crop is removed. Such would be the case in the annual rotation with spring wheat, spring oats, or other small grain.

Two-year Rotations.—Two market crops may be grown in alternation with each other and frequent or constant use may be made of cover crops. Under careful management winter wheat may follow corn. When the wheat is harvested a cover crop is grown until the next spring when corn is planted. A cover crop may be composed wholly or in part of leguminous plants, and the nitrogen supply will then be maintained.

When cotton and tobacco are both grown one may follow the other if a cover crop is used after each.

Early potatoes and corn may be used in a two-year rotation with a cover crop following each main crop.

Three-year and Four-year Rotations.—In systems of farming where livestock are used and general farm crops are produced, four-year rotations are commonly found. The four-year rotation already described is a very common one. If more oats are produced by this method than are desired for the farm teams, Canada field peas may be sown with the oats every other time the oats are planted. The mixture of oats and Canada peas may be cut for hay just at the close of the blossom period (Fig. 92). Some of the oats and peas may be allowed to mature and then ground together to be used as feed for dairy cattle, swine, poultry or other livestock. This use of Canada peas with oats is a success in northern and middle states but not far south.

A good three-year rotation on a livestock farm may have corn, followed by a cover crop, the first year; spring grain the second year; clover which was seeded with the grain is cut for hay the third year and the second growth of clover the third year is used as green manure and turned under before corn is planted. Thus two legumes may be used in the three-year rotation.

This plan gives no timothy hay, but the rotation could easily be extended one more year and if timothy seed is used with the small grain, in addition to the clover, mixed hay is obtained the third year and nearly clear timothy may be cut the fourth year.

A good four-year rotation is illustrated in the main plots of figure 93, a five-year rotation in figure 94, a seven-year rotation in

figure 95, a three-year rotation in the three plots back of the orchard in figure 96.

Three-year Rotation for the South.—A good rotation for a southern farm raising its own feed may be planned as follows:

First year, corn with cow peas sown at the time of the last cultivation, followed with winter oats and vetch sown at the time the corn is cut.

Second year, oats and vetch for hay or grain, followed by cow peas for hay, followed by crimson clover or bur clover as winter cover crop, to be pastured and cut for hay or seed the next spring.

FIG. 93

FIG. 94

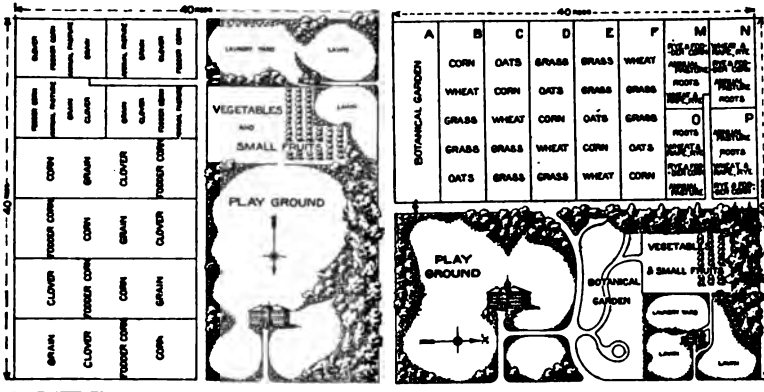

FIG. 93.—Rotation of crops in a ten-acre school farm where the public roads are on the north and west sides. The crops in the rotation should be changed to suit the region. (U. S. D. A.)

FIG. 94.—Another plan for a school farm, both the main building and the principal's house facing the road along the east side. (U. S. D. A.)

Third year, cotton with crimson clover or bur clover sown between the rows at the time of the last cultivation; or oats and vetch may follow the cotton after an early harvest—this latter plan being better in the boll weevil region.

Another plan for a three-year rotation, to use just north of the cotton belt, is as follows:

First year, corn followed by winter oats or other winter grains (with or without crimson clover) sown when the corn is cut or before.

Second year, oats, in which red clover or alsike were sown in very early spring; cut oats for grain or for hay, and the

clover will make enough growth to furnish some pasture that season.

Third year, clover hay one or two cuttings, and pasture through the following winter.

In the growing of alfalfa a rotation may be followed. Corn followed by a cover crop may be used the first year. In the spring oats and peas are sown and the crop cut for hay in the blossom stage. The soil is prepared immediately for alfalfa and kept

Fig. 95

Fig. 96

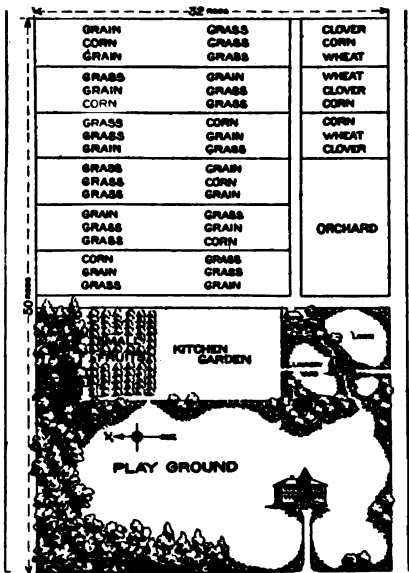
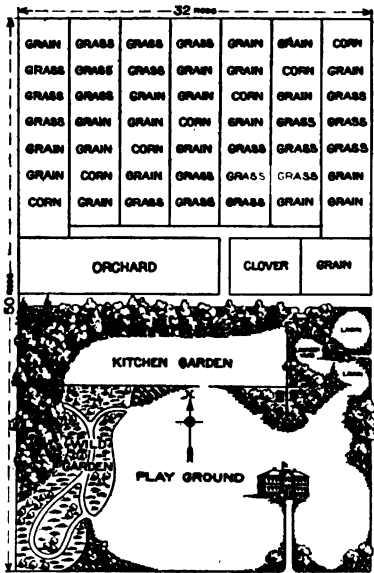

FIG. 95.—A ten-acre school farm showing the building facing south. The crops in the rotation are merely suggestive. (U. S. D. A.)
 FIG. 96.—A school farm plan in which the school building faces west. The principal's home yard opens on the side road. (U. S. D. A.)

fallow until August when the alfalfa seed is sown. Alfalfa may then occupy the ground for three or four years, or as long as the stand remains good. It is then plowed up for corn.

Long rotation courses are sometimes followed in regions where a single crop is desired for market. This may be the case where cotton is to be grown as frequently as possible without detriment to the soil. In the corn belt and in wheat growing states long rotations are sometimes adopted.

Winter wheat is sometimes followed by winter wheat with a catch crop of very early cow peas or soy beans started quickly by disking the stubble. This plan is pursued for two, three or four years, and then the ground is seeded to clover and timothy after the last crop of wheat. After one year of clover and one or two years of timothy the sod is turned under and corn is grown two or three years with a winter cover crop sown in the corn each summer until that fall when wheat is to be started again.

In cotton fields the crop should be followed each year with a winter cover started each summer in the cotton. After three years of cotton on the field, corn crops, or perhaps early potatoes, are grown for two seasons. Or corn is grown one season and potatoes one season. A winter cover crop should follow in each case. The ground is then given one year's rest from any market crop by leaving the winter cover for an early hay crop during that summer. A crop of cow peas may be grown and the soil prepared for cotton the following spring.

Shorter rotation courses are always more beneficial to the soil. The yields are better and other advantages of rotation are realized.

Washington's Rotation.—In the years preceding 1800, George Washington was using the following seven-crop rotation on one of his farms in Virginia:

Wheat, fall sown.

Buckwheat, for manure.

Wheat, fall sown.

Clover or grass, three years.

Corn and potatoes in alternate rows.

Rotation for Peanut Growers.—Southern peanut growers may adopt a four-year rotation somewhat like this:

First year, cotton and bur clover.

Second year, corn and cow peas.

Third year, peanuts, followed by winter oats.

Fourth year, peanuts for hogs after oats.

In some sections the peanut crop is grown between the rows of corn as shown in figure 91. In that case the rotation may be much shorter, and cotton need not enter into the rotation.

Rotations for Truck Farming.—In gardens and truck farming, rotations should be practiced. It is in such places that the greatest benefits are realized. When a single crop is grown continuously, in the same part of the garden, some of the greatest difficulties are found. Beets, potatoes, turnips and other root crops are

subject to scab and similar diseases which live over in the soil. For these the best remedy is rotation. The use of short season crops, called catch crops, grown between the seasons of the main crops, may often be used in market gardening as well as in the home garden. Whether these catch crops be used for green manure or not, some benefit will arise from their use. The greatest benefit, however, usually comes from plowing them under as green manure.

Succession cropping may be practiced in market gardening by having the rows of one crop far enough apart to start a second crop between the rows before the first is removed. This plan, known as succession cropping, may be helpful to the soil, or much less injurious than the growth of a single crop. For example, if sweet corn is grown with the rows wide enough, start peanuts in alternate rows with the corn. Nitrogen will be gathered from the air by the peanut plants.

Companion cropping is only slightly different from succession cropping, and has the same advantages. Examples of these are the growth of garden peas with early spinach or either of these with lettuce.

Acres in the Rotation.—It is often found that the number of acres used for a given crop may not suit the number of acres to be used for the crop which is to follow on the same field. For example, in the first four-year rotation here described the owner used the same number of acres for each of the four crops or purposes. If another farmer wished to adopt the same plan he might prefer to have more corn than oats. In any such case the area for a given crop may be reduced by using a part of the field for a subsidiary crop. Thus the size of the field devoted to oats in that case could be reduced by using a part of it for potatoes. This could be done systematically, and if planned in advance would cause no variation in the rotation system.

Market Fluctuations.—It frequently happens that the price of a market crop is very low for a year or two, and many farmers change their system and stop growing the crop. This may result in the price being very high immediately. Then the pendulum swings back and all farmers raise more of that crop because the price was high last year. This condition is due to a desire on the part of many farmers to speculate on the market conditions. It usually results disastrously. A better plan is to adopt a definite rotation system and follow it in spite of slight annual variations in price.

What Crops to Grow.—The young farmer starting for himself in a given locality will usually be guided in the selection of crops by observing what crops are grown to good advantage in his neighborhood. This is usually a wise course to follow. There are a few respects in which it may be misleading. It is well also to consult with the authorities of the State Experiment Station regarding the adaptation of the soil and climate to the particular crops desired. Recent changes in market conditions for the given locality should also be studied. These may include new methods of transportation or new industrial conditions in nearby cities.

Much time may be saved by making such studies in advance, even before the farm is purchased, if possible. Rotation courses cannot well be established without knowing the possibilities of the soil, and the suitability of crops to the climate, markets and transportation facilities.

It should be remembered by the young manager that it is usually better to produce several kinds of crops than only one. Diversified farming has many advantages: better rotations can be planned; the returns may not always be so great, but they are more certain year by year; the men and teams on the farm may be used to better advantage; more livestock can be kept, and thus more manure produced for the upkeep of the soil.

FIELD AND LABORATORY EXERCISES

1. **Charts of Actual Rotation.**—Visit farms and gardens where systematic rotations of crops are carried on. Make charts showing the rotation on each of the fields and discuss the merits and demerits of these. If a number of places are studied, the benefits of the system in each case should be considered with reference to the objects in view by the owners.

2. **Rotation and Labor.**—Study local rotations with reference to the amount of labor required in putting in the crops used in the rotation, *i. e.*, the number of plowings required during the seasons of yield, the number of harrowings, applications of fertilizer, etc. Suggest if possible any improvements, considering the fighting of insects, weeds and other enemies.

3. **Rotation and Nitrogen Supply.**—Find, if possible, a rotation system in use in the vicinity which does not sufficiently provide for the natural supply of nitrogen by growth of legumes. Suggest a plan by which more legumes could be grown without changing the number of money crops during the seasons of rotation. Calculate the increase in cost of producing these legumes considering seed, sowing, and other items. Determine from this what saving of commercial fertilizer or farm manure would be effected by the growth of the legumes. In cases where no fertilizers are being used, determine what increase in money crops would be necessary to overbalance the cost in growing the legumes. Would the growth of the legumes improve the soil?

4. **Find examples of bad rotation or lack of rotation, showing some of their disadvantages on those farms.** Consider each of the ten points mentioned in this chapter.

5. **Good Local Rotations.**—Outline one-year rotations, two-year rotations, three-year rotations and four-year rotations. Use crops producing yields suited to the market conditions of the region. This exercise should give systems different from those suggested in this chapter.

6. **Succession Cropping.**—Find examples of succession cropping among gardeners nearby. Give a description of the time of planting and other points of management for each of the crops in succession.

7. **Companion Cropping** can easily be found among commercial gardeners and in home gardens. Each example should be described in detail.

QUESTIONS

1. Distinguish between general crop production and special farming.
2. Give some idea of the manager's problem in establishing rotation systems.
3. What are the underlying principles which the manager must keep in mind?
4. Explain what is meant by one-year rotations and give examples.
5. Give illustrations of two-year rotations.
6. Why are three-year and four-year rotations better suited to livestock farming?
7. Give an example of each of these.
8. Give some good rotations for truck growing regions.
9. Explain what is meant by succession cropping and companion cropping.
10. How may market fluctuations tend to change rotation systems?

References.—United States Farmers' Bulletins: 144, Rotation of Crops; 242, An Example of Model Farming; 294, Farm Practice in the Columbia Basin Uplands; 310, A Successful Alabama Diversification Farm; 337, Cropping Systems for New England Dairy Farms; 365, Farm Management in Northern Potato-growing Sections; 614, Efficient Farm System for the Corn Belt.

Cornell Farm Crop Series No. 2, The Rotation of Farm Crops.

CHAPTER XII

FORAGE CROPS—GRASSES

Isn't it wonderful when you think,
How the creeping grasses grow,
High on the mountain's rocky brink,
In the valley down below?
A common thing is a grass-blade small,
Crushed by the feet that pass,—
But all the dwarfs and giants tall,
Working till doomsday shadows fall,
Can't make a blade of grass.

—JULIAN S. CUTLER.

THERE are two great families of plants from which are produced nearly all of the hay, pasture and soiling forage for live-stock—grasses and legumes. Grasses have certain definite characteristics by which they are distinguished from other families of plants. The leaves have parallel veins and are usually very long, slender and pointed—the bases sheathing the stem. The stem has fiber bundles scattered through it, except in those which have hollow stems. The scattered bundles are shown in the stem of a corn stalk. The stems are marked with closed and enlarged joints or nodes. The flowers are inconspicuous and when the pollen is carried it is usually by the wind. To this family belong the numerous grasses used for pasture and hay, as well as a number of the cereal plants, corn, wheat, rye, oats and barley.

Definitions.—When the leaves and stems of plants are used for stock feed, such plants are called *forage crops*. The plants may be eaten by stock while growing, as in a *pasture*; or the plants may be cut green and fed before drying. They are then called *soiling crops*; and such a practice of feeding is called *soiling*. When a forage crop is cut and dried before feeding it is then called *hay* or *fodder*. Forage from the finer grasses and plants is called *hay* and that from the coarser leaves and stems is called *fodder*. Examples of fodder plants are corn, kafir and sorghum. When corn has had the ears removed the remaining feed is called *stover*. When corn or other forage plants are cut up and preserved in a silo the feed is known as *silage* or *ensilage*. *Straw* is the resulting stems, leaves and chaff after seed has been thrashed from the mature crop. Examples are legume straw of several kinds, and straw from buckwheat, small grains, millet and others.

Pastures may be classified into permanent and temporary, as the crops used in each case vary widely. Temporary pastures may be produced by the growth of annual crops or other plants having a short duration. A field may be used as a temporary pasture after a crop has been harvested and aftermath has started. The second growth of clover is very commonly used as a temporary pasture. Stock are frequently allowed to graze on young grain in the fall, winter or spring before the plants begin to form true stems. If conditions are favorable this practice induces plants such as wheat and rye to "stool-out," and send up many more stems from the plant. The result is usually a better crop than where grazing is not practiced.

Permanent pastures are usually kept on farms where there are hillsides too steep for tillage. Fields that are too stony, or too wet, or otherwise unsuitable for cultivation, are used as permanent pastures. The amount of stock feed grown in a permanent pasture will depend largely upon the grasses and legumes used, and upon the attention or conditions given them for suitable growth.

The plants to use must be adapted to the conditions. In low lands, where water stands much of the year, alsike clover is one of the best legumes to use, and redtop is one of the best grasses. These should of course be mixed with other plants, such as Kentucky blue-grass, white clover, meadow fescue and perhaps some timothy.

On uplands, where the drainage is better, less redtop and alsike clover should be used. A mixture of timothy, Kentucky blue-grass, white clover and fescue are suitable for the north-eastern states where the climate is cool and humid. In states farther south, Bermuda grass may take the place of timothy in such a pasture, but the best of all pasture grass in humid climates is Kentucky blue-grass and this should form the bulk of the mixture. In semi-arid regions smooth brome grass is probably the best permanent pasture grass, besides the native grasses of the region.

Permanent pastures should be given some attention to make them more permanent and profitable. There is often much danger from weeds and other adversities. Places where the grass becomes thin should be re-seeded from time to time. Harrowing a pasture is often beneficial, particularly when more seed is sown. Lime is often helpful to a pasture where the roots and decay of vegetation have made the soil sour. Most grasses and legumes

are improved by the use of lime. A top dressing with commercial fertilizer, or with barnyard manure, will often stimulate the pasture growth and promote good returns.

Pasture Mixtures in Different Sections.—In regions where blue-grass is easily grown, this is the chief crop used in permanent pastures. As the crop does not thrive well in dry regions, and is not well adapted to soils deficient in lime, it is often found advisable to mix with it grass or clover to supplement the pasturage. Timothy is a fairly good pasture grass for upland places and is often mixed with blue-grass. Creeping white clover when mixed with blue-grass pastures has the tendency when approaching maturity to cause horses to slobber severely. Particularly in the wet season, as early spring, it may cause bloating of cattle. However, it furnishes good feed and may be used with caution. For low grounds, add to the mixture some redtop.

In some of the western states where the climate is comparatively dry, smooth brome grass is mixed with other grasses such as blue-grass, white clover, redtop and timothy.

In the gulf states and some of the other southern states, Bermuda grass is commonly used in permanent pastures. Mix with this small grains, as wheat, oats and barley and sow in the fall to form a winter pasture, and for the same season have crimson clover and hairy vetch sown at the same time. In the early spring the same pasture may be sown with lespedeza to improve the pasture through the summer season.

Soiling crops are valuable particularly for dairy and swine feeding. They are used chiefly during the dry summer season when pastures are poor. The manager must have the crops growing in time to cut for soiling purposes at any time when the hot summer weather destroys much of the pasture forage. The flow of milk from dairy cattle is kept up by this means at a very nominal cost and much loss is thereby prevented. Corn is one of the best soiling crops, but in some sections is not mature enough for use in this way when the dry weather begins. It is then well to have some other green feed ready for use. Oats and Canada peas grown together may be cut in the green state and used for soiling. Red clover is also fed green. Alfalfa is perhaps the most satisfactory of all crops for soiling, as it is ready to cut at almost all times and the crop itself is better when cut frequently.

Hay.—Timothy is the chief hay plant in the cool, humid districts of America. Smooth brome grass and various native



FIG. 97.—Tall meadow oat grass.
(Productive Farm Crops.)

grasses are used in the arid and semi-arid sections of the middle west. In the southern and southeastern states efforts are made to find satisfactory substitutes for timothy. Johnson grass is grown in the western portion of this area, but has the objection of being a very bad weed where cultivated crops are grown. Bermuda grass in the gulf states yields well enough to be suitable for hay. In other sections of the South annual crops are more frequently grown. Redtop and fescue are well suited to the interior states of the South.

In southern states it is even more important than elsewhere to grow a mixture of grasses for hay. Timothy orchard grass, redtop, Italian rye grass, tall meadow oat grass (Fig. 97), fescue, and others may be mixed together and will make a better stand of hay than any one alone. If alfalfa or clover be mixed with some or all of these grasses a better crop is produced (Fig. 98).

Fodder Crops.—Corn is the leading coarse fodder crop of America. By careful selection of varieties or strains its adaptation has been widely extended northward. In the drier climates of the West kafir corn is sometimes substituted for it, or used to supplement it. True sorghums are used in dry, warm climates. Kafir is a non-saccharine sorghum (Figs. 99–100). Milo-maize and durra are also of this type.

Most fodder crops are grown for seed, as well as for forage. These may all be used to advantage in a silo. They are run through a cutter

which may be adjusted to produce pieces varying in length from one-half inch to two inches. The fine cut ensilage is usually best, as it is more completely used by stock. Many other forage plants



FIG. 98.—Hay demonstration in South Carolina. First cutting May 8, yielding 7000 pounds per acre. (U. S. D. A.)

have been tried in silos and with more or less success. Corn is the chief silage crop of America.

Timothy (Fig. 101) is popular as a hay crop because it grows



FIG. 99.—Types of grain sorghums; these crops are of increasing importance for grain and forage in western and southwestern States. They thrive better than corn under dry farming. From left to right: 1 and 2, yellow Milo; 3 and 4, white and brown Kaoliang; 5, Feterita (Sudan Durra); 6 to 8, red, pink, and black-hulled kafir corn. (Productive Feeding.)

well in the cool, humid regions of the northeastern quarter of the United States. The seed is abundant and cheap. The plants are usually completely killed by plowing, and do not persist as weeds in cultivated fields. In most soils timothy does not live many years. When used in pasture mixtures it produces a good sod the first year or two, but is soon run out by other grasses. In hay fields it is better the first year or two than afterward. It is, therefore, well suited to a short rotation of crops.



FIG. 100.—Kafir corn, a non-saccharine sorghum, well suited to dry seasons. The tonnage of fodder and seed compares well with corn.

There are several plans for seeding timothy: (1) The most common plan is to sow about ten or twelve pounds of seed per acre at the time small grain is sown. (2) A newer plan and perhaps better in regions where weeds are very troublesome, is to plow the grain stubble in and thoroughly prepare the seed bed to be sowed with fifteen to twenty pounds of timothy seed in August, or as soon thereafter as the ground is moist enough to start the seed. (3) In several New England states, and less commonly elsewhere, timothy seed is sowed in corn fields after the last cultivation in July or August. The last cultivation is such as to make the surface very level. Corn is cut very low, or the stubble may be recut to avoid difficulty in the mowing of hay the next season.

Timothy usually produces a good aftermath, or second growth, after the first cutting if the moisture conditions are favorable. In dry sections, however, there is but one cutting and very little aftermath to be used for pasture.

The best timothy hay should be cut as soon as the seed is well formed and before the crop is entirely mature. In this condition it is not quite so easy to cure as when it is more mature. It is more relished by stock and there is less waste in the manger.

The amount of aftermath depends somewhat upon the stage when the main crop is cut. Maturing the seed takes the life from the roots and is more detrimental to growth the same season and future years.

Kentucky Blue-grass is botanically known as *Poa pratensis* to distinguish it from Canada blue grass (*Poa compressa*). The latter is sometimes called wire grass in the North and is a very poor plant for either pasture or hay. Kentucky blue-grass is the best pasture grass in the moister parts of the country (Fig. 102). From the mountainous regions of the South it extends into Canada. In most of this wide range it requires no seed, but when timber is cleared off it takes possession of the soil, forming a tough sod which yields a nutritious growth for grazing stock. Close cropping by sheep or other stock seems to improve its growth. Running root stalks near the surface of the ground maintain the life of the plants during dry weather and a luxuriant growth again reappears when rains fall.

The amount of feed per acre is not so great as for many other grasses. Because of the shallow root system, growth quickly stops when dry weather sets in. If the early summer growth is allowed to form stems and produce a crop of seed it is very detrimental to the pasture. The drying effect, as seed is matured, saps the life from the underground parts. When pastures are not used by enough stock to prevent the formation of stems and seed it is well to clip the growth with a mower. This will conserve the life of the plants and improve the pasture during the dry summer.



FIG. 101.—Timothy is the most popular hay crop of America. (Productive Farm Crops.)

Blue grass seed is light and chaffy and is easily adulterated with the Canada blue grass and other similar seeds. Samples should be tested before using. This may be done either by the grower or by the state seed analyst.



FIG. 102.—Kentucky blue-grass on left and Canada blue-grass on right. Note the erect stem and open head of the former. (Productive Farm Crops.)

Redtop (Fig. 103) is a true grass and should not be confused in the student's mind with red clover. There is no resemblance between the two plants. Redtop is adapted to the same climate as timothy, but will endure much moister conditions. The growth is rank and very good crops may be produced on fields that are too dry or too poor to yield a good crop of timothy. The shallow root system causes the crop to suffer much from dry weather, but makes it well adapted to low, wet places. Because of the numerous rootstalks near the surface of the soil the sod produced is tough and even. The seed is abundant and cheap. About fifteen pounds to the acre will produce a good stand. When seeded in spring, or when seeded alone or with other grasses in early fall, it will produce a good crop the following season. Under favorable conditions the plants persist well and a good yield may be harvested for many years in succession.

Orchard grass (Fig. 104) is best adapted to the regions where timothy is grown. Its special advantage is its growth in shady places. It matures earlier than timothy, producing a tall, heavy

growth fairly well suited for hay. It grows in tufts or clumps, producing an uneven sod. For this reason it is not much used in pastures.

Meadow Fescue.—There are several types of meadow fescues



FIG. 103.—Redtop is well suited to low, sour soils. (Productive Farm Crops.)

FIG. 104.—Orchard grass. (Productive Farm Crops.)

the tall form being the best adapted for hay. They all make good sods and are useful in pastures as well as in hay fields, particularly when mixed with other grasses. They thrive in the climate where timothy is grown, but extend much farther into



FIG. 105.—Smooth brome grass. (Productive Farm Crops.)

the drier climates. They are frequently found among the self-sown grasses of the prairie regions.

Smooth brome grass (*Bromus inermis*) should not be confused with the spiny or rough forms. This plant (Fig. 105) is used in the colder climates of the middle west where the rainfall is not enough for timothy. The plant makes a tall growth, producing one or two cuttings of good hay in a season. The abundance of underground rootstalks causes the plant to form a tough sod well suited for pastures. It is more permanent in the soil than most other "tame" grasses. When it is used in moist climates some criticism arises from the fact that it is not all entirely killed by plowing. A little extra attention will overcome this difficulty.

Bermuda grass is widely grown throughout the South. It is better suited to use in pastures than in hay fields. Except in the Gulf states the growth is usually not tall enough for hay. The stems are often trailing and take root at the nodes, causing a dense mat over the surface. Because of this method of spreading, the plants are not easily killed by ordinary plowing and may persist in cultivated crops, such as cotton and corn. In farm pastures, where it is cropped close, the yield is comparable with that of blue-grass but is usually not so palatable.

It is adapted to much warmer climates than Kentucky bluegrass, and extends into the tropics.

Millets.—There are several types of millet. Common Hungarian and German millets all belong to the type known as foxtail millet. In these the head is a compact spike, more or less erect. Barnyard grass or foxtail is often called barnyard millet. The head is an open panicle. Broom corn millet or hog millet has been recently introduced from Russia. It has broad hairy leaves and is grown more for seed than for forage. Pearl millet might well be classed with the coarse fodders, as it grows from six to ten feet high. The head is a compact, erect spike. Because of its likeness to the wild cat-tail of the swamps it is sometimes called cat-tail millet.

All the millets are annuals (Fig. 106). The common variety of foxtail millet has nodding heads about six inches long. These turn yellowish brown when ripe. It matures earlier than the other millets and is more popular for this reason. The plant is very leafy and produces large yields of hay. It is sometimes thrashed for the seed, which is used for poultry and birds. The hay from millets is coarse and fibrous and not so nutritious as hay from other grasses. When used for horses it must be fed cautiously or mixed with other hay in the day's ration. If fed alone it may act injuriously upon the kidneys of horses.

Millets are hot weather crops and should not be seeded before late spring or early summer. They are often used as summer catch crops, and for this purpose should be mixed with cow peas or other small legumes.

Sudan grass (Fig. 107) is closely related to the millets and its feeding value is about the same. It is similar in growth to Johnson grass except that it has no underground rootstalks and



FIG. 106.—Common millet is a summer annual, easily killed by frost. (Productive Farm Crops.)

is an annual plant. It is native of Africa and is well adapted to our southern states. It endures the dry climate of the semi-arid states, and will produce several cuttings of hay in a season where the weather is favorable. It may be either sown broadcast or



FIG. 107.—Sudan grass is an annual closely related to the sorghum group. This photograph was taken at Hays, in western Kansas. The crop endures a dry climate but in moister regions will make three or four cuttings a year. (U. S. D. A.)

drilled in rows. The latter method is common where seed is to be harvested.

FORAGE CROP MACHINERY

Mowers (Fig. 108), rakes and machines for special crops are used in connection with the harvesting of forage crops. The modern mowing machine is so well known that a description of it is hardly necessary. The improvement of the mower has caused the farmer to lay aside the scythe and cradle. With it forage crops are harvested rapidly.

Hay rakes are of several types. The most common is one which rakes the hay with curved teeth, and the driver of the team or horse dumps the load at a certain place in the field so as to leave the hay in windrows. The dumping is by means of a hand or foot lever. The side delivery hay rake (Fig. 109) requires no dumping,



FIG. 108.—A crop of mixed timothy and clover. A popular mixture in the red clover belt. (I. H. Co.)

but the hay is pushed to one side by a series of rakes on a revolving cylinder. By this method the hay is wadded and twisted more than by the other method. The sweep hay rake is used in the full handling of cured hay. It slides along the ground or is run on



FIG. 109.—The side delivery hay rake rolls the hay into a wind row at one side. (I. H. Co.)

very low trunnion wheels. If a horse is hitched to each end, each travels at his own side of a windrow. The sweep takes up a large part of the windrow and carries it to the central stack. One form of this rake allows the horses to walk behind it and push it along.

There are *large hoisting machines* which are well adapted for

use in stacking hay in the open field. These are used in the drier regions of the middle west, or in the irrigated regions. *Hay loaders* (Fig. 110) are of several types. The most common form of these



FIG. 110.—The hay loader saves the work of two men. (I. H. Co.)

raises the hay from the swath and delivers it at the back of the wagon at the rear of which the machine is drawn. One man, with



FIG. 111.—Baling straw with engine-driven press. Note the self-feeding arm above. (I. H. Co.)

a team which requires little care in driving, may place the hay on the wagon without assistance.

Hay balers (Fig. 111) are far more common since hay is sold in the cities so abundantly. A large proportion of the timothy

and alfalfa crops in America is pressed into bales before packing. Portable balers are used on thousands of farms. They may be operated either by engines or by horse power. In the latter case, a sweep is used, the horse or team being driven in a circle. The hay is fed into the machine either by hand tools or by an automatic arm on the machine. As each bale is pressed, it is tied with two or more wires running lengthwise around the bale. Three standard sizes of bales are found. The cross sections in inches are 14 x 18, 16 x 18 and 17 x 22. The lengths of the bales may be varied during the baling process, but commonly vary from 38 to 42 inches.

Hay forks of several types are used in handling loads of hay. The double harpoon fork, the single harpoon fork, the grapple hay fork, and the derrick hay fork are all found in different sections where hay is being made. A wagon hay sling is a stretcher of ropes and poles. This spreads over the back of the hay wagon and allows for the handling of a large amount of hay at once. Three or four slings are enough for one wagon load.

The feeding values of some of the leading forage crops are given in the following table. The table also shows fertilizer ingredients contained in these crops:

Name of feed	Dry matter in 100 lbs.	Digestible parts in 100 lbs.		Fertility in 1000 lbs.		
		Protein	Carbohydrates (+fat ×2.25)	Nitrogen (N)	Phosphoric acid (P ₂ O ₅)	Potash (K ₂ O)
Brome grass, smooth	85.7	6.6	47.9
Bermuda grass	92.9	6.4	48.5	17.1
Corn ensilage	26.4	1.4	15.7	4.3	1.1	3.7
Corn fodder, green	20.7	1.0	12.8	2.9	1.1	3.9
Kafir corn	48.0	1.1	24.8
Kentucky blue grass, hay	86.0	4.4	41.8	12.5	4.0	15.7
Kentucky blue grass, green	34.9	2.8	21.5	6.6
Meadow fescue	80.0	4.2	40.3	11.2	4.0	21.0
Millet, barnyard	86.0	5.2	40.4	16.9	4.3	28.8
Oat straw	90.8	1.3	41.3	5.8	3.0	17.7
Orchard grass	90.1	4.9	45.6	12.9	3.7	16.9
Prairie hay	90.8	3.0	46.5	9.9
Red top, hay	91.1	4.8	49.1	12.6	3.6	10.2
Sorghum	58.3	1.3	29.6
Timothy, green	38.4	1.5	21.2	5.0	2.6	7.6
Timothy, hay	86.8	2.8	45.3	9.4	3.3	14.2

FIELD AND LABORATORY EXERCISES

Pasture Plants.—Examine several pastures of the vicinity, and make a list of the legumes, grasses, or other pasture crops grown therein.

Improving Pastures.—Consult the managers or owners and determine what treatment, such as liming, manuring, harrowing, subsoiling, or re-seeding have been done to make the pastures more permanent. What indications do you find of any of these operations? Do any of them show beneficial results?

3. **Pasturing Fields.**—Study the management of temporary pastures where stock are moved from field to field during the summer season. Make a chart of a farm using a rotation of temporary pastures. Indicate the crop that is or should be grown in each field. Give approximate dates for pasturing each field.

4. **Study the soiling system** on some farm where it is systematically practiced. Make a list of soiling crops that are or should be grown for each part of the season. Give the order in which these crops are to be harvested for feeding.

5. Describe the owner's management of the barnyard manure under the soiling system, stating to what fields the manure is taken at different times.

6. **Make collections of forage grasses**, including heads, stalks, and leaves of all you can obtain. The smaller grasses may be pressed and mounted as botany specimens, and the larger ones may be neatly tied in bundles and hung in a convenient place for study. Label each plainly.

QUESTIONS

1. Define the terms forage crops, soiling crops, ensilage, stover and fodder.
2. Give kinds of places where permanent pastures are most commonly found.
3. Explain the soiling system with reference to dairy farms. What crops are grown for dairy soiling?
4. Compare the advantages of certain grasses useful for hay.
5. What pasture crops or pasture mixtures are grown in your section?
6. Why is timothy so highly prized as a hay crop?
7. Discuss the value of blue-grass for pastures.
8. Give the adaptations for redbud; for orchard grass.
9. Where is smooth brome grass most grown? Compare it with timothy.
10. Where is Bermuda grass grown and what are the arguments in its favor?
11. Discuss the millets as hay plants.

References.—United States Farmers' Bulletins: 101, Millets; 164, Rape as a Forage Crop; 246, Saccharine Sorghums for Forage; 271, Forage Crop Practices in Western Oregon and Western Washington; 292, The Cost of Filling Silos; 312, A Successful Southern Hay Farm; 361, Meadow Fescue: Its Culture and Uses; 382, The Adulteration of Forage-plant Seed; 402, Canada Blue-grass: Its Culture and Uses; 431, The Peanut; 458, The Best Two Sweet Sorghums for Forage; 477, Sorghum-airup Manufacture; 494, Lawns and Lawn Soils; 502, Timothy Production on Irrigated Lands; 508, Market Hay; 509, Forage Crops for the Cotton Region; 515, Vetches; 605, Sudan Grass; 677, Growing Hay in the South for Market; 726, Natal Grass—A Southern Perennial Hay Crop;

Cornell Bulletin 313, The Production of New and Improved Varieties of Timothy. Vt. Bul. 94. Vermont Grasses and Clovers, Farm Grasses of the United States, Spillman, Orange Judd Co., N. Y. Grasses and How to Grow Them, Shaw, Webb Pub. Co., St. Paul. A Text Book of Grasses, Hitchcock, Macmillan Co., N. Y.

CHAPTER XIII

LEGUMINOUS CROPS

THE legume family of plants is sometimes called the clover family, as it includes all the clovers. Here are also found the soy bean, cow pea, all true beans, field and garden peas, vetches, lupine, serrodella, the locust tree and many other valuable plants. Several of these are considered in the present chapter. The plants of this family all have divided leaves of one form or another. The flowers are irregular in shape with five sepals and five petals. The seeds are borne in one-celled pods, and the products, whether seeds or forage, are always rich in protein, which is one-sixth nitrogen, hence any feeds made from these crops are especially valuable for dairy stock and for growing animals of all kinds.

The members of this family have the characteristic power of obtaining nitrogen from the atmosphere when they are supplied with their own special bacteria. No other families of plants have this power. It is for this reason that it is important to provide the proper bacteria in the field where legumes are growing. Of course in many cases these bacteria are found naturally. The great value of legumes for use in upbuilding the soils and providing nitrogen for all other crops is appreciated by farmers in all regions where the soils are deficient in nitrogen. Members of the legume family, if supplied with the nitrogen-gathering bacteria, will not only secure their supply of nitrogen from the air, but will also leave a supply for use of succeeding crops of other kinds. This supply is left chiefly in the roots, stubble, stems and leaves of the leguminous crop. The decay of these tissues soon liberates nitrogen for corn, potatoes, wheat or other crops growing in that field.

CLOVERS.—The true clovers most used for forage are: Red clover, alsike clover and white clover. The latter is used only in pastures. Crimson clover is used as a winter cover crop and is frequently cut for hay in early spring or may be grown as a summer annual and cut for hay.

Red Clover (Fig. 112) is far the most popular clover grown in the United States. It is well suited to humid climates and is grown throughout the eastern states and on the western coast. The seed is commonly sown in early spring, using about fourteen quarts

to the acre, in fields of grain, which may be started either at the same time or the preceding fall. It is a very common practice to grow the crop with timothy or other grasses. The length of life of the common red clover is about two years. When grown with



FIG. 112.—Young plant of red clover, showing nodules (tubercles) on the roots. These contain the bacteria which enable the plant to take its nitrogen from soil air. (Fights of the Farmer.)

grain it produces only a few blossom heads the first fall and may be used as timothy pasture if the soil is good. The next season a crop of hay is cut in early summer and a second crop is usually produced and may be used for pasture or for hay.

When seed is to be saved, the second crop is used (Fig. 113). If this be the intention of the owner the first cutting should be made very early, before the blossoms begin to turn brown. This will give more time for the second growth to mature a crop of seed and will save more of the vitality of the plants for the second crop. The plant is pollinized through the work of bumble-bees or Italian honey-bees having very long tongues. As bumble-bees are not so active in the spring, little seed can be obtained from the early growth.

In districts where red clover is commonly grown and used for hay, the manure will spread the inoculation to all fields of the farm and no artificial inoculation will be necessary. In regions where clover is seldom grown inoculation may be necessary to secure a good stand. It is often beneficial to use some lime on the soil at the time clover is started. The frequent use of clover in the farm rotation will usually insure good soil. Clover hay does not bring

as good prices in the market as timothy hay, although it is more nutritious. There is more danger of its being spoiled by bad management, and horse owners are fearful of injurious results when it is used by careless feeders. Under such unfavorable conditions it is believed to aggravate the trouble known as heaves in horses. When clover is mixed with timothy in the field the clover will nearly all disappear by the second cutting season and nearly pure timothy hay may be obtained that year.

The clover root-borer is one of its worst enemies and the death of the plants the second summer may often be attributed to this enemy.

Mammoth Clover.—A variety of red clover known as mammoth or "sapling" clover is much taller than the common variety and



FIG. 113.—Hulling red clover seed. The second crop is used for seed because the bumblebees that carry the pollen for seed-production are more abundant during the last half of the summer.

produces larger yields on soil that is not so fertile. For this reason it is grown where the common variety produces a light crop.

White clover (*Trifolium repens*) is commonly used in pastures and lawns (Fig. 114). It is a low, creeping perennial which is very hardy, even in the extreme north. It has a shallower root system than any of the other clovers. It usually thrives without special inoculation, but is much more thrifty when on soils well supplied with lime. Forage produced by this plant is fine and palatable, but the yield per acre is very light. It is not used for hay alone, and even in pastures it is usually mixed with bluegrass, Bermuda grass and other pasture crops. After the plant

has reached the blossoming and seeding stage, it tends to cause horses pasturing upon it to slobber severely. For this reason it is considered objectionable in pastures intended for horses.

The plant readily spreads by seed, and by runners, helping to make a very dense covering of the soil.

Alsike clover is midway in size of stems, leaves and blossom heads between common red clover and the low white clover. It was once thought to have been produced by a crossing of these two clovers. It is more successful than red clover on poor soils, on very dry soils, or very wet soils. Because of its ability to grow on acid soils it is not so much improved by the use of lime as red clover. Because of the fineness of the stems the hay is of good



FIG. 114.—White clover (*Trifolium repens*) when not pastured becomes tall enough to mow for hay, but the yield is light.

quality but the yield is small and in many sections only one cutting a year is made. Its fineness of stem makes it easy to cure and the hay is improved partly for this reason. The plant is sometimes spoken of as an annual because it will produce a cutting of hay the year after it is started, if seeded with other grasses or grain in early spring. But under favorable conditions it will live from three to five years, because the roots are less subject to attacks of clover root-borers. The seed is slightly smaller than that of red clover and is sowed at the rate of four to six pounds per acre when mixed with timothy. A crop of seed is easily obtained in the northeastern states. Pollenizing is done by the work of common honey-bees and much honey is secured by them from alsike clover.

Crimson clover (Fig. 115) is an annual usually used as a winter cover crop. The heads are long and usually of a bright crimson or scarlet color, but there is a variety with white blossoms. In the southern states and as far north as Ohio the crop is usually sown in summer or very early fall. The growth produced during the fall season makes a green cover over the soil throughout the winter. This may be used for grazing purposes when the soil is not too muddy. In early spring the growth becomes more rapid and the flower stems shoot up quickly. It may then be cut for hay or may be turned under as a green manure for improvement of the soil.

The hay crop is best suited for dairy cattle and for sheep, as the plant is very fuzzy and should not be used to any great extent for horses.



FIG. 115.—Crimson clover was a new thing in this community and all are pleased with it. (E. Thomas.)

The crop is often sown with a mixture of winter vetch and winter grain, or with either of these separately. These mixtures make a more dense growth on the soil during the winter and more green manure is produced to turn under in the spring. The mixture may also be cut for hay if desired. The presence of the grain makes the hay coarser and not so rich in protein.

The seed of crimson clover has been produced chiefly in Europe. American farmers are also beginning to produce it. The heads are sometimes stripped with simple home-made devices corresponding to wooden combs and are caught in a carrier behind the comb. They are then cured and the seed thrashed out by the use of hulling machines. The rifle seed heads are sometimes cut with a common mower to which a carrier is attached. As the carrier

is filled it is dumped, leaving the heads in piles to be hauled to the barn. Improved methods of seed harvesting will tend to reduce the cost, and will greatly encourage the more extensive growth of this valuable winter cover.

ALFALFA (Fig. 116) is closely related to the clovers, but is not considered a true clover, belonging to a different genus. Although this plant has only recently come into general use in the United States, it is one of the oldest hay plants of the world. George Washington tried it on his farm at Mount Vernon. It usually produces more hay in a year than other forage crops used for this purpose. The plant is a perennial and will live for many years under favorable conditions. It may be crowded out by weeds after a few years, and should then be plowed under. In the eastern states the seeding is usually done in August (Fig. 117), but in the West it is more commonly seeded in spring, and may be grown either with or without a nurse crop to start it. The nurse crop used is small grain.



FIG. 116.—The crown root system, and nodules of alfalfa plant. The long tap root may extend to a depth of many feet. (U. S. D. A.)

Alfalfa usually requires special inoculation for the soil, except in fields where it has recently been grown before. In the middle west this is not always found to be necessary, probably because there are enough wild legumes that use a similar kind of bacteria. The easiest method of inoculating the soil is to spread some bacteria-laden soil on the field after it is prepared for seeding. The new soil is taken from a field where alfalfa has recently been grown successfully. It should be harrowed in before the sun shines upon it enough to kill the bacteria.

Lime is more helpful to alfalfa than to any other crop. If the soil is not of limestone origin it will pay to make heavy applications of lime before growing the crop. Use at least one ton of pulverized limestone per acre or half that amount of burned lime.

In the northeastern and southern states there is much danger from weeds in the alfalfa field (Figs. 118 and 119). A smother crop, such as oats and peas, planted in early spring may be grown



FIG. 117.—Early rather than late fall sowing of alfalfa is best as here shown. The large plant is from August sowing, the others from September and October sowings respectively. (Productive Farm Crops.)

for hay and removed before midsummer. The soil is then immediately plowed and prepared for seeding and is kept in bare fallow until the middle of August when the crop is seeded. During the interval the field should be harrowed several times.

The amount of seed per acre varies in different sections. Twenty to thirty pounds is recommended in the extreme East and Southeast. Farther west farmers use ten to twenty pounds.

Much care must be exercised in having the seed perfectly clean and free from weed seed.

Alfalfa is not a good crop to fight weeds. One of the most common causes of failure with this crop is that the field becomes infested with weeds within a few years after planting. For this reason, it is probably more important to have pure seed than with almost any other farm crop. The seed should be secured from regions where the fields are as free from weeds as possible, and before planting the seed should be run through a fanning mill cleaner and thus freed from many of its impurities.



FIG. 118.—The seeds of dodder (shown above) are smaller than the seeds of alfalfa, and may be separated by properly sifting them. (Productive Farm Crops.)

There are several varieties or strains of alfalfa. The Grimm is the hardiest variety and the best for northern regions. Other strains are not so well established. Some of these are of trailing habit, and thus better suited to pasture than the more upright forms. The alfalfas also vary in their root systems from the long deep tap roots to the spreading roots. Some have a jointed root-stalk which sets up growth from the nodes or joints. Most of these forms are not well distinguished, and the seed of distinct varieties is difficult to obtain. Dealers handle seed from Turkestan under that name. The Grimm variety is also found in the market. Most of the seed sown in America is of the so-called

“common” type, and is grown in the arid and semi-arid climates of the middle west and extreme west. Usually the seed is thrashed each season from the second growth.

Alfalfa should be cut frequently (Figs. 120, 121 and 122). The plant thrives better under this treatment. A common cause



FIG. 119.—Dodder is a parasite weed which attacks alfalfa, clover, and many other plants. (Productive Farm Crops.)

of loss on the crop arises from failure to cut it soon enough. In some irrigated regions of California and other warm climates it may be cut five times a year or oftener. As far north as New Jersey it should be cut four times a year. Where it is grown farther north it will produce at least three cuttings a year. When the plants are beginning to show their purple blossoms the crop should be cut. At about this stage of maturity the plants begin to send up new shoots from the buds at the crown. Cuttings should take place before these shoots have grown more than an inch, if possible. If the new shoots grow enough to be cut by the machine when the old stems are mowed the future growth is likely to be ruined.

Alfalfa hay is difficult to cure in moist climates early in the season. Under such circumstances it may be advisable to use hay caps over the shocks in the field during the curing process.

At other seasons and in drier regions this is usually unnecessary. The hay should be handled carefully to avoid breaking off the heads (Fig. 123). It should not be allowed to dry as much as clover or timothy before it is hauled to the stack or hay mow. If some natural moisture is still in the hay the leaves will not shatter off as much and better hay will be produced.



FIG. 120.—The first cutting of alfalfa is the most difficult to cure and may be hauled in the green condition to the barn for feeding immediately; or it may be put in a silo.



FIG. 121.—Alfalfa in Virginia, first cutting 6,390 pounds cured hay per acre, second cutting 1,466 pounds. Two other cuttings to follow in the same season. (U. S. D. A.)



FIG. 122.—Making the fourth cutting of alfalfa, the five acres averaged five and one-half tons per acre for the season. (U. S. D. A.)

Hay caps (Fig. 124) can be made of heavy muslin or of light duck about 3 x 4 feet or a little larger. Common eightpenny nails, each with two bends in it, are run through each corner and when the cap is in place each nail is hooked to a wisp of hay drawn by



FIG. 123.—Stacking alfalfa in South Carolina. The hay is brought to the stack with rakes called "go-devils," and is then stacked with the crane stacker. (I. H. Co.)

the finger from the under part of the hay shock. Hay caps provided with such light fasteners are easily handled in the field without a wagon. Enough for several acres may be carried by men or on the back of a horse.



FIG. 124.—It pays to use hay caps in a moist climate if the price of hay is high. (Courtesy R. P. Lambert, Alabama.)

THE COW PEA is a comparatively new plant in American agriculture, having been introduced from Southern China. It is now extensively grown in the central and southern latitudes of this country (Fig. 125). It is the most important legume for the states south of the red clover area. But its area is being rapidly

extended because of its many uses. It is a summer annual and can be profitably grown for forage and for green manure wherever the summers are warm. It will mature seed best in the warmer climates. The uneven ripening of the seed makes its harvest very difficult.

The plant resembles the true bean. Its leaves are large, smooth, and divided into three large leaflets. The pods are long and slender, containing many seeds which are of several colors among the different varieties. Some seed is brown or clay-colored, as in varieties called "Clay" and "Iron." Some have reddish seed, some black and some nearly white. "Blackeye" has white seed with black spot at the scar.



FIG. 125.—Cow peas grown in a peach orchard to gather nitrogen from the air and supply it to the young trees. (Fights of the Farmer.)

The varieties differ widely in their habit of growth, time required for maturity and yields of hay and seed. New Era is low, erect, and matures in about six or eight weeks after germination, but the yield is light. Whippoorwill, Clay and Unknown are varieties with vigorous, somewhat upright growth, well suited for hay or for soiling.

The cow pea does well on any soil but prefers a rich loam. It is one of the best legumes for soil improvement, when used as green manure or even when only the stubble and roots are used for that purpose.

Seeding is done after the weather is warm—about corn-planting time or later. When drilled in rows for cultivation about three pecks of seed per acre is used when a grain drill is used, or when sown broadcast, five to eight pecks are required. The seed should be well covered to a depth of one-half to two inches.

The crop may be cut for hay as soon as one-third of the pods have turned brown. It is usually cut with a mower, partly cured in the swath, and then raked and piled to complete the curing process before stacking.

Cow peas are often planted with corn or are drilled between the rows of cultivated crops in midsummer. They may be broadcast with sorghum, millet, kafir, and other crops for forage. They will improve the quality and yield of feed and will gather nitrogen for the soil.

THE SOY BEAN (Fig. 126) is also of Asiatic origin, and is a hot weather crop. In appearance it differs from the cow pea in having very short pods with usually only two or three seeds. The plant is densely hairy throughout. It is less used for forage partly for this reason, and partly because the leaves drop off badly before the seed is ripe. The seed is chiefly of three colors, black, yellow and green. Varieties are distinguished chiefly in this way.

In addition to its use for forage and for the improvement of soils it is coming to be grown more for the seed, which ripens more uniformly than in the cow pea. The entire seed may be ground and used for stock feed or the oil may be pressed out and used as salad oil and for numerous other purposes. The oil cake is used as stock feed.

THE CANADA FIELD PEA resembles the common garden pea and is well suited to growth in cool sections in the extreme North, as well as in the South. It is a climbing plant and should be grown with grain to aid in harvesting the crop. In northern latitudes it may be planted with early spring grain, as with oats and barley intended for stock feed. In southern latitudes it may be grown with winter oats and will endure the mild winter.

Such a mixed crop, if cut for hay when in the blossom stage, compares favorably with red clover hay in dairy feeding. If the seed is allowed to mature the grain and peas may be thrashed together. The mixture may be separated if desired, but is usually ground together for use in feeding swine, sheep, dairy cows and poultry. The straw is much relished by stock.

As pasture during the green growing stage, this mixture is

very valuable for swine, sheep and cattle. The stock should not be allowed to pasture upon the crop until the peas have made a good growth.



FIG. 126.—The soy bean plant retains its pods and seeds until all are mature. The cow pea plant often allows many seeds to shell before the last ones are ripe. (Productive Farm Crops.)

The use of Canada field peas as a soil improver is becoming more common. An early spring growth may be produced and the green manure turned under in time for late crops of other kinds

JAPAN CLOVER, or *Lespedeza*, is grown throughout the southern states from Texas eastward. It is said to have been extensively introduced as packing material from Japan. The leaves and blossoms are finer than alfalfa and the growth is seldom over twelve inches high, except on very rich soil. Throughout its district it



FIG. 127.—Vetch plants are vine-like and should be grown with oats or other crops which will support them. (Productive Farm Crops.)

runs wild and is of great benefit to permanent pastures. It is seldom cut for hay because of the light yield, but when cropped frequently by stock the growth is rapid and the yield per acre is much larger. Although it is classed as an annual plant, it reseeds itself and spreads rapidly. It is helpful to the soil, but is not much used as a green manure because of the light growth.

VETCHES are of several kinds (Fig. 127). Two of these are commonly cultivated in America: (1) The hairy or winter vetch (*Vicia villosa*) is a winter annual, much used as a winter cover crop south of the northern tier of states. (2) Spring vetch or summer vetch (*Vicia sariva*) is a much coarser plant and is not hairy. It is grown as an early spring or cool weather plant, but does not endure severe freezing.

Hairy vetch is abundantly used when mixed with winter grain, or crimson clover, as a winter cover crop in orchards, gardens and fields. In the spring it may be cut for hay or for soiling, or the crop may be turned under as green manure.

Spring vetch is very useful for hay and soiling purposes, and is usually grown with grain to support the viney growth.

The seed of the different vetches should not be confused or mixed, because one plant is hardy and the other is not. Hairy vetch has smaller seeds, which are black or nearly so. Seeds of spring vetch are larger, brownish in color, and more nearly kidney shape than the others. Its pods are longer and more slender than those of hairy vetch and the plant is smooth throughout.

THE VELVET BEAN is grown in Florida and other gulf states. During warm summer weather it will produce a vigorous growth in latitudes much farther north if plenty of water is supplied. It will mature seed only in or near the gulf states. The stems are vine-like and may grow to a length of twenty or thirty feet in a season. Much forage is produced, but it is difficult to cure. The plant is valuable for green manure when worked into the soil by the use of a disk harrow. The seeds and pods are ground into meal for stock.

MISCELLANEOUS LEGUMES.—Sweet clovers are of two kinds, the white (Fig. 128) being much more common than the yellow. They are perennial plants with stems and leaves resembling alfalfa, but the growth is usually much more rank. Chiefly by natural means the sweet clovers have become widely distributed throughout the East and South. Their principal use is for the improvement of soils, but when stock acquire a liking for them they are also valuable as forage. The feeding value is equal to that of alfalfa, but the taste is bitter and is at first disliked by most farm animals. Sweet clovers are sometimes grown by beekeepers because of the abundance of honey produced.

Bur clovers belong to the same genus as alfalfa, *Medicago*. There are two common species, the spotted medic and the tooth

medic. The latter is grown somewhat in California and in the South, but spotted medic is much more common in the southern states. It is sown on farm pastures in the fall and will produce a fresh growth after Bermuda grass dies to the ground. If the winter is not severe the bur clover will survive and produce good



FIG. 128.—The tall sweet clover of the white variety is often grown for forage. (Productive Farm Crops.)

pasture in fall, winter and early spring. If it is not pastured too closely it will reseed itself and furnish an annual winter pasture. The bur clovers are valuable for winter cover crops in cultivated fields, and when used as green manure are beneficial to the soil.

The Peanut (Fig. 129).—The names “goober” and “goober pea” are given to those forms of the peanut which have no true stem and only one pea in each pod. This form grows wild, and is cultivated somewhat in the gulf states. Although the peanut is really a seed, the word “nut” is applied to it because of its flavor. The large Spanish peanut is chiefly grown for those purposes with which we are most familiar.

The peanuts are grown for forage as well as for seed. The plant produces many leafy stems and makes good hay. The crop is grown commercially in the South Atlantic States and inland to Tennessee, Missouri and Kansas, southward and westward to Texas and California. The small yellow flowers are borne in the angles of the leaves and branches. After they pollinate and the



FIG. 129.—Two types of peanuts. Large Virginia type, at left; small Spanish type, at right. (U. S. D. A. in Productive Farm Crops.)

petals have fallen, the slender flower stems grow much longer and enter the soil. The development of the nuts is below the surface of the ground and the soil must be rather loose. (Figs. 13 and 14).

The peanut prefers a light sandy loam. Although it will grow well on heavy soils, the nuts are apt to be discolored and less marketable. The soil should not be sour and lime is always applied with increased returns. The crop endures a rather light rainfall during the growing period.

For the maturity of the crop the season between spring and fall frosts should be from 90 to 125 days. The crop is very tender, even more so than the garden bean. The seeds of the large varieties are hulled before planting, but some growers succeed in starting by merely soaking the hulls instead of shelling them off.

The results are less satisfactory. Small or single seeded varieties are seldom hulled before planting.

The ground should be very mellow and well stirred so as to produce a good seed bed and should be entirely free from weeds at planting time. The distances between rows should be enough to allow of thorough cultivation, which is kept up until the vines spread well over the ground. A good crop to precede planting of any field should be one which is well tilled, or which otherwise keeps the weeds under control. Peanuts are often planted after the harvest of the oat crop in June. Farther north corn or potatoes may have been on the field the preceding year. A systematic rotation should be maintained rather than growing peanuts on the same field continuously. Stable manure should not be applied the same year that peanuts are grown on the field. Commercial fertilizers, if used, should contain all three of the essential elements in the proportion of three of nitrogen, seven phosphoric acid and six of potash. From 200 to 800 pounds of this mixture may be applied to an acre, depending on the natural fertility of the soil. Lime may be applied at the rate of one-fourth to one-half ton per acre.

If peanuts are turned under, they add nitrogen to the soil, as the crop, when accompanied by the bacteria, is a strong gatherer of nitrogen. If the crop is entirely harvested, as by cutting for hay and then allowing hogs to root out the underground parts, the soil will not be improved in its fertility by the growth of the crop.

The crop should be mature before the first fall frosts. The vines may be lifted with special machines, or may be pulled by hand when the soil is loose. They are piled up in slender shocks around rigid posts or poles to cure and after the nuts are removed the fodder is fed to the stock. Care in curing keeps the nuts of a better color, and the price is correspondingly higher. Better forage is also produced by a little pains in curing them. The process is rather slow, as the stems are fleshy.

The removal of the nuts from the vines after curing may be either by hand or by machines. The hand method is still much practiced in some sections, as better results are obtained, but the expense is somewhat greater.

The nuts must be kept thoroughly dry and protected from any dampness to maintain a bright color of the shells. For nuts that are to be sold without shelling, a cleaning process to remove all dirt is required.

Besides for eating out of hand, the peanuts are used for a number of purposes. They are ground and made into peanut butter by the addition of peanut oil or other vegetable oils. In some cases the oil is extracted and is used for a number of purposes. The by-product from the manufacture of oil is ground into peanut-oil-meal and is used for feed for stock.

Other less important leguminous crops grown in limited areas are: Lupines, Florida beggar-weed, serrodella, sainfoin, bird's-foot trefoil, Egyptian clover, horse bean, lotus and kidney vetch.

Digestible Nutrients and Fertilizing Values of Leguminous Crops.—The following table gives the feeding values and fertilizer ingredients of some of the most important leguminous crops:

Name of feed	Dry matter in 100 lbs.	Digestible parts in 100 lbs.		Fertility in 1,000 lbs.		
		Protein	Carbohydrates (+fat ×2.25)	Nitrogen (N)	Phosphoric acid (P ₂ O ₅)	Potash (K ₂ O)
Alfalfa, green	28.2	3.6	13.0	7.7	1.3	5.6
Alfalfa, hay	93.6	11.7	43.1	26.1	6.1	17.9
Alsike (in bloom) green . .	25.2	2.6	12.5	6.2	1.1	2.0
Alsike clover, hay	90.3	8.4	42.2	20.5	5.0	13.9
Canada field pea meal! . . .	89.5	16.8	53.28	32.3	8.2	9.9
Cow peas, green	16.4	1.8	9.1	3.8	1.3	4.6
Cow peas, hay	89.5	5.8	42.2	14.3	5.2	14.7
Crimson clover, hay	90.4	10.5	37.6	24.3	4.0	13.1
Lespedeza (Japan clover)	89.0	9.1	40.9	22.1
Peanuts (dried vines)	92.4	6.7	49.0	17.1	3.2	11.6
Red clover, green	29.2	2.9	16.4	7.0	1.5	4.8
Red clover hay	84.7	7.1	41.8	19.7	5.5	18.7
Soy beans, hay	88.2	10.6	43.6	23.8
Spring vetch, green	15.0	1.9	7.1	4.3	1.0	4.5
Sweet clover, green	20.0	2.5	9.3	6.1	2.4	6.7
Sweet clover, hay	90.8	11.9	37.8	28.8	5.6	18.3
Velvet beans, hay	90.0	9.6	55.7	22.4
Velvet bean meal	89.0	19.7	61.6
White clover, dry weight	90.3	11.5	45.6	25.1	7.8	13.2
Winter vetch, hay	88.7	11.9	44.3	27.2	9.7	24.4

FIELD AND LABORATORY EXERCISES

1. **Clover Roots.**—Dig samples of growing clover plants, getting as much of the root system in each case as possible. Compare the root systems of the different kinds of clover. Also compare the differences in the tap-rooted clovers as they appear in different types of soil. Does a hard subsoil make the roots branch more?

2. **Comparing Clovers for Hay.**—Study the clovers with respect to their leafiness and fineness of stems. Which ones will produce the best qualities of hay? Which ones are objectionable in any respect?

3. **Collection of Legumes.**—Make collections of the different clovers, drying, pressing and mounting as with botany specimens. Label each with scientific and common names.

4. **Make minute study of the flowers of the different clovers and alfalfa.** By what means is each pollinated?

5. **Effect of Lime on Legumes.**—Make plot studies showing the value of lime in growing red clover and alfalfa. An unlimed plot should be compared with a limed plot in each case.

6. **Inoculation of Legumes.**—Make a similar study showing the need, or lack of need, for inoculation. Use several different legumes, as alfalfa, red clover and soy beans. These plot experiments may be either on the school grounds, on a neighboring farm, or at the homes of pupils.

7. **Artificial bacteria culture for alfalfa or some other legume** should be obtained from the U. S. Department of Agriculture, and used according to directions to inoculate the seed, or the soil, or both.

8. **Soy Beans Compared with Cow Peas.**—Compare samples of soy bean plants with cow pea plants. Note the differences in smoothness of leaves, stems and pods. Which is more leafy? Which has the greater number of seeds to the pod? Which develops its pods more uniformly? Which holds its leaves longer? From which would it be easier to harvest a crop of seeds of uniform ripeness? Which is probably the better crop for hay?

9. **Canada Peas and Garden Peas.**—Compare plants of Canada field peas with the common garden peas. Note the differences.

10. **Japan Clover and Alfalfa.**—Compare plants of Japan clover with alfalfa and with tall sweet clover. Note the similarity in leaves, and the differences in the size, height and woodiness of stems. Compare the flowers and seed cases.

11. **Varieties of Vetch.**—Compare samples of different varieties of vetch. Which ones are hairy? Which has the largest seeds? Which would probably produce the largest yields of hay?

12. **Peanut Plants.**—Obtain samples of peanut plants in different stages of growth. Note elongation of the flower stem just after pollination. At what stage should the soil be left loose for the covering of the nuts? Examine some of the underground parts a few days after the nuts are formed.

13. **Roots of Legumes.**—Make a large collection of the roots of legumes, both wild and cultivated. If possible, see how many of these bear nodules for bacteria on their roots.

QUESTIONS

1. Give the characteristics of the members of the legume family.
2. By what other names is this family known?
3. Tell of the difficulties in growing red clover and how to overcome them.
4. Compare alsike clover with red clover as a hay crop.
5. Discuss creeping white clover as a pasture crop.
6. Under what conditions would you use hay caps in curing alfalfa or clover?
7. What are the special uses for which crimson clover is adapted?
8. What is the best season for the sowing of alfalfa? How does this agree with the practice in your section?
9. What is the importance of liming before sowing alfalfa?
10. How may the soil for alfalfa be inoculated?
11. Discuss the importance of cutting the alfalfa crop frequently.
12. What are the signs indicating when alfalfa should be cut?

13. Give the special uses and advantages of cow peas?
14. Compare soy beans and cow peas as hay producers. As grain producers.
15. What is the practice in growing Canada field peas as regards season, mixtures, harvesting and use?
16. Discuss Japan clover as a pasture plant.
17. Give the differences between the different kinds of vetch.
18. Tell what you can of the velvet bean.
19. What two main types of peanut are grown in America?
20. Why should the soil be free from iron or other coloring matter in growing market peanuts?
21. Enumerate the products obtained from the peanut crop.

References.—United States Farmers' Bulletins: 194, Alfalfa Seed; 224, Canadian Field Peas; 278, Leguminous Crops for Green Manuring; 289, Beans; 318, Cow Peas; 323, Clover Farming on Sandy Jack-pine Lands of the North; 339, Alfalfa; 372, Soy Beans; 373, Irrigation of Alfalfa; 431, The Peanut; 441, Lespedeza, or Japan Clover; 455, Red Clover, 485; Sweet Clover; 495, Alfalfa Seed Production; 515, Vetches; 529, Vetch Growing in the South Atlantic States; 550, 570, and 646, Crimson Clover; 561, Bean Growing in Eastern Washington and Oregon, and Northern Idaho; 676, Hard Clover Seed and Treatment in Hulling; 690, Field Pea; 693, Bur Clover; 730, Button Clover.

Cornell Bulletin 260, American Varieties of Beans. Cornell Circular 15, Legume Inoculation. Alfalfa, Test of Varieties, Nevada Bul. 72. Alfalfa, Test of Varieties, S. Dakota Rep. 1910. The Soy Bean, R. I. Exp. Sta. Bul. 92. Alfalfa, Coburn, Orange Judd Co., N. Y. Alfalfa Farming in America, King, Sanders Pub. Co., Chicago.

CHAPTER XIV

CORN

But let the good old corn adorn
The hills our fathers trod;
Still let us, for his golden corn,
Send up our thanks to God.

WHITTIER.—The Corn Song.

ALTHOUGH corn is a grass it does not have a hollow stem, and the inflorescence is quite unlike other grasses.

The new world is the home of the corn plant, and the United States is the greatest corn country of the world, producing more than all other countries combined. Argentine Republic stands second in corn production, where the yield is about one-sixteenth as great as that of the United States. Over two and one-half billion bushels are grown in the United States annually. It is the leading crop of the country in money value and exceeds all other crops, except potatoes, in tonnage. The grain is chiefly used for stock feed and in the production of meal for human food. For stock it is also used as roughage in the form of green feed, dry fodder, stover and silage. The grain is also used as human food in the form of corn flakes and other breakfast dishes. It is eaten as green corn and certain types are used for canning and popping. Starch, corn syrup and corn oil are now extensively manufactured from the grain. The syrup is a wholesome substitute for cane syrup. The oil when refined is used in cooking and as a salad oil. A number of stock feeds are produced as by-products from factories where corn is used. Gluten meal is perhaps the leading by-product. It is a rich stock feed obtained from corn starch factories. Husks and cobs are also useful by-products.

Figure 130 shows at a glance the distribution of the corn crop in the United States. The area where corn is intensively grown is gradually moving northward. Great attention has recently been given to the improvement of corn through the work of corn contests and boys' corn clubs (Fig. 131) throughout the corn growing states. This has increased and doubtless will continue to increase the average yield of corn in many sections.

Classes of Corn.—There are six main types or classes of corn shown in figure 132. In order of importance the four main

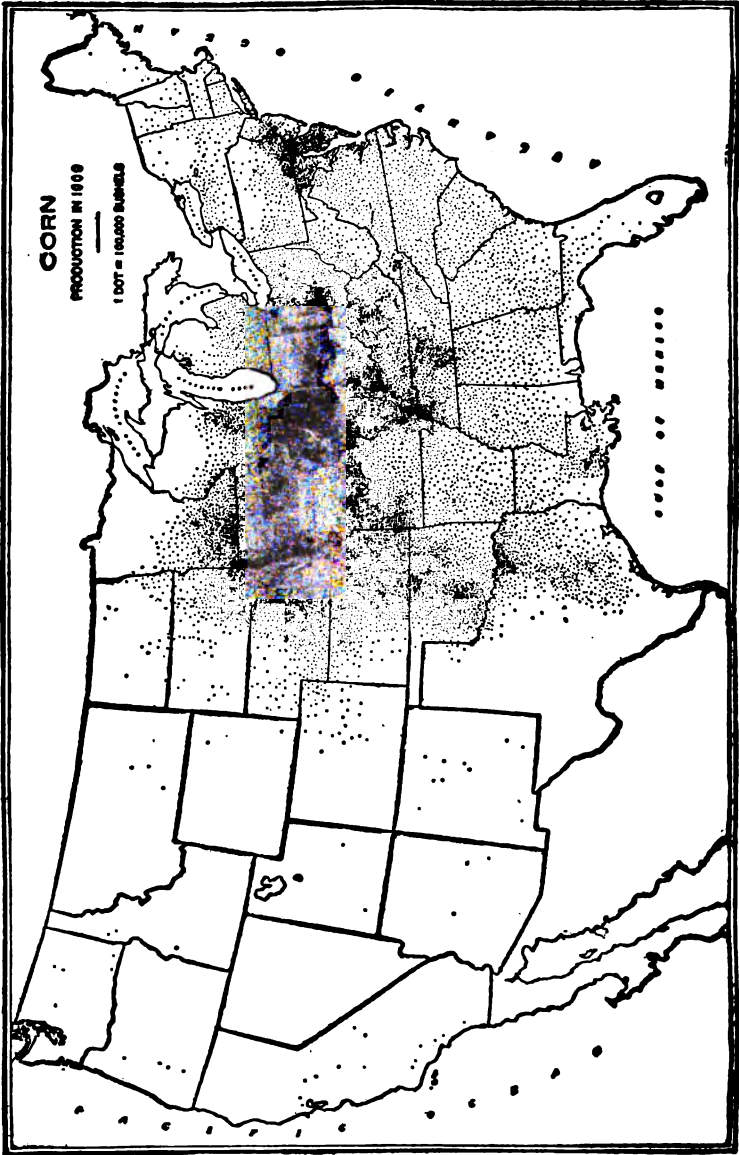

FIG. 130.—Map of corn distribution 1909 (U. S. Census). (Productive Farm Crops.)

commercial types may be named as dent corn, flint corn, sweet corn, and pop corn. In the botanical sense there are two other types, pod corn and soft or flour corn, but these have no particular value in agriculture and commerce.

Most of the field corn grown is dent corn. The crown of the kernels is usually dented in because the hard or flinty portion of the kernel is on the sides only. The crown is much softer than in flint and pop corn. The yield in pounds or bushels per acre is greater than with other types of corn. The corn plants of the dent varieties do not sucker so much as the flint varieties. The length of season required for maturing the crop is greater for dent corn, but short season varieties are being developed.



FIG. 131.—One hundred sixty-seven bushels of Boone County white corn raised by this young man on one acre in Virginia. Note the large proportion of very good ears. (U. S. D. A.)

Flint corn is hard on the crown, as well as on the sides of the kernel, and stock do not masticate it so well. The ears are usually very slender and bear a small number of rows of kernels. The crop will mature in a shorter period and is therefore grown farther north than most varieties of dent corn. The fodder of flint corn is valuable because of the great number of leaves and suckers.

Sweet corn has a supply of sugar instead of so much starch. The amount of hard or horny part of the kernel is limited, or wanting. This type is grown chiefly for use as green corn and for canning purposes for human food, but the stalks are valuable for fodder. In soiling systems of feeding some varieties of sweet corn are much used because they mature even earlier than flint corn.

Pop corn is especially valuable as human food when popped.

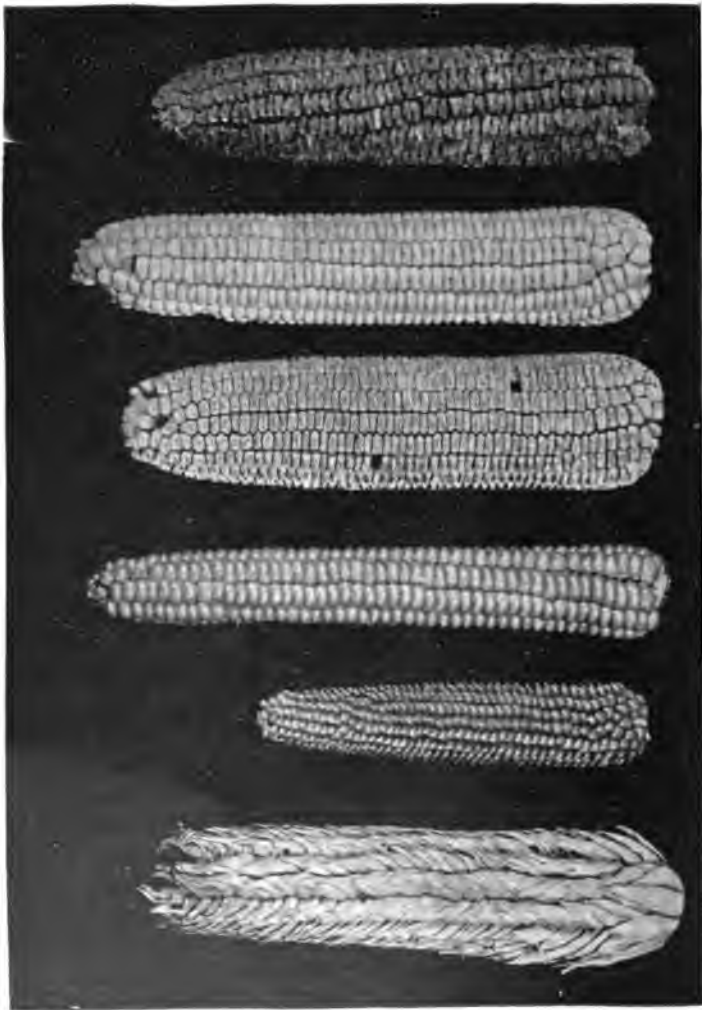

FIG. 132.—The six main types of corn. From left to right, pod corn, flint corn, dent corn, sweet corn, and flour corn. (Productive Farm Crops, Courtesy Macmillan Pub. Co.)

Its ability to turn inside out when subjected to great heat is due to the presence of volatile oil contained in the kernels.

Varieties.—A corn grower in any section should make a careful study of the varieties grown there successfully. This will enable him to determine which variety will produce the greatest yield, the largest proportion of corn on the cob and the best seed for future crops. It is not essential that variety or strain selected should have a special name.

It is usually not profitable to introduce new varieties from a distance, but if this seems necessary, because there is no good strain nearby, the new seed should be grown for a few years in a seed plot under careful selection before it is used as the main field crop. The best of it may be found to adapt itself to the local soil and climate.

The composition of the different types of corn and their products is given in the table with other grains for the sake of easy comparison (see chapter on Small Grains).

Preparation of Soil.—In the extreme northern states the ground to be used for corn should be plowed the preceding fall, particularly if the soil is heavy. Elsewhere, and on light soils, early spring plowing may be practiced. In either case the ground should be harrowed as early as possible and put into fine tilth. The harrowing should be repeated as soon after each heavy rain as it may be done safely. The warm spring air is thus allowed to enter the soil and bacteria action is increased. Weeds will germinate and the next harrowing will destroy the sprouts. If several weeks elapse during this harrowing season the soil will be made so warm as to cause the corn to germinate more readily, and much of the weed seed will be entirely destroyed. This process also conserves much of the soil moisture, allowing it to penetrate a little deeper into the soil instead of evaporating. The crop will suffer from drought much less because of the long and thorough preparation of the soil before planting time. If the rains have been very heavy, and the soil becomes too compact, it is sometimes advisable to disk the soil or stir it with a cultivator just before planting time.

Planting.—A common distance between rows is three feet eight inches, but farther south, or when the growth is unusually large, the distance may be four feet between rows. In the check-row plan three stalks in a hill is very common, but slight variations are found for different varieties and for different purposes.

Corn planters may be operated either by hand, by one animal, or by a two-horse team. Hand planters are very inexpensive. They will plant a single row of corn as quickly as the one-horse planters, but the kernels are left in close bunches and the plants crowd each other while growing.

The horse planters have advantages over hand planters by drilling the seed better, and carrying fertilizer boxes for the distribution of commercial fertilizer. They open their own trenches and also cover the seed.

The two-horse planters plant two rows at a time. They may also be provided with chains by which the corn is planted in rows



FIG. 133.—Riding cultivators with small shovels are much used by corn growers in all sections of the country. (Bateman Mfg. Co.)

both ways like a checker board. This method of planting is called "check rowing." In the greatest corn growing states check-row planters are often used. If the fields be weedy the cross-row system of cultivation gives better results, and less hand work, or none whatever, is required in keeping down the weeds.

Tillage.—Corn is not a tender crop when young. About the only danger in the tillage of the crop is when the plants become covered with soil. The root system has a firm hold on the soil before the plants are large enough to mark the rows. This allows the grower to make free use of the harrow and the weeder through the corn field, regardless of the young corn plants, before weeds can be seen, and the work of sprouting and killing weed

seeds, which was begun before planting, may be continued after each rain until the corn is so high as to be broken by the cross bars of the harrow. Danger may accompany this practice in stony or cloddy fields. The harrowing on a young corn field should be done late enough in the day to allow the surplus moisture to escape from the plants, and they will be bent instead of broken by the harrow.

After the crop is perhaps eight or ten inches high the use of



FIG. 134.—The root-system of corn plants sixty days after the date of planting. The whole field of soil would be permeated with the feeding roots, which should not be destroyed by deep tillage.

cultivators may begin (Fig. 133). Cultivators with small teeth or narrow shovels are usually to be preferred, unless the soil has been allowed to stand after heavy rains without tillage and a dense crust has formed. In such cases heavy shovels are necessary. Corn growers are familiar with the extensive shallow root system of the corn plant (Fig. 134) and realize the great danger resulting from the use of heavy shovels which till the soils very deep. There is less actual labor in using the finer machines more frequently.

An ordinary team can easily cultivate two rows at a time with a light cultivator. If cover crops are to occupy the field after the corn is harvested the field may need to be given extra cultivation once or twice to make a good seed bed for the cover crop. This is usually done after the corn is in tassel.

Machines for cultivating corn are of many kinds. In some sections the old-fashioned two-shovel cultivator is still in use, but better forms are rapidly replacing them. Small-tooth cultivators with about fourteen teeth are becoming popular, as they cultivate an entire middle and are drawn by one animal. The same is true of some of the spring-tooth cultivators. Two-horse machines are



FIG 135.—The corn husker and shredder removes the ears and carries them to the rear where they may be caught in a wagon box. It shreds fodder very fine and blows it into a suitable storage place. Any corn shelled may be caught in bags, as shown. (I. H. Co.)

arranged for cultivating two sides of a row at once, but some cultivate the entire middle and also two sides of the two adjacent rows. Thus two entire rows are cultivated at once.

The chief features to be remembered in choosing a cultivator are that it shall have small shovels or teeth and have a number of them. This makes the draft light; the work is rapid; frequent cultivation is possible; a crust is not allowed to form on the soil, and tillage may therefore be shallow; the roots are not injured, and the growing crop thrives better.

Harvesting.—There are several methods of harvesting the corn crop. In the central corn states the most common practice is to husk the ears from the standing stalks and store them in

cribs. Livestock are then allowed to pick over the fields and eat much of the remaining crop. In more intensive farming the stalks are cut either by hand or by machine when the corn is ripe, or nearly so. It is put in shocks varying in size according to the climate, and well tied so it will not blow over or be seriously injured by the weather. The ears are husked from the shocks and stored in cribs and the stalks are tied in larger shocks or put in stacks for stock roughage during the winter. Figure 135 shows the work being done by machinery.

Corn harvesting machines are very valuable where much corn



FIG. 136.—On a Florida farm at silo-filling time. (Agriculture and Life.)

is grown. The machine ties the stalks in small bundles, which are easily gathered by hand and placed in shocks.

In some southern states it is still a common practice to go through the corn field just before the crop is ripe and pick off the leaves and perhaps out off the top of the stems above the ears. This fine fodder is tied in small bundles and dried for stock feed. Later in the year the ears are either husked in the fields or snapped off and stored in cribs with the husks on. The practice of snapping corn in southern latitudes is due to the attacks of the grain moth. When husks are left on, the damage from this insect is not so great.

When corn is to be used as silage (Fig. 136) it should be cut after the corn is nearly mature. It will then contain the maximum amount of nourishment and will not sour so badly in the silo.

There are several types of corn-harvesting machines. A simple form is to have a sharp blade attached to one side or at two sides of a sled drawn between the rows by one horse. A man on the sled grasps the tops of the corn and draws them over onto the sled as the knives cut them. A single knife on one side of the sled makes it easier for the operator. A different form of this type of harvester has low trunion wheels to make the draft easier.

Corn binders are much more complicated machines (Fig. 137). They cut the corn by means of two blades between which the corn



FIG. 137.—This type of corn harvester cuts the crop, ties it in bundles and throws them to one side. (Productive Farm Crops.)

is forced by traveling chains operated on revolving wheels or pulleys in the machine. When cut, the stalks are carried by chains to the binder itself where they are tied automatically with binder twine. The bundles may be dropped either singly or several in one place. The economic use of a self-binder for corn harvesting depends upon the number of acres of corn grown by the farmer. The expense of the machine makes the investment more doubtful. Joint ownership among neighbors sometimes solves this problem.

Seed Corn.—The grower should go through the field just before the main harvest and select the ears he is to save for seed. This should be dried and stored in a place where mice and rats cannot molest it. See figures 138, 139 and 140.



FIG. 138.—Seed corn ready to hang up. (I. H. Co.)



FIG. 139.—Seed corn may be hung on cards in a dry place to dry out thoroughly. This is to be done before freezing weather begins. (I. H. Co.)



FIG. 140.—Racks for drying corn in a wholesale way are necessary when much corn is grown for seed. Care must be experienced to keep mice out of the room. Plenty of air must circulate about the ears of corn. (U. S. D. A.)



FIG. 141.—Students should have practice in the use of the corn score card, and then become proficient in selecting good seed corn without the score card. (Agriculture and Life.)

CORN JUDGING.—In the selecting of seed corn, attention should be given to the points mentioned in the score card. Practice in judging by the use of the score card will greatly aid any one in becoming proficient in the selection of seed corn at harvest

FIG. 142



FIG. 143



FIG. 142.—Corn judging exercise. Selecting the ears. (I. H. Co.)
 FIG. 143.—Removing the kernels to study their character. (I. H. Co.)

time (Figs. 141, 142 and 143). The main points to consider are yield, variety, characters, vitality, and market condition. The yield should count as much as the other three features combined.

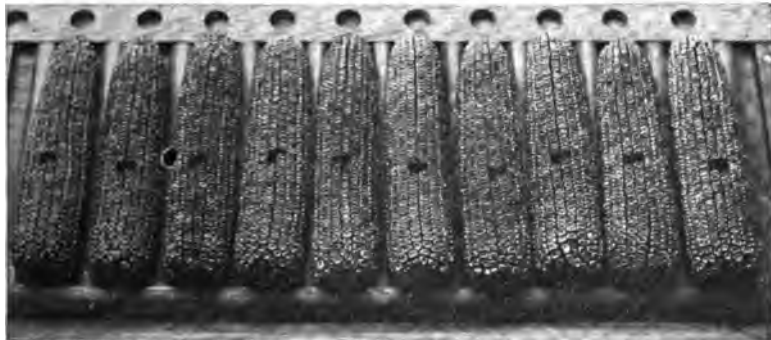

FIG. 144.—A ten-ear sample of prize-winning corn. Variety, Reid's Yellow Dent. (Agriculture and Life.)

Discussion has already been given regarding the improvement of corn, selecting and storing of seed (Chapters II and III).

Rules for Corn Judging and Explanation of Points of Score Card

Cuts.—Where the number of points to be cut is not specified, the scorer must use his best judgment and cut each off ear according to its degree of variance from the standard and the value of the perfect ear.

Disqualifications.—A white cob in yellow corn or a red cob in white corn shall disqualify the exhibit. One or more dead ears shall disqualify the exhibit. One or more ears having 12 or more crossed kernels shall disqualify the exhibit.

1. *Uniformity of Exhibit.* 10 Points.—All the ears in the exhibit should be similar in size, shape, color, indentation size and shape of kernel, and other characteristics (Fig. 144).

2. *Shape of Ears.* 10 Points.—In variety classes the shape of the ear should conform to the variety standard. In general classes the shape of the ear should be cylindrical or nearly so; it should be full and strong in the middle portion, and the circumference should be approximately three-quarters of the length. The rows of kernels should be straight and not less than 16 or more than 22 in number.

3. *Length of Ears.* 10 Points.—In variety classes the length should conform to the variety standard. In general classes the length should be

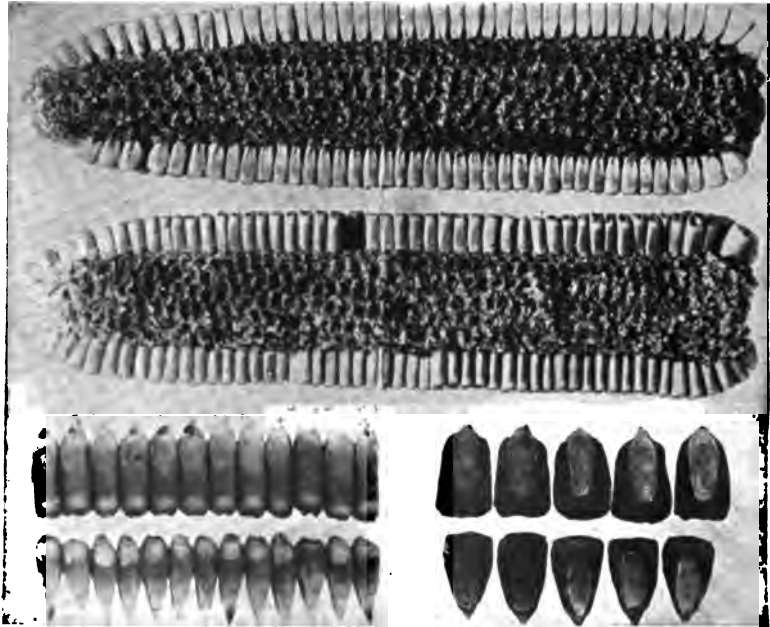

FIG. 145.—Note the poor, shoe-peg kernels at the bottom of the figure, taken from the upper ear. The other kernels allow no vacant space at the cob. These are much better and will score higher in a contest. (Agriculture and Life.)

10 to 11 inches in southern sections; $9\frac{1}{2}$ inches in northern sections; $9\frac{1}{2}$ to 10 inches in middle sections; for deficiencies in length, cut at the rate of one point for each inch.

4. *Color of Grain and Cob.* 10 Points.—The color of the grain should be true to variety, even in shade, and free from mixture. White corn should have white, and yellow corn, red cobs. For each mixed or crossed kernel on an ear a cut of two-tenths of a point should be made. Varying shades of color in grain or cob should be cut according to the degree of variance from the standard.

5. *Tips of Ears.* 5 Points.—The form of the tip should be regular and not too tapering. It should be well covered with straight rows of regular kernels, of uniform size and shape. Proportion of tip covered must be considered, but irregular, shallow or small kernels may be more objectionable than un-

covered tips. Cut one-half point for each tip exposed one inch. For irregularities and lesser exposures cut from one-tenth to one-half point according to judgment.

6. *Bulls of Ears.* 5 Points.—The rows of kernels should extend in regular order over the end of the cob, leaving a depression when the shank is removed.

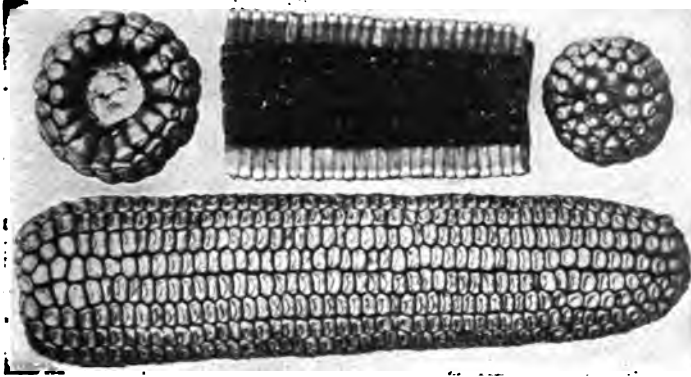

FIG. 146.—Good seed corn, with small shank, deep impression as shown at left; tip well covered with kernels; the rows are regular and the kernels deep. (U. S. Farmers' Bulletin, 229.)

Open, swelled, expanded, flattened and pinched butts are objectionable. Cut from one-tenth to one-half point according to judgment.

7. *Kernel.* (a) *Shape,* 10 Points.—In variety classes the shape of the ker-

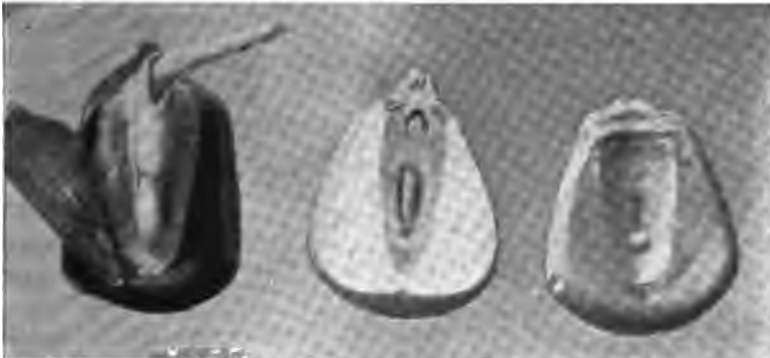

FIG. 147.—The embryo of corn. In the left is a dry kernel; in the center is one with the surface shaved away showing the germ; on the right is a kernel beginning to germinate. (Productive Farm Crops.)

nel should conform to the variety standard (Figs. 145 and 146). In general classes the shape of the kernel should conform to the general standard of perfection for your state. The tips of the kernels should be full and strong leaving no space between them near the cob. Towards the crowns the edges of the kernels should be so shaped as to leave merely enough space between the rows to facilitate drying. Shrunken or pointed tips and badly rounded crowns should be heavily cut.

(b) *Indentation. 5 Points.*—The crowns of the kernels should be rather deeply dented but not pinched or chaffy. The dent should extend evenly across the kernel and there should be no sharp or pointed margins.

(c) *Uniformity. 10 Points.*—Whatever the character of the kernel, it should be uniform for each ear and throughout the exhibit.

8. *Seed Condition. 15 Points.*—The ears should be well matured, firm and sound. The germ should be uninjured, large, bright, fresh and vigorous looking.

9. *Proportion of Grain to Cob. 10 Points.*—In variety classes the proportion of grain to cob should conform to the variety standard. In general classes it should be not less than 86 per cent. For each per cent below standard, cut the exhibit two points.

The following score card is suitable for use of students as well as corn growers (from Indiana Circular 18).

Corn Score Card

Name of Variety Table No.....

Name of Scorer Sample No.

		1	2	3	4	5	6	7	8	9	10
1. Uniformity of Exhibit	10										
2. Shape of Ears	10										
3. Length of Ears	10										
4. Color of Grain and Cob	10										
5. Tips of Ears	5										
6. Butts of Ears	5										
7. Kernel—											
a Shape	10										
b Indentation	5										
c Uniformity	10										
8. Seed Condition	15										
9. Proportion of Grain to Cob	10										
Total	100										

Remarks and reasons for cuts to be given below.

FIELD AND LABORATORY EXERCISES

1. Obtain samples of corn on the cob, getting all varieties and types obtainable for your state and for your neighborhood.

2. **Types of Corn.**—Make type studies of the several varieties of dent corn, comparing them in number of rows to the cob, depth of kernel, and size of cob. Which varieties seem to mature best or earliest?

3. **Scoring Corn.**—Compare the ears in a sample of ten with respect to best corn to meet the requirements of the score card. This exercise should be repeated with a number of ten-ear samples so that some accuracy and speed may be attained in selecting and scoring corn.

4. **Composition of Kernels.**—Make cross sections and longitudinal sections of two kernels from each ear in corn of different types or different varieties. Compare the kernels as to sizes of germs (Fig. 147), amount of flinty matter, and amount of starchy matter in the kernels. What do these differences indicate?

5. Make similar comparisons between dent corn, flint corn, sweet corn and pop corn.

6. **Proportion of Corn to Cob.**—With simple weighing apparatus make studies of the comparative yields of corn as shown in different ears of one variety or in different varieties. The proportion of corn to the cob is obtained by weighing the corn and cob together, then shelling off the kernels into a small paper bag. Weigh the corn and the cob separately. The percentage of corn is expressed in its ratio to the weight of the entire ear. This may be expressed in percentage which is obtained by dividing the weight of the kernels alone by the weight of the entire ear. Thus 86 per cent means that the kernels weigh 86 per cent as much as the entire ear. The cob in that case would weigh 14 per cent as much as the entire ear, but this latter percentage is seldom used. This exercise should be repeated several times to obtain skill in estimating the proportion of corn to the ear when scales are not available, or when time forbids their use. Students may roughly estimate the percentage of kernels by breaking an ear and then verifying the estimate by weighing.

7. **Selecting Seed Corn.**—A group of students may go to a field of corn and select the ears most suitable for seed. During winter seasons this practice may best be done in a corn crib. A score card may be used as a guide for a little while, and then its points should be carried in mind and the work done more rapidly.

8. **Corn Machinery.**—Visit a machine dealer's stock and study all the forms of corn and grain machinery, including planters, cultivators, harvesters, shredders, and huskers. Study the advantages and disadvantages which may be found in each machine.

9. **Cost of Machinery.**—Compare the cost of machinery with the average number of years each machine will last with good care. Take into consideration the cost of repairs, interest on investment, and the number of acres on which the machine is to be used. Determine in each case the minimum size of field or farm which will warrant the purchase of that type of machine.

QUESTIONS

1. Enumerate the classes of corn.
2. How can a grower select the variety of corn best suited to his soil and climate?
3. Describe the preparation of soil and planting of corn.
4. Give suggestions and rules regarding the proper tillage of corn.
5. Describe the several methods of harvesting the corn crop.
6. Give the main points to be observed in the selection of seed corn.

References.—United States Farmers' Bulletins: 81, Corn Culture in the South; 199, Corn Growing; 229, Production of Good Seed Corn; 292, The Cost of Filling Silos; 303, Corn Harvesting Machinery; 313, Harvesting and Storing Corn; 317, Increasing the Productiveness of Corn; 325, Small Farms in the Corn Belt; 400, A More Profitable Corn Planting Method; 414, Corn Cultivation; 415, Seed Corn; 537, How to Grow an Acre of Corn; 546, How to Manage a Corn Crop in Kentucky and West Virginia; 578, The Handling and Feeding of Silage; 617, School Lessons on Corn; 729, Corn Culture in the Southeastern States.

CHAPTER XV

SMALL GRAINS

Our rural Ancestors, with little blest,
Patient of labor when the end was rest,
Indulg'd the day that hous'd their annual grain,
With feasts, and offerings, and a thankful strain.

—POPE—Second Book of Horace.

THE grain crops are sometimes called cereals from the old Roman name. This term usually includes corn, wheat, oats, rye, barley, rice and buckwheat. Flax, when grown for seed, is sometimes called a grain crop, but is seldom classed as a cereal. Several of the plants of this group,—wheat, rye, oats, barley, corn and rice—are members of the grass family. These are true grasses in their characteristics. The grain plants have similar culture. They are usually sown broadcast or in drills and covered to a depth of about one inch, depending on the texture and moisture of the soil. The roots are fibrous and the plants usually send up several stems, except in the case of flax, which sends up one stem from the seed.

WHEAT

This crop has been grown for grain since prehistoric times. It has probably always been the leading small grain crop of the world. About four billion bushels of wheat are now annually produced in the world. Of this amount America produces about one-fifth, and Europe produced more than one-half. The grain is chiefly used in the form of flour as human food. The by-products, including bran and middlings, are used as stock feed. For the making of bread, wheat flour is used the world over. Such bread is called "white bread" to distinguish it from bread made from darker flours, such as barley, rye, millet and others. The dark breads are most extensively used in certain foreign countries.

New soils are best for wheat. As wheat soils become worn out the profit from the crop is much less and other lines of farming are undertaken. This causes the wheat area to move on to new sections. In more permanent forms of agriculture the crop is grown in systematic rotations without serious reduction in yields. Such fixed rotations for wheat are practiced in the old world and

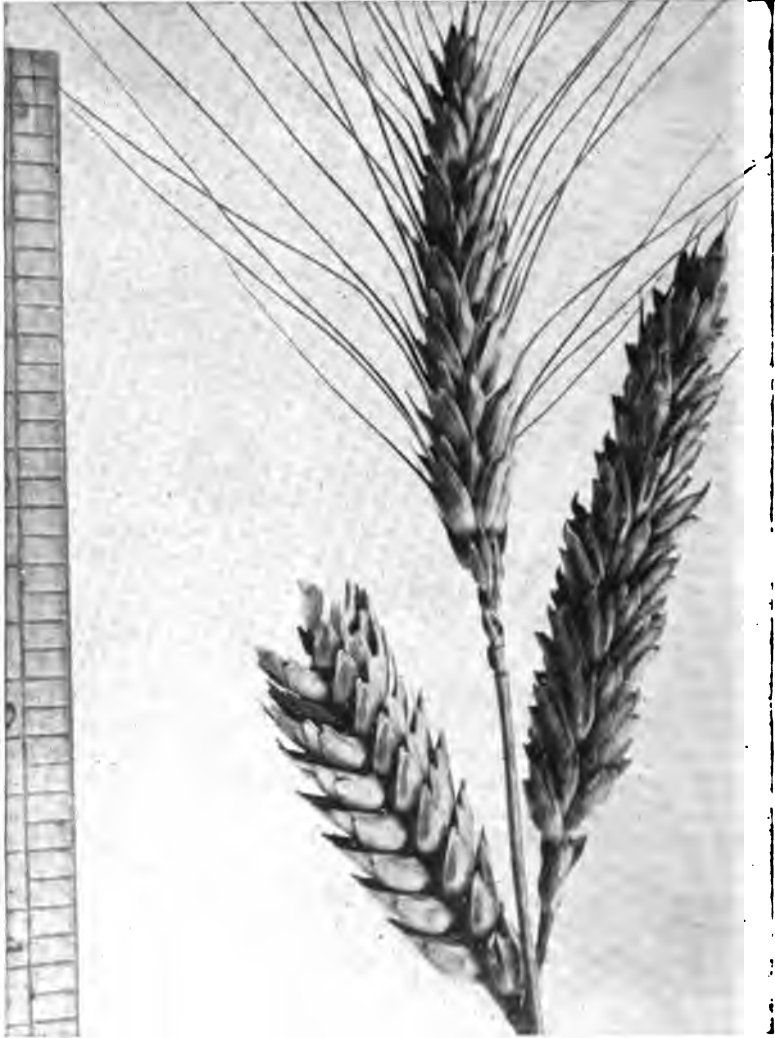

FIG. 148.—Bread wheats. Club wheat, common bearded or Turkey and beardless or velvet chaff. (Productive Farm Crops.)

are now more generally practiced in America. The crop is much better adapted to northern latitudes than corn, because it grows quickly and endures cold.

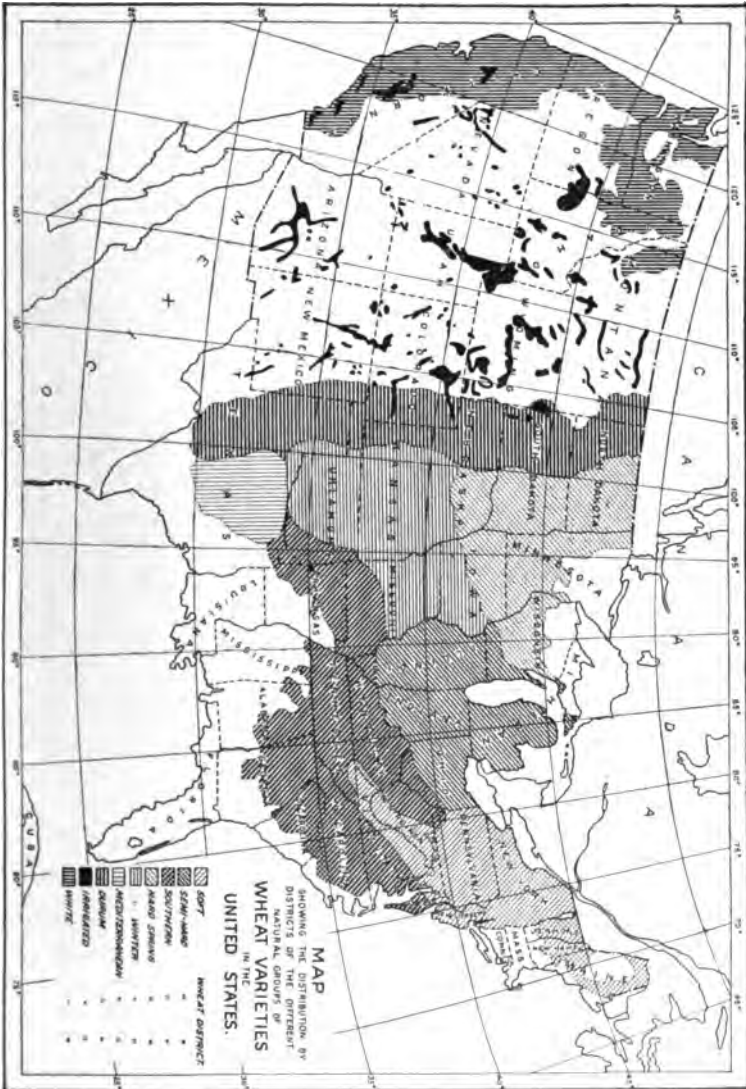

FIG. 149.—Map showing what types of wheat are most common in each section of the United States. Note the key in right lower corner. (U. S. D. A.)

Kinds of Wheat.—From the grower's standpoint there are two main types of wheat—winter wheat and spring wheat. Commercially wheat is always classified as hard and soft. As both winter and spring wheat have hard and soft varieties, two other commercial classes are added. Subdivisions of these groups are sometimes made (Fig. 148). The well known market types are: Hard winter wheat, semi-hard winter wheat, soft winter wheat, macaroni wheat, hard spring wheat, and soft spring wheat. The map, figure 149 shows the distribution of the different types of wheat. Winter varieties are usually grown in southern and middle latitudes while spring wheat is grown in northern latitudes. In humid regions wheat is usually soft, the hardness depending



FIG. 150.—Wide grain drill drawn by four heavy horses. It is well adapted to the large farms in the grain belt. (I. H. Co.)

upon the dryness of the climate. Very hard spring wheat is grown in the cold, dry regions of the northwest. Wheats suitable for macaroni are the hardest varieties. Durum wheat is the leading one of this type. Its recent introduction to America has extended the wheat growing areas farther into the semi-arid regions. Durum wheat can be grown with less rainfall than other varieties. In the middle latitudes both spring and winter varieties are grown, but the winter varieties are preferable. The yield is usually high, because the crop can make use of the winter rainfall, and harvest will take place before the extreme dry weather of midsummer. Winter wheat furnishes a cover for the soil for a much longer period. Some temporary pasture is furnished to stock, and the

work of man and teams is more evenly distributed if winter wheat is grown in the farm rotation.

Growing the Crop.—Wheat prefers heavy soils and then suffers much less from drought than where the soil is light. The field should be plowed several weeks before the seed is sown.



FIG. 151.—Harvesting grain with modern self-binder. (I. H. Co.)

This makes the moisture conditions better for germination. If conditions require the plowing of the field only a short time before planting a heavy roller should be used to bring the plowed soil again in close contact with the lower soil. A light harrow should always be used immediately after the roller to prevent evapora-



FIG. 152.—A Montana field. In dry climates the grain ripens rapidly and much may be lost by shelling unless the field is quickly cut. (I. H. Co.)

tion. If the plowing is done in the fall for spring wheat the soil will become well settled and rolling is usually not necessary.

The seed should be drilled (Fig. 150) as this method gives much better results than broadcast sowing. The depth of covering for the seed depends upon the moisture at time of drilling and upon the texture of the soil.

Wheat is almost universally harvested with self-binders (Figs. 151 and 152). The ancient method was as shown in figure 153. The bundles are placed in small shocks properly capped to exclude the rain, and allowed to pass through a curing process.



FIG. 153.—Grain was formerly cut with a cradle. An expert cradler could cut six to ten acres per day. (F. A. Waugh.)



FIG. 154.—The modern thrasher removes the grain from straw and fans out the dust and chaff. The straw is usually blown through a pipe to the stack. (I. H. Co.)

Two common practices are in vogue: (1) The grain may be thrashed directly from the shocks without stacking. This saves the labor of stacking, but the quality of grain is usually not so good. (2) The grain may be placed in stacks and left for one or

more months before thrashing. This plan usually produces better grain and much better straw. A modern thrasher with windpipe for blowing away the straw is shown in figure 154.

In very dry climates, where no rainfall occurs during the harvest seasons, combined harvesters and thrashers are sometimes used. These large machines are drawn either by traction engines or by twenty-five to thirty horses. They cut the grain and thrash it at one operation. These combination machines are well suited



FIG. 155.—A "Blue Sky" granary near Idaho Falls, Idaho—33,500 bushels of wheat from 1,300 acres in one "dry farm." (I. H. Co.)

to such dry climates as the eastern parts of Oregon and Washington. In such climates the wheat may be stored in the open, as shown in figure 155.

OATS

The second most important of the small grains, both in the old world and in America, is oats. The crop is grown chiefly for stock feed, the whole grain being the most popular grain for horses. In the ground form it is used for other farm animals. For human consumption it is extensively used in the form of breakfast food, as rolled oats. It is now less commonly ground into oatmeal for use in baking. The straw is the most valuable for stock of the straws produced by the small grains.

Oats are grown extensively in the middle and northern latitudes, the region extending farther north than for corn or wheat. Winter varieties are grown somewhat in the southern states. The crop is not well suited to the semi-arid regions, except under irrigation.

Growing the Crop.—Oats thrive best on a moderately rich heavy loam, but will be more profitable than wheat if the soil is poor or light. Fall plowing is usually practiced for heavy soils, because the field can be seeded much earlier in the spring. The

crop is sown in the fall in the South, and both winter and spring varieties are used in some regions. The yield of spring oats largely depends upon the earliness of planting. Drilling is usually preferred to broadcast sowing. It is not an uncommon practice to sow the oat crop without previously plowing the field. After corn or other cultivated crop the field may be disked and a crop of oats grown with fairly good returns (Fig. 156). In livestock farming of the northern states and Canada oats are commonly mixed with Canada field peas or with barley or with spring vetch. The yields of grain are much improved by the mixing (see Figs. 93 and 94 in Chapter on Rotations).



FIG. 156.—Shocks of oats when well capped may remain in the field until thrashing time. (Productive Farm Crops.)

BARLEY

This crop has been grown by man since the early Egyptian ages. The world's crop at present is about one-third as great as the wheat crop. Between six and seven million acres are annually devoted to barley growing in the United States. The average yield is about twenty-five bushels per acre. California and Minnesota each produce about one-fifth of the crop. Barley is much grown in Wisconsin, North Dakota and South Dakota.

The best soil is well-drained loam. Light rich loams are well suited for barley growing. Because of its ability to endure the so-called alkali conditions of semi-arid regions, it is grown on such soil more than other small grains after irrigation is introduced.

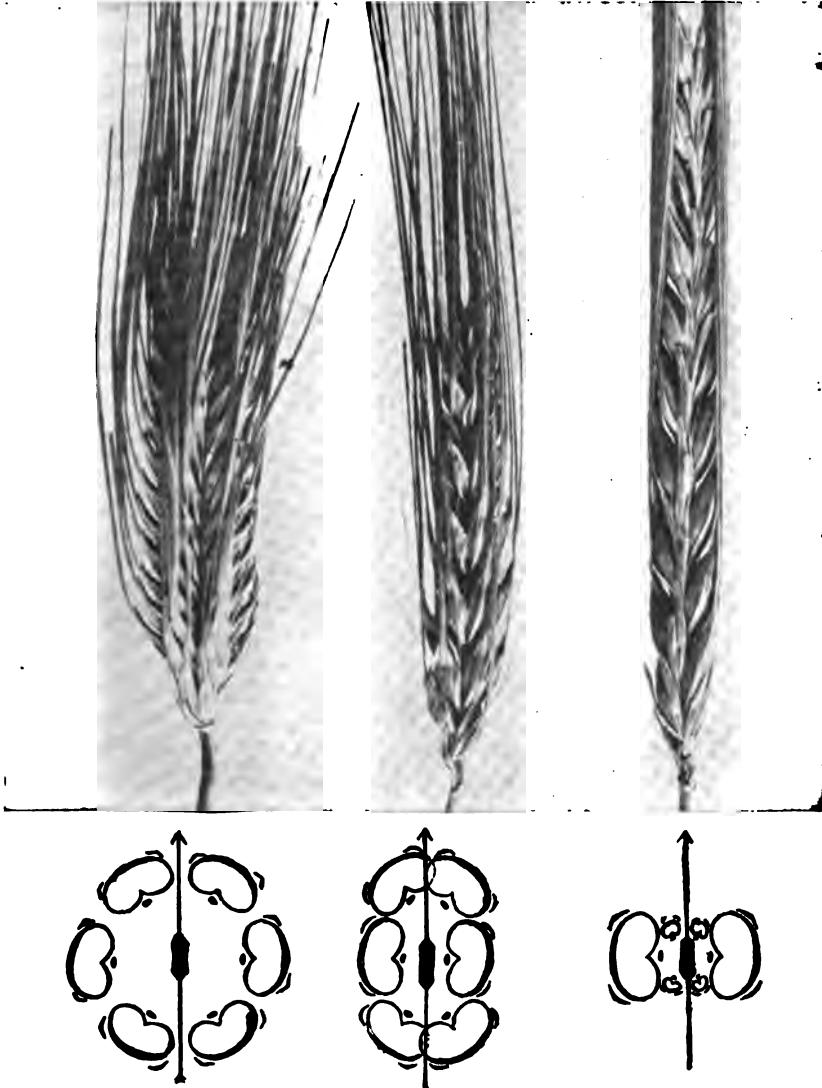

FIG. 157.—The upper photograph shows heads of six-row, four-row, and two-row barley. The lower diagram in cross-section shows the position of spikelets in each type. Note that in the four-row barley the lateral rows overlap, while in the two-row they are sterile. (Productive Farm Crops.)

Types of Barley.—There are three main types of barley, based upon the number of rows of grain in the head—six, four, or two rows (Fig. 157). The six-row variety is far the most common in America. Hullless varieties of barley are sometimes preferred to those where the hull persists, but the yield is usually less and for this reason the hull bearing varieties are more commonly grown. The most common varieties of barley bear beards or spears in the head. After threshing, the beards remain in the straw and sometimes cause irritation of the mouths of livestock feeding upon the straw. For this reason the beardless varieties are preferable for stock.

The grain is used for both human food and stock feed, but the bulk of the crop is often used for brewing purposes. The by-products from brewing are used for stock feed. They include brewers' sprouts and grains, the latter being fed either as "dried grains" or "wet grains."

Hops for Brewing.—In the brewing process, hops which have been cured properly are extensively used. Hop growers make a specialty of producing their crop of the right quality and curing it in perfect condition to suit the particular brewers to whom they sell the product. Hops are grown in special districts in all parts of the country. In some sections where the soil is favorable, the production is very intense, and many hop growers are found. Methods of growing hops are well described in United States Farmers' Bulletin 304, "Growing and Curing of Hops."

Culture for Barley.—The barley crop is usually seeded in the spring a little later than oats. It may be either drilled or broadcasted at the rate of seven to eleven pecks per acre. In warm climates the crop is started in the fall. This causes the plants to stool out much more.

Care must be exercised to harvest the crop before it is too ripe, chiefly to avoid discoloration. When the grain is shocked care must be taken to avoid wetting by rain, as this may also result in discoloring of the heads. Brewers prefer the clear grain.

RYE

Rye is of more recent origin than the other small cereals, and was not grown by Roman farmers.

This crop may be grown throughout the wheat-growing areas of America, but the states where it is most grown are Pennsylvania, Wisconsin, Michigan, Minnesota, New York, Nebraska, New Jersey and Illinois.

In some countries rye is much used in bread-making, but it is less used for human food in America. The bread is dark in color. A few breakfast foods contain some rye. The chief use of the grain is for the manufacture of alcohol and beverages. It is used in combination with other grains for the feeding of hogs, horses and other livestock.

The rye crop is much grown as a winter cover crop, and as green manure in all parts of the country.

The flowers of the rye plant are readily cross-pollinated and distinct varieties cannot be kept distinct as with other small grain cereals, which are self-pollinated. For this reason improved varieties are not permanent.

Culture.—Reasonably fair yields of rye may be produced on poorer soils, as compared with wheat or oats, but the crop responds well to good treatment and rich soil. The preparation of the soil and seeding are the same as for wheat. As a grain crop rye is seldom started in the spring, but if spring sowing is tried it should be very early, and more seed used because the plants will not stool out so much. For fall seeding about five to seven pecks of seed are used per acre. If the crop is to be used for grain only it can be sown much later than wheat.

RICE

This crop stands fifth in the list of the world's greatest agricultural products. It has long been extensively grown in China, India and other parts of the Old World, but its growth in this country is quite limited. Lowland rice has been grown for two centuries along the coastal regions of South Carolina, and has extended from there to North Carolina, Georgia and Florida. After the Civil War the growing of lowland rice was much developed in the river bottoms of Louisiana. A generation later upland rice was introduced from China and Japan and was extensively grown in the southwest part of Louisiana and eastern Texas. This section now produces the bulk of the American product, which is estimated at from fifteen to twenty-five million bushels per year.

Uses of Rice.—The crop is chiefly used for human food. The husks are removed and the seed is usually polished for the American trade, but not for use in the Old World. Unpolished rice is better for cooking, if it can be obtained. A by-product of rice, called "rice polish" resulting from the polishing process, is used for livestock. Rice hulls are sometimes ground with this, but

contain little nourishment. The mixture is often sold as rice bran.

Types.—The rice grown in America is chiefly of two varieties—Honduras and Japan. The Honduras has much grain and tall stiff stalk. The Japanese has short grain with thick hull, and stalk not so tall. It mills more hard rice than Honduras, partly because the grains are less broken in hulling and polishing processes.

Culture.—In the South Carolina district, where lowland rice is grown, the seed is drilled in trenches about eighteen or twenty inches apart. The trenches or furrows are flooded with water till the seed sprouts, after which the water is drawn off until the rice plants are several inches high. Water is again kept on the field for ten days or two weeks, partly to kill the weeds and partly to give the rice crop the desired moisture conditions. The field is flooded a third time shortly before the grain is mature. To carry out this plan it is necessary to have the flooding and drainage conditions under control. Where a water supply is available for flooding it may be controlled by means of dams with gates, which are opened or closed as desired.

Where upland rice is grown in Louisiana, Texas and Arkansas the soil is prepared as for wheat and the seed is drilled with ordinary grain drills. Some of the upland strains of rice are not flooded or irrigated, but where water is available it should be used. Upland rice is also grown in drills far enough apart for cultivation for the purpose of keeping down the weeds. Sometimes the seed is sown with a number in a hill, the distances between hills in the row being wide enough to allow the use of a hoe if necessary. Where irrigation is possible the weeds may be kept in check by this method and less cultivation and hand labor required. The yield and quality are both improved by irrigation.

Harvesting the Crop.—Self-binders are used in the harvest of rice on fields from which the water can be readily drained. The shocking is carefully done to prevent damage to the heads from rains and weather. A slow drying process is desirable. After the grain is very hard it is thrashed with an ordinary grain thrashing machine. A fair yield for irrigated rice is thirty-five to seventy bushels per acre. A bushel of rough rice weighs forty-five pounds.

BUCKWHEAT

Buckwheat is not a true grass, but belongs to a different botanical family. Its value as grain, however, is similar to that of the other cereals. It is much used for human food in the form of

pancake flour. It is used in the whole or ground form for the feeding of poultry, hogs and other livestock. The straw is of little value, except for bedding and manure. The crop is often grown to be turned under as green manure. The flowers yield much honey and are valuable as bee pasture.

The plant is a native of the Caspian shores of Asia, but has been grown in all civilized countries for many years. About fifteen or twenty million bushels of buckwheat are annually produced in this country, more than half of this coming from New York and Pennsylvania.

It prefers a deep black soil and a cool moist climate as the grain matures. It is usually drilled or broadcasted in early summer after the weather is warm. This condition favors the early growth of the young plants. The crop will mature seed in less time than the small grains, only eight or ten weeks before frost being necessary. The plants continue blossoming and producing grain until frost time. The crop is then harvested. This is done by the use of an old-fashioned reaper or a common mower. The thrashing may be done at any time after the stems are thoroughly dry. The grain is usually sacked and allowed to stand in a well aired place, as there is danger of its heating if stored in large quantities in bins before very cold weather.

FLAX

Flax is grown both for seed and for fibre. The plant belongs to a distinct family from the true cereals. It bears a light blue or purple blossom. Pollinating is chiefly carried on by insects. The stems are somewhat branching and many flower heads are produced at a height of about twelve to twenty inches. A long tap root is formed, this being harvested with the plant for the best yields of fibre.

For the production of seed North Dakota, Minnesota and South Dakota are the leading states of this country. Soil rich enough to grow good corn will also produce good yields of flax. The soil is prepared much the same as for early spring wheat, but the seeding is usually done in May or a little earlier, about two to four pecks of seed per acre being used. For the production of the best fibre about twice as much seed is used. This prevents the plants from branching so much. The seeding should be done with the grain drill, but broadcasting is somewhat common. If the crop

is intended for fibre the plants are usually pulled by hand in order to secure the lower portion of the stem and upper part of the root. They are tied by hand in small bundles and allowed to cure in shocks before delivery to the fibre works. The grower may remove the heads before selling the stems. When the crop is grown for flaxseed harvesting is done with self-binders and the thrashing may follow after the stems are well dried. Yields are about ten or fifteen bushels per acre.

The seeds are small, smooth and brown in color. They are of

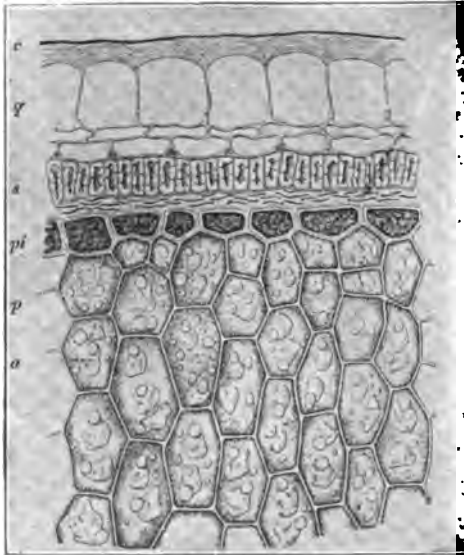

FIG. 158.—Cross-section of flaxseed showing the different layers of cells: *c*, cuticle; *q*, mucilage cells; *s*, stone cells; *pi*, pigment cells; *p*, protoplasm and oil; *a*, aleurone (protein) grains; when soaked in water the mucilage cells swell and form the peculiar flaxseed jelly. (Productive Feeding.)

a flattened lens shape.

Two important products are obtained from the seeds: (a) Linseed oil, used in painting because of its drying properties.

(b) Linseed meal used for feeding livestock because of its richness in protein.

The structure of the seed is shown in figure 158.

The old process was to simply remove the oil by heavy pressure. This is applied by means of hydraulic presses. Most of the oil is thus extracted.

The new process is to follow the preceding method by removing most of the

remainder of the oil by dissolving it with ether or gasoline. The new process leaves a less propor-

tion of the oil in the linseed meal, and feeders find it necessary to determine by which process the oil has been extracted from the meal. Tests for the two meals are shown in figure 159. Whole flaxseed is sometimes used either in the ground or unground condition in feeding calves and some other stock. It also constitutes a part of some health foods, or breakfast foods.

See chapter on Minor Fibre Crops for the treatment of flax as a fibre crop.

IMPLEMENTS FOR SMALL GRAIN CROPS

Grain drills put the seed in the ground much better than the broadcast methods of planting. Less seed is required per acre to make a good stand. There are several types of grain drills, differing chiefly in their methods of making the small trenches or furrows in which the grain is drilled. Some do this by means of one or two disks for each furrow. Others open the furrow with a "shoe," and others with a shovel. Drills vary also in the distance between rows, the common distance being four to seven inches. The number of drills and the width of a machine depend upon the choice of the purchaser. Some grain drills have a fertilizer attachment and also a box from which grass seed is drilled at the same time that grain is drilled.

Grain Harvesters.—The small grains and rice are almost universally harvested with self-binding machines. These machines cut the grain, bind it in bundles of convenient size and drop the bundles, several in one place, ready to be put into shocks. The use of self-binders in the grain belt is very common. Each grower usually has his own machine as the time of harvesting is very limited, but two who own the same machine

may be able to use it at different times if different kinds of grain are grown or if there is a variation in the type of soil, so that the ripening is not simultaneous. Some farmers are willing to harvest the grain at a much earlier stage than others. Indeed, cutting may begin as soon as the grain is passed the "dough" stage and just begins to harden. For fear of shrinkage at this time, many farmers delay the cutting even until some of it begins to shatter.

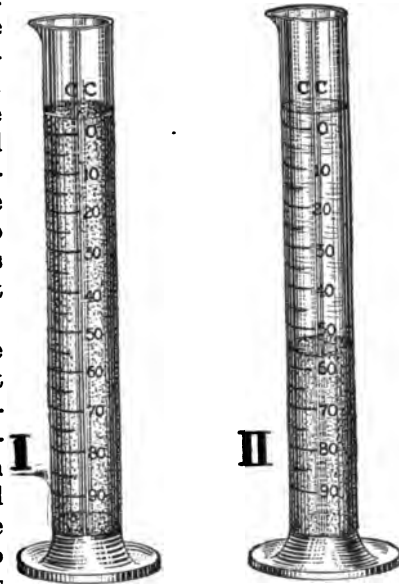

FIG. 159.—The swelling test. I, old-process oil meal; II, new-process oil meal. In case of the former, the meal stirred in water remains in suspension on standing, while the new-process meal soon settles so as to leave a clear yellowish solution on top, only about half the quantity of water added being absorbed. (Productive Feeding.)

Grain Thrashers.—A good grain thrasher combs the heads and thus loosens the kernels from their cases. The separator then sifts the grain from the straw and chaff and carries it to the blower where the cleaning is continued. Most modern thrashing machines

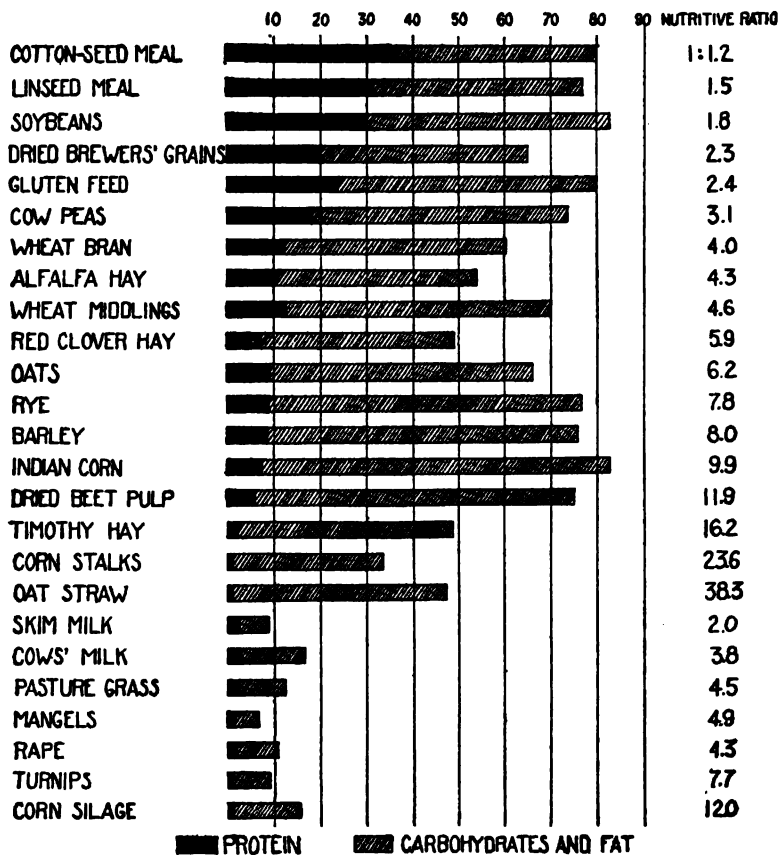

FIG. 160.—Digestible components in common feeds (in per cent). The nutritive ratio, given at the right, is the ratio existing between the protein (1) and the carbohydrates and fat. (Productive Feeding.)

blow the chaff and straw out on the stack where it may be either baled or used in the loose condition for stock feed and bedding. If baled, it is commonly sold for use in cities, or places where grain is not grown.

It is common to find a thrashing machine owned by a man who

also has a steam or gasoline engine in the form of a tractor to not only run the thrasher, but to pull it from farm to farm. He does the thrashing for many in his neighborhood, charging a fixed price per bushel for the work.

Digestible Nutrients and Fertilizing Values of Grain Crops.—The table below shows the digestible feeds and also the fertilizer ingredients in corn, cereal grains, their by-products, and the several forms of roughage obtained from these crops (see also Fig. 160).

Name of feed	Dry matter in 100 lbs.	Digestible parts in 100 lbs.		Fertility in 1,000 lbs.		
		Protein	Carbohydrates (+fat ×2.25)	Nitrogen (N)	Phosphoric acid (P ₂ O ₅)	Potash (K ₂ O)
Barley	89.2	8.4	68.9	19.2	7.9	4.8
Brewers' grains (dried)	91.3	20.0	45.7	40.0	16.1	2.0
Brewers' grains (wet)	23.0	4.9	11.3	10.7	4.2	0.5
Malt Sprouts	90.5	20.3	49.2	42.1	17.4	19.9
Buckwheat	86.6	8.1	53.6	17.3	6.9	3.0
Buckwheat bran	91.8	5.9	38.5	20.2	4.2	12.7
Buckwheat flour	85.4	5.9	65.7	11.0	6.8	3.4
Buckwheat hulls	86.8	1.2	29.7	7.3	4.3	14.7
Buckwheat middlings	87.2	22.7	51.2	42.7	12.3	11.4
Corn, dent	89.4	7.8	76.5	16.5	7.1	5.7
Corn flint	88.7	8.0	75.9	16.8	7.1	5.7
Corn, sweet	91.2	8.8	79.5	18.6	7.1	5.7
Corn ensilage	26.4	1.4	15.7	4.3	1.1	3.7
Corn fodder, green	20.7	1.0	12.8	2.9	1.1	3.9
Cornmeal (all)	85.0	6.7	72.2	14.7	6.3	4.7
Corn stalks with ears	57.8	2.5	37.3	7.2	5.4	8.9
Corn stalks without ears	59.5	1.4	32.7	6.1	3.8	10.9
Corn and cob meal	84.9	4.4	66.5	13.6	5.7	4.7
Corn bran	90.6	6.0	63.3	17.9	10.1	6.2
Corn germ oil meal	91.4	15.8	63.1	34.7	3.9	2.1
Corn gluten meal	90.5	29.7	56.2	54.8	3.3	0.5
Corn hominy feed (corn hearts)	90.4	6.8	77.2	16.8	9.8	4.9
Corn dried distillers' grain	92.4	22.8	65.8	49.9	6.0	1.7
Flax seed	90.8	20.6	82.4	36.2	13.9	10.3
Linseed meal (old process)	90.2	30.2	47.5	54.2	16.6	13.7
Linseed meal (new process)	91.0	31.5	41.1	60.0	17.4	13.4
Oats	89.6	10.7	58.7	18.2	7.8	4.8
Oat hay	86.0	4.7	40.5	14.2	6.7	25.4

Digestible Nutrients and Fertilizing Values of Grain Crops—Continued.

Name of feed	Dry matter in 100 lbs.	Digestible parts in 100 lbs.		Fertility in 1,000 lbs.		
		Protein	Carbohydrates (+fat $\times 2.25$)	Nitrogen (N)	Phosphoric acid (P_2O_5)	Potash (K_2O)
Oat hulls.....	92.6	1.3	39.9	5.3	1.6	4.9
Oat meal.....	92.1	11.9	80.2	23.5
Oat middlings.....	91.2	13.1	69.3	25.9	22.5	15.3
Oat and pea hay.....	89.5	7.6	44.9	16.5	6.1	18.1
Oat straw.....	90.8	1.3	41.3	5.8	3.0	17.7
Rice.....	87.6	6.4	80.1	11.8	1.8	0.9
Rice bran.....	90.3	7.6	54.2	19.0	2.9	2.4
Rice hulls.....	91.2	0.3	20.1	5.1	1.7	1.4
Rice meal.....	89.8	7.4	75.1	19.2
Rice polish.....	89.2	7.9	70.5	19.0	26.7	7.1
Rye.....	91.3	9.5	72.1	18.1	8.6	5.8
Rye bran.....	88.4	11.2	50.9	23.3	22.8	14.0
Rye flour.....	86.9	5.6	73.3	10.7	8.2	6.5
Rye middlings.....	88.2	11.0	58.8	22.9	12.3	9.6
Rye straw.....	92.9	0.7	40.5	5.0	2.5	8.6
Wheat.....	89.5	8.8	70.8	19.0	5.5	8.7
Wheat bran (winter)	88.5	12.1	43.4	25.1	26.9	15.2
Wheat—high grade flour.....	87.6	10.6	67.4	19.2	5.7	5.4
Wheat—red dog flour	90.1	16.2	64.7	29.4
Wheat middlings (shorts).....	88.8	13.0	55.8	27.0	26.3	15.3
Wheat straw (roughage).....	90.4	0.8	44.2	5.0	2.2	6.3
Wheat screenings.....	88.4	9.6	52.5	20.0	11.7	8.4

FIELD AND LABORATORY EXERCISES

1. **Withstanding the Winter.**—In regions where several kinds of winter grains are sown in the fall, compare the different varieties or kinds of grain with respect to climate-endurance. Which are injured during heaving by frost? Which produce the best winter pasturage? What relation exists between the date of sowing and the value as pasturage?

2. **Fighting Hessian Fly.**—In regions where Hessian fly is sometimes injurious, compare the damage done on different fields under early and late sowing of the fall crop. Observe the damage where cleaning up of hedge-rows and fence-rows is practiced, and where volunteer grain is kept down until late planting time. Compare these with other fields where such methods are not practiced.

3. **Varieties of Barley.**—Collect samples of different types of barley, and make laboratory studies of these.

4. **Samples of different varieties of wheat and oats** should be collected in the ripe stage of unthreshed grain, and also get threshed grain samples. Note the differences in color of grain, forms of head, proportion of grain to weight of the grain and straw.

5. **Variation in Yields.**—In a field of growing grain just before harvesting, or in grain shocks after harvesting, select the stalks which show the largest proportion of grain. What improvement, if any, could be made by planting grain from such heads instead of the others?

QUESTIONS

1. In what ways are the small grains alike in their culture?
2. Discuss the adaptation of different soils to wheat growing.
3. What are the chief kinds of wheat grown for market?
4. Give the details for growing the crop.
5. Compare the straw of the four cereal grains as to feed value.
6. Describe the growing of oats.
7. Give the different types of barley.
8. Why are there fewer varieties of rye than of the other cereals?
9. Compare the growing of rice by the upland and the lowland methods.
10. Describe the culture of buckwheat.

References.—United States Farmers' Bulletins: 139, Emmer: A Grain for Semiarid Regions; 304, Growing and Curing Hops; 322, Milo as a Dry-land Crop; 395, Sixty Day and Kherson Oats; 399, Irrigation of Grain; 417, Rice Culture; 420, Oats: Distribution and Uses; 424, Oats: Growing the Crop; 427, Barley Culture in the Southern States; 436, Winter Oats for the South; 443, Barley: Growing the Crop; 448, Better Grain-sorghum Crops; 466, Winter Emmer; 518, Winter Barley; 534, Durum Wheat; 596, The Culture of Winter Wheat in Eastern Half of the U. S.; 616, Winter-wheat Varieties for the Eastern U. S.; 678, Growing Hard Spring Wheat; 680, Varieties of Hard Spring Wheat; 704, Grain Farming in Corn Belt, with livestock as side line.

N. J. Exp. Sta. Circ. 51, Diseases of Grains and Forage Crops. The Cereals in America, Hunt, Orange Judd Co., N. Y. Examining and Grading Grains, Lyon and Montgomery, Ginn & Co., Boston. The Small Grains, Carleton, Macmillan, N. Y. Field Crops, Wilson and Warburton, Webb Pub. Co., St. Paul. Southern Field Crops, Duggar, Macmillan, N. Y.

CHAPTER XVI

POTATOES

Let me be no assistant for a state,
But keep a farm, and carters.—SHAKESPEARE.

UNDER the term potatoes are usually included two very distinct crops, Irish potatoes and sweet potatoes. These are not at all similar except that each is the fleshy store of food of a plant. The Irish potato is a true underground stem with "eyes" or true buds. It belongs to the nightshade family which also includes the tomato, tobacco, Jimson weed, and other economic plants. The sweet potato belongs to the morning-glory family. The part used for food is a true root, having no real buds.

WHITE OR IRISH POTATO

This crop, commonly known as Irish potatoes, because it is grown extensively in Ireland, really originated in America. It is native of the valleys of Peru and was introduced from Peru to Europe about 1542. It is grown in nearly all countries of the world and leads all other agricultural crops of the world in tonnage. The leading countries in potato growing are in this order: Germany, European Russia, Austria-Hungary, France, United States and United Kingdom. The average yields per acre in these countries range from about two hundred bushels in Germany to only ninety-two bushels in this country.

The eight leading states in the production of potatoes are: New York, Michigan, Wisconsin, Maine, Pennsylvania, Minnesota, Ohio, and Iowa. Maine leads all others in the number of bushels per acre.

Varieties.—There are a number of distinct types and varieties of potatoes. Many of the variety names are synonyms, being given by seedsmen to old forms to attract a new attention to them. The different types of potatoes grown under same conditions of soil and climate are easily distinguished; but any one type may vary so much under different conditions of growth as to appear as a different variety in different places. Soil and climate cause great variation in the form, texture and growth of the tubers.

The chief differences among the types or varieties of potatoes

are the depth of eyes, the shape of tubers, the color of skin and flesh, and period required for maturing the crop. Farmers most commonly classify potatoes as early or late.

Common early varieties in order of earliness are: Early Rose, Early Ohio, Triumph and Irish Cobbler. The time for producing potatoes with these varieties varies from sixty to one hundred days. Early potatoes are usually harvested and marketed as soon as they are large enough—not always waiting for them to be thoroughly mature. Late potatoes are allowed to remain in the ground until they are thoroughly mature. They will keep much better and may be stored and sold, or used much later. So-called late varieties would include Rural New Yorker, Burbank, Sir Walter Raleigh, and Carman No. 3. Green Mountain is a variety which will keep fairly well and is usually considered of the late type. It will produce a crop in about one hundred days. Other late varieties mentioned usually require a little longer.

The keeping quality of potatoes depends not only upon the variety, but also upon the maturity of the crop and season of harvesting. Early varieties may be grown late in the season, and keep well for winter and spring use. The late grown crop is often called the second crop, but it is seldom grown on the same field where the first crop was harvested. Two crops of potatoes in one season are frequently grown in southern latitudes.

In the selection of varieties for market purposes a study should be made of the market requirements. Potatoes of white flesh and white skin usually bring a better price than the red varieties. The tubers should be smooth—not rough; the eye should be shallow—not deep; the tubers should be round and somewhat flat, rather than long or irregular. In size they should not be too large nor too small. Those of medium size are always preferred.

Soils and Fertilizers.—Rich sandy loams produce a better quality of potatoes than heavier soils. Early potatoes are not quickly produced on heavy soils, but late varieties may be grown on clay loams if there be plenty of organic matter present. Potato soils can usually be much improved by the use of green manure. The heavier soils are also much benefited by drainage. The use of barnyard manure will help to increase the amount of humus present, but it should be applied on the field for the preceding crop in the rotation, as fresh manure upon potato soils increases the development of the disease known as potato scab. For early

potatoes an annual rotation is possible. As soon as the early crop is harvested a winter cover crop is started. This is turned under as green manure before planting the next crop of potatoes in the spring. For late potatoes, which may occupy the ground until nearly freezing time, a longer rotation is necessary.

The growth of potatoes without commercial fertilizers is very successfully carried on if an annual crop of green manure is plowed under and barnyard manure is liberally used. When these conditions are not secured commercial fertilizer may be profitably used. This is practically true for the growth of early potatoes. For such a crop on a good sandy loam, growers often use as much as 800 to 1200 pounds per acre of the following mixture: Nitrate of soda, 100 pounds; sulfate of ammonia, 100; bone tankage, 100; acid phosphate, 500; and sulfate or muriate of potash, 200. This mixture has a formula of about 4:8:10. If green manure and some barnyard manure are used the chief fertilizer to be purchased would be acid phosphate, or rock phosphate.

The use of lime on potato soils is not to be recommended. If it be applied the year that the potato crop is grown it is likely to cause a development of the scab disease.

Preparation of Soil.—Potatoes prefer a loose, open soil, and to secure this it is common to plow the field in the spring not long before time for planting. The plowing should be as deep as possible without turning up too much of the poor subsoil. Deep tillage disk plows prepare the soil well by thoroughly mixing all parts together. Deep plowing is always better suited to rich soils. If an ordinary turning plow is used the ground should be disked before planting. This treatment is also beneficial when the field has been plowed the preceding fall. After this a smoothing harrow may be used.

Seed Potatoes.—Much attention should be given by potato growers to the matter of good tubers for seed. In Chapter III the hill-row method of improving the yield is described. Southern growers often buy seed potatoes from northern states. This is because the southern-grown seed has a tendency to "run out," and the yield is often less than with northern-grown potatoes. Many carloads of seed are shipped to the South from Minnesota, Wisconsin, Michigan, Maine and New York. Another cause for using northern-grown seed is the inability to store seed potatoes from one season until the next. Storage companies take advantage of this and are able to buy southern-grown potatoes,

store them and sell them to growers for seed the next spring at greatly advanced prices.

It is the most common practice to cut seed potatoes into small pieces, each bearing one or two eyes, but experiments have been tried with larger pieces, and have proved the plan to be more successful. See Figure 161 for method of sprouting tubers in light. In all regions where potato scab disease is serious the seed potatoes should be treated with formalin solution, either before or after cutting. Use one pound of full strength formalin liquid to 32 gallons of water and soak the seed for two hours.

The tendency of seed potatoes to sprout as spring approaches

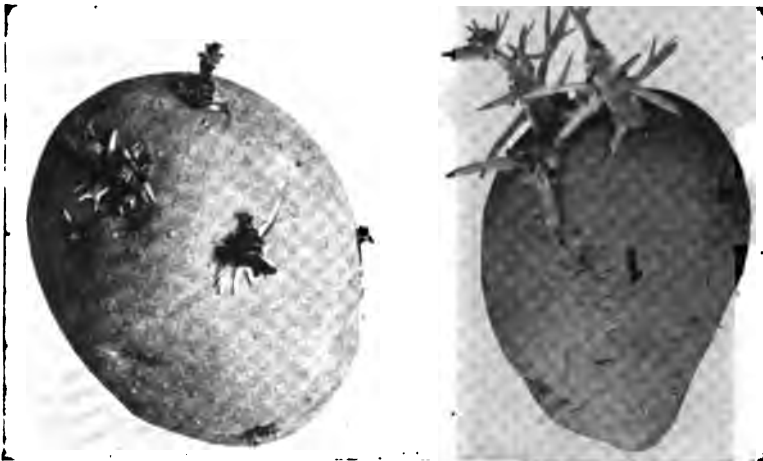

FIG. 161.—Comparing tubers sprouted in strong light and in darkness. Both tubers were taken from same lot and germinated for 30 days. The one on left in greenhouse in strong light, the one on right in dark chamber. Note long, weak sprouts, and shrunken tuber due to germinating in dark. Strong light "greens" the tuber and prevents shrinkage to a large degree. (Productive Farm Crops.)

may result in weakening the seed if the sprouts are long enough to be broken off. If the potatoes are kept in a cold place this may be prevented. This tendency to sprout is sometimes made use of by growers. After the potatoes are cut and treated they are placed on the floor of a light room where short, strong, green buds, or leaf clusters, will develop in a few days. This produces a more vigorous growth as soon as the potatoes are planted.

Planting.—The usual method of planting potatoes is in rows thirty to forty-two inches apart, and the seed pieces are drilled about twelve to eighteen inches apart, in the rows.

Machine planters are of several types (Fig. 162). These differ chiefly in their method of distributing the pieces of seed. A good machine will open the furrow, distribute the seed pieces as desired, spread some fertilizer in such a way as to not bring it in contact with the seed, and will cover the row to any depth desired. Such a machine is drawn by one team and can be operated by one man, but in some types of planters he is assisted by an active boy who helps in the even distribution of the pieces of seed.

The depth of covering varies considerably, due to custom, kind of soil and method of cultivation. Potatoes will sprout readily in light soil when covered to a depth of four or five inches. If the soil is heavy and the season is wet they should be covered much less.



FIG. 162.—This type of planter requires two men to operate it—one drives the team and the other distributes the potatoes in the dropping disk to insure uniform planting. (Bateman Mfg. Co.)

When machine planters are not used the rows are usually opened by the use of a plow and the seed is dropped by hand. The covering may be done either by harrow, drag, plow, or by the use of hoes.

Cultivating the Crop.—There are two chief methods of cultivating potatoes: Level culture and the ridging method.

Level culture is best suited to light soils and to dry seasons. In either method the harrow may be used over the field after planting is done, and may be continued during the sprouting and early growth of the plants until the vines begin to spread or lie down. The cultivator is then used between the rows. Frequent cultivation to prevent the crusting of the ground is more important with this crop than with corn or cotton, because the crop cannot develop unless the ground be kept mellow and the supply of moisture is saved. If the ground is heavy and has become packed, some very deep cultivating is usually practiced to advantage before the roots have reached far into the middles. After that shallow tillage is necessary.

Ridging is most common for early potatoes, but is sometimes

practiced on the late crop. It is well suited to wet seasons, as much loose soil is thrown up to the row in which the tubers may develop without growing into the deep soil when there is too much water. Ridging is done by use of cultivators so adjusted as to throw the soil toward the row a little at each cultivation. Extreme ridging is not commonly practiced in most sections. Where conditions are favorable level culture usually brings larger yields.

Irrigation is practiced with profit in the growing of potatoes. The crop requires much water. In dry seasons potatoes suffer for lack of enough soil moisture and the yield is greatly reduced. Where irrigation is practiced, even in humid climates, the potato yield may be enormously increased. Two methods are well suited to this crop: (1) Furrows are run between the rows and the water from the head ditch or head furrow is let into the row furrows until the ground is saturated. (2) The overhead pipe system is used to a considerable extent.

Spraying.—In all parts of the country where potatoes are grown commercially, spraying is necessary to control the potato beetles. The beetles feed upon the plants



FIG. 163.—Where potatoes are grown abundantly machines drawn by horses are used for digging. (Bateman Mfg. Co.)

and are readily killed by such poisons as Paris green, arsenate of lead and arsenite of soda. Arsenite of zinc is also used. Paris green is used in either the form of a spray or as a dust. In the latter form it is diluted by being mixed with ashes or lime and the mixture is dusted upon the plants when they are wet with dew. A spray mixture is prepared by mixing from eight ounces to one pound in fifty gallons of water. Strong solutions are usually injurious to the plants. The addition of one-half pound or one pound of lime to this mixture will help to hold the poison on the plants, will help mark the area sprayed, and will help to prevent injury to the plants by the arsenic.

Arsenate of lead is commonly put up in paste form so that it will more readily mix with water. Two or three pounds of this poison may be mixed with fifty gallons of water for spraying potatoes.



FIG. 164.—Potato harvest where large areas are grown for market. The machine digger leaves the tubers in rows on the top of the soil. They are then picked in boxes or barrels to be hauled to market or storage. (U. S. D. A.)

In regions where late potato blight is likely to be injurious to the crop the damage may be prevented by the use of either Bordeaux mixture of lime-sulfur with either of these poisons. For



FIG. 165.—This simple potato digger has several tines instead of a moldboard, allowing the soil to fall through but keeping the potatoes on top. (New Jersey Station.)

this purpose the amount of water mentioned above may be replaced with the same amount of Bordeaux mixture or lime-sulfur mixture. The formula for Bordeaux mixture to be used on potatoes is five pounds of copper sulfate and five to six pounds of freshly

burned lime to fifty gallons of water. (See chapter on Control of Insects and Diseases.)

Fighting potato beetles must begin early. As soon as the old beetles appear they may be destroyed before the eggs are deposited. As soon as the eggs hatch the young begin feeding and poison must be kept upon the plants until the crop is produced, or until the insects are destroyed. The frequency of spraying depends upon whether the poison is washed off or not, but after the vines produce much new growth this must be covered with the poison.

Harvesting.—On large commercial plantations potatoes are dug with machines. There are several types of diggers. The best machines lift the potatoes and soil over a carrier, which travels above the axle of the machine and leaves the tubers in a row behind (Figs. 163 and 164). The soil is separated from the potatoes as they move backward. These machines are very successful and save much hand labor. Small areas of potatoes are commonly harvested by the use of hand diggers. An inexpensive plow-digger is shown in figure 165.

Scoring Potatoes.—Judging potatoes is a good exercise for students. Nothing else will call such close attention to the characters of the different varieties as this. The score card used by the growers near Greeley, Colorado, is as follows:

Size.....	20
Too large, cut 2	
Too small, cut 12	
Not even, cut 6	
Appearance.....	60
Not bright, cut 10	
Dirty, cut 10	
Scabby or wormy, cut 40	
Shape.....	10
Quality.....	10
Unsound, cut 5	
Brittle or spongy, cut 5	
Total.....	100

SWEET POTATOES

As a market crop sweet potato growing is rapidly gaining in importance in this county. It is a crop well suited to warm climates and commercial fields are found throughout the southern states. For home use it is also grown to more limited extent in all northern states.

Varieties.—The so-called “yam” of the South has sweeter and softer flesh than the “Jersey sweets.” The true yam is a tropical plant quite different from the sweet potato of this country.

Common varieties of the soft, sweet type are Dooley, Southern Queen and Georgia. Popular varieties of the firm Jersey type are Nansemon, Big Stem and Red Jersey. Markets favor certain varieties and the kind grown should be suited to the particular market for which the crop is grown.

Soils and Fertilizers.—Light sandy soils are well suited to the sweet potato. If the soil is very loose and open, and the subsoil is heavy so the moisture will be retained, the conditions will favor a good crop. Too much organic matter in the soil tends to develop the vines at the expense of the roots. For this



FIG. 166.—Bedding sweet potatoes under sash in early spring to produce the plants for setting in open fields much later. (New Jersey Station.)

reason the use of green manure and barnyard manure on sweet potato fields should be very limited unless the soil is very deficient in humus. Crimson Clover is often grown in rotation with and used as green manure for sweet potatoes.

It is well to use commercial fertilizers in growing sweet potatoes. From five hundred to eight hundred pounds per acre of the following mixture is recommended: Tankage, 300 pounds, dried blood, 100 pounds, acid phosphate, 400 pounds, and muriate of potash, 200 pounds. This should have a formula of about $2\frac{1}{2}$: 9:10.

Preparation of Soil.—Sweet potato fields should be plowed long enough before planting to allow the soil to settle. After plowing it may be harrowed several times to help sprout the weed seed, warm the soil and thoroughly aerate it. If the soil is well drained

level culture may be practiced, if the soil is in good tilth. The ridge method of culture is suitable to land having a very heavy subsoil, or otherwise not well drained; it is more expensive than level culture. In the level method of planting the rows are two to two and one-half feet apart, and the plants about the same distance apart in the rows, and they may be set in rows both ways to allow of cultivation in both directions while the plants are

FIG. 167



FIG. 168



FIG. 167.—Sweet potato plants when pulled from the bed will vary greatly in size and vigor. The best should be selected for setting in the field. (New Jersey Station.)

FIG. 168.—Short stems and many leaves, as shown at the right, are the result of keeping the plants pulled from the seed bed as fast as they develop. The small plant at left is not desirable. (New Jersey Station.)

small. If the ridge method is to be used two or more furrows are thrown together with a turning plow, forming ridges about four feet apart. After the ridges settle the plants may be set. If only slight ridges are desired the work of the plow is followed by the harrow before the plants are set. The harrow will reduce the height of the ridges. Slight ridging or level culture is best for dry seasons. When the plants are set in the ridges a distance of about eighteen inches is left between plants in each row.

Propagating the Plants.—The plants are started by sprouting the potatoes in beds or by cuttings from the vines. Bedding the potatoes is shown in figure 166. The seed potatoes are seldom planted in the field, as in the case of Irish potatoes. Hot-beds for starting the plants for small fields are heated with fresh horse manure. About twelve inches of manure should be well tramped down. The fermenting manure is covered with a few inches of fresh sandy loam; then the roots are placed as shown in the figure. The roots are then covered with about three inches



FIG. 169.—Sweet potato bed where the young plants are grown from the seed-potatoes before setting in the field. (New Jersey Station.)

of fresh sand, or loose loam. The temperature is carefully watched and when it reaches about 80 degrees F., it is kept at 80 to 85 until a short time before pulling out the plants; then it is lowered to about 60 degrees.

Each potato sends up many shoots, as shown in figure 44. The first plants, when six or eight inches high, may be pulled out and others will continue to grow and refill the bed (Figs. 167 and 168). A bushel of good roots will furnish about two thousand plants of the first growth, but several times this many may be taken from the bed later if desired (Fig. 169).

When very large fields are to be set the plants are often started in extensive beds heated with fuel. A long trench is dug in the ground about three feet deep. At one end a fire-place is constructed and a smoke pipe leads from this the entire length of the trench, where it rises like a chimney. The beds are constructed above this in such a way as to receive all the heat from the fire-place and pipe. Loose boards may serve as the floor for the beds, and heat will thus be supplied from below.

As the young plants are pulled from the beds they are bunched and sometimes puddled by dipping the roots in thin mud. This prevents much loss and causes the plants to start more promptly when set in the fields.

Setting the Plants.—When enough plants are ready to begin setting and when the weather conditions are favorable for starting a quick growth of the plants, the field is marked with special markers. In the ridge method, the place for each plant on the ridge may be marked by the use of a light roller, on the surface of which are fastened strips at a distance of about eighteen inches. As the roller turns on the surface of the soil the strips will mark lines across two ridges at a time. The horse drawing this light marker walks between two ridges. More commonly the plants are set on the ridges without such marks. In the level method of planting, the rows may be marked by using a drag or rake marker having either prongs or runners at suitable distances to mark the rows. Such a marker may be used to lay off the field in squares, if the plants are to be in rows both ways.

Planting is done either by hand or by machine transplanters. The latter are used for large plantations and do satisfactory work. The machine is drawn by one team and may be operated by a driver and one or two men or boys to place the plants in the setting pockets. These machines will mark the rows, open the soil, set the plants and water them. No marking of the field is required when machine planters are to be used.

Setting by hand is much slower and a far more expensive process. Boys are often used to distribute the plants along the rows so that the men setting the plants in the soil carry only their hand dibbers or other tools.

Cultivation.—The cultivation does not need to be deep, if the soil is light and well suited to sweet potatoes. Frequent shallow cultivating is the general rule. If a strip of land was left between the ridges in the preparation of the field this is broken by

a sweep or middle-buster, similar to that used in cotton fields. Small-tooth cultivators are used on the sides of the ridges very near the plants until the vines run and nearly cover the ridges. When the plants are in rows only one way, in the ridge method, it is necessary to use hand hoes to keep the field free from weeds. The great expense of this method has caused some large growers to abandon the ridge method so that horse tools can largely displace the hand hoeing. When cultivation must be stopped because of the growth of the vines, the field is "laid by." In this process considerable soil is moved from the middles toward the rows, whether they have been in ridges or not. This will destroy many of the small weeds at that time and the growth of the plants will aid in keeping down future growth of weeds.

Digging.—The crop must be harvested before severe frost, as the killing of the vines by freezing may also injure the potatoes. Some delay may be allowed by cutting the vines and digging the roots later. If the vines are not first removed before the roots are plowed out two rolling coulters on the beam of the plow are used to cut the vines. A turning plow covers the vines and leaves the potatoes somewhat on top of the soil. In the plowing, picking and handling of sweet potatoes much care must be exercised to avoid bruising, as this will greatly injure their keeping qualities. The potatoes are usually graded at sorting sheds or store houses, rather than in the field as they are picked up.

Storage of Sweet Potatoes.—Early sweet potatoes are produced in southern fields for northern markets. They are usually sold as soon as harvested. If they are to be kept some time careful storage is necessary. Well ventilated buildings or pits supplied with heat are planned for this purpose. The roots should pass through a curing process, known as "sweating," at a temperature of perhaps 85 or 90 degrees F. A few weeks later after the curing process is completed the temperature is gradually lowered to about 60 degrees, or a little less. If the ventilation is good the potatoes may be held at this temperature for several months.

Diseases.—Black-rot is the worst disease of the sweet potato plant. It is first noticed in the shriveled condition of the terminal buds of the plants. It may also be seen as small black spots on the roots. After the potatoes are formed the disease appears on their surface in brown patches, becoming darker at the centre of each patch. The disease may first be noticed at digging time, or

perhaps not until spring when roots are being selected for bedding purposes.

Stem-rot is often a serious disease of the plants. This causes the plants to die, beginning near the surface of the ground. As the disease works itself along the stems it may cause the death of the plant and also a rotting of the potatoes. The disease is very injurious and much damage is caused in any field where it becomes well established.

The best remedy for both of these diseases is rotation of crops. When a disease has been found to exist in the soil sweet potatoes should not be grown again until several other crops have intervened.

FIELD AND LABORATORY EXERCISES

1. **Potato Growing Competition.**—A good home project is to grow potatoes by the hill-row method as described in chapter IV. A competition may be started to see who can obtain the largest yield by this method or who can make the greatest increase in yield per hill.

2. **Preventing Potato Scab.**—Before planting time, methods of treating the seed for scab should be practiced, using potatoes which are evidently affected with the disease. Let some be planted without the treatment and some with. Then compare the yields on these plots as to freedom from scab.

3. **Prepare seed potatoes** in three different ways for planting: (a) Cut each piece to have only two eyes. (b) Cut each piece to have four eyes, or this plot may have whole potatoes if small. (c) Use whole potatoes of about four ounces each. Plant each lot of potatoes separately, and at the end of the season calculate the differences in yield, and compare the yields with the weight of potatoes used for seed in each case.

4. **Compare the different methods of planting** as used in your region. Which methods are best suited for gardens? Which for large fields?

5. **The depth of planting** should be tested by starting the crop at different depths, as two inches, four inches and six inches. What advantages do you find of one method over another?

6. **Methods of Tillage.**—In a field or garden where the conditions are uniform, cultivate a few rows by very deep tillage, and the remainder by frequent shallow tillage. Compare the results and give your conclusions.

7. **Irrigation for Potatoes.**—Plot experiments may be conducted to show the benefits of irrigation. Does the potato crop need a large supply of water?

8. **Methods of spraying** as practiced by growers should be studied if possible during the spraying season. What size of machine would you choose for a five-acre field? What size for a small home garden?

9. **Different varieties** of sweet potatoes and of Irish potatoes should be collected and studied in the laboratory. The advantages claimed by growers for each variety may be considered in this connection.

10. **Fertilizer Tests.**—Grow both sweet potatoes and Irish potatoes in plots, using different fertilizers in each case. The value of different fertilizers for each kind of potatoes may thus be learned.

11. **Starting Sweet Potato Plants.**—Make a bed for starting sweet potato plants. Care for it by the best methods until the plants are grown, pulled and set in the field. Study among growers the different methods of setting plants, and the different methods of preparing the ground for the plants. Give arguments for the different degrees of enriching and explain the suitability of these different degrees to different soils.

12. **Storing Sweet Potatoes.**—If sweet potatoes are stored by dealers or growers, study the different methods in use and formulate, if possible, any fixed rule or method practiced by different ones.

QUESTIONS

1. In what ways do the varieties of Irish potatoes differ from each other?
2. Describe the soils best suited to the Irish potato, and tell what fertilizers are usually needed.
3. Give directions regarding the preparation of soil and preparation of seed for planting.
4. What are the common practices regarding methods of planting Irish potatoes in your section?
5. What kind of machines and what methods of cultivation are most practiced in the potato growing districts nearest you?
6. What are the two chief enemies which require the spraying of Irish potatoes and what materials are used for them?
7. Give methods of harvesting Irish potatoes.
8. Mention some different types and varieties of sweet potatoes and compare them in qualities.
10. What kinds of soil are best suited to the growing of sweet potatoes?
11. Describe the special preparation of soil for sweet potatoes. How are the plants propagated?
12. Describe the setting of the field.
13. What is the common practice regarding cultivation of sweet potatoes where you have seen it?
14. When and how is the crop harvested?
15. Give directions regarding the storage of sweet potatoes.
16. What is said regarding control of black rot and stem rot?

References.—United States Farmers' Bulletins: 295, Potatoes and Other Root Crops as Food; 324, Sweet Potatoes; 342, Potato Breeding; 365, Farm Management in Northern Potato-Growing Sections; 386, Potato Culture on Irrigated Farms of the West; 407, The Potato as a Truck Crop; 533, Good Seed Potatoes and How to Produce Them; 544, Potato-tuber Diseases; 557, The Potato Tuber Moth; 598, Storing and Marketing Sweet Potatoes.

Cornell Bulletin: 350, Potato Scab and Sulphur Disinfection. R. I. Exp. Sta., Bul. iii, Potatoes, Wash. Bul. 94, Potatoes, Test of Varieties.

CHAPTER XVII

SUGAR BEETS AND OTHER ROOT CROPS

THE growth of sugar beets on a commercial scale in the northern states is of recent origin. The crop is grown chiefly in northern or cool latitudes. The leading states in the growth of this crop are Colorado, California, Michigan, Utah, Idaho and Wisconsin. More than a billion pounds of sugar are annually produced from beets in the United States. The area devoted to sugar beets is unlimited and will probably continue to increase.

Relationships.—The sugar beet belongs to the same species as garden beets and mangel-wurzels. It is really an improved form of the latter. Much improvement was made in beets containing sugar about the year 1800 when the sugar supply from warm climates was cut off from Europe. During the Napoleonic wars further improvements were made by careful selection and the percentage of sugar was increased from about five per cent to fifteen per cent. The true sugar beet is white, while mangel-wurzels vary greatly in color. The latter grows with the fleshy root far out of the ground, while the sugar beet grows chiefly underground, the part extending above ground being very poor for sugar making. This makes sugar beets more difficult to harvest. Mangels are usually two or three times as heavy as sugar beet roots. The latter should weigh about one or one and one-half pounds. Mangels may contain five or six per cent of sugar, but the true sugar beet will average about fifteen to eighteen per cent sugar. Records of fields averaging twenty per cent in sugar content are not uncommon. Beet sugar factories usually buy the beets from the grower according to the tonnage, and sugar analysis. Samples of the crop are analyzed for sugar before payment is made. Yields containing a high percentage of sugar are, therefore, most profitable.

Soils and Fertilizers.—The best soil for beets grown under irrigation is sandy loam, but in humid climates, where the crop is grown without irrigation, medium or heavy clay loams are better, because of their moisture-holding capacity. If the crop is grown on soils containing too much organic matter a surplus growth of leaves is produced at the expense of the roots. Com-

mercial fertilizers are used, particularly where barnyard manure is not available. The fertilizer should be composed chiefly of phosphate—200 to 300 pounds per acre of acid phosphate may be used. If suitable manure is applied no nitrate is required, but

fifty to seventy-five pounds of nitrate of soda per acre will aid the young plants in making a vigorous growth early in the season.

The soil should be very thoroughly prepared by deep tillage the preceding fall. Early in the spring it should be deeply tilled with a disk harrow or maybe cross-plowed. The seed bed should be made very fine before planting time.

Planting.—The seed is usually drilled thickly in rows about eighteen to twenty-four inches apart. As the seed of the beet is low in germination, the seed is drilled much thicker than the plants are to stand. The so-called seeds are really seed cases, each containing several seeds. These reasons fully explain why thinning of beet fields is necessary. The drilling of seed is done both by hand machines and horse drills. The rows are marked and the seed drilled and covered at one operation. The depth of covering the seed varies from one-half inch in very moist soil to one and one-half inches in dry soil. When



FIG 170.—The long form of sugar beet root. After harvest the top slice with leaves is cut off at the mark shown in the figure. The part above is fed to stock. (U. S. D. A.)

fields are to be irrigated it is a common practice to drill two rows about ten inches apart and then leave from twenty-seven to thirty inches before drilling the next double row. This allows room for irrigating furrows with wide aisles.

Thinning Young Plants.—This is considered one of the most difficult parts of beet growing. Thinning should begin when the plants first form their second pair of leaves. Eight-inch hoes are used to remove most of the surplus plants. This work should leave the plants standing in bunches eight to twelve inches apart in the row. This first step in thinning is sometimes called bunching. The bunches are then thinned by hand, leaving only one strong plant in a place. By the work of thinning the individual beets grow large and the yield is heavier (Fig. 170).

Cultivation.—If the seed should not start promptly after planting the harrow should be used several times to keep the weeds under control until the plants are started. One cultivation may take place before thinning and another should follow immediately after thinning. If at this time the field is free from weeds



FIG. 171.—Students harvesting sugar beets on their school farm in Wisconsin.

probably no hoeing will be necessary. Several cultivations should follow to keep the soil surface in good condition, to stimulate the growth and conserve the moisture. After the tops shade the ground cultivation should cease.

Harvesting.—The beets are lifted from the ground by means of special beet lifters drawn by one or two horses. Sometimes a plow is used with a side prong at the back of the mold board, which aids in holding the beets up out of the soil after the mold board has lifted them.

The roots are then picked up by hand (Fig. 171), thrown into the piles, with one row of piles for each ten or twelve rows of beets. The next step is to remove the tops. This is usually done by hand with large knives, resembling large butcher knives, or small corn knives. As the tops are cut off the roots are thrown together—four small piles forming one large one.

Harvesting takes place late in the fall before the ground freezes. The topping may be done immediately, and if the crop is not marketed before the roots freeze they should be covered to avoid thawing. Freezing is not injurious if they are kept frozen until the sugar is extracted.

Yields of sugar beets vary from ten or fifteen tons per acre without irrigation, to about fifteen to twenty tons where conditions for irrigations are favorable.

By-Products—In topping the beets the slice above ground is cut at a single stroke. This furnishes a large amount of feed suitable for dairy cows and other livestock. It is usually fed in early winter while fresh. Sugar beet factories supply the beet pulp to farmers, after the sugar is extracted. This has been ground fine and may be fed to stock either wet or dry. It is now commonly known in the dairy sections as dried beet pulp and is usually soaked with water before feeding.

OTHER ROOT CROPS

There are a number of plants usually treated under the head of root crops because in several of them the stored food is found in the underground parts, or so-called roots. Because of the relationship to the root crops, several plants are here included, such as rape, kale, cabbage and kohlrabi. Several of the members of the group have the stored matter in the head above ground, as in the case of cabbage and kohlrabi.

The following table gives the yields, food value, and seed per acre for a number of crops treated under this head:

Comparison of Root Crops and Potatoes—Seed Required, Yield, Dry Matter, etc

Kind	Seed per acre	Average yield per acre	Per cent of dry matter in crop
Irish Potatoes.....	8-15 bu.	90-300 bu.	20
Sweet Potatoes.....	3-8 bu. for 10,000 plants.	10-300 bu.	30
Sugar Beets.....	12-16 lbs.	10-15 tons	13-18
Mangel-wurzels.....	6-8 lbs.	20-30 tons	9-12
Rutabagas.....	4-5 lbs.	19-20 tons	11
Common Turnips.....	2-3 lbs.	5-15 tons	10
Carrots.....	4-6 lbs.	10-20 tons	12
Parsnips.....	5-6 lbs.	10-20 tons	17
Kohlrabi.....	2-4 lbs.	12-20 tons	9
Cabbage.....	¾-1 lb.	10-20 tons	9

Mangel-Wurzels.—Comparison with Sugar Beet. This crop is not rich in sugar as compared with the sugar beet. It is grown in much the same way and throughout the same regions. The yields per acre are about double those of the sugar beet, and the mangel is therefore grown in preference to the sugar beet where the purpose is stock feeding.

The mangel-wurzel resembles the sugar beet in character of leaf and general habit of growth (Fig. 172). but the individual roots are usually much larger. A large proportion of the mangel grows above ground.

The soil requirements are much the same as for the sugar beet. If any difference is made in the fertilizer for these two crops, a little more potash should be used for the mangels.



FIG. 172.—Half sugar mangels, recommended as the most desirable for stock feeding. (Productive Feeding.)

Planting, Thinning and Cultivating.—The seeds are in clusters, as in the case of other kinds of beets, so that several plants are likely to come from each so-called seed. The seed is drilled in rows far enough apart to allow for the cultivation with horse cultivators. There should be from twenty to twenty-four inches between rows.

When the plants are forming their second pair of leaves, thinning should begin. A hoe eight inches in width is best for this operation. Cut all the beets in the row except small bunches left eight to ten inches apart. After the whole field has thus been "bunched," the next operation is to use the fingers and pull all the plants except the strongest one in each bunch. This process

is slow and tedious and greatly increases the cost of production of this crop.

After the thinning is completed, cultivation should follow immediately. Perhaps one cultivation will be necessary before this. Rather deep tillage is practiced at first, but it should be done with fine-tooth cultivators and not with large shovels, as it is not advisable to throw much of the soil toward the rows at this time, if at all. The cultivation should be frequent and should be continued until the tops completely fill the space between the rows. In moderately clean soil, no hand weeding or hoeing should be necessary at the time of thinning.

Harvest and Yields.—Harvesting may be done by plowing the roots up with a common turning plow and then they are picked up by hand and thrown into piles. This shakes off most of the soil. A row of piles for every ten to twelve rows of mangels is usual. They may lie in the field until danger of severe freezing requires that they be covered. Early fall frosts do not even injure the growing crop, and it will continue growing until the ground begins to freeze in the colder climates.

The yield should be from twenty to thirty tons of fresh beets, not including the tops. The best mangels will produce from 5,000 to 10,000 pounds of dry matter per acre after deducting the large percentage of water.

Storing Mangel-Wurzels.—If the roots are allowed to freeze they must be kept frozen until about time for using them. It is better not to allow the roots to freeze at all. They should be covered with coarse corn stalks, sorghum fodder, or other coarse material. A layer of this over a pile of the roots will be sufficient until severe winter weather. By that time the roots are well enough cured so that they may be covered with soil which is thrown on top of the litter. From such piles, the roots may be removed for feeding at almost any time during the winter, except in the most severe climates. It is better to have the roots in a cellar or root pit where they may be more easily obtained during the long periods of freezing. There is less danger of freezing the whole stock if the roots are in a room or pit that can be opened and closed conveniently.

Feeding.—Mangel-wurzels are used almost entirely for stock feed. They are specially valued for their succulence and are particularly good for milk cattle, sheep and hogs. Before being fed, they should be chopped fine or run through a root-slicing machine.

GARDEN BEETS are usually planted much earlier than the other types of beets, not because they are hardier, but because it is desired to get the crop earlier. They will withstand some late spring frosts and also survive the summer heat fairly well.

In the growing of beets for the table, it is necessary that they make a quick, continuous growth so that little, if any, woody tissue will be found. If the growth is checked by dry weather or from any other cause, the fibrous tissue becomes woody and the crop is less palatable, and perhaps not edible at all.

Young beets are always preferred in the market, and to secure a marketable product during all the summer season a number of plantings are made. These may succeed each other at intervals of about three or four weeks. The late summer or early fall planting should be given time to reach a desired size before the actual freezing of the ground. There is no time at which the roots may be called mature, as they are commonly harvested for table use in a young condition.

Canning factories put up the best crop while in the young stage and thus preserve the vegetable while in a palatable condition for winter use. The roots are also stored in cellars for sale and use during the winter, but the crop for this purpose should be in an advanced stage of growth, and many of the roots will usually be found to contain much fibrous material, but if their growth has been rapid and steady up to the end of the growing season, the roots may ripen without much of the objectionable fibre being developed.

Growing the Crop.—The soil conditions and planting are much the same as for other types of beets already described. As the roots are smaller, the rows may be grown closer together, and when the tillage is chiefly or entirely by hand tools, the distances between rows may be only twelve to fourteen inches.

The drilling of seed is usually done by hand and a little more care may be exercised than in the case of other beets which are usually planted in large quantities. Thinning is not practiced in the same way as with other beets. The seed itself is very similar to the others and the plants will come up too thick for their best growth, but the beet tops are valuable for cooking as greens and the thinning is delayed until a crop of greens can be harvested. The thinning is then done by hand as the crop of greens is picked. At that time the largest roots are left for further growth. Shortly after this more thinning can be done when the largest roots are

pulled, tied in bunches and marketed. Each row is therefore given several thinnings or pullings each time a crop is harvested. If the slowest growing plants in the garden become too fibrous for table use, they are used for stock feed. They may be pulled and dried at any time desired during the summer or fall, and are easily kept for a few weeks during feeding time.

SWISS CHARD.—Although this crop is classified among the root crops, it is used chiefly for the tops, which are served in two ways: They are either cooked as greens, or the thick mid-ribs of the leaves, including the lower stems, are served as asparagus.

Chard is sown in rows about fifteen inches apart to allow of a little tillage between the rows. The crop is started in early spring and may be harvested as soon as enough growth develops. If the tillage is good and the moisture conditions of the soil are favorable, the tops will become very large before they are too fibrous for table use. A large crop of greens is then secured. Before this, some thinning of the stand is necessary. A very young crop of greens is secured during the thinning process and the main crop is left standing at distances of five to eight inches. The main crop may be harvested by cutting without injuring the crowns, in which case a second growth will shoot up from the roots. If the leaves are broken or pulled singly without injuring the central bud of the crown, the plants will continue to produce new leaves and a perpetual crop is thus secured through the summer season.

This is one of the few crops of greens that endure summer heat. It is seldom seen in city markets, but is gradually becoming more popular as its merits are better known.

The crop may be forced to produce an early growth by starting the seed in hotbeds and transplanting the plants in the open garden as is sometimes done with spinach and garden beets. The plants are moved to the open garden after danger of spring frost is over.

CARROTS.—The common yellow rooted carrots with their finely divided leaves are well known in gardens and in city markets (Fig. 173). The roots are of several forms, the long cylindrical form, the short cylindrical form, and the long tapering form. Different varieties vary not only in shape, but also in color from white through yellow and orange to almost red.

This crop is grown chiefly for use on the table, but is sometimes fed to stock. Horses relish the carrots, and the crop is often used by horse feeders. The yield per acre is far less than that of mangel-wurzels, and the feeding value is very little, if any greater.

Growing the Crop.—A rich sandy loam is desired, but the crop will grow in any good garden soil. As the growth is very slow at first, and as the tops are very small, it is necessary to prepare the soil very thoroughly and have it very free from weeds at the time of planting. Some more rapidly growing crop as radishes or white turnips may be sown in the row with the carrots so that the early growth will help to mark the row while the carrots are growing to a sufficient size. Radishes and turnips will develop some size of root first and can be harvested before the carrots are crowded too much.

If the crop is grown for stock feed, in large enough areas to require horse tillage, the rows should be two feet apart or more.



FIG. 173.—Carrots for stock feeding (Improved Rubicon and Danvers Half-long), fairly easy to harvest and capable of good yields. (Cornell Station.)

More care must be exercised in early tillage of the crop than with most of the other root crops, as there is so much danger of covering. The horse has difficulty in keeping his place between the rows at first.

Special thinning may not always be necessary if care is exercised in planting, but it is usually found advantageous to pull the larger roots first, and at that time see that no bunches of roots are left to crowd each other. The first thinning may therefore be the first harvesting. If it is found necessary to do some hand weeding before any of the roots are large enough to harvest, the thinning work is perhaps best done at that time; but if clean culture has been practiced and if the soil is reasonably free from weed

seed, the crop may be produced with much more profit, as this extra hand work will be avoided.

During the summer season the largest roots are not desired in the market, but roots half grown or less are usually preferred. These are washed and tied in bunches with the fresh tops remaining on. To secure roots in best market condition during the growing season, it is necessary to make several plantings at intervals of three or four weeks.

The harvest of the main crop in the fall must be made before the ground freezes, although the tops will stand a little frost. The roots are harvested with much more difficulty than mangels or sugar beets, as they are smaller and many of the roots are apt to be covered as the plow turns up the row. Another method of harvesting is sometimes practiced. The turning plow is used to throw the dirt away from the row and then the roots are pulled by hand and thrown into piles. If the crop is to be stored for table use, the tops are usually cut off within a few days after pulling, and the roots are then stored in a cellar where they keep reasonably well. For stock use the tops need not be removed, but the crop is left in piles in the open for a longer period to let the tops dry more thoroughly. Feeding may begin immediately after pulling, and continue throughout the winter, if the roots are stored in a cellar or barn where they will not freeze.

RUTABAGAS AND TURNIPS.—The species *Brassica rapa* is the true turnip and the species *Brassica campestris* is the rutabaga. From the cultural point of view the two crops are very similar. The flesh of the rutabaga is usually yellow and the name Swedish turnip is often given to the group. The flesh of the true turnip is more commonly white. The shapes in both groups vary widely from the flattened form to the long cylindrical form. The rutabagas mature more slowly and the crop is easily kept through the winter feeding season.

Both types are grown for the feeding of stock (Fig. 174). This practice is not so common in America as in some parts of the old world. They are replaced here largely by mangels, because of larger yields of the latter. Pig feeders value the rutabaga highly.

Where both crops are raised the turnips should be used first and the rutabagas kept until later in the winter.

Growing the Crop.—Both of these crops are well suited to the cold, moist climates of the northern states and Canada. They prefer a loose, sandy loam, but will thrive in any rich garden soil.

They endure more cool weather than members of the beet family, and may therefore be planted earlier in the spring and grow later in the fall. It is not uncommon to sow the crop broadcast and give it no cultivation whatever. During the early growth the largest roots are pulled for sale or use, and this thinning gives more room for the development of other plants.

When planted in the home garden for table use the seed is often drilled in rows and the plants given some cultivation. Several plantings may be made during the season, but the turnips are not well suited to hot summer conditions, particularly in the middle and southern states. Plantings in early spring and in late summer or early fall will thrive better than crops started in hot



FIG. 174.—Rutabagas of the Bloodsdale variety, suitable for stock feeding. (Productive Feeding.)

weather. For the turnips about two months should be allowed for the development of the crop and three months for rutabagas.

In producing a crop for feeding to stock, one common practice is to sow the seed in a pasture from which the stock are excluded until the growth is well advanced. Then hogs and sheep may be turned in to harvest the crop. Another plan is to sow rutabaga seed in the spring with red clover in a grain field. After the grain is harvested the rutabagas will make a rapid development and may be harvested in the fall by pulling the largest roots. The remainder are left in the field as fertilizer or hogs may feed on them for a few days without serious damage to the growing clover.

RAPE AND KALE.—Although not true root crops, these plants by their relationship and uses may be treated under this head. *Brassica napus* is the Latin name of the rape plant (Fig. 175). In America the best variety known is Dwarf Essex rape. This is a true biennial, as its seed is not developed until the second season. The seed is inexpensive and the cost of starting the crop is small.

Kale belongs to the species *Brassica oleracea*. It is spoken of as a headless cabbage because the cabbage is of the same species. Kale is grown chiefly in the milder climates as a winter crop. But rape is grown in both the North and South as a late summer and fall crop. Both produce pasturage for sheep, hogs and cattle. They are both also harvested and used as soiling crops for dairy



FIG. 175.—Dwarf Essex rape is a succulent pasture for pigs and sheep. (Wisconsin Station, Productive Feeding.)

cows and other animals. Kale is extensively used as a salad crop and is cooked as greens. The leaves are cut near the crown and new growth is allowed to spring up, thus a continuous harvest is obtained so long as the season is favorable.

Movable fences are often used in pasturing a crop of rape or kale, as the results are much more satisfactory when the stock pasture it closely for a short time only, and then are moved to another part of the field. Less feed is thus wasted by the tramping of the animals. In feeding value they are both comparable with cabbage, rutabagas and mangels. As the growth is rapid and springs up quickly after each pasturage period these are highly recommended for use with swine and sheep.

Growing the Crop.—While these plants will thrive on light

soil, only moderately supplied with plant food, they thrive better on very rich moist loam. The seed is commonly sown broadcast, and if the crop is to be for forage the seed is mixed with barley or oats, and sometimes with winter or spring vetch to make a denser growth of pasturage. Kale is usually sown in late summer or fall and in mild climates will be green much of the winter season, some of the crop being harvested in early spring. Dwarf Essex rape may be sown at any time during the spring or early summer and the fall crop may be sown in August to be used as late fall pasture.

Either of the crops may be sown in drill rows, at distances which will allow of cultivation. Clean tillage is given during the early growth of the plants. This practice is more common with kale which is to be harvested for market purposes.

CABBAGE AND KOHLRABI.—These two plants differ chiefly in the place in which the food is stored. They belong to the same species *Brassica oleracea*. In the cabbage the valuable food is stored in the thickened leaves and their ribs. In the kohlrabi, the food is stored in the enlarged stem, which resembles a turnip growing above ground. The cabbage is more commonly used for stock feed than kohlrabi, because the yield per acre is much greater. Both are abundantly used as human food in regions where they are grown.

Growing the Crop.—These crops are both well adapted to cool, moist climates, and thrive best in very rich, black loam, provided with an abundance of organic matter and nitrogen.

Large fields of cabbages are grown for the manufacture of kroust and for sale in city markets. It is common to start the early crop in hotbeds or coldframes and to transplant the plants by hand or by machine transplanters in the open ground when the soil is ready to work in early spring. For this spring crop quick-maturing varieties such as Cumberland Wakefield and Early Jersey Wakefield are used.

The main crop, or so-called late crop, is often planted in the open in late May or June, and the work of transplanting is avoided. Several seeds are dropped in one place, and the hills are from two to three feet apart in the row, and the rows are set at the same distances. A little lime is dropped where the seed is planted to mark the spot and indicate the row by the color. This aids in the early cultivation, particularly if weeds start too soon. Suitable varieties for the crop are Late Flat Dutch, Drum Head, and other large-headed varieties.

Kohlrabi (Fig. 176) is a little more suited than cabbage to hot, dry climates of the southern states. This crop is usually drilled in rows about twenty-four inches apart, leaving room for cultivation. Thinning may be practiced to let the plants stand in the row about eight to ten inches apart.

Both these crops should be given frequent and thorough tillage during the early part of the growing season. After the leaves shade the ground, cultivation may be less frequent.

These crops are easily stored in long trenches on well drained knolls where the heads are carefully placed, roots upward, and



FIG. 176.—A thrifty plant of kohlrabi. The hard central portion is used in much the same manner as turnips. (Productive Vegetable Growing.)

then covered with corn stalks or coarse straw, and then with soil enough to prevent severe freezing. If there be warm spells after the crop is stored, there may be some damage from rotting. For this reason, root cellars are more satisfactory for the storage of these crops.

FIELD AND LABORATORY EXERCISES

1. **Sugar from Beets.**—In the regions of beet sugar factories, methods of extracting the sugar should be studied.

2. **The management of the beet crop** from the time it is shipped to the factory until it is made into sugar should be observed and reported.

3. **Beet Relationships.**—Compare the leaves and other parts of the plants and note the resemblance of sugar beets, mangel-wurzel, spinach, Swiss chard and garden beet.

4. **Grow some sugar beets** in the garden, using the methods described in this chapter. Study their development and calculate the yields. Interesting experiments with fertilizer may be carried on at the same time.

5. **Sprout some beet seeds** between wet blotters or wet cloths, and note the number of sprouts from each so-called seed. Can you decide why beet plantings always require thinning?

6. **Seeds of the Root Crops.**—Make a collection of the seeds of each of the crops mentioned in this chapter and compare them enough to be able to know each, if possible, when separated from the rest. What ones do you consider most alike? Make a description of such to bring out the characteristic differences.

7. **Comparing Farming Seedlings.**—Sprout a few seeds of each of the different kinds and note their differences when sprouting. This may be either in the garden or in a seed-flat in the laboratory.

8. **Preparation for Market.**—Visit a market where these and similar crops are being sold and study methods of preparing them for market. Which are considered most in demand?

QUESTIONS

1. Explain why sugar beets and mangel-wurzels must be thinned.
2. Give directions for the growing of the sugar beet crop.
3. Describe the steps in harvesting.
4. How are the beets kept until manufacturing time?
5. What is the chief by-product from the beet-sugar factory? In what two conditions is it sold?
6. Compare the root crops in yields per acre.
7. Compare them with sweet and Irish potatoes in percentage of dry matter.
8. What root crops are most easily kept for winter use? Which most difficult?
9. Describe a good condition for the storage of root crops for winter sale or for stock feeding.
10. Which ones of the crops of this group should be stored, and which used fresh?
11. Which are best if planted several times during the season?
12. Which of these crops are usually drilled in rows? Which are usually broadcasted?

References.—United States Farmers' Bulletins: 295, Potatoes and Other Root Crops as Food; 392, Irrigation of Sugar Beets; 567, Sugar-beet Growing Under Irrigation; 568, Sugar-beet Growing Under Humid Conditions; 618, Leaf-spot, a Disease of the Sugar Beet.

CHAPTER XVIII

VEGETABLE GARDENING

"To own a bit of ground, to scratch it with a hoe, to plant seeds and watch their renewal of life—this is the commonest delight of the race, the most satisfactory thing one can do."—WARNER.

THE word horticulture originally meant garden culture and the term was used to include all crops grown within the garden inclosure. As these crops were moved outward into fields their growth has continued under the name of horticulture. More recently the term has been subdivided and specialized terms have come into use. Olericulture is the growing of vegetables; pomology is the growing of fruits; and floriculture is the growing of flowers.

It is important that the farmer as well as the village resident should have his own home garden (Figs. 177 and 178). It will give much return in the form of fresh products for the table and greatly reduce the actual outlay of money for table supplies. The farmer's home garden and his "truck patch" should not be distinct. The table garden should be so closely associated with the truck patch that practically no extra work is required in caring for the former. One of the greatest objections to the home garden on a farm, where every one is so busy in the spring, is the fact that labor required in the small garden is very irksome. Most of it is hand work and back work. Men and boys alike commonly shun the task of caring for such gardens.

If the small garden is so connected with the large truck patch, where corn, potatoes, tomatoes and other extensive crops are grown, the hand labor may be almost entirely avoided, and the few moments required to plow or to cultivate the area for the small crops will be reduced to a minimum. Such crops as lettuce, radishes, spinach, peas, string beans, and others, that are grown on a small scale for table use, may each occupy a part of the long rows, and a few such rows at the side of the field where more extensive crops are grown will make it possible to use horse labor in preparing the soil for planting, in controlling the weeds and moisture, and very little hand work will be necessary. The use of hand wheel hoes under such circumstances is also possible.

Let the home garden be a place where the young members of the family can grow extra products for the early markets. Interest



FIG. 177.—Farmer's home vegetable garden, with long rows and ample room for tillage with a horse. (Productive Vegetable Growing.)

in the home garden will thus be maintained and from this the interest in the whole farm is stimulated. It may be a source of training in the proper methods of marketing, and some business training may also be acquired.

Soils for Gardens.—For most garden crops deep, black soil, rich in organic matter, gives best results. If very early crops are desired soils should contain more sand, but this is not always essential in home gardens. The depth to which the black soil extends is not so important for shallow rooted crops, such as lettuce, spinach and radish, but for beets, turnips, potatoes and other deep rooted crops it is essential that the good soil be very



FIG. 178.—Even North Dakota gardeners find it advisable to stake their tomato vines. It is more important in the moister climates of the East and South. (U. S. D. A.)

deep. If soils are very heavy they may be very much improved by large quantities of barnyard manure or green manure. If such a large amount is turned under at one time it should be done some weeks in advance of planting time to allow time for decay. Rolling the soil will usually hasten the decay, and if the harrow is used afterward the plants will suffer less from dry weather. On farms where much of the soil is very heavy a study of different fields, not too far from the residence, should be made with a view to selecting those containing the moist sand. After using all available methods for the improvement of the garden soil it may be easily warmed and aerated and produce even better crops than soils which are naturally light and dry.

Among the methods to be used in the improvement of the heavier types of soil are deep tillage (see Fig. 71) and occasional use of lime, particularly after organic matter has been plowed under. There should be care in the use of lime as it should not be applied to those portions of the garden which are to be used the same year for potatoes and other root crops.

A Compost.—Well rotted manure is best for gardens. The seeds are usually small, and coarse material as well as clods on the surface, are very objectionable. Make the surface fine and mellow. The farmer, in studying conditions for a good home garden can well follow the example of the market gardener. The latter plans ahead in preparing for a supply of well rotted manure. He usually keeps a compost heap rotting for use a few months later. To avoid damage to the manure in a compost heap it may be prevented from heating by leaving the surface flat so as to catch an abundance of rain, and to prevent leaching the manure is placed in layers alternated with thick grass sods or other absorbing material. The compost is much improved by moving it at least once during the rotting period. This is done by forking it over into a new pile, during which the layers are more thoroughly mixed.

Commercial fertilizers are often used by market gardeners and are most common where barnyard manure cannot be obtained at a reasonable cost. It should never become necessary to entirely abandon the use of green manure and barnyard manure. These help more in keeping up the proper texture of soil so necessary in good gardening. Commercial fertilizers, if used, should be supplemental to the others, and not entirely displace them. A good general mixture for use for either home gardens or for market garden truck is the following:

Nitrate of soda	250 lbs.
Ground bone	100 "
Acid phosphate	550 "
Muriate of potash	100 "

This has a composition of about four per cent nitrogen, seven per cent available phosphoric acid and five per cent potash. The rate of application for market crops may be about 800 pounds per acre, but the amount should vary according to the fertility of the soil.

Starting Early Plants.—There are a number of plants, such as early cabbage and others, that should be started earlier than the season will permit in the open field. Where small num-

bers of plants are to be used this can be done in window boxes or the plants raised by market gardeners may be purchased at the time they are to be transplanted. Where large numbers of plants are required a hotbed or coldframe is necessary.

Hotbeds are most suitable for the growth of early garden plants. They should be located in protected places where they can have free exposure to the sun and receive as little of the west and north winds as possible (Fig. 179). The frames are covered with glass and should be so constructed as to give the glass a good pitch toward the sun. If the frames are to be permanent, concrete walls may extend a little below ground and rise to suitable heights to give the desired pitch to the glass frames, which are laid on top of the concrete walls. Temporary frames may be made of two-inch lumber nailed to stakes driven in the ground at the corners



FIG. 179.—The construction, use, and management of a hotbed in winter should be considered by students in vegetable gardening.

of the bed. Movable frames are often used on farms. For such frames two-inch lumber is nailed to corner pieces, and a suitable size is about 6 by 6 feet for each frame. One strip across the top of the middle will divide the two lines of sash and will strengthen the frame. The source of heat in a true hotbed is chiefly from rotting manure. After the frame is in place it is properly banked on the outside, if not set in the ground. About one foot of fresh horse manure is firmly packed in the bottom. This is covered with about six inches of good garden soil, preferably containing a good proportion of sand. The glass is then placed over the frame and left until the manure begins to heat. When the temperature is favorable seeds may be planted. The proper degree of moisture must be studied closely and watering should be frequent, but only a little at a time. On warm days much danger may be done by

too much heat in the bed, if the glass is not raised to allow of proper ventilation. It is well to have suitable supports for the glass so that the ventilating may be done easily and to any degree desired. Sometimes hinges are used at one end of each sash and supporting rods with notches are used at the other end. There is less danger of damage to the glass by wind when hinges are used. As the plants grow larger and the weather is warmer the glass may be left open all day and closed at night. This will aid much in "hardening off" the plants before they are transplanted to the open garden. Thinning the plants in the hot-bed is usually necessary. A small bed may start enough small seedlings to fill a very large hotbed or coldframe when they are first transplanted. It is sometimes the practice of gardeners to transplant tomatoes, cabbage, head lettuce, cauliflower, egg-plant, peppers, and others more than once in the beds. Those transplanted without serious damage are handled in this manner. At the first transplanting they are set two inches or so apart, and at the second transplanting are set far enough apart to not crowd until moved to the garden. By planning the amount of space required for the first seeds and for the final beds the space required to be heated may be reduced to a minimum.

Coldframes.—Frames of suitable size, so that a person may readily reach from one edge to the center, may be covered with glass or muslin. If no heat is applied from below the soil it is known as a coldframe. Vegetable crops started in the fall in open coldframes may be protected through the winter and produce a rapid growth in very early spring when covered with glass or cloth. Kale, spinach, winter onions and other somewhat hardy vegetables may thus be grown. In reality the coldframe is a winter garden. Early spring crops of such small plants as radish, lettuce, and others which require little time may be grown from seed to maturity in coldframes. The coldframe is also useful for the protection of tomato plants and others which are to be "hardened off" before they are set in the open garden.

When plants are to be stored in coldframes through winter the frames should have some protective covering to be used over the glass when the weather is most severe. This protection may consist of woven mats of rye, straw, old carpets or feed sacks sewed together in strips a little wider than the coldframes. These coverings may be rolled from one end of the frame when they are to be removed. If properly cared for they may last for several years.

Transplanting the Garden.—The proper season of transplanting plants to the open garden differs somewhat with different plants. Those grown in hot beds are usually started there because they cannot be grown in the garden before late spring frosts are over. The gardener must know the hardiness of his plants, but has to take some risk regarding the weather. An early transplanting of a few plants may be risked and the bulk of the crop set out later. For the home garden this is not so neces-

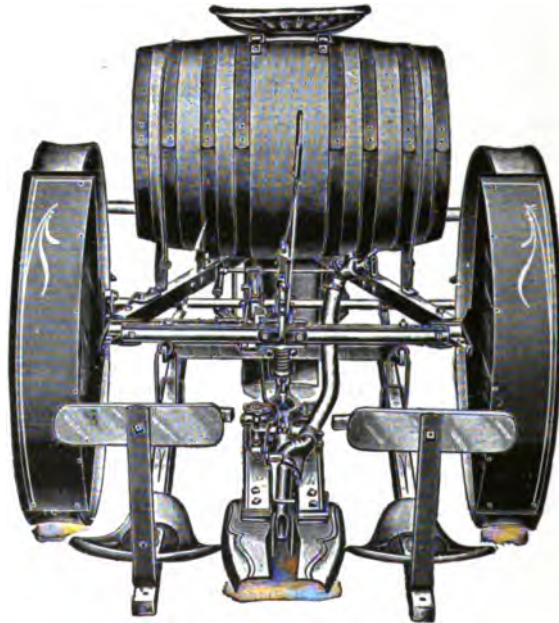

FIG. 180.—The transplanting machine is used on farms growing large crops of cabbage, cauliflower, tobacco and sweet potatoes. Water is supplied to each plant from the barrel. (see also figure 255.) (Productive Vegetable Growing.)

sary, but may result in a few very early vegetables for the table.

Transplanting is most successful on cloudy days or just before a rain. In small gardens plants may be set in the evening and watered when set. This will help to prevent wilting. It is best to place the young plants a little deeper in the soil than before. Very tall, slender plants may be placed somewhat horizontally in the soil so that much of the slender stem is under ground. If this plan is followed for tomatoes they will send roots out all along the covered part of the stem.

The soil for transplanting should be freshly prepared, in good condition of moisture, and as free from clods as possible. When the young plant is set press the soil down firmly against the roots, then put a little loose soil on top of the packed soil. This will prevent baking and reduce the loss of moisture. Watering at this time helps to pack the soil as well as to cause a quick growth of new roots. Loose soil should always be raked over after watering. Machines are often used in transplanting cabbage, cauliflower, lettuce, and some other plants that are not too brittle (Fig. 180).

TYPES OF GARDEN PLANTS.—Various vegetables grown in gardens may be classified as (1) hardy, not injured by white frost after sprouting; (2) tender vegetables, injured by slight frost either when young, or by early fall frosts. Plants of the hardy group may be started in very early spring as soon as the ground is fit to work, without regard to the possibility of heavy frosts occurring later. Seed or plants of the tender group should not be planted in the open until all danger of late spring frosts is past. A number of these plants are started in hotbeds much earlier.

Tender Plants.—Among tender vegetables may be mentioned beans of all kinds, corn, cucumber, egg-plant, muskmelon, okra, pepper, pumpkin, squash, sweet potato, tomato and watermelon.

Hardy Garden Vegetables.—The following is a list of the more common vegetables which may be started in very early spring or can stand at least a light frost: asparagus, beets, cabbage, carrot, cauliflower, celery, cress, endive, horse-radish, kale, lettuce, onions, parsley, potato, parsnip, peas, radish, rhubarb, salsify, spinach, and turnip. See the more detailed classification of garden crops in the next chapter.

Other Classes.—Gardeners often classify plants according to the treatment which they may require. Beans and peas are grouped together because they often require supports. The vine plants, such as cucumber, muskmelon, watermelon, squash and pumpkin, belong to the gourd family, and are alike in many respects. They have the same insect enemies, and the distance at which they are planted is very great. They are also warm weather crops.

Root crops, such as beets, rutabagas, carrots, parsnips, salsify and perhaps onions and potatoes require similar soil and soil treatment. A number of them have the same soil diseases and are badly affected by too much lime freshly applied.

Perennial garden plants, such as rhubarb and asparagus, are considered together, because they should be placed at one side of

the garden and not disturbed by plowing for the annual crops.

Salad plants include such crops as lettuce, kale, cabbage, cauliflower, celery, cress, endive, parsley and sometimes spinach. If grown in hot weather they are much benefited by shade, or by a wind break which keeps off the hot, blasting winds from the southwest. They also require similar soil treatment and are much improved by plenty of organic matter in the soil and a good supply of nitrogen, because a strong leaf growth is desired.

FIELD AND LABORATORY EXERCISES

1. **Manure for Garden.**—With a fork or spade, compare well rotted compost with fresh manure, and report which is more suitable for use in the garden.

2. **Prepare a mixture of commercial fertilizers**, using the ingredients recommended in this chapter for a market garden. The amounts may be reduced to ounces or grams instead of pounds if the exercise is to be carried on in the laboratory.

3. **Making a Hotbed.**—Students should make a hotbed by constructing a frame about 6 by 6 feet and using two pairs of sash or two regular hotbed sashes as a cover. Properly install the manure and soil and as soon as ready begin garden projects suitable to the season.

4. **Make a muslin-covered coldframe** of suitable size for growing some of the early garden crops, such as the starting of sweet potato plants.

5. **Transplanting Seedlings.**—A suitable exercise for one laboratory period is to transplant into tin cans or pots a number of seedlings that have been started in the hotbed or coldframe. Young tomato plants, cabbage plants and others may be used.

6. **Garden Seeds.**—Procure seeds of the types of garden plants mentioned in this chapter, and start at least some of each lot in the garden at the proper season.

7. **Home projects in growing vegetable crops** should be started by all students. Notes should be kept covering cost and time involved in each crop. Records of yields and income should be also reported.

8. **Canning Vegetables.**—Exercises in canning vegetables should be carried on at the school as practice. Materials for this, including cans and produce may be provided by members of the class or parents in the vicinity. The value of the canned produce should more than compensate for this.

QUESTIONS

1. Discuss good soils for gardens.
2. Describe the making of a compost for garden soil.
3. Give the composition of good commercial fertilizer to be mixed at home for garden use.
4. Give the advantages of having a hotbed for the home garden.
5. Give directions for the construction of a hotbed.
6. Distinguish between a hotbed and a coldframe. Tell how the latter is heated.
7. How are plants hardened off and why?
8. Give a list of garden vegetables that can stand the spring frosts.

References.—United States Farmers' Bulletins: 218, *The School Garden*; 255, *The Home Vegetable Garden*; 359, *Canning of Vegetables in the Home*; 460, *Frames as a Factor in Truck Growing*.

Manual of Gardening, Bailey, The Macmillan Co., N. Y. *Vegetable Gardening*, Watts, Orange Judd Co., N. Y. *Garden Farming*, Corbett, Ginn and Co., N. Y. *Productive Vegetable Growing*, Lloyd, J. B. Lippincott Co., Philadelphia.

CHAPTER XIX

THE CULTURE OF VEGETABLES

Well may we labor, still to dress
This garden, still to tend plant, herb and flower.

MILTON—*Paradise Lost*.

THE following grouping of garden vegetables is borrowed from "Productive Vegetable Growing," by J. W. Lloyd. It will aid the student in grasping the details regarding the many vegetable crops to have them grouped according to heat endurance, culture and uses.

LLOYD'S SEASONAL CLASSIFICATION OF VEGETABLES

I. COOL SEASON CROPS:—

1. Cool season crops that quickly reach edible maturity:

(a) Spring salads—

Leaf lettuce, *Lactuca sativa*.
Garden cress, *Lepidium sativum*.
Corn salad, *Valerianella olitoria*.

(b) Spring greens—

Spinach, *Spinacea oleracea*.
Mustard, *Brassica nigra*, *B. alba*, *B. juncea*, and *B. Japonica*.

(c) Short season root crops—

Radishes, *Raphanus sativus*.
Turnips, *Brassica rapa*.
Kohlrabi, *Brassica oleracea*, var. *caulo-rapa*.
Rutabagas, *Brassica campestris*.

(d) Peas, *Pisum sativum*.

2. Cool season crops that usually are transplanted:

(a) Spring crops that mature before the heat of summer—

Head lettuce, *Lactuca sativa*, var. *capitata*.
Cos lettuce or romaine, *Lactuca sativa*, var. *Romana*.
Early cabbage, *Brassica oleracea*, var. *capitata*.
Early cauliflower, *Brassica oleracea*, var. *botrytis*.

(b) Crops that make their principal growth in the cool weather of autumn—

Late cabbage, *Brassica oleracea*, var. *capitata* and var. *bullata*.
Late cauliflower, *Brassica oleracea*, var. *botrytis*.
Broccoli, *Brassica oleracea*, var. *botrytis*.
Brussels sprouts, *Brassica oleracea*, var. *gemmifera*.
Celery, *Apium graveolens*.
Celeriac or turnip-rooted celery, *Apium graveolens*, var. *rapaceum*.

3. Cool season crops that will endure summer heat:

(a) Root crops that endure summer heat but not winter freezing—

Beets, *Beta vulgaris*.
Carrots, *Daucus Carota*.

- (b) Root crops that withstand winter freezing as well as summer heat—
 Parsnips, *Pastinaca sativa*.
 Salsify, *Tragopogon parrifolius*.
 Horse-radish, *Cochlearia Armoracia*.
- (c) Greens that endure heat—
 Chard or Swiss chard, *Beta vulgaris*.
 Kale or borecole, *Brassica oleracea*, var. *acephala*.
 Collards, *Brassica oleracea*, var. *acephala*.
 New Zealand spinach, *Tetragonia expansa*.
 Dandelion, *Taraxacum officinale*.
- (d) Salad plants that endure heat—
 Parsley, *Carum Petroselinum*.
 Upland cress, *Barbarea vulgaris*.
 Endive, *Cichorium Endivia*.
- (e) The onion group—
 Onions, *Allium Cepa*.
 Leeks, *Allium Parrum*.
 Garlic, *Allium sativum*.
 Shallots, *Allium Ascalonicum*.
 Chives, *Allium Schænoprasum*.
- (f) Potatoes, *Solanum tuberosum*.
- (g) Perennial crops—
 Asparagus, *Asparagus officinalis*.
 Rhubarb, *Rheum Rhapanticum*.
 Globe artichoke, *Cynara Scolymus*.
 Sea-kale, *Crambe maritima*.

II. WARM SEASON CROPS:—

1. Warm season crops usually not transplanted:

- (a) Beans—
 String beans, *Phaseolus vulgaris*.
 Green shell beans (including Limas, *Phaseolus lunatus*).
 Dry shell beans, *Phaseolus vulgaris*.
- (b) Corn—
 Sweet corn, *Zea saccharata*.
 Pop corn, *Zea everta*.
- (c) Okra or gumbo, *Hibiscus esculentus*.
- (d) The vine crops—
 Muskmelons, *Cucumis Melo*.
 Watermelons, *Citrullus vulgaris*.
 Citron or preserving melon, *Citrullus vulgaris*.
 Cucumbers, *Cucumis sativus*.
 Gherkins, *Cucumis Amquria*.
 Squashes, *Cucurbita, maxima*, *C. Pepo* and *C. moschata*.
 Pumpkins, *Cucurbita Pepo* and *C. maxima*.

2. Warm season crops that require transplanting:

- (a) Tomatoes, *Lycopersicum esculentum*.
 (b) Eggplant, *Solanum Melongena*.
 (c) Peppers, *Capsicum annum*.
 (d) Sweet potatoes, *Ipomœa Batatas*.

Lettuce.—Select good, rich, moist soil in which to sow this crop, and keep it well tilled and watered, as this will ensure rapid growth, and tender, well-flavored heads. For succession crops, the seed should be sown about every three weeks. For an early

crop, it is best to start the plants in a hotbed, or in boxes in the house, and then set out in a well-prepared bed in the garden. Sow in late summer or early fall for fall and winter crops, using seeds of well-known hardy varieties. To protect the plants from freezing during severe weather, cover them with coarse straw. They will then head up in the spring. Or they can be transplanted under glass or a canvas covering to head up for winter use.

There are three main types of lettuce grown: Leaf lettuce, head lettuce, and Cos or Romaine lettuce. The last is more upright than the others. Head lettuce is most in demand for salad purposes, and it is this form which is most commonly transplanted. In Europe the Cos lettuce is most popular. It requires blanching to be of the best quality. When not blanched it may be used as garnish. This form of lettuce endures more summer heat than the other types.

Spinach.—This plant is grown exclusively for greens and is considered a splendid tonic. It is a cool season crop, and should be planted as early as possible, as it will run to seed as soon as warm weather comes. It will be ready for table use in from six to eight weeks. In the South this may be planted in the fall, and will winter with no protection, as a general thing.

When planted in the fall it is usually sown broadcast, but in the spring it is sown in drills about one foot apart, and should be well tilled until ready for use. The fall-sown crop is given no tillage. It requires good soil, rich in nitrogen, and thrives best in cool, moist weather.

One ounce of seed will plant 100 feet of drill. In sowing broadcast about one-fourth more seed should be allowed than if sown in drills.

New Zealand spinach is a hot weather plant. That is, it does not go to seed when the hot days come, but continues to grow. It is not a dense, compact plant like the ordinary spinach, but continually forms branches and new growth. These may be broken off and used, whereas in the other varieties the entire plant is pulled and used. The seed is sown in drills some distance apart, and the plants are thinned to one foot apart in the row, where they continue to grow during the entire season.

Mustard.—In the South this plant is grown as a winter crop and may be cut at almost any time during open winter weather. It is usually sown broadcast in September or October, but may also be sown in February or April. Early spring sowing is usually prac-

ticed in the northern states. Mustard is occasionally drilled in rows, but seldom cultivated between the rows. One ounce of seed will give about eighty feet of drill, and about five ounces will sow one acre. The white mustard has dark green leaves and is smoother than the black. The latter is stronger and more pungent in flavor.

Radishes.—This crop must be tender and crisp to be relished on the table. The growth must therefore be rapid and not checked by dry, hot weather. The soil must be rich, and too much manure is impossible, providing enough moisture is supplied. Make the first planting as early in the spring as possible, and sow at intervals of ten days or two weeks. As the largest roots are pulled more room is left for the others and no other thinning should be required. It is good practice to drill radish seeds along with beets, lettuce, onions, parsnips, carrots, salsify and others that make a much slower growth and that are very small when they first start. The quick growth of the radishes will mark the rows and aid much in the protection of the other plants during the tillage with hand tools or wheel hoes. As the radishes develop quickly they may be harvested in time to avoid crowding of the companion crops.

For fall and winter use certain varieties may be selected from catalogues and sown in August or September. Allow one ounce for fifty feet of drill if sown alone. Market gardeners often sow the crop broadcast in narrow strips across the garden. In such a plan allow eight to ten pounds of seed per acre.

Peas are dwarf, medium or tall and must be cared for accordingly, as the medium and tall ones will need support, while the dwarf ones will not. The latter are usually grown commercially, as they require less care.

Peas are either smooth or wrinkled, the smooth-seeded varieties being hardier, while the wrinkled varieties are considered of better quality, being sweeter in flavor.

They must be planted early, so as to mature the pods before hot weather comes. For this reason they are better adapted to the cooler northern summers. By making a succession of plantings, peas may be had during the entire summer and fall in the North, while in the South they must be planted very early. As they are hardy, they will stand the cold, frosty weather of late winter and early spring, and mature the pods before hot weather.

Planting may be done in double drills with a support of wire netting between. One pound of seed will sow 100 feet of drill. Two hundred pounds are required for an acre.

Germination may be hastened by soaking the seed for a time in warm water. Seed should be planted in light, rich loam. The drills should be far enough apart to allow horse tillage. The dwarf varieties do not need so much room. They are dropped one or two inches apart in the drills, and covered one or two inches in depth.

This crop is grown by the acre in localities where canneries are situated. In this case the seed is sown with grain drills and no further care is given. Varieties which mature their pods uniformly are used for this purpose, and when the peas have reached the desired stage, the whole crop is cut with a mowing machine.

FIG. 181

FIG. 182



FIG. 181.—Head of cauliflower poorly developed because of hot, dry weather. (Productive Vegetable Growing.)

FIG. 182.—A typical head of early cauliflower developed in a favorable season. (Productive Vegetable Growing.)

At the factory the peas are hulled by machinery, silage is made of the vines, and the peas are canned.

Cauliflower.—This crop somewhat resembles the cabbage, requiring similar treatment and cultivation, but is not as hardy. The soil should be rich in fertilizer and kept well watered during the summer (Figs. 181 and 182), and the young plants should be protected during extreme cold weather. The seed should be sown in a hotbed in January or February for an early crop, and the transplanting done when freezing weather is past. Sow in late spring or early summer for a late crop. The plants can be set about fifteen or eighteen inches apart in rows three feet apart and cultivated frequently, keeping them in moist condition. As soon

as they have attained a growth of at least two inches across the head, the outer leaves should be tied up in order to protect against sun and weather, and to blanch the heads. It also prevents them from becoming discolored or bitter. Sometimes the ribs of the inside leaves are broken and allowed to cover the heads. Cut for use as soon as the heads are hard and compact, otherwise they are not so good in quality.

This crop is usually badly attacked by the cabbage worm. To save the crop several practices are resorted to: Dusting the young plants with such powders as wood ashes, fine road dust, air-slacked lime or fine tobacco dust, and often Paris green is mixed with one of these powders. The dusting itself is chiefly to keep the white butterflies from laying their eggs on the plants where the worms which hatch from the eggs would eat the plants. The dusting is done while the early morning dew is still on the plants. This makes it stick better.

Broccoli.—This crop makes its chief growth in the fall. The plants are often started in the early spring in a hotbed or cold-frame, and the young plants are afterwards transplanted to the garden. They need much the same garden conditions as cauliflower.

For the fall crop, the seed is sown in the open in late summer, and the row is marked with a little lime dust as in the fall seeding of late cabbage.

Brussels Sprouts.—In many sections this crop is not well known. The cultural methods are similar to those for cauliflower and late cabbage. The plants may be started under protection and then transplanted in late spring to the garden. On the tall stalks are produced small heads resembling minute cabbage heads. These are considered rare delicacies, and are cooked and served in much the same way as cauliflower. The harvest is usually delayed until after some frosts have attacked the crop, as this improves the flavor.

Celery (Fig. 183).—This plant is considered especially valuable when the stalks are thick, crisp and tender, and blanched to a creamy whiteness. It is now a staple vegetable, and may be served in several ways—in salads, or the crisp stalks are carefully trimmed and washed and eaten raw with the addition of a little salt. It is also cooked. Celery contains certain medicinal qualities, and is valuable as a nerveine.

Seed sown from February to April will be ready to transplant

from July to October. Set plants six to eight inches apart in rows about four feet apart. It requires rich, fine soil, with good, clean culture in order to keep the young plants from being smothered by weeds. The young plants should be topped when they have attained a growth of about four inches. This will tend to make them stocky. It is better to set out the plants in August and September than earlier in the season, as they require less attention.

As winter approaches the stems should be blanched by being mounded with earth, or by setting boards on edge at each side of the row and filling in between with leaves or straw. This will blanch the stalks, and they may be easily removed whenever needed.



FIG. 183.—Celery may be easily blanched by banking it with earth. (Productive Vegetable Growing.)

To harvest the crop for winter use, dig up the plants with roots, and place upright in wet soil in a dark cellar. This will serve as a method of blanching.

Celeriac.—This is also known as turnip-rooted celery. It is easier to cultivate, as it does not require blanching, being planted solely for its roots which are used for salads and soups.

Parsnip.—This vegetable is higher in nutritive value than the turnip, and the yield is good if planted under favorable conditions, such as good, well worked sandy loam. It is very popular for table use, and is excellent for stock feed. Plant early in the spring, covering the rows lightly. One ounce of seed is sufficient for 200 feet of drill. As germination is slow in parsnips, it is well to sow a few radish seeds along with the others in order to mark the rows,

thus allowing early cultivation. The roots may be allowed to remain in the ground until after frost as they are improved in flavor by this method.

Salsify.—This is a very palatable winter vegetable, with long, white, tapering roots. When cooked and served with milk or cream it is thought to resemble the oyster in flavor, hence it is also known as the “vegetable oyster.”

The seeds should be sown in March or April, and the cultivation should be frequent in order to keep down weeds. A deeply-worked, very rich and light soil is necessary to produce a good crop, and coarse manure should be avoided, otherwise the roots will be badly shaped and uneven. This plant is very hardy and will stand cold weather. It is often left in the garden until mid-winter or early spring before the last is harvested.

Horse Radish.—The root of this plant is used as a condiment or appetizer, the roots being grated and stored in vinegar. In this form it is used on meats and some other foods. The plant is a persistent perennial, and will live indefinitely when it is once established in a corner of the garden. The plants are started by setting small fingerling roots in rows or in small beds. Bury the roots so that the crowns are about three inches below the surface in rich garden soil. Dig the crop in late fall before the freezing of the ground, and after washing thoroughly, grate the roots and preserve in vinegar. If this is carefully done, a very white attractive product may be obtained.

If the whole crop is taken up, the smallest roots may be stored and used next spring for replanting.

Collards.—This crop is another form of headless cabbage similar to kale. It however endures the hot weather of the southern states better than cabbage or kale. It makes excellent greens at any time in the year. Both kale and collards endure the cold and seem to be somewhat improved by frost. If the crop is desired in early spring when greens are most relished, the seed may be sown in early fall to produce considerable growth before winter. In regions where the winter is severe, the plants may be protected by a loose leaf or straw mulch after fall weather has begun. The plants may be started in hotbeds and transplanted in the open garden, but this method is too laborious to be commercially profitable. The seed may be sown either broadcast or in drills, the former method being more common. The culture and soil are the same as for cabbage.

Parsley is used for flavoring in salads and soups, and for garnishing. The seed germinates slowly, and must have plenty of moisture. The plants are hardy and may be planted early in the open ground, or started inside and transplanted to the garden whenever early cabbage is put out. The plants should be about six or eight inches apart in rows eighteen inches apart. By picking only a few leaves from each plant, the same plants will thrive throughout the season. They may be taken up in the fall and put into cold frames, or into boxes or flower pots, and kept in a sunny window all winter. The green leaves may also be dried in summer and used as flavoring for soups in the winter.

Upland Cress is another hot weather salad plant easily grown, and much liked by the few who cultivate it. It should be better known. Like parsley it will continue to furnish leaves if care is taken in gathering. It is used as a substitute for water cress. The seed is sown in drills in good garden soil, early in the spring. In the South a fall-sown crop may be grown for spring use.

Endive also endures the heat of summer. The leaves are much cut and very curly, growing in dense heads like lettuce. The flavor is bitter unless the plants are tied and blanched. Only a few heads are tied at a time as they rot quickly. Two or three weeks are necessary to blanch properly, and they must not be tied up on a rainy day. The plants should be thinned to one foot apart in rows which are eighteen inches apart. Good soil and good tillage are necessary. The crop is harvested in the fall.

Onions.--The onion crop includes also leeks, garlic, shallots and chives.

For the fall crop of onions, sow seed in early spring in very clean, rich soil. It should be particularly well drained because of the season at which the seed is to be started. Sandy loam is usually preferred, but it should be black and well provided with organic matter to produce the best crops. Drill in rows about fifteen or eighteen inches apart to allow of cultivation either by wheel hoes or by small horses. The plants will need thinning to about two inches apart. Practice clean and thorough cultivation and avoid the growth of weeds in the rows. As maturity of the bulbs approaches the tillage should be stopped so as not to start them into a second growth. As the tops begin to die, the onions should be pulled and if the weather is favorable leave them on the field exposed to the sun for several days. They are then put into shallow crates, care being taken not to bruise them. They may be hauled

in and either sold immediately or stored in a cool but dry place for future use.

Bunch onions for use or for sale, as green onions may be produced in one of two ways:

1. Sow the seed of Silver Skin or other hardy white variety of onion in late summer or early fall in soil such as that described above. They should produce a good growth that fall, and in the latitudes of Maryland and southward they should winter well with no protection. Farther north they may be given a slight mulching of clean straw during the winter. The crop is ready for bunching for market or for use early the next spring.

2. Onion sets may be planted a few inches apart in rows one foot apart. This is usually done in the very early spring. The crop is usually sold as bunch onions. It is produced quickly because of the store of nourishment in the onion sets.

There are three colors of onions popular on the market and each market or section seems to have a preference for one of the colors, either yellow, white or red. Seeds or onion sets of any of these colors may be chosen to suit local markets.

Leeks are sometimes considered superior to onions for soup flavoring. The culture and soil are similar to those for onions. Some hilling up of the soil at each side of the row is often practiced for the purpose of blanching the necks of the green plants. They are sometimes grown in coldframes during the winter to provide flavoring for use in the kitchen during the winter.

Garlic has such a strong penetrating odor that a small bit of it rubbed on the inside of the salad dish will flavor every morsel in the whole dish. It is also used in flavoring soups and vegetable dishes. The crop is propagated by small bulbs instead of by seeds. These are planted as onion sets and the mature bulbs are stored as ripe onions.

Shallot bulbs are matured in clusters all attached to the same base. These are broken apart and planted instead of planting the seeds. These are started in the early fall in southern states, where they may produce a good fall growth and remain in the garden over winter for use during the open winter days or in early spring. In the North, the bulbs are set out in early spring as is the practice with onion sets.

Chives grow in dense tufts forming a matted sod. The slender stems are used for flavoring purposes. When they are cut at any season, new growth will be quickly formed. Propagation is ac-

complished by division of the mass of roots either in the fall or early spring.

Asparagus is a perennial and should be planted in the permanent garden, where it may remain undisturbed for many years.

Some good variety should be decided upon and a good, deep bed prepared, on rich land that was manured the preceding year. It should be plowed in the fall for spring planting, and plowed again, very deeply, just before planting.

Seed may be planted and the plants raised at home, but the quickest and most satisfactory method is to plant roots, either one or two years old. They should be placed in rows four or five feet apart, about ten inches deep, or so the roots may be covered to a depth of six inches when the bed is leveled. The plants are put two feet apart in the rows. The furrows made for planting the roots should not be completely filled at first, or the shoots may never find their way through, the first season.

When they have started to grow, however, tillage should begin at once. A cultivator is used between the rows and a hoe close to the plants. With the latter tool, the earth is gradually worked in around the plants, so that by fall the bed or field is levelled. In the fall the tops should be mowed and removed from the field. This takes away some insects which might be harmful the next season. A mulch of manure should be spread over the bed to remain all winter. In the spring this should be worked into the bed before there is any chance of the shoots being injured. A disk harrow is good for this work.

None should be cut until the third spring—or two years from planting time. The first season the cutting should be light. After that the plants will be so well established that there will be no great danger of weakening them, unless the cutting is continued too late. Six weeks is as long as plants should be expected to yield without danger of permanently injuring them.

Each fall the bed should be disked and a generous supply of good manure spread on the field, or bed. This should be worked in again in the spring. The size of the shoots will depend more on the care and fertilization than on the variety planted.

Rhubarb requires a rich, moist soil, and an out-of-the-way place in the garden where it need not be disturbed, as it is a perennial and will live indefinitely if it receives proper care.

It may be grown from seed, but is usually propagated by root division, and the part of the root planted must bear a bud, or a

new plant will not be formed. The plants should be allowed plenty of room, at least a square yard of ground for each one. They should be kept well manured, as they require a great deal of available plant food for the quick, heavy, succulent growth they make in early spring. In the fall the manure should be placed entirely over the plants, and raked away from the crown in early spring.

This is one of the earliest succulent vegetables to be had, and is greatly relished for that reason. It has a medicinal value also. If it is desired extra early, a frame may be put around one or two plants and these covered with glass. This will force the plants.

When the leaf stalks become small, it is a sign the plant is getting past its best producing period. It should then be taken up and the root divided and the bed renewed.

Globe artichokes are not commonly grown. The edible portion of the plant is the undeveloped flower bud. They are cooked much the same as asparagus and are considered a great delicacy by the few who grow them, or those who buy them in the markets.

The seeds are sown under glass, or indoors, as early as February or March. The young plants should be shifted once, and planted to the open ground late in April. They should be placed in very rich soil, about four feet apart each way. This will allow for horse cultivation, which should be thorough. If planted early enough they may yield some buds the first year.

In the North the plants must be protected through the winter by covering them deeply (about twelve inches) with soil and perhaps also some coarse litter.

In the spring many suckers start from the plants, and these may be used in starting a new field, or bed. A small piece of crown must be taken with each sucker, the same as in the case of rhubarb plants. The artichoke is a perennial and may be given a permanent place in the garden, but the plants do well for only three or four years, after which time they must be renewed.

Jerusalem artichoke is a perfect perennial, persisting indefinitely. The root of this is the edible portion, and is used something like potatoes. However, this is usually grown for hog feed, and the hogs are allowed to do their own harvesting, rooting out the tubers.

Sea kale is a hardy perennial vegetable, used as a substitute for asparagus. The succulent leaf stalks are ready for cooking in the spring before asparagus comes up.

It may be grown from seeds or cuttings. The final bed should

have the rows three or four feet apart, and the plants two or three feet apart in the rows. Like asparagus the first crop can be taken in two years from setting time. The plants should never be allowed to go to seed, and should have annual applications of good manure, to produce strong, succulent growth.

The stalks must be blanched for table use. This is done by mulching with coarse litter, or covering the plant with a box or flower pot, or something that will exclude all the light.

Beans are annual plants and must be grown after the last spring frost and before the first frost of fall. Succession plantings may be made, and the season prolonged in the case of "snap beans."



FIG. 184.—Bush-lima beans in a young peach orchard. The crop pays for itself and for the tillage of the orchard. The beans gather nitrogen from the air and improve the soil. (New Jersey Station.)

One pint will plant nearly 100 feet. If planted by the acre for commercial purposes it will require from one and a half to two bushels per acre of seed.

Beans are used in different stages of development, as "snap" beans where the entire green, succulent pod is cooked in various ways. Others are shelled and eaten green, as Lima beans, called "butter beans" in some localities. Still other varieties are allowed to become entirely mature and are shelled and stored to be used in the dry state in winter.

There are some dwarf and climbing varieties of each type, and every taste may be suited in growing beans. Each gardener must

choose his own kind and plant what his gardening conditions will permit, or his market demands.

Beans require good soil, and deep, thorough cultivation before planting. Subsequent tillage should not disturb the roots. Dwarf string beans are very easily grown, and are probably found in every garden of any size whatsoever, in every section of the country. They are planted in drills or in hills, the rows being far enough apart to allow horse cultivation.

Pole varieties require support and are for this reason often planted with corn.

Limas (Fig. 184) require even better soil than other varieties, and being a little less hardy should be planted two or three weeks later in the spring. Where earliness is very much desired, Lima beans may be transplanted.

The varieties grown for winter use in the dry state are usually grown as a field crop, and sown with a grain drill. They are usually white seeded varieties, heavy yielding, and maturing evenly. They may thus be thrashed by machinery.

Beans belong to the legume family, and are one of the so-called "meat substitutes," being rich in protein. They form a valuable article in the diet and should be used freely in place of meat.

Corn—Directions for the growing of field corn are given in another chapter. The culture of sweet corn is quite similar. In order to have roasting ears continuously after the first harvest, it is advisable to make plantings about two or three weeks apart. At the first planting time it is a good plan to start with about three different varieties which mature in different lengths of time. A good selection of sweet corn would be: (a) Golden Bantam or Peep of Day. (b) Country Gentleman or Hiawatha Sugar. (c) Stowell's Evergreen. Two or three plantings of a variety from each of these three groups should produce a succession of crops to last throughout the roasting ear season. For those who desire very large ears with little sugar, a successor can be made by using Extra Early Adams and Early Adams, each being planted several times to produce a succession.

Roasting ears are badly affected with the corn ear worm. Where this insect is troublesome, varieties should be selected which have long husks covering the tips of the kernels. This never serves as a complete protection against the worms, but will help. Rotation of crops and fall plowing are standard methods for combating this insect.

Popcorn.—The cultural methods for growing popcorn are much the same as for other kinds of corn. The seed is usually planted by hand or with a common garden drill. The rows are marked off three feet apart and the corn may be drilled to produce a stand of plants about ten to twelve inches apart in the row. There are several types of popcorn, and if the crop is to be sold inquiry regarding the demands of the particular market should be made. Usually white varieties will sell better than the red, yellow or mottled. The rice type of white popcorn usually proves to be the most popular. When the crop is harvested, the husks should be removed from the ears and the corn spread in a clean, dry place for curing. An attic floor may prove suitable, providing mice are



FIG. 185.—Okra or "gumbo" is much grown in the South and used in soups, for frying, for boiling, and for pickling. (Productive Vegetable Growing.)

kept away. After drying for a few weeks, it may be put in sacks or bins where it can be protected from rodents. The best price is usually obtained about Christmas time, or late in the winter.

Okra or gumbo (Fig. 185) is a popular vegetable in the South, but less known in the North. The immature seed pods are cooked, and the smaller they are the more tender and dainty.

It is a hot weather crop, and the seeds are planted in good soil about the same time as corn and beans. They are sown in drills and later thinned to eight inches apart. As the seeds germinate slowly, better and quicker results are sometimes obtained by soaking several hours in warm water just before planting. Ordinary good tillage and care should be given the plants.

Muskmelons.—It is not easy to transplant this crop, though it may be done if conditions are very favorable, and much care is exercised. The seeds are usually planted in hills where the vines are wanted. Manure or fertilizer is placed in the hills with the seed, to force a quick growth, as they are naturally slow in starting and easily fall a prey to various insect enemies, while still small and tender.

The two types of muskmelons are the large and small fruited.

Soil for muskmelons should be very rich, with much available plant food, and well drained. Different soils and exposures have much influence on this crop. The soil should be warm when the seeds are planted. Then with favorable weather they will sprout and grow quickly past the danger from the striped beetles. About fifteen seeds should be planted in each hill. The hills should be about four feet apart each way on poor soil, but farther apart on soil which will cause more abundant growth of vines.

After the danger of attacks from various enemies is over, the hills should be thinned and only two or three of the strongest plants left. Cultivation should be deep and thorough, and continued as long as possible, or until there is danger of injuring the vines. Horse tillage may be used in large fields, with the addition of hand work close to the hills. In a small garden, hand hoeing alone may suffice.

Melon rust is another enemy of these plants. It can be controlled more or less successfully by spraying with Bordeaux mixture, using a weak solution.

In selecting muskmellons for the garden, a variety which shows well developed netting will be found the most satisfactory, as the flavor is usually much better than in those showing little or no netting.

Striped beetles attack the young plants and make short work of them unless great care is exercised. Repeated spraying with Bordeaux mixture in which some Paris green is dissolved will poison many. Others may be driven away with land plaster or sifted ashes. The odor of turpentine or carbolic acid will sometimes drive them away.

Melon lice begin their depredations when the plants begin to vine out. As the lice suck the juice of the plants, they must be killed by suffocation. Spray with kerosene emulsion or nicotine sulfate, or fumigate under tubs, using tobacco paper.

Watermelons are an important truck crop. They can be grown

a long distance from market because of their good shipping qualities. They require sandy soil and hot weather to produce the best melons. If grown in the North with any success they must have particularly favorable conditions, and the very earliest varieties must be used.

Growing in the loose, sandy soil as they should, very little preparation of it need be made at planting time. A few furrows may be turned, in which the hills are made at intervals of several feet. Rotted manure should be placed in the hills as in planting muskmelons. The field should be cultivated and hoed about the hills. The treatment for muskmelons may be followed in the case of watermelons with equally successful results.

Citron Melon.—This variety is sometimes known as preserving melon, and resembles a small watermelon. It is used for pickles and preserves. It has also another quality which makes it valuable to housekeepers. This is the abundance of pectic acid—that substance requisite in making fruit juices “jell”—which it contains. By adding equal parts of juice and pulp of the citron melon to such fruits as cherries, blueberries, or others which will not “jell” of themselves, one can make perfect jelly.

Cucumbers.—This crop requires a rich, moist soil, and should be planted in hills, thinned, tilled, and cared for about the same as muskmelons. In a small garden where only a few are desired for home use, they may be planted about a barrel which is partly sunk into the ground and filled with manure. This barrel is flooded with water frequently.

As cucumbers are nearly all used in the immature state, they are very frequently picked, when more will set on the vines. This may be kept up throughout an entire season. They are used in all stages. The very small ones are pickled whole. In fact, they are pickled in all sizes, up to the large dill pickles. The ripe ones are preferred by many cooks for making sweet pickles. The larger green ones are sliced and used as salad. For either purpose they must be used before the seeds harden.

Gherkins resemble cucumbers in their appearance and habits of growth, though they are more easily grown than cucumbers. The fruit of the true gherkin is small, oval and prickly. They make very fine pickles, but are hard to gather, being so small and prickly. A few vines will raise all one family will need.

Squashes.—There are two types of this vegetable—the summer and the winter squash. The summer squash is small and is used

in an immature state, so that frequently seeds, shell and all are cooked and eaten. They are often watery and flavorless. On the other hand, winter squashes mature well and the flesh is solid, fine, dry and of splendid flavor, making this vegetable highly prized by the housekeeper for winter use.

The summer varieties are more easily grown than the winter ones. They all thrive best in good, rich soil which is prepared the same as for melons or cucumbers. The planting and care are also the same, and the same kinds of "bugs" destroy the vines if given a chance. They make such rapid growth that they are likely to overrun other plants, and for this reason are not suited to small gardens, but should be planted out in a field where they have ample room for spreading out. Such varieties of squash as Hubbard or Winter Crookneck may be kept until late in the winter if placed in warm, dry atmosphere, where there is free circulation.

Pumpkins.—The pumpkin crop should not be neglected, for it yields one of the best kinds of pie material known to the human race. The kind known as "pie" pumpkins are grown especially for this purpose, though any kind may be used

Field pumpkins are often grown with corn and used for stock feed, though naturally they will grow a heavier crop if planted to themselves, and the richer the soil on which they grow, the larger the pumpkins will be. They are easily grown, and a good thing to have in every garden.

Tomatoes.—It is hard for us to think it possible that the tomato was once considered poisonous and was grown merely as an ornamental plant. In those days it was called "love apple." It is now one of the most universally grown and best liked vegetables to be found anywhere. So well is it liked that it may be found in its fresh state in the markets of all large cities about every month in the year. It is shipped long distances and commands a high price when sold out of season.

Few garden crops are more easily grown, or pay better for the care given them, and few vegetables are raised which may be used in such a great variety of ways.

The earlier the fruit matures the better, so an early start should be made with the plants by sowing the seeds under glass in hot-beds, or in boxes in the living-room window. They may be thus started two months before planting out time, and reset and re-potted until they will be of considerable size when they are put out. They should be gradually "hardened off" so they will be

able to withstand a light frost, should one occur after they are transplanted.

The soil should be of good quality and in a fine state of cultivation. A cloudy day should be chosen for setting out, or the work should be done toward nightfall, so that the plants will not wilt. In a small family garden they may be shaded through the hot part of the first few days to their advantage.

One of the most modern ways of growing tomatoes is to plant them rather closely together in rows, and tie them to wires which are stretched along the row. The vines are pruned considerably. This makes the fruit larger, and allows it to ripen better.

In whatever way they are planted, they should be well cultivated and kept free from weeds.

Unless dwarf varieties are used, the plants are commonly staked (Fig. 186). The stakes should be stout and about five feet long. One is driven beside each plant, and the plant tied to it with soft cord or strips of cloth. The fruit is thus given every advantage for growth and maturity, and the vines may be cultivated longer if they are tied up out of the way.

Pruning the vines may reduce the yield somewhat, and is not practiced to any extent in gardens where very few vines are grown. But late in the season when there are still many tomatoes on the vines which it is desired to have ripen, if the vines are well shorn of the many extra and straggling branches and tips of other branches, the sunlight will do much toward maturing the best of the fruit still left.



FIG. 186.—Tomato plants are sometimes pruned to a single stem and supported by tying to a stake. (Productive Vegetable Growing.)

If early frosts occur when there are still many good-sized green tomatoes growing, the vines may be pulled up by the roots and hung in the cellar or in some cool, rather dark place. Much of the remaining fruit will ripen. Another method of treatment is shown in figure 187.

If partially ripened tomatoes are picked for any reason and it is desired to ripen them, they should be wrapped separately in soft paper and put in a dark place, instead of being laid in a sunny window as is sometimes done.

There are so many varieties to be had it is hard to say which



FIG. 187.—Frost in the fall may sometimes be controlled by a spray of running water. This photograph was taken when the spray was frozen with icicles on tomato plants, but the water was kept running until the heat of the sun allowed no more to freeze. This saved the plants and the fall crop.

is the best. Personal preference and the use to which the crop is to be put must be the guides in selecting those to be planted. For home use and home canning, one would probably choose different varieties than for shipping or for a canning factory.

Such diseases of the tomato as leaf spot and fusarium wilt may be prevented by spraying in advance, with Bordeaux mixture. If Paris green or arsenate of lead be added to this, it will take care of the tomato worm at the same time. See directions for preparing Bordeaux mixture in Chapter XXX.

Egg plant is a hot weather crop. It does not thrive if the plants are set in the garden too early, but to get an early start the seeds

may be sown in hotbeds in very early spring, and one or two plantings are made in the beds. After all danger of frost is over and the cut-worms are gone, the plants may be transplanted to the garden and put in rows about three feet apart and at nearly the same distance between the plants in the rows. Rich black soil is preferred.

Frequently the plants are badly affected with flea beetles, or other leaf-eating insects. They should be dusted with tobacco dust, or sprayed with arsenical poisons, the latter being more effective. Black Beauty and Improved Purple are two varieties popular among market gardeners.



FIG. 188.—Sweet peppers are harvested in both the green and ripe condition. (New Jersey Station.)

Peppers.—(Fig. 188). This is another hot weather crop. The plants are started in hotbeds in early spring and transplanted after all danger of frost is over. The plants are set about two feet apart in rows three feet apart. Very rich soil is preferred. It is almost impossible to apply too much manure if enough moisture is present. Clean culture should be practiced until danger of breaking over the plants.

Two kinds of crops are harvested from the same plant, the green peppers and the ripe peppers. Some markets handle both the green and the ripe peppers and consumers often use both kinds.

The culture for the small hot pepper is similar to that of the

other peppers, but as the plants are much smaller they are set closer. A large crop of sweet peppers could be marketed with much more ease and profit than even a small crop of the hot peppers.

FIELD AND LABORATORY EXERCISES

1. **Market Gardens.**—If possible, visit the grounds of a market gardener and make lists of the crops he grows in succession in various parts of his garden. Make a separate list of his crops sown in late fall. Determine from this what crops will survive during the winter in your climate. What crops does the market gardener consider best for hot, dry weather? Determine if possible what crops are not injured by spring frosts.

2. **Home Gardens.**—Several of the points called for above may be determined from home gardens raised in the neighborhood.

3. **Garden Contests.**—Home projects in garden work should be started. Let contests be arranged for largest yields, greatest income from a given area, as one-tenth acre.

4. **New plants not familiar to the students** may be assigned; let one or more students try each of the new crops and report results to the others.

5. **Contests for Earliness.**—Valuable points in contests are earliest production of certain specified crops, as first radishes, first peas, first sweet corn, first string beans, and others.

6. **Starting early hotbeds** should be assigned for laboratory practice. Students may work in groups of two or more.

7. **Early plantings in hotbeds and coldframes** should be made profitable to the school. At least enough should be realized to pay for their cost of operation, including the hauling of manure, soil, and the replacing of broken glass or other covers.

8. **Canning exercises** should be conducted, either with the regular canning outfits or with steam and barrel as suggested in another chapter. Lady members of the class would do well to have practice in and preparation of vegetables in new ways, making them palatable for the table. A number of exercises along this line may prove profitable. The drying of corn and the drying of fruits are good exercises in connection with this chapter.

9. **Methods of Growers.**—If possible, study the methods of different growers in the culture, harvesting, preparation for market and selling of the leading money crops of the region. For example, the following where they are grown: Onions, rutabagas, asparagus, rhubarb, sweet corn, greens, beans, peas and others.

10. **Cost-accounting** in connection with the production of vegetables is important and gives an opportunity for good practice by young people.

QUESTIONS

1. Give the main divisions of the seasonal classification of plants.
2. Mention five crops of each main division, and state the subdivision for each.
3. What are the advantages of classifying garden crops by seasons?
4. Describe the culture of loose-leaf lettuce and head lettuce.
5. Compare the different forms of lettuce.
6. What vegetables of the early hardy group should be planted several times for the sake of freshness?
7. Compare the pea crop with the snap bean crop in every way you can—hardiness, season, time for maturing, succession, ways of marketing, etc.

8. What vegetables in the seasonal list have you ever seen growing? Which have you eaten?
9. Describe the methods of growing a few of those you have not seen grow.
10. What are the differences in habit of growth between crops of the cabbage group—early cabbage, late cabbage, kale, broccoli, cauliflower, brussels sprouts and kohlrabi?
11. Give the special uses of paraley, endive, celeriac, garlic, and horse radish.
12. Give directions for the growing of asparagus.
13. How are cantaloupes and muskmelons managed for the production of an extra early crop?
14. Compare the growing of tomatoes with and without staking.
15. What other vegetables have you seen managed according to different methods? Explain the differences for a few of these.

References.—United States Farmers' Bulletins: 61, Asparagus Culture; 62, Marketing Farm Produce; 196, Usefulness of the American Toad; 204, The Cultivation of Mushrooms; 220, Tomatoes; 232, Okra: Its Culture and Uses; 254, Cucumbers; 282, Celery; 289, Beans; 354, Onion Culture; 433, Cabbage; 434, The Home Production of Onion Seeds and Sets; 553, Popcorn for the Home; 554, Popcorn for the Market; 559, Use of Corn, Kafir and Cow Peas in the Home; 642, Tomato Growing in the South; 647, Home Gardening in the South.

American Varieties of Beans, Cornell Bulletin 260. Planting the Home Vegetable Garden, Cornell Reading Courses No. 58. Vegetable Growing, Mass. State Bd. of Agr. Bul. 5. Cabbage Seed Beds, Protection, N. Y. State Bul. 234. Asparagus, N. J. Exp. Sta. Circ. 57.

CHAPTER XX

COTTON GROWING

"I wish I were in de land ob cotton,
Good times dar am not forgotten, look away.
Look away, Dixie Land."
—*Negro Melody.*

COTTON is the leading fibre crop of the world. There are no records of when it was first grown. It is now the leading crop of the so-called cotton belt, including the states south of Virginia and Tennessee and extending west to include Texas and Oklahoma.

Not only is the fibre of great value in the production of thread and cloth, but the seed is of great value for the production of oil, stock feed and high grade fertilizer. The yield of seed is about twice as heavy as the lint. The cotton crop in 1909 was estimated in value at more than eight hundred million dollars. This included both seed and fibre. This is approximately forty per cent of the world's product. If the world's crop were baled in ordinary bales of five hundred pounds each, and the bales placed in a line along the equator they would form a belt reaching one and one-quarter times around the earth. Practically all nationalities of the world use cotton grown in our southern states. About two-thirds of the cotton and cotton seed products grown in the United States are exported to other countries.

The cotton plant belongs to the botanical group known as the Mallow family, to which the hollyhock, althea and other familiar plants belong (Figs. 189 and 190). The best cotton plants are strong and bushy and grow to a height of about four feet. In climates where frosts form, cotton is an annual plant.

Types of Cotton.—There are four leading types of cotton:

1. Sea Island cotton is suited to low, moist soil and moist air, and is grown in the coastal regions scattered about the shore of South Carolina, extending south into Georgia and Florida. The lint separates entirely from the black seed, leaving it naked. The fibres are very long and sell for a high price in the market, being used to mix with the other types of cotton.

2. Upland cotton is of two main types, hairy and smooth. Both are suited to inland culture. The hairy variety is the chief one grown in the United States and produces the bulk of our

product (Fig. 191). The staple is shorter than in the smooth type. The seeds retain the fuzz and are slightly greenish in color.

3. Tree cotton is grown in India. It is a perennial plant living for several years and grows many feet in height. The fibre is very fine and short.



FIG. 189.—Flowers of the cotton plant showing the resemblance to the mallow, hollyhocks althea, etc. (U. S. D. A.)

4. India bush cotton is more commonly grown in India. It is characterized by having small bolls bearing few seeds.

Varieties.—There are many named varieties and strains of upland cotton in use in the southern states. These differ from each other in resistance to diseases, their productiveness, earliness of

maturing, length of lint, size of boll, shape of plant and other features. It is possible for a grower to select the variety which suits his purpose best and then by annually selecting seed with great care from among the plants of his field or seed plot, he may improve the strain or make it more suited to his soil surroundings and his own ideals. Varieties which mature their crop in a short period of time, make their growth rapidly and have short internodes and have short boll stems or limbs are most resistant to the attacks of the boll-weevil and are more popular in sections where the boll-weevil has become injurious. The King type of variety fulfills these requirements fairly well; it is of the small-boll type. Besides the true King variety may be mentioned Peterkin and Welborn, which are of the same type.

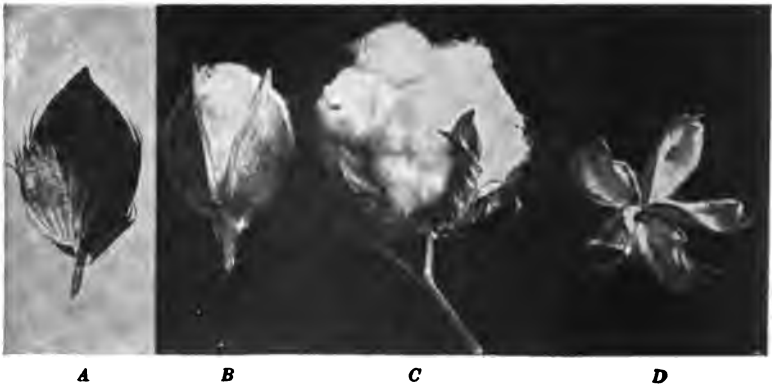

FIG. 190.—Stages in the development of the cotton boll. A, the unopened boll; B, boll partly opened; C, boll fully opened showing locks of fibre; D, the empty pod after the lock-cotton has been gathered. (Productive Farm Crops.)

The big-boll type is also much desired by some growers. The size of boll under this type seems to be associated also with its resistance to storm, as the bolls do not open and expose the lint so badly as some others. Varieties of this type are Duncan, Texas, Stormproof, Jones Improved, Russell and Truitt.

Another popular type of upland cotton is known as the long staple type. The lint brings a higher price in the market, but the yield is usually not so great. Good varieties of the long staple cotton are Allan, Cook, and Griffin. In these the boll is long, slender and pointed. The seeds are rather large and weigh more than twice as much as the lint after ginning. As long staple varieties are late in maturing they are not used in the boll-weevil districts.

There are several other groups of varieties, but the three types mentioned are much more popular than the others.

Judging Cotton.—Methods of selecting seed have been discussed in the chapter on Breeding.

The grower should not only keep in mind the characteristics of the plant, bolls, maturity, productiveness, early and rapid fruiting, and influences of environment, but should also bear in



FIG. 191.—A typical cotton plant of the Dixie wilt-resistant variety. Note the short-internodes and the compact habit of the plant. (U. S. D. A.)

mind the market requirements for the product he is growing. The following scale of points is used in judging both the upland cotton and Sea Island cotton:

SCORE CARD

	Counts.
Size of bolls.....	15
Length of lint.....	20
Fineness of lint.....	10
Yield.....	20
Uniformity in length of lint.....	7
Strength of lint.....	10
Per cent of lint.....	18
Total.....	100

Preparation for the Crop.—Cotton will grow on almost any soil where the climate is favorable. The plants of upland cotton will adapt themselves to varying conditions. If the soil is poor and light the plants will be very small and yet produce a few bolls; while if the soil is heavy silt or a rich clay loam the growth and yield will be proportionally larger. Rich black soil of river bottoms and prairies is most productive.

If cotton is to be grown on the same field in succession, it is best to plow the soil in the fall as early as the preceding crop can be picked. Stock are often allowed to pasture on the plants after picking, but the returns from this practice do not compensate for the loss of the time in preparing the soil. Plowing in early fall will add the stalks and weeds to the soil as green manure. These begin to decay immediately. Insect enemies of cotton, such as boll-worm and boll-weevil, are best kept in check by fall plowing. This also prevents a fall growth of cotton from seeds and old stems, which would maintain the boll-weevils until they go into winter quarters.

The old plants are dragged down and may be cut to pieces with stalk-cutters to aid in plowing them under. It is well to grow a winter cover crop of winter grain mixed with crimson clover. If this is started in early fall the growth will produce a good crop for the winter grazing of stock, and will improve the soil when turned under or disked under in the spring before the new cotton crop is planted. The stock feed and the manure will pay well for the extra labor.

There are two methods of preparing the soil for seed: (1) In the older method, still much used, two small furrows are thrown together with a small turning plow, which may be drawn by one animal. A small ridge or bed is thus formed for each row of cotton, the intervening spaces between the rows being left unbroken until later. It is broken with a double-mold-board plow or "middle-buster." This bedding plan has the advantage of warming the soil easily and is favorable for wet sections and poorly-drained lands. (2) A second method is now used on the larger plantations and the farms of those who realize the value of using more horses and mules for each man. The ground is all plowed with disk plows or turning plows, by the use of the most efficient implements and more horse power. No ridges and beds are necessary for the warming of the soil if the tillage is deep and a few weeks are allowed between plowing and planting time. The frequent

use of the harrow during the interval will warm the soil and thoroughly aerate it, and will allow the surface water to penetrate enough to be out of the way.

Planting.—The time for planting cotton is after all danger of frost is over. It is usually begun in April and is completed before the middle of May. In the ridge or bed method of starting the crop a furrow is opened in the middle of the bed and the seed is planted with one-horse drills. Good planting machines open the furrows, plant the seed, and cover it in one operation. The space between rows in either the level culture or the bed system varies from two and one-half to five feet, according to the size of plants and the richness of the soil. The plants are seldom grown in hills or in rows both ways, but this method is gradually coming into more general practice. It is more common to drill the seed in the row, and later thin the plants to a distance of one or two feet, leaving a single plant in the space. The seed is covered with one and one-half to two and one-half inches of soil, depending chiefly upon the moisture and texture of the soil.

Fertilizing.—Cotton is not hard on the soil if the lint only is sold from the farm. If the cottonseed is fed to farm animals, and the manure well cared for and returned to the land, the soil may be kept up by the use of green manures without the use of commercial fertilizers. On farms where the manure is wasted, or on farms from which the entire drop of seed and lint is sold, it is necessary to use commercial fertilizers to maintain the fertility of the soil.

Where commercial fertilizers are used two hundred pounds of acid phosphate per acre will be enough. This is applied to the field about two weeks before planting time, or is sometimes drilled during the operation of seeding. The fertilizer attachment of the drill should distribute the chemical in such a way as to prevent it from coming in contact with the seeds. On farms where little or no green manure is turned under it is advisable to use fertilizer containing organic nitrogen, such as cottonseed meal, or tankage. This may be applied with the acid phosphate. Potash as a fertilizer for cotton is not much used, except on light soils.

Culture of the Crop.—The process of removing surplus cotton plants from the rows is called chopping. This is done by hand with heavy hoes. The most vigorous plants are left standing. Weeds are removed from the row at the same time. Before the

chopping begins it is sometimes the practice to use a small turning plow in the field and throw a little of the soil away from the plants. This leaves a narrow row to be cleaned with a hoe. A cultivator or plow is then used in such a way as to throw some dirt toward the plants. The subsequent cultivation of the cotton should be frequent and shallow. About five thorough cultivations will save much of the hand work, but hoeing by hand, chiefly for the purpose of removing weeds in the row, is usually found to be necessary.

Two-horse Cultivators.—Two-horse cultivators should be used if it is possible to do so, as the work is more rapid and the results usually more satisfactory (Fig. 192).



Courtesy Planet Jr. Company.

FIG. 192.—Two-row riding cultivators at work in a field of young cotton. (Productive Farm Crops.)

In the level system of planting, used on the larger plantations, the fields are usually harrowed or gone over with weeders before the thinning takes place. This destroys many weeds and keeps the surface of the soil from becoming hard or crusty. A few of the cotton plants may be killed by the operation, but this may be a benefit rather than a detriment. By using weeders several times the seeds of weeds and grasses are sprouted and killed. The field is much freer from weeds later in the season and the hand work is reduced to a minimum.

By careful planting much of the work of thinning is obviated. If the cotton seed be well selected and tested the stand will be much more even and this will save some of the work of thinning.

Picking Cotton.—Several machine pickers have been invented

and tried, but they pick so much trash, such as boll-bracts and leaves, that none of them are yet very extensively used. Picking the cotton by hand is usually cleaner, although the harvest is slow and expensive. Negro labor is used. The season is a joyous one for the pickers and the singing of southern melodies adds charm to the operation and takes away the monotony of work. A good picker has nimble fingers and passes rapidly along the rows picking the locks of cotton with the seeds from the open bolls. About one hundred and seventy-five to two hundred pounds of seed cotton is a day's work. This is placed in bags hanging from



FIG. 193.—Upland cotton in Mississippi, ready to harvest. The yield is very promising.
(U. S. D. A.)

the shoulder of the picker, who is usually paid according to the amount picked. The prices paid to pickers vary according to the scarcity of labor, the character of the yield, and the evenness with which the crop matures. The price per hundred pounds of seed cotton varies from forty to eighty cents, or may be even higher in some localities.

Two or perhaps three pickings are made, the first beginning in August or early September. Varieties which mature evenly and early, as in figure 193, may be harvested by October, but cotton-picking often continues through November and perhaps into December. Late picking subjects the crop to loss by wind and

storm. Lower grades of cotton are likely to result from late picking.

Yields.—If five hundred pounds of lint are obtained from one acre the yield is considered very good, the average for this country being less than half this weight. Much larger yields are often produced on rich soil by good farmers.

Ginning and Baling.—Public gins are to be found throughout the cotton belt (Fig. 194). Suction pipes are used to lift the seed cotton, delivered in wagons by farmers. It is usually passed through cleaners before going to the gin proper. The work of the



FIG. 194.—A typical cotton-gin house in the rural district of the cotton belt. Note the basket of loose cotton entering at the top. After ginning the fibre is baled. The seeds piled at the rear of the house may be stored in the shed until taken to the oil press. (U. S. D. A.)

gin is to remove the seeds from the lint. This is done by means of circular saws which remove the lint on their teeth as they revolve at rapid speed. Brushes are so placed as to remove the lint from the saw teeth. The cotton is then passed in great layers into receivers, and is ready for baling (Fig. 195).

The lint is now comparatively clean, and is pressed into large rectangular bales weighing approximately five hundred pounds, and containing about thirty-five cubic feet. Coarse bagging is used to cover the bales, which are held together with iron bands. More careful protection of the cotton with good bagging is coming into practice.

The cotton should also be protected from injury by weather until marketed. When exposed to rain it is somewhat damaged, but the loss by this means is sometimes more than balanced by the increase in market price while it is held. Good packing and tight baling will do much to avoid damage to cotton during the storage period. Cotton is sometimes put in round bales which are made under heavy pressure. Rebaling or further compression is then not necessary.

Sea Island cotton is often ginned with machines of different types from the common saw gins. The seeds in this type of cotton are naked and are easily separated from the lint by means of rollers.



Courtesy Johnson & Johnson.

FIG. 195.—Interior view of gin showing the cotton as it comes from the gin ready for baling.

The roller type of gin was in use in India for centuries before the invention of the American machine by Whitney and Holmes, in 1792.

The invention of the gin and its development into the modern saw tooth cotton gin has done more to advance the cotton growing industry than anything else. The slow process of removing the seeds by hand greatly increased the cost. Only about one pound of lint could be removed from the seed in one day by the average workman.

Market Classes or Grades of Cotton.—In the markets cotton is closely graded and the price varies according to the grade. The market standards or grade names of cotton in order of value

are: (1) fair, (2) middle fair, (3) good middling, (4) middling, (5) low middling, (6) good ordinary, (7) ordinary. These principal grades are subdivided into intermediate grades by prefixing, the word "strict" to any of these names. For example, strict good middling is a half grade better than good middling. Quarter grades are sometimes indicated by prefixing "fully" to indicate a quarter better, and "barely" to indicate a quarter poorer than the principal grade. Little cotton is marketed from the southern states of a higher grade than strict good middling.

In the markets, grading is done by experts who take into con-

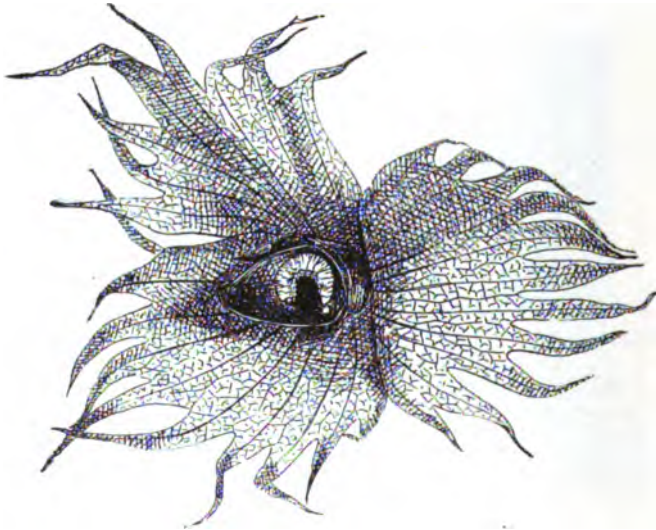

FIG. 196.—Square of cotton showing attack of boll-weevil larvae.

sideration the length and strength of fibre, the color, the amount of immature fibres, called "nap," the presence of trash, and the presence of damaged cotton, or other sources of loss when the cotton is being cleaned and used by the spinners. The length of fibre influences the price more than it does the grade of cotton. Long staple cotton is of much value for mixing with short staple, and adds much spinning quality to cotton.

Insect Enemies of Cotton.—The boll-weevil and the boll-worm are the worst insect enemies of cotton. The boll-worm has long been an injurious insect in cotton fields, but the boll-weevil, which was known in Mexico for many years, was first found in southern

Texas in 1892. Since that time it has advanced northward and eastward quite rapidly over the cotton belt, extending the radius of its area about one hundred miles in one year.

The boll-weevil will completely cover the cotton growing states by 1930, unless some natural enemy destroys it. Thus far no work of man can stop its spread, but much has been done through the efforts of the national government and experiment stations to reduce the enormous damage due to the ravages of this insect.

The adult beetle is reddish brown in color and about one quarter inch in length. The eggs are laid in the young "squares" as the bolls are then called. Egg laying begins soon after the petals fall from the flowers. In warm weather the eggs hatch quickly, and the larvæ eat their way into the young bolls, destroying much fibre (Fig. 196). A larva will become full grown in about ten days. It then transforms into a pupa, in which condition it rests and transforms into the adult beetle or weevil, which emerges a few days later. The chief injury is done by the larvæ feeding within the bolls, but the adult weevils also puncture the bolls in feeding. This insect multiplies very rapidly. In the extreme south there are sometimes five generations in one season and four in its northern area. Four females may have as many as a million descendants in one season.

The winter is passed in the mature or weevil stage. From this it has been found that the best method of fighting the insect is to destroy the adult weevils in the winter. They prefer to hide in empty cotton burs, stems of cotton and similar litter in the cotton field. They sometimes spread to hiding places adjacent to cotton fields. Fall plowing, which has been suggested, is one of the best ways of destroying the hibernating weevils. It is well to also clean up the hedge rows and road sides adjacent to cotton fields. This is sometimes accomplished by burning or by mowing and raking off the litter.

The boll-weevil seems to greatly prefer the young squares as a place to lay its eggs. If cotton is planted early, and rapidly grown, so that many of the bolls will be developed beyond the stage desired by weevils, so early in the season that there are not many insects to attack them, a good crop of cotton may result in spite of this serious enemy. Later in the season squares which continue to form will be completely destroyed by weevils which have become abundant by that time. Selection of quick maturing varieties, early rapid growth, the use of stimulating fertilizers,

fall plowing to destroy adult weevils, cleaning up the adjacent grounds, the burning of any stalks which are not plowed under, the prevention of fall volunteer cotton—all of these methods have been learned and are more generally practiced since the advent of the Mexican boll-weevil.

The boll-worm is the same insect which is more commonly known in other states as the corn ear worm.

The adult moth is said to lay as many as one thousand eggs for one generation. These are often deposited on young corn silks. When the larvæ hatch they find their way to the tip of the ear and produce the effects commonly seen on green corn. If no young corn is growing, the adults will lay their eggs on cotton plants, preferring the leaves. Here the larvæ feed on any tender parts, especially the buds. If poison is applied to the growing cotton the larvæ will be destroyed. As the larvæ grow they attack the bolls of growing cotton and much damage is done. When full grown the larva burrows its way into the ground a few inches, where it passes the pupa stage, emerging in a few days in the form of a mature moth. Five generations are usually produced in a summer in warm latitudes. Early in the season there may be enough young corn to prevent the adults from laying their eggs on cotton plants to any great extent. Later in the season young ears of corn are less abundant and insects turn their attention to cotton, where fresh buds and young bolls are always to be found.

Preventive measures are now well known and practiced by the best cotton growers. The same methods which were recommended for combating the boll-weevil are applicable here. The growth of any early variety of cotton will do much to produce a good crop before midsummer, when the boll-worms abandon the corn crop and attack cotton.

By growing trap crops of corn near the cotton field a succession of green succulent ears may be produced throughout the season and the attacks on cotton will be almost entirely prevented. A few rows of corn are planted at different seasons on all sides of the cotton field, or perhaps in strips across it. This corn will produce enough good stock feed to pay for the cost of the method.

Poisoning the cotton plants is sometimes extensively practiced. This should be done at the season when the boll-worms are apt to abandon the corn fields, because of the advancement of the corn. The poisoning is done more commonly by dusting than by spraying. Paris green, mixed with ashes, road dust, lime, or

other material for diluting it, is applied by different dusting methods.

Fall plowing, which is so destructive to boll-weevils, is also very destructive to boll-worms. The pupæ pass the winter in the ground. By fall plowing they are turned up and destroyed by the weather and by birds. In sections where fall plowing of corn fields and cotton fields is commonly practiced the boll-worm is no longer a serious enemy.

Cotton Diseases.—Probably the greatest cause for the attacks on cotton by fungous diseases is due to a continuous growth of the crop on the same fields without rotation. Cotton diseases, when once introduced, may develop so rapidly as to practically destroy the crop. With these diseases, as with other plant diseases, prevention is more important than cure. Among the most serious diseases of cotton are cotton wilt and root rot.

Cotton wilt is caused by a fungous growth which attacks the young plants through the root-hairs in the soil. It is sometimes called black root, because of the change in color of the roots within. The growth of the threads of fungus close the ducts in the roots and stems and prevent the plant from obtaining water. The growth of the young cotton plants is immediately checked; they turn yellow and die. Resistant varieties or strains may be developed by careful selection. In fields where the disease exists certain plants are sometimes found which have resisted the disease. Seed should be saved from such plants. Rotation of crops is the best preventive. The disease is most common in the southeastern cotton states.

Cotton root rot is chiefly confined to the western part of the cotton belt and is common on the stiff black soils of Texas. The fungus which causes this disease produces a whitish thread-like growth on the surface of the roots. The growth also enters the roots. The surface may become darker and wart-like bodies often appear. As the disease lives in the soil, fall plowing is helpful. Rotation of crops will largely control the damage. Grasses and small grains may be used in the rotation, as they are not affected by this disease. Alfalfa and sweet potatoes are sometimes attacked by the same fungus and should not be used where cotton root rot is known to exist.

Cotton-growing Machinery.—Cotton seeding is chiefly done by planters drawn by animals. The machine resembles a one-horse corn planter, and indeed is used for both purposes. A fertilizer attachment is commonly used.

Two-horse planters are used on the larger plantations and resemble corn planters in operation.

Cotton is too frequently cultivated with "middle busters" and turning plows. In the modern cotton culture fields are prepared by turning the soil entire, and breaking the middle between rows is not necessary. By this plan the cotton cultivating machinery is used for most of the cultivation. As the large roots of cotton reach deeper than in the case of corn, deep tillage, particularly in the early stage of growth, is not so objectionable.

Cotton pickers are of several types, but most growers consider them impracticable, and none of the inventions have become popular. The most practical form of picker is that which uses the principle of the vacuum cleaner by which cotton is drawn into a bag by the suction of the machine. As this draws with it the bracts, leaves and other impurities, the harvested crop requires much cleaning.

Digestible Nutrients and Fertilizing Values of Cotton.—The following table gives the composition of cotton seed and its products. It shows also the fertilizing constituents.

	Dry matter in 100 lbs.	Digestible parts in 100 lbs.		Fertility in 1000 lbs.		
		Protein.	Carbohydrates (+ fat × 2.25).	Nitrogen.	Phosphoric acid (P ₂ O ₅)	Potash (C ₂ O)
Cotton seed	89.7	12.5	68.9	29.4	10.5	10.9
Cottonseed meal.....	93.0	37.6	43.0	72.5	30.4	15.8
Cottonseed hulls.....	88.9	0.3	34.0	6.7	4.3	10.4
Cotton seed, roasted....	93.9	7.9	47.8	26.9

FIELD AND LABORATORY EXERCISES

1. **Cotton Type Samples.**—Obtain samples of the different types of cotton grown in all parts of the world. Some of the samples may be obtained by correspondence with teachers or students in different cotton regions. Arrange the samples of fibre between two pieces of glass and bind the glass on the edges with black paper, or in small wooden frames. Each of the samples should be labeled, giving the type name, variety name, and region where grown.

2. **Variation in Cotton Plants.**—In the cotton belt obtain plants characteristic of each variety grown in the region, or near enough by, so that reasonably fresh samples may be obtained. Study the differences regarding habit of growth, number of bolls, arrangement and number of flower stems, length of internodes, size of bolls, weather-proof features, earliness of maturity and other points.

3. **Grading Cotton.**—If possible, visit a cotton market where cotton is

graded and practice grading different lots of cotton after the market methods are learned.

4. **Cotton Insects.**—Obtain samples of boll-worm, and boll-weevil, each in different stages of development. Place these in bottles of formalin for study from time to time. Samples showing cotton diseases may also be collected and preserved either in formalin or by mounting as dried specimens.

5. **Paying Cotton Pickers.**—Fields of cotton may be visited and methods of checking and crediting the work done by each picker should be learned. Which of the methods is best? Give your reasons.

6. **Cotton Fertilizers.**—Calculate the yields on different plots where different fertilizers are used and where different varieties are grown. Such an exercise may be used as a home project where cotton is grown.

7. **Selecting Seeds.**—Practice selecting seed before the main crop is harvested.

8. **Methods at Gins.**—Visit one or more gins and study the methods of handling the incoming loads, the methods of baling, the disposal of seed, the disposal or use of waste, and other features about each gin.

9. **Cottonseed Oil and Meal.**—If possible, visit a mill where oil is extracted from the cotton seed. Learn what uses are made of the oil and to what markets the products are shipped. What percentage of protein is found in the cottonseed meal? For what is the meal used?

QUESTIONS

1. Compare cotton with other fibre crops in uses and popularity.
2. What are the chief types of cotton?
3. What are the differences in varieties of cotton?
4. Give the main points to be considered in judging the cotton crop.
5. Describe the best preparation of soil for cotton.
6. How should good seed be selected?
7. Give directions regarding fertilizing and cultivation to combat the boll-weevil.
8. Describe the ginning and baling of cotton.
9. What are the market classes of grades of cotton?
10. Give full directions for combating the boll-weevil.
11. Give the trap crop method of controlling boll-worm.
12. Mention two cotton diseases and tell how to control them.

References.—United States Farmers' Bulletins: 36, Cotton and Its Products; 47, Insects Affecting the Cotton Plant; 48, The Manuring of Cotton; 209, Controlling the Boll-Weevil in Cotton Seed and at Gineries; 211, The Use of Paris Green in Controlling the Cotton Boll-Weevil; 217, Essential Steps in Securing an Early Crop of Cotton; 223, Miscellaneous Cotton Insects in Texas; 286, The Advantages of Planting Heavy Cotton Seed; 290, The Cotton Boll-worm; 302, Sea Island Cotton; 364, A Profitable Cotton Farm; 500, The Control of the Boll-Weevil; 501, Cotton Improvement Under Weevil Conditions; 512, The Boll-Weevil Problem; 555, Cotton Anthracnose and How to Control It; 577, Growing Egyptian Cotton in the Salt River Valley, Arizona; 591, The Classification and Grading of Cotton; 601, A New Method of Cotton Culture and Its Application; 625, Cotton Wilt and Root Knot; 735, Red Spider on Cotton and How to Control It.

Comparative Spinning Tests of the Different Grades of Arizona-Egyptian with Sea Island and Sakellaridis Egyptian Cotton, Bulletin 359, U. S. Dept. Agriculture.

CHAPTER XXI

MINOR FIBRE CROPS

Close at her father's side was the gentle Evangeline seated,
Spinning the flax for the loom, that stood in the corner behind her.
Silent awhile were its treadles, at rest was its diligent shuttle,
While the monotonous drone of the wheel, like the drone of a bagpipe,
Followed the old man's song, and united the fragments together,
—LONGFELLOW, *Evangeline*.

FIBRES are used by man in the manufacture of fabrics for clothing and other purposes. Ropes and cables are also made from fibres. Commercial fibres are either of animal or vegetable origin. The chief animal fibres are wool and silk. Plant fibres are formed from cells of plants. The commercial forms are obtained chiefly from cotton, flax, hemp, Manila hemp, Sisal hemp, jute, ramie, Maguey, Istle or Tampico fibre, New Zealand hemp. Only those commercially grown in America will be discussed in this chapter.

FLAX

This crop is grown for its fibre as well as for its seed, but it is for seed that it is chiefly grown in America. (See Chapter on Small Grains for a discussion of flax as a grain crop.)

Flax Fibre.—If a flax stem be examined, it will be seen that the central portion is largely filled with pith. Surrounding this is a wood layer, then a band composed of clusters of long fibrous cells. This is called bast. Outside of this bast is the middle bark, and then the outer bark or epidermis. It is the bast layer which produces the fibre of commerce. The separation of the fibre from the other tissues is considered later in this chapter.

Relationships.—Flax is the most prominent member of the flax family of plants. It is from the genus *Linum* that we get the name linen, this cloth being made from flax fibre.

The wild toad-flax is a closely related plant found in the northern and eastern states. The western Indians used a wild species of flax for making cords, nets and baskets.

The origin of flax growing is prehistoric. Indeed, the most ancient records tell of the use of this crop for the production of fibre. Egyptians and Hindoos apparently used the fibre for the manufacture of cloth, but there is no record of the ancient use

of the seeds for oil and for stock feed. Wherever flax has been grown in different parts of the world, plants are found to spread from self-sown seed, and will run wild everywhere.

World Producers of Flax.—The crop was early introduced into the northern states and Canada where it is now abundantly grown.

Russia grows nearly four-fifths of the world's supply of flax—about one million tons. The Argentine Republic produces the greatest amount of flax seed, the United States ranking second. North Dakota is by far the largest flax producing state. Minnesota and South Dakota each produce nearly one-half as much. The last census shows one and one-half million acres for North Dakota with an average yield of about eight and one-half bushels of seed per acre.

Description.—Flax is an annual plant with a rigid upright stem and a rather straight tap root. If grown thickly there will be very few side branches on the roots and stems. The mature plants reach a height of one to two feet, depending upon the soil, season or variety. The flowers are five-parted with light blue petals, followed by a large seed case in which a number of seeds are borne. The leaves are narrow and pointed.

Growing the Crop.—Flax is seldom grown on old soil. It is well adapted to virgin prairie soil of the northwestern states and Canada. After a number of crops are grown, the yield rapidly becomes less, and wheat or grain is then grown. The reduction in yield is attributed to flax diseases rather than to loss of fertility of the soil.

In preparing the soil, the sod is killed by turning over in thin slices. This is preferably done in the late fall preceding the planting. In early spring, a disk harrow may be used to cut up the surface, and the seed is drilled with the ordinary grain drill. If the plowing is not done until spring, the planting should be followed with a roller to repack the soil as the crop grows best in a firm seed-bed.

Well-cleaned seed should be obtained for seeding, and about three pecks to the acre should furnish a good stand of plants, if the main purpose of the crop is the production of seed. On the other hand, if the object is to produce fibre, about eight to ten pecks of seed is sown. As flax is susceptible to frost, it is sown as early in the spring as possible to escape injury from spring frosts, and is harvested in the fall in time to escape the early fall frosts. A period of about 10 days is the minimum in which the crop may be produced.

Harvesting.—A common grain binder is used for harvesting flax when it is grown for seed. The bundles are placed in shocks and may remain for some weeks without injury. The ordinary

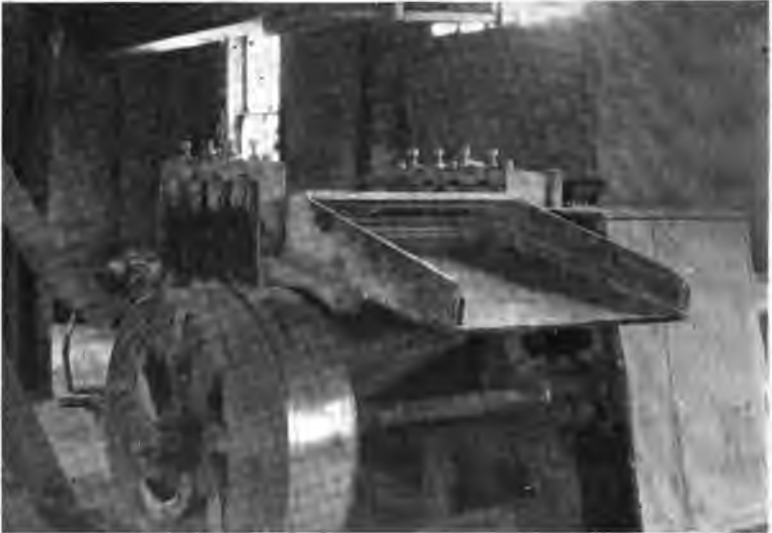

FIG. 197.—Fiber flax in Michigan. The flax is pulled by hand, tied in bundles and cured in shocks, and when dry the farmer sells it to the scutching companies, who thrash the seed, and ret, break and scutch the straw. (U. S. D. A.)

FIG. 198.—Flax brake. Four pairs of fluted rollers, with an interrupted or partly reversed motion to give a rubbing effect, through which the dew-retted straw is fed rather slowly and only a handful at a time. Two men will break 300 to 500 pounds of fibre per day. (U. S. D. A.)

grain thrashing machine is used for separating the seed from the straw. After the thrashing is over, the seed may be stored for future marketing, or may be hauled directly to market from the

thrashing machine. The flax straw which has run through the thrashing machine is not used as a high grade fibre. It is, however, sometimes put through a retting process and a low grade fibre is obtained for use in making fibre tubs and other vessels, and sometimes a fibre useful in making bagging.

High grade flax fibre is obtained from a different variety grown densely on the field. Harvesting of the crop for this purpose is done chiefly by hand (Fig. 197). No weeds or other refuse materials are allowed to become mixed with the flax. The roots are pulled up, as much of the best fibre is in the stubble and roots. As much hand labor is involved in this work, the chief production of high grade fibre is less profitable in America than in Central Europe and Russia.



FIG. 199.—Flax hackles. Dressed or hackled flax is prepared by drawing the scutched fibre first over the coarse hackle, then over the finer ones, combing out shives and coarse and tangled fibres. (U. S. D. A.)

During the harvesting process the fibre is tied in small bundles of about one handful each. Afterward the seed is thrashed out by hand or by pulling the bundle between rollers. The small bundles of straw are then spread out for the retting process. The purpose of this is to prepare for the removal of the fibre from the pith, wood and bark of the stalks. Retting consists in spreading the straw on the ground or clean grass where it remains for several weeks exposed to the rain and weather. The next step is to put the straw through the breaking process. By use of sticks, wooden mallets or some simple machine (Fig. 198), the straw is broken in very short joints. This in itself will remove much of the refuse material from the fibre. The fibre is then put through the scutch-

ing process, which is beating with paddles, or combing the fibre through revolving rollers and then through long comb-like rods (Fig. 199). After all of the foreign material is removed, the fibre is ready for sorting and baling. The bales contain about 200 pounds each. It is then ready to be spun into thread and woven into cloth. Pure linen is made from the flax fibre, but much of the fibre is combined with cotton during the manufacture. The coarser fibre is called tow and is used for twine, for upholstery and for bagging.

Flax wilt is the chief enemy of this crop. It is almost completely prevented by treating the seed with formalin solution, which is made by mixing one pound of formalin (40 per cent strength) with 40 gallons of water. Immerse the seed for ten minutes and spread it out to dry before planting. The solution may be applied by sprinkling it on a pile of the seed on a clean barn floor. When the disease is not prevented it stunts the growth of the plant and gives the impression that the soil is deficient in plant food. Growers call it "flax sick soil."

HEMP

This plant has been in cultivation for thousands of years. It belongs to the mulberry family and is related to the hop, osage orange and mulberry tree. It is a native of Central and Western Asia, where it was doubtless first used and from whence it has travelled across the continent of Europe and throughout the world. The crop in this country is produced chiefly in Kentucky and Tennessee, but smaller quantities are produced in New York and Nebraska.

Hemp is an annual plant and must be grown after spring frost and before fall frost. It has a rank growth reaching a height of eight to twelve feet. Two kinds of flowers are borne upon separate plants. The staminate plants are less branched than the pistillate plants and their fibre is more valuable.

Any good corn soil will produce a crop of hemp, but in Kentucky and Tennessee it is chiefly grown on the blue grass soils of the central parts of those states where limestone formations are found. Rich nitrogen soils produce increased yields. In America the waste parts of the plant are usually left in the fall and the fibre and seed only are removed. In this way the drain on the soil is very light.

Seeding is done a little before planting time, and the seed is sown broadcast at the rate of five or six pecks per acre. This should be on well prepared soil, but if the ground has been plowed the same spring the seeding should be followed with a roller to make the soil firm again.

As the growth of the plants is very rapid, they soon smother out any weeds and no trouble is likely to be found from this source.

When the first seed begins to ripen, about 100 or 110 days from seeding time, the crop is cut, if wanted for fibre, but for seed it is left until a larger proportion of the seed is ripe. The methods



FIG. 200.—Harvesting hemp. Most of the hemp in the United States is cut with self-rake reapers, leaving it in gavel on ground. After drying it is either cured in shocks to be retted later or in the North spread for retting immediately. (U. S. D. A.)

of harvesting are varied to suit the rankness of growth. Heavy, thick stems are usually cut with a corn knife and the crop is laid in piles on the ground to ret or rot. If the stems are not so coarse, a reaper or self-rake mower is preferred. After exposure for a few weeks to the rains and dews, the stems are tied in bundles and put in shocks or small stacks, or as usually practiced in America, the stems are broken in the field and the waste parts are not hauled in. The fibre is tied in bundles for marketing.

A better grade of fibre is produced when the retting process is carried on under water in a stream, but this method is much more expensive as more handling is required.



FIG. 201.—Hemp fibre. After retting and breaking out the woody huds it is tied in "hands" or "heads" before baling for market. (U. S. D. A.)

The yield may be from six to twelve hundred pounds of fibre per acre (Fig. 200), and of seed from fifteen to twenty-five bushels per acre. In the old world the seed is extensively grown, and oil from it is extracted by pressure. It contains thirty to thirty-five per cent of oil, which is useful in cooking, making salads, and the poor grades are used for burning and soap making. The leaves and stems of hemp also produce a resinous product used for making intoxicants. The fibre (Fig. 201) is used for rope, cordage, twine, carpet making and other purposes.

ABACA OR MANILA FIBRE

This is one of the chief sources of fibre for the best qualities of rope (Fig. 202). It gets its name from the city of Manila from which it is shipped in large quantities. This has been for years one of the chief exports of the Philippine Islands. The plant is closely related to and resembles the common banana plant. Its luxuriant growth is produced by an abundant rainfall, and moist climate, but where the soil is well-drained.

The plants are chiefly propagated by cuttings made from side shoots, but they may also be propagated by seeds. As the crop is perennial, it is good for

many years. The plant must be three or more years of age before a crop can be obtained, but when one crop is cut it again grows from the base without replanting. The harvesting begins when the flower buds appear on the plants. At that time they may have reached a height of from ten to fifteen feet. The long leaves which constitute a large part of the harvest may be ten feet in length.

This crop is not put through a retting process, as in flax and true hemp, but the leaves when cut are ripped into long narrow strips by use of knives. These are drawn by hand under the edge of a knife resting on a wooden board. This scrapes away the

FIG. 202.

FIG. 203.



FIG. 202.—Abaca (Manila hemp) plants making a very poor growth in Porto Rico. The leaves are badly torn by the wind and the stems more slender than those in the Philippines. Fibre is obtained from the overlapping leaf stem forming the trunks. A variety of sisal is growing in the background. (U. S. D. A.)

FIG. 203.—Henequin ten-year-old plants from which five crops of leaves have been cut. The fibre used for making binder-twine is cleaned by machines directly from the freshly cut leaves. (U. S. D. A.)

epidermis and pulp, leaving the leaf fibres as the desired product. This hand labor is slow and constitutes the chief expense in the production of the crop. Five hundred pounds per acre of the finished fibre is a good annual yield.

“Manila” rope as found in our markets is chiefly made of this fibre and a good idea of it may be obtained by ravelling out a piece of such rope and combining it with a coarse hair comb or with the fingers. Its great value as compared with other fibres of the world is due to the great length of the individual fibres in addition to their natural strength.

SISAL AND HENEQUIN

These two plants both belong to the genus *Agave* and are thus related to our common century plant (Figs. 203, 204 and 205). If the leaves of a century plant be examined, fibres may be discovered along the edge of the leaves, or if a leaf is broken much of the fibre may be found.

The crop has long been produced in Central America, where it is called by the Spanish name Henequin. The large, thick leaves of the *Agave* plant are crushed between rollers and the work is done very rapidly, but many tons of leaves are required for a single ton of fibre. Where grown extensively, the yield may reach one thousand pounds of fibre per acre. Large balls of buds called

FIG. 204.



FIG. 205.



FIG. 204.—The sisal plant, having green leaves without marginal prickles, is cultivated in the Bahamas, tropical East Africa, Hawaii, and Java. The leaves are cut one at a time with a large case knife and the fibre is cleaned by machines. (U. S. D. A.)

FIG. 205.—Sisal fibre drying. Sisal fibre is usually rinsed in running soft water immediately after leaving the cleaning machine, then hung in the sun to dry. Henequin fibre in Yucatan and Cuba is dried without rinsing. (U. S. D. A.)

“mast” are produced on the sides of the flower stalks of the plant, and these, as well as suckers springing from the root, are used in propagating the plants. They are set in rows during the winter or rainy season, the soil being limestone itself. Indeed, crow-bars are used for making the holes in the soft coral rock. The holes may be blasted with gunpowder and the plants will then grow readily. Of course no cultivation is possible. Enough soil must be present on the rocks to retain plenty of moisture and supply some plant food, but the presence of lime rock seems to be essential.

As the plants live indefinitely, one setting of a field will last many years. The lower whorl of the leaves is taken at each harvest time, perhaps twelve or fifteen leaves a year being the yield of a single plant. When the crop begins to blossom or go to seed its strength is exhausted, and it will soon die.

Articles made from sisal fibre are commonly found in the markets and elsewhere. So-called rope mats, binder twine, and many

Fig. 206.



Fig. 207.

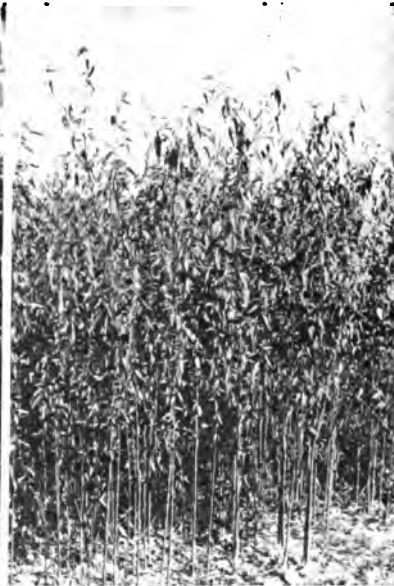

FIG. 206.—The ramie grown from perennial rootstocks, sending up two or three crops of herbaceous stalk each year. It has never been cultivated profitably outside of China and Japan, owing to lack of successful decorticating machines. (U. S. D. A.)

FIG. 207.—Jute is sown broadcast, like hemp, over an area of about 3,000,000 acres of rich alluvial soil in India. It is sown, weeded, harvested, water-retted and fibre-cleaned all by hand labor. (U. S. D. A.)

other articles are made from it almost entirely, and the fibre, which is coarser than Manila, is mixed with Manila for many purposes. The name Yucatan matting is given to one of the chief manufactured products, as sisal fibre is grown more abundantly in Yucatan and the West Indies than elsewhere. A good percentage of the world's product comes from the Hawaiian Islands.

RAMIE

Ramie (Fig. 206) is a crop well suited to the gulf region of the United States. It likes an abundance of moisture in the atmosphere, but the soil must be well drained. The fibre is similar to hemp in its qualities and uses. The plant is of a woody character and is propagated by cuttings, but may also be increased by division of the roots and by seeds. The root divisions are set out in rows about four feet apart and the plants distanced at about three feet in the rows. The fibre is not easily separated from the tough, gummy bark, and until an economical process is devised, its growth in this country is entirely experimental.

JUTE

This is an annual plant resembling hemp (Fig. 207), but belonging to the same family as our linden trees, which are themselves supplied with a valuable fibre in the inner bark. The climate for the growing of jute is about the same as for the growing of cotton. It prefers a moist, warm climate and rich, black soil.

About twenty pounds of seed may be sown broadcast about corn planting time on soil well prepared as for corn. The harvesting of the crop is done by means of corn knives, or the plants may be pulled up by the roots.

The difficulty in extracting the fibre from the stalks makes the production on a commercial scale practically impossible in the United States, but in India, where hand labor is cheap, jute forms an important article of export. After cotton and sisal it is perhaps the most extensively used plant fibre in American manufactures, being used in the making of carpets, twine, bagging, bale covering and other articles. The articles made of jute are susceptible to moisture and decompose readily in moist atmosphere, or after being wet a few times.

FIELD AND LABORATORY EXERCISES

1. **Seeds of Fibre Crops.**—In glass bottles make a collection of the seed of each of the fibre crops, as flax, hemp and others. Label these and save for future study.

2. **Oil in Flax Seed, etc.**—Examine seeds of flax for oil by cutting off the seed coats, and then pressing the endosperm between two hard surfaces, as a knife point and a piece of wood, or between the nails of your two thumbs. Examine the oil pressed out. Make similar studies of the seeds of other fibre crops.

3. **Collection of Fibres.**—Make a collection of the fibre of all the fibre crops, and mount each as indicated for samples of cotton. (See Chapter on Cotton). Place with each of these a product manufactured from the same kind of fibre.

4. **Plants for Study.**—Collect a few plants of hemp, flax and any other of the fibre crops available. Tie each kind in a neat bundle and hang where they may be studied from time to time. Persons living outside the regions of these fibre crops should obtain them by writing to friends or public school teachers, or officials living in the regions where these crops are grown.

QUESTIONS

1. What are the two types of flax grown for fibre?
2. Give the differences in management of the two.
3. Give the regions for the growth of each of the minor fibre crops mentioned in this chapter.
4. Describe the growth and culture of hemp.
5. What are the differences between the fibres of these crops so far as you have seen them?
6. Make a list of the uses for each of these fibres.

References.—United States Farmers' Bulletins: 274, Flax Culture; 669, Fibre Flax; also Hemp, Yearbook 1913, U. S. D. A.

CHAPTER XXII

SUGAR CANE

UNTIL comparatively recent years the sugar produced in the United States was made entirely from sugar cane, but now more is made from beets than from cane. The proportion of sugar from beets is increasing. The world's supply of sugar is made about equally from the two crops.

Chemically the sugar from these two sources is exactly the same. Bakers and other users are unable to detect any difference in it, except that confectioners claim that sugar from beets will not crystallize or harden into candy after melting so readily as sugar from cane. They are both spoken of as "cane sugar" because the name is older. The name distinguishes them from fruit sugar, glucose, milk sugar and other kinds.

Sugar cane has been grown for many centuries in tropical and other warm climates. It is profitably grown for sugar in the gulf states. The plant is a perennial of the grass family, but the stems instead of being hollow, as in common grasses, are filled with pith and ducts and fibres, with an abundance of sap saturated with sugar. Sugar and syrup are made from the juice. The stems are ten to twenty feet high, usually upright and clustered—several from one root system.

Methods of Propagation.—In the sugar belt the cane is propagated by planting the stalks, or sections of stalks (Fig. 208) containing the eyes or buds, which are borne at the nodes or joints. The buds are a little smaller than garden peas at the time of planting and are well protected by several coats and by the bases of the leaves around them.

Stalks which are intended to be used for propagation of the next crop should be cut before frost and protected from freezing until time for planting. They are sometimes buried in trenches and covered with earth or with litter to prevent freezing. If the soil is not well drained there is danger of the canes rotting in trenches. Another method of storage is to strip off the leaves, lay the stalks, or the parts of stalks which are desired for propagation, in piles and cover them with the leaves. Some soil may be used to hold the leaves from blowing. Sheltered places are desirable for the storing of seed-canes.

Whole canes are sometimes planted in furrows; they may be cut in sections, bearing one or more buds, and distributed along the furrows. Annual planting is usually not necessary, even in the gulf states, as one planting will usually yield profitable cuttings of cane for two or three years. In warmer climates replanting is much less frequent. It has been found that certain varieties are best propagated by using only the tops of the canes, as the buds there are more vigorous.

The crop is grown in rows four to six feet apart, and pieces of cane bearing one or two buds are dropped about two feet apart



FIG. 208.—Stripped sugar cane to be planted in furrows for the next crop; dipping the "seed cane" in whale-oil soap solution before planting to disinfect it and prevent root disease in the growing crop. (Louisiana Station.)

in the furrows. These are covered to a depth of about three inches, by the use of a plow or cultivator.

A less common practice of planting the sections of cane is to thrust one end in the mellow ground in a slanting position, leaving one end with its bud protected above the surface. New varieties of sugar-cane are developed by seed propagation. Seed is often developed at the top of the cane in tropical climates, and some fertile seed is sometimes secured.

Soils and Fertilizers.—Rich, well drained bottom lands, or other fertile soils, produce good crops of sugar cane. Good drainage is more essential in the cooler regions of the cane belt. The quality of the syrup is said to be affected by poor drainage.

The soil should contain much vegetable matter to aid in forcing a vigorous growth and to cause the soil to hold capillary moisture better.

If in the removal of the crop the entire stems and leaves are removed and not returned to the soil much fertility is lost. In some sections the leaves and tops are burned in the fields and practically all of the nitrogen is lost. Where such is the practice much fertilizer rich in nitrogen is purchased. As much as two hundred or four hundred pounds of nitrate of soda per acre, or the equivalent in cottonseed meal, may be applied where this burning is practiced; two hundred and fifty pounds of acid phosphate per acre gives good returns. Little potash is needed. The



FIG. 209.—Cutting the cane crop; standing cane at right; cut cane in center; strippings at left. (Louisiana Station.)

supply of organic matter in the soil, as well as the nitrogen, may be maintained by growing the crop in rotation with cow peas, which are turned under as green manure. If the rows are far enough apart crimson clover may be seeded in early fall and produce a winter cover for the field after the cane is cut.

Cultivation.—As the rows cannot be cultivated by machines crosswise, it becomes necessary to remove the weeds in the rows by hand hoeing. Cultivation should be frequent, and the fields kept free from weeds. Both disk cultivators and ordinary corn cultivators are used in cane fields. As the crop bears a large number of broad leaves it soon shades the ground thoroughly. After this the cultivation is usually stopped for the season.

Harvesting of Cane.—The cane is tall and heavy and harvesting is very laborious, as it is chiefly done by hand (Fig. 209). In climates where frost occurs the cane is allowed to ripen as much as possible before cutting, as this will increase the sugar content. The expert learns from the appearance of the plants just when to harvest the crops (Fig. 210). The sugar content decreases if the cane is kept too long before grinding. For this reason the harvest should be prolonged and the grinding may begin when harvest begins. To have all the cane in its best condition through a long period of harvest is somewhat difficult. It is accomplished by the use of varieties which mature at different times, by harvesting from light soils first and from heavy soils later, and by the use of



FIG. 210.—An up-to-date cane harvester. This machine will do the work of a hundred men. (Louisiana Station.)

fertilizers, as more nitrogen tends to delay ripening and less nitrogen will hasten the ripening.

Before the grinding is done the leaves and tops of the canes are removed. This is usually done in the field before the cane is cut. Danger of frost may require cutting the crop before the tops and leaves are removed, but their removal afterward requires more labor. Cane is usually hauled directly from the field to the grinders. Cane harvesters have been devised, but have not come into general use, and most of the crop is still cut by hand, because many of the canes are blown down or bent over. In much of the sugar cane belt hauling from the fields is done on wagons. It is thence taken by rail to the sugar factories to be rolled or ground

in the mills. In a few districts railroads are built into the cane fields and one handling of the crop is avoided. Loading machines are quite commonly used, particularly in Louisiana.

About twenty tons per acre is a good yield of stripped cane from bottom lands, but many fields produce twenty-five or thirty tons per acre. The sugar content varies from one hundred and fifty to one hundred and sixty pounds of refined sugar per ton.



FIG. 211.—Interior of a sugar cane mill, showing the vacuum "pans." The sap is evaporated under pressure much below that of the atmosphere to lower the temperature of boiling. (Louisiana Station.)

The yield of sugar, therefore, may vary from about 3000 to 8000 pounds per acre.

Manufacture of Sugar.—The modern method of removing the juice from the stalks is by heavy rollers. The cane is passed through one series after another until practically all of the juice is removed. The bégasse or crushed material is passed through furnaces for drying and is then used as fuel to operate the mill.

The juice is boiled down and impurities are removed by the addition of lime, or milk of lime, which helps to absorb them. A scum forms on top and is removed by skimming. This product, rich in lime and other fertilizing ingredients, is suitable for use on the fields. After the syrup is clarified in this manner it is boiled in vacuum pans at low heat (Fig. 211). As it begins to crystallize it is dried chiefly by centrifugal process, and is ready to be packed in sacks and barrels for shipment.

Other Products.—Besides the yield of sugar the chief product is molasses, and after the above amounts of sugar are extracted there may be about one hundred or one hundred and twenty-five gallons of molasses per acre. Much syrup is obtained from sugar-cane that may never be condensed and refined into sugar. The juice is boiled down to any desired density. This is not called

molasses, but the latter is a by-product in the making of sugar, being that part in which the sugar does not readily crystallize. Very inferior grades of molasses are sold for stock feed under the name of "blackstrap."

The leaves and tops, if cared for when freshly harvested, are very good as forage for livestock.

FIELD AND LABORATORY EXERCISES

1. Study sugar cane plants and find where the new shoots are formed when stalks are planted in the ground for propagation. Also study the internal structure of the stem, and determine the location of the sweet sap. Is it chiefly in the ducts or in the pith cells?

2. **Sugar from Cane.**—If possible, visit a cane mill in operation and by taking weights of stalks before and after grinding and pressing, determine the percentage of sap which the plants contain. From data obtained at the mill also learn the percentage of sugar in the sap, and from these facts calculate the percentage of sugar in the stalks themselves.

3. **Purifying the Sap.**—Study methods of removing impurities from the boiling sap, and determine the uses made of the various by-products.

4. **Two Kinds of Sugar in Cane.**—If a polariscope is available for use either in the laboratory, or at a nearby college, or at the sugar refinery, it will be interesting to study the differences in the sap used for making molasses and that used in making refined sugar. (Levulose and dextrose.)

QUESTIONS

1. What regions are suited to the growing of sugar cane?
2. Describe the methods of propagating cane.
3. How is the crop cultivated?
4. Tell what you can of the harvesting of the crop.
5. How is the sugar obtained from the cane?
6. What is the chief by-product?

CHAPTER XXIII

FRUIT GROWING

Each tree
Laden with fairest fruit, that hung to th' eye
Tempting, stirr'd in me sudden appetite.
—MILTON.—*Paradise Lost*,

THERE are many types of fruits, as well as many varieties of each type. If fruit can be grown on the general farm where the farmer and his family are making their home, much pleasure as well as profit may be derived from the orchard and small-fruit garden. The use of fruit adds much to the satisfaction and healthfulness of the daily menu. Among the great pleasures of farm life is the picking of fresh fruit for use on the table. Canned fruits put up at home are likely to be more wholesome than those purchased in the market. If enough fruit can be grown to allow for a surplus to be sold in the markets, members of the family may receive benefits therefrom. There are few if any lines of farming that are more profitable than successful fruit growing.

Methods of propagating plants used in fruit growing have been described in an earlier chapter.

Orcharding.—Tree fruits, such as peaches, apples and pears, are commonly grown in orchards. The old apple orchard is a common sight on all farms in those parts of the country that have been settled by man for a number of years. Too frequently it is noticeable that the only treatment the orchard has had was the setting of it. Trees were apparently expected to yield good returns of fruit without any care in the form of pruning, cultivating, fertilizing and spraying. In many cases the orchard area was compelled to yield returns in the form of other crops, such as hay. It is surprising that under such treatment many of the trees actually lived through the ordeal and gave enough fruit to encourage the owner to set more trees from time to time. There are now so many examples of successful orcharding in nearly all parts of the country that it is needless to say here that there is more net profit from trees that are properly cared for.

Starting the Young Orchard.—Whether the young orchard is to be for home use or chiefly for market fruit, the soil should be well suited to the trees and the exposure, if possible, should

be such as to avoid the blasting winds of the southwest in the warmer climate, and of the winter northwest winds in the colder climates. The exposure usually preferred is northeast, because of the protection from northern winds and because the fruit is not forced into blossom so early in the spring as the southerly exposures.

Trees for the new orchard should be young and vigorous. If one-year-old apple trees can be secured of large size they are better than older trees which have been stunted in their growth. When the trees are secured from the nursery they should be heeled in—that is placed in a sloping position with the roots in a trench covered with soil (Fig. 212). When the orchard is ready for planting the tree is examined and pruned carefully (Fig. 213);

FIG. 212.



FIG. 213.



FIG. 212.—When trees are first received from the nursery they should be unpacked promptly and "heeled in" by placing the roots in a trench and covering well with soil, as here shown. (New Jersey Station.)

FIG. 213.—Young peach trees received from the nursery to be set in the orchard. Those in the man's hands have been pruned; the others are yet to prune as much as those. (New Jersey Station.)

the roots are pruned to cut off wounded or broken parts, and the top may be pruned then or just after setting. Some of the top should be removed to reduce the bud and leaf area in harmony with the root. The lower branches, if any, are usually left as they are to form the main branches of the tree as it grows larger. Trees of one year's growth have side buds on the main switch and by properly heading back the switch the location of the lateral branches may be forced out at any height desired. Trees with the side branches very low are called low-headed trees. It is now more common to head the trees low than formerly. They may be pruned and sprayed with much less labor and the cost of harvesting is not so great. The trees will require some annual pruning

while young to keep them in good shape, heading back some of the long growths and perhaps to open the heads on thin branches and to encourage growth in certain parts.

In setting the tree it should be placed a little deeper in the soil than it was when in the nursery. The hole should be amply large so that plenty of top may be placed about the roots. The soil should be well tramped down over the roots to cause the rapid formation of root-hairs. If the season be dry, watering at setting time is very helpful. Loose soil should always be left on the surface. The distance apart for planting orchard trees varies with the variety, soil and climate. Apples are planted from

FIG. 214.



FIG. 215



FIG. 214.—The main pruning of trees should be done in the winter. About half the new growth on the top is cut back to reduce the height of the tree and keep the fruit from breaking the limbs. This tree was "headed" about eight inches from the ground. (New Jersey Station.)

FIG. 215.—It is well to practice some summer pruning on all kinds of orchard trees. This work is chiefly done with the fingers. It consists in removing sprouts on the trunk and lower limbs and any other places on the tree. (New Jersey Station.)

twenty-five feet each way to forty feet each way. Peaches vary in distance from fifteen feet to twenty feet each way.

Methods of Pruning.—Pruning should be practiced only by those who have had special instruction. There are several things to be remembered: (1) Never cut a large limb if the removal of a few small limbs will do (Fig. 214). (2) The pruning should be annual to keep the trees in best condition, and to avoid having to cut large limbs. (3) Remove limbs that interfere or tend to rub. (4) Cut the limbs as close as possible, never leaving a stub. This will allow nature to heal the wound and prevent decay. (5) Always make the cuts as smooth as possible, never allowing a limb to split down while being cut. (6) Large wounds should always

be covered within a day or two with good paint, grafting wax or other protective material. (7) When a cut is made it should be in such a position or slope as to shed off water. (8) In pruning to remove blight, canker, or other diseases, the tools should be disinfected by dipping in corrosive sublimate water or other disinfectant. (9) In pruning small twigs the cut should be made just above a bud, and the direction of growth may be governed by the location of the bud where the cut is made. (10) For such fruits as apples and pears the fruit spurs must be protected and enough growth cut away to allow sunlight to strike them.



FIG. 216.—When trees are small and crops are grown between the rows, the two-horse corn cultivator may be used to straddle the trees as here shown. (New Jersey Station.)

Figure 215 is to illustrate the work of summer pruning; note the small bunches of leaves on the ground that have been removed with the fingers. This plan enables the grower to keep the growth within his control with the utmost ease.

Tillage.—Young trees need tillage even more than old ones (Fig. 216). The growth should be forced and clean culture is the best method. To bring some returns for this work it is common to grow some market crop between the rows of young trees. Suitable crops for this purpose are much discussed by fruit growers. In some states potatoes and other root crops are much used. Near

the large markets lima beans, string beans, garden peas and similar crops have been tried successfully. The trees should not be crowded by the other crops, but wider strips for the trees should be left from year to year.



FIG. 217.—Clean culture in apple orchard gives no chance for insects to hide in litter. Soil moisture is conserved, and the fruit is larger and more abundant. The heavy shower of petals on the ground indicates it is proper time for the main spraying for codling moth. (New Jersey Station.)

On reasonably level land clean culture should be practiced even in older orchards (Figs. 217, 218 and 219). Allowing grass sod to grow permanently in the orchard should not be practiced,

FIG. 218.



FIG. 219.



FIG. 218.—The cutaway disk harrow with extension bar and truck. (New Jersey Station.)

FIG. 219.—The above machine at work in an orchard. The disks till the soil under the trees while the team walks in the center. (New Jersey Station.)

unless the hillside is steep. If other crops can be used to hold the soil from washing for the first few years the sod may be allowed to grow afterward. If sod is grown the grass should be cut each summer and used as a mulch about the trees.

Fertilizers.—The best fertilizer for the young orchard is green manure formed by a winter cover crop started late in the summer and plowed under the next spring. This furnishes a good supply of nitrogen which the young trees need so much. Some phosphoric acid and potash may be applied after the trees are older. Professor Waugh recommends for each young apple tree:

Nitrate of soda.....	1 oz.
Basic slag meal.....	10 oz.
Low grade sulfate of potash.....	6 oz.

As the trees come to bearing age a less proportion of nitrogen is required.

If there are no attacks of San José scale or other insects injurious to the young trees, the spraying may not be required before fruiting age.

Varieties.—The choice of varieties for any orchard will depend chiefly on whether the fruit is to be used for home consumption or is to be sold in the markets. Home orchards may reasonably contain a larger assortment of varieties ranging through the ripening season. It is important to select varieties which are family favorites and have good qualities for home use; while for market, varieties must be selected which are well known and will stand handling. In the home orchard new varieties may also be experimented with, but the commercial orchard should not contain untried sorts.

Spraying.—In most sections of America insect enemies and diseases of fruit are so common that even the farmer with a small orchard should not attempt to produce good fruit without spraying. The cost of equipment, material and labor is slight compared with the results attained. He should understand the nature of the different insect enemies and fungus diseases. All efforts at spraying must be well directed and well suited to the purpose. The principles underlying the various operations are given in the chapter on Control of Insects and Diseases.

The culture of tree fruits is commonly called pomology, but that term is often extended to include all kinds of fruit growing. The real tree fruit may be grouped under two heads: (1) Pome fruits, those containing a core, such as the apple, pear and quince. (2) Stone fruits, or those containing a single seed with a hard, stony shell, such as the peach, plum and cherry.

Apples.—Wild crab-apples are found in America, but the ancestry of most of our important crabs, and the foundation stock

of the true apple, are from the Old World. There are many valuable varieties of apples, most of which have originated in America. As varieties which are suitable for one part of the country are not always the best for other districts, reference is here made to United States Farmers' Bulletin 113, "The Apple and How to Grow It." In this Bulletin are given lists of varieties well classified according to the different apple growing districts of the United States.

Varieties may be classified according to their season of maturing, as summer, fall and winter. The last group includes apples which are best for storage, as they keep the best.

Apples of different varieties adapt themselves to a rather wide range of soil, but in general the loams or heavy loams are much better for apples than lighter soils. It is partly because of the variation in soils in the different apple growing districts that special varieties must be selected by local growers. (See Chapter on Control of Insects and Diseases.)

Pears were first grown in Asia and later in Europe before being introduced to America. In the eastern states the best pear regions for commercial orchards are in New England, Ontario and westward along the Great Lakes. On the Pacific coast they are grown abundantly in California, Oregon and Washington, but pears are grown for home purposes in many other states. The crop may be grown well on very heavy soils.

A number of varieties of pears are self-sterile, and should be set near others which can furnish them pollen during the blossom season. The Keiffer pear is a late maturing variety of very poor quality, but a heavy yielder and a good keeper. The Seckel pear is also widely grown. Its quality is very fine but the fruit is of small size. Flemish Beauty, Le Conte, and Angouleme are all well known by pear growers. The foregoing will usually pollinize themselves and aid in pollinizing others grown near them. Bartlett, Clapp's Favorite and Lawrence are very popular varieties of good quality, but these are self-sterile.

Quinces are commonly grown on low, wet soils, because their roots are shallow and will live in such soil. They also do well on uplands with better drainage. The fruit is chiefly used to mix with other fruits of poor flavors. It has good jelly-making properties and may be used for jelly, either alone or with other fruits.

Peaches were first grown in China. They were introduced to the West through Persia, Europe and then to the New World,

reaching here in the early Colonial days. As the peach is very susceptible to frost during the blossom period, and the trees are somewhat tender, in severe winter climates its distribution is not so general as the apple. Large commercial peach orchards are most commonly found where the climate is moderated by lakes, oceans or other large bodies of water. The peach belts of Michigan and Ontario, Connecticut, and the eastern seaboard, are possible for this reason. Peaches are also grown in interior states and are most successful where the air drainage is very good, as this tends to prevent damage by frost at blossom time. Winter killing of buds is much more common in districts not protected by large bodies of water. Soils may be lighter for the peach than for the apple. Indeed they are sometimes grown successfully on very light sandy soils, if plenty of organic matter is present and fertilizers are used.

There are many varieties of peaches which are grouped under two main types—free-stone and cling-stone. The former are usually preferred for eating out of hand and for canning purposes. Cling-stone peaches are very rich in flavor and are used in making sweet pickles, as well as for cooking as sauce. Further classifications are made according to the color of the flesh—white, yellow and marked with red. Elberta is the most popular free-stone peach, with yellow flesh, but its quality is poor as compared to many others. Crawford Early, Crawford Late, Champion, Belle of Georgia and Stump-the-World are well known free-stone varieties. Carmen is probably the most popular cling-stone variety, because of its early ripening.

Plums are of three main types: (1) Those of American origin are from the species *Prunus Americana*, including such varieties as Hawkeye, DeSoto, Weaver, and others. (2) Those of European origin are from the species *Prunus domestica*. Good varieties of this group are Green Gage, Lombard, and Goliath. (3) Plums of Japanese origin are from a distinct species, and include Red June, Satsuma, Burbank, Abundance and others which are of fine quality and abundant flesh.

There are other minor groups such as the Wildgoose and the Damsons.

The range of soils for plums is quite variable. As a rule the Japanese plums are well suited to heavy loams and the others are successful on soils which are much lighter.

Cherries are of two classes. (1) Sweet or heart cherries,

several varieties of which mature quite early in the season. (2) Sour cherries, which usually mature later in the season. Cherries of the first group are most commonly found in the markets, and much of the crop is produced on the Pacific coast. Sour cherries are more commonly grown in the East for canning and for pies.

The soil for cherries should be well drained and may vary from light loam to medium loam. The crop thrives best where the weather is moist up to picking time. As the trees do not always transplant well, it is sometimes the practice, particularly with the sweet varieties, to start the young trees from seed in the orchard and bud them as soon as they are large enough. Sour varieties are usually propagated by budding the stocks in nursery rows.

The most popular sweet varieties of cherries are Windsor and Black Tartarian. Among the sour cherries which are much grown are Early Richmond, English Morello and Montmorency.

Citrus fruits include the orange, the lemon and the pomelo or "grape fruit." These must be grown in climates where there is no serious danger of frost. The trees are evergreen. They are propagated by budding the young seedling stocks in nursery rows. In California lemons and oranges are much grown by aid of irrigation. In Florida rainfall is usually depended upon for the water supply.

Oranges are of two main types—seed-bearing and seedless. Those having no seeds are of most recent origin and are called navel oranges. They bring higher prices in the markets than the older varieties. Some of the seeded varieties are more hardy and may be grown farther north in the Florida districts.

Harvesting.—When the fruit is to be used immediately poor methods of harvesting are not so objectionable as when the fruit is to be kept for some time, or when it is to be offered for sale in the markets. Fruit to be kept should be handled carefully. Do not shake fruit from the trees, but pick it by hand. Ladders may be used in picking such fruits as apples and pears. Suitable picking baskets will prevent any mashing, crushing, or bruising of the fruit, and when properly handled it will keep much longer. Peaches may be picked chiefly from the ground if the trees are headed low. If fruit is to be shipped some distance it must be picked after it has reached full growth and begins to show some signs of ripening, but the flavor is not so good as when it is allowed to more completely ripen upon the trees. This is true of peaches, plums, and apples; but pears should always be taken from the

trees a little before they are ripe. They mature with less grit and better flavor if kept in a dark place during the ripening period.

Peaches, and sometimes other fruits, need thinning, just after the fruit begins to grow (Figs. 220 and 221). This will make better

FIG. 220.



FIG. 221.



FIG. 220.—When fruit is growing in dense clusters the crowding retards growth, spreads disease, and injures the tree. The clusters should be thinned while the fruit is small. (New Jersey Station.)

FIG. 221.—When fruit is thinned it grows much larger, is less affected with rot and sells at a higher price. (New Jersey Station.)

fruit and will greatly simplify the work at harvest time. The fruit is more uniform in size and less sorting is necessary.

There is a close relationship between the system of pruning and the labor involved at harvest time, at least with the tree fruits. If apple trees, peach trees, and others have their heads all near the

ground the work of picking is much reduced. When the trees are headed several feet above the ground, the long shaft adds that much to the height which the picker must surmount at picking time. Ladders are sometimes, so tall that it is difficult to manage them, or to move them from place to place around the tree. Light ladders should be used, not only because they are more easily handled, but because they will break fewer of the twigs and limbs when the picker ascends them.

If peach trees can always be picked from a common step-ladder five or perhaps seven feet in height, the work is much simplified and the picking is much more rapid than if heavy picking stands or trucks have to be moved about for this work.

Special harvesters are sometimes used for fruits that are otherwise out of reach. A small wire basket surmounted with a few sharp tines arranged like comb teeth is mounted on the end of a light pole. The tines will pull off the fruit which is held in the little basket until it is brought down and removed by hand. Another simple plan is to have a Y-shaped piece of metal projecting a few inches at right angles to the end of a light pole. Just below this is attached a ring from which hangs a bag or sleeve of cloth. The operator uses the Y piece of metal to pick off the fruit which drops into the sleeve without bruising it. Another form of picker is provided with a pair of tongs at the end of a pole, the tongs being closed by pulling on a cord or wire which is fastened to the lower end of the pole. The tongs are provided with two concave jaws which grasp the fruit firmly and prevent its dropping.

When to Pick.—Much judgment and considerable practice are required to determine just the right stage of development of peaches, apples, pears and plums that are to be picked. If the distance for shipment is great, the development of the ripening period is less than if they are to be marketed more locally. If picked too green, fruits are likely to reach market in a bitter or tough condition, and their immaturities will be very evident. On the other hand, if the picking is delayed too long, the fruit will not "hold up" during shipment, and the result may be a serious loss to the shipper.

Even with small fruits such as blackberries and strawberries, the same is true. Strawberries must have completely colored to the tip before being picked or they will not be well received in market. Blackberries to be properly ripened should be soft, and the sharp acid taste should be passed. Of course they cannot be

left on the vines this long if they are to be shipped some distance, but for local or home use they should be ripened on the bushes.

Peaches that are to be shipped may be picked when full grown, if the characteristic color of ripeness has begun to develop. Little color is added after picking time. Japanese plums, on the other hand, will gain considerable color after picking, and for that reason can be shipped farther than they otherwise could. Pinching the fruit to detect ripeness is a bad practice. A gentle pressure with the soft part of the thumb on the surface of the peach will aid in detecting its maturity. The fruit will give slightly under such



FIG. 222.—At harvest time the peaches are often sorted and packed in the orchard, with or without a shed for protection from sun and rain. Note the style of picking baskets, shown in the foreground. (New Jersey Station.)

pressure if it is ready to pick for a distant market. All stone fruits are subject to attack by fruit rot fungus if they are too ripe at the time of picking. This disease often attacks plums and cherries as well as peaches if the fruit is ripe enough to eat at the time of shipment. This makes it necessary to pick the fruit somewhat earlier and start it on its way so that it will reach the consumer in sound condition. Solid baskets with handles as shown in figure 222, are good for picking fruit.

Winter apples are usually not allowed to color up very much on the tree before they are picked and stored for sale during the

winter. If the weather permits they may be allowed to remain on the trees until considerable color is attained, and this is also possible if the marketing is to soon follow the picking season. The keeping of fruits in cold storage makes it possible to allow them to



FIG. 223.—The best grades of peaches are commonly marketed in the small baskets crated as shown, called "Georgia carriers." The inferior grades are marketed in common peach baskets as shown on the right. (New Jersey Station.)

more completely ripen before picking, but when they are taken from the storage house they are certain to decay quickly if too ripe at storing time.

As already stated, pears will ripen best off the tree. Gritty

FIG. 224.

FIG. 225.

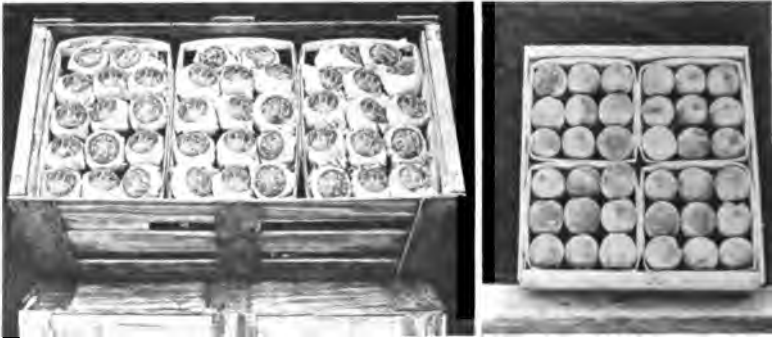

FIG. 224.—The very choicest peaches are sometimes wrapped in paper bearing the grower's name and brand. (New Jersey Station.)

FIG. 225.—Nectarines and choice Japanese plums may be attractively packed in paper-lined berry boxes. (New Jersey Station.)

mineral matter or woody tissue forms in the cells of the fruit and the quality is greatly reduced thereby. Pears are therefore best picked as soon as they reach full size, or have only slightly begun to show signs of ripening. The ease with which the fruit stem is picked from the spur will indicate the advancement of the fruit.

By turning the fruit up, the stem is snapped from the spur at the natural joint for separation.

Pears may be wrapped in paper, stored in boxes and kept in a cool, dry cellar. It is important to keep them away from the light. During this period of course they can be shipped long distances if desired. Even the soft pears such as Bartlett and Lawrence will require a week or two for the final ripening period after picking. Such pears as the Keiffer are usually ripened in bulk and may be stored for a longer period without damage.

Grading Fruit for Market.—It is not easy for the beginner to determine the grades of fruit. Experience in the work along with other graders and pickers will aid materially in fixing the grades in mind. Just what makes up the first grade in any kind of fruit will be learned accurately by association and handling of the fruit itself. The importance of grading to suit the markets where the fruit is sold is often not recognized nor well understood by inexperienced growers. Too often fruit is sent to market without grading. The first grade will bring a better price if separate from the remainder, and even the second grade fruit will bring as high as the mixture would have brought. Thus it is more profitable to the fruit man to carefully sort the fruit and sell it in its different grades than to "dump" it all on the market together (Fig. 223).

Packing for Market.—As the sorting is done the fruit is packed in receptacles in which it is to be sold. The so-called "gift package" is commonly found for all kinds of fruits. Comparatively few fruits are now marketed in other ways. Special baskets (Fig. 224 and 225) are used for peaches and plums. Some of these are also occasionally used for apples, but more commonly apples are packed in boxes holding approximately one bushel. The use of barrels for marketing apples is still quite common in the eastern and southern states, and here we find an exception to the use of the "gift package" in marketing the crop. Usually berries are packed in their own quart or pint boxes and these are regularly placed in crates, the whole being shipped by express or in refrigerator cars by freight. The crates and boxes (Figs. 226 and 227) are not returned, but are delivered to the consumer.

Special methods are used in packing any one kind of fruit in its own type of package. For example, in apple boxes the layers of apples are placed mainly according to fixed rules of practice and the rows are arranged in certain fixed ways under each system. The size of the fruit often governs the system in this regard. In

barrels, apples are placed so as to present an attractive appearance when either end of the barrel is opened. A layer of fruit of uniform size is placed at the lower end of the barrel, and then the barrel is filled with the graded fruit until within about two layers of the top. The fruit is well shaken down and the final layers are regularly placed with the stems upwards. After covering this with the heading paper and the barrel head, the latter is forced into place by use of a lever which presses the fruit slightly and prevents bruising when the barrels are handled.

Judging Fruit.—The following score cards should be used by

FIG. 226.



FIG. 227.



FIG. 226.—The peach grower must buy his crates "in the flat" and put them together as here shown. The operator here is working on a stand used for sorting fruit. (New Jersey Station.)

FIG. 227.—A storeroom for fruit awaiting shipment. Sometimes the fruit is cooled before shipment and less icing of the cars is required. (New Jersey Station.)

growers preparing fruit for market and for exhibition. The same score is also used in judging fruit at shows.

Score Cards for Apples, Plums, and Peaches

	Apples.	Plums.	Peaches.
Form	15 points	10 points	15 points
Size	10 "	15 "	10 "
Color	20 "	15 "	15 "
Uniformity	20 "	20 "	20 "
Quality	15 "	20 "	20 "
Freedom from blemishes...	20 "	20 "	20 "

The form should be smooth, regular, and typical of the variety.

The size indicates good culture and should be moderate to large, but not overgrown.

The color should be as bright and high as is typical of the variety.

Uniformity relates to the specimens in the collection, whether on plates, in boxes, in baskets, in barrels, or in cartons.

Quality includes both texture and flavor, and these should be true to the variety. If specimens are true to variety in other respects the quality is not questioned and the fruit is not tasted.

Freedom from blemish is very important. Fruit is often rejected for bruises, diseases, or insect marks. Perfect specimens should be selected for exhibition.

FIELD AND LABORATORY EXERCISES

1. **Nursery Trees.**—Compare the structure of one-year-old and two-year-old apple trees at time of planting. Note in the two-year-old trees what part of the top was produced during the second season of growth in the nursery.

2. **Tree Growth.**—Study older trees in the orchard and determine the amount of top each season.

3. **Pruning Young Trees.**—With pruning shears or pruning knife practice pruning young peach trees or young apple trees, applying the principles of pruning as studied in the text. Older trees should also be practiced upon.

4. **The Next Fruit Crop.**—Examine a young peach tree in the winter season and determine, if possible, the approximate number of fruit buds the tree is bearing. The difference in structure between fruit buds and leaf buds will soon be recognized.

5. **Fruit Spurs.**—Apple and pear trees should be surveyed for their fruit spurs, and observations made regarding their probable fruit production the ensuing season.

6. **Winter Killing of Buds.**—After severe winter weather, if there be danger of killing of fruit buds, learn to determine what buds are still alive and what ones have been killed. A study of a number of these will reveal the differences.

7. **Spraying.**—Try spraying large fruit trees with small hand sprayers and thus determine the need of larger machines, and long spray rods.

8. **Harvesting.**—Compare good and bad methods of harvesting apples, peaches and other fruits. Note the bruised spots followed by rot on fruits shaken from the trees.

9. **Degree of Ripeness.**—Learn to detect the proper stage of development for harvesting such perishable fruit as peaches and plums. Varieties will differ in this regard and a little practice or trial with each variety will help to decide the matter in each case.

10. **Varieties of Apples.**—Make collections of several varieties of apples grown in the locality or found in the local market. Study them as to quality, characteristic shapes, color-markings and other points so that each variety will be known wherever it is found.

11. **An apple show or other fruit show** may be held. This will furnish a splendid opportunity for judging of fruits of different kinds. If prizes are offered, a number of the less common varieties may be brought to the exhibit.

QUESTIONS

1. Give directions for starting the young orchard.
2. Enumerate a number of things to be remembered while pruning.
3. Give reasons for growing a culture crop between orchard rows. Mention some good crops for this.
4. Make a collection of varieties of apples suited to your region.
5. Give reasons for careful picking of fruit.
6. Say what you can regarding the stage of picking for different classes of market.
7. Give reasons for grading fruit for market.
8. What are the three types of plums.
9. Mention bad diseases of the apple orchard.
10. What is the worst disease in the peach orchard? Give its control.

References.—United States Farmers' Bulletins: 104, Notes on Frost; 113, The Apple and How to Grow It; 181, Pruning; 404, Irrigation of Orchards; 482, The Pear and How to Grow It; 491, The Small Apple Orchard on the General Farm; 538, Sites, Soils and Varieties for Citrus Groves in the Gulf States; 539, Propagation of Citrus Trees; 542, Culture, Fertilization and Frost Protection of Citrus Groves; 631, 632, 633, Growing Peaches; 685, The Native Persimmon; 727, Growing Fruit for Home Use in the Great Plains Area.

Productive Orcharding, Sears, Lippincott Co., Philadelphia. Systematic Pomology, Waugh, Orange Judd Co., N. Y. Manual of Fruit Growing, Bailey. The Macmillan Co., N. Y. The American Peach Orchard, Waugh, Orange Judd Co., N. Y. Fruit Harvesting, Storing, and Marketing, Waugh, Orange Judd Co., N. Y.

CHAPTER XXIV

SMALL FRUITS

THIS group includes the raspberry, blackberry, dewberry, gooseberry, currant and others which are borne on plants somewhat bushlike in their habit of growth. These are true bush fruits.

Strawberries and grapes are less commonly spoken of as small fruits, but are sometimes included here.

Raspberries are of two main types: (1) The true blackcap varieties, such as Kansas, Black Diamond, Gregg and others. (2) The red and yellow varieties. The red varieties are Cuthbert, Miller and Marlboro. A good yellow variety is Golden Queen.

Blackcap raspberries are chiefly propagated by tip layering, as described in an earlier chapter. They grow on any good, well-drained loam. They respond well to heavy applications of manure, and much well rotted organic matter in the soil is beneficial. The berries are borne on shoots arising from canes only one year old. As these same canes usually do not bear a crop more than one year, they should be removed by pruning them away as soon as the crop is picked. New canes are formed each year for the crop of the following season. In wet seasons and in fertile soils the new canes may make a very rapid growth and should be clipped back to cause them to produce more branches, and later form more fruit clusters.

The soil should be well tilled between the rows until late in the season. About August or September a cover crop may be started in the middles. This should not be sown too close to the rows, as it will be difficult to remove the plants the following spring. Each spring the winter cover may be turned under or disked under as green manure. The rows are usually planted four or five feet apart to allow room for tillage.

Red raspberries send up many suckers and are propagated by plowing or digging these up to be used in setting new grounds. They may also be propagated by root cuttings. The pruning for red raspberries consists chiefly in cutting out the oldest canes from each cluster. The highest canes may also be cut back in early spring.

Blackberries are widely grown in America. Good varieties

are Lawton, Snider, and Eldorado. The fruit is borne on canes of the preceding year's growth and the old canes are harmful to the young ones if not cut away. This should be done as soon as the crop is harvested. In middle latitudes where the season is long, the bushes may be mowed down with bush hooks just after harvest. A new growth of canes will then be produced to bear the next season's crop. This plan prevents a very high growth at any time (Fig. 228).

Blackberries ripen later than raspberries (Fig. 229). For this reason tillage must be kept up longer to save moisture necessary



FIG. 228.—Blackberry bushes may be kept low by close pruning (New Jersey Station)

for ripening the crop. Otherwise the tillage and annual care are similar.

Gooseberries.—There are several types of gooseberries, but the type most commonly grown here originated in America. Common varieties of this type are Champion, Downing (Fig. 230), and Pearl. A few European varieties are used in America, particularly on the Pacific coast. Among these may be mentioned Chautauqua and Industry. Gooseberries may be propagated either by cuttings or by mound layering and stem layering. When grown on a commercial scale the bushes, which are set in early spring, are

placed in rows about four feet apart to allow for tillage and the use of cover crops. Because of the difficulty in removing plants from among the bushes in the rows, it is a good practice to sow cow peas or soy beans in midsummer instead of a cover crop which will live through winter. The frost will kill the cow peas or soy beans and the dead plants may be worked into the soil the following spring. Pruning consists chiefly in removing the very oldest growth, but the stems should be allowed to remain for several years.



FIG. 229.—When blackberries ripen rather uniformly the labor of picking the crop is much reduced but the marketing season is shortened. The uniformity of ripening is governed by the season, soil and variety. (New Jersey Station.)

Currants are propagated easily by cuttings. In late summer cuttings are made from the new growth. These may be set in the ground immediately with two or three buds exposed above the soil. If put in rows in the garden they may be transplanted after one full season's growth. In a permanent location they are set in rows four feet apart. The soil should be heavy loam, as the roots should have a cool situation. There should be some annual tillage early in the spring. After that it is well to mulch the soil with strawy manure or similar litter to shade it well to hold the moisture and keep down weeds and grass. The rainfall will leach much

of the valuable constituents of the manure into the soil. The fruit is borne on stems which are at least one year old. The only pruning required is to cut away the very oldest stems that show deterioration.



FIG. 230.—A twig of the Downing gooseberry showing the blossoms. It is only a short time after this stage before the berries will be ready to pick. (New Jersey Station.)

Cutting away those four years old or more will usually keep the bushes thin enough. The currant is subject to severe attacks of the currant worm which eats off the leaves. Spraying with Paris green as for potatoes will keep this enemy in check.

True currants are of two colors—red and white, and both are of European origin. Good red varieties are Cherry (Fig. 231), Dutch, Fay, Pomona and Wilder. White Dutch and White Grape are good white varieties. The red currants are chiefly used for making jelly and jam. White varieties are less popular, but are used for eating out of hand and cooking as sauce.

Grapes of different varieties are popular in all parts of America. They are used in the form of fresh fruit or for cooking or for the making of jelly and unfermented grape juice. In the Old World the crop is extensively used in the manufacture of wines, but this use is less common in America. Our best varieties are of American origin. Indeed a large proportion of the European grapes are grown on American stocks. This was started a number of years ago because of the damage done to the roots of European grapes by a parasitic enemy known as phylloxera. The



FIG. 231.—The cherry currant is a favorite red variety with large berries and dense clusters. (New Jersey Station.)



FIG. 232.—Grapevines should be pruned to suit the trellis or method of support. Here two wires are used. This system is known as the four-cane Kniffin system, in which the new shoots from the four canes are usually allowed to hang down from the canes tied to the wire. (New Jersey Station.)

grapes most used as fresh fruit are of three different colors, all originating from the same native American species. Concord is by far the most popular purple variety. Others of this color are Moore's Early and Worden. Delaware is the most popular red variety and is well supplemented by Brighton and Salem. Niagara is more grown than any other white variety, but Martha and Diamond are also popular. All grapes of this type are readily



FIG. 233.—The grapevine should be well supported to keep the crop up off the soil. In the first row, posts with cross arms are used. This is the overhead system. (New Jersey Station.)

propagated by cuttings, which are made in the fall after the leaves are off, and stored in damp packing material in a cold place over winter. In spring, after all danger of frost is over, they are set in rows in the nursery or garden with one bud projecting above the ground. The rows should be far enough apart to allow of cultivation. After one or perhaps two seasons' growth they may be transplanted to the permanent vineyard.

There are a number of good ways of supporting the bearing vines (Figs. 232 and 233), and the practices regarding pruning are quite variable. If the crops are wanted for shade about the home grounds the pruning may be very light, but if the crop is grown in a vineyard for commercial purposes the pruning is much closer to keep the vines in control and allow the use of smaller supports. The fruit is borne from buds of the new growth, but must start each spring from buds of the preceding season. If a few inch buds are left to start the new growth there will be plenty of bearing wood produced for the new crop of fruit. The pruning should be done in winter when the ground is frozen, if possible. There will then be much less danger of loss of sap by "bleeding."

Grapes will do well on very light soil, but they will also thrive on any well drained rich loam. If good drainage is provided and plenty of organic matter is in the soil little fertilizing will be necessary. Annual tillage should be practiced.

Grapes for Shows.—Students and growers of grapes should have practice in selecting good specimens for exhibition or for market windows. The following scale of points will aid in such practice.

<i>Grape Score Card</i>	
Flavor	15 points
Form of bunch	20 "
Size of bunch	15 "
Size of berry	10 "
Color	10 "
Firmness	5 "
Bloom	5 "
Freedom from blemish	20 "
Total.....	100 points

Strawberries are chiefly propagated by the rooting of runners, as described in an earlier chapter. They thrive well on any good garden soil, adapting themselves to a wide variation in soil. Setting the plants in August immediately from propagating beds is a very common practice. This can be done readily without the loss of many plants if the soil is moist and the weather is not too dry and hot. The plants may also be set in early spring, but in that case they should not be allowed to bear fruit the same season. One year's time is really saved by setting the plants in August.

In selecting plants for strawberry beds, it should be remembered that some varieties are called pistillate because they do not have enough stamens to pollinate themselves (Fig. 234). Many other

varieties have both stamens and pistils in abundance and are called perfect varieties. If pistillate varieties are chosen they should be set near others which are perfect; otherwise no crop will be produced. If plants are purchased the varieties will be listed in the catalogues, indicating which are pistillate and which are perfect. Bederwood, Clyde, Gandy, Kansas, Parker Earle and Senator are good perfect varieties; and Warfield is one of the best in the pistillate group.

Plants are set according to two or three different plans. The hedge-row system (Fig. 235) is common among growers wishing to produce large crops of superior fruit for special markets. The plants are set in rows about three feet apart with the plants about twelve to eighteen inches apart in the rows. Runners are not



FIG. 234.—Strawberry blossoms on the left have both stamens and pistils and are called "perfect"; those on the right no stamens or only rudimentary ones. The latter kind must have the perfect varieties grown near them or no crop of fruit will be formed. (New Jersey Station.)

allowed to take root outside the row, but a few are allowed to grow in the rows. Many runners have to be cut off during the early part of each summer. This is quickly done with wheel cutters run by hand. Thorough cultivation is practiced between the rows each year after the crop is picked and is continued until winter. When the ground freezes the vines are covered with litter such as clean wild hay, straw, or leaves. This winter mulch is opened along the rows in the spring after danger of heavy frost is over. Between the rows the mulch may be left until the crop is harvested. During that time it will help to keep down weeds, save the moisture and prevent suffering from drought, and will keep the berries clean (Fig. 236).

The vines are then mowed down and raked off with the mulch



FIG. 235.—Strawberries are often grown in the narrow row and are not allowed to spread at the sides at all. This is called the hedge-row system. The plants are stronger and the berries larger and more uniform than in the matted-row system. (New Jersey Station.)



FIG. 236.—The straw mulch is left between the strawberry plants until after the picking season is over. Its value in protecting the berries from the soil is here shown. (New Jersey Station.)

and burned or put in a compost for use in other fields. This destroys the leaf spot disease and various forms of insect life.

The hill-row system is very similar to the hedge-row system,



FIG. 237.—The matted-rows of strawberries may be held from covering the entire ground by pruning off the side runners or by the frequent use of the cultivator. (New Jersey Station.)

except that no runners are allowed to set in the rows after the plants are set. Each hill becomes a very large clump of stems and



FIG. 238.—Students studying the methods of growing strawberries.

leaves, producing the vines and fruit and bearing heavily. This method requires more labor because of the difficulty of cutting off the runners from all sides of each plant.

The matted-row system (Fig. 237) is the oldest and in some

sections still most common. The rows are first set about four or five feet apart and the runners are given freedom until they cover a strip two or three feet wide, or perhaps the whole area. Mulching is less common in this practice, and tillage, if given, is much more difficult. A modification of the plan is to leave narrow strips which are cultivated once a year. Most of the weeding has to be done by hand pulling, and if grass gets started it is difficult to control.

In any of the systems of planting, strawberries are usually not profitable after bearing two good crops. Sometimes they are kept for a third crop before plowing under. New beds should be started each year if the best results are desired.

FIELD AND LABORATORY EXERCISES

1. Practice pruning, care and management of various kinds of bush fruits.
2. **Systems of Growing Strawberries.**—Grow strawberries by the matted-row system and the hedge-row system. Do this at home, if possible. Compare the results in yield, size of fruit, cleanliness of fruit, market value, ease of picking, ease of cultivation and other points.
3. **Study market conditions** when berries are in the market. Make a list of varieties grown, methods of preparing for market, length of time elapsing from picking to consumption.
4. **Pollen for Pistillate Strawberries.**—By inquiry or visitation (Fig. 238) determine the plans usually followed by growers of strawberries regarding the mixing of pistillate and perfect varieties. How many rows of each type are set before setting the other?
5. **Local Growth of Small Fruits.**—Compare the acreages of the various small fruits as grown in your vicinity. Explain, if possible, why the acreage is so small.

QUESTIONS

1. Give directions for the growing of raspberries.
2. What varieties of grapes are grown in your section?
3. What systems of training grapes have you seen?
4. Compare the hedge-row system with the matted-row system of growing strawberries.
5. Give the stage of harvesting for each of the small fruits.
6. Which ones of the small fruits grow wild in your vicinity?
7. What influence, if any, does this have upon the sale of cultivated varieties of the same kind?

References.—United States Farmers' Bulletins: 154, The Home Fruit Garden: Preparation and Care; 156, The Home Vineyard, with Special Reference to Northern Conditions; 176, Cranberry Culture; 178, Insects Injurious to Cranberry Culture; 181, Pruning; 198, Strawberries; 208, Varieties of Fruits Recommended for Planting; 213, Raspberries; 293, The Use of Fruit as Food; 471, Grape Propagation, Pruning and Training; 643, Blackberry Culture; 664, Strawberry Growing in the South; 709, Muscadine Grapes; 728, Dewberry Culture.

U. S. Department Bulletin 349—The Raisin Industry. R. I. Exp. Sta. Bul. 91, Bush Fruits. Mass. Sta. Bd. of Agr., Bul. 4, Small Fruits and Berries.

CHAPTER XXV

PRODUCTS OF THE FOREST AND WOOD LOT

"If thou art worn and hard beset
With sorrows that thou wouldst forget,
If thou would read a lesson that will keep
Thy heart from fainting and thy soul from sleep,
Go to the woods and hills! No tears
Dim the sweet look that nature wears."

—H. W. LONGFELLOW.

It is natural for us to think of lumber, railroad ties, telegraph and telephone poles, fence posts and fuel as among the chief forest products. The early pioneers in forested districts have considered the greatest forest product as being the rich soil which is left after the forest is cleared away. The rich black soil, or leaf mold, formed from the decay of forest leaves, twigs, branches and trunks for ages past, was the great source of wealth left to the pioneer when he destroyed the forest. This soil was so valuable and so greatly appreciated by settlers that it was several centuries before the prairie areas outside the timber belts were settled and used for farming.

There are many other articles used by man obtained from forest trees. A suggestive list is given by Prof. Jackson in *United States Farmers' Bulletin 468*, as follows:

"Food products, such as the nuts and fruits of forest trees; maple sugar and syrup.

"Medicinal products, such as quinine from cinchona, salicin from willow bark, oil of sassafras from sassafras bark, etc.

"Small household articles, as matches, toothpicks, clothespins, pencils, penholders, tool handles, wooden baskets, shoe pegs, and wooden dishes.

"Oils, such as eucalyptus oil, beechnut oil, olive oil, etc.

"The products of wood distillation, as wood alcohol, acetates, wood tar, and common potash from wood ashes.

"Naval stores and their related products, such as turpentine, rosin, creosote, and pitch.

"Miscellaneous products, such as cork, tannic acid, charcoal, spruce gum, lamp-black, excelsior, etc."

The Value of Wood.—It is difficult for us to realize the immense value of wood because it is so easily accessible. The early settlers of America thought of the forest as an enemy to their progress. The wood had to be cleared from the land and burned

to make room for crops. It was a laborious task to remove the stumps. The change in this feeling toward our native forests has come only recently. We are now beginning to feel the need of saving our forests and to grow more trees in forest areas. Many states of the Union establish schools of forestry and have laws and officers for the protection of forest growth. The United States government, through its Forest Service, makes strenuous efforts to preserve the native growth of large forest reservations (Fig. 239).

FIG. 239



FIG. 240.



FIG. 239.—A mountain lake surrounded by rough hills—a region well suited to the growth of mixed timber.

FIG. 240.—This sturdy old white pine tree was too crooked for lumber, but when such trees are left in the forest area they may supply abundant seeds for reforestation.

To fully appreciate the real importance of the value of wood in commerce and manufacture, we need only to visit a land where wood is not abundant, or where it is not found at all. The natives and settlers of Greenland have little or no wood to use. The immense value of a piece of wood to them is shown when they offer to trade for a small bit of wood almost an equal amount of ivory. They will trade the most costly furs for wood from other countries. They want wood for making sledges and for other articles requiring limited amounts of wood.

FIG. 241.

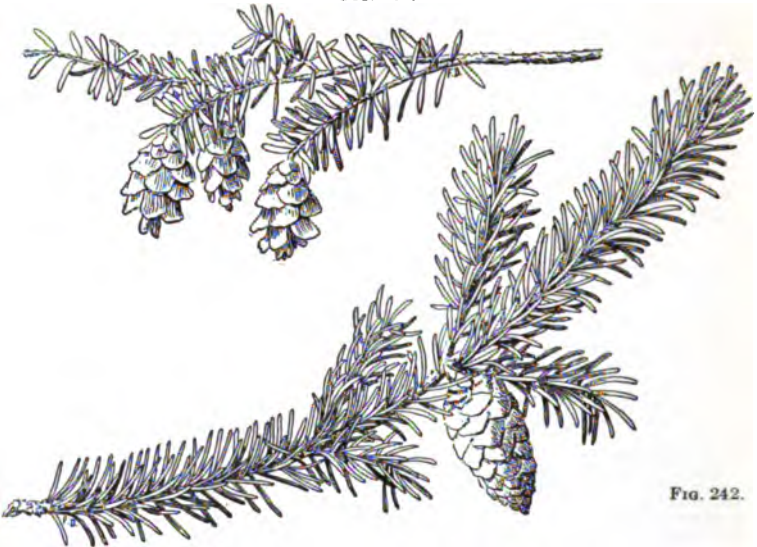

FIG. 242.

FIG. 241.—The hemlock becomes a large, graceful tree, native east of the Mississippi River. The bark is harvested for tanning and wood is used for paper or sawed for framing lumber.

FIG. 242.—White spruce is one of the most graceful evergreens for ornamental planting. The tree is native in the northern states and Canada to Alaska. The woods of this and black spruce are used for general construction, span, flooring, sounding boards of musical instruments, paper pulp, etc.



FIG. 243.—Black spruce is not an ornamental tree, as the dead cones hang on and the lower branches die. The native ranges and uses are much the same as white spruce.

In the United States we are already coming to deplore the lack of many valuable woods which can now be secured only in limited quantities. White pine, (Fig. 240) which is the most valuable for building purposes of all our native woods, formerly occupied the great belt along the northern tier of states as far west as Minnesota. This species is now so nearly exhausted that substitution of very inferior grades of wood is necessary. Hemlock and spruce (Figs. 241, 242, 243 and 244) help fill this gap, and the yellow pines of the South are more in demand. Many of the hard woods which were formerly used in the manufacture of implements of many kinds are so nearly gone that they are replaced by iron. This change is so marked as to cause the present time to be spoken of as the "iron age."

Timber for telegraph and telephone poles is becoming so scarce that already companies are beginning to use steel and concrete poles. Fence posts are sometimes made of concrete or steel as a substitute for wood. Railroad companies are using preservatives to lengthen the life of railroad ties, and substitutes for wood are being tried. Building materials of other kinds are being used more and more for exterior structures, because of the rapidly increasing price of lumber.

Use and Abuse of Forests.—The most notable new use for wood is the manufacture of paper. Several species of wood are extensively used in the manufacture of wood pulp to be made into several products, chiefly paper (Fig. 245). So rapid has been the cutting for this purpose that trees are cut when very small. As the supply becomes less, smaller trees are used, so that trees too small for use as lumber are used by pulp mills. When the forest is cut so close as to use small saplings, reforestation by natural



FIG. 244.—Norway spruce is used more for ornamental planting than any other spruce, for which purpose it is grown in nurseries from seed. The tree is readily distinguished by its six inch cones and its pendulous branches.

means is prevented (Fig. 246). Seed bearing trees are destroyed and nothing is left to replace the cut timber. Making of paper from wood is legitimate and necessary, but plans should be devised whereby the reproduction of valuable trees may continue and the forest may be permanent. About one-third of the area of the United States is classified as "forested." If our present forests could be properly cared for they would be a permanent resource.

The present alarming destruction of forests is not so much a result of their proper use for lumber, as the many wastes arising from several causes: (1) Forest fires; (2) destruction by insects and fungous diseases, due to improper management; (3) too close



FIG. 245.—A log-jam in a small stream, formerly used for transporting large saw logs to the saw mill, but here used to transport second growth and other small "sticks" to the paper mill. The transition and the present condition in regions near paper mills is heart-rending to one who realizes the need of permanent forestry.

cutting, which destroys trees of seed bearing age; (4) destruction of trees too small to be of commercial value when cutting large trees; (5) the waste of parts not immediately useful to those who are cutting for special purposes; millions of trees are cut for tanbark and the trees allowed to rot or are burned.

Preventing Waste.—All citizens owning or living near wooded areas can aid materially in preventing forest fires. They should coöperate with the United States and state authorities by posting up fresh legal notices warning hunters and campers against forest fires. When fires and storms have devastated wooded areas they should often be replanted with seeds or seedlings.

Forest insects and diseases may be largely controlled by re-

moval of trimmings when trees are cut. Trees damaged by storm should be harvested, as insects often attack such weak or dying trees and thus make a place from which to spread to live trees.

Seed trees should always be left if the area is to be a permanent forest. This need not reduce the value of the harvest. Trees which are of little value for lumber or poles may be left for this purpose.

When large trees are felled it should be done in such a way as to avoid the destruction of saplings, as these should be left to take the place of the trees being harvested. The methods in use in the



FIG. 246.—Land skinned, burned over, and left a barren waste. (U. S. D. A.)

government forests of Germany could well be followed by the American lumbermen and woodsmen.

Forestry and Agriculture.—The farmer is as much or more interested in forestry as any one else. The destruction of forests brings on floods followed by droughts. In many agricultural sections of the country the forest area is so limited that the water from heavy rainfall is not checked, but rushes in great torrents to the fields, valleys and water courses carrying with it destruction of crops and devastation of homes. As soon as the water is gone the free water table of the soil is rapidly lowered and crops suffer from drought. Formerly the dense mass of leaves and growth on the "forest floor" held the water from heavy rains

like a sponge or blotter will hold the water poured on it from a glass. The escape of water from this forest floor was gradual, so that no floods occurred. The water escaped gradually and supplied free water for the subsoils of the surrounding fields. The effect of long periods of dry weather was much less serious; stream flow was more uniform at all seasons; springs were more permanent and pastures were well supplied with water for stock where now it must be pumped. The flow in wells is regulated by forests. Wells that were supplied with an abundance of good water go dry a part of each year after nearby forests are destroyed.

The actual loss of soil from erosion is often due to the removal of forests from the hills above. Many areas which were once considered useful fields for raising crops become so badly washed and gullied that they must be abandoned. In many cases the best remedy is to reclothe them with forest growth.

It is needless to say that the farmer is economically interested in forestry because it will supply him with better and longer fence posts, lumber and fuel.

Growing the Crop on the Farm.—In the more humid regions of America, and where the land is not in the form of a perfect floor, there are often rough lands which could be more profitably used for timber than for other farm crops. The great advance in prices paid for good posts, poles, railroad ties, and lumber will warrant the growth of a farm woodlot as a farm crop. The wood lot may also furnish to the grower his own supply of fuel and perhaps leave some for sale each year. At present the income from such wood lots in the United States is greater than from the sale of any other single farm crop, except corn. As land is used for this purpose that would otherwise be wasted, the profit from such sales is usually much greater in proportion to the income than for other crops. Eroding hillsides should be used for trees. Rough, strong land, whether high or low, is found better for trees than for other crops. Low, wet lands may be used for certain species of trees when drainage would be too expensive.

High knolls, where the surface soil has become too thin to yield good returns from field crops, may prove to be good soils for the production of locust posts and other wood products. On many farms in all sections the areas along ravines and streams are already well supplied with natural mixed growth. Proper care and management will aid nature in making areas far more profitable.

Using Good Farm Land.—Whether land well suited to the raising of farm crops should ever be planted with forest trees or not must be decided by the owner. In cases where this is done it is best to plant the trees in groves rather than in narrow lines as fence rows. Where windbreaks are much needed it is better to plant wide shelter belts than narrow rows. The trees themselves will be of better form and the wasted strip along the side of the line of trees will be less in proportion to the number of trees produced. Field crops usually do not grow close to the line of trees because of the drying influence of the trees. This waste area can be much reduced by using trees with tap-roots at the edge of the shelter belt or grove. Another method of reducing the waste is to open a deep furrow or trench close up to the trees on the side next to the field crop. This will cut the shallow, lateral roots which tend to draw moisture from the adjoining field. The ditch can be closed and perhaps not opened again for several years. In some states it becomes more profitable to use good agricultural land for trees because the tax on such land is remitted by state law when it is devoted to forestry. The land near the farm buildings, although the most valuable on the farm, should be early devoted to either fruit trees or forest or both. A grove planted near the buildings will not only serve as a good windbreak for livestock and man at all times, but will often prevent much damage from severe storms. It will serve as suitable shelter for stock taking exercise during the winter. It may be so planted as to add beauty to the farm. It is an admirable place to be used for poultry runs. Grazing animals should not be allowed to destroy the young growth in the woodlot during the growing season. Seedlings and other young growth should be allowed to start and be ready to replace the mature timber as it is harvested.

Trees Along Fences and Roads.—Trees planted along roads should not be thought of as productive of crops. As they blow down or become aged they may be useful as wood, but usually they yield no other valuable product to the owner. When broken by wind they should be pruned (Fig. 247). For æsthetic reasons they may be very useful. They are sometimes objected to by road engineers if they cause the roads to remain muddy long after the rainy season, or if they cause snow to accumulate in drifts across the road.

Trees and undergrowth along fences are usually not profitable to the owner. If they are pasture lands they may furnish suitable

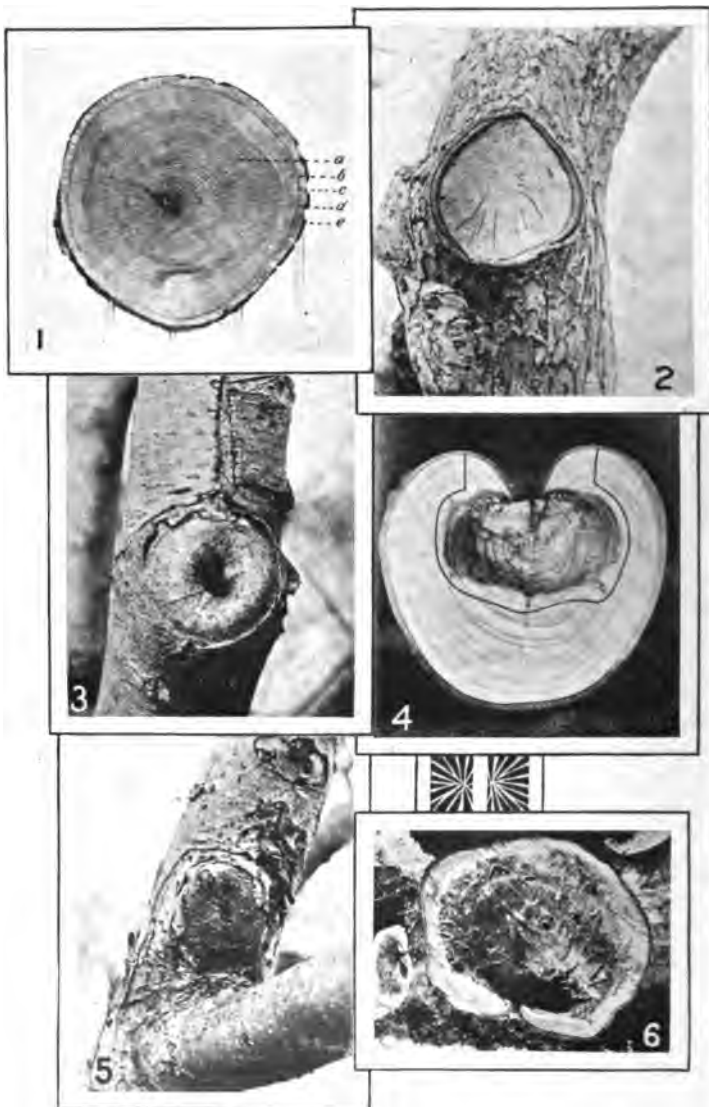

FIG. 247.—Pruning and tree surgery: 1. *a*, heart wood; *b*, sap wood; *c*, cambium or growing layer; *d*, inner bark; *e*, outer bark. 2. When a large limb is cut it should be sawed very close to the body so that the growing layer and bark can produce a new growth to cover it. The cut surface should be painted to prevent decay. 3. A new growth over an old wound leaves a deep hole at the center if decay begins too soon. 4. A cross section showing the affected part. 5. The growth in many cases may continue and almost or entirely hide the affected part. 6. A section showing the decayed heart wood commonly known as "hollow tree." (U. S. D. A.)

shade for grazing stock, but along other fields they are usually objectionable. The trees are unshapely from the forester's point of view and the adjoining crops will often suffer because of the trees. If windbreaks are needed the fence row may be the best place to have the line of trees.

How and What to Plant.—In many sections of the country nature will be a good guide in deciding what varieties of trees should be used in the farm wood lot. Perhaps some of the best species that have been entirely destroyed by the hand of man would be the most profitable for replanting. This is true in many parts of the white pine belt. Very few trees are more profitable than white pine in the region where it was once native. A few species, such as the chestnut, have been made unprofitable be-



FIG. 248.—The raising of seedling trees for the farm woodlot is of vast importance and many large forest nurseries are producing millions of trees of many kinds. (U. S. D. A.)

cause of certain diseases or insects, although the chestnut disease has not destroyed that species throughout the country, but the possibility of the spread of the disease makes its growth uncertain. Black walnut grows reasonably fast and the price paid for the wood makes the profit very great. Short-lived trees, if used at all, should be mixed with more permanent trees. A few very rapidly growing trees also produce very superior wood. The hardy catalpa, for example, makes a quick growth, yielding returns in a few years. The wood is very durable and is used for many purposes, such as cabinet work, furniture, and farm posts. Among the tap-rooted trees, suitable for the borders near field crops, may be mentioned hickories, walnut, butternut, hardy catalpa, chestnut and locust.

Forest trees are propagated in large quantities from seed, and can usually be obtained from forest nurseries at very reasonable prices (Fig. 248).

Trees should be set close enough together so that side branches will be formed chiefly near their tops. Tall, slender trees are more suitable for most purposes than branched trees. With many species the distance apart should not be less than four feet, nor more than six or eight feet. If the wood lot is to be started on



FIG. 249.—A well-managed wood lot, where timber and wood keep coming as a perpetual crop. The waste twigs and limbs are removed or piled and carefully burned to prevent the breeding of forest insects. The "ripe" trees are cut without injury to the younger ones. (U. S. D. A.)

valuable farm land, the rows may be far enough apart to allow intercropping with other products for several years.

There are a number of advantages derived from having the wood lot made up of a mixed planting rather than of one species. (See Productive Farming).

In rough areas, where the soil cannot be prepared by plowing or other tillage, waste or useless brush or brush growth may be mowed away and the planting of young seedlings may be done with grubbing hoes. A small area may be cleared for the seedling.

Vigorous species may be merely set in holes made with a grubbing hoe. Areas which are already naturally partly wooded with good species may need additional planting in the open or thinner places. This must be done by hand and the spade or grubbing hoe should be used.

Management and Harvest.—Some of the crop from the wood lot will be ready to harvest much sooner than many are likely to expect. Where much of the forest is planted by nature, there will be considerable thinning of leaning or otherwise poor growth. The growth from green stumps, called coppice growth,



FIG. 250.—Buckets catching sap from spouts in sugar maple trees. (U. S. D. A.)

will usually be too crowded and must be thinned. Storms will make some cutting necessary.

The early harvest of young timber may be useful as fuel; some can be used for barrel hoops; some for broom, hoe and rake handles, and some for rustic seats and other furniture.

In any plantation, whether planted by nature or by man, attention must be given to the harvesting of sickly, injured, or mature trees before they are seriously attacked by bark beetles or other forest insects. This will prevent the rapid multiplication of the insects and help to save the healthy trees.

The experienced woodsman will soon learn to study the loca-

tions of old and young trees and can determine what young growth must be saved to renew the forest when the ripe trees are harvested (Fig. 249).

Forest fires are much less destructive and are easier to control when the waste trimmings are piled and burned.

Maple Sugar Products.—The sugar maple is a native in the northern and northeastern states and far into Canada. It supplies two important products found in our markets—maple sugar and maple syrup. A maple woods is commonly spoken of as a “sugar orchard.” In the spring about the time of the melting of the last



FIG. 251.—The making of maple syrup and sugar is of community interest. It takes place with the melting of snow in early spring. The hot sap suddenly cooled by pouring on snow makes a delicious honey-like wax relished by all.

snow, and as the frost is leaving the ground, the sap of the tree begins to flow rapidly. During this period if the tree is tapped, a considerable quantity of the flowing sap may be drained from the tree and caught in buckets (Fig. 250). This sap is very watery and must be boiled down to make it usable as syrup. The boiling is usually done in open vats to allow of rapid evaporation. When of the right density the syrup may be strained and put in cans for market. The gallon size of can is generally used. If the boiling process is carried beyond the syrup stage, it becomes sugar when cooled (Fig. 251). This is usually molded in cakes to suit the various markets or the fancy of the producer.

CULTURE OF NUTS

There are a number of the native nut trees found in America, and there is evidence that the ancient mound-builders who lived in America before the Indians made use of the nuts as food. Besides the native species there are a number of others introduced from the old world. Not until recently were the native nuts improved or brought under cultivation, but at present many orchards of both native and foreign nuts have been started and are maintained with profit.

Walnuts.—The so-called English walnut is really a Persian walnut, belonging to the species *Juglans regia*. This is perhaps the most popular walnut in the American markets. It is grown extensively on the Pacific coast, especially in southern California. There is little difficulty in its care and management, but the trees sometimes fail to set fruit because of insufficient pollination. When trees are isolated they are less likely to bear a crop. It is probably for this reason that the trees found throughout the eastern states southward from Washington are seldom known to bear full crops, but where real orchards are planted they are more successful.

The trees have deep tap roots and thrive well in soil composed of deep loam underlaid with gravel, or with clay if not too hard.

The trees are commonly propagated by seeds, but a few named varieties are recognized, and these are propagated either by grafting or budding.

The distance between trees in the orchard is forty feet or more. The distance should be increased in very rich soil as the trees will become much larger. In commercial orchards clean tillage is given at least until bearing of the first crop. Intercropping with crops that require cultivation is advisable and will insure sufficient tillage of the orchard. As the trees advance in age, the area is often seeded to grass which may be used for grazing purposes. The trees are seldom pruned except at the time of setting the orchard, when they are caused to form their heads at a suitable height of about four feet from the ground.

There are two native walnuts found in our markets. *Juglans nigra* or black walnut, and *J. cinerea*, or butternut. These are grown in much the same way as the English walnut, but there are fewer commercial orchards of these species. These are both hardier than the English walnut and are consequently grown farther north, being found in the northern states and Canada.

Hickory Nuts.—(Figs. 252 and 253). One of the most popular native nuts is the hickory nut. There are several recognized species and varieties of this, but those most highly prized on the market belong to the shellbark hickory, known as *Carya alba*, and *C. sulcata*. The range of *C. alba* is from New England to Minnesota, south to Florida and Texas, *C. sulcata* being more limited than this. These are sometimes designated as the “sweet



FIG. 252.—Commercial hickories. The wood of the shellbark hickory is very tough and is manufactured into handles, agricultural implements, carriages, and wagons. The hickory nuts of commerce are produced by this species. The trees are native from Maine to Florida, westward to Texas, Kansas, and Minnesota. (U. S. D. A.)

hickory nuts,” in contrast to the others, which are slightly bitter.

The varieties differ from each other in size, thickness of shell, time of maturing and climate in which they grow naturally. As yet few of these are grown under cultivation, and then not on a commercial scale. They are chiefly propagated by seeds. They come rather true to type, and grafting or budding is yet seldom used.

The **Pecan** is a native of the gulf states, but some are found wild as far north as Illinois and Iowa in the Mississippi Valley. It is of the same genus as the hickory. The southern varieties are more popular because of their thin shells. It is these which are chiefly used in commercial plantations.

They are commonly propagated by seeds, but grafted and budded varieties are much preferred because of the certainty as to the character of the crop produced. A uniform product is obtained from an orchard started from budded trees, while the crop from seedling orchards varies widely in the thickness of shells, size of nuts, and flavor. The grafting operation is not always successful, and for this reason the trees grown on grafted or budded stocks are rather expensive. The stocks used are grown from seeds and are usually budded near the ground.

In rich soil the trees attain a spread of fifty feet or more and should be given this distance at least when planting the orchard. Crops are grown between the rows for the first eight or ten years so that some return may be obtained from the land while waiting for the bearing to begin.

Chestnuts.—(Fig. 254). While native chestnuts are found on the market and are desired for their rich flavor, it is the foreign varieties which are chiefly used and which are grown commercially. Native chestnuts are found throughout the eastern states and southern Canada. Much of this region, however, has been devastated by a disease called the "chestnut blight" which has wiped out the native trees. Improved varieties of the native sorts are being established. The Paragon chestnut is the most prominent variety of the European species. The Ridgely is also grown in nurseries



FIG. 253.—Hickory nuts vary greatly in size, thickness of shell, and quality of meat. The best should be selected for planting.

for sale to orchards. Some Japanese varieties are also grown. These are propagated as in the case of other improved varieties by bark-grafting and cleft-grafting.

Grafted trees are placed about forty feet apart in orchards and intercropping systems are adopted for a number of years when permanent grass is usually started.



FIG. 254.—“The opening of a chestnut burr.” The native nuts are sold in our markets. There are a number of the larger foreign sorts grown in America by grafting on our native species. The wood of the chestnut tree is light and soft but durable and has many uses.

Almonds.—Cultivated almonds were commercially grown in California long before the culture of other kinds of nuts. In the irrigated regions of the mountain states from New Mexico to Idaho, the crop is now commercially grown.

The almond is a relative of the peach, and its culture is similar. The trees blossom very early in spring and are likely to be killed by late spring frosts. This requires that care be taken to place the orchards in situations well provided with air drainage.

Cocoanuts are grown in the warmer parts of Florida where the climate is moist. Groves of several thousand trees are found near Biscayne Bay and in the vicinity of Lake Worth and Cape Sable, Florida. The trees are started from seed and begin bearing as young as six or eight years from time of planting.

Other nuts are grown either wild or cultivated less extensively than those treated here. Under the head of “Nuts,” the Standard Cyclopedia of Horticulture gives a list of more than 250 different kinds, most of which represent different species. These are not all used for home food and some are not at all edible.

FIELD AND LABORATORY EXERCISES

1. **Collecting Forest Products.**—It would be interesting to make up a collection showing most of the forest products as mentioned in Farmers' Bulletin 468, quoted in this chapter.

2. **Visit a wood lot** or forest and study the wastes as usually allowed—fallen trees, decaying wood, destruction by beetles, damage by fires, and others.

3. **Depth of Forest Carpet.**—In a woods of old trees, examine the “forest carpet” of leaves, twigs, leaf mold and undergrowth.

4. **How Forests Prevent Floods.**—On a large board or small table top, place a desk blotter or flannel cloth about two feet square. Tip the board or table at an angle of about 45 degrees and pour on it near the upper edge a glass of water. Note how well the blotter absorbs and holds the water. Now remove the blotter from the table and pour on another glass of water and see

how quickly the water runs off from the hard surface still tipped at the same angle as before. Compare the results in the two trials with a hillside once clothed with a forest carpet and now made bare by burning or clearing. What is the effect of a forest carpet on springs and wells in the vicinity?

5. **Saving Forest Monarchs for Reseeding.**—Near some of the large seed-bearing trees, such as oaks, maples, white pines or others, study the distribution of seeds and the growth of young seedlings. Of what value is the practice of leaving such old trees standing when the main forest is first cut over?

6. **Selecting Forest Areas.**—In a rough, hilly country, examine several farms and estimate number of acres on each suitable for forest growth. Determine, if possible, why all areas that should be planted to forests are not so used.

7. **Trees to Plant.**—Make a list of trees of the region which would be suitable for use in forests. Which ones are considered best for lumber? Which for poles? Which for railroad ties?

8. **Choosing Trees to Harvest.**—In a woods which may be kept permanently as a forest, indicate by tying a strip of white rag on trees which may be cut for harvest during the next winter season. Then with strips of another color mark those to be cut the next winter, and then mark those to be cut the third winter. Be prepared to give reasons for your choice of what trees to harvest at each time.

QUESTIONS

1. Give at least one forest product in each class outlined in this chapter.
2. By inquiring of older citizens, find how prices have increased for railroad ties, telephone poles, lumber, and other forest products.
3. Give the chief causes of wastes in forests and woodlots.
4. Suggest methods of preventing wastes.
5. Show the farmers' interest in forestry.
6. What kinds of places are best suited for the farm wood lot? Why use waste lands?
7. Where should shelter belts be planted?
8. Enumerate their uses.
9. Give some suggestions as to what kinds of trees to plant.
10. Describe the making of maple syrup and sugar.
11. Discuss the growing of walnuts.
12. Give directions for setting a pecan orchard.
13. What effect will the chestnut disease have on the planting of chestnut groves?
14. Where are coconuts grown in the United States?

References.—United States Farmers' Bulletins: 99, Insect Enemies of Shade Trees; 173, Primer of Forestry, Part I: The Forest; 228, Forest Planting and Farm Management; 252, Maple Sugar; 332, Nuts and Their Uses as Food; 358, Primer of Forestry, Part II: Practical Forestry; 423, Forest Nurseries for Schools; 476, The Dying of Pine in the Southern States: Cause, Extent and Remedy; 516, The Production of Maple Syrup and Sugar; 700, Pecan Culture; 711, The Care and Improvement of the Wood Lot; 715, Measuring and Marketing Wood Lot Products.

Cornell Bulletin 333, Control of Two Elm Tree Pests. Cornell Bulletin 347, Endothia Canker of Chestnut. Cornell Bulletin 366, Wood-lot Conditions in Broome County, N. Y. Cornell Bulletin 368, Wood-lot Conditions in Dutchess County, N. Y. Cornell Bulletin 371, The Leaf Blotch Disease of Horsechestnut. Improvement of the Wood Lot, Cornell Reading Courses, Forestry Series No. 1. U. S. Forest Service, Bul. 86, Windbrakes. U. S. Forest Service Circ. 61, Forest Planting. Circ. 97, The Timber Supply of the United States. Circ. 117, Preservative Treatment of Fence Posts. Circ. 130, Forestry in the Public Schools.

CHAPTER XXVI

TOBACCO

It is a great mortification to the vanity of man that his utmost art and industry can never equal the meanest of nature's productions either for beauty or value.—HUME.

THREE of the eight leading field crops of the United States are natives of the New World—corn stands first in the list, Irish potatoes sixth, and tobacco eighth. The annual crop of raw tobacco is valued at about seventy-five million dollars. The internal revenue on manufactured tobacco, including cigars and cigarettes, is more than double this amount, but this includes the tax on imported tobacco.

In the early Colonial days of Virginia and Maryland this was an important article of commerce. It was used in place of money in exchange for both foreign and domestic articles. It was used by the North American Indians for smoking and in South America as snuff and for chewing. Its introduction into countries of the Old World for all these purposes was very rapid. The stems are used in making insecticides and as fertilizers.

Its use by human beings depends upon the presence of a sedative principle, chiefly the narcotic alkaloid nicotine, which has a quieting effect upon the nerves. In this class of sedative plants may be mentioned the opium poppy, used chiefly for smoking, and the betel-nut, of the palm family, used for chewing. Although nicotine is a poison, the tobacco leaves containing the largest percentage of it are considered the best. This is partly due to the fact that such leaves are also the largest and firmest.

Kentucky is now the leading state in the growth of tobacco, producing over one-third of the American crop. Other important tobacco states are North Carolina, Virginia, Ohio, Wisconsin, Tennessee, Pennsylvania, Connecticut and Maryland.

Soils for Tobacco.—There are several types of tobacco, each to be used for a different purpose, as for wrappers, for binders, for fillers, for chewing, for pipe smoking, for export, etc. The quality of the tobacco grown for any special purpose is greatly influenced by the soil as well as by the weather and general climatic conditions. As the market price depends very largely upon the odor and

flavor, much attention must be given to the soil as well as to the variety and to the curing processes.

Light loams as a rule give best results, but tobacco of different grades is grown on a wide range of soils, varying from sandy loams to very heavy loams. If the soil be loose and open and the subsoil heavy the moisture conditions are likely to be most favorable for producing a steady, continuous growth. It is proverbial among growers to say that "tobacco is hard on the land," and much fertilizing is necessary to keep up the fertility of the soil.

For the tobacco grower the use of proper fertilizers is as important as careful selection of soil. Fertilizer must suit the type of tobacco to be grown and must be well balanced and contain no ingredients which are detrimental to the tobacco leaf. If too much phosphate is used it affects the ash of cigars. The grower should never use kainit or muriate of potash, but should obtain the potash in the sulfate form. For the supply of nitrogen it is best to use well-rotted barnyard manure, green manure, or commercial nitrogen in the organic form, as from dry blood, tankage and cottonseed meal. If nitrate of soda is used it should be in small amounts.

The young plants for tobacco fields are first started in seed beds and later transplanted to the fields. About two months are usually allowed from seeding time to transplanting time. This requires some heating and protection of the seed beds in many localities. As the transplanting should take place soon after the latest spring frost, the beds are started in late winter or very early spring.

Tobacco seed is very fine and to properly sow it in the beds it is usually mixed with sand or well sifted ashes to aid in sufficiently distributing it. It is covered very lightly and kept well watered. The beds are commonly made in the form of long hotbeds, and may be covered either with glass or with light muslin. The latter may be so arranged that it can be rolled up when the weather is warm. When glass is much used care must be exercised to prevent the "damping off" of the plants, due to bad ventilation and excessive heat on warm days.

In the Field.—As excessive growth of the root system is not desired it is usual to practice spring plowing, but if the field be plowed in the fall it may be disked very deep in the spring or plowed crosswise. The surface soil should be made very fine. If several

weeks elapse between spring plowing and the setting of the plants, the field should be harrowed several times to warm and air the soil and kill as many weed seeds as possible by the sprouting system. The fertilizer to be used should be mixed at home and applied to the field about planting time.

Plants should be set as soon as the weather conditions are favorable and all danger of frost is past. On all large plantations transplanting machines are used (Fig. 255). They are similar to the machines described for the transplanting of sweet potatoes.



FIG. 255.—Machine at work setting tobacco plants in the open field. The boys behind place the plants in the planting pocket one at a time. The machine opens the furrow, waters the plants, and presses in the soil around them. (U. S. D. A.)



FIG. 256.—Tobacco in Maryland. Topped plants, bagged seed plants and tobacco barn. (U. S. D. A.)

It is not necessary to mark off the field in rows if planting machines are to be used, but if the planting is done by hand the marking may be done with furrowing plows, leaving small furrows for setting the plants. The rows are usually three to four feet apart and the plants one and one-half to two feet apart in the rows, the distance depending upon the variety and character of soil.

Culture.—The depth of early tillage between the rows will



FIG. 257.—Wagon rack of tobacco plants being taken from field to curing barn. Note also seed plants bagged. (U. S. D. A.)



FIG. 258.—Interior of tobacco barn with strings of tobacco being cured. (U. S. D. A.)

depend upon the thoroughness of the preparation before the plants were set. Later, shallow cultivation is usually practiced until the plants are so large as to be in danger of injury by the process.

The production of seeds by plants takes from the leaf stem much of its value and size. For this reason topping or cutting off the blossom stems is necessary. The skilful grower learns the proper stage at which to do this work. Under certain conditions



FIG. 259.—Tennessee tobacco barn used in curing dark tobacco, by fire process of removing the moisture. (Productive Farm Crops.)

suckers may develop in the angles of the leaves from the main stem as a result of the topping. The continued growth of suckers will reduce the growth of valuable leaves. It is often necessary to go through a field a number of times, not only to cut flower stems, but to remove the suckers.

It is a good plan to select a few good plants in the fields for production of seed (Fig. 256). On these the flower stems are not removed, and the grower will thus produce his own improved seed from plants well suited to his own soil.

Harvesting and Curing.—Toward the end of the season as the leaves mature the plants are cut by hand and taken on racks (Fig.

257) to curing sheds or tobacco barns. The grower learns to detect carefully the proper stage at which to harvest the crop. The curing and the manner of subsequent handling of the crop depend upon the type of tobacco and the use for which it is intended (Fig. 258). In some cases the large wrapper leaves are strung on racks singly, being detached from the stem. Curing must be done without causing mold or other fungous growth. Curing barns are provided with numerous ventilators for the removal of moisture from the leaves. The grower must give careful attention to the ventilation, keeping out the air when the weather is wet and allowing free access when the air is drier. Artificial heat is seldom necessary, but is often used. This is usually produced by the burning of charcoal in small sheet-iron stoves. The color is likely to be affected if artificial heat is applied in the curing (Fig. 259).

When the tobacco is dry it is ready to be graded for market. The work of stripping leaves from stems and grading the product should be done when the weather is moist enough to prevent the leaves from breaking. The leaves may be marketed in the loose condition if factories are nearby, but if the tobacco is to be shaped it is packed in large bales, or pressed into barrels and hogsheads. In the tobacco districts of the South this latter process is called "prizing."

FIELD AND LABORATORY EXERCISES

1. **Management of Plant Beds.**—Visit tobacco plant-beds and note the development of plants under the covers as compared with volunteer or chance plants growing outside the beds. Study the methods of watering, transplanting, preparation of fields, and other points incident to this crop.

2. **Tests with Fertilizers.**—Tobacco plants should be grown in the garden under different treatments of fertilizer. Compare the growth when other conditions are all alike. Does the tobacco crop require more nitrogen or more potash as compared with corn and potatoes in the same kind of soil?

3. **Curing Tobacco.**—In the fall of the year tobacco barns of different types should be examined and descriptions or drawings made to show the methods of arranging the tiers of plants. Also compare the methods of ventilation and methods of drying.

QUESTIONS

1. What type or types of tobacco are grown in your state?
2. What regions grow wrapper tobacco? What filler tobacco? What chewing tobacco?
3. How are tobacco beds started?
4. How are the plants transplanted?
5. Describe the cultivation of the crop.
6. Describe the harvesting and curing of tobacco.

References.—United States Farmers' Bulletins: 120, Insects Affecting Tobacco; 343, The Cultivation of Tobacco in Kentucky and Tennessee; 416, The Production of Cigar-leaf Tobacco in Pennsylvania; 523, Tobacco Curing; 571, Tobacco Culture.

CHAPTER XXVII

WEEDS

Consider the lilies of the field how they grow; they toil not, neither do they spin. And yet I say unto you that Solomon in all his glory was not arrayed like one of these.—BIBLE.

IN the broad sense, a weed is any plant that is out of place. Corn in the rose garden or roses in the corn field are examples. In the usually accepted meaning of the term, a plant is a weed only when it is never cultivated or grown as a crop, but there are some exceptions even to this meaning. Plants such as the dandelion are considered weeds by most gardeners and farmers, but they are sometimes grown intentionally for market as greens. Because a few grow some plants for market does not prevent the rest of us from considering them as weeds.

Noxious weeds are those which are usually considered weeds by everyone and in all places, but there are a few plants that have run wild or escaped from cultivation that are classed among the noxious weeds, and are listed as such in the laws of various states. Examples of these are the ox-eye daisy, purple and white aster, mustard, the bulbous rooted buttercup and others. Most of the noxious weeds exist as such because they are more or less difficult to eradicate. Each has some special characteristic in its nature by which it is able to withstand the treatment it receives during the tillage of the fields in which it grows. Examples of these special advantages are:

The wild onion has a bulbous root which will grow from its large store of nourishment even after it has been rooted up and the top killed by tillage of any kind.

The Johnson grass and quack grass (witch grass) have very long horizontal rootstalks running just under the surface of the ground. From the nodes of these rootstalks new stems may be sent up, and the more they are cut to pieces by the use of cultivators, harrows and other tillage implements, the more plants there will be.

The Burdock, cockle burr, Spanish bayonet, bidens, beggar weed and numerous others have devices by which the seeds cling to the coats of animals and thus are spread into numerous out-of-

the way places which would not otherwise be reached by weeds not thus equipped.

Classification of Weeds.—With respect to the length of time which weeds may live, they may be classified as (1) annuals, (2) biennials, and (3) perennials.

Annual weeds start from seed each year, as none of the roots or other parts live over. They develop stems, root systems, leaves and flowers and then bear seeds and die. This is all within one year, or perhaps one growing season. There are a few annual weeds that are called winter annuals which begin their growth in the fall just as wheat and other winter grain does. The winter chickweed is a very common example of this.

FIG. 260.



FIG. 261.



FIG. 260.—Hay-field in late summer with wild carrots or Queen Anne's lace.
FIG. 261.—The wild aster is often a bad weed in pastures and hay fields. (Productive Bee Keeping.)

Biennial weeds do not develop seed until the second year of their growth, but after the seed matures the whole plant dies. In the case of all such biennials, the plant develops a store of nourishment the first growing season. During the second growing season the plant uses up this store of nourishment which aids it in developing and ripening its seeds. Burdock and wild carrot (Queen Anne's lace, Fig. 260) are very common biennial weeds.

Perennial weeds are of two main types: The herbaceous perennials, which die to the ground each year, but the underground parts including the roots live from year to year for several or many years. The other form of perennials may live above ground as well as under ground for several years. These are usually more or



FIG. 262.—The mullein plant is often a bad weed in pastures if mowing is neglected. Large numbers of seeds are borne at the top and the plants will increase rapidly if allowed to ripen the seed. (U. S. D. A.)

less woody plants such as the wild rose, poison ivy (poison oak), prairie willow and others.

Herbaceous perennial weeds begin bearing seed as soon as they are old enough—perhaps by the second year. They bear seed each year and die to the ground by winter time. The next season they spring from the ground and develop a new flower stalk and bear another crop of seeds. Weeds of this character are the most persistent and most difficult to eradicate. (See Fig. 261.)

Another classification of weeds may be made on the basis of the habitat or place of growth. The lines between these classes are not definitely marked out but may be somewhat as follows:

(1) Those which are found chiefly in cultivated fields or among “hoed” crops. Examples are: Purslane, lamb’s-quarter, pig weed, field bindweed, and numerous others.

(2) Those which are found in grain fields in places where the ground is not tilled or plowed more than about once during the growing season. An example is ragweed, which springs up after grain harvest and fills the stubble field. Corn cockle is often common in the grain.

(3) Pasture weeds, including those which are found in permanent hay fields and permanent pastures. These prefer a soil which is not disturbed by tillage and plowing. They are usually not killed by mowing and cropping. Examples are the ox-eye daisy, wild asters, golden rod, dandelion,

mullein (Fig. 262) perennial milk weed, iron weed, tall verbena, English plantain (Fig. 263) and many others.

(4) Road-side and fence-row weeds are often the same kinds of weeds as are found in the other classes, but there are a number of weeds that are somewhat restricted to such places. May weed, dog fennel, burdock, chicory (Fig. 264), wild lettuce, beggar weed and others seem to prefer neglected places.

Losses Due to Weeds.—Weeds growing with our farm crops tend to smother the main crop, rob it of its plant food or shade it

FIG. 263.

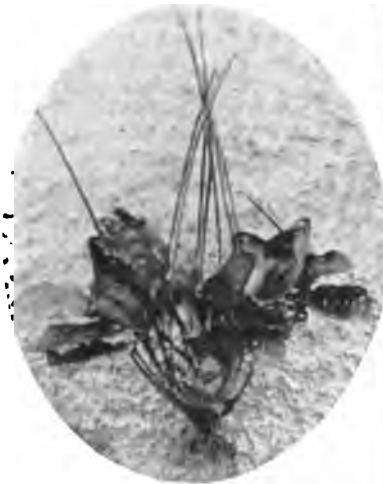

FIG. 263.—Wide-leaved plantain hanging by the seed stems. A weed in pastures, lawns and hay fields.

FIG. 264.



FIG. 264.—Chicory (Weed's Wild Flower Families).

from the light and air and thus may greatly reduce the yield of the crop. Even rapidly growing crops such as corn are often choked out by weeds where the tillage has been neglected. In spots where Canada thistle, Johnson grass, or quack grass has taken possession, the crop is reduced to a minimum.

Loss in Pasture.—Some weeds when grown in pastures are injurious because of their bad taste and bad odor, or because of thorns and prickles. The grass growing near them is avoided by pasturing animals and much loss is thus experienced. Fibrous weeds found in pastures are sometimes injurious to the animals themselves. Cattle are sometimes killed by eating the wild woody

ferns found in pasture lands bordering the low woodland. The animals may learn to love the ferns and eat so much of the woody tissue that they suffer from impaction of the stomach. In other cases animals are actually poisoned by the weeds, and much loss is often experienced. Loco weed often causes serious loss.

Animal products are injured by weeds. For example: Dairy cows eating wild onions or wild garlic will have their milk badly flavored and thus greatly reduced in value. The wool of sheep is often filled with burrs or other parts of weeds. The market value of the wool is thus much reduced. When such burrs and refuse collect in the manes and tails of horses, or in the tails of cattle, their appearance is marred, and the real value of the cattle is at least apparently reduced.

The value of field products is often injured by the presence of weed seeds in the harvested crop. When grain is infested with weed seed the buyer greatly discounts or "docks" the value of it. It receives a much lower grade or classification in the market. Millers are unwilling to buy wheat containing the bulblets of onion and garlic. Corn cockle and a few other forms of weed seeds are very difficult to separate from the grain by fans or screens, because they are nearly of the same size and weight. In case weed seeds can be separated from grain, the cost of the product is much increased by this labor. When weeds are mowed in hay fields, the grade of the hay is reduced and the market value is consequently much lower. In some cases the weeds are slow in curing, and the hay itself is thus reduced in value or may be left exposed to the weather until damaged by storm. The increased bulk of the harvest both of hay and grain increases the cost without increasing the returns.

Weeds Poisonous to Man.—Poison ivy has already been mentioned. Its injury to many persons when they come in contact with it is a matter of common knowledge. Wild parsnips if eaten during the second season of their growth, as they may be through mistake, are very poisonous. United States Farmers' Bulletin 86 on thirty poisonous plants should be read in this connection.

Value of Land Reduced.—The extremely noxious weeds will reduce the value of farm land. Prospective buyers are loath to buy farms infested with such persistent weeds as wild onions, Johnson grass, quack grass and Canada thistles. Any farm badly infested with weeds of any kind along road-sides, fence-rows or in

the fields is much less attractive to visitors or others contemplating purchase or rental of that particular farm or others in the vicinity.

Weeds Are Sometimes Beneficial.—If it were not for weeds, many farmers would not practice rotation of crops. Indeed, rotation is one of the very best ways for the control of certain classes of weeds.

Cultivation of the soil is required because of weeds. Many a poor farmer would neglect the crops if it were not for the growth of weeds which he feels in duty bound to kill by cultivation. The other benefits arising from the cultivation, such as the aëration of the soil and the saving of moisture, would not be realized if the farmer were not forced by weed growth to continue to cultivate corn, potatoes, garden truck and garden crops. Some one has said that "weeds make lazy men more diligent."

Weeds may serve as feed for animals, as they are often eaten by sheep, pigs, cattle and horses.

Certain succulent weeds are used by man as greens, particularly in the spring of the year.

Cover crops are often found to consist entirely of weeds of one or more kinds. Nature tries to cover the soil wherever it is left bare by man. This is no small benefit arising from weed growth. The growth of a cover of weeds not only serves all the purposes of a cover crop but it produces a cover of green manure which may be turned under for the improvement of the soil before the next money crop is started.

Plant food which is leached into the subsoil is often recovered by the growth of deep-rooted weeds reaching their tap roots into the subsoil and feeding upon those elements which are out of reach of most of our field crops. This plant food thus recovered may be made available for succeeding crops by the use of the weeds as green manure. The deep-rooted weeds may also be credited with the benefit arising from soil aëration and the formation of water channels along the many deep roots.

No one should defend the growing of weeds for the purposes here mentioned. The careful farmer will grow other crops which will accomplish each of these purposes better.

Dissemination of Weeds.—There are two main ways for the spread of weeds as well as of other plants. (1) By seed distribution, and (2) by the growth of vegetative parts, such as runners, rootstalks, and bulblets.

Distribution of Seeds.—There are a number of provisions in nature for the spread of seeds. The snapdragon throws its seed at

the time the seed case ripens. This is typical of a number of others. The carrying of seeds on the coats of animals has been mentioned and illustrated, and numerous examples are everywhere found. Wind is an important factor in the spread of seed "flying machines." The dandelion, thistle and milk weed seeds are carried long distances in high winds. Certain seeds are carried on the water and may be left in inundated fields, or along the banks of streams. Edible seeds are carried by birds, squirrels and other animals, and a large proportion of them are left in places where they may grow. The almost incredible number of seeds produced by single plants plays an important part in the problem of weed dissemination.

Commercial Operations Spread Weeds.—A number of the worst weeds in America have been introduced from the Old World through the use of packing material containing weed seeds. In like manner eastern weeds have been sent to the western states. The shipment of grains, stock feeds, hay, straw and similar materials from one part of the country to another will spread the weed seed which may chance to exist therein.

Farm Practices Spread Weeds.—Farmers who buy their feeds raised in distant places will find that manure when spread on their own fields is infested with new forms of weeds, and from this field or farm the weeds may spread to the neighboring fields.

Thrashing machines become infested with weed seeds on one farm and from there they go to other places where the seed is blown out and finds congenial soil on which to produce a new crop. Manure is hauled from the cities to the country. City stables may have been using feeds, bedding or roughage from distant places, the manure is full of the seeds and the farmer plants them when he spreads the manure. This is one of the strongest arguments used by gardeners against the use of stable manure and in favor of commercial fertilizers.

It is a far too common practice to allow weeds to go to seed along fence-rows, roadsides and other waste places. From here many fields are badly infested.

Tillage implements such as harrows and cultivators will often carry parts of weeds or their seeds from one part of the farm to another. This is particularly true with such weeds as those having long rootstalks as Canada thistle, quack grass and Johnson grass.

Foul seeds purchased from dealers or from farmers are among the sources of weed infection. Growers cannot be too careful in selecting clean seed, and avoiding the use of seeds grown in places where noxi-

ous weeds are common. The purchase of Sudan grass seed from a region where Johnson grass is found is likely to result in the sowing of Johnson grass. These two plants are compared in figure 265. Canada thistles have been introduced in many states through the use of grass seeds purchased from regions where Canada thistle is



FIG. 265.—Young plants of Sudan grass (left), and Johnson grass (right), showing the difference in roots. Note the many nodes on the rootstalks of Johnson grass—no wonder it is a persistent weed. (U. S. D. A.)

growing. Dodder is spread through the use of foul alfalfa and clover seed.

The laws of nearly all the states forbid the growth of noxious weeds on our farms. Certain regulations are made regarding the enforcement of these laws, but too often they are not enforced.

The laws regarding the spread of weed seeds through the sale of commercial seeds are comparatively well enforced in nearly all the states and Canada. Provision is made for the inspection of samples of seeds and the testing of them for impurities. Dealers are required to furnish statements of purity and freshness.

Control.—Prevention of Annual Weeds.—As the annuals do not have any underground root stalks or other means of spreading by vegetative growth, they are disseminated entirely by their seeds. The seed supply is very abundant in annuals. The keynote to prevention of annual weeds, therefore, is to prevent the maturing of seed. The weeds should be kept down in some way until frost kills them.

Probably the best management for the control of annual weeds is clean tillage. Mowing will accomplish a great deal, but some will produce seed very close to the ground after the higher growth has been clipped off.

Troubles With Biennials.—This group naturally produces less seed, as each plant requires two years in which to develop its crop of seeds. Although the underground parts live for two years they are not disseminated by this means. Most of the biennials are easily destroyed by plowing, hence they are not commonly found in fields that have been plowed recently. For this reason, it is more common to find burdock and similar biennials along fence-rows than along roadsides. In such places the weeds should be prevented from going to seed by cutting them below the surface of the ground with a knife or spading tool, or by keeping them mowed low enough to prevent the development of flowers and seeds.

Wild carrot is a biennial which becomes very abundant in pastures and hay fields. Rotation of crops probably is the best means of curbing it. Mowing the hay crop early will, to a great extent, prevent seed formation. When such hay is cut twice a year, the crop of wild carrots is largely controlled.

Eradication of Perennials.—Except in special cases, plowing, rotation of crops, and thorough cultivation are the best remedies for the control of perennial weeds. Most perennials do not like to have their root systems disturbed. As already mentioned, a few of the weeds with underground rootstalks are not controlled by such methods. This is true of Canada thistle, Johnson grass, quack grass and a few others. There are numerous perennials with fleshy roots, such as dandelion, true dock and others, that are entirely destroyed by plowing and cultivation.

In cases where it is impracticable to use these methods for the eradication of perennials, smother-crops may be of considerable value. Grain crops, dwarf Essex rape and other rank-growing crops may shade the weeds, largely preventing their growth.

Canada Thistle is one of the worst weeds known. It is found chiefly in the Northern states and Canada, and is found in all kinds of fields. Many special methods for its eradication have been tried and recommended. None of these is entirely successful in all cases.

A small patch of weeds may be smothered by placing over the patch a straw stack, or a hay stack. A pile of manure is sometimes used to smother the area. Even builders' paper or tar paper is sometimes tried. Anything will weaken the plants which will prevent the growth of new leaves. This will tend to starve the underground root stalks and thus allow them gradually to decay, but they will live underground without decay for more than a year.

If the surface of the ground be kept well tilled, the leaves will gather very little nourishment for the rootstalks.

Some have been successful in controlling small patches by the use of pigs or chickens penned closely on the small area.

A plan which may be followed for a large field infested with Canada thistle is to spray the field with copper sulfate solution, using fifteen pounds of the sulfate to fifty gallons of water. This amount should be enough for one acre. Spray when the weeds have formed their flower stalks, but have not yet developed any seed. Of course this is best done before the grain crop is forming its heads. The spraying kills only the part above ground and new growth is certain to follow, but this will be so short when the grain harvest is on that most of the thistles will be kept out of the bundles of grain. After harvest is over the ground should be plowed and then kept harrowed every week or so for the remainder of the summer. This will reduce the leaf surface sufficiently to weaken the rootstalks by the time winter comes on. The next year the field should be put into a cultivated crop such as corn or potatoes, and this should be so thoroughly tilled as to prevent any leaf growth of the weeds.

Johnson Grass.—This weed is a southern grass and is one of the worst, having an abundance of rootstalk surface. The grass becomes very tall, and smothering it by the growth of money crops is practically impossible. Several of the methods above mentioned for Canada thistle may be applied effectively in controlling Johnson grass. Hogs required to pasture on the field will eat the rootstalks and destroy the weeds.

When fields are only partially infested with Johnson grass

with a patch here and there over much of the field, some have adopted the method of seeding the whole area to such a crop as Sudan grass. This crop may be cut several times in one season. This will prevent the Johnson grass from forming seed, and to this extent will control its spread. This should not be considered a means of entirely eradicating it, but rather a means of making the best of it while we have it.

Quack Grass.—(Witch Grass). This is a northern weed and has slender running rootstalks with nodes only an inch or less apart. The rootstalks are readily broken to pieces by tillage machinery and the plant is thus rapidly spread over the farm, as each piece will grow wherever it comes in contact with the soil. Small areas may be kept down by pasturing closely with hogs or poultry. As in the case of Canada thistle and Johnson grass, the keynote to destruction is the prevention of leaf growth and the starvation of the underground parts. The rootstalks are very shallow and the field plowing will be helpful. Small areas of the plant may be smothered by applications of salt to prevent the leaf growth.

Wild Onions and Garlic.—Weeds of this group are severe pests in pastures, hay fields and rich meadow lands. They are sometimes very bad in cultivated fields. Stock do not object to eating the tops, but the milk of dairy cows and the meat of other animals is affected in flavor when these weeds form a large proportion of the feed. Land infested with wild onions and garlic will often have to be abandoned for pasture purposes because of the bad flavors resulting in the products.

One plan of control is to plow the crop under in April or May and to again plow in November. In the middle and southern states the crop will grow throughout the winter. These two plowings will help to prevent the leaf growth, particularly if each of the plowings be followed with some harrowing or cultivation. During the summer season a culture crop is grown and kept thoroughly tilled, and thus the use of the ground will not be lost.

Very small patches may be planted and used for cattle lots during the winter season in regions where the ground is not frozen much of the time. The puddling of the soil by the trampling of the animals will cause most of the bulbs to rot and little or no growth will come thereafter.

If sheep be used to pasture the onion field, they may be induced to eat the tops readily if all the salt the animals get is ap-

plied to the ground where the onions are growing. Before the animals are needed for slaughter they should be taken from the pasture and given other feeds for several days. This will help to remove the distasteful flavor from the meat.

Where very few onions have started in the soil, they should be pulled out and destroyed. The field should then be limed and enriched with commercial fertilizers and plenty of seed of good grass or other crops should be sown. Liming and fertilizing will encourage the growth of the other crops and this in turn will greatly help to crowd out the onions and garlic.

Spraying is one of the best remedies for the control of weeds in grain fields, and may be used in hay fields and pastures. The principle involved is that a solution of a spray material may be made strong enough to injure weed tissues without seriously injuring the leaves of the grain. This is because the grain leaves are provided with a "bloom," which is a covering somewhat resembling wax in protecting the surfaces of the leaves. The spray will attack the unprotected weeds but will not affect the grain. Sulfate of iron is most commonly used, the mixture being made at the rate of 100 pounds of the sulfate to fifty gallons of water, and this should spray about one acre of weeds.

Probably the best time for spraying is when the weeds are beginning to send up their flower stalks and just before the grain begins to form its heads. One spraying at that time should be enough to kill practically all the weeds then above ground, and others will be smothered to some extent by the grain crop being so much ahead of them.

Pasture Weeds.—Weeds in permanent pastures are hard to control. As already stated they are chiefly perennials. Weeds of this group are most easily destroyed by plowing, but if the pasture is to be a permanent one, plowing is out of the question. Of course if the circumstances are such as to allow the owner to plow up the pasture and put it into some other crop until the perennial weeds are destroyed, this plan would probably be the best, but in many cases the permanent pasture is a rocky field, or a stumpy field, or a low wet field, or very hilly, and any of these conditions might make thorough plowing impossible. Other methods must then be resorted to.

When the pasture grass is short, sheep may be allowed to graze for a short period and thus crop many of the weeds. Mowing should also be practiced. If a mowing machine can be run

over the pasture twice a year, it will wonderfully improve its grazing qualities. Grass is much improved by clipping. The grass seed stalks are cut, and this in turn makes the grass form more leafy and succulent growth for the stock. On the other hand, the clipping is injurious to the weeds and two clippings a year will destroy many of them.

Liming and fertilizing are both beneficial to the grass, and will encourage it in its efforts to crowd out the weeds. More grass seed should be sown in the pasture each fall and spring, particularly in the bare places or parts where the weeds are most abundant. If possible, a harrow should be used over the surface at each seeding time to help cover the seed and to help destroy the weeds.

Along Roadsides.—It is a common sight to see crops of weeds going to seed in waste places along fences and roads. These furnish enough seed to supply the farms along both sides of the road, and the fields bordered by the fences. No efforts should be spared in trying to induce all farmers, both the thrifty and the neglectful, to keep such places along their farms mowed or otherwise cleaned of growing weeds. Such areas should be grassed, if possible, as this will tend to keep down the weeds. The grass itself may be cut or pastured, and some value of the area will thus be obtained. Along railroads, wide strips are sometimes left which may be used for growing clean culture crops such as potatoes.

How Rotation Helps to Control Weeds.—Perennial weeds are more common in pastures and meadows than they are in cultivated fields. The annuals are more common in cultivated fields than they are in pastures and meadows. Wherever certain annual weeds have become a serious pest in a field, they may be subjugated by first cleaning the field up well and preparing a good seed bed for grass, clover, alfalfa or other perennial crop which, if properly grown, will smother out the annual weeds. The annual weeds fail to persist because the ground becomes well settled and the cutting of the hay will prevent them from going to seed—two conditions unfavorable to them.

Wherever perennial weeds are becoming too well established in grass lands of any kind, the ground should be plowed, and as one plowing is usually not enough entirely to destroy them all, it is advisable to follow with clean tillage for a season or more. To do this economically requires the growth of an annual crop which is to be cultivated, such as potatoes, corn, tobacco, garden crops, or cotton.

Without waiting for either class of weeds to become a serious pest on the farm we may control both classes by systematically and regularly practicing this kind of rotation which requires the change from rather permanent fields, such as grass lands, to the cultivated fields, and then reseeding the cultivated fields with the perennial crops. Examples of rotations for different sections are suggested in Chapter XI.

Principles of Weed Control.—The following brief memoranda will help students and young farmers to keep in mind the various methods of weed control, and the study of these principles will serve as a sort of review of the points already given.

(1) Never sow foul seed (Figs. 266 and 267). Have the seed cleaned thoroughly before sowing it. Remember that numerous

FIG. 266.



FIG. 267



FIG. 266.—The wet thumb will pick up a layer of seeds from the sample. The reading glass or lens will help in detecting impurities.

FIG. 267.—One of the quickest ways of roughly examining a seed-sample for impurities.

weeds may be started directly by the farmer who sows clover, grass or other farm seeds which are infested with weeds. Figures 268 and 269 will aid in identifying weed seeds found in samples.

(2) If grains or other seeds are harvested on the farm itself, they should be cleaned thoroughly by the use of the screen and fanning mill before being used for seeding other fields.

(3) Always cut annuals, biennials and perennials (all kinds of weeds) before they ripen seed. Never allow seeds to mature if it can be prevented.

(4) Weeds are easier to kill during the stage that they are sending up their flower stalks than at any earlier time in their growth.



FIG. 268.—Noxious weed seeds found in farm seeds: a, sand bur; b, wild oat; c, chess. d, darnel; e, quack-grass; f, dock; g, black bindweed; h, Russian thistle; i, corn cockle; j, white campion; k, bladder campion; l, night-flowering catchfly; m, cow cockle; n, penny-cress; o, field peppergrass; p, large-fruited false flax; q, small-fruited false flax; r, ball mustard; s, black mustard; t, English charlock. (Enlarged and natural size) (U. S. D. A. in Fights of the Farmer)

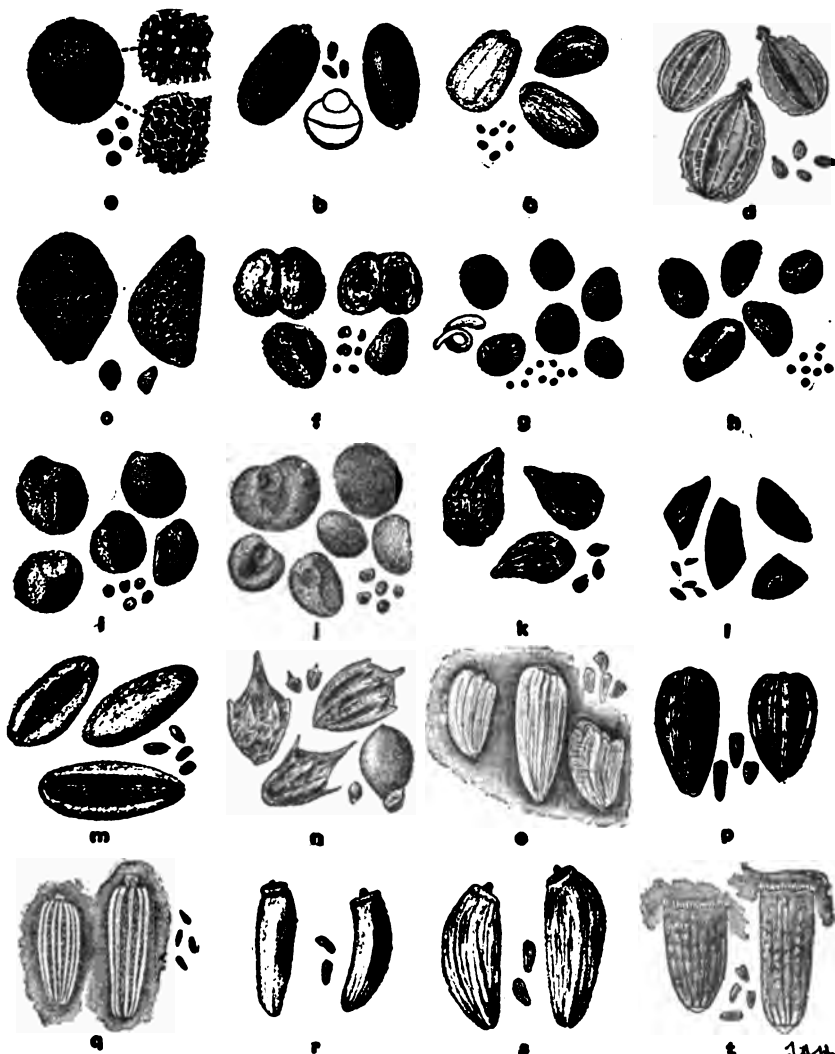

FIG. 269 —Noxious weed seeds found in farm seeds: a, Indian mustard; b, hare's-ear mustard; c, tumbling mustard; d, wild carrot; e, field bindweed; f, flax dodder; g, clover dodder; h, small-seeded alfalfa dodder; i, field dodder; j, large-seeded alfalfa dodder; k, corn gromwell; l, rat-tail plantain; m, buckhorn; n, ragweed; o, gum weed; p, wild sunflower; q, oxeye daisy; r, Canada thistle; s, bull thistle; t, wild chicory. (Enlarged and natural size.) (U. S. D. A. in *Fights of the Farmer*.)

Of course this does not apply to those weeds having a very persistent underground rootstalk.

(5) Crops of weeds bearing mature seed should be mowed, raked and piled into compost heaps to rot instead of plowing them under directly. The rotting process will destroy many of the weed seeds.

(6) This composting process should be used with manures which are known to be badly infested with weed seeds.

(7) Be particularly diligent in fighting weeds new to your region.

(8) Make the best use possible of sheep, hogs and other animals for the control of weeds in pastures and elsewhere.

(9) Use rotation of crops for the control of weeds, if for no other reason.

(10) Use chemical sprays in all cases where they can control the weeds in a wholesale manner and with economy.

(11) Do everything possible to aid in the enforcement of weed laws of your state; both the laws relating to clean seed and those relating to the growth of noxious weeds.

FIELD AND LABORATORY EXERCISES

1. **Study Growing Weeds.**—Many field trips should be taken to study weeds as they grow in the fields. Make lists and indicate the kind of place in which each is found. In the laboratory or study room, these should be grouped according to their length of life as annuals, biennials, and perennials. The perennials may again be sub-divided into those which have runners and running rootstalks.

2. **Freshly collected specimens** should be brought to the laboratory and classified the same as the lists have been classified before. This will aid in becoming familiar with the name as well as with the length of life of each weed.

3. **Press and dry good specimens** of weeds showing all the characteristic parts as well as possible, such as the underground rootstalks, runners, bulbs, flowers and stalks. Mount these on sheets as botany specimens. The label for each should give the name, family, group name indicating length of life, kind of place where found, and date of collection.

4. **Spraying to Kill Weeds.**—Try different spray materials in combating such weeds as mustard, wild aster and others.

5. **Salt and Chemicals on Weeds.**—Where weeds or grass come through cracks in walks, or in other similar places where they are not wanted, try killing them with salt. Use copper sulfate solution on some of them. Which do you consider better?

6. **Sheep May Kill Weeds.**—In a pasture where sheep are grazing, put their salt on some of the bad weeds and note the results later.

7. **Weeds Shipped in Hay.**—Examine packing materials where goods have been shipped in hay, straw and similar litter. Put some of this material in a sieve, and try to shake out weed seeds on a smooth floor. Sprout some of these seeds in a box of soil. Determine the kinds of weeds, either by the seeds or from the sprouts.

8. **Weed Seeds in Feeds.**—Obtain samples of feeds at feed stores. Try sprouting a number of these by planting them in boxes of soil. Samples of molasses feed are specially apt to be laden with weed seeds.

9. **Seeds in Molasses Feeds.**—Wash several samples of molasses feeds in a little water in glass dishes or plates. Then pour off the water, and when dry examine with a lens for weed seeds.

10. **Weed Seeds in Field Seeds.**—Obtain samples of grass seed and clover seed and make studies with a hand lens to determine the percentage of weed seed in each case.

11. **Fighting Noxious Weeds.**—Find a place where some persistent perennials are present—Canada thistle, Johnson grass, quack grass, or wild onion. Apply some of the special methods suggested in this chapter and note the results.

12. **Percentage of Weeds in Hay.**—Examine samples of hay in the market or in hay mows and stacks. Determine the percentage of weeds present in them.

13. **Weed Seeds in Hay Mow.**—From the floor of a hay mow obtain a handful of seeds shattered from the hay. After sifting to remove the coarse chaff, examine with a lens to determine the percentage of weed seeds present.

14. **Seeds in Barnyard Manure.**—Take a sample of well rotted compost which is about a year old. Take another sample from a manure pile not over a month old. Spread these samples in a box of soil under conditions favorable for germination. Compare the weed growth from each.

QUESTIONS

1. Define the terms, weeds and noxious weeds. Give examples of each.
2. Define the terms annual, biennial and perennial, with relation to weeds, and give examples.
3. Give a classification of weeds with reference to their places of growth, with examples of each.
4. What are the chief losses due to weeds?
5. What are some of the benefits of weeds?
6. Describe the distribution of weed seeds, by natural methods.
7. By commercial operations.
8. What farm practices are likely to spread weed seeds?
9. Give general directions for the control of annual weeds.
10. Mention some biennial weeds and tell how to control them.
11. Explain what kind of rotation will best control perennials.
12. Suggest all the methods you can for fighting Canada thistle.
13. Same for Johnson grass.
14. Same for quack grass.
15. Why are wild onions and garlic so obnoxious?
16. How may they be controlled?
17. Give the principles of weed control by spraying.
18. Why should roadsides and fence rows be kept free from weeds?
19. Give eleven principles of weed control.

References.—United States Farmers' Bulletins: 28, Weeds and How to Kill Them; 86, Thirty Poisonous Plants of the U. S.; 188, Weeds Used in Medicine; 279, A Method of Eradicating Johnson Grass; 306, Dodder in Relation to Farm Seeds; 334, Vitality of Weed Seeds in Manure; 368, The Eradication of Birdweed, or Wild Morning-glory; 380, The Loco-weed Disease; 428, Testing Farm Seeds in the Home and in the Rural School; 464, The Eradication of Quack-grass; 531, Larkspur, or "Poison-Weed;" 545, Controlling Canada Thistle; 610, Wild Onion: Methods of Eradication. Cornell Circular 9, Orange Hawkweed or Paintbrush. R. I. Exp. Sta. Bul. 133, Weeds, their Eradication and Control. A Manual of Weeds, Georgia, Macmillan Co., N. Y. Weeds of the Farm and Garden, Pammel, Orange Judd Co., N. Y.

CHAPTER XXVIII

ECONOMIC INSECTS

A little worm in a hickory-nut
Sang happy as he could be,—
Oh I live in the heart of the whole round world,
And it all belongs to me.

—JAMES WHITCOMB RILEY.

ENORMOUS losses occur from the damage done by insects in the destruction of farm produce and attacks upon livestock, to say nothing of the spread of human disease (Figs. 270 and 271). The loss to farmers alone is estimated at more than one billion dollars annually. To properly combat insects it is necessary to understand their methods of feeding, mode of life, and in many cases a knowledge of their general structure is very helpful.

True insects have six legs. The body is usually covered with a more or less hard or tough chitinous material. They take their food through mouth parts which are of two different types, either *sucking* or *biting*. The method of fighting them depends much upon whether they get their food by biting or by sucking.

The breathing of insects is through pores or spiracles along the body—not through the head. The smothering of certain insects by the use of oils depends upon this structure.

Insects have good digestive systems and will consume quantities of food very great in proportion to the size of their bodies. This is due to the fact that they use tissues which are easily digested, and because their growth and transformations are sometimes quite rapid.

The power of reproduction among insects is usually so great as to rapidly multiply the species and produce numbers in alarming degrees when their natural enemies are absent. Insects have circulatory systems and have several of the special senses found among higher animals, such as hearing, feeling, smelling, tasting and seeing. Some of these special senses are often very highly developed.

Metamorphosis.—Insects of any kind are usually grouped under one of two heads: Those having *complete* metamorphosis, and those having *incomplete* metamorphosis. Flies, for example, have complete metamorphosis; that is the insect goes through four

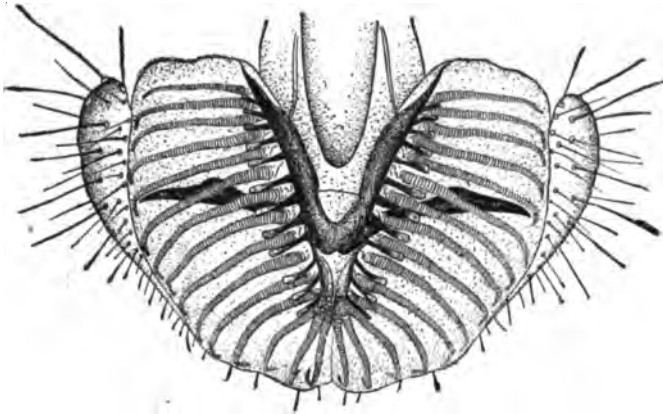

FIG. 270.—Enlarged lapping organ at the tip of the fly's mouth. Typhoid and other germs are easily taken up and carried by the fly's mouth and feet. (Fights of the Farmer.)

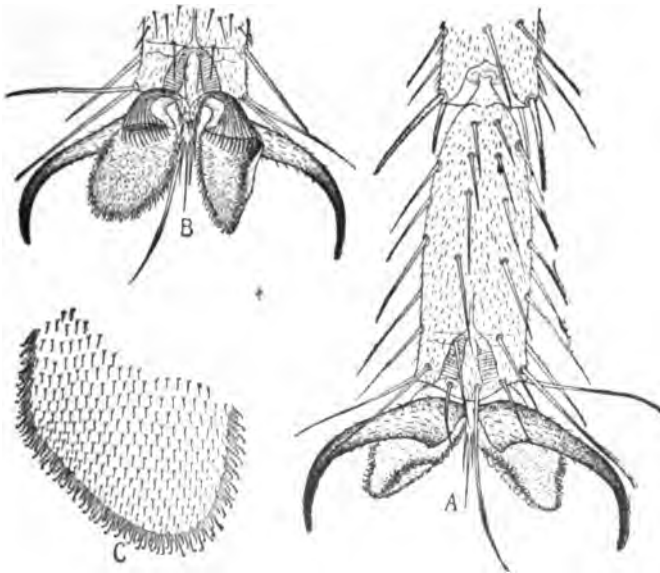

FIG. 271.—Foot of the house fly showing how numerous bacteria can be carried on the hairs. *A*, last joint and claws; *B*, claws and pads; *C*, small section of pad much more enlarged, showing hooked hairs. (Fights of the Farmer.)

stages of life during its existence: egg, larva, pupa and adult.

All insects having complete metamorphosis have these four stages of life. All the growth of the insect takes place during the larva stage, although some feeding may also be done in the adult stage. During the larva stage the insect moults, or sheds its skin, several times to allow of increases in size. Instead of the outside coat growing or stretching, it is cast off and a new and larger one inside soon becomes hardened and when the insect is large enough to fill it this in turn is cast off.

The pupa stage is usually a resting or very quiet stage. Sometimes it is the winter stage of the insect, but often the pupa stage is brief and is passed in the ground or other hiding place. During this time the insect changes in structure and appearance a great deal. New sets of internal organs are produced. The method of digestion is sometimes changed. Rudimentary legs, wings and other appendages are formed. Such complete change is made here that the insect emerges from the pupa case as a very different insect, so far as appearance and habits are concerned. The covering of the pupa may be simply a leathery coat, or this may be covered with a more or less hairy cocoon, as in the case of moths.

When the adult insect emerges from the pupa case the rudimentary appendages, such as the wings, are expanded and hardened by exposure to the air, within a few minutes. The insect is then full grown. No insects ever grow after reaching this stage. Small flies never become large flies, and small butterflies never become large butterflies. The adults of some species feed abundantly, but in other species practically no food is taken during this stage. In such cases the adult seems to exist chiefly for the purpose of reproducing the species. After mating, suitable places are found for laying eggs. A great instinct is exhibited in the search for suitable places where the larvæ when hatched from the eggs may find proper food and surroundings. After the egg-laying period is over the adults usually die. In some cases adults live in a more or less dormant condition in secluded places through the winter and lay their eggs in the spring.

The chief orders or great groups of insects which have complete metamorphosis and which are of great economic importance, are: True beetles; butterflies and moths; flies and mosquitoes; bees, ants and wasps.

Incomplete metamorphosis differs from the complete type in having no quiet or true pupa stage. The stage following

the egg usually resembles the adult in many respects, differing chiefly in the absence of wings. This is usually called the nymph stage. The insect is then active and feeds abundantly. It goes through several moulting periods and gradually develops wings like the adult. Eggs are laid during the adult stage, but feeding may be continued as during the nymph stage. The chief orders of insects having incomplete metamorphosis are: True locusts, grasshoppers, katydids and crickets; true bugs, such as squash bug, chinch bug and numerous others.

Orders of Insects.—The farmer is chiefly concerned with six orders or main divisions of the insect class, but entomologists classify insects into twenty-one orders, many of them being of limited economic importance. The most destructive and most beneficial insects belong to the following six orders:

Orthoptera (straight winged), or true locusts, grasshoppers, (Figs. 272 and 273) katydids, crickets, roaches, and others. All this group have biting mouth parts and the metamorphosis is incomplete.

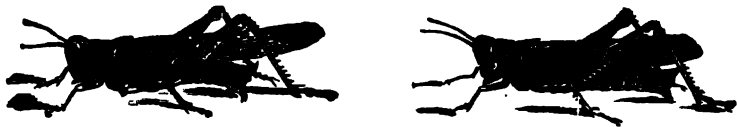

FIG. 272.—The "Rocky Mountain" locust (left) and the "lesser locust" (right) are two of the most destructive of the locust group. The former has wrought destruction in the western states several times. The latter is often very injurious to alfalfa, clover and other crops in eastern states. (Economic Entomology.)



FIG. 273.—The American grasshopper or locust showing the first and last stages in its development (metamorphosis). A destructive species of the southeastern states. (Economic Entomology.)

Hemiptera (half-winged), or bugs, include many kinds of plant bugs (Fig. 274), plant-lice, San José scale (Fig. 275) and other scale insects, cicada and leaf hoppers. The mouth parts are constructed for piercing and sucking juices. The metamorphosis is incomplete. The order includes many of the most destructive insects.

Coleoptera (horn-winged), or true beetles. Some of the beneficial insects of this order are ground-beetles, tiger-beetles, water-

The larvæ of the injurious species or families have biting mouth parts, but the adults have long sucking tubes, not adapted to piercing tissues. In this stage they are harmless.

Diptera (two-winged) flies and mosquitoes. There are a few



FIG. 279.—A male and female (left) of the white cabbage butterfly. *a*, green, velvety larva; *b*, chrysalis or pupa. (Economic Entomology.)

beneficial flies: robber-flies, which prey upon other insects, and a few which are parasitic upon other insects.

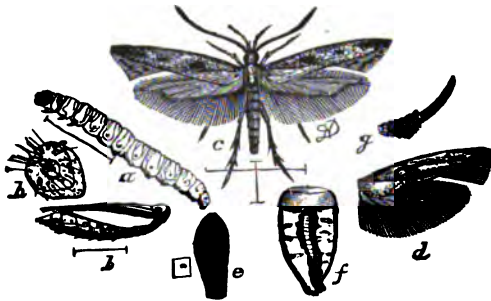

FIG. 280.—Grain moth. *a*, larva; *b*, pupa; *c*, moth; *e*, egg; *f*, larva feeding in kernel of corn. In the middle and southern states this pest is very destructive to stored corn. (Economic Entomology.)

include mosquitoes, house-flies, stable-flies, Hessian fly (Fig. 281), pear-midge, buffalo gnat, horse-fly, ox-bot, sheep-bot, horn-fly, cabbage-maggot, "sheep-tick," and bee-louse. The mouth parts of mosquitoes are adapted to piercing and sucking.

This is also true of many species of true flies, but in the case of the house-fly and some others the mouth is not suited to piercing. The food



FIG. 281.—Hessian-fly galls on wheat stem *h*, and healthy wheat at left. *a*, egg; *b*, larva; *c*, "flaxseed" or winter stage of larva; *d*, pupa; *f*, adult female; *g*, adult male; *i*, the parasite which often destroys the Hessian-fly or holds it in check. (Economic Entomology.)

is lapped and sucked. The larvæ of true flies are called maggots. The metamorphosis is complete.

Hymenoptera (membrane winged), bees, wasps, ants and saw-flies. The most beneficial representatives are true honey-bees, bumble-bees and ichneumon. The latter is parasitic upon injurious insects. Among the harmful group may be mentioned currant worm, pear-slug, grape-slug, saw-fly, several forms of ants and some species of wasps. The metamorphosis is complete. True bees have mouth parts adapted to both biting and lapping or sucking during their adult stage. Wasps and ants have strong jaws for biting. In the larval stage the mouth parts of many of the families are very rudimentary, while in others they are highly developed and adapted to biting and chewing.

Life History of Insects.—After determining the order to which any injurious insect may belong much may be known about its life history, but certain definite information is necessary about each species to know how best to combat the enemy. Its most vulnerable points may be determined only by knowing the places where the eggs are laid, the kind of food preferred by the larvæ, in what stage the winter is usually passed, and other important points. After such information is once obtained and published, it is usually easy for the farmer or gardener to apply suitable remedies.

Remedies.—There are a number of suitable remedies to use in fighting insects: Rotation of crops will often rob the enemy of the food which it must have. Fall plowing will often destroy those which live through the winter under the surface of the ground. Insects are then more likely to be destroyed by winter weather or by birds and parasitic insects. Trap crops are useful in many cases; they provide plants on which the injurious insects will accumulate and where they may be destroyed more easily and without danger to the main crop.

Spraying and dusting are often thought of as the chief remedies against injurious insects. In many cases spraying is much more effective than dusting, but the latter is much less expensive, where it can be used at all. More chemical may be used in the dusting of potatoes than in spraying them, but the labor is much less.

Natural Enemies.—Insects are often kept in control by their natural enemies. Serious scourges of the Rocky Mountain locust, for example, are seldom known. It is believed that a fungous disease, and perhaps other enemies, hold them in check. So it is with many species of insects.

Birds are believed to be the best insect destroyers in nature. They feed upon insects in all stages. During the nesting period, birds which are ordinarily classed as seed eaters gather large numbers of insects to feed to their young daily. It has been carefully estimated that a robin will use 300 larvæ in a day while feeding her young. The nuthatch, chickadee, hairy woodpecker, brown creeper and similar birds find the hiding places of insects throughout the winter season, thus destroying the few remaining insects of many species in any locality where such birds are not molested.

The ruthless destruction of birds by man, in search for millinery feathers and plumes or for game or for mere sport, has doubtless done more than any other one thing to destroy the "balance in nature," and allow injurious insects to obtain supremacy. The farmers are willing to suffer losses amounting to hundreds of millions of dollars for the sake of giving a few others the privilege of destroying birds. Many states have laws favoring the protection of birds at certain seasons of the year, or throughout the year. Enforcement of such laws results in great good to crops. All possible means for the protection of birds and encouragement of their work should be used. Suitable nesting places for birds may be provided. Bird houses may be erected where cats cannot reach them.

Toads are wonderful insect destroyers. Some one has said that a toad in a garden is worth twenty dollars a season. Surely their value should not be underestimated and when found they should never be molested.

There are many insects which prey upon injurious species. These are called predaceous insects. Examples of these are several species of lady bird beetle, certain forms of solitary wasps, wheel-bugs, crane-flies, robber-flies, ground-beetles, tiger-beetles and others. Still other forms are parasitic upon injurious insects. The minute chalcis-flies lay their eggs in scale insects, many injurious caterpillars, such as the cabbage worm and others. When the eggs of chalcis-flies hatch, their larvæ feed upon the tissues of their victims and many injurious forms are thus destroyed. It is not an uncommon thing to make a large collection of injurious insects and find them all parasitised by the chalcis-fly. Other common parasitic insects are ichneumon-flies, braconids and others.

Fungous diseases doubtless play an important part in keeping many species of insects within bounds. The ravages of locusts, chinch-bugs and others are greatly reduced by fungous diseases.

Efforts have been made by man from time to time to introduce

the various enemies of insects into new localities. Some of these have proved successful. Chinch-bugs were in this way kept within bounds by distributing "sick" bugs in fields where attacks were severe. When the weather is favorable this method has proved successful. One notable effort to introduce insect-eating birds has proved disastrous. All are familiar with the history of the English sparrow in America. It was first introduced with the hope that it would be valuable in the destruction of insects, but on reaching the American shores this species reverted to the habits of its ancestors, which lived chiefly upon seeds and grain. While the English sparrow does destroy many insects during the nesting season, it is a grain destroyer much of the time. The main charge against the English sparrow is that it has driven out many of our valuable insect-eating species.

Potato beetles are injurious both in the adult and larval stages. They were doubtless formerly kept in control by the quail (Bob-white) and other valuable birds which are now too scarce to check the march of such a formidable enemy. Methods of fighting the potato beetle are given in the chapter on potatoes.

Cotton boll-weevils have made their advance upon the American cotton growing states from the south of Texas. They threaten to spread through the entire cotton belt. Millions of dollars have been spent in efforts to control this enemy. The chief remedies are mentioned in the chapter on cotton growing.

The corn ear-worm is also called the cotton boll worm. The larvæ feed upon young corn ears until they approach maturity. In the southern states they attack cotton plants, feeding upon tender bolls and other parts, if young corn is not available. Remedies were mentioned in the chapter on cotton. In corn growing states north of the cotton belt the ear-worm is a serious enemy, particularly to sweet-corn growers. Fall plowing over the whole neighborhood is perhaps the most practical remedy. Rotation of crops will also help.

Chinch bugs are destructive to small grains, corn and grasses. Both young and adult bugs suck the juices from the stems, beginning near the ground and working upward. A remedy sometimes practiced by farmers to prevent the spread of chinch bugs is to plow deep furrows around the field that is to be protected. In this furrow drag a log frequently to produce and maintain a fine dust. As the bugs attempt to cross the furrows they are buried in the dust by the use of the log. This method is modified by the

addition of kerosene or tar, or other destructive material, to the dust in the furrow. Another practical remedy is to thoroughly destroy in the fall or winter all hiding places, such as grass and rubbish, in or near fields where the bugs have been injurious. Coöperation in these efforts among farmers of a neighborhood has been tried with much success.

The Hessian fly is one of the most serious pests infesting wheat. There are several broods in a season. The insects attack fall grain near the surface of the ground and pass the winter in the pupa stage, or so-called "flaxseed stage." The adults emerge in the spring and lay their eggs in the bases of the leaves of wheat, grasses and similar plants. The crop is stunted in growth and often so weak that little or no grain can be produced.

The best remedies are to plow early and deep and sow the grain late. If a "volunteer" crop of grain sprouts early from waste seed this should be disked in or carefully destroyed.

Apple Worm or Codling Moth.—The adult is a small moth which lays eggs in the green calyx leaves of the fruit just after the petals fall. The insects attack apples, pears and quinces. The larvæ when hatched from the eggs eat their way to the core of the fruit and feed near it until full grown. They then emerge and fall to the ground, form cocoons in the bark of the tree or in rubbish near the tree. There is usually but one brood in northern latitudes, two broods in middle latitudes and perhaps three or more in the South. The fall brood passes the winter in the pupa stage.

The best remedy is to spray the trees thoroughly with poison, such as Paris green or arsenate of lead just after the petals fall. This must be done before the calyx cup has closed, or before the small fruits have begun to droop. If poison falls in the calyx cup the larva will be destroyed and no damage follows. Sound fruit is easily produced where such spraying is practiced. A second spraying should be done about two weeks after the first. In some sections it is necessary to spray about the time the most eggs are laid for the second brood later in the season.

Other methods of combating this serious pest are: (1) Destroy all fallen fruit in the early part of summer, as these are usually infested with larvæ. This is best done by allowing hogs or sheep to run in the orchard a few weeks at this time of year. (2) Banding the tree-trunks with burlap or heavy paper in the fall is sometimes practiced. This traps many larvæ and pupa which may be destroyed by removing the bands and crushing or burning the insects.

The plum curculio is the insect which causes stone fruits to be wormy. Peaches, plums and cherries are usually badly affected unless remedies are successfully used. The adult is a beetle having a long "snout" with jaws at the end of it. The insect attacks the fruit soon after the stamens disappear. Crescent-shaped wounds are made on the small green fruits (Figs. 282 and 283) and eggs are laid near these. When the larvæ hatch they soon eat their way toward the seeds of the fruits (Fig. 284). Many fruits drop off and others are prematurely ripened as a result of these attacks. All fruit is wormy and is rendered unfit for use or for market.



FIG. 282.—Although the curculio insect does not make pears and apples wormy, the bites of the insect cause deformed growth as shown here. (New Jersey Station.)

The best remedy is to spray the orchard thoroughly with poison soon after the petals fall and again about ten days later.

Jarring the trees frequently in early morning during the egg-laying period will cause many adults to fall. They may be caught in sheets or stretchers under the trees. They are easily destroyed in cans containing a little kerosene. All fruits which fall to the ground should be destroyed if possible. Swine and poultry will aid much in this work.

The San José scale is the worst insect enemy of orchards. The leaves, young twigs and also the fruits are attacked by the scale insects, which suck the juices and reduce the vitality or actually kill the trees. Enormous losses result unless systematic remedies are applied. The great damage is due to the rapidity



FIG. 283.—Injury to peaches due chiefly to curculio bites. The crop should be sprayed with arsenate of lead about the time the "shucks" fall. (New Jersey Station.)



FIG. 284.—Inside of young peach showing the curculio larva as a white "worm" near the pit. The path eaten by the insect is shown. (New Jersey Station.)

with which the insects multiply. If a few are left in the orchard in the spring they may multiply and spread so rapidly as to kill some trees and infest the whole block of trees by fall. They are very small and may easily escape detection. The young are carried from tree to tree by other insects and on the feet of birds.

Several spray materials are successfully used in controlling the scale. The most successful are: (1) Soluble oils, or miscible oils, and (2) lime-sulfur preparations. Lime-sulfur has the great advantage of being a good fungicide, as well as a good insecticide, for this class of insects. It is claimed for the soluble oils that they will last longer and will destroy insects that may be brought to the tree after it is sprayed.

Both materials are used when the trees are in the dormant stage. The very dilute self-boiled lime-sulfur is also used on trees when the foliage is well developed.

Canker worms, sometimes called measuring worms, attack apple trees and sometimes pears and others, defoliating them. These larvæ are very difficult to poison. Strong solutions of arsenate of lead are most successful. Spraying should be done while the larvæ are very small—when their work is first seen.

Another method of control is learned from the knowledge of their life history. The female moths are wingless and must crawl up the trunk of the trees to lay their eggs on the leaves, where the larvæ may feed. Bands may be placed around the trees to prevent the ascent of the female moths or the larvæ. The band may be made of a soft tar-like preparation, or may consist of wool or cotton tied on with cord. There are commercial preparations used for this purpose, and sticky fly paper is sometimes used.

Two Apple Tree Borers.—The more common apple tree borer is called the *flat-headed borer*. The eggs are laid on the bark of tree trunks and the larvæ dig and feed chiefly in the sap wood. They live from one to three years before emerging as adults. They are then beautiful bronze or black beetles, which live for only a short period.

The work of the borers should be observed closely and the larvæ may be killed by use of a wire or a knife.

The *round-headed apple tree borer* is usually less common than the other, but its work extends deeper after the first year and it is more difficult to remove from the deep channels. The larvæ live for about three years, after a short pupal stage, appearing in early summer as brown-and-white striped beetles. (Figs. 276 and 277).

A prevention against the work of both these borers is to tie fine wire netting or tar paper about the trunks of the trees. The bands should extend two feet or so above the soil and there be closely tied to keep out the adult beetles when trying to lay their eggs on the trunk.

The flat-headed borer attacks many other trees besides the apple, while the round-headed borer seems to prefer the quince, but is also found in the pear.

Peach tree borers attack peach, plum and cherry trees, usually near the surface of the soil, but less commonly several feet above. The adult is a true moth but has membranous wings, resembling very large bees. The larvæ dig chiefly in the sap wood, and when several are present in one tree, it is seriously damaged or killed. When the borers are full grown they spend a short time in the pupal stage near the bark or in crevices outside, or rarely in litter on the ground, before emerging as moths.

The remedies consist in digging out the borers when their work can first be discovered by the exuded gum and by the borings; and by protecting the trunks with wire netting or heavy paper to prevent the deposit of eggs there.

Old peach trees often become very badly infested and a few may supply enough adults each summer to badly infest any young orchard trees growing near them. The egg laying season extends throughout the warm summer months, but the annual brood seems to be most active in early summer.

Cabbage worms are the larvæ of cabbage butterflies. The eggs are laid on the leaves of cabbage, kale, cauliflower, turnip and a few other plants. The chief damage is done to the late cabbage crop. The "worms" eat their way into the heads, doing much damage. There are several broods in a season. The adult butterflies appear in early spring, emerging from the pupa stage, in which the insect has passed the winter. The first adults may lay their eggs on wild mustard and other similar weeds. The second brood of adults appears about a month later and these are usually most damaging to the garden crops which they attack.

The best remedy is to spray the plants before much damage is done, using arsenate of lead—6 ounces to 50 gallons of water. On cabbage, such a spray can be used without any danger of poisoning human beings, because plants grow from within forming the heads and pushing the outer leaves containing the most poison away. These are trimmed off before being used on the table.

Paris green may be mixed with large quantities of finely sifted ashes, road dust or air-slaked lime; and the mixture may be used as a dust upon the plants when they are moist with dew.

Tomato or Sphinx worms are the larvæ of hawk moths or sphinx moths. They eat the leaves of tomato, tobacco and other closely related plants. As the feeding is in the open, they may be controlled by the use of poison spray, such as Paris green and arsenate of lead. Judgment should be used to avoid spraying too shortly before harvesting the crop. When there is danger in the use of poison, the "worms" are sometimes picked off into cans of kerosene-on-water. Trap crops may be grown near the main crop; and poison may be used freely on the trap plants. The insect passes the winter in the form of a brown or leather-like pupa having a loop resembling a jug handle near one end. The adults emerge in early summer to lay their eggs.

Squash vine borers attack the stems of melons, pumpkins, squash and other green vine crops. They feed along the inside of the stems and kill the plants. The adults are moths which lay their eggs on the young plants about the time the young plants begin to form vines.

The most practical remedy is to stimulate the growth by use of manure in the hill and by thorough culture. The vines should all be covered with a little loose moist soil at distances of one to two feet from the main root. This will cause new roots to form which may save a number of the vines. The borers may be killed by running a knife along the affected parts, before the vines are killed.

Striped cucumber beetles are very destructive to the green vine crops, by feeding on all parts. They fly readily, and often gather on the leaves of plants in great numbers, retarding the growth or killing the plants. It is when the plants are young that there is the greatest danger.

The larvæ live in the larger roots of the same plants and do much damage while feeding there. The adults live over winter, and all vines where they may be hiding should be destroyed after the crop is harvested.

Gardeners often use box frames, about 2 by 2 feet and six or eight inches deep, covered with wire netting, to keep off the striped beetles. These frames are placed over the hills when sprouting begins and are kept there until the plants fill them. The same frames may be used several seasons.

The beetles may be kept off to some extent by the use of fine tobacco dust, ashes or lime mixed with Paris green. The insects are seldom killed by the poison, but they may be somewhat warded off the main crop in this way.

FIELD AND LABORATORY EXERCISES

1. **Make poison bottles** for the collection of insects by using wide mouthed bottles with good stoppers, each bottle about one-half pint in size. Put a piece of potassium cyanide as large as the end joint of a man's thumb in the bottom of each bottle. Cover this with dry plaster of Paris, and then pour in enough water to wet the mass and cover it to a depth of one-quarter of an inch or more. Allow the bottles to stand with the corks in until the plaster has hardened. Then remove the corks, pour off the water and insert a piece of blotting paper to absorb the surplus moisture. When the bottle has dried out it is ready for use. Cut a piece of stiff paper or cardboard to cover the surface of the plaster inside the bottle. Care must be exercised to keep the bottles closed at all times as the air in them is poisoned.

2. **Collect insects** of all kinds and in all places possible. Put the live insects into a poison bottle and keep them there for a few hours. They may then be removed and pinned into a collection.

3. **Pin insects** according to the usual custom, the pin passing through a little to the right of the central line.

The pin should be thrust through until only one-quarter of an inch remains above. The best insect pins are very long and have small heads. Pinning boxes or cages may easily be made of cigar boxes by gluing in the bottom of each a layer of corrugated pasteboard, having a smooth surface on top. The pins holding the insects may be thrust into this corrugated paper. Always arrange insects in groups according to relationships—beetles in one box, moths in another, flies in another, grasshoppers and locusts in another, and so on.

4. **Classify and name the insects** in the collection, using Comstock's *Manual of Insects* or other guides.

5. **Collect cocoons** from trees, shrubs and other places. Put these in pasteboard boxes provided with ventilation holes and provided with rough sticks under which the emerging moths may climb when they develop in the spring.

6. **Examine rapid development of wing surface** of a large moth just emerging from its cocoon. Note the wonderful rapidity and the conditions under which the insect seems to develop best—with wings hanging downward.

7. **Find clusters of eggs** of potato beetles, butterflies, grasshoppers, squash bugs, and others. Put these into boxes or cages (Fig. 285) or keep the leaves on which they may be found fresh in glasses of water until the larvae hatch from the eggs. Development studies of this nature are always interesting and instructive.



FIG. 285.—Breeding cages for insects in laboratories and school rooms. The upper one on the left may be used for water insects with some water plants growing in the bottom for them. Two of the others may have soil in the base for growth of plants. (U. S. D. A.)

8. **Life-histories of insects** should be studied wherever possible, and all points observed should be noted and reported.

9. **Insects Destroyed by Birds.**—Make observations regarding the destruction of insects by various birds and estimate the number of insects destroyed in a given time by birds, particularly during their nesting season.

10. **Toads in Gardens.**—Make similar studies regarding the value of toads.

11. **Cocoons and their Parasites.**—Collect many specimens of any kind of cocoon, such as the tent caterpillar. After collecting 100 or more, allow them to develop for a few weeks, and then dissect them all, and decide what proportion are healthy and normal, and what proportion have already been destroyed by parasites. The great value of parasitic insects may thus be appreciated.

12. **Amount of Insect Work.**—Interesting studies of the destructive work of any of the biting insects may be made. Study the amount of destruction wrought by the corn ear-worm, the potato beetle, the tomato worm, the codling moth or any of the others common in the vicinity.

13. **Detect Insects by their Work.**—Learn to recognize the minute insects, such as San José scale, plant lice and others. Not only the structure and appearance of the insects, but also the appearance of the plants when attacked should be recognized.

14. **Tree Borers.**—Examine orchard trees for borers and practice destroying them with a knife or wire.

QUESTIONS

1. Classify true insects according to mouth parts.
2. What is the difference between complete and incomplete metamorphosis in insects?
3. Mention the chief orders of insects with examples of each.
4. What natural enemies of insects aid in their control?
5. Give some idea of the value of these.
6. Mention three garden insects which are injurious in your section, and state to what order they belong, and what kind of mouth parts they have.
7. Make another group of fruit insects.
8. Tell what you can of the San José scale.

References.—United States Farmers' Bulletins: 99, Insect Enemies of Shade Trees; 172, Scale Insects and Mites on Citrus Trees; 264, The Brown-tail Moth and How to Control It; 275, The Gipsy Moth and How to Control It; 453, Danger of Spread of Gipsy and Brown-tail Moths Through Imported Nursery Stock; 543, Common White Grubs; 557, The Potato Tuber Moth; 606, Collection and Preservation of Insects and other Material for Use in the Study of Agriculture; 626, The Carpet Beetle, or "Buffalo Moth;" 627, The House Centipede; 636, Chalsis-fly in Alfalfa Seed; 637, Grasshopper Problem and Alfalfa Culture; 640, Hessian Fly; 657, Chinch Bug; 658, Cockroaches; 659, True Clothes Moth; 662, Apple Tree Tent Caterpillar; 675, Round-headed Apple Tree Borer; 679, House Flies; 681, Silver Fish: An Injurious Household Insect; 683, Fleas as a Pest of Man and Animals; 691, Grasshoppers on Sugar Beets and Truck Crops; 701, Bag Worm: An Injurious Shade Tree Insect; 705, Catalpa Sphinx; 708, Leopard Moth: An Enemy of Shade Trees; 721, Rose Chafer; 722, Leaf Blister Mite; 723, Oyster-shell Scale and Scurfy Scale; 725, Wireworms Destructive to Cereal and Forage Crops; 731, True Army Worm and Its Control; 737, Clover Leafhopper; 739, Cutworms and their Control; 740, House Ants; 741, The Alfalfa Weevil. Also: Nos. 223, 284, 290, 456, 493, 506, 564, 609, 621, 630, 733, 735.

Economic Entomology, Smith, J. B. Lippincott Co., Phila.

CHAPTER XXIX

PLANT DISEASES

DISEASES of plants are chiefly caused by fungous growth, but some very bad diseases, such as apple and pear blight, are caused by bacteria. The causes of a few very destructive diseases, such as peach yellows, have not been determined, as to the exact germ.

A fungous disease is usually easier to control than others. Its work is more or less noticeable, particularly during the advanced stages; the cause of such a disease is more easily determined and more easily prevented.

Fungi (fun-ji, plural of fungus) are real plants but they are propagated by spores instead of by true seeds. There are two very different types of fungi: (1) Those which live on dead or dying organic matter, such as mushrooms and molds, called saprophytes; (2) those which live on the tissues of living organisms, such as wheat rust, apple scab, oat smut and many others. These are called parasites. Parasitic fungi cause much damage to farm, garden, and orchard crops.

Potato scab (Fig. 286) is a fungous disease which lives in the soil where diseased potatoes have grown and also on the tubers themselves. The disease is harmful in reducing the yield and in rendering the crop less salable. The tubers are actually much less valuable for use because of the deep "scabs" or "sores" in the surface, which cause much waste when they are being prepared for the table.

As the spores of this disease live in the soil, as well as upon the seed potatoes, great precaution should be exercised to avoid introducing the spores into a garden or field. This may be prevented by treating the seed potatoes to kill the spores before planting time. The simplest treatment is to soak the potatoes for about two hours in a mixture of formalin and water, using one pint of full strength (40 per cent) formalin to 32 gallons of water. The mixture may be used a number of times in the same day, and as the material is inexpensive the cost of the treatment is very slight.

A number of other treatments are sometimes used, such as copper-sulfate solution and dusting with sulfur.

It is of little value to treat the seed potatoes if the disease is

already in the soil, but the treatment may be used when planting is to be on a field free from the disease. Practically all of the crop will then be free from scab.

It has been observed that when the spores are in the soil the crop is often made more "scabby" by the use of fresh horse manure, applied to the soil the same year the crop is grown. When potatoes are grown in rotation over a series of years the lime and manure may be applied to the field for some other crop, such as corn or clover.

Potato Blight.—Irish potatoes are affected with two distinct blights. One is called early blight and the other late blight.



FIG. 286.—Potato tubers badly attacked by the scab disease. (U. S. D. A.)

Early blight is much less injurious to the crop, as it seldom affects the crop of early potatoes much before they are ready for harvest. Sometimes it attacks the leaves and gradually covers the whole plant in the form of dark spots surrounded by concentric rings of different shades on the leaves. The entire crop may be destroyed by it.

Late blight attacks the plants near the ground and the spread, both upward and downward, is quite rapid. The leaves and stems turn dark brown as they wilt. The spore-distributing stage of the disease is seen in the darkest areas. Spores often fall to the

ground and infest the tubers. The crop may show only a little of the rot due to this disease at the time of harvest, but if the tubers are affected they may continue to rot in storage. If the tubers show some signs of being attacked by late blight, the crop should be sold or used before the disease gains great foothold and causes too serious a loss.

Potato blight of either kind may be prevented by use of Bordeaux mixture. Some growers have been successful in preventing the disease by the use of lime-sulfur mixture, using the summer strength. (See Chapter XXX.) Either the Bordeaux mixture or the lime-sulfur may be combined with the poisons which are sprayed on the plants in fighting the potato beetle, thus no extra labor is required in the actual spraying work. The use of either of these mixtures when combined with the poisons makes the latter more effective, because it is not so readily washed off by rain.

After potato blight has become established in the field or garden there is no remedy. Spraying must be used entirely as a preventive before any sign of the disease is noticeable. Several applications are usually necessary, for the purpose of keeping the new growth covered with the spray material. Such preventive spraying has been found very profitable in many potato growing sections, while in others the disease is not bad enough to warrant the spraying as an annual prevention of blight.

Grain Smut.—Wheat is affected by two distinct smut diseases: (1) The "stinking" smut produces a small bundle of spores in place of each grain of wheat. When thrashing takes place these smut balls often burst and reduce the milling value of grain, which is otherwise sound. The yield is greatly reduced by the attack of stinking smut. (2) Loose smut is usually less destructive to wheat than to other small grains, such as barley and oats (Fig. 287). This fungus attacks not only the kernels but also the glumes or husks surrounding them.

Oats and barley are affected with two kinds of smut, known as the covered smut and the loose smut. These are similar in their appearance and growth. The spores are upon the seed at planting time. When germination begins the spores also germinate and attack the young plants, living in the stems, and gradually reduce their vitality until time for the grain to head out. Then the black spores of the disease appear in great abundance in place of the healthy grain. The difference between these two smuts is indicated by their names. Loose smut attacks both husks or chaff

and grain, as it does in wheat, and the covered smut remains inside, destroying only the grain. The reduction in yield, due to these diseases, sometimes reaches as much as 90 or 100 per cent of the crop.

The method of preventing these diseases is simple and usually very successful. The seed grain may be treated with a solution of



FIG. 287.—Oats attacked by smut disease on left compared with sound oats on right. (Agriculture and Life.)

formalin, using one pint of full strength formalin (40 per cent) in forty gallons of water. The seed should always be thoroughly wet by soaking about ten minutes. This may be done in loose sacks or may be done by sprinkling the seed in large boxes or wagon beds. If the sprinkling method is used the grain must be stirred thoroughly during the process to be certain that all parts are wet with the formalin water. Formalin is a good fungicide and kills the spores. When wheat is affected by the stinking smut this treatment is not always successful, because some of the smut balls are not wet through. If such grain is poured into formalin

water much of the badly affected grains will float and may be easily separated from the good seed. Another method used for the stinking smut is to treat the seed with hot water at a temperature of about 130 F. The water should be kept at this temperature for about ten minutes, and any grain which floats should be skimmed off.

Corn Smut.—This is a very different disease from the smuts which affect small grains. Large round or oval masses containing black smut spores are found on the ears of corn. Often these take the place of kernels on the cob. Tassels, leaves and stems are also sometimes affected.

It is believed the disease lives over winter in the soil and may be spread to the new crop from the soil or from manure spread in the field which contains the spores from the feed lot or barn.

The best method, therefore, to reduce the attacks of this disease is to practice rotation of crops and to prevent masses of the smut from being scattered in the manure. Smutted ears should never be taken to the feed lot or barnyard.

Grain Rust.—Leaves and stems of small grains are often badly affected with two diseases, known as leaf rust and stem rust. The former is brown, and the latter appears in black spots on both leaves and stems. Stem rust is less common but more injurious when present. Weather conditions seem to greatly influence the growth of these diseases. These are not within the control of the farmer. Well drained soil should always be used in regions where rust is prevalent. Small grains grown in southern latitudes are more subject to rust than in the North.

Apple Scab.—This disease attacks both the leaves and the fruit, on which brownish, scab-like spots are formed, and the size of the fruit is often much diminished because of the disease. The market value of the fruit is much reduced, and the grower often loses many dollars by not preventing the disease. The rusty, irregular blotches often deform the fruit, and sometimes pits are formed.

The two chief spray materials used as prevention of this disease are lime-sulfur, applied when the trees are in their winter condition, or Bordeaux mixture, the strength of which is varied to suit the condition of the trees. With either of these materials Paris green or arsenate of lead may be mixed to aid in the control of codling-moth and canker worm. (See Chapter XXX for proportions.)

The first spraying should be done when the trees are dormant, and if lime-sulfur is used, the San José scale will be largely controlled by this early application. The arsenic need not be used for this first spraying. The second application is made at the time the petals fall. At this time poison is very essential. A third spraying is given about two or three weeks later. At this time Bordeaux is somewhat preferable to the lime-sulfur. (See Chapter XXVIII for insects affecting the apple orchard.)

Apple Rust.—This disease is also known by the name "cedar apple." The disease is a fungous growth which appears in two forms, one attacking the apple, forming a so-called rust growth on the leaves, young twigs and green fruit; the other form growing on red cedar trees, and appearing in the form of brown or yellow swellings the size of small apples which when dry are much shrivelled and may have a purplish color. As this alternate growth of

the fungus is absolutely necessary for its perpetuation, and as the disease is not known to appear on other plants than the apple and the cedar a remedy naturally suggests itself, namely that of destroying all cedar trees in the vicinity of the apple orchard. In fact, no other satisfactory remedy for the control of the disease has yet been devised. Legislation has been enacted in some states to require the cutting of cedar trees in the vicinity of commercial orchards.

Brown Rot.—This is probably the worst disease of the stone fruits, attacking the leaves and fruit of peaches, plums, cherries



FIG. 288. —*Monilia* (brown rot) of peach showing the attacks on fruit and twigs. Plums and cherries are likewise affected. (New Jersey Station.)

and their allies (Fig. 288). The leaves turn brown or are otherwise discolored, and ripening fruit rots on the trees. Many of the fruits at this time prematurely drop to the ground. Others cling to the trees, and if not picked will later dry up and become mummified, in which condition they are often seen after the leaves fall.

Spray the trees while in their dormant condition with lime-sulfur (1-40). A second application is made just after the blossoms fall. With the peach, this is when the shucks are shed from the young fruit. A third spraying is given about ten days or two weeks later. Poison is usually mixed with these materials for the

second and third sprayings for the control of curculio. (See Chapter XXX.) A fourth application is sometimes made about one month before the ripening of the fruit. At this time, Bor-



FIG. 289.—Peach leaf-curl disease on the twigs at the right. The disease also attacks other stone fruits. It is controlled by spraying with Bordeaux mixture in early spring. (New Jersey Station.)



FIG. 290.—The black-knot disease attacks plum, cherry, and a few other trees. (Agriculture and Life.)

deaux mixture is preferred by some growers. (See Chapter XXIX for insects affecting stone fruits.)

Peach leaf curl is a disease which attacks the leaves and twigs of the stone fruits. It is often quite serious and checks the growth. The character of its work is shown in figure 289. It is largely

controlled by spraying with Bordeaux or lime-sulfur in very early spring.

Black-knot is a fungous disease which attacks the twigs, limbs and trunks of such trees as cherry, plum, and others. Trees that are systematically sprayed with lime-sulfur or Bordeaux mixture for other troubles are seldom attacked by black-knot. But when the disease is once established (Fig. 290) it can be removed only by severe cutting away of the affected parts. The wounds should be treated with lime-sulfur and then painted.

FIELD AND LABORATORY EXERCISES

1. Collect samples of fungi which live on dead or dying organic matter.
2. Collect **Plant Diseases and their Work**.—Make another collection of plant diseases such as rust on blackberry leaves, rust on wheat, "cedar apple" on cedar trees, and the corresponding form on apple trees, oat smut, black-knot on cherry and plum trees, brown rot of peach and plum fruits and others.
3. Study the fruit clusters in as many of these cases as possible. Explain how spraying with a fungicide controls the spread of the disease. Why should the spray material be applied in advance of the disease?

QUESTIONS

1. Give several conditions which encourage the potato scab disease, and a remedy for each.
2. Describe the two kinds of blight on potatoes.
3. What can you say of the losses due to grain smut?
4. Describe the effects of apple scab.
5. What is the nature of the brown-rot disease? What fruits does it attack?
6. What is the leaf-curl disease?
7. Tell what you can of black-knot disease.
8. What diseases of plants are you familiar with from your own observation? Make a list of them.

References.—United States Farmers' Bulletins: 15, Some Destructive Potato Diseases; 219, Lessons from the Grain Rust Epidemic of 1904; 221, Fungous Diseases of the Cranberry; 488, Diseases of Cabbage and Related Crops and Their Control; 489, Two Dangerous Imported Plant Diseases; 507, The Smuts of Wheat, Oats, Barley and Corn; 544, Potato-tuber Diseases; 618, Leaf-spot, a Disease of the Sugar Beet; 714, Sweet Potato Diseases; 742, The White Pine Blister Rust. Also 492, 555, 625, 648, 714.

Cornell Bulletin 358, Some Important Leaf Diseases of Nursery Stock. Cornell Circular 20, The Fire Blight Disease and Its Control in Nursery Stock. Mass. Sta. Bul. 138, Tomato Diseases. N. J. Sta., Circ. 50, Common Diseases of Beans. N. J. Sta., Circ. 51, Diseases of Grains and Forage Crops. U. S. Department Bulletin 368, Brown Rot of Prunes and Cherries in the Pacific Northwest.

CHAPTER XXX

METHODS OF CONTROLLING INSECTS AND PLANT DISEASES

GARDENERS and farmers find it necessary to keep up a constant fight against insect enemies and plant diseases. It is estimated that the annual loss due to insect pests of crops reaches the enormous total of one and one-half billion dollars. Every producer of crops stands his share of this enormous tax. It is better to fight the enemies than to let them destroy the crops. Most of the damage done by insects is preventable by spraying, or by some

FIG. 292.

FIG. 291.

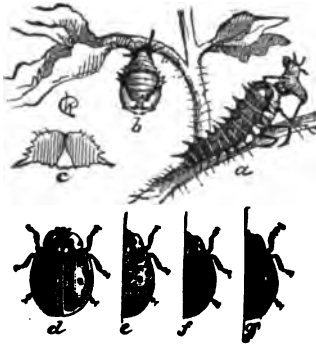

FIG. 291.—Fifteen-spotted lady-beetle; a, larva; b, pupa; d—g, adult varieties. This insect is very beneficial, destroying other injurious insects. These insects are very beneficial, destroying other birds should be protected. (Agriculture and Life.)

other approved method of combating the pests. Birds and beneficial insects if given an opportunity will help control insect enemies (Figs. 291 and 292).

Good farm management requires that the operator look ahead and know the probable effect of certain methods upon injurious insects. It is always safe to assume that the insects will appear in due season unless they are forestalled by proper man-

agement. Do not wait until the crop is seriously injured before methods are considered for the prevention and control of the pests. Watch the crops while young for any evidence of the enemy. Get them upon their first appearance.

Planting at the proper time will help control insects. Early planting of a quick-maturing variety of cotton helps to control the boll-weevil and boll-worm. Early potatoes and early cabbage are both less affected by their worst enemies. Fall wheat may be sown late to prevent attacks of the Hessian fly.

Rotation of crops is usually planned by careful farmers or gardeners. When one crop is badly affected with insects it should not be followed with the same kind of crop next time. Systematic rotation should be followed for a number of other reasons, but the control of insects gives us ample need for forethought in this regard. (See chapter on rotation of crops.)

Volunteer Plants and Weeds.—Although many insects feed on only one crop, they will often feed on a closely related species of weed or perhaps upon volunteer plants of the same variety growing near by. Potato beetles, for example, will feed upon other plants of the potato family—the wild night shade, sand brier and others. Such weeds may be kept down to help starve out the insects and prevent their breeding, or these plants may be sprayed and the insects thus “trapped” may be prevented from attacking the main crop.

Volunteer grain growing in the fall before the sowing of the main crop may feed the Hessian fly and furnish it a breeding place throughout the early fall. An extra harrowing or disking of the field may prevent this.

Forcing Rapid Growth.—If the crop is stimulated to rapid growth, it may overcome the bad effects of attacks made by insects. The apple worm and the plum curculio are sometimes actually killed by the rapid growth of the fruit after the insects enter. Weakened plants are most likely to suffer from the attacks of insects. It is a well-known fact that many insect enemies are most destructive during seasons when the growth of plants is retarded by drought, or in places where the growth is retarded by an impoverished soil.

Cleaning up after each crop is a good thing to practice. Cleaning the fence rows so that the insects will not find good hiding places should be systematically practiced. Plant as close to the fences as possible and then cut the weeds, grass and bushes and rake out the litter at least once a year. When a cabbage crop,

potato crop or any other crop is harvested, the stubs, vines or other remains should not be left in the field to harbor insects and diseases. They should be plowed under or raked up and piled into composts where they will rot and destroy the enemies.

Seasonal Plowing.—It is much cheaper to plow a field well, and to plow it at a season when the insects are at rest, than to spray the crop or otherwise fight the insects after they have developed. Plow deep. This will kill many a larva and pupa. It will also turn up many for the attacks of birds, poultry and "Jack Frost." Plowing late in the fall after insects have hibernated for the winter will thus destroy countless numbers of them. The farmer finds this practice one of the best methods of treating the soil, to say nothing of its effect upon insect life. Grub worms, cut worms, corn ear-worms, stalk-borers, chinch bugs, grasshoppers and numerous others attempt to pass the winter in the ground and most of them will be destroyed by the late fall plowing. Early spring harrowing also destroys insects. Frequent harrowing and cultivating of the corn crop, potato crop and most garden crops are recommended.

Trapping the insects is also practiced with much benefit in particular cases. The trap crop may be a natural weed, or may be planted as a bait crop to attract the insects so they will avoid the main crop. The brood of insects may be poisoned or otherwise killed before the attack of the main crop. In the case of the cotton boll-worm, which also attacks the ears of young corn, the cotton crop is often protected by making successive plantings of corn in narrow strips through the cotton field. As the corn matures it is used for stock feed, and the cotton is grown without much injury.

Plant Diseases.—In the fighting of plant diseases, "prevention is better than cure." If the gardener or farmer is aware of what diseases are likely to appear, he can always prevent them by proper methods. These should be intelligently carried out without interruption. A common mistake is to hope that the diseases may not appear, and preventive measures are not practiced. Nearly all spraying for insect diseases should be in advance of the attack and not after it (Fig. 293). When a disease starts in one part of the field a large part of the crop is sometimes saved by the quick application of remedies. In nearly all cases, however, the infection is so general and so complete before the outbreak is noticed that remedial measures are of no avail. It is perhaps for this reason that spraying for plant diseases is so often discredited by the uninformed.

INSECTICIDES AND FUNGICIDES

The principles involved in combating insects are based upon their methods of feeding. Chewing or biting insects are killed by arsenical poisons. Insects with sucking mouth parts live upon the juices of plants and cannot be killed by such poisons. If they are to be killed by spraying, it must be with a "contact insecticide," i.e., some material such as oil or dust which will smother the insect by clogging the breathing pores located along the sides of the body.



FIG. 293.—A spray pump operated by hand which pumps the liquid from the big tank and delivers it at high pressure through the spray hose. (New Jersey Station.)

Fungous diseases can be usually prevented by the application of a fungicide applied by spraying the surface of the plant before the disease finds a starting place there.

In many cases, spraying may be made to serve two purposes. Thus by combining two spray materials such as a fungicide with an arsenical poison we may combat a fungous disease and kill leaf-eating insects. Examples of these combinations are given in this chapter.

Arsenical Poisons.—White arsenic is a cheap form often used in preference to Paris green or arsenate of lead. Arsenic alone is injurious to the leaves and should be combined with sal soda at the rate of one pound of arsenic to two pounds of sal soda dis-

solved in one gallon of water. The dry powder should first be mixed with a little water to form a thick paste before the other ingredients are added. The mixture should then be boiled until dissolved. Care must be exercised in handling this and other similar poisons. This solution may be kept to mix with water or Bordeaux mixture as needed. When spraying for diseases and insects combined, mix one quart of this stock solution with 50 gallons of Bordeaux mixture containing plenty of lime. If water is used in place of Bordeaux mixture, use two quarts of the stock solution to fifty gallons of water and add two pounds of lime slaked and diluted to the consistency of cream.

Paris green is a common commercial form of arsenical poison. It varies somewhat in its composition, but should contain from 50 to 58 per cent of arsenous oxide. To avoid danger of burning the leaves when spraying with this material, lime should be added to the mixture at the rate of one or two pounds to 50 gallons. In spraying potatoes, it is usually used at the rate of eight ounces of Paris green to 50 gallons of water. For apples, one-half this amount of poison is used.

Arsenate of lead is a poison more easily combined with lime-sulfur in its different forms. It is more adhesive than Paris green, and is seldom known to cause injury to the foliage. It is coming to be the most popular poison for use in spraying orchards. Commercially this poison is prepared in two forms: As thick paste, and as a powder. If the paste form is used, allowance must be made for the water it contains, which is about 50 per cent of its weight. Five pounds of the paste to 100 gallons of water or 100 gallons of lime-sulfur is used in spraying apples. On the peach we may use four pounds of the paste with 100 gallons of lime-sulfur or 100 gallons of water. As much as eight or ten pounds to 100 gallons of water may be used in fighting the rose beetles on grape vines. As such a strong solution is very bitter, it may be sweetened by adding two gallons of molasses to each hundred gallons of liquid. It is difficult to get the powdered arsenate of lead to mix readily with water, but if it is fine enough to do so, the above proportions may be reduced one-half, as the powder is twice as strong as the paste.

Arsenite of zinc is a light powder which is coming to be used by vegetable growers and others in place of arsenate of lead. It should seldom be mixed with water alone because of the injury to leaves. Lime or Bordeaux mixture may be used to prevent this

injury. Use one-third as much arsenite of zinc as we would of arsenate of lead paste in the above formulas.

Hellebore is a poisonous light brown powder. It is often applied in the form of dry dust either alone or mixed with flour. It must be fresh to be effective. This material is not recommended because so much of the commercial product has lost its strength before it is sold. As a spray four ounces of the fresh poison may be mixed with three gallons of water. As its poisonous properties disappear soon, it may be used instead of the arsenical sprays on fruits or crops that are approaching maturity.

Contact Insecticides.—Lime-sulfur solution is now one of the most common spray materials. It will smother scale insects, and acts also as an effective fungicide. There are three main forms of this in use: (1) concentrated lime-sulfur solution, (2) commercial lime-sulfur solution, (3) self-boiled lime-sulfur.

Concentrated lime-sulfur contains thirty pounds powdered sulfur, fifteen pounds burned lime and fifteen gallons of water. Start the lime to slaking and add the wet sulfur to it. Then add the remainder of the fifteen gallons of water and boil until dissolved. This may be kept in a closed vessel until wanted. A layer of oil on top of the liquid will keep the air away sufficiently. For winter spraying of apples this is diluted nine times its volume of water. Before diluting the concentrated solution, find the specific gravity of the liquid. Divide the decimal of this number by three hundredths (.03), and the quotient will tell the number of times to dilute the liquid. If the specific gravity of the boiled stock solution is 1.27, divide the .27 by .03 which gives us 9, and indicates the number of parts of water to use. The winter spray for peaches should be a little more dilute than this.

An easy way of boiling the lime-sulfur solution is to use an open kettle with a fire underneath. Sometimes a barrel or tank is used, and the boiling is done with a steam pipe from a small boiler.

Commercial forms of the concentrated lime-sulfur are offered by many dealers. Usually the specific gravity is indicated on each of these preparations or directions are given for the diluting of the material for different purposes.

Self-boiled lime-sulfur contains eight pounds powdered sulfur, eight pounds fresh burned lime in 50 gallons of water. The principle involved in making this preparation is that the heat produced by the slaking of the lime will be sufficient to dissolve most of the sulfur. Place the lime in a barrel or wooden tub and

nearly cover with water. As the heat develops, the sulfur is added, care being taken to avoid any lumps of sulfur. Stir constantly. As much as three or four gallons of the water may be added gradually. The mixture should boil for several minutes. Then more water is added until the solution is cooled. The remainder of the water is added to complete the above formula, 8-8-50. This is used as a summer spray to prevent disease and to control scale insects, particularly on the stone fruits, such as peaches, plums and cherries, but it is also used effectively against diseases of leaves and fruit on the apple, pear, and others.

Fish Soaps.—Whale-oil soap is used in spraying for plant lice. It is effective against soft-bodied insects. One pound of the soap to six gallons of water is effective. It is not injurious to the foliage of plants. Although whale-oil soap solution was formerly used in fighting scale insects, other remedies are now usually preferred, i.e., miscible oils and lime-sulfur wash.

Miscible Oils.—There are several commercial products bearing trade names which are made up chiefly of miscible or soluble oils. These contain mixtures of petroleum or its products with some vegetable oils, made "soluble" by the addition of an alkali such as sodium hydroxide. This makes the oil combine readily with water. Each of these preparations should be diluted according to the directions; the proportion is usually ten to twelve parts of water to one part of the commercial mixture as a winter spray against San José scale. Twenty-five to thirty parts of water are used as a summer treatment for plant lice and other soft-bodied insects.

Tobacco Decoction.—This is made by boiling tobacco stems and other tobacco refuse in water, using one part to about two gallons. Its strength may be varied according to the insects on which it is used. Commercial preparations of uniform strength are found in the market.

Ground tobacco stems are often applied in dry form against apple root aphid, or may be dusted upon leaves to drive away various insect enemies, as in the case of the tarnished plant bug on melons and other vines.

Nicotine sulfate under various commercial names is found in the market. It contains the active principle of tobacco, and is often very strong. "Black Leaf 40" is one of these preparations which requires one hundred parts of water. In this strength it is effective in spraying melon lice.

Persian insect powder is made from the blossom of the pyrethrum plant. This is used as a dust and smothers the insects. As it is not poisonous to human beings, it may be used in windows or other places where flies collect in great numbers. Like hellebore, it deteriorates with age, and so becomes ineffectual. When combined with water as a spray, one ounce of pyrethrum is mixed with two gallons of water. This should be boiled a few minutes before using. The fumes of burning pyrethrum powder will destroy flies and mosquitoes, if the fumes are confined in a closed room.

Kerosene emulsion is made of one-half pound of hard soap, one gallon of water and two gallons of kerosene. Dissolve the soap in the water made boiling hot. Then remove from the fire and add the kerosene. This should be mixed vigorously for ten minutes. A good way is to use a small spray pump and turn the nozzle back into the mixture. It will become a creamy mass when all of the oil is thoroughly emulsified. This mixture may be kept in bottles any length of time desired. It is to be diluted when used with ten to fifteen parts of water for summer use against plant lice and soft insects. As a winter spray, only three or four parts of water to one part of the stock solution are used. This is one of the oldest and one of the best remedies for use in the garden and greenhouse against any form of sucking insects.

This emulsion is modified by substituting crude petroleum for the kerosene, or some petroleum distillates are sometimes used.

Crude Oil.—For mange on horses and cattle and for lice on hogs, poultry and other animals, nothing is better than crude petroleum. This is rubbed on the coat of the animal, or sprayed among the feathers of poultry with an air blower. If light applications are made, little or no injury results, but the parasites are destroyed and the eggs when hatched are killed by the residue of oil yet remaining in the hair or feathers. Light weight crude oil is preferred for these purposes.

Pure sulfur is used against the red spider in grain houses, and is dusted on infested plants and trees such as citrus fruits in warm climates.

Carbon bisulfide is used in destroying grain moths, weevils and other pests in stored seeds, stored grain, and other fruits in the pantry. Bins of wheat or other grain may be covered tightly with canvas and the liquid placed in a dish above the grain under the cloth. The liquid evaporates and the fumes penetrate through-

out the mass of grain, destroying the adults, larvæ and pupæ. Keep all fire or flames away from the materials. Use one teaspoonful of the liquid to each two cubic feet of tightly closed air space.

FUNGICIDES

Bordeaux mixture is the most common fungicide used to prevent disease of plants. The most common formula is five pounds copper sulfate (blue stone), and five pounds fresh burned lime to 50 gallons of water. Dissolve the copper sulfate at the rate of one



FIG. 294.—Bordeaux mixture is made by making the two stock solutions separately and then pouring the two together as shown. (U. S. D. A.)

pound to one gallon of water. This may be done by hanging it in a bag suspended in the water over night, or by boiling the water for a few minutes. Slake the lime carefully until it is of a creamy consistency. Add water to make one gallon per pound of lime. These two solutions may be kept any length of time, and are called stock solutions. When needed for spray, stir each mixture well; dilute each as much as convenient before pouring them together. To mix them, pour the two diluted solutions at the same time into a third vessel (Fig. 294), then more water may be added to agree with the formula here given. Strain the Bordeaux mixture through cheesecloth before spraying.

Paris green, arsenate of lead, or other poison may be mixed with this to poison insects at the same time that the Bordeaux mixture is preventing disease.

A few examples for which this combined spray would be used are:

Apple scab and codling moth.
 Potato blight and potato beetle.
 Brown rot of peach and curculio.
 Tomato "wilt" and tomato worm.

PRINCIPLES OF SPRAYING

Never spray without knowing what you are spraying for.

Be sure that the application is made at the most suitable time



FIG. 295. —This four-row sprayer is operated by chain gear on the axle. It is suitable for spraying potatoes, cabbage, and other truck crops. (Courtesy Osborn Co.)

to accomplish its purpose. Do not wait until the calyx is closed before spraying for controlling codling moth. Do not wait until the leaves are nearly all destroyed before fighting a leaf-eating insect, such as canker worm, or potato beetles (Fig. 295).

Spraying is always more effective if the work is done on a bright, calm day (Fig. 296). The material should dry on the surface soon after its application.

Be sure that all parts of the plants are touched with the spray, as the unsprayed parts may feed the insects and defeat your main purpose.

Learn of the horticulturist at your state experiment station

the very latest forms of improved nozzles before purchasing. Usually a wide nozzle (No. 8 in Fig. 297), in which the liquid is given a whirling motion before it strikes the outer edge, is considered best for producing a mist. Such nozzles are recommended for use with Bordeaux mixture and lime-sulfur.

Combine spray materials in preference to separate applications. An insecticide and a fungicide are often used together to save time and labor.

Winter sprays are always made stronger than summer sprays of the same materials (Fig. 298).



FIG. 296.—Spraying shade trees with arsenate of lead to control the leaf-eating insects. Much power is required to force the stream to such a height. (New Jersey Station.)

Lime-sulfur is a good fungicide, and is a special insecticide for the control of scale insects. Its strength is varied according to the purpose and the season. It may be combined with arsenate of lead when biting insects are to be killed and disease prevented.

In the purchase of spray pumps and other machinery, use forethought so as to suit the apparatus to the area and purpose (Figs. 299 and 300). Often a small outfit which may be carried by hand on a small cart will accomplish as much as a more expensive outfit. More spraying would be done by gardeners and fruit growers if this were appreciated. Simple inexpensive equip-

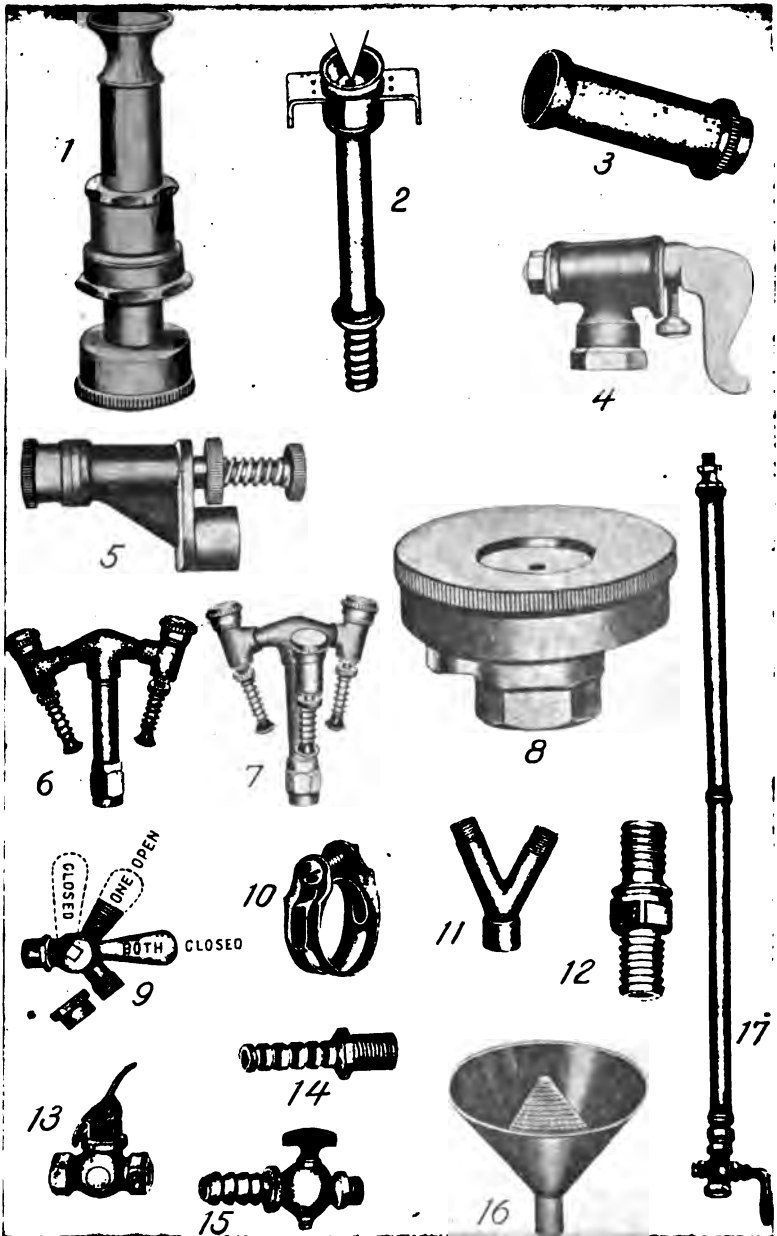

FIG. 297.—Spraying accessories. 1, simplest type nozzle; 2, 3, types little used; 4, Bordeaux nozzle; 5, 6, 7, Vermorel type much used, also nozzle clusters; 8, recent type, similar to Vermorel but of greater capacity; 9, cut-off; 10, hose clamp; 11, Y for cluster; 12, hose coupling; 13, 15, stopcocks; 14, connection, 16, strainer; 17, bamboo rod, with cut-off. (Fights of the Farmer.)

ments should be used by beginners, but if a much larger outfit will be needed in a year or two, do not be afraid to make the investment at first.



FIG. 298.—Spraying is much less laborious when a gas engine is employed for the work (New Jersey Station.)



FIG. 299.—Spraying outfit with tank for liquid below, air pressure tank above, and air pump operated by chain gear from hub of truck wheel. (Fights of the Farmer.)

FIELD AND LABORATORY EXERCISES

1. **Potato Scab.**—Make up a solution of formalin, using one ounce to two gallons of water. Use this for treating a small quantity of seed potatoes to kill spores of the scab disease.

2. **Copper Sulfate Solution.**—Dissolve two pounds of copper sulfate in two gallons of water by hanging the sulfate in a piece of cheesecloth tied to a

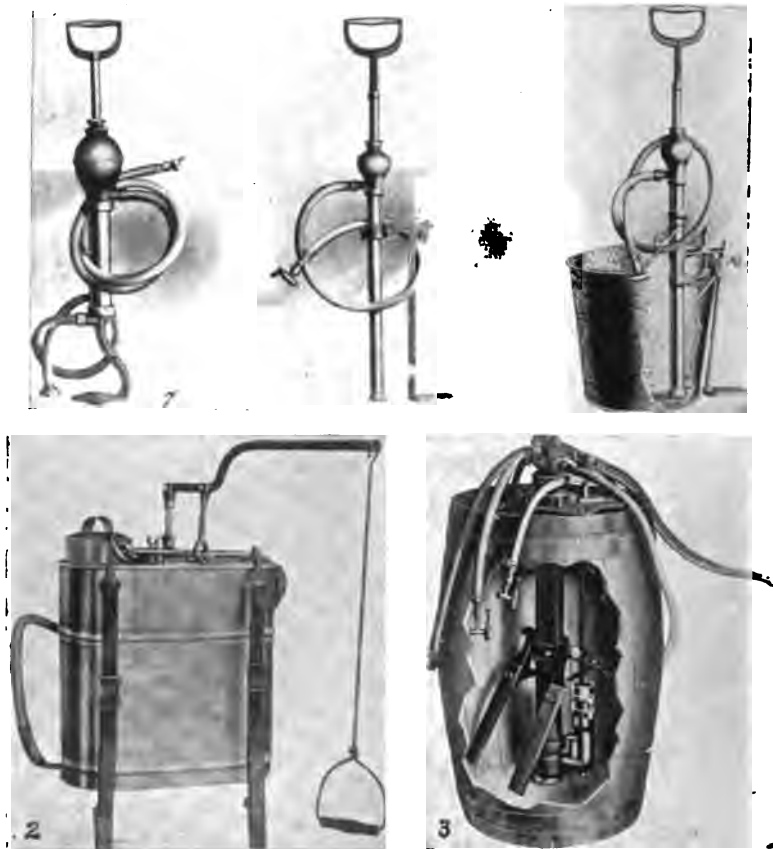

FIG. 300.—Types of spray pumps. 1, bucket pump, in which the agitation is by a jet at base of pump; 2, knapsack sprayer, carried on back of the operator; 3, barrel sprayer with wooden agitator and two lines of hose. (Fights of the Farmer.)

stick across the top of the vessel which should be of earthenware, wood or glass, (not metal). As the sulfate dissolves, the solution settles to the bottom and a circulation is thereby kept up during the dissolving process. Keep this as a stock solution and label its strength "One pound to one gallon."

3. **Lime Solution.**—Slake two pounds of lime by moistening with a little

water, and as the lime begins to heat, pour on a little more water to prevent its burning. After the slaking is completed, increase the quantity of water to make two gallons, which should be of a creamy consistency. Strain this through cheesecloth. Keep this as a stock solution in a covered vessel to prevent evaporation.

4. **Make Bordeaux mixture** from a little of each of the two stock solutions described above. Stir each one thoroughly and take an equal amount of each in two cups or glasses. Dilute each with four times its volume. Then pour these two solutions into a third vessel so that the streams mingle while pouring. Note the change of color. Stir immediately. This is Bordeaux mixture and is to be used as soon as possible after mixing. Put enough water with it to make the same proportion as called for in the formula, which is one pound of lime and one pound of copper sulfate in ten gallons of water. The equivalent of this may be obtained by dividing each by sixteen which will equal one ounce of lime, one ounce of copper sulfate in five pints of water. Keep the stock solution for future use.

5. **Mix Paris green with some Bordeaux** at the rate of one level teaspoonful of powder with five quarts of the Bordeaux mixture. This makes a combined spray material suitable for combating biting insects and plant diseases.

6. **Test Bordeaux mixture** by putting a clean steel knife blade in the solution for a moment when the mixture is first made and properly diluted. If a deposit of copper forms on the blade, more lime is needed. A little more of the lime water should then be added.

7. **Another test for Bordeaux mixture** is to pour a little of the solution in a shallow plate and allow it to stand for ten minutes or more, undisturbed. If the Bordeaux has sufficient lime, a thin film will be formed over the top of the mixture, which is detected by looking across the surface. Touch the surface with the point of a tooth pick. If a good film is found, it will show plainly. If the mixture does not stand this test, add more lime water, as there is more danger of injuring the foliage if there is not enough lime present.

8. **Paris Green Spray.**—Make a mixture of one level teaspoonful of Paris green in five quarts of water. Use this with a small blow spray for plants attacked by biting insects, as Irish potatoes. Keep well shaken while using. Note the results the following day. Do you find any dead potato beetles?

9. **Test for free arsenic** in a mixture of Paris green and water by pouring off some of the clear water after the Paris green has settled. Put a few drops on a silver coin or on a clean tin surface. If free arsenic is present, a deposit of metallic arsenic will discolor the other metal. As free arsenic is usually present in a mixture with Paris green, lime should always be added. Use one or two pounds of lime to each fifty gallons of water. The free arsenic will thus be taken up, and injury of the foliage is largely prevented.

10. **Make a solution of arsenate of lead** in water, calculating the proportions to agree with those given in this chapter. Test this solution for free arsenic as in the above exercise. Can you give a good reason for using arsenate of lead instead of Paris green on trees and other plants?

11. **Compare several of the poison mixtures** with each other and see which ones remain in suspension best. What danger is likely to occur with those which settle quickly?

12. **Make a stock solution of kerosene emulsion**, using the directions and formulas given in this chapter.

13. **Killing Plant Lice.**—After properly diluting a part of the stock solution, use it as a spray on plant lice, or on soft-bodied insects, and note the effects.

14. **Make a concentrated lime-sulfur solution**, reducing the quantities to suit the laboratory requirements. If possible, test this for specific gravity, label it and save as a stock solution for future use.

15. **Killing San José Scale.**—Dilute a part of the concentrated lime-sulfur solution and use as a spray on San José scale or other scale insects in a winter condition. Some weeks later, the sprayed plants should be examined to see if any insects have survived.

16. **Self-boiled lime-sulfur** should be made up in the laboratory, using a large enough quantity to produce the heat necessary for the boiling. Label the stock solution, indicating the strength, and save for future use.

17. **Make up a solution of the self-boiled lime-sulfur** to use as a summer spray, and apply it to peach trees or plum trees to prevent plum rot and to kill any young scale insects present.

18. **Other Spray Materials.**—Make up preparations of each of the other materials mentioned as insecticides and fungicides. If possible, use each of these materials and note their effects.

19. **Spray Nozzles.**—If possible, make a collection of spray nozzles of different types, and study the merits and demerits of each.

20. **Spraying machines** if used in the vicinity, should be visited and studied with reference to their adaptation to the work expected of them.

QUESTIONS

1. How may good farm management aid in the control of insect enemies and plant diseases?
2. Give an illustration of the value of planting at the proper time.
3. Explain the value of rotation of crops in this regard.
4. What is the influence of volunteer plants and weeds in the spread of insects and plant diseases?
5. Why should we try to force a rapid growth where insect enemies are present?
6. Explain the importance of cleaning up after each crop.
7. How does fall plowing help to control insects?
8. Give an example of a trap crop and explain its use.
9. Why is prevention more important than "cure" in the control of plant diseases?
10. For what type of insects are the arsenical poisons used? And for what are the contact insecticides used?
11. Discuss one of the arsenical spray materials.
12. Describe how to make, test and use concentrated lime-sulfur.
13. Give directions for making self-boiled lime-sulfur solution.
14. For what is it used?
15. Tell how to make kerosene emulsion and give its uses.
16. Give directions for making Bordeaux mixture.
17. For what may combined spray materials be used? Give several examples.
18. Give the chief principles of spraying.

References.—United States Farmers' Bulletins: 127, Important Insecticides; 172, Scale Insects and Mites on Citrus Fruits; 196, Usefulness of the American Toad; 219, Lessons from the Grain Rust Epidemic of 1904; 231, Spraying for Cucumber and Melon Diseases; 243, Fungicides and Their Uses in Preventing Diseases of Fruits; 247, The Control of the Codling Moth and Apple Scab; 284, Insect and Fungous Enemies of the Grape East of the Rocky Mountains; 440, Spraying Peaches for Control of Brown Rot, Scab, and Curculio; 456, Our Grousebeaks and Their Value to Agriculture; 488, Diseases of Cabbage and Related Crops and Their Control; 506, Food of Some Well-known Birds of Forest, Farm, and Garden; 564, The Gipsy Moth and Brown-tail Moth With Suggestions for Control; 595, Arsenate of Lead Against the Tobacco Hornworm; 609, Bird Houses and How to Build Them; 621, How to Attract Birds in Northeastern United States; 630, Common Birds Useful to the Far-

mer; 648, Control of Root Knot; 650, San José Scale and Its Control; 662, Apple Tree Tent Caterpillar; 668, Squash Vine Borer; 675, Round Headed Apple Tree Borer; 691, Grasshoppers and Their Control on Sugar Beets and Truck Crops; 699, Hydrocyanic-acid Gas Against Household Insects; 701, Bagworm: An Injurious Shade Tree Insect; 708, Leopard Moth: An Imported Insect Enemy of Shade Trees; 714, Sweet Potato Diseases; 721, Rose Chafer; 722, Leaf Blister Mite; 723, Oyster-shell Scale and Scurfy Scale; 731, True Army Worm and Its Control; 733, Corn and Cotton Wire Worms and their Control; 737, Clover Leafhopper and Its Control; 739, Cutworms and Their Control; 740, House Ants and Methods of Control; 741, Alfalfa Weevil; 742, White Pine Blister Rust; 755, Birds of Southeastern U.S.

Cornell Bulletins: 283, Control of Insect Pests and Plant Diseases. 325, Cherry Fruit Flies and How to Control Them. 354 and 369, Dusting and Spraying Experiments with Apples. 367, The Fruit Tree Leaf Roller. Circular 26, Peach Cankers and Their Treatment. Circular 28, Apple Cankers and Their Treatment. Circular 31, Fall Spraying for Peach Leaf Curl. Circular 32, Dusting Nursery Stock for the Control of Leaf Disease. Circular 20, Fire Blight Disease.

CHAPTER XXXI

THE BUSINESS OF FARMING

The farmer should be a philosopher. I like to think of him as having been so thorough and timely and resourceful with his work, that he can sit on the fence at least one day in the week and enjoy the fun of seeing things grow.
—L. H. BAILEY.

THE attractions of present-day farm life are enticing. In recent years thousands of men who have been engaged in other lines of business have taken up farming either as their chief occupation or as an avocation—merchants, bankers, professional men, and indeed people from all walks of life. This has been called the back-to-the-farm movement. Some of the causes of this movement have been: (a) The attractions of rural life. (b) The larger profits to be derived from improved farming. (c) The overcrowded conditions in cities. (d) The need for more knowledge in farming. (e) Diversification and specialization in farming.

The Knowledge Necessary to Manage a Farm.—The farm calls for men with knowledge along nearly all lines of science. Engineering to manage the modern machinery and the farm power; chemistry to manage the soil, the feed, the spraying of plants and disinfection of premises; biology to understand the nature of plants and their requirements. The farmer must have a technical knowledge of each of the crops which he is attempting to produce on his farm. He must be a thorough student of soils; understand the best management of fertilizers and other means of soil improvement. He must know the composition of plants in order to produce those needed for his stock. He needs to be a sanitary engineer to protect his family and his stock from diseases and insect enemies. Above all, he must be a good business man, a strict accountant, an alert financier, a man of quick decision, with much natural intuition in all matters of farming, and wide experience in the management of men with whom he deals, both on the farm and off of it. The successful farmer should be physically strong if he is to manage and conduct the details of his business. To succeed in his dealings with other men he must be morally above reproach, and stand as an exemplary citizen among his fellows.

The prospective farmer should have a natural inclination to live in the country. He should have a natural desire to do things with his hands, and ere long should attain some skill in the manipu-

lation of all things with which he has to deal in farming. No one should expect to go into farming who dislikes to handle tools, machinery, the soil itself, animals and plants.

A feeling that the farm is to be a permanent home should enter into the heart of the prospective farmer. It should not be thought of as a stepping-stone to something else, although many farmers are called to legislative halls and to other public positions.

In deciding whether to be a farmer or not there are a number of things to be taken into consideration: (a) The comparative cost of living on farms and in cities. This when figured correctly always results in favor of the farm. The cost of living is then reduced far below the average cost in the city. Many of the articles are produced on the farm, and indeed much of the living is obtained from products that would otherwise go to waste. (b) the farm land naturally increases in value far more than the home in the city. Many a farm has netted the owner a handsome income above the original investment, to say nothing of the profits from the farming operations and the value of the place as a home, in the meantime. (c) The profits to be reasonably expected in the farming operations should be the chief item for consideration; that is, the income from crops or animals as compared with the cost of producing and preparing them for market should be considered the labor income from farm operations. It is not fair to merely compare this labor income with city wages, because the city wage is used chiefly, or perhaps entirely, in cost of living, including rent or maintenance of the home, while the farm may furnish all of that in addition. (d) The investment in farm land is always safer than the investment in city property. Deterioration in land values due to hard times, or falling prices in general, is less marked in farm real estate than in city properties. (e) The attractions of farm life are numerous. Freedom and independence of action, opportunities for suiting environment to the personal desires of the owner, really make the owner a "captain of industry." (f) The farm is a suitable place to train the younger members of the family. With improved rural schools and rural churches, and the natural freedom from vice and contaminating surroundings, the young boy or girl has far better opportunities in the country than in the city. (g) Less extreme poverty and less extreme wealth are found on the farm as compared with the city.

Methods of Getting Started.—When a young man has a true ambition to become a farmer he will find a good way of making a

start. There are a number of plans, any one of which he may follow in doing this: (1) He may rent a farm already equipped. (2) He may become a farm laborer and gradually accumulate experience and a little money with which to start. (3) Opportunities are afforded for borrowing money to be invested in farm lands, and the necessary equipment. (4) He may earn money in some other occupation and save for the first investment. (5) He may start in a small way by buying enough land to start some small line of farming such as poultry keeping or gardening.

There are several methods in vogue of renting farms, among tenants and land owners in different parts of the country. Probably the most satisfactory for both parties concerned is cash rent. Share rental is practiced in many cases. The tenant usually gets two-thirds or three-fifths of the grain sold, if it be a grain farm. In cases where the owner furnishes considerable equipment in the form of machinery, stock, rather expensive buildings and barns, the landlord usually receives one-half the returns. Where special crops, such as small fruit, garden truck, sugar beets and others requiring much labor are produced, the tenant receives a correspondingly large share of the returns. Whether to start into farming as a tenant or not will depend very much upon the experience and industry of the operator himself. He may succeed very well and soon be able to buy a farm for himself. On the other hand many farmers remain tenants all their lives and move about from place to place, taking little interest in the community in which they live. This condition is very deplorable.

A young man with a little farm experience and with a determination to do the best he can—his hands and his heart full of willingness to make the farm pay his employer a good return—may receive board and washing, and perhaps a dollar a day as an average throughout the year on the farms of the East and Middle West. Wages will vary considerably in different regions. Such a wage is fully equivalent to fifty or sixty dollars a month in a city where he must pay out much of his income for board and washing. His incidental expenses are naturally much less on the farm. If he is married his house rent is given instead of his board on the farm. Indeed, a single man may be able to save most of his wages and start a bank account at interest from the very beginning.

If a young man chooses a suitable farm on which to hire out as a laborer, he should count as no small asset the experience which he will gain in a few years in the management of the soils, the

raising of special crops, the operation of improved machinery, and the knowledge of livestock. If he has already studied agriculture, he may add such experience to his scientific training, and soon be able to command a higher wage perhaps on a better farm. By this means he may be able to apply his knowledge to better advantage, and get increased returns on his investment. His special training is thus capitalized.

When a young man is able to make his first payment on a farm, it is never difficult to borrow money at reasonable rates of interest sufficient to complete the payment on the real estate and provide for the equipment. In some cases it is even possible to start with nothing, or nearly nothing, and borrow the entire capital necessary for the purchase of the farm and its equipment.

When money is raised in one way or another for the purchase of a farm, it is usually better to buy a small farm which will give good returns on the acreage than to buy a very large farm and not have enough capital left with which to operate it properly.

Choosing the Region for Farming.—When a farm is to be chosen, the general region in which to locate is the first matter of consideration.

Among the important matters for consideration are: (1) The general prosperity as shown by the people living in the region. This may be indicated by their buildings, equipment, livestock, good crops, schools, churches, roads and other matters which may be easily observed. (2) Climate is no small matter for consideration, as the health of the family is often injured by severe changes in climate. The amount of rainfall, the losses due to winds and hail must all be considered. The suitability of the season to the crops which are to be grown must also be considered at this time. (3) The richness of the soil of the region in general. This may be studied at first hand on the ground.

Selecting the Farm Itself.—Among the things which should be taken into consideration in choosing the farm are size, fertility of soil, natural drainage, or possibility of artificial drainage, water supply, possible irrigation, freedom from erosion, buildings and other improvements on the place, orchards or other permanent plantings, roads, distance to markets and shipping points, neighbors, school, church, taxes, coöperative efforts in the community, and possibility of future development. In visiting the farms that are for sale in any region, they should be listed and scored with reference to each of the points just mentioned.

Equipping the Farm.—Investment in equipment is usually too small in proportion to the investment in land itself. Doubtless this has originated from the speculative spirit. More land was purchased than was needed because of the prospective rise in price. If the available capital be taken as 100 per cent, then less than 50 per cent should be invested in the land. Forty-five per cent. may be invested in buildings, fences, roads, livestock, implements and tools. This would leave 5 per cent as working capital, which is indeed small enough.

Type of Farm.—There are a number of features which will govern the type of farming to be followed: (1) Climate; (2) character and fertility of the soil; (3) character of the roads and distances to market; (4) kind of market available; (5) the original cost of the land as a relation to intensive or extensive farming; (6) the amount of working capital available for annual operations; (7) the kind and cost of labor available; (8) the type of farming practiced in the neighborhood; (9) such enemies as weeds, insects and plant diseases.

Plan of the Farm.—When an old farm is purchased, it is seldom planned exactly to suit the needs of the purchaser. It will need replanning, and before the plan is made considerable studying will have to be done (Figs. 301 and 302). As all parts of the farm are not alike in fertility, and as the crops that have been grown on different parts will leave the fields in different conditions, a gradual transformation from the old plan to the new will usually be necessary. Of course the farmstead cannot be moved; the orchard and similar permanent features remain about as they were.

In the new plan of any farm there are a number of things to be considered: (1) The accessibility of the farmstead from all fields or parts of the farm. Have the most distant fields used for crops that will require the least travelling back and forth. (2) Have the fields of such size and shape as to make the work most economical. The larger each field is, the better, and the fewer number of fields there are, the better, providing systematic rotations can be maintained. (3) Lay out the fields so that the plowing may be done lengthwise, and may also suit the topography of the slope, and prevent seasonal erosion. (4) Locate the buildings not too far distant from the public highway. (5) Suit the new plan of the farm to make the changes from the old plan as inexpensive as possible. If the fences are poor and will need rebuilding, or if for other reasons extreme changes are not objectionable, the new plan

may be made more ideal. (6) For a systematic rotation, the plan should provide for a series of fields about equal in size.

Utilizing Farm Labor.—One of the greatest sources of loss on the average farm is the failure to utilize the available man labor and horse labor to the best advantage. It is lying idle too many days in the year. Work for stormy days is seldom provided. On

FIG. 301.

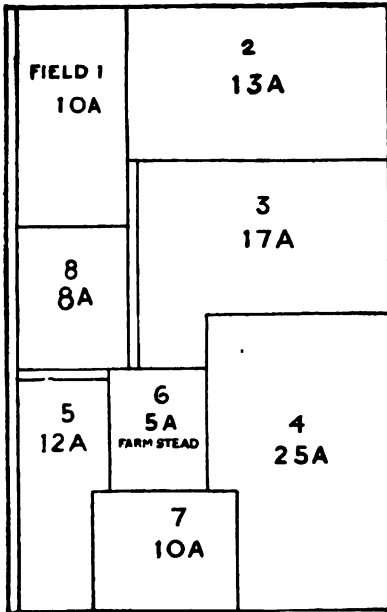

FIG. 302.

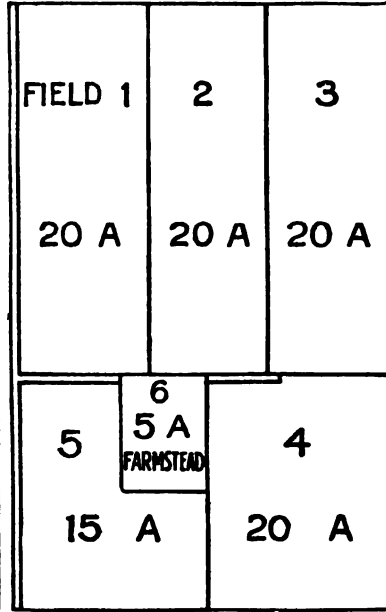

FIG. 301.—Map of 100-acre farm too much cut up into small fields. (Agriculture and Life.)
 FIG. 302.—The farm of the preceding figure remapped to save distance to fields and to save fence material. (Agriculture and Life.)

dairy farms the man labor is usually well employed throughout the year, but in market gardening, fruit growing and the raising of field crops, there is little to do when the weather or soil conditions are unfavorable. Where there are occasional stormy days, work should be planned along the following lines: Grinding tools, grinding feed, cleaning out poultry houses, white-washing interiors of buildings, disinfecting barns, reglazing of broken windows, using the fanning mill in cleaning seed, repairing and painting machinery, wagons and carriages, shoeing horses, trim-

ming the coats of animals, oiling harness, making and repairing double-trees, single-trees, axe handles, pick handles, hammer handles, repairing furniture, painting and papering the farm house, and many other things which occur incidentally.

Planning winter work for the farm teams is an important item in good farm management. If the roads are fit to use, the teams may haul fertilizer, lime, manure from town, and may haul to town any products that are to be sold, such as hogs or other livestock, and perhaps wheat or other grain. Teaming work may be obtained in a nearby town, or contracts may be taken for the marketing of produce in other regions. The hauling of wood, logs, lumber and other materials may be contracted before the winter season comes on. If the teams can be kept steadily employed they will be far more profitable. Such labor will give steady employment for the men who take care of the teams, and who may also be used in caring for other animals on the farm mornings and evenings.

If work animals are to be idle through the winter, they should also be used for breeding purposes, if possible.

Marketing.—One of the greatest problems connected with marketing of farm produce is to decide when to sell. For standard products such as livestock, grain, fibre crops, tobacco and others, the market prices should be studied carefully. A paper which gives reliable market reports should be a regular visitor at the farm.

Make a record of the market prices of any one product, as wheat or corn, showing the price on the first of each month throughout the preceding year, or if possible through a number of years. An examination of such a record will indicate the best month in which to sell those crops. The man who has capital enough so that he can afford to hold until the best market month of the year will usually realize the best returns. Prices are often greatly depreciated because of the great numbers of farmers who are not thus supplied with capital and cannot afford to hold their produce.

Selling.—There are a number of ways of selling products. On farms making specialties of certain crops, the owner will soon discover the best method of marketing. Poultry products, for example, may be sold to dealers who travel through the country and offer a cash price at the farm. This is one form of wholesaling. They may also be sold to stores or special dealers at wholesale prices. In contrast with this, many of the products are sold to consumers at retail prices. This usually requires the farm wagon

to go from place to place about the village or city to make deliveries to customers. A more recent method of retailing is to ship the products by parcels post direct to the consumer. Any or all of these methods of marketing the various farm products may be tried and the best one finally adopted as the method to be followed.

Coöperation in Marketing.—Among the best examples of marketing are those conducted by coöperative associations running butter factories, cheese factories, fruit packing establishments, grain selling, and others. The methods used are entirely legitimate, and usually bring better returns to the producer. The market is not so badly glutted with worthless products if the packing and marketing are done under the rules of a coöperative association. Bad butter, bad cheese, poor fruit and other products are eliminated. These are simply not produced at all by the members of the coöperative association. One of the chief benefits resulting from such coöperation is that it teaches the members to produce articles which the market demands. For example, fruit is thinned to make it larger, and it is sprayed to keep it from being damaged by insects and diseases. Selling by coöperative societies usually allows the use of wholesale methods, such as shipping in carload lots, and the holding of products in cold storage for better prices.

Cost of Crop Production.—Much study has been given in efforts to devise the best method of keeping accounts of the cost of production of crops. In contrast with these efforts, we find thousands of farmers who do not keep any record of production. A simple method of cost-accounting should be devised and intelligently followed by every farmer. Ordinary bookkeeping will not fit the conditions on a farm. Special accounts must be kept with each crop, and a simple method of charging up the man labor, horse labor, machine depreciation and maintenance, fertilizer, seed and other items must be used. A simple method of keeping records is described in *Productive Farming* (which see).

Successful Farming.—Whether farming operations are successful or not will depend to a very great extent upon the losses sustained in the operations. Losses are common along the following lines: (a) Climate and weather conditions, which are largely beyond the control of the farmer. (b) Bad management of the manure. (c) Erosion due to bad management. (d) Unprofitable use of the time of hired hands. (e) Loss from sickness and death of work horses or other animals. (f) Failure to spray or otherwise combat insects and plant diseases. (g) Bad manage-

ment regarding the control of weeds. (h) Failure to plant, drill and harvest at the proper time. (i) Bad methods in marketing.

Overcoming Losses.—The young farmer who can best overcome all of these difficulties is the one who will be most successful in farming. Losses along one or more of these lines will greatly reduce the profits which a man would otherwise have a right to expect from his farming operations. Special lines of farming are usually more profitable than general farming, and yet much more profit is often made by the general farmer. More knowledge is required to operate a farm running a number of lines than a farm run along one special line. The corollary of this is that a man can usually succeed best in a special line, but he is likely to have a number of losses overtake him. He has less opportunity for rotation of crops, and the consequent control of insects, diseases and weeds. In most special lines he has lost opportunity for distribution of labor throughout the year. If the market is bad for his specialty his losses are more severe than if he has a number of different crops to sell.

A word of encouragement should be given to the young man who contemplates farming as his vocation. Read again the first few paragraphs of this chapter. The farm is calling for men who are willing to call themselves men, and who are willing to stand up and do as well in this occupation as they would in mercantile lines or professional lines. There is always room at the top, and there is plenty of room for successful farmers. This business is never overcrowded. The calling is dignified and elevating. If the young man surrenders and says he cannot make a success of farming, it will be because he decides he cannot put his best life into it, and that he cannot master the intricacies of the business. He is either too ignorant or too indolent. We find few complete failures in farming. On the other hand, we find numerous successes. In entering the agricultural field, one should aim high and have the strongest ambitions, and a firm determination to succeed against all adversities.

FIELD AND LABORATORY EXERCISES

1. Obtain prices of land in the vicinity, either from agents or owners. Then calculate the average price per acre of all such places. Get also the range in price per acre, and explain, if possible, the cause for the wide difference found.

2. Make a rough inventory of the farm equipment on several of the farms which are included in the preceding exercise. In each case what is the per cent of value of equipment and value of land, counting the total investment 100 per cent?

3. **More Equipment.**—Determine, if possible, what additional equipment you would want in each of the cases above referred to.

4. **Make a regional score card** for use in choosing the region for farming. Give proper percentages for each of the points to be considered.

5. **Make a farm score card** for use in choosing the farm itself, indicating the proper percentages for each of the points to be considered.

6. **Score the region** in which you live, using the regional score card.

7. **Classifying Farms.**—Make lists of farmers for five miles along a certain highway, and classify these according to type of farming followed by each. If this survey can be extended over a larger area, so much the better.

8. **Storing Farm Products.**—Investigate, either by inquiry or by visiting, the methods of storing crops for winter sale or winter use. Compare the places and methods of storing fruits, root crops, corn, small grain, cotton, tobacco, and other staple products.

9. **Marketing Staple Crops.**—Investigate and write a report showing the methods of marketing staple crops by the farmers of your region.

10. **Marketing Perishable Crops.**—Make a report for perishable crops, such as fruits, fresh vegetables, eggs, butter and others, as suggested in preceding exercise.

11. **Farm Accounts.**—Determine if, possible, what farmers, if any, keep systematic records of the cost of production of crops, and of other farm operations. Compare the numbers who do this with numbers of those who do not. Report the reasons assigned by farmers for not keeping accounts.

12. **Compare methods of recording** in use and show the advantages of those which you consider best.

QUESTIONS

1. Enumerate the things a good farmer needs to know.
2. Mention the several advantages to consider in deciding whether to be a farmer or not.
3. What are the methods of getting started into farming?
4. Compare these methods.
5. Describe fully the three main features of the region in which you might wish to farm.
6. Give a list of the points to consider in choosing the particular farm in a given region.
7. Give all the suggestions you can to be considered in equipping a farm.
8. What things will govern the type of farming to follow?
9. Give some directions for replanning an old farm. For planning a new farm.
10. What attention should be given to the steady employment and use of farm labor and teams?
11. What benefits arise from improved methods of marketing?
12. What examples of bad methods in marketing have you observed?
13. Give examples of cooperative marketing—if possible from your own observation.
14. Describe a method of cost-accounting.
15. What are the chief causes of losses in farming?
16. What losses have you actually observed?

References.—U. S. Farmers' Bulletins: 242, An Example of Model Farming; 347, The Repair of Farm Equipment; 370, Replanning a Farm for Profit; 437, A System of Tenant Farming and Its Result; 445, Marketing Eggs Through the Creamery; 474, The Use of Paint on the Farm; 475, Ice Houses; 480, Practical Methods of Disinfecting Stables; 511, Farm Book-keeping; 572, A System of Farm Cost-accounting; 589, Homemade Silos; 593, How to Use Farm Credit; 635, What the Farm Contributes Directly to the Farmer's Living; 656, Community Egg Circle; 703, Suggestions for Parcel Post Marketing; 746, The Farmers' Income. Also 239, 277, 403, 432, 461.

CHAPTER XXXII

THE RURAL COMMUNITY

The better I am acquainted with agricultural affairs, the better I am pleased with them; insomuch, that I can nowhere find so great satisfaction as in those innocent and useful pursuits.—GEORGE WASHINGTON.

ANYONE living in the country, whether he be gaining his livelihood from farming operations or from other sources, should have a deep interest in the welfare of the community in which he lives. Too often there are members of the community who allow matters to take their own course and never show a community interest in things that are vital to its welfare, as well as to their own. This state of mind is more common among tenant farmers than among owners of real estate.

There are a number of special lines to which members of the community should give their constant attention: (1) Educational facilities. (2) Social and religious advantages. (3) Good roads and means of transportation. (4) Telephones for intercommunication. (5) Mail service. (6) Coöperative projects. (7) Good health and sanitary surroundings. (8) Civic improvement. (9) Beautifying of the home.

Good Rural Schools.—We should strive to have a school run as many months in the year as possible. The best teacher available should be employed for the work. Several teachers are usually better than one.

Where several schools may be consolidated by selling old buildings and erecting one large one with several rooms, this will allow of the maintenance of a much better school. The school can then be more completely graded, and more of the vocational work be introduced. This may permit the introduction of agriculture, cooking, sewing and shop work. It may give some opportunity on the part of the teachers to take a lively interest in the general welfare of the community, particularly as regards social matters. Young people will then feel more contented with rural life and not wish to leave the farm.

In places where a new school is to be erected, provision should be made, if possible, for living quarters for the teacher, or for the principal, who should in that case be a married man. If a

home for the teacher is provided, the use of the living quarters may be a part of his compensation. The man should be qualified to manage the gardens, agricultural plots, or a small farm connected with the school. He may be able to raise much of the garden and farm produce for his own family, and in connection therewith teach the most vital lessons in agriculture to his pupils. There is much need for having schools operated as many months in the year as possible, and if a home for the teacher is provided, the school should be open the entire twelve months of the year. In order to provide vacation for the pupils themselves, certain grades may take their vacations at different times of the year. This will reduce the actual expense for the salaries of teachers employed in the school, but will utilize the school building and grounds throughout the year.

Social Interests.—Human beings are what the naturalists would call “social creatures.” They must mingle with each other



FIG. 303.—A neighborhood meeting with a demonstration in canning vegetables. (Agriculture and Life.)

and if opportunity is not provided for this in one place, they will go to another instinctively. It is in the lives of young people that this instinct is most highly developed. Hundreds and thousands of communities in America are almost deserted by young people who are old enough to get away. The small children and the aged parents only are found in the homes.

There are many ways in which social life may be improved. Canning clubs (Fig. 303) and home improvement clubs, among girls, have aided in this matter. Corn clubs (Fig. 304), pig clubs, and poultry clubs among boys have helped (Fig. 305). Rural



FIG. 304.—Field meeting to examine a high-yielding acre of corn. Much community interest may be aroused by farm demonstrations, boys' corn clubs and girls' canning clubs, (U. S. D. A.)



FIG. 305.—A community meeting of colored farmers listening to a lecture on improved methods of farming from a "cotton special" train. (U. S. D. A.)

athletics bring the young people together in track meets, field games, and lawn sports where friendly contests and wholesome rivalry prevail.

During the winter seasons, when the evenings are long, socials should be held at the school, the rural church, or at the homes of the neighbors. Music, household games, spelling contests, debating and declamation often prove effective.

The Rural Church.—If the neighborhood does not have a church building, there may be a church organization or at least a Sunday school organization. Young people as well as older ones must have the religious instinct nurtured. One great difficulty with the rural church is that it does not take an active interest in other community affairs. The religious side of man is not a separate and distinct thing, and should never be treated as such. It is part of human nature and must be interwoven with other threads of interest to make up the fabric of man's life. Religious and social instincts go hand in hand. Church organization, and the pastor who is the leader in this, must make much of the religion of everyday life and show how the upbuilding of the religious spirit will better the members here on earth as well as hereafter. The present-day teachings are that the different denominations can and should work in harmony with each other under the same roof. Surrender a little of the denominational feeling and make the community a better one by helping to maintain and improve work already started.

Bad Roads.—Local effort should be expended in the improvement of roads, bridges and means of transportation. Dirt roads may be greatly improved by the use of road drags, but a road drag is chiefly for the maintenance of roads already graded. It may be said that the keynote to good road construction is good drainage (Fig. 308). Mistakes in road construction are nearly always mistakes in drainage.

After a well-drained road surface is prepared, nature will help to maintain it. The wearing of the surface of the road by vehicles will tend to produce holes and ruts in the road. If the road surface is dirt and therefore plastic when wet, these ruts and holes can be quickly and easily remedied by the use of a heavy drag (Fig. 306). This is drawn at such an angle as to move the dirt back into the ruts and holes on the crown of the road. If the ground is wet the soil will be plastered on the surface much as mortar is plastered on a wall, and the wet condition will make it possible to

make the surface that much smoother. When this begins to harden by baking in the wind and sun, the surface of the road will soon support animals and vehicles.

Easy means of transportation is so closely linked with the marketing of farm produce and with the prices at which produce may be sold that all must admit that good roads mean more profit on the farm (Figs. 307 and 308). Usually merchants in villages and cities are eager to have better roads reaching their trading centers. They are always willing to help in providing public funds for the construction of bridges and more permanent roads.

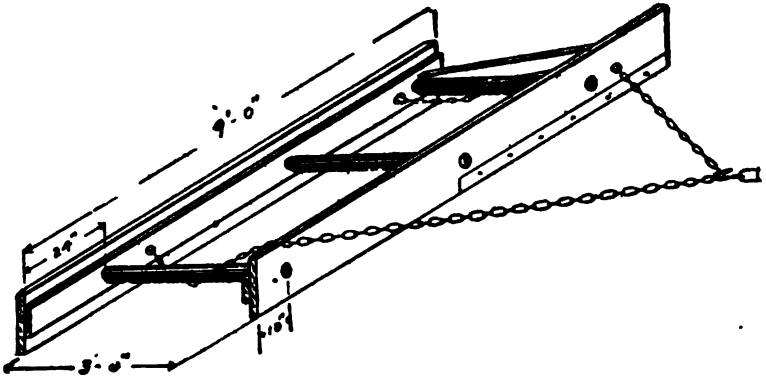

FIG. 306.—This drag is made from two pieces of ten or twelve inch plank, two or three inches thick and eight or nine feet long, reinforced by a two-inch by six-inch strip. The cross braces are four-inch sticks shaped to fit a two-inch hole. A board platform, not shown in the cut, is laid on the cross pieces for the driver to stand upon. (U. S. D. A.)

The farmer is able to take advantage of the fluctuation in markets if he can take his produce over good roads at any time. As good roads are necessary for the transportation of mails, the Post Office Department has demanded improvement of roads before mail routes are started. This has been no small factor in good roads improvement.

Rural Telephones.—There are several advantages of having a telephone in the farm house: social, marketing, medical, household supplies, emergencies.

Often the easiest way to secure a telephone in the farm home is to organize a local company, each member buying stock in the company. Terms for long distance contracts are much more easily secured if the local company is a substantial one and has a large number of members.

Extension lines from such exchanges as the county seat or

nearby village. Several members along the line subscribe for the use of telephones and the company will extend a wire and install the machines for a fixed rental and service charge.

The rural free delivery mail service is so well understood that



FIG. 307.—One bale of cotton was a heavy load on the bad roads. (U. S. D. A.)

its merits need not be emphasized. Daily mail service may supply the daily news, market reports, parcels post and frequent news from friends.



FIG. 308.—Ten or more bales of cotton may be drawn to market over the improved roads. All the cotton can be marketed while the price is at its best. Thus the road pays its cost. (U. S. D. A.)

Coöperative Projects.—In dairy sections, the establishment of local creameries or cheese factories is of the utmost benefit to

the farmers and often results in making them more prosperous. Farmers may cooperate in buying supplies in carload lots to be divided among themselves. These may include seeds, fertilizers, fuel and standard supplies. One of the best projects for cooperative effort is in the selling of farm produce, such as grain, eggs, pork and other meats, green corn, tobacco and other things.

Limited cooperation is seen in joint ownership of thrashing

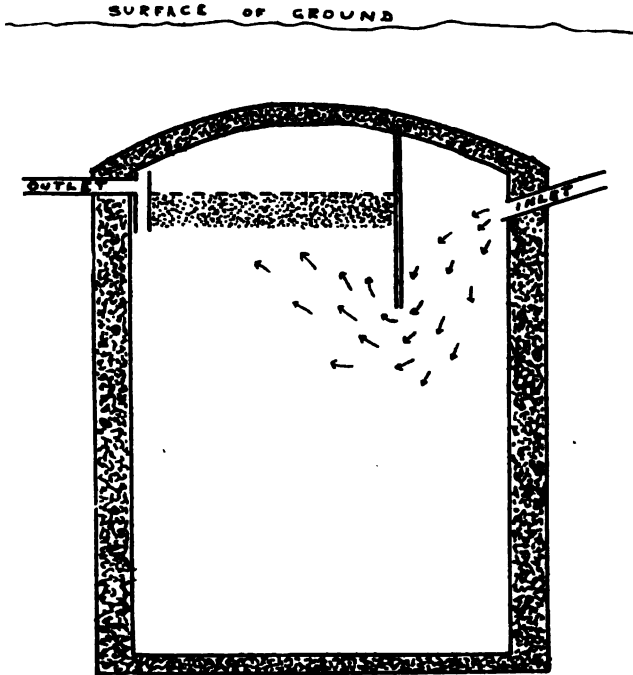

FIG. 309.—A septic tank should receive all wastes from the kitchen and bath room. It will destroy these materials and allow only clear water to pass on.

machinery, grain binders, corn harvesters, shredders, rock crushers, lime kilns, road machinery, ensilage cutters, and orchard sprayers. Pure bred sires, such as stallions, are sometimes owned in cooperation.

Health of the Family.—It is easy and perhaps more economical to provide sanitary surroundings in the country than in the city. The coal smoke nuisance is not objectionable. Neighbors are not so near as to contaminate each other. Drainage facilities can easily be provided. Sanitary practices must be rigidly enforced. Modern

conveniences are not more expensive in the country than in the city. Provide a toilet, bath, and kitchen sink. A septic tank should be installed for the use of every country home. If this is not done the sanitary privy described in United States Farmers' Bulletin 463 is the next best plan. It costs no more to provide for health than it does to be sick, to say nothing of the doctor's

bills and the remorse and suffering which follow sickness. A water pressure system is a great convenience and aid to health (Fig. 310).



FIG. 310.—Hydro-pneumatic pressure system with tank containing air and water under high pressure. The pressure is maintained with a pump operated by engine, motor, or wind mill. (Flint and Walling Mfg. Co.)

and where it enters the tank it has an elbow reaching one foot or more below the point of entrance or may have a baffle board in front of it as shown in figure 309. The purpose of this is to prevent agitation of the scum on the top of the water in the tank when the tank is full.

The outlet pipe which takes the water from the tank should be on a level with the inflow pipe, but inside the tank this should have connected with it a joint of pipe which reaches one or two feet below the surface of the liquid. The purpose is to prevent the drawing off of the scum by drainage. The outlet pipe may

A septic tank (Fig. 309) for the average family may be made a few rods from the house and some distance from the well. It is a hole in the ground about five feet deep and five or six feet in diameter. This may be walled with brick or stone laid in cement mortar, or the walls and floor may be of concrete. An inflow pipe should run from the bath room in the house to the tank and be covered with earth the entire distance. This should be deep enough to prevent freezing. The pipe is four inches in diameter

extend some distance away and terminate in a pile of débris such as broken rocks, bricks or other refuse. For the septic tank to operate successfully in destroying the wastes, it must have an undisturbed scum at the top of the liquid where beneficial bacteria are doing their work.

Civic Improvement.—Societies for the general improvement



FIG. 311.—A bleak-looking farm house not suited to keeping the children contented with the farm house.



FIG. 312.—The same home after being painted and beautified with vines, shrubbery and flowers. (U. S. D. A.)

of the community in ways which are not necessarily of an economic nature should be operative in all sections. They may have public lecturers instruct along lines of improvement: (a) The beautifying of the home grounds. (b) The improvement of the landscape along private roads and highways. (c) Roadside trees. (d) School grounds, church grounds and public parks. (e) Rural

architecture. (f) Removal of unsightly objects, as sign boards and unsightly shanties. (g) Planning roads and driveways.

Beautifying of the Home.—Landscape gardening in the country is practiced chiefly by suburban residents, but the farmer who owns a home should try to make it attractive. The planting of trees, shrubs and vines according to a fixed plan which the owner has worked out after careful study will do much to make the place attractive and the cost will be very slight. The use of paint and whitewash on the buildings and fences will help to give a feeling of prosperity, comfort and contentment. The cleaning up of the premises will aid not only in the training of young people and the public in general, but it will have a wholesome influence upon the farmer and his family (Figs. 311 and 312).

FIELD AND LABORATORY EXERCISES

1. **Rural School Conditions.**—Get reports from the County Superintendents or others who may be informed regarding the work and conditions existing in several rural schools of your county. Compare these regarding all of the information obtainable. For example: (a) Efforts for the beautification of the grounds. (b) The teaching of such practical subjects as school gardening, cooking, sewing, woodwork, and other handiwork. (c) The correlation of these subjects to the old line subjects of the school. (d) The number of school months in the year. (e) The percentage of attendance. (f) The extension of the school work to the people of that district.

2. **A social and religious survey of the region** may be conducted by members of the school to obtain the numbers of people who would be glad to participate in social activities such as some of those mentioned in this chapter, or who are already doing so. Find what percentage of the people who are old enough—say over eight years of age—are actually attending religious exercises, either church or Sunday school, somewhat regularly. If there be no church meetings or Sunday school meetings in the community, ascertain the total number who would attend such meetings if they were started.

3. **Compare with Other Communities.**—Obtain reports from other communities either in the same county or in nearby counties, and compare the facts obtained in the local survey with those in other places. Have any of these communities more churches to support than they need? Can you suggest a solution of this difficulty?

4. **Road Materials.**—Collect and study the materials available in your neighborhood that are suitable for road building. What combinations of these materials are sometimes made? Classify the materials according to superiority and also according to cost.

5. **Make a road survey** of the region and determine the percentage of graded roads and also the percentage of hard surfaced (paved) roads.

6. **Rural Telephones.**—If there are no local telephones in the neighborhood, obtain prices from telephone companies or houses supplying telephone materials and calculate the cost of poles, wires and instruments for a suitable local line or exchange.

7. **Make a survey of the region** chosen to determine how many would consider the installation of a telephone in their homes.

8. **Use of Rural Mail Service.**—By inquiry ascertain how many of the people nearby who are served by the rural free delivery of mails make daily use of the mails, by obtaining market reports, taking daily papers, or otherwise.

9. Rules for Coöperative Companies.—Get copies of the constitution and by-laws of the nearest coöperative project, or any others obtainable. If possible, compare the rules of different coöperative companies, marketing associations and others.

10. Comparison of Rules.—Make a tabulated comparison showing their differences in produce and sale of stock, voting privileges, penalties for violation of rules, powers of managers and other points.

11. A health survey of a certain community should be made. The local premises may be graded on each of a number of points such as: (a) Proper location of well, or ground near well. (b) Disposal of kitchen waste. (c) Disposal of sewerage and offal. (d) Screening against flies and mosquitoes. (e) Destruction of their breeding places. (f) Regular use of disinfectants about cellars. (g) General cleanliness of houses, barns and other buildings.

12. Make a list of all of the unsightly objects along roads, trolley lines, railroads or elsewhere that should and could be readily improved. In such case, determine, if possible, who is responsible for the existence of such nuisances.

13. Best Trees.—Along certain lines of road count the number of trees either planted or native which may furnish shade for the roadway. Make a list of the kinds of trees used for this purpose and compare them as to which are most suitable.

14. More Tree Planting.—For a strip of road which is not provided with shade trees make a list of the numbers and kinds you would recommend for planting. Indicate the distances between trees and the distances from the side of the road at which the trees are to be set. Whose duty would it be to have such trees planted?

15. Compare five farmsteads in regard to the number of shrubs used for beautifying the grounds; the number of vines growing and the suitability of these to the objects upon which they are climbing. Rank these five places, putting the best at the top of the list.

16. Improvements Needed.—Make suggestions for the further improvement of each of the places included in the preceding list.

QUESTIONS

1. What are the special lines of interest to which members of the community should give their attention?
2. Discuss the features of a good rural school.
3. What are some of the means of maintaining the social interests of the community?
4. Give points concerning the improvements of the rural school.
5. Give reasons for the building and maintenance of good roads.
6. Describe a home-made road drag and give its uses.
7. Give different plans of establishing rural telephone lines.
8. What are the uses of a rural telephone?
9. Describe the workings and rules of a coöperative creamery.
10. What other coöperative projects can you describe?
11. What are some of the conditions that must be improved, in order to maintain health in rural districts?
12. Mention some of the lines of endeavor for civic improvement.
13. What examples of this have you observed? Explain their workings.
14. Give reasons for trying to beautify the farmstead and make it attractive.

References.—United States Farmers' Bulletins: 345, Some Common Disinfectants; 377, Harmfulness of Headache Mixtures; Also on roads, Nos. 311, 333, 505, and 597.

Cornell Reading Courses, Country Life Series, No. 1: The Rural School and the Community, Rural Improvement, Waugh, Orange Judd Co., N. Y.

INDEX

- Abaca (Manila fibre), 308
Adaptation, 26
Agriculture and forestry, 353
Air for germination, 3
 in soils, 72
Alfalfa, 144, 170-173
 in rotation, 144
 cutting, 173
 curing, 173
 amount of seed, 171
 inoculation for, 170
 lime for, 171
 varieties of, 172
Almonds, 364
Ammonia sulfate, 117
Annuals, 373, 380
Apple rust, 413
 scab, 413
 tree borers, 404
 flat-headed, 404
 round-headed, 404
Apples, 325
 culture, 324-5
 fertilizers, 325
 pruning, 321-2
 setting, 322
 spraying, 325
 storing, 331
 varieties, 325
Aquarium, 11
Arsenate of lead, 421
Arsenic, test for, 431
Arsenical poisons, 420
Arsenite of zinc, 421
Artichokes, Globe, 274
 Jerusalem, 274
Ashes, 112
 potash from, 124
Asparagus, 273
Bacteria in soils, 72
Barley, 212
 culture of, 214
 types of, 214
Barnyard manure, 103
 care of, 105
 preservatives in, 106
 rotted, 108
 spreading of, 107
 testing, 124
Basic slag, 119
Bean, velvet, 180
Beans, 275
 lima, 276
Beautifying home, 453
Beets, garden, 245
 growing, 245
 sugar, chapter on, 239
Bermuda grass, 158
Biennial, 373, 380
Blackberries, 337
Black-knot, 416
Blue-grass, Kentucky, 155
Boll-weevil, 297
Boll-worm, 298
Bordeaux mixture, 425, 431
 test for, 431
Borers, peach, 405
 squash vine, 406
 apple tree, 404
Breathing of plants, 6
Breeding, 34
 corn, 36, 37
 cotton, 39
 seed, 34
 tobacco, 39
Broccoli, 268
Brome grass, smooth, 151, 158
Brown rot, 414
Brussels sprouts, 268
Buckwheat, 216
Budding, annular, 61
 H, 61
 practice of, 68
 plate, 61
 ring, 61
 shield, 62
Bulbs, 56
Business of Farming, chapter
 on, 434
Cabbage, 251
 worms, 405
Calcium cyanimid, 117
Canada field peas, 117
 thistle, 381
Cane sugar, manufacture of, 318
Canning clubs, 446
Canker worms, 404
Carbon bisulfide, 424

- Carrots, 246
 growing, 247
 Cauliflower, 267
 Celery, 269
 Celery, 268
 Cherries, 327
 Chestnut, 363
 Chinch bug, 400
 Chives, 272
 Chlorophyll, 4
 Citron melon, 279
 Citrus fruits, 328
 Civic improvement, 452
 Cleaning up, 418
 Clovers, 165
 alsike, 168
 bur, 180
 crimson, 169
 Japanese, 179
 mammoth, 167
 red, 165
 sweet, 180
 white, 167
 Cocoanuts, 364
 Codling moth, 401
 Coldframes, 259
 Coleoptera, 393
 Collards, 270
 Commercial fertilizers, 115
 for gardens, 257
 Compost, 108, 257
 Conservation of moisture, 88
 of soil, chapter on, 94
 Coöperative projects, 449
 Corn, chapter on, 187
 binders, 196
 breeding, 36
 by-products, 187
 classes of, 187
 curing, 197
 dent, 189
 distribution of, 188
 ear-worm, 400
 flint, 189
 harvesting, 194
 judging, 199
 planters, 192
 planting, 191
 pop, 189
 preparation of soil for, 191
 rules for judging, 199
 score card, 203
 seed, 196
 sweet, 189, 276
 tillage of, 192
 Corn, testing seed for, 48
 types of, 190
 varieties, 191
 Cost of production, 441
 Cotton, growing, chapter on, 286
 baling, 295
 breeding, 39
 boll-weevil, 297, 400
 boll-worm, 298
 culture of, 291
 diseases, 299
 fertilizing, 291
 grades of, 295
 ginning, 294
 insect enemies, 296
 judging, 289
 long staple, 288
 machinery, 299
 picking, 292
 planting, 291
 preparation for crop, 290
 root rot, 299
 score card, 289
 seed, 117
 types of, 286
 varieties, 287
 wilt, 299
 yields, 294
 Cover crops, 90
 Cowpea, 175
 seeding, 177
 varieties, 176
 Cress, upland, 271
 Cropping, companion, 146
 succession, 146
 Crop rotations, chapter on, 137
 management, 138
 principles, 138
 Crossing, 27
 Cross-pollination, 15, 30
 Crude oil, 424
 Cucumbers, 279
 striped beetle, 406
 Curculio, 402
 Currants, 339
 Cuttings, 59
 grape vine, 60
 practice in making, 68
 Diecious, 14
 Digestible components in feeds
 (table), 220
 nutriments, in cotton (table),
 300
 in grain crops (table), 221
 in legumes (table), 184

- Diptera, 396
 Diseases, plant, chapter on, 409, 419
 Control of, chapter on, 417
 Division, propagation by, chapter on, 55
 of crowns, 56
 Drainage and Irrigation, chapter on, 126
 effects of, 130
 profits from, 128
 where it helps, 126
 Drains, kinds of, 129
 under, 129
 Dust mulch, 89

 Egg plant, 282
 Endive, 271
 Environment, 24, 33
 Erosion, 74
 Exercises, at end of each chapter

 Farm, crops, principles of, chapter on, 34
 equipping, 438
 knowledge necessary, 434
 level, 135
 losses, 442
 mapping, 439
 plan of, 438
 selecting, 437
 type of, 438
 Farm and Garden Seeds, chapter on, 44
 Farming, business of, chapter on, 434
 methods of starting, 435
 region for, 437
 successful, 441
 Fescue, 152
 meadow, 157
 Fertilizers, analysis, 121, 122
 buying, 121
 commercial, 115
 formulas, 122
 home mixing, 123
 samples, 124
 use of, 120
 Fertilizing value of cotton (table), 300
 of grain crops (table), 221
 of legumes (table), 184
 Fiber crops—minor, chapter on, 302
 flax, 302
 Field and Laboratory exercises, end of each chapter

 Fish, 116
 Field pea, Canada, 177
 soaps, 423
 Flax, 217, 302
 growing, 303
 harvesting, 304
 origin of, 302
 retting, 305
 seeds, 218
 wilt, 306
 world's production of, 303
 Flowers, chapter on, 13
 Fodder crops, 152
 Forage crops, chapter on, 149
 definition of, 149
 Forests and Woodlot, chapter on, 348
 products of, 348
 Forestry and Agriculture, 353
 Forests, use and abuse, 351
 preventing waste, 352
 Fruit growing, chapter on, 320
 harvesting, 328
 Fungicides, 420

 Gardening, vegetable, chapter on 254
 soils for, 256
 Garden seed, chapter on, 44
 testing, 49
 Garlic, 272
 wild, 382
 Germination, 1
 what it is, 3, 11
 Gherkins, 279
 Gooseberries, 338
 Grafting, 64
 cleft, 66
 double working, 67
 whip-tongue, 64
 Grafts, 63
 Grain drills, 219
 harvesters, 219
 rust, 413
 smut, 411
 thrashers, 220
 Grains, small, chapter on, 205
 storage of, 53
 Grapes, 340
 score card for, 343
 Grasses, chapter on, 149
 Green manure, 100
 from cover crops, 100
 improvement from, 101
 Guard cells, 7
 Gumbo (okra), 277

- Harvesting fruit, 328
 grading for market, 333
 judging, 334
 packing for market, 333
 special harvesters, 330
 when to pick, 330
- Hay, 151
 caps, 175
 balers, 162
 forks, 163
 rakes, 161
- Health, 450
 Hellebore, 422
 Hemiptera, 393
 Hemp, 306
 seeding, 307
 soil for, 306
 yield, 308
- Henequin, 310
 Heredity, 22
 Mendel's law of, 31, 33
- Hessian fly, 401
 Hickory nut, 302
 Hops for brewing, 214
 Horse radish, 270
 Hotbeds, 258
 Humus, 70, 87
 adding, 91, 103
- Hybridizing, 33
 Hymenoptera, 398
- Insect enemies, 398
 natural, 399
 predaceous, 399
 remedies for, 398
- Insecticides, 420
 contact, 422
- Insects, economic, chapter on, 390
 control of, 417
 by crop rotation, 418
 trap crops for, 418
 life histories of, 398
 orders of, 393
 pinning, 407
 trapping, 419
 true, 390
- Irrigation, and drainage, chapter on, 126
 methods of, 134
 overhead, 134
 of potatoes, 229
 systems, 132
 water for, 133
- Japan clover, 179
 Johnson grass, 152, 381
 Jute, 312
- Kainit, 120
 Kale, 250
 sea, 274
- Kerosene emulsion, 424
 Kohlrabi, 251
- Laboratory exercises, end of each chapter
- Labor, utilizing, 439
 Land-plaster, 106
 Layering, mound, 59
 tip, 58
 vine, 59
- Leaves, 4
 in relation to light, 7
 office of, 5
 structure of, 6-12
- Leeks, 272
 Leguminous crops, chapter on, 165
 Lepidoptera, 394
 Lespedeza, 179
 Lettuce, 264
- Level, farm, 135
 running, 135
- Lime, 108
 action of, 112
 air-slaked, 111
 burned, 110
 concentrated, 422
 effects of, 109
 forms of, 110, 124
 for alfalfa, 171
 hydrated, 111
 need of, 110
 rate of application, 113
 self-boiled, 422
 sulfur, 422
- Liming, methods of, 114
- Loam, Carrington, 78
 Fargo clay, 78
 Heavy clay, 77
 Marshall silt, 78
 Miami clay, 78
 sandy, 77
- Machinery, forage crop, 160
 Mangel-wurzels, 243
 cultivating, 243
 feeding, 244
 harvest, 244
 planting, 243
 storing, 244
 thinning, 244
- Manila, fiber (abaca), 308
 Manure effect of, 124

- Manure, 100**
 barnyard, 103
 green, 100
 liquid, 100
 rotted, 108
 use of, 103
Manurial value of feeding stuffs, 104
Maple sugar, 360
Marketing, 440
 coöperation in, 441
Market fluctuations, 146
Meadow oat-grass, 152
Mendel's law, 31, 33
Metamorphosis, 390
 complete, 390
 incomplete, 392
Millets, 150
Miscible oils, 423
Moisture, 2, 11
 conservation of, 88
 fine film, 83
 hygroscopic, 85
 in dust, 92
 loss of, 88
Monecious, 14
Mound layering, 59
Mowers, 160
Mulch, dust, 89
 effect of, 93
Muskmelons, 278
Mustard, 265
Mutation, 22

Nicotine sulfate, 423
Nitrate of soda, 117
Nitrogen, 116

Oats, breeding, 40
 growing, 211
Oil, test for, 11
Okra, 277
Onions, 271
 wild, 382
Orangees, 328
Orchard grass, 156
Orchards, 320
 culture of, 325
 fertilizers for, 325
 setting trees, 322
 spraying, 325
 starting, 320
 tillage, 323
Organic matter, 70
Organisms in soil, 71

Orthoptera, 393
Osmosis, 9, 12
Oxygen for germination, 3

Parsley, 271
Parasnips, 269
Paris green, 421
Pastures, 150
 mixtures, 151
 permanent, 150
Peaches, 326
 leaf curl, 415
 packing, 331
Peanut, 182
 culture of, 183
Pears, 326
 ripening, 332
Peas, Canada field, 117
 garden, 266
Pecan, 363
Pedigrees, 32
Peppers, 283
Perennial, 373, 380
Persian insect powder, 424
Phosphoric acid, 118
 availability, 124
Plant breeding, principles of, chapter on, 22
 diseases, chapter on, 409
 diseases, 419
 life, chapter on, 1
 cycle of, 1
Plants, hardy, 261
 perennial, 261
 self-pollinated, 34
 starting early, 257
 tender, 261
 transplanting, 260
 types of garden, 261
Planting, depth of, 4
Plate budding, 61
Plot trial, 120
Plowing, deep, 95
 depth of, 123
 fall, 99
 fall or spring, 124
 seasonal, 419
Plum curculio, 402
Plums, 327
Poison bottles, 407
Pollination, 14
 artificial, 29
 by insects, 18
 by wind, 18
Popcorn, 277

- Potato beetles, 231, 400
 scab, 409
 treatment for, 409
 blight, 410
- Potatoes, chapter on, 224
 breeding, 41
 cultivating, 228
 fertilizers for, 225
 harvesting, 231
 Irish, 224
 irrigation, 229
 planting, 227
 by machine, 228
 preparation of soil, 226
 scoring, 231
 seed, 226
 soils for, 225
 spraying, 229
 sweet, 231
 varieties, 224
- Potash, 119
 from ashes, 124
 muriate of, 199
 sulfate of, 119
- Prepotency, 24
- Propagation of plants by division,
 chapter on, 55
- Protoplasm, 4
- Pruning fruit trees, 322
- Pumpkins, 280
- Pyrethrum, 424
- Quack grass, 382
- Quinces, 326
- Radishes, 266
 "Rag doll" method, 48
- Rainfall, average annual, 81
 distribution of, 92
- Ramie, 312
- Rape, 250
- Raspberries, 337
- Red top, 152, 156
- References, end of each chapter
- Reversion, 24
- Rhubarb, 273
- Rice, 215
 culture, 216
 harvesting, 216
 types, 216
 uses of, 215
- Roads, 447
 drag for, 448
- Rock phosphate, 118
 value of, 124
- Rocks, disintegration of, 73
- Root crops, chapter on, 242
 comparison of (table), 242
 cuttings, 67
 propagation, 55
 soils for, 242
 stocks, 56
 hairs, 8, 12
- Roots, purpose of, 8
- Rotation, to kill weeds, 384
- Rotations, acres in, 146
 and labor, 147
 and nitrogen, 147
 crop, 137
 for peanuts, 145
 for truck farmers, 145
 four-year, 142
 for South, 143
 long, 144
 one-year, 141
 three-year, 142
 two-year, 142
 Washington's, 145
- Runners, 57
- Rural community, chapter on, 444
 church, 447
 free delivery, 449
 schools, 444
 telephones, 448
- Rutabagas, 248
- Rye, 214
 culture of, 215
- Salaify, 270
- San José scale, 402
- Scion, 63
- Seed, farm and garden, chapter on,
 44
 analysis, 44, 47
 breeding, 34, 36
 detection of impurities, 44
 distribution of weed, 377
 obtaining good, 50
 production, chapter on, 13
 testing, 47
- Seeds, cleaners for, 53
 growth of, 18
 home grown, 50
 improving poor, 52
 local growers, 51
 parts of, 21
 purpose of, 20
 sources of, 51
 storage of, 53
 vitality of, 21
- Selection, 24, 33
- Selling, 440

- Septic tank, 451
 Shallots, 272
 Shelter belts, 91
 Sisal, 310
 Small fruits, chapter on, 337
 Small grains, chapter on, 205
 implements for, 219
 Smut, grain, 411
 corn, 412
 Social interests, 445
 Soil, analysis, 120
 air in, 72
 blowing, 75
 chemical changes in, 98
 classified, 75
 conservation and improvement
 of, 94
 for potatoes, 226
 grains, 73
 inoculation, 71, 79
 limestone, 77
 liming of, 108
 live organisms in, 71
 maintenance, 94
 movements, 74
 packing, 100
 physical changes, 98
 types, 78
 water, movements of, 85
 what it is, 69
 Soiling crops, 151
 Soils and their uses, chapter on, 69
 for vegetables, 256
 germs in, 79
 special crop, 70
 water in, chapter on, 81
 water-holding power, 86, 93
 Soy bean, 177
 Sphinx moth, 406
 Spinach, 265
 "Sports," 22
 Spraying, accessories, 428
 principles of, 426
 Spray pumps, 427, 430
 Sprouting, 4, 11
 Squashes, 279
 Squash vine borers, 406
 Starch, formation of, 5, 11
 Stocks, 62
 Stomates, 6
 Storage, of grains, 53
 of seeds, 53
 Strawberries, 343
 propagation of, 58
 Subirrigation, 134
 Sudan grass, 159
 Sugar, 11
 Sugar beets, chapter on, 239
 by-products, 242
 cultivation, 241
 fertilizers for, 239
 harvesting, 241
 planting, 240
 soils for, 239
 thinning, 241
 Sugar cane, chapter on, 314
 by-products, 318
 cultivation, 316
 fertilizers for, 315
 improvement of, 41
 manufacture or sugar, 318
 propagation of, 314
 soils for, 315
 harvesting, 317
 Sulfate of ammonia, 117
 Sulfur, 424
 Superphosphate, 119
 Sweet potatoes, 41, 231
 breeding, 41
 cultivation, 235
 digging, 236
 diseases, 236
 fertilizers for, 232
 planting, 233
 preparation of soil, 232
 propagating, 234
 setting plants, 235
 soils for, 232
 storing, 236
 varieties, 232
 Swiss chard, 246
 Tankage, 116
 Testing seed, 47, 48
 methods of, 48, 49
 value of, 48
 Tillage, 95
 effects of, 96
 Timothy, 151, 153
 breeding, 40
 Tip layering, 58
 Tobacco, chapter on, 366
 breeding, 39
 culture, 369
 curing, 370
 decoction, 423
 harvesting, 370
 soils for, 366
 setting, 368
 young plants, 367
 Tomatoes, 280

- Tomato worms, 406
- Top-working, 63
 - methods of, 66
 - of fruit trees, 65
 - with buds, 63
- Trees along roads, 355
- Tubers, 56
- Turnips, 248
- Type, purity of, 30
- Under-drainage, 87
- Variation, 22, 33
- Vegetable gardening, chapter on, 254
- Vegetables, culture of, chapter on, 263
 - Lloyd's classification, 263
- Velvet bean, 180
- Vetches, 180
- Vine layering, 59
- Walnuts, English and black, 361
- Warmth for germination, 3
- Water, acquired by plants, 8
 - capillary, 82, 84
 - free, 82, 83
 - hygroscopic, 82
 - required in season, 81
 - in soils, chapter on, 81
 - soil, 82
 - table, depth of, 92
- Watermelons, 279
- Water system, 451
- Weeds, chapter on, 372
 - along roadsides, 384
- Weeds, annual, 373
 - biennial, 373
 - beneficial, 377
 - classification of, 373
 - control of, by rotation, 380, 384
 - dissemination of, 377
 - distribution of seed, 377
 - eradication of, 380
 - injuries and losses from, 376
 - laws against, 379
 - losses due to, 375
 - noxious seeds, 386, 387
 - pasture, 383
 - perennial, 373
 - poisonous, 376
 - principles of control, 385
 - spraying for, 383
 - spreading, 378
- Wheat, 205
 - distribution of, 207
 - growing, 209
 - harvesting, 210
 - kinds of, 208
 - types of, 208
- Wild onions, 382
- Wind breaks, 91
- Wood lot, chapter on, 348
 - good land for, 355
 - management and harvest, 359
 - on the farm, 354
 - products of, 348
 - value of, 348
 - what to plant, 357



its a
175 m

YC 59223

