





THE LIBRARY
OF
THE UNIVERSITY
OF CALIFORNIA
LOS ANGELES

GIFT OF

G . J. Cummings



I. C. S. REFERENCE LIBRARY

A SERIES OF TEXTBOOKS PREPARED FOR THE STUDENTS OF THE
INTERNATIONAL CORRESPONDENCE SCHOOLS AND CONTAINING
IN PERMANENT FORM THE INSTRUCTION PAPERS,
EXAMINATION QUESTIONS, AND KEYS USED
IN THEIR VARIOUS COURSES

PROPERTIES OF GASES
MINE GASES
MINE VENTILATION
FUELS

35030

SCRANTON
INTERNATIONAL TEXTBOOK COMPANY

Copyright, 1907, by INTERNATIONAL TEXTBOOK COMPANY.

Entered at Stationers' Hall, London.

Properties of Gases: Copyright, 1906, by INTERNATIONAL TEXTBOOK COMPANY.
Entered at Stationers' Hall, London.

Mine Gases: Copyright, 1906, by INTERNATIONAL TEXTBOOK COMPANY. Entered
at Stationers' Hall, London.

Mine Ventilation: Copyright, 1896, 1897, 1900, by THE COLLIERY ENGINEER COM-
PANY. Copyright, 1906, by INTERNATIONAL TEXTBOOK COMPANY. Entered at
Stationers' Hall, London.

Fuels: Copyright, 1906, by INTERNATIONAL TEXTBOOK COMPANY. Entered at Sta-
tioners' Hall, London.

All rights reserved.

PRINTED IN THE UNITED STATES.



Library
TN
301
I 61 p

CONTENTS

PROPERTIES OF GASES	Section	Page
Physics of Gases	5	1
Definitions	5	1
Specific Gravity	5	2
Determining Specific Gravity	5	6
Heat	5	12
Measurement of Temperature	5	13
Absolute Temperature	5	17
Quantity of Heat	5	18
Sensible Heat	5	19
Specific Heat	5	19
Latent Heat	5	23
Total Heat	5	24
Expansion of Bodies by Heat	5	25
Atmospheric Pressure	5	28
Measurement of Atmospheric Pressure	5	29
Volume and Pressure of Gases	5	34
Mixture of Gases	5	36
Chemistry of Gases	5	38
Table of Molecular Weights and Densities of Mine Gases	5	47
The Atmosphere	5	51
Combustion	5	54
Spontaneous Combustion	5	58
Physical Properties of Mine Gases	5	59
· Gob Fires	5	65
MINE GASES		
Occurrence, Properties, Behavior, and Detection of Mine Gases	6	1
Gases Common to Mines	6	1

<i>MINE GASES—Continued</i>	<i>Section</i>	<i>Page</i>
Marsh Gas, Methane or Carbureted Hydrogen	6	2
Carbon Monoxide, Whitedamp, or Carbonic Oxide	6	2
Carbon Dioxide, Blackdamp, or Carbonic-Acid Gas	6	3
Hydrogen Sulphide, Stinkdamp, or Sulphureted Hydrogen	6	4
Olefiant Gas, Ethene, or Ethylene	6	4
Nitrous Oxide	6	5
Nitrogen	6	5
Oxygen	6	6
Hydrogen	6	6
Mixtures of Mines Gases	6	7
Firedamp	6	7
Afterdamp	6	11
Ignition of Gases	6	12
Effect of Coal Dust	6	22
Mine Explosions	6	22
Gas Explosion	6	22
Dust Explosion	6	23
Combined Gas and Dust Explosion	6	25
Phenomena of Explosions	6	26
Entering a Mine After an Explosion	6	30
Rescue Work	6	30
Rescue Appliances and Mine Supplies	6	31
Prevention of Explosions	6	33
Testing for Gases in Mines	6	35
Safety Lamps	6	35
Special Lamps	6	47
Safety-Lamp Details	6	52
Oils for Safety Lamps	6	57
Relative Illuminating Power of Oils	6	60
Relative Illuminating Power of Safety Lamps	6	61
Testing for Gas	6	62
Gas Indicators	6	67

CONTENTS

v

MINE GASES— <i>Continued</i>	<i>Section</i>	<i>Page</i>
Safety-Lamp Houses	6	73
Portable Electric Lamps	6	77
MINE VENTILATION		
General Principles of Mine Ventilation	13	1
Production and Control of Air-Currents	13	1
Form and Size of Airways	13	9
How Air-Currents Are Produced	13	13
General Principles of Ventilation	13	16
Mine Resistance	13	17
Air Measurements	13	25
To Measure the Velocity of Air in an Air- way	13	25
To Measure the Ventilating Pressure	13	31
Calculations in Ventilation	13	34
Practical Problems	13	39
Single Airways or Circulations	13	46
Special Calculations	13	49
Comparing Different Circulations	13	52
Power	13	54
Relation Between the Length of an Air- way and the Power	13	54
Relation Between Velocity or Quantity of Air to Power	13	55
Relation Between Area and Power	13	55
General Power Ratio	13	56
Choice of Airways	13	65
Comparing Similar Airways	13	67
Splitting Air-Currents	14	1
Air Splits	14	8
Calculations in Splitting	14	10
Natural Splitting	14	10
Proportionate Splitting	14	20
The Ventilation of a Mine	14	24
Ventilations of Different Types of Mines	14	26
Means for Ventilating Mines	14	37
Natural Ventilation	14	37

MINE VENTILATION— <i>Continued</i>	<i>Section</i>	<i>Page</i>
Furnace Ventilation	14	50
Mechanical Ventilation	15	1
Waterfall, or Trompe	15	1
Wind Cowl	15	3
Steam Jet	15	3
Ventilating Fans	15	3
Disk Fans	15	4
Centrifugal Fans	15	5
Details of Fan Construction	15	7
Types of Centrifugal Fans	15	21
Fan Designs	15	28
Fan Calculations	15	42
FUELS		
Properties of Fuels	16	1
Combustible Elements	16	1
Impurities in Fuels	16	3
Methods of Expressing the Composition of a Fuel	16	4
Solid Fuels	16	8
Wood	16	8
Charcoal	16	11
Peat or Turf	16	12
Coal	16	13
Classification of Coal	16	14
Composition of Coal	16	18
Valuation of Coal as a Fuel	16	23
Spontaneous Ignition of Coal	16	32
Coal Dust as a Fuel	16	36
Pressed Fuel, or Briquets	16	38
Coke	16	40
Liquid Fuels	16	41
Petroleum	16	41
Method of Burning Petroleum	16	46
Gaseous Fuels	16	52
Producer Gas	16	56
Coal Gas	16	60

CONTENTS

vii

<i>FUELS—Continued</i>	<i>Section</i>	<i>Page</i>
Water Gas	16	63
Uses of Gaseous Fuel	16	67
Combustion of Fuel	16	69
Heat of Combustion	16	85
Calorific Value of Fuels	16	90
Analysis of Coal and Coke	16	91
Proximate Analysis	16	91
Ultimate Analysis	16	96
Report of Analysis	16	97
Coal Hoisting, Coal Conveying, and Stor- ing	16	97
Self-Filling Buckets	16	98
Cranes	16	100
Conveyers	16	104
Flight Conveyers	16	104
Belt Conveyers	16	106
Bucket Carriers	16	109
Chutes	16	115
Combinations of Hoisting and Conveying Systems	16	117
Car-Dumping Machines	16	118
Brown Car-Dumping Machine	16	118
McMyler Car-Dumping Machine	16	120
Coal Storage	16	121

PROPERTIES OF GASES

PHYSICS OF GASES

DEFINITIONS

1. Matter is the substance of which all things consist. It may be defined as anything that possesses weight or that occupies space. There are three divisions of matter: **masses**, which are bodies of matter appreciable to the senses; **molecules**, which are the smallest particles of matter that a body can be divided into without losing its identity; **atoms**, which are elementary, or chemically indivisible, portions of matter. Atoms unite to form molecules and molecules unite to form masses. Matter may exist as a solid, a liquid, or a gas.

2. Natural Forces.—The force that binds atoms together to form a molecule is a chemical force called **affinity**. The force of attraction that binds molecules together to form mass is a molecular force called **cohesion**. Besides these forces of attraction, the molecules of all matter are acted on by an opposing force, called **repulsion**, which tends to drive them apart. The force of repulsion, unlike that of attraction, is not inherent in the mass, but is an induced or applied force that is largely the result of heat or the temperature of the body.

3. Mass and Volume.—The mass of a body is the matter that it contains, and is proportional to the weight of the body; thus, a body weighing 2 pounds contains twice as much matter as a body weighing 1 pound. A pound of cork

Copyrighted by International Textbook Company. Entered at Stationers' Hall, London

contains exactly the same amount of matter as a pound of lead. The volume of a body is the space that it occupies.

4. Density.—Density is compactness of mass and has reference to the amount of matter in a given volume. Thus, there is more matter in a cubic foot of iron than in a cubic foot of water; therefore, we say that iron is more dense than water.

5. Weight.—Weight is the result of the attraction that exists between the mass of the earth and the mass of any other body. It is because the attractive force of the earth is exerted equally on each unit of mass that the weight of a body is always proportional to its mass, at any one place.

SPECIFIC GRAVITY

6. The **specific gravity** of a body is the ratio between its weight and the weight of an equal volume of another substance taken as a standard. The usual standard for solids and liquids is water, and its weight is commonly taken as 62.5 pounds per cubic foot, although 62.425 should be used when extreme accuracy is desired.

Iron has a specific gravity of 7.21; this means that a given volume of iron is 7.21 times as heavy as an equal volume of water; or, in other words, iron contains 7.21 times as great a mass.

Since gases are so much lighter than water, it is usual to take the specific gravity of a gas as the ratio between the weight of a certain volume of the gas and the weight of the same volume of air at the same temperature and pressure.

7. The specific gravity of any substance is found by the following rules:

Rule I.—*For solids or liquids, divide the weight of any given volume of the solid or liquid by the weight of an equal volume of water; the quotient will be the specific gravity required.*

Rule II.—*For gases, divide the weight of any given volume of the gas by the weight of an equal volume of air at the same*

pressure and temperature; the quotient will be the specific gravity required.

Or, expressed as a formula,

$$\text{Sp. Gr.} = \frac{w}{W}$$

in which w = weight of any given volume of substance;
 W = weight of an equal volume of standard.

EXAMPLE.—If the weight of a cubic foot of mercury is taken as 850 pounds at 32° F., what is its specific gravity at this temperature, taking the weight of a cubic foot of water at 62.5 pounds?

SOLUTION.—Substituting the given values in the formula,

$$\text{Sp. Gr.} = \frac{850}{62.5} = 13.6. \quad \text{Ans.}$$

8. The practical application of specific gravity in mining is to determine thereby the weight of a given body or substance when its volume is known. For this purpose, the rules given in Art. 7 are reversed, making them read as follows:

Rule I.—*For liquids or solids, multiply the weight of any given volume of water by the specific gravity of the solid or liquid; the product will be the weight of an equal volume of such solid or liquid.*

Rule II.—*For gases, multiply the weight of a cubic foot of air at the given temperature and pressure by the specific gravity of the gas; the product will be the weight of an equal volume of the gas at the same temperature and pressure.*

Or, expressed as a formula,

$$w = W \times \text{Sp. Gr.}$$

in which the quantities have the meanings given in Art. 7.

EXAMPLE 1.—Find the weight of a cubic foot of anthracite having a specific gravity of 1.5.

SOLUTION.—Substituting the given values in the formula,

$$w = 62.5 \times 1.5 = 93.75 \text{ lb.} \quad \text{Ans}$$

EXAMPLE 2.—Find the weight of 1 cubic foot of carbon dioxide (carbonic-acid gas) having a specific gravity of 1.5291 at 60° F. and

TABLE I

Substance	Average Specific Gravity	Average Weight of 1 Cubic Foot Pounds	Substance	Average Specific Gravity	Average Weight of 1 Cubic Foot Pounds
Water	1.00	62.50	Lead	11.38	711.25
Ice92	57.50	Iron pyrites	4.80	300.00
Anthracite	1.50	93.75	Powder, separate grains {	1.50	93.75
Bituminous coal	1.35	84.38		to	
Dry clay	1.90	118.75		1.85	115.63
Dry earth	1.40	87.50	Powder, in bulk	1.00	62.50
Dry sand, loose	1.60	100.00	Live oak, dry95	59.26
Limestone	2.70	168.75	White oak, dry77	48.13
Sandstone	2.41	150.63	White pine40	25.00
Slate	2.80	175.00	Yellow pine, northern55	34.38
Shale	2.60	162.50	Yellow pine, southern72	45.00
Cast iron	7.20	450.00	Mercury (32° F.)	13.62	851.25
Wrought iron	7.75	484.38	Oil, whale, olive92	57.50
Steel	7.85	490.63	Petroleum878	54.88

29.925 inches barometric pressure (sea level), assuming the weight of a cubic foot of air, at this temperature and pressure, as .07638 pound.

SOLUTION.—Substituting the given values in the formula,
 $w = .07638 \times 1.5291 = .11679$ lb. Ans.

9. Table I gives the specific gravities and weights per cubic foot of some of the solids and liquids important in mining. In calculating the weight per cubic foot, the weight of 1 cubic foot of water is taken as 62.5 pounds. Table II gives the specific gravities of the common mine gases, air of the same temperature and pressure being taken as the standard.

TABLE II

Gas	Specific Gravity
Air	1.000
Hydrogen <i>H</i>0693
Oxygen <i>O</i>	1.1057
Nitrogen <i>N</i>9714
Carbureted hydrogen } <i>CH₄</i>5590
Methane (marsh gas) }	
Ethylene (olefiant gas) <i>C₂H₄</i>9700
Carbon monoxide (carbonic oxide) <i>CO</i>9670
Carbon dioxide (carbonic acid) <i>CO₂</i>	1.5291
Hydrogen sulphide <i>H₂S</i>	1.1912

EXAMPLES FOR PRACTICE

1. What is the weight of a cubic foot of anthracite, having a specific gravity of 1.55? Ans. 96.875 lb.
2. Find the weight of 100 cubic yards of earth, having a specific gravity of 1.4. Ans. 118.125 T.
3. What is the weight of 200 cubic feet of carbon dioxide, at 60° F., and barometer at 30 inches, the specific gravity of the gas being 1.5291? Weight of 1 cubic foot of air at this temperature and pressure is .0766 pound. Ans. 23.4258 lb.
4. Find the weight of 500 cubic feet of marsh gas at a temperature of 60° F., and a pressure due to 30 inches of barometer, the gas having a specific gravity of .559. Ans. 21.41 lb. (nearly)

DETERMINING SPECIFIC GRAVITY

10. The specific gravity of solids and liquids may be determined by balances, by hydrometers, and by specific-gravity bottles.

11. **Determination of the Specific Gravity of Solids by a Balance.**—The principle on which the determination of the specific gravity of solids depends is that a body entirely submerged in any liquid is buoyed up by a force exactly equal to the weight of the volume of the liquid displaced, and the volume of the liquid displaced is equal to the volume of the submerged body.

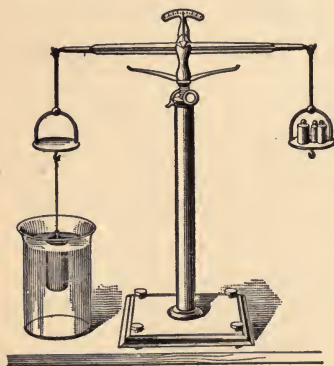

FIG. 1

This principle is applied as follows: Weigh the body first in the air, then in water, suspending it by a string attached to a scale pan, as shown in Fig. 1. The difference between the two weights will be the weight of an equal volume of water.

The ratio of the weight

in air to the difference thus found will be the specific gravity.

Let W = weight of substance in air;
 w = weight of substance in water;
 $W - w$ = weight of displaced water.

Then,
$$\text{Sp. Gr.} = \frac{W}{W - w}$$

12. If the body is lighter than water, attach to it a piece of iron or other substance sufficiently heavy to sink both. Then weigh both bodies in air and both in water. Weigh each separately in air and weigh the iron in water. Subtract the weight of the two bodies in water from their weight in air, and the

result will be the weight of a volume of water equal to the volume of the two bodies. Find the difference of the weights of the iron in air and in water; this will be the weight of a volume of water equal to the volume of the iron. Subtract this result from the weight of the volume of water equal to the volume of the two bodies, and the result will be the weight of a volume of water equal to the volume of the light body. The weight of the light body in air divided by the weight of its equal volume of water is the specific gravity of the light body.

Let W = weight of both bodies in air;
 W' = weight of both bodies in water;
 w = weight of light body in air;
 W_1 = weight of heavy body in air;
 W_2 = weight of heavy body in water.

Then, the specific gravity of the light body is given by

$$\text{Sp. Gr.} = \frac{w}{(W - W') - (W_1 - W_2)}$$

13. Determination of Specific Gravity of Solids by a Specific-Gravity Bottle and Balance.—In this method,

a bottle, Fig. 2, having a tightly fitting stopper perforated by a small glass tube is used. The substance whose specific gravity is to be determined must be insoluble in water and in the condition of small grains or powder. It is first weighed; the bottle is then weighed filled with water; and finally, the weighed substance is introduced into the bottle, displacing an amount of water equal to its own volume or bulk, and the bottle again weighed. Each time before weighing, the bottle is carefully



FIG. 2

filled to the top of the small tube, all excess of water being removed with a small piece of blotting paper. In this case the following formula is used:

Let W = weight of substance;
 w_1 = weight of bottle filled with water;
 w_2 = weight of bottle, water, and substance.

Then,
$$\text{Sp. Gr.} = \frac{W}{W + w_1 - w_2}$$

14. The specific gravity of any substance soluble in water may be determined with the specific-gravity bottle, by using instead of the water any liquid in which the substance is insoluble. This will give its specific gravity referred to such liquid. Afterwards, the specific gravity of the liquid, referred to water, is determined, as already explained, and the specific gravity of the substance as first obtained is multiplied by the specific gravity of the liquid employed. The result will be the specific gravity of the substance.



FIG. 3

15. Determining Specific Gravity of Liquids by Balance.—There are two methods of determining the specific gravity of liquids by means of the balance. The simpler and better method is to weigh out equal volumes of the liquid and water, and the most accurate way to do this is to weigh them in succession in the same vessel, taking care to have it equally full on both occasions. The vessel shown in Fig. 3 is convenient when small quantities are to be weighed. It is easily made by blowing a bulb on a glass tube. On that portion of the tube that is narrowed by being drawn out over a flame, a scratch is made with a file. The bulb, after being filled up to the scratch with the liquid, is weighed, emptied, cleaned, dried, filled with water, and weighed again. Care should be taken that both liquids have the same temperature. This is easily accomplished by immersing the bulb filled with liquid for some time in water, part of which is later used in the second weighing. In this case,

Let w = weight of bulb empty;
 W_1 = weight of bulb filled with water;
 W_2 = weight of bulb filled with liquid.

Then,
$$\text{Sp. Gr.} = \frac{W_2 - w}{W_1 - w}$$

16. The other method consists of three operations, as follows: A small solid substance, as a coin or other piece of metal, is weighed successively in air, in water, and in the liquid whose specific gravity is to be determined. In this case,

Let W = weight of substance in air;
 w_1 = weight of substance in water;
 w_2 = weight of substance in the liquid.

It will be readily observed that $W - w_2$ equals the weight of a certain volume of the liquid whose specific gravity is

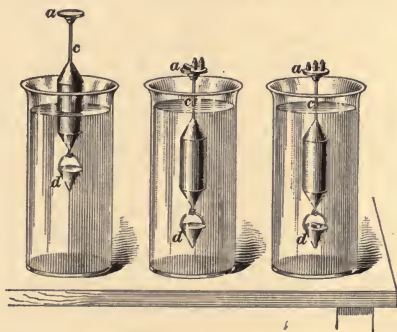

FIG. 4

to be determined, and $W - w_1$ equals the weight of an equal volume of water.

Then,
$$\text{Sp. Gr.} = \frac{W - w_2}{W - w_1}$$

17. Determining Specific Gravity by the Hydrometer.—There are two types of the hydrometer employed—Nicholson's constant immersion hydrometer and Baumé's variable immersion hydrometer. Different forms of each type are in use.

18. Nicholson's hydrometer, Fig. 4, for determining the specific gravity of insoluble solids consists of a hollow

cylinder carrying at its lower end a basket d heavy enough to keep the apparatus upright when placed in water. At the top of the cylinder is a vertical rod to which is attached a shallow pan a for holding the weights, etc. The cylinder is of such a size and buoyancy that a certain weight W must be placed on the pan to sink it to a given point c on the rod. The body whose specific gravity it is desired to find, is placed in the pan a and enough weight w is added to sink the point c to the water level. It is evident that the weight of the given body is $W - w$. The body is now removed from the pan a to the basket d , and an additional weight is added to the pan to sink the point c to the water level. Represent the weight now in the pan by W' . The difference $W' - w$ is the weight of a volume of water equal to the volume of the body.

$$\text{Hence,} \quad \text{Sp. Gr.} = \frac{W - w}{W' - w}$$

EXAMPLE.—The weight necessary to sink the hydrometer to the point c is 16 ounces; the weight necessary when the body is in the pan a is 7.3 ounces, and when the body is in the basket d , 10 ounces; what is the specific gravity of the body?

SOLUTION.—Substituting in the formula,

$$\text{Sp. Gr.} = \frac{W - w}{W' - w} = \frac{16 - 7.3}{10 - 7.3} = \frac{8.7}{2.7} = 3.222. \quad \text{Ans.}$$

19. To obtain the specific gravity of any liquid with this hydrometer, it is floated in the liquid whose specific gravity is to be obtained, and a sufficient number of weights are placed in the scale pan to sink it to the standard mark, giving the following results:

$$\text{Sp. Gr.} = \frac{W + w_2}{W + w_1}$$

in which W = weight of hydrometer;

w_1 = weights required to sink hydrometer in water;

w_2 = weights required to sink hydrometer in the liquid.

It will be readily observed that $W + w_1$ and $W + w_2$ are the buoyant pressures, or the exact weights, of like volumes of the water and the liquid, respectively, displaced by the hydrometer. The liquid may be heavier or lighter than

water. If but a small amount of the liquid whose specific gravity is to be determined is at hand, its specific gravity may be found by placing 1 cubic centimeter (.061 cubic inch) of the liquid in a small vial that has been balanced in the scale pan of the hydrometer to determine its weight. The weights required to sink the hydrometer with the vial and liquid, when subtracted from the weight required to sink it with the vial alone, will give the weight of 1 cubic centimeter of the liquid; and the specific gravity of the liquid is then obtained by dividing this weight by the weight of 1 cubic centimeter of water (1 gram = 15.432 grains). In these determinations, the hydrometer takes the place of the balance.

20. Beaumé's hydrometer, Fig. 5, consists of a glass tube, near the bottom of which are two bulbs. The lower and smaller bulb is loaded with mercury or shot, so as to cause the instrument to remain in a vertical position when placed in the liquid. The upper bulb is filled with air, and its volume is such that the whole instrument is lighter than an equal volume of water. The point to which the hydrometer sinks when placed in water is usually marked, the tube being graduated above and below in such a manner that the specific gravity of the liquid can be read directly. It is customary to have two instruments: one with the zero point near the top of the stem, for use in liquids heavier than water; and the other with the zero point near the bulb, for use in liquids lighter than water.



FIG. 5

21. Determining the Specific Gravity of Gases. The determining of the specific gravity of gases requires such delicate apparatus and skill that it cannot be done except by an experienced person in a well-equipped laboratory. The method of calculating the specific gravity of a gas from its chemical composition is explained in Art. 93.

HEAT

22. Heat is a form of energy, and is conceived to be a motion, or vibration, of the molecules composing matter. It is this movement of the molecules that is generally believed to cause the sensation of warmth. Another effect of this motion is to cause the molecules to separate farther apart and cause a body to expand in volume. The hotter the body becomes, the more rapid become the vibrations of its constituent molecules and the greater the expansion.

23. Forms of Matter.—There are three forms of matter—*solid*, *liquid*, and *gaseous*. The form of matter is determined by the freedom of its molecules; in **solids**, the molecules are more or less rigid and fixed; in **liquids**, the molecules move freely among one another; in **gases**, the freedom of the motion of the molecules is greatly increased and cohesion is entirely overcome. The form of matter is closely associated with the amount of heat that the substance contains. Many kinds of matter assume different forms under different conditions of heat and pressure; for example, water exists as a solid (ice), a liquid (water), or a gas (steam). The air that we breathe as a gas has been changed to a liquid and even to a solid under certain conditions of temperature and pressure. The natural form of any kind of matter is that form in which it exists under natural conditions. Most kinds of matter have but one natural form, and require the application of heat, or of pressure and cold, to cause them to exist in any other form. Mercury exists naturally as a liquid, but at a lower temperature (-39°F.) is frozen, or converted into a solid, and at a higher temperature (675°F.) is vaporized, or converted into a gas. In all these cases the identity of the matter remains unchanged—the mercury is mercury whether existing as a solid, a liquid, or a gas. In other words, the change of form is not caused by a chemical change in the molecules of the matter; they do not form another substance.

24. Sources of Heat.—Heat is produced in various ways: by friction, by percussion, by chemical action. In all these cases, heat is the result of the vibration of the molecules of matter. Other sources of heat are the sun's rays, the heat of the earth, animal heat; heat is always produced where combustion takes place, and is sometimes accompanied with light and flame.

25. Transmission of Heat.—Heat is transmitted, according to conditions, by radiation, by conduction, and by convection. Radiated heat is that portion of the heat of a body which passes into the surrounding air or other medium; the body is then said to lose heat by *radiation*. The heat of a stove is radiated to an object near it.

Conduction refers to the travel of heat from one portion of a solid body to another; or the heat may pass from one body to another with which it is in contact. When one end of an iron rod is heated, the heat travels to the other end by conduction.

Convection takes place only in fluids (liquids or gases), and refers to the carrying of heat from one place to another by the circulation of the fluid. Convection is best illustrated by the circulation in a steam boiler, where the water, heated by contact with the crown sheets over the fire, rises and circulates, carrying its heat to cooler portions of the boiler.

MEASUREMENT OF TEMPERATURE

26. Temperature is a term used to express the intensity of heat, or the rapidity of vibration of the molecules. A hot body is said to have a *high temperature*; and a cold body, a *low temperature*. The most common measure for temperature is the sensation of warmth that it produces. According to the character of this sensation, a body is cold, warm, or hot. For scientific purposes, however, the sense of feeling is not a sufficiently accurate method for measuring temperatures; accordingly, temperature is measured by certain of the effects produced by heat. For all ordinary temperatures, the most convenient effect to note is, that most bodies expand

with a rise of temperature. For general purposes of temperature measurement, mercury and alcohol are the most convenient substances to use—the former because it boils only at a very high temperature, and the latter because it does not solidify at the lowest temperature produced by ordinary

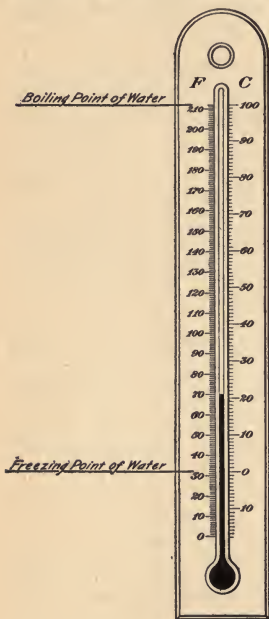

FIG. 6

means. The tube is attached to a base on which is marked the scale.

28. **Thermometer Scales.**—Fig. 6 shows a mercurial thermometer with two sets of graduations. The one on the left, marked *F*, is the Fahrenheit scale commonly used in the United States and in England; the one on the right, marked *C*, is the Celsius, or centigrade, scale, and is used throughout

For ordinary mine use, the mercurial thermometer serves every purpose and is the one commonly used.

27. **The Thermometer.**—The thermometer, Fig. 6, consists of a capillary glass tube with a bulb at one end. The bulb and a portion of the tube are filled with the liquid to be used. The liquid is then boiled to expel the air, and the tube is sealed at the top, so that the upper part of it is a vacuum except for a small quantity of vapor due to the evaporation of the

the world for scientific work, on account of the graduations being better adapted for calculation. Another scale, the Réaumur, is largely used in Germany and Russia. In graduating thermometers, two fixed points, the melting point of ice (or the freezing point of water) and the boiling point of water at sea level, are determined. In the Fahrenheit scale, the melting point of ice is marked 32° and the boiling point of water 212° ; in the centigrade scale, the melting point of ice is marked 0° , or zero, and the boiling point of water 100° ; in the Réaumur scale, the melting point of ice is marked 0° and the boiling point of water 80° . The graduation of each of these scales is continued above the boiling point and below the freezing point. On the Fahrenheit scale, 0° is 32° below the freezing point. Below the zero point on each scale, the readings are negative and are preceded by a minus (—) sign; thus, -10° means 10° below 0° . All readings above 0° are positive, but the plus sign (+) is omitted.

It will be seen that 180° on the Fahrenheit scale covers the same range in temperature as 100° on the centigrade scale and as 80° on the Réaumur scale. In expressing a temperature, the letters F., C., or R. placed after the figures indicate whether the temperature is expressed in the Fahrenheit, centigrade, or Réaumur scale, respectively.

29. It is often necessary to express a temperature given in one scale in terms of another.

To change centigrade temperatures into their corresponding Fahrenheit values:

Rule I.—*Multiply the temperature, centigrade, by $\frac{9}{5}$ and add 32° ; the result will be the temperature, Fahrenheit.*

To change Fahrenheit temperatures into their corresponding centigrade values:

Rule II.—*Subtract 32° from the temperature, Fahrenheit, multiply by $\frac{5}{9}$, and the result will be the temperature, centigrade.*

To change Réaumur temperatures to their corresponding Fahrenheit values:

Rule III.—Multiply the temperature, Réaumur, by $\frac{9}{4}$ and add 32° ; the result will be the temperature, Fahrenheit.

To change Fahrenheit temperatures to their corresponding Réaumur values:

Rule IV.—Subtract 32° from the temperature, Fahrenheit, multiply by $\frac{4}{9}$, and the result will be the temperature, Réaumur.

To change Réaumur temperatures into their corresponding centigrade values:

Rule V.—Multiply the temperature, Réaumur, by $\frac{5}{4}$, and the result will be the temperature, centigrade.

To change centigrade temperatures into their corresponding Réaumur values:

Rule VI.—Multiply the temperature, centigrade, by $\frac{4}{5}$, and the result will be the temperature, Réaumur.

Expressing these rules by means of formulas,

Let t_c = temperature centigrade;

t_f = temperature Fahrenheit;

t_r = temperature Réaumur.

Then, $t_f = \frac{9}{5} t_c + 32^\circ$ (1)

$t_c = \frac{5}{9} (t_f - 32^\circ)$ (2)

$t_f = \frac{9}{4} t_r + 32^\circ$ (3)

$t_r = \frac{4}{9} (t_f - 32^\circ)$ (4)

$t_c = \frac{5}{4} t_r$ (5)

$t_r = \frac{4}{5} t_c$ (6)

30. In using the above formulas, the sign must always be considered as indicating whether the temperature is above or below 0° .

EXAMPLE 1.—Convert 50° C. into the corresponding Fahrenheit reading.

SOLUTION.—Using formula 1, Art. 29,

$$t_f = \frac{9}{5} \times 50 + 32 = 122^\circ \text{ F. Ans.}$$

EXAMPLE 2.—Convert -10° C. into the corresponding Fahrenheit reading.

SOLUTION.—Using formula 1, Art. 29,

$$t_f = (\frac{9}{5} \times -10) + 32 = -18 + 32 = 14^\circ \text{ F. Ans.}$$

EXAMPLE 3.—Convert -30° C. into the corresponding Fahrenheit reading.

SOLUTION.—Using formula 1, Art. 29,

$$t_f = \left(\frac{9}{5} \times -30\right) + 32 = -54 + 32 = -22^{\circ} \text{ F. Ans.}$$

EXAMPLE 4.—Convert -4° F. into the corresponding centigrade reading.

SOLUTION.—Using formula 2, Art. 29,

$$t_c = \frac{5}{9} (-4 - 32) = \frac{5}{9} \times -36 = -20^{\circ} \text{ C. Ans.}$$

31. It will be noticed that in these formulas 32 is added and subtracted algebraically; that is, when the signs are like, the quantities are added together, their sum having the same sign; but, when the signs are unlike, the lesser quantity is subtracted from the greater; and the remainder takes the sign of the greater. Thus, in example 2, where $+32$ is added to -18 , subtract 18 from 32, and the remainder, 14, takes the plus sign. In example 3, subtract 32 from 54, and the remainder, 22, takes the minus sign.

EXAMPLES FOR PRACTICE

1. What temperature Fahrenheit corresponds to 100° C.?
Ans. 212° F.
2. Convert 290° C. into the corresponding Fahrenheit reading.
Ans. 554° F.
3. What reading on the centigrade scale corresponds to 5° F.?
Ans. -15° C.
4. Convert -40° F. into the corresponding centigrade reading.
Ans. -40° C.

32. Absolute Temperature.—From experiments and mathematical calculations, it has been concluded that at 460° below zero on the Fahrenheit scale, or 273° below zero on the centigrade scale, all molecular vibrations cease. This point is called *absolute zero*. *Absolute temperature* is the temperature measured from the absolute zero.

33. For converting ordinary temperatures to absolute temperatures use the following rules:

For the Fahrenheit scale:

Rule I.—Add 460° to the Fahrenheit thermometer reading, and the result will be the absolute temperature, Fahrenheit.

For the centigrade scale:

Rule II.—*Add 273° to the centigrade thermometer reading, and the result will be the absolute temperature, centigrade.*

Expressed by formulas, these rules for finding the absolute temperature are as follows:

For the Fahrenheit scale:

$$T_f = 460 + t_f \quad (1)$$

in which T_f = absolute temperature (F.);
 t_f = ordinary temperature (F.).

For the centigrade scale:

$$T_c = 273^\circ + t_c \quad (2)$$

in which T_c = absolute temperature (C.);
 t_c = ordinary temperature (C.).

NOTE.—Unless otherwise stated, T signifies absolute temperature and t ordinary temperature.

QUANTITY OF HEAT

34. The quantity of heat in a body is quite different from its temperature. A pail of water and a barrel of water may be of the same temperature, yet it is plain that the barrel of water contains the greater quantity of heat. The quantity of heat in a body is expressed in heat units.

35. Heat Units.—The **British thermal unit** (abbreviated to B. T. U.) is the heat unit most commonly used in the United States and England, and is the quantity of heat that will raise the temperature of 1 pound of water at its maximum density (39.1° F.) through 1° F.

The **French calorie** is a heat unit based on the metric system, and is the amount of heat necessary to raise 1 kilogram of water 1° C. at 4° C. It is equal to 3.968 B. T. U.

The **pound calorie**, which is also largely used, is the amount of heat required to raise the temperature of 1 pound of water 1° C.; it is equal to 1.8 B. T. U.

36. Mechanical Equivalent of Heat.—Since one form of energy can be converted into another, heat can be converted into mechanical energy, and, conversely, mechanical

energy can be converted into heat. There is a definite relation between heat energy and mechanical energy. It has been found, by experiment, that 778 foot-pounds of work is required to produce 1 B. T. U., and, conversely, the expenditure of 1 B. T. U. produces 778 foot-pounds of work. The knowledge of this fact enables us to calculate the theoretical work that may be performed by the energy stored in 1 pound of coal. For example, if the heating value of 1 pound of bituminous coal is 14,400 B. T. U., and if, as experiment has shown, 1 B. T. U. will develop 778 foot-pounds of work, the work stored in 1 pound of bituminous coal is $778 \times 14,400 = 11,203,200$ foot-pounds. This means that the energy stored in 1 pound of coal, if totally utilized, would raise a weight of over 5,000 tons through a vertical height of 1 foot. Only a very small percentage of this total stored energy of the coal, however, is realized in a steam engine, for with good coal and a good boiler only from 4 to 5 per cent. of the stored energy can be converted into useful work.

37. Sensible Heat.—If a certain amount of heat is absorbed by a substance, a portion of this heat is utilized in changing the temperature of the substance; this portion is known as **sensible heat**. The temperature of a substance considered alone does not measure the quantity of heat absorbed, since all matter has not the same capacity for heat. Different substances acted on by the same amount of heat for an equal length of time do not attain the same temperature. The quantity of heat absorbed by any substance, for a given rise of temperature, when there is no change in the state of the substance, is in proportion to the weight of matter heated and its capacity to absorb heat, that is, its *specific heat*.

38. Specific Heat.—The specific heat of a substance is the ratio between the quantity of heat required to raise the temperature of equal weights of that substance and water at maximum density through an equal number of degrees. The specific heat of any substance, referred to water as unity, expresses, therefore, the number of B. T. U. required to raise

the temperature of 1 pound of that substance through 1° F. The specific heat of a solid is referred to water as a standard; the specific heat of a gas may be referred to either water or air.

39. Suppose that two iron balls of the same weight are heated to a temperature of 212° F. Being of the same weight, they possess the same quantity of heat. Plunge one of the balls into a vessel containing 10 pounds of water and the other into a vessel containing 10 pounds of mercury, both mercury and water being at a temperature of 62° F. The size of the balls is such that the temperature of the water is raised from 62° to 64° F. by the heat contained within the ball. It will be found that the mercury will be raised from 62° to 122° F. That is, the same amount of heat that raises 10 pounds of water 2° raises 10 pounds of mercury 60° , or through a range of temperature thirty times as great. It is plain, therefore, that to raise a pound of mercury from 62° to 63° F. requires one-thirtieth the heat necessary to raise a pound of water from 62° to 63° F. Hence, we say the specific heat of the mercury is one-thirtieth, or .0333.

EXAMPLE 1.—It is found that to raise the temperature of 20 pounds of iron from 62° to 63° requires 2.276 B. T. U.; what is the specific heat of iron?

SOLUTION.—To raise 20 lb. of water from 62° to 63° requires 20 B. T. U. The specific heat of the iron is, according to the definition, the ratio between the quantities of heat required to warm the iron and the water, respectively, through 1° ; that is, it is the ratio $2.276 : 20 = 2.276 \div 20 = .1138$. Ans.

EXAMPLE 2.—The specific heat of silver is .057; how many B. T. U. are required to raise 22 pounds of silver from 50° to 60° ?

SOLUTION.—To raise the temperature of a pound of water 1° requires 1 B. T. U. Since the specific heat of silver is .057, only .057 B. T. U. is required to raise 1 lb. of silver 1° . Hence, to raise 22 lb. of silver 10° must require $.057 \times 22 \times 10 = 12.54$ B. T. U. Ans.

40. Rule.—*To find the number of B. T. U. required to raise the temperature of a body a given number of degrees, multiply the specific heat of the body by its weight, in pounds, and by the number of degrees.*

Let U = number of B. T. U. required;
 c = specific heat;
 W = weight;
 t = temperature before heat is applied;
 t_1 = temperature after heat is applied.

Then, $U = c W (t_1 - t)$

The specific heats of some of the more common substances are given in Table III, which follows.

TABLE III

Substance	Specific Heat	Substance	Specific Heat
Water	1.0000	Tin0562
Sulphur2026	Mercury0333
Iron1138	Lead0314
Copper0951	Ice5040
Silver0570		

41. The specific heats of the more common mine gases are given in Table IV (see page 22).

These specific heats are all referred to water as unity. Taking as unity the quantity of heat necessary to raise the temperature of 1 pound of water 1° F. at its maximum density, columns 1 and 2 of Table IV show the quantity of heat (B. T. U.) that will produce the same rise of temperature in an equal weight of each of the several mine gases for ordinary temperatures. Column 3 shows, likewise, the quantity of heat (B. T. U.) necessary to produce the same rise of temperature in a volume of each gas, equal to the volume of a pound of air at the same constant pressure. The specific heats given in column 1 of Table IV, for equal weights and constant pressure, are those determined by actual experiment by the most reliable authorities; they are mostly based on the experiments of Regnault. The specific heats given in column 2 of the table, for equal weights and constant volume, have been derived by calculation from the specific heats in column 1 for constant pressure, by dividing

TABLE IV
SPECIFIC HEATS OF MINE GASES AND VAPORS (WATER = 1)

Gas or Vapor	Symbol	Specific Heats of Equal Weights of Gas and Air		Specific Heats of Equal Volumes of Gas and Air
		Constant Pressure (1)	Constant Volume (2)	
Air2374	.1689	.2374
Oxygen	<i>O</i>	.2175	.1548	.2405
Nitrogen	<i>N</i>	.2438	.1735	.2368
Hydrogen	<i>H</i>	3.4090	2.4260	.2361
Methane (marsh gas, carbureted hydrogen)	<i>CH₄</i>	.5929	.4219	.3314
Carbon monoxide (carbonic oxide)	<i>CO</i>	.2479	.1743	.2369
Carbon dioxide (carbonic-acid gas)	<i>CO₂</i>	.2170	.1539	.3307
Hydrogen sulphide	<i>H₂S</i>	.2432	.1731	.2897
Ethylene (olefiant gas)	<i>C₂H₄</i>	.4040	.2875	.3951
Aqueous vapor	<i>H₂O</i>	.4805	.3419	.2996
Nitrous oxide	<i>N₂O</i>	.2262	.1610	.3450

67

the latter by 1.405, which is the most generally accepted ratio for the specific heat of a gas, for *constant pressure*, to the specific heat for *constant volume*.

The figures given in column 3 express the relative heats for equal volumes of gas and air at constant pressure, instead of equal weights. These are not, therefore, strictly speaking, specific heats, but are generally so termed. The values in this column have been derived by calculation by multiplying the specific heats in the first column by the specific gravity of the gas.

42. The specific heat of a gas varies as the gas is allowed to expand (constant pressure) or is confined in a given space, or volume (constant volume). When the gas is allowed to expand, its specific heat is always higher than when it is confined, owing to the decrease of pressure and density caused by the expansion of the gas. These two conditions are referred to as *specific heat under constant pressure* and *specific heat under constant volume*.

The specific heat of gases is not constant, but varies with the temperature of the gas, increasing as the temperature rises. It is stated by some reliable authorities that at a temperature of 1,200° F. the specific heat of carbon dioxide is practically double that given in Table IV. This gas is probably more sensitive in this respect than any of the other gases. The specific heat of steam or aqueous vapor increases very rapidly above 212° F. The specific heats of the simple gases and of air do not increase as rapidly at the higher temperatures.

43. **Latent heat** is the heat absorbed without change of temperature when a substance changes its form from a solid to a liquid, or from a liquid to a gaseous form. Examples of latent heat are the latent heat of fusion, when a solid becomes a liquid, as when ice melts to water, and latent heat of vaporization, when a liquid body becomes a gas, as in the generation of steam from water.

44. Careful experiments show that about 144 B. T. U. are required to change a pound of ice at 32° F. to water at 32° F.; hence, the latent heat of water is 144 B. T. U.

Experiment has also shown that 965.8 B. T. U. are required to convert a pound of water at 212° F. into steam at 212° F.; hence, the latent heat of steam is 965.8 B. T. U. The quantity of heat absorbed by a substance when changing from a solid to a liquid, or from a liquid to a gaseous form, is again given out when the gas is condensed to a liquid or the liquid becomes a solid.

45. Total Heat.—The total quantity of heat absorbed by any substance, solid, liquid, or gas, in changing its temperature or passing from one state to another, may be calculated by the following rule:

Rule.—Multiply the specific heat of each form of the substance by the respective number of degrees of change of temperature, and add to the product the total number of B. T. U. expressing the latent heat absorbed in each change of form that takes place. Multiply this sum by the weight of the substance. The last product will be the total quantity of heat absorbed by the substance.

EXAMPLE 1.—How much heat will be required to melt a cubic foot of ice, or to convert a cubic foot of ice at 32° F. into water at 32° F.?

SOLUTION.—The specific gravity of ice is .92 (Table I); the weight of a cubic foot of ice is, then, $62.5 \times .92 = 57.5$ lb. The latent heat of ice being 144 B. T. U., the total heat required to melt this weight of ice is $57.5 \times 144 = 8,280$ B. T. U.

EXAMPLE 2.—Supposing no heat to be lost during the operation, (a) how many gallons of boiling water at sea level will be required to melt a cubic foot of ice at 32° F., so that the resulting temperature of the water will be 32° F.? (b) how many gallons of water will result finally?

SOLUTION.—(a) The fall in the temperature of the water is $212^\circ - 32^\circ = 180^\circ$ F.; 1 lb. of water will therefore yield 180° B. T. U., and to produce 8,280 B. T. U. will require $\frac{8,280}{180} = 46$ lb. Since 231 cu. in. = 1 gal., and 1,728 cu. in. = 1 cu. ft., 1 cu. ft. contains $\frac{1,728}{231} = 7.48$ gal.; and since 1 cu. ft. of water weighs 62.5 lb., 1 gal. weighs $\frac{62.5}{7.48} = 8.355$ lb.; hence, 46 lb. of water will equal $\frac{46}{8.355} = 5.5+$ gal. Ans.

(b) The weight of the ice being 57.5 lb., the total weight of water produced will be $46 + 57.5 = 103.5$ lb., or $\frac{103.5}{62.5} \times 7.48 = 12.38+$ gal. Ans.

EXAMPLES FOR PRACTICE

1. How much heat is absorbed in converting 100 pounds of water at a temperature of 60° F. into steam at 212° F.?

Ans. 111,780 B. T. U.

2. Find the quantity of heat given out by a bar of iron weighing 150 pounds, in cooling from 300° F. to 60° F. Ans. 4,096.8 B. T. U.

3. How many B. T. U. will be given up by 50 pounds of steam at 212° F. in condensing to water and cooling to a temperature of 75° F.?

Ans. 55,140 B. T. U.

EXPANSION OF BODIES BY HEAT

46. The volume of any body—solid, liquid, or gaseous—is always changed if the temperature is changed; nearly all bodies expand when heated, and contract when cooled. In solids having definite figures, the expansion may be considered in three ways, according to the conditions: *linear expansion*, where the expansion is in one direction, as the elongation of an iron bar; *surface expansion*, where the area is increased; and *cubical expansion*, where the increase in the whole volume is considered.

47. **Coefficients of Expansion.**—The coefficient of linear expansion for a body is the amount of linear expansion that a unit length of the body undergoes when its temperature is raised 1°. The coefficient of surface expansion is the increase in area that a unit area undergoes on raising its temperature 1°. The coefficient of cubical expansion is the increase in volume that a unit volume of a body undergoes on raising its temperature 1°.

48. Table V gives the coefficients of expansion for a number of solids, mercury, and alcohol, and the average cubical expansion of gases. No liquids are given, except mercury and alcohol, for the reason that the coefficient of expansion for liquids is different at different temperatures.

TABLE V
TABLE OF COEFFICIENTS OF EXPANSION

Name of Substance	Linear Expansion C_1	Surface Expansion C_2	Cubical Expansion C_3
Cast iron00000617	.00001234	.00001850
Copper00000955	.00001910	.00002864
Brass00001037	.00002074	.00003112
Silver00000690	.00001390	.00002070
Bar iron00000686	.00001372	.00002058
Steel (untempered) .	.00000599	.00001198	.00001798
Steel (tempered) . .	.00000702	.00001404	.00002106
Zinc00001634	.00003268	.00004903
Tin00001410	.00002820	.00004229
Mercury00003334	.00006668	.00010010
Alcohol00019259	.00038518	.00057778
Gases00203252

49. The following formulas may be used to calculate the amount of expansion:

$$l = L C_1 t \quad (1)$$

$$a = A C_2 t \quad (2)$$

$$v = V C_3 t \quad (3)$$

in which L = length of any body;

l = amount of expansion or contraction due to heating or cooling the body;

A = area of any section of the body;

a = increase or decrease of area of same section after heating or cooling the body;

V = volume of body;

v = increase or decrease in volume due to heating or cooling the body;

C_1, C_2, C_3 = coefficients of expansion taken from Table V;

t = difference of temperature, in degrees F., of body before and after it has been heated or cooled.

EXAMPLE.—How much will a bar of untempered steel 14 feet long expand, if its temperature is raised 80°?

SOLUTION.—Since only one dimension is given, that of length, linear expansion only can be considered. From Table V, the coefficient of linear expansion per unit of length for a rise in temperature of 1° is found to be .00000599 for untempered steel. Hence, using formula 1, $l = L C, t$, and substituting, $14 \times .00000599 \times 80 = .0067088$ ft., or $.0067088 \times 12 = .0805056$ in. Ans.

50. Volume of Gases.—The volume of a given weight of gas depends on its temperature and the pressure to which it is subjected. The relation between the temperature, volume, and pressure of a gas is an important one, and is expressed by two laws, known as *Gay-Lussac's*, or *Charles's, law*, Art. 52, and *Mariotte's*, or *Boyle's, law*, Art. 63. The pressure that a gas exerts, or its expansive force, is usually expressed in pounds per square inch.

51. The effect of heat on all gases is to increase their volume. Experiment has shown that, when the pressure remains constant, the volume of a gas expands or contracts $\frac{1}{460}$ of its volume at 0° F. for each degree of change in temperature, and this rate of expansion or contraction has been found uniform through all practicable ranges of temperature. Since the rate of change is true whatever the volume of the gas, if we have a volume of 460 cubic feet at 0° F., the expansion or contraction for this volume will be 1 cubic foot for each degree rise or fall in temperature. If the temperature is lowered 460° to the absolute zero, it is evident that, as the temperature cannot be below the absolute zero, that point will also be the lowest limit at which contraction can take place. This has given rise to another definition for the absolute zero of the temperature scale, viz., the point from which the expansion of air and gases proceeds or is calculated.

52. Volume and Temperature of Gases.—The law expressing the relation existing between the temperature and volume of any given weight of gas at a constant pressure is known as *Gay-Lussac's*, or *Charles's, law*. This law may be stated as follows:

Gay-Lussac's Law.—*The pressure remaining the same, the volume of any given quantity of gas is proportional to its absolute temperature.*

Expressed as a proportion, this law is,

$$v_2 : v_1 = (460 + t_2) : (460 + t_1), \text{ or } \frac{v_2}{v_1} = \frac{460 + t_2}{460 + t_1};$$

hence,
$$v_2 = v_1 \left(\frac{460 + t_2}{460 + t_1} \right)$$

in which v_2 = volume of gas at temperature t_2 ;

v_1 = volume of the same gas at temperature t_1 .

EXAMPLE.—If 10,000 cubic feet of air at 32° F. is heated, while passing through a mine, to a temperature of 60° F., what is the increased or expanded volume of this air?

SOLUTION.—If v_2 is the required expanded volume, at the temperature 60°, then substituting the given values in the formula, $v_2 = 10,000 \left(\frac{460 + 60}{460 + 32} \right)$; or, $v_2 = 10,000 \times \frac{520}{492} = 10,569$ cu. ft. Ans.

ATMOSPHERIC PRESSURE

53. The atmosphere surrounding the earth, like all other matter, is acted on by gravity, causing what is called **atmospheric pressure**.

The pressure on each square inch of surface, due to the weight of the atmosphere, is 14.7 pounds at sea level, and decreases at higher elevations. Air being a fluid, transmits this pressure equally in all directions; in other words, atmospheric pressure is not only exerted downwards as weight, but with equal force sidewise and upwards.

54. The upward pressure of the atmosphere is well illustrated in Fig. 7. Here a glass tumbler is filled with water to the brim, and a piece of stiff paper placed over it, in contact with the surface of the water, so as to exclude all air. The paper is held in position while the tumbler is inverted; the upward pressure of the atmosphere on each square inch of the surface of the paper, as indicated by the arrows, supports the weight of the water in the tumbler.

55. Measurement of Atmospheric Pressure.—The principle utilized for measuring the pressure of the atmosphere is illustrated in Fig. 8. A glass tube about 3 feet long and closed at one end is filled with mercury. The tube is inverted and the open end placed in a cup of mercury with the end dipping beneath the surface. The mercury in the tube will fall and come to rest with the top of the column at



FIG. 7



FIG. 8

a height of about 30 inches above the surface of the mercury in the cup. This column of mercury is supported by the pressure of the atmosphere on the surface of the mercury in the cup. The upper end of the tube contains no air, so that there is no opposing force except the weight of the column of mercury. The two forces are in delicate equilibrium and

any variation in the atmospheric pressure causes a corresponding variation in the length of the mercury column to maintain the equilibrium.

If water had been used instead of mercury, since mercury has a specific gravity of 13.6, the height of the column of water to balance the pressure of the atmosphere would have been $30 \times 13.6 = 408$ inches = 34 feet. That is, if a tube were filled with water, inverted, and placed in a dish of water in a manner similar to the experiment made with the mercury, the resulting height of the column of water would be 34 feet.

56. The Mercurial Barometer.—The mercurial barometer is an instrument for measuring atmospheric pressure, and the principle on which it works is that described in the preceding article. Fig. 9 is a common form in which the glass tube is placed within a metal casing having a slot opening provided with a sliding vernier at the top of the tube, and a glass cylinder for observing the level of the mercury in the basin at the bottom of the tube. This basin generally consists of a metallic rim to which is secured a chamois-skin bag for holding the mercury.

57. Adjustment.—The level of the mercury in the cup or basin at the bottom of the tube is adjusted by means of the screw at the lower end of the instrument. By means of this screw pressing on the bottom of the chamois-skin bag, the level of the mercury in the cup is raised or lowered. It is thus adjusted until a fixed metallic point, or needle, projecting downwards from the metallic casing within the glass cylinder is observed to indent the surface of the mercury.



FIG. 9

This point forms the zero of the scale, and when the surface of the mercury in the cup has been adjusted, the height of the mercury column is read from the scale by adjusting the

movable vernier to the upper surface of the column. The movement of the vernier is controlled by the thumbscrew shown near the top of the instrument. A thermometer is adjusted to the metal casing of the barometer to indicate the temperature of the observation. After reading the barometer, the atmospheric pressure, in pounds per square inch, is calculated by multiplying the barometric height by the weight of 1 cubic inch of mercury, which may be assumed at ordinary temperatures as approximately .49 pound (.4911 pound at 32° F.). Thus, the atmospheric pressure corresponding to 30 inches of mercury is $.49 \times 30 = 14.7$ pounds per square inch.

58. It is common, in estimating the pressure supported by any gas or air, to speak of such pressure as so many **atmospheres**, and it is quite common practice to consider that one atmosphere equals a pressure of 15 pounds per square inch; a pressure of 30 pounds per square inch is then two atmospheres, 45 pounds three atmospheres, etc. This pressure is the *absolute pressure* or the total pressure supported by the gas or air in question, and not the gauge pressure.

59. The Vacuum.—The space in the tube above the mercury column, Fig. 8, is called a **vacuum**, meaning an empty space. This space is practically a perfect vacuum, being entirely empty of air or other substance. It is customary to measure or describe a vacuum by the inches of mercury supported by atmospheric pressure against it. To make this clear, suppose that a small quantity of air or gas is allowed to enter the space above the mercury column. However small the quantity may be, it will at once fill the entire space, and the mercury column will be lowered more or less, according to the quantity of air entering the tube. The tension of this expanded air causes a slight pressure on the top of the mercury column, thus balancing a portion of the atmospheric pressure and lowering the column of mercury supported by it. The space is then called a **partial vacuum**, and is measured or described by the height of the mercury column

supported by atmospheric pressure against it; this is the principle of the **vacuum gauge**. Since the atmospheric pressure decreases as we ascend above sea level, a perfect vacuum will be indicated by a shorter mercury column; thus, at an elevation of 10,000 feet above sea level the atmospheric pressure supports, under normal conditions, 20.92 inches of mercury. At this elevation, 20.92 inches of mercury will indicate a perfect vacuum. Changes in atmospheric conditions also alter the height of the mercury column indicating a perfect vacuum. For example, at sea level, the height of the mercury column will vary from 29 to 31 inches, according to atmospheric conditions.

60. Vacuum Gauge.—The vacuum gauge is used to measure the vacuum produced in the working of pumps, condensers, etc. With the most perfect machinery, it is not possible to obtain a perfect vacuum, there being, as a rule, a small amount of air remaining that gives a back pressure on the pump or engine of 3, 4, 5, etc. pounds per square inch, according to the character of the work and the machine.

61. The Aneroid Barometer.—The aneroid barometer, Fig. 10, consists of a cylindrical metal box, or vacuum chamber, hermetically sealed. The face of this box is of thin, elastic, corrugated metal; when the atmospheric pressure increases, this plate is pressed inwards, and when it is diminished it is forced outwards by its own elasticity, aided by a spring beneath. These movements of the plate are transmitted and multiplied by a combination of levers that act on an index hand and cause it to move over a graduated dial. These barometers are self-correcting (compensated) for variations in temperature, and are very portable, occupying but a small space. The mercurial barometer is, however, the standard. Most aneroid barometers have two concentric scales, as shown in Fig. 10: the outer, or altitude, scale starting from 0 and giving the elevation above sea level to the nearest 10 feet; and the inner, or mercury, scale giving the atmospheric pressure in inches, tenths, and hundredths, usually from 27 inches to 33 inches, corresponding to the

readings of the mercurial barometer. The outer, or altitude, scale is often made so that it can be moved by the milled screw shown, and its zero set to correspond to any desired reading on the mercury scale. Some barometers have a small thermometer attached to the dial, and from its reading, a correction for temperature can be made. This correction, however, is usually omitted in preliminary work. Formulas

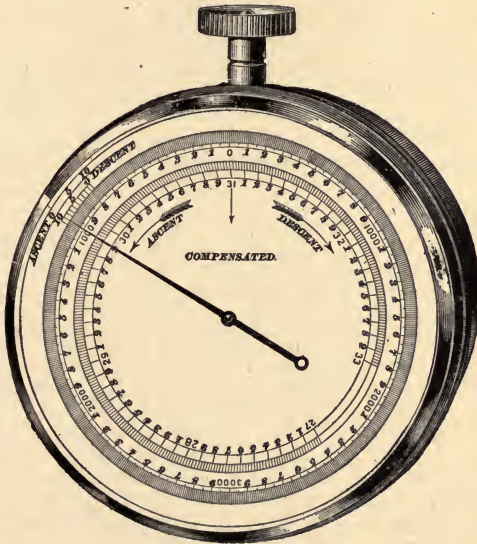

FIG. 10

and tables for determining it are to be found in most engineers' pocketbooks.

62. Gauge Pressure.—In considering the expansive force of air, steam, and other gases, it is customary to measure the pressure they exert above the atmospheric pressure by some form of gauge especially designed for the purpose. Water gauges are used for light pressures; compressed-air gauges, manometers, and different forms of spring gauges

are used for the higher pressures. The pressure indicated by such a gauge is called the **gauge pressure**, and it is evident that the total pressure supported by gas—that is, the absolute pressure—is the atmospheric pressure plus the gauge pressure.

63. Volume and Pressure of Gases.—The law expressing the relation existing between the pressure and volume of any given quantity of gas at a constant temperature is known as **Mariotte's**, or **Boyle's**, law.

Mariotte's Law.—*The temperature remaining the same, the volume of any given quantity of gas is inversely proportional to its absolute pressure.*

Expressed as a proportion, this law is $v_2 : v_1 = p_1 : p_2$, or

$$\frac{v_2}{v_1} = \frac{p_1}{p_2},$$

hence,

$$v_2 = v_1 \left(\frac{p_1}{p_2} \right) \quad (1)$$

$$p_2 = p_1 \left(\frac{v_1}{v_2} \right) \quad (2)$$

in which v_2 = volume corresponding to an absolute pressure p_2 ;

v_1 = volume corresponding to an absolute pressure p_1 .

EXAMPLE.—When the atmospheric pressure is 14.7 pounds per square inch, what volume of free air must be compressed into a cylinder having a capacity of 20 cubic feet to give a gauge pressure of 80 pounds per square inch in the cylinder, assuming the temperature to remain constant?

SOLUTION.—Calling v_2 the required quantity of free air at atmospheric pressure, and substituting the given values in formula 1,

$$v_2 = 20 \times \frac{80 + 14.7}{14.7}$$

$$v_2 = 20 \times \frac{94.7}{14.7} = 128.84 \text{ cu. ft. Ans.}$$

64. Volume, Temperature, and Pressure of Gases.

In the preceding articles, it has been found that the ratio of the volumes is equal to the ratio of the absolute temperatures, or the inverse ratio of the absolute pressures, the pressure

or the temperature in each respective case remaining constant. It may happen that both pressure and temperature may change, in which case the ratio of the volumes will be equal to the product of the ratio of the absolute temperatures and the inverse ratio of the absolute pressures, or

$$\frac{v_2}{v_1} = \frac{T_2 p_1}{T_1 p_2} \quad (1)$$

$$v_2 = v_1 \left(\frac{T_2 p_1}{T_1 p_2} \right) \quad (2)$$

in which v_2 = volume corresponding to the absolute pressure p_2 and the absolute temperature T_2 (or $460 + t_2$);

v_1 = volume corresponding to the absolute pressure p_1 and the absolute temperature T_1 (or $460 + t_1$).

EXAMPLE.—At an elevation of 10,000 feet above sea level, the atmospheric pressure is practically 10 pounds per square inch. At this elevation, how many cubic feet of free air at a temperature of 32° F. must be compressed into a cylinder having a capacity of 20 cubic feet, to give a gauge pressure of 80 pounds per square inch—assuming that the temperature of the compressed air has risen to 60° F.?

SOLUTION.—Calling v_2 the required quantity of free air at atmospheric pressure, and substituting the given values in formula 2,

$$v_2 = 20 \times \frac{460 + 32}{460 + 60} \times \frac{10 + 80}{10}$$

$$v_2 = 20 \times \frac{492}{520} \times \frac{90}{10} = 170.3 \text{ cu. ft. Ans.}$$

65. Temperature and Pressure of Gases.—So far, air has been considered free to expand or contract. It is also necessary to consider the effect of a change of temperature and pressure of air in a confined space where the volume is constant. In this case, the ratio of the absolute temperatures is equal to the ratio of the absolute pressures, or

$$\frac{T_2}{T_1} = \frac{p_2}{p_1}$$

EXAMPLE.—The temperature of compressed air falls in the transmission of the air from the compressor to the drills from 80° F. at the compressor where the gauge pressure is 60 pounds, to 50° F. at

the drills; find the gauge pressure available for operating the drills. The plant is located at an elevation of 5,000 feet above sea level, where the atmospheric pressure is, say, 12.2 pounds per square inch.

SOLUTION.—Calling p_2 the required pressure at the drills, and substituting the given values in the formula,

$$\frac{460 + 50}{460 + 80} = \frac{p_2 + 12.2}{60 + 12.2}; \quad p_2 = 72.2 \frac{510}{540} - 12.2 = 55.98 \text{ lb. Ans.}$$

MIXTURE OF GASES

66. Mixtures of Gases of the Same Temperature and Pressure.—When two or more gases are mixed, there will be no change of pressure unless there is a change in the temperature or total volume of the gases; or, in other words, when two or more gases having the same temperature and pressure are mixed without changing the total volume, the pressure of the mixture will be the same as that of the gases before mixing.

For example, if 1 cubic foot of air, at a temperature of 32° F. and pressure of 5 pounds per square inch, and 1 cubic foot of methane (marsh gas), also at a temperature of 32° F. and at 5 pounds per square inch pressure, are made to occupy a vessel of just 2 cubic feet capacity without any change in the temperature, the pressure of the mixture will also be 5 pounds per square inch.

67. Mixtures of Equal Volumes of Gases Having Unequal Pressures.—If two gases having the same volume and temperature, but different pressures, be mixed in a vessel whose volume equals one of the equal volumes of the gas, the pressure of the mixture will be equal to the sum of the two pressures, provided that the temperature remains the same as before.

EXAMPLE.—Two vessels containing 3 cubic feet of gas, each at a temperature of 60°, and at a pressure of 40 pounds and 25 pounds per square inch, respectively, are placed in communication with each other, and all the gas is compressed into one vessel. If the temperature of the mixture is also 60°, what is the pressure?

SOLUTION.—According to the law just given, the pressure will be $40 + 25 = 65$ lb. per sq. in.

68. Mixtures of Two Gases Having Unequal Volumes and Pressures.—In this case, the relations of the pressures and volumes can best be shown by an equation.

Let v and p = volume and pressure of one gas;

v_1 and p_1 = volume and pressure of the other gas;

V and P = volume and pressure of the mixture.

Then, if the temperature remains the same,

$$PV = pv + p_1 v_1$$

$$P = \frac{pv + p_1 v_1}{V} \quad (1)$$

$$V = \frac{pv + p_1 v_1}{P} \quad (2)$$

EXAMPLE 1.—Two gases of the same temperature, having volumes of 7 cubic feet and $4\frac{1}{2}$ cubic feet, and tensions of 25 pounds and 18 pounds per square inch, respectively, are mixed together in a vessel whose volume is 10 cubic feet; the temperature remaining the same, what is the resulting pressure?

$$\text{SOLUTION.}— P = \frac{pv + p_1 v_1}{V} = \frac{(25 \times 7) + (18 \times 4\frac{1}{2})}{10} = \frac{256}{10} = 25.6 \text{ lb.}$$

per sq. in. Ans.

EXAMPLE 2.—What must be the volume of a vessel that will hold two gases whose volumes are 7 cubic feet and $4\frac{1}{2}$ cubic feet, and whose pressures are 25 pounds and 18 pounds per square inch, respectively, in order that the pressure may be 25.6 pounds per square inch, the temperature remaining the same throughout?

$$\text{SOLUTION.}— V = \frac{pv + p_1 v_1}{P} = \frac{(25 \times 7) + (18 \times 4\frac{1}{2})}{25.6} = 10 \text{ cu. ft. Ans.}$$

CHEMISTRY OF GASES

GENERAL PRINCIPLES

69. Chemistry is that branch of science which treats of the composition of substances and the alterations they undergo in their composition, by a change in the kind, number, and relative position of their atoms.

From a chemical standpoint at least, the atom is not divisible, and is, therefore, always simple or composed of the same kind of matter. The molecule, being formed by the union of two or more atoms, may be either simple or compound, according as the atoms forming the molecules of a substance are like or unlike. When they are like, the substance is an *element* or *elementary*; when unlike, it is a *compound*.

70. Atomic Weight.—The atoms of every element have a definite weight, but this weight differs for different elements. Atoms are so small that they cannot be weighed directly, but their weights, relative to the weight of the atom of some element chosen as a unit, can be determined. The atom of hydrogen is commonly chosen as the standard because hydrogen is the lightest known element. When, for example, an atom of an element is found to be sixteen times as heavy as an atom of hydrogen, it is said to have an atomic weight of 16; or if twenty-three times as heavy as an atom of hydrogen, its atomic weight is said to be 23, and so on. It must be remembered that atomic weight is simply relative weight and not the actual weight of the atoms.

71. Symbols.—For the sake of convenience, the different elements are expressed by letters, called *symbols*. These symbols are usually the first letter of the name of the element; for example, *H* stands for hydrogen, *O* for oxygen, *C* for carbon. When several elements begin with the same

TABLE VI

Element	Sym- bol	Atomic Weight $H = 1$	Element	Sym- bol	Atomic Weight $H = 1$
Aluminum . . .	<i>Al</i>	26.9	Neodymium . .	<i>Nd</i>	142.5
Antimony . . .	<i>Sb</i>	119.3	Neon	<i>Ne</i>	19.9
Argon	<i>A</i>	39.6	Nickel ;	<i>Ni</i>	58.3
Arsenic	<i>As</i>	74.4	Nitrogen	<i>N</i>	13.93
Barium	<i>Ba</i>	136.4	Osmium	<i>Os</i>	189.6
Bismuth	<i>Bi</i>	206.9	Oxygen	<i>O</i>	15.88
Boron ,	<i>B</i>	10.9	Palladium	<i>Pd</i>	105.7
Bromine	<i>Br</i>	79.36	Phosphorus . . .	<i>P</i>	30.77
Cadmium	<i>Cd</i>	111.6	Platinum	<i>Pt</i>	193.3
Cæsium	<i>Cs</i>	131.9	Potassium	<i>K</i>	38.85
Calcium	<i>Ca</i>	39.7	Praseodymium . .	<i>Pr</i>	139.4
Carbon	<i>C</i>	11.91	Radium	<i>Rd</i>	223.3
Cerium	<i>Ce</i>	139.2	Rhodium	<i>Rh</i>	102.2
Chlorine	<i>Cl</i>	35.18	Rubidium	<i>Rb</i>	84.9
Chromium	<i>Cr</i>	51.7	Ruthenium	<i>Ru</i>	100.9
Cobalt	<i>Co</i>	58.55	Samarium	<i>Sm</i>	149.2
Columbium	<i>Cb</i>	93.3	Scandium	<i>Sc</i>	43.8
Copper	<i>Cu</i>	63.1	Selenium	<i>Se</i>	78.6
Erbium	<i>Er</i>	164.8	Silicon	<i>Si</i>	28.2
Fluorine	<i>F</i>	18.9	Silver	<i>Ag</i>	107.11
Gadolinium	<i>Gd</i>	154.8	Sodium	<i>Na</i>	22.88
Gallium	<i>Ga</i>	69.5	Strontium	<i>Sr</i>	86.94
Germanium	<i>Ge</i>	72.	Sulphur	<i>S</i>	31.82
Glucium	<i>Gl</i>	9.03	Tantalum	<i>Ta</i>	181.6
Gold	<i>Au</i>	195.7	Tellurium	<i>Te</i>	126.6
Helium	<i>He</i>	4.	Terbium	<i>Tb</i>	158.8
Hydrogen	<i>H</i>	1.000	Thallium	<i>Tl</i>	202.6
Indium	<i>In</i>	114.1	Thorium	<i>Th</i>	230.8
Iodine	<i>I</i>	126.01	Thulium	<i>Tm</i>	169.7
Iridium	<i>Ir</i>	191.5	Tin	<i>Sn</i>	118.1
Iron	<i>Fe</i>	55.5	Titanium	<i>Ti</i>	47.7
Krypton	<i>Kr</i>	81.2	Tungsten	<i>W</i>	182.6
Lanthanum	<i>La</i>	137.9	Uranium	<i>U</i>	236.7
Lead	<i>Pb</i>	205.35	Vanadium	<i>V</i>	50.8
Lithium	<i>Li</i>	6.98	Xenon'	<i>Xe</i>	127.
Magnesium	<i>Mg</i>	24.18	Ytterbium	<i>Yb</i>	171.7
Manganese	<i>Mn</i>	54.6	Yttrium	<i>Yt</i>	88.3
Mercury	<i>Hg</i>	198.5	Zinc	<i>Zn</i>	64.9
Molybdenum . . .	<i>Mo</i>	95.3	Zirconium	<i>Zr</i>	89.9

letter, as, for example, carbon, calcium, chlorine, copper, etc., one only of these elements is expressed by the first letter, the others being expressed by two letters; thus, *C* for carbon, *Ca* for calcium, *Cl* for chlorine, *Cu* for copper. Sometimes the symbol is an abbreviation of the Latin name of the element; for example, copper (Latin, *cuprum*), *Cu*; iron (Latin, *ferrum*), *Fe*; silver (Latin, *argentum*), *Ag*.

When a single letter forms a symbol, such letter must be written as a capital; when two letters are used as a symbol the first letter is always a capital and the second letter is always a small letter. The symbol of an element standing alone always expresses a single atom; thus, *H* expresses one atom of hydrogen, *O* one atom of oxygen, etc. When it is necessary to express more than one atom, it is done by placing a small figure, called a **subscript**, to the right of and a

TABLE VII

Element	Sym- bol	Atomic Weight	Element	Sym- bol	Atomic Weight
Calcium . . .	<i>Ca</i>	40	Nitrogen . .	<i>N</i>	14
Carbon . . .	<i>C</i>	12	Oxygen . . .	<i>O</i>	16
Chlorine . . .	<i>Cl</i>	35	Phosphorus .	<i>P</i>	31
Copper . . .	<i>Cu</i>	63	Silicon . . .	<i>Si</i>	28
Hydrogen . .	<i>H</i>	1	Sodium . . .	<i>Na</i>	23
Iron	<i>Fe</i>	56	Sulphur . . .	<i>S</i>	32
Lead	<i>Pb</i>	206	Tin	<i>Sn</i>	118
Mercury . . .	<i>Hg</i>	199	Zinc	<i>Zn</i>	65

little below the symbol; *H₂* means two atoms of hydrogen, *H₃* three atoms of hydrogen, etc. Sometimes a figure, called a **coefficient**, is placed before the symbol to indicate the number of atoms, as *2O*, *3O*, etc.

72. Table VI gives the names, symbols, and atomic weights of all the elements now known.

73. For such calculations as are necessary in most mining work, the approximate atomic weights of the most

common elements given in Table VII are sufficiently accurate, and should be used in solving examples relating to mine gases.

74. Chemical Compounds.—A chemical compound is a substance composed of unlike atoms united in definite fixed proportions, according to chemical laws, that give to the atoms of each element certain combining powers. For example, water is a chemical compound, being always formed by the union of two atoms of hydrogen and one atom of oxygen.

In like manner, when one atom of carbon unites with one atom of oxygen, carbon monoxide (often called carbonic oxide) CO is formed; but when one atom of carbon unites with two atoms of oxygen, carbon dioxide (often called carbonic acid) CO_2 is produced. These gases are both chemical compounds, each having different properties.

NOTE.—The compound CO was formerly known as *carbonic oxide*, but this name does not describe the compound and does not agree with the naming of compounds as now used by chemists. The term carbonic oxide has therefore been given up universally in chemical literature and is being rapidly done away with in all scientific and technical literature: the term *carbon monoxide* has been substituted for it. This name means that one atom of carbon is combined with one atom of oxygen.

The compound CO_2 was formerly called *carbonic acid*, but this name has also been given up, for a similar reason, in scientific and technical literature and the term *carbon dioxide* substituted. This term means that one atom of carbon is combined with two atoms of oxygen. The modern terms will be used in this Section, although the old terms will usually be given in parentheses to avoid confusion, as the older terms are used in much of the older mining literature and many of the mine examining boards still adhere to them.

Again, when one atom of carbon unites with four atoms of hydrogen, methane, commonly known as carbureted hydrogen, or marsh gas CH_4 , results; but, when two atoms of carbon unite with the four atoms of hydrogen, ethylene, or ethene, commonly known as olefiant gas C_2H_4 , is produced. These are all examples of chemical compounds, as are also salt, blue vitriol, nitric acid, etc., for they are all formed by the chemical union of unlike atoms.

75. Mechanical Mixtures.—A mechanical mixture is not a chemical compound, being composed of unlike

molecules simply mixed together instead of unlike atoms chemically united. The molecules of the different substances forming the mixture are mixed in any proportions, and the mixture has properties varying with the proportion of the ingredients. The atmosphere about us is a good example of a mechanical mixture, as we shall see later, for it consists principally of oxygen and nitrogen gases, mixed in a free state and having no chemical bond of union.

76. Mixtures of some liquids, if allowed to stand, will remain mixed, but others, on standing, will separate and the several liquids arrange themselves in accordance with their specific gravities. Mixtures of gases, however, are permanent, and when once two or more gases are thoroughly mixed there is no separation of the gases in the mixture. This property of the mixing of gases is an important one, for, if a mixture of gases acted like mixtures of most liquids, and the several ingredients of the mixture separated on standing, life on the earth would be impossible, as the heavy carbon dioxide or carbonic-acid gas in the atmosphere would separate from the other gases composing the atmosphere and form a layer next to the surface in which the present forms of animal life could not exist.

77. Expressing a Molecule by Symbols.—The molecules of all elements that exist ordinarily as gases consist each of two like atoms; for example, the molecule of hydrogen consists of two atoms (H_2). This is not true of all molecules of the solid elements; as the molecules of mercury, cadmium, and zinc contain only one atom, while those of phosphorus and arsenic contain four atoms, etc. The molecules of a compound may contain two or more atoms, according to the nature of the atoms in combination.

A compound molecule is expressed by writing the symbols of the elements composing it together and indicating by means of subscripts the number of atoms of each element present. Such an expression is called a **chemical formula**. A molecule of water is composed of two atoms of hydrogen and one atom of oxygen, and its formula is H_2O ; a

molecule of sulphuric acid consists of two atoms of hydrogen, one atom of sulphur, and four atoms of oxygen, and its formula is H_2SO_4 . When more than one molecule is to be indicated, a coefficient is placed before the formula, as $2H_2O$ means two molecules of water. Table VIII gives the formulas and number of atoms in the molecules of various compounds.

TABLE VIII

Name of Compound	Formula	Number of Atoms in One Molecule
Carbon-monoxide gas (carbonic-oxide) . . .	CO	2
Carbon-dioxide gas (carbonic-acid)	CO_2	3
Ammonia gas	NH_3	4
Carbureted hydrogen (methane, or marsh gas)	CH_4	5
Ethylene or olefiant gas	C_2H_4	6
Sulphuric acid	H_2SO_4	7

The molecules of some organic or carbon compounds contain a far greater number of atoms than is expressed in Table VIII. The correct symbol for those substances common to mining must be memorized as met with.

78. Molecular Weight.—Since a molecule of any compound contains a definite number of atoms, it is plain that all molecules of the same substance have the same weight. The molecular weight of a compound is the weight of the molecule, as compared with the weight of an atom of hydrogen, and is equal to the sum of the atomic weights of the elements composing the molecule, each taken as many times as there are atoms of that element in the molecule. For example, the molecular weight of sulphuric acid H_2SO_4 is found as follows:

$$\begin{array}{r}
 \text{SULPHURIC ACID} \\
 H_2 = 2 \times 1 = 2 \\
 S = 32 \times 1 = 32 \\
 O_4 = 4 \times 16 = \underline{64} \\
 \text{Molecular weight} = 98
 \end{array}$$

Table IX gives the molecular weights of some of the most common gases.

TABLE IX

Substance	Molecule	Molecular Weight
Hydrogen	H_2	$(2 \times 1) = 2$
Oxygen	O_2	$(2 \times 16) = 32$
Nitrogen	N_2	$(2 \times 14) = 28$
Marsh gas (carbureted hydrogen or methane)	CH_4	$12 + (4 \times 1) = 16$
Olefiant gas	C_2H_4	$(2 \times 12) + (4 \times 1) = 28$
Carbon monoxide (carbonic oxide)	CO	$12 + 16 = 28$
Carbon dioxide (carbonic acid)	CO_2	$12 + (2 \times 16) = 44$
Hydrogen sulphide	H_2S	$(2 \times 1) + 32 = 34$
Ammonia gas	NH_3	$14 + (3 \times 1) = 17$

79. Percentage Composition.—It is often necessary to calculate the percentage composition of a substance from its chemical formula. For example, it may be desired to know the percentage, by weight, of hydrogen in a given weight of marsh gas, or it may be desired to calculate the weight of carbon dioxide formed in burning a given weight of coal, and to determine therefrom the volume of the gas produced. The percentage, by weight, of any element of a substance is equal to the atomic weight of such element multiplied by the number of atoms of the element in the molecule, divided by the molecular weight of the substance, and the result multiplied by 100. Expressed as a formula, this rule is,

$$\text{per cent.} = \frac{w \times 100}{W};$$

in which w = total weight of any element in substance =
atomic weight of the element \times the number
of atoms of that element in the molecule;

W = molecular weight of substance.

EXAMPLE 1.—Find the percentage of hydrogen in marsh gas (methane) and the weight of hydrogen contained in 10 pounds of this gas.

SOLUTION.—The symbol expressing a molecule of marsh gas is CH_4 ; we have, then,

Parts by weight of hydrogen H_2	$4 \times 1 = 4$
Parts by weight of carbon C	$= 12$
Molecular weight of marsh gas CH_4	$= 16$

The percentage, by weight, of hydrogen in marsh gas is, then,
 $\frac{4}{16} \times 100 = 25$ per cent. Ans.

The weight of hydrogen in 10 pounds of marsh gas is
 $10 \times \frac{25}{100} = 2.5$ lb. Ans.

EXAMPLE 2.—Find the weight of water that can be formed from 2.5 pounds of hydrogen.

SOLUTION.—The symbol expressing a molecule of water is H_2O , and we have,

Parts by weight of hydrogen H_2	$2 \times 1 = 2$
Parts by weight of oxygen O	$= 16$
Molecular weight of water H_2O	$= 18$

Hence, the percentage of H is $\frac{2}{18} \times 100 = \frac{200}{18} = 11\frac{1}{9}$ per cent.
 Then $11\frac{1}{9}$ per cent. : 100 per cent. = 2.5 lb. : x .

Weight = $2.5 \times \frac{100}{11\frac{1}{9}} = 2.5 \times 9 = 22.5$ lb. Ans.

NOTE.—It should be observed in these two examples that the weight of water that will be formed in the complete explosion of 10 pounds of marsh gas has been calculated.

EXAMPLES FOR PRACTICE

1. What percentage by weight of carbureted hydrogen (marsh gas) CH_4 is pure hydrogen? Ans. 25 per cent.
2. If the specific gravity of carbureted hydrogen (marsh gas) (Table I) is .559, what weight of hydrogen will be contained in 1,000 cubic feet of this gas, at a temperature of 60° F., barometer 30 inches? Ans. 10.701 lb., nearly.
3. If all the hydrogen in example 2 were to unite with oxygen (in the proportion of two atoms of hydrogen to one atom of oxygen) to form water, what weight of water would be produced? Ans. 96.309 lb.
4. What weight of carbon is contained in 100 cubic feet of carbon monoxide CO , a molecule of this gas containing one atom of carbon and one atom of oxygen, temperature = 60° F., barometer 30 inches? Ans. 3.173 lb.

80. Avogadro's Law.—The Italian physicist, Avogadro, in 1811, established the law that *equal volumes of all substances, either elementary or compound, when in the gaseous*

state and at the same temperature and pressure, contain an equal number of molecules.

From this law, it follows: (1) That the molecules of all gaseous bodies must be of equal size. (2) That the weight of any gaseous molecule—compared with that of a molecule of hydrogen—is proportional to the weight of any given volume compared with an equal volume of hydrogen; and conversely, that the weights of equal volumes of any gases are proportional to the molecular weights of the gases.

If, for instance, 1 cubic foot of marsh gas weighs 8 times as much as 1 cubic foot of hydrogen, one molecule of marsh gas must weigh 8 times as much as one molecule of hydrogen; and conversely, if the above law is true, since the molecular weight of marsh gas is 16 and that of hydrogen is 2, 1 cubic foot of marsh gas weighs $\frac{16}{2} = 8$ times as much as 1 cubic foot of hydrogen. Hence, we have the following general rule:

Rule.—The density of any gas, simple or compound, when referred to hydrogen as unity, is equal to one-half its molecular weight.

81. Density of Mine Gases.—In Table X are given the molecular weights and densities, referred to hydrogen, of the important mine gases, including the gases that form the atmosphere, and hydrogen gas, which is the standard for density.

82. Chemical Reactions.—All substances are liable to chemical change, particularly when molecules of different kinds are brought into intimate contact under proper conditions. Any change in the arrangement of the atoms among molecules is termed a **chemical reaction**. The ease with which chemical reactions take place differs with different substances. Compounds that react with difficulty are said to be *stable*; those that react with ease are said to be *unstable*.

83. Chemical Equations.—A chemical equation is an equation expressing the reaction that takes place between two or more substances. Since every chemical change or

reaction is simply an alteration in the number or position of the atoms within the molecules, and consequently a change in the constitution of the molecules, a reaction may be expressed by an equation of the formulas entering into and

TABLE X

Gas	Molecular Weight	Density Referred to Hydrogen
Hydrogen H_2	2	1
Oxygen O_2	32	16
Nitrogen N_2	28	14
Carbureted hydrogen } Methane } CH_4	16	8
Marsh gas }		
Olefiant gas } Ethylene } C_2H_4	28	14
Carbon monoxide } Carbonic oxide } CO	28	14
Carbon dioxide } Carbonic acid } CO_2	44	22
Hydrogen sulphide } Sulphureted hydrogen } H_2S	34	17

resulting from the reaction. The substances entering into the reaction are called the *factors*; those resulting from the reaction are called the *products*. The equation representing a reaction is written according to the following rule:

Rule.—Place the formulas of the factors, connected by the sign of plus, as the first member of the equation, and the formulas of the products, also connected by the sign of plus, as the second; and finally indicate by means of coefficients the number of molecules of the factors and of the products.

84. Writing Chemical Equations.—One of the most important reactions in mining is that which takes place in the complete explosion of firedamp, a mixture of methane (marsh gas) and air. In this reaction, the gases present before the

reaction takes place are methane (marsh gas) CH_4 and air, the air consisting chiefly of oxygen O and nitrogen N . The gases resulting from the reaction are carbon dioxide (carbonic-acid gas) CO_2 , moisture H_2O , and nitrogen N . In order to write the equation representing the reaction that takes place, the gases present before the reaction are written for the first member of the equation, and those resulting from the reaction for the second member; and the equation reads: $CH_4 + O_2 + N_2 = CO_2 + H_2O + N_2$. It will be observed that in this equation only one molecule of each gas is indicated, since the number of molecules of each gas required to satisfy the reaction is not yet known; the equation is, therefore, not complete.

85. The carbon and the hydrogen of the methane (marsh gas) separate from each other, each combining with the oxygen of the air to form carbon dioxide CO_2 and water H_2O , respectively. The nitrogen of the air is neutral and remains unchanged. It will be noticed that sufficient oxygen O is required in the first member to satisfy all the carbon and all the hydrogen of the marsh gas. In one molecule of marsh gas CH_4 , there is one atom of carbon C and four atoms of hydrogen H ; the one atom of carbon C takes up two atoms of oxygen O_2 , forming one molecule of carbon dioxide CO_2 . But one molecule of water H_2O contains two atoms of hydrogen H_2 and one atom of oxygen O ; the four atoms of hydrogen H_4 will, therefore, form two molecules of water $2H_2O$, requiring for this purpose two atoms of oxygen. The total oxygen, therefore, required to satisfy both the carbon and the hydrogen of the marsh gas is four atoms, or two molecules $2O_2$. But since the nitrogen and oxygen are present in air in the ratio of 4 : 1, these two molecules of oxygen will correspond to eight molecules of nitrogen, which latter gas is present, but takes no part in the reaction. To complete the equation, therefore, write before each term the figure indicating the number of molecules; thus, $CH_4 + 2O_2 + 8N_2 = CO_2 + 2H_2O + 8N_2$. That the equation is now complete is shown by the fact that there is the same number

of each kind of atoms on each side of the equation; that is, the equation is balanced.

86. Change of Volume of Gases Due to Chemical Changes.—Chemical reactions of gases are often accompanied by a change in the volume of the gases. The volume of the gases before the reaction takes place may be greater or less than that of the gases resulting from the reaction. For example, when 1 cubic foot of nitrogen gas and 3 cubic feet of hydrogen gas are intimately mixed and caused to combine chemically by an electric spark, there is formed 2 cubic feet only of ammonia gas NH_3 . Here the original volume of 4 cubic feet has been reduced to 2 cubic feet. When 2 cubic feet of hydrogen and 1 cubic foot of oxygen are intimately mixed and caused to combine chemically by an electric spark, there results 2 cubic feet of water vapor. The original 3 cubic feet of gases are here reduced to 2 cubic feet. It must be remembered that taking the volume of the hydrogen atom as unity, the volume of any gaseous atom is one and the volume of any gaseous molecule is two, regardless of the number of atoms that have united to form the molecule, as is shown by the examples given above.

87. Calculation of Change of Volume.—The change of volume of a gas due to any chemical reaction can be calculated by the aid of Avogadro's law, Art. 80, as follows: First write the equation expressing the reaction. The number of molecules of the factors in the equation represent the volume before the reaction; the number of molecules of the products represent the volume after the reaction.

For illustration, take the reaction for the formation of ammonia NH_3 , already given.

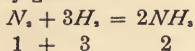

Here there were present 1 volume or molecule of nitrogen and 3 volumes or molecules of hydrogen, which, when combined, resulted in 2 volumes or molecules of ammonia.

88. In calculating the change of volume of the explosion of carbon monoxide (carbonic oxide) in air, we have,

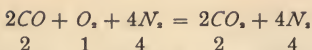

Before the explosion there are, for the factors, $2 + 1 + 4 = 7$ volumes of gas; after the explosion there are, for the products, $2 + 4 = 6$ volumes of gas.

This principle should be used for calculating the changes of volume for all reactions between gases.

EXAMPLE.—(a) How many cubic feet of carbon dioxide (carbonic acid) will be formed from the explosion of 500 cubic feet of marsh gas CH_4 in air at constant temperatures and pressures? (b) How many cubic feet of oxygen will be consumed in forming the CO_2 ?

SOLUTION.—(a) The reaction representing the explosion is

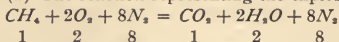

From this it is seen that 1 volume of CH_4 produces 1 volume of CO_2 ; hence, 500 volumes of CH_4 produce 500 volumes of CO_2 . Ans.

(b) Since, as seen from the reaction, 1 volume of CH_4 requires 2 volumes of oxygen for its complete combustion, and one-half of this is for the combustion of the carbon, 1 volume is required for 1 volume of CH_4 ; hence, for 500 cu. ft. of CH_4 , 500 cu. ft. of oxygen is required.

Ans.

EXAMPLES FOR PRACTICE

In the following examples, assume constant temperature and pressure.

1. How many cubic feet of oxygen will be consumed in the formation of 100 cubic feet of carbon monoxide (carbonic-oxide) gas CO ?

Ans. 50 cu. ft.

2. If the hydrogen in 100 cubic feet of ammonia gas were set free, what volume would it make?

Ans. 150 cu. ft.

3. The formula for ethylene, or olefiant gas, is C_2H_4 ; what volume of oxygen will be required to convert 100 cubic feet of this gas into CO_2 and H_2O ?

Ans. 300 cu. ft.

89. Change of Pressure Due to Change of Volume.

The change in volume due to any chemical reaction is always accompanied by a change of pressure and temperature. To calculate this change of pressure, calculate first the change of volume as explained in the preceding article, then assume that the temperature is constant, and calculate the pressure at the new volume by the formulas in Art. 63.

EXAMPLE.—Calculate the change of pressure due to the chemical change of volume in an explosion of carbon-monoxide gas CO , according to the equation given in Art. 88.

SOLUTION.—In Art. 88, it was found that in this explosion the volume was reduced in the ratio of 7 : 6; hence, if p_2 = pressure after the explosion and p_1 the pressure before the explosion, from formula 2, Art. 63, $p_2 = p_1 \frac{v_1}{v_2}$, we have,

$$\frac{p_2}{p_1} = \frac{6}{7}, \text{ or } p_2 = \frac{6}{7} p_1$$

THE ATMOSPHERE

90. Composition of the Atmosphere.—An analysis of the atmosphere about us shows it to consist of a mixture of oxygen and nitrogen, with varying amounts of carbon dioxide (carbonic-acid gas) and ammonia. The oxygen and nitrogen are always free, or uncombined, and are present in the proportions given in Table XI.

TABLE XI

Gases Forming Air	Parts by Volume	Parts by Weight
Nitrogen	79.3	77.0
Oxygen	20.7	23.0
Total	100.0	100.0

While the percentages of oxygen and nitrogen remain practically the same, there is a varying amount of carbon dioxide, ammonia, and moisture in the air of different localities. For example, the air of a crowded room may contain a comparatively high percentage of carbon dioxide; mine air may likewise be laden with carbon dioxide, moisture, and mine gases from the workings of the mine.

91. Weight of 1 Cubic Foot of Air.—The common formula employed in mining for calculating the weight of 1 cubic foot of air is based on the weight of 1 cubic foot of air at 1° F. above the absolute zero and an atmospheric pressure corresponding to 1 inch of mercury. This weight is

1.3273 pounds. The weight of 1 cubic foot of air at any other temperature and pressure is found by multiplying 1.3273 by the atmospheric pressure (inches of mercury), and dividing by the absolute temperature.

This rule expressed as a formula is,

$$w = \frac{1.3273 B}{460 + t}$$

in which w = weight of 1 cubic foot of air at a temperature t and barometric pressure B ;

B = barometric pressure, inches of mercury;

t = temperature of air, degrees F.

92. Density of Air Referred to Hydrogen.—In comparing the weights of equal volumes of air and gas, we observe that the smallest volume of air that we can take for comparison consists of four molecules of nitrogen $4N_2$, and one molecule of oxygen O_2 , making five molecules of these mixed gases that we call air. The relative weight of these five molecules, compared to that of five molecules of hydrogen $5H_2$, will give, approximately, the density of air referred to hydrogen. This density is only approximate because of small traces of other gases in the atmosphere, but it is sufficiently close for practical purposes. The calculation is as follows:

SUBSTANCE	QUANTITY	SYMBOL	RELATIVE WEIGHT
Nitrogen	4 molecules	$4N_2$	$4(2 \times 14) = 112$
Oxygen	1 molecule	O_2	$(2 \times 16) = 32$
Air	5 molecules		Total, 144
Hydrogen	5 molecules	$5H_2$	$5(2 \times 1) = 10$

Density of air referred to hydrogen $\frac{144}{10} = 14.4$.

93. Density and Specific Gravity of Gases.—The terms relative density and specific gravity, as referred to gases, are similar, the former referring to hydrogen or some other unit and the latter to air. It is evident that, if the density of air, referred to hydrogen, is 14.4; or, in other words, if air is 14.4 times as heavy as hydrogen, the specific gravity of any gas referred to air is $\frac{1}{14.4}$ of its density referred to

hydrogen. By this means it is possible to calculate the specific gravity of any gas from its molecular weight as shown in Table XII.

As will be observed by comparing the calculated specific gravities, as given above, with the true specific gravities of these gases referred to air as determined by experiment, there is but slight difference between the two, and this is largely due to the approximate figure (14.4), used for the density of air referred to hydrogen and to the fact that the densities given for the several gases, as well as the atomic weights used, are only approximate.

TABLE XII

Gas	Density	Specific Gravity	
		Calculated	Determined by Experiment
Hydrogen <i>H</i>	1	$\frac{1}{14.4} = .0694$.0693
Oxygen <i>O</i>	16	$\frac{16}{14.4} = 1.1110$	1.1057
Nitrogen <i>N</i>	14	$\frac{14}{14.4} = .9722$.9714
Methane, (carbureted hydro- gen or marsh gas) . . . } <i>CH</i> ₄	8	$\frac{8}{14.4} = .5556$.5590
Ethylene (olefiant gas) <i>C</i> ₂ <i>H</i> ₄ . .	14	$\frac{14}{14.4} = .9722$.9700
Carbon monoxide (carbonic- oxide gas) } <i>CO</i>	14	$\frac{14}{14.4} = .9722$.9670
Carbon dioxide (carbonic- acid gas) } <i>CO</i> ₂	22	$\frac{22}{14.4} = 1.5278$	1.5291
Hydrogen sulphide (sul- phureted-hydrogen gas) } <i>H</i> ₂ <i>S</i>	17	$\frac{17}{14.4} = 1.1805$	1.1912

94. Heat of Chemical Reactions.—With all chemical reactions, heat is either given out or absorbed, thus materially affecting the pressures and volumes of the gaseous products of the reaction. The amount of heat given out or absorbed in like reactions is always the same between equal weights of the same substances.

COMBUSTION

95. Combustion is the act of burning. As commonly used, it means the combination of a substance with oxygen, although other chemical reactions are sometimes included under the same term. Combustion may be either slow or rapid. *Slow combustion* is attended by heat only, while *rapid combustion* is generally attended by heat and light. Examples of slow combustion are found in the consuming of the animal tissues of the body, by which animal heat is produced; and in the slow consumption of carbonaceous matter and fine coal in the gob heaps or waste of a mine, which is accompanied by heat but no flame. The consuming of any substance by fire furnishes an example of rapid combustion, producing heat and light.

96. Oxidation.—As oxygen is the great supporter of combustion, the process of combustion is often called **oxidation**. While there is a similarity between combustion and oxidation, all combustion is not oxidation, and all oxidation is not combustion. For example, phosphorus burning in chlorine gas is an example of combustion but not of oxidation, while the corroding of iron or other metal surfaces by the action of the atmosphere is an example of oxidation, but not of combustion according to the usual acceptance of the term combustion. The use of the term combustion to describe other chemical reactions than oxidation is unusual, and will not be used in this Section, so that by combustion a process of oxidation will always be meant. Deoxidation, the reverse of oxidation, is known as **reduction**.

97. Heat of Combustion.—A given weight of a combustible gives out by its combustion a definite amount of heat. The *heat value* (calorific value) of a combustible is expressed by the number of heat units developed in burning a pound of such combustible. Whether the combustion is slow or rapid the same quantity of heat will be given out per unit of weight, and the total heat generated by burning any combustible is proportional to the weight of combustible

burned. Although the same amount of heat is always given out by the combustion of a given weight of a substance, the temperature produced by the combustion varies greatly, depending on the conditions under which the combustion takes place; in slow combustion, much of the heat generated is lost by radiation, convection, or conduction; the more rapid the combustion of a given substance the higher is the resulting temperature.

98. A **combustible substance** is one that will burn; that is, all the elements composing it will combine with oxygen to produce heat. The products of combustion are usually gaseous, though not always so. Many substances, such as coal, although mainly composed of combustible materials, contain also incombustible portions that do not burn and remain as ash when the substance is burned.

The chief combustible elements in ordinary fuels are hydrogen and carbon, and the chemical reactions expressing the combustion are given in the following paragraphs.

99. When hydrogen is burned in air or oxygen, water is formed according to the reaction, $2H_2 + O_2 = 2H_2O$. The heat given off by this reaction is 62,032 B. T. U. per pound of hydrogen burned.

100. When carbon burns, any one of three reactions may take place: (1) In an ample supply of oxygen, carbon dioxide (carbonic acid) CO_2 is formed according to the reaction $C + 2O_2 = 2CO_2$, in which 1 pound of carbon burning to carbon dioxide CO_2 produces 14,600 B. T. U. (2) If the supply of oxygen is deficient, carbon monoxide (carbonic oxide) CO is formed according to the reaction $C + O_2 = 2CO$, by which the burning of 1 pound of carbon produces 4,450 B. T. U. (3) When there is too little oxygen for all the carbon to burn to carbon dioxide CO_2 , and more than is required for it to burn to CO , a mixture of CO_2 and CO is formed.

101. In burning a compound of carbon and hydrogen, as marsh gas CH_4 , in a plentiful supply of air, the reaction

is expressed by the equation: $CH_4 + 2O_2 + 8N_2 = CO_2 + 2H_2O + 8N_2$. The heat given out in this case is 23,513 B. T. U. per pound of methane, or marsh gas CH_4 , burned. In the case of olefiant gas burned in oxygen, the reaction is $C_2H_4 + 3O_2 = 2CO_2 + 2H_2O$. The heat given out in this case is 21,344 B. T. U. per pound of ethylene, or olefiant gas C_2H_4 , burned.

102. Sulphur burns in air according to the equation $S + O_2 = SO_2$, giving out 4,050 B. T. U. per pound of sulphur.

103. Table XIII gives the heating value (calorific power) of a few of the important fuels and gases. The heating value is expressed in B. T. U. per pound of fuel.

TABLE XIII

Substance	B. T. U. per Pound
Hydrogen to H_2O	62,032
Carbon to CO_2	14,544
Marsh gas to H_2O and CO_2	23,513
Carbon monoxide CO to CO_2	4,325
Anthracite	12,600
Bituminous coal	13,500
Wood (average dry)	8,000

The following example will illustrate the use of this table:

EXAMPLE.—How many cords of wood (hickory), thoroughly dry, and having a calorific power of 6,000 B. T. U. per pound, may be considered as equivalent to 1 ton of bituminous coal having a heating value of 13,500 B. T. U. per pound?

SOLUTION.—Assuming the weight of 1 cord of hickory as 4,500 lb., we have, for the relative heating value of a ton (2,000 lb.) of bituminous coal and a cord of hickory,

$$\frac{2,000 \times 13,500}{4,500 \times 6,000} = 1 \text{ cord}$$

Therefore, 1 cord of dry hickory may be considered as equivalent to 1 ton of bituminous coal.

104. Initial Force of an Explosion of Methane (Marsh Gas).—The chemical equation expressing the reaction that takes place in the explosion of a body of fire-damp at its most explosive point is:

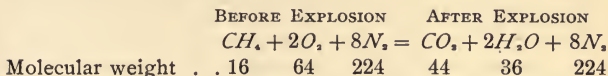

The numbers written below the symbols in this equation show the relative weights (molecular weight), respectively, of the different gases concerned in the reaction. For each 16 parts, by weight, of marsh gas exploded there are formed the following: carbon dioxide CO_2 , 44 parts; water H_2O , 36 parts; nitrogen N , 224 parts. Hence, for each pound of methane or marsh gas that is burned there results $\frac{44}{16} = 2.75$ pounds of carbon dioxide CO_2 ; $\frac{36}{16} = 2.25$ pounds of water H_2O ; $\frac{224}{16} = 14$ pounds of nitrogen N . Knowing the weight of each of the gaseous products per pound of marsh gas burned, it is possible to calculate the initial temperature at the moment of explosion as follows: Multiply the weight of each gas formed by its specific heat; the sum of the several products thus obtained gives the number of B. T. U. required to raise the temperature of these gases 1° F. Then, dividing the total heat (B. T. U.) produced by the burning of 1 pound of methane (marsh gas) by this result, gives the rise in temperature at the moment of explosion. The total heat produced by the burning of 1 pound of marsh gas (see Art. 101) has been found to be 23,513 B. T. U. The specific heats of the gases as given in Table IV, referred to water as unity, express the amount of heat (B. T. U.) required to raise 1 pound of the substance 1° F. Calculating the total heat required to raise the temperature of the gases produced by the burning of 1 pound of marsh gas 1° F., we have,

	B. T. U.
Carbon dioxide CO_2	$2.75 \times .2170 = .5968$
Water vapor (steam)	$2.25 \times .4805 = 1.0811$
Nitrogen	$14 \times .2438 = 3.4132$
Total heat for 1° F.	<u>5.0911</u>

Then, since the total heat evolved by burning 1 pound of methane (marsh gas) is 23,513 B. T. U., the total rise in the temperature of the gaseous products of the explosion will be $\frac{23,513}{5.0911} = 4,618^\circ \text{ F.}$; or, assuming an original temperature of 60° F. before the explosion, the temperature resulting from the explosion is $4,618^\circ + 60^\circ = 4,678^\circ \text{ F.}$

105. The high temperature produced by the explosion creates the expansive force of the gaseous products, the absolute pressure or the tension of the gases increasing in the same ratio as the absolute temperature; or, expressed as atmospheres, the total pressure created by the explosion is, in this case, $\frac{460 + 4,678}{460 + 60} = \frac{5,138}{520} = 9.88$ atmospheres.

SPONTANEOUS COMBUSTION

106. Spontaneous combustion is said to take place when the heat necessary to start the burning or combustion is produced by chemical reaction originating within the body itself. The cause of the spontaneous ignition of coal was formerly thought to be the oxidation of pyrites contained in it; it has been learned, however, that this is not the principal cause, although, in the presence of air and moisture, the oxidation of pyrites, if present in sufficient quantity, may aid in the generation of heat. Coal naturally absorbs oxygen from the air, undergoing a process of slow combustion, and in so doing generates heat. The temperature attained depends on the rapidity of the absorption of the oxygen and the rate at which the heat generated escapes. The former fact is greatly influenced by the degree of fineness of the coal and the temperature of the interior of the pile; and the latter by the size of the heap and the ventilation of its interior. The finer the coal, the greater is the surface exposed to the action of the air, and the absorption of oxygen becomes more energetic as the temperature is increased; hence, it is evident that the cooler the heap can be kept and the freer from fine coal, the less will be the

danger of spontaneous ignition. Large heaps hold the heat more than small ones, and are not so readily ventilated. While good ventilation cools the heap, very poor ventilation may not allow sufficient oxygen to enter the pile to cause spontaneous combustion, therefore the greatest danger lies midway between the two conditions.

Although the amount of heat produced by the oxidation of the pyrites in the coal is small, this oxidation breaks up the coal and thus presents fresh surface for the absorption of oxygen.

PHYSICAL PROPERTIES OF MINE GASES

107. Diffusion of Gases.—The diffusion of liquids is an intermingling of the molecules of two liquids in direct contact with each other or separated by a porous membrane. This diffusion or intermixture of the molecules is brought about by their power of moving among each other, which enables the molecules of the two liquids to become thoroughly intermingled. The power of diffusion is possessed by the gaseous molecules to the highest degree, and all gases are capable of perfect and comparatively rapid intermixture. Some liquids diffuse similarly, though comparatively slowly, while others mix very imperfectly, if at all.

108. The diffusion of gases should not be confused with mixtures by mechanical force or by the action of gravity, although mixtures produced in this way assist in the diffusion of gases, and cause it to take place more rapidly as fresh surfaces of the different gases are constantly brought together and diffusion thereby promoted. For example, when methane (marsh gas) issues from the floor of mine workings, the gas being lighter than air has a natural tendency to rise. The upward motion of the gas assists its distribution in the air and promotes its diffusion. On the other hand, when this gas issues from a feeder in the roof of the workings, it forms a thin layer at the roof, except as it may be disturbed by the air-current. In this case, the diffusion of the gas is less rapid owing to its slower distribution in the

air. In like manner, when carbon dioxide (carbonic-acid gas) CO_2 issues from the roof, this gas being heavier than air tends to fall, and its distribution is more complete and its diffusion more rapid than when this gas issues from the floor of the workings.

109. Rate of Diffusion.—The rate, or velocity, at which diffusion takes place between air and gas, or between two bodies of different gases, has been found, by experiment, to be inversely proportional to the square root of the densities or specific gravities of the gases. This law relates to the diffusion that takes place at the surface of contact and does not allow for any mechanical mixing of gases. Thus, if a jar of hydrogen gas is connected with a jar of oxygen gas diffusion will at once begin, a portion of the hydrogen gas passing over into the oxygen, while a portion of the oxygen passes over into the hydrogen. The density of hydrogen is 1, and that of oxygen is 16; that is, their densities are as 1 : 16. It is found that for every volume of oxygen that passes into the hydrogen there are four volumes of hydrogen passing into the oxygen, and, therefore, the rate of the diffusion of the hydrogen is four times the rate of the diffusion of the oxygen. In like manner, all gases diffuse into each other in the inverse ratio of the square roots of their densities.

110. Table XIV gives the density or specific gravity, the square root of the density, and its reciprocal, which expresses the relative velocity of diffusion, for each of the common mine gases, referred to air as unity.

The table also shows the relative velocity of diffusion for each gas into air, as determined by experiment. It will be observed that the velocity of diffusion, as determined by experiment, in each case agrees very closely with the calculated velocity.

111. Occlusion of Gases.—A gas is occluded (hidden) when it exists in the pores of a solid substance. A familiar example of the occlusion of gases is found in the coal seams, where gases often exist in large quantities and are a source of danger in mining.

TABLE XIV

Gas	Density, or Specific Gravity	Square Root of Density	Velocity of Dif- fusion	
			Calcu- lated I	Deter- mined by Experi- ment
			$\sqrt{\text{Density}}$	
Hydrogen0693	.2632	3.7987	3.830
Methane (marsh gas) . .	.5590	.7477	1.3375	1.344
Carbon monoxide9670	.9834	1.0169	1.015
Ethylene (olefiant gas) .	.9700	.9849	1.0154	1.019
Nitrogen9713	.9855	1.0147	1.014
Air	1.0000	1.0000	1.0000	
Oxygen	1.1057	1.0515	.9510	.949
Hydrogen sulphide . . .	1.1912	1.0914	.9163	.950
Carbon dioxide	1.5291	1.2366	.8087	.812

The conditions that have held these gases in the coal and adjoining strata, till set free by the penetration of mine workings, are largely a close coal and an impervious roof and floor. The kind and amount of gases occluded in different coal seams, and even in different parts of the same seams, vary much.

The gases most commonly occluded in coal seams are methane (marsh gas), nitrogen, carbon dioxide (carbonic acid), and traces of oxygen, carbon monoxide (carbonic oxide), ethylene (olefiant gas), and some other hydrocarbons.

The relative percentages of these gases vary largely in different localities, even in freshly mined coals.

112. Pressure of Occluded Gases.—The pressure of occluded gases has been shown, by a number of experiments in England, France, and Belgium, to often reach as high as 150 or 250 pounds per square inch; and, in exceptional cases, pressures were recorded varying between 400 and 500 pounds per square inch. Whatever degree of exactness these experiments may have, they serve to show,

at least, the enormous pressures under which occluded gases may be projected from a newly exposed face of coal. This pressure is often manifested by a sharp cracking and hissing sound caused by the escaping gas, the splintered coal at times being thrown with considerable violence into the face of the miner. The gases occupying the pores, or capillary tubes or openings in the coal, are driven by this pressure into the cracks and crevices and larger openings in the seam, from which they flow in a continuous stream into the atmosphere of the mine; or, these gases may exude directly from the pores or capillary openings into the mine atmosphere wherever a fresh face of coal is exposed.

TABLE XV

Gas	Relative Velocity of Transpiration
Hydrogen	2.066
Olefiant gas	1.788
Marsh gas	1.639
Hydrogen sulphide	1.458
Carbon dioxide	1.237
Carbon monoxide	1.034
Nitrogen	1.030
Air	1.000
Oxygen903

113. Transpiration of Gases From Coal.—The term *transpiration*, as here used, relates to the more or less steady outflow of occluded gases from the pores of the coal. It has been found by numerous experiments that the velocity of transpiration, like the velocity of diffusion, is different for different gases subjected to the same pressure. The velocity of transpiration, however, follows a different law from that of diffusion. Table XV gives the relative velocity of transpiration for each of the common mine gases as obtained from Graham's experiments.

It will be observed that the velocity of transpiration, unlike that of diffusion, is independent of the density of the gas.

114. Effect of Rate of Transpiration.—The rate of transpiration of the different gases occluded in the coal has an important effect in determining the character of the gaseous mixtures issuing from the seam and the gaseous condition of the mine workings. The more rapid transpiration of the hydrocarbon gases, as methane (marsh gas) and ethylene (ethylene or olefiant gas), tends to increase the percentage of these gases in the mine air; while the percentage of carbon dioxide (carbonic acid) and nitrogen, which are always present to some extent in the coal, is decreased by the same cause. Owing to this difference in the rate of transpiration of the gases, it has been a difficult matter to determine, with accuracy, the percentage of different gases in different coals. The results of a large number of analyses, however, show that the principal occluded gases are methane (marsh gas), nitrogen and carbon dioxide (carbonic acid). In some coals, methane has been shown to form 93 per cent. of the occluded gases of the coal; in other coals, nitrogen gas has formed 91 per cent. of these gases; while in still other coals, carbon dioxide (carbonic-acid gas) has formed 54 per cent. Oxygen rarely exceeds 4 or 5 per cent. of the occluded gases of coal, and is usually much less.

115. Feeders and Blowers.—Wherever a cavity, crevice, or fissure exists in proximity to or in connection with a gaseous seam, it becomes charged with the occluded gases of the seam, under the same pressure. A dangerous reservoir of gas is thus formed, which may at any moment be pierced or tapped by the drill of the miner, or find vent into the mine workings through a crack or crevice. Such cavities, crevices, or fissures charged with gas are termed *feeders*, and, when tapped, the stream of gas issuing is called a *blower*. A blower may continue to discharge gas for a length of time depending on the size of the blower, the size of the feeders, and the area drained thereby.

116. Outbursts.—In working coal seams in some localities, the presence of occluded gases is frequently manifested by a violent outburst at the working face. These outbursts often take place without warning and produce an effect similar to that of an explosion, throwing down the coal in large quantities.

The cause is a feeder of gas finding access to a more or less vertical crevice or cleat behind the working face of the coal. Its pressure thus becomes distributed over a considerable area of coal, and exerts a powerful localized force.

Fig. 11 represents a dangerous pocket of gas lying beneath an impervious stratum of close-grained rock, which



FIG. 11

has prevented its escape. The gas is under enormous pressure, incident to the great weight of the overlying strata. The cleats or vertical fissures shown in the coal seam are "face cleats," the entry or gangway being driven "end on." The pressure of the gas causes the foliated roof shale to rest heavily on the timbers, and finally breaks the shale, thus opening a communication for the gas with the cleats of the coal. The pressure of the gas is thereby distributed over a large area, often throwing down tons of coal or shale with the force of an explosion.

There are well-authenticated, although seemingly incredible, cases on record where headings and chutes have been completely blocked by a compacted mass of from 15 to 20 tons of fine coal, thus thrown from the face without the

slightest warning. In other instances, the outburst may be accompanied by a subterranean pounding, or "bumping," as the miners term it, or by a sudden report, similar to that of a blast. This pounding, or "bumping," sometimes continues at intervals for 2 or 3 days prior to the outburst. By far the larger number of violent outbursts are of methane (marsh gas); although instances are recorded of very violent outbursts of carbon dioxide (carbonic-acid gas).

GOB FIRES

117. A **gob fire** is a fire occurring in the gob or waste material produced in mining coal and left underground. The gob consists of rock, slate, bony coal, which is more or less combustible, and also a considerable amount of fine coal or slack. The moist condition of the mine workings assists the slow combustion of the fine coal and slack and not infrequently sufficient heat is developed in the mass to produce the spontaneous combustion of the coal, or the woody material with which it may be in contact. The gas produced by the incomplete combustion of the carbon is largely carbon monoxide CO , which is combustible and which therefore assists in spreading the fire.

Gob fires occur more frequently under moist conditions and where the ventilation is sluggish. Some coals, more highly inflammable than others, are particularly subject to spontaneous combustion, and gob fires occur more frequently in mines producing such coals. Gob fires are often a menace to the mine on account of the noxious gases given off and because the fire may extend to the unmined coal. If gas feeders occur in the floor of the workings, the gas is often fired by the heat of the combustion in the gob, and the flame travels back in the waste, where it continues to burn, often resisting all efforts to extinguish it.

TREATMENT OF GOB FIRES

118. The first indications of fire in the gob should receive prompt attention, as any delay can only result in increasing the danger and difficulty to be encountered in the

treatment of the fire. The method of treatment will depend on the stage of progress of the fire, and may be described as follows.

119. Loading Out.—If the fire is a small one and is so located that it can be reached by cars or barrows, all the hot material undergoing slow combustion should be loaded into cars and taken to the surface, and no trace of fire allowed to remain; no water should be used in this case, as the addition of moisture tends to increase the difficulty. The locality should then be thoroughly ventilated by a good current of pure air, to remove as far as possible the gases that still remain in the gob, and to reduce the temperature of the mine by carrying away the heat generated by the slow combustion. By this means, the conditions favoring the combustion are gradually removed.

120. Exploding Dynamite.—When gas feeders have become ignited by a gob fire or by the flame of a blast or otherwise, and the flame has traveled back through the gob, it may often be extinguished by the explosion of a small portion of a stick of dynamite close to the place. The concussion produced by the explosion of the dynamite will often extinguish the flame of the burning gas when other means have failed.

121. Sealing Off With Stoppings.—If fire has penetrated into the gob to such an extent that the method of loading out the material is impracticable, owing to the large amount of waste material to be handled, the section of the mine in which the fire is located must be isolated by stoppings built at the mouth of the room or rooms if the fire is local, or at all points leading to the affected section of the mine if it is more general. The work of building these stoppings must be commenced at the return end of the district, and proceed in order toward the intake, the stopping at the intake end being closed last, in order to avoid a dangerous accumulation of explosive gas, which might result in a serious explosion if the stopping were built in the reverse order. The stoppings are built of brick laid in fireclay, or of concrete,

and should be well sealed to prevent air reaching the fire. Tubes or pipes should be built in the first and last stoppings or at other suitable points, to afford the means of testing, from time to time, the gas coming from the enclosed space; these pipes should be tightly closed with plugs.

122. Sealing Off With Culm.—Instead of brick or concrete stoppings, culm is often used very successfully for closing off a mine fire. The culm mixed with water is run into the mine through pipes, just as is done when the workings are flushed with culm to support the top so that the pillars may be removed. In this way, a practically airtight barrier is made around the fire, which barrier is allowed to remain until all the fire dies out through lack of oxygen to support it. The culm is then loaded out if it is desired to get at the place where the fire was; or, if it is not necessary to reach the place, the culm is allowed to remain and thus prevents any recurrence of the fire.

123. Flooding.—The flooding of a mine or any portion of it, for the purpose of extinguishing a mine fire, should only be employed as a last resort. The enforced idleness of the mine, or any portion of it, and the damage caused by the water, together with the expense of pumping out the water when the fire is extinguished, are sufficient reasons why this means should not be employed till other methods have failed or been proved impracticable. Where flooding is necessary, substantial dams are built across the openings leading to the section of the mine where the fire is located. The dam should be located so as to reduce the area of the workings to be flooded to a minimum. The flooding may be accomplished from an opening connected with the workings, or through a bore hole sunk from the surface. The water may be pumped or drained into the workings. A sufficient length of time is allowed for the water to penetrate all portions of the affected area.

124. When a sufficient time has elapsed for the extinguishment of the fire, which should not be less than a month or 6 weeks, and sometimes longer, according to the size of

the fire and the area flooded, the water is drained or pumped from the workings, which are then ventilated and dried by a strong current of pure air. The work of opening a flooded section of a mine should proceed with caution, the return stoppings being taken down first, and afterwards the stoppings at the intake end of the district. As early as possible, an examination should be made of the flooded area, to ascertain if the fire has been thoroughly extinguished. The drying of the workings should be accomplished as quickly as possible, and a careful watch kept for any evidences of heat in the gob. Safety lamps should always be used when entering an area that has been closed for any length of time, and a careful test made for any accumulations of gas.

MINE GASES

OCCURRENCE, PROPERTIES, BEHAVIOR, AND DETECTION OF MINE GASES

GASES COMMON TO MINES

1. The gases met with in mines are comparatively few in number, but a thorough knowledge of their occurrence, properties, behavior, and the manner of their detection is important. In Table I are given the names, chemical symbols, and specific gravities of the gases most commonly occurring in mines, considered in the order of their importance.

TABLE I

Gas	Symbol	Specific Gravity (Air = 1)
Marsh gas (methane, or carbureted hydrogen)	CH_4	.559
Carbon monoxide, carbonic oxide (white-damp)	CO	.967
Carbon dioxide, carbonic-acid gas (black-damp, or chokedamp)	CO_2	1.529
Hydrogen sulphide, sulphureted hydrogen (stinkdamp)	H_2S	1.175
Olefiant gas (ethene, or ethylene)	C_2H_4	.973
Nitrous oxide (laughing gas)	N_2O	1.525
Nitrogen	N	.971
Oxygen	O	1.106
Hydrogen	H	.069

2. Marsh Gas (Methane, or Carbureted Hydrogen, *CH₄*).—Marsh gas issues from the coal, being one of the gases occluded, or imprisoned, in coal during its formation. It was produced by the gradual change that converted vegetable matter into coal, wherever this has taken place with the exclusion of air and under water. Marsh gas is a colorless, odorless, and tasteless gas having a specific gravity of .559. It diffuses rapidly in the air, forming an explosive mixture. The gas is not poisonous, and when mixed with air in sufficient proportion a person may breathe it with impunity for a considerable time, suffering only a slight dizziness, which passes off when the person returns to fresh air. Pure marsh gas will not support life, but suffocates by excluding oxygen from the lungs. It is combustible and burns with a blue flame, but will not support combustion; that is, unmixed with air, it extinguishes the flame of a lamp. Being lighter than air, this gas accumulates at the roof and in the higher portions of the mine workings, except when removed by the ventilating current. The presence of marsh gas in mine air is detected by its effect on the flame of a safety lamp. When present in sufficient quantity, it produces a flame cap, the height of which increases with the percentage of gas present.

3. Carbon Monoxide, Whitedamp, or Carbonic Oxide, *CO*.—Carbon monoxide occurs in the coal as an occluded gas to a limited extent only. Its chief source of production in the mine is the slow combustion of carbonaceous matter in a limited supply of air; it is one of the chief products of gob fires, and is also produced largely in the imperfect explosion of blasting powder. In mine explosions, it may be produced in large quantities by the reaction of incandescent carbon or soot on carbon dioxide (carbonic-acid gas). It is an odorless, colorless, and tasteless gas having a specific gravity of .967; its diffusion in the mine air is not so rapid as that of marsh gas (methane); it is combustible, burning with a pale blue flame, but, by itself, does not support combustion. Lamps burn more brightly in air

containing it than in pure air, which fact, added to its poisonous character, renders it the most deadly and dangerous of all mine gases. Mixed with air, it has the widest explosive range of any of the mine gases, except hydrogen; its effect, when present in a firedamp mixture, is to widen the explosive range of the firedamp. Carbon monoxide, even in small proportions, is extremely poisonous; it combines with the coloring matter of the blood and prevents it from carrying oxygen to the tissues. It acts on the human system as a narcotic, producing drowsiness or stupor, followed by acute pains in the head, back, and limbs, and afterwards by delirium and death if relief is not obtained. Being lighter than air, this gas accumulates in the roof and upper portions of mine workings, except when removed by the air-current. The presence of this gas is detected in the mine air by its effect in brightening and lengthening the flame of the lamp; the gas, when present in sufficient quantity, causes the flame to reach upwards in a slim, quivering taper.

4. Carbon Dioxide, Blackdamp, or Carbonic-Acid Gas, CO_2 .—Carbon dioxide always exists as an occluded gas in the coal; its chief source of production in the mine, however, is the combustion of carbonaceous matter, whether slow or rapid, in a plentiful supply of air; it is a product of the burning of lamps, breathing of men and animals, combustion of coal and powder, and decay of timber; it is also given off in considerable quantity in the evaporation of calcareous mine water that has been under pressure and from which the pressure has been removed. It is a colorless and odorless gas having a specific gravity of 1.529; when breathed in sufficient quantity, it produces a distinctly acid taste; it diffuses slowly in the air, which increases the difficulty of its removal by the ventilating current. This gas is not combustible and does not support combustion. The presence of small quantities of the gas dims the flame of the lamp; when larger quantities are present, the flame is extinguished. When present in firedamp mixtures, its effect is to reduce the explosive violence of the mixture. It is not

poisonous, but suffocates by excluding oxygen from the lungs; when breathed for some length of time, small quantities of the gas cause headache and nausea, followed by pains and weakness in the back and limbs; larger quantities produce death. Being heavier than air, this gas accumulates at the floor and in the lower mine workings, except as removed by the air-current. The presence of this gas in mine air is detected by the dimness of the lamps, and the total extinction of the flame when a large percentage of the gas is present. It is called *blackdamp* because it puts out a light, and *chokedamp* because it produces a choking sensation when breathed.

5. Hydrogen Sulphide, Stinkdamp, or Sulphureted Hydrogen, H_2S .—Hydrogen sulphide is produced in the mine by the disintegration of pyrites occurring in the coal or the underlying or overlying strata. It is produced in smaller quantities by the explosion of powder and the evaporation of mine water. It is a colorless gas having a disagreeable taste and possessing a strong odor resembling that of rotten eggs; its specific gravity is 1.175; it diffuses slowly into the air; the gas is combustible but will not support combustion. Mixed with seven times its volume of air, it forms a violently explosive mixture.

It is extremely poisonous, combining with the coloring matter of the blood. When breathed in small quantities, it deranges the system; and in larger proportions produces unconsciousness, prostration, and death. Being heavier than air, this gas accumulates at the floor and in the lower mine workings. The presence of this gas is easily detected by its smell.

6. Olefiant Gas, Ethene, or Ethylene, C_2H_4 .—Though present in small amounts, olefiant gas forms one of the important gases occluded in coal. It is one of the products of the formation of coal. It is a colorless gas having a faint odor resembling ether; its specific gravity is .974; it diffuses rapidly in the air; it is combustible, burning with a brilliant white flame, but will not support combustion. Mixed with

air, it is powerfully explosive, requiring twice its volume of oxygen for its complete combustion. It is not poisonous; in the mine it is always associated with marsh gas (methane) to a greater or less extent, and possesses like properties with this gas; it will not support life or flame, but is never present in sufficient quantity, however, to produce suffocation. It is lighter than air, and with marsh gas accumulates at the roof. In the mine, it does not form a distinct gas; its presence in firedamp mixtures, however, is important, as it widens the explosive range and increases the explosive force of the firedamp. The gas is not easily detected in the mine, but its presence is manifested by the more active behavior of the flame and the tendency of the lamp to fill with flame almost before a cap is observed. Olefiant gas produces very much the same effect on the lamp as is produced by marsh gas.

7. Nitrous Oxide, N_2O .—This gas, commonly known as *laughing gas*, and often employed by dentists to produce unconsciousness, frequently forms one of the constituent gases of the afterdamp produced in a mine explosion. It is a colorless and odorless gas having a distinctly sweet taste and a specific gravity of 1.525; it diffuses slowly in the air; it supports combustion with almost as great energy as oxygen. When breathed, the gas quickly produces unconsciousness; it is not, however, a poisonous gas, and its narcotic effect is only of short duration. Owing to the fact that lamps burn freely in this gas, its presence in afterdamp, like that of carbon monoxide (carbonic oxide), is unsuspected except by the effect produced on the system. The gas is heavier than air, its density being almost equal to that of carbon dioxide (carbonic-acid) gas.

8. Nitrogen, N .—Nitrogen occurs as an occluded gas in coal in widely varying proportions. On the average it is probably below 10 per cent., but it has been found to constitute as much as 95 per cent. of the gas from pockets in some localities. One of the chief sources of nitrogen, however, is the atmosphere, of which it forms about 80 per cent.,

or four-fifths, by volume, and about 75 per cent., or three-fourths, by weight. As the oxygen of the air-current is consumed, in its passage through the mine, by the various forms of combustion, the percentage of nitrogen remaining in the air is greatly increased. Nitrogen is a colorless, odorless, and tasteless gas, and has a specific gravity of .971; it is not combustible and will not support combustion; it is not poisonous, but suffocates by excluding oxygen from the lungs in the same manner as carbon dioxide. It is lighter than air, and when present in large quantities should be found at the roof of the mine workings; it is distinguished in the mine from carbon dioxide by its lower density, carbon dioxide collecting at the floor and nitrogen at the roof. The effect of nitrogen is to dim the flame of the lamp and to extinguish it when present in sufficient quantity.

9. Oxygen, *O*.—Oxygen is the greatest supporter of animal life and combustion; it exists in very minute quantities as an occluded gas in some coals; its chief source, however, is the atmosphere, of which it forms 20.7 per cent. by volume, or practically one-fifth. It is a colorless, odorless, non-poisonous, and tasteless gas somewhat heavier than air and has a specific gravity of 1.106. When present in excess in the atmosphere it produces an exhilarating effect on the system, increasing the circulation of the blood.

10. Hydrogen, *H*.—The occurrence of free hydrogen in mines is very rare; it is produced in the afterdamp of some mine explosions, particularly when the firedamp mixture contains more than 9.5 per cent. of marsh gas—in other words, when the percentage of marsh gas (methane) in the firedamp is in excess of that required to produce a maximum explosive force. Hydrogen is a colorless, odorless, and tasteless gas, having a specific gravity of .069, and diffuses with great rapidity in the air, being the lightest gas known. It is not uncommon for miners to mistake marsh gas, or carbureted hydrogen, for hydrogen.

MIXTURES OF MINE GASES

11. The several mine gases described rarely occur in mines in a pure state, or unmixed with air or other gases. The kinds and proportions of the gases found in different mines vary greatly. Not only is the composition of the gaseous mixture given off from different coals quite variable, but the mixture of gases issuing from the coal is constantly being varied by mixing with air and by the various processes of oxidation continually taking place in the mine, producing frequently quite complex and varying mixtures. The nature of these gaseous mixtures is determined by the kinds and proportions of the several gases of which they are composed. The gases are mechanically mixed and have no chemical effect on each other, except as they combine owing to a rise of temperature. The various forms of oxidation that are continually taking place in the mine consume a portion of the oxygen of the mine air, leaving the remaining atmosphere poor in oxygen and containing an excess of nitrogen and a considerable percentage of carbon dioxide.

12. Firedamp.—In American practice, the term **firedamp** relates to any explosive mixture of marsh gas (methane) and air, together with such other gases as may be associated with marsh gas. In England, firedamp is another name for marsh gas and its associated gases. The explosive character of any gas is only developed when the gas is mixed with air in certain proportions. The maximum explosive force is developed when the proportion of air is such as is required for the complete combustion of the gas. Too little air results in a partial combustion of the gas and reduces the force of the explosion; too much air dilutes the gas and also lessens the force of the explosion. The reaction that takes place and the gaseous products of the explosion also vary with the proportion of air in the mixture.

13. Pure marsh gas will extinguish the flame of a lamp, but the flame will burn in a mixture of this gas with a sufficient quantity of air. If an increasing proportion of air is

added to pure marsh gas, the effect is manifested by an increased disturbance of the flame of a lamp, and the mixture begins to be explosive when the proportion of marsh gas to air is 1 to 5, which is called the *lower explosive limit*. The maximum explosive force is developed when the proportion of gas to air is 1 to 9.66; and the mixture ceases to be explosive when the proportion of gas to air is 1 to 13, which is called the *higher explosive limit*.

Table II expresses the proportion of gas to air, and the percentage of gas in the mixture for firedamp, at its lower explosive limit, its maximum explosive point, and its higher explosive limit.

TABLE II

Explosive Range	Proportion of Gas to Air		Percentage of Marsh Gas in the Firedamp Mixture
	Gas Volumes	Air Volumes	
Lower explosive limit . .	1	5.00	20.00
Maximum explosive point	1	9.66	9.38
Higher explosive limit . .	1	13.00	7.14

14. A more or less definite mixture of marsh gas with carbon dioxide is often found in mine workings generating both of these gases. The name **flashdamp** has been proposed for this mixture, for the reason that it is difficult to observe the flame cap produced by it in the Davy lamp owing to its short duration. The mixture to which this name has been given contains sufficient carbon dioxide to render it inexplusive. When a safety lamp containing fresh air within the gauze is raised quickly into the mixture, a flame cap appears for a moment, but passes away as quickly as the mixed gases enter the lamp, the flame also growing dim and often dying out. When the mixture contains more marsh gas than it does carbon dioxide, it is lighter than air and is found near the roof; when it contains more carbon dioxide than marsh gas, it is heavier than air and is found near the floor.

15. Effect of Other Gases and Dust on Firedamp.

The effect of the presence of other gases is to narrow or widen the explosive range of the firedamp according to the kind and amount of the gases present.

1. *Carbon dioxide (carbonic-acid gas)*, CO_2 , mixed with firedamp makes the mixture less explosive, or, in other words, narrows the explosive range of the firedamp. The addition of one-seventh of its volume of carbon dioxide, CO_2 , to a mixture of firedamp at its most explosive point, renders the firedamp inexplusive.

2. *Carbon monoxide (carbonic oxide)* mixed with firedamp widens the explosive range of the firedamp, thereby making mixtures explosive that would not otherwise be explosive.

3. *Olefiant gas (ethylene)*, C_2H_4 , in a firedamp mixture renders it more easily ignitable; this gas also increases the explosive force of the mixture.

4. *Coal dust* suspended in the air widens the explosive range in the same manner as does carbon monoxide. Under the influence of flame, carbon monoxide, CO , is formed by the partial combustion of the coal dust suspended in the air.

5. *Nitrogen* in a firedamp weakens the explosive force of the mixture by the dilution of the gas, the nitrogen being inert. The addition of one-sixth of its volume of nitrogen to a mixture of firedamp at its most explosive point, renders the mixture inexplusive.

16. Effect of Pressure and Temperature on Fire-damp.—An increase of pressure raises the temperature of ignition of any combustible gas. When firedamp is exploded under an increased pressure, not only is the temperature of the explosion raised, but the explosive force is very much increased. The volume and intensity of the flame are important factors in maintaining the combustion of a body of gas. The larger the volume of flame, the greater is the amount of heat developed, which overcomes the cooling of the gases and extinction of the flame due to the lower temperature of the surfaces in contact with the gas. This is illustrated by the fact that a mixture of one part of marsh

gas with thirteen parts of air will not explode in a glass tube $\frac{3}{4}$ inch in diameter, while a mixture of one part of gas to twelve of air fails to explode in a tube $\frac{1}{2}$ inch in diameter, due in each case, to the cooling effect of the tube on the smaller volume of gas passing through it.

The size of the openings in a mine also exerts a similar effect on the ignition and explosion of accumulated bodies of gas. This would indicate, to a certain degree at least, that the ignition of a body of gas is more difficult, or requires a larger volume or higher temperature of flame, or both, in narrow contracted openings than in larger openings. Whatever decreases the temperature of gases or increases their tension (pressure) decreases likewise the danger of their ignition; but when the pressure is thus increased and the gas ignited, the explosion is more powerful. It may be stated further, however, that, when an explosion has once started, the force of the explosion and the temperature developed is greater in thin seams and contracted openings than in thick seams and wider openings, owing to the contracted openings affording less opportunity for the expansion of the gases and the consequent reduction of the temperature.

17. The explosive limits of firedamp under the varying conditions of mining are extremely variable, and it is practically impossible to place any exact limits within which mixtures of marsh gas and its associated gases are explosive when mixed with the air of the mine, since this depends on the character of the gases and the proportions in which they are mixed, as well as on the volume of the explosive gases and the volume and intensity of the flame causing the ignition. Bodies of gas that are not explosive under ordinary conditions may suddenly become explosive under conditions that are liable to be produced at any moment in mine workings.

A gaseous condition of the mine air that is considered safe under ordinary conditions may be rendered explosive: (*a*) by the suspension of dust in the mine air; (*b*) by the increase of pressure due to a blast or to the explosion of another body of gas; (*c*) by the flame of a blown-out shot.

18. Afterdamp.—The mixture of gaseous products resulting from the explosion of a body of gas in a mine is called **afterdamp**; its composition is extremely variable, depending on the conditions of the explosion—whether or not they were favorable to complete combustion. The character of the afterdamp is greatly affected by the relative proportions of the air and marsh gas (methane) forming the firedamp. When the firedamp contains 9.66 per cent. of marsh gas, there is sufficient air in the mixture for the complete combustion of the carbon and hydrogen of the marsh gas. When the firedamp contains a greater proportion of gas than this, there is insufficient air for its complete combustion; and when less gas is present, there is an excess of air over what is needed for the combustion of the gas. The complete combustion of firedamp in air produces carbon dioxide (carbonic-acid gas), CO_2 , and water, H_2O , mixed with the nitrogen of the air that remains unchanged. Firedamp containing an excess of marsh gas, CH_4 , or an insufficiency of air for its complete combustion, produces carbon dioxide, CO_2 , carbon monoxide, CO , water, H_2O , and free hydrogen, H ; the proportion of carbon dioxide and water produced decreases, and the proportion of carbon monoxide and free hydrogen increases, as the excess of marsh gas in the original firedamp mixture is increased. Experiments in the laboratory show that a mixture of one volume of marsh gas with four and one-half volumes of air produces nine volumes of carbon monoxide for one of carbon dioxide, and much free hydrogen, together with a little water. It has been concluded, therefore, that under favorable conditions of temperature the burning of a firedamp mixture containing one volume of gas to three volumes of air will produce only carbon monoxide and free hydrogen mixed with the remaining nitrogen of the air; this forms the most deadly afterdamp.

Afterdamp frequently contains a limited proportion of nitrous oxide (laughing gas). Both this gas and carbon monoxide act as narcotics to produce stupor and unconsciousness. Extremely small percentages of carbon monoxide are quickly fatal. Victims of this gas have been often found in

lifelike positions, and with a peaceful and smiling expression on their dead faces. In one instance, a man was found with his hand to his mouth in the act of biting a piece of bread; these victims show no bruises or injury to the body, but have died from the poisonous effects of the afterdamp.

IGNITION OF GASES

19. Inflammable Mine Gases.—The inflammable gases commonly occurring in mines are marsh gas (methane, or carbureted hydrogen), CH_4 , carbon monoxide (white-damp), CO , and hydrogen sulphide (sulphureted hydrogen, or stinkdamp), H_2S . Any of these gases will ignite in the presence of air or oxygen when the temperature of the gas is raised to its point of ignition. Mines giving off marsh gas in dangerous quantities are called **gaseous**, or **fiery**, **mines**, and the working of such mines is often extremely difficult owing to the danger of igniting the gas and causing an explosion more or less disastrous in its results.

20. Temperature of Ignition.—Each of the inflammable gases requires for its ignition a certain definite temperature, known as the **temperature of ignition** of the gas. After ignition has taken place and flame is produced, if the burning gas is cooled by contact with a cold surface below the temperature of ignition, the flame is extinguished. The temperature of ignition of the common mine gases is given, approximately, in Table III.

TABLE III

Gases	Temperature of Ignition Degrees F.
Marsh gas (methane, carbureted hydrogen), CH_4	1,202
Ordinary illuminating gas	1,198
Carbon-monoxide, CO	1,202
Hydrogen, H	1,080
Hydrogen sulphide, H_2S	750

21. Temperature of the Flame.—The temperature of the flame of a burning gas is not a fixed temperature, as is its temperature of ignition. The combustion of a given weight of a gas produces a certain number of heat units, but the temperature of the combustion will vary greatly according to the conditions under which the combustion takes place. If flame is produced, the temperature of the flame will likewise vary according to the surrounding conditions. While the rapidity of the combustion tends to increase the temperature, the influx of cold air, or contact with cold surfaces, reduces it, and may even extinguish the flame. The presence of moisture and its conversion into steam also reduces the temperature of the resulting products of combustion. The flame of an explosion of marsh gas (methane) may have any temperature varying from 1,202° F. to 3,902° F. (assuming gas at constant volume), the former being the temperature of ignition and the latter the greatest initial temperature developed by the complete explosion of this gas. A free expansion of the gases produced in an explosion rapidly lowers the temperature of the burning gases, while a contracted condition of the mine workings increases this temperature.

In blasting with black powder, the flame of the blast may likewise vary from 1,200° F. to about 3,600° F., according to the conditions under which the charge is exploded. Ordinarily, the flame projected from the mouth of a hole in blasting, or the flame of a blown-out shot, may be assumed as having a temperature of about 2,000° F. A knowledge of the temperature of flame is important in considering the ignition of mine gases, mine explosions, the safety lamp, and the use of explosives for blasting in the mine.

22. Causes of the Ignition of Mine Gases.—The ignition of an inflammable gas requires some means of raising its temperature to a point at least equal to the temperature of ignition. The cause of ignition may be: the flame of a naked lamp, of a match, or of a defective safety lamp; the flame incident to blasting; sparking or incandescence of

electric wires; a mine fire; etc. Each of these causes produces a temperature greater than the temperature of ignition of marsh gas (methane), which cannot be ignited by a glowing ember or spark of wood where no flame is present.

A peculiarity in the ignition of marsh gas is that the temperature must be maintained at or above the temperature of ignition of the gas for a certain period of time before the ignition of the gas will take place. This time, although but the fraction of a second, is of the utmost importance in mining, since it renders possible the use of many detonating explosives without fear of the ignition of the gas. The explosion of dynamite, for example, develops a high initial temperature much above the ignition temperature of marsh gas, but so rapid is the action of the explosive that this high temperature is only maintained for a very short time. The expansion of the gas that immediately follows the explosion lowers the temperature to a point considerably below the ignition temperature of marsh gas, and prevents the ignition of this gas. This fact also accounts for the absence of any considerable amount of flame in the use of such explosives.

23. Ignition of Mine Gas by Incandescent Lamps.

The breaking of an incandescent electric lamp may or may not be attended by the ignition of a surrounding body of firedamp; much will depend on the kind of lamp used. Incandescent lamps are of two general types, for low and high voltage, the lamps differing chiefly in the style of filament used. A low-voltage lamp designed for large currents has generally a short, thick filament, or carbon, while a high-voltage lamp with a small current has a long, thin filament. The character of this filament, together with the manner in which the lamp is broken, in a large measure determines whether the gas will be ignited or not.

In the breaking of a lamp, two cases may arise: (1) The filament may remain unharmed when the glass is broken, in which case the ignition of a surrounding body of firedamp is almost certain to take place, either by the contact of the gas with the glowing filament or by the sparking that occurs

when the latter burns out or is broken. (2) More commonly, in mining practice, the globe and filament are both broken by the same blow; in this case, the question of the ignition of the gas will depend almost wholly on the kind of filament. The rush of the gas and air into the vacuous space at the instant of the breaking of the lamp causes a momentary cooling not only of the explosive mixture but also of the filament. The thin filament of a high-voltage lamp is cooled very rapidly, much more quickly than the thick filament of the low-voltage lamp, and during this short moment of cooling, the filament is broken by the same blow that broke the globe. The rapid cooling of the thin filament is accomplished before the temperature of the explosive mixture can be brought to the point of ignition of the gas; in other words, the thin filament of a high-voltage lamp does not contain sufficient heat to raise the temperature of the explosive mixture rushing on it to its point of ignition. The thicker filament of a low-voltage lamp contains more heat, and is not cooled as rapidly by the rush of the expanding air and gas, and enough heat is retained by this filament to cause the ignition of the gas.

24. The Condition of Air in Mines.—The gaseous condition of mine air means the proportion of noxious gases contained in the air circulating through the mine. A certain proportion of such gases in mine air produces: (1) an explosive atmosphere; (2) a dangerous atmosphere, which if breathed affects the respiration and may produce insensibility; (3) a fatal atmosphere, producing death in a short time; (4) an extinctive atmosphere, in which the flame of a candle or an ordinary oil lamp will not burn. The nature of the gas present and the extent to which the oxygen of the air has been diminished determine which of these effects is produced.

25. An explosive condition of the mine air is developed when the air contains a certain proportion of inflammable gas. There is a definite proportion of air and each of the explosive gases that produces the maximum explosive effect, but for each gas there is a lower and a higher explosive limit,

and any proportion of gas and air between these limits forms an explosive mixture. The lower and higher limits determine the *explosive range* of the gas. Marsh gas (methane) has the least explosive range of any of the inflammable mine gases, and hydrogen the greatest; the explosive range of carbon monoxide (carbonic oxide) is almost equal to that of hydrogen. Table IV gives the proportions of gas and air forming the lower and higher explosive limits for the more important mine gases.

TABLE IV

Gases	Lower Explosive Limit	Higher Explosive Limit
Marsh gas (methane), CH_4 .	1 : 5	1 : 13
Ethylene (olefiant gas), C_2H_4 .	1 : 4	1 : 22
Carbon monoxide (carbonic oxide), CO	1 : 13	1 : 75
Hydrogen, H	1 : 5	1 : 72

26. In a **dangerous atmosphere**, the danger may arise from an explosive condition of the air or from the presence of poisonous or other noxious gases. A **fatal atmosphere** is one containing such a percentage of these gases as will produce results fatal to life. A dangerous atmosphere when breathed for a long period of time may produce fatal results. The poisonous mine gases are carbon monoxide, CO , $\frac{1}{2}$ per cent. of this gas being fatal to life when breathed for some time, and hydrogen sulphide, H_2S , about 1 per cent. of this gas being likewise fatal when breathed a sufficient length of time. An atmosphere in which lights are extinguished is not always dangerous to life, nor will lights always go out in an atmosphere that is dangerous to life. Lights are often extinguished by an atmosphere that may be breathed for a long time without injury further than a possible headache; on the other hand, lights often continue to burn brightly in an atmosphere that will cause insensibility and death in a short time.

TABLE V

	Irrespirable and Extinctive Gases					
	O Per Cent.	N Per Cent.	CO ₂ Per Cent.	Inflammable Gases		Poisonous Gases Per Cent.
				CH ₄ Per Cent.	CO Per Cent.	
Pure air	20.7	79.3	trace			
FATAL ATMOSPHERES						
Air and nitrogen	7.0	93.0				
Air and carbon dioxide (carbonic-acid gas), CO ₂	17.2	64.8	18.0			
Air and methane (marsh gas), CH ₄	7.0	26.3		66.7		
Air and carbon monoxide (carbonic oxide), CO Air and hydrogen sulphide	20.6 20.5	78.9 78.5			.5	1.0

Dangerous or fatal atmospheres depend on the amount of oxygen and the nature of the gases present in the air. Table V gives the composition, by volume, of the fatal atmospheres produced by the mixture of air with the several mine gases that are commonly said to be irrespirable.

It will be observed that, in the case of the poisonous gases, a very small percentage of the gas added to the air produces a fatal atmosphere, notwithstanding that the percentage of oxygen in this case remains almost normal. In the case of both nitrogen and marsh gas, the addition of the gas to the air does not produce a fatal effect until the amount of oxygen in the mixture has been reduced below what is necessary to support life. The minimum amount of oxygen required in the air to produce fatal results varies somewhat with the individual. A strong, healthy person may be revived from insensibility after exposure to an atmosphere containing a less percentage of oxygen, while a weak person may succumb to an atmosphere containing a somewhat greater percentage than that given in the table; when an atmosphere containing but 10 per cent. of oxygen has been breathed for 10 or 12 hours, the result will prove fatal in the majority of cases. It will be observed, also, that, although carbon dioxide (carbonic-acid gas) is not considered one of the poisonous mine gases, a fatal atmosphere is produced when 18 per cent. of this gas is present in the air, although the oxygen of the air has only been reduced thereby to 17.2 per cent. This is due to the effect produced by the carbon dioxide on the system, there being a marked difference between the action of this gas and that of marsh gas or nitrogen.

27. The **extinctive character** of an atmosphere depends chiefly on the absence of a sufficient amount of oxygen to support combustion. Table VI gives the composition, by volume, of pure air in comparison with that of several atmospheres in which the flame of a candle or an ordinary oil lamp is extinguished. These atmospheres have been determined by experiment, and represent in each case the point where extinction begins.

Each of the atmospheres mentioned in Table VI is respirable, although the last would be breathed with difficulty and produce panting. The air expired from the lungs has practically the same composition as the air left in a vessel in which a candle has been allowed to burn until extinguished by the products of its own combustion. These two atmospheres also show an amount of oxygen slightly less than the percentage of oxygen in the extinctive atmosphere formed when nitrogen is mixed with air. When carbon dioxide (carbonic-acid gas) is mixed with air, the

TABLE VI

	Oxygen	Nitrogen	Carbon Dioxide, CO_2
Pure Air	20.70	79.30	trace
Extinctive Atmospheres			
Air expired from the lungs . .	16.15	79.90	3.95
Atmosphere remaining after candle or oil flame has burned until extinguished . .	16.05	80.80	3.15
Mixture of air and nitrogen .	16.38	83.60	
Mixture of air with carbon dioxide	18.06	67.94	14.00

candle is extinguished when about 2 per cent. more oxygen is present than is the case with the other gases given, probably owing to the fact that the heavy carbon dioxide settles in the bottom of the vessel. In this atmosphere it is interesting to note that the percentage of carbon dioxide is very much greater than in any of the other extinctive atmospheres, showing that the extinction of the flame depends more largely on the diminution of the oxygen than on the character of the extinctive gases—nitrogen and carbon dioxide.

28. Extinction of Oil and Gas Flames.—There are three flames used for giving light—the candle flame, the oil flame, and the gas flame. In the candle flame, three operations are required: the melting of the solid combustible matter, followed by the distillation of the gas, and the burning of the gas to produce flame; the oil flame requires but two operations, the distillation of the gas, followed by the burning of the gas; and the gas flame requires only the burning of the gas. The extinction of the flame in each of these is due to the cessation of combustion, owing either to the fall of the temperature below the point of ignition of the gas, or to the lack of a sufficient quantity of air (oxygen) to support the combustion. The appearance of the flame, however, at the moment of extinction is quite different in the case of the candle or oil flame from that of a gas-fed flame. In a candle or other wick-fed flame, the effect of any cause impairing the combustion is to decrease the distillation of the gas and diminish the size of the flame. In the case of a gas-fed flame, if the supply of gas fed to the flame remains constant, and the supply of air or oxygen is reduced, the flame enlarges instead of diminishing, in its effort to reach a larger supply of oxygen, and it is finally killed or dies out suddenly owing alike to the inadequate supply of oxygen and the reduction of the temperature.

29. There is a great difference in the effect of the same atmosphere on different flames. This difference is most manifest in the flames produced by the burning of different gases. The extinctive effect of any given atmosphere is fairly uniform for all wick-fed flames, but differs with different atmospheres; thus, 13 to 16 per cent. of carbon dioxide (carbonic-acid gas) or 18 to 23 per cent. of nitrogen is required to extinguish different wick-fed flames, while gas-fed flames require for their extinction, according to the flame used, from 10 to 58 per cent. of carbon dioxide, or 17 to 70 per cent. of nitrogen, showing a wide variation in the extinction of gas flames, as compared with wick-fed flames. Table VII shows the composition of extinctive atmospheres

formed by the mixture of carbon dioxide and nitrogen, respectively, with air.

Since the combustible mine gases are not supporters of combustion, the peculiar phenomenon is often manifested in the extinction of the flame of the lamp when the latter is surrounded and filled with an atmosphere containing a sufficient percentage of such gas, the combustible gas itself burning within the gauze of the lamp, the flame of which it has extinguished. The products of the combustion of the

TABLE VII

Kind of Flame	Fuel	Air and Carbon Dioxide			Air and Nitrogen	
		O	N	CO ₂	O	N
Wick-fed flames	Alcohol (methyl or wood)	18.3	68.7	13	17.2	82.8
	Alcohol (absolute)	18.1	67.9	14	16.6	83.4
	Candle	18.1	67.9	14	16.4	83.6
	Paraffin oil	17.9	67.1	15	16.2	83.8
	Colza oil and petroleum (equal parts)	17.6	66.4	16	16.4	83.6
Gas flames	Marsh gas (methane)	18.9	71.1	10	17.4	82.6
	Carbon monoxide (carbonic-oxide gas)	16.0	60.0	24	15.1	84.9
	Ethylene (olefiant gas)	15.5	58.5	26	13.2	86.8
	Hydrogen	8.8	33.2	58	6.3	93.7

gas assist in the extinction of the wick-fed flame of the lamp, while the extinctive gas itself continues burning, owing to the different effect of the same atmosphere on different flames. This principle is illustrated in the application of the hydrogen flame to the safety lamp. Such a flame will continue to burn long after the common oil-fed flame has been extinguished, and the same principle may have much to do with the wide propagation of a flame by carbon monoxide.

30. Effect of Coal Dust.—Coal dust suspended in the air of mine workings is a most important factor on account of its influence on flame. Much depends on: (1) the quantity and fineness of the dust suspended in the air; (2) the inflammability of the coal; (3) the presence of gas in the air; (4) the volume and intensity of the flame acting on the suspended dust. In a dry, dusty atmosphere, the flame of an ordinary lamp is lengthened. A flame of larger volume and greater intensity, such as the flame of a blast or the flame of an explosion, is often carried long distances by feeding on the carbon monoxide (carbonic oxide) that is formed from the dust suspended in the air. All coal dust is not equally inflammable, and the effect produced on flame is proportionate to the fineness and inflammability of the dust and the amount of volatile matter contained in it. The dust of anthracite, for example, is far less inflammable than the dust of bituminous coal, and for this reason a gaseous and dusty anthracite mine is not as dangerous as a gaseous and dusty bituminous mine. The dust of anthracite is, however, not without effect on a flame; and the fine dust of any combustible substance, when suspended in the air and acted on by a flame, will increase the volume of the flame.

MINE EXPLOSIONS

TYPES OF EXPLOSIONS

31. The term **mine explosion** relates to a more or less violent explosive disturbance caused by the ignition of gas or dust present in the air of the mine. There are three general types of mine explosions: *gas explosions, dust explosions, an explosion of gas and dust combined.* These types differ both in the character of the explosion and the composition of the afterdamp or gaseous products remaining after the explosion.

32. Gas Explosion.—The ignition of a body of fire-damp is accompanied by an extremely rapid expansion of the

gases, due to the high temperature produced by the combustion. The expansion is sudden and violent and occurs without warning, and the force of the explosion is often sufficient to do great damage. When the firedamp mixture consists of more or less pure marsh gas (methane), the effects of the explosion are perhaps more local than when the mixture contains a considerable amount of other gases, particularly carbon monoxide (carbonic oxide), or when coal dust is present.

The effect of a gas explosion depends on numerous conditions: (1) The size of the workings with relation to the body of gas exploded; the explosion of a body of gas in contracted mine workings will produce more violent effects than the explosion of a similar body of gas when the workings are more spacious and the free expansion of the gas is unhindered. (2) The kinds and amounts of gas present in the explosive mixture determines its explosive condition. (3) The temperature and velocity of the air in circulation. A low temperature of the air-current tends to limit the extent of the explosion, while a high velocity of the air-current tends to increase the extent of the explosion. These conditions and many others connected with explosions of mine gases, such as the wet or dry condition of the workings, accumulations of dust, etc., are so varied that it is difficult to analyze the effects of such an explosion. The entire subject of mine explosions is necessarily more or less enshrouded in mystery, for owing to the suddenness of their occurrence and their generally fatal results, the most important witnesses of the occurrence are usually killed.

33. Dust Explosion.—The term **dust explosion** refers to the rapid conversion of fine coal dust suspended in the mine air into gas by the action of a flame, and the explosion of the gas thus produced. A dust explosion thus embraces two operations: the distillation of gas from the fine dust suspended in the air, or the rapid formation of gas from the dust by partial combustion, and the ignition and rapid combustion of the gas produced, accompanied by the

expansion, with explosive force, of the gaseous products of the combustion.

The most important factors in a dust explosion are the fineness and inflammability of the dust, and its free suspension in the mine air; also, the volume and intensity of the flame causing ignition. Perhaps no subject of mining has received more careful attention at the hands of experimenters than that of dust explosions. It was supposed at one time that an explosion of dust was impossible in the absence of gas, many experimenters claiming that the presence of a small amount of marsh gas (methane), less than what could be detected by an ordinary Davy lamp, was absolutely necessary for the ignition and explosion of fine dust. The explosions that occurred in the Camerton collieries, Somersetshire, England, November, 1893, and that in the Timsbury collieries of the same place, February, 1895, both of which were non-gaseous mines, led to renewed experiments and discussion. The results of these later experiments confirmed the opinion that certain inflammable coal dusts were explosive when suspended in air having no trace of explosive gas.

A dust explosion is necessarily not as sudden, though fully as destructive in its effects, as an explosion of firedamp under similar conditions. In general, the effects are more widespread, and, owing to the relatively limited supply of air, the combustion is more incomplete; large volumes of black smoke containing quantities of unburned carbon and coke are produced and forced through the mine passages and often projected far up the shaft and into the outer air. The afterdamp of a dust explosion almost invariably contains much carbon monoxide, *CO*, which, owing to its wide explosive range, is not as liable to be extinguished by the expansion and cooling of the gas in more open workings as is marsh gas (methane); this accounts in part for the transmission of the flame of an explosion over great distances when coal dust is present.

The liability of the flame of an explosion to recoil or return on its own path is greater in the case of a dust

explosion than in a gas explosion, as this recoil is due to carbon monoxide (carbonic oxide) left in the passageways traversed by the explosion. The hot gas collects at the roof, and, to render it again explosive, it needs only the admixture of fresh air, which it receives from the chambers or rooms driven off the passageway. This explosive condition is usually found in the trail of the first explosion, and the slightest cause, such as an expansion of the area of the passage, will cause the ignition of the explosive mixture in the trail, and the flame will burn back along the roof of the passageway, but more quietly than on the advance.

34. Combined Gas and Dust Explosion.—The presence of dust increases both the violence and the extent of an explosion of gas, as there results in this case the combined effects described of the gas and the dust. The initial explosion of the gas loses none of its violence, but its flame is extended and made more voluminous, and projected through the passageways with a more or less continuous effect, depending on the quantity, fineness, and inflammable nature of the dust, and other causes previously stated. It often happens that an otherwise local explosion of a small body of firedamp accumulated at the face of a heading is transmitted long distances through the influence of accumulations of dust, causing the ignition and explosion of other isolated bodies of firedamp. Under such conditions, it is frequently very difficult, if not impossible, to trace the explosion by its observed effects back to its initial point, since each following explosion sets up another center of energy, obliterating more or less the effects produced by the first explosion, and it may frequently happen that any one of the following explosions may be greater in its effect than the first or initial explosion, and may advance on the trail of the first explosion. It may be practically impossible to determine the first cause except by the evidence of the survivors, which, however, is always more or less conflicting owing to the terror and excitement of the situation.

PHENOMENA OF EXPLOSIONS

35. The character of a mine explosion depends entirely on the conditions with respect to the explosive mixture of gases, size and condition of the workings, quantity of air in circulation, etc. No two explosions under seemingly like conditions present the same phenomena, and it often happens that, owing to the multitudinous conditions attending explosions, the results are widely different. The following are, however, a few general phenomena that apply to all explosions.

36. The force developed by the explosion of a body of gas is evidenced by the destruction it accomplishes, and depends on the quantity and composition of the explosive mixture. The immediate destructive effect of the explosion is inversely proportional to the size of the workings; for example, the explosion of a small body of gas in a thin seam with contracted openings will prove equally destructive with that of a much larger body of gas in a thick seam with wider and more extended openings. The center of an explosion is generally made known by the evidences of explosive force radiating from a common point. The direction in which loose material, as coal, timbers, cars, and even doors and brattices, have been blown, indicates the direction of the force and locates the center of the explosion. Each local explosion due to the ignition of a separate body of firedamp forms the center of an explosive force representing more or less closely the quantity and explosiveness of the gas accumulated at that point.

37. An important phenomenon attending nearly all mine explosions is the **transmission of the flame** of the initial explosion to other parts of the mine, igniting other bodies of gas, and propagating throughout the mine what would otherwise have been a local explosion. The manner and the distance the flame of an explosion is transmitted will depend on the amount and composition of the explosive mixture and on numerous conditions with respect to the air-current and

the mine entries and workings. The flame may advance at a moderate velocity, quietly sweeping the roof of the passage, or as a wild rush of fire filling the entire entry with flame, dust, and debris, propelled at a high velocity by the explosive energy. The path traversed by the flame is frequently a haulage road in preference to other passageways, which may be explained by the fact that the powdered coal and dust of the haulage road feed the flame of the explosion. On the other hand, an explosion may pass by a dry, dusty heading and advance for a long distance over a wet haulage road, for the reason, probably, that the supply of fresh air needed to propagate the explosion, as well as a larger quantity of fine coal, is found along the haulage road. In general, it may be said that the question of air supply determines very largely the course of the explosion, since the oxygen of the air is necessary for the combustion that takes place.

In a dusty mine, where the flame has been propagated long distances by the dust of the roadways, or where the flame of a second explosion travels back on the trail of the initial explosion, it is often difficult, if not impossible, to determine the starting point and to ascertain with certainty the first cause, so as to fix the responsibility for the occurrence.

38. The advance of a mine explosion is almost invariably greatest in a direction against the air-current. The distance the flame of an explosion will advance in the opposite direction, or with the air, is dependent on the size of the entries, the quantity of air in circulation, and the amount of fresh air that can reach the entry on the return side of the explosion; on this side, the flame dies out sooner or later for lack of air to support the combustion. On the other hand, there is always a plentiful supply of air to support the combustion on the intake side of the explosion, and for this reason the flame advances more rapidly and further against the air-current.

The distance traveled, the rapidity of the advance, and the violence of the explosion depend on the initial explosive force, the quantity of air in circulation, its gaseous condition

and temperature, and the condition of the entry as being dry or wet, and as containing a greater or less quantity of dust, and the inflammability and fineness of the dust; also, the size of the passageway traversed, and the area of standing workings connecting with or opened off from the entry.

39. The arrest of an explosion may be due to numerous causes. On the return side of the explosion, the flame is checked and finally arrested usually from an insufficient supply of air. On the intake side of the explosion, the flame is usually arrested by a reduction of temperature from contact with the cold air-current, or by a sudden expansion of the burning gas due to an enlargement of the sectional area of the passageway or the proximity of adjoining workings. At times, the advance of the flame is so sudden, owing to the initial force of the explosion, as to cause a too rapid expansion and a consequent reduction of the temperature, and the flame is extinguished from no other apparent cause. A sufficient quantity of carbon dioxide (carbonic-acid gas) or blackdamp might cause the extinction of the flame. Only 10 per cent. of this gas is necessary for the extinction of the flame of pure marsh gas (methane) and 24 per cent. for the extinction of the flame of carbon monoxide (carbonic oxide). Where a certain percentage of ethylene (olefiant gas) is mixed with the marsh gas, a larger percentage of carbon dioxide would be required for the extinction of the flame. The spraying or wetting of the roof, sides, and floor of a dusty passageway, while reducing the quantity of fine dust ordinarily suspended in the air, does not have the effect of materially arresting the advance of the flame of an explosion. This can only be accomplished by the presence of a much larger quantity of water than it is possible to introduce by spraying. In many cases, the flame of an explosion has traversed 200 yards of entry where the roof, sides, and floor were in a very wet condition.

40. The recoil of an explosion is the return of the flame on its own path. Fig. 1 represents a portion of a mine and the manner in which the flame of an explosion

advancing against the air may be arrested and the recoil take place. In the figure, the flame of the burning gases has advanced along the intake against the air-current to a point where the entry widens to provide a double track or parting. At this point, the volume of the flame is expanded

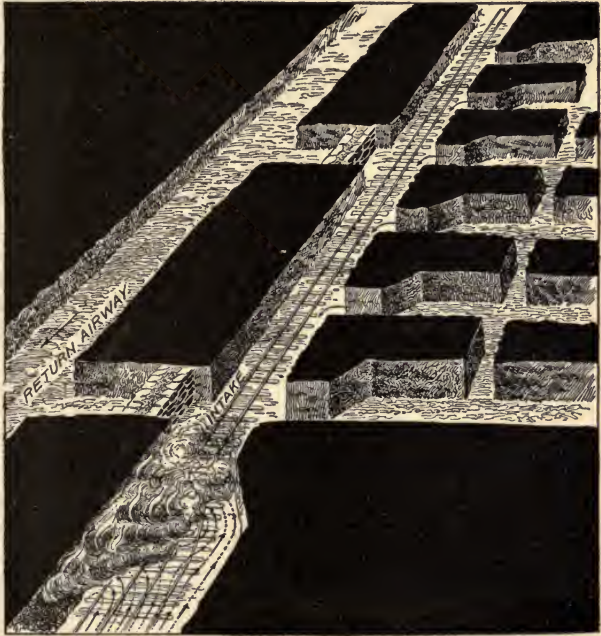

FIG. 1

and its temperature reduced, extinguishing the flame on the side toward the air and arresting its further advance, and permitting the access of the fresh air to the trail of hot combustible gas behind; the flame then starts to burn back on this trail, obtaining a sufficient supply of air for this purpose from the adjoining rooms or chambers.

ENTERING A MINE AFTER EXPLOSIONS

41. Rescue Work.—The work of rescuing any who have been injured or shut in a mine by an explosion must be undertaken promptly and prosecuted with the utmost diligence; only experienced men should be employed for this purpose. Immediately after the occurrence of an explosion, messengers should be despatched for medical aid, and a call made for volunteers to enter the mine; the ventilating apparatus should be examined to ascertain that it is still in working order. The best and most experienced men are selected from the volunteers, and these men are provided, with safety lamps that are in good condition. The necessary materials for repair work, such as brattice boards, canvas, timber, nails, hammers, saws, and axes are carried to the entrance of the mine. The mine must be entered on the intake, and care taken not to proceed in advance of the air. The party is divided into two divisions, one for exploring the air-courses in advance, the other, and larger division, for making the necessary repairs to brattices, doors, stoppings, and air bridges that have been destroyed by the explosion. Only such repairs as are necessary to maintain the air-current ahead of the exploring party are made. The following suggestions are good:

(a) Talk little, and give no advice that is not asked.

(b) Keep a watchful eye on the light of your lamp, and halt the moment the flame becomes unusually dull or bright, or is elongated.

(c) Make no advance ahead of the air, and retreat on feeling the first symptoms of weakness or relaxation of the muscles.

(d) Any survivors should be carried at once to the surface, or to a point where fresh air is traveling and where they can receive medical aid.

42. Care must be taken in the removal of the injured; and, as far as possible, rough handling should be avoided. The treatment of the patient will depend on the character of

the injury; when possible, lay the patient on his back with head and shoulders slightly raised. If he is unconscious, loosen all collars, waistbands, and belts, and dash cold water on the face; rub the body and limbs briskly to start the circulation. If this fails to revive consciousness and medical aid has not arrived, an effort should be made to restore breathing by artificial means, as follows: The tongue should be drawn forwards in the mouth to prevent the obstruction of the throat. The patient lying on his back, the operator kneels at his head and reaching forwards grasps the arms near the elbows and carries them up in an extended position. This movement allows air to enter the lungs. The arms are held in this position for 2 seconds, and then carried downwards and pressed firmly against the sides, forcing the air from the lungs. This movement is repeated, at the rate of, say 15 times per minute until natural breathing returns. The fumes of ammonia or smelling salts are also beneficial. No attempt should be made to give stimulants to an unconscious person through the mouth, as there is danger of strangulation.

Where bleeding results from the injury, means should be taken to stop the flow of blood, especially if from the arteries, which would be indicated by the bright red color of the blood, the venous blood being dark. Profuse bleeding is checked by binding a chord, rope, or bandage tightly around the bleeding member above the wound, or between the wound and the heart. A knot previously tied in the bandage or rope and placed so as to press more tightly against the artery stops the flow of blood more quickly. A short stick is often inserted in the bandage, and the latter tightened by turning the stick.

43. Rescue Appliances and Mine Supplies.—At every mine, there should always be maintained a plentiful supply of materials that may be needed in case of emergency, such as props, caps and timbers of the sizes used, oak tracking, iron rails, iron pipes, ties, brattice cloth, boards, nails, and spikes, together with a sufficient number of extra lamps and tools. In some states, the mine laws specify

that certain emergency supplies shall be kept at the mine; for instance, the bituminous mining law of Pennsylvania requires that there shall be constantly on hand at the mine a full supply of all materials required to preserve the health and safety of the employes, including a stretcher properly constructed, and a woolen and a waterproof blanket in good condition for use; when more than 200 persons are employed, two stretchers, two woolen, and two waterproof blankets are

required. In mines generating firedamp, there is required also a sufficient quantity of linseed or olive oil, splints, bandages, and linens for use in case of accident.

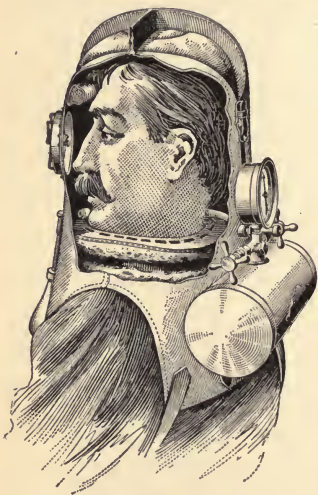

FIG. 2

the end of the tube in the mouth. By this means, a person has been enabled to advance 50 yards ahead of the air. A more common form of apparatus consists of a helmet, or head-protector, fitting over the head and resting on the shoulders. This helmet is made of a double thickness of leather and horsehide chemically treated to render it fire-proof and waterproof.

Fig. 2 shows the Vajen-Bader helmet, which is made in two sizes, the larger size being capable of supplying fresh

44. For entering mine workings after an explosion and before the circulation has been restored, various appliances have been used by which a sufficient amount of air or oxygen is supplied to sustain life for a short time. In some of these appliances, the air is supplied through a pipe or small tube, and inhaled by placing

air for several hours. The helmet is about the same weight as that of a thick overcoat, and is held in place by two straps passing under the arms. An air cylinder containing air, at 150 pounds pressure per square inch when fully charged, is attached to the back of the helmet; a small tube conducts the air from this cylinder to a point within the helmet close to the nostrils. The fresh air thus forced into the helmet creates a slight downward pressure that drives the foul air through a collar of absorbent lamb's wool, and out at the bottom of the helmet. The helmet is supplied with two outlooks or windows, made of double plates of clear mica protected on the outside by cross-wires. There are also ear pieces having special sounding diaphragms that render the hearing distinct. A whistle is attached in front to provide a means of signaling. When suitable apparatus is not at hand, a dash may often be made into an impure atmosphere for the recovery of a person overcome by gas, if a wet cloth or a sponge saturated with vinegar is tied over the mouth and nose. This affords a temporary protection from the inhalation of the noxious gas.

PREVENTION OF EXPLOSIONS

45. Reducing the Liability to Explosion.—The liability to explosion may be reduced by removing, as far as possible, those causes and conditions that lead to them. Briefly stated, the causes of mine explosions are: the ignition of a body of firedamp by any means; or the raising and firing of an atmosphere of dust by the flame of a blast or a blown-out shot; or the successive quick firing of two or more shots in a close place. To remove these causes and lessen the liability of the occurrence of a mine explosion, the following precautions should be adopted: (1) The ventilating current should be sufficient to dilute, render harmless, and sweep away the gases produced in the mine. (2) The air should be distributed to the several districts of the mine in such quantities that the velocity of the current will not exceed 450 feet per minute in any place where safety lamps are used.

(3) The velocity of the air-current at the face should not be less than 4 or 5 feet per second, and should be sufficient to sweep away the gases that would otherwise accumulate in the cavities of the roof or other places in the workings; when necessary, special brattices should be erected to deflect the air-current so as to sweep the places where gas is liable to collect. (4) A careful and regular examination should be made of all gaseous workings by a competent fire boss before the time of commencing each shift, and due precautions should be taken to prevent men from entering places where gas has been found. (5) The use of naked lights should not be permitted in a gaseous mine. (6) All safety lamps should be carefully cleaned, examined or tested, and securely locked before being taken into the mine. (7) Where blasting is performed, and it is practicable to do so, the shots should be inspected and fired by experienced shot firers after the men have left the mine. (8) Dust or fine coal should not be allowed to accumulate in the working places or on the haulage roads. When the coal is very inflammable and the mines dry and dusty, some uniform system of spraying should be adopted, both at the face and on the haulage roads throughout the mine. Too much reliance should not, however, be placed on the spraying of the coal. According to the conclusions reached by the Prussian Firedamp Commission, the ignition and explosion of coal dust is prevented by this means only when 50 per cent. of its weight of water is present—a much larger quantity than can be introduced by any system of spraying, however efficient.

TESTING FOR GASES IN MINES

SAFETY LAMPS

46. The miner's **safety lamp** is a lamp in which the flame is isolated from the outside air by means of a wire gauze chimney, or a glass chimney and gauze combined. The openings in the lamp for the ingress and egress of air are all protected by wire gauze in such a manner as to prevent the passage of the flame of the lamp through the gauze under ordinary conditions.

47. The Principle of the Safety Lamp.—The essential principle of all safety lamps consists in the cooling effect that a metal surface exerts on a flame with which it comes in contact. The cool metal lowers the temperature of the burning gas in immediate contact with it, to a point below the temperature of ignition of the gas supporting the flame, and the latter is thereby extinguished. This cooling effect is observed whenever any cold surface of metal is exposed to a flame, a deposit of soot being formed on the surface of the metal, as evidence of the incomplete combustion produced at that point by the cooling. The result of this cooling is the extinction of the flame.

This principle was first applied to the construction of the safety lamp by Sir Humphrey Davy in 1815, who devised at that time what has since been known as the **Davy safety lamp**. Davy surrounded the flame of the lamp with an iron wire gauze in the form of a cylinder closed at the top. His experiments showed that the gauze best adapted to this purpose was one composed of twenty-eight parallel wires (No. 28 Birmingham wire gauge) to the inch, forming a mesh of 784 openings per square inch, which is the standard wire gauze used in all safety lamps today.

The gauze permits the free passage of the air and gas into and out of the lamp. The mesh of the gauze divides the passing air or gas into fine streamlets, which insures its direct contact with the cool surface of the metal. When the lighted lamp is placed in a mixture of air and gas, the gas enters with the air and burns within the lamp, the products of the combustion passing out through the upper part of the gauze. When sufficient gas is present, it sometimes happens that the entire lamp fills with flame, which is only prevented from passing outside the lamp by the cooling effect of the gauze, the streamlets of burning gas being cooled and extinguished in their attempt to pass through the mesh of the gauze. This condition is known as the *flaming* of the lamp.

Under certain conditions, the flame may pass through the gauze and ignite the gas outside of the lamp. When a lamp is exposed for some time to an atmosphere containing a considerable percentage of gas, the lamp and the gauze surrounding the flame become heated. This soon destroys the protection afforded by the lamp, as the passage of the flame through a hot gauze will occur sooner or later, according to the condition of the gauze and the velocity of the air passing the lamp. When the flame of the lamp is allowed to smoke owing to its being too high, or to the poor trimming of the wick, or to the burning of an inferior oil, the gauze becomes covered with a deposit of soot, and in this condition will pass the flame more readily. The fine dust floating in the mine air and collecting on the gauze of the lamp has the same effect. A gauze is also rendered unsafe by the slightest defect, which may be so small as to easily pass unnoticed. For this reason, lamps are frequently tested, as well as examined, before being carried into a mine.

TYPES OF SAFETY LAMPS

48. There are many kinds of safety lamps, all of which embody the same essential principles relating to the isolation of the flame of the lamp from the outside air. Only such

lamps will be described as present distinct and important features. As far as possible, these features will be described in the order of their development, and the lamps classified according to their use in the mine.

Lamps may be divided into two general classes: (*a*) lamps for testing for gas; (*b*) lamps for general mining use. These types differ essentially in their requirements and construction. In general, a lamp designed for the purpose of testing for gas, does not make a good lamp for general work, and a lamp adapted to general work is not and should not be as sensitive to gas as one required to make an accurate test. A few lamps, however, are designed, as far as possible, to meet both of these requirements.

49. Lamps for Testing for Gas.—The chief points considered in choosing a lamp for testing for gas are: (1) free entry of air at a point below the flame; (2) a sliding glass or metal shield to protect the flame from strong currents; (3) no reflecting surfaces behind the flame; (4) a scale for measuring the height of the flame cap produced.

50. Lamps for General Use.—The points mainly considered in choosing a lamp for general use are: (1) maximum illuminating power; (2) safety in strong currents; (3) minimum liability to accident; (4) diffusion of light upwards; (5) simplicity of construction and security of lock fastenings; (6) appliance for relighting the lamp when extinguished without opening the lamp.

51. Davy Lamp.—Fig. 3 (*a*) shows a perspective and Fig. 3 (*b*) a sectional view of the common unbonneted Davy lamp. The lamp consists of a solid-brass oil vessel, to which is secured, by three upright standards, a gauze cylinder surmounted by a gauze cap, giving double protection against the transmission of the flame at the top of the cylinder, where there is greater liability of the gauze becoming heated or being burned through. The gauze cylinder is generally $1\frac{1}{2}$ inches in diameter, and, with its cap, varies from 4 to 6 inches in height, in different lamps. Iron wire is commonly used in making the gauze, although copper

wire is sometimes employed, because it does not rust as quickly as iron. The oil vessel, standards, and top of the lamp may be made of aluminum, to reduce the weight of the lamp. The air for combustion enters as shown by the arrows *a, a*, Fig. 3 (*b*). The products of combustion pass out as shown by the arrows *b, b*.

52. A form of this lamp known as the *fire-boss Davy* is provided with a small narrow oil vessel often having the

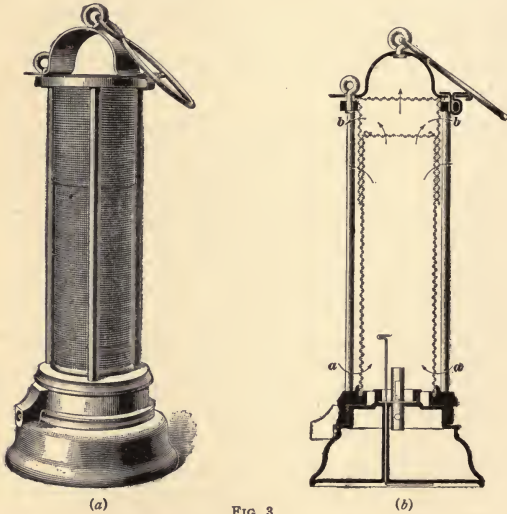

FIG. 3

shape of a dice cup, which is a convenient form for handling. The height of the gauze cylinder of this lamp does not usually exceed 5 inches. A similar form of lamp, in which the height of the chimney is reduced to about $3\frac{1}{2}$ or 4 inches, is known as the *pocket Davy*, and when not in use is frequently carried in the pocket by the fire boss.

The Davy lamp is often provided with a movable metal shield encircling the gauze for two-thirds of its circumference,

and arranged to slide upwards when desired. This shield protects the flame of the lamp against strong air-currents, and is important when testing for gas in airways or other places where the air is moving with some velocity.

Owing to the free admission of air through the gauze, the Davy lamp gives a good flame cap in gas, and is a general favorite with fire bosses. The lamp, however, in its simple form, is not a suitable lamp for general work, because of its liability to flame; its illuminating power, also, is less than that of many other types of lamps. The unbbonneted Davy is not safe when exposed to a current of air having a velocity greater than 6 feet per second. In the hands of a careful and experienced man, the presence of gas in amounts as low as $2\frac{1}{2}$ per cent., or 2 per cent. under particularly favorable conditions, can be detected by means of this lamp.

53. Bonneted Davy.—As the unprotected gauze of the Davy lamp permits the passage of the flame in a strong current of air, it was found necessary, soon after the invention of this lamp, to enclose the gauze in a tin case having a glass window to emit the light; this form of the lamp was commonly known as the *tin-can Davy*. Later, the tin can was supplanted by a brass case having an all-around glass window to emit the light. In another form, commonly known as the *Jack Davy*, the tin or brass case was replaced by a glass cylinder reaching the entire height of the gauze. In some lamps, the glass cylinder was placed within the gauze, and in others outside of the gauze. In still another form, a low glass cylinder surrounding the lower portion of the gauze was made to slide up and down, being held in position by a small spring or screw. This form of bonneted

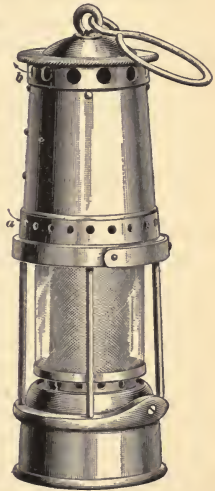

FIG. 4

Davy, Fig. 4, has come into very general use both in England and in America.

The bonneted Davy is the only form of the Davy lamp used in England, the unbonneted Davy being prohibited by law. The unbonneted Davy and Clanny lamps are also prohibited for general work by the Bituminous Mine Law of Pennsylvania, but mine officials are permitted to use these lamps for the purpose of examining the workings for gas. The bonnet adds much to the security of both of these lamps when exposed to strong currents. There are numerous forms of bonneted Davy lamps in addition to those already mentioned, many of them combining features of other lamps. Various forms of deputy or gas-tryer's lamps consist in some simple modification of the Davy lamp. In many cases, these features are not of sufficient importance to warrant the designation of the lamp by another name.

54. The favorite lamp for testing for gas has always been the common Davy lamp, which is most sensitive to gas owing to the unobstructed passage of the air in and out of the lamp. Ordinary sperm or lard oil is used in this lamp, and the test for gas is made either with a small flame or with the normal flame. The flame cap indicating the presence of gas is non-luminous and difficult to be observed when there is less than 2 or $2\frac{1}{2}$ per cent. of gas present. The more the flame is reduced in size the more readily this cap is observed; but the small flame is very apt to be extinguished by the gas, making the test for gas by this means extremely delicate for amounts of gas less than $2\frac{1}{2}$ per cent. When the normal flame is used for testing, the light of the flame interferes with the observance of the flame cap and lessens the delicacy of the test.

Since the gas cap formed above the flame gives great heat and but little light, fine platinum wire has been employed to indicate by its incandescence the presence of the cap, or, in other words, to make visible the heat of the cap. By this means, the presence of as low as $\frac{1}{2}$ per cent. gas is indicated on the normal working flame of the lamp. Lamps are made

that burn special fluids—such as alcohol, naphtha, benzine, etc., or hydrogen gas—the flames of which are more sensitive to gas than those of the common safety-lamp oils. By the use of these lamps, gas may be detected in amounts varying from $\frac{1}{4}$ to 2 per cent.

55. The Stephenson, or “Geordie,” lamp was invented in the same year (1815) as the Davy lamp, by George Stephenson, a mine blacksmith. The lamp consisted of a glass chimney surmounted by a perforated copper cap and surrounded by a perforated copper shield. Owing to the numerous perforations in the metal shield forming the chimney of this lamp, its principle has been, to a certain extent, confounded with the principle of the Davy lamp. The two, however, are distinct: in the Davy lamp, the extinction of the flame is accomplished by its contact with the cool metal of the gauze; while in the Stephenson lamp, the flame is extinguished, before it can pass outside the chimney, by restricting the circulation of the air in the lamp, thus confining the products of the combustion within the lamp. The Stephenson principle, though unrecognized, is operating in many of the types of safety lamps at the present day, being often effective in extinguishing the flame of the lamp in gas. In most bonneted lamps, the burned air in the upper portion of the chimney adds greatly to the protection afforded by the lamp.

56. The Clanny lamp was designed by Doctor Clanny, to secure greater protection for the flame and at the same time a better light than is afforded by the Davy lamp. Fig. 5 (a) is a perspective and Fig. 5 (b) a sectional view of the unbonneted lamp. A glass cylinder surrounds the flame below the gauze, greatly improving the illuminating power of the lamp and making it a favorite lamp for general use. The air enters this lamp through the lower portion of the gauze and descends to the flame; there is of necessity, therefore, a conflict of the descending and ascending air-currents within the lamp, creating a tendency to smoke, dimming the glass and obstructing the light, besides often clogging the gauze and increasing the work of cleaning the lamp.

The lamp is not a good lamp for testing, as the conflicting air-currents interfere with and prevent the formation of the flame cap. The unbonneted Clanny is not safe when exposed to a current having a velocity greater than 8 feet per second.

57. The bonneted Clanny is a good lamp for general mining work. There are many modifications of this lamp constructed to burn ordinary sperm or lard oil, or special fluids, as alcohol, petroleum, naphtha, benzine, etc., with the

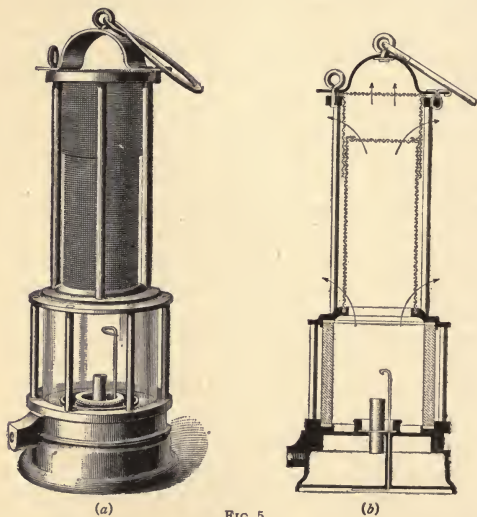

FIG. 5

purpose of improving the illuminating power of the lamp and increasing its usefulness. Many essentially Clanny lamps embody one or more features of other lamps; perhaps the most important of these features is the deflector arranged in the lower portion of the gauze to deflect the entering air and prevent, to a large extent, the conflict of the air-currents within the lamp. By this means, the tendency of the lamp to smoke is greatly reduced and its illuminating power

increased. The deflector may be applied to many lamps. Some forms of the bonneted Clanny have been tested without failure in an explosive atmosphere free from dust and having a velocity as high as 13 to 16 feet per second. The security of the lamp under these conditions, however, will depend very much on the manner in which it is handled.

58. The **Howat deflector** is a common device for deflecting the current of air downwards on the flame of the lamp. It is shown in Fig. 6 attached to a bonneted lamp. The device consists of a brass shield *a* midway between the outer gauze and the bonnet and about $1\frac{1}{4}$ inches high. About $\frac{1}{4}$ inch above the top of this shield is the bottom of the angle ring *b*. This ring fits close to the gauze, and the top flange entirely closes the space between the gauze and the bonnet. The course of the air to and from this lamp is shown by the arrows.

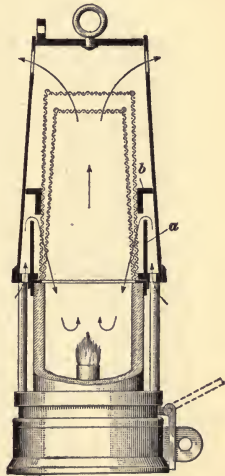

FIG. 6

59. The **Evan Thomas lamp** is a name given to a number of lamps that aim to improve the illuminating power and security of the Clanny lamp. The original Evan Thomas lamp was provided with a double steel bonnet surmounting a double glass chimney. The air was drawn in at the top and descending between the two bonnets and glass chimneys entered the lamp through protected openings below the flame. These protected openings form the characteristic feature of an early type of lamp known as the *Eloin lamp*. The entering air passing downwards between the double bonnets and glasses of the Evan Thomas lamp not only kept these cool and improved the power of transmission of light in the glass, but the air became heated and, entering the lamp at a higher temperature, increased the

rapidity of the combustion and improved the illuminating power of the lamp. Owing, however, to the liability of the inner glass to be cracked by the heat when much gas was present, thus destroying the security of the lamp, this form was abandoned for a lamp having a single glass and provided with a deflector or metal shield arranged in the lower part of the gauze. This form of the lamp is shown in Fig. 7, and differs in no respect from a bonneted Clanny lamp to which the Howat deflector previously described has been attached.

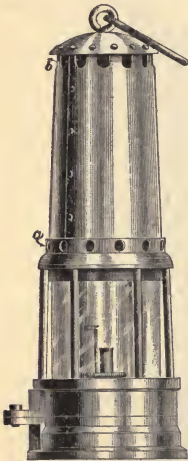

FIG. 7

The air enters the lamp by the small apertures shown at *a*, and passing upwards a short distance over the rim of the deflector within the bonnet, descends to the flame; the products of the combustion leave the lamp through the upper part of the gauze and the openings *b* in the bonnet. The lamp presents the same tendency to smoke as the Clanny lamp; it is a good lamp, however, for general work, and may be considered safe in currents having a velocity of 20 or 25 feet per second.

60. The Mueseler lamp is shown in perspective in Fig. 8 (*a*) and in section in Fig. 8 (*b*). The principal feature of the lamp is the central conical tube or sheet-iron chimney *d*, which increases the draft within the lamp, decreasing its tendency to smoke and improving its illuminating power, besides adding greatly to the security of the lamp against internal explosions and reducing the tendency of the lamp to flame. The metal of the sheet-iron chimney, by conducting away the heat, kills the flame of the gas burning in the lamp. The air enters the lamp through the lower portion of the gauze, as shown by the arrows *a, a*, and descends to the flame through the protected openings *e, e*; the inner tube or chimney *d* thus acts as a deflector to divide

the ascending and descending currents. The unbonneted Mueseler shown in the figure may be considered safe in a current having a velocity of 10 feet per second.

61. The bonneted Mueseler lamp is particularly adapted to gaseous mines. There are two general types of this lamp, known as the *Belgian Mueseler* and the *English Mueseler*, differing only in the dimensions of the gauze and the dimensions and position of the conical chimney. The

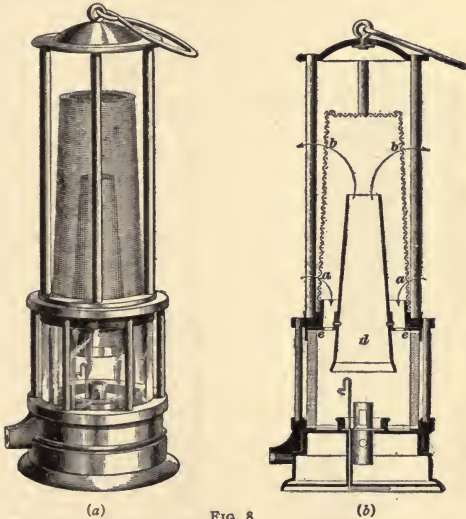

FIG. 8

former type has been made the legal lamp for use in Belgian mines. The inner conical chimney of the English Mueseler is set higher above the flame than in the Belgian type, and the area of its upper end much enlarged. The Belgian Mueseler is generally considered as being the safer lamp. In the work of the Royal Commission in England, these lamps were each exposed to an explosive current having a velocity of 48 feet per second. The Belgian lamp was

simply extinguished after a few seconds, while the English Mueseler, having a shorter inner tube of larger sectional area, caused an explosion in every instance. Though a generally safe lamp, the Mueseler lamp is particularly sensitive to oblique currents caused by the air striking it at any angle other than a right angle to the axis of the lamp. Attention was called to this fact in the report of the Belgian Commission (1873), and confirmed by the report of the English Commission (1886). The Mueseler lamp, like the Clanny, is not a good lamp for testing for gas.

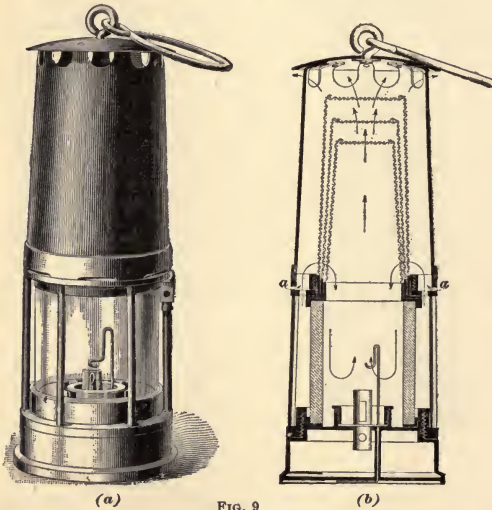

FIG. 9

62. The Marsaut lamp is shown in Fig. 9 (a) and (b), and like the Mueseler it is derived from the Clanny lamp. Its characteristic feature is the multiple gauze chimneys, the object of which is to afford increased protection against strong currents of air and internal explosion. In the sectional view, Fig. 9 (b), three gauzes are shown; at times but two gauzes are used. As shown by the arrows, the air enters

the lamp through the small openings *a, a* under the bonnet and, passing through the lower portion of the gauze, descends to the flame. There is in this lamp perhaps an even greater tendency to smoke than in the Clanny lamp, owing to the conflicting descending and ascending currents and the increased resistance to the circulation offered by the several gauzes; the lamp also heats more quickly in gas than any of the other forms of protected lamps. In this lamp, however, the increased confinement of the gaseous products of combustion in the upper portion of the gauze adds much to the security of the lamp, and illustrates the principle sought to be attained in the Stephenson lamp. Like the Mueseler lamp, the unbonneted Marsaut may be considered safe in a current having a velocity not exceeding 10 feet per second.

63. The bonneted Marsaut lamp presents, perhaps, even greater security against strong air-currents than the bonneted Mueseler, and has been known to withstand without failure an explosive current having a velocity of 50 feet per second. In all these cases, however, much depends on the handling of the lamp and the conditions under which the test is made with respect to the explosiveness of the air and the presence of coal dust. The lamp is not a good lamp for testing for gas.

SPECIAL LAMPS

64. Under this heading such lamps are included as present special features of construction, or require a special burning fluid, other than the oils in common use. There are a large number of these lamps, a comparatively few of which have come into general use and will be described.

65. The Ashworth-Hepplewhite-Gray lamp is a bonneted Clanny lamp combining several special features of construction first brought out in the Ashworth and Gray lamps, respectively. The lamp is designed for both testing and general use. A sectional view of the lamp is shown in Fig. 10; the four standards of the lamp are hollow tubes. When the lamp is used for testing, the air enters the top of

the standards, as shown by the arrows *a, a*, and passing downwards enters the combustion chamber through protected openings below the flame. By this means, a thin layer of air close to the roof may be tested without tilting the lamp.

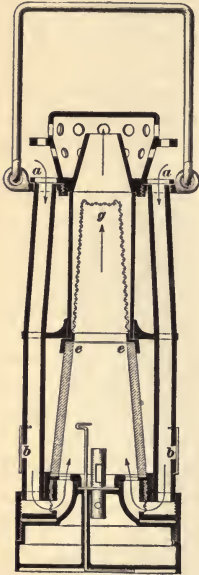

FIG. 10

In the ordinary use of the lamp, the lower apertures *b, b*, in the standards, which are kept closed while testing for gas, are opened to admit air more freely to the lamp. The flame of the lamp is surrounded by a conical glass chimney *e*, surmounted by a small conical gauze *g*, and a cylindrical steel bonnet, terminating in a truncated cone which reduces the area of its opening at the top and more effectually controls the circulation and prevents downward currents in the lamp. This opening is protected above by a perforated dome or cap. The conical shape of the glass chimney aids in the upward diffusion of the light, making easier the examination of the roof, while the same conical shape of the glass chimney and gauze above adds to the security of the lamp against internal explosions, and assists also in preventing downward currents in the lamp. Owing to

the small area of the outlet gauze in all the Gray lamps, an internal explosion is particularly dangerous in these lamps. The lamp is constructed to burn ordinary sperm or lard oil, and is a good lamp for general work.

66. The Wolf safety lamp, Fig. 11, is a bonneted lamp presenting several special features in its construction. The corrugated shield, or bonnet, *a* of the lamp is provided with openings, or slots, that deflect the air-current entering the lamp and prevent it from being blown directly on the

gauzes. The lamp has double gauzes, as shown in Fig. 11; these, together with the shield, enable the lamp to safely withstand a 9-per-cent. gas mixture moving at a velocity of 59 feet per second. Naphtha is the burning fluid used, which increases the illuminating power and renders the lamp much more sensitive to gas, as it will indicate as low as $\frac{3}{4}$ per cent. of marsh gas (methane). Another special feature of the Wolf lamp is its magnetic lock, which can only be opened

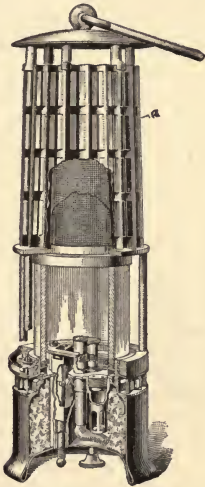

FIG. 11

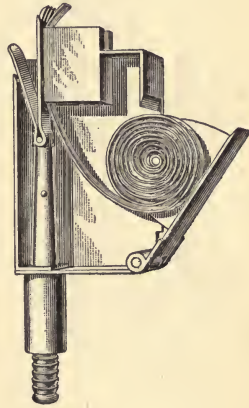

FIG. 12

by means of a powerful magnet that is kept in the lamp room. The self-lighting device, Fig. 12, contained in this lamp has also proved of very great importance, as lamps extinguished by an explosion or otherwise can be relighted, and the men are thus better able to escape from the after-damp due to an explosion. The relighting is accomplished without opening the lamp, and can therefore be done, even in the presence of explosive gases, without any danger whatever.

67. The Clowes hydrogen lamp, Fig. 13 (a) and (b), is practically a Hepplewhite-Gray lamp with a somewhat taller glass chimney, for the purpose of observing the flame caps formed by the gas in testing. To supply a small hydrogen flame that is better adapted to the purpose of testing for gas, a seamless copper tube *c* is inserted in the oil vessel by the side of the wick tube, and connected either below or at the side of the lamp with a supply of compressed hydrogen gas contained in a small portable cylinder *a*, which is about 5 inches long and 1 inch in diameter, attached to the lamp,

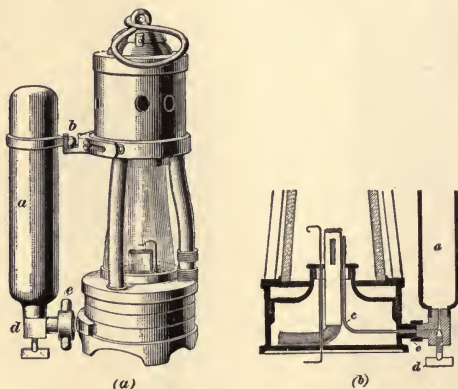

FIG. 13

as shown, by a clip *b* and a screw *e*. When a test is to be made for gas, a valve *d* is opened between the hydrogen cylinder and the lamp, and the jet of hydrogen is at once ignited by the oil flame. The wick is now pulled down by the picker until the oil flame is extinguished. The height of the hydrogen flame is then regulated by the valve *d* controlling the supply of this gas, and the tip of the flame is adjusted to the zero of the scale in the lamp. This scale is for the purpose of reading the percentage of gas, and consists of a number of cross-bars supported in a ladder-like frame in a position in front of the flame of the lamp. The

several cross-bars are arranged at heights corresponding to the heights of the flame caps formed by different percentages of gas. The cross-bars appear as dark lines against the flame. This lamp is intended for the detection of the lower percentages of gas, from $\frac{1}{4}$ per cent. to 3 per cent.; when gas is present in larger amounts the percentage is determined by the use of the oil flame. $\frac{1}{4}$ per cent. with the hydrogen flame gives a cap $\frac{1}{2}$ inch high, and 2 per cent. a cap about $1\frac{1}{2}$ inches high.

68. The Stokes lamp is also a Gray lamp adapted to the purpose of testing for gas by introducing a small alcohol flame at one side of the oil flame. The lamp is shown in section in Fig. 14, having the small alcohol lamp *a* screwed beneath the oil vessel of the lamp. The alcohol lamp is provided with a long, slim neck or wick tube *b* that extends up through the oil vessel of the lamp. When the screw plug *c* is removed and this lamp screwed in place, its wick is readily ignited by the oil flame at *d*, and the latter may then be extinguished by drawing down the wick with the bent wire picker that extends through the lamp body to the top of *d*. In other respects, the Stokes lamp corresponds to the Clowes hydrogen lamp, except that the alcohol flame is not as persistent as the hydrogen flame of the Clowes lamp, but is more easily extinguished in gas; the flame is not as quickly extinguished by gas, however, as the oil flame, although it is more easily blown out by wind. The lamp is designed for the detection of the lower percentages of gas, varying from $\frac{1}{2}$ per cent. to 3 per cent. Like other Gray lamps, it is not a safe lamp in the presence of larger percentages of gas.

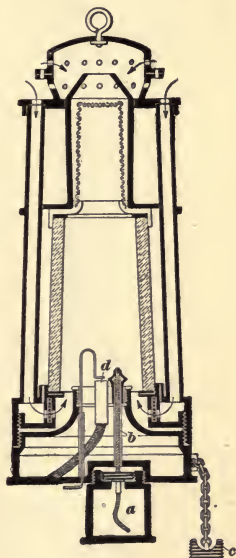

FIG. 14

69. The Pieler lamp is another form of special lamp designed for testing for gas. It has the form of a large "tin-can Davy," or a "Davy in case." It is constructed to burn alcohol. This lamp is provided with a higher gauze

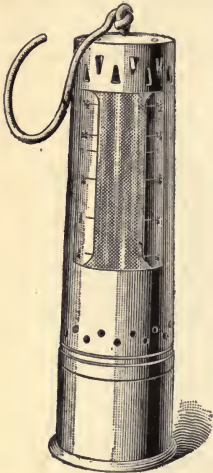

FIG. 15

than any other type of lamp, to permit of the observance of the high flame caps formed over the alcohol flame, which is extremely sensitive to gas. A perspective view of this lamp is shown in Fig. 15. The alcohol flame is adjusted in fresh air, so that its tip just reaches the lower edge of the window in the bonnet of the lamp. The scale for reading the percentages of gas indicated by the various heights of the flame cap is marked on the case on each side of the window or on the window itself. The lamp shown in the figure is designed to read percentages of gas varying from $\frac{1}{4}$ per cent. to $1\frac{1}{2}$ per cent. Some Pieler lamps, provided with a gauze measuring 8 inches in height, allow the observance of 2 per cent. of gas;

when more gas is present the lamp fills with flame. The Pieler lamp is by no means a safe lamp for mine use, and would be almost certain to cause an explosion if brought into contact with a body of explosive gas.

SAFETY-LAMP DETAILS

70. Locks for Safety Lamps.—All safety lamps should be securely locked to avoid the possibility of their being opened in the mine. If for any reason a fire boss or foreman carries an unlocked lamp, he should not allow it to pass out of his hands while in the mine. There are three general plans pursued with reference to the locking of safety lamps. These embody: (1) a simple screw pin, or other catch that

will prevent the lamp being opened accidentally, but which may be opened by any person possessing an ordinary amount of ingenuity; (2) a lock that can be opened, but will reveal the slightest attempt to tamper with it; (3) a lock that cannot be opened outside of the lamp room or relighting station.

Although all safety lamps were formerly locked in the first manner, this kind of lock is rapidly falling into disuse, as being wholly unsafe in a gaseous mine where a large number of safety lamps are in use. The second class of locks represents by far the majority of those in common use. Although locks belonging to this class can be opened in the mine, they do not easily get out of order, and are extensively used on account of their cheapness and simplicity of construction. In the use of these locks, the discipline of the mine should be such as to go very far toward preventing any one from tampering with them or in any way attempting to open a lamp.

71. The **lead-plug lock**, which belongs to the second class and has the general form shown in Fig. 16, is perhaps the most common lock in use; it is a good lock for cheapness and security, allowing the lamp to be quickly locked or opened, and revealing with certainty any attempt on the part of the miner to open the lamp. It is important that the date or a given letter should be stamped on the lead plug each day, and means should be adopted to prevent the stamp used for this purpose being duplicated by any one employed in or about the mine. As shown in the figure, the lower part of the lamp is encircled with a movable ring *R*, to which is at-

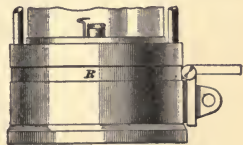

FIG. 16

attached a hinged lock that drops over a projecting lug attached to the oil vessel. The lead plug is inserted through a hole in this lug and punched flat to prevent its removal. The punch used stamps the date or letter for the day on the plug. The lamp is opened in the lamp room or relighting

station by cutting the plug, the lead being saved and remelted for use again.

72. Another form of lock belonging to the second class is that formerly used in what were known as the "Protector" lamps. This lock is shown in section and detail in Fig. 17. The wick tube *a* is provided with a screw thread that allows a collar *b* having two flanges, as shown in perspective at (*a*), to be screwed over it; this is done before lighting the lamp. The lamp is then lighted and after being trimmed is screwed into place. The flange tube *c* is then fastened by pushing in the bolt *d*, which is provided with a spring, as shown at (*a*),

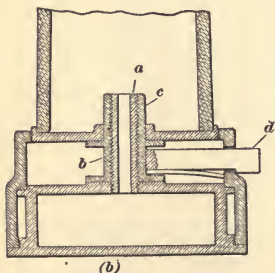
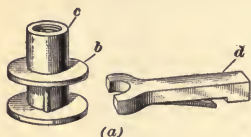

FIG. 17

that prevents the bolt being withdrawn until the oil vessel is removed. It will be observed that, while the oil vessel may easily be unscrewed, the flange tube cannot be removed, but must remain stationary in the lamp until the bolt *d* is drawn back. As a result, any attempt to unscrew the oil vessel will cause the lamp to be extinguished by its wick being drawn down through the collar or flange tube *c*.

73. The magnetic locks that have been used on some safety lamps belong to the third class. When properly constructed, such a lock cannot be opened outside of the lamp room or relighting station, where a powerful magnet is kept. These locks consist of a pin or lever that slips into a recess in the oil vessel and is kept there by a spring, until a magnet is applied to the outside of the lamp and the pin or lever is drawn out of the recess, when the oil vessel can be unscrewed. Some forms of magnetic locks can be opened by a sudden jar

or blow on one side of the lamp, the oil vessel being turned at the moment the blow is given, but this defect can be overcome by the use of a spring of sufficient strength.

Fig. 18 shows a magnetic lock that is in very successful use in connection with the Wolf lamp. A key *a* on the end of the lever pivoted at the center is pressed inwards by means of a spring *b*, so that it runs in the thread of the oil well when this is screwed up, and when it is in place drops into a socket and thus securely locks the lamp. The lock mechanism is protected by a hardened-steel plate *c* on the outside of the ring. To open the lock, two poles *d, e* at the ends of this ring are placed against the poles *f, g* of a horse-shoe magnet, as shown, which draws the

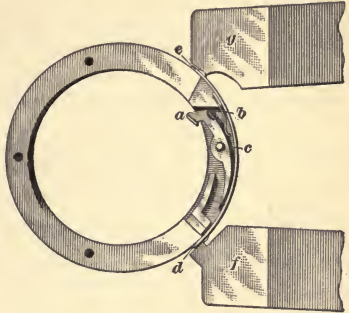

FIG. 18

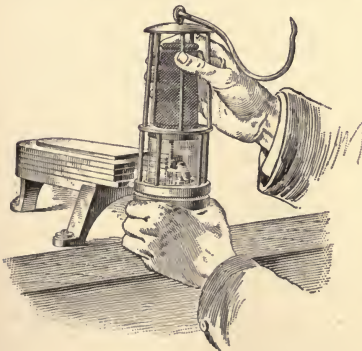

FIG. 19

key *a* from its seat in the oil vessel and permits the bottom of the lamp to be unscrewed. If a weak spring is used, the lamp may be unlocked with a hand magnet; but a spring of such strength is generally used that a powerful magnet is required, such as is shown in Fig. 19. Instead of a permanent magnet, an electro-

magnet suitably connected with the electric current used about the mine may be employed.

74. Lamp Wicks, Wick Tubes, Etc.—A better light will usually be obtained by using a short wick and renewing it often, than by employing a long wick for a greater period of time. The wick is round or flat according to the kind of wick tube used; a round wick is composed of several strands of cotton yarn very slightly twisted. A little practice will show the size of wick or number of strands that should be used to give the best results with each kind of oil. It is important that the wick should not fit so tightly in the wick tube as to obstruct the free flow of the oil to the flame. When a flat wick is used, the thickness and width of the wick should only be slightly greater than the inside dimensions of the wick tube. A flat wick consists of several strands of cotton yarn plaited very loosely together. Lamp wicks should always be thoroughly dried before being placed in the lamp, since the slightest moisture in the wick impedes the flow of the oil and lessens the light.

75. The wick tube of a lamp is made either round or flat, both forms being in common use. A flat wick tube should be corrugated on one side, to reduce the friction and give proper air space in the tube. The top of the tube, when the lamp is screwed in place, should be about $\frac{1}{2}$ inch above the lowest sight line of the glass chimney. If the flame sets too low in the lamp, the shadow cast on the ground by the body of the lamp is increased; and if the flame sets too high in the lamp, its luminosity will be decreased. The wick tube is provided on one side with a narrow slot to allow the wick to be raised by the picker. This slot should not be wider or longer than necessary for this purpose, as the heat of the lamp will then cause vaporization of the oil at this point, decreasing the flow of oil to the flame; and the wick may become ignited at the slot.

76. The purpose of the picker is to cleanse the wick from time to time of the incrustation caused by the imperfect burning of the oil and the wick. The incrustation is greater when a poor oil is used; also with some vegetable oils than with most animal oils; and generally greater with

vegetable and animal oils than with the lighter mineral oils. The usual form of picker permits but one half of the wick of the lamp to be cleansed, and it is often difficult or impossible to free the other half of a wick of a closed lamp from the adhering incrustation. Owing to a poor picker, it is often difficult to trim a closed lamp without extinguishing the flame; the flame is often extinguished also by the awkward handling of the picker. The best form of picker should sweep the entire top of the wick with a motion somewhat inclined to the horizontal.

77. The gauze may be made of iron, copper, or brass wire, but an iron gauze, being the least fusible, is considered the safest, and the use of copper and brass gauze should be restricted to working lamps, in which the gauze is not apt to be exposed to a flame.

OILS FOR SAFETY LAMPS

78. The oils commonly used in safety lamps are of three general classes: *vegetable oils*, *animal oils*, and *mineral oils*.

79. The vegetable oils most commonly used for mining purposes are *cottonseed* and *rape*, or *colza*, oils. The latter, used in Europe, are derived from the seed of a variety of turnip largely cultivated for this purpose. The *summer rape* is often called *colza*, whence the name colza oil; the name cabbage-seed oil has also been applied to this oil. Rape, or colza, oil is a safe oil for mining use, but its illuminating power is not as great as that of petroleum or mineral oil. The poorer qualities of this oil cause considerable incrustation of the wick in burning, and they do not feed as readily as the lighter mineral oils. The best grade of colza oil, however, has long been a favorite in certain localities for use in safety lamps. The oil, after being pressed out of the rape, or colza, seed, is purified by treatment with sulphuric acid, which carbonizes or burns out much of the organic matter contained in the oil as an impurity; the oil is then washed to cleanse it from the acid.

80. The **animal oils** used in lamps are *seal oil*, pressed out of the blubber or fat of the seal; *whale oil*, obtained from the blubber of the whale; and *lard oil*, obtained from the lard secured by refining hog fat. Lard oils are now, perhaps, the animal oils most commonly used in safety lamps. Animal oils, like vegetable oils, do not possess a high illuminating power; much depends on the purity of the oil. A good quality of lard oil or whale oil does not incrust the wick rapidly.

The illuminating power of both vegetable and animal oils may be increased and the incrustation of the wick decreased by the addition of one-half their volume of petroleum; the tendency of the flame to smoke, however, is somewhat increased, and the mixture burns more rapidly.

81. **Mineral oil, or petroleum,** is obtained from the earth by boring holes from the surface into oil-bearing strata. When the crude petroleum obtained from the oil well is heated, a number of volatile products are distilled from it. The products that come off below 302° F. are known as the *light oils*. Between 302° and 572° F., the *burning oils* (or *kerosene*) are given off. At this higher temperature there still remain the *heavy, or lubricating, oils* and the solid ingredients of the oil, such as tar, wax, etc. There are a large number of the light oils, and the ones commonly used are gasoline, naphtha, and benzine. The exact temperatures between which each of these several oils is given off vary considerably for crude oils of different composition and according to different authorities, but for the present purpose it will be sufficient to assume that gasoline is distilled at from 65° to 140° F., naphtha at from 140° to 230° F., and benzine at from 230° to 302° F. The more volatile of these light oils should not be used for burning purposes, as they are dangerous. The naphtha that is sold for burning purposes is generally a product distilled at from 212° to 302° F.

82. The report of the British Accidents Commission made some years ago was unfavorable to the use of benzine and naphtha in safety lamps, as these oils were said to produce a flaring flame, which increased the danger if the lamp

reservoir became warm. The report of this commission has created a prejudice against the use of naphtha, in the minds of many, which does not seem to be justified by later experiments made under the auspices of the German government, and more recently by government officials in Belgium. These latest Belgian tests, reported in 1904, show that as the result of many thousands of experiments, made both in the laboratory and in the mines under working conditions, less volatile of the light oils should not be considered dangerous. The same tests also showed that dust in the mine air does not materially affect the safety of a lamp.

The conclusions of the British Accidents Commission briefly stated are as follows: (1) Rape (colza) oil of good quality, burned alone in a safety lamp, incrusts the wick after a brief period of time. (2) Good clear seal oil is superior to rape (colza) oil in maintaining a uniform height of flame for a longer period of time without trimming. (3) The addition of one-half volume of petroleum having a flashing point of 80° F., to a refined rape (colza) oil of good quality, greatly improved its burning qualities and lessened the incrustation of the wick, but the luminosity of the flame was not materially increased; when one volume of the petroleum was added, the flame maintained a uniform height for a longer period of time, and its luminosity was somewhat increased. (4) A like addition of one-half volume of petroleum to a seal oil of good quality increased the length of time during which the flame maintained a uniform height, and improved its luminosity; when the addition of petroleum to seal oil was increased to one volume, the length of time the flame maintained a uniform height was greatly increased and its luminosity improved, but the consumption of oil and wick was also considerably increased. The refined petroleum used for this purpose is the last of the products of distillation mentioned previously, and is commonly known as *kerosene*, or *coal oil*.

83. The flashing point of petroleum for use in a safety lamp—that is, the temperature at which the oil gives off

explosive vapors—should not in any case fall below 73° F., while the minimum flashing point of this oil recommended by many is 80° F. The flashing point of any oil may be roughly determined by placing a sample of the oil in a small vial uncorked, and introducing the vial into a vessel of hot water in which a thermometer is placed. As the temperature of the water is gradually raised by the application of heat to the vessel, the point at which vaporization of the oil takes place is determined by holding a match over the mouth of the vial and noting when the vapor inflames.

TABLE VIII

Illuminant	Relative Volumes of Oils Mixed	Light Value	Remarks
Standard candle		1.00	
Rape oil (English)32	
Colza oil (best quality)47	
Seal oil35	
{ Rape oil (English)	2 }	.30	
{ Royal daylight petroleum	1 }		
Safety-lamp oil43	Different makers
Safety-lamp oil38	
Safety-lamp oil51	

84. Relative Illuminating Powers of Oils.—It is perhaps unfair to compare the illuminating powers of different oils by burning them in the same lamp, since some of the oils may be better adapted to the lamp used than others. Table VIII gives the relative illuminating power of several oils in common use when burned in a common Clanny lamp, referred to a standard candle as unity. This standard candle burns 120 grains of spermaceti per hour. The results given in Table VIII are the averages of numerous determinations, and can only be taken as suggestive of the light value of the oil, as these values for the same kind of oil vary widely according to the quality of the oil and the manner in which it is burned.

85. The Relative Illuminating Power of Safety Lamps.—The illuminating power of a safety lamp depends more on the construction of the lamp than on the kind of oil burned. Table IX is of interest as giving the average illuminating power as determined by a large number of tests of different kinds of safety lamps burning, for the most part, rape, colza, or seal oil.

TABLE IX

Name of Lamp	Illuminating Power Standard Candle = 1
Davy (common)13
Davy (Jack)08
Davy (in case)16
Clanny34
Mueseler (Belgian)32
Mueseler (English)36
Gray34
Evan Thomas43
Marsaut (three gauzes)45
Marsaut (two gauzes)55
Marsaut (with Howat's deflector)65
Ashworth-Hepplewhite-Gray65
Wolf (burning naphtha)	1.00

The values given in Table IX are only suggestive and fairly comparative, as the difference in the illuminating powers of lamps of the same type is very wide, and the values given are merely the average values for each type.

TESTING FOR GAS

TESTING FOR GAS WITH THE DAVY LAMP

86. The universal method of testing for gas in mine air is by means of the flame of the safety lamp. Although the expression *testing for gas* may refer to the detection of the presence of any of the mine gases, marsh gas (methane) is nearly always meant. The manner of making the test with the Davy lamp is as follows: Holding the lamp in an upright position in one hand, and with the other screening the eyes from the body of the flame, the miner slowly raises the lamp toward the roof, observing the flame carefully to detect the first appearance of a flame cap that indicates the presence of gas. On the first appearance of a cap, the lamp is promptly

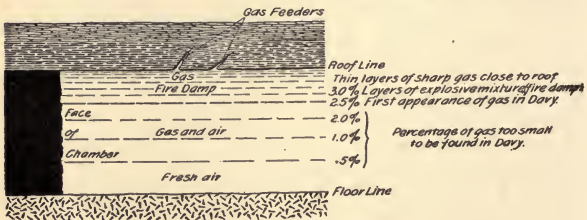

FIG. 20

but slowly withdrawn from the gas, noting the distance of the lamp from the roof when the flame cap appears.

As marsh gas (methane) is lighter than air, it is often found more or less stratified at the roof, particularly if the gas is issuing from the roof instead of from the floor and if the air-current is not very strong. It is customary therefore to report the depth of a body of gas at the roof, in inches or feet.

This condition will be made more clear by referring to Fig. 20, in which the horizontal dotted lines indicate the decreasing percentage of gas downwards. The heavy dotted line marked 2.5% indicates the lowest position in

which gas would be detected by the Davy lamp. With a more delicate means of testing, gas would be detected lower down from the roof.

87. When the gas is issuing from the floor of the workings, even the air is quiet in a room or chamber, the conditions will be materially changed from those just described. The diffusion of the gas as it rises from the floor is more rapid, and much of the gas is carried off in what air is passing in the place; the gas is less stratified and there is no layer of nearly pure gas at the roof. The conditions with respect to testing are much less dangerous than in the former case, where the gas at the roof may enter and fill the top of the lamp; and when the latter is being withdrawn the entry of fresh air below may create a highly explosive condition of the air in the lamp and cause a violent internal explosion that may be communicated to the body of gas outside of the lamp. When the gas comes from the floor and diffuses upwards, there is generally a more uniform percentage of gas indicated in any position of the lamp between the roof and the floor.

88. Approaching a Body of Gas.—The movement of a person entering a chamber in which there is gas near the roof often disturbs this layer of gas, and causes it to descend and surround him before he is aware of its presence. On this account, great care is required in entering a chamber when the gas is coming from the roof or when there is an opportunity for the accumulation of a body of gas in the roof. It is always more dangerous to approach a body of gas on the intake side, where the fresh air creates a highly explosive condition, than to approach the same body of gas on the return side, where the diffusion is greater and the change to a dangerous explosive condition less abrupt.

An explosion of gas inside the lamp is almost certain to take place when the lamp is withdrawn from a body of gas into fresh air. Such an internal explosion may or may not be communicated to a body of gas surrounding the lamp, according to the security afforded by the lamp. The lamp

in which an explosion has taken place may be moved slowly toward the feeder of gas until the gas filling the lamp nearly extinguishes the flame, when the lamp may be slowly withdrawn without disastrous results. With a bonneted lamp, the danger from internal explosion on withdrawing the lamp from a body of gas is greater than with an unbonneted lamp, owing to the restricted circulation in the lamp, but the security afforded by the former lamp against the transmission of the explosion is greater.

89. Height of Flame Cap Corresponding to Different Percentages of Gas.—The height of the cap formed above a flame burning in air containing marsh gas (methane) indicates, approximately, the percentage of gas in the air, as the flame cap is caused by the ignition of this gas. A standard flame adopted for any purpose is a flame burning a known weight of a certain combustible in a unit of time; thus, a standard candle has been assumed as a candle burning 120 grains of spermaceti per hour. A standard flame, therefore, represents a certain amount of gas burned per unit of time. The flames of different illuminants are not equally sensitive to gas.

Table X gives the heights of the flame caps corresponding to different percentages of marsh gas (methane) contained in the air supporting the flame. The heights of the flame caps given in this table for an oil flame were determined with the flame reduced to about $\frac{1}{4}$ inch or $\frac{1}{8}$ inch, or less, which is the height most commonly used in testing. The heights of the caps obtained will vary somewhat from those given in Table X, according to the original height of the flame, but a flame smaller than $\frac{1}{8}$ to $\frac{1}{4}$ inch is apt to be extinguished when introduced into gas, and is not often used.

The flame of burning hydrogen, as shown by Table X, is the most sensitive; although alcohol and the very volatile oils distilled from petroleum, such as naphtha, furnish flames only slightly less sensitive. All these flames give caps that are clearly perceptible for the smaller percentages of gas varying from $\frac{1}{2}$ to 3 per cent. The naphtha or benzine flame

permits the observance of caps corresponding to smaller percentages of gas than is possible with the oil flame, and with the naphtha flame from $\frac{3}{4}$ to 1 per cent. of gas is quite easily detected. With the oil flame, however, even when drawn to its lowest possible point, only the most experienced eye can detect some of the lower caps given in the table. Experiments have shown that, for sperm oil, the height of flame cap varies as the cube of the percentage of gas contained in the air mixture.

Fig. 21 represents the heights of the several flame caps corresponding to different percentages of gas as they appear

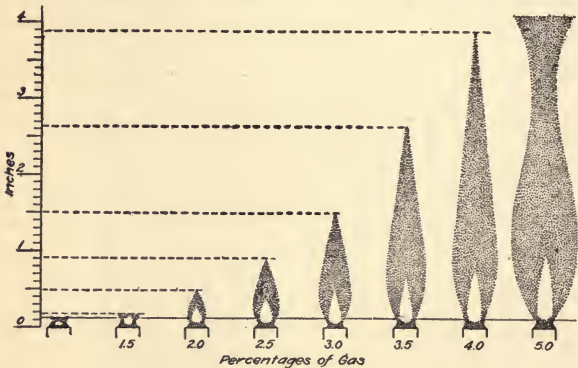

FIG. 21

on the oil flame. In the use of the oil flame, the caps below that marked 2.5 per cent. cannot ordinarily be discerned.

Fig. 22 shows the corresponding height of caps from the naphtha flame, the heights being given in both inches and centimeters.

The alcohol flame used in the Pieler lamp and the Stokes lamp gives the largest flame caps of any lamp; that in the Pieler lamp being $5\frac{1}{2}$ inches in height for 2 per cent. of gas. This flame is, however, easily extinguished by a slight draft or rapid movement of the lamp. The hydrogen flame of the Clowes lamp is usually set to a standard height of $\frac{2}{3}$ inch, for

detecting the smaller percentages of gas, or a flame $\frac{3}{8}$ inch in height may be used; but for the detection of the higher percentages the height of the flame must be reduced to $\frac{1}{8}$ inch.

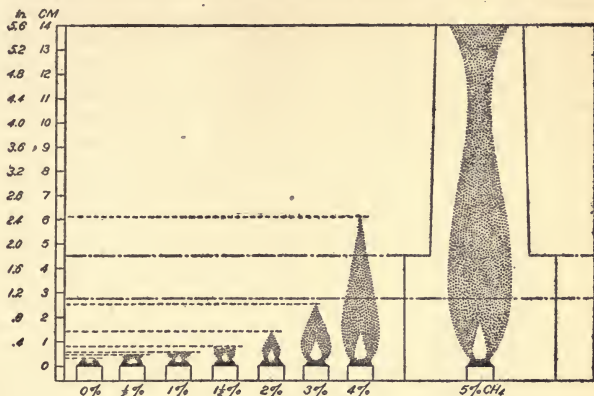

FIG. 22

The presence of carbon dioxide (carbonic-acid gas) does not affect the formation of the flame cap or its height, except when this gas is present in sufficient quantity to dim the ordinary flame of the lamp.

GAS INDICATORS

90. Numerous devices have been employed at different times for indicating the gaseous condition of the mine air. Most prominent among these, perhaps, is the indicator devised by Mr. Liveing, which depends on the increased brilliancy of an incandescent coil of platinum wire, through which a current of electricity is passing, when the wire is surrounded by an atmosphere containing marsh gas (methane). The incandescence of the wire ignites the gas in contact with it, and the heat caused by the combustion of the gas increases the temperature of the wire and causes it to glow more brightly, the brilliancy increasing with the percentage of gas present.

91. The **Living indicator** consists of two coils of platinum wire of equal electrical resistance. One of these spirals is enclosed in a tube with a glass cover at the end facing the second spiral; this tube is air-tight, being filled with pure air. The second spiral is surrounded by a cylinder of wire gauze having a glass cover at the end facing the first spiral. The two ends of the cylinders having glass covers are 4 inches apart, and directly between them is a small wedge-shaped screen or mirror so arranged as to reflect the images of these spirals upwards to the eye of the observer. The whole is enclosed in a box having a small glass window in the top, through which the incandescent spirals are observed. By means of two rubber tubes attached to the box, the latter may be filled with the air to be tested by drawing the air from the box through one of the tubes, with the mouth or with a small air pump, while the end of the other tube is held near the roof or where gas is suspected. In the bottom of the box is a small magneto-electric machine for generating the current, and which is operated by turning a handle on the side of the box. The electric current passing through both of the platinum coils causes them to glow with equal brilliancy when no gas is present in the air drawn into the box. If, however, this air contains gas, the spiral enclosed in the gauze cylinder will glow more brightly. The small mirror between the two spirals is then moved nearer to the other spiral until the two appear of equal brilliancy. The position of the mirror is read on a scale graduated in percentages, and by this means the percentage of gas in the air tested is determined. This indicator, although cumbersome and expensive, has been employed in numerous instances for the examination of mine workings.

92. The **Beard-Mackie sight indicator** depends on the incandescence of fine platinum wires suspended in a ladder-like frame above the flame of any ordinary safety lamp. This indicator, which is shown in Fig. 23 attached to a common Davy lamp, consists of a No. 14 Birmingham wire gauge brass wire *a* bent in the form of an inverted **U** and

firmly fixed to a thin brass disk, as shown in Fig. 23 (a), fitting into the neck of the lamp, and held firmly in a vertical position by the nipple that holds the wick tube in place; sometimes this standard is attached firmly to the nipple itself, as shown at *b*, Fig. 23 (b), and cannot then be detached from the lamp without also removing the nipple. On this standard, fine platinum cross-wires are arranged at such heights above the flame as to indicate by their incandescence the percentage of gas present in the air. The indicator thus shows the presence of gas varying in amount from $\frac{1}{2}$ per cent. to 3 per cent., each successive strand of platinum wire showing by its incandescence an increase of $\frac{1}{2}$ per cent.

of gas. The percentage of gas indicated by the several wires is marked opposite each wire in Fig. 23 (a). This indicator may be attached to the lamp or detached as desired. In the use of the sight indicator, the flame is first adjusted in fresh air to such a height that the lowest wire of the scale only is aglow; this is called the *standard wire*, and is a straight platinum wire.

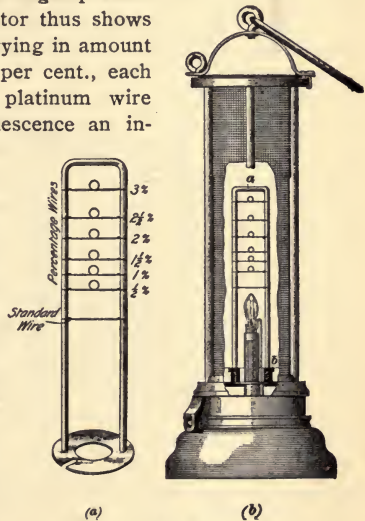

FIG. 23

The percentage wires are looped, which makes them more plainly visible through the gauze.

The principle on which the sight indicator depends may be briefly stated as follows: The combustion of the marsh gas (methane or light carbureted hydrogen), which is the chief constituent of firedamp, produces great heat but little light, the flame being practically non-luminous. Platinum wire

possesses the property of absorbing this gas to a greater or less extent, and is thereby rendered more sensitive to its presence; the incandescence of the wire makes visible, so to speak, the heat of the non-luminous flame cap formed by the burning gas. It is well known that this flame cap is not commonly perceived in the Davy lamp burning ordinary oil, even when the flame of the lamp is reduced to its smallest size, when less than $2\frac{1}{2}$ per cent. of gas is present, and many experienced miners have difficulty in perceiving the cap in 3 per cent. of gas. By means of the indicator, the presence of $\frac{1}{2}$ per cent. is clearly revealed by the bright incandescence of the lowest wire of the scale, this taking place with the normal working flame of the lamp. Much time is thus saved in making a test for gas, as it is not necessary to draw down the flame of the lamp when the test is to be made. The scale of incandescent wires also affords a positive reading, which is always the same for the same gaseous condition of the air, and enables an intelligent comparison to be made between the reports of different fire-bosses in different sections of the mine, since the percentages in these reports are all measured by the same standard.

A modified form of the indicator just described, for use in the working lamp, has but two cross-wires or strands, adjusted to such heights as, in the opinion of the fire-boss, are best adapted to the conditions of the particular mine where the indicator is to be used. The lower of these two strands is called the *warning line*, and it gives a warning of the gaseous condition of the air; the upper is the *danger line*, and indicates a point where all naked lamps in use should be extinguished. The position of both the warning line and the danger line in the lamp will evidently vary with the character of the coal, its inflammability, hardness, etc. In the working of anthracite, no alarm is commonly felt until the amount of gas exceeds 2 per cent., when an effort is made to increase the ventilation and reduce the percentage of gas. In the working of bituminous mines, particularly where there is dust and the coal contains much volatile matter, the danger point is reached at a lower percentage.

93. The Shaw gas-testing machine, Fig. 24, is a simple and quite accurate mechanical device for determining the percentage of marsh gas (methane) in a mixture of gas. On account of its size and lack of portability, its use is restricted to laboratory purposes, and it cannot replace the method of testing for gas at the working face by means of a safety lamp. The cylinders *a*, *b* are fitted with pistons that are connected to the lever *c* by the piston rods *d*, *e*, the rod *d* being permanently attached to the end of the lever *c*, but the end of *e* being movable along *c*. The cylinder *b* is also movable along the base *f*, which is graduated, as shown, to

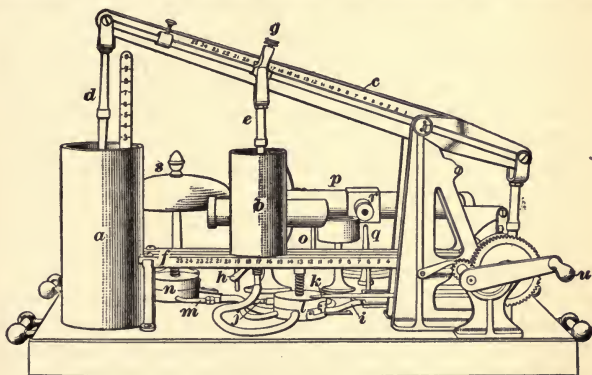

FIG. 24

correspond with graduations along *c*, so that when *b* is placed at a certain graduation on *f*, the upper end of *e* is placed at the corresponding graduation on *c*; the piston rod is then clamped firmly by the clamp screw *g* and the cylinder *b* by the clamp *h*. By means of the handle *u*, the gearing, and the rod, the short end of the lever *c* is moved up and down, and in this way the pistons within *a* and *b* are caused to move up and down. As the long end of the lever *c* rises, the piston connected to *d* draws air into the cylinder *a*, while the piston connected to *e* draws in a mixture of air through *i* and of gas to be tested through *j* into the cylinder *b*. The relative

amounts of air drawn into *a* and of the gaseous mixture to be tested drawn into *b* depend on the relative sizes of the cylinders *a* and *b* and the position of the cylinder *b* on the base *f* and the arm *c*. When the longer end of the lever arm *c* descends, the rod *k* turns the valve *l* so that the openings into *i* and *j* are closed, and at the same time it opens the valve to the pipe *m*, which connects with another valve *n* through which the mixture of air and gas from the cylinders *a, b* is pumped by the descending pistons, then through a pipe underneath the base and up through the tube *o*, into the hollow cylinder *p*. If the mixture of air and gas in *p* is explosive, it is fired by means of a flame from the burner *q* through the opening *r*, which connects with the inside of *p*. Inside the cylinder *p* is a piston that is driven outwards by an explosion, ringing the gong *s*. The amount of gas in the explosive mixture is determined by the position of the cylinder *b* as given by the readings on the arms *c* and *f*, the percentage for the various readings being given by a table furnished with the machine.

94. Testing for Gas by the Shaw Machine.—In order to test the mine air for gas by the Shaw machine, samples of the air must be collected in large rubber bags supplied for this purpose. The bags are first rolled up flat to drive out all the air they contain; the mouth of the bag is then held at the roof, or wherever it is desired to take a sample of the air, and the bag is unrolled and expanded by pulling out the sides. Sometimes a small pump is used to fill the bag with the mine air. The bag containing the mine air is then brought to the surface and attached to the small pipe *i* shown on the right of the distribution box *l*. When the valve in the mouth of the bag is opened and the machine started, the air from the bag is pumped into the cylinder *a*, instead of fresh air as formerly; if this air contains any gas, it is evident that a loud explosion will be caused by the mixture pumped into the combustion chamber *p*. To avoid this, the small cylinder pumping pure gas is set back a sufficient distance to allow for the supposed percentage of

gas contained in the mine air; thus, if the standard gas gave an explosion at 8 per cent., and the mine air is supposed to contain, say, 2 per cent., the small cylinder *b* will be set back to $8 - 2 = 6$ per cent. on the upper and lower scales. If an explosion does not occur in this position of the cylinder, it shows that the mine air contains less than 2 per cent. of gas, and the small cylinder is then advanced slowly till an explosion does occur when the machine is operated. If this explosion occurs at, say, 6.5, the percentage of gas in the mine air is $8 - 6.5 = 1.5$ per cent.

The Shaw gas machine is valuable and accurate as a means of testing the percentage of gas present in air, but its disadvantage, in connection with the testing of mine air, is the inability to make the test in the entry at the point where the danger exists. By the time the mine air has been bagged and carried to the surface, and the report of the test returned to the mine, the conditions may have changed and the danger passed or perhaps largely increased. The testing for gas in the mine, to be efficient, must be accomplished at the moment and at the point where the danger exists; this can only be done by a portable machine or lamp.

SAFETY-LAMP HOUSES

95. Fig. 25 shows a very convenient lamp house as used at Heworth Colliery, England. The circular and revolving lamp stands *a* are placed in a circle around the cleaning machine *b*, and by this arrangement a person standing at the machine can, with very little movement, reach any safety lamp in the house. The walls of the cabin are circular and 18 inches thick. There are six windows *c*, at which the lamps are handed out to the workmen, and two stands are conveniently placed adjacent to each window. The entrance door *d* is placed at one end of the building, and at the opposite end there is a door leading to the repair shop *e*. Outside the wall of the cabin, and $4\frac{1}{2}$ feet distant from it, is another wall 9 inches thick, enclosing a passageway traversed by the workmen while getting their safety lamps.

The structure is covered by a glass roof, so as to obtain a good light. The floor is made of cement, and except for the windows, doors, and cleaning machine, there is no wood that can become saturated with oil or catch fire.

The double lamp-cleaning machine *b* is driven by a small steam engine.

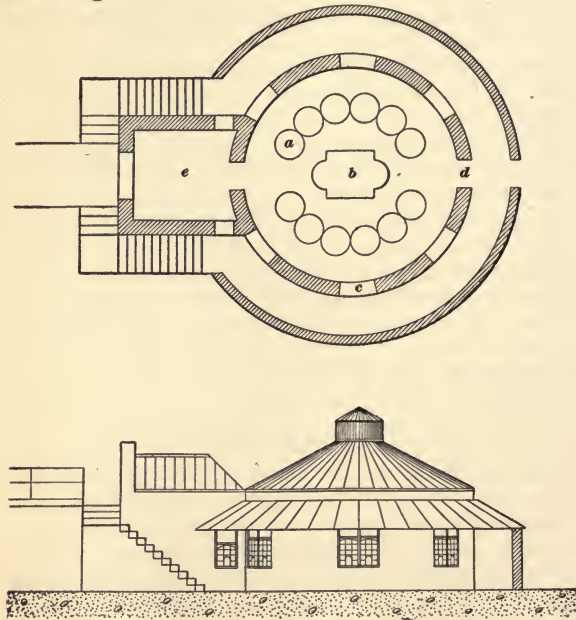

FIG. 25

The oil is conveyed in pipes from the storehouse to taps placed at each end of the cleaning machine. The lamp stands, shown in detail in Fig. 26, are made of wrought iron and hold 100 lamps each. There are five pair of shelves for each stand, one shelf *f* of each pair for the lamp tops being placed back of and slightly higher than the other shelf *g*,

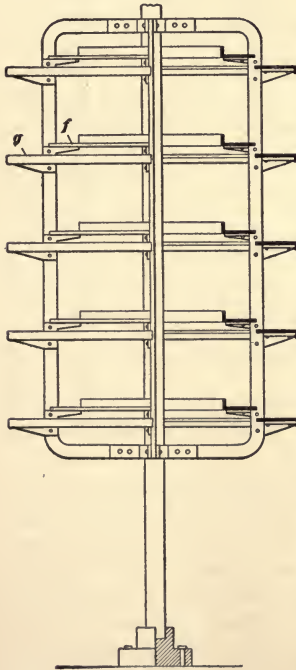
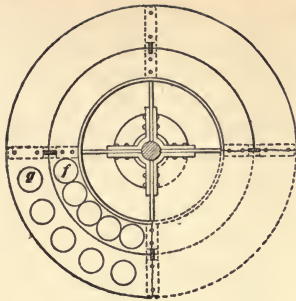

FIG. 26

which is for the bottoms. The shelves are $10\frac{1}{2}$ inches apart, and the lowest one is $2\frac{1}{2}$ feet from the ground. The tops of the stands are joined by a ring, and the standard of each stand rests at the bottom in a bearing that is cup-shaped, so as to hold oil.

Two men only on each shift are authorized to lock the lamps, in order to prevent an unlocked lamp being given out, although ten men and boys are employed on each shift in cleaning, repairing, and giving out the lamps.

Each workman using a safety lamp deposits a tag or check numbered to correspond to the number on his lamp when the lamp is given to him. The check is hung on a board containing hooks for 100 checks and placed beside the window nearest the lamp stand on which the lamp is stored. Each hook on this board has a label containing the name of the workman and the number of his lamp, and by inspection of this board it is possible to tell who is in the mine. If two shifts of men use the same lamps, a slate is hung

between the boards, with the names of the men or the different shifts on opposite sides.

Lamps needing repairs are left at the repair room *e*, Fig. 25, instead of at the window *c*.

A barometer, thermometer, and copies of the mining laws and any special colliery regulations are placed in a conspicuous place between the lamp house and the pit head.

96. The lamp house, of which Fig. 27 is a plan, is used at the Edenborn mine of the H. C. Frick Coke Company. At

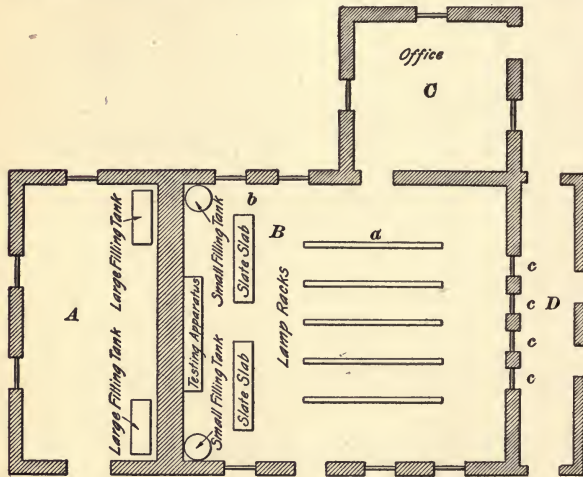

FIG. 27

this mine, Wolf lamps burning naphtha exclusively are used. The walls are of brick surmounted by a slate roof. *A* is the storeroom; *B*, the lamp room; *C*, the office; and *D*, the room in which the men receive and return the lamps. The floor of the storeroom and lamp room is of cement and tile, but that of the office is of pine. In the lamp room are a number of lamp racks *a* with hooks attached for the lamps, each hook being numbered and reserved for the lamp bearing the

same number. The two slate-topped tables *b* are used for cleaning and filling the lamps.

The cleaning tables are fitted with powerful magnets for unlocking the lamps—the Wolf lamp being provided with a magnetic lock—and with compressed-air attachments for blowing the dust and dirt from the lamps.

For filling the lamps, there is a 5-gallon tank on the cleaning table. This tank is filled by a pump from one of the tanks or barrels in the storeroom *A*, only enough naphtha to fill the lamps required for use being kept in the lamp room. The tank is equipped with an automatic attachment for filling the lamps without overflowing them.

To clean the lamps, they are unlocked and the globes, gauzes, and expansion rings removed. The cups are then put under the filling tap, and while they are being filled the lampman cleans the other parts by means of compressed air and brass-wire brushes and soft cloths to polish the glasses.

No one is allowed inside the lamp house except such persons as are required to care for and distribute the lamps.

The men receive their lamps at the small windows *c*. Each man is required to deposit a brass check with his number stamped on it before he is given a lamp. Each lamp is tested before being given out.

When the lamp is returned, the man receives his check back. This checking system shows the number of men in the mine and also prevents the loss of lamps, as no one can get his check unless he returns a lamp or can give a satisfactory excuse for not returning it.

PORTABLE ELECTRIC LAMPS

97. Many unsuccessful attempts have been made to provide an electric lamp for lighting the inner workings of a mine. For numerous reasons, arc lamps are not adapted to mine work. Incandescent lamps protected by strong glass globes have been used, the wires conducting the current from the surface to the lamps being usually laid on the floor or buried in a ditch at the side of the roadway. These lights,

however, have given little satisfaction, owing not only to their stationary character and the dark shadows thrown on certain portions of the work, but also to the difficulty of extending the lead wires from time to time, and the annoyance caused by these wires being constantly in the way. So great have these annoyances proved that the use of such lights at the working face has been quickly abandoned wherever introduced. Beside the annoyance mentioned, there is always present, in gaseous mines, the danger of the ignition of the gas by the breaking of a lamp. The numerous attempts made to design a portable electric lamp have been but little more successful, the difficulty being the inability to construct in a lamp of moderate weight a battery capable of yielding a suitable light for a period of at least 8 or 10 hours at a time without recharging. In a few instances, lamps have been made that would yield a good light for the required length of time, but owing to their weight and expense they have not come into general use.

One of the chief objections to the use of the electric light in mine workings is the fact that such a light affords no indication of the gaseous condition of the mine air with respect to explosive, poisonous, or suffocating gases. To the miner, this is almost a fatal objection, since he has always depended on his lamp to give him the first warning of a dangerous condition of the air.

MINE VENTILATION

(PART 1)

GENERAL PRINCIPLES OF MINE VENTILATION

PRODUCTION AND CONTROL OF AIR-CURRENTS

INTRODUCTION

1. The subject of **mine ventilation** includes the various methods and appliances for producing air-currents in a mine and for conducting a sufficient quantity of air through the mine passages and workings. The purpose of this air-current is to dilute, and thus render harmless, the noxious gases given off from the coal and rock strata, and also to sweep away these gases and those resulting from blasting and the exhalations of the men and animals. It is necessary that the air in a mine be constantly changed, because men and animals cannot live and lights will not burn without an adequate and constant supply of pure air. The proper ventilation of a mine requires that a sufficient air-current be so distributed throughout the workings as to sweep the entire working face with a velocity sufficient to dislodge and carry away the gases that accumulate at the face and in the cavities of the roof, and often also those accumulating in places that have been worked out.

CONDUCTING AIR-CURRENTS

2. **Definitions.**—In order to control the direction and amount of the air-currents passing through a mine, some of the principal means employed are airways, cross-cuts, mine

Copyrighted by International Textbook Company. Entered at Stationers' Hall, London

doors, curtains, regulators, brattices, stoppings, and air crossings. The term a **mine**, as here understood, refers to a system of underground passageways and openings, as shown in Fig. 1, driven for the most part in the seam or stratum it is desired to remove and connected with the surface by a **drift** or **tunnel**, which is a horizontal opening, a **shaft**, which is a vertical or nearly vertical opening, or a **slope**, which is an inclined opening.

The ventilation of a mine requires an air current passing through the mine. An **air-shaft** is a shaft sunk from the surface to the mine workings, for the purpose of ventilation; a **downcast shaft** is a shaft by which air enters a mine; an **upcast shaft** is one by which the return air is discharged from a mine. The passageways, shown in Fig. 1, called **gangways**, **entries**, or **headings**, and **air-courses**, or **airways**, furnish a way out of the mine for the material mined, and a way into the mine for the fresh air or a way out for foul air and noxious gases; they also block out the mine and enable the coal to be mined at a number of points at the same time. To provide for an air-current into and out of the mine, the passageways are generally driven in pairs. The passageway by which the air is conducted into the mine is called the **intake**, and the one by which the air is carried out of the mine, the **return**.

Openings, called **rooms** or **chambers**, are turned off one or both sides of a pair of passageways or entries. The **mouth** of an entry, airway, or room, is its outer end or opening. The innermost ends, or **faces**, of all entries and rooms are the working places of the mine, where the coal is mined. The face of a room is sometimes called the **breast** of the room; the side walls of all entries, airways, and rooms are called **ribs**.

Cross-cuts, or **break-throughs**, are openings made at regular intervals between the two entries of a pair, or between two adjoining rooms to conduct the air from the intake into the return entry, or from room to room, and thus keep the air in circulation at all the working faces in the mine. As shown in Fig. 1, each cross-cut is closed by building an

air-tight **stoppings** as soon as a cross-cut is made near the face.

If, for any reason, a single entry is driven instead of two entries, the air is carried into the face of the entry and then to the room nearest the face of the entry by a **brattice**, which is a partition of boards or canvas placed so as to divide a single airway into two parts, one for the incoming and the other for the outgoing air. The air passes up the

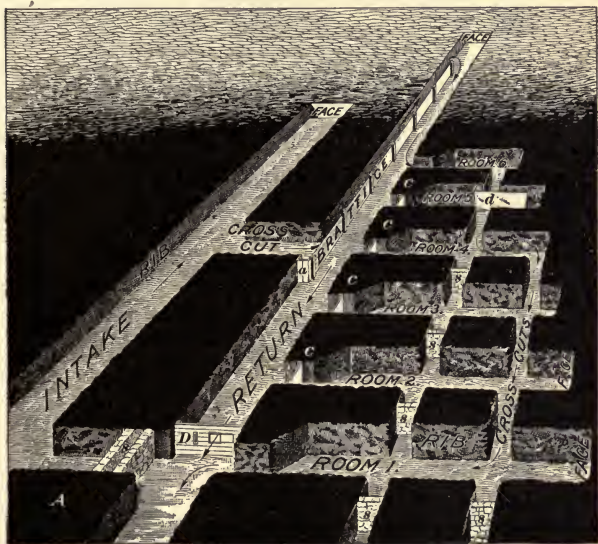

FIG. 1

room nearest the face of the entry and along the faces of the tier of rooms, and is then carried to the upcast shaft by a special airway connecting the room nearest the upcast shaft with the upcast shaft.

3. Mine Doors.—To deflect the air-current from the entry in which the door is placed into a side or cross-entry or passage, mine doors, Fig. 2 (a), are generally used; these

are constructed of a double thickness of boards made to cross each other diagonally so as to add to the strength of the door. The door is hung in a substantial frame made of timber firmly wedged between the floor and the roof. Before setting the door frame, the sides and roof of the entry are dressed so as to form a good bed for the timbers and proper clearance for the door. The door should be hung on the side of the frame toward the direction from which the air comes, so that the force of the air-current will keep the door closed. Large strap hinges are bolted to the door in such a way as to give it a sufficient fall to prevent its standing open. To do this, the lower staple supporting the end of the hinge is set in the door frame about $1\frac{1}{2}$ inches farther back from the door than the upper staple. If the

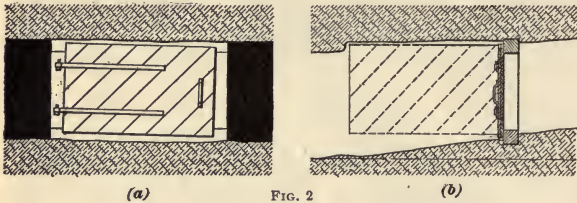

FIG. 2

seam has a slight pitch, as shown in the figure, it will be necessary to cut the roof so as to give the proper clearance to the door when it is open, as shown in Fig. 2 (b).

4. A canvas door, or curtain, consists of a piece of canvas hung from a cross-bar by rings, and serves the purpose of a temporary door where the requirements will not warrant the expense of a timber door. A canvas door or curtain is often used where it is desired to turn only a portion of the air-current, as the air that leaks through the curtain ventilates the passageway beyond the curtain. A canvas brattice used to deflect the air-current to the face of a room is shown at *d*, Fig. 1.

5. Regulators.—Any device constructed in an airway to divide an air-current proportionately between two airways is

a regulator. There are two forms in use, known as the *box regulator* and the *regulator door*. The *box regulator*, Fig. 3, consists of a solid board stopping *a*, or of a door, with a hole cut in the center and provided with a shutter *b* that

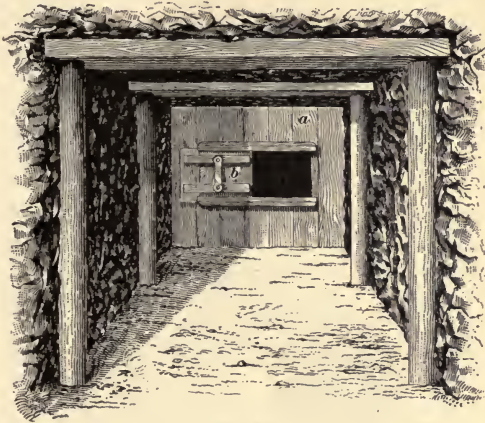

FIG. 3

can be slid over the opening so as to regulate the size of the opening through which the air is allowed to pass. By this means, the volume of air passing through the regulator is made greater or less, as desired. The box regulator is usually placed at the inby end of the air-current that it controls, on an

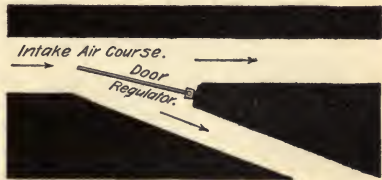

FIG. 4

entry or air-course that is not used as a haulage road, so as not to interfere with the passage of the cars.

The *door regulator*, Fig. 4, is a door provided with a set lock, so that it may be secured in any desired position. It is always placed at the mouth of an entry, and

is so arranged that it may be swung to one side or the other, so as to increase or decrease the quantity of air passing in either entry. The angle at which this door is set and the amount of opening left in the box regulator are usually ascertained by trial, so as to give the desired division of the air between the two entries. The method of calculating the amount of air passing through a regulator will be explained later.

6. Brattices.—The most common form of a brattice is the board brattice shown in Fig. 1, where it is built on the return airway to conduct the air-current forward to the face of this airway, which is some distance ahead of the face of the intake airway. It would be impossible to ventilate a single airway without a brattice or some similar device. This brattice is built by setting a row of posts in the airway, several feet from one rib, and nailing boards or canvas to them so as to form an air-tight partition. Brattices are also extensively used in the rooms for conducting the air from the last cross-cut to the face. When a brattice is used, it is customary to carry the air behind the brattice and allow it to return on the roadway, instead of carrying the air in on the roadway and returning it behind the brattice.

7. Stoppings.—A wall built to close off an airway or a

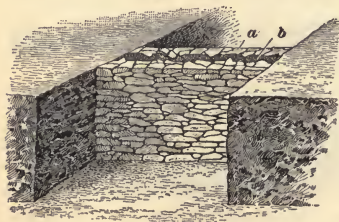

FIG. 5

break-through is called a stopping. A common form, Fig. 5, consists of two loose walls of slate *a* a few inches apart and having the space between filled with fine dirt or sand. The back wall of slate is first built up to the roof,

and the front wall is then started, the space *b* between the walls being filled in and rammed as this wall is built up. Care must be taken to pack the material tightly against the roof to prevent the leakage of air through the stopping.

There is no economy in building a poor stopping, as this causes great trouble and expense in the future working of the mine. Stoppings are sometimes built of concrete or brick laid in clay, and the face of such a brick stopping may be plastered with clay to prevent any leakage of air or gas. Such a stopping is called a sealed stopping, and the opening that it closes is said to be *sealed* or *sealed off*. Board stoppings are sometimes used for temporary purposes.

8. **Air Crossings, Air Bridges, Overcasts, Undercasts.**—Any form of construction by which one air-current is made to pass over or under another air-current is called

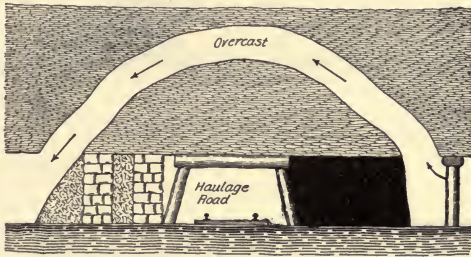

FIG. 6

an **air crossing**; air crossings are called **overcasts** when they pass over another airway, Figs. 6 and 7, and **undercasts** when they pass under another airway, Fig. 8. An air crossing, Fig. 6, may be driven entirely in the roof strata and some distance above the other airway; in this form of crossing there is no connection between the two airways at the point where they cross each other. A more common form of air crossing, called an **air bridge**, is shown in Fig. 7. An undercast is shown in Fig. 8. The relative advantages and disadvantages of these different kinds of air crossings are as follows:

An overcast driven entirely in the rock is often more expensive to build than the common form of air bridge, but it is perfectly air-tight and there is no loss of air by leakage. It is often stated as an advantage that such an overcast

cannot be destroyed by the force of a mine explosion, but the conditions in a mine in this respect are so numerous that the destruction of an overcast may or may not prove a disadvantage. If the force of the explosion finds relief by blowing down an air bridge, this may prevent the extension of the explosion into another section of the mine, owing to the



FIG. 7

immediate expansion and cooling of the gases in the mine. On the other hand, if there is not a way of escape for men from other portions of the mine, the destruction of an air

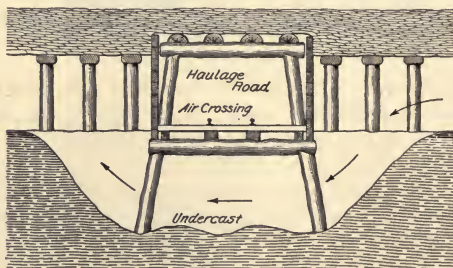

FIG. 8

bridge may spread the afterdamp to parts of a mine to which it might not otherwise have gone. Again, if an air bridge is not destroyed by an explosion, it may cause the air-current to force a large volume of poisonous gases into sections of the mine that otherwise would not be affected by the explosion. For these reasons, it is a question whether tight

stoppings or loosely built stoppings that will be easily blown out by an explosion are the better.

An undercast constructed as shown in Fig. 8 has the decided disadvantage that a basin is formed in which water or gas may collect. Any accumulation of water under the air bridge reduces the sectional area of the air passage, and may completely close the airway. In case of emergency, the undercast may be found impassible and perhaps the only means of escape thereby cut off. The common form of air bridge shown in Fig. 7 is constructed by blowing down the roof in the cross-entry on each side of the haulage road or air-course, and driving a passage up through the roof strata overlying the haulage road. When this has been done and the rock dressed, strong timber frames *a* are constructed on each side of the haulage road and heavy cross-beams *b* are laid over these in line with the air crossing; rails are sometimes used for this purpose. A double thickness of plank *c*, *d* laid at right angles to each other or so as to break joints is then laid on these cross-beams and over them a bed of sand or clay. The joints between the overcast and the haulage road are then carefully sealed with clay or other luting material, so that no air can leak from the overcast into the roadway. Timber is then set to secure the roof of the overcast, either as shown in the figure or as called for by the local conditions.

The construction of overcasts, mine doors, brattices, and stoppings is often regulated by law and must in some states be approved by the mine inspector for the district.

FORM AND SIZE OF AIRWAYS

9. The five forms of airways more or less commonly used in mines are shown in Fig. 9; these are the circular (*a*), square (*b*), rectangular (*c*), arched (*d*), and trapezoidal (*e*). The **perimeter** of an airway is the polygon or curve bounding a cross-section of an airway. The perimeter of a circular airway is its circumference. The perimeter of a square airway is four times the length of one of its sides. The

perimeter of a rectangular airway is the sum of the length of the four sides of the airway, and may be found by adding the height of the airway to its width and multiplying their sum by two. The perimeter of the arched airway is the sum of the lengths of the three straight sides and the curve. The perimeter of the trapezoidal airway is the sum of the lengths of the four sides.

The **sectional area** of an airway, often referred to simply as the **area**, is the area of a cross-section of the airway. This area is designated a in ventilation formulas. The area of a circular airway is equal to the area of a circle whose

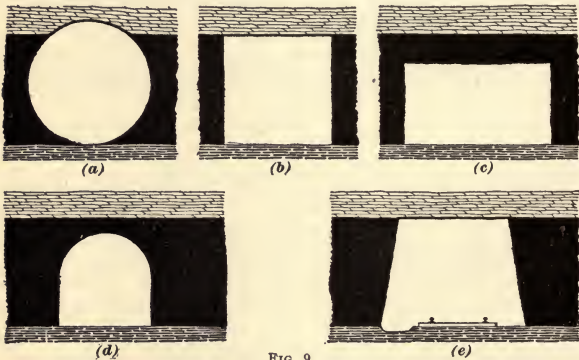

FIG. 9

diameter is the diameter of the airway. The area of a square airway is equal to the square of one side of the airway. The area of a rectangular airway is the product of the height and width of the airway. These dimensions are found by carefully measuring the height of the airway where the observation is taken and the average width, making allowance, as the judgment may dictate, for unavoidable timbers. The area of a trapezoidal airway equals the product of the height by one-half the sum of the top and bottom widths. The area of an arched airway is found by separately calculating the area of the lower cross-section bounded by straight lines, and that of the upper section

bounded by the roof curve and the top line of the lower section, and adding these two areas together.

The rubbing surface of an airway is the entire inner surface of the airway composed of the roof, floor, and sides. It is estimated in square feet and is found by multiplying the perimeter of the airway by its length. Expressed as a formula, this is

$$s = lo$$

in which s = rubbing surface of airway, in square feet;
 l = length of airway, in feet;
 o = perimeter of airway, in feet.

EXAMPLE.—Find the perimeter, rubbing surface, and area of an airway 6 ft. \times 10 ft. and 1,000 feet long.

SOLUTION.—The perimeter is $2(6 + 10) = 32$ ft. Ans.

The rubbing surface is $32 \times 1,000 = 32,000$ sq. ft. Ans.

The area is $6 \times 10 = 60$ sq. ft. Ans.

10. Comparison of Forms of Airways.—The resistance offered to the passage of an air-current through an airway depends on the amount and character of the rubbing surface; and since air-ways having the same area of cross-section may have different perimeters, it is advisable, if practicable, to choose that form of airway that has the smallest perimeter for a given sectional area. For the same amount of rubbing surface and the same perimeter, the larger the sectional area, the greater will be the quantity of air in circulation. As the circular airway presents the smallest perimeter or rubbing surface for a given area, it will offer the least resistance to the passage of the air and will pass the largest quantity of air with the least expenditure of power.

Practical considerations, however, determine to a great extent the form of airway to be adopted in any particular case. The circular is not a practical form for an airway, since it furnishes no roadbed, the shape is difficult to maintain in driving, and in stratified material the sides and top of this form are difficult to support. The height of the airway is generally determined by the height of the seam, except in thick seams, and the nearer a rectangular airway approaches to a square airway, the more air it will pass.

Table I shows that for a given sectional area the circular airway has less rubbing surface than a square airway, and the square airway less rubbing surface than a rectangular airway. That form of rectangular airway which most nearly approaches the square form has the less rubbing surface. The arched airway, which combines the circular and the square or rectangular form is better in this respect than the square or rectangular form alone. Since circular airways are seldom practicable, arched or square airways should be used whenever possible, and if rectangular or trapezoidal

TABLE I

Form of Section	Dimensions of Section	Length Feet	Perimeter Feet	Rubbing Surface Square Feet	Sectional Area Square Feet
Circular . .	9.026' diam.	1,000	28.36	28,360	64
Arched . .	8' wide \times 8.86 high	1,000	30.29	30,290	64
Square . .	8' \times 8'	1,000	32.00	32,000	64
Trapezoidal	(10' and 6') \times 8.25'	1,000	32.50	32,500	64
Rectangular	10.666' \times 6'	1,000	33.33	33,333	64
Rectangular	16' \times 4'	1,000	40.00	40,000	64

airways are absolutely necessary, they should, in so far as is practicable, approach the square form.

EXAMPLES FOR PRACTICE

1. Find the perimeter, rubbing surface, and sectional area of an airway 9 ft. \times 12 ft. and 2,000 feet long.

Ans. { Perimeter, 42 ft.
 Rubbing surface, 84,000 sq. ft.
 Sectional area, 108 sq. ft.

2. Find the sectional area of an airway that measures 6 feet in width at the top, 10 feet in width at the bottom, and is 8 feet high.

Ans. 64 sq. ft.

3. Find the perimeter, rubbing surface, and sectional area of a circular airway 9 feet in diameter and 1,000 feet long.

$$\text{Ans. } \begin{cases} \text{Perimeter, 28.27 ft.} \\ \text{Rubbing surface, 28,274 sq. ft.} \\ \text{Sectional area, 63.6 sq. ft.} \end{cases}$$

4. Find the perimeter, rubbing surface, and sectional area of an arched airway 10 feet wide 10 feet high to the crown of the arch, and 1,000 feet long.

$$\text{Ans. } \begin{cases} \text{Perimeter, 35.7 ft.} \\ \text{Rubbing surface, 35,708 sq. ft.} \\ \text{Sectional area, 89.27 sq. ft.} \end{cases}$$

5. What is the total rubbing surface in a circular shaft 15 feet in diameter and 1,200 feet deep divided into two equal compartments by a partition, the thickness of which may be neglected? Ans. 92,549 sq. ft.

11. Similar Airways.—Two airways are similar when their cross-sections are similar figures. Two figures are similar when their corresponding angles are equal and their corresponding sides proportional. Circles and squares are always similar. When the smaller of two similar rectangles or trapezoids is placed within the larger, so that any two corresponding sides are parallel, the two other corresponding sides will also be parallel, each to each. Fig. 10 shows two similar trapezoids so placed that their corresponding sides are parallel. Many of the problems in mine ventilation are considerably shortened by the application of special rules or formulas, when it is known that they relate to similar airways.

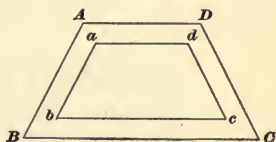

FIG. 10

HOW AIR-CURRENTS ARE PRODUCED

12. *Fluids always move from a point of higher pressure toward a point of lower pressure; the moving force is the difference between the two pressures, and it is on this principle that the production of an air-current depends. No air-current is produced in an airway when the pressure is the same at both ends of the airway; but if by some means the pressure at either end is increased or decreased with respect to that at*

the other end, a current of air is at once produced in the airway, its direction being from the greater toward the lesser pressure. The end where the air enters the airway is called the *intake end*, or simply the *intake*, and that where the air is discharged into the atmosphere the *return end*, or the *return*, of the airway. The pressure at the intake end is always greater than that at the return end of the airway or the air would not flow, and the difference between these pressures is called the **ventilating pressure**, as it is this difference in pressure that causes the circulation of air through the airway.

The *unit of ventilating pressure* is the amount by which the intake pressure exceeds the return pressure expressed in pounds per square foot.

The ventilating pressure is given by the following formula:

$$P = p a$$

in which, P = ventilating pressure, in pounds;

p = unit of ventilating pressure, in pounds per square foot;

a = sectional area of airway, in square feet.

The pressure creating an air-current is well illustrated by the difficulty experienced in opening a door in a mine against the air-current. For example, if a mine door is 5 feet high and 6 feet wide and the unit of ventilating pressure is 10 pounds per square foot, the total pressure against the door is $5 \times 6 \times 10 = 300$ pounds; and this must be overcome before the door can be opened.

13. A circulation of air through a mine airway may be produced by natural or artificial means. **Natural ventilation** includes all circulations of air caused by the natural heat of the mine in a shaft or slope or in rise or dip workings. **Artificial ventilation** is produced by such means as the *waterfall, wind cowl, furnaces, steam jets*, and all forms of *air pumps and fans*. All these means for producing a circulation of air in a mine or airway act by creating a difference of pressure between the intake and the return openings of the airway. The action of each of these means of producing ventilation will be described later.

14. **Systems of Ventilation.**—There are two general systems of mine ventilation, known as the *blowing*, or *plenum*, system, and the *exhaust*, or *vacuum*, system. In the **blowing system**, as shown in Fig. 11, the pressure on the air in the mine, known as the *mine pressure*, is always above the atmospheric pressure, while in the **exhaust system**, Fig. 12, the mine pressure

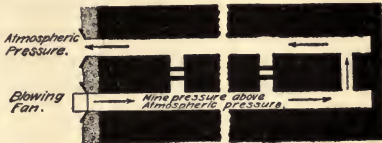

FIG. 11

is below the atmospheric pressure. In a blowing system, the means of ventilation is placed at the intake end of the airway and increases the pressure at that point above the atmospheric pressure. This increase of pressure is the ventilating pressure. In the exhaust system, the means of ventilation is placed at the return end of the airway and

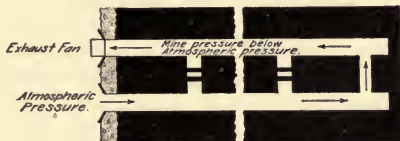

FIG. 12

reduces the pressure at that point below the atmospheric pressure; the decrease in this case is the ventilating pressure. In the blowing system, as the mine pressure is greater than the atmospheric pressure, every crack or crevice in the surface furnishes a way of escape for the mine air and gases. In the exhaust system, on the other hand, as the mine pressure is less than the atmospheric pressure, every crack and crevice in the surface furnishes a way for the atmospheric air to enter the mine. In the first case, the pressure acts from the mine into the atmosphere; in the second case, it is from the atmosphere into the mine.

GENERAL PRINCIPLES OF VENTILATION

15. Factors of a Circulation of Air.—Briefly stated, the general principles underlying the subject of mine ventilation are as follows: In every circulation of an air-current, *power* is used in overcoming the *resistance* of the airway, and in doing this, a certain *velocity* and *pressure* are produced and a certain *quantity* of air is circulated, thereby accomplishing a certain amount of *work*.

The factors concerned in the circulation of air in an airway may be grouped in the following three classes:

Producing Factors—the power producing the circulation;

Resisting Factors—the total rubbing surface and the unit of resistance. Then, *the unit of resistance* is the resistance offered to the passage of an air-current by a unit area of rubbing surface for a velocity of 1 foot per minute;

Resulting Factors—the velocity, quantity, and pressure of the air, and the work accomplished in moving a certain quantity of air at a given velocity and pressure.

When an air-current passes through an airway as the result of a certain ventilating pressure having been applied to the air, it is opposed by a certain resistance developed in the airway due to the rubbing surface. Three conditions may be presented as follows:

1. If an airway has the ends closed, the power applied produces pressure, but no velocity and consequently no flow of air or no quantity; this is called the *static condition*, and is only considered in special cases in mine practice.

2. If an airway consists of an opening in a thin plate so that it has practically no length, the power applied produces velocity and quantity but no pressure; this is the theoretical condition and does not represent any condition existing in a mine and its only use is in certain theoretical calculations.

3. In an airway with the ends open and of some length, the power applied produces pressure, velocity, and quantity; this is the normal working condition of a mine as presented in the general practice of mine ventilation.

16. Quantity of Air in Circulation.—The quantity of air passing through an airway is found by multiplying the sectional area of the airway by the velocity of the air-current, as expressed by the formula

$$q = av$$

in which q = quantity of air in circulation, in cubic feet per minute;

a = sectional area of airway, in square feet;

v = velocity of air-current, in feet per minute.

The quantity of air passing through a given section of airway, therefore, depends on the velocity of the air-current, and anything that affects the velocity will affect the quantity in the same proportion.

EXAMPLE.—Calculate the quantity of air passing in an airway 8 ft. \times 10 ft., when the velocity of the air-current is 600 feet per minute.

SOLUTION.—Substituting the given values in the formula, the quantity of air in circulation is

$$q = 8 \times 10 \times 600 = 48,000 \text{ cu. ft. per min. Ans.}$$

The velocity of the air-current is the rate of travel of the air in the airway expressed, generally, in feet per minute. The quantity of air passing out of the mine by the return airway is almost always greater than the quantity of air passing into the mine by the intake airway for several reasons; there is always some gas given off in the mine workings, and the volume of this gas goes to increase the volume of the return current; the return current is generally warmer than the intake and the air is thereby expanded and its volume increased; and as the pressure on the return air-current is always less than that on the intake there is a slight increase in the volume of the return current due to this cause. In speaking of the amount of air circulating in a mine, the quantity of air passing on the main intake airway is referred to and not that on the return.

MINE RESISTANCE

17. Definition.—Every airway offers a certain resistance to the passage of an air-current by virtue of its rubbing surface and its sectional area. The resistance of the airway is caused by the rubbing of the air-current on the sides, top,

and bottom of the airway; it is frictional resistance. The amount of resistance offered depends on the amount of the rubbing surface and on the velocity of the air-current, and this depends on the power applied. The application of a certain power to an airway will produce a velocity v , which will be greater or less according to the resisting power of the airway. For the same power applied, the greater the resisting power of the airway, the less will be the velocity produced; and the less the resisting power of the airway, the greater will be the velocity produced. This will be more clearly understood by the following illustration: Suppose that a small blower is attached to one end of a long garden hose; it is possible to increase the length of the hose so that with the greatest force or pressure that can be produced by the blower there is very little flow of air through the hose owing to the great resistance due to its length and rubbing surface. A pressure gauge attached to the hose near the blower will show a high pressure, while the velocity of the air in the hose is very small. If, now, the hose is cut off a short distance from the blower, the conditions with respect to velocity and pressure are at once reversed, there is a large quantity of air flowing through the short length of hose, and the pressure as shown by the gauge has dropped to a small amount. This illustration also shows that the pressure of the air, and consequently the resistance of the airway, is due to the resisting power of the airway as determined by its length and size, and to the ventilator producing the current.

While every airway has a certain resisting power dependent on its rubbing surface and area, there is no resistance developed in any case until a current has been established.

18. The *value* of an airway for purposes of ventilation is determined by its capacity for passing the largest quantity of air with the least expenditure of power. In general, the larger the area of an airway the greater is its capacity for passing air; but, on the other hand, the greater its resisting power, the smaller is the quantity of air for the same power producing the current.

The resisting power of an airway, which reduces its capacity for passing air by reducing the velocity at which the air flows, is equal to the product of the unit resistance k by the amount of rubbing surface s . The unit of resistance, generally called the *coefficient of friction*, is the resistance, in pounds, offered by 1 square foot of rubbing surface to an air-current having a velocity of 1 foot per minute. Multiplying the unit of resistance by the rubbing surface of an airway gives the resistance ks of that airway for a velocity of 1 foot per minute. As the velocity of the air-current increases, the same volume of air strikes a larger extent of rubbing surface in the same time and with a greater force. If the velocity be doubled, each particle of air rubbing against the rubbing surface meets twice the number of resisting particles as before, and strikes each particle with a blow twice as hard, making the resistance in this case $2 \times 2 = 4$ times as great as before. If the velocity is increased to three times the original velocity, each particle of air meets with three times the number of resisting particles and strikes each particle with a blow three times as hard as when moving at the original velocity, making the total resistance in this case $3 \times 3 = 9$ times the original resistance; thus the resistance is seen to increase as the square of the velocity. Therefore, the resistance of an airway is given by the formula

$$R = ks v^2$$

in which R = resistance of airway, in pounds;
 k = unit of resistance in pounds .00000002;
 s = rubbing surface, in square feet;
 v = velocity of air, in feet per minute.

19. Value of Unit of Resistance, or Coefficient of Friction, k .—The unit of resistance, commonly called the *coefficient of friction*, varies with the nature of the rubbing surface, but is practically a constant for any given class or type of mines. Numerous values, shown in Table II, have been given by different authorities for the coefficient of friction, many of which perhaps apply to different classes of mines.

In American practice, the Atkinson and Fairley coefficients have been mostly used. The Atkinson coefficient, which is more than twice as great as the Fairley coefficient, has been found, however, to give practical results in seams from 4 feet to 6 feet in thickness. If this coefficient is too high, it errs on the safe side, since it is always advisable to have plenty of air throughout a mine. The method of mining, mode of timbering, and other details of working, as well as the thickness of the seam, all of which vary considerably in different localities, determine practically the coefficient of friction best

TABLE II

	Values of k
J. J. Atkinson0000000217
W. Fairley00000001
G. G. Andre000000022424
Peclet000000003697
D'Aubuisson000000001955
Navier000000001872
J. Stanley James00000000929
D. Murgue000000008242

adapted to such local conditions or types of mines. The value of the coefficient of friction should, therefore, be regarded as representing a particular class of mines.

Owing to the wide difference in the values given by different authorities for the coefficient of friction, and further, owing to the fact that it is possible to determine this value only approximately, and because such value is often applied indiscriminately to all types of mines, the Atkinson coefficient will be abbreviated and the value $k = .00000002$ will be used in all the calculations and examples following.

20. Calculation of the Resistance of an Airway. Since the ventilating pressure, $P = pa$, which is the total pressure exerted on the sectional area of the airway, overcomes the resistance of the airway when the current is

established and the velocity of the air is uniform, the ventilating pressure is equal to the resistance R of the airway to the air-current. $R = k s v^2$. Then, since $P = R$,

$$R = p a \quad (1)$$

and

$$R = k s v^2 \quad (2)$$

$$p a = k s v^2 \quad (3)$$

Since the unit resistance is given in pounds, the total resistance will also be in pounds.

The resistance of an airway to the passage of an air-current depends therefore on three elements—the unit resistance, the rubbing surface, and the velocity of the air-current. Opposed to the mine resistance R is the ventilating pressure $P = p a$.

EXAMPLE.—Find the resistance of an airway 8 ft. \times 10 ft. and 2,500 ft. long, when the velocity of the air-current is 600 feet per minute.

SOLUTION.—The perimeter of this airway $o = 2(8 + 10) = 36$ ft., and the rubbing surface is $s = lo = 2,500 \times 36 = 90,000$ sq. ft. If $k = .00000002$, substituting the given values in formula 2,

$$R = .00000002 \times 90,000 \times 600^2 = 648 \text{ lb. Ans.}$$

21. Illustration.—Fig. 13 illustrates the manner in which the mine resistance or the resistance of an airway opposes the ventilating pressure of the air. The cross-section xy of an airway is represented as a piston. The small arrows on the left of xy represent the units of ventilating pressure acting on each square foot of the sectional area, giving a total pressure $p a$ acting in the direction of the

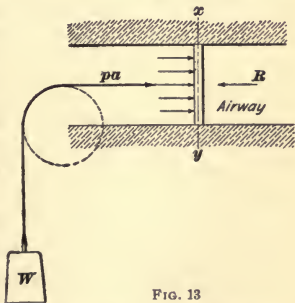

FIG. 13

small arrows. The total pressure $p a$ may be supposed to move against the resistance R of the airway in the same manner as it would move in raising a weight W equal to R . The vertical height through which this weight is raised in

1 minute is equal to the velocity of the air-current v expressed in feet per minute. Since the resistance of an airway is equal to the total pressure $p a$ exerted on the sectional area of such airway, the unit of ventilating pressure p , or the pressure per square foot of area, is equal to the resistance of the airway divided by the sectional area, that is,

$$p = \frac{R}{a}$$

22. Calculation of Unit of Ventilating Pressure.

Since the resistance of an airway $k s v^2$ is equal to the ventilating pressure $p a$, the unit of ventilating pressure p in any circulation is always equal to the resistance of the airway divided by its sectional area, as expressed by the formula

$$p = \frac{k s v^2}{a}$$

EXAMPLE.—Find the unit of ventilating pressure in an airway 8 ft. \times 10 ft. and 2,500 feet long, when the velocity of the air-current is 600 feet per minute.

SOLUTION.—The resistance of this airway was found in the example in Art. 20 to be, $k s v^2 = 648$ lb. The sectional area of the airway is

$a = 8 \times 10 = 80$ sq. ft.; then, $p = \frac{k s v^2}{a} = \frac{R}{a} = \frac{648}{80} = 8.1$ lb. per sq. ft.

Or, substituting the given values in the above formula,

$$p = \frac{.0000002 \times 90,000 \times 600^2}{80} = 8.1 \text{ lb. per sq. ft. Ans.}$$

POWER AND WORK IN PRODUCING AN AIR-CURRENT

23. Work.—Whenever a force acts through a given distance, work is performed, and the quantity of work is then measured by the product of the force, in pounds, and the distance through which it acts, in feet. That is, suppose that it takes a force (pressure) of 25 pounds to move a certain body; then, if the resistance is uniform, as, for example, in lifting a weight, and the body is moved through a distance of 36 feet, the work done is $25 \times 36 = 900$ foot-pounds. Work may, therefore, be expressed in foot-pounds, and represents a given weight (pounds) raised through a vertical height (feet), or a given pressure (pounds), exerted through

a given distance (feet). Work is independent of the time in which it is performed; that is, in the case just cited, no matter whether it takes 1 second or 1 year to move the body 36 feet, the work done is 900 foot-pounds.

24. Calculation of Work.—When the velocity of the air-current is expressed in feet per minute, the work performed each minute is equal to the product of the total moving pressure, or the ventilating pressure, pa and the velocity v of the air-current; or, since the ventilating pressure is equal to the mine resistance ksv^2 , the work performed each minute may be found by multiplying the mine resistance by the velocity of the air-current, giving the formulas,

$$u = pav \quad (1)$$

and

$$u = ksv^3 \quad (2)$$

Since the distance through which the pressure moves in ventilation is expressed as velocity in feet per minute, the work performed each minute is equal to the power on the air. The work performed in the circulation of air in an airway is illustrated in Fig. 13, the vertical height through which the weight is raised in 1 minute being equal to the velocity of the air-current expressed in feet per minute.

EXAMPLE 1.—Find the power on the air, in an airway 8 ft. \times 10 ft., when the velocity of the air-current is 600 feet per minute, and the unit of ventilating pressure is 8.1 pounds per square foot.

SOLUTION.—The area a is $8 \times 10 = 80$ sq. ft.; then, substituting the given values in formula 1, the power on the air is

$$u = pav = 8.1 \times 80 \times 600 = 388,800 \text{ ft.-lb. per minute.}$$

The horsepower of this circulation is

$$h = \frac{u}{33,000} = \frac{388,800}{33,000} = 11.782 + \text{H. P. Ans.}$$

EXAMPLE 2.—Calculate the power on the air required to produce a velocity of 600 feet per minute in an airway 8 ft. \times 10 ft. and 2,500 feet long.

SOLUTION.—The rubbing surface $s = 2(8 + 10) \times 2,500 = 90,000$ sq. ft.; substituting the given values in formula 2, the power on the air is

$$u = ksv^3 = .0000002 \times 90,000 \times 600^3 = 388,800 \text{ ft.-lb. per min.}$$

Ans.

This example can also be worked by first finding the resistance of the airway, and multiplying this resistance by the velocity; thus,

$$R = k s v^2 = .00000002 \times 90,000 \times 600^2 = 648 \text{ lb.}$$

$$u = k s v^3 \times v = 648 \times 600 = 388,800 \text{ ft.-lb. per minute. Ans.}$$

Again, since the quantity of air in circulation q is equal to the sectional area a multiplied by the velocity v , by substituting q for av in formula 1,

$$u = p a v = p q \quad (3)$$

EXAMPLE 3.—Find the power on the air when the quantity in circulation is 48,000 cubic feet per minute, and the unit of ventilating pressure is 8.1 pounds per square foot.

SOLUTION.—Substituting the given values in formula 3, the power on the air is

$$u = 48,000 \times 8.1 = 388,800 \text{ ft.-lb. per min. Ans.}$$

The three formulas given in this article show that the work performed each minute or the power on the air in any circulation is equal to the ventilating pressure pa , or the resistance of the airway ksv^2 , multiplied by the velocity of the air v ; also to the quantity of air in circulation q multiplied by the unit of ventilating pressure p .

25. Power on the Air.—Any given work can be performed in a greater or less time, according to the power applied; thus, if two men have twice the power of one man, they will perform twice the work of one man in a given time. On the other hand, one man will perform the same work as two men, in twice the time of the two men working together. The term **power**, therefore, relates to the performance of a given work in a given time. In order to compare the work done by different machines, time must be considered. Hence, the amount of work done in overcoming a resistance of 1 pound, through a space (distance) of 1 foot in 1 minute (foot-pounds per minute), is called the **unit of power** in ventilation. The power on the air is, then, the number of foot-pounds of work performed in 1 minute.

26. Horsepower.—To estimate the power of machines and to avoid the use of high numbers, the commonly adopted unit of power is the **horsepower**, or the power that will

perform 33,000 foot-pounds of work per minute; or, in other words, the power necessary to raise 33,000 pounds through a vertical height of 1 foot in 1 minute, or 330 pounds a height of 100 feet, or 33 pounds a height of 1,000 feet, in the same time. Expressed as a formula,

$$h = \frac{u}{33,000}$$

in which h = horsepower;
 u = units of power (foot-pounds per minute).

EXAMPLES FOR PRACTICE

1. (a) Calculate the resistance of an airway 6 ft. \times 8 ft. and 12,650 feet long, when the velocity is 480 feet per minute. (b) Find the unit of ventilating pressure in this circulation.

$$\text{Ans. } \begin{cases} (a) & 1,632 + \text{ lb.} \\ (b) & 34 + \text{ lb. per sq. ft.} \end{cases}$$

2. (a) Find the unit of ventilating pressure that will produce a velocity of 600 feet per minute in an airway 6 ft. \times 8 ft., and 5,000 feet long. (b) What quantity of air is in circulation in this airway? (c) Find the power on the air, or the power producing this circulation.

$$\text{Ans. } \begin{cases} (a) & 21 \text{ lb. per sq. ft.} \\ (b) & 28,800 \text{ cu. ft. per min.} \\ (c) & 604,800 \text{ ft.-lb. per min.} \end{cases}$$

3. (a) What work will be performed or what power on the air will produce a velocity of 500 feet per minute in an airway 8 feet square and 3,000 feet long? (b) What is the horsepower of this circulation?

$$\text{Ans. } \begin{cases} (a) & 240,000 \text{ ft.-lb. per min.} \\ (b) & 9,454 \text{ H. P.} \end{cases}$$

4. What work will be performed or what power on the air will circulate 60,000 cubic feet of air per minute against a pressure of 5.2 pounds per square foot and what horsepower is required to maintain this circulation?

$$\text{Ans. } \begin{cases} 312,000 \text{ ft.-lb. per min.} \\ 7,272 \text{ H. P.} \end{cases}$$

AIR MEASUREMENTS

TO MEASURE THE VELOCITY OF AIR IN AN AIRWAY

27. Before the quantity of air passing in an airway can be calculated, it is necessary to measure the velocity of the air-current. For this purpose, a place is selected in the airway where the sectional area represents a fair average of

the whole airway, in order that the velocity may be the average velocity of the air. The airway should also be straight and free from any obstruction that would cause the air-current to travel on one side of the airway more than on the other. In a bend of the airway or near the junction of two airways, the current is often deflected to one side of the passage, especially if a large quantity of air is moving. In such cases, it is not easy to obtain an average velocity for the airway. The velocity of the air is measured by an instrument called the *anemometer*.

28. The **Biram anemometer**, Fig. 14, consists of a

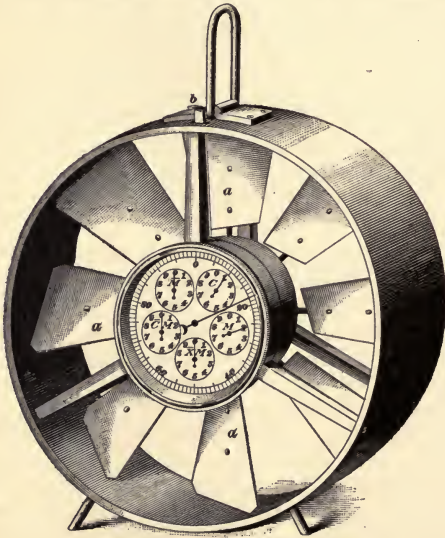

FIG. 14

number of small arms supported on a light axle that has almost frictionless bearings. Blades *a* are attached to these arms, and the axle, arms, and blades constitute what is called the **vane**. The blades of the vane are inclined to the plane

of revolution and are given such a pitch that one revolution of the vane corresponds to a velocity of the air-current equal to 1 foot per minute. At the center of the instrument is a graduated dial for registering the number of revolutions made by the vane. This dial contains one large circle divided into one hundred equal divisions; each of these divisions corresponds to one revolution of the vane, so that one revolution of the large dial hand, or pointer, indicates one hundred revolutions of the vane. Within the large circle of the dial, there are five small circles, each provided with a separate hand or pointer. These small dials are marked *C*, *M*, *XM*, *CM*, and \bar{M} , indicating that they register, respectively, 100, 1,000, 10,000, 100,000, and 1,000,000 feet. For example, in the figure, the dials *XM*, *CM*, and \bar{M} all read zero; the dial *M* reads two divisions, indicating 2,000 feet; the dial *C* reads one division, indicating 100 feet; the large dial reads eighteen divisions, indicating 18 feet. The total reading of the anemometer is, therefore, 2,118 feet. There is a small catch *b* at the top of the instrument by which the hands of the dial are thrown out of or into gear with the vane, so that the dial hands may be started or stopped at any time while the vane is moving rapidly.

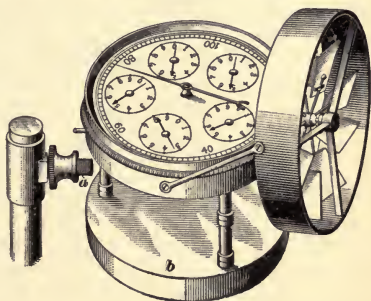

FIG. 15

Another form of Biram anemometer is shown in Fig. 15. This is entirely similar in its action and use to the anemometer shown in Fig. 14; a handle *a* can be screwed into the bottom of the base *b*.

29. Special Anemometers.—The special form of self-timing anemometer shown in Fig. 16 does away with the

use of a watch, since the reading is obtained in feet per second. It works on an entirely different principle from the ordinary Biram anemometer. The dial contains two graduated circles *a* and *b*, which are continuous in their readings. The large pointer *c* gives the reading of the instrument, while the small index hand *d* shows whether the reading is to be taken from the outer or the inner circle. The instrument is held with its back to the air-current, and when the vane is moving rapidly the plunger rod *e* is suddenly pushed down, thus

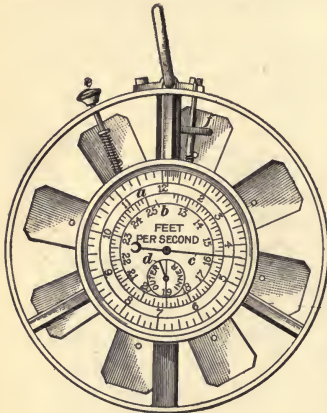

FIG. 16

releasing the pointers *c* and *d*, which immediately swing around to positions indicating the velocity of the air-current, in feet per second. If the velocity exceeds 12 feet per second, the reading is taken from the inner circle. The instrument will not record a higher velocity than 25 feet per second. This instrument requires but a moment's exposure to the air-current to ascertain its velocity, but possesses the

disadvantage that an average reading cannot be taken in an airway where the velocity is not uniform in all parts of the airway. The instrument will only indicate the velocity of the air at the point where it is held when the plunger *e* is depressed. After the reading has been taken, the small milled head *f* is screwed down until the plunger *e* is released. The milled head is then unscrewed and the pointers return to their original position at zero.

30. Another special form of anemometer designed for velocities exceeding 30 feet per second, which might injure

the ordinary Biram anemometer, is shown in Fig. 17. This instrument requires no further explanation than that given with reference to the Biram anemometer. Its dial is read in the same manner as that instrument. The front view, Fig. 17 (a), of the instrument, shows the dial face, and the back view, Fig. 17 (b), the arrangement of the vanes, or blades, which are constructed on the principle of a ventilating fan, the air entering at the center of the back of the instrument and passing out at the circumference. As in the Biram anemometer, the instrument is provided with a catch *a*

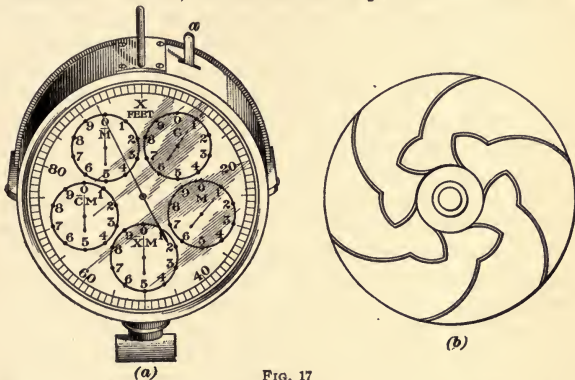

FIG. 17

for throwing the dial hands into and out of gear. The instrument is exposed to the air-current for any given length of time, and its reading divided by the time, in minutes, gives the velocity of the air, in feet per minute.

31. Use of the Anemometer.—In using the anemometer, the instrument should be held at about arm's length from the body of the observer and in such a position that it is constantly exposed to the full force of the air-current; that is, perpendicular to the direction in which the air is traveling. The instrument is not to be held in one position, but should be moved slowly and regularly into different parts of the airway so as to obtain the average velocity of air in the airway. The reason for this is that the velocity of the air is always greatest

in the center of the airway and less near the sides, top, or bottom, where it is retarded by the friction of these surfaces; the velocity is the least in the corners of an airway.

An observer, when measuring air, usually stands facing one side of the airway and a little off from the center of the passage. Holding his watch in one hand and the anemometer in the other so that it is exposed to the full velocity of the air-current, the observer starts the instrument on the minute, and then moves it slowly up and down and from side to side in a continuous line or arc of a circle, avoiding any sudden movements and remaining as still as possible himself so as not to disturb the air-current unnecessarily. If the observation is continued for 2, 3, or 5 minutes, the total reading of the anemometer is divided by the number of minutes to obtain the velocity of the air, in feet per minute.

In reading the anemometer, an allowance may be made by adding to the reading a certain constant given by the makers for each instrument; this constant is supposed to make due allowance for the inertia of the instrument. In general mine practice, this correction is unnecessary, as the reading of the anemometer gives at best only a rough approximation of the average velocity of the air-current, owing to the fact that the velocity of the air varies in different portions of the airway. Again, the body of the observer occupies a certain portion of the sectional area of the airway, and thus slightly increases the velocity of the moving air at the point of observation. The amount of this increase, however, is very slight and not in proportion to the area taken up by the body of the observer. The increase of the velocity due to this cause will help to compensate for the inertia of the instrument without the addition of the constant given by the makers. The main point to be observed in measuring the velocity of the air in any given airway is to measure always in the same place and in the same manner, so that comparative readings will be obtained, regardless of whether these readings are somewhat low or high.

In many states, the law provides when, where, and by whom systematic readings with the anemometer must be taken.

TO MEASURE VENTILATING PRESSURE

32. The unit of ventilating pressure in an airway is measured by the water column it will support. This unit pressure, in pounds per square foot, is, therefore, often expressed in terms of a water column or *inches of water gauge* as it is called.

If a cubical box measuring 1 foot (12 inches) on each edge, Fig. 18, is filled with water; the capacity of the box is 1 cubic foot, and the weight of the water is 62.5 pounds. When the box is filled, the pressure on the bottom of the box is equal to the weight of the water

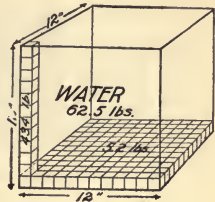

FIG. 18

(62.5 pounds); in other words, *the pressure per square foot due to a water column 1 foot high is 62.5 pounds.* If the water in the box were only 1 inch deep, its weight would be $\frac{62.5}{12}$

$= 5.2$ lb. and the pressure on the bottom of the box would then be equal to this weight of water; that is, *the pressure per square foot due to an inch of water column is 5.2 pounds.* As shown in the figure, the weight of a prism of water having a base of 1 square inch and a height of 1 foot is $\frac{62.5}{144}$

$= .434$ pound; hence, *the pressure per square inch due to a foot of water column is .434 pound.*

33. **The Water Gauge.**—The ventilating pressure causing the circulation of air in a mine is measured by an instrument called the **water gauge**, which consists of a glass tube bent in the form of the letter **U**, and having both arms of the tube open at the top for the free admission of the air. The glass tube is firmly attached to a wooden base and the upper end of one arm, as shown in Fig. 20, is bent at a right angle so as to pass through the wooden back and is cemented to a short brass tube. In Fig. 19, *C* and *D* represent two parallel entries; *E* is a wooden brattice placed in a cross-cut between these two airways. If one of the airways is the intake and the other the return, and a water

gauge *A* is placed on the brattice *E*, so that the extended arm of the water gauge will pass through a hole in the brattice, as shown at *B*, one arm of the gauge will be open to the intake pressure while the other is open to the

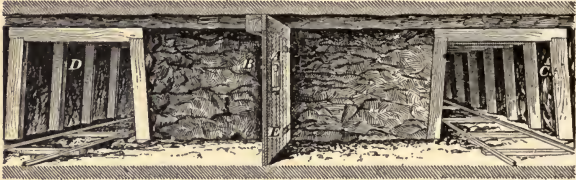

FIG. 19

return. It makes no difference on which side of the brattice the water gauge is placed. The intake pressure being the greater, will always depress the water in the arm of the tube

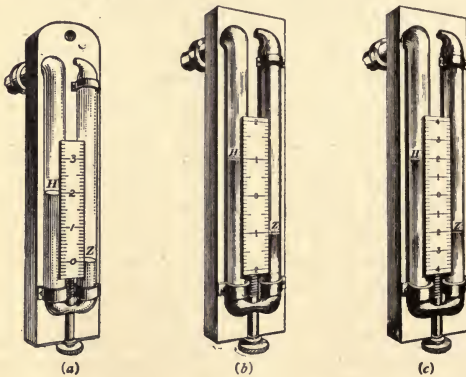

FIG. 20

to which it has access, and the water will rise in the arm open to the return pressure.

In Fig. 20 are shown three forms of water gauges in common use, which differ only in the graduation of the scale by which the difference in the level of the water in the two arms of the gauge is measured. The simplest of these scales,

shown at Fig. 20 (a) has its zero at the bottom of the scale and is graduated in inches and tenths of an inch. This scale must be adjusted after the water gauge is placed in position, and the water has come to rest in the two arms of the tube. When the zero of the scale is made to correspond to the lower level of the water in the gauge, the upper level indicates the inches of water gauge, from which the ventilating pressure is calculated, in pounds per square foot. A second form of scale is shown in Fig. 20 (b) having its zero at the center of the scale, and being graduated each way in inches and tenths of an inch. This scale should be adjusted to the level of the water in each arm of the tube before the gauge is placed in position. When in position, the level of the water will fall in one arm as much as it rises in the other, and the sum of the two readings in this case is the total water-gauge reading. In order to avoid the necessity of taking the sum of the two readings, a third scale, shown in Fig. 20 (c), is sometimes used, having its zero at the center and being graduated both ways in half inches, each half inch being divided into five equal parts. Since each half inch on this scale is marked as a whole inch, the reading of either arm of the gauge represents the entire water column. In each of these three scales, the reading of the water gauge is 2 inches.

Since each inch of water column represents a pressure of 5.2 pounds per square foot, the unit of ventilating pressure in any case is found by multiplying the inches of water gauge by 5.2.

34. Calculation of Water Gauge.—Since 1 inch of water gauge corresponds to a pressure of 5.2 pounds per square foot, the inches of water gauge i produced in any circulation are equal to the unit of ventilating pressure, pounds per square foot, divided by 5.2, as expressed by the formula,

$$i = \frac{p}{5.2}$$

The pressure, or water gauge, increases with the extent of the mine workings, other things being equal, since the mine

resistance increases as the workings increase in extent unless the air is divided into separate currents. The water gauge depends on the resistance and not on the quantity of air.

EXAMPLE 1.—What is the water gauge corresponding to a ventilating pressure of 20.8 pounds per square foot?

SOLUTION.—Substituting in the formula,

$$i = \frac{p}{5.2} = \frac{20.8}{5.2} = 4 \text{ in. Ans.}$$

EXAMPLE 2.—What water gauge will produce a velocity of 600 feet per minute in an airway 8 ft. \times 10 ft. and 2,500 ft. long?

SOLUTION.—The unit of ventilating pressure in this circulation is found, from the formula,

$$p = \frac{k s v^3}{a} = \frac{.0000002 \times 2(8 + 10) \times 2,500 \times 600^3}{8 \times 10}, = 8.1 \text{ lb. per sq. ft.};$$

then, substituting this value in the formula for water gauge,

$$i = \frac{p}{5.2} = \frac{8.1}{5.2} = 1.56 \text{ in. Ans.}$$

CALCULATIONS IN VENTILATION

35. Degree of Accuracy.—The volume of an air-current cannot be estimated probably, in practice, within 100 cubic feet per minute; hence, it is unnecessary to attempt to calculate the volume of an air-current closer than that amount. The same is true, even to a greater extent, in regard to the rubbing surface of an airway. For example, suppose that the length of an airway 8 ft. \times 10 ft. measures 2,510 feet. The actual rubbing surface, in this case, is $2(8 + 10)2,510 = 90,360$ square feet; but except in very close calculations, and when comparing the circulations of two airways, this may be taken as 90,000 square feet. In general, the actual calculated rubbing surface may be increased or decreased to the extent of 1 per cent. without affecting the practical value of the calculation.

The calculation for horsepower should be carried to three decimal places for less than 100 horsepower; but two decimal places are sufficient when the power exceeds 100 horsepower. In general, velocity expressed in feet per minute requires no decimals; water gauge should be read to hundredths of an inch, and units of ventilating pressure less than

10 pounds per square foot should be carried to two decimal places, but for 10 pounds per square foot or greater, one decimal place is sufficient. In discarding figures, if the first figure of those discarded reading from the left toward the right is 5 or over 5, 1 should be added to the last figure at the right of those retained. Thus, if the calculated quantity is 507,605 cubic feet, 508,000 cubic feet should be used; but if the quantity is 507,400 cubic feet, 507,000 cubic feet should be used.

36. Elementary Formulas.—The following elementary or fundamental formulas, for calculations in mine ventilation and the methods of using them have been given in the articles mentioned in connection with each formula.

For rubbing surface, Art. 9,

$$s = lo \quad (1)$$

For total pressure, Art. 12,

$$P = pa \quad (2)$$

For quantity of air per minute, Art. 16,

$$q = av \quad (3)$$

For mine resistance, Art. 18,

$$R = ksv^2 \quad (4)$$

For mine resistance, Art. 20,

$$R = pa \quad (5)$$

For unit of ventilating pressure, Art. 22,

$$p = \frac{ksv^2}{a} \quad (6)$$

For units of work per minute, Art. 24,

$$u = pav \quad (7)$$

and

$$u = ksv^3 \quad (8)$$

For horsepower, Art. 26,

$$h = \frac{u}{33,000} \quad (9)$$

For water gauge, Art. 34,

$$i = \frac{p}{5.2} \quad (10)$$

in which a = sectional area of airway, in square feet;
 h = horsepower;
 i = water gauge, in inches;
 k = coefficient of friction = .00000002;
 l = length of airway, in feet;
 o = perimeter of airway, in feet;
 p = ventilating pressure, in pounds per square foot;
 P = total ventilating pressure, in pounds;
 q = quantity of air in circulation in cubic feet per minute;
 R = resistance of airway, in pounds;
 s = rubbing surface of airway, in square feet;
 u = units of power, in foot-pounds per minute;
 v = velocity of air current, in feet per minute.

37. Transposition of Formulas.—Numerous transpositions of the formulas in Art. 36 may be made so as to give other formulas for determining the factors—velocity, quantity, etc.—appearing in the formulas in other terms than those used in the fundamental formulas. For example, suppose that it is desired to find the velocity that a given horsepower will produce in a given airway. None of the elementary formulas contain both of the terms h and v , but by combining formulas 8 and 9 and calling the required velocity x , its value is determined as shown in the following example:

EXAMPLE 1.—Find the velocity that 11.782 horsepower will produce in an airway 8 ft. \times 10 ft. and 2,500 feet long.

SOLUTION.—The rubbing surface of this airway, as determined by the formula $s = lo$, is $2,500 \times 2(8 + 10) = 90,000$ sq. ft. Then, since $u = 33,000 h$, multiplying the horsepower by 33,000 reduces it to foot-pounds; substituting these values in formula 8, Art. 36, $11.782 \times 33,000 = .00000002 \times 90,000 \times v^2$; or, $388,800 = .0018 v^2$; then $v^2 = \frac{388,800}{.0018} = 216,000,000$, and

$$v = \sqrt{216,000,000} = 600 \text{ ft. per min. Ans.}$$

EXAMPLE 2.—Find the quantity of air that will pass in an airway 8 ft. \times 10 ft. and 2,500 ft. long, under a water gauge of 1.56 inches.

SOLUTION.—Find the pressure corresponding to this water gauge by multiplying it by 5.2 (Art. 33), thus $p = 5.2 \times i = 5.2 \times 1.56$

= 8.1 lb. per sq. ft. Now, finding the velocity v by substituting this value for p in the formula $p = \frac{k s v^2}{a}$, and making the rubbing surface as before, $s = 90,000$ sq. ft., $8.1 = \frac{.00000002 \times 90,000 \times v^2}{8 \times 10}$ and

$$8.1 = .0000225 v^2; \text{ then } v^2 = \frac{8.1}{.0000225} = 360,000, \text{ and}$$

$$v = \sqrt{360,000} = 600 \text{ ft. per min.}$$

Finally, finding the quantity of air in circulation by substituting this value for v in the formula $q = a v$,

$$q = (8 \times 10) 600 = 48,000 \text{ cu. ft. per min. Ans.}$$

38. In like manner, as shown in the last two examples, it is always possible to substitute the given values in the elementary formulas given in Art. **36** and thus obtain any required factor of a ventilation problem. This method of calculation greatly reduces the number of formulas that it is necessary to memorize. There are two formulas that can be derived from those already given, as explained above, but which it is convenient to memorize as they are so frequently used. These are the formulas for obtaining the power or pressure required to pass a certain quantity of air in a given airway.

Power.—Since $v = \frac{q}{a}$ and $v^2 = \frac{q^2}{a^2}$, this value can be substituted for v^2 in the formula $u = k s v^2$ giving,

$$u = \frac{k s q^2}{a^2} \quad (1)$$

Pressure.—Since $v = \frac{q}{a}$ and $v^2 = \frac{q^2}{a^2}$, this value can be substituted for v^2 in the formula $p = \frac{k s v^2}{a}$ giving,

$$p = \frac{k s q^2}{a^3} \quad (2)$$

EXAMPLE 1.—What quantity of air will be circulated by 11.782 horsepower in an airway 8 ft. \times 10 ft. in cross-section and 2,500 feet long?

SOLUTION.—The area a of the airway is $8 \times 10 = 80$ sq. ft.; the rubbing surface s of the airway is $2,500 \times 2(8 + 10) = 90,000$ sq. ft.; the

power $u = 33,000$ *h*. Then, substituting these values in formula 1,

$$u = \frac{k s q^3}{a^3},$$

$$33,000 \times 11.782 = \frac{.00000002 \times 90,000 \times q^3}{80^3}$$

transposing the formula and extracting the cube root

$$q = 80 \sqrt[3]{\frac{33,000 \times 11.782}{.00000002 \times 90,000}} = 80 \sqrt[3]{216,000,000}$$

$$= 80 \times 600 = 48,000 \text{ cu. ft. per minute. Ans.}$$

EXAMPLE 2.—What quantity of air will a pressure of 8.1 pounds per square foot circulate in an airway 8 ft. \times 10 ft. and 2,500 feet long?

SOLUTION.—The area and perimeter of the airway are the same as in the preceding example. Then, substituting the given values in

formula 2, $p = \frac{k s q^3}{a^3},$

$$8.1 = \frac{.00000002 \times 90,000 \times q^3}{80^3}$$

transposing the formula and extracting the square root

$$q = 80 \sqrt[3]{\frac{80 \times 8.1}{.00000002 \times 90,000}} = 80 \sqrt[3]{360,000} = 80 \times 600$$

$$= 48,000 \text{ cu. ft. per minute. Ans.}$$

EXAMPLE.—A current of 48,000 cubic feet per minute is circulated in a mine by a pressure of 8.1 pounds per square foot. If the size of the airway is 8 ft. \times 10 ft., what is the rubbing surface approximately?

SOLUTION.—The area is the same as in the preceding examples;

then, substituting the given values in formula 2, $p = \frac{k s q^3}{a^3},$

$$8.1 = \frac{.00000002 \times s \times 48,000^3}{80^3}$$

transposing the formula,

$$s = \frac{8.1 \times 80^3}{.00000002 \times 48,000^3} = 90,000 \text{ sq. ft. Ans.}$$

39. Although any of the problems in ventilation can be worked by means of the fundamental formulas given in Art. 36, by transposing the terms of one formula or substituting for any term in a formula its equivalent from another formula, it is convenient to have the formulas tabulated as given in Table III, so that when it is desired to find any particular factor of a ventilation problem the formula may be quickly obtained by consulting the table and finding the desired factor in terms of the factors given in the problem.

No attempt should be made to memorize all of these formulas, and, in general, it will be found best to depend on transposition of and substitution in the elementary formulas given in Art. 36, but for reference purposes the following tabulation will be found useful. The formulas printed in heavy type and numbered 1 to 12 are the only ones that need be memorized.

The basis for the calculations is an airway 5 feet wide by 4 feet high and 2,000 feet long, the velocity to be 500 feet per minute, produced by a pressure of 9 pounds per square foot.

PRACTICAL PROBLEMS

40. There are two general classes of problems in mine ventilation. The first class considers the relation existing between the factors or elements of a single airway, as, for instance, the power or the pressure required to produce a certain velocity or quantity of air in a given airway; or the question may be reversed and ask, what velocity or quantity will be produced in a given airway by a certain power or pressure. In examples of this class, the solution is based on the unit of resistance or coefficient of friction. For example, multiplying the unit resistance ($k = .00000002$) by the entire rubbing surface in the mine or airway and that product by the square of the velocity gives the total mine resistance ($ksv^2 = pa$). Dividing the mine resistance by the sectional area of the airway gives the unit of ventilating pressure, and dividing this by 5.2 gives the inches of water gauge required to produce the given velocity in this mine or airway. Or, multiplying the total mine resistance ($ksv^2 = pa$) by the velocity of the air-current gives the work per minute or the power required to produce the given velocity in this mine or airway.

The second general class of problems compares the circulation in one airway with that in another airway; for instance, the velocity or quantity produced by a given power or pressure in one mine is compared with the velocity or quantity that the same power or pressure will produce in another mine.

TABLE III

Formulas	Specimen Calculations
To find the rubbing surface in square feet:	
$s = l o$ (1)	$s = 2,000 \times 18 = 36,000$ sq. ft. Ans.
$s = \frac{u}{k v^2}$	$s = \frac{90,000}{.00000002 \times 500^2} = 36,000$ sq. ft. Ans.
$s = \frac{p q}{k v^2}$	$s = \frac{9 \times 10,000}{.00000002 \times 500^2} = 36,000$ sq. ft. Ans.
$s = \frac{P}{k v^2}$	$s = \frac{180}{.00000002 \times 500^2} = 36,000$ sq. ft. Ans.
$s = \frac{p a}{k v^2}$	$s = \frac{9 \times 20}{.00000002 \times 500^2} = 36,000$ sq. ft. Ans.
To find the length of the airway:	
$l = \frac{s}{o}$	$l = \frac{36,000}{18} = 2,000$ ft. Ans.
To find the perimeter of the airway:	
$o = \frac{s}{l}$	$o = \frac{36,000}{2,000} = 18$ ft. Ans.
To find the area:	
$a = \frac{P}{p}$	$a = \frac{180}{9} = 20$ sq. ft. Ans.

$$a = \frac{k s v^2}{p}$$

$$a = \frac{q}{v}$$

$$a = \frac{u}{p v}$$

$$a = \frac{33,000 h}{p v}$$

$$a = \frac{k s v^2 q}{u}$$

To find the total pressure:

$$P = p a \quad (2)$$

$$P = k s v^2$$

$$P = \frac{u}{v}$$

$$P = \frac{33,000 h}{v}$$

$$P = \frac{k s q^2}{a^2}$$

To find the quantity of air passing in cubic feet per minute:

$$q = a v \quad (3)$$

$$a = \frac{.00000002 \times 36,000 \times 500^2}{9} = 20 \text{ sq. ft. Ans.}$$

$$a = \frac{10,000}{500} = 20 \text{ sq. ft. Ans.}$$

$$a = \frac{90,000}{9 \times 500} = 20 \text{ sq. ft. Ans.}$$

$$a = \frac{33,000 \times 2.727}{9 \times 500} = 20 \text{ sq. ft. Ans.}$$

$$a = \frac{.00000002 \times 36,000 \times 500^2 \times 10,000}{90,000} = 20 \text{ sq. ft. Ans.}$$

$$P = 9 \times 20 = 180 \text{ lb. Ans.}$$

$$P = .00000002 \times 36,000 \times 500^2 = 180 \text{ lb. Ans.}$$

$$P = \frac{90,000}{500} = 180 \text{ lb. Ans.}$$

$$P = \frac{33,000 \times 2.727}{500} = 180 \text{ lb. Ans.}$$

$$P = \frac{.00000002 \times 36,000 \times 10,000^2}{20^2} = 180 \text{ lb. Ans.}$$

$$q = 20 \times 500 = 10,000 \text{ cu. ft. per min. Ans.}$$

TABLE III—Continued

Formulas	Specimen Calculations
$q = \frac{u}{p}$	$q = \frac{90,000}{9} = 10,000 \text{ cu. ft. per min. Ans.}$
$q = \frac{33,000 h}{p}$	$q = \frac{33,000 \times 2.727}{9} = 10,000 \text{ cu. ft. per min. Ans.}$
$q = \frac{k s v^3}{p}$	$q = \frac{.00000002 \times 36,000 \times 500^3}{9} = 10,000 \text{ cu. ft. per min. Ans.}$
$q = a \sqrt{\frac{p a}{k s}}$	$q = 20 \sqrt{\frac{9 \times 20}{.00000002 \times 36,000}} = 10,000 \text{ cu. ft. per min. Ans.}$
To find the resistance:	
$R = k s v^3$ (4)	$R = .00000002 \times 36,000 \times 500^3 = 180 \text{ lb. Ans.}$
$R = p a$ (5)	$R = 9 \times 20 = 180 \text{ lb. Ans.}$
$R = \frac{u}{v}$	$R = \frac{90,000}{500} = 180 \text{ lb. Ans.}$
$R = \frac{33,000 h}{v}$	$R = \frac{33,000 \times 2.727}{500} = 180 \text{ lb. Ans.}$
$R = \frac{k s q^3}{a^2}$	$R = \frac{.00000002 \times 36,000 \times 10,000^3}{20^2} = 180 \text{ lb. Ans.}$

To find the pressure in pounds per square foot:

$$p = \frac{P}{a}$$

$$p = \frac{k \cdot s \cdot v^2}{a} \quad (6)$$

$$p = \frac{u}{q}$$

$$p = \frac{33,000 h}{a v}$$

$$p = \frac{33,000 h}{q}$$

$$p = \frac{k \cdot s \cdot v^3}{q}$$

$$p = \frac{k \cdot s \cdot q^3}{a^3} \quad (12)$$

$$p = 5.2 i$$

To find the units of power in foot-pounds per minute:

$$u = P v$$

$$u = p q$$

$$u = 33,000 h$$

$$u = p a v \quad (7)$$

$$p = \frac{180}{20} = 9 \text{ lb. per sq. ft. Ans.}$$

$$p = \frac{.00000002 \times 36,000 \times 500^2}{20} = 9 \text{ lb. per sq. ft. Ans.}$$

$$p = \frac{90,000}{10,000} = 9 \text{ lb. per sq. ft. Ans.}$$

$$p = \frac{33,000 \times 2.727}{20 \times 500} = 9 \text{ lb. per sq. ft. Ans.}$$

$$p = \frac{33,000 \times 2.727}{10,000} = 9 \text{ lb. per sq. ft. Ans.}$$

$$p = \frac{.00000002 \times 36,000 \times 500^2}{10,000} = 9 \text{ lb. per sq. ft. Ans.}$$

$$p = \frac{.00000002 \times 36,000 \times 10,000^2}{20^3} = 9 \text{ lb. per sq. ft. Ans.}$$

$$p = 5.2 \times 1.73 = 9 \text{ lb. per sq. ft. Ans.}$$

$$u = 180 \times 500 = 90,000 \text{ ft.-lb. per min. Ans.}$$

$$u = 9 \times 10,000 = 90,000 \text{ ft.-lb. per min. Ans.}$$

$$u = 33,000 \times 2.727 = 90,000 \text{ ft.-lb. per min. Ans.}$$

$$u = 9 \times 20 \times 500 = 90,000 \text{ ft.-lb. per min. Ans.}$$

TABLE III—Continued

Formulas	Specimen Calculations
$u = k s v^3$ (8)	$u = .00000002 \times 36,000 \times 500^3 = 90,000 \text{ ft.-lb. per min. Ans.}$
$u = \frac{k s q^3}{a^3}$ (11)	$u = \frac{.00000002 \times 36,000 \times 10,000^3}{20^3} = 90,000 \text{ ft.-lb. per min. Ans.}$
To find the horsepower:	
$h = \frac{u}{33,000}$ (9)	$h = \frac{90,000}{33,000} = 2.727 \text{ H. P. Ans.}$
$h = \frac{P v}{33,000}$	$h = \frac{180 \times 500}{33,000} = 2.727 \text{ H. P. Ans.}$
$h = \frac{p q}{33,000}$	$h = \frac{9 \times 10,000}{33,000} = 2.727 \text{ H. P. Ans.}$
$h = \frac{p a v}{33,000}$	$h = \frac{9 \times 20 \times 500}{33,000} = 2.727 \text{ H. P. Ans.}$
To find the water gauge in inches:	
$i = \frac{p}{5.2}$ (10)	$i = \frac{9}{5.2} = 1.73 \text{ in. Ans.}$
To find the velocity in feet per minute:	
$v = \sqrt{\frac{p a}{k s}}$	$v = \sqrt{\frac{9 \times 20}{.00000002 \times 36,000}} = 500 \text{ ft. per min. Ans.}$
$v = \sqrt{\frac{P}{k s}}$	$v = \sqrt{\frac{180}{.00000002 \times 36,000}} = 500 \text{ ft. per min. Ans.}$

$$v = \frac{q}{a}$$

$$v = \frac{u}{P}$$

$$v = \frac{33,000 h}{P}$$

$$v = \frac{33,000 h}{p a}$$

$$v = \sqrt[3]{\frac{u}{k s}}$$

$$v = \sqrt[3]{\frac{p q}{k s}}$$

$$v = \sqrt[3]{\frac{p a}{k s}}$$

To find the coefficient of friction:

$$k = \frac{P}{s v^2}$$

$$k = \frac{p a}{s v^2}$$

$$k = \frac{u}{s v^2}$$

$$k = \frac{p q}{s v^2}$$

$$v = \frac{10,000}{20} = 500 \text{ ft. per min. Ans.}$$

$$v = \frac{90,000}{180} = 500 \text{ ft. per min. Ans.}$$

$$v = \frac{33,000 \times 2.727}{180} = 500 \text{ ft. per min. Ans.}$$

$$v = \frac{33,000 \times 2.727}{9 \times 20} = 500 \text{ ft. per min. Ans.}$$

$$v = \sqrt[3]{\frac{9,000}{.00000002 \times 36,000}} = 500 \text{ ft. per min. Ans.}$$

$$v = \sqrt[3]{\frac{9 \times 10,000}{.00000002 \times 36,000}} = 500 \text{ ft. per min. Ans.}$$

$$v = \sqrt[3]{\frac{9 \times 20}{.00000002 \times 36,000}} = 500 \text{ ft. per min. Ans.}$$

$$k = \frac{180}{36,000 \times 500^2} = .0000002 \text{ lb. per sq. ft. Ans.}$$

$$k = \frac{9 \times 20}{36,000 \times 500^2} = .0000002 \text{ lb. per sq. ft. Ans.}$$

$$k = \frac{90,000}{36,000 \times 500^2} = .0000002 \text{ lb. per sq. ft. Ans.}$$

$$k = \frac{9 \times 10,000}{36,000 \times 500^2} = .0000002 \text{ lb. per sq. ft. Ans.}$$

To illustrate the application of the foregoing formulas, a series of practical examples such as are asked at examinations for mine foreman, together with their solutions, will now be given. By paying particular and careful attention to the statements of the examples and the solutions following them, similar ones should be worked without trouble by means of the elementary formulas given in Art. 36 or by transposing them as explained in Art. 37.

SINGLE AIRWAYS OR CIRCULATIONS

41. The following examples relate to single airways or circulations of air. The velocity, quantity, pressure, and other factors of the airway or circulation in these examples, are calculated from the value of the unit resistance ($k = .00000002$).

EXAMPLE 1.—In an airway 8 ft. \times 9 ft., and 5,000 feet long, including the return: (a) find the resistance of the airway for a velocity of 480 feet per minute; (b) find the quantity of air passing in the airway; (c) find the unit of ventilating pressure. (d) What is the power on the air, expressed in foot-pounds per minute? (e) What is the horsepower of the circulation?

SOLUTION.—(a) $R = k s v^2 = .00000002 \times 2 (8 + 9) 5,000 \times 480^2 = 783.36$ lb. Ans.

(b) $q = a v = (8 \times 9) 480 = 34,560$, say 34,600 cu. ft. per min. Ans.

(c) $p = \frac{R}{a} = \frac{783.36}{8 \times 9} = 10.88$ lb. per sq. ft. Ans.

(d) Since $R = p a$, its value, substituted for $p a$ in the following formula, gives $u = p a v = 783.36 \times 480 = 376,013$, say 376,000 ft.-lb. per min. Ans.

Or, another way, taking the values $q = 34,600$ and $p = 10.88$, $u = q p = 34,600 \times 10.88 = 376,448$, say 376,000 ft.-lb. per min. Again, in another way, $u = k s v^3 = .00000002 \times 2 (8 + 9) 5,000 \times 480^3 = 376,013$, say 376,000 ft.-lb. per min.

(e) $h = \frac{u}{33,000} = \frac{376,000}{33,000} = 11.394$ H. P. Ans.

EXAMPLE 2.—If the velocity of the air-current is 550 feet per minute in an airway 6 ft. \times 10 ft., what is the quantity of air in circulation?

SOLUTION.— $q = a v = (6 \times 10) 550 = 33,000$ cu. ft. per min. Ans.

EXAMPLE 3.—If the mine resistance is 1,000 pounds in an airway 8 ft. \times 10 ft., what is the water gauge produced by the circulation?

SOLUTION.— $p = \frac{R}{a} = \frac{1,000}{8 \times 10} = 12.5$ lb. per sq. ft.

then, $i = \frac{p}{5.2} = \frac{12.5}{5.2} = 2.4$ in. Ans.

EXAMPLE 4.—What velocity will 15 horsepower produce in an airway 6 ft. \times 10 ft., and 3,000 feet long?

SOLUTION.— $u = 33,000 h = 33,000 \times 15 = 495,000$ ft.-lb. per min. Then, since $u = k s v^3$, by substituting values and calling the required velocity v ,

$$495,000 = .00000002 \times 2(6 + 10) 3,000 \times v^3$$

and $495,000 = .00192 v^3$, and $v^3 = \frac{495,000}{.00192} = 257,812,500$

$$v = \sqrt[3]{257,812,500} = 636 + \text{ft. per min. Ans.}$$

EXAMPLE 5.—What is the area of an airway in which a current of 60,000 cubic feet of air is passing per minute, if the velocity of the air is 10 feet per second?

SOLUTION.—In this case, $v = 60 \times 10 = 600$ ft. per min., and substituting values in the formula, $q = a v$, calling the required area a , $60,000 = 600 a$, and

$$a = \frac{60,000}{600} = 100 \text{ sq. ft. Ans.}$$

EXAMPLE 6.—Calculate the approximate amount of rubbing surface in a mine in which it is assumed the coefficient of friction is $k = .00000002$ when the sectional area of the airway is 60 square feet and a current of 40,000 cubic feet of air is passing per minute under a 3-inch water gauge.

SOLUTION.—The unit of ventilating pressure corresponding to a 3-in. water gauge is $p = 3 \times 5.2 = 15.6$ lb. per sq. ft.; transposing the

formula $p = \frac{k s q^3}{a^3}$, $s = \frac{p a^3}{k q^3}$.

$$s = \frac{15.6 \times 60 \times 60 \times 60}{.00000002 \times 40,000 \times 40,000} = 105,300, \text{ or, about } 105,000 \text{ sq. ft. Ans.}$$

EXAMPLE 7.—What quantity of air is passing down a shaft 12 feet in diameter when the current has a velocity of 325 feet per minute?

SOLUTION.—Since the diameter is specified, the shaft is evidently circular.

$$q = a v = 12^3 \times .7854 \times 325 = 36,756.72 \text{ cu. ft. per min., or say } 37,000 \text{ cu. ft. Ans.}$$

EXAMPLE 8.—Where the airway is 12 feet wide at the bottom, 10 feet 4 inches wide at the top, and 6 feet 6 inches high, and the velocity of the air is 340 feet per minute, what is: (a) the sectional area of the airway; (b) the quantity of air passing per minute?

SOLUTION.—(a) The section is a trapezoid; hence, since 4 in. = $\frac{1}{3}$ ft., and 6 in. = $\frac{1}{2}$ ft.

$$a = \frac{10\frac{1}{3} + 12}{2} \times 6\frac{1}{2} = 72\frac{7}{12} \text{ sq. ft. Ans.}$$

(b) $q = av = 72\frac{7}{12} \times 340 = 24,678\frac{1}{3}$ cu. ft. per min. or say 25,000 cu. ft. Ans.

EXAMPLE 9.—If a shaft 8 ft. \times 24 ft. in section is the intake, and the fan is exhausting 160,000 cubic feet of air per minute, what is the velocity of the air-current in the shaft?

SOLUTION.—Transposing the formula $q = av$,

$$v = \frac{q}{a} = \frac{160,000}{8 \times 24} = 833 \text{ ft. per min. Ans.}$$

EXAMPLE 10.—An air-course is 500 yards long, 6 feet high, and 7 feet wide; what is: (a) its sectional area? (b) its perimeter? (c) its rubbing surface?

SOLUTION.—(a) Sectional area $a = 6 \times 7 = 42$ sq. ft. Ans.

(b) Perimeter $o = 2(6 + 7) = 26$ ft. Ans.

(c) Rubbing surface $s = lo = 500 \times 3 \times 26 = 39,000$ sq. ft. Ans.

EXAMPLE 11.—The rubbing surface of an airway is 25,000 square feet and the perimeter 50 feet; what is the length?

SOLUTION.—Transposing the formula $s = lo$,

$$l = \frac{s}{o} = \frac{25,000}{50} = 500 \text{ ft. Ans.}$$

EXAMPLE 12.—When the water-gauge is 1.85 inches, what pressure per square foot does it indicate?

SOLUTION.—Transposing the formula $i = \frac{p}{5.2}$,

$$p = 5.2i = 5.2 \times 1.85 = 9.62 \text{ lb. per sq. ft. Ans.}$$

EXAMPLE 13.—What is the total ventilating pressure of an airway 6 ft. \times 7 ft., the water gauge being .5 inch?

SOLUTION.—Pressure per square foot = $5.2 \times .5 = 2.6$ lb.; area = $6 \times 7 = 42$ sq. ft.

$$P = pa = 2.6 \times 42 = 109.2 \text{ lb. Ans.}$$

EXAMPLE 14.—If 80,000 cubic feet of air is required per minute in a mine, and the shaft velocity must not exceed 800 feet per minute, what is the smallest sectional area that the shaft may have?

SOLUTION.—Transposing the formula $q = av$,

$$a = \frac{q}{v} = \frac{80,000}{800} = 100 \text{ sq. ft. Ans.}$$

SPECIAL CALCULATIONS

42. Regulator Calculations.—A regulator placed in an airway offers a certain resistance to the passage of the air-current. This resistance is added to the resistance of the airway and therefore it has the same effect as would be produced by increasing the length of the airway; that is, it increases the mine resistance. The amount of air passing through the regulator depends on the size of the opening; the smaller the opening, the smaller is the quantity of air passing under the same pressure.

In the use of a regulator, two pressures are considered: the natural pressure due to the frictional resistance of the airway and the pressure due to the regulator. The sum of these two pressures is the unit of ventilating pressure on the air at the mouth of the airway; this is true whether the regulator be placed at the mouth or at the end of the airway.

The amount of the opening in a box regulator is determined, practically, by moving the shutter backwards or forwards until the desired amount of air is obtained, but it is possible to calculate the quantity of air that will pass through any size of opening in the regulator when the pressure due to the regulator is known. To find this pressure, it is first necessary to calculate the pressure due to the frictional resistance of the airway when the desired quantity of air is passing, by substituting the values for the length, perimeter and area of the airway and the desired quantity of air in the formula $p = \frac{k s q^2}{a^3}$. The pressure thus found is subtracted from the mine pressure at the mouth of the airway, as shown by the water gauge, and the difference or remainder is the pressure due to the regulator. Dividing this pressure by 5.2 will give the inches of water gauge due to the regulator, which is theoretically the reading of a water gauge placed on the regulator, not too close to the opening, but about midway between the opening and the rib or side of the airway. This water-gauge reading indicates the difference of pressure between the intake and the return sides of the regulator.

The quantity of air q in cubic feet per minute that will pass through an opening whose area is a , in square feet, under a water gauge i , in inches, is given by the formula,

$$q = 2,630 a \sqrt{i} \quad (1)$$

To find the area of an opening that will pass any required quantity of air under a given water gauge, this formula is written,

$$a = .00038 \frac{q}{\sqrt{i}} \quad (2)$$

The use of these formulas is shown by the following examples:

EXAMPLE 1.—What quantity of air will pass each minute through a regulator having an opening 2 ft. \times 3 ft., when the water-gauge reading taken on the regulator is 2.5 inches?

SOLUTION.—Substituting the given values in formula 1, the quantity of air passing through the regulator is

$$q = 2,630(2 \times 3) \sqrt{2.5} = 24,950, \text{ say } 25,000 \text{ cu. ft. Ans.}$$

EXAMPLE 2.—Find the area of the opening in a regulator placed in an airway 6 ft. \times 8 ft. in section and 2,000 feet long, so as to reduce the quantity of air passing in this airway to 30,000 cubic feet per minute. The ventilating pressure at the mouth of this airway is 15 pounds per square foot.

SOLUTION.—The perimeter of this airway is $2(6 + 8) = 28$ ft., and the area $6 \times 8 = 48$ sq. ft.; the rubbing surface is $2,000 \times 28 = 56,000$ sq. ft. Substituting the given values in the formula $p = \frac{k s q^2}{a^3}$ to find the natural pressure due to the circulation of 30,000 cu. ft. of air in this airway,

$$p = \frac{.00000002 \times 56,000 \times 30,000^2}{48^3} = 9.11 \text{ lb. per sq. ft.}$$

Subtracting this natural pressure from the mine pressure at the mouth of the split, and dividing by 5.2, the water-gauge reading at the regulator is, $i = \frac{15 - 9.11}{5.2} = 1.13$ in.; and, finally, substituting values in formula 2,

$$a = .00038 \frac{30,000}{\sqrt{1.13}} = 10.72 \text{ sq. ft. Ans.}$$

EXAMPLE 3.—If 5,000 cubic feet of air is passing each minute through a regulator and there is a difference of $\frac{1}{4}$ inch in the water-gauge readings on the two sides of the regulator, how far is the regulator slide open if the opening in the regulator is 2 feet high?

SOLUTION.—Substituting in formula 2,

$$a = .00038 \frac{5,000}{\sqrt[4]{5}} = \frac{.00038 \times 5,000}{.5} = 3.8 \text{ sq. ft.}$$

If the height of the opening is 2 ft., the width will be $\frac{3.8}{2} = 1.9 \text{ ft.}$

Ans.

43. Quantity Produced by Two or More Ventilators.

In the development of a mine, it often happens that the means used for producing a ventilating current becomes inadequate for the production of the quantity of air required as the extent of the workings increases. To increase the circulation, it is often proposed to duplicate the ventilating apparatus in use by adding another fan or furnace similar to the one already in operation. This means an increase of ventilating power, which, of course, produces an increase of the quantity of air in circulation. Assuming that no change is made in the course of the circulation of the air through the mine, any increase of quantity will require an increase of power in proportion to the cube of the ratio in which the quantity is increased, as is shown by the following comparison of power and quantity for a given airway:

If u_1 represents the power on the air for a given airway when a quantity q_1 is circulating, using formula 1, Art. 38, $u_1 = \frac{k s q_1^3}{a^3} = \left(\frac{k s}{a^3}\right) q_1^3$; if u_2 represents the power on the air when a quantity q_2 is circulating through the same airway, $u_2 = \frac{k s q_2^3}{a^3} = \left(\frac{k s}{a^3}\right) q_2^3$; then,

$$\frac{u_1}{u_2} = \frac{\left(\frac{k s}{a^3}\right) q_1^3}{\left(\frac{k s}{a^3}\right) q_2^3}$$

As the same airway is considered in each case, $k, s,$ and a are the same and by canceling, $\frac{u_1}{u_2} = \frac{q_1^3}{q_2^3}$ or $u_1 : u_2 = q_1^3 : q_2^3$; that is, for the same airway, the power is proportional to the cube of the quantity, or the ratio between the powers for two quantities of air equals the cube of the ratio between

the quantities. For example, if the quantity is to be doubled, the quantity ratio is then 2 and the power ratio is $2^3 = 8$. That is to say, it will require eight times the power to double the quantity of air in the same mine or airway. This shows that two fans of the same size and running at the same speed will not produce double the quantity of air circulated by one of these fans alone.

When two or more ventilating motors are employed, it is evident that the total power producing the circulation is equal to the sum of the powers of the several motors.

Now, calling the quantities produced by several motors working separately on the same airway q_1, q_2 , etc., the powers of these several motors u_1, u_2 , etc., and the total quantity produced when all the motors are working together, Q , $Q^3 \left(\frac{ks}{a^3} \right) = q_1^3 \left(\frac{ks}{a^3} \right) + q_2^3 \left(\frac{ks}{a^3} \right) + \text{etc.}$ Or, dividing both members of the equation by $\frac{ks}{a^3}$, $Q^3 = q_1^3 + q_2^3 + \text{etc.}$, and, finally,

$$Q = \sqrt[3]{q_1^3 + q_2^3 + \text{etc.}}$$

This formula shows the quantity of air produced by the combined action of two or more ventilating motors working on the same mine or airway, and which, when working alone, produce the quantities q_1, q_2 , etc. in the same mine or airway.

EXAMPLE.—A fan ventilating a certain mine is capable of producing 42,600 cubic feet of air when operated alone, and another fan ventilating the same mine will produce 57,400 cubic feet when working alone; what quantity of air will be produced in this mine when both fans are in operation, assuming that the general conditions in the mine remain the same?

SOLUTION.—Substituting the given quantities in the formula, and calling the unknown quantity x , the total quantity of air produced by the combined action of the two fans

$$x = \sqrt[3]{42,600^3 + 57,400^3} = 64,300 \text{ cu. ft. per min. Ans.}$$

COMPARING DIFFERENT CIRCULATIONS

44. The following examples will serve to illustrate the method of calculation to be employed when the circulation in one mine or airway is compared with that in another mine or

airway. For example, suppose that 10 horsepower is circulating 50,000 cubic feet of air in an 8' × 12' airway of a certain length. It is possible from these data to calculate the power that would pass the same quantity of air in a 6' × 8' airway of twice the length. Or, it is possible to find the quantity of air the same power will produce in an airway 8 feet square of any given length. Such problems as these are sometimes calculated by first completing the data relating to the first mine or circulation by the use of the methods explained in the previous examples, and then calculating the required power or quantity in the second mine or circulation by applying the same methods to this mine. For example, in the first case given, the length of the airway is not given, but may be found by substituting the given values in the formula $u = \frac{k s q^3}{a^3}$. Having found the length of this

airway, that of the second airway is made twice this length, and the power required to circulate the same quantity of air is then found by substituting the values for the other airway in the same formula, as has been explained. While this method of calculation is simple, it is long and cumbersome, and the method now to be explained has the advantage of permitting the cancelation of all factors common to both airways, thus greatly reducing the work of the calculation.

In comparing two or more airways, it is necessary to remember that a change in the sectional area of an airway may or may not be accompanied by a change in the rubbing surface. For example, an 8' × 12' airway 3,000 feet long has the same rubbing surface as a 6' × 9' airway 4,000 feet long, although the first airway has an area of 96 square feet, while the second airway has an area of only 54 square feet. Again, a 4' × 12' airway of any length has the same rubbing surface as an airway 8 feet square of the same length, although the area of the first airway is 48 square feet, while that of the second airway is 64 square feet.

In comparing two or more airways, the same symbols will be used to indicate the same factors in different airways, but a small subscript figure will indicate the airway to which

the factor belongs. Thus, the power applied to airways 1, 2, 3, etc. is written u_1, u_2, u_3 , etc. In like manner, the lengths of these airways are indicated by l_1, l_2, l_3 , etc.; the perimeters by o_1, o_2, o_3 , etc.; the areas by a_1, a_2, a_3 , etc. When the symbol is written without a subscript, this indicates that its value is the same for all the airways being compared.

POWER

45. Relation Between the Length of an Airway and the Power.—The formulas expressing the powers required to produce the same velocity in two airways having the same cross-section but different lengths are as follows, substituting $l o$ for s in the formula $u = k s v^3$:

$$u_1 = k l_1 o v^3 \quad (a)$$

and
$$u_2 = k l_2 o v^3 \quad (b)$$

Dividing equation (a) by equation (b), member by member, and canceling the common factors,

$$\frac{u_1}{u_2} = \frac{l_1}{l_2}$$

This shows that the ratio between the powers required to produce the same velocity in these airways is equal to the ratio between the lengths of the airways; or, briefly stated, *the power ratio is equal to the length ratio of the airways.*

Instead of being expressed as a ratio, this relation may be stated as a proportion since $\frac{u_1}{u_2} = \frac{l_1}{l_2}$ is merely another way of expressing the proportion $u_1 : u_2 = l_1 : l_2$; that is, for the case given, *the powers are directly proportional to the lengths of the airways.* Similarly, all the ratios given in the following articles may be expressed as proportions, but for purposes of calculation the expression by ratios has some advantages and will therefore be used. The terms *power ratio*, *length ratio*, etc. are used as abbreviations for the expressions ratio between the powers of two airways, ratio between the lengths of two airways, etc.

46. Relation Between Perimeter and Power.—The powers required to produce the same velocity in two airways

having the same lengths but different perimeters are expressed by the formulas,

$$u_1 = k l o_1 v^3 \quad (a)$$

and

$$u_2 = k l o_2 v^3 \quad (b)$$

Dividing equation (a) by equation (b), as before, member by member, and canceling the common factors,

$$\frac{u_1}{u_2} = \frac{o_1}{o_2}$$

This expression shows that the ratio of the powers required to produce the same velocity in these airways is equal to the ratio of the perimeters of the airways; in other words, *the power ratio is equal to the perimeter ratio.*

47. Relation of Velocity or Quantity to Power.

The powers required to produce different velocities in the same airway are expressed by the formulas,

$$u_1 = k l o v_1^3 \quad (a)$$

and

$$u_2 = k l o v_2^3 \quad (b)$$

Dividing equation (a) by equation (b), member by member and canceling the common factors,

$$\frac{u_1}{u_2} = \frac{v_1^3}{v_2^3} = \left(\frac{v_1}{v_2}\right)^3$$

This expression shows that the ratio of the powers required to produce different velocities in the same airway is equal to the cube of the ratio of the velocities; in other words, *the power ratio is equal to the cube of the velocity ratio.* In like manner, it may be shown that *the power ratio is equal to the rubbing surface ratio.*

$$\frac{u_1}{u_2} = \frac{s_1}{s_2}$$

48. Relation Between Area and Power.—The powers required to produce the same quantity in two airways having the same length and perimeter but different areas are expressed by the following formulas obtained by writing $l o$

for s in the formula $u = \frac{k s q^3}{a^3}$

$$u_1 = \frac{k l o q^3}{a_1^3} \quad (a)$$

and

$$u_2 = \frac{k l o q^3}{a_2^3} \quad (b)$$

Dividing equation (a) by equation (b), member by member, and canceling the common factors,

$$\frac{u_1}{u_2} = \frac{k l o q^3}{a_1^3} \div \frac{k l o q^3}{a_2^3}; \text{ or } \frac{u_1}{u_2} = \frac{k l o q^3}{a_1^3} \times \frac{a_2^3}{k l o q^3} = \frac{a_2^3}{a_1^3}$$

or
$$\frac{u_1}{u_2} = \left(\frac{a_2}{a_1}\right)^3$$

This expression shows that the ratio between the powers required to produce the same quantity in these airways is equal to the cube of the inverse ratio of the sectional areas of the airways; in other words, *the power ratio is equal to the cube of the inverse area ratio.*

In like manner, it may be shown that *the power ratio is equal to the cube of the quantity ratio.*

$$\frac{u_1}{u_2} = \left(\frac{q_1}{q_2}\right)^3$$

49. General Power Ratio.—In the above explanation, in order to show the effect of each factor separately, it was assumed that one element only changed at a time, the other elements being the same for each airway. If all the factors in the two airways are different and the quantities of air in circulation and the powers producing the circulations in the two airways are also different,

$$u_1 = \frac{k l_1 o_1 q_1^3}{a_1^3} \quad (a)$$

$$u_2 = \frac{k l_2 o_2 q_2^3}{a_2^3} \quad (b)$$

Dividing equation (a) by equation (b), member by member, and canceling the common factors,

$$\frac{u_1}{u_2} = \frac{l_1}{l_2} \times \frac{o_1}{o_2} \times \frac{q_1^3}{q_2^3} \times \frac{a_2^3}{a_1^3}$$

or
$$\frac{u_1}{u_2} = \frac{l_1}{l_2} \times \frac{o_1}{o_2} \left(\frac{q_1}{q_2} \times \frac{a_2}{a_1}\right)^3$$

This is a general expression for comparing the powers producing the circulation in any two airways. It shows that, in every case, *the power ratio is equal to the continued product of the length ratio, perimeter ratio, the cube of the quantity ratio, and the cube of the inverse area ratio.* Each of these

ratios acts separately, and the value of any one of them may become 1, if the value of that factor is the same in each airway. If the length, perimeter, and area of the two airways are the same, these ratios each become 1, and the power ratio is then equal to the cube of the quantity ratio as previously stated. Art. 48.

A comparison of the circulations in two airways as illustrated shows clearly the effect of each factor of the formula. For example, it shows in what proportion the power increases with respect to the length of the airway for a constant velocity, or in what proportion the power increases with respect to the rubbing surface for a constant velocity, or how a change in the sectional area of an airway affects the quantity of air in circulation, the power or the pressure being constant. Expressed as a proportion, the preceding expression shows that when the other factors in the formulas for the two airways are the same, the powers on two airways are directly proportional to lengths; directly proportional to the perimeter; inversely proportional to the cubes of the quantities; and inversely proportional to the cubes of the areas. A few examples will show the use of the general expression for comparing the powers of two airways.

EXAMPLE 1.—If 100 horsepower is required to circulate a given quantity of air in an airway 6 ft. × 12 ft. and 4,000 feet long, what horsepower will be required to produce the same circulation in an airway 8 ft. × 10 ft. and 2,000 feet long?

SOLUTION.—Calling the required power x and writing the given values for the power, length, perimeter, and area of each of these airways as follows and omitting the quantities, which are the same for each airway:

	POWER	LENGTH	PERIMETER	QUANTITY	AREA
First airway	100	4,000	36		72
Second airway	x	2,000	36		80

Substituting these values in the general expression,

$$\frac{x}{100} = \frac{2,000}{4,000} \times \frac{36}{36} \left(\frac{72}{80} \right)^3$$

NOTE.—It is always simpler to write the unknown quantity x as the numerator of the ratio in which it occurs, which in this case makes the subscript figures 1 refer to the second airway, while the subscript figures 2 refer to the first airway. The subscript figures 1 do not necessarily mean the first airway or the subscript figures 2 the second airway, but these figures merely indicate different airways.

the perimeter ratio reduces to 1, because these values of o_1 and o_2 are equal. Then, canceling the common factors and reducing,

$$\frac{x}{100} = \frac{1}{2} \left(\frac{9}{10} \right)^3 = \frac{1}{2} \times \frac{729}{1,000} = .3645, \text{ and}$$

$$x = 100 \times .3645 = 36.45 \text{ H. P. Ans.}$$

EXAMPLE 2.—If 60,000 cubic feet of air be circulated in an airway 8 feet square and 2,500 feet long, what quantity will the same power circulate in an airway 6 ft. \times 8 ft. and 3,000 feet long?

SOLUTION.—Calling the required quantity x , and writing the given values for the quantity of air and the length, perimeter, and area of the airway, and omitting the powers, which are the same for each airway,

	POWER	LENGTH	PERIMETER	QUANTITY	AREA
First airway . . .		2,500	32	60,000	64
Second airway . .		3,000	28	x	48

Substituting these values in the same expression, and remembering that in this case, the power being the same in each airway, the power ratio is 1,

$$1 = \frac{3,000}{2,500} \times \frac{28}{32} \left(\frac{x}{60,000} \times \frac{64}{48} \right)^3$$

Then, canceling the common factors,

$$1 = \frac{6}{5} \times \frac{7}{8} \left(\frac{x}{60,000} \times \frac{4}{3} \right)^3 = \frac{21}{20} \times \left(\frac{x}{45,000} \right)^3$$

Extracting the cube root of each member,

$$1 = \sqrt[3]{\frac{21}{20}} \times \frac{x}{45,000} = \frac{\sqrt[3]{1.05}}{45,000} \times x = .00002259 x$$

and, finally,

$$x = \frac{1}{.00002259} = 44,267, \text{ or about } 44,300 \text{ cu. ft. per min. Ans.}$$

EXAMPLE 3.—If a current of 28,000 cubic feet of air per minute is passing in an airway 6 ft. \times 7 ft., what quantity will the same power pass in an airway 5 feet square having the same length?

SOLUTION.—Here, the power and the length of the airway are the same in each case and their ratios reduce to 1. The perimeter of the first airway is $2(6 + 7) = 26$ ft.; and that of the second airway $2(5 + 5) = 20$ ft.; the area of the first airway is $6 \times 7 = 42$ sq. ft., and that of the second airway $5 \times 5 = 25$ sq. ft. Hence, calling the required quantity of air circulating in the second airway x , and substituting the given values in the general expression, $1 = 1 \times \frac{20}{26} \left(\frac{x}{28,000} \times \frac{42}{25} \right)^3$. Cancel-

ing the common factors, $1 = \frac{10}{13} \left(\frac{x}{2,000} \times \frac{3}{25} \right)^3$. Multiplying both members of this equation by $\frac{13}{10}$ gives $\frac{13}{10} = \frac{13}{10} \times \frac{10}{13} \left(\frac{3x}{50,000} \right)^3$. Then extracting

the cube root of both members, $\sqrt[3]{\frac{13}{10}} = \frac{3x}{50,000}$; or, $3x = 50,000 \sqrt[3]{1.3}$
 $= 50,000 \times 1.091 = 54,500$, and finally,

$$x = \frac{54,500}{3} = 18,167, \text{ or about } 18,200 \text{ cu. ft. per min. Ans.}$$

EXAMPLE 4.—For the same power applied to each, what is the relative length of two airways that will pass the same quantity of air, the first airway being 6 ft. \times 6 ft., and the second airway 6 ft. \times 8 ft.?

SOLUTION.—The perimeter of the first airway is $2(6 + 6) = 24$ ft., and that of the second airway $2(6 + 8) = 28$ ft.; the area of the first airway is $6 \times 6 = 36$ sq. ft., and that of the second airway $6 \times 8 = 48$ sq. ft. The power and the quantity being the same in each case, their ratios are each 1, and substituting the given values in the general expression, Art. 49, and calling the length of the first airway 1,000 ft.,

and that of the second airway x , there is obtained, $1 = \frac{x}{1,000} \times \frac{28}{24} \left(1 \times \frac{36}{48}\right)^2$.

Canceling the common factors,

$$1 = \frac{x}{1,000} \times \frac{7}{6} \left(\frac{3}{4}\right)^2 = \frac{x}{1,000} \times \frac{7}{6} \times \frac{27}{64} = \frac{63x}{128,000}; \text{ or } 63x = 128,000$$

and, finally, $x = \frac{128,000}{63} = \text{say } 2,000$ ft. Hence, the length of an airway 6 ft. \times 8 ft. must be practically double that of an airway 6 ft. square, in order to pass the same quantity of air under the same power. Ans.

50. If the problem contains factors not included in the general expression given in Art. 49, the equivalent factors, as given by other formulas, may be substituted for both airways as was explained for a single airway in Art. 37. For example, instead of $\frac{u_1}{u_2}$, the equivalent values $\frac{h_1}{h_2} \times \frac{33,000}{33,000}$ may be substituted.

This reduces to $\frac{h_1}{h_2}$; therefore,

$$\frac{h_1}{h_2} = \frac{l_1}{l_2} \times \frac{o_1}{o_2} \times \left(\frac{q_1}{q_2} \times \frac{a_2}{a_1}\right)^2$$

EXAMPLE 1.—If 10 horsepower produces a circulation of 50,000 cubic feet of air per minute in a certain mine, what power will be required to increase the circulation to 90,000 cubic feet per minute?

SOLUTION.—In this case, all the elements of the airway—the length, perimeter, and area—are the same in each airway and their ratios are 1; hence, calling the required power x , and substituting the given values in the general expression as given above,

$$\frac{x}{10} = 1 \times 1 \left(\frac{90,000}{50,000} \times 1\right)^2; \text{ or } \frac{x}{10} = \left(\frac{9}{5}\right)^2 = \frac{729}{125}$$

and, finally, $x = 10 \times \frac{729}{125} = 58.32$ H. P. Ans.

EXAMPLE 2.—If 60 horsepower will circulate 40,000 cubic feet of air in an airway 6 ft. \times 8 ft. and 6,000 feet long, what horsepower will be required to circulate 50,000 cubic feet of air in an airway 6 ft. \times 10 ft. and 4,000 feet long?

SOLUTION.—Call the required horsepower x and write the values given for the power and quantity of air in circulation and the length, perimeter, and area of this airway as follows:

	HORSEPOWER	LENGTH	PERIMETER	QUANTITY	AREA
First airway . . .	60	6,000	28	40,000	48
Second airway . . .	x	4,000	32	50,000	60

Then, $\frac{x}{60} = \frac{4,000}{6,000} \times \frac{32}{28} \left(\frac{50,000}{40,000} \times \frac{48}{60} \right)^3$. Canceling the common factors,
 $\frac{x}{60} = \frac{2}{3} \times \frac{8}{7} \left(\frac{5}{4} \times \frac{4}{5} \right)^3 = \frac{16}{21}$; and, finally,
 $x = 60 \times \frac{16}{21} = 45.7 + \text{H. P. Ans.}$

EXAMPLE 3.—If the circulation of 36,000 cubic feet of air in an airway 6 ft. \times 10 ft. and 5,000 feet long requires 10.9 horsepower, what quantity of air will 16.35 horsepower circulate in an airway 8 feet square, 8,000 feet long?

SOLUTION.—Call the required quantity of air x , and write the given values for the power, quantity of air and the length, perimeter and area of each of the airways, as follows:

	HORSEPOWER	LENGTH	PERIMETER	QUANTITY	AREA
First airway . . .	10.9	5,000	32	36,000	60
Second airway . . .	16.35	8,000	32	x	64

Substituting these values, $\frac{16.35}{10.9} = \frac{8,000}{5,000} \times \frac{32}{32} \left(\frac{x}{36,000} \times \frac{60}{64} \right)^3$. Then, canceling the common factors, $\frac{3}{2} = \frac{8}{5} \left(\frac{x}{36,000} \times \frac{15}{16} \right)^3$. Multiplying both members of this equation by $\frac{5}{8}$,

$$\frac{3}{2} \times \frac{5}{8} = \frac{5}{8} \times \frac{8}{5} \left(\frac{x}{36,000} \times \frac{15}{16} \right)^3, \text{ or } \frac{15}{16} = \left(\frac{x}{2,400 \times 16} \right)^3$$

Then, extracting the cube root of both members of this equation,
 $\sqrt[3]{\frac{15}{16}} = \frac{x}{38,400}$; and, finally, $x = 38,400 \sqrt[3]{.9375} = 37,582$, or about 37,600 cu. ft. per min. Ans. _____

PRESSURE

51. General Pressure Ratio.—In a similar way, as before, when considering power, it may be shown from the general formula $p = \frac{k l o q^3}{a^3}$, that $\frac{p_1}{p_2} = \frac{k l_1 o_1 q_1^3}{a_1^3} \div \frac{k l_2 o_2 q_2^3}{a_2^3}$;

hence,
$$\frac{p_1}{p_2} = \frac{l_1}{l_2} \times \frac{o_1}{o_2} \left(\frac{a_2}{a_1} \right)^3 \left(\frac{q_1}{q_2} \right)^3$$

This expression is the general expression for comparing the pressures producing the circulations in any two airways. It shows that in every case *the pressure ratio is equal to the continued product of the length ratio, perimeter ratio, the cube of the inverse area ratio, and the square of the quantity ratio.* As before, with respect to power, each of these ratios acts separately, and the value of any one of them may become 1 if the value of that factor is the same in each airway. For instance, if two airways have equal areas and perimeters and pass the same quantity of air $\frac{o_1}{o_2} = 1$, $\frac{a_2}{a_1} = 1$, and $\frac{q_1}{q_2} = 1$, and hence

$$\frac{p_1}{p_2} = \frac{l_1}{l_2} \quad (1)$$

that is, *the pressure ratio equals the length ratio.*

Similarly, if $l_1 = l_2$, $o_1 = o_2$ and $q_1 = q_2$,

$$\frac{p_1}{p_2} = \left(\frac{a_2}{a_1}\right)^3 \quad (2)$$

that is, *the pressure ratio equals the cube of the inverse area ratio for equal quantities.*

And if $l_1 = l_2$, $o_1 = o_2$, and $a_1 = a_2$,

$$\frac{p_1}{p_2} = \left(\frac{q_1}{q_2}\right)^2 \quad (3)$$

that is, *the pressure ratio equals the square of the quantity ratio.*

From the formula $p = \frac{k l o v^2}{a}$,

$$\frac{p_1}{p_2} = \frac{k l_1 o_1 v_1^2}{a_1} \div \frac{k l_2 o_2 v_2^2}{a_2} = \frac{l_1}{l_2} \times \frac{o_1}{o_2} \times \left(\frac{v_1}{v_2}\right)^2 \times \frac{a_2}{a_1}$$

then, if $l_1 = l_2$, $o_1 = o_2$, and $a_1 = a_2$,

$$\frac{p_1}{p_2} = \left(\frac{v_1}{v_2}\right)^2 \quad (4)$$

that is, *the pressure ratio equals the square of the velocity ratio.*

If $l_1 = l_2$, $o_1 = o_2$, and $v_1 = v_2$,

$$\frac{p_1}{p_2} = \frac{a_2}{a_1} \quad (5)$$

that is, *the pressure ratio equals the inverse area ratio.*

EXAMPLE 1.—If an airway 4 ft. \times 12 ft., and 6,000 feet long, is passing a certain quantity of air under a pressure of 10 pounds per square foot, what pressure will be required to pass the same quantity of air in an airway 6 ft. \times 8 ft., and 10,000 feet long?

SOLUTION.—The perimeter of the first airway is $2(4 + 12) = 32$ ft., and that of the second airway $2(6 + 8) = 28$ ft.; the area of the first airway is $4 \times 12 = 48$ sq. ft., and that of the second airway $6 \times 8 = 48$ sq. ft. Here, the quantity of air being the same in each case, the quantity ratio is 1, and calling the required unit of ventilating pressure x and substituting the given values in the general expression for the pressure ratio,

PRESSURE LENGTH PERIMETER AREA QUANTITY

$$\frac{x}{10} = \frac{10,000}{6,000} \times \frac{28}{32} \left(\frac{48}{48} \right)^2 \quad (1)^2$$

Canceling the common factors, $\frac{x}{10} = \frac{5}{3} \times \frac{7}{8}$; and, finally,

$$x = 10 \times \frac{35}{24} = 14.6 \text{ lb. per sq. ft. Ans.}$$

EXAMPLE 2.—If a certain pressure is circulating 10,000 cubic feet of air per minute in an airway 4 ft. \times 12 ft. and 6,000 feet long, what quantity will the same pressure circulate in an airway 6 ft. \times 8 ft. and 10,000 feet long?

SOLUTION.—The airways being the same as in the previous example, the perimeters and areas are the same. In this case, the pressure ratio is 1, and calling the required quantity of air x and substituting the given values in the formula,

$$1 = \frac{10,000}{6,000} \times \frac{28}{32} \left(\frac{48}{48} \right)^2 \left(\frac{x}{10,000} \right)^2$$

Canceling the common factors,

$$1 = \frac{5}{3} \times \frac{7}{8} \left(\frac{x}{10,000} \right)^2 = \frac{35}{24} \left(\frac{x}{10,000} \right)^2$$

Multiplying both members of this equation by $\frac{24}{35}$,

$$\frac{24}{35} = \frac{24}{35} \times \frac{35}{24} \left(\frac{x}{10,000} \right)^2, \text{ or } .6857 = \left(\frac{x}{10,000} \right)^2$$

Extracting the square root of both members of this equation, $\sqrt{.6857} = \frac{x}{10,000}$; and, finally,

$$x = 10,000 \sqrt{.6857} = 8,280, \text{ or about } 8,300 \text{ cu. ft. per min. Ans.}$$

EXAMPLE 3.—If it is necessary to double the amount of air in a mine or airway: (a) in what proportion should the pressure be increased? (b) in what proportion should the power be increased?

SOLUTION.—(a) Here, the length, perimeter, and area are constant, and their ratios each 1. Since the quantity of air is to be doubled, the quantity ratio is $\frac{2}{1}$. Now, calling the original pressure 1 and the required pressure x , and substituting the given values in formula 2,

$$\frac{x}{1} = \left(\frac{2}{1} \right)^2; \text{ or, } x = 2^2 = 4. \text{ Ans.}$$

That is to say, the pressure required to double the quantity of air in circulation is four times the original pressure.

(b) As before, the length, perimeter, and area being the same, these ratios are 1 and the quantity ratio is 2. Hence, calling the original power 1 and the required power x , and substituting the given values in the expression for power, Art. 48, or in the general expression for power, Art. 49,

$$\frac{x}{1} = 1 \times 1 (2 \times 1)^2; \text{ or, } x = 2^2 = 8. \text{ Ans.}$$

That is to say, the power required to double the quantity of air in circulation is eight times the original power.

EXAMPLE 4.—If a given pressure per square foot will circulate 40,000 cubic feet of air in an airway 9 ft. \times 6 ft., what should be the length of a side of a square airway that will pass 70,000 cubic feet of air under the same pressure, the length of both airways being the same?

SOLUTION.—Here, the pressure and the length of the airway are the same in each case and their ratios 1. The perimeter of the first airway is $2(9 + 6) = 30$ ft. and its area $9 \times 6 = 54$ sq. ft. Calling the required length of one side of the square airway x , its perimeter is $4x$ and its area x^2 . Substituting these values in the expression for pressure,

$$1 = 1 \times \frac{4x}{30} \left(\frac{54}{x^2}\right)^3 \left(\frac{70,000}{40,000}\right)^2$$

Canceling the common factors, $1 = \frac{4x}{30} \left(\frac{54}{x^2}\right)^3 \left(\frac{7}{4}\right)^2$. In order to simplify the operation as far as possible, the last equation above may be written as follows:

$$1 = \frac{4x}{30} \times \frac{54}{x \times x} \times \frac{54}{x \times x} \times \frac{54}{x \times x} \times \frac{49}{16} = \frac{64,298}{x \times x \times x \times x \times x} = \frac{64,298}{x^5}$$

Then, $x^5 = 64,298$; and,

$$x = \sqrt[5]{64,298} = 9.15, \text{ say } 9 \text{ ft. Ans.}$$

EXAMPLE 5.—If a water gauge of 1.5 inches produces 95,000 cubic feet of air in a certain airway, what quantity will a 2-inch water gauge produce in the same mine?

SOLUTION.—Here, the mine being the same in each case, the length, perimeter, and area ratios are each 1, $\frac{p_1}{p_2} = \left(\frac{q_1}{q_2}\right)^2$; since $p = 5.2 i$, $\frac{p_1}{p_2} = \frac{5.2 i_1}{5.2 i_2} = \frac{i_1}{i_2}$; hence, $\frac{i_1}{i_2} = \left(\frac{q_1}{q_2}\right)^2$. Therefore, calling the required quantity x ,

$$\frac{2}{1.5} = \left(\frac{x}{95,000}\right)^2; \text{ or, } \frac{4}{3} = \left(\frac{x}{95,000}\right)^2$$

Extracting the square root of both members, $\sqrt{1.33} = \frac{x}{95,000}$; and, finally,

$$x = 95,000 \sqrt{1.33} = 109,687, \text{ or about } 109,700 \text{ cu. ft. per min. Ans.}$$

EXAMPLE 6.—If 36,000 cubic feet of air is passing in an airway 6 ft. \times 10 ft., under a pressure of 3.6 pounds per square foot, what pressure will be required to pass the same quantity of air through an airway 5 ft. + 10 ft. of the same length?

SOLUTION.—The perimeter of the first airway is $2(6 + 10) = 32$ ft., and the area $6 \times 10 = 60$ sq. ft.; the perimeter of the second airway is $2(5 + 10) = 30$ ft., and the area $5 \times 10 = 50$ sq. ft. The length ratio and the quantity ratio are each 1. Hence, calling the required pressure x ,

$$\frac{x}{3.6} = 1 \times \frac{30}{32} \left(\frac{60}{50} \right)^3 \times 1^2. \text{ Then, canceling the common factors, } \frac{x}{3.6} = \frac{15}{16} \left(\frac{6}{5} \right)^3; \text{ and, finally,}$$

$$x = 3.6 \times \frac{15}{16} \times \frac{216}{125} = 5.8 \text{ lb. per sq. ft. Ans.}$$

EXAMPLES FOR PRACTICE

1. If you have two airways under the same pressure, one 6 feet wide, 6 feet high, and 5,000 feet long, the other 8 feet wide, $4\frac{1}{2}$ feet high, and 5,000 feet long, which will pass the greater quantity of air, and why?

Ans. The first airway; because it has less rubbing surface for the same area of cross-section.

2. With a water gauge of $\frac{9}{16}$ inch, the quantity of air passing is 24,000 cubic feet per minute; what water gauge will be required to pass 36,000 cubic feet per minute? Ans. 1.35 in.

3. If 16,500 cubic feet of air is passing per minute with a pressure of 4.68 pounds per square foot, what quantity will pass with a pressure of 6.24 pounds per square foot?

Ans. 19,052, or about 19,000, cu. ft. per min.

4. If 3 horsepower passes 15,000 cubic feet of air per minute, what horsepower will be required to double the quantity in the same airway?

Ans. 24 H. P.

5. If 32,000 cubic feet of air is passing through an airway 6 ft. \times 5 ft., under a pressure of 3.6 pounds per square foot, what pressure is necessary in an airway 9 ft. \times 5 ft. to pass the same quantity, both airways being of the same length? Ans. 1.3575 lb. per sq. ft.

6. If a pressure of 3.2 pounds per square foot produces a velocity of 560 feet per minute, what pressure is required to produce a velocity of 700 feet per minute in the same airway? Ans. 5 lb. per sq. ft.

7. If 24,000 cubic feet is passing through an airway having a rubbing surface of 75,000 square feet, what quantity will the same pressure pass if the rubbing surface is increased to 100,000 square feet,

the increase of rubbing surface being due to the lengthening of the airway?
 Ans. 20,785, or, about 21,000 cu. ft.

8. If in an airway 1,200 feet long the air has a velocity of 400 feet per minute under a pressure of 3 pounds per square foot, what must the pressure be to maintain the same velocity if the length of airway is increased to 1,800 feet?
 Ans. 4.5 lb. per sq. ft.

9. If the air passes with a velocity of 600 feet per minute through an airway whose sectional area is 64 square feet, what will the velocity be for an area of 48 square feet, the pressure and the rubbing surface remaining the same?
 Ans. 520 ft. per min.

10. Two circular airways of the same length have diameters of 3 feet and 4 feet, respectively; if a pressure of 5 pounds per square foot will force the air through the 4-foot airway, what pressure is required to pass the same quantity through the 3-foot airway?
 Ans. 21.07 lb. per sq. ft.

11. If 10,000 cubic feet of air passes per minute through a circular airway 12 feet in diameter, how many cubic feet per minute will pass through an airway 6 feet in diameter and having the same length, the pressure being the same in both cases?
 Ans. 1,768 cu. ft. per min., or, say 1,800 cu. ft.

12. If 40,000 cubic feet of air is circulated in an airway 6 ft. \times 8 ft. by a certain power, what quantity of air will the same power circulate in an airway 8 ft. \times 12 ft. of the same length?
 Ans. 71,032, or 71,000 cu. ft. per min.

CHOICE OF AIRWAYS

52. Aside from other questions that may determine the form of airway best adapted to any given case, the economical ventilation of the mine requires that form of airway that will pass the largest quantity of air with the least expenditure of power. That is, the ratio of the quantity of air in circulation to the cube root of the power should be a maximum. Hence, in deciding between two or more forms of airway that should be adopted, as far as ventilation is concerned, that offers the least resistance to the passage of the air.

EXAMPLE 1.—Which of two airways of equal length will pass the larger quantity of air with the same expenditure of power, if one is 4 ft. \times 16 ft. and the other is 8 ft. \times 8 ft?

SOLUTION.—The area of these airways is the same; the perimeter of the first airway is $2(4 + 16) = 40$ ft. and that of the second $2(8 + 8) = 32$ ft.

The formula for the quantity of air passing through an airway is $u = \frac{k l o q^3}{a^3}$, or $q = a \sqrt[3]{\frac{u}{k l o}}$, then if q_1 is the quantity passing through the first airway and q_2 the quantity passing through the second airway, the relative amounts passing through the two airways when the powers, lengths, and areas are the same are given by the expression

$$\frac{q_1}{q_2} = \frac{a \sqrt[3]{\frac{u}{k l o_1}}}{a \sqrt[3]{\frac{u}{k l o_2}}}$$

or, canceling common factors, $\frac{q_1}{q_2} = \sqrt[3]{\frac{o_2}{o_1}}$, and substituting the values for o_1 and o_2 , then $\frac{q_1}{q_2} = \sqrt[3]{\frac{32}{40}} = \sqrt[3]{\frac{4}{5}} = \sqrt[3]{.8} = .928$, or $q_1 = .928 q_2$; that is, for 1,000 cu. ft. of air passing through the second airway, 928 cu. ft. will pass through the first airway. Ans.

EXAMPLE 2.—If you had your choice of the following intake airways, which would you prefer and why, all the airways being of the same length? The first airway is 10 ft. \times 10 ft.; the second, 5 ft. \times 20 ft.; the third circulation includes two airways each 5 ft. \times 10 ft.

SOLUTION.—The perimeters and areas in each case are as follows:

First circulation, perimeter $2(10 + 10) = 40$ ft.; area $10 \times 10 = 100$ sq. ft.

Second circulation, perimeter $2(5 + 20) = 50$ ft.; area $5 \times 20 = 100$ sq. ft.

Third circulation, perimeter $2 \times 2(5 + 10) = 60$ ft.; area $2 \times 5 \times 10 = 100$ sq. ft.

Using the same formula as in Example 1, $q = a \sqrt[3]{\frac{u}{k l o}}$.

If q_1 is the quantity of air passing in the first airway; q_2 , the quantity of air passing in the second airway; q_3 , the quantity of air passing in the third airway; since a , u , k , and l are the same for all the airways, they will cancel and $\frac{q_2}{q_1} = \sqrt[3]{\frac{o_1}{o_2}} = \sqrt[3]{\frac{40}{50}} = \sqrt[3]{.8} = .928$. Similarly $\frac{q_3}{q_1} = \sqrt[3]{\frac{40}{60}} = \sqrt[3]{.666} = .873$. That is to say, if the same power be applied to each airway, for every 1,000 cubic feet of air passing in the first mine, there will be 928 cu. ft. in the second, and 873 cu. ft. in the third. The last circulation, or the third mine, includes two airways each having the same length as the airways in the first and second mines. The first airway is, therefore, the most economical form to adopt.

Ans.

COMPARING SIMILAR AIRWAYS

53. Although similar airways may be compared in the same manner as any other airways using the methods previously described, it is often desired to compare circulations for such airways without reference to either the perimeter or the area of the airways, but by basing the comparison on the length of any corresponding sides or dimensions of the airways. When comparing the circulation of air in these airways, the perimeter o and the area a of the airway may be omitted, substituting instead the diameter of the circle or side of a square, a side or the altitude of a triangle or trapezoid, or any other corresponding dimension. In such a case, the corresponding dimension, whether the diameter of a circle or the side of a square, triangle, or trapezoid, is denoted by the same symbol d with a small subscript figure 1, 2, 3, etc., to indicate the airway to which it belongs.

It is proved in geometry that the areas of similar figures are to each other as the squares of any corresponding side, the squares of their perimeters, or the squares of any line similarly placed in them, as, for example, a diagonal or diameter.

54. General Power Ratio for Similar Airways.

By substituting in the general power ratio given in Art. 49, $\frac{d_1}{d_2}$ for $\frac{o_1}{o_2}$ and $\left(\frac{d_2}{d_1}\right)^2$ for $\left(\frac{a_2}{a_1}\right)^2$, $\frac{u_1}{u_2} = \frac{l_1}{l_2} \times \frac{d_1}{d_2} \times \frac{d_2^2}{d_1^2} \times \left(\frac{q_1}{q_2}\right)^3$; hence,

$$\text{by cancelation, } \frac{u_1}{u_2} = \frac{l_1}{l_2} \left(\frac{d_2}{d_1}\right)^3 \left(\frac{q_1}{q_2}\right)^3$$

This is the general expression for comparing the powers producing the circulations in any two similar airways; it shows that in every case the *power ratio is equal to the continued product of the length ratio, the fifth power of the inverse diameter or side ratio, and the cube of the quantity ratio.*

55. General Pressure Ratio for Similar Airways.

In like manner, by substituting these values in the general pressure ratio given in Art. 51, and reducing as before by

$$\text{cancelation, } \frac{p_1}{p_2} = \frac{l_1}{l_2} \left(\frac{d_2}{d_1}\right)^3 \left(\frac{q_1}{q_2}\right)^3$$

This is the general expression for comparing the pressures producing the circulation in any two similar airways, and it shows that in every case, *the pressure ratio is equal to the continued product of the length ratio, the fifth power of the inverse diameter or side ratio, and the square of the quantity ratio.* A few examples will show the use of these formulas.

EXAMPLE 1.—In a certain mine, 20,000 cubic feet of air is passing in an airway 6 ft. \times 8 ft. It is proposed to enlarge this airway in the same rectangular form so as to circulate 60,000 cubic feet of air with the same power. What will be the dimensions of the airway to accomplish this purpose?

SOLUTION.—The power and the length of the airways being the same in each case, their ratios are each 1. Calling the ratio of any side of the new airway to the corresponding side of the old airway x , and substituting the given values in the general power ratio given in Art. 54, $1 = 1 \times x^5 \left(\frac{20,000}{60,000} \right)^2$. Canceling the common factors,

$$1 = x^5 \left(\frac{1}{3} \right)^2 = \frac{x^5}{9}; \text{ or } x^5 = 9; \text{ and } x = \sqrt[5]{9} = 1.55$$

Hence, the length of any side in the new airway is 1.55 times the length of the corresponding side in the old airway; therefore, the height of the new airway is $1.55 \times 6 = 9.3$ ft. Ans.

Width of new airway is $1.55 \times 8 = 12.4$ ft. Ans.

EXAMPLE 2.—If a given pressure circulates 20,000 cubic feet of air in an airway 10 feet in diameter, how many cubic feet of air will the same pressure circulate in an airway 6 feet in diameter, each airway having the same length?

SOLUTION.—The pressure and the length of the airway being the same in each case, these ratios are each 1. Calling the required quantity of air x , and substituting the given values in the general pressure ratio given in Art. 55, $1 = 1 \times \left(\frac{10}{6} \right)^5 \left(\frac{x}{20,000} \right)^2$. Canceling the common factors,

$$1 = \left(\frac{5}{3} \right)^5 \left(\frac{x}{20,000} \right)^2 = \frac{3,125}{243} \left(\frac{x}{20,000} \right)^2$$

Multiplying both members of this equation by $\frac{243}{3,125}$ gives $\frac{243}{3,125} = \frac{243}{3,125} \times \frac{3,125}{243} \left(\frac{x}{20,000} \right)^2$, or $\frac{243}{3,125} = \left(\frac{x}{20,000} \right)^2$. Now, writing the second member of the equation first and extracting the square root

of each member, $\frac{x}{20,000} = \sqrt{\frac{243}{3,125}} = \sqrt{.0777} = .278$; and, finally,

$$x = 20,000 \times .278 = 5,600 \text{ cu. ft. per min. Ans.}$$

MINE VENTILATION

(PART 2)

SPLITTING AIR-CURRENTS

GENERAL PRINCIPLES

1. When a mine is first opened, the air is conducted in a single current throughout the mine. As the development of the mine advances, the distance the air must travel increases rapidly, and it may be assumed that the rubbing surface increases approximately in the same proportion. If the power producing the circulation of air remains constant, an increase of rubbing surface produces a decrease in velocity, as is shown by the formula,

$$u = ksv^3$$

For example, suppose that the rubbing surface s in a certain mine is 100,000 square feet and that the velocity v is 600 feet per minute; the power on the air is then $u = .00000002 \times 100,000 \times 600^3 = 432,000$ foot-pounds per minute.

With the same power applied to the air, increasing the rubbing surface eight times will decrease the velocity one-half, as is shown in the following equation, $u = .00000002 \times 800,000 \times 300^3 = 432,000$ foot-pounds. That is, as was shown in *Mine Ventilation*, Part 1. *For the same power applied, the velocity varies inversely as the cube root of the rubbing surface.*

This explanation also shows that the application of a certain power against a certain rubbing surface produces a certain

Copyrighted by International Textbook Company. Entered at Stationers' Hall, London

velocity in the mine or airway, regardless of the sectional area of the airway. Advantage is taken of this fact to increase the quantity of air circulated in a mine or airway by a given power, by increasing the sectional area, or, the area of passage of the air through the mine. In order to do this without increasing the rubbing surface in the mine, it is necessary to divide the air-current into two or more currents, each of which is called an **air split**. Dividing a single air-current into two or more currents is called *splitting the air-current*, or *splitting the air*. For example, it may be possible to divide an airway 12,000 feet long into two airways each 6,000 feet long or three airways each 4,000 feet long. By doing this, the rubbing surface remains unchanged, but the sectional area or the area of passage for the air through the mine is increased two, three, etc. times, according to the number of separate airways, because there are two or three, or more, shorter passageways instead of one long airway. This is on the same principle that three 4-inch pipes each 5 feet long will discharge more water from a tank than one 4-inch pipe 15 feet long.

2. Effect of Splitting the Air.—If the total rubbing surface of the several airways is the same as that of the single airway, the application of the same power will produce the same velocity in each of the two or three airways as was formerly produced in the single airway; then, since $q = av$ and since a and v are the same for each airway as for the single airway, it is evident that by thus splitting the air the total quantity of air circulating through the mine is increased two, three, etc. times, according to the number of airways. This, however, is a theoretical case, inasmuch as it is not generally possible to divide the entire air-current at the mouth of the mine into two or more currents, but the circulation in the mine will always consist of a single main intake from which the several air splits are taken. The several splits usually unite to form a single return. For this reason, the power on the air becomes less just after the split is made, owing to the greater consumption of power

by the increased quantity of air that must pass through the single main airway before the point of splitting is reached. Splitting the air at any point in the mine causes a fall of pressure at that point, because there are then two or more avenues of escape for the air instead of one. The power on the air at the mouth of the mine remaining constant, any relief or fall of pressure in the mine causes an increased quantity of air to pass into and through the mine. Since this increased quantity must all pass through the main airway, before reaching the point of split, there is evidently an increase of the power consumed in the main airway, and, as a result, there is less power on the air at the mouth of the splits.

For example, suppose that 50,000 cubic feet of air is circulated in a single current in a mine by 10 horsepower and that 2 horsepower is consumed in the shaft and main intake airway before the air reaches the point where it is to be divided. The power on the air at this point is then $10 - 2 = 8$ horsepower. When the split is made, a larger quantity of air will pass into the mine, and the velocity of the air-current and, consequently, the resistance in the shaft and the main intake airway is very much increased, and the power now consumed in the shaft and main intake airway may be 6 horsepower instead of 2 horsepower, leaving only $10 - 6 = 4$ horsepower on the air at the mouth of the splits. Although the quantity of air in circulation would be doubled by dividing the current into two splits, if the power on the air remained constant at this point, the effect of splitting is reduced because the power on the air at the mouth of the splits is one-half the original power at this point. But, in any circulation, the quantity of air varies as the cube root of the power producing that circulation; hence, the power being one-half, the quantity will be on this account, $\sqrt[3]{.5} = .79$, or about four-fifths of the original quantity. The combined effect of splitting the air, in this case, is, therefore, $2 \times \frac{4}{5} = 1\frac{2}{5}$. That is to say, the effect of splitting the air-current at this point in the mine will be to increase the entire circulation in the mine three-fifths of the original quantity.

producing $1\frac{1}{2} \times 50,000 = 80,000$ cubic feet of air by the same power applied at the mouth of the mine.

The following three examples show the effect of splitting the air-current. In the first example, the power required to circulate a given quantity of air in a continuous current is calculated. In the second example, the power required to circulate the same quantity of air through the same length of airways in four splits is calculated; this includes the power absorbed by the two shafts. In the third example, the quantity of air that will be circulated by the original

power in four splits is found, the size and length of airways being the same in all the examples.

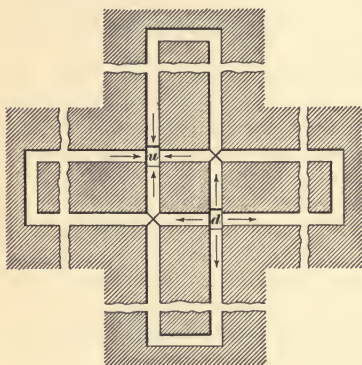

FIG. 1

EXAMPLE 1.—Find the power that will circulate 24,000 cubic feet of air per minute under the following conditions: The air to be circulated through the mine in one continuous current 16,000 feet long including the length of the return airway and the depths of the downcast and up-cast shafts. The size of

all the airways and shafts is to be 6 ft. \times 10 ft.

SOLUTION.—The perimeter of airways and shaft is $o = 2(6 + 10) = 32$ ft., and the area $6 \times 10 = 60$ sq. ft. Substituting the given values in the formula for power, $u = 33,000$ $h = \frac{k l o q^3}{a^3}$ and dividing by 33,000 to obtain the horsepower,

$$h = \frac{k l o q^3}{33,000 a^3} = \frac{.0000002 \times 16,000 \times 32 \times 24,000^3}{33,000 \times 60^3} = 19.859 \text{ H. P. Ans.}$$

EXAMPLE 2.—Find the power that will circulate 24,000 cubic feet of air through a mine under the following conditions: The air is divided at the foot of the downcast d , Fig. 1, into four splits, each 3,600 feet long and 6 ft. \times 10 ft. in section, and is finally united at the foot of the upcast u . The shafts are each 800 feet deep and are also

6 ft. \times 10 ft. in section. It will be noticed, that the size and total length of airways and shafts are the same as in example 1.

SOLUTION.—It is evident that the total power producing the circulation is equal to the sum of the powers absorbed in the two shafts and in the four splits in the mine. Since the size of each shaft is equal to the size of the airways, the two shafts each 800 ft. deep may be considered as an airway 1,600 ft. long. As before, the perimeter is 32 ft. and the area 60 sq. ft. Substituting these values in the same formula as in example 1 to obtain the horsepower,

$$h = \frac{k l o q^3}{33,000 a^3} = \frac{.00000002 \times 1,600 \times 32 \times 24,000^3}{33,000 \times 60^3} = 1.986 \text{ H. P.}$$

The horsepower absorbed in passing the air through four equal splits is four times the power required for one split. Since the area and the perimeter are the same as before, and the length of each split is 3,600 ft., and since the quantity of air passing in each split is $\frac{24,000}{4} = 6,000$ cu. ft., the power absorbed in the four splits is found by substituting these values in the formula for the horsepower,

$$h = \frac{4(.00000002 \times 3,600 \times 32 \times 6,000^3)}{33,000 \times 60^3} = .279 \text{ H. P.}$$

The total power producing the circulation is, therefore, $1.986 + .279 = 2.265$ H. P. Ans.

The horsepower in this case is more easily figured by comparing this circulation with that in example 1. In the general expression for comparing powers $\frac{u_1}{u_2} = \frac{l_1}{l_2} \times \frac{o_1}{o_2} \times \frac{q_1^3}{q_2^3} \times \frac{a_2^3}{a_1^3}$. Since the dimensions of the cross-section of the airway are the same in each case, and the quantity of air in circulation in the shafts is also the same, the perimeter, area, and quantity ratios are all 1, and $\frac{u_1}{u_2} = \frac{l_1}{l_2}$. Then, calling the required horsepower x , $\frac{x}{19.859} = \frac{1,600}{16,000} = \frac{1}{10}$; and $x = 19.859 \times \frac{1}{10} = 1.986$ H. P. In the same manner, the power consumed in each of the four splits is found by comparing the circulation in one split with the circulation in example 1. In making this comparison, the length ratio is $\frac{3,600}{16,000} = \frac{9}{40}$, the perimeter and area ratios are each 1 and the quantity ratio is $\frac{1}{4}$; hence, substituting these values in the same general expression as the preceding and multiplying by 4, to obtain the total power for the four splits, and calling this power x , $\frac{x}{19.859} = 4 \times \frac{9}{40} \times \left(\frac{1}{4}\right)^3 = \frac{9}{640}$; and, finally, $x = \frac{19.859 \times 9}{640} = .279$ H. P. As before, the total power consumed in the two shafts and the four splits or airways is $1.986 + .279 = 2.265$ H. P. Ans. This result shows that,

in this case, it required, after splitting, but 11.4 per cent. of the power originally required to pass the same quantity of air through the mine.

EXAMPLE 3.—Find the quantity of air that the original power found in example 1 will circulate in the four splits described in example 2, all the conditions in the mine being the same as in example 2, except that the power at the mouth of the mine is increased from 2.265 horsepower to 19,859 horsepower.

SOLUTION.—Since the conditions with respect to the mine in this circulation are the same as in example 2, the length ratio, perimeter ratio, and area ratio of the airways are all 1 in the general power ratio, and the power ratio is equal to the cube of the quantity ratio. Hence, calling the required quantity of air in this case x , and substituting the given values in the general power ratio, $\frac{19.859}{2.265} = \left(\frac{x}{24,000}\right)^3$. Extracting the cube root of both members of this equation and writing the second member of the equation first, $\frac{x}{24,000} = \sqrt[3]{\frac{19.859}{2.265}} = \sqrt[3]{8.767} = 2.062$; and, finally,

$$x = 24,000 \times 2.062 = 49,488, \text{ say } 49,500 \text{ cu. ft. per min. Ans.}$$

Comparing the result in example 3 with the quantity circulated in example 1, it will be seen that, by splitting as in example 2, over twice as much air is passed through the mine with the same power.

3. The practical effect of splitting the air-current is thus seen to be to increase the circulation of air in the mine per unit of power applied. Theoretically, splitting the air-current in the mine does not decrease the mine resistance, as it does not in any way change the rubbing surface; the velocity of the air-current would therefore not be changed if it were not that the entire circulation must pass through a single airway for a portion of the distance. On this account, the velocity is increased in the main airway, which increases the power consumed in that portion of the mine and decreases the power on the air beyond the point of splitting. The decrease of power on the air at the mouth of the several splits causes a decrease of velocity in the splits, the rubbing surface remaining constant. Although the resistance of the main airway is increased by the increased velocity at that point, the resistance of the splits is very much decreased on account of the reduced velocity in the splits, and the net mine resistance is also decreased. The practical effect of splitting is,

therefore, an increased quantity of air per unit of horse-power, or a decrease of power required for the same quantity of air in circulation, a decrease of mine resistance, and a decrease of pressure.

4. Limit of Splitting Air.—The practical limit of splitting the air in a mine is determined by the velocity of the air in the several splits. Owing to the decrease of power at the mouth of the splits, each new split made in the mine causes another decrease in the velocity of the air. When this velocity is too low to sweep away the gases accumulated in the workings, the limit of splitting in that section of the mine has been reached and any further increase of the quantity of air in circulation must be obtained by increasing the power on the air, or by *scaling* the air traveling in another split.

The term **scaling** is used to describe the practice of robbing one air split to supply another. A scale of air is a small air split taken from the main current or from another split for a special purpose, as, for example, the ventilation of the mine stables. It is often possible to increase the quantity of air circulating in any section of the mine by cleaning up the falls, enlarging the break-throughs and straightening the air-courses, and short-circuiting the air-current wherever possible, thus reducing the resistance in that section.

5. Advantages of Splitting the Air.—The chief advantages of splitting the air-current in a mine are: (1) A larger volume of air may be circulated by the same power, or a less power will be required for the same quantity of air in circulation. (2) By this means, the entire circulation of the mine is divided into separate districts, and the circulation in each district can thus be easily adjusted to meet the requirements. (3) Purer air is supplied to the working face throughout the mine since the return air from each district is conducted directly into the main return without passing through another district of the mine. (4) If a small explosion occurs in one district of the mine, its effect is often confined to that district. (5) A large volume of air is

circulated in the mine at a lower velocity than when the air is not split, thereby reducing the mine resistance and the dangers arising from high velocities of the air-current in a gassy mine.

6. Requirements of Law in Regard to Splitting the Air.—Some of the state mining laws require that the air circulating in a mine shall be so divided or split as to give a separate current of air to each section of the mine and specify the maximum number of men permitted to work on a single current or split. The Anthracite Mining Laws of Pennsylvania specify that not more than seventy-five persons shall be permitted to work on a single air split. The Bituminous Mining Laws of Pennsylvania limit this number to sixty-five persons, provided, however, that a larger number, not exceeding one hundred, may be permitted to work on a single current at the discretion of the mine inspector and with his permission. The Illinois State Mining Laws permit one hundred men to work on a single current, giving the inspector, however, authority to reduce this number in any given case at his discretion. The Indiana Mining Law makes it unlawful for more than fifty persons to work on a single air-current and further gives the inspector authority to reduce this number in any particular case at his discretion. For this reason, the splitting of the air-current in a mine is important aside from the question of producing a larger volume of air by the same power or decreasing the power required to circulate a given quantity of air.

AIR SPLITS

7. Designation of Split.—When an air-current is divided into two or more branches, it is said to be split once, twice, or three times, according to the number of times it is divided. When an air-current is split once, it travels in two separate splits or currents, each branch being termed a split. In this sense, the number of splits in a mine is understood as meaning the number of currents into which the main current is divided.

A split or division of the main current is called a *main split*, *primary split*, or *split of the first degree*; a split or division of a primary split is called a *secondary split*, or *split of the second degree*; a split or division of a secondary split is called a *tertiary split*, or *split of the third degree*. *Equal splits* are equal divisions of the air-current, provided that the division of the air is natural and not accomplished by the use of a regulator. The *length* of a split is the length of the air-current from the point of split to the point where the current is again divided, or to the point where it joins another current. A *free*, or *open*, *split* is one in which the entire length of the airway is unobstructed by any form of regulator or device for gauging the quantity of air passing in that split. The resistance of a free or open split is always the natural frictional resistance of the airway.

8. Natural Division of the Air-Current.—Whenever there are two or more airways by which the air may travel in its passage through the mine, the current will divide naturally between these airways, the quantity of air passing in each airway being proportional to the resistance of each airway; the division is then called a **natural division of the air**.

9. Proportionate Division of the Air-Current.—It generally happens in mining practice that the natural division of the air-current does not meet the requirements in the mine. For example, the longer the airway and the greater the number of men employed, the greater is the amount of air required, and, vice versa, the shorter the airway and the smaller the number of men working on that airway, the smaller is the amount of air required. The natural division of the air, however, is the reverse of this, the larger volume of air being circulated in the shorter airway and the smaller volume in the longer airway. Therefore, to give the required quantity of air in the several districts of the mine, it is generally necessary to place regulators in the airways that naturally take more than the desired quantity of air. If the airways have the same sectional area, this will generally mean the placing of regulators in all the airways except

the longest one, but this is not always the case, since there may be natural obstructions in one of the shorter airways that have the same effect as increasing its length. In such case, the regulator may be required in the longer airway. The position of the regulator under these varying conditions can only be determined in practice by the special requirements in any given case.

CALCULATIONS IN SPLITTING

NATURAL SPLITTING

10. In all calculations on the splitting of air-currents, it is assumed that the pressure at the mouth of the two or more splits starting from the same point in the mine is the pressure producing the circulation in each split, and, therefore, the pressure for all the splits starting at one point in a mine is the same. It will be assumed that this is the case in the following examples and also that other conditions are the same in all the splits:

The quantity of air passing in any airway may be obtained from the formula,

$$q = a \sqrt{\frac{a p}{k s}}$$

As p is assumed to be the same for all the splits and since k is also the same, the quantity of air for any split is always proportional to the expression $a \sqrt{\frac{a}{s}}$, or $a \sqrt{\frac{a}{l o}}$ for that split.

The expression $a \sqrt{\frac{a}{l o}}$ is a constant for any given airway and may therefore be conveniently used in comparing the amounts of air circulating through two different airways. This expression is sometimes called the *relative potential* of an airway, and for convenience it may be represented by X , and X_1 , X_2 , etc. will then represent the relative potentials for the different splits or airways compared, that is,

$$X = a \sqrt{\frac{a}{s}} = a \sqrt{\frac{a}{l o}} \quad (1)$$

Then if q_1 and q_2 represent the quantities of air passing through two splits,

$$\frac{q_1}{q_2} = \frac{a_1 \sqrt{\frac{a_1}{l_1 o_1}}}{a_2 \sqrt{\frac{a_2}{l_2 o_2}}} = \frac{X_1}{X_2} \quad (2)$$

Since the quantity of air passing in any airway in the natural division of air is proportional to the relative potential for that airway, it follows that the ratio of the quantity of air in any airway to the total quantity of air in circulation is equal to the ratio of the relative potential for that airway to the sum of the relative potentials of the several airways or splits, as expressed by the formula,

$$\frac{q_1}{q_1 + q_2 + \text{etc.}} = \frac{X_1}{X_1 + X_2 + \text{etc.}} \quad (3)$$

It is customary to denote the sum of a series of quantities or factors of the same kind by writing the plain symbol without any subscript with the sign Σ before it. Thus, formula 3 may be written, $\frac{q_1}{\Sigma q} = \frac{X_1}{\Sigma X}$; or calling the total quantity $\Sigma q = Q$,

$$\frac{q_1}{Q} = \frac{X_1}{\Sigma X} \quad (4)$$

The relation expressed by this formula is true in regard to any number of free or open splits starting from the same point.

A few examples will show the manner of calculating the natural division of a quantity of air Q between two or more airways whose resisting powers are represented by the potentials X_1 , X_2 , etc.

EXAMPLE 1.—If a current of 10,000 cubic feet of air is passing in the main airway of a mine, how will this quantity divide between two splits or airways, one of which is 4 ft. \times 12 ft. and 6,000 feet long, and the other is 6 ft. \times 8 ft. and 10,000 feet long?

SOLUTION.—The perimeter, area, and length of the first airway are $o_1 = 2(4 + 12) = 32$ ft., and $a_1 = 4 \times 12 = 48$ sq. ft., $l_1 = 6,000$ ft.;

for the second airway $o_2 = 2(6 + 8) = 28$ ft., and $a_2 = 6 \times 8 = 48$ sq. ft., $l_2 = 10,000$ ft. Calculating the relative potential for each of these airways by substituting the given values for each respective airway in the preceding formulas,

$$X_1 = a_1 \sqrt{\frac{a_1}{l_1 o_1}} = 48 \sqrt{\frac{48}{6,000 \times 32}}$$

$$X_2 = a_2 \sqrt{\frac{a_2}{l_2 o_2}} = 48 \sqrt{\frac{48}{10,000 \times 28}}$$

Before performing the operations indicated in these expressions, it is better to cancel all factors common to both. This can be done because they are to be used as a ratio. Then canceling the factors common to both expressions,

$$X_1 = \sqrt{\frac{1}{3 \times 8}} = .204$$

$$X_2 = \sqrt{\frac{1}{5 \times 7}} = .169$$

$$\Sigma X = X_1 + X_2 = .373$$

The quantity of air passing in each of these airways, respectively, is found as follows from formula 4, $\frac{q_1}{10,000} = \frac{.204}{.373}$, and

$$q_1 = 10,000 \times \frac{.204}{.373} = 5,469, \text{ say } 5,500 \text{ cu. ft. per min. Ans.}$$

Again, for the second airway, $\frac{q_2}{10,000} = \frac{.169}{.373}$, and

$$q_2 = 10,000 \times \frac{.169}{.373} = 4,531, \text{ about } 4,500 \text{ cu. ft. per min. Ans.}$$

EXAMPLE 2.—How will 100,000 cubic feet of air divide between the following three airways or splits? Split *A*, 6 ft. \times 6 ft. and 2,000 feet long; split *B*, 6 ft. \times 5 ft. and 4,000 feet long; split *C*, 6 ft. \times 4 ft. and 6,000 feet long.

SOLUTION.—The perimeter, area, and length of each of these airways are as follows:

$$A, o_1 = 2(6 + 6) = 24 \text{ ft.}; a_1 = 6 \times 6 = 36 \text{ sq. ft.}; l_1 = 2,000 \text{ ft.}$$

$$B, o_2 = 2(6 + 5) = 22 \text{ ft.}; a_2 = 6 \times 5 = 30 \text{ sq. ft.}; l_2 = 4,000 \text{ ft.}$$

$$C, o_3 = 2(6 + 4) = 20 \text{ ft.}; a_3 = 6 \times 4 = 24 \text{ sq. ft.}; l_3 = 6,000 \text{ ft.}$$

Substituting these values in formula 1,

$$A, X_1 = a_1 \sqrt{\frac{a_1}{l_1 o_1}} = 36 \sqrt{\frac{36}{2,000 \times 24}}$$

$$B, X_2 = a_2 \sqrt{\frac{a_2}{l_2 o_2}} = 30 \sqrt{\frac{30}{4,000 \times 22}}$$

$$C, X_3 = a_3 \sqrt{\frac{a_3}{l_3 o_3}} = 24 \sqrt{\frac{24}{6,000 \times 20}}$$

Canceling the factors common to all of these expressions, the relative values are

$$A, \quad X_1 = 6\sqrt{\frac{6}{1 \times 12}} = 6\sqrt{5} = 4.242$$

$$B, \quad X_2 = 5\sqrt{\frac{5}{2 \times 11}} = 5\sqrt{.227} = 2.383$$

$$C, \quad X_3 = 4\sqrt{\frac{4}{3 \times 10}} = 4\sqrt{.133} = 1.460$$

$$\Sigma X = X_1 + X_2 + X_3 = 8.085$$

Finally, for the quantity of air passing in each airway,

$$A, \quad q_1 = 100,000 \times \frac{4.242}{8.085} = 52,468, \text{ say } 52,500 \text{ cu. ft. per min.} \quad \text{Ans.}$$

$$B, \quad q_2 = 100,000 \times \frac{2.383}{8.085} = 29,474, \text{ say } 29,500 \text{ cu. ft. per min.} \quad \text{Ans.}$$

$$C, \quad q_3 = 100,000 \times \frac{1.460}{8.085} = 18,058, \text{ say } 18,000 \text{ cu. ft. per min.} \quad \text{Ans.}$$

$$\text{Total, } \frac{100,000}{100,000}$$

EXAMPLE 3.—The velocity of the air-current in the downcast shaft of a certain mine is 700 feet per minute. The size of the shaft is 15 ft. \times 10 ft. There are at the foot of this shaft four splits of air of the following sizes: Split *A*, 5 ft. \times 8 ft. and 2,000 feet long; split *B*, 6 ft. \times 9 ft. and 1,500 feet long; split *C*, 7 ft. \times 9 ft. and 3,000 feet long; split *D*, 8 ft. \times 10 ft. and 1,800 ft. long. How will the air passing down the shaft divide naturally between these four splits?

SOLUTION.—The total quantity of air passing into this mine is $Q = av = (15 \times 10)700 = 105,000$ cu. ft. per min. The perimeter area and length of each of these airways is as follows:

$$A, \quad o_1 = 2(5 + 8) = 26 \text{ ft.}; \quad a_1 = 5 \times 8 = 40 \text{ sq. ft.}; \quad l_1 = 2,000 \text{ ft.}$$

$$B, \quad o_2 = 2(6 + 9) = 30 \text{ ft.}; \quad a_2 = 6 \times 9 = 54 \text{ sq. ft.}; \quad l_2 = 1,500 \text{ ft.}$$

$$C, \quad o_3 = 2(7 + 9) = 32 \text{ ft.}; \quad a_3 = 7 \times 9 = 63 \text{ sq. ft.}; \quad l_3 = 3,000 \text{ ft.}$$

$$D, \quad o_4 = 2(8 \times 10) = 36 \text{ ft.}; \quad a_4 = 8 \times 10 = 80 \text{ sq. ft.}; \quad l_4 = 1,800 \text{ ft.}$$

$$A, \quad X_1 = a_1 \sqrt{\frac{a_1}{l_1 o_1}} = 40 \sqrt{\frac{40}{2,000 \times 26}}$$

$$B, \quad X_2 = a_2 \sqrt{\frac{a_2}{l_2 o_2}} = 54 \sqrt{\frac{54}{1,500 \times 30}}$$

$$C, \quad X_3 = a_3 \sqrt{\frac{a_3}{l_3 o_3}} = 63 \sqrt{\frac{63}{3,000 \times 32}}$$

$$D, \quad X_4 = a_4 \sqrt{\frac{a_4}{l_4 o_4}} = 80 \sqrt{\frac{80}{1,800 \times 36}}$$

Canceling the factors common to all of these expressions, we have for the relative values,

$$A \quad X_1 = 40 \sqrt{\frac{40}{20 \times 13}} = 40 \sqrt{\frac{2}{13}} = 40 \sqrt{.154} = 15.697$$

$$B, \quad X_2 = 54 \sqrt{\frac{54}{15 \times 15}} = 54 \sqrt{\frac{6}{25}} = 54 \sqrt{.240} = 26.454$$

$$C, \quad X_3 = 63 \sqrt{\frac{63}{30 \times 16}} = 63 \sqrt{\frac{21}{160}} = 63 \sqrt{.131} = 22.802$$

$$D, \quad X_4 = 80 \sqrt{\frac{80}{18 \times 18}} = 80 \sqrt{\frac{20}{81}} = 80 \sqrt{.247} = 39.759$$

$$\Sigma X = X_1 + X_2 + X_3 + X_4 = 104.712$$

Finally, for the quantity of air passing in each airway,

$$A, \quad q_1 = 105,000 \times \frac{15.697}{104.712} = 15,740, \text{ say } 15,700 \text{ cu. ft. per min.} \quad \text{Ans.}$$

$$B, \quad q_2 = 105,000 \times \frac{26.454}{104.712} = 26,527, \text{ say } 26,500 \text{ cu. ft. per min.} \quad \text{Ans.}$$

$$C, \quad q_3 = 105,000 \times \frac{22.802}{104.712} = 22,865, \text{ say } 22,900 \text{ cu. ft. per min.} \quad \text{Ans.}$$

$$D, \quad q_4 = 105,000 \times \frac{39.759}{104.712} = 39,868, \text{ say } 39,900 \text{ cu. ft. per min.} \quad \text{Ans.}$$

$$\text{Total, } 105,000 \quad 105,000$$

11. Pressure and Power Required: Equal Splits.

In natural splitting, when the splits are equal, the total quantity of air in circulation is equally divided among all the splits. The pressure at the point of split is the same for all the splits starting at that point, whether the splits are equal or unequal. When the splits are equal, an equal power is consumed in each split; hence, in equal natural splitting, since the air is equally divided among the several splits, the pressure and the power producing the circulation in one of these splits only is first calculated. The pressure thus obtained for one split is the same for all the splits, and is the pressure producing the total circulation in the splits. It must be remembered that the same pressure on the air at the point of split circulates the air in all the splits starting from that point. The power producing the circulation in one split, however, must be multiplied by the number of splits in order to obtain the power producing the total circulation; or the total power producing the circulation may be found

by multiplying the pressure at the point of split by the total quantity of air in circulation in all the splits. An example will make this point clear.

EXAMPLE.—Find the unit of ventilating pressure and the power required to circulate 90,000 cubic feet of air per minute in three equal splits, each being 6 ft. \times 10 ft. and 2,000 feet long.

SOLUTION.—The splits being equal, the quantity of air passing in each will be $\frac{90,000}{3} = 30,000$ cu. ft. per min. The perimeter and area of each of these splits are as follows: $o = 2(6 + 10) = 32$ ft.; $a = 6 \times 10 = 60$ sq. ft. Substituting the given values in the formula for pressure,

$$p = \frac{k l o q^2}{a^3} = \frac{.0000002 \times 2,000 \times 32 \times 30,000^2}{60^3} = 5.33 + \text{lb. per sq. ft.,}$$

which is the unit of ventilating pressure at the point of split, or the pressure per square foot producing the circulation in all the splits.

Ans.

The power required to circulate 30,000 cu. ft. of air per min. in a single split 6 ft. \times 10 ft., 2,000 ft. long, is found by substituting the given values in the formula for power, thus,

$$u = \frac{k l o q^3}{a^3} = \frac{.0000002 \times 2,000 \times 32 \times 30,000^3}{60^3} = 160,000 \text{ ft.-lb.}$$

The total power consumed in the three splits is then $3 \times 160,000 = 480,000$ ft.-lb., or $480,000 \div 33,000 = 14.545 +$ H. P. Ans.

The same result would have been found by multiplying the unit of ventilating pressure first found by the total quantity of air in circulation as expressed by the formula $u = q p = 90,000 \times 5.33 = 479,700$ or about 480,000 ft.-lb. Ans.

12. Pressure and Power Required: Unequal Splits.

When two or more splits starting from the same point in a mine are unequal in length or sectional dimensions, the air will be divided unequally between the several splits. While the pressure per square foot at the point of split is the same for each split, a different power will be consumed in each split. The first step in this case is to calculate the natural division of the air, or, in other words, to find the quantity of air passing in each split. The pressure per square foot producing the circulation in each split, which is the pressure producing the total circulation in all the splits starting from that point, may then be found by calculating the pressure necessary to circulate, in any one split, the quantity of air thus calculated. Having found the pressure per square foot

for any one split or the pressure producing the total circulation in all the splits, the total power producing the circulation is then found by multiplying this pressure by the total quantity of air in circulation. An example will make this calculation clear.

EXAMPLE.—(a) Find the unit of ventilating pressure that will circulate 90,000 cubic feet of air per minute in three splits as follows: Split *A*, 6 ft. × 10 ft. and 3,000 feet long; split *B*, 5 ft. × 9 ft. and 2,500 feet long; split *C*, 5 ft. × 6 ft. and 1,500 feet long. (b) What is the power on the air at the point of split?

SOLUTION.—The perimeter, area, and length in each split are as follows:

$$A, o_1 = 2(6 + 10) = 32 \text{ ft.}; a_1 = 6 \times 10 = 60 \text{ sq. ft.}; l_1 = 3,000 \text{ ft.}$$

$$B, o_2 = 2(5 + 9) = 28 \text{ ft.}; a_2 = 5 \times 9 = 45 \text{ sq. ft.}; l_2 = 2,500 \text{ ft.}$$

$$C, o_3 = 2(5 + 6) = 22 \text{ ft.}; a_3 = 5 \times 6 = 30 \text{ sq. ft.}; l_3 = 1,500 \text{ ft.}$$

Then, to calculate the natural division of the air between these three splits, substitute the values for these airways in formula 1 of Art. 10,

$$A, X_1 = a_1 \sqrt{\frac{a_1}{l_1 o_1}} = 60 \sqrt{\frac{60}{3,000 \times 32}}$$

$$B, X_2 = a_2 \sqrt{\frac{a_2}{l_2 o_2}} = 45 \sqrt{\frac{45}{2,500 \times 28}}$$

$$C, X_3 = a_3 \sqrt{\frac{a_3}{l_3 o_3}} = 30 \sqrt{\frac{30}{1,500 \times 22}}$$

Then, canceling the factors common to all these expressions,

$$A, X_1 = 4 \sqrt{\frac{4}{6 \times 16}} = 4 \sqrt{.0416} = .816$$

$$B, X_2 = 3 \sqrt{\frac{3}{5 \times 14}} = 3 \sqrt{.0428} = .621$$

$$C, X_3 = 2 \sqrt{\frac{2}{3 \times 11}} = 2 \sqrt{.0606} = .492$$

$$\Sigma X = X_1 + X_2 + X_3 = 1.929$$

Then, for the quantity of air passing per minute in each split,

$$A, q_1 = 90,000 \times \frac{.816}{1.929} = 38,070$$

$$B, q_2 = 90,000 \times \frac{.621}{1.929} = 28,970$$

$$C, q_3 = 90,000 \times \frac{.492}{1.929} = 22,960$$

$$\text{Total, } 90,000$$

(a) The unit of ventilating pressure may now be calculated in the usual manner from any of these splits, the same value being found in each case as follows:

$$A, \quad p = \frac{k l o q^2}{a^2} = \frac{.00000002 \times 3,000 \times 32 \times 38,070^2}{60^2}$$

$$= 12.88 \text{ lb. per sq. ft. Ans.}$$

$$B, \quad p = \frac{k l o q^2}{a^2} = \frac{.00000002 \times 2,500 \times 28 \times 28,970^2}{45^2}$$

$$= 12.89 \text{ lb. per sq. ft. Ans.}$$

$$C, \quad p = \frac{k l o q^2}{a^2} = \frac{.00000002 \times 1,500 \times 22 \times 22,960^2}{30^2}$$

$$= 12.88 \text{ lb. per sq. ft. Ans.}$$

It is only necessary to calculate the pressure for one split, since this pressure is the same for all the splits starting from the same point in the mine. It is the pressure at the mouth of these splits. In speaking of ventilating pressure, the difference of pressure between the intake and return airways at this point is meant; it is not the total pressure on the air.

(b) The power required to circulate 90,000 cu. ft. in splits *A*, *B*, and *C* in this case is then found by substituting the values for the quantity and unit of ventilating pressure in the formula for power; thus,

$$u = q p = 90,000 \times 12.88 = 1,159,200 \text{ ft.-lb.}$$

or for the horsepower

$$h = \frac{q p}{33,000} = \frac{90,000 \times 12.88}{33,000} = 35.127 \text{ H. P. Ans.}$$

The pressure and the power required to circulate a given quantity of air in any number of unequal splits can be found directly and more quickly by the use of the following formula:

$$p = k \left(\frac{Q}{\sum X_p} \right)^2 \quad (1)$$

in which p = pressure in pounds per square foot;

$$k = .00000002;$$

Q = total quantity of air in circulation;

$$\begin{aligned} \sum X &= X_1 + X_2 + X_3, \text{ etc.} = a_1 \sqrt{\frac{a_1}{l_1 o_1}} + a_2 \sqrt{\frac{a_2}{l_2 o_2}} \\ &+ a_3 \sqrt{\frac{a_3}{l_3 o_3}}, \text{ etc.} \end{aligned}$$

For the sake of comparison, the example in Art. 12, when worked by this formula, gives the following solution:

SOLUTION.—As before,

$$A, \quad o_1 = 2(6 + 10) = 32 \text{ ft.}; \quad a_1 = 6 \times 10 = 60 \text{ sq. ft.}; \quad l_1 = 3,000 \text{ ft.}$$

$$B, \quad o_2 = 2(5 + 9) = 28 \text{ ft.}; \quad a_2 = 5 \times 9 = 45 \text{ sq. ft.}; \quad l_2 = 2,500 \text{ ft.}$$

$$C, \quad o_3 = 2(5 + 6) = 22 \text{ ft.}; \quad a_3 = 5 \times 6 = 30 \text{ sq. ft.}; \quad l_3 = 1,500 \text{ ft.}$$

Then, substituting these values in formula 1 of Art. 10, for airways

$$A, \quad X_1 = 60 \sqrt{\frac{60}{3,000 \times 32}} = 1.5000$$

$$B, \quad X_2 = 45 \sqrt{\frac{45}{2,500 \times 28}} = 1.1409$$

$$C, \quad X_3 = 30 \sqrt{\frac{30}{1,500 \times 22}} = .9045$$

$$\Sigma X = X_1 + X_2 + X_3 = 3.5454$$

Then, substituting the given values in the formula for the unit of ventilating pressure circulating 90,000 cu. ft. of air in these three splits,

$$p = k \left(\frac{Q}{\Sigma X} \right)^2 = .00000002 \left(\frac{90,000}{3.5454} \right)^2 = 12.88 \text{ lb. per sq. ft.}$$

The power required to circulate 90,000 cu. ft. of air per min. in splits *A*, *B*, and *C* is then found by multiplying the pressure by the quantity in the same manner as before; thus,

$$h = \frac{q p}{33,000} = \frac{90,000 \times 12.88}{33,000} = 35.127 \text{ H. P. Ans.}$$

13. Total Mine Pressure and Power Required.

The main air-current in a mine, after passing down the shaft, is often conducted for a considerable distance through a single airway before reaching the place where the air is to be divided. This requires that the entire circulation be carried for a certain distance through a single air conduit, which includes the upcast and downcast shafts and the main intake and return airways outside of the point of split. In this case, the total pressure producing the circulation in the mine is equal to the sum of the pressures absorbed in passing the air through the two shafts and the main airways and the splits, respectively. If desired, each of these pressures may be calculated separately by the formulas and methods previously described for finding the unit of ventilating pressure. The operation, however, is

much shortened by calculating the expression $a \sqrt{\frac{a}{l o}}$ for each section of the air passage, namely, the shafts, main airways, and the splits, and substituting these values in the following formula

$$p = k Q^2 \left[\frac{1}{X_1^2} + \frac{1}{X_2^2} + \frac{1}{X_3^2} + \text{etc.} + \frac{1}{(\Sigma X_p)^2} \right]$$

in which p = pressure, in pounds per square foot;

k = .00000002;

Q = quantity of air circulating;

X_1, X_2, X_3 = constant $a\sqrt{\frac{a}{l_0}}$ for several parts of the air-current that are not split, such as in the upcast, main airway, etc.

X_p = sum of constants $a\sqrt{\frac{a}{l_0}}$ calculated for the several splits of air.

This formula applies alike when the splits are equal or unequal and may be extended indefinitely so as to include any sections of the airway having different cross-sections by finding the values of X_1, X_2 , etc. for each section of the airway, but always using the sum of these constants for the several splits in determining the value $\sum X_p$. If there are no splits in the mine, the last term containing $\sum X_p$ will disappear.

The following example will show the manner of using this formula:

EXAMPLE.—In a shaft mine, the downcast shaft is 6 ft. \times 14 ft.; the upcast shaft, 8 ft. \times 12 ft.; both shafts being 1,000 feet deep. At a point 100 feet from the foot of the downcast shaft the air-current is divided into two splits; these splits unite 100 feet before reaching the foot of the upcast. The size of the main intake and main return airways from the foot of each shaft to the splits is 6 ft. \times 12 ft. and 100 feet long for each airway. The air split ventilating the east portion of the mine called the east split is 5 ft. \times 9 ft. and 2,500 feet long, while the west split is 5 ft. \times 8 ft. and 1,500 feet long. What pressure and power will be required to circulate 75,000 cubic feet of air per minute in this mine when no regulators are used to divide the air?

SOLUTION.—The perimeter, area, and length of the downcast and upcast shafts, the main intake and main return airways, and the east and west splits, respectively, are as follows:

Downcast shaft, $o_1 = 2(6 + 14) = 40$ ft.; $a_1 = 6 \times 14 = 84$ sq. ft.;
 $l_1 = 1,000$ ft.

Upcast shaft, $o_2 = 2(8 + 12) = 40$ ft.; $a_2 = 8 \times 12 = 96$ sq. ft.;
 $l_2 = 1,000$ ft.

Main intake, } $o_3 = 2(6 + 12) = 36$ ft.; $a_3 = 6 \times 12 = 72$ sq. ft.;
Main return, }
 $l_3 = 200$ ft.

East split, $o_4 = 2(5 + 9) = 28$ ft.; $a_4 = 5 \times 9 = 45$ sq. ft.;
 $l_4 = 2,500$ ft.

West split, $o_5 = 2(5 + 8) = 26$ ft.; $a_5 = 5 \times 8 = 40$ sq. ft.;
 $l_5 = 1,500$ ft.

Then for the several airways,

$$\text{Downcast shaft, } X_1 = 84 \sqrt{\frac{84}{1,000 \times 40}} = 3.8494$$

$$\text{Upcast shaft, } X_2 = 96 \sqrt{\frac{96}{1,000 \times 40}} = 4.7030$$

$$\text{Main airways, } X_3 = 72 \sqrt{\frac{72}{200 \times 36}} = 7.2000$$

$$\text{East split, } X_4 = 45 \sqrt{\frac{45}{2,500 \times 28}} = 1.1409$$

$$\text{West split, } X_5 = 40 \sqrt{\frac{40}{1,500 \times 26}} = 1.2810$$

$$X_4 + X_5 = \Sigma X_p = 2.4219$$

Substituting the given values in the formula for the unit of ventilating pressure producing the circulation,

$$p = .00000002 \times 75,000^2 \left(\frac{1}{3.8494^2} + \frac{1}{4.703^2} + \frac{1}{7.2^2} + \frac{1}{2.4219^2} \right) = 34.03,$$

or about 34 lb. per sq. ft.

The power producing this circulation is then found by multiplying the unit of ventilating pressure by the total quantity of air passing into the mine and dividing by 33,000; thus,

$$h = \frac{75,000 \times 34}{33,000} = 77.27. \quad \text{Ans.}$$

PROPORTIONATE SPLITTING

14. Any division of the air-current other than the natural division that takes place when all the airways are open to the passage of the air is called a *proportionate division*. The air is then divided between the several parts of the mine according to the needs or requirements in each district, by means of regulators such as were described in *Mine Ventilation*, Part 1. A regulator placed in an airway has the same effect as lengthening the airway and thus increasing its resistance. The natural frictional resistance of the airway is increased by the resistance due to the regulator.

In proportionate splitting, as in natural splitting, the pressure per square foot at the point of split is equal for all

splits starting from the same point. It is therefore evident that, for any desired proportionate splitting of the air-current in a mine, that split having the greatest natural pressure per square foot, calculated for the desired quantity of air, will be the open or free split, and all the other splits must be supplied with regulators so arranged as to increase the pressure in each, so as to make the pressure per square foot at the point of split equal for all the splits starting from this point. An example will show the method of making the calculation necessary to determine in which splits regulators should be placed to accomplish any required division of the air-current.

EXAMPLE.—Where must regulators be placed and what must be the size of the opening in each in order to produce the following circulation of air?

- Split *A*, 6 ft. × 10 ft., 3,000 feet long, 50,000 cu. ft. per min.;
 Split *B*, 5 ft. × 9 ft., 2,500 feet long, 30,000 cu. ft. per min.;
 Split *C*, 5 ft. × 6 ft., 1,500 feet long, 10,000 cu. ft. per min.

What will be the pressure per square foot at the point where the air is divided, and what horsepower will be required for the circulation of the air in the splits?

SOLUTION.—This is the same mine described in the example in Art. 12 where the natural division of the air was found to be approximately as follows: Split *A*, 38,000 cu. ft.; split *B*, 29,000 cu. ft.; split *C*, 23,000 cu. ft.

The natural pressure for each split may be found by substituting in the general formula for pressure, $p = \frac{k l o q^2}{a^3}$ as follows:

$$A, p_1 = \frac{.00000002 \times 3,000 \times 32 \times 50,000^2}{60^3} = 22.22 \text{ lb. per sq. ft.}$$

$$B, p_2 = \frac{.00000002 \times 2,500 \times 28 \times 30,000^2}{45^3} = 13.82 \text{ lb. per sq. ft.}$$

$$C, p_3 = \frac{.00000002 \times 1,500 \times 22 \times 10,000^2}{30^3} = 2.44 \text{ lb. per sq. ft.}$$

The natural pressure may also be calculated by first calculating the relative potential for each split and substituting in the formula $p = k \frac{q}{X}$ as follows:

The relative potentials for these splits were found in Art. 12 to be $X_1 = 1.5$; $X_2 = 1.1409$; $X_3 = .9045$.

$$\text{Then, } A, p_1 = .00000002 \left(\frac{50,000}{1.5} \right)^2 = 22.22 \text{ lb. per sq. ft.}$$

$$B, p_2 = .00000002 \left(\frac{30,000}{1.1409} \right)^2 = 13.82 \text{ lb. per sq. ft.}$$

$$C, p_3 = .00000002 \left(\frac{10,000}{.9045} \right)^2 = 2.44 \text{ lb. per sq. ft.}$$

Split *A* having the greatest natural pressure will therefore be the open or free split, and this pressure of 22.22 pounds per square foot will be the ventilating pressure at the point of split where the air is divided. Regulators must be placed in splits *B* and *C*. The openings in these regulators are found by first calculating the pressure due to each regulator in inches of water gauge by subtracting the natural pressure for each split from the ventilating pressure at the point of split and dividing by 5.2; thus,

$$B, \quad i_2 = \frac{22.22 - 13.82}{5.2} = 1.61 \text{ in.}$$

$$C, \quad i_3 = \frac{22.22 - 2.44}{5.2} = 3.8 \text{ in.}$$

The openings in these two regulators are then found by substituting the values thus obtained in the formula for finding the area of the opening in a regulator (Art. 42, *Mine Ventilation*, Part 1); thus,

$$B, \quad a_2 = .00038 \frac{q_2}{\sqrt{i_2}} = \frac{.00038 \times 30,000}{\sqrt{1.61}} = 8.98, \text{ or } 9 \text{ sq. ft.};$$

$$C, \quad a_3 = .00038 \frac{q_3}{\sqrt{i_3}} = \frac{.00038 \times 10,000}{\sqrt{3.8}} = 1.95, \text{ or } 2 \text{ sq. ft.}$$

The regulator in split *B* should therefore have an opening of 9 square feet, and that in split *C* an opening of 2 square feet.

The pressure per square foot at the point of split where the air is divided is equal to the natural pressure producing the circulation in the open split, split *A*, and is 22.22 pounds per square foot.

The total horsepower producing the circulation in splits *A*, *B*, and *C* is found by multiplying the total quantity of air in circulation by the pressure at the point of split and dividing by 33,000; thus,

$$h = \frac{Q p}{33,000} = \frac{90,000 \times 22.22}{33,000} = 60 + \text{ H. P. } \text{ Ans.}$$

EXAMPLES FOR PRACTICE

1. In a certain mine, the total quantity of air passing down the downcast shaft is 45,000 cubic feet per minute; at the foot of the downcast, it is divided into four splits as follows: Split *A*, 6 ft. \times 6 ft. and 1,500 feet long; split *B*, 6 ft. \times 7 ft. and 1,800 feet long; split *C*, 6 ft. \times 5 ft. and 1,350 feet long; split *D*, 5 ft. \times 5 ft. and 1,500 feet long.

Calculate the amount of air passing in each split when no regulators are used.

$$\text{Ans. } \begin{cases} A, 12,582 \text{ cu. ft. per min.} \\ B, 13,905 \text{ cu. ft. per min.} \\ C, 10,537+ \text{ cu. ft. per min.} \\ D, 7,976+ \text{ cu. ft. per min.} \end{cases}$$

2. A current of 60,000 cubic feet of air per minute is circulated in a certain mine in five splits as follows: Split *A*, 8,000 cubic feet; split *B*, 10,000 cubic feet; split *C*, 12,000 cubic feet; split *D*, 14,000 cubic feet; split *E*, 16,000 cubic feet. Calculate the sectional area for each split in order that the air may travel at a uniform velocity of 5 feet per second in all the splits.

$$\text{Ans. } \begin{cases} A, 26\frac{2}{3} \text{ sq. ft.} \\ B, 33\frac{1}{3} \text{ sq. ft.} \\ C, 40 \text{ sq. ft.} \\ D, 46\frac{2}{3} \text{ sq. ft.} \\ E, 53\frac{1}{3} \text{ sq. ft.} \end{cases}$$

3. How will an air-current of 10,000 feet per minute divide if split *A* is 4 ft. \times 12 ft. and 6,000 feet long and split *B* is 6 ft. \times 8 ft. and 10,000 feet long?

$$\text{Ans. } \begin{cases} A, 5,470 \text{ cu. ft. per min.} \\ B, 4,530 \text{ cu. ft. per min.} \end{cases}$$

4. How will an air-current of 50,000 feet per minute divide if split *A* is 5 ft. \times 8 ft. and 3,000 yards long and split *B* is 6 ft. \times 9 ft. and 5,000 yards long?

$$\text{Ans. } \begin{cases} A, 23,462- \text{ cu. ft. per min.} \\ B, 26,538+ \text{ cu. ft. per min.} \end{cases}$$

5. (a) Calculate the natural division of 150,000 cubic feet of air between the following splits: Split *A*, 8 ft. \times 9 ft. and 4,000 feet long; split *B*, 6 ft. \times 9 ft. and 3,500 feet long; split *C*, 8 ft. \times 12 ft. and 5,000 feet long. (b) Where should regulators be placed in order to accomplish the following division of air in these airways: Split *A*, 60,000 cubic feet; split *B*, 50,000 cubic feet; split *C*, 40,000 cubic feet? (c) Calculate the size of the opening in each regulator.

$$\text{Ans. } \begin{cases} (a) \begin{cases} A, 49,853 \text{ cu. ft. per min.} \\ B, 36,852 \text{ cu. ft. per min.} \\ C, 63,295 \text{ cu. ft. per min.} \end{cases} \\ (b) \text{Regulators should then be placed} \\ \quad \text{in } A \text{ and } C, B \text{ being the open} \\ \quad \text{or free split} \\ (c) \begin{cases} \text{Area of opening in regulator in} \\ A \text{ is } 19.55 \text{ sq. ft.}; \text{ area of opening} \\ \text{in regulator in } C \text{ is } 6.78 \\ \text{sq. ft.} \end{cases} \end{cases}$$

VENTILATION OF A MINE

PRACTICAL CONSIDERATIONS

15. The efficient ventilation of a mine is dependent on four essential elements: (*a*) Volume of the current or quantity of air in circulation; (*b*) distribution of the air in the mine workings; (*c*) velocity of the air-current; (*d*) manner of conducting the air-current.

The proper ventilation of a mine requires that a quantity of air should be passing into the main intake airway sufficient to meet the requirements of the mining law of the state in which the mine is located. This volume of air must be so divided between the several districts of the mine that each district will receive a sufficient quantity of air to dilute, sweep away, and render harmless the gases produced in that district. The abandoned workings and falls must be thoroughly ventilated. The velocity of the air-current at the working face must be such that there will be no accumulations of gas in the cavities of the roof and other void spaces. In a gaseous mine the velocity of the air-current at the working face should not exceed 8 feet per second or about 500 feet per minute. For reasons of economy, at least, it is important that all the air taken into any given part of a mine, except what is required for the ventilation of stables, pump rooms, etc., should be made to sweep the working face. This can be accomplished only by building substantial air-tight stoppings in the cross-cuts between the airways, and, where necessary, by special brattices to deflect the air-current so that it will sweep any cavities or lodging places for gas in the roof or sides of a passageway.

16. Quantity and Velocity of Air Required.—It is customary to estimate the quantity of air required for the

ventilation of a mine on a basis of 100 cubic feet or more per man per minute, and from five to six times this amount per horse or mule per minute, the amount depending on the gaseous condition of the mine. This is an arbitrary standard without reference to the fact that a high and often dangerous velocity of the air may be necessary to produce this amount of air in the contracted airways of thin seams and that only a low and inefficient velocity would be needed to give the same quantity in the larger airways of thick seams. As the velocity in the airways and at the working face should be maintained within certain prescribed limits it must be considered in connection with the amount of air required.

In a mine generating marsh gas, the velocity of the air in the workings should not exceed 8 feet per second or 480 feet per minute, while in any case the velocity at the working face should not fall below 3 or 4 feet per second, or about 200 feet per minute. In the absence of gas, the velocity on the main airways often varies from 600 to 1,500 feet per minute. The velocity of the air-current is an important consideration where gas is given off in large quantities, since a sluggish current having a low velocity will not remove the heavy gases from the lower or dip workings or the lighter gases from the rise workings. The removal of large bodies of gas from rise or dip workings often requires that the velocity of the air-current be temporarily increased beyond what is a safe working velocity of the air-current. It must be remembered that a safety lamp carried against an air-current is subjected to a current velocity equal to the velocity of the air plus the velocity with which the lamp is moving. For this reason it is well, if possible, in the examination of main airways to travel with the air and to carefully protect the lamp from the air-current when it is necessary to halt in the airway.

17. Quantity of Air Required by Law.—The Anthracite Mining Laws of Pennsylvania (Art. X, Sec. 7) provide that all air passages shall be of sufficient area to allow the free passage of not less than 200 cubic feet of air per minute

for every person working therein, and a velocity not to exceed 450 feet per minute where safety lamps are used, except in the main intake and return airways. Not more than seventy-five persons are permitted by law to work in the same air split, except by special permission from the mine inspector.

The Bituminous Mining Laws of Pennsylvania provide that the minimum quantity of air shall not be less than 100 cubic feet per minute for every person employed in a mine; but in a mine where firedamp has been detected the minimum shall be 150 cubic feet, and as much more in either case as one or more of the mine inspectors may deem requisite. It limits the number of men working in an air split to sixty-five. The law in Illinois provides for 100 cubic feet per minute for each person and 600 cubic feet per minute for each animal, measured at the foot of the downcast, but this amount may be increased at the discretion of the mine inspector. The number of men in any one split is limited to 100, or less, at the discretion of the mine inspector.

The amounts of air and the number of men allowed in a split as given above are simply examples of state laws, and as they are subject to change from time to time they should not be used in answering examination questions, but the latest law for each state should be consulted.

VENTILATION OF DIFFERENT TYPES OF MINES

18. Ventilation of a Drift Mine.—The simplest case of mine ventilation is where the seam lies flat or nearly so and where the mine is entered by a practically horizontal passageway, called a **drift** when it is driven in the coal or a **tunnel** when it is driven in the rock. In the plan, Fig. 2, the entrance to the mine is shown at the top of the illustration. The main drift and haulage road *a* is usually made the intake airway. An upcast shaft may be sunk at a convenient point where it is easily reached by the main return airway of the mine and where the depth of the seam below the surface is as small as possible, so as to decrease the cost of sinking the shaft; or the return airway *b*, Fig. 2, may be

parallel to the intake and the ventilator placed at the mouth of this return. Any form of mine ventilator may be used to produce the circulation. The mine is divided into sections by *cross-entries c, d* and *e, f* driven in pairs as shown. The main air-current passing along the main drift or air-course *a* is divided at the mouth of each pair of cross-entries as shown at *g* and *h*, one split of the air continuing along the main airway and the other passing along the side entry through a cross-cut near the face of the entry and back along the

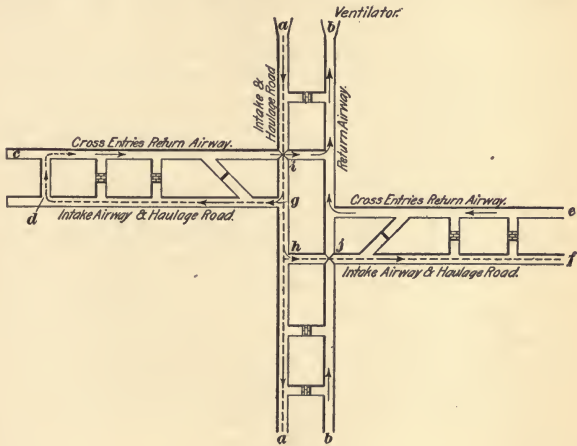

FIG. 2

return *c* or *e*, as indicated by the arrows. The crossed lines at the mouth of one entry of each pair of cross-entries at *i* and *j* indicate the position of overcasts. The one at *i* carries the return air from the entry *c* to the return airway *b*. The overcast *j* carries the main return air, passing in *b*, over the haulage road *f*. The dotted lines in the center of the intake entries show the position of the haulage track and indicate the haulage roads of the mine, which maintain a continuous grade, while any air crossings pass over or under them. Before the cross-entries have reached a stage of

development requiring the building of an air bridge, doors are used to deflect the main current into these entries.

19. Ventilation of Slope or Shaft Mines: Flat Seams.—The ventilation of a flat seam opened by a slope or shaft differs from the ventilation of a drift mine just described only in the arrangements about the bottom of the slope or shaft in connection with the hoisting of the loaded cars to the surface, the underground stables, etc., which are not generally needed at a drift mine. In the case of a shaft or slope mine, the main hoisting shaft or slope is generally used either as a main intake or a return for the air. Another shaft or slope not far from the first is used as a return or intake, depending on which way the air passes through the main shaft. Sometimes, and especially if the mine has been extended for some distance from the main shaft, an air-shaft or slope is sunk to some point in the inside workings for the purpose of shortening the distance the air must travel in passing through the mine, and furnishing more direct circulation of air through the mine. In order to avoid the use of doors on the main haulage road at the bottom of the shaft or slope, it is necessary to use an exhaust fan when the hauling is done on the intake airway, and a blower fan when hauling is done on the return airway of the mine.

The important feature with reference to the ventilation of a shaft or slope bottom is to so arrange the airways as to furnish the most direct passage for the air-currents between the bottom of the shaft and the mine workings. Provision must be made in this arrangement for the future development of the mine and for the ventilation of the stables, pump rooms, hospital, tool and other shanties or wash rooms, and also so that the main air-current may be split as near as possible to the foot of the downcast shaft. The stables, if possible, should be located between the upcast and downcast shafts so as to secure better ventilation of the stables and to make them of easy access in case of accident and also to keep the stable air from circulating through the mine. Two arrangements of the circulation and airways,

stables, etc. at the bottom of a shaft are shown in Figs. 3 and 4. In each of these, the mine stables are ventilated by a separate split of air taken off the main intake current, and returned at once to the main return airway. To accomplish this, a regulator is placed at the intake end of the stables at *a*, Figs. 3 and 4, the return end of the stable being open to the return airway or to a cross-cut *b* leading to the return airway. In Fig. 3, the first splitting, made a short distance from the foot of the downcast shaft at *c*, divides the air-current into two primary splits that pass, respectively, to opposite

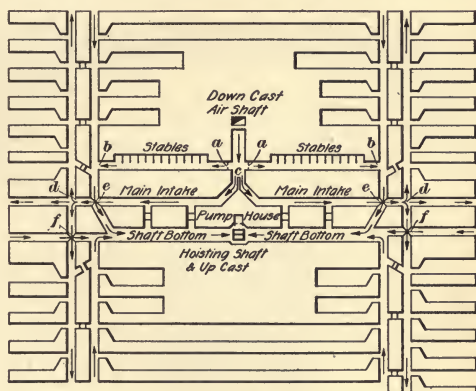

FIG. 3

sides of the shaft, each split being again divided at the mouth of the first pair of cross-entries at *d*. The figure shows the main hoisting shaft as an upcast and hauling as being done on the return airways of the mine. The division of the air at the mouth of each pair of cross-entries requires air-crossings at *e* and *f*, as shown in the figure by the cross-lines at these points. As the hauling is done on the return air, the intake air must travel through the air bridge, passing over or under the haulage road. In this figure, a door regulator is shown at the first split at *c*, and box regulators at *a*.

In Fig. 4, the air-current is divided at the foot of the downcast shaft into three main splits *c*, *d*, and *e*, which are divided as required at the mouths of the cross-entries. Here, also,

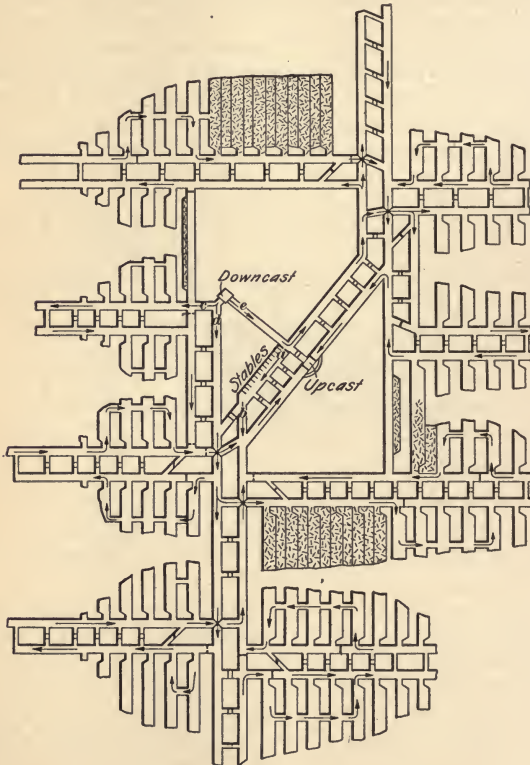

FIG. 4

hauling is done on the return air, and the intake air must travel over the air bridge. In this figure, box regulators are used near the mouths of the return airway in the several splits

where necessary to accomplish the required division of air. A door regulator may be used, if necessary, at the foot of the downcast shaft.

20. Ventilation of a Long-Wall Mine: Flat Seam.

The general disposition of the air-current in the ventilation of a long-wall mine is shown in Fig. 5. In the long-wall method of working, all the coal is taken out and no pillars are left except about the shaft. The face at which the coal is mined is a continuous line a, a , while the haulage roads and airways are passages between walls of loose rock. In

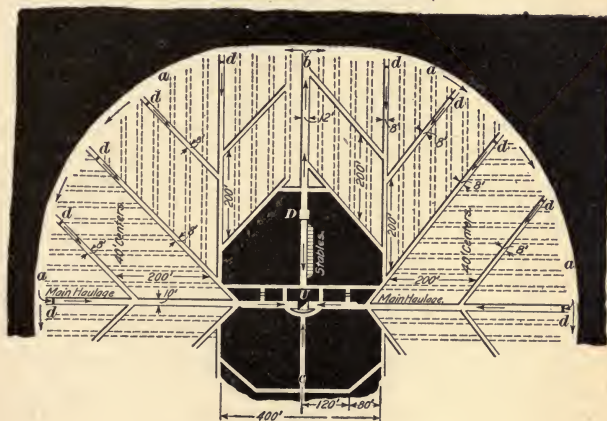

FIG. 5

the case illustrated, the hoisting shaft U is the upcast, hauling being done on the return airway. The downcast shaft D is located in the shaft pillar and the mine stable is between the two shafts. The air is divided into two splits at the working face at the head of the main intake airway at b , separate currents passing to the right and left around the working face, and returning by the main road c on the opposite side of the shaft to the shaft bottom at the foot of the upcast or hoisting shaft. By this arrangement, the entire working face is ventilated by two splits only. In the

later development of the mine, it will be necessary, however, to divide the main air-current into two splits at the foot of the downcast shaft, and by building an air bridge across the main haulage road at the shaft bottom, carry one of these main splits directly to the opposite side of the shaft. Each of these main, or primary, splits will then be again split at the working face, passing to the right and left of the main road, thus dividing the circulation in the mine into four splits or currents, each split ventilating a quarter of the entire circle of the working face. In this arrangement, the two splits from the opposite sides of the shaft meet at the heads of the main haulage roads and return by these roads to the foot of the upcast shaft. In any of these arrangements, curtains or canvas doors *d* are hung at the head of each crossroad and working place, or permanent doors are located at the mouths of these roads, so as to prevent the air returning by them to the shaft bottom. In any case, a small quantity of air is allowed to traverse these roads sufficient for their ventilation. In any circulation of air, it is important to conduct the air, as far as practicable, at once to the farthest point in by in the workings, whence it is allowed to traverse the working faces on its return. Long-wall workings are usually more easily ventilated than room-and-pillar workings, as the air-current is carried directly along the working face where it is most required. For the same length of working face, the distance traveled by the air is less in long-wall work than in room-and-pillar work, and there is consequently less loss of air due to leaky stoppings, doors, etc.

21. Ventilation of Inclined Seams.—The chief feature in the ventilation of an inclined seam is to so arrange the air-current that the circulation of the air through the workings shall be ascensional; that is, the air circulating through the workings shall tend to rise. This is not always practicable, but where it can be accomplished easily there is a great saving in expense for ventilation.

Fig. 6 shows a mine opened by a pair of slopes *a* and *b* driven to the full dip of the seam. Cross-entries *c* or

gangways are driven on the strike of the seam, at regular intervals to the right and left from the main slope, and the coal is worked by driving chambers to the rise of these gang-

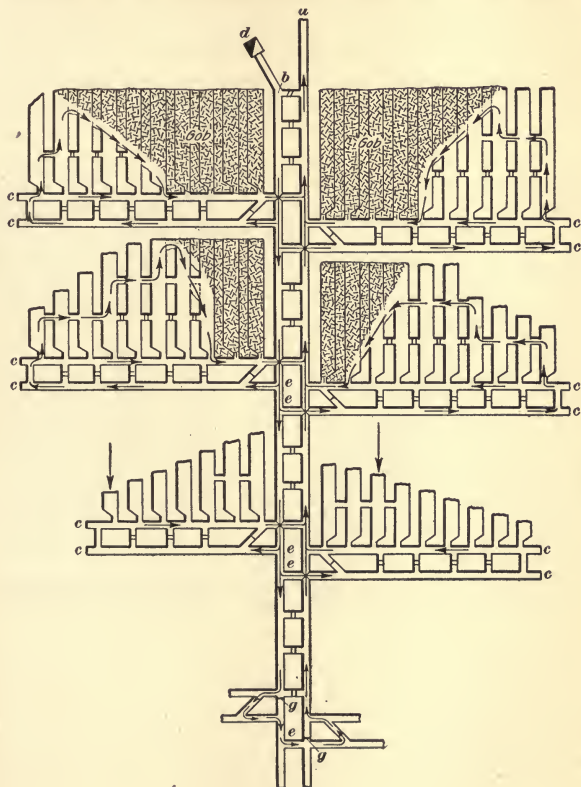

FIG. 6

ways. The haulage slope *a* is shown as the main return airway, the air being blown into the mine by a blower fan located at the top of a shallow shaft *d* connecting with the intake

slope b . The air is split as shown at the mouth e of the lower one of each pair of cross-entries as soon as the development of these entries warrants the expense of building the necessary air bridges. Doors are used for deflecting the main current into the gangways until such time as the air bridge is constructed. The current is not divided at the last two pairs of cross-entries that have just been turned, but these are ventilated with the same current traveling in the main slope airways, doors being used at g on the main and return slopes to deflect the air to the faces of the entries.

When practicable, the ventilation of an inclined seam is greatly assisted by having two openings, the one to the dip being made the intake opening, and the one to the rise being the discharge opening. In this arrangement, the circulation throughout the mine is truly ascensional.

22. In the ventilation of a steeply inclined thick seam, the airway is often driven close to the roof, as shown at c in Fig. 7 (b), and above the gangway g . The room or breast is opened by a narrow chute an driven up the pitch from the gangway g . After this has been driven up a certain distance, depending on the thickness of the seam, it is gradually widened out as shown at k to the width of a room. The section (b) shown is made on the lines lk and ij and the plan (a) is made on the line pq . The plan therefore does not show the airway c nor the cross-cut d . The breast is allowed to fill with coal, and only enough is drawn out through the narrow chute a at the bottom to keep the broken coal near the face so that the men may stand on it while mining. n is a narrow manway so that the men can work about the chute and control the flow of the coal. A small manway m is driven up from the gangway g between the chutes, and after being driven for a certain distance, depending on the thickness of the seam, branches s, s are turned off this manway until they intersect the breast on each side; the tops of these branches s connect with the manways w along each side of the breast.

A small airway *d*, driven between the airway *c* and the manway *m*, serves as a cross-cut between *c* and *g* while they are being driven, but cross-cuts are also necessary between the airway *c* and the gangway *g* where much gas is given off. The small cross-cut *d* and the airway *c* are not used for circulating the air ordinarily, while the breasts are working; but if any accident takes place in the room manway *w* by which the current of air is blocked, the air may be conveyed past the room through the airways *d* and *c*.

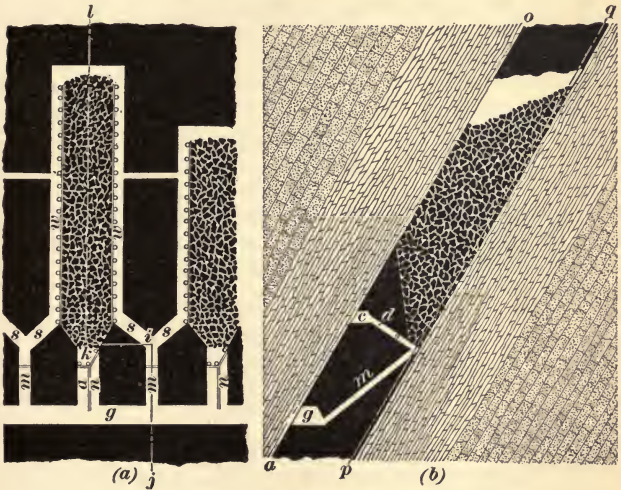

FIG. 7

23. Ventilation of Gaseous Mines.—The ventilation of a gaseous mine requires such an arrangement of the airways as will furnish an abundance of air, and give the best possible control over the ventilating current and furnish the largest area for the return currents. For this reason, the entries are often driven three abreast, an arrangement called the **triple-entry system**. In Fig. 8, the main entries *a*, *b*, and *c* are shown as triple entries, while the cross-entries *d* and *e* are driven in pairs and known as **double entries**.

In the triple-entry system, the middle entry of the three should be made the intake entry and haulage road, while the two side entries flanking the haulage road form the return for each side of the mine, respectively.

In the figure, the air is shown as split at *f*, each pair of cross-entries receiving a separate split. Air bridges *g* carry the return air over the haulage roads leading from the side entries. Where the cross-entries are long and the mine very gaseous, these also are driven as triple entries. The top of the figure is toward the mine opening.

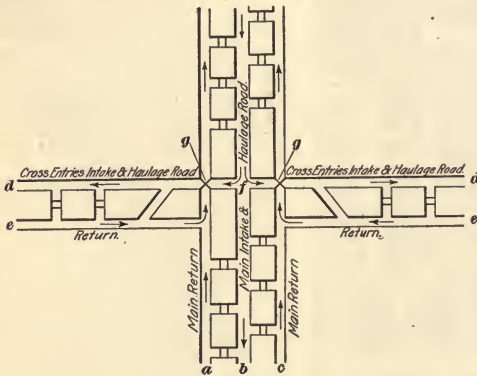

FIG. 8

In a gaseous mine, the ventilation should be so arranged that the hauling can be done on the intake air-course, as this is safer, since it avoids the danger of the ignition of gas by the lamps of the drivers. This will require the use of an exhaust fan instead of a blower, in order to avoid the necessity for doors on the main haulage road at the foot of the shaft or slope, or at the mouth of a drift, as the case may be. Hauling on the intake has the following disadvantages: The intake air is laden with the dust of the haulage road, which is carried into and deposited in the workings. The movement of the loaded cars against

the air-current obstructs the circulation more than do the empty cars moving with the return current. Any refuse accumulating on the haulage road vitiates the air-current before it reaches the working face. The coal that falls from the cars along the roadways and is crushed to a fine dust is more an element of danger on an intake airway than on the return, in case of a dust explosion in the mine. For these reasons, it is better in the absence of gas to make the haulage road the return airway of the mine.

The number of doors used in connection with the ventilation of a mine should be as small as possible, as doors on haulage roads obstruct the roads, increase the expense for trappers, or door tenders, and also increase the danger of explosions, since if a door is left open the entire air-current may be disarranged. Again, in case of an explosion, if a door is destroyed the entire air-current of the mine may be disarranged until the door can be restored. Hence, wherever possible, the plan of ventilation should be such that overcasts may be used and doors avoided. A gaseous mine should be ventilated in separate districts as far as possible, so as to confine the effects of an explosion to a single district.

MEANS FOR VENTILATING MINES

NATURAL VENTILATION

24. **Natural ventilation** means the production of an air-current without the use of any form of ventilator. The principle on which all natural ventilation depends is the difference in weight between two columns of air of different densities. This difference in weight produces a flow of air from the heavier to the lighter air column.

The pressure of the atmosphere on the surface of the earth is due to the weight of the air. The pressure on each square inch of surface, at sea level (14.7 pounds) is equal to the weight of a column of air whose base is 1 square inch and whose height is the height of the atmosphere. The pressure

on each square foot of surface (2,116.8 pounds) is equal to the weight of a column of air whose base is 1 square foot and whose height is that of the atmosphere.

25. Air Columns.—An air column in ventilation is a column of air having a base of 1 square unit (usually 1 square

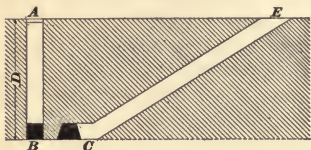

FIG. 9

foot) and a height equal to the height of the air considered. Thus, the height of an air column in a shaft is the depth of the shaft; the height of the air column in a slope is the vertical height of the slope. In Fig. 9, the depth of the shaft AB is equal to the vertical height of the slope CE ; hence, in this case, the height of air column in the shaft is equal to that in the slope. In comparing the weights of these two air columns, it is evident that it is not necessary to consider the air columns extending up through the atmosphere above A and E , since they are alike in each case, and their weights will, therefore, balance each other.

26. How Air Columns Produce Air

Currents.—As was fully explained in *Mine Ventilation*, Part 1, when the two ends of an airway ab ,

Fig. 10, are acted on by air columns ac and bd of different densities or weights,

the air at the ends of the airway is subjected to different pressures and will,

therefore, move in a direction from the greater pressure toward the lesser pressure, as shown by the arrows.

The difference between these two pressures, or the weights of the two air columns, is the unit of ventilating pressure p

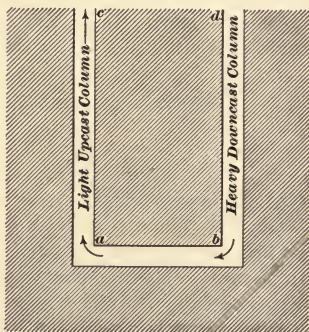

FIG. 10

therefore, move in a direction from the greater pressure toward the lesser pressure, as shown by the arrows. The difference between these two pressures, or the weights of the two air columns, is the unit of ventilating pressure p

for the same unit of cross-section, which is usually taken as 1 square foot. The total pressure producing circulation here also, is equal to the entire pressure pa exerted on the sectional area of the airway. In natural ventilation, the ventilating pressure pa is dependent on the difference of the weights of the two air columns and the sectional area of the airway.

Suppose, for example, a mine to be ventilated by two shafts, each having a depth of 500 feet. The average temperature of the downcast shaft is assumed to be 32° F., and the average temperature of the upcast shaft 60° F., and the barometer to read 30 inches. To calculate the ventilating pressure due to the difference between the weights of these two air columns, it is necessary to first find the weight w_1 of 1 cubic foot of air in the downcast, and the weight w_2 of 1 cubic foot of air in the upcast by the formula,

$$w = \frac{1.3273 B}{460 + t} \quad (1)$$

in which w = weight of 1 cubic foot of air at a temperature t and a barometric pressure B ;

B = barometric pressure, in inches of mercury;

t = temperature of air, in degrees F.

$$w_1 = \frac{1.3273 \times 30}{460 + 32} = .08093 \text{ pound}$$

and, $w_2 = \frac{1.3273 \times 30}{460 + 60} = .07657 \text{ pound}$

Multiplying each of these weights, in turn, by the depth D of the shaft gives the total weight of the downcast and upcast air columns; thus,

Weight of downcast column,

$$D w_1 = 500 \times .08093 = 40.465 \text{ pounds}$$

Weight of upcast column,

$$D w_2 = 500 \times .07657 = 38.285 \text{ pounds}$$

Difference, 2.180 pounds

The weight W of any air column Dw is therefore given by the formula

$$W = D \frac{1.3273 B}{460 + t} \quad (2)$$

The difference between the weights of these two air columns is the unit of ventilating pressure, which may also be found thus:

$$D(w_1 - w_2) = 500(.08093 - .07657) = 2.180 \text{ pounds}$$

Expressed as a formula, this is

$$p = D(w_1 - w_2) \quad (3)$$

in which p = unit of ventilating pressure, in pounds per square foot;

D = depth of shaft, in feet;

w_1 = weight, in pounds, of 1 cubic foot of air in downcast;

w_2 = weight, in pounds, of 1 cubic foot of air in upcast.

By substituting, in formula 3, the expressions for w_1 and w_2 obtained from formula 1,

$$p = D \left(\frac{1.3273 B}{460 + t_1} - \frac{1.3273 B}{460 + t_2} \right)$$

$$p = D(1.3273 B) \left(\frac{1}{460 + t_1} - \frac{1}{460 + t_2} \right)$$

$$p = D(1.3273 B) \left[\frac{t_2 - t_1}{(460 + t_1)(460 + t_2)} \right] \quad (4)$$

in which the letters p , D , and B have the same significance as in formula 3 and t_1 is the average temperature in downcast shaft and t_2 is the average temperature in upcast shaft.

27. Motive Column.—The term **motive column** is often used to express the unit of ventilating pressure in mine ventilation. It is an imaginary column of air having a base of 1 square foot and a height such that the weight of the air column will be equal to the unit of ventilating pressure, or the pressure per square foot in the airway

Since the motive column is an imaginary column of air of such height that its weight will produce a certain pressure, it may be assumed to consist of air of any given density. For the same pressure, the height of the motive column will be greater or less, according to the density of the air. For

example, for the same pressure, the motive column of upcast air will have a greater height than that of downcast air, because the upcast air is lighter and requires a larger amount to produce the same pressure. Although the motive column is usually now given in terms of the downcast air column, some writers give it in terms of the upcast. This gives rise to two formulas for motive column and unless this is understood confusion is occasioned. To make this clear, assume a mine ventilated by two shafts, each being 600 feet deep, the upcast having an average temperature of 150° F., and the downcast an average temperature of 40° F. The weights of these two shaft columns are as follows, using formula 2, Art. 26.

$$\text{Downcast column, } W = 600 \times \frac{1.3273 \times 30}{460 + 40} = 47.7828 \text{ pounds}$$

$$\text{Upcast column, } W = 600 \times \frac{1.3273 \times 30}{460 + 150} = 39.1662 \text{ pounds}$$

The unit of ventilating pressure in this case is then $47.7828 - 39.1662 = 8.6166$ pounds.

The weight of 1 cubic foot of the downcast air is then .079638 pound; and the weight of 1 cubic foot of the upcast air is .065277 pound. The heights of motive column of downcast and upcast air, respectively, that alone would produce this pressure are as follows:

Motive column, downcast air, $8.6166 \div .079638 = 108.2$ feet, nearly.

Motive column, upcast air, $8.6166 \div .065277 = 132.0$ feet.

Both of these motive columns produce the same unit pressure, which is found by multiplying the height of the motive column by the weight of 1 cubic foot of the air of which it is composed. Thus, the unit of ventilating pressure in each case is as follows:

$$p = 108.2 \times .079638 = 8.616+;$$

or, $p_1 = 132.0 \times .065277 = 8.616+$

Unless otherwise stated, the motive column will always be given in terms of the downcast air. The downcast air is always the heavier, and as shown in Fig. 11, when the upcast is heated by a furnace, as will be explained in detail later, a

portion only of the downcast column is necessary to balance the entire weight of the upcast column. The remainder of the downcast column, or the excess of weight of the

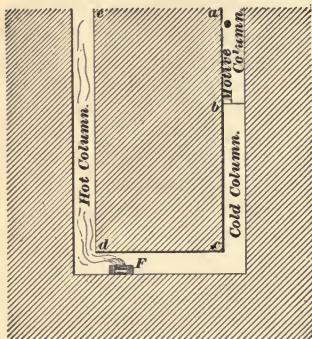

FIG. 11

downcast air, will then represent the motive column of downcast air. If the motive column were estimated in upcast air, it would not be possible to illustrate it in this manner as it would then be purely an imaginary column.

To obtain the height of the motive column in terms of the downcast air divide the unit of ventilating pressure as found in Art. 26, by the weight

of 1 cubic foot of downcast air; thus,

$$M = D(1.3273 \times B) \frac{t_2 - t_1}{(460 + t_1)(460 + t_2)} \div \frac{1.3273 \times B}{460 + t_1}$$

$$\text{or, } M = D(1.3273 \times B) \frac{t_2 - t_1}{(460 + t_1)(460 + t_2)} \times \frac{460 + t_1}{1.3273 \times B}$$

$$\text{and, } M = D \frac{t_2 - t_1}{460 + t_2} \quad (1)$$

In like manner, the height of motive column in terms of the upcast air is found by dividing the unit of ventilating pressure given above, by 1 cubic foot of the upcast air, giving the formula,

$$M = D \frac{t_2 - t_1}{460 + t_1} \quad (2)$$

To show the application of these formulas, the height of motive column, in terms of the downcast and the upcast air, respectively, in the example given in Art. 27, may be calculated directly by substituting the values $D = 600$ feet, $t_1 = 40^\circ$ F., $t_2 = 150^\circ$ F., in turn, in each of the above formulas; thus,

Motive column (downcast air) $M = 600 \frac{150 - 40}{460 + 150}$; or,
 $M = 600 \times \frac{110}{610} = 108+$ feet; motive column (upcast air)
 $M = 600 \frac{150 - 40}{460 + 40}$; or, $M = 600 \times \frac{110}{500} = 132$ feet. The calculation by these formulas is thus seen to be much shorter than by the previous method.

28. When a ventilating current is due to the difference in weight of the downcast and upcast air columns, it is important to remember that, for the same temperatures, the unit of ventilating pressure p due to these air columns remains constant; and for the same sectional area a of the airway, the total pressure pa producing ventilation, or the ventilating pressure, is constant. Hence, in considering such circulations, the mine resistance ($pa = ksv^2$) is a constant, and the velocity of the air passing through the mine decreases with any increase in the rubbing surface.

Or, again, the ventilating pressure pa being constant, any increase or decrease of the velocity v , due to a change in the rubbing surface of the airway, results in a corresponding increase or decrease in the power on the air. In other words, the sectional area of the airway and the ventilating pressure both being constant, any increase in the length, and, consequently, in the rubbing surface of the airway, produces a decrease in the power on the air, and, vice versa, any decrease in the length produces an increase in the power on the air. In this respect, there is an important difference between the consideration of air columns in natural or in furnace ventilation and any form of fan ventilation, since, with fans, the power delivered to the fan shaft remains constant and the power on the air is also practically constant for any given case.

EXAMPLES FOR PRACTICE

1. The downcast shaft of a mine is 437 feet deep, the mean barometric pressure is 30.25 inches, and the mean temperature of the air in the shaft is 67° F.; what is the weight of a column of air in this shaft, having a base of 1 square foot? Ans. 33.2939 lb.

2. The downcast shaft of a mine is 1,147 feet deep, the mean barometric pressure is 29.9 inches, and the mean temperature of the air in the shaft is 50° F.; what is the weight of a column of air in this shaft, having a base of 1 square foot? Ans. 89.2552 lb.

3. The upcast shaft of a mine is 347 feet deep, the mean barometric pressure is 30 inches, and the mean temperature of the air in the shaft is 187° F.; what is the weight of a column of air in this shaft, having a base of 1 square foot? Ans. 21.35578 lb.

4. The upcast shaft of a mine is 1,170 feet deep, the mean barometric pressure is 29.5 inches, and the mean temperature of the air in the shaft is 160° F.; what is the weight of a column of air in this shaft, having a base of 1 square foot? Ans. 73.8899 lb.

5. The ventilating shafts of a mine are each 950 feet deep, the temperature of the downcast column is 60° F., that of the upcast is 230° F., and the barometric pressure is 30 inches. (a) What is the length of the motive column in terms of the downcast air? (b) What is the difference in the weights of the ventilating columns per square foot of area? Ans. $\begin{cases} (a) & 234 + \text{ft.} \\ (b) & 17.923 \text{ lb.} \end{cases}$

6. The ventilating shafts of a mine are each 760 feet deep, the temperature of the downcast is 52° F., and that of the upcast is 280° F. and the barometric pressure is 30 inches. (a) What is the length of the motive column in terms of the upcast air? (b) What is the difference in the weights of the ventilating columns per square foot of area? Ans. $\begin{cases} (a) & 338 + \text{ft.} \\ (b) & 18.2 \text{ lb.} \end{cases}$

29. Average Temperatures of Air Columns.—Where a considerable current of air is passing into a mine, it will require a very deep shaft to materially increase the temperature of the intake air above that of the outside atmosphere. For this reason, it is rarely necessary to consider more than two temperatures in calculating the pressure producing the circulation of air; these are the average downcast and upcast temperatures. The average downcast temperature will rarely exceed to any appreciable extent the temperature of the outside air, except in very deep shafts or where the downcast air is warmed by steam pipes or other artificial means.

The temperature of an upcast column is subject to more variation than that of the downcast column, and the fall of temperature in the upcast is often much greater than the rise

of temperature in the downcast, since there are more agencies acting to cool the upcast current. The amount of cooling will depend largely on the difference between the temperature at the bottom of the upcast and the temperature of the outside air. Where this difference is considerable, as in furnace ventilation, the amount of cooling is increased. The influence of moisture in a deep upcast shaft is to transfer the heat from the bottom to the upper portion of the shaft. This is due to the evaporation of the water and the consequent absorption of heat in the lower portion of the shaft, and its condensation and the consequent development of heat in the upper portion of the shaft. The evaporation of the water in the lower portion of the shaft is, however, always greater than the condensation in the upper portion, as by far the larger portion of the water evaporated is carried away in the air. Occasionally, in a fan drift at the top of an upcast shaft, the condensation of the water from the air-current is like the downpour of a heavy rain. The average temperature of the upcast can be accurately estimated only after long experience.

30. Influence of Seasons on Mine Ventilation.—In the winter season, the outside air is generally colder than the mine air. This has the effect of reducing the temperature of the intake air, and increasing its weight above that of the

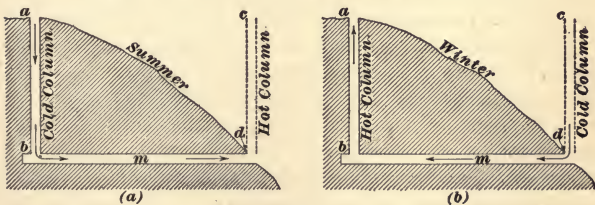

FIG. 12

return air of the mine. In the summer season, the outside air being generally warmer than the air of the mine, the temperature of the intake is increased, and may be higher than the temperature of the return air of the mine while the

weight is decreased. Hence, the influence of the winter season is to assist the circulation in the mine wherever the intake passes downwards and the return air upwards, and to oppose all circulations where the intake passes to the rise and returns to the dip. The effect of the summer season is the reverse of this.

In a drift mine connected to a shaft, as shown in Fig. 12, and ventilated by natural means only, the circulation may be reversed in the summer from what it is in the winter season due to the differences in temperature between the mine air and the outside air. In summer, a cold and therefore heavier shaft column of air is opposed to a hot outside air column producing a current down the shaft and out the drift; in winter, a hot and therefore lighter shaft column is opposed to a cold outside column producing a current into the drift and up the shaft. Thus the shaft is a downcast in summer and an upcast in winter. At certain periods of the spring and fall, when there is little difference in temperature between the mine and outside air, the ventilation in such mines will be very poor. Where artificial means of ventilation are used, the effect produced by the change of the seasons will depend on the character of the mine and the system of ventilation employed. If an exhaust fan be placed at the top of the shaft shown in Fig. 12, the natural ventilation will assist the artificial ventilation of this mine in winter and oppose it in summer. If a blower fan be placed at the top of the shaft, the natural ventilation will assist the artificial ventilation in summer and oppose it in winter. In the use of the blower fan, the temperature of the air in the fan shaft is very nearly uniform throughout the entire depth of the shaft.

The effect of the changes of seasons on the ventilation produced by a blower fan will be very slight, however, for such a fan fills the downcast shaft with air at a temperature that varies but slightly from the temperature of the outside air and the shaft air column is very nearly balanced by the outside air column; this is not the case when an exhaust fan is used.

31. In the ventilating of a mine having two openings, the one an intake and the other a discharge opening at practically the same level, as shown in Fig. 13, artificial means must be employed to produce the circulation. In this case, there is no natural ventilation until an air-current is established, by a furnace or ventilator, but if the mine is operated through a shaft or slope and there is a difference between the temperature of the outside air and that of the mine air, a shaft air column or a slope

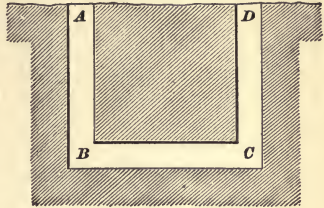

FIG. 13

column forms in the shaft or the slope immediately on a current being artificially established. The effect of the change of the seasons in this case is the same whether an exhaust or a blower fan is used. In the winter the natural shaft column will assist the artificial ventilation produced by either an exhaust or a blower fan, and in the summer the natural shaft column will oppose the artificial ventilation produced by either of these ventilators.

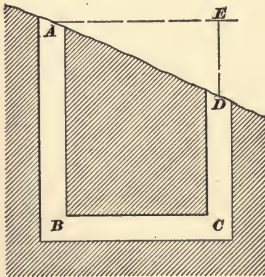

FIG. 14

32. In a slope or shaft mine at which the intake and discharge openings of the mine are at different levels as shown in Fig. 14, there is always a natural outside air column having a height ED equal to the difference in vertical distance between the tops of these two openings, and this air column

will produce a natural circulation of air in the mine in exactly the same way as was explained in connection with the drift mine shown in Fig. 12. The air column EC is made up of two parts—the column of air DC inside the mine and

column *DE* outside the mine—while the column *AB* is wholly inside the mine. The effect of this natural air column *ED* in the absence of any artificial means of ventilation is to make the higher opening of the mine an intake or downcast in the summer and a discharge or upcast in the winter, in the same manner as was explained with regard to a drift mine ventilated by a shaft and shown in Fig. 12.

The effect of artificial ventilation applied to this mine, whatever its arrangement, would be to fill the downcast shaft with the hot outside air in the summer and with the cold outside air in the winter, which would produce an unfavorable motive column in the summer, but a favorable motive column in the winter. In other words, in this case, the change of the seasons would oppose the artificial ventilation in the summer and assist it in the winter. This influence of the seasons on the artificial ventilation of shaft and slope mines where the mine openings are at different elevations is, therefore, practically the same as in the case of shaft or slope mines where the openings are at the same level; because, if the higher opening is the intake, the natural outside air column is practically destroyed as soon as artificial ventilation is established, owing to the downcast shaft column then having practically the same temperature as the outside air; if the lower opening be the intake, the outside air column becomes the extension of the downcast shaft column which also has practically the same temperature as the outside air.

33. Rise and Dip Workings.—It is a matter of common observation that rise workings are, in general, more difficult to ventilate than dip workings. The reason for this is that the intake current is usually cooler than the return current, and there is thus formed a negative air column opposing the circulation in rise workings and a positive air column assisting the circulation in dip workings. The influence of dips and rises in mine workings is often a powerful one, at times completely controlling the ventilation of the workings. On this account, seams having any considerable inclination should be ventilated as far as practicable

so that the intake air will flow to the dip and the return to the rise. When it is practicable to so arrange the ventilation of a mine, the air should be taken into the mine at its lowest point and discharged at its uppermost point, so that the circulation of the mine may be ascensional.

34. Density of Air Columns.—Whatever affects the density of the air affects the weight of the air column; temperature, pressure, moisture, presence of gases, all affect the weight of the air column to a greater or less degree. In very accurate calculations, all these factors might be considered in determining the weights of the respective air columns, but ordinarily only the temperature of the air column and the barometric pressure are considered. The effect of moisture in this respect is very slight, but the presence of any considerable amount of carbon-dioxide gas, or of carbureted-hydrogen gas in the upcast current, or in the return current of an inclined seam, may affect the air column to an extent that will depend on the amount of either gas present.

35. Ventilation of a Shaft During Sinking.—There is not much difficulty experienced from the lack of air in sinking a shaft until a depth of 15 or 20 yards is reached, depending somewhat on the size of the shaft. When it becomes necessary to provide for the ventilation of the shaft, it should be divided into two compartments by an air-tight partition, which may be temporary or permanent. This partition should extend from the top of the shaft to within 3 or 4 yards of the bottom, and, in general, the natural heat produced by the workmen at the bottom of the shaft will cause a current of air to descend on one side of this partition and ascend on the other. This movement of the air may be assisted by providing a stack of common 12-foot or 16-foot boards at the top of the air compartment or manway, as shown in Fig. 15.

When a depth is reached at which the natural ventilation thus provided is insufficient, a small hand blower may be used at the surface of the shaft, or a fire-basket may be used

consisting of an iron grating in the form of a basket in which a bed of coals or fire may be placed, and which is then lowered into the shaft. Sometimes, a steam pipe is conducted down the shaft, and a steam jet is used to create an upward current

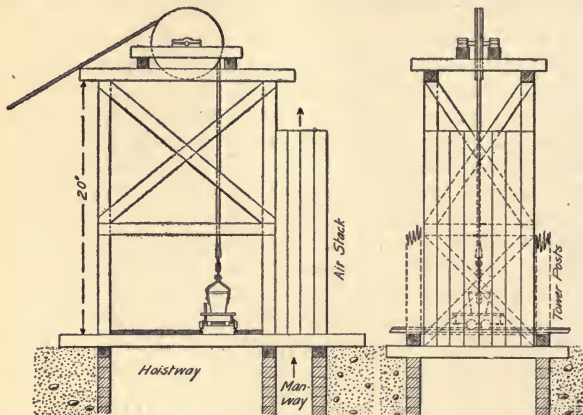

FIG. 15

of air. When compressed air or steam is used for the operation of the drills at the bottom of the shaft, there is generally no need for further ventilation than that produced by the exhaust air or steam.

FURNACE VENTILATION

36. Furnace ventilation depends on exactly the same principles as natural ventilation and all that has been said with respect to air columns in natural ventilation applies alike to furnace ventilation. The purpose of a mine furnace, as illustrated in Fig. 11, is to heat the upcast column to a much higher temperature than is possible by the natural heat of the mine. The high temperature produced by the furnace greatly reduces the weight of the upcast column and therefore increases the unit of ventilating pressure. The chief difference, therefore, between natural ventilation and

furnace ventilation is that in the former the air is heated by natural means and in the latter by artificial.

37. Construction of a Mine Furnace.—As the furnace is still used in many localities for the ventilation of mines where the output does not justify the erection of a ventilating fan, its construction and use should be known.

Fig. 14 illustrates a good type of furnace. It is important in building a furnace to construct it so as to keep the excessive heat of the fire from the rib coal at each side, and from the roof rock above. In Fig. 16, *l* is the rib coal; *p*, the ash-

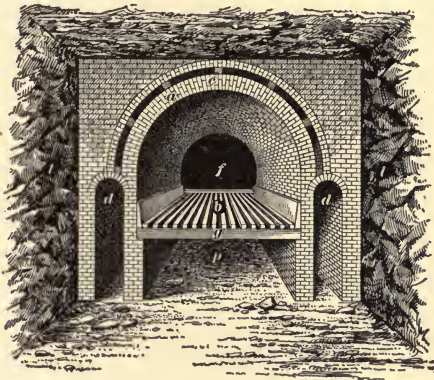
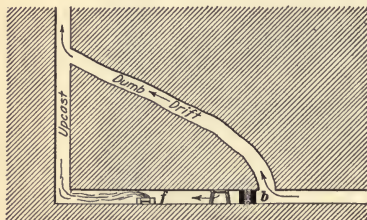
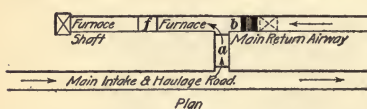

FIG. 16

pit; *g*, the bearing bar or front fire-grate girder; and *b* are the grate bars that form the fire-grate surface. The furnace arch *a* is generally semicircular and double, the height from the grate bars to the under surface of the arch being generally $1\frac{1}{4}$ times the width of the fire-grate. The side drifts *d* and the annular space above the fire-arch *a* keep the heat from the coal and the roof. Ribs of brick *c* separate the two arches and serve to keep the air space open so that a current of air may freely pass through it and keep the heat from the roof. The importance of this arrangement lies in the fact that in cases where the roof contains water, the

fire-arch *a*, if not so protected, is continually buckling with the pressure produced by the steam formed in the roof strata, and this causes the roof to break and fall.

38. The Dumb Drift.—What is called a **dumb drift** in furnace ventilation is a short connection driven from a point 30 or 40 yards back from the foot of the furnace shaft upwards through the roof strata to intersect the shaft at a sufficient height to avoid the ignition of the gases in the return air-current by the flame of the furnace. This connection, called a *dumb drift*, may be driven in any manner



Elevation

FIG. 17

most convenient and best adapted to the conditions existing in any particular case. It is not ordinarily considered good practice to ventilate a gaseous mine by means of a furnace, and the practice is fast becoming obsolete. When a dumb drift is used, a substantial air-tight stopping *b*, Fig. 17, is built just outside of the point where the dumb drift leaves the entry, its purpose being to deflect the return air-current into the drift by which it is conducted into the upcast or furnace shaft at a suitable height above the bottom of the shaft. The furnace *f* is built 10 or 15 yards from the foot of the shaft, and between the stopping *b* and the furnace *f* a cross-cut or heading *a* is driven to connect the furnace drift with the main intake airway. In this cross-heading, two regulator doors are built to prevent the short-circuiting of the intake current at this point. A small split of air is allowed to pass through the regulators in these doors, sufficient to feed the furnace with fresh air. By means of

this arrangement, the furnace shaft is heated to such a temperature as is necessary to create a sufficient motive column in the shaft for the proper ventilation of the mine, but the flame of the furnace cannot reach the point in the shaft where the return current laden with explosive gases enters. This point is at least 50 yards above the bottom of the shaft, depending on the size of the furnace, the depth of the shaft, and the gaseous character of the mine.

39. Pressure Due to a Furnace.—The unit of ventilating pressure in furnace ventilation is equal to the difference between the weight of a column of air heated to a certain temperature by a furnace and the weight of an air column of equal height but not artificially heated. This second air column may be an air column in the outside atmosphere, as cd , Fig. 12, having a height corresponding to the depth of the furnace shaft, or it may be an air column in the downcast shaft or slope ac , Fig. 11, or it may be composed of both an inside and an outside column EC , Fig. 14. This latter case would at times necessitate considering three temperatures; namely, that of the outside air column DE , that of the downcast slope or shaft column CD , and that of the upcast or furnace shaft column AB .

It is evident from the explanation given under Natural Ventilation that the unit pressure any furnace can produce will depend on the difference in the weights of these two air columns. To determine this unit pressure, the first step is to calculate the weight of 1 cubic foot of air having a temperature equal to the average temperature of the downcast air column, and of 1 cubic foot of air of the same temperature as the average temperature of the upcast column, then multiply each of these unit weights by the heights of their respective air columns, and the difference between the weights of the downcast and upcast columns will give the unit of ventilating pressure. Multiplying this pressure by the sectional area of the airway gives the total pressure producing circulation, or the ventilating pressure pa .

40. Power of a Mine Furnace.—In furnace ventilation, as in natural ventilation, for any given motive column, which determines the unit of ventilating pressure, the velocity of the air-current is determined by the rubbing surface and area of the mine airways. As explained under Natural Ventilation, any increase in the rubbing surface of the mine or airway in furnace ventilation causes a decrease in the power on the air, and vice versa, any decrease in the rubbing surface causes an increase in the power on the air for a constant area. This means that the same depth of furnace shaft and the same conditions with respect to the densities of the upcast and downcast columns will develop a greater or less power, according as the rubbing surface of the mine is less or greater for a constant area. The reason for this is that the power in any circulation is determined by the quantity of air passing in the airway and the unit of ventilating pressure causing the circulation; that is, $u = q\phi$. For the same conditions of the furnace, depth of furnace shaft and densities of upcast and downcast columns, the unit of ventilating pressure is constant and the quantity of air in circulation varies inversely as the rubbing surface for a constant area.

The power of a mine furnace may be found from the formula for horsepower by substituting for q its value in

the formula $q = a\sqrt{\frac{a\phi}{ks}}$,

$$h = \frac{Q\phi}{33,000} = \frac{a\sqrt{\frac{a\phi}{ks}} \times \phi}{33,000} = \frac{a\phi\sqrt{\frac{a\phi}{ks}}}{33,000}$$

EXAMPLE.—(a) Find the unit of ventilating pressure produced by a mine furnace when the temperature of the downcast is 60° and that of the upcast 340° , the depth of the furnace shaft being 1,500 feet. (b) Find the quantity of air in circulation in this mine, the size of the upcast and downcast shafts being each 8 ft. \times 15 ft. and 1,500 feet deep, the air traveling in a single current through the mine, the size of the airways being 8 ft. \times 10 ft. and 5,000 feet long, including the return. (c) Find the horsepower producing the circulation in this case.

SOLUTION.—(a) Finding the motive column in this case, in terms of the downcast air, by substituting the given values in formula 1 of Art. 27,

$$M = 1,500 \frac{340 - 60}{460 + 340} = 1,500 \times \frac{280}{800} = 525 \text{ ft.}$$

The weight of 1 cu. ft. of the downcast air having a temperature of 60° and assuming a barometric pressure of 30 in., is

$$w = \frac{1.3273 \times 30}{460 + 60} = \frac{39.819}{520} = .0766 \text{ lb., nearly}$$

The unit of ventilating pressure is then found by multiplying the motive column by the weight of 1 cu. ft. of the downcast air which gives $p = 525 \times .0766 = 40.2$ lb. per sq. ft. Ans.

(b) It will be necessary here to calculate the rubbing surface, sectional area, and the relative potential $X = a\sqrt{\frac{a}{l \cdot o}} = \sqrt{\frac{a^3}{s}}$ for the shafts and the mine airways separately; thus,

$$\text{Two shafts} \quad \cdot \cdot \cdot \begin{cases} s_1 = 2 \times 1,500 \times 2(8 + 15) = 138,000 \text{ sq. ft.} \\ a_1 = 8 \times 15 = 120 \text{ sq. ft.} \end{cases}$$

$$\text{Airways (intake and return)} \quad \cdot \cdot \cdot \begin{cases} s_2 = 5,000 \times 2(8 + 10) = 180,000 \text{ sq. ft.} \\ a_2 = 8 \times 10 = 80 \text{ sq. ft.} \end{cases}$$

The general expression for the total pressure in this case, as explained in Art. 13, is given by the formula $p = k Q^2 \left(\frac{1}{X_1^2} + \frac{1}{X_2^2} \right)$. Calculating the values of X_1 and X_2 for the shafts and airways,

$$X_1 = \sqrt{\frac{a_1^3}{s_1}}, \text{ or } X_1^2 = \frac{a_1^3}{s_1}; \text{ hence,}$$

$$\text{Shafts, } \frac{1}{X_1^2} = \frac{s_1}{a_1^3} = \frac{138,000}{120^3} = \frac{138,000}{1,728,000} = \frac{23}{288} = .0798, \text{ nearly}$$

$$\text{Airways, } \frac{1}{X_2^2} = \frac{s_2}{a_2^3} = \frac{180,000}{80^3} = \frac{180,000}{512,000} = \frac{45}{128} = .3515, \text{ nearly}$$

$$\frac{1}{X_1^2} + \frac{1}{X_2^2} = .4313$$

Substituting in the formula given the values for p and $\frac{1}{X_1^2} + \frac{1}{X_2^2}$ and solving, with respect to Q , for the quantity of air a furnace can circulate in this mine,

$$40.2 = .00000002 \times Q^2 \times .4313 = .000000008626 Q^2,$$

Then, $Q = \sqrt{\frac{40.2}{.000000008626}} = \sqrt{4,660,329,237} = 68,300$ cu. ft. per min. Ans.

(c) The power on the air in this circulation or the power of the furnace in this case is then,

$$h = \frac{Qp}{33,000} = \frac{68,300 \times 40.2}{33,000} = 83.2 \text{ H. P. Ans.}$$

41. Temperature of the Air in Furnace Ventilation.—Aside from the effect produced on the density of the upcast column by the presence of mine gases in the

upcast air, the densities of both the upcast and downcast columns are determined by their average temperatures. The average temperature of the downcast column will seldom vary to any extent from that of the outside air. The average temperature of the upcast or furnace column is usually estimated as equal to one-half the sum of the temperatures at the bottom and at the top of the furnace shaft, respectively.

Theoretically, the temperature of the air-current passing over a mine furnace is determined by the weight and heating value of the coal burned per hour, and the weight and specific heat of the air passing over the furnace in the same period of time. There is, however, a practical limit to the rise of temperature that can be imparted to the air in its passage over the furnace, owing to the increased velocity of the air-current as its temperature rises and the depth of the furnace shaft increases. Owing to the greater cooling surface of deep shafts and the generally higher velocity of the upcast current, the average temperature of the column of air above a furnace will generally be lower for a deep shaft than for a shallow one; this, however, is not an absolute rule, as much depends on the quantity of coal burned per hour and the mine resistance, which determines the quantity of air in circulation for any given air column.

The unit of ventilating pressure that a mine furnace can produce may be expressed by the formula,

$$p = \frac{D}{30 \sqrt[4]{400}}$$

EXAMPLE.—(a) Calculate the approximate pressure that a furnace can produce under average conditions, at a depth of 300 feet below the surface. (b) Find the approximate pressure due to a furnace at a depth of 600 feet.

SOLUTION.—(a) Substituting in the formula, the approximate pressure at a depth of 300 ft. is

$$p = \frac{300}{30 \sqrt[4]{400}} = \frac{10}{\sqrt[4]{75}} = 10.59 \text{ lb. per sq. ft. Ans.}$$

(*b*) Substituting the given values in the same formula, the pressure due to a furnace at a depth of 600 feet below the surface is

$$p = \frac{600}{30 \sqrt[4]{\frac{600}{400}}} = \frac{20}{\sqrt[4]{1.5}} = 18.44 \text{ lb. per sq. ft. Ans.}$$

42. Coal Burned Per Hour.—Under the ordinary conditions in furnace ventilation a rise of temperature varying from 300° F. to 500° F. is produced in the air passing over the furnace. The weight of coal necessary to be burned per hour to produce the required rise of temperature in the air-current will depend on the heating value of the coal and the weight and specific heat of the air to be heated in that time. The weight of air in circulation multiplied by its specific heat will give the total heat required each minute to produce a rise of 1° in the temperature of the air-current. The heat required per hour to raise the temperature *t* degrees F. is then expressed by the formula,

$$\Delta = 60t(Qw\phi) \quad (1)$$

in which Δ = total heat required, in British thermal units per hour;

t = the rise in temperature of the air current in degrees F.

Q = quantity of air in circulation, in cubic feet per minute;

w = weight of air before reaching furnace, in pounds per cubic foot;

ϕ = specific heat of air-current, in British thermal units.

The total heat required as given by the formula divided by the heating value of the coal will give the weight of coal required in pounds per hour.

Assuming an average value of 12,000 British thermal units for the heating value of the coal, and an average rise of temperature demanded of the furnace of 400° F., and ignoring the effect of moisture and gases present in the upcast current, which would alter to some extent the specific heat of the upcast air, the weight of coal required in an

average mine furnace is given approximately by the following formula:

$$C = 36 Q_m \quad (2)$$

in which C = weight of coal burned, in pounds per hour;

Q_m = number of thousands of cubic feet of air in circulation per minute.

That is to say, under ordinary conditions a mine furnace will require 36 pounds of coal per hour for each 1,000 cubic feet of air in circulation. The following examples will serve to show the use of formulas 1 and 2:

EXAMPLE 1.—Find the weight of coal necessary to be burned per hour to produce a rise of temperature of 400° F. in an air-current of 100,000 cubic feet of air per minute, assuming the weight of the air before reaching the furnace is .0766 pound per cubic foot, and the specific heat of the air .2374, the heating value of the coal being 13,000 British thermal units per pound.

SOLUTION.—Substituting the given values in formula 1 and dividing by the heating value of this coal, letting C equal the required weight of coal,

$$C = \frac{60 \times 400(100,000 \times .0766 \times .2374)}{13,000} = 3,357.2 \text{ lb. per hr. Ans.}$$

EXAMPLE 2.—What weight of coal will be required per hour under ordinary average conditions to produce a circulation of 40,000 cubic feet of air per minute?

SOLUTION.—Substituting the given value for Q_m in formula 2, the required weight of coal in this case is

$$C = 36 \times 40 = 1,440 \text{ lb. per hr. Ans.}$$

43. Area of Fire-Grate Surface.—When the quantity of air is known or has been determined, as previously explained, the weight of coal that must be burned per hour to cause a rise in temperature in the air-current of, say, 400° F. is first found by formula 1 of Art. 42. The area of fire-grate surface required to burn this weight of coal per hour will depend chiefly on the character of the coal and is obtained by dividing the weight of coal burned per hour by the amount of coal consumed per hour on each square foot of grate surface of an ordinary furnace when the draft is about the same as that produced by the shaft above a mine furnace. Approximately, for rough calculation, 15 to

25 pounds of coal may be assumed as being burned per hour on each square foot of grate surface.

44. The fire-grate surface required may also be found by the following formula for each horsepower of the furnace:

$$s = \frac{34}{\sqrt{D}}$$

in which D = depth of furnace shaft, in feet;

, 34 = a constant number proved by many experiments;

s = square feet of fire-grate surface required per horsepower of the ventilation.

EXAMPLE 1.—The depth of the shaft is 400 feet, and the horsepower required in the ventilation is 37.8; what area of fire-grate is required?

SOLUTION.—By applying the formula, $s = \frac{34}{\sqrt{400}} = 1.7$ sq. ft. of fire-grate surface required per horsepower. Since 37.8 H. P. is required, the fire-grate surface should be $37.8 \times 1.7 = 64.26$ sq. ft. Ans.

If the bars of the fire-grate are 5 feet long, the breadth of the furnace, in feet, will in this case be equal to $\frac{64.26}{5} = 12.85$ feet.

EXAMPLE 2.—Let a furnace shaft be 900 feet deep, and the ventilating current be equal to 200,000 cubic feet per minute, with a mine resistance equal to 2 inches of water gauge; what must be the breadth of the furnace when the length of the fire-bars is taken at 5 feet?

SOLUTION.—The horsepower required is found by the formula $h = \frac{Qp}{33,000}$; hence, $h = \frac{200,000 \times 2 \times 5.2}{33,000} = 63$ H. P. The fire-grate surface per horsepower, by use of formula for grate area is found to equal $\frac{34}{\sqrt{900}} = 1.133$ sq. ft.; and, therefore, the square feet of fire-grate surface required are equal to $63 \times 1.133 = 71.379$ sq. ft.; and, if the length of the fire-bars be taken at 5 ft., the breadth of the furnace is equal to $71.379 \div 5 = 14.28$ ft. Ans.

An examination of the two examples will show that, notwithstanding the fact that the horsepower required in the latter case is so much greater than in the former, yet the

grate area is very little increased, owing to the greater depth of the shaft.

45. Effect of Furnace Stack.—It is customary to erect a rough board stack above the mouth of a furnace shaft; this stack is not usually over 20 feet in height, as its main object is to protect the mouth of the shaft and prevent persons or animals from falling into the shaft, but at the same time the smoke of the furnace is carried above the surface and a better draft is thereby afforded. Sometimes a substantial stack of considerable height is erected. In any case, the erection of a stack over the furnace shaft has the effect of increasing the depth of the shaft and the height of the furnace column. For the same average temperature of the furnace shaft, the motive column and the pressure are increased in the ratio of the height of this column, and the quantity is increased as the square root of this ratio.

Calling the depth of the shaft D and the height of the furnace stack S , the ratio between the quantity of air Q_1 in circulation without the stack and the increased quantity of air after the erection of the stack Q_2 is

$$\frac{Q_2}{Q_1} = \sqrt{\frac{D+S}{D}}$$

Hence, for the increased quantity of air due to the erection of a furnace stack,

$$Q_2 = Q_1 \sqrt{\frac{D+S}{D}}$$

EXAMPLE.—The circulation due to a furnace in a certain mine is 20,000 cubic feet of air per minute; how much will this circulation be increased by the erection of a stack 21 feet high, the depth of the furnace shaft being 100 feet?

SOLUTION.—The increased circulation after the erection of the stack in this case will be

$$Q_2 = 20,000 \sqrt{\frac{100+21}{100}} = 20,000 \times \frac{11}{10} = 22,000 \text{ cu. ft. per min.}$$

The increase due to the stack is, therefore, $22,000 - 20,000 = 2,000$ cu. ft. **Ans.**

EXAMPLES FOR PRACTICE

1. What grate surface will be required to produce a current of 75,000 cubic feet per minute, assuming a fuel consumption of 25 pounds of coal per hour per square foot of grate? **Ans. 108 sq. ft.**

2. What width of furnace will be required to produce a current of 40,000 cubic feet per minute, taking the fuel consumption as 20 pounds of coal per hour per square foot of grate; the grate bars of the furnace are 6 feet long? **Ans. 12 ft.**



MINE VENTILATION

(PART 3)

MECHANICAL VENTILATION

INTRODUCTION

1. The subject of **mechanical ventilation** embraces all systems of ventilation in which the circulation of air is produced by means of some mechanical device. Some of the primitive and now almost obsolete mechanical methods of producing ventilation, as the waterfall and the wind cowl, are so simple that they are often included under the head of natural ventilation.

2. **Waterfall, or Trompe.**—The falling of water down a properly arranged vertical shaft is capable of producing a considerable current of air in the mine below. The adoption of this means of ventilation, however, depends on an abundant water supply and natural conditions of mine drainage such as are afforded by a drainage tunnel, or other means of readily and cheaply disposing of the water at the foot of the shaft. Without these features, the waterfall cannot be permanently adopted, but it may be used for producing temporary ventilation in case of emergency. On account of the burning of a large breaker and the destruction of the ventilating fans at the Pancoast Colliery, near Scranton, Pennsylvania, the expedient was successfully adopted of turning a stream of water

Copyrighted by International Textbook Company. Entered at Stationers' Hall, London

down one of the shafts for the purpose of temporarily driving back the mine gases so as to afford protection for the men while fighting the fire at the bottom of the main shaft, beneath the burning breaker. When sinking a shaft, a small amount of water may be poured down the shaft to clear away the smoke after a blast.

The trompe shown in Fig. 1 is still used in some metal-mining districts and consists of a vertical space, or compartment, in the shaft, in which inclined shelves *a* are arranged,

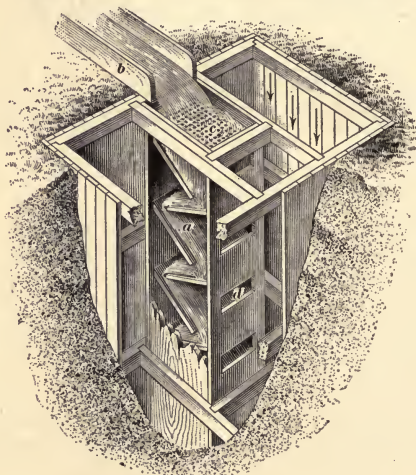

FIG. 1

over which the water pours from a trough or ditch *b*. A perforated plate *c* is placed at the top to break up the solid stream of water into numerous small streams better calculated to entrap the air in falling down the shaft. Openings *d* are arranged in the sides of the compartment for the admission of air, which is carried down the shaft by the falling water. The water drops into a basin or sump at the bottom of the shaft, while the air is thrown out into an air drift leading to the mine airways.

3. Instead of the trompe just described, a *brush mat* is sometimes arranged at the top of the shaft to receive the stream of water, which filters through it and is broken into numerous small streams of water that drip down the shaft. This method is not used to any extent at the present time and is only suggestive of means that might be adopted temporarily or in an emergency that has destroyed the ventilators at a mine.

4. The *wind cowl* is any contrivance in the form of a sail or other means of deflecting the natural surface winds into the mine airways so as to produce a circulation of air through the mine. The arrangement is very primitive and can be used only as a temporary means of ventilation in case of emergency or for the sinking of a shaft or for the ventilation of a very small mine.

5. The *steam jet*, or *blower*, is an appliance used for producing a draft or current by the force of steam escaping from a pipe or nozzle; it gives good results in creating a comparatively small current of air as, for instance, under a boiler, but the application to mine ventilation is limited to the ventilation of a shaft or slope during sinking or to a small shaft or slope mine.

VENTILATING FANS

6. **Classification.**—A ventilating fan is a device for producing a current of air by the rotation of flat or curved blades or paddles attached by arms to a central shaft called the *fan shaft*. Mine ventilating fans are divided into two general classes, depending on the principle of their action. These two classes are *disk*, or *propeller*, fans and *centrifugal fans*. A large number of fans of different makes and styles belonging to each of these two classes are now in operation and giving good satisfaction as mine ventilators. Centrifugal fans are, however, by far the more numerous, particularly for mine ventilators and for supplying large volumes of air.

DISK FANS

7. The distinguishing features of a disk, or propeller, fan, Fig. 2, are the shape and position of the blades *a*, which resemble the arms of an anemometer, or the blades of a propeller. The blades are attached to a central hub *b* on the shaft *c*. This shaft is revolved by a crank or a belt operated by an engine or by an electric motor *d*, as shown. On account of the high speed at which electric motors

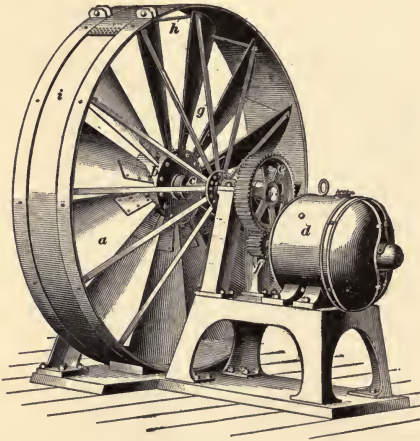

FIG. 2

usually run, it is necessary to use the gears *e* and *f* to give a suitable speed for the fan. The blades are supported from the center by the stay-rods *g* and are connected by the short rods *h*. The casing *i* acts mainly as a protection for the blades. In a windmill or anemometer, the force of the wind acting on the wheel causes it to revolve, but in the disk fan the revolution of the wheel by the fan motor moves the air and produces a current in the airway.

The disk fan has the following advantages and disadvantages: It is easily erected, and the first cost of the fan and

of its erection is small. The air-current may be reversed by simply reversing the direction of the revolution of the fan. It can be run at a high speed by a motor directly connected with the fan shaft. The great disadvantage of the disk fan is that it is not possible with it to give a large volume of air at a high water gauge, or, in other words, when there is considerable mine resistance. Beyond a certain volume of air delivered by the fan at a low water gauge, its capacity is limited, and the volume cannot be largely increased by increasing the speed of the fan as is possible with fans of the centrifugal type.

CENTRIFUGAL FANS

8. General Definitions.—Fig. 3 shows the general arrangement of the simplest form of the centrifugal fan, the fan wheel or the revolving portion only being shown without any casing or support for the wheel. The blades *a* are straight and radial and are made up of flat plates of metal or wood. In large fans these are often joined together by the broad, thin metal plates *b*, or by narrow metal rings. In small fans, there is often no connection between the blades.

Two fan circles are shown; the inner circle *ccc* is the circumference of the intake opening and is sometimes called the *intake circle*; the outer circle *ddd* is the circumference of the fan. The *diameter* of the fan, sometimes also called the *outer diameter*, is the diameter of the outer circle; the *inner diameter* of the fan is the diameter of the inner, or intake, circle. Likewise, the outer and inner radii of the fan are the radii of the outer and inner circles, respectively. The *depth*, or, as it is sometimes called, the *length*, of the fan blades, is the difference between the outer and inner radii or the radial distance *ef* between the two fan circles.

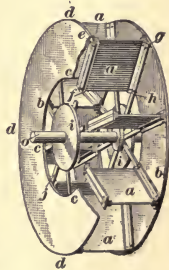

FIG. 3

The width of a blade *eg* is the width of the fan. The outside line *eg* is the tip of the blade and the inside line *fh*

is the lip of the blade. The *throat* of the fan is the cylindrical surface described by the lip of the blade or the line fh when the fan is revolved.

Commonly, the outer diameter and the width are the distinguishing dimensions of a centrifugal fan, but the diameter of the intake circle should also be mentioned, or the depth of the blade. The description of a fan should also state, besides the number of blades, their position with respect to a radial line and whether they are straight or curved, and if curved give an outline of the curvature.

Centrifugal fans may be divided into two general classes—*open-running fans* and *closed-running fans*—differing in the manner in which the air is discharged from the fan. **Open-running fans** have no casing surrounding the circumference of the fan, the air being discharged from the fan at once into the atmosphere, all around the circumference. In **closed-running fans**, the air is discharged from the fan, at its circumference, into an enclosed air space or passage that surrounds the circumference of the fan, often called the *spiral passage* or *spiral conduit*, by which it is conducted either into the fan drift leading to the mine, or into a chimney opening to the atmosphere.

Centrifugal fans also differ essentially from each other in the following points: the shape and number of the blades; the curvature of the blades; the position of the blades with respect to a radial line; the expansion of the spiral casing surrounding closed-running fans; the expansion of the chimney; the style of cut-off; and the general proportions of the fan. Each of these features contributes its share to increase or decrease the general efficiency of the fan as a ventilating motor and will be treated separately.

9. Principle of Action of the Centrifugal Fan.—The principle on which a centrifugal fan acts is as follows: The air contained between the fan blades has a certain weight and when the fan is revolved a certain force is developed, called a *centrifugal force*, that acts on each particle of the air in revolution and tends to throw it outwards or away

from the fan shaft and toward the circumference. The air within the fan being free to move in a radial direction, when acted on by this force, moves outwards, or toward the circumference of the fan. This movement of the air outwards in a radial direction causes an area of depression, or partial vacuum, within the fan, and the outside air under the influence of the atmospheric pressure at once flows into this area of depression. The air enters the fan at the center and flows toward the circumference, where it is discharged. This action is continuous and causes an uninterrupted flow of air into and through the fan as long as the fan is revolved. A centrifugal fan thus produces motion, or velocity, in the air within and surrounding the fan. If resistance to the flow of the air is present at the intake opening of the fan, a depression or fall of pressure below the atmospheric pressure is caused at that point; but if the resistance is present at the discharge opening of the fan, a compression of the air is caused at that point, and a pressure above the atmospheric pressure results. Therefore, in the ventilation of a mine or airway, the fan will create a pressure below the atmospheric pressure when the *intake* of the fan is connected with the mine or airway, but when the *discharge* opening of the fan is connected with the mine or airway a pressure above the atmospheric pressure is produced. In the former case, the fan is called an *exhaust fan*; in the latter case, a *force fan*, *blower fan*, or *blow-down fan*.

DETAILS OF CONSTRUCTION

10. Support of Fan Blades.—The stability of a fan depends largely on the manner of connecting the fan wheel with the central shaft by which it is rotated. A common form of support consists of two cast-iron rings *i*, Fig. 3, called *spiders*, that vary in diameter according to the size of the fan. These spiders are fitted closely to the fan shaft *o*, to which they are keyed at a distance apart corresponding to about the width of the fan. The radial arms *j*, to which the fan blades are attached, are firmly bolted to

these spiders. While this construction gives a firm support to the blades, the spiders and radial arms in this position offer an unnecessary obstruction to the air entering the fan,

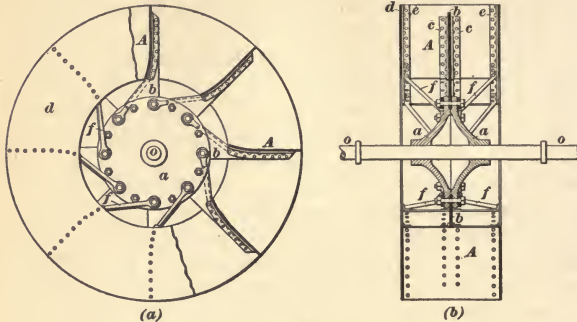

FIG. 4

and they reduce the intake area. A better form of construction, and one that has been largely adopted since its introduction, is shown in Figs. 4 and 5.

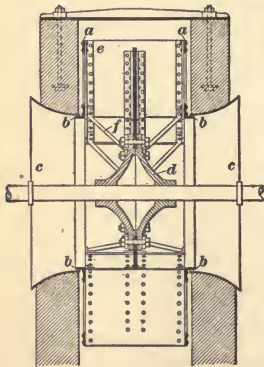

FIG. 5

castings *a, a*. In this construction, there is but one radial arm for each blade and each arm is firmly riveted to the center of a blade *A* by means of angle irons *c*. The sides

of the fan, giving a greater efficiency at less cost. Instead of the two spiders set apart, one on each side of the fan as in Fig. 3, two conical castings *a*, Fig. 4, are set back to back at the center of the fan shaft *oo*, to which they are keyed. The radial arms *b* are of boiler-plate steel, and are broadened at the base where they fit into and are firmly bolted between the two

of the blades are supported either by an annular ring of steel plate *d* whose width is equal to the depth of the fan blades, as shown in Fig. 4, or by means of two narrow rings *a, a*, Fig. 5, set into the blade so as to be flush with the side edge. The construction shown in Fig. 4 would also be used in an open-running fan, the sides of the fan wheel in this case taking the place of the fan casing. In a closed-running fan, however, this would be a waste of material. Angle irons *e* are used to stiffen the sides of the blades, in either case, and to the inner ends of these angle irons one end of the sway-braces *f* is riveted. The other end of the braces *f* is bolted to the central casting *a* and by means of these braces the whole system of blades is tied together and stiffened so as to prevent any side motion or swaying of the blades. Instead of a plain ring at the lip of the blade, an angle iron *b*, Fig. 5, is sometimes used, one arm of which projects beyond the edge of the fan casing so as to form a collar that fits into the intake opening. This completely closes the space at each side of the fan at this point and overcomes the tendency of the air to escape and cause eddies. In order that the air may enter into the intake opening regularly and evenly from all directions, a conchoidal ring is sometimes used as shown at *c*, Fig. 5, the depth of this ring varying from 12 to 18 inches, according to the size of the fan.

11. The Fan Casing or Housing.—Except in open-running fans that discharge their air into the atmosphere all around the circumference, it is necessary to encase the entire fan so as to conduct the air discharged from the fan into the fan drift or by a special passage into an expanding chimney from which it escapes into the atmosphere. The casing surrounding the fan is called the **fan housing**. An open-running fan only requires a sufficient housing to carry the air from the fan drift leading from the mine to each side of the center of the fan.

In a closed-running fan, the fan wheel is enclosed in a special casing or housing. The fan casing consists of two

flat sides with central openings corresponding to the intake openings of the fan, the outer line of the casing taking the form of the spiral so as to provide a gradually expanding air passage surrounding the circumference of the fan. Fig. 6 gives the general outline of the fan wheel and the spiral casing, together with the expanding chimney into which the fan discharges its air when exhausting. The center of the fan wheel is at o ; aa is the inner and bb the outer fan circle, the heavy lines ab being the fan blades. The outer line of the casing of the fan, starting from the point c where it is tangent to the inner vertical line cd of the chimney, follows the circumference of the fan wheel as far as the point e , the portion ce being the arc of a circle

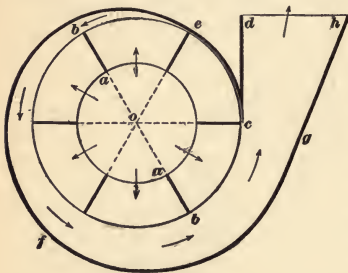

FIG. 6

having a length equal to at least the distance between two consecutive blade tips. From the point e , the casing expands uniformly, forming the spiral efg around the circumference of the fan, and becoming tangent to the outer line gh of the chimney at a point g .

The point c is called the *point of cut-off*, because at this point the air passing between the blades of the fan is cut off from passing up the chimney. The portion of the fan casing ce being the arc of a circle, fits closely to the outer fan circle, and there is but about 1 inch of clearance between them. The purpose of this is to cut off any connection between the spiral space surrounding the fan and the chimney, at this point, thus compelling all the air entering the spiral from the fan to flow around the fan in the direction in which the blades revolve. This causes a uniform flow of the air around the fan and prevents the formation of eddies. When the casing is thus parallel to the periphery of the wheel for a distance ce , there is no air passing through the first

compartment ce of the fan, as this is for a moment practically closed by the casing.

From e , the fan casing should expand uniformly around the fan so that the sectional area of the spiral passage will increase uniformly with the number of compartments discharging into it, and the velocity of the air at all points of the casing will then be the same. The velocity of the air in the spiral passage at the point of cut-off is, therefore, equal to the total quantity of air passing through the fan divided by the sectional area of the passage at that point. The sectional area at the point of cut-off is equal to the width of the fan multiplied by the distance cg from the point of cut-off perpendicular to the outer side of the spiral.

12. The method of laying out the fan spiral is as follows: For a blower fan, locate the center T , Fig. 7, of the fan with respect to the shaft or fan drift through which the air is to be drawn so that the spiral passage of the fan may be expanded easily to connect with the line of this shaft or drift. With an exhaust fan, the spiral is not connected with the mine opening

and is not therefore dependent on it. Using the point so taken as a center, describe the inner and outer fan circles with radii Ta and Tb . Next, select for the point of cut-off c that point of the outer fan circle where the tangent to the circle will make the best connection with the chimney for an exhaust fan or with the fan drift or shaft curbing for a blower fan. From the point of cut-off, the fan casing follows the arc of a circle for a distance at least equal to the distance between two consecutive blade tips of the fan; i. e., from c to e . The spiral is then started at this point e of the circumference of the fan and is laid out by means of a wire or string s wound about a small

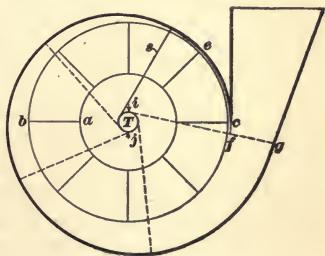

FIG. 7

chimney for an exhaust fan or with the fan drift or shaft curbing for a blower fan. From the point of cut-off, the fan casing follows the arc of a circle for a distance at least equal to the distance between two consecutive blade tips of the fan; i. e., from c to e . The spiral is then started at this point e of the circumference of the fan and is laid out by means of a wire or string s wound about a small

circular wooden templet or disk T securely fixed at the center of the fan so that the disk or templet cannot revolve. The diameter of the templet must be such that the unwinding of the string as the spiral is described will produce the required expansion at the point of cut-off. If the spiral is started at a distance from the point of cut-off equal to one-fifth of the circumference of the fan, the diameter of the small templet should be about three-eighths of the expansion of the casing at the end of the spiral g nearly opposite the point of cut-off; that is, in Fig. 7, ij is three-eighths of fg . The diameter of the templet must be determined for each fan by trial. Having described the fan circles and the spiral as far as the point g opposite the point of cut-off, this point is connected by an easy curve or tangent with the line of the fan drift or shaft curbing for a blower fan; and when an exhaust fan and chimney are used, the tangents to the fan circle at the point of cut-off and to the spiral are extended to form the sides of the expanding chimney. Sometimes, the expansion of the chimney is increased by starting the tangent to the spiral before the point of cut-off is reached. This gives a wider and naturally a shorter chimney than where the tangent is started at a point opposite the point of cut-off.

13. The **fan chimney** is a simple chimney expanding as shown in Fig. 6. The width of the chimney perpendicular to the plane of revolution is generally constant and corresponds with the width of the fan casing, the expansion being produced in a direction corresponding to the plane of revolution of the fan. This chimney is sometimes called the *évasé chimney*. The purpose of the expanding chimney is to reduce the velocity of the air after passing through the fan, so that it is discharged into the atmosphere at a low velocity. The inner wall cd of the chimney, which is tangent to the circumference of the fan at c , is preferably made vertical, the expansion being produced entirely by the inclination of the outer wall gh . When the inner wall of the chimney is inclined toward the fan and the outer wall made vertical, there is a

decided tendency of the air-current to strike against the outer wall and be deflected to such an extent as to produce eddies, thus decreasing the efficiency of the chimney. The lower end of the chimney is sometimes called the *throat* of the chimney, but must not be confused with the throat of the fan.

14. Fan Shutter.—The shutter of a fan is a sliding door or shutter *a*, Fig. 8, so arranged as to slide up and down the back face of the fan chimney and by means of it the point of cut-off may be shifted farther up or down the chimney, thereby increasing or decreasing the area for the discharge of air from the fan. The shutter is supported by the

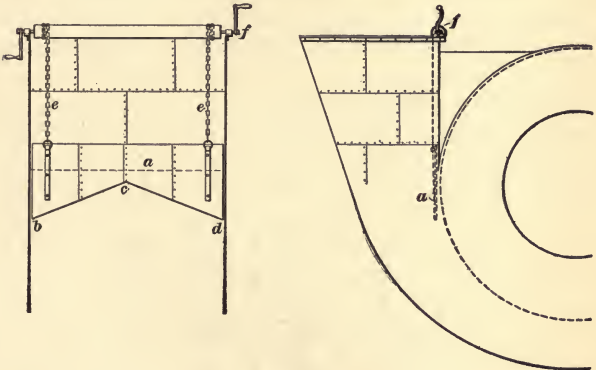

FIG. 8

chains *e* attached to a windlass *f* by which it is raised and lowered. The purpose of the shutter is to reduce the vibrations set up in the fan and which are often due to lack of proper proportionment of the different parts of the fan. Another cause of vibration is the striking of the air-current against abrupt angles or surfaces, by which means eddies are established in the current. At times, the cause of vibration in the fan lies wholly outside of the fan itself, these vibrations being transmitted from the point of disturbance through the air to the plates of the fan, which are sensitive to vibration. Vibration is often caused by the rapidly succeeding blows

produced on the air when the blade tips of the fan pass an abrupt cut-off.

Vibration may be prevented in great part by the use of the **V**-shaped cut-off, as shown by the lower edge *bcd* of the shutter in Fig. 8, so that the air is cut off gradually instead of instantly when the fan blades pass this point. The apex of the **V** should be at the center *c* of the cut-off plate or shutter, and the **V** should point in the direction in which the fan revolves. What is called the *Walker shutter* is a movable plate, or shutter, having the cut-off edge of the shutter in the shape of a **V**, as shown in the figure. The use of the shutter for the purpose of stopping vibration in a fan is fast becoming obsolete, owing to the greater care taken in fan design, and because the use of a shutter may decrease the discharge of the fan.

15. Fan Pit and Foundation.—In order to reduce the height of the fan above the surface of the ground and to increase its stability, a part of the wheel revolves in a pit *a*, Fig. 9, called the **fan pit**. This pit is walled in with brick

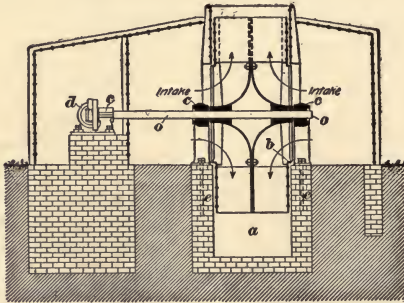
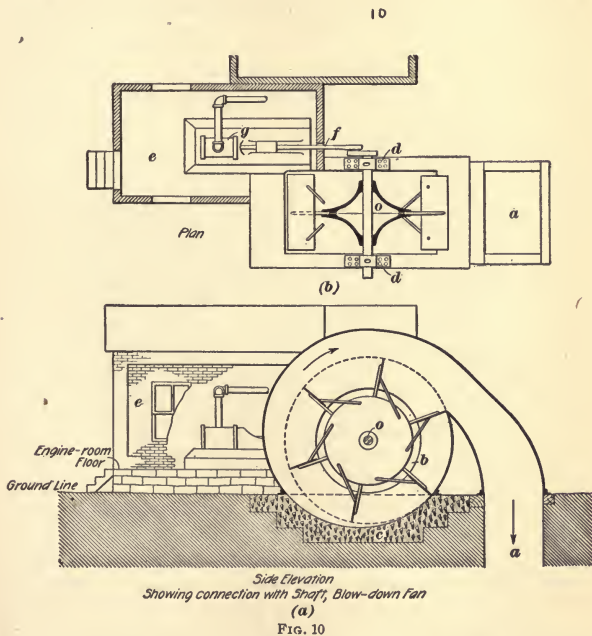

FIG. 9

as shown in Fig. 9, or with concrete, as shown in Fig. 10, and these walls also generally form the foundation for the fan-shaft journals *c* and the fan casing. The depth of the pit is such that the lowest point *b*, Fig. 9, of the intake circle is about level with the ground. From 4 to 6 inches of rock ballast is often

first laid in the bottom of the excavation for the pit and leveled; this is covered with a bed of concrete or brick. The floor and walls of this pit, when it is completed, form a section of the lower portion of the fan casing, and must be made smooth and flush with the fan casing built over this foundation. The foundation walls may be carried above the ground as high as the center of the fan, and the journals or bearings



for the fan shaft can then be set directly on a solid foundation, or the journals may rest on pedestals as illustrated in Fig. 9. Anchor bolts *e* are built into the foundation walls to hold the journal-boxes in place.

The fan shaft *o* must be of sufficient length to afford good bearings on each side of the fan and with large fans these

bearings are often water-jacketed to prevent the overheating of the journals. When the fan is built to exhaust, in order that the engine *d* may not be too close to the fan intake and thus interfere with the entry of air into the fan, three journals are required, one on each side of the fan pit and one outside of the fan drift next to the engine. Every precaution must be taken to prevent the settlement of the foundation on which the journals rest, as a slight settlement of one of the bearings may break a fan shaft or result in other serious injury to the fan.

16. Connection of Fan With Mine Opening.—The position of the fan with respect to the mine opening and its connection with the opening depend on the kind of mine opening, on the type of fan, and on the local arrangements about the opening. The fan should, of course, be placed so that it will not interfere with the arrangements for hoisting and hauling. The intake opening of a mine should be located so that air entering the mine may be as pure and free from dust as practicable.

Fig. 10 shows an arrangement for a blower fan connected to a mine shaft *a*; (*a*) is the elevation, and (*b*) the plan. A similar arrangement could also be adapted to a drift opening. The foundation *c* for the fan in this case is of concrete and the lower part of the foundation is shown stepped to save material. The foundations are represented as carried up only to the ground line, and this necessitates supporting the journals of the fan shaft *o* on heavy iron pedestals *d* with broad bases securely bolted to the foundation walls. The steel housing of the fan is also set on this foundation and firmly bolted by means of anchor bolts. The engine house *e* joins the fan casing at the corner, and an opening *f* is left in the end of the engine house for the passage of the connecting-rod of the engine. This is necessary in order not to obstruct the intake opening on this side of the fan, and to enable the air to be drawn from the outside atmosphere into the fan through both of the intake openings. As shown in the plan, the fan is direct-connected to the engine *g*. The

center of the fan is set back a short distance only from the side of the shaft *a* and in line with the center of the shaft.

Fig. 11 shows an exterior of a blower fan and engine house similar to that shown in Fig. 10, but seen from the other side. The casing or fan house *a*, is made of boiler plate steel strengthened by angle irons *b*.

The arrangement illustrated in Figs. 10 and 11 is not well adapted to a gaseous mine, as the air-current cannot be quickly reversed when such a change is required.

17. Reversing the Air-Current.—It is always advisable to arrange the ventilator of a large mine, and especially

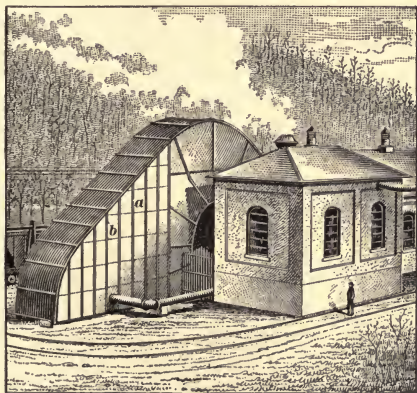

FIG. 11

a gaseous one, so that the air-current can be reversed promptly in case of emergency. In the mine, the reversal of the current will of course tend to open all the doors to a greater or less extent, depending on the force of the current, and this will prevent a very large proportion of the air from circulating through the mine. It is, however, often necessary to produce this change in the direction of the air-current in order to permit rescue parties to enter the mine in case of accident, and to drive back the gases that would otherwise be forced into the workings and suffocate or otherwise

endanger the workmen before they could make their escape. The ventilation of every large and gaseous mine should be carefully arranged with respect to such an emergency, and escape ways provided and kept open by which the men can be got out of the mine.

The action of the fan is the same before and after reversing the current. The air still enters the fan at the center and is discharged at the circumference. When the fan is blowing or forcing air into the mine, the intake openings of the fan must be open to the atmosphere and the discharge of the fan must then be connected with the fan drift or shaft leading to the mine. Doors are provided, however, by which this order may be reversed so that the intake openings of the fan may be connected with the fan drift or shaft leading from the mine, while the discharge is then closed to the mine and opened to the atmosphere. This changes the fan from a blowing, or forcing, fan into an exhaust fan. Such an arrangement is shown by Fig. 12.

In the arrangement shown in Fig. 12, the center of the fan is set some distance back from the shaft so as to afford room for the doors *ab* and *de* used in reversing the air-current. The section of the fan shown does not give the structural details, but is merely diagrammatic. The center line of the fan is placed on line with the center of the shaft. Two side drifts *f* are provided, connecting the intake opening at each side of the fan with the main fan drift *g*, at a short distance from the side of the shaft. At the junction of the main and side air drifts, *shunting doors* are arranged as shown in the plan, Fig. 12 (*a*). These doors are for the purpose of connecting the side drifts with the atmosphere or with the main drift leading to the shaft and the mine, as may be desired. The full lines *ab* and *de* show the position of the doors when the side drifts and intake openings of the fan are connected with the main drift, and the fan is running as an exhaust. The dotted lines *ac* and *db* show the position of these doors when the side drifts and intake openings are connected with the atmosphere. In this position of the doors, the main drift *g* is open to the spiral passage, which

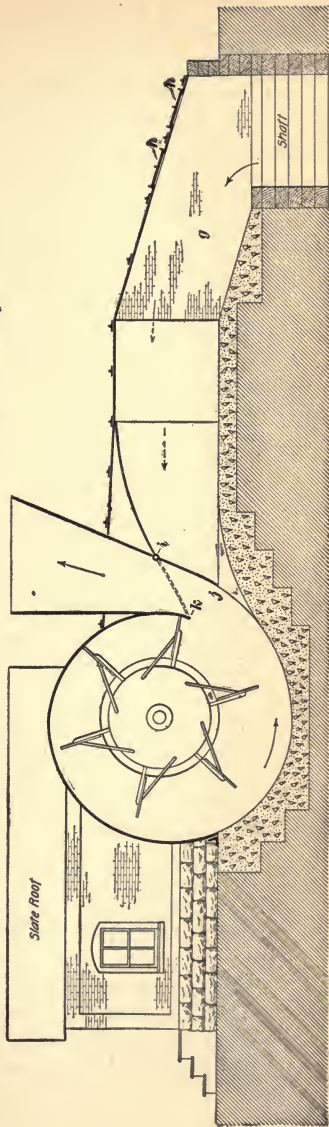
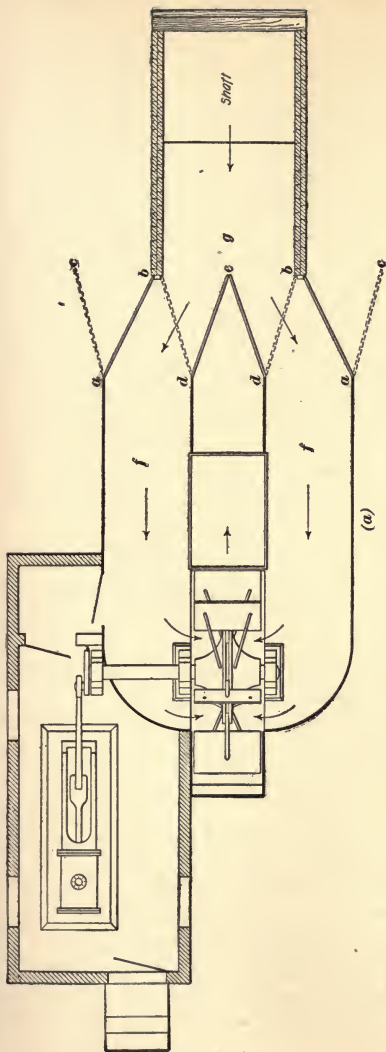

is the discharge opening of the fan and closed to the intake openings, and the fan is running as a blower. In the figure, the arrows show the direction of the air-current coming from the shaft and passing through the side drifts into the intake openings of the fan, whence it passes radially through the fan and is conducted by the spiral passage to the chimney, where it is discharged into the atmosphere. By this arrangement, the air is exhausted from the mine by the action of the fan.

When the position of the doors is changed to that indicated by the dotted lines ac and db , the air from the outside atmosphere will enter the intake openings of the fan, and after passing through the fan will be conducted by the spiral passage to the main drift g and thence forced into the mine. In order to deflect the air passing through the spiral passage and cause it to enter the main drift and shaft instead of passing out through the chimney, a second door ij is arranged near the foot of the chimney, and this is swung into the position indicated by the dotted line ik , the point k being the point of cut-off where the outer fan casing starts. By means of this door, the spiral passage of the fan may be connected either with the chimney or with the main drift g .

18. Explosion doors should be provided in the fan drift as shown at h . These doors are so heavy that they cannot be opened by the ordinary pressure of the air in the fan drift, but in case of an explosion they will be blown open and the greater part of the pressure of the explosion thus taken off the fan.

To prevent accidents, it is provided by law in many states that the ventilating fan must be run continuously night and day unless the mine suspends operations indefinitely. It cannot be stopped or the direction of the current reversed without the permission of the superintendent or manager of the mine and due notice of any stopping of the fan must be posted conspicuously at the mine opening giving the hours when the fan will be stopped.

TYPES OF CENTRIFUGAL FANS

19. The most prominent types of fans in use at the present time are the *Nasmyth*, *Guibal*, *Waddle*, *Schiele*, and *Capell*. These types embody practically all the essential features of fan construction, but there are numerous modifications and combinations of the general types. Numbers of fans, such as the *Combes*, *Biram*, and *Rittinger*, have been designed embodying features that have since been proved to be valueless. The failure of most of these types of fans was due to features that reduced the strength of the centrifugal force developed in the fan, as, for example, improper curvature of the fan blades, or the too great expansion of the fan casing, while in many cases the construction of the fans was too complicated and expensive to render them serviceable for mine work. Only such types of fans will be here described as are in common use and which will illustrate the leading features of centrifugal fans.

20. **Nasmyth Fan.**—The general arrangement of the **Nasmyth fan wheel** has been shown in Fig. 3. This fan is probably the earliest type of centrifugal fan as it is the simplest. It is open-running and discharges its air into the atmosphere all around the circumference. No provision is made to reduce the shock given to the entering air by the revolving blades, or to reduce the tendency of the air to produce eddies in passing through the fan. The blades are straight and radial and are supported on a number of radial arms that are firmly attached to central spiders or iron castings *z*, fitted to the fan shaft. Some fans of this type are in use at the present time, the advantage claimed for them being the simplicity of their construction, reduction of first cost and a fair amount of efficiency when operated under low water gauges.

21. **Guibal Fan.**—The first of the early types of centrifugal fans that marked a decided improvement in fan construction and efficiency was the **Guibal**. One of the characteristic features of this fan is the construction of the

frame that supports the fan blades. This frame at each side of the fan consists of a series of bars *a*, Fig. 13, bolted to a spider *b* on the fan shaft and also bolted together so that the outer end of each bar forms a support for the blade, while the inner end of the bar serves as a brace to strengthen another blade. This construction is cheap and effective in furnishing a substantial fan wheel, but the supporting bars, on account of their size and number, and the central spiders obstruct the flow of air through the fan and thus decrease its efficiency. The Guibal fan is encased in a housing that forms a circle that fits closely to the outer circle of the fan wheel for about three-fourths of the circumference of the fan. At this point, the expansion of the casing begins and is made sufficiently rapid to connect with the

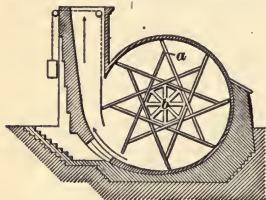

FIG. 13

outer line of the chimney. The Guibal chimney is comparatively tall and narrow, and at its lower end is supplied with a movable or sliding shutter, so that the sectional area at the throat of the chimney can be decreased or increased as desired.

The disadvantage of the close-fitting casing in the original Guibal fan was soon manifested when the work of this fan was compared with that of other types. As a result, there are at the present time improved Guibal fans erected in which the expansion of the casing has been carried farther around the circumference of the fan so as to increase the spiral air passage. This has given an added efficiency to the Guibal fan and the improved fan with spiral casing is capable of giving a good quantity of air against a fairly high water gauge or mine resistance.

It is important to note that the blades of the Guibal fan are straight but not radial; in the general type of this fan, they are inclined at an angle of about 45° with a radius passing through the inner edge or lip of the blade. This position of the blade allows the entering air to slide on to the

blade with less shock than in the straight radial blades of fans of the Nasmyth type, but when the blades are not radial the centrifugal force by means of which the air is thrown out from the fan is greatly reduced.

22. Waddle Fan.—The general form of the Waddle fan is shown in Fig. 14. The blades are curved backwards

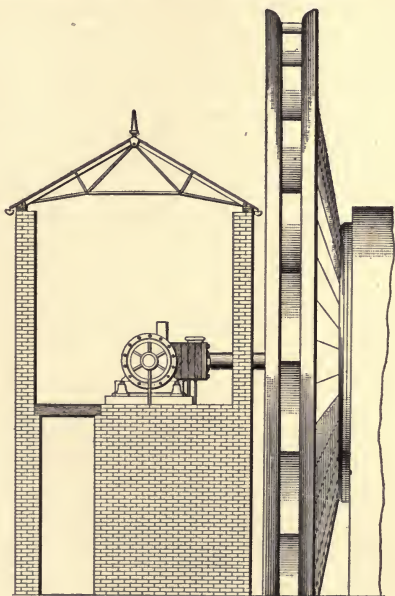

FIG. 14

from the direction of motion and are so tapered toward the circumference as to maintain a uniform sectional area for the passage of the air through the fan. The fan is open-running and there is no casing surrounding it, but the air is discharged at once into the atmosphere all around the circumference of the fan. In order to protect the discharge opening at the circumference of the fan and to reduce to some extent the

velocity of the air discharged into the atmosphere, the sides of the more recent forms of this fan have been extended beyond the blades at the circumference so as to form an expanding flange on each side of the opening.

The construction of the Waddle fan is complicated and expensive. The fan is designed to produce a fair quantity of air against a high water gauge, but gives in general a low efficiency. It receives its air on one side only, but the air is guided into the fan by inclined passages so as to reduce the shock of the revolving blades. In the later forms of the Waddle fan, the intake area is supplied with inclined wings or scoops designed to assist the entry of air into the fan. The fan is commonly built with a large diameter giving a high peripheral speed for a moderate speed of the engine. A diameter of 40 feet is not uncommon and fans of even larger diameter have been used. In common with other open-running fans, there is an almost total absence of vibration in the Waddle fan.

23. Schiele Fan.—The characteristic features of the Schiele fan, Fig. 15, are a spiral casing, curved and

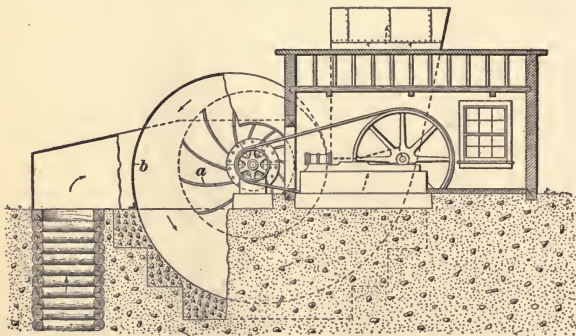

FIG. 15

tapered blades, and a central disk or plate that practically divides the fan at the center into two single intake fans, and

furnishes the necessary support for the fan blades. Like the Waddle fan, the blades *a* are curved backwards from the direction of motion and are tapered toward the circumference, as shown in Fig. 19, Art. 41, so as to produce a uniform section of area for the passage of the air through the fan. Unlike the Waddle fan, however, the Schiele fan is enclosed with a spiral casing *b* that expands rapidly around the circumference in the direction in which the fan revolves. The effect of the spiral casing is almost lost, however, because of its large size. The fan is practically an open-running fan but enclosed in a large space or chamber from which the air is discharged through an expanding chimney into the atmosphere. The fan is practically a double intake fan receiving its air from both sides, but into separate compartments, however. It is run at a high speed and gives a large volume of air, under a low water gauge. The fan is usually driven by a belt and pulley in order to obtain the high speed desired.

24. The Capell fan is one of the more recent types of centrifugal ventilators, and its general arrangement and characteristic features are shown in Fig. 16. It has two sets

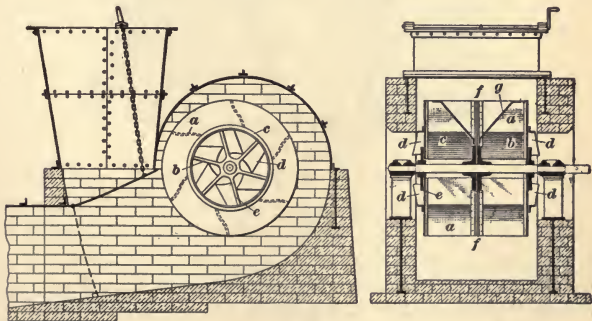

FIG. 16

of wings, one set *a* extending from the circumference of the intake circle to the perimeter of the fan; these are called the *outer wings*, and in exhaust fans are usually made to fall back on a simple curve away from the direction of the rotation;

in a blowing fan, they are usually but not always reversed. Another set of wings *b*, called the *inner wings*, extend from the circumference of the intake toward the center of the fan; these wings are not set parallel to the axis of the fan but at an angle with it, which angle is varied with the conditions under which the fan operates. The wings always, however, lead in the direction of rotation. The two sets of wings *a* and *b* are solidly joined together by the rings *c*. Curved vanes *d*, called *scoops*, are placed at the intake with their leading ends bent in the direction of rotation. These scoops are

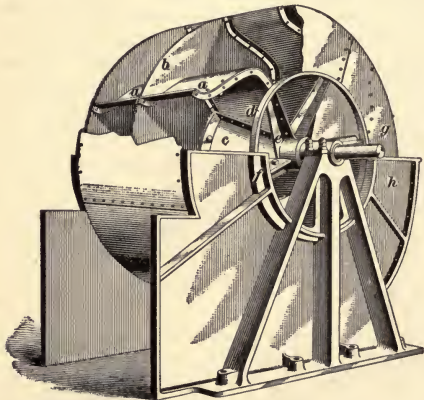

FIG. 17

intended to gather in the air as the fan revolves. They project a few inches outside the body of the fan and are usually made in one piece with the inner plates *b* and are riveted to arms *e* made of angle iron. These arms are bolted to a central hub and to the rings *c*. In the center of the breadth of the fan, there is a steel disk *f*, which is connected to the shaft by means of hubs, as shown. To this disk, stays *g* are bolted, the other end of each stay being riveted to a blade *a* to stay it. In the original Capell fan, the large outer blades *a* were curved well backwards from the direction of rotation and terminated in a tangent to the circumference of

the fan. In the more recent forms of the Capell fan, the shapes of the outer blades have been materially changed so that they terminate normally to the circumference, thus increasing the ability of the fan to give a high water gauge. The fan is usually designed to run at a high speed and is much smaller in diameter than the fans of the Guibal type designed to give an equal volume of air.

25. Robinson Fan.—The Robinson fan, shown in Fig: 17, consists of two sets of curved blades *a* divided by a

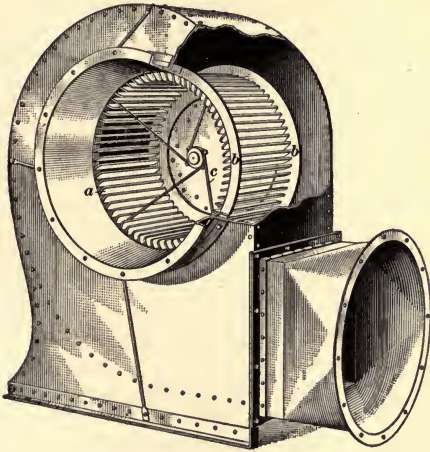

FIG. 18

central disk *b* of sheet iron. This disk is bolted to a cone *c* in the center, which deflects the air entering the fan and thus gradually changes its direction. The rim *d* that encircles the cast-iron spiders *e* revolves just inside of the edges of the housings *f*. The ends of the blades *a* are covered by plates *g* that revolve just inside the housing *h*. This fan is designed to give a large quantity of air at a high water gauge.

26. Sirocco Fan.—The Sirocco fan, Fig. 18, represents a recent revival of some of the early ideas in regard to

centrifugal fans, as illustrated by the Combes and the Biram fans. The Sirocco is a high-speed fan that can hardly be described as a mine fan, although an attempt has been made to introduce it in mine work. This fan consists of a large number of small blades *a* attached to rings *b* that are supported from the center by the rods *c*. The chief objection to this small high-speed fan is, however, the limited extent to which its capacity may be increased.

FAN DESIGN

27. General Considerations.—The ventilation of every mine is a separate problem; and in order to secure the best results, such a plan of ventilation should be adopted in the mine as will make it possible to maintain a mine resistance within certain limits. A ventilator should then be designed and constructed to suit the conditions and the limits of mine resistance adopted for the given mine. To make this clear, it is only necessary to recall the fact that the mine resistance changes rapidly with the development and extension of the workings. The application of a certain horsepower against a given mine resistance will produce a given quantity of air at a certain water gauge or pressure, but the development of the mine by increasing the rubbing surface increases the mine resistance; and unless it is possible to increase at the same time the sectional area of the airways through the mine by splitting the air-current, the quantity of air furnished by a given power will decrease. It is often possible and practicable to maintain the mine resistance within the limits of the power of the ventilator, as every well-designed ventilator is capable of a considerable range in speed without a great loss of efficiency, but beyond these prescribed limits a decrease or increase of speed is had at a large expense of efficiency. When this point is reached in the requirements at the mine, it should be possible to make some change in the circulation of the air through the mine so as to again reduce the mine resistance and perhaps make possible a slower speed of the fan. In certain

cases, it will be found impracticable or impossible to do this, while in other instances a proper system or plan of ventilation adopted when the mine is first opened will make it possible and economical.

In designing a mine fan due regard should be had for the elevation of the proposed ventilator above sea level and the average atmospheric conditions of temperature and moisture under which the work must be performed. The treatment of the subject of the design and construction of mechanical ventilators will be given briefly and only the essential points mentioned, as the detailed design of a mine fan to meet all of these conditions should be attempted only by a competent engineer who has had experience in the work of designing ventilators. The treatment of the subject will be based on experimental data, which is now commonly used in designing mine fans.

28. Size of Intake Opening, Inner Diameter.

When practicable, the fan should always take air from both sides, the prime object being to get the air into the fan with as little loss of power as possible. For a given atmospheric pressure or a given elevation above sea level, a certain centrifugal force produces a certain depression or vacuum within the fan and a certain velocity of the air entering the fan, depending on the resistance affecting the inflow of air into the fan.

Experiment has shown that the best results are obtained when the velocity of the air entering the fan is estimated at from 1,000 to 1,500 feet per minute, 1,200 feet per minute being a good average velocity. This velocity forms the basis for calculating the size of a centrifugal fan. To assume a higher velocity of the entering air would be to contract the intake opening and largely increase the resistance of the fan and decrease its efficiency.

The quantity of air Q entering the fan with this velocity, calling the inner diameter of the fan d , is for a single intake, $Q = 1,200 (.7854 d^2) = 942.48 d^2$; for a double intake, $Q = 1,200 \times 2 (.7854 d^2) = 1,884.96 d^2$, from which the

diameter of the intake opening is obtained by the following formulas:

$$\text{Single intake, } d = .03257 \sqrt{Q} \quad (1)$$

$$\text{Double intake, } d = .023 \sqrt{Q} \quad (2)$$

Thus, for a given style of fan, the size of the intake opening or the inner diameter of the fan depends only on the quantity of air in circulation.

EXAMPLE.—(a) Find the diameter of the central orifice of a single-intake fan designed to furnish 90,000 cubic feet of air per minute. (b) What will be the diameter of the intake of a fan that receives its air from both sides for the same quantity of air in circulation?

SOLUTION.—(a) Substituting the given values in formula 1 for a single-intake fan,

$$d = .03257 \sqrt{90,000} = 9.771, \text{ approximately, } 9 \text{ ft. } 9 \text{ in. Ans.}$$

(b) For a double-intake fan designed to furnish the same quantity of air as in the previous case, substituting the given values in formula 2,

$$d = .023 \sqrt{90,000} = 6.9, \text{ say } 7 \text{ ft. Ans.}$$

29. Breadth of Fan.—The air passing through the intake circles of the fan is deflected through an angle that is approximately a right angle before it passes into the space between the fan blades. This change in the direction of the current causes either a loss of velocity or an absorption of power. If the velocity of the air passing through the throat of the fan were the same as the entering velocity, the area of the throat would be equal to the total intake area, which for double-intake fans is the sum of the areas of the two intake circles. It may be assumed that the loss of velocity due to the deflection of the current does not exceed 20 per cent., which makes the throat velocity of the air eight-tenths of the entering velocity. To allow for this loss of velocity at the throat, the breadth of the fan should be such that the throat area will be increased in the same ratio that the velocity is decreased. Or, the entire intake area is made .8 of the throat area, giving the formulas,

$$\text{Single intake, } .8 b (\pi d) = \left(\frac{\pi}{4} d^2 \right)$$

$$\text{Double intake } .8 b (\pi d) = 2 \left(\frac{\pi}{4} d^2 \right)$$

Or, for the breadth of the fan,

$$\text{Single intake, } b = \frac{5}{16} d \quad (1)$$

$$\text{Double intake, } b = \frac{5}{8} d \quad (2)$$

EXAMPLE.—(a) Find the diameter of the intake opening and the breadth of a fan designed to pass 40,000 cubic feet of air per minute when the air is received on one side of the fan only. (b) Find the same dimensions of a double-intake fan designed to pass the same quantity of air.

SOLUTION.—(a) The diameter of the intake opening is first found by substituting the given values in formula 1 of Art. 28. Thus, $d = .03257\sqrt{40,000} = 6.514$, about 6 ft. 6 in. The width of this fan is found by substituting this value for d in formula 1 of this article. Then,

$$b = \frac{5}{16} \times 6.514 = 2.03, \text{ about 2 ft. Ans.}$$

(b) For a double-intake fan passing the same quantity of air, the diameter of the intake opening and the width of the fan are as follows:
Inner diameter,

$$d = .023\sqrt{Q} = .023\sqrt{40,000} = 4.6, \text{ about 4 ft. } 7\frac{1}{2} \text{ in. Ans.}$$

Width of fan,

$$b = \frac{5}{8} d = \frac{5}{8} \times 4.6 = 2.875, \text{ about 2 ft. } 10\frac{1}{2} \text{ in. Ans.}$$

30. Volume of Fan.—The volume of a fan is the total air space between the fan blades; that is, it is the space occupied by the revolving air. The volume of the fan and the density of the air determine the weight of air revolved by the fan, and the amount of centrifugal force developed.

Let V = volume of fan, in cubic feet;
 D = outer diameter of fan, in feet;
 d = inner diameter of fan, in feet;
 b = breadth of fan, in feet.

Then, for fans having the same width throughout,

$$V = .7854(D^2 - d^2)b$$

EXAMPLE.—What is the volume of a fan whose outer and inner diameters are 24 feet and 12 feet, respectively, the width of the fan being 7 feet 6 inches?

SOLUTION.—Substituting the given values in the formula,

$$V = .7854(D^2 - d^2)b = .7854(24^2 - 12^2)7.5 = 2,544 + \text{cu. ft.}$$

Ans.

If the weight of 1 cubic foot of this air is .0788 pound, the weight of air revolved in the fan under these conditions is $W = 2,544 \times .0787 = 200 + \text{lb.}$

31. Centrifugal Force Developed by Revolution of Fan.—If a fan is revolved, a force is set up that tends to throw the air within the fan radially outwards; this force is known as the **centrifugal force**. It may be calculated by the following formula:

$$F = \frac{W v_g^2}{g R_g} \quad (1)$$

in which F = centrifugal force, in pounds;

W = weight revolved, in pounds;

v_g = velocity of revolved weight W , in feet per second;

g = force of gravity, expressed in feet per second;

R_g = distance of center of gravity of revolved weight from center of revolution, in feet.

In calculating the centrifugal force developed by a fan, the weight of air in each compartment of the fan must be considered. In calculating the centrifugal force produced by the revolution of the fan, the weight of air in each compartment is assumed to be concentrated at a point known as the center of gravity of the air in the compartment, and the velocity of revolution v_g is the velocity at which the center of gravity revolves.

The distance of the center of gravity of the air in each compartment R_g from the center of the fan shaft, assuming a uniform density of the air revolved in the fan, is given by the formula,

$$R_g = \frac{2}{3} \left(\frac{R^2 - r^2}{R^2 - r^2} \right) \quad (2)$$

in which R = radius of outside fan circle, in feet;

r = radius of inside fan circle, in feet.

EXAMPLE.—What centrifugal force is developed by the fan in the example given in Art. 30, if the weight of air revolved is 200 pounds and the fan makes 100 revolutions per minute?

SOLUTION.—According to formula 2, the center of gravity would be $\frac{2}{3} \left(\frac{12^2 - 6^2}{12^2 - 6^2} \right) = \frac{2}{3} \left(\frac{1,512}{108} \right) = 9.3+$ ft. from the center of the fan shaft. For each revolution of the fan, the center of gravity would pass over $3.1416 \times 18.6 = 58.43$ ft. If the fan makes 100 rev. per min., the

velocity of the center of gravity would be 5,843 ft. per min., or approximately 100 ft. per sec. Then, substituting the given values in formula 1,

$$F = \frac{W v_g^2}{g R_g} = \frac{200 \times 100^2}{32.16 \times 9.3} = 6,687 \text{ lb. Ans.}$$

32. Work of the Centrifugal Force.—If a force acts on a body free to move, it will move at a certain velocity and will continue to move at this velocity unless acted on by another force, which increases or retards the original velocity. If the force continues to act on the body, the velocity will gradually increase and the rate of change in the velocity is called the *acceleration*.

The centrifugal force developed by the revolution of a fan is continually employed in imparting velocity to a given mass of air. By means of the revolution of the fan, the air is brought from a state of rest outside the fan to a state of motion within the fan and after it leaves the fan. The power applied to the fan shaft is not entirely converted into power on the air in the airway, but, owing to frictional and other losses, the power on the air in the airway is not equal to the power applied to the engine or other motor that moves the fan. The ratio between the effective power, that is, the power on the air at a point in the fan drift near the fan, and the power applied to the fan shaft expresses the *efficiency* of the fan. If F represents the force developed by the power applied to the fan shaft, and K the efficiency of the fan, the power on the air at or near the fan is expressed by KF . When determining the efficiency of a fan, the power on the air should be measured in the fan drift as near as practicable to the fan and before any appreciable amount of the power has been used in overcoming the mine resistance, but at a sufficient distance from the fan to avoid the variations in pressure and velocity in the fan drift just at the fan; the variations are greater for some fans than for others.

In explanation of the mine resistance of an airway in *Mine Ventilation*, Part 1, it was shown that the mine resistance is equal to the total ventilating pressure pa and may be represented by a weight W ; this weight W , or its equivalent value pa , divided by the force of gravity gives

the expression $\frac{pa}{g}$, which represents the mass of the air and is equivalent to the mine resistance pa against which the air is accelerated by the centrifugal force of the fan.

A force producing acceleration in a body, as the centrifugal force of the fan accelerates a given weight of air, is equal to the mass of the body moved multiplied by the acceleration produced in feet per second; or, expressed as a formula,

$$F_1 = Mf = \frac{pa}{g} f \quad (1)$$

in which F_1 = force moving a body, in pounds;

M = mass of the body moved;

f = acceleration of the body, in feet per second;

p = unit ventilating pressure, in pounds per square foot;

a = area of airway, in square feet;

g = acceleration due to gravity, 32.16 feet per second at sea level.

Then, transposing the formulas,

$$f = \frac{F_1}{pa} g$$

and, since $F_1 = KF$,

$$f = \frac{KF}{pa} g \quad (2)$$

in which, in addition to the letters just given,

F = centrifugal force developed in the fan, in pounds:

K = efficiency of fan

EXAMPLE.—Assuming the efficiency K of the fan in the example in Arts. 30 and 31 to be 60 per cent. and the water gauge against which the fan is operating at a speed of 100 revolutions per minute to be 4 inches, or $p = 4 \times 5.2 = 20.8$ pounds per square foot, the sectional area a of the fan drift where the water gauge and velocity of the air is measured to be 110 square feet, find the acceleration due to the centrifugal force, which was found to be 6,687 pounds.

SOLUTION.—Substituting the values given in the formula,

$$f = \frac{KF}{pa} g = \frac{.60(6,687) \times 32.16}{20.8 \times 110} = 56.4 \text{ ft. per sec. Ans.}$$

The foregoing example shows that the centrifugal force developed in this fan will produce against the resisting conditions in this case an acceleration of 56.4 feet per second. It must be remembered, however, that the acceleration is only the gain in velocity per second; or, starting from rest, it is the velocity attained at the end of 1 second of time. The actual velocity developed in the airway will depend on the length of time during which acceleration takes place, and this depends on the relation between the power and the resistance. The total power U of the ventilator or the work performed each second of time, however, can be found by multiplying the force F producing motion by one-half the acceleration f as expressed by the formula,

$$U = F \frac{f}{2} \quad (3)$$

But the effective work or the power on the air Qp for a minute of time is $60 (KU)$; hence,

$$Qp = 60 \left(KF \frac{f}{2} \right) \quad (4)$$

33. Quantity of Air Delivered.—The quantity of air that this fan will yield under the given conditions is expressed by the formula,

$$Q = 60 \left(\frac{KF}{p} \times \frac{f}{2} \right)$$

Substituting the given values in this formula, the quantity of air is

$$\begin{aligned} Q &= 60 \left(\frac{.60 \times 6,687}{20.8} \times \frac{56.4}{2} \right) \\ &= 326,377, \text{ say } 330,000 \text{ cubic feet per minute} \end{aligned}$$

34. Power Required.—It will be observed from the foregoing that the volume of the fan determines the quantity of air the fan will circulate against a given mine resistance or water gauge. The power required to turn the fan under these conditions is found by dividing the power on the air Qp by the efficiency of the ventilator. For example, the horsepower required to operate the fan in the example in

Art. 33 at a speed of 100 revolutions per minute under the conditions named would be

$$H = \frac{Qp}{33,000 K} = \frac{330,000 \times 20.8}{33,000 \times .60} = 347 \text{ horsepower}$$

It may be explained, briefly, that the volume of the fan determines its power. But the volume of the fan depends on the two dimensions, the width of the fan and the depth of the fan blades, and these dimensions correspond, respectively, to the quantity of air in circulation and the unit of ventilating pressure. In general, the wider the fan the larger is the quantity of air that it will circulate under like conditions; and the deeper or longer the fan blades the greater pressure will the fan produce, other conditions being equal. These remarks are suggestive of the elements of design of centrifugal ventilators, as they show the particular effect of each dimension of the fan.

It is usually assumed that the quantity of air furnished by a fan is proportional to the speed of the fan, while the pressure of the air is proportional to the square root of the speed.

EXAMPLE 1.—If a fan making 100 revolutions per minute produces 40,000 cubic feet of air, how much air should the same fan produce in the same airway when its speed is increased to 125 revolutions per minute?

SOLUTION.—Assuming the quantity of air to be proportional to the number of revolutions of the fan per minute, the quantity produced by the fan at a speed of 125 revolutions would be

$$\frac{125}{100} \times 40,000 = 50,000 \text{ cu. ft. per min. Ans.}$$

EXAMPLE 2.—If a fan making 50 revolutions per minute gives a pressure of 4.5 pounds per square foot, what will be the pressure produced in the same airway, if the speed of the fan is increased to 75 revolutions per minute?

SOLUTION.—Assuming the quantity to be proportional to the speed, since the pressure varies as the square of the quantity, the pressure will vary as the square of the speed, or $50^2 : 75^2 = 4.5 : x$;

$$x = 4.5 \times \left(\frac{75}{50}\right)^2 = 10.12 \text{ lb. Ans.}$$

35. Outer Diameter of Fan.—In a well-designed fan, the outer diameter bears a certain ratio to the inner diameter,

or the diameter of the intake opening, which is an element depending alone on the quantity of air in circulation. A formula expressing the ratio of the outer to the inner diameter of the fan is as follows:

$$m = \sqrt[3]{\frac{\sqrt{a} Q}{n^2} \left[c + \left(\frac{3,000}{X} \right)^2 \right]} + 1$$

in which m = ratio of outer to inner diameter ($m = \frac{D}{d}$);

Q = quantity of air in circulation, in cubic feet per minute;

a = sectional area of fan drift where power on the air is measured, in square feet;

n = speed of rotation of fan, in revolutions per minute;

c = fan constant, ordinarily $c = 4$ to 6 ;

$$X = \sqrt[3]{\frac{Q^2}{p}}$$

The value of the fan constant will vary according to the style of the fan and its construction with respect to the amount of resistance offered to the passage of the air through the fan, but in general this value may be assumed as varying from $c = 4$ to $c = 7$. The more obstructed the intake area, or the greater the resistance to the flow of air through the fan, the higher will be the value of this constant. In using the above formula, it is important to determine by experiment the proper constant corresponding to the conditions for which the fan is designed. This formula has been developed from the formulas already given, and an example will make clear its use.

EXAMPLE.—Calculate the size of fan required to deliver 200,000 cubic feet of air per minute against a water gauge of 1.5 inches at a speed of 60 revolutions per minute under normal conditions.

SOLUTION.—Assuming a double-intake fan, the diameter of the intake openings of this fan is found by substituting the given values in the formula,

$$d = .023 \sqrt{Q} = .023 \sqrt{200,000} = 10.28 \text{ ft. Ans.}$$

$$X = \sqrt[3]{\frac{Q^2}{p}} = \sqrt[3]{\frac{200,000^2}{1.5 \times 5.2}} = 1,724. \text{ Ans.}$$

The ratio of the outer diameter to the inner diameter $m = \frac{D}{d}$ is then determined for a speed of rotation $n = 60$ revolutions per minute, assuming a sectional area of the fan drift $a = 120$ square feet, by substituting the given values in the formula for m ; thus,

$$m = \sqrt[3]{\frac{\sqrt{120 \times 200,000}}{60^2} \left[4 + \left(\frac{3,000}{1,724} \right)^2 \right]} + 1 = 2.387$$

The outer diameter of the fan is then $D = m d = 2.387 \times 10.28 = 24.54$ ft. Ans.

A common "rule of thumb" makes the outer diameter of the fan twice the inner diameter. Although this rule has been widely used, it does not, of course, consider any of the conditions that should properly be considered in the design of a fan.

36. Expansion of Casing.—The purpose of the casing surrounding the fan has been explained in the general description of centrifugal fans. The amount of the expansion or the maximum depth of the spiral is measured at the point of cut-off. The amount of this expansion at the cut-off, assuming the velocity of the air at this point to be equal to the speed of the fan-blade tips—that is, the peripheral speed—is calculated by means of the formula

$$e = \frac{Q}{\pi D n b}$$

in which e = expansion of casing at cut-off, in feet;

Q = total quantity of air passing in cubic feet per minute;

D = outer diameter of fan, in feet;

n = speed of rotation, in revolutions per minute;

b = width of fan, in feet.

EXAMPLE.—Find the amount of expansion of the outer casing of a 24-foot fan 8 feet wide, designed to pass 200,000 cubic feet of air per minute at a speed of 60 revolutions per minute.

SOLUTION.—Substituting the given values in the formula the expansion of the casing is

$$e = \frac{200,000}{3.1416 \times 24 \times 60 \times 8} = 5.5 \text{ ft. Ans.}$$

37. Number of Blades.—The number of blades in a fan is important in order that the air shall receive sufficient

support at the circumference of the fan, where it meets the resistance due to the discharge of the air-current either into the atmosphere or into the spiral conduit surrounding the fan. The number of the fan blades should be proportional to the outer circumference or the diameter of the fan, and inversely proportional to the depth of the fan blades. As a guide in determining the number of blades for any size of fan, the following formula is useful:

$$N = \frac{D}{\sqrt{D-d}}$$

EXAMPLE 1.—How many fan blades should be used in a fan 10 feet in diameter when the depth of the blades is 2 feet?

SOLUTION.—Subtracting twice the depth of the blades from the outer diameter of the fan gives, for the inner diameter, $d = 10 - 2 \times 2 = 6$ ft. Then, substituting values in the formula for the number of blades,

$$N = \frac{D}{\sqrt{D-d}} = \frac{10}{\sqrt{10-6}} = 5 \text{ blades. Ans.}$$

EXAMPLE 2.—How many blades will be required in a fan 32 feet in diameter and having an intake opening 16 feet in diameter?

SOLUTION.—Substituting the given values in the formula for the number of blades,

$$N = \frac{32}{\sqrt{32-16}} = 8 \text{ blades. Ans.}$$

38. Secondary Blades.—It is often a good plan in building a large fan to introduce intermediate or supernumerary blades or wings at the circumference of the fan midway between the regular blades to prevent the formation of eddies toward the outer edge of the fan wheel. These small blades or wings should conform in shape and position to the corresponding portion of the large blades. When these small blades are used, the number of large blades required may be taken as two-thirds of the number calculated by the formula in Art. 37.

39. Curvature of Blades.—Until recently, there has been a wide difference of opinion in regard to the relative efficiency of straight and curved blades. The straight, or *paddle, blade*, as it is often called, acts only to revolve the

air passing through the fan, the radial velocity being imparted to the air in this construction wholly through the agency of the centrifugal force developed by the revolution. The inclination of a blade backwards from the direction of its motion was supposed to offer a less resistance to the passage of the air through the fan. It was forgotten, however, that in doing this there resulted a great loss in the centrifugal force, developed, and in order to compensate for this loss it was necessary to revolve the fan at a much higher speed when the blades were curved backwards than when straight blades were used. This increase of speed, in most cases, is accomplished at the expense of efficiency.

Recent experiments performed in England and in this country show that the form of blade giving the highest efficiency is that in which the blade terminates in a radial line, or the end of the blade for a certain distance is perpendicular to a tangent to the circumference at that point, while the lip or inner edge of the blade is curved forwards in the direction of motion so that it is tangent to the resultant of the velocity of the entering air and the tangential velocity of the lip of the blade at the throat of the fan. The purpose of the forward curvature at the lip of the blade is to cause the air entering in a radial direction to slide along the blade without shock. The air is thus deflected from a radial path and given the necessary motion of rotation without undue loss of power. Experiments performed on fans in which the tips of the blades were bent forwards in the direction of rotation showed an increase in the pressure, but a larger decrease in the quantity of air produced per unit of power and a consequent decrease of efficiency. The forward curvature of the blade, whether at the inner or outer end of the blade is sometimes spoken of as the *cupping* of the blade.

40. Inclination of Blades.—In some fans, the blades are flat, but are set in an inclined position, so that the blade makes an angle with a radial line. This construction is typical of the Guibal fan. The inclination of the blade in this case is always backwards from the direction of motion, and

its effect is the same as has just been described in reference to the backward curvature of blades.

41. Tapered Blades.—In some types of fans, such as the Waddle and the Schiele fans, the blades are tapered, that is, the width of the blade a decreases from its inner toward its outer diameter, either in a curve cb as shown in Fig. 19, or in a straight line. The purpose of this is to maintain a uniform area of passage through the fan. Since this area of passage at any point in the fan is equal to the product of the circumference of a circle of the fan drawn through that point and the width of the blade at that point, it follows that the width of the blade should decrease as the radius of the circle increases, in order to maintain a constant area of passage for the air.

For example, if the width of a fan blade at the throat of the fan is 4 feet, the diameters of the inner and outer circles of the fan being 10 feet and 16 feet, respectively, the required width of the blade at its tip is $b = \frac{10}{16} \times 4 = 2.5$ feet. The maintaining of a constant area of passage through the fan prevents the possibility of eddies

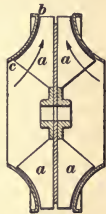

FIG. 19

within the fan due to the expansion of area. It, however, presents a disadvantage of decreasing the volume of the fan that more than offsets the advantages gained. The curved edge bc is not an essential feature of a tapered blade, but is characteristic of the blades of the Schiele fan. This edge may be straight instead of curved.

42. Guide Blades.—In some fans, as for instance the Capell, blades are used outside the fan casing in order to gather the air into the intake. Interior **guide blades** are also sometimes used, as in the case of the Capell fan, Fig. 16, to deflect the air-current from the intake to the regular radial blades; or instead of extra blades of this character, a cone is sometimes used, as in the case of the Robinson fan, Fig. 17, or as shown in Figs. 5 and 10.

FAN CALCULATIONS

43. Calculation of Water Gauge Due to Action of Fan.—The method that has been employed for calculating the water gauge any given fan may produce at a given speed is based on the theoretical height of air column or head due to the tangential velocity of the fan. The *tangential velocity* of a fan is the velocity of the blade tips and is usually measured in feet per second. This velocity is also often called the *peripheral velocity* or *peripheral speed*, and is then measured in feet per minute. For example it is often stated that experience has shown that the peripheral velocity of the Guibal fan giving the best results varies from 5,000 feet to 6,000 feet per minute, corresponding to a tangential velocity of about 80 to 100 feet per second. The following formula is used to calculate the theoretical height of air column due to a tangential speed of fan equal to v_t feet per second:

$$h = \frac{v_t^2}{g} \quad (1)$$

in which h = height or head of air column of the same density as the flowing air, in feet;

v_t = tangential velocity of fan, in feet per second;

g = acceleration due to gravity in feet per second, 32.16 feet.

The theoretical water gauge produced by a centrifugal fan having a tangential speed v_t is derived by multiplying the head of air column in this formula by 12, to reduce it to inches, and this result by the ratio of the weight of air to the weight of an equal volume of water—this ratio for average conditions is approximately $\frac{1.2}{1,000}$. Hence, the formula expressing the theoretical water gauge I for a centrifugal fan at any given speed v_t is,

$$I = \frac{v_t^2}{g} \times \frac{1.2 \times 12}{1,000} \quad (2)$$

The head of air column and the water gauge expressed by these two formulas are purely theoretical values based on the

assumption that the air is received into the fan and discharged without shock, the velocity of discharge being zero. The formulas are theoretically incomplete since they do not consider the resistance against which the fan is operated. It is important to remember that, practically, the pressure and water gauge produced by a fan are not due to the size or speed of the fan, but are determined by the resistance of the airway to which the fan is connected. The same fan at the same speed will produce a different pressure, according to the resistance against which it is operated. For this reason, the peripheral speed of a centrifugal fan is not a true indication of the pressure produced; it is rather an index of the power consumed in turning the ventilator. Other conditions being the same, the same power must be applied to a ventilator to produce a given peripheral speed under all conditions of resistance, but the pressure and the velocity produced depend on the resistance against which the ventilator works. The quantity of air produced depends on the velocity of the air-current in the airway and the sectional area of the airway.

EXAMPLE.—Find the theoretical water gauge that may be produced by a fan 20 feet in diameter revolving at a speed of 75 revolutions per minute.

SOLUTION.—The tangential velocity of this fan at the given speed is found by multiplying the circumference of the fan by the number of revolutions per minute and dividing by 60; thus,

$$v_t = \frac{3.1416 \times 20 \times 75}{60} = 78.54 \text{ ft. per sec.}$$

Then, substituting values in formula 2, the theoretical water gauge due to this fan at the given speed is

$$I = \frac{78.54^2}{32.16} \times \frac{1.2 \times 12}{1,000} = 2.76 \text{ in. Ans.}$$

The speed of revolution of a fan may vary, although the steam pressure on the engine remains constant. This will be caused chiefly by an increase or decrease of the mine resistance, although a variation in the readings of the barometer and thermometer may cause a slight variation in speed. If the doors separating the downcast and upcast are left open, the air-current will be short-circuited and the

resistance reduced. This increases the amount of air passing through the fan and increases the resistance within the fan, causing it to slow down.

44. Manometrical Efficiency.—The manometrical efficiency of a fan is the ratio of the actual water gauge produced by a fan at a given speed to the theoretical water gauge at that speed, as calculated by formula 2 in Art. 43. This term is, therefore, rapidly being given up, as it does not express the efficiency of the fan working under all conditions, but depends on the resistance of the airway in any given case.

Since a fan running at a given speed will produce a water gauge depending on the resistance of the airway, a fan may give a manometrical efficiency of 50 per cent. at one mine and only 40 per cent. manometrical efficiency at another mine.

EXAMPLE.—The water-gauge reading taken from the fan drift at the top of a shaft is 2 inches; the fan is 10 feet in diameter and is running at a speed of 160 revolutions per minute. What is the manometrical efficiency of this fan at the given speed in this case?

SOLUTION.—The tangential velocity of the fan at this speed is

$$v_t = \frac{3.1416 \times 10 \times 160}{60} = 83.78 \text{ ft. per sec.}$$

Substituting values in formula 2 of Art. 43 for the theoretical water gauge, at this speed of the fan,

$$I = \frac{83.78^2}{32.16} \times \frac{1.2 \times 12}{1,000} = 3.14 \text{ in.}$$

The actual water gauge being 2 inches, the manometrical efficiency in this case is

$$K = \frac{2 \times 100}{3.14} = 63.69 \text{ per cent. Ans.}$$

45. Static Pressure Due to a Centrifugal Fan. Air being a compressible fluid is subject to what may be called a *kinetic condition* whenever the continuous flow of the air is interrupted. For a steady flow, the pressure producing the flow is constant, but any change in the velocity of the flowing air or interruption of the steady flow causes an increase in the pressure for all velocities less than twice the acceleration due to gravity ($2g = 64.32$ feet per second)

and a decrease in the pressure for all velocities greater than this. Practically, this condition may be expressed by the formula,

$$p_s = \frac{2g}{v} \times p$$

in which p_s = static pressure, in pounds per square foot;
 p = pressure due to velocity v , in pounds per square foot;
 v = velocity in open airway for same power, in feet per second;
 g = acceleration due to gravity, in feet per second.

The same formula will apply when the pressure is expressed in inches of water gauge, as in the following example:

EXAMPLE.—If a certain fan produces an actual water gauge of 3.1 inches at a speed of 200 revolutions per minute, the velocity of the air in the fan drift being 2,400 feet per minute (40 feet per second), what will be the static gauge produced by this fan at the same speed?

SOLUTION.—Here the pressure is expressed in inches of water gauge. Substituting values in the formula for the static gauge of this fan at the given speed,

$$p_s = \frac{2(32.16)}{40} \times 3.1 = 4.98, \text{ say } 5 \text{ in. Ans.}$$

If the velocity of the air-current in the fan drift in the example had been 64.32 feet per second instead of 40 feet per second, the static gauge when the fan drift was closed would have been the same as the working gauge when the fan drift was open. On the other hand, if the conditions were such as to make the velocity of the air-current in the open drift greater than 64.32 feet per second, the static water gauge when the drift was closed would be less than the working gauge for an open drift.

46. Mechanical Efficiency of Fan.—The term **mechanical efficiency** of a fan should mean the ratio of the effective work performed on the air per minute (that is, the power on the air as determined from any of the formulas for h or u given in *Mine Ventilation*, Part 1) to the work per minute or the power delivered to the fan shaft by the engine. The method usually employed in practice for finding the mechanical efficiency of a fan is such that the results express

the combined efficiencies of the fan and engine or other motor operating the fan instead of the efficiency of the fan alone. This difference may be of considerable importance; for example, the efficiency of an engine may be low, while the efficiency of the fan operated by this engine may be high; in this case, the combined efficiency of the fan and engine would be considerably lower than the efficiency of the fan alone. Much depends, therefore, on the efficiency of the engine driving the fan if this efficiency is included in the efficiency of the fan. Unless the efficiencies of the fan and engine are separate, there can be no true comparison of ventilators driven by different engines or even of the same fan when driven at different speeds, as the maximum efficiency of the fan may be obtained at a certain speed and the maximum efficiency of the engine at a different speed.

To avoid confusion as to what is meant by the term *efficiency* whenever the efficiency of a machine is given, it should be accompanied by a clear statement of exactly what the term means. The efficiency of a machine depends on the speed and the conditions under which the machine operates, and the maximum efficiency should be obtained when the machine is operated at the speed for which it was designed. In the case of a fan, the speed at which the fan is designed to be operated should correspond to the average working conditions under which the mine must be ventilated, although in the early development of the mine the actual speed of the ventilator may be less than this, and in emergencies the fan may be operated at higher speeds; the efficiency will probably be less in either case than at the speed for which the fan was designed.

47. Determination of Mechanical Efficiency.—A new fan should be operated for at least 10 days or 2 weeks before a test is made to determine its efficiency so as to insure as nearly as possible the actual working condition of the machinery when the test is made.

In making the test, the fan should be run at different speeds. While the observations are taken at different

speeds of the fan, preference and special attention should be given to that speed for which the ventilator was designed. At each speed, the following observations should be taken: Indicator cards to determine the power of the engine, readings of the barometer, thermometer, water gauge, and anemometer to determine the quantity and pressure of the air furnished by the fan.

Indicator cards should be taken from the engine by some one thoroughly familiar with such work, and as is explained, in detail, in *Steam Engines*, and at the same time as the other observations are taken in the fan drift and elsewhere. The barometer should be read at regular intervals throughout the test to determine the atmospheric pressure.

Whenever practicable, the water-gauge, thermometer, and anemometer readings should be taken in the fan drift at a distance from the fan sufficient to avoid the oscillations in the air that would render the observations unreliable. When the observations can not be taken in the fan drift, they may be taken in the mine at the first break-through or cross-cut between the main intake and main return airways, but, it will then be necessary to allow for the natural air column in the shaft or slope if such column exists and for the absorption of power between the point of observation and the ventilator. Wherever taken, it is absolutely necessary that the anemometer, water-gauge, and thermometer readings should be taken at the same point in the fan drift or the mine airways and that they be taken simultaneously with indicator cards from the engine. When the water-gauge reading is taken in the fan drift, the gauge is preferably located outside of the drift wall, a pipe being inserted in the wall through an opening that is carefully sealed around the pipe after it is inserted. The pipe should extend to the center of the fan drift and the end of the pipe should not be directed either against or in the direction of the passing current, but the opening at the end of the pipe should be parallel to the direction of the current. To avoid any undue pressure or suction due to the velocity of the current at this point, the end of the pipe should be cut square, and may be covered

with a flat plate of sheet iron 6 to 8 inches square firmly secured to the end of the pipe so that the plane of the plate will correspond with the direction of the current. All volumes of air must be calculated for the same temperature and atmospheric pressure; hence, it is necessary to take the readings of the thermometer and barometer at the same time as the other readings.

The power calculated from the several indicator cards taken from the engine will show the total power consumed in the operation of the engine and the fan combined, at the time of making each test. The unit of ventilating pressure, as calculated from the reading of the water gauge, multiplied by the quantity of air passing the point of observation, as calculated from the anemometer readings and the sectional area of the passageway at this point, makes known the power on the air, or the effective power. The ratio of this effective power to the total power consumed in driving the engine and the fan, multiplied by 100, gives the percentage of the combined efficiencies of the fan and engine for the speed at the time of observation.

48. It will be possible to determine the efficiency of the ventilator separate from that of the engine only when the fan can be disconnected from the engine. When this can be done, the best method to adopt is to employ a device such as the Prony brake, and to run the engine at practically the same speed and under the same conditions with respect to the steam pressure and other details that go to make up the power and resistances of the engine and its load, respectively. Under these conditions, the Prony brake has virtually replaced the ventilator as far as the load on the engine is concerned, and it is possible then to estimate the load due to the ventilator at this speed of the engine. Indicator cards are taken for each speed of the engine when running under the load due to the ventilator, and these are compared with corresponding cards taken when the ventilator has been replaced by the brake. It is necessary to make this comparison in order to make certain that the power of the engine

is the same in each case, or to reduce the results to a common basis of power. It would not be sufficient to disconnect the fan and run the engine at the same speed but under no load, as this would alter the frictional resistances of the engine.

In estimating the efficiency of the ventilator separate from that of the engine, the load due to the ventilator, as determined by the Prony brake for any given speed, is taken as the net power delivered by the engine to the fan shaft. Dividing the power on the air in the fan drift by this net power delivered to the fan shaft and multiplying by 100 will give the percentage of efficiency of the fan alone.

It is not usually convenient or practicable to use the Prony brake or a similar device in testing a mine fan at the mine, consequently the mechanical efficiency usually includes the efficiency of both the fan and the engine, the engine being considered as a part of the fan.

49. Effect of Mine Resistance on Mechanical Efficiency of a Ventilator.—The air-current produced by a fan must pass through the fan itself and the fan like any other air passage offers a resistance to the passage of the air. A portion of the power of the fan is thus absorbed within itself, and is lost as far as the ventilation of the mine is concerned. The resistance of a fan to the passage of air through it is due to the friction of the air against itself and against the surfaces of the fan and the necessary deflection of the current through the various passages of the fan. The power lost in the fan may be assumed as proportional to the cube of the quantity of air passing, and may be expressed by the formula,

$$u_1 = c_1 q^3 \quad (1)$$

in which u_1 = power lost in the fan, in foot-pounds per minute;

c_1 = constant for the particular fan;

q = quantity of air entering the fan, in cubic feet per minute.

The formula for the power on the air, as given in *Mine Ventilation*, Part 1, is $u = \frac{k s q^3}{a^3}$.

Letting U = net power applied to the fan shaft, in foot-pounds per minute;

K = efficiency of the fan;

KU = effective power or the power on the air, in foot-pounds per minute;

then,
$$KU = \frac{k s q^3}{a^3}$$

which gives for the power applied to the fan shaft,

$$U = \frac{k s q^3}{K a^3} \quad (2)$$

The effective power or the power exerted on the air by the action of the fan is equal to the net power applied to the fan shaft less the power absorbed within the fan. If the efficiency of the fan be taken as the ratio of the effective power to the net power applied to the fan shaft, the efficiency of the ventilator is given by the formula,

$$K = \frac{U - u_1}{U} = 1 - \frac{u_1}{U} \quad (3)$$

Now dividing formula 1 by formula 2, member by member, we have for the ratio of the power lost in the fan to the net power applied to the fan shaft,

$$\frac{u_1}{U} = \frac{c_1 Q^3}{k s q^3} = \frac{c_1 K a^3}{k s} \quad (4)$$

Substituting this value in formula 3, and solving with respect to K , the efficiency of a fan when producing a given circulation is given by the formula,

$$K = 1 - \frac{c_1 K a^3}{k s}$$

transposing and reducing,

$$K = \frac{1}{1 + c_1 \frac{a^3}{k s}} \quad (5)$$

Since the value of the constant c_1 is expressed by a small decimal, while the value of the expression $\frac{a}{\sqrt[3]{k s}} = X_n$ is large and unwieldy, the above formula is improved by adopting for this constant the value $c_1 = \frac{c}{3,000^3}$, which gives a more

convenient value. The formula for the efficiency of the ventilator in terms of the circulation then becomes

$$K = \frac{1}{1 + c \left(\frac{X_u}{3,000} \right)^2} \quad (6)$$

The value of the factor c is practically constant for the same type of fan, and therefore this may be called the fan constant.

It will be observed from the above reasoning that a ventilating fan may have a different efficiency when circulating air in different mines or airways. In other words, the efficiency of a fan depends not only on the fan itself, but also on the mine resistance with which it is connected. This is due to the fact that for any given power applied, the mine resistance determines the quantity of air in circulation, and this quantity, in turn, determines the power lost in the ventilator, and the efficiency of the machine.

50. Equivalent Orifice.—If a thin plate with an opening in it is placed across the path of an air-current, a certain resistance will be offered to the passage of the current and the amount of resistance will depend on the size of the opening. The resistance offered by such an opening to the flow of an air-current through it is equal to the resistance offered by a certain amount of rubbing surface in a mine to the flow of the same air-current through the mine. Daniel Murgue some years ago proposed expressing the resistance of any mine by the size of the orifice in a thin plate that will produce a resistance equal to the resistance of the mine when a current is flowing under a certain head. This orifice he calls the *equivalent orifice*. The term equivalent orifice has been used by many writers, particularly in connection with fan tests, to compare the work of different fans, as the work done by each fan can by this means be compared.

The formula for the equivalent orifice is determined as follows: The velocity of the flow of a fluid through an orifice is given by the formula,

$$v = \sqrt{2gh} \quad (1)$$

in which v = velocity of air, in feet per second;

g = acceleration due to gravity, 32.16 feet per second;

h = head, in feet of air column producing the velocity.

Multiplying both sides of this equation by A , the area of the equivalent orifice,

$$Av = A\sqrt{2gh}$$

then, since $q = Av$, $q = A\sqrt{2gh}$, and

$$A = \frac{q}{\sqrt{2gh}} \quad (2)$$

When a fluid flows through an orifice in a thin plate, the stream is contracted a short distance beyond the orifice, but soon expands again to the full size of the orifice. The contraction is called the *contracted vein* or *vena contracta*. In consequence of this contraction, the velocity of flow through the orifice is reduced from the theoretical amount, and for air it is assumed as from .62 to .65 of the theoretical value. On account of the *vena contracta*, the area of the orifice must be correspondingly increased. Using decimal .62, this formula becomes

$$A = \frac{q}{.62\sqrt{2gh}} \quad (3)$$

Reducing this formula to cubic feet per minute and inches of water gauge, the equation for the equivalent orifice is

$$A = .00038 \times \frac{q}{\sqrt{i}} \quad (4)$$

51. Advantages of Centrifugal Fans.—The centrifugal fan is the most reliable of all the ventilating motors used in mining work because its action is more constant and more readily controlled than that of any other kind of ventilator. Mining work often requires a sudden increase of the ventilating power, and in the use of the fan this can be done at once by increasing the speed of the fan. Other ventilating motors, as the furnace or the steam blast, are capable in most cases of producing but a slow and very limited increase in the quantity of air circulated. The cost

of running a fan is much less than that of running a furnace for the same circulation, and there is not the same danger of fire in the operation of a fan as in the use of a furnace. A ventilating fan at a mine is quite frequently arranged so that the ventilating current in the mine may be reversed by opening and closing doors made for that purpose. While it is possible to arrange a furnace in a like manner, this is not done, for the reason that the doors controlling such a change of the ventilating current would, in the case of a furnace, be located in the mine and would be destroyed or difficult to reach in case of an accident requiring the current to be changed.

52. Efficiency of Mine Furnace Compared With Fan.—Previous to the general adoption of the centrifugal fan as a mine ventilator, the mine furnace was very generally used, and in the case of deep shafts it was for a long time held to be better adapted to the ventilation of mines than any other means of ventilation, though the fan was admitted to be better adapted for shallow shafts than a furnace. This view of the relative efficiency of the furnace and the fan in deep mining was supported by the fact that as the depth of the mine below the surface increased the power of the furnace was increased in the same proportion, while on the other hand, in fan ventilation the increase in the depth of the shaft caused no increase of power but an increase of resistance due to the shafts through which the entire current of air must pass.

The work of a mine furnace is best compared with that of a fan on the basis of their respective powers. It has been explained that the pressure due to a mine furnace under ordinary conditions is dependent on the depth of the furnace shaft, while the power is determined by the depth of the shaft and the mine resistance. For the same furnace, therefore, the power will vary as the resistance of the mine varies, the power decreasing as the resistance increases, thus making the furnace less efficient as the development of the mine increases, except as recourse is had to splitting

the air-current and thereby increasing the volume of the air in circulation and the power of the furnace.

It must be remembered that the power of a furnace is wholly effective in producing the circulation of air in the mine. Hence, in comparing a mine furnace with a ventilating fan, the power of the furnace must be divided by the general efficiency of a ventilating fan in order to find the gross power of the fan that will give the same effective power in the mine as is given by the furnace. Suppose that the power of a furnace producing 75,000 cubic feet of air in a certain mine at a depth of 1,500 feet below the surface was found to be 109.454 horsepower. Assuming the general efficiency of a ventilating fan to be 60 per cent., the gross power of a fan producing the same power on the air as this furnace will be $\frac{109.454}{.60} = 182+$ horsepower. A fairly good

slide-valve fan engine will consume, say 5 pounds of coal per horsepower per hour, making the total coal consumed in this case $182 \times 5 = 910$ pounds per hour. It may be assumed that the furnace accomplishing this work will consume 2,700 pounds of coal per hour, or practically three times the quantity required for operating a fan.

In addition to the increased consumption of coal, the furnace requires constant attendance. In the case just considered, there would probably be required two furnaces and the constant attention of two furnace men to handle this quantity of coal and keep the fire in good condition.

FUELS

PROPERTIES OF FUELS

COMPOSITION AND CLASSIFICATION

1. A fuel is any substance that is burned for the purpose of generating heat, as wood, charcoal, coal, coke, oil, or gas. It is composed of certain elements, such as carbon, hydrogen, and sulphur, that are combustible and that give out heat when burned, and of certain impurities, such as moisture and ash, that detract from the heating value. The study of fuels involves a consideration of their physical characteristics, chemical composition, and geographical distribution, also their theoretical and practical, or available, heating values, and the chemical theory of combustion.

2. Fuels are classified as: (1) *solid fuels*, including wood, charcoal, coal, coke, and peat; (2) *liquid fuels*, including petroleum and its derivatives, naphtha, gasoline, etc.; (3) *gaseous fuels*, including natural gas, and various manufactured gases, such as coal gas, water gas, producer gas, etc.

COMBUSTIBLE ELEMENTS

3. Carbon is the principal heat-giving constituent of all fuels. It is found in three forms, which differ greatly in their physical properties and yet are the same chemically; viz., the diamond and graphite, which are crystalline forms of carbon; and amorphous carbon, which is not crystallized. The latter form is the chief constituent of coal, charcoal

Copyrighted by International Textbook Company. Entered at Stationers' Hall, London

coke, etc., and is the only form that is combustible in an ordinary fire and of value as a fuel.

4. Hydrogen, the second important heat-giving element contained in fuels, exists in the free, or uncombined, state in certain manufactured fuel gases, such as water gas, but is more commonly combined with carbon, as a hydrocarbon, or with oxygen in the form of water.

If both hydrogen and oxygen exist in a fuel, it is assumed that all the oxygen is combined with hydrogen in the form of water, H_2O . The hydrogen thus combined has no fuel value and must therefore be deducted from the total amount of hydrogen present in calculating the heating value of the fuel. The hydrogen left after deducting what is combined with oxygen is called the *available hydrogen*. Since the weight of hydrogen in water is one-eighth the weight of the oxygen, the percentage of available hydrogen is obtained by the formula,

$$h = H - \frac{O}{8}$$

in which h = percentage of available hydrogen in the fuel;

H = percentage of hydrogen in the fuel;

O = percentage of oxygen in the fuel.

EXAMPLE.—Find the amount of hydrogen in the form of moisture and the amount of available hydrogen in a piece of dry wood that contains 50 per cent. of carbon, 6 per cent. of hydrogen, 42 per cent. of oxygen, and 2 per cent. of ash.

SOLUTION.—Using the formula $h = H - \frac{O}{8}$, we have, hydrogen as moisture = $\frac{O}{8} = \frac{42}{8} = 5.25$ per cent. Ans.

Available hydrogen, $h = 6 - 5.25 = .75$ per cent. Ans.

It is evident, therefore, that the greater the amount of oxygen in a fuel, the less will be its heating value.

5. Sulphur, which is present in most coals and in some other fuels in an amount ranging from .5 to 5 per cent., is usually combined with iron as iron sulphide or pyrites, FeS_2 , and its presence is indicated by the high iron content of the ash. In this form, 1 pound of sulphur has about one-half

the heating value of 1 pound of carbon. The sulphur that exists in the form of sulphates, usually as calcium sulphate or sulphate of lime, $CaSO_4$, has no heating value.

Sulphur is always an objectionable element in coal, since the iron with which it is usually combined is one cause of the troublesome clinker on the grates of furnaces. When coal is used for smelting or heating iron, the sulphur is still more objectionable, since it is partly absorbed by the iron and deteriorates its quality.

IMPURITIES IN FUELS

6. Most fuels contain varying amounts of incombustible substances that may be regarded as impurities, since they detract from the heating value of the fuel. These are oxygen, which is combined with the carbon and with hydrogen as moisture; nitrogen, the inert chemical element, which is found in a small percentage; and various mineral substances, such as silica, alumina, iron, and lime, which compose the ash of the fuel. Potash, or potassium carbonate, is a large constituent of the ashes of wood or charcoal.

7. **Moisture** is contained in nearly all fuels. A part of this moisture will evaporate if the fuel is exposed to the air, but a part can be driven off only by heating the fuel at a temperature slightly above the boiling point of water. This second part is called *hygroscopic* moisture. Moisture, or water, in a fuel has no heat value and is an inert constituent that is handled and finally expelled at a cost of fuel. Each per cent. of moisture means 20 pounds less fuel for each ton of coal.

8. **Ash** is an inert constituent, and for each per cent. of ash present 20 pounds of useless weight has to be handled, and there is a loss of 20 pounds per ton of fuel. Water in a fuel is removed at the cost of heat of the fuel, while ashes are removed at extra cost of labor. With coal at \$3 per ton and labor at \$1 per day, it is estimated that if the cost of stoking the coal is $6\frac{2}{3}$ per cent. of the cost of the

coal, and cost of handling ashes is double that of stoking the coal, 5 per cent. of ash will lessen the fuel value of the coal over 6 per cent.; 10 per cent. of ash, over 12 per cent.; and so on. Iron in a fuel gives a reddish color to the ash, and the intensity of the color of the ash furnishes a rough means to estimate the amount of iron contained in a fuel. Iron in an ash makes it more fusible and increases its tendency to clinker. In domestic consumption, where the temperature is low, the quantity of ash is of more importance than its fusibility, but for steam purposes, where high temperature is required, ashes of a clinkering coal will fuse into a vitreous mass and accumulate on the grate bars and exclude the passage of air necessary for combustion. The practicability of employing a coal will often be determined by the quality of the clinkering of the ashes. For steam purposes, those coals are best whose ashes are nearly pure white and which contain little or no alkali or iron, and contain only silica and alumina.

METHODS OF EXPRESSING THE COMPOSITION OF A FUEL

9. Two methods of analyzing fuels are in common use, known as *proximate* and *ultimate analyses*. The proximate analysis determines the amounts of moisture, volatile matter, fixed carbon, and ash contained in the fuel; the ultimate analysis determines the amounts of the elements, carbon, hydrogen, oxygen, nitrogen, and sulphur in the dry fuel, and the amount of ash; the ash may be analyzed further, if necessary, to determine the silica, alumina, iron, etc. contained in it.

10. In making a proximate analysis, the moisture is first driven off by heating the sample to 219° to 225° F.; the volatile matter is then expelled by heating to a red heat without access of air; the remainder is then thoroughly burned at a white heat by the aid of a gentle current of air or of oxygen gas until nothing but the ash remains. The detailed method of making a proximate analysis will be given later. The proximate analysis thus gives the four constituents—moisture, volatile matter, fixed carbon, and ash—and the sum of their percentages is 100. If the content of

sulphur is desired, it is determined separately by the methods of ultimate analysis. It is also sometimes convenient to consider the fuel to be free from moisture before an analysis is made and to express its composition as consisting of volatile matter, fixed carbon, ash, and sulphur.

In some cases, the amounts of fixed carbon and volatile matter are expressed as percentages of the total combustible. Thus, the analysis of the same coal may be expressed by any, of the following forms:

1. ULTIMATE ANALYSIS

	PER CENT.
Carbon	76.10
Hydrogen	4.89
Oxygen	6.90
Nitrogen	1.40
Sulphur	1.96
Ash	8.75
	<u>100.00</u>

2. PROXIMATE ANALYSIS

	PER CENT.
Moisture	1.50
Volatile matter	34.33
Fixed carbon	55.42
Ash	8.75
	<u>100.00</u>
Sulphur	1.96

3. PROXIMATE ANALYSIS OF SAMPLE FREE FROM MOISTURE, OR DRY COAL

	PER CENT.
Volatile matter	34.85
Fixed carbon	56.27
Ash	8.88
	<u>100.00</u>

Sulphur 1.99

4. ANALYSIS OF COMBUSTIBLE

	PER CENT.
Volatile matter	38.25
Fixed carbon	61.75
	<u>100.00</u>

The second form of expressing the composition is the one generally used for coal and coke.

11. There is, unfortunately, a lack of uniformity among chemists as to the method of reporting a proximate analysis. The percentages of moisture, volatile matter, fixed carbon, and ash should be reported exactly as they are determined by analysis and without any deductions being made on account of the amount of sulphur; and these percentages should add up to 100 per cent. The sulphur, which is separately determined by the methods used in ultimate

analysis, is not usually included in the total of 100 per cent. In some methods of reporting analyses, however, the sulphur must be included to make the total of 100 per cent., because the sulphur has been subtracted from the fixed carbon and the volatile matter as found in the proximate analysis, one-half from each, according to the custom of some chemists, or .4 from the fixed carbon and .6 from the volatile matter, according to others. The common practice now is to report the fixed carbon and the volatile matter in the figures actually obtained by the proximate analysis, whether the sulphur is determined or not. Owing to the different methods of reporting proximate analyses, any analysis used in a calculation must be first examined to determine on what basis the fixed carbon and volatile contents have been reported.

12. To reduce the figures given in form 2, Art. 10, so that the analysis will be for a sample free from moisture, subtract the percentage of moisture from 100 and divide the percentage of each of the other substances by this difference; the result multiplied by 100 will be the percentage of each for a sample free from moisture.

EXAMPLE.—Express analysis 2 so that it may be for a sample free from moisture.

SOLUTION.—The sample dried is $100 - 1.50 = 98.50$ per cent. of the original.

$$\frac{34.33 \times 100}{98.50} = 34.85 \text{ per cent. volatile matter}$$

$$\frac{55.42 \times 100}{98.50} = 56.27 \text{ per cent. fixed carbon}$$

$$\frac{8.75 \times 100}{98.50} = 8.88 \text{ per cent. ash}$$

$$\frac{1.96 \times 100}{98.50} = 1.99 \text{ per cent. sulphur. Ans.}$$

13. To express an analysis in terms of combustible, divide the percentage of fixed carbon and the percentage of volatile matter, as given in the proximate analysis, by the sum of the percentages of fixed carbon and volatile matter and multiply the result by 100, similarly to the method used in calculating the analysis of a sample free from moisture.

14. The **volatile combustible matter** is that part of a coal that is driven off as a combustible gas when the coal is heated out of contact with oxygen. When a large percentage of volatile combustible matter is present, fuels ignite easily and burn with a long yellow flame, and, in ordinary combustion, give off dense smoke. The amount of the volatile matter in a coal shows approximately whether it is suitable for the manufacture of illuminating gas, but it tells very little as to the quality of the gas. The coking of coal also is dependent to some extent on the volatile matter, but in just what manner is not understood.

15. The composition of the volatile matter varies in different coals. In anthracite and semibituminous coals, it has nearly the composition of marsh gas (methane), CH_4 , and it then has a heating value of about 60 per cent. more, pound for pound, than that of carbon. In the bituminous coals, however, the volatile portion contains more or less oxygen, usually combined as moisture, the quantity varying greatly in different coals, but usually increasing as we travel westwards in the United States. In such cases, the fuel value of the volatile combustible may be not much more than half that of carbon, pound for pound.

Too much stress is frequently laid on the fuel value of the volatile portion of a fuel, and in many cases through careless firing or improper furnace construction, little of the theoretical calorific power of the volatile combustible matter is obtained in the furnace.

16. **Fixed carbon** is the carbon that exists in a fuel in the solid state and that is left after the moisture and volatile part of the fuel are driven off by heating. The amount of fixed carbon added to the amount of ash in a coal gives the theoretical amount of coke obtainable from the coal. This amount is only an approximate indication of the amount of coke obtainable in the coke oven, as the beehive oven produces less than the theoretical yield and the by-product oven more.

EXAMPLE.—A certain coal has the following analysis: moisture, 8 per cent.; volatile matter, 36 per cent.; fixed carbon, 46 per cent.;

ash, 10 per cent.; what is the analysis: (a) of the dry coal? (b) of the combustible?

SOLUTION.—(a) The dry coal is $100 - 8 = 92$ per cent. of the original; hence,

$$\text{the volatile matter is } \frac{36 \times 100}{92} = 39.13 \text{ per cent.}$$

$$\text{fixed carbon is } \frac{46 \times 100}{92} = 50.00 \text{ per cent.}$$

$$\text{ash is } \frac{10 \times 100}{92} = 10.87 \text{ per cent. Ans.}$$

(b) The combustible is $100 - (8 + 10) = 82$ per cent. of the original; hence,

$$\text{the volatile matter is } \frac{36 \times 100}{82} = 43.90 \text{ per cent.}$$

$$\text{fixed carbon is } \frac{46 \times 100}{82} = 56.10 \text{ per cent. Ans.}$$

SOLID FUELS

WOOD

17. Composition of Wood.—Wood is composed of three substances: (1) woody fiber, or cellulose, $C_6H_{10}O_5$, which makes up the chief part of its bulk; (2) the constituents of the sap; (3) water. The most important of the sap constituents is a soluble gum (lignine) amounting, on the average, to 13 per cent. of the wood. The woody fiber and the gum of the sap are both combustible, while the water is not only not combustible, but its evaporation, while the wood is burning, absorbs part of the heat and detracts from the heating value of the other constituents. Dry wood is, therefore, a better fuel than undried wood.

Newly felled wood contains from 25 to 50 per cent. of water, the amount varying greatly with different kinds; but averaging about 40 per cent. Exposed to the air at ordinary temperatures, wood loses a large part of its moisture and shrinks, reaching a minimum of about 20 per cent. of moisture after about 2 years of air drying, but it absorbs water and swells in air highly charged with moisture.

Ordinary air-dried wood may be considered as having the following average composition: hygroscopic water, 20 per cent.; oxygen and hydrogen in the proportion in which they unite to form water, H_2O , 40 per cent.; and charcoal, including 1 per cent. of ash, 40 per cent.

TABLE I

Kind of Wood	Weight of 1 Cord Pounds	Weight of Coal Equiv- alent to 1 Cord of Wood Pounds
Hickory or hard maple . . .	4,500	1,800 to 2,000
White oak	3,850	1,540 to 1,715
Beach, red and black oak . .	3,250	1,300 to 1,450
Poplar, chestnut, and elm . .	2,350	940 to 1,050
The average pine	2,000	800 to 925

18. Fuel Value of Wood.—According to S. P. Sharpless, the heating value of perfectly dry wood varies from 6,600 B. T. U. per pound for white oak, to 9,883 B. T. U. for long-leaf yellow pine.

The weight and coal equivalent of 1 cord of different woods, thoroughly air-dried, is about as given in Table I.

TABLE II

Kind of Wood	Composition					Calorific Value	
	<i>C</i>	<i>H</i>	<i>N</i>	<i>O</i>	Ash	Calories	B. T. U.
Oak	50.16	6.02	.09	43.36	.37	4,620	8,316
Ash	49.18	6.27	.07	43.91	.57	4,711	8,480
Elm	48.99	6.20	.06	44.25	.50	4,728	8,510
Beech	49.06	6.11	.09	44.17	.57	4,774	8,591
Birch	48.88	6.06	.10	44.67	.29	4,771	8,586
Fir	50.36	5.92	.05	43.39	.28	5,035	9,063
Pine	50.31	6.20	.04	43.08	.37	5,085	9,153

It is safe to assume that from $2\frac{1}{4}$ to $2\frac{1}{2}$ pounds of dry wood is equivalent to 1 pound of average quality soft coal and that the fuel value of the same weight of different woods is very nearly the same; that is, a pound of hickory is worth no more for fuel than a pound of pine, assuming both to be dry.

In Table II, Gottlieb gives the values for the composition and calorific values of different varieties of wood.

19. Burning of Wood.—Wood may be burned without smoke provided that there is an ample supply of highly heated air. If a small stick or shaving is burned in the open air, the flame is comparatively cool and the evaporation of the water and the distillation of the hydrocarbons proceeds slowly, so that each particle of hydrocarbon vapor is brought in contact with highly heated air and burns completely. When burned in large masses in a furnace, smoky gas is first formed, and this must later come in contact with very hot air in order to be burned, or the smoke will escape from the chimney.

An experiment made with a narrow strip of paper (which is made from wood fiber) shows how a slight change in the conditions may produce a smoky or a smokeless flame. Roll the paper into a tube $\frac{1}{4}$ inch in diameter, and holding the tube in the hand light one end of it. If it is held so that the lighted end is the higher, the volatile matter is distilled slowly and little or no smoke is produced; but if inclined so that the lighted end is below, it will burn and distil the volatile matter rapidly, and a column of smoke will escape from the unlighted end.

20. In burning wood in furnaces, a large combustion chamber is needed to insure smokeless combustion, and provision must be made for mixing the distilled gases with a sufficient quantity of hot air to burn them.

21. Sawdust, straw, wet tan bark, and bagasse are often used as fuel. Wet tan bark is the spent tan from tanneries. Bagasse is the refuse of sugar cane after the juice has been extracted. These fuels are practically all of the same composition as wood, but tan bark and bagasse may contain from 50 to 60 per cent. of water.

The burning of wet tan bark and bagasse can be successfully accomplished only in specially constructed firebrick furnaces with large combustion chambers. The rate of feeding must be carefully regulated so that the furnace will not become chilled by an excess of the wet fuel.

CHARCOAL

22. Charcoal is made from wood, or sometimes peat, by driving off the volatile portions by heat and leaving the fixed carbon and ash. By one method of doing this, the wood or peat is piled in a conical heap and covered over with earth, and the heat for driving off the volatile matter is furnished by the combustion of a portion of the wood; by another method, the material to be charred is placed in a closed retort and heat is applied to the outside of this retort.

According to Pelet, 100 parts, by weight, of ordinary wood containing 25 per cent. of moisture yields 17 to 22 parts of charcoal if charred in a heap, or 28 to 30 parts if charred in a retort. One-half of the carbon of the wood is burned in making charcoal in a heap and one-fourth in charring in retorts. To char 100 parts, by weight, of wood in a retort, $12\frac{1}{2}$ parts of wood must be burned to heat the retort, hence, $112\frac{1}{2}$ parts of wood are required to produce 28 to 30 parts of charcoal in a retort.

The composition of wood charcoal varies greatly, depending on the temperature at which the wood is carbonized. Charcoal made from black alder at about 800° F. analyzed: carbon, 81.64 per cent.; hydrogen, 1.96 per cent.; oxygen and nitrogen, 15.24 per cent.; ash, 1.16 per cent.; while that made from the same wood at about 2,700° F. analyzed: carbon 94.57 per cent.; hydrogen, .74 per cent.; oxygen and nitrogen, 4.03 per cent.; ash, .66 per cent. In general, the higher the temperature at which the carbonization is effected the higher will be the percentage of carbon and ash and the lower the percentage of hydrogen, oxygen, and nitrogen.

23. Uses of Charcoal.—Charcoal was at one time the principal fuel used for smelting iron in blast furnaces. It is

still used to a small extent for producing a very fine quality of pig iron, but most furnaces now use coke.

In some localities, charcoal is still used to some extent as a domestic fuel. It is also largely used in the manufacture of black powders (gunpowder and blasting powder). Owing to its power to absorb gases and coloring matters, it is frequently used in filters to purify water. Charcoal also finds some use in medicine.

EXAMPLE.—One hundred pounds of wood contains 39 pounds of carbon, 1 pound of ash, 60 pounds of oxygen and hydrogen in proportion to form water; one-third of the carbon is burned away in making charcoal. How many pounds of charcoal will be made, and what percentage of ash will it contain?

SOLUTION.—Two-thirds of 39 = 26 lb. of carbon to which is added 1 lb. of ash = 27 lb. charcoal. Ans.

$$\frac{1 \times 100}{27} = 3.7 \text{ per cent. ash. Ans.}$$

PEAT OR TURF

24. Peat is a fuel that is produced in nature by the accumulation of partly decomposed water plants, ferns, mosses, and other vegetable material. It is found all over the world in locations such as bogs or marshes, that are favorable to the growth of vegetation and to the retention of the decaying products. Recent peat shows the structure of the roots and stems of the plants from which it is formed. In older peat, the fibrous organic structure has given place to an earthy structure more or less dense. The freshly cut surface of denser varieties appears smooth and shining like wax or pitch.

25. Composition.—Freshly cut peat may contain as much as 80 per cent. of moisture; air-dried peat usually contains from 25 to 30 per cent. of moisture. The moisture may be expelled by heating the peat to 250° F. or upwards, but it will reabsorb from 10 to 20 per cent. if exposed to air.

The composition of entirely dry peat of the best quality is given by Regnault as carbon, 58 per cent.; hydrogen, 6 per cent.; oxygen, 31 per cent.; ash, 5 per cent. Peat

from Oswego, N. Y., gave the following composition: carbon, 44.11 per cent.; hydrogen, 6.14 per cent.; oxygen, 33.39 per cent.; nitrogen, .79 per cent.; ash, 15.57 per cent. A proximate analysis of peat from Dismal Swamp, Va., is fixed carbon, 24.52 per cent.; volatile matter, 52.31 per cent.; water, 20.22 per cent.; ash, 9.25 per cent. One pound of air-dried peat will evaporate about $5\frac{1}{2}$ pounds of water.

The quantity of ash in peat depends on the ash in the plants from which it is derived and also on the earthy matter that collects in the bog in which it is deposited. The ash in many samples of peat from different parts of Europe has been found to range from 1 to 33 per cent.

26. Peat may be compressed by machinery to from one-half to one-third its original volume, losing much of its water in the operation; it is thus made denser than wood. Such compressed peat will prove a highly valuable fuel in districts remote from coal mines or gas wells, where wood is expensive.

COAL

27. Origin of Coal.—Coal is of vegetable origin and the manner of its formation has been fully described in *Geology of Coal*. The progressive change in the chemical composition that takes place when woody fiber is changed to coal is shown in Table III.

TABLE III
CHANGES IN CHEMICAL COMPOSITION FROM WOOD TO ANTHRACITE

Substance	Carbon Per Cent.	Hydrogen Per Cent.	Oxygen Per Cent.
Woody fiber	52.65	5.25	42.10
Peat from Vulcaire	59.57	5.96	34.47
Lignite from Cologne	66.04	5.27	28.69
Earthy brown coal	73.18	5.58	21.14
Coal from Belestat, secondary	75.06	5.84	19.10
Coal from Rive de Gier	89.29	5.05	5.66
Anthracite, Mayenne, transition formation	91.58	3.96	4.46

CLASSIFICATION OF COALS

28. Coals may be classified from different standpoints depending on their compositions, their behavior on the grate, or the use to which the coal is put. The most convenient and common classification is one based on the composition as given by the relative percentages of fixed carbon

TABLE IV

Kind of Coal	Fixed Carbon Per Cent.	Volatile Matter Per Cent.	Total Combustible Per Cent.
Anthracite	97.0 to 92.5	3.0 to 7.5	100
Semianthracite	92.5 to 87.5	7.5 to 12.5	100
Semibituminous	87.5 to 75.0	12.5 to 25.0	100
Bituminous, Eastern United States	75.0 to 60.0	25.0 to 40.0	100
Bituminous, Western United States	65.0 to 50.0	35.0 to 50.0	100
Lignite or brown coal	under 50	over 50	100

and volatile matter determined by a proximate analysis; such a classification, in terms of combustible matter, is shown in Table IV.

Anthracite and semianthracite are commonly called *hard coal*, the other varieties *soft coal*.

TABLE V

Locality	Moisture Per Cent.	Volatile Matter Per Cent.	Fixed Carbon Per Cent.	Ash Per Cent.	Sulphur Per Cent.
Cannelsburg County, Ind.	1.47	49.08	26.35	23.10	1.48
Carter County, Ky.60	66.30	28.30	4.80	1.32
Johnson County, Ky. . . .	1.20	49.20	44.00	5.00	.85
Johnson County, Ky. . . .	1.80	64.39	26.36	8.05	1.67
Kanawha County, W. Va.		58.00	23.50	18.50	

29. Cannel coal is a peculiar variety of bituminous coal distinguished by being high in hydrogen. It is used

as an *enricher* in gas making, on account of the illuminating quality of its volatile matter, and is highly valued as a fuel for open fireplaces. In the United States it is found only to a limited extent, chiefly in Virginia, West Virginia, Tennessee, and Kentucky.

Table V gives the proximate analyses of some American cannel coals.

Table VI gives the ultimate analyses of some foreign cannel coals.

TABLE VI

ULTIMATE ANALYSES OF SOME FOREIGN CANNEL COALS

Locality	C	H	O + N	S	Ash
Boghead, Scotland	63.10	8.91	7.25	.96	19.78
Albertite, Nova Scotia . .	82.67	9.14	8.19		
Tasmanite, Tasmania . .	79.34	10.41	4.93	5.32	

30. Caking and Non-Caking Coal.—Bituminous coals are sometimes classified as caking or non-caking, according to their behavior when heated to a temperature approaching red heat. **Caking**, or **coking**, coals, when thrown into a hot fire or heated in an oven, partially melt and run together, forming a cake or crust. When this crust is heated to a red heat, or higher, the volatile matter distils off, leaving a compact but porous mass called **coke**. **Non-caking coals** hold their original shape when highly heated and do not form a crust. Chemical analysis does not explain the difference in action of the two kinds of coals, for a caking and non-caking coal may have the same chemical composition. This subject is fully treated in *Principles of Coking*.

31. Long-Flaming and Short-Flaming Coals.—A long-flaming coal is one that has a high percentage of volatile matter and gives off a long flame when burned in an ordinary furnace. The long flame, however, is evidence that the combustion is incomplete in the furnace, rather than an indication of the quality of the coal itself, for a coal that in one furnace burns with a long flame, may in

another furnace, in which there is a sufficient supply of very hot air, be made to burn with a short flame.

32. A free-burning coal is one that burns easily with a light draft. This term is, however, often used rather indefinitely, and some use it synonymously with non-caking, while others apply it to a coal containing a larger amount of volatile matter.

33. Coals are also classified in accordance with the use to which they are put, as *steam coal*, *gas coal*, *domestic coal*, *blacksmith coal*, *sea coal*, etc.

34. Steam Coals.—For steam making, the superiority of coals high in combustible constituents is admitted, and those containing from 75 to 90 per cent. of fixed carbon, with 25 to 10 per cent. of volatile matter, in the combustible are the most desirable. Of coals high in fixed carbon, the semianthracites and the semibituminous rank higher than the anthracites in meeting the various requirements of a quick and efficient steaming coal.

In semibituminous coals the comparative absence of smoke, which means loss of combustible matter, is sufficient to suggest their superiority over bituminous coals for steam raising. Semibituminous coals are specially well suited for small tubular boilers, firebox steam boilers, or other forms with small unlined combustion chambers, in which the gases from bituminous coals become cooled, are not burnt, and deposit soot in the tubes. The high rate of combustion and the strong draft necessary in locomotives is particularly unfavorable to the economical combustion of bituminous coal.

Steaming coal should kindle readily and burn quickly but steadily, and should contain only enough volatile matter to insure rapid combustion. It should be low in ash and sulphur, should not clinker, and when it is to be transported should not easily crumble and break.

The consideration of the steaming qualities of a coal involves, also, a consideration of the form of furnace and of all the conditions of combustion. The evaporative power of a coal in practice cannot be stated without reference to the

conditions of combustion, and every practical test of a coal, to be thorough, should lead to a determination of the best form of furnace for that coal, and should furnish knowledge as to what class of furnaces in actual use such coal is specially adapted. It is not sufficient that in comparative tests of coals, the same conditions should exist with each, but there should also be determined the best conditions for each coal.

35. Domestic Coals.—In domestic use, coal is burned in open grates and in closed stoves. The coal that sustains a mild, steady combustion, does not coke nor smoke, and remains ignited at a low temperature with a comparatively feeble draft, is the best. A coal burning with a smoky flame is objectionable as producing much soot and dirt, especially for open grates or cooking purposes. For self-feeding stoves, a dry, non-caking coal is necessary. A very free and fiercely burning coal is not desirable, particularly in stoves, as the temperature cannot be easily regulated. A sulphurous coal is also bad, as it gives off stifling gases when burning, and corrodes the grates and fire-pots. Clinkering is not so serious a matter in domestic use as it is under boilers, as the temperature is not generally high enough to fuse the ash. A stony, hard ash that will not pass between the grate bars is bad, and light, pulverulent ash is best.

36. Gas Coals.—Good gas coal should not contain more than 5 per cent. ash, and $1\frac{1}{2}$ per cent. sulphur, and it should contain 30 to 40 per cent. of volatile hydrocarbons. It should yield from 10,000 to 11,000 cubic feet of gas per ton of coal. It should be sufficiently dense to bear transportation well, so that, when carried long distances, it will not arrive at its destination largely reduced to slack or fine coal; it should possess coking qualities that will bring from the retorts, after carbonization, about 60 per cent. of coke.

37. Blacksmith Coals.—A good coal for blacksmith purposes should have a high heating power, should contain but a small amount of sulphur, if any, should coke sufficiently to form an arch on the forge, and should also be low in ash.

38. Sea coal is a name that still persists in iron foundries. It is given to the bituminous coal that is ground fine and used for facing the molds. The name originated in England, where coal brought by sea from Newcastle was called sea coal. Pulverized anthracite, coke, and graphite are used for the same purpose, but are called **facings**.

COMPOSITION OF COAL

39. Moisture.—The moisture in coal consists of two portions, first, **surface moisture**, or that which is on the exterior surface of each lump, and which may be dried off in ordinary dry air; second, the **hygroscopic moisture**, or that which is held by capillary attraction in the pores of the coal and can only be driven out of a lump of coal by heating it considerably above 212° F. The percentage of surface moisture that may be held in a pile of coal depends on the size of the pieces, the smaller the coal, the greater is the amount of moisture that it will hold. Thus, buckwheat anthracite, or slack bituminous coal, after exposure to rain, may hold as much as 8 or 10 per cent.

The amount of hygroscopic moisture depends on the kind of coal; thus, anthracite contains practically none, or less than 1 per cent.; semibituminous coal rarely over 1 per cent.; bituminous coal from Pennsylvania, between 1 and 2 per cent.; from Ohio, about 4 per cent.; from Illinois, 8 to 14 per cent.; while lignite may contain 20 per cent. or more. A sample of Illinois coal originally containing 14 per cent. of moisture, and thoroughly dried by heating to from 240° F. to 280° F., reabsorbed the same amount of moisture when exposed to ordinary air for 2 months.

40. Ash in Coal.—The composition of coal ash approximates that of fireclay, with the addition of ferric oxide, sulphate of lime, magnesia, potash, and phosphoric acid.

White-ash coals are generally freer from sulphur than red-ash coals, which contain iron pyrites, but there are exceptions to this rule, as in a Peruvian coal, which contains more than

10 per cent. of sulphur and yields not a small percentage of white ash.

The fusibility of ash varies according to its composition. It is the more infusible the more nearly its composition approaches fireclay, or silicate of alumina, and becomes more fusible with the addition of other substances, such as iron, lime, etc. Coals high in sulphur usually give a very fusible ash, on account of the iron with which the sulphur is in combination. A fusible ash tends to form a clinker on the grate bars, and therefore is objectionable.

The quantity of ash in different coals as they are sent to market differs greatly according to the quality of the coal itself and the care taken to remove the slate, dirt, etc. that accompany them as they come from the mine. A lump of coal may contain only 5 per cent. of ash, while the average of the coal, including slate and dirt as it is mined, may contain 15 per cent. A considerable part of the slate may be removed from the larger sizes by picking after screening, and from the smaller sizes by washing. Usually the ash in marketable coal is higher in the smaller sizes, as shown in Table VII, which gives analyses of anthracite made in 1901.

TABLE VII

Size of Coal	Fixed Carbon Per Cent.	Volatile Matter Per Cent.	Water Per Cent.	Ash Per Cent.
Broken	88.300	5.750	.800	5.150
Egg	88.300	5.750	.800	5.150
Stove	88.650	5.150	.950	5.250
Nut	87.325	5.650	.825	6.200
Pea	86.925	6.315	.935	5.825
Buckwheat . . .	85.725	6.160	.840	7.275
Rice	83.900	6.585	.765	8.750
Bird's eye . . .	85.775	6.500	.700	9.025

41. The purest varieties of semibituminous and bituminous coals often contain less than 2 per cent. of ash in

TABLE VIII
PROXIMATE ANALYSIS AND HEATING VALUE OF
AMERICAN COALS

Locality and Kind of Coal	Moisture	Volatile Matter	Fixed Carbon	Ash	Sulphur	Heating Value per Pound of Coal B. T. U.	Fixed Carbon, Per Cent. of Combustible. (Sulphur, Not In- cluded as Combustible)
<i>Anthracite</i>							
Northern coal field	3.65	4.38	83.27	8.70	.73	13,160	95.00
East Middle coal field	3.89	3.08	86.40	6.63	.58	13,420	96.56
West Middle coal field	3.40	3.72	81.59	11.29	.50	12,840	95.64
Southern coal field	3.33	4.28	83.81	8.58	.64	13,220	95.15
Lykens Valley, Pa.		5.00	81.00	14.00			94.19
Crested Butte, Colo.	1.56	5.93	88.76	3.75	.48		93.74
Las Cerillos, N. Mex.	2.90	3.18	88.71	5.21			96.54
<i>Semianthracite</i>							
Loyalsock Field	1.48	8.10	83.34	7.08	1.63	13,920	91.14
Bernice Basin75	9.40	83.69	6.16	.91	13,700	89.90
Coal Hill, Ark.	4.02	10.84	76.12	8.35	9.02		87.53
<i>Semibituminous</i>							
Broad Top, Pa.	1.59	15.61	77.30	5.50	.90	14,870	83.19
Clearfield County, Pa.	1.56	22.52	71.82	4.10	.91	14,950	76.12
Cambria County, Pa.	1.94	19.20	71.12	7.74	1.70	14,450	78.74
Somerset County, Pa.	3.08	16.42	71.51	8.99	1.87	14,200	80.53
Cumberland, Md.	1.73	17.30	73.12	7.85	.74	14,400	80.86
Pocahontas, Va.	1.50	21.00	74.39	3.11	.58	15,070	77.98
New River, W. Va.	1.05	17.88	77.64	3.43	.27	15,220	81.28
<i>Bituminous (Carboniferous)</i>							
Connellsville, Pa.	1.86	30.12	59.61	8.41	.78	14,050	66.43
Youghiogheny, Pa.	1.63	36.50	59.05	2.82	.81	14,450	61.80
Pittsburg, Pa.	3.37	35.90	52.21	8.02	1.80	13,410	59.25
Jefferson County, Pa.	1.96	32.53	60.99	4.52	1.00	14,370	65.21
Middle Kittanning Seam, Pa.	3.31	35.33	53.70	7.66	1.98	13,200	60.31
Upper Freeport Seam, Pa. and Ohio	3.93	35.90	50.19	9.98	2.89	13,170	58.29
Thacker, W. Va.	2.38	35.04	56.03	6.55	1.28	14,040	61.52
Jackson County, Ohio	3.83	32.07	57.60	6.50		13,090	64.24
Brier Hill, Ohio	4.80	34.60	56.30	4.30		13,010	61.93
Hocking Valley, Ohio	7.84	34.97	48.85	8.34	1.59	12,130	58.28

TABLE VIII—(Continued)

Locality and Kind of Coal	Moisture	Volatile Matter	Fixed Carbon	Ash	Sulphur	Heating Value per Pound of Coal B. T. U.	Fixed Carbon Per Cent. of Combustible. (Sulphur Not In- cluded as Combustible)
<i>Bituminous (Carboniferous)</i>							
Vanderpool, Ky.	4.00	34.10	54.60	7.30		12,770	61.55
Muhlenberg County, Ky.	5.58	33.65	55.50	5.27	1.57	13,060	62.25
Scott County, Tenn.	2.76	35.76	53.14	8.34	1.80	13,700	59.77
Jefferson County, Ala.	3.05	34.44	59.77	2.74	1.42	13,770	63.44
Pratt Seam, Ala.	1.12	32.17	63.37	3.34	1.04		66.33
Sewanee, Tenn.		27.81	61.52	10.67	1.22		68.87
Big Muddy, Ill.	7.50	30.70	53.80	8.00		12,400	63.67
Streator, Ill.	12.00	33.30	40.70	14.00		10,580	55.00
Polk County, Iowa	7.05	40.06	43.17	9.27	4.25		51.87
Rose Hill, Iowa	4.91	41.69	43.01	10.39	5.01		50.78
Brazil, Ind.	8.98	34.44	50.30	6.28	1.39		59.36
Osage, Kans.	7.19	40.03	41.13	11.65			50.68
Missouri	6.44	37.57	47.94	8.05			56.06
<i>Bituminous (Post Carboniferous)</i>							
Nanaimo, Vancouver Island (Creta- ceous)	1.70	38.10	48.48	11.72			55.99
Trinidad, Colo. (Cretaceous)	1.15	30.20	58.04	10.61	.59		65.75
Carbonado, Wash. (Cretaceous)	1.74	30.70	58.30	9.26			65.51
Skagit River, Wash. (Cretaceous)	1.52	18.68	70.21	9.59	.95		78.98
Cook's Inlet, Alaska (Cretaceous)	9.31	46.14	40.85	3.70			46.96
Great Falls, Mont. (Cretaceous)	5.86	18.40	64.33	11.41	.43		77.77
Rocky Fork, Mont. (Cretaceous)	8.11	43.29	46.56	2.04			51.82
Rock Springs, Wyo. (Cretaceous)	7.00	36.87	54.40	1.73			59.60
Richmond, Va. (Triassic)		32.00	59.25	8.75			64.93
<i>Lignites and Lignitic Coals</i>							
Wyoming	8.19	38.72	41.83	11.26		10,390	51.93
Utah	10.39	41.97	44.37	3.27	1.18	11,030	51.40
Oregon Lignite	16.55	42.98	33.52	7.15	1.66	8,540	43.67
Coos Bay, Ore.	15.45	41.55	34.95	8.05	2.53		45.69
Vogel Mine, Tex.	18.45	37.85	37.40	6.30	.80		49.70
Lytle Lignite, Tex.	14.45	40.62	36.47	8.46	1.26		47.31
Monte Diablo, Cal.	13.01	42.15	34.23	10.61			44.81

TABLE IX

	Water	Carbon	Hydrogen	Oxygen	Nitrogen	Sulphur	Ash	Analyst
<i>Anthracite</i>								
Lykens Valley, Pa.73	82.89	4.53	.40	.64	.68	10.13	
Spring Mountain, Pa.	1.97	91.40	2.59	.08	.21	.71	3.04	
Queen Charlotte's Island90	75.95	6.03	6.81	1.40	.95	7.96	
South Wales		92.56	3.33	2.53			1.58	Regnault
<i>Bituminous</i>								
Connellsville, Pa.89	82.48	4.50	5.61	1.45	.94	4.13	Col. S. M. Lillienthal
Blossburg, Pa.69	81.15	5.21	2.24	1.30	.68	8.73	Col. S. M. Lillienthal
Brazil, Ind.	5.45	76.05	5.88	8.13	1.37	.80	2.32	Col. S. M. Lillienthal
Carbon, Wyo. (Cretaceous) . . .	7.35	63.65	4.60	19.44	1.40	.76	2.80	Munsell
Morrison, Colo.	8.20	64.05	4.80	17.24	.70	.51	4.50	Munsell
Coos Bay, Ore. (Tertiary) . . .	13.28	56.24	3.38	21.81	.42	.81	4.06	Munsell
Caking Coal, South Wales12	82.56	5.36	8.10	1.65	.75	1.46	Noad

picked samples, and less than 5 per cent. as marketed. Any coal with less than 10 per cent. is usually considered to be good, marketable coal. Some of the poorer coals run much higher than 10 per cent. of ash on the average, some varieties containing 30 per cent. or more.

42. Table VIII gives the proximate analysis and heating value of a large number of coals from the different fields of the United States.

43. Table IX gives the ultimate or elementary analyses of a number of coals.

VALUATION OF COALS AS FUEL

44. **Relation of Heating Value of Coal to Composition of Combustible.**—The volatile combustible matter in coal consists of carbon, hydrogen, and oxygen in various proportions, differing with the character of the coal. It is found that, with the exception of cannel coal, the larger the percentage of volatile matter in a coal, the greater, usually, is the proportion of oxygen in the volatile matter. It also appears that in the semibituminous coals, after deducting as much of the hydrogen as is needed to form water with the oxygen, that is, one-eighth as much as the oxygen, the remainder, or the available hydrogen, is combined with carbon in about the proportion forming methane, or marsh gas, CH_4 , or three parts, by weight, of carbon to one part of hydrogen; while in the bituminous coals it is combined in about the proportions of five parts, by weight, of carbon to one part of hydrogen. The low heating values per pound of combustible, in coals, which are high in volatile matter and in oxygen, are thus accounted for. According to William Kent, a relation exists between the amount of fixed carbon in the combustible portion of a coal, and its heating value per pound of combustible, which is shown in Table X.

These figures are correct within 2 per cent. for all coals containing more than 63 per cent. of fixed carbon in the combustible, but for coals containing less than 60 per cent. fixed carbon or more than 40 per cent. volatile matter in the

combustible they are liable to an error, in either direction, of about 4 per cent. The greater variation in the coals low in fixed carbon and high in volatile matter is due to the fact that they differ considerably in the percentage of oxygen in the volatile matter.

TABLE X
APPROXIMATE HEATING VALUE OF COALS

Fixed Carbon in Coal Dry and Free From Ash Per Cent.	Heating Value per Pound Combustible	
	B. T. U.	Calories
100	14,580	8,100
97	14,940	8,300
94	15,210	8,450
90	15,480	8,600
87	15,660	8,700
80	15,840	8,800
72	15,660	8,700
68	15,480	8,600
63	15,120	8,400
60	14,760	8,200
57	14,220	7,900
55	13,860	7,700
53	13,320	7,400
51	12,420	6,900

EXAMPLE.—What is the approximate heating value of a coal whose proximate analysis is: moisture, 2 per cent.; volatile matter, 18 per cent.; fixed carbon, 72 per cent.; ash, 8 per cent.?

SOLUTION.—Since the coal contains 2 per cent. moisture and 8 per cent. ash, the amount of combustible is $100 - (2 + 8) = 90$ per cent. The percentage of fixed carbon in the combustible, that is to say, in the coal dry and free from ash, is $\frac{72 \times 100}{90} = 80$ per cent. By Table X, the approximate heating value per pound of combustible for a coal dry and free from ash and containing 80 per cent. fixed carbon is 15,840 B. T. U., and since the coal contains 90 per cent. combustible, $15,840 \times .90 = 14,256$ B. T. U. per lb. of coal. Ans.

45. Practical Values of Fuel for Different Uses.

The total heating value of a fuel, as determined by a calorimeter, would be a correct measure of its practical value for use in the industrial arts if all fuels were equally convenient to handle and all could be used with the same efficiency; that is, if the same proportion of their total heating value could be utilized. In practice, however, it is found that of two fuels of the same heating value, one may be more valuable for some specific use than another, on account of difference in its physical condition or in the conditions under which it is used. For example, clean anthracite lump may be crushed and sorted by screens into different sizes, ranging from broken to buckwheat, and if equally free from slate, all the sizes may have the same heating value per pound, yet one size will be preferred for a certain use, and a different size for another use; and the market values of the several sizes may vary considerably, according to the relative supply and demand of each. Again, an anthracite and a bituminous coal may have the same heating value, but the anthracite will be preferred for use under a steam boiler provided with an ordinary furnace, for the reasons that a greater percentage of the heat generated may be utilized in making steam, and that it may be burned without smoke. So, $\frac{2}{3}$ ton of coke made from 1 ton of bituminous coal, and having less than two-thirds of the heating value of the ton of coal, may have a market value considerably higher than the ton of coal, on account of its being better suited for use in a blast furnace, or the cupola of an iron foundry. Anthracite may be used in a blast furnace, but coke of the same heating value, even at a higher price, will be preferred, on account of the fact that with coke the furnace may be driven much faster. Coke is far superior to bituminous coal for a blast furnace, for the reason that the volatile matter of the coal is all driven off in the upper part of the furnace, where it is of no use, at the expense of fuel burned at the bottom of the furnace.

46. In estimating the relative practical value of different fuels, account must be taken not only of the cost of fuel

having a certain heating value, but also of the percentage of the total heating value that may be utilized. The cost for storage, insurance, labor in handling the fuel, and the ashes made from it, must also be considered, as well as the first cost, and cost of maintenance and operation of apparatus required for handling it; such as automatic stokers for coal, steam jets for oil, etc. Regard must also be had for the capacity of the furnace for burning a sufficient quantity of the coal to produce the desired result; for instance, if a furnace boiler and chimney are designed to produce a given maximum horsepower from semibituminous coal and the full capacity of the boiler is required, it would be impossible to obtain it with anthracite buckwheat without a reconstruction of the furnace or the use of forced draft. It may also be necessary to change the grate bars and substitute shaking grates for plain grates in order to prevent obstruction of the draft by ashes and clinker.

TABLE XI
HEATING VALUE OF DIFFERENT COALS

Coals	Average Relative Heating Value of Different Coals						
	Moisture Per Cent.	Ash Per Cent.	Fixed Carbon in Dry Coal Free From Ash Per Cent.	Heating Values		Relative Values Semibitumi- nous = 100	
				Per Pound Combust- ible	Per Pound Coal	Combust- ible	Coal
Anthracite	2	12	95	14,700	12,600	93	89
Semianthracite . .	2	12	90	15,100	13,000	96	92
Semibituminous .	2	8	80	15,750	14,200	100	100
Bituminous, Eastern	2	8	65	15,000	13,500	95	95
Bituminous, Western	8	15	55	14,200	11,000	90	77
Lignite	15	20	45	12,200	7,900	77	56

47. **Relative Practical Values of Steam Coals.** Table XI shows, approximately, the relative total, or theoretical heating values of different classes of coal. Table XII shows their relative practical values for steam-boiler purposes, based on the assumption that a clean boiler, provided with an ordinary form of furnace, gives the several specified

percentages of efficiency with the different coals. The heat utilized is computed by multiplying the heating value, in B. T. U., by the boiler efficiency.

TABLE XII
RELATIVE PRACTICAL VALUES OF COALS, ASSUMING
DIFFERENT EFFICIENCIES OF BOILER

Coals	Heating Value per Pound Coal B. T. U.	Effi- ciency of Boiler Per Cent.	Heat Utilized per Pound Coal B. T. U.	Relative Value Semibitumi- nous = 100
Anthracite	12,600	77	9,700	91.1
Semianthracite . .	13,000	76	9,880	92.8
Semibituminous . .	14,200	75	10,650	100.0
Bituminous, Eastern	13,500	70	9,450	88.7
Bituminous, Western	11,000	65	7,150	67.1
Lignite	7,900	60	4,740	44.5

48. In Table XII, the figures in the column headed Efficiency of Boiler are about the maximum that can be obtained with ordinary furnaces and with the most skilful firing. With special furnaces, adapted to burn all the volatile matter distilled from the coal, the efficiency of the boiler may be brought up to 75 per cent. with bituminous coals, and to nearly that figure with lignites.

The figures in the last column show that a ton of lignite may be worth to the user only 44.5 per cent. as much as a ton of semibituminous coal. It really may be worth much less than this, on account of the extra labor required to handle it, and of the trouble given by the ashes; and it may even be worth nothing when semibituminous coal is procurable at any reasonable price, if the boiler furnace is of restricted size, having the capacity to develop the rated power with the good coal but not with the lignite.

In order to develop the rated power of a boiler with poor coal, high in ash, it is necessary to have either a larger

grate surface or a stronger draft than with good coal. Sometimes a strong draft is of no avail, on account of clinkering of the ash, in which case a large grate surface is absolutely required.

EXAMPLE 1.—Assuming that a coal having a heating capacity of 14,256 B. T. U. is burned under a boiler giving an efficiency of 75 per cent., what is the evaporation from and at 212° F. if it takes 965.8 B. T. U. to evaporate 1 pound of water from and at 212° F.?

SOLUTION.— $14,256 \times .75 \div 965.8 = 11.07$ lb. of water. Ans.

EXAMPLE 2.—Suppose that this coal costs \$5 per ton, and another coal of 12,000 B. T. U. heating value can be obtained, giving a boiler efficiency of only 60 per cent.; what is the value of this other coal?

SOLUTION.— $\frac{12,000 \times .60}{14,256 \times .75} \times 5 = \3.367 per ton. Ans.

49. Valuing Coals by Test and by Analysis.—Coal is usually sold by the name of the mine or of the district in which the mine is located, without any other guarantee of its quality. For the purchaser's interest, it should be sold on a guarantee of the quality as determined by a trial test or by analysis.

The best way to obtain the relative value of different coals for any particular steam-boiler plant is to have a car load of each coal tested under the ordinary running conditions of the plant, and then to check the results by a proximate analysis of each. The coal that is most economical for one boiler plant is not necessarily the most economical for another, on account of the differences in conditions, such as kind of furnace, area of grate surface, draft available, etc. A plant designed for the purpose may be able to use, with satisfaction, the poorest quality of the fine sizes of anthracite, while another may not be able to use anything cheaper than the best pea coal, and still another, having deficient grate surface, may be compelled to use egg size, or even semi-bituminous coal.

Furthermore, it is equally evident that no comparison of the steaming qualities of coals can be made when burned under different types of boilers. Not only must the boilers be the same, but also all other conditions (though some can be allowed for) even to having the same fireman. A test is

of value in showing what a certain coal will do under a certain boiler, and if some other coal has been tested under the same conditions a comparison is possible, but it does not prove that the one is absolutely the best, only the best under that particular boiler. It can be imagined that were the boilers or furnaces changed to a type better suited to the coal making a poor showing, the results might be reversed.

These tests are usually made by trained engineers and the details need not be entered into here. The coal is fired as usual, but the amount of steam generated and its temperature are noted, the temperature of the escaping gases and their composition are determined, the coal is weighed before firing and the ash afterwards, and the amount and temperature of feedwater entering the boiler are measured. From these and other data the efficiency of the boiler with that particular coal is determined.

TABLE XIII

	1	2	3
Moisture, per cent.	3.00	.82	.163
Volatile matter, per cent.	19.15	25.54	32.08
Fixed carbon, per cent.	68.39	64.39	58.28
Ash, per cent.	9.46	9.25	8.01
Sulphur (separate determination), per cent.	1.33	1.37	1.75
Theoretical B. T. U.	12,203	12,653	13,072
Theoretical evaporation from and at 212° F. (pounds of water) . .	12.635	13.101	13.535
Actual evaporation from and at 212° F. (pounds of water) . . .	9.788	9.990	9.712
Efficiency of boiler, per cent. . . .	77.4	76.2	71.7

50. Table XIII shows the results obtained with three coals under the same boiler. The theoretical B. T. U. were calculated from the analyses, from which the theoretical evaporating powers, that is, pounds of water evaporated from and at 212° F. per pound of coal, were determined by

dividing by 965.8, the number of B. T. U. required to change 1 pound of water at 212° F. into steam at 212° F.

It will be noted that these coals, in the order of theoretical evaporation, are 3, 2, 1 and in actual results, 2, 1, 3. This was natural, as the boiler used was one designed for burning short-flamed anthracite. The shortest flame semibituminous coal, No. 1, though the poorest of the three, in theoretical heating value gave the highest boiler efficiency. This was probably due to the fact that this coal was more completely burned in the furnace, on account of its having the lowest percentage of volatile matter.

51. The value of such tests is apparent, although usually but little understood or appreciated by consumers of coal. A pure coal at a high price is frequently cheaper in the end than an inferior fuel at much less cost. A saving is effected in every way; there is less coal required to do the same work and consequently less labor to pay for handling; fewer ashes to cart off, hence less cost of teaming. Not having to renew grate bars destroyed by clinker is a further pecuniary gain.

52. Selling Coal by Analysis.—Besides testing the coals by burning them under the boilers and weighing the quantity of water evaporated, a proximate analysis of each coal should be made so as to arrive at a standard of quality, by reference to which future purchases may be made. A schedule of relative values may then be prepared, something like the following:

Anthracite and Semianthracite.—The standard is a coal containing 5 per cent. volatile matter, not over 2 per cent. moisture, and not over 10 per cent. ash. A premium of 1 per cent. on the price will be given for each per cent. of volatile matter above 5 per cent. up to and including 15 per cent. and a reduction of 2 per cent. on the price will be made for each 1 per cent. of moisture and ash above the standard.

Semibituminous and Bituminous.—The standard is a semibituminous coal containing not over 20 per cent. volatile matter, 2 per cent. moisture, 6 per cent. ash. A reduction of 1 per cent. in the price will be made for each 1 per cent. of

volatile matter in excess of 25 per cent., and of 2 per cent. for each 1 per cent. of ash and moisture in excess of the standard.

EXAMPLE.—If the standard semibituminous coal is worth \$5 per ton, what should be the market value of a coal containing 40 per cent. of volatile matter, 8 per cent. of moisture, and 16 per cent. of ash?

SOLUTION.—The excess of volatile matter is $40 - 20 = 20$ per cent.; of moisture, $8 - 2 = 6$ per cent.; of ash, $16 - 6 = 10$ per cent. The deductions on account of these excesses are:

	PER CENT.
For volatile matter, 20×1	20
For moisture, 6×2	12
For ash, 10×2	20
Total	52

The value of the coal is $100 - 52 = 48$ per cent. of \$5; $\$5 \times .48 = \2.40 per ton. Ans.

53. Market Value of Coal.—The items that enter into the making of the market price of coal are the following: Cost of the coal in the ground, or royalty to the owner; cost of mining, crushing, screening, picking, washing, etc. at the mine, including repairs, interest on investment, and profit to the mine operator; freight rates; cost of selling, storage, insurance, distribution to the final consumer, agents' and retail dealers' profits, etc.; relative demand and supply of the different qualities and sizes; prejudice in favor of a coal of a particular name; etc.

54. Weathering of Coal.—It is commonly believed that coal when exposed to the weather for a long time loses much of its heating value. Careful experiments show that the loss is usually very slight. The only change that takes place in anthracite on exposure to weather is the oxidation of such iron pyrites as it may contain to iron sulphate. As this salt is soluble and may be washed away, the change is rather of advantage than otherwise. Analyses and calorific determinations of unweathered and weathered samples of several bituminous and semibituminous coals, the latter exposed to the weather for 11 months, showed an average decrease of heating value of about 2 per cent., as calculated from the analyses, but only one-half of 1 per cent. as determined by the calorimeter. A sample of Pocahontas coal exposed in a

coal yard 3 years, showed a heating value per pound of combustible as calculated from the analysis, of 16,113 B. T. U. per pound. This is a very high figure, considerably above the average for freshly mined Pocahontas coal.

55. Such effect as weathering may have seems to be due to the oxidation of a part of the disposable hydrogen of the coal, increasing the percentage of oxygen, but the effect is usually slight.

Richters found that at a temperature of 158° to 180° F., three coals lost in 14 days an average of 3.6 per cent. of calorific power.

It appears from the experiments of Richters and Reder that when there is no rise in the temperature of coal piled in heaps and left exposed to the air during 9 to 12 months, it undergoes no sensible change in any respect; and that, on the other hand, when the coal becomes heated, it suffers precisely the same kind of change that was found by Richters to be effected in coal by heating it in contact with atmospheric air to a comparatively low temperature; namely, an increase in the absolute weight of the coal owing to the oxidation of some of the carbon and hydrogen.

56. The foregoing statements refer more particularly to the theoretical heating values of coals. Certain coals, on exposure to the weather, slack or break into fine pieces or even dust, in which form they cannot be transported or burned by the ordinary methods. Hence, while the theoretical calorific power of such coals may remain practically unchanged by weathering, the value of the coal may be impaired by exposure to the air. Some semibituminous coals, however, give as good results when they are largely reduced to dust by weather and handling as when they are in lumps.

SPONTANEOUS IGNITION OF COAL

57. Coal kept in storage, either in stock piles or in the coal bunkers on steamships, etc., may, under certain conditions, take fire spontaneously. This is particularly true of

bituminous coals, but it seldom occurs with anthracite, except in the case of culm banks. The cause of the spontaneous ignition of coal was formerly thought to be the oxidation of pyrites contained in it; it has been learned, however, that this is not the principal cause, although in the presence of air and moisture the oxidation of pyrites, if present in sufficient quantity, may aid in the generation of heat. Coal naturally absorbs oxygen from the air and in so doing generates heat, undergoing a process of slow combustion. The temperature attained depends on the rapidity of the absorption of the oxygen and the rate at which the heat generated escapes. The absorption of oxygen is greatly influenced by the degree of fineness of the coal and the temperature of the interior of the pile; and the latter by the size of the heap and the ventilation of its interior. The finer the coal the greater is the surface exposed to the action of the air, and the absorption of oxygen becomes more energetic as the temperature is increased; hence, it is evident that the cooler the heap can be kept and the freer from fine coal, the less will be the danger of spontaneous ignition. Large heaps hold the heat better than small ones, and are not as readily ventilated. While good ventilation cools the heap, very poor ventilation may not allow sufficient oxygen to enter the pile to cause spontaneous combustion; therefore, the greatest danger lies midway between the two conditions. Although the amount of heat produced by the oxidation of the pyrites in the coal is small, this oxidation breaks up the coal and thus presents fresh surfaces for the absorption of oxygen. The greatest occurrence of spontaneous combustion of coal is on steamships, where the coal bunkers become heated owing to their poor ventilation.

58. The subject of the spontaneous ignition of coal was investigated, in 1899, by a board appointed by the Secretary of the United States Navy. The following excerpts taken from the report of this board are of interest. While the condensation and absorption of oxygen is always going on to a limited extent, the general immunity of bunker coal in the Navy from spontaneous ignition shows that where fire

results there is probably a further exciting cause producing the ignition of the coal, and this is generally thought to be due chiefly to external heat.

Spontaneous ignition is of infrequent occurrence, and the total number of fires due to this cause in the United States Navy in $3\frac{1}{2}$ years, counting fire in each bunker as a separate fire, was only twenty that occurred on ten ships; and when we reflect that during that time there have been at least forty ships in commission averaging probably forty bunkers each, and that these have probably coaled an average of twenty times, the percentage of bunker fires is seen to be very low. Diligent inquiry has not developed a single instance of spontaneous ignition of anthracite in such sizes as come on board ship. With bituminous coal, lumps of large size and as free as possible from small coal and slack should be preferred; and if practicable, the coal should be screened before taking on board.

Whenever possible, coal with a low percentage of combustible volatile matter and little or no pyrites should be used on board ship and in like places. In any case, coals of established reputation should be chosen, even at a higher price. Such coal is generally freer from slack and pyrites than another coal, and not only less liable to spontaneous ignition, but is cheaper in the end.

With respect to moisture, it is always preferable to take coal on board dry; but when wet coal must be taken it should be used first, if practicable, and the bunkers into which it is put examined at regular intervals. In general, recently mined coal should not be taken, as the fresh coal is more greedy of oxygen than after the absorbing process has proceeded for some time. The coal should be mined at least a month previous to being stored.

59. With respect to the temperature likely to cause ignition, Professor Lewes states: "If the bunker coal next the bulkhead be kept at 120° F., any coal having a tendency to absorb oxygen will run a great chance of igniting within a few days."

60. Fires in Coal Piles.—The United States Navy Department records show only five or six fires in coal piles as having occurred in a period of probably 20 years. Information furnished by a number of firms using large quantities of coal, was mostly of a negative character, as they had never experienced spontaneous ignition in their own coal piles.

The Pacific Mail Steamship Company has had trouble in its coal piles, but found it due to sulphur, and after assuring the absence of this ingredient has had no further trouble, whether the coal was wet or dry. Other firms have stated that in the rare cases of spontaneous ignition in coal piles, within their experience, they believe them due to the presence of sulphur.

61. Precautions in Storage of Bituminous Coal to Prevent Spontaneous Ignition.—Professor Lewes's recommendations on coal storage are as follows: "The coal store should be well roofed in, and have an iron floor bedded in cement; all supports passing through and in contact with the coal should be of iron or brick; if hollow iron supports are used, they should be filled solid with cement. The coal must never be loaded or stored during wet weather, and the depth of coal in store should not exceed 8 feet, and where possible, should only be 6 feet. Under no conditions must a steam or exhaust pipe or flue be allowed in or near any wall of the store, nor must the store be within 20 feet of any boiler, furnace, or bench of retorts. No coal should be stored or shipped to distant ports until at least a month has elapsed since it was brought to the surface. Every care should be taken during loading or storing to prevent breaking or crushing of the coal, and on no account must a large accumulation of small coal be allowed. These precautions, if properly carried out, will amply suffice to entirely do away with spontaneous ignition in stored coal on land."

62. Extinguishing a Coal-Pile Fire.—When a coal pile has ignited, the best way to extinguish the fire is to remove the coal, spread it out, and then use water on the burning part. The incandescent portion is invariably in the

interior, and when the fire has gained any headway usually forms a crust, if the coal is bituminous, that effectually prevents the water from acting efficiently.

COAL DUST AS FUEL

63. Coal dust, when mixed in air, burns with such extreme rapidity as in some cases to cause explosions. Coal may be burned without smoke, and with high economy if, instead of being introduced into the firebox in the ordinary manner, it is first reduced to a powder by pulverizers, and if, instead of the ordinary boiler firebox, there is a combustion chamber in the form of a closed furnace lined with firebrick and provided with an air-injector nozzle similar in construction to those used in oil-burning furnaces. The nozzle throws a constant stream of the fuel into the chamber, and is so located that it scatters the powder throughout the whole space of the firebox. When this powder is once ignited, which is readily done by first raising the lining to a high temperature by an open fire, the combustion continues in a regular manner under the action of the current of air that carries in the fuel.

Powdered fuel has recently been adopted successfully in this country in the rotary kilns used in the manufacture of Portland cement.

64. The best results in burning coal dust can only be obtained when the following essentials are complied with, viz.: (1) The fuel must be reduced cheaply to a very finely divided powder and must be of a strictly uniform grade and size, and must be equally dry throughout; and the drier the better. (2) The coal powder mixed with air must be carried in an unbroken stream into the combustion chamber. (3) The air-current must be so regulated that it will hold the coal powder in suspension, when within the furnace, until complete combustion is effected. (4) A sufficiently high temperature must be continuously maintained in the furnace, to insure perfect combustion of the powder.

The problem of how to reduce the coal economically to the required standards of fineness and uniformity is the one

thing that has given great trouble in developing new devices in firing-apparatus.

65. The advantages of the use of powdered fuel may be summarized as follows: (1) The economical and complete combustion of the fuel; (2) complete smokelessness; (3) reduced labor expenses, since one man can easily manage several furnaces; (4) adaptability and ease of regulation to meet any requirements, especially when the work is that of steam generation; (5) decreased wear and tear of furnaces in the case of internally fired boilers; (6) saving of time in starting up furnaces, and rapid stoppage of firing in case of

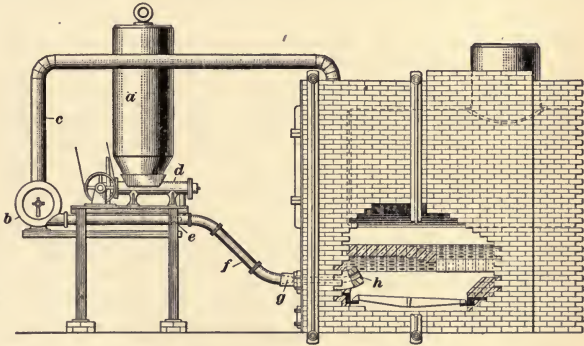

FIG. 1

necessity; (7) less labor in removing refuse, which is small in quantity and in the form of slag; (8) intimate contact of the fuel with the air, whereby a minimum excess of air over the theoretical volume required is employed, and waste of heat thus avoided.

66. **Coal-Dust Burner.**—Fig. 1 shows the general arrangement of the Rowe system of feeding dust into a furnace. The coal is ground to a dust, dried, and conveyed to a storage hopper, and is ready for delivery into the blast pipe. *a* is the storage hopper for the coal dust; *b*, a fan that receives hot air from the pipe *c* and delivers it into the air spout *f*.

The conveyer *d* carries the coal dust from the bottom of the hopper *a* and delivers it into the air spout *f* just in front of the nozzle *e*, which serves to concentrate the air so that it is thoroughly mixed with the dust. At *g*, is a second nozzle for thoroughly mixing the dust and air just before it enters the furnace. The feed-spout *h* is made of cast iron and has a semi-circular opening so as to spray the dust against the arch wall, where it is ignited and burned in suspension. The coal dust is ignited by contact with the walls of the furnace, which have been heated by a fire on the grate. This system can be used with any furnace without alteration of the grates; and in case of accidents, coal can be fed at the furnace doors the same as before.

PRESSED FUEL, OR BRIQUETS

67. Finely crushed coal mixed with warm pitch or other cementing material may be pressed by machinery into blocks or briquets; these make a very good fuel when the coal from which they are made is of good quality. The dust, or culm, that is thrown away at the anthracite mines might thus be made into valuable fuel, but attempts thus far to use it have generally proved commercially unsuccessful in America, on account of the cost of manufacture and the low prices of marketable coal. In Europe, however, the manufacture of briquets from coal dust is quite a large industry.

68. The following are some of the advantages claimed for briquets: They are sound throughout and will not depreciate while burning, thus reducing the loss by fine material working through the grates. The bond, if properly selected, renders the briquets practically waterproof, so that they are not injured if kept in storage, do not evolve combustible gases nor ignite from spontaneous combustion. There is no fine material mixed with the briquets, and hence a more uniform fire can be maintained with them. They can be made of such a form as to occupy less space than the original fuel. The French navy has found it possible to store 10 per cent. more briquets than coal in a given space, and also that the loss by breakage and pulverization is very much less.

69. In Germany, the briquetting of lignite, peat, etc. has reached its greatest development. The crude lignite is crushed and pulverized; it is then heated by steam until it is plastic, when it is carried to the machine press, where it is pressed, between heated iron jaws, into hard, firm briquets.

The present tendency is to employ no inorganic bonding materials, as they increase the ash. The material to be briquetted should be as clean and free from dirt or slate as possible, and the particles should be of practically uniform size. In Europe, it is considered that a lignite for briquetting should contain about 45 per cent. of water, so that after it is dried it will contain just the proper amount needed to form the briquet.

The briquetting of peat has become an important industry in some localities where it can compete with other fuels. It may be compressed with or without the admixture of other inflammable materials such as bituminous coal dust, anthracite culm, or dry sawdust.

70. Machines for Briquetting Fuel.—Fuel, fuel dust, and other products may be briquetted by a number of styles of machines, but all these may be divided into two classes, briquet and eggette machines. The eggette machines have a pair of rollers, the faces of which are provided with semi-spherical or semiovoid openings. The material that is fed between these rolls crowds into the openings of the two rolls, thus forming small spheres. The material is thoroughly mixed with a suitable bond before being fed to the rolls, and the eggettes are received on any suitable form of traveling belt or chute and removed for drying or storage. The briquetting machines all act, more or less, on the principle of the brick machine, having some kind of a die or mold into which the material is crowded. The material is either pressed as it is being fed into the mold or subsequently by some form of plunger. For some materials, common brick machines, such as are used in the manufacture of building brick, are employed; while in others, special forms are necessary.

COKE

71. Coke is the solid material left after driving off the volatile portion of a coal. In general, there are two classes of coke: (1) gas-house coke, which is the residue left in the retort after the gases have been expelled in the manufacture of coal gas; (2) oven coke, which is made in the beehive or by-product retort oven. The manufacture of coke in the beehive and retort ovens is fully described in *Principles of Coking, Coking in the Beehive Oven, and By-Product Coking.*

Gas-house coke is partly used in heating the retorts in which the coal is placed in making coal gas; another portion is used in the manufacture of water gas, and some is sold for fuel purposes.

The coke made in beehive and retort ovens is divided into two classes: *furnace coke*, which is used in blast-furnace smelting, and *foundry coke*, which is used in melting iron in the foundry cupola. Probably 95 per cent. of all the coke produced is used in blast furnaces and foundries.

Coke is also sometimes crushed and sized similar to anthracite and used as a domestic fuel in competition with anthracite. The demand for coke in the manufacture and melting of iron is, however, so great that very little progress has thus far been made in introducing it as a domestic fuel. Table XIV gives analyses of a few standard cokes.

TABLE XIV
ANALYSES OF COKE

(From report of John R. Procter, Kentucky Geological Survey)

Where Made	Fixed Carbon	Ash	Sulphur
Connellsville, Pa., average of 3 samples . . .	88.96	9.74	.810
Chattanooga, Tenn., average of 4 samples . .	80.51	16.34	1.595
Birmingham, Ala., average of 4 samples . .	87.29	10.54	1.195
Pocahontas, Va., average of 3 samples . . .	92.53	5.74	.597
New River, W. Va., average of 8 samples . .	92.38	7.21	.562
Big Stone Gap, Ky., average of 7 samples . .	93.23	5.69	.749

LIQUID FUELS

PETROLEUM

72. Advantages and Disadvantages of Petroleum as a Fuel.—Next to natural gas, the use of which is restricted to a few localities, petroleum is the ideal fuel. One pound of it has a heating value about 50 per cent. greater than an average pound of coal. It may be transported with great facility in pipes, tank cars, and tank vessels, and it may be burned under steam boilers or in heating furnaces without smoke or ashes, and with a great saving of labor as compared with coal.

Its chief disadvantages are its limited supply and, in most localities, its price. The total petroleum output of the United States in 1900 was 63,362,704 barrels, equal, if all had been used as fuel, to about 20,000,000 tons of coal, but the greater portion of it found a more valuable use in the manufacture of lubricating and illuminating oils, and other products. It is not probable that the oil wells of the world will ever contribute more than 1 or 2 per cent. of the total fuel supply.

73. In many parts of the world in which coal is expensive, as in California, Texas, Mexico, and South America, petroleum will be largely used in place of coal on account of its relatively lower price. The possibility of economically substituting petroleum for coal as fuel in any particular place depends chiefly on the relative prices of the two fuels at that place, and as the prices of both fuels are continually varying, there may be some years at any given place when it is more economical to use oil, and others when it is more economical to use coal.

74. Heating Value.—The average heating value of crude petroleum is about 20,000 B. T. U. per pound or 147,400

B. T. U. per gallon. The heating value of a pound of coal is from about 10,000 to 15,000 B. T. U.

75. One barrel of petroleum contains 42 gallons. Taking the specific gravity of petroleum as .885, 1 gallon weighs 7.37 pounds and 1 barrel, $42 \times 7.37 = 310$ pounds, nearly. From this, the relative value of a barrel of oil and a ton (2,000 pounds) of coal as given in Table XV is found.

TABLE XV

Thermal Value of Different Coals B.T.U. per Pound	Pounds of Coal Equivalent to 1 Pound of Petroleum	Pounds of Coal Equivalent to 1 Barrel of Petroleum	Barrels of Petroleum Equivalent to 1 Ton of Coal
10,000	2.000	620	3.23
11,000	1.818	564	3.55
12,000	1.667	517	3.87
13,000	1.538	477	4.19
14,000	1.429	443	4.52
15,000	1.333	413	4.82

If we take an average coal at 12,400 B. T. U. per pound, which would represent an anthracite with about 15 per cent. of ash and moisture, a ton of average coal is equivalent to 4 barrels of oil.

The figures in Table XV represent what may be called the theoretical relative values of petroleum and coal. They are also the practical relative values if the two fuels cost the same for labor in handling, storage, insurance, etc., and if they are burned with equal efficiency in the furnaces. These conditions vary considerably in different cases. In ocean steamers, for instance, there is a great advantage in favor of petroleum on account of the carriage being cheaper, since for a given heating value only about two-thirds of the weight, on an average, has to be stored and carried. There is also a great saving of labor in the handling of the fires, and the troubles due to ash and clinker are avoided.

EXAMPLE 1.—If a coal having a heating value of 12,000 B. T. U. per pound is worth \$3 per ton of 2,000 pounds, what is crude petroleum, having a heating value of 20,000 B. T. U. per pound, worth per barrel of 310 pounds if both fuels can be burned with equal efficiency and cost the same for handling?

SOLUTION.—The heating value of 1 ton of the coal is $12,000 \times 2,000 = 24,000,000$ B. T. U. With the coal worth \$3 per ton, 1 cent will buy $\frac{24,000,000}{300} = 80,000$ B. T. U. The heating value of 1 barrel of petroleum is $20,000 \times 310 = 6,200,000$ B. T. U. Hence, 1 barrel is worth $\frac{6,200,000}{80,000} = 77\frac{1}{2}$ ct. Ans.

EXAMPLE 2.—Under the conditions in example 1: (a) how many pounds of coal are equivalent to a barrel of oil? (b) How many barrels of oil are equivalent to a ton of coal?

SOLUTION.—(a) $\frac{20,000 \times 310}{12,000} = 516\frac{2}{3}$ lb. Ans.
 (b) $\frac{2,000}{516\frac{2}{3}} = 3.87$ bbl. Ans.

76. Composition of Petroleum.—Crude petroleum is a mixture of hydrocarbons, which may be separated by distillation at different temperatures; thus, gasoline is driven off by heating from 140° to 158° F.; a light benzine or naphtha at from 158° to 248° F.; heavier benzines at 248° to 347° F.; kerosene, or ordinary illuminating oil, at 338° F. and upwards; lubricating oils at 482° F. and upwards; paraffin wax at a higher temperature; leaving a tarry residuum that may be further distilled until nothing but a small quantity of coke remains in the still.

77. Petroleum is composed mainly of carbon and hydrogen, though small amounts of oxygen and nitrogen are usually present and sometimes sulphur, which is particularly annoying to the refiner.

Table XVI gives the composition of petroleums from different localities.

78. The analyses in Table XVII are by fractional distillation and are an indication of the value of the oils for commercial purposes.

TABLE XVI

Locality	Specific Gravity at 0° C.	Elementary Composition		
		C	H	O by Difference
<i>United States</i>				
California		86.93	11.82	2.70
California		86.62	12.92	.54
California		86.93	13.07	
Kentucky		85.20	13.36	1.11
Ohio887	84.20	13.10	.70
Ohio, Mecca		86.30	13.07	
Pennsylvania ¹ , near Franklin886	84.90	13.70	1.40
Pennsylvania, Oil Creek816	82.00	14.80	3.20
Texas, Beaumont920	86.80	13.20	
West Virginia841	84.30	14.10	1.60
West Virginia857	83.20	13.20	3.60
<i>Foreign Countries</i>				
Canada, W. Canada857	81.30	13.40	2.30
Canada, Petrolia870	84.50	13.50	2.00
China, Fu-li-fu860	83.50	12.90	3.60
Galicía, West Galicía ²855	85.30	12.60	2.10
Galicía, East Galicía870	82.20	12.10	5.70
Germany ³ , Hanöver892	80.40	12.70	6.90
Germany, Pechelbronn892	85.70	12.00	2.30
Germany, Schwabweiler861	86.20	13.30	.50
Italy, Parma786	84.00	13.40	1.80
East India, Burmah875	83.80	12.70	3.50
Java, Rembang923	87.10	12.00	.90
Java, Tjabados, Fanga827	83.60	14.00	2.40
Java, Gagor927	85.00	11.20	2.80
Roumania901	83.00	12.20	4.80
Russia, Baku ⁴882	87.40	12.60	.10
Russia, Baku, very heavy938	86.60	12.30	1.10
Russia, Baku954	85.30	11.60	3.10

¹The Pennsylvania crude oil consists principally of the paraffins, with a small percentage of the aromatic series and a minute quantity of the naphthenes in the heavy distillates. All American petroleum contains oxygen and sulphur compounds and a few, also, nitrogen compounds.

²The Galicía oils consist of mixture of paraffins, naphthenes, and aromatic hydrocarbons.

³The German oils are principally paraffins, containing also aromatic hydrocarbons and naphthenes.

⁴The Baku oils are composed of naphthenes and a few other hydrocarbons, as well as oxygen and sulphur compounds; in the lighter fractions small quantities of paraffin are found.

79. Uses of Petroleum.—Crude oil, as well as its various distillates, may be used as fuel if proper provision is made for burning it; but since the gasoline and benzine vapors that it gives off at low temperatures form explosive mixtures with air, it is not a safe fuel to be kept in storage; therefore, these vapors should be distilled from it before it is shipped.

Gasoline and benzine are used as fuel for oil engines, and as fuel for steam boilers of small pleasure yachts, but they must be handled with great care to avoid leakage and consequent danger of fire and explosion.

By blowing air into either crude oil or its lighter distillates, such as naphtha, it becomes charged with light oil vapors, and may be used like a gas in gas engines or for other fuel purposes.

Kerosene makes an excellent fuel for small oil stoves, and for oil engines that are especially made for its use, but it is generally too expensive to be used on a large scale, where cheap fuel oils, residuum; etc. are available.

METHOD OF BURNING PETROLEUM

80. Although the use of liquid fuel for steam making has not become general, it is constantly growing in favor. When burned in properly constructed burners its combustion is complete, giving no smoke and no ash. It can be burned under any boiler with very little alteration of the furnace so that in case of accident the firing may be continued with coal with but little delay. For the successful burning of petroleum without smoke, it is apparent that the combustion must be complete in the furnace. To accomplish this, there must not only be a sufficient air supply, but the fuel must be in a finely divided condition and intimately mixed with the air. Under these conditions, the combustion will be instantaneous and complete. The spray is produced by means of atomizers of various designs.

81. Numerous forms of petroleum burners are on the market, but all are designed to effect an atomization of the oil and to mix it thoroughly with air. When properly operated,

any one of these forms is efficient. The form or type of burner is less essential than the furnace in which it is used, or than the proper regulation of the supply of oil and air. The most common forms of burners use a jet of steam at high pressure for spraying the oil and for inducing a current of air to mix with the spray. Air compressed to 15 pounds per square inch, or upwards, may be used instead of steam. The only advantage of steam is the facility with which it may usually be obtained. Its disadvantage is that it costs not only the heat required to generate it, but the heat required for superheating it to the temperature at which it finally escapes in the chimney. In driving a steam boiler with oil fed by a steam jet, the jet may require as much as 10 per cent. of the whole quantity of steam generated by the boiler, or much more than would be required to run an air compressor supplying an air jet. Petroleum burners driven by air jets produce a higher temperature than those driven by steam jets.

Petroleum burners may be divided into two general classes, the *flat-jet* and the *injector*.

82. Flat-Jet Burners.—Two forms of the flat-jet type are shown in Figs. 2 and 3. Fig. 2 is a form that consists of two tubes fastened together. In this, *a* is the oil pipe; *b*, a cock for regulating the supply of oil; *c*, the steam pipe; *d*, the steam valve; *e*, a guard around the pipe to guide the oil over the steam jet.

A stream of oil flows from the supply tank through *a* and is distributed in a thin sheet over the jet of

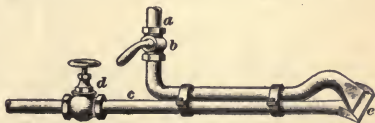

FIG. 2

steam, with the result that the oil is carried forwards in the form of a finely divided spray. By changing the shape of the jet of steam, different shapes may be given to the flame.

83. The other form of the flat-jet burner, Fig. 3, has an oil passage *a* below which is the steam passage *b*. The burner is tapped at the side for a $1\frac{1}{4}$ -inch oil pipe at *c* and a

$\frac{1}{2}$ -inch steam pipe at *d*. The oil coming through the passage *a* falls directly on the steam shooting through the narrow slit *e* at the end of the passage *b* and is completely atomized. Two holes at the back of the burner are closed by plugs *m, n*, which are removed for cleaning.

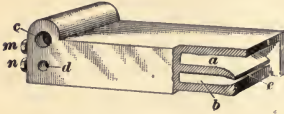

FIG. 3

Fig. 4 shows the arrangement of this burner in a locomotive firebox. The back damper is completely closed, and a large front damper with about 2 square feet of superficial opening is arranged in front. A plate with an air opening 20 by 14 inches supports the firebrick at the back of the firebox, which receives the vaporized oil. The supply of air is regulated by the front damper, and the supply of oil by a

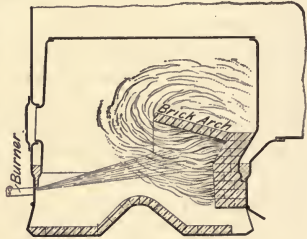

FIG. 4

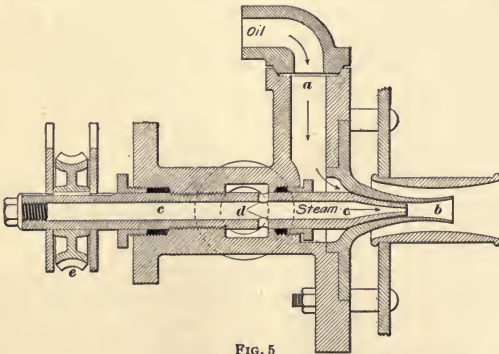

FIG. 5

wheel valve in the cab. With the air and oil under perfect control, there is no difficulty in obtaining perfect combustion.

84. Injector Oil Burners.—Of the injector type of oil burner, the one invented by Thomas Urquhart and used on locomotives in Russia many years ago, as shown in Fig. 5, is a fair example. The oil runs down a pipe *a* that ends in the external nozzle *b* of the injector, while the steam passes through the inner nozzle *c*, which it enters through a ring of holes *d*, the steam and oil cavities being separated by a stuffingbox packed with asbestos. The steam supply is regulated by a valve and the oil supply by screwing the steam

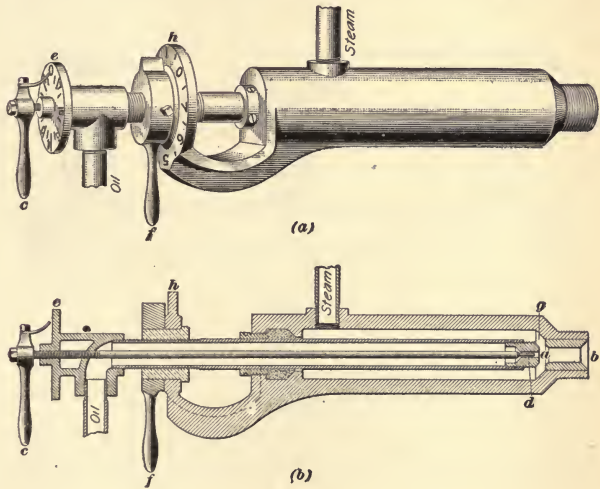

FIG. 6

nozzle backwards and forwards in the external nozzle by means of a worm-wheel *e*, thus varying the size of the annular passage between the two nozzles *b, c*. The amount of steam required to operate the injector on the Russian railway, according to Mr. Urquhart, is from 8 to 13 per cent. of the steam made by the boiler, the higher percentage being required in winter.

85. Fig. 6 (*a*) and (*b*) shows the Kirkwood burner or atomizer. The oil enters through the opening shown and

passes through the inner nozzle *a*, when it comes in contact with the steam jet, which vaporizes the oil and projects it through the nozzle *b* into the furnace. The amount of oil passing through *a* is regulated by the handle *c*, which opens or closes the valve *d*, the disk *e* indicating the amount the valve is open. Similarly, by means of the handle *f*, the steam passage *g* may be regulated, the amount of opening being indicated by the disk *h*.

86. Fig. 7 shows a burner in which the oil is atomized by compressed air at a pressure of about 15 pounds per

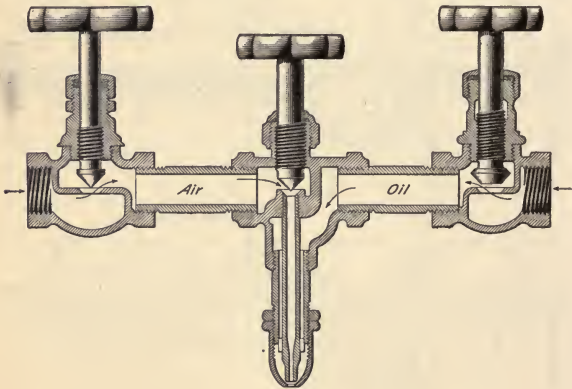

FIG. 7

square inch. Lower pressures have been found insufficient to properly atomize the oil. The oil centers through the right-hand valve, follows the course of the arrow leading from the chamber marked *Oil* until it reaches the end of the central nozzle, where it is vaporized by a stream of compressed air which enters through the left-hand valve, passes through the chamber marked *Air*, and flows down the central nozzle.

87. Fig. 8 shows a method of installing an oil-burning system in a steam-boiler plant, designed by The International Gas and Fuel Company, of Chicago. Four ducts of hollow

tile *a*, are laid in the ash-pit, extending nearly to the bridge-wall; the ash-pit door openings are closed by brickwork *b* above the outer ends of the tile. The forward grate-bar bearer is dropped, about half the forward set of bars removed, and a course of firebrick laid with fireclay over the upper surface of the grate. Air entering through the tiles passes under the grates to an opening in front, then into the combustion chamber. The spray of burning oil strikes a

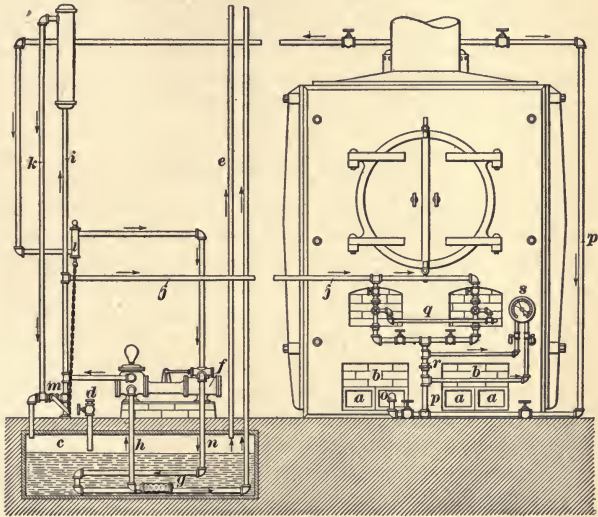

FIG. 8

checkerwork of loose firebrick built over the rear part of the grates. The fire-doors are closed with brick, excepting small openings for the burner nozzles and for lighting the burners.

Oil is delivered from barrels through the pipe *d* into a closed tank *c* sunk in the ground; *e* is a vapor vent pipe. A steam pump *f* draws oil through the strainer *g* and pipe *h* and delivers it to the stand pipe *i*, whence it flows by the pipe *j* to the burner under a head of about 10 feet. The

pump runs constantly, and the surplus oil flows back to the tank *c* through the pipe *k*. A device *l* having a piston connected by a chain with a cock *m*, automatically opens the cock to empty the stand pipe when the boiler is not under steam pressure. The exhaust pipe *n* passes through the tank, to heat the oil in cold weather. A blow-off pipe *o* drains the burner steam pipe of water. At the point where the steam and oil mix, hot air is supplied to the burners by the pipe *q*, which passes through the fire-door into a brick flue over the grate and down into the ash-pit. The steam going to the burner flows through a coupling *r* containing a perforated disk; the duplex gauge *s* shows the pressure on each side of the orifice in this disk.

GASEOUS FUELS

88. The different gases used as fuel are the following, arranged in the order of their heating value: (a) *Natural gas*, which is obtained from wells in different parts of the world; (b) *illuminating gas*, or *coal gas*, which is made either by distilling coal in retorts or by enriching water gas with the volatile matter distilled from cannel coal or with vapors distilled from petroleum; (c) *coke-oven gases*, which are mainly those coming from by-product ovens, as explained in the Sections on coking, although occasionally the gases from the beehive ovens are used under boilers; (d) *water gas*, which is made by blowing steam through a bed of glowing anthracite or coke, by the reaction $C + H_2O = CO + 2H$; (e) *producer gas*, which is made by blowing air into burning bituminous coal, in which case the volatile matter, including condensable tarry vapors, is distilled, and the coke is burned to carbon monoxide; producer gas is also made by blowing air into burning anthracite, thus producing carbon monoxide; (f) *combined water gas* and *producer gas*, which is made by blowing air mixed with steam into a producer charged with burning bituminous coal; (g) *blast-furnace gas*, which is the waste gas coming from the top of a blast furnace, and which contains a certain amount of carbon monoxide available as fuel.

TABLE XVIII
ANALYSES AND HEATING VALUES OF VARIOUS GASES

Constituent Gases	Pittsburg Natural Gas	Coal Gas (Illuminating)	Solvay Coke-Oven Gas	Lencanhez Producer Gas	Dowson Producer Gas	Siemen's Producer Gas	Mond Producer Gas
	Volume Per Cent.	Volume Per Cent.	Volume Per Cent.	Volume Per Cent.	Volume Per Cent.	Volume Per Cent.	Volume Per Cent.
Hydrogen <i>H</i>	22.0	48.0	56.9	20.0	18.7	8.6	24.8
Marsh gas (methane) <i>CH</i> ₄	67.0	39.5	22.6		.3	2.4	2.3
<i>C</i> _n <i>H</i> _{2n} gases	6.0	3.8	3.0	4.0	.3		
Carbon monoxide, <i>CO</i>6	7.5	8.7	21.0	25.1	24.4	13.2
Carbon dioxide, <i>CO</i> ₂6		3.0	5.0	6.6	5.2	12.9
Nitrogen, <i>N</i>	3.0	.5	5.8	49.5	49.0	59.4	46.8
Total volume (approximate)	100.0	100.0	100.0	100.0	100.0	100.0	100.0
Total combustible gases	95.6	98.8	91.2	45.0	44.4	35.4	40.3
Heating value (B. T. U. per cubic foot at 64° F.)	892.4	686.0	511.0	207.5	160.0	134.5	154.6

89. Table XVIII shows the composition and heating value of different gases, as given by H. A. Humphrey in the Proceedings of the Institution of Civil Engineers of Great Britain, 1897.

90. Table XIX gives some additional analyses of natural, producer, and coke-oven gases, together with their average heating values.

91. Blast-furnace gas varies greatly in its composition, and in six analyses made in 1 day, the carbon dioxide varied from 6.6 to 7.7 per cent., the carbon monoxide from 20.1 to 31.7 per cent. and the nitrogen and hydrocarbons from 60.5 to 72.2 per cent. by volume. The heating value calculated from the average analyses was 1,175 B. T. U. per pound, and at the temperature of 584° F., at which it entered the steam boiler furnace, it carried 140 B. T. U. per pound additional heat. The 1,175 B. T. U. per pound are equal to about 94 B. T. U. per cubic foot, measured at 32° F., or only about one-tenth of the value of a cubic foot of natural gas.

92. As shown by Tables XVIII and XIX, all the fuel gases are mixtures of several gases. The gases highest in heating value contain the largest percentages of hydrogen and hydrocarbons; and those lowest in heating value contain the largest percentages of nitrogen and carbon dioxide. Producer gases contain all the nitrogen of the air blown into the producer and also some carbon dioxide on account of the great difficulty of burning all the carbon to monoxide.

93. The heating value per pound and per cubic foot, measured at 32° F., and atmospheric pressure, of the several constituents of a mixed fuel is given in Table XX. The figures in the first column are those of Favre and Silbermann excepting in the two cases noted. Other heating values differing slightly from these are given by different authorities, owing to a difference in the experiments by which the values have been determined. In the third column are shown approximate figures, giving B. T. U. per pound of combustible, that are within the limits of error of chemical

TABLE XIX

Constituent	Natural Gas				Producer Gas			By-Product Coke-Oven Gases		
	No. 1 Per Cent.	No. 2 Per Cent.	No. 3 Per Cent.	No. 4 Per Cent.	Maxi- mum Per Cent.	Mini- mum Per Cent.	Average Per Cent.	*Otto-Hoffman		Oven Not Stated
					Rich Gas (Illumina- ting)	Poor Gas (Fuel Gas)				
Carbon dioxide, CO_280	.60			3.0	8.0	5.5	2.9	2.0	1.30
Carbon monoxide, CO . . .	1.00	.80	.58	1.00	18.0	25.0	23.0	6.2	5.0	6.00
Oxygen, O	1.10	.80	.78	2.10		.5		.1	.4	.45
Ethylene, C_2H_470	.98	.80	.80		.5				
Ethane, C_2H_6	3.60	5.50	7.92	5.20						3.40
Marsh gas (methane), CH_4	72.18	65.26	60.70	57.85	1.0	4.0	3.0	37.4	29.2	33.50
Hydrogen, H	20.62	26.12	29.03	9.64	6.0	12.0	8.0	44.3	51.8	50.45
Nitrogen, N			23.41		58.0	65.0	60.5	4.1	9.1	4.90
Average heating value B. T. U. per cubic foot.			1007				120 to 140	707.8	515.0	

*From the Everett Plant near Boston, Mass., where the gases coming from the ovens are separated into a rich portion used for illuminating purposes and a poor portion used for fuel purposes.

analyses and calorimetric experiments, and may be used in making calculations.

TABLE XX

Substance	Burned in Oxygen		Approximate Values per Pound B. T. U.
	Per Pound B. T. U.	Per Cubic Foot B. T. U.	
Hydrogen to H_2O	62,032	346.75	62,000
Carbon to carbon dioxide, CO_2 . . .	14,544		14,600
Carbon to carbon monoxide, CO . .	4,451		4,450
Carbon monoxide, CO , to carbon dioxide CO_2 , per unit of CO . . .	4,325	338.00	4,300
Carbon monoxide, CO , to carbon dioxide, CO_2 , per unit of carbon C			10,150
Marsh gas (methane), CH_4 , to H_2O and CO_2	23,513	1,050.00	
Ethylene (olefiant-gas), C_2H_4 , to H_2O and CO_2	21,344	1,568.00	
Benzole gas, C_6H_6 , to H_2O and CO_2	17,847		
Acetylene, C_2H_2 , to H_2O and CO_2 .	18,196*	1,351.60	
Sulphur to SO_2	4,050†		4,000

* Calculated.

† N. W. Lord.

94. The equivalent centigrade values, in pound-calories, may be obtained by dividing the B. T. U. by 1.8. Thus, 62,000 B. T. U. = $\frac{62,000}{1.8} = 34,444$ pound-calories.

NOTE.—The *pound-calorie* is the amount of heat necessary to raise the temperature of 1 pound of water $1^\circ C$. The French calorie is the amount of heat necessary to raise the temperature of 1 kilogram (2.2 pounds) of water $1^\circ C$. When the term calorie is used in this Section, the pound-calorie is meant.

PRODUCER GAS

95. The **producer** or the apparatus in which **producer gas** is made, is a cylindrical riveted shell of boiler plate, lined with firebrick. The early producers were made rectangular in section, but the circular section was adopted as offering many advantages, and is now wholly used. The principal

improvement in producers since the original Siemens producer has been the adoption of a closed bottom. To accomplish this, the producer proper rests in a water pan, through which the ashes or clinkers are raked out. This water acts as a seal, preventing the escape of gas and the introduction

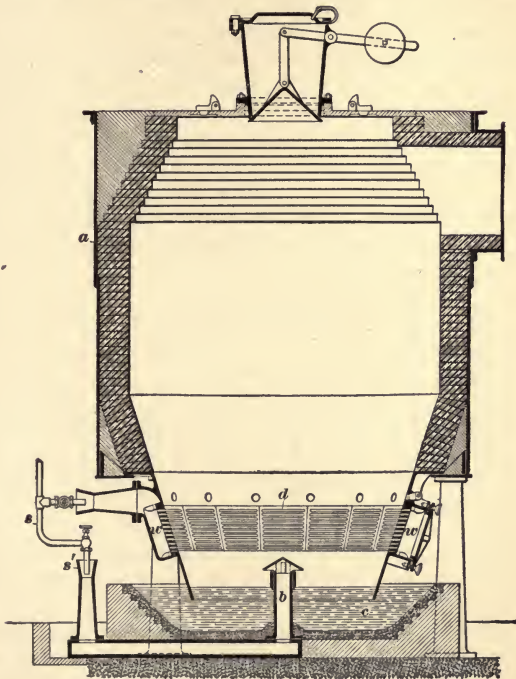

FIG. 9

of air, which occurred in the old producers while the fires were being cleaned, contributing much to their irregular working and the poor quality of gas. Instead of being flat, the grate is conical, and underneath it the pipe conveying air and steam terminates, introducing these in the center of the

producer, thus insuring an even and regular circulation within the chamber.

96. Forter Water-Seal Producer.—Fig. 9 shows one of the most successful and a general type of the water-seal producer. It has the usual brick-lined shell of steel *a*. There are usually but two steam jets *s* on opposite sides to introduce the air and steam into the wind box *w* and under the grate. In this one, a third steam jet *s'* forces steam and air into the center of the producer by means of a pipe terminating beneath the grate *d*, as shown at *b*, and protected from ashes by a cone-shaped hood. The wind box has a number of air-tight doors, through which sections of the grate can be removed to bar out any large clinkers accumulating on the bottom. The ashes drop into water in the ash-pan *c* as the coal is burned, and are removed from time to time without interfering with the working of the producer.

TABLE XXI

Number of Sample	Proximate Analysis			Ultimate Analysis				
	Volatile Matter Per Cent.	Fixed Carbon Per Cent.	Ash Per Cent.	Total Carbon Per Cent.	Hydrogen Per Cent.	Oxygen and Nitrogen Per Cent.	Ash Per Cent.	Sulphur Per Cent.
1	36.20	58.20	5.60	75.63	4.30	13.62	5.60	.85
2	34.70	58.45	6.85	76.63	4.57	10.95	6.85	1.00
3	32.80	58.10	9.10	73.92	4.73	11.53	9.10	.92
4	33.75	55.00	11.25	72.87	4.76	10.10	11.25	1.02

97. Fuel Employed for Making Producer Gas. Producer gas can be made from anthracite, bituminous coal, coke, charcoal, peat, or even wood. The coal used should be of good quality, quite free from sulphur, if the gas is to be used in steel making, and should have a low or moderate percentage of ash, and be of such a character as not to clinker on the grate. While practically all bituminous coals (if not too high in sulphur) may be used, there is a decided difference in their value. Proximate and ultimate analyses of four samples of

good average coal for producer gas are given in Table XXI. The proximate analysis (with the sulphur) is all that is necessary for the ordinary valuation of a coal for this purpose.

Ordinarily, the higher the coal is in volatile matter, the richer is the gas produced, as it contains more hydrocarbons. Sulphur should not exceed 1 per cent., but this depends on its condition in the coal—if it is in such a combination that it is mostly oxidized, remaining with the ash as sulphate, it may be much higher; if principally volatilized, even this amount may allow the steel to absorb too much of it from the gas.

98. Producer Reactions.—The reactions that take place in making producer gas are:

1. Carbon burned to carbon dioxide,

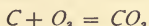

2. Reduction of the CO_2 by the hot coal to carbon monoxide,

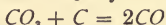

3. Incandescent carbon decomposing water vapor,

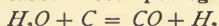

On the grate in the bottom of the producer are the ashes, which serve to heat the steam and air; and, in connection with the water seal, prevent the escape of gas in cleaning the fires. Next above this is the bed of incandescent fuel, where the air and steam combine with the carbon in the above reactions. On top of this is the section where distillation occurs. The temperature is constantly lowered by the addition of fresh coal, but the heat of the bed beneath keeps up the distillation of the volatile products of the fuel. While the ash bed is sharply separated from the bed above, the two upper beds overlap and their reactions occur to a considerable extent in the same region.

The reactions are not all as simple as expressed in the above equations, as a series of more or less complicated processes occur. Under certain conditions, part of the distillation may take place lower in the hotter section, when the original hydrocarbons will be partly broken up and new ones formed. The production of gas is regulated nearly automatically, as the amount of gas withdrawn determines

the supply of air to the grate—assuming, of course, that the producer is otherwise properly managed. One volume of carbon monoxide produced requires $2\frac{1}{2}$ volumes of air containing 2 volumes of nitrogen to pass through the grate; 1 volume of water vapor on decomposition gives 1 volume of hydrogen and 1 volume of carbon monoxide.

99. Operation of the Producer.—The fuel is fed through a bell and hopper, by shoveling, or by chutes from overhead storage bins. As the coal in the producer becomes hot, it partially disintegrates and cakes, forming layers, through which the air is forced with difficulty, or channels are made through the coal so that a large part of the carbon dioxide first formed will not be brought in contact with carbon and reduced to carbon monoxide. To avoid this, "poke holes" are placed in the top of the producer, through which the incandescent mass is broken and stirred with long pokers at intervals of a few minutes. Ashes and clinkers are removed about every other day, depending on the quality of the fuel and the rate at which the producer is driven. Other conditions being right, the hotter and deeper the fire, the better the reactions take place. The usual depth of fire is about 6 feet, varying with the ashes on the grate and the rate of feeding the fuel. If the fire gets much deeper than this, it is impossible to keep the lower part of it broken up, however well it is poked; if much shallower, the carbon dioxide and water vapor are not decomposed.

COAL GAS

100. Coal gas is made by heating bituminous coal in -shaped fireclay retorts that are arranged as shown in Fig. 10. These retorts are about 15 inches high, by 26 inches wide, inside, and 9 to 10 feet long if single-ended, or 18 to 20 feet long if double-ended. The retort walls are about 4 inches thick and each retort is connected with a pipe that allows the gas to escape as fast as formed.

Three, six, or nine retorts, depending on the size of the works are generally grouped together to form a bench; this

is heated by a single furnace placed beneath the retorts. A **stack** consists of several benches built side by side. The fuel for heating the retorts is the gas coke that is left after the gas has been distilled from the coal.

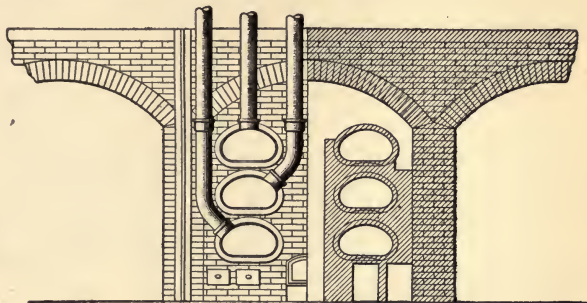

FIG. 10

101. Operating a Bench.—The retorts are first heated to a red heat and then from 200 to 400 pounds of coal, depending on the size of the retort, is put in with a long shovel and carefully leveled. The mouth of the retort is next closed with a lid, which is sealed with cement. The charge remains in the retort for about 4 hours when the lid is taken off and the coke pulled out by a rake.

102. Fig. 11 gives a general idea of a complete coal-gas plant. The gas, which is drawn from the retorts by means of a pump or an exhauster, passes up the vertical pipe shown in Fig. 11, which curves downwards into the hydraulic main *e*. This main is partly filled with water, which cools the gases so that a considerable amount of the tar and ammonia contained in them is condensed. From the hydraulic main, the gas passes through *c*, *d* to the condenser *f*, which removes the balance of the tar. This condenser consists of curved pipes that are either cooled by the air or else by water surrounding them. Gases next pass through the scrubber *g*, which is filled with coke or small brushwood over which water is running. This water further cools the gas and

removes any tar that has not been removed in the hydraulic main *e* or in the condenser *f* and also takes out the ammonia. The gas next passes through the purifier *p*, which contains trays of dry or slightly dampened lime, which removes the last traces of impurities. The gas then passes through the pipe *l* into the gas holder *q*.

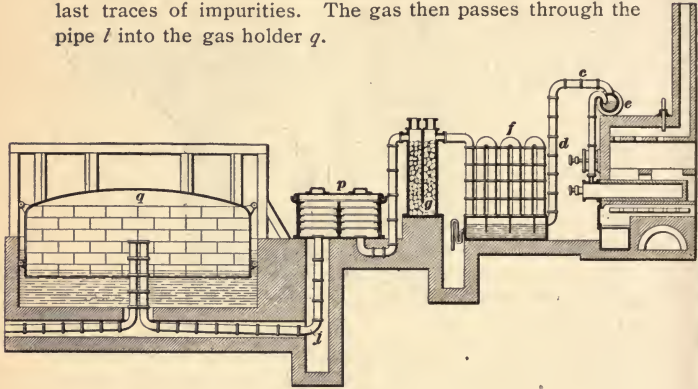

FIG. 11

103. Gas Coals.—Table XXII gives analyses of typical American gas coals.

TABLE XXII
GAS COALS

Constituents	Westmoreland Coal Company			Pennsylvania Gas Coal Company		
	South Side Mine	Foster Mine	Larrimer No. 2	Irwin No. 1	Irwin	Sewickley
Water	1.410	1.310	1.560	1.78	1.280	1.490
Volatile matter	37.655	37.100	39.185	35.36	38.105	37.153
Fixed carbon	54.439	55.004	54.352	59.29	54.383	58.193
Sulphur636	.636	.643	.68	.792	.658
Ash	5.860	5.950	4.260	2.89	5.440	2.506
Total	100.000	100.000	100.000	100.00	100.000	100.000

Under ordinary conditions, a ton of such coal should produce about 10,000 cubic feet of gas of 17 candlepower; 1,400 pounds of coke, 12 gallons of tar, and 4 pounds of ammonia.

104. The following may be considered as the average composition of purified coal gas:

	PER CENT.
Hydrocarbon vapors6
Heavy hydrocarbons	4.4
Carbon dioxide, CO_2	3.4
Carbon monoxide, CO	10.1
Marsh gas, CH_4	30.6
Oxygen, O3
Hydrogen, H	45.9
Nitrogen, N	4.7
Total	<u>100.0</u>

WATER GAS

105. **Water gas** is a mixture of hydrogen and carbon monoxide. It is manufactured commercially by the contact of steam with incandescent carbon, in the form of anthracite or coke which decomposes the steam, the hydrogen being separated from the oxygen. The oxygen takes up carbon from the coal or coke and forms carbon monoxide, along with a small amount of carbon dioxide. The resultant gases therefore are mainly hydrogen and carbon monoxide mechanically mixed together. This is what is called **blue**, or **uncarbureted, water gas**. It burns with a non-luminous flame and is consequently useless for lighting purposes, except in incandescent lamps of the Welsbach type. In actual practice, this water gas is always enriched with oil gas, which furnishes the hydrocarbons necessary to make a luminous flame. The oil gas was made separately in many of the older forms of apparatus, but it is now commonly produced in the same apparatus in which the water gas is made.

106. Impurities in Water Gas.—The only impurity that must be removed from water gas is hydrogen sulphide, which is formed from the sulphur that is always present in varying amounts in the coal or coke and sometimes in the oil. The hydrogen sulphide is removed by purification with lime or iron oxide in the same way that the purification of coal gas is accomplished.

Carbon dioxide, which is formed either by imperfect contact of the steam with the incandescent carbon, or because the temperature of the carbon is too low, is not a dangerous impurity, but is merely an inert gas incapable of combustion. It, however, absorbs heat when the gas is burned, and is consequently injurious to the heating and lighting power. It can be removed by purification with lime, but this is not necessary if the generating apparatus is handled properly, as the quantity made will be very small. No ammonia is produced.

107. Composition of Purified Water Gas.—The following is a volumetric analysis of a sample of purified water gas:

	PER CENT.
Hydrocarbon vapors	1.2
Heavy hydrocarbons	12.6
Carbon dioxide, CO_2	3.0
Carbon monoxide, CO	28.0
Marsh gas, CH_4	20.2
Oxygen, O4
Hydrogen, H	31.4
Nitrogen, N	3.2
Total	100.0

108. Water gas requires from 30 to 40 pounds of coal or coke per 1,000 cubic feet of gas made, and from 4 to 5 gallons of oil, depending on the candlepower required. Usually between 5 and 6 candlepower is obtained from each gallon of oil used. The specific gravity of 24-candlepower water gas is about .625, air being taken as unity.

Pure uncarbureted water gas has no perceptible odor, but the carbureted gas has an odor fully as strong as coal gas.

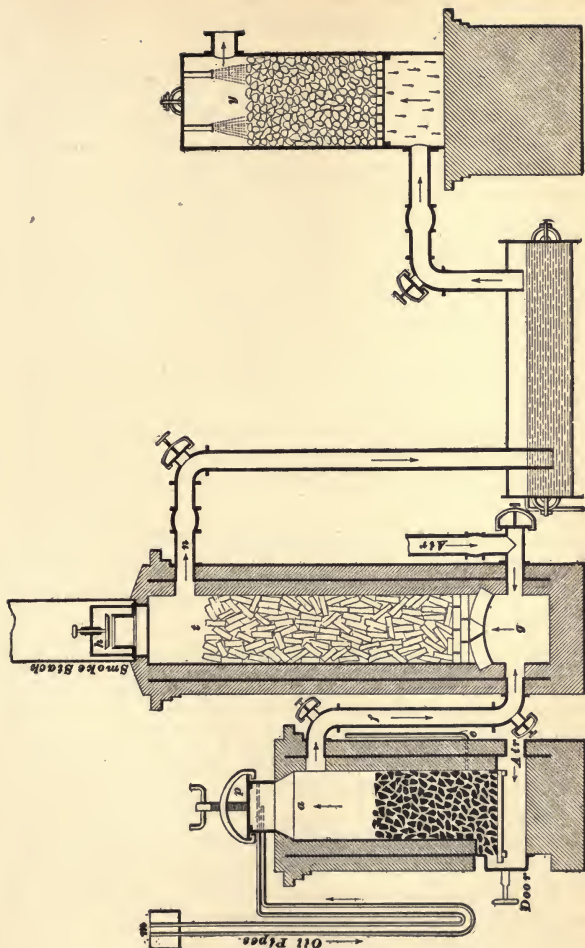

FIG. 12

This is mainly due to the hydrocarbons from the oil that is used for enriching.

109. A good example of a water-gas plant is given in Fig. 12. The generator *a* is first filled, to the height shown in the figure, with clean anthracite, egg size. The coal is fed through *p* from the second floor, where it is stored. The coal in the generator is ignited and raised to a very high temperature by means of an air blast. The gases, passing through the pipe *f* in the direction of the arrows, again meet with an air blast at *g*, which blows them in a hot flame through the superheater *l* and out through the valve *h* to the smokestack. The body of the superheater is filled with loose firebricks, which take up the heat from the passing gases.

As soon as the bricks become sufficiently heated, the air blast is shut off, the valve *h* is closed, and steam at a very high temperature admitted through the pipe *e*. The steam, on coming in contact with the white-hot coal, gives up its oxygen which combines with the carbon of the coal to form carbon monoxide; the hydrogen of the steam is set free, and, mixing with the carbon monoxide, forms water gas. This gas passes through the superheater, where any steam remaining is further broken up, and flowing out through *n* passes through the washer to the scrubber *y* and thence to the condensing apparatus.

110. The water gas, as it now is, burns with a pale-blue flame, giving little or no light. On this account, it is necessary, in order to make the gas a good light giver, to add some hydrocarbon. For this purpose, oil is allowed to flow in a fine stream into the generator from the reservoir *m*, during the passage of the steam. These hydrocarbons make the gas flame white, and water gas, properly treated in this way, gives a much brighter flame than coal gas. The hydrocarbons are often added after the gas is purified; they are not needed, however, when the gas is to be used for heating purposes or for gas engines.

USES OF GASEOUS FUEL

111. Whenever natural gas can be obtained cheaply, it is an ideal fuel for all heating purposes, and it is also most valuable for use in gas engines. Having the highest fuel value per cubic foot of any of the mixed gases, it requires smaller pipes than any other for conveying a quantity having a given heating value. It may also be burned in furnaces for metallurgical purposes, giving a high temperature without any preheating of the gas or air. For very high temperatures the air should be heated.

Producer gases of various kinds, and water gas, are used in heating furnaces, but in order to produce a high temperature with them, such as that required for melting steel, it is necessary to heat both the gas and the air in a *regenerator* before they are admitted into the furnace.

The waste gases of blast furnaces are burned under steam boilers without preheating the air or the gas, but the gas is usually delivered from the furnace at a temperature of from 400° to 600° F. They are also burned in ovens for heating the air supply of the blast furnace, and recently they have been used to some extent in large gas engines.

112. Distribution of Gaseous Fuel.—The use of gaseous fuel made in producers, instead of solid fuel, is especially advantageous in iron and steel works, where it is convenient to have one large central gas-producing plant operated with a minimum of labor, and to distribute the gas over moderate distances through pipes to the several furnaces, to be used as desired. In such plants, however, it has not been found profitable to use producer gas under steam boilers, chiefly for the reason that there is a certain waste of fuel and of heat in making the gas and conveying it to the boilers. This loss is saved by burning the coal directly under the boilers.

113. It has often been suggested that it would be economical to have large central stations in cities in which fuel gas would be produced from coal, to be distributed in pipes

for domestic use, and many ventures have been made in this direction, but they have all proved commercial failures. In order to be profitable, the gas would have to be sold at the works at a much higher price than the coal from which it is made, and the cost of storage and distribution of producer gas to meet a varying demand is usually much greater than that of storing and carrying coal.

114. In connection with the by-product process of coking, there is a large amount of gas given off and this gas is used for fuel purposes about the steel plants, at which many of the by-product coking plants are located, or the gas is enriched and used for lighting and general fuel purposes as is done at the plant of the New England Gas and Coke Company at Everett, near Boston, Massachusetts.

115. Use of Gas in Gas Engines.—Whenever it is possible to obtain a given number of heat units from gas, cheaper than they can be obtained from coal, as in the case of the use of blast-furnace gas, or the waste gases from retort coke ovens, or natural gas when it can be obtained cheaply, it becomes cheaper to obtain power from gas engines than from steam engines and boilers using coal. It is even possible to obtain a given horsepower from a gas engine using gas made in a producer from anthracite, with a less expenditure of coal than would be required for the same power by a steam boiler and steam engine. Of the total heating value of coal, only about 5 per cent. is utilized in the shape of mechanical energy by small ordinary steam engines, and less than 16 per cent. by a triple- or quadruple-expansion engine of the best type; while in a gas engine using gas made from anthracite or coke, from 12 to 20 per cent. of the heating value of the coal may be utilized. The best result yet obtained from a steam engine of the highest grade is 1 horsepower per hour from 1.05 pounds of the best steam coal, while the best results from gas producers and gas engines are from .85 to 1 pound of coal per horsepower-hour.

116. The special fields of the gas engine are in localities where gaseous fuel can be obtained cheaply, either natural

gas, or waste gas from furnaces or coke ovens; or for small powers, 50 horsepower or less, using illuminating gas, the extra cost of fuel being offset by the saving of labor of operating a steam boiler. The gas engine is also well adapted for occasional or intermittent service, since it can be started instantly, without the delay of getting up steam in a boiler.

COMBUSTION OF FUEL

117. Chemistry of Combustion.—In burning fuel in a furnace, any of the following reactions may take place, according to whether hydrogen or moisture is present in the fuel, and according to the conditions under which air is supplied.

(a) Hydrogen combines with oxygen, forming water, the reaction being expressed by the formula,

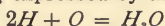

$$2 + 16 = 18 \text{ parts by weight}$$

giving 62,000 B. T. U. per pound of hydrogen burned.

(b) Carbon unites with oxygen, forming carbon monoxide,

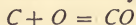

$$12 + 16 = 28 \text{ parts by weight}$$

giving 4,450 B. T. U. per pound of carbon burned.

(c) Carbon unites with oxygen, forming carbon dioxide,

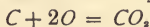

$$12 + 32 = 44 \text{ parts by weight}$$

giving 14,600 B. T. U. per pound of carbon burned.

(d) Carbon unites with oxygen, forming a mixture of carbon monoxide and carbon dioxide, according to the amount of oxygen present,

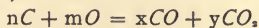

(e) If both hydrogen and carbon are present in a fuel as marsh gas, CH_4 , and the supply of oxygen is ample, the marsh gas burns according to the following reaction,

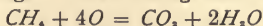

$$16 + 64 = 44 + 36$$

giving 23,513 B. T. U. per pound of marsh gas, CH_4 , burned.

If the supply of oxygen is deficient, the temperature being moderately low, the hydrogen burns first, part of the carbon

escaping as smoke or soot. With a greatly deficient supply of air, part of the hydrogen may also escape unburnt, the furnace then becoming a gas producer. The burning of the hydrogen alone, leaving all the carbon unburnt, is expressed by the formula,

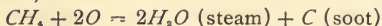

$$12 + 4 + 32 = 36 + 12 \text{ parts by weight}$$

(f) If the temperature of the furnace be previously made high, however, by burning carbon to carbon dioxide, and steam be injected into the white-hot coke remaining in it, the above reaction may be practically reversed, giving at a very high temperature and a partial supply of steam,



$$12 + 18 = 28 + 2 \text{ parts by weight}$$

or a mixture of carbon monoxide and hydrogen, which is water gas.

(g) If the steam supply be greater, and the temperature lower, the reaction may be



$$12 + 36 = 44 + 4 \text{ parts by weight}$$

or carbon dioxide and hydrogen.

118. The last two reactions (f) and (g) may be called *unburning*; they take as much heat from the furnace as the burning of the same weight of hydrogen to water, H_2O , would generate, less the heat that is made by burning the carbon. This heat production and absorption may be computed as follows:

In equation (f), the heat produced in burning 12 pounds of carbon to carbon monoxide is $12 \times 4,450 = 53,400$ B. T. U.

The heat absorbed in setting free 2 pounds of hydrogen is $2 \times 62,000 = 124,000$ B. T. U.

Net absorption of heat is $124,000 - 53,400 = 70,600$ B. T. U.

In equation (g), the heat produced by burning 12 pounds of carbon to carbon dioxide is $12 \times 14,600 = 175,200$ B. T. U.

The heat absorbed in setting free 4 pounds of hydrogen is $4 \times 62,000 = 248,000$ B. T. U.

The net absorption is $248,000 - 175,200 = 72,800$ B. T. U.

119. If air be blown in at the bottom of a deep bed of hot coal, two reactions take place:

(a) The oxygen supplied by the air to the bottom layers of coal is sufficient to burn the carbon to carbon dioxide according to the reaction,

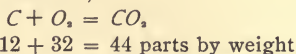

producing 14,600 B. T. U. per pound of carbon burned.

(b) The carbon dioxide passing through the upper layers of coal is reduced to carbon monoxide by taking up an equal weight of carbon to that burned in the previous reaction, according to the reaction,

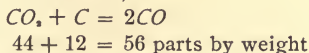

and in so doing absorbing $14,600 - 4,450 = 10,150$ B. T. U. per pound of carbon burned. The combined result of these two reactions is as follows:

	B. T. U.
Heat produced burning 1 pound of carbon to carbon dioxide	14,600
Heat absorbed reducing the carbon dioxide to carbon monoxide (14,600 - 4,450)	<u>10,150</u>
Net heat produced	4,450
Heat produced burning 1 pound of carbon to carbon monoxide	<u>4,450</u>
Total heat produced burning 2 pounds of carbon to carbon monoxide	8,900

or, $\frac{8,900}{2} = 4,450$ B. T. U. per pound of carbon

Since the final product is carbon monoxide, CO , the total net heat produced by the combined reactions is the same per pound of carbon as when carbon is burned to carbon monoxide.

EXAMPLE.—What is the amount of heat produced by the combustion of a pound of coal whose analysis is: carbon, 86 per cent.; hydrogen, 5 per cent.; oxygen, 8 per cent.; nitrogen, 1 per cent.; if all the available hydrogen is burned, three-fourths of the carbon is burned to carbon dioxide, and one-fourth to carbon monoxide?

SOLUTION.—The available hydrogen is $5 - \frac{1}{2} = 4$ per cent.
Heat produced per pound of fuel burned is as follows:

	B. T. U.
For hydrogen, $.04 \times 62,000$	2,480
For carbon burned to carbon dioxide, $\frac{3}{4}(.86)$ × 14,600	9,417
For carbon burned to carbon monoxide, $\frac{1}{4}(.86)$ × 4,450	956
Total heat due to carbon burned	10,373
Total heat produced	12,853
	Ans.

120. Weight and Volume of Gases.—Table XXIII gives the weight and volume of the various gases that enter into problems relating to combustion when measured at 32° F. and mean atmospheric pressure at sea level, which is 14.7 pounds per square inch.

121. To find the volume at any other temperature and pressure, the following formula is used,

$$v_1 = v_2 \frac{p_2 T_1}{p_1 T_2}$$

in which v_2 = volume corresponding to the absolute pressure p_2 and the absolute temperature T_2 (or $460 + t_2$);

p_2 = any given absolute pressure (for the figures in Table XXIII it is 14.7 pounds per square inch);

v_1 = volume at any other pressure p_1 and absolute temperature T_1 (or $460 + t_1$).

EXAMPLE.—What is the volume of 4 pounds of dry air at 75° F. and under an absolute pressure of 20 pounds per square inch?

SOLUTION.—From Table XXIII, it is found that 1 lb. of air, at 32° F. and 14.7 lb. per sq. in. absolute pressure, occupies 12.388 cu. ft., hence, under the same conditions, 4 lb. occupies $4 \times 12.388 = 49.552$ cu. ft. Substituting, in the formula, the values $v_2 = 49.552$, $p_2 = 14.7$ lb. per sq. in., $p_1 = 20$ lb. per sq. in., $t_1 = 75^\circ$ F., we get

$$v_1 = 49.552 \times \frac{14.7}{20} \times \frac{535}{492} = 39.6 \text{ cu. ft. Ans.}$$

122. Fuel Burned in Air.—In the preceding statements, the fuel was considered to be burned by oxygen gas.

TABLE XXIII

Gases	Density, Air = 1	Density, $H = 1$	Density, Approximate $H = 1$	Grams per Liter	Pounds per Cubic Foot	Cubic Feet per Pound
Air	1.0000	14.444	14.4	1.2931	.080723	12.388
Oxygen, O	1.1052	15.963	16	1.4291	.089210	11.209
Hydrogen, H0692	1.000	1	.0895	.005590	178.931
Nitrogen, N9701	14.012	14	1.2544	.078310	12.770
Carbon monoxide, CO9671	13.968	14	1.2505	.078070	12.810
Carbon dioxide, CO_2	1.5197	21.950	22	1.9650	.122670	8.152
Marsh gas (methane), CH_45530	7.987	8	.7150	.044640	22.426
Ethylene, C_2H_49674	13.973	14	1.2510	.078090	12.805
Acetylene, C_2H_28982	12.973	13	1.1614	.072510	13.792
Sulphur dioxide, SO_2	2.2130	31.96	32	2.8633	.178650	5.598
Water vapor, H_2O6218	8.981	9	.8041	.050200	19.922

In burning with air, the chemical reactions are the same, for the nitrogen in the air passes through the furnace unchanged. In calculations of temperature, however, account must be taken of the nitrogen, since it is heated by the combustion and therefore absorbs heat and causes the furnace to have a lower temperature than if oxygen alone were used.

123. Properties of Air.—Pure dry air is composed of a mixture of 20.91 parts of oxygen and 79.09 parts of nitrogen, by volume, or 23.15 parts of oxygen and 76.85 parts of nitrogen, by weight.

The approximate proportions usually given in textbooks are: by volume, 21 parts of oxygen and 79 parts of nitrogen; and by weight, 23 parts of oxygen and 77 parts of nitrogen.

The proportion of nitrogen to oxygen by weight is $76.85 \div 23.15 = 3.320$; by volume, $79.09 \div 20.91 = 3.782$.

The proportion of air to oxygen, by weight, is $100 \div 23.15 = 4.320$; by volume, $100 \div 20.91 = 4.782$.

Ordinary atmospheric air, outdoors, contains about 4 parts in 10,000 of carbon dioxide, and a quantity of vapor of water depending on the temperature and the relative humidity of the atmosphere. The **relative humidity** of the air at any time is the percentage of moisture contained in it as compared with the amount that it is capable of holding at the same temperature.

124. Table XXIV gives the weights of air, water vapor, and saturated mixtures of air and water vapor at different temperatures, under the ordinary atmospheric pressure of 14.7 pounds per square inch, or 29.92 inches of mercury.

EXAMPLE 1.—A coal whose heating value is 12,000 B. T. U. per pound, is burned with 20 pounds of air (not including water vapor) per pound of coal. The relative humidity of the air is 90 per cent., and its temperature is 92° F. How much heat is lost in the chimney gases on account of the moisture in the air, if the chimney gases escape at 512° F.?

SOLUTION.—From Table XXIV, it is found that 1 lb. of air will hold, when fully saturated, .03289 lb. of water vapor at 92° F.; hence, 20 lb. of air will hold $20 \times .03289 = .6578$ lb. of water vapor; at 90 per cent. relative humidity, it will hold $.6578 \times .90 = .59202$ lb. water vapor.

The amount of heat absorbed in heating 1 lb. of water from 92° F. to 512° F. is: (a) From 92° to 212°, or through 120°, is 120×1 (specific heat of water) = 120 B. T. U.; (b) from 212° to 512°, or through 300°, is $300 \times .48$ (specific heat of superheated steam) = 144 B. T. U. The total absorption is $120 + 144 = 264$ B. T. U. .59202 lb. water will

TABLE XXIV

Temperature Degrees F.	Weight of a Cubic Foot of Dry Air at Differ- ent Temperatures Pounds	Elastic Force of Water Vapor Inches of Mercury	Mixtures of Air Saturated With Vapor				
			Elastic Force of Air in Mixture of Air and Vapor Inches of Mercury	Weight of Cubic Foot of Mixture of Air and Water Vapor			Weight of Vapor Mixed With 1 Pound of Air Pounds
				Weight of Air Pounds	Weight of Vapor Pounds	Total Weight of Mixture Pounds	
0	.0864	.044	29.877	.0863	.000079	.086379	.00092
12	.0842	.074	29.849	.0840	.000130	.084130	.00155
22	.0824	.118	29.803	.0821	.000202	.082302	.00245
32	.0807	.181	29.740	.0802	.000304	.080504	.00379
42	.0791	.267	29.654	.0784	.000440	.078840	.00561
52	.0776	.388	29.533	.0766	.000627	.077227	.00819
62	.0761	.556	29.365	.0747	.000881	.075581	.01179
72	.0747	.785	29.136	.0727	.001221	.073921	.01680
82	.0733	1.092	28.829	.0706	.001667	.072267	.02361
92	.0720	1.501	28.420	.0684	.002250	.070717	.03289
102	.0707	2.036	27.885	.0659	.002997	.068897	.04547
112	.0694	2.731	27.190	.0631	.003946	.067046	.06253
122	.0682	3.621	26.300	.0599	.005142	.065042	.08584
132	.0671	4.752	25.169	.0564	.006639	.063039	.11771
142	.0660	6.165	23.756	.0524	.008473	.060873	.16170
152	.0649	7.930	21.991	.0477	.010716	.058416	.22465
162	.0638	10.099	19.822	.0423	.013415	.055715	.31713
172	.0628	12.758	17.163	.0360	.016682	.052682	.46338
182	.0618	15.960	13.961	.0288	.020536	.049336	.71300
192	.0609	19.828	10.093	.0205	.025142	.045642	1.22643
202	.0600	24.450	5.471	.0109	.030545	.041445	2.80230
212	.0591	29.921	0.000	.0000	.036820	.036820	Infinite

absorb $264 \times .59202 = 156.29$ B. T. U., or $\frac{156.29 \times 100}{12,000} = 1.3$ per cent. of the heating value of the coal. Ans.

EXAMPLE 2.—How many cubic feet of dry air per pound of coal are used in the case of example 1, if the air is at the mean atmospheric pressure of 14.7 pounds per square inch?

TABLE XXV
OXYGEN AND AIR REQUIRED FOR THE COMBUSTION OF CARBON, HYDROGEN, ETC.

Fuel	Chemical Reaction	Pounds <i>O</i> per Pound Fuel	Pounds <i>N</i> = $3.32 \times O$	Air per Pound = $4.32 \times O$	Gaseous Product per Pound Fuel
Carbon to CO_2	$C + 2O = CO_2$	$2\frac{2}{3}$	8.85	11.52	12.52
Carbon to CO	$C + O = CO$	$1\frac{1}{3}$	4.43	5.76	6.76
Carbon monoxide to CO_2	$CO + O = CO_2$	$\frac{1}{2}$	1.90	2.47	3.47
Hydrogen to H_2O	$2H + O = H_2O$	8	26.56	34.56	35.56
Marsh gas (methane), CH_4 , to CO_2 and H_2O	$CH_4 + 4O = CO_2 + 2H_2O$	4	13.28	17.28	18.28
Sulphur to SO_2	$S + 2O = SO_2$	1	3.33	4.32	5.32

SOLUTION.—From the Table XXIV, by calculation, it is found that 1 lb. of air at 32° and at the mean atmospheric pressure oc-

cupies $\frac{1}{.0807} = 12.39$ cu.

ft. At 92° it occupies

$12.39 \times \frac{92 + 460}{492} = 13.9$

cu. ft.; 20 lb. will occupy

$13.9 \times 20 = 278$ cu. ft.

Ans.

EXAMPLE 3.—How many cubic feet of air must be delivered per minute by a fan, to drive 1,000 horsepower of boilers under the conditions of examples 1 and 2, if 4 pounds of coal is burned per horsepower-hour?

SOLUTION.—

$\frac{4 \times 1,000 \times 278}{60} = 18,533$

cu. ft. per minute. Ans.

125. Quantity of Air Required for Combustion. Table XXV shows the chemical reactions involved in the combustion of hydrogen, carbon, and sulphur, the weights of oxygen required per pound of fuel, of the nitrogen mixed with the air, of the air, and of the gaseous products.

126. It is found, in practice, that if air is blown through a bed of hot anthracite or coke, and the resulting gases are analyzed, they always contain some carbon monoxide, showing imperfect combustion, unless they contain a considerable quantity of uncombined oxygen, or air. The excess of air required to effect complete combustion to carbon dioxide is usually not less than 50 per cent. of that theoretically necessary, so that about 17 pounds of air is required to insure the complete combustion of 1 pound of carbon instead of 11.52 pounds, the figure given in Table XXV. It is probable, also, that more than 34.56 pounds of air is required to effect the combustion of each pound of hydrogen in a furnace, although, experimentally, one volume of oxygen and two volumes of hydrogen mixed together, or eight parts by weight of oxygen to one of hydrogen may be exploded by a spark, and converted into water vapor. The excess of air required in furnaces may be due to the presence of the great volume of nitrogen and carbon dioxide, which dilute the oxygen and make it less active in causing combustion.

EXAMPLE 1.—How much air is required for the complete combustion of 1 pound of coal containing 5 per cent. moisture, 20 per cent. volatile matter, 60 per cent. fixed carbon, 15 per cent. ash, assuming the volatile matter to be of the composition of marsh gas (methane), CH_4 ?

SOLUTION.—The molecular weight of marsh gas is $12 + 4 = 16$; hence, three-fourths of the weight of the volatile matter is carbon and one-fourth hydrogen. The carbon of the volatile matter is $\frac{3}{4} \times 20 = 15$ per cent. of the fuel. The fixed carbon is given as 60 per cent. The total carbon is $15 + 60 = 75$ per cent. The hydrogen of the volatile matter is $\frac{1}{4} \times 20 = 5$ per cent. of the fuel.

Since from Table XXV, 11.52 lb. of air is required to burn 1 lb. of carbon to CO_2 , and 34.56 lb. of air is required to burn 1 lb. of hydrogen, the theoretical amount of air required to burn the fuel will be:

	POUNDS
For the carbon $.75 \times 11.52$	8.640
For the hydrogen $.05 \times 34.56$	1.728
Total	10.368
	Ans.

If an excess of 50 per cent. of air be allowed, the amount will be $1.5 \times 10.368 = 15.552$ lb. Ans.

EXAMPLE 2.—How many cubic feet of dry air at 62° F. will be required in example 1?

SOLUTION.—The weight of 1 cu. ft. of air at a temperature of 62° F. and a barometric pressure of 29.92 is .0761 lb.; hence, 10.368 lb. = $\frac{10.368}{.0761} = 136.24$ cu. ft. and 15.552 lb. = $\frac{15.552}{.0761} = 204.36$ cu. ft. Ans.

127. **Temperature of Ignition.**—Every combustible must be heated to a certain temperature, known as the *temperature of ignition*, or kindling point, before it will combine with oxygen, or burn. Table XXVI gives the temperatures of ignition of various fuels as determined by different authorities.

TABLE XXVI

Fuel	Temperature of Ignition Degrees F.
Marsh gas (methane), CH_4	1,202*
Carbon monoxide, CO	1,202 to 1,211
Carbon monoxide, CO , in presence of a large quantity of carbon dioxide CO_2 ,	1,292
Ethylene (olefiant gas), C_2H_4	1,022
Hydrogen	1,031 to 1,130
Anthracite	925
Semibituminous coal	870
Bituminous coal	766
Cannel coal	668
Soft charcoal, prepared at 500° F.	650
Sulphur	470

It appears from Table XXVI that it requires a considerably higher temperature to ignite the gases distilled from coal than to ignite the coal itself, the temperature of ignition of the carbon being lower than that of ignition of the gases.

*The temperature of ignition of marsh gas diluted with carbon dioxide and nitrogen in the proportions ordinarily found in a furnace is given by the French Coal Commission as 1,436° F.

128. The temperature of ignition of charcoal varies with the temperature at which the charcoal was made, the higher the temperature of manufacture or preparation, the higher the temperature of ignition, as is shown in Table XXVII.

129. **Temperature of the Fire.**—Assuming that a pure fuel, such as carbon, is thoroughly burned in a furnace, all the heat generated will be transferred to the gaseous products of combustion, raising their temperature above that at which the fuel and the oxygen or air are supplied to the furnace. Suppose that 1 pound of carbon is burned with $2\frac{2}{3}$ pounds of oxygen, forming $3\frac{2}{3}$ pounds of carbon dioxide, both the carbon and the oxygen being supplied at 0° F. The combustion of the pound of carbon generates 14,600 B. T. U., which will all be contained in the $3\frac{2}{3}$ pounds of carbon dioxide. The specific heat of carbon dioxide is .217 at constant pressure; that is, it requires .217 B. T. U. to raise

TABLE XXVII

	Degrees F.	Degrees F.	Degrees F.	Degrees F.	Degrees F.
Temperature of preparation	1,000	1,500	2,000	2,500	3,000
Temperature of ignition	800	900	1,100	1,300	2,500

the temperature of 1 pound of carbon dioxide, 1° F. To raise $3\frac{2}{3}$ pounds of carbon dioxide 1° F. will require $3\frac{2}{3} \times .217 = .7957$ B. T. U., and 14,600 B. T. U. will therefore raise its temperature $14,600 \div .7957 = 18,348.6^{\circ}$ F. (approximately $18,350^{\circ}$ F.) above the temperature at which the carbon and the oxygen were supplied. The temperatures thus calculated are known as theoretical temperatures, and are based on the assumptions of perfect combustion and no loss by radiation. The temperature of $18,350^{\circ}$ is far beyond any temperature known in the arts, and it is probable that long before it could be reached, the phenomenon of dissociation would take place; that is, the carbon dioxide would be split into carbon and oxygen, and the elements would lose their affinity for each other.

130. The theoretical elevation of temperature of the fire may conveniently be calculated by the formula

$$\text{Elevation of temperature} = \frac{\text{B. T. U. generated by the combustion}}{\text{Weight of gaseous products} \times \text{their specific heats}}$$

It is evident from this formula that the rapidity of the combustion, or the time required to burn a given weight of fuel, has nothing to do with the temperature that may theoretically be attained. In practice, the temperature of a bed of coal in a furnace and that of the burning gases immediately above the coal are reduced, to some extent, by radiation; and as the quantity of heat radiated from a given mass of fuel is a function of the time during which it takes place, a considerable portion of the heat generated may be lost by radiation when the combustion is very slow. With ordinary rates of combustion, however, that is, of about 10 pounds of coal per square foot of grate surface per hour, and firebrick furnaces, the percentage of loss of heat by radiation is quite small, 1 per cent. or less, and the actual temperature that may be attained will be very nearly as high with that rate of combustion as with a rate of 20 or 40 pounds.

131. The elevations of temperatures given in Table XXVIII were determined by means of the preceding formula. In this table, the specific heat of the chimney gases is taken as .24.

132. Maximum Theoretical Temperature of the Fire Due to Burning Hydrogen in Dry Air.—To burn 1 pound of hydrogen, 8 pounds of oxygen is required, and there is also present $8 \times 3.32 = 26.56$ pounds of nitrogen, which is mixed with the oxygen in the air. The gaseous products are 9 pounds of water, in the shape of superheated steam (specific heat .48), and 26.56 pounds of nitrogen (specific heat .2438). The heat produced is 62,000 B. T. U. If the temperature of the atmosphere is 62° F., 150 B. T. U. is absorbed during the combustion in heating 1 pound of water, H_2O , from 62° to 212° F. per pound, 965.8 B. T. U., in evaporating it at that temperature, and .48 ($T+t - 212$) in superheating it from 212° to the temperature $T+t$ of the

TABLE XXVIII

Carbon Burned Partly to CO and Partly to CO ₂ With Deficient Supply of Air										Carbon Burned to CO ₂ With Excess of Air					Carbon Burned Partly to CO ₂ and Partly to CO With Excess of Air				
Air Supply Below 11.52 Pounds Per Cent.	Air per Pound of Carbon, Pounds	Chimney Gases (Air and Carbon) Pounds	Carbon Burned to CO ₂ , Per Cent.	Carbon Burned to CO, Per Cent.	Heat Generated in Forming CO ₂ B. T. U.	Heat Generated in Forming CO B. T. U.	Total Heat Generated B. T. U.	Elevation of Temperature of Fire Degrees F.	Air Supply Above 11.52 Pounds, Per Cent.	Air per Pound of Carbon, Pounds	Chimney Gases (Air and Carbon) Pounds	Elevation of Temperature of Fire Degrees F.	Carbon Burned to CO ₂ , Per Cent.	Carbon Burned to CO, Per Cent.	Excess of Air Per Cent.	Chimney Gases (Air and Carbon) Pounds	Elevation of Temperature of Fire Degrees F.		
0	11.52	12.52	100		14,600		4,858	25	14.40	15.40	3,950	100	100		50	18.28	3,328		
10	10.37	11.37	80	20	11,680	890	4,606	50	17.28	18.28	3,328	80	80	20	40	15.52	3,375		
20	9.22	10.22	60	40	8,760	1,780	4,298	75	20.16	21.16	2,875	60	60	40	30	12.99	3,350		
30	8.06	9.06	40	60	5,840	2,670	3,914	100	23.04	24.04	2,530	40	40	60	20	10.67	3,323		
40	6.91	7.91	20	80	2,920	3,560	3,413	150	28.80	29.80	2,041	20	80	10	10	8.60	3,139		
50	5.76	6.76	100		4,450	4,450	2,743	200	34.56	35.56	1,711	100	100		100	6.76	2,743		

fire, T being the increase of temperature and t the temperature of the atmosphere, which in this case is 62° F. All this heat may be recovered by condensing the steam and cooling the water of condensation to 62° . We, therefore, obtain the following equation:

$$62,000 = 9[150 + 965.8 + 0.48(T + 62 - 212)] \\ + 26.56 \times .2438 T$$

which being solved gives, $T = 4,873^\circ$ F. $T + t = 4,935^\circ$ F. Showing that hydrogen and carbon, when perfectly burned, give about the same maximum theoretical temperature.

133. Temperature of the Fire, the Fuel Containing Hydrogen and Water.—By a process of reasoning similar to the preceding, the following formula is derived, to obtain the maximum theoretical temperature of the fire, when the fuel contains hydrogen and moisture with a varying supply of air.

$$T = \frac{616 C + 2,220 H - 327 O - 44 W}{f + .02 W + .18 H}$$

in which T = elevation of temperature above that of atmosphere;

C = percentage of carbon in fuel;

H = percentage of hydrogen in fuel;

O = percentage of oxygen in fuel;

W = percentage of water in fuel;

f = pounds of dry gases of combustion (H_2O excluded) per pound of fuel.

EXAMPLE 1.—What would be the temperature of the fire, the temperature of the atmosphere being 62° F., in burning a coal having the composition, excluding ash and sulphur, carbon 75 per cent., hydrogen 5 per cent., oxygen 10 per cent., moisture 10 per cent.; the dry chimney gases amount to 20 pounds per pound of this combustible, including the moisture?

SOLUTION.—Applying the formula,

$$T = \frac{616 \times 75 + 2,220 \times 5 - 327 \times 10 - 44 \times 10}{20 + .02 \times 10 + .18 \times 5} = 2,540^\circ \text{ F.} \\ T + t = 2,540^\circ + 62^\circ = 2,602^\circ \text{ F. Ans.}$$

EXAMPLE 2.—What is the maximum temperature attainable by burning moist wood of the composition carbon 38 per cent., hydrogen

5 per cent., oxygen 32 per cent., nitrogen and ash 1 per cent., moisture 24 per cent.; the dry gases are 15 pounds per pound of wood, and the temperature of the atmosphere is 62° F.?

SOLUTION.—Applying the formula,

$$T = \frac{616 \times 38 + 2,220 \times 5 - 327 \times 32 - 44 \times 24}{15 + .02 \times 24 + .18 \times 5} = 1,403^\circ \text{ F.}$$

$$T + t = 1,403^\circ + 62^\circ = 1,465^\circ \text{ F. Ans.}$$

EXAMPLE 3.—What will be the temperature of a fire of Pocahontas coal analyzing carbon 84.22 per cent., hydrogen 4.26 per cent., oxygen 3.48 per cent., nitrogen .84 per cent., sulphur .59 per cent., ash 5.85 per cent., water .76 per cent.; the dry gases are 20 pounds per pound of combustible, the heating value of the sulphur being neglected?

SOLUTION.—The combustible, carbon and hydrogen, is 88.48 per cent. of the coal, hence $t = 20 \times .8848 = 17.69$. Applying the formula,

$$T = \frac{616 \times 84.22 + 2,220 \times 4.26 - 327 \times 3.48 - 44 \times .76}{17.69 + .02 \times .76 + .18 \times 4.26} = 3,257^\circ \text{ F.}$$

$$T + t = 3,257^\circ + 62^\circ = 3,319^\circ \text{ F. Ans.}$$

134. Actual Temperature Lower Than Theoretical.

When the combustion is perfect, and the furnace is entirely enclosed in walls of firebrick, highly heated, the temperatures calculated by the formula are nearly attained, the only loss being that due to external radiation. In ordinary practice, with the boiler immediately above the fire, the temperature is lowered by radiation, and also, when soft coal is used, by imperfect combustion.

135. Estimation of Air Supply.—The theoretical amounts of air required to burn the several combustible elements in a fuel were given in Table XXV, but when burning coal in a furnace only a rough estimate of the quantity of air supplied may be obtained by direct measurement by an anemometer, or by counting the revolutions of a fan. If it were practicable to measure the air in a large tank like a gasometer, or to pass it through a gas meter, a correct measurement might be obtained, but this is not practicable except in a laboratory experiment. The best, and, in fact, the only available method of closely approximating the amount of air supplied, is by making a proximate analysis of the gases of

combustion, taken from a point close to the furnace, but beyond the point of visible flame. If taken from the chimney, the gas may be of different composition on account of inward leaks of air through cracks in the brickwork. The analysis of the gases gives the percentage of carbon dioxide, oxygen, and carbon monoxide, in this order, the quantity of these gases being determined by absorption; nitrogen is determined by difference; that is, the remainder after subtracting the sum of the other three gases from 100. Unburned hydrogen or hydrocarbon gases cannot be conveniently determined by ordinary analysis. If the combustion is complete, the percentage of nitrogen will always be found between 79 and 80 per cent. If it exceeds 80 per cent., it is evidence either of the presence of unburned hydrogen, or hydrocarbons, or of error in the analysis, or possibly, of the burning of the hydrogen of a gaseous fuel, leaving carbon unburned. Thus, in burning marsh gas (methane), CH_4 , with an insufficient supply of air, the hydrogen only may be burned to water, H_2O , leaving the carbon unburned in the shape of soot, which is caught in a filter attached to the gas-collecting apparatus. The water, or water vapor, is condensed, and is not determined in the analysis, leaving the nitrogen that accompanied the oxygen, alone to be determined. In this manner, the nitrogen in the gases may actually exceed 80 per cent.

136. The following formula may be used for calculating the air supply:

$$\text{Pounds of dry air per pound of carbon} = \frac{3.032 N}{CO_2 + CO}$$

in which CO_2 , CO , and N are percentages, by volume, of the dry gas.

EXAMPLE.—How many pounds of air are supplied per pound of carbon in burning a coal, if the gases analyze carbon dioxide 11.74 per cent., carbon monoxide .10 per cent., oxygen 7.71 per cent., nitrogen 80.45 per cent?

SOLUTION.—Substituting in the formula,

$$\frac{3.032 \times 80.45}{11.74 + .10} = 20.6 \text{ lb. Ans. })$$

HEAT OF COMBUSTION

137. Every combustible chemical element, such as carbon, hydrogen, and sulphur, and every gaseous fuel of definite chemical composition, containing two or more elements, such as carbon monoxide, CO , and marsh gas (methane), CH_4 , when completely burned in oxygen or in air generates a definite quantity of heat per pound of the combustible, which quantity may be ascertained with a close approximation to accuracy by means of an instrument known as a *fuel calorimeter*, in which all the heat generated is absorbed in a weighed quantity of water and is measured by the rise in temperature of the water and the vessel that contains it. The exact determination of the heat of combustion, or calorific value, of any combustible requires a very delicate apparatus, a high degree of skill on the part of the operator, and an allowance for certain unavoidable errors, such as loss by radiation, so that the calorific values of different combustibles as reported by different authorities show a slight variation.

138. Dulong's Formula.—The heating value of any fuel, such as coal, consisting of a mixture of combustible and non-combustible substances may be directly determined by means of a calorimeter, or it may be calculated from its ultimate chemical analysis by **Dulong's formula**, which is:

$$\text{Heating value} = \frac{1}{100} \times \left[14,600 C + 62,000 \left(H - \frac{O}{8} \right) + 4,000 S \right]$$

$$\text{or, heating value} = 146 C + 620 \left(H - \frac{O}{8} \right) + 40 S$$

in which C , H , O , and S are the percentages of carbon, hydrogen, oxygen, and sulphur in the fuel, as determined by ultimate analysis. The available hydrogen $\left(H - \frac{O}{8} \right)$ or that which is not combined with oxygen, is found as explained in Art. 4.

139. For all the common varieties of coal—cannel coal and some lignites excepted—the formula is accurate within

the limits of error of chemical analysis and calorimetric determinations.

EXAMPLE.—What is the heating value of a coal whose analysis is moisture 5 per cent., carbon 70 per cent., hydrogen 5 per cent., oxygen 12 per cent., nitrogen 1 per cent., sulphur 2 per cent., ash 5 per cent.?

SOLUTION.—Substituting in the formula given in Art. 138,
 $146 \times 70 + 620(5 - 1.5) + 2 \times 40 = 12,470$ B. T. U. Ans.

140. Lord and Haas's Formula.—The following formula is based on extensive experiments made at the Ohio State University by Messrs. Lord and Haas and the results calculated by it have been found to agree very closely with those obtained with the Mahler calorimeter.

$$\text{B. T. U.} = \frac{K(100 - A - S - M) + (S \times 4,050)}{100} \quad (1)$$

in which the ash A , sulphur S , and moisture M are expressed as percentages, and K is a constant determined from a number of chemical and calorimetric determinations by the following formula, in which the values substituted are the averages of a number of analyses:

$$K = \frac{\text{B. T. U.} - (\text{sulphur} \times 4,050)}{100 - (\text{ash} + \text{sulphur} + \text{moisture})} \quad (2)$$

141. Table XXIX gives the average values of K as determined for different coals by Lord and Haas.

TABLE XXIX

Coal	Value of K
Upper Freeport, Ohio and Pa.	15,116
Pittsburg, Pa.	15,183
Middle Kittanning (Darlington coal), Pa.	15,062
Middle Kittanning (Hocking Valley coal), Ohio	14,265
Thacker, W. Va.	15,410
Pocahontas, W. Va.	15,829
Fairmont, W. Va.	15,675

EXAMPLE.—An average sample of Fairmont, W. Va., coal is moisture 1.5 per cent., volatile matter 36 per cent., fixed carbon 54.8 per cent., sulphur 2.1 per cent., ash 7 per cent.; what is the calorific power?

SOLUTION.—From Table XXIX, the value of *K* for Fairmont coal is found to be 15,675. Substituting this value in formula 1 of Art. 140,

$$\text{B. T. U.} = \frac{15,675(100 - 7 - 2.1 - 1.5) + 2.1 \times 4,050}{100} = 14,098.5 \text{ B. T. U.}$$

Ans.

142. Calculating Heating Value of a Compound Gas.—The heating value of a compound or mixed gas is generally taken as the sum of the heating values of its elementary fuel constituents, carbon and hydrogen. The rule does not apply in the case of carbon monoxide, *CO*, on account of the partial oxidation of the carbon. According to Favre and Silbermann's figures, 1 pound of carbon in carbon monoxide generates only 10,093 B. T. U. in burning to carbon dioxide, while 1 pound of carbon burning directly to carbon dioxide, generates 14,544 B. T. U. The difference, 4,451 B. T. U., is the heat generated when the carbon monoxide was formed by burning carbon with oxygen. It also does not appear to apply in the case of marsh gas (methane) and other gases.

143. In making the calculation of the heating value of a compound gas, the atomic or combining weights of the several elements have to be taken into account. For example, marsh gas (methane), *CH₄*, consists of twelve parts, by weight, of carbon and four parts, by weight, of hydrogen, or sixteen parts in all. To find the calorific value of 1 pound of the gas compute the calorific value of 12 pounds of carbon and 4 pounds of hydrogen and divide the sum of these two quantities by 16, thus:

	B. T. U.
Calorific value of 12 pounds carbon,	
12 × 14,600	175,200
Calorific value of 4 pounds hydrogen,	
4 × 62,000	248,000
Total	423,200

The calorific value of 1 pound of marsh gas is 423,200 ÷ 16 = 26,450 B. T. U.

The value obtained by the calorimeter as given in Table XX is 23,513 B. T. U., a difference of 2,937 B. T. U. The calculated values of ethylene, C_2H_4 , and of benzole vapor, C_6H_6 , are, respectively, 21,370 and 18,246 B. T. U., which are very close to the calorimetric values. This difference is due to the heat absorbed by the decomposition of the compound.

144. Heat Absorbed by Decomposition.—By the decomposition of a chemical compound as much heat is absorbed or rendered latent as was evolved when the compound was formed. If 1 pound of carbon is burned to carbon dioxide, generating 14,600 B. T. U., and the carbon dioxide thus formed is immediately reduced to carbon monoxide by being passed through a body of glowing carbon, by the reaction $CO_2 + C = 2CO$, the result is the same as if the 2 pounds of carbon had been originally burned to carbon monoxide, generating $2 \times 4,450 = 8,900$ B. T. U. The 2 pounds of carbon burned to carbon dioxide will generate $2 \times 14,600 = 29,200$ B. T. U., the difference, $29,200 - 8,900 = 20,300$ B. T. U., being absorbed or rendered latent in the carbon monoxide, or 10,150 B. T. U. for each pound of carbon.

In like manner, if 9 pounds of water (which might be formed by burning 1 pound of hydrogen with the generation of 62,000 B. T. U. and cooling the resulting water to the atmospheric temperature) be injected into a large bed of glowing coal, it will be decomposed into 1 pound of hydrogen and 8 pounds of oxygen. The decomposition will absorb 62,000 B. T. U., cooling the bed of coal this amount, and the same quantity of heat will again be evolved if the hydrogen is subsequently burned with a fresh supply of oxygen. The 8 pounds of oxygen will enter into combination with 6 pounds of carbon, forming 14 pounds of carbon monoxide (since carbon monoxide is composed of twelve parts carbon to sixteen parts oxygen), generating $6 \times 4,450 = 26,700$ B. T. U., and $6 \times 10,150 = 60,900$ B. T. U. will be latent in this 14 pounds of carbon monoxide, to be evolved later if it is burned to carbon dioxide with an additional supply of 8 pounds of oxygen.

145. Available Heating Value of Fuel Containing Hydrogen and Water.—In burning a fuel containing hydrogen and water in a furnace, some of the heat is unavoidably lost on account of the original water and the water formed by burning the hydrogen escaping into the chimney in the form of superheated steam. In calculating the efficiency of a steam boiler, it is customary to charge it with the total heating value of the fuel consumed and to consider the loss due, to this superheated steam as part of the several losses in the operation of the boiler, such, for instance, as the heating of the air that also passes through the furnace and enters the chimney. It is sometimes convenient, however, to compute the loss due to the superheated steam as a deduction from the heating value of the fuel itself, and in such cases the following formula is used to obtain the amount of this loss:

$$\text{B. T. U. lost} = \left(9 \frac{H}{100} + \frac{W}{100}\right) \times [(212 - t) + 965.8 + .48 (T - 212)]$$

in which H = percentage of hydrogen;

W = percentage of water in fuel;

t = temperature of air supply;

T = temperature of chimney gas.

EXAMPLE.—A coal has the following analysis: Moisture, 5 per cent.; carbon, 70 per cent.; hydrogen, 5 per cent.; oxygen, 12 per cent.; nitrogen, 1 per cent.; sulphur, 2 per cent.; ash, 5 per cent. (a) What will be the loss in heating power due to the presence of the hydrogen and moisture, assuming that the chimney gases escape at a temperature of 562° F., the temperature of the atmosphere being 62° F.? (b) If the weight of the chimney gases is 20 pounds per pound of coal and the specific heat of the gases is .24, what is the loss of heat due to the escape of the chimney gases? (c) What is the total amount of heat utilized in the furnace, assuming that there is no loss from radiation?

SOLUTION.—(a) Substituting in the formula in Art. 145,

$$\text{B. T. U. lost} = (9 \times .05 + .05) \times [(212 - 62) + 965.8 + .48(562 - 212)] \\ = 641.9 \text{ B. T. U. Ans.}$$

$$(b) \quad 20 \times (562 - 62) \times .24 = 2,400 \text{ B. T. U. Ans.}$$

(c) From the formula in Art. 138, the heating value of this coal is found to be, $146 \times 70 + 620 (5 - 1.5) + 2 \times 40 = 12,470$ B. T. U.

The total heat lost is $641.8 + 2,400 = 3,041.8$ B. T. U.

The heat utilized is $12,470 - 3,041.8 = 9,428.2$ B. T. U. Ans.

CALORIFIC VALUE OF FUELS

146. When it is necessary to determine the actual calorific value of a fuel, it is done by means of an instrument called a calorimeter. Though there are many forms of this instrument, all are so constructed that a weighed quantity of a fuel can be burned in a vessel submerged in a weighed quantity of water, which absorbs the heat developed. The calorific value is computed from the rise in temperature of the water.

147. **Mahler's Bomb Calorimeter.**—The most accurate apparatus for ascertaining the heating value of a solid or liquid fuel is known as Mahler's bomb calorimeter, shown in Fig. 13. It consists of a shell *a* of forged steel, about 6 inches high and 4 inches in diameter, with a tight

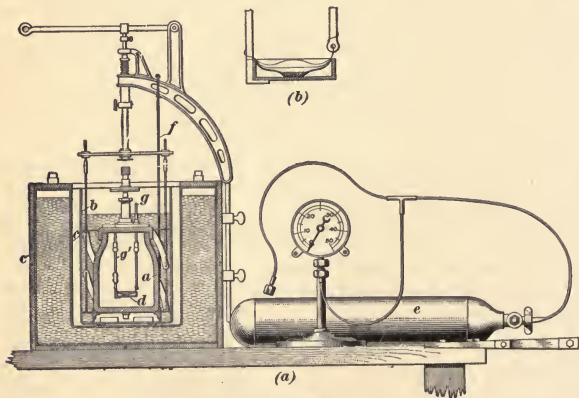

FIG. 13

cover, inserted in a thin brass vessel *b* containing water, and surrounded by non-conducting substances and by a larger annular vessel *c* containing water, to minimize losses of heat by radiation. The inner vessel *b* contains a device for stirring the water. About 1 gram of the pulverized fuel

whose heating value is to be determined is placed in a small tray *d* [shown enlarged at (*b*)] inside the bomb. The bomb cover being tightly closed, the shell *a* is filled with oxygen at a pressure of 20 to 25 atmospheres from the gas cylinder *e* alongside. The temperature of the water in the inner vessel *b* is carefully noted to .01° C., by the thermometer *f*, and then the coal or other fuel is set on fire by means of an electric spark from wires *g, g'* that are carried through gas-tight nipples in the cover. The fuel burns instantly with an explosion, and the heat generated is radiated through the bomb into the water in the inner vessel, which is constantly stirred. Observations of the rise of temperature are made and recorded every quarter minute, until often the temperature has been considerably reduced by radiation. A study of the temperature record is then made to determine what would have been the maximum temperature if there had been no external radiation, and the heat units generated are computed by multiplying the weight of water in *b* by the corrected rise of temperature, and applying a correction for the *water equivalent* of the metal bomb and the brass vessel; that is, the weight of the metal parts multiplied by their average specific heat.

ANALYSIS OF COAL AND COKE

PROXIMATE ANALYSIS

148. A proximate analysis of coal is the one nearly always required; and, although the results obtained are, to a great extent, merely comparative, yet, when the directions given are strictly followed, the results obtained are accurate enough to be of great service in determining the value of the coal for various purposes. It is of the utmost importance that the directions given should be followed exactly in every case, for slight variations in the method give large differences in the results; and as the results, so far as moisture, volatile, combustible matter, and fixed carbon are concerned, are only comparative, they must be obtained under exactly the same conditions in every case if they are

to be of any value. The following is the standard method recommended by the American Chemical Society.

149. Sampling.—In selecting a sample, about 5 pounds of the coal should be taken, exercising care, of course, to get a sample representing the whole quantity. Break this up and quarter it down until a sample weighing about 100 grams is left. Pulverize this, and keep it in a tightly stoppered bottle until analyzed. The quartering and pulverizing should be carried on as rapidly as possible, to prevent the absorption or the loss of water, and, as coal in the powdered form changes in other respects, especially when exposed to air, it should be kept in a tightly stoppered bottle, and the analysis should be made as soon as convenient after the sample is taken. A method of analysis recommended by the American Chemical Society, that gives concordant results, and is probably more largely used than any other at the present time, is as follows:

150. Moisture.—When coal is dried at a temperature slightly above 212° F., it loses in weight for a time, and then begins to grow heavier. Consequently, dry all samples for a certain time at a fixed temperature to obtain comparative results.



FIG. 14

The following method of doing this has been generally adopted: Weigh 1 gram of the pulverized sample in a porcelain or platinum crucible. Place the crucible, uncovered, in an air bath having a temperature from 219° to 225° F., and heat it at this temperature for exactly 1 hour. Place the crucible in a desiccator, Fig. 14, cover it, allow it to cool. As soon as cool, weigh covered, and call the loss in weight moisture.

151. Kent's Method.*—The following method of determining moisture has been proposed by Wm. Kent, who claims that it gives more accurate results for western coals than the standard method, but it has not been accepted by the

*Recommended by Committee on Boiler Tests of the A. S. M. E.

American Chemical Society and is not generally used by commercial chemists.

Weigh from 10 to 20 grams of the sample coarsely crushed in a common coffee mill into a porcelain crucible or other dish. Place the crucible, uncovered, in an air bath having a temperature ranging from 240° to 280° F., and heat it at this temperature for 1 hour. Place the crucible in a desiccator, cover it, and allow it to cool. As soon as cool, weigh uncovered, and call the loss in weight moisture. Heat again for $\frac{1}{2}$ hour at 280° F., cool and weigh, and repeat the operation until the weight ceases to decrease. The total loss of weight by drying is recorded as the moisture.

152. Volatile Combustible Matter.—Weigh 1 gram of the pulverized sample into a clean platinum crucible weighing 20 to 30 grams and having a tightly fitting cover. Place the cover on tight and heat over a good Bunsen burner for exactly 7 minutes. The burner should be adjusted so that it gives a good flame 20 centimeters (7.87 inches) high. The crucible should be supported on a platinum triangle so that the bottom is 7 centimeters (2.76 inches) above the top of the burner. The determination should be made in a place free from drafts. Cool the crucible in a desiccator and weigh as soon as cool. From the loss in weight caused by this treatment, subtract the amount of moisture found; the remainder is the volatile combustible matter. This determination should always be made on a fresh sample of coal and not on the sample used for the determination of moisture.

153. Fixed Carbon and Ash.—After weighing the crucible for the determination of volatile combustible matter, draw the cover a little to one side, place the crucible in an inclined position on a triangle, as shown in Fig. 15, place a good Bunsen burner under it, and heat until the carbon is completely burned off. This operation is likely to prove tedious, and may be hastened by letting the crucible cool from time to time, and by stirring the contents with a stout piece of platinum wire, taking care, of course, not to lose any of the material in the crucible while stirring it up. Care

must also be taken not to produce too strong a current of air in the crucible while heating it, as, in this way, particles may be carried out, and a fictitious value given to the coal or coke by the apparent increase in fixed carbon and decrease in ash. When the residue in the crucible no longer shows any unburned carbon, heat it a few minutes longer, then cool it in a desiccator and weigh. The difference between this weight and



FIG. 15

that at the beginning of the operation is the weight of fixed carbon in the sample, and the substance remaining in the crucible is ash. The percentages of the different constituents are, of course, calculated in the usual manner. The sum of the percentages of fixed carbon and ash is approximately the percentage of coke that may be obtained from the coal.

154. Sulphur.—Sometimes the percentage of sulphur is desired in connection with the proximate analysis; it is obtained in a separate determination by the method used in ultimate analysis. Thus, for coal, weigh out 1 gram of the pulverized coal or coke and mix thoroughly with 1.5 grams of Eschka mixture (see Art. 156) in a thin platinum dish of from 75 to 100 cubic centimeters capacity. A large

crucible may be used instead of a dish. Support the dish on a triangle and heat slowly, holding the burner in the hand at first. If the gas ordinarily used contains sulphur—and all coal gas does—an alcohol lamp should be used instead of a Bunsen burner. Stir the mixture frequently with a platinum wire and keep the flame in motion, only touching the dish with the flame until strong glowing has ceased. Then gradually increase the heat until, in about 15 minutes, the bottom of the dish is at a low red heat. Keep at this temperature, stirring every few minutes with the platinum wire, until the carbon has completely burned; this will usually require about 1 hour. When the carbon is completely burned, allow the dish to cool, transfer the mass to a beaker, and rinse out the dish, using about 50 cubic centimeters of water. Add 15 cubic centimeters of a saturated solution of bromine in water, boil for 5 minutes, allow to settle, decant the clear liquid through a filter, add 30 cubic centimeters of water to the residue in the beaker, boil 5 minutes, allow to settle, decant the clear liquid through the filter, and boil the residue again for 5 minutes with 30 cubic centimeters of water. Filter through the same paper and wash until a few drops of the liquid running through the funnel gives no precipitate when acidified with nitric acid and tested with silver nitrate. The total volume of the liquid in the beaker under the filter should now be about 200 cubic centimeters. Add 2 cubic centimeters of concentrated hydrochloric acid and boil until the bromine is completely expelled. Test a drop of the liquid with litmus paper to make sure that it has an acid reaction. If not acid, add one or two drops of hydrochloric acid and again boil. When all the bromine has been driven off and the liquid is slightly acid, add slowly to the solution, which should be kept at about the boiling point, 10 cubic centimeters of a 10-per-cent. solution of barium chloride. Stir constantly while adding the barium chloride, and add it slowly, not more than one drop a second.

Stand the beaker in a warm place for the precipitate to settle; filter, wash thoroughly with hot water acidulated

with a few drops of hydrochloric acid, ignite moderately, and weigh as barium sulphate, $BaSO_4$, which contains 13.73 per cent. of sulphur.

155. Although chemicals that are absolutely free from sulphur may be obtained for this determination, a careful blank should be run with each new lot of reagents, for some so-called *C. P.* (chemically pure) chemicals are not strictly as represented.

156. Eschka Mixture.—Weigh out a convenient quantity of magnesium oxide, which must be free from sulphur and has been previously ignited to expel all moisture; add to this half its weight of pure dry sodium carbonate, grind them together until they are thoroughly mixed, and keep the mixture in a tightly stoppered bottle. A bottle with a ground glass stopper is preferred for this purpose; at all events, the mixture must be kept dry.

ULTIMATE ANALYSIS

157. In the ultimate analysis of coal and other fuels, a chemist's combustion furnace is used. The process is a tedious and difficult one, and requires the facilities of a good laboratory, and considerable experience in chemical manipulation. For details of the method, treatises on analytical chemistry should be consulted.

158. Notes.—The following is a convenient method of keeping the notes of a coal analysis:

Weight of crucible and coal	32.000 grams
Weight of crucible	30.000 grams
Coal taken	2.000 grams
Weight of crucible + coal	32.000
Weight of crucible + coal, after drying	31.992
Loss = water008 = .40 per cent.
Weight of crucible + coal, dried	31.992
Weight of crucible + coal, heated (closed)	31.448
Loss = volatile combustible544 = 27.20 per cent.

Weight of crucible + coal, heated (closed) . . .	31.448	
Weight of crucible + coal, heated (open) . . .	<u>30.100</u>	
Loss = fixed carbon	1.348	= 67.40 per cent.
Weight of crucible + contents, heated (open)	30.100	
Weight of crucible	<u>30.000</u>	
Residue = ash100	= 5.00 per cent.
Sulphur		1.00 per cent.

REPORT

Moisture40 per cent.
Volatile combustible		27.20 per cent.
Fixed carbon		67.40 per cent.
Ash		<u>5.00</u> per cent.
		100.00 per cent.

NOTE.—The several percentages are found by dividing each remainder by the weight of the original sample, which in this case was 2 grams.

For accurate analysis a good balance is essential, but for the work outlined above, a druggist's scales will give fair results.

REPORT OF ANALYSIS

159. The proximate analysis of a coal may be reported in three forms, as percentages of the moist coal, of the dry coal, and of the combustible, as explained in Art. 10.

COAL HOISTING, CONVEYING, AND
STORING

160. Until within recent years, the only method of handling coal after it had reached its destination in the cars or boats in which it was shipped, was the use of the shovel and wheelbarrow. The first improvement on this method was the use of elevated trestles with inclined planes and pockets or bins under the trestles. Cars were run on to the trestles and the coal was dumped into the bins through movable doors provided in the bottoms of the cars. If the bottoms of the coal pockets were raised high enough chutes were provided, through which the coal could be run into carts. For unloading boats, a simple rope hoist and a bucket were commonly used, the hoist being operated by a horse or

small steam engine and the bucket filled by men with shovels.

The vast growth of the coal trade, and the fluctuations of supply and demand, which make it desirable to store millions of tons of coal near the points of largest consumption during certain seasons, have led to the development of systems of hoisting and conveying machinery, by means of which coal can be unloaded and stored or reloaded into cars at an expense of only 3 or 4 cents per ton. The erection of power houses in cities on valuable real estate has also necessitated the erection of large storage coal bins above the boiler houses from which coal may be delivered to the boilers.

The principal means of cheaply handling and transferring coal in large quantities from one point to another, are the following: (1) Self-filling buckets; (2) flight conveyers; (3) belts; (4) continuous trains of iron buckets; (5) chutes; (6) car-dumping machines.

SELF-FILLING BUCKETS

161. Self-filling buckets are made in the several forms shown in Figs. 16 to 19 and are largely used where the coal can be attacked from above. They are hoisted by ropes wound on drums operated by steam engines or electric motors and are transferred from place to place by derricks or cranes of various types. Many of them dump automatically.

162. The clam-shell bucket, Fig. 16 (*a*) and (*b*), consists of two shells *a* that are supported by rods *b* from the yoke *c* and connected at *d* by a journal *e*. On the journal is the pulley *f* to which the chain *g* is attached to a pin *h*. When the chain *g* is taut, the bucket is closed, as in (*a*), and the slack of the chains *i i* is coiled about the journal *e*. When the chain *g* is loosened, the weight of the bucket and the pulley *h* assisted by any material in the bucket causes the bucket to open, as in (*b*). When the chain *g* is pulled upwards, the bucket closes and fills with the material to be hoisted. The entire bucket and attachment is raised and lowered by means of the rope *j* working about the pulley *k*.

163. The orange-peel self-filling type of bucket, Fig. 17 (a) and (b), works very similarly to the clam shell.

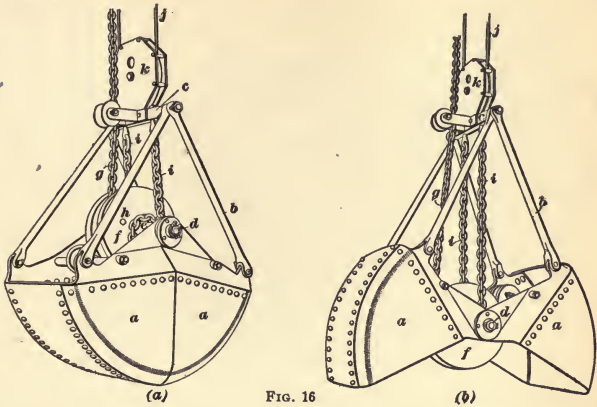

When the chain *g* that is coiled about the pulley *h* is pulled up, it raises this pulley and thus raises the end *k* of an arm

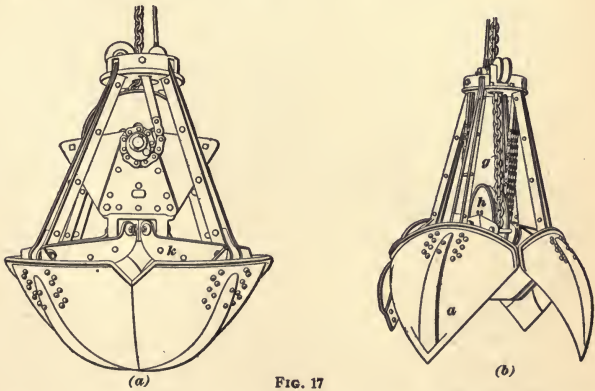

that is attached to the side *a* of the bucket and this closes the bucket.

Clam-shell and orange-peel buckets are made with a capacity varying from 15 cubic feet to 5 cubic yards and



FIG. 18

varying in weight from 2,200 to 18,000 pounds. With such buckets 60 to 80 per cent. of a ship's cargo can be unloaded without hand shoveling.

164. The drop-bottom bucket, Fig. 18, is loaded as shown and unloaded by loosening the catch *a* so that the bottom *b*, which is hinged at *c*, drops downwards.

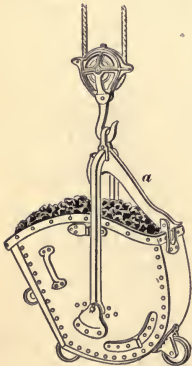

FIG. 19

165. The shovel bucket, shown in Fig. 19, is loaded similarly to the one shown in Fig. 18, but is dumped automatically by turning over when the catch *a* is loosened.

CRANES

166. The Locomotive Crane. Fig. 20 shows a locomotive crane used for unloading coal by means of a clam-shell or orange-peel bucket and transferring it from a boat to a railroad car or from a car to a boat. The crane runs on tracks *aa* placed

between the boat and the car. The gauge of the tracks depends on the radius of the crane swing and when not already fixed by existing tracks is about as follows:

- 4 feet 8½ inches for a maximum radius of swing of 30 feet
- 14 feet 6 inches for a maximum radius of swing of 45 feet
- 16 feet for a maximum radius of swing of 60 feet
- 20 feet for a maximum radius of swing of 100 feet

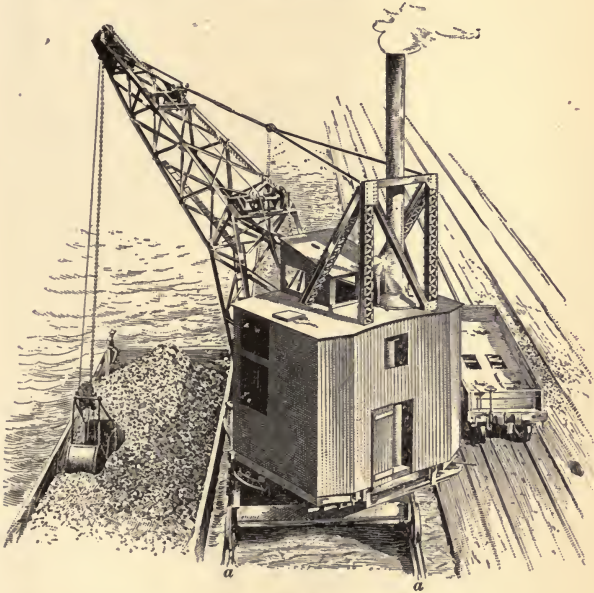

FIG. 20

Steam or electric power may be used to propel the crane along its tracks and to operate the bucket. The operator, who is on the covered platform, closes and thus loads the bucket, hoists and dumps it, and at the same time that he is hoisting it revolves the crane. A speed of one bucket per minute for all sizes and loads is a fair average, though this speed is often exceeded.

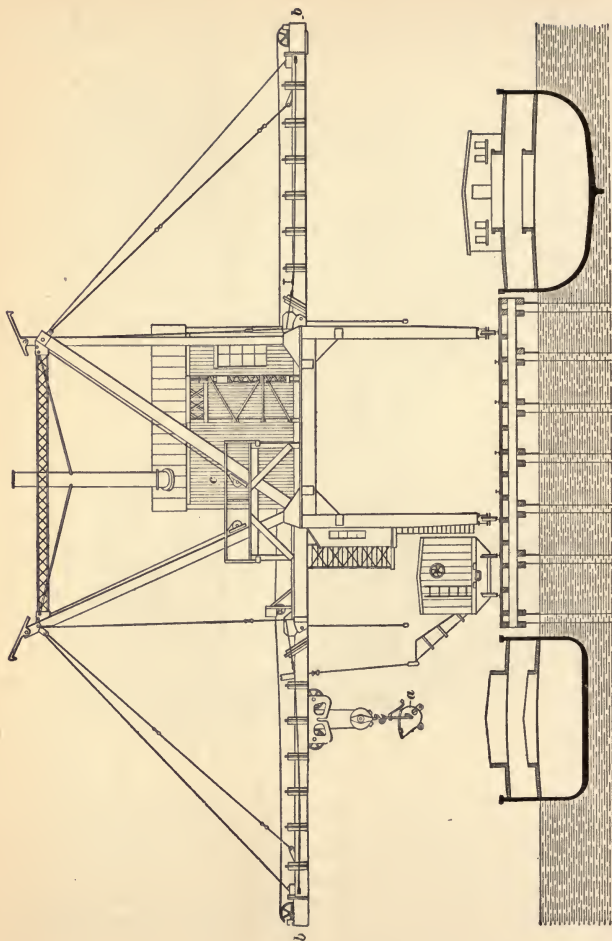

FIG. 21

167. Overhead Crane.—The overhead crane for unloading coal, Fig. 21, runs on tracks. The bucket *a*, which is loaded, hoisted, and transported along the track *bb* by machinery located in the shed *c*, is dumped either into a box car, a gondola, or on a stock pile as desired.

168. The fixed steel derrick, Fig. 22, is used for hoisting coal buckets and dumping them into a car or bin at a higher level. In the illustration, the coal is dumped from the cars into the hopper *a*, which discharges into the bucket

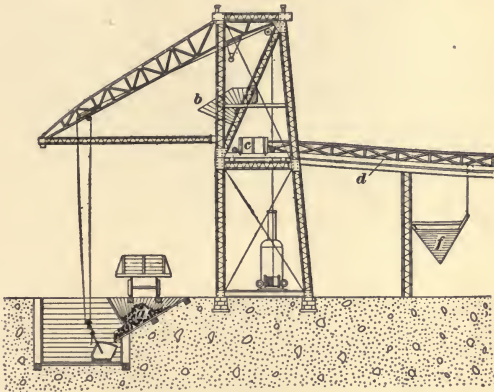

FIG. 22

through a short chute, as shown. The bucket dumps automatically into the hopper *b*, which discharges into the car *c*, which is carried away and dumped by means of the *Hunt automatic railway*, shown in Fig. 23. The car *c* runs down the inclined plane *d* and at a given point it comes in contact with a truck *e*, Fig. 23, which, by means of the momentum attained in going down the plane, it pushes along the truck and thus raises the weight *f*, Fig. 22, until the tripping mechanism *g* on the side of the car comes in contact with the wedge-shaped tripping block *h* alongside the track. The two side bars are connected by a wire rope and the toggle

is so arranged that the tripping mechanism is on one side only, the weight of the coal opening both doors. Both side doors of the car are opened at the same time and as the bottom of the car has a center ridge sloping to the sides, the

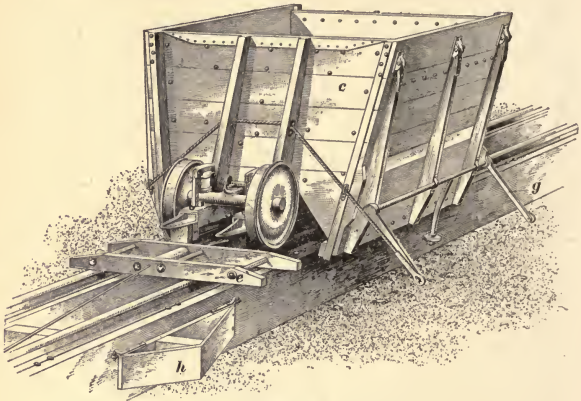

FIG. 23

load dumps very quickly and evenly so that the car will not tip to the side. When the car has dumped, the weight *f*, Fig. 22, falls and, by means of the cross-bar *c*, pulls the car along the trestling and gives it sufficient momentum to return up the inclined plane to the chute.

CONVEYERS

FLIGHT CONVEYERS

169. Flight conveyers, which are used to convey coal horizontally or up an incline, consist of a trough, made of timber and lined with iron, or entirely of iron or steel, and a chain or wire rope, to which iron plates, or *flights*, are attached at frequent intervals at right angles to the

chain or rope. These drag the coal along the trough, the chain or rope being driven by suitable gearing. There is a

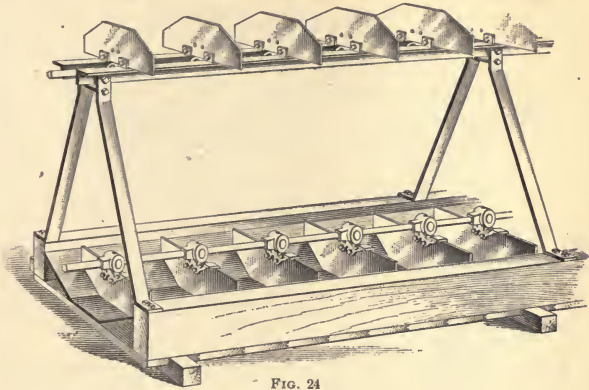

FIG. 24

large variety of these flights, differing in structural details, but all acting on the same principle.

Fig. 24 shows a simple form of single-strand flight conveyor for light work with overhead return. Similar conveyers with double strands for carrying the flight are much used for conveying anthracite from the mine to the top of the breaker.

Fig. 25 shows a similar form for heavy work where a double chain is used, carried on rollers to avoid the noise produced by a conveyer in which the flight drags on the bottom.

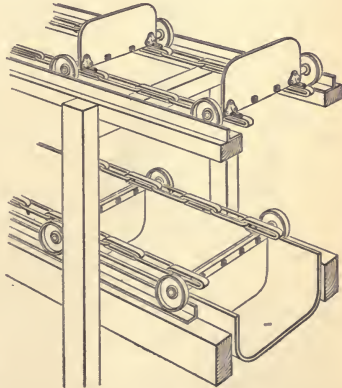

FIG. 25

Fig. 26 shows a form much used for conveying coal that is in large lumps.

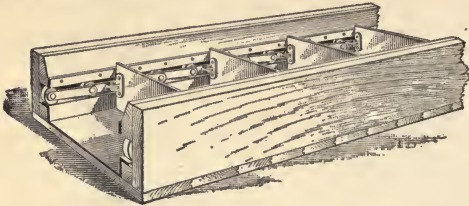

FIG. 26

Fig. 27 shows a conveyer in which disks of metal are attached to a wire cable or to a chain.

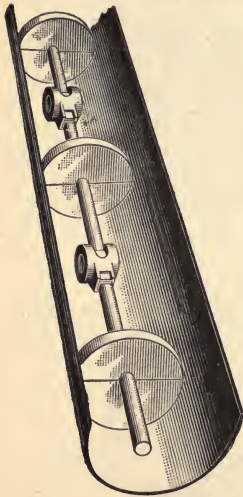

FIG. 27

BELT CONVEYERS

170. Belts, made of layers of canvas and rubber and moving at high speeds, are rapidly coming into use as coal conveyers, and by them a constant stream of coal may be carried horizontally or up inclinations as great as 26° .

Fig. 28 shows the cross-section of half the width of a conveying belt composed of a canvas core covered with specially prepared tough rubber that is thickest in the center, where the most wear comes.

The loaded belt, Fig. 29, is supported on rollers or idlers placed so as to shape the belt into the form of a trough. The empty returning



FIG. 28

belt is supported on horizontal rollers *b*. The upper idlers are placed 6 feet or less apart depending on the load on

the belt and the width of belt, the wider the belt and the heavier the load, the closer are the idlers. The bottom idlers for the returning belt are placed 8 to 12 feet apart.



FIG. 29

171. A tripper, Fig. 30, is used where it is desired to discharge the material carried by the belt at any point

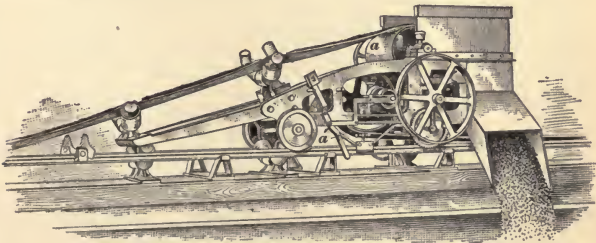

FIG. 30

excepting at the head end. This tripper consists of two pulleys *a*, *a'* placed so that the belt runs over one and under



FIG. 31

the other. When the belt makes the first bend, it discharges its load into a chute as shown. The tripper may be fixed so as to discharge at a distinct point along the belt, or it may be moving so as to discharge uniformly along the whole or any part of the length of the belt.

172. An installation of the Robins belt conveyer located at the coke works of Jones & Laughlin, Pittsburg, Pennsylvania, and having a capacity of 500 tons per hour, is shown in Fig. 31. A large elevator, consisting of a double row of steel buckets, elevates the coal to the belt conveyer, which carries it across the tracks of a railroad and distributes it by means of an automatic tripper into hoppers.

BUCKET CARRIERS

173. Bucket carriers consist of series of buckets attached to an endless chain or link belt, which passes over and receives its motion from suitable pulleys or sprocket wheels, which are connected by gearing or belting to some source of power. The buckets frequently join or overlap so that a practically continuous stream of material is carried.

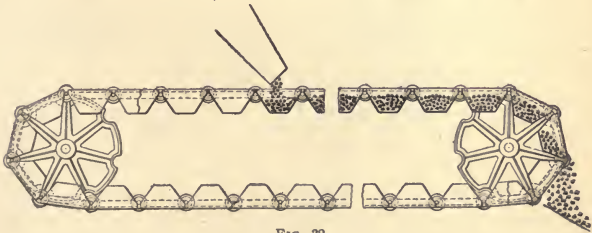

FIG. 32

174. The simplest form of bucket carriers, Fig. 32, consists of a series of buckets rigidly attached to a link belt, which passes over sprocket wheels at its two ends. To prevent sagging, the ends of each link are fitted to axles having a wheel at each end; these wheels roll on tracks placed on each side of the conveyer line. The load is

received at any point along the line and is discharged over the end.

Fig. 33 shows a bucket elevator having buckets rigidly attached to a chain that passes over sprocket wheels at the top and bottom, the bottom sprocket being placed in a boot where the buckets receive their loads.

Instead of being rigidly connected to the chain, the buckets are frequently so balanced and hung from the supporting belt or chain that they remain upright whether the chain is horizontal, vertical, or inclined.

Such carriers are also usually arranged so that they can be loaded or discharged automatically at one or a number of points. Great ingenuity has been displayed by manufacturers in adapting the buckets and the arrangements for operating them to the varied conditions under which such carriers must be used, and it is possible therefore to give only a few of the commoner uses.

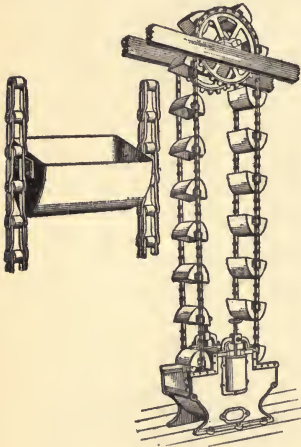

FIG. 33

bucket *a* is pivoted at *b* between two link belts *c*, which are supported by wheels *d* running on a track *e*, which may be horizontal, inclined, or vertical. The coal is loaded from the automatic hopper *f* into the buckets. The line of buckets is driven by the sprocket wheel *h* which is driven by the gearing shown; power to operate the automatic feeder *f* is taken from the sprocket wheel *g* by gearing. The buckets are dumped at any desired point by fixed dumping blocks or by the movable automatic dumper *i*.

175. Fig. 34 shows a train of link-belt overlapping carrier buckets. The

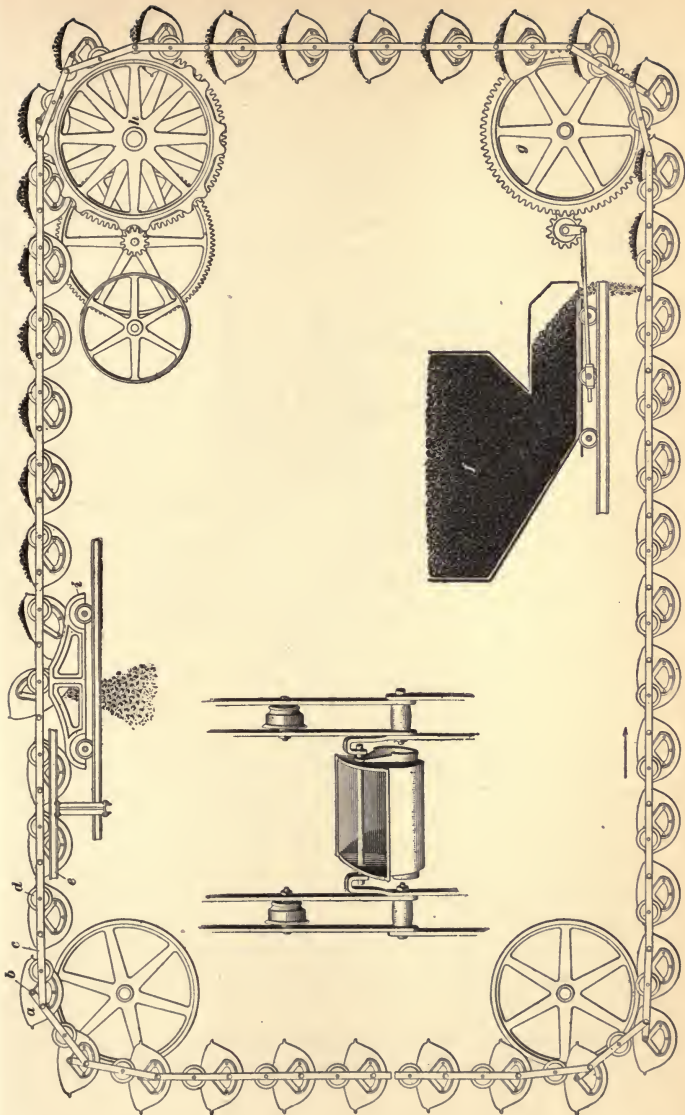

FIG. 34

176. Fig. 35 shows another form of bucket for transferring material horizontally and another dumping device. The buckets are secured on one side only to a single chain *a*, and when the wheels *b* enter the guide track *c* the bucket turns upside down and discharges into the chute *d*. The dumping frame *e* runs on the wheels *f* and by shifting will distribute the coal at any point desired.

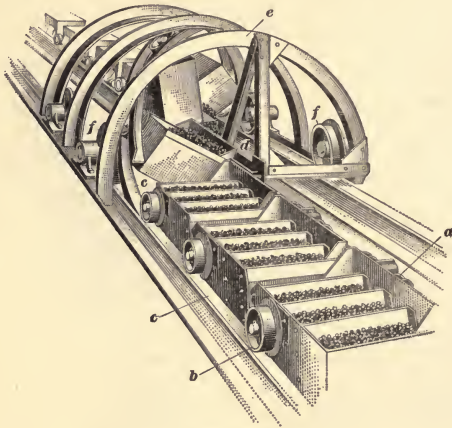

FIG. 35

177. Fig. 36 shows the application of such a transfer system *a* used in connection with some form of bucket or belt elevator *b*, which takes the coal from a hopper *c* beneath a car and elevates it into the bin, where the transfer system distributes it uniformly around the bin. A square storage bin is considered cheaper than a long, narrow one, and a distributing system, such as is shown in Fig. 36, permits such a bin to be filled uniformly instead of only partially, as is the case when the material is all dumped along the center line, as shown by the dotted lines.

178. Fig. 37 shows an arrangement of a locomotive coal and ashes handling station of the Philadelphia and

Reading Railroad. The coal drops from the cars in which it is received into a pocket *a*, from which it is fed into the elevating buckets *b*, which deliver it to a chute *c*, from which a horizontal flight conveyer distributes it to any point

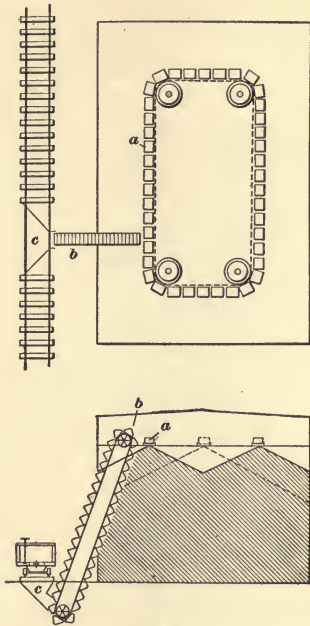

FIG. 36

along the length of the storage pile. Another bucket conveyor *d* receives the ashes from the locomotives and elevates them to a storage bin *e*, whence a chute delivers them to the cars *f*, in which they are removed. A similar arrangement can be used for supplying coal to a boiler house.

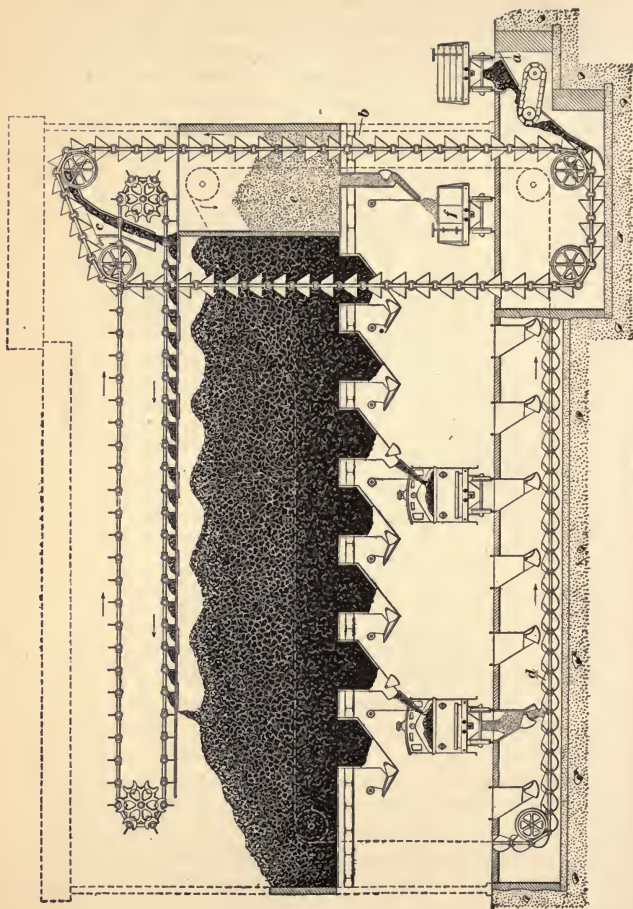

FIG. 37

CHUTES

179. Chutes are often used for conveying coal from a bin, pocket, or car into a vessel, pocket, or pile. Such chutes must be arranged so as to subject the coal to a minimum of shock, so as to avoid breakage. To accomplish this, they are usually made adjustable so that they can be raised and lowered at will, and the lower end of the chute kept close to the top of the pile of coal. By doing this and by keeping the chute full, the coal slides slowly and does not drop, thus avoiding breakage.

180. Fig. 38 shows a common method of loading vessels by means of an adjustable chute. The coal is dumped from the car into the pocket *a*, which may be of any desired size, and if space permits may be used for storage purposes. These pockets usually contain only a small amount and they serve merely as a hopper to feed the chute. A vertically sliding hopper *b* permits adjustment for height of tide and the depth of the vessel. The delivery of the coal is controlled by a regulating gate *c*, and the flow is shut off by the gate *d*.

With anthracite, screens to take out the fine coal are placed at some point in the chute, often at the bottom *e* of the sliding chute *b*. Instead of an open chute as shown, telescopic pipe chutes are sometimes used, that is, one part slides within another, so that the end may be kept close to the pile of coal.

181. Pitch of Chutes.—The following may be taken as average figures for the angle or grade of chutes for anthracite to be used where the chutes are lined with sheet steel: For broken or egg coal, $2\frac{1}{2}$ inches per foot; for stove or chestnut coal, $3\frac{1}{2}$ inches per foot; for pea coal, $4\frac{1}{4}$ inches per foot; for buckwheat coal, 6 inches per foot; for rice coal, 7 inches per foot; for culm, 8 inches per foot.

If the coal is to start on the chute by gravity, 1 inch per foot should be added to each of the above figures; while if the chutes are lined with manganese bronze in place of steel, the above figures can be reduced 1 inch per foot for coal

in motion, or would remain as given to start the coal. When the run of mine is to be handled, the angle should be not less than 5 inches per foot, or practically $22\frac{1}{2}^{\circ}$ from the

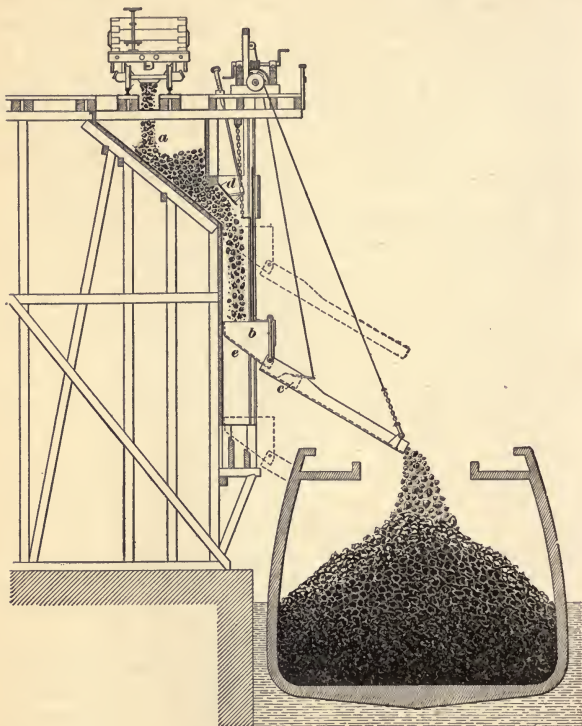

FIG. 38

horizontal. If chutes are lined with glass, the angle can be reduced from 30 per cent. to 50 per cent., depending somewhat on the nature of the coal. In all cases, the flatter the coal, the steeper the angle must be, on account of the large

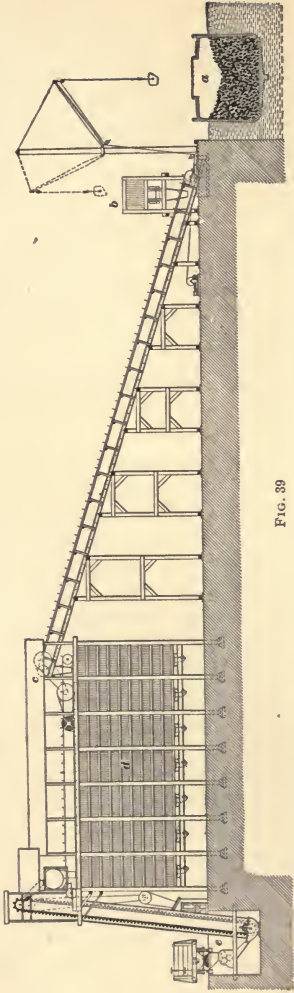

FIG. 39

friction surfaces exposed, compared with the weight of the piece. If chutes are lined with cast iron, the angle should be about the same as that employed for steel, though sometimes a slightly greater angle is allowed.

When run-of-mine bituminous coal is to be handled, the angle of the chutes, if iron or steel lined, should be about 32° from the horizontal, but if not lined, an angle of 45° may be required. If the coal is wet, the angle should always be steeper than when it is dry, and coarse coal will slide on a flatter angle than slack or fine coal.

COMBINATIONS OF HOISTING AND CONVEYING SYSTEMS

182. Fig. 39 shows diagrammatically how several of the forms of conveying and hoisting apparatus already explained may be combined in one plant. The coal may be taken from the scow *a*, by any form of bucket and the bucket transferred above the bin *b* by any form of derrick. Then from *b*, it passes through by a chute and is carried up the incline by a flight conveyer *c*, by a bucket train, or by a belt,

and at the head it empties into the bin *d* and is distributed by a conveyer, such as is shown in Fig. 36. The coal bin may also be filled from the cars by dumping the coal into the hopper *e*, and then elevating it by a bucket elevator as shown. The apparatus on either end can also be arranged to operate in the reverse direction from that described, so that *d* can be used as a storage bin and be unloaded into either the barge or the car.

CAR-DUMPING MACHINE

183. During the past few years, several styles of car-dumping machines have been introduced, in which a railroad car filled with coal is lifted bodily and either tipped up endwise so that the coal slides out from a hinged door at the end, or rotated parallel to its length so as to pour the coal out from one side.

184. The **Brown car-dumping machine** is shown in Fig. 40; the car *a* is pushed by the barney *b* on to a cradle *c*, where it is clamped on the top and sides with hydraulic clamps, and the cradle is then slowly raised and turned over until the car is upside down, thus gradually discharging its contents through six hopper compartments *d* attached to the cradle into a series of transfer tubs *e*, which are resting on a flat car on an adjoining track. This transfer flat car is then run to any point desired, and the tubs lifted by a crane *f* to the position *g* and run out to *h* and dumped on a stock pile or into the hold of a vessel. As the full transfer tubs are being moved out of the way and empty ones put in place, the cradle is lowered and the empty car replaced by a full one. The system has been so thoroughly perfected that in loading a vessel from cars the coal is handled without breakage. The vessel is kept on even keel while loading; the entire cargo is put aboard without moving the vessel; the vessel is loaded rapidly and economically, and the loaded and empty cars are moved to and from the machine by a car-pushing device without the aid of a locomotive.

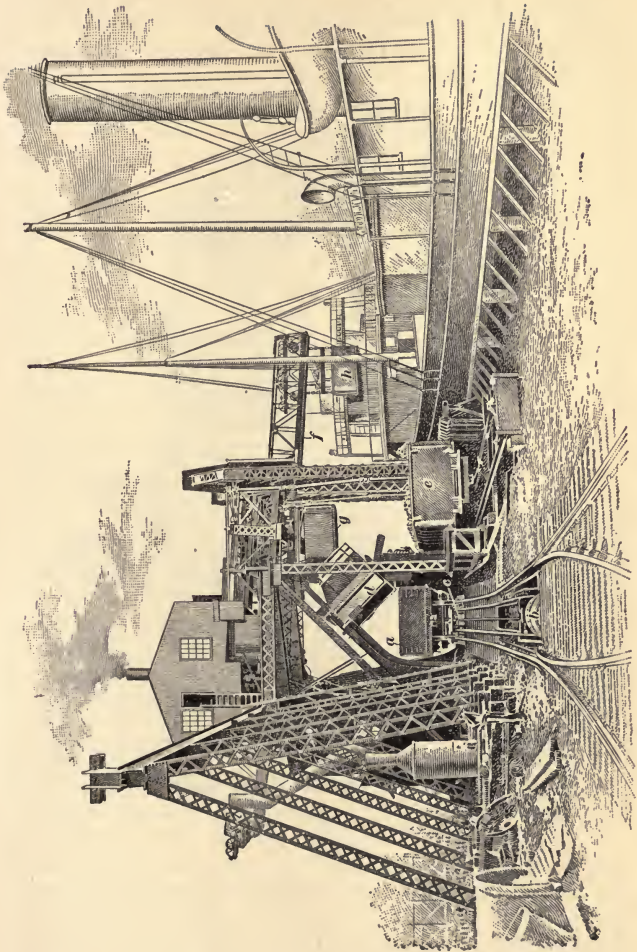

FIG. 40

185. The McMyler car-dumping machine, Fig. 41, consists of a steel tower, underneath which, and at the track level, is a cradle on which the loaded car is run to be dumped.

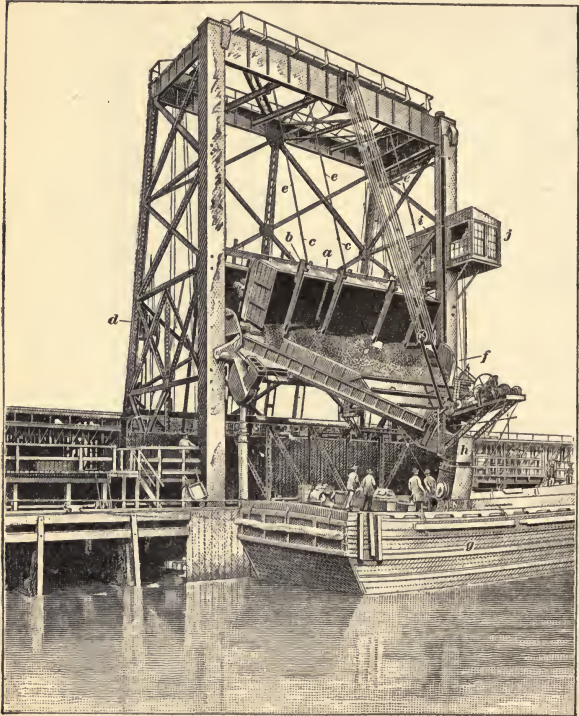

FIG. 41

The cars are pushed on to the cradle from one end and the empties off at the other. The car *a* is held by clamps that grip it when the cradle is raised and hold it in place. These clamps are not shown in the figure on account of the tilted

position of the car. The hollow bars *b* through which the chains *c* pass also support the car when tilted, as shown, and prevent its tipping too far, the weight of the car being counterbalanced by the weights *d* attached to the ends of the ropes *e* that slide up and down the inclined legs of the tower. The cradle and loaded car are hoisted by means of ropes driven by an engine placed between the back legs of the tower. At the proper height, guides on the front of the cradle strike against stops on the frame and hold the front of the cradle while the back side continues to rise, thus turning both cradle and car over to the dumping position as shown. The contents of the car fall on the hopper *f* and are delivered into the hold of barge *g* through the telescopic chute *h*. The hopper *f* can be raised or lowered as circumstances may require. As soon as the car is empty the cradle returns to a horizontal position and is lowered to the track level. The empty car is then pushed out of the way by the loaded one that takes its place on the cradle. The movement of the cars is governed from the house *i* and the dumping from the house *j*.

COAL STORAGE

186. Coal is stored: (1) to insure a constant supply at points where it is to be used and which will not depend on uncertain transportation facilities, labor troubles, etc.; (2) to permit of the mines being run steadily even though the market for the coal varies with the season, as is the case with coal used largely for domestic purposes, such as anthracite; (3) to take advantage of cheaper transportation by water, which is open only during a portion of the year, as, for instance, the Lake trade in the United States.

Bituminous coal is much less frequently stored in large quantities than anthracite, since much of it deteriorates on exposure to the weather and because it is so widely distributed throughout the country and the demand for it throughout the year is quite uniform.

A coal-storage plant should be arranged so that both in unloading and loading the coal it will move by gravity as

much as possible and with the use of the smallest possible amount of machinery, and so that there may be the least possible breakage of the coal.

Pockets or bins are used only for storing small quantities, as, for instance, on ship piers, where there is not room for an extensive storage system.

Coal is usually stored in piles, which are generally uncovered. For storage in large quantities, special facilities are required and the following are some of the principal methods now used.

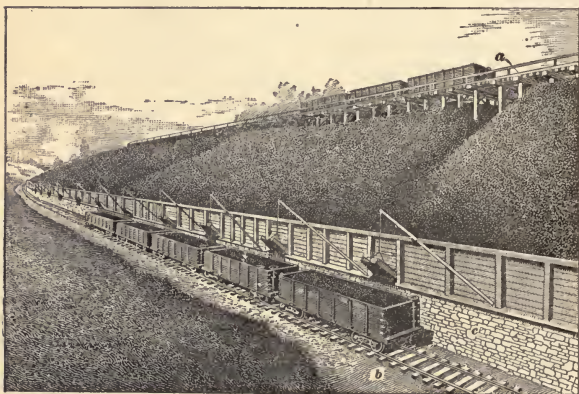

FIG. 42

187. Side-Hill Storage.—Where a suitable hillside is available, the system illustrated in Fig. 42 may be used. The dumping track *a* is laid on a trestle placed on top of the hill and the reloading track *b* on a level space at the bottom of the hill with an inclined plank floor between. The coal is held by a timber bulkhead provided with gates at frequent intervals for loading the cars and supported on a retaining wall *c*. To relieve the pressure on the retaining wall and to increase the stockage capacity, a horizontal area is often left between the bottom of the hill and the loading track, but

much of the coal on this level space will not run from the chutes and hence must be shoveled.

188. Trestle Storage.—In this system, the coal is dumped into a pile from cars running on the trestle, as shown in Figs. 43 and 44, and is reloaded, when needed,

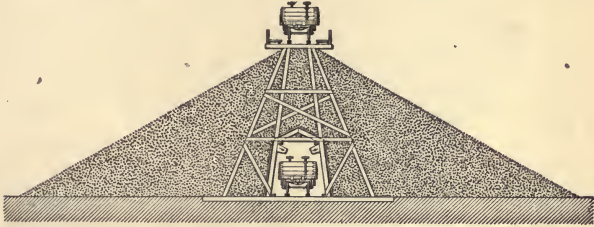

FIG. 43

through chutes into other cars running in a tunnel built within the pile, as in Fig. 43, or better below it, as in Fig. 44. The grade of the tracks on the trestle and in the tunnel may be made such that the cars can be handled by gravity, by a locomotive, or by a hoisting engine, as circumstances

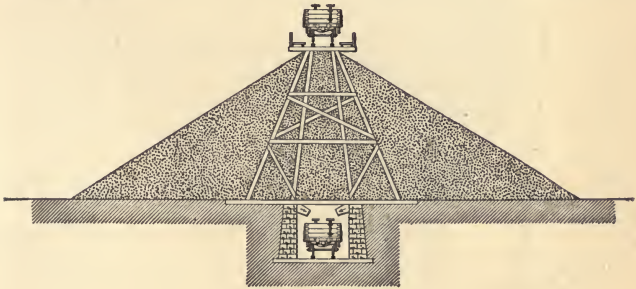

FIG. 44

require. The capacity of such a plant may be increased by building retaining walls along the sides, but even with such retaining walls, and with the tunnel below the bottom of the pile, a considerable amount of the coal cannot be loaded

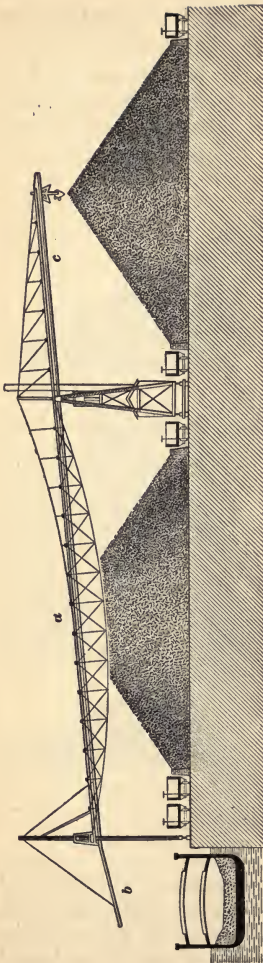

FIG. 45

into the car by gravity, but must be shoveled, thus considerably increasing the cost of handling.

Instead of stocking and unloading the piles with cars, conveyers may be placed on the trestle and in the tunnel, and the system thus made more or less automatic.

189. The bridge tramway storage system consists of a steel bridge spanning the storage space, and having at one end a boom that extends out over the hatch of a vessel and is sometimes also provided at the other end with a cantilever extension, as shown at *c*, Fig. 45.

A bucket traverses the system from the end of the boom to the end of the cantilever extension and may dump its load either into the storage piles as shown, or into cars. The bridge span *a* is usually from 180 to 190 feet with a boom *b* 30 to 40 feet long and an extension *c* of 80 to 105 feet. The ends of the bridge are supported on single or double A-shaped frames that are mounted on wheels and run on tracks. The system is a very flexible one, as

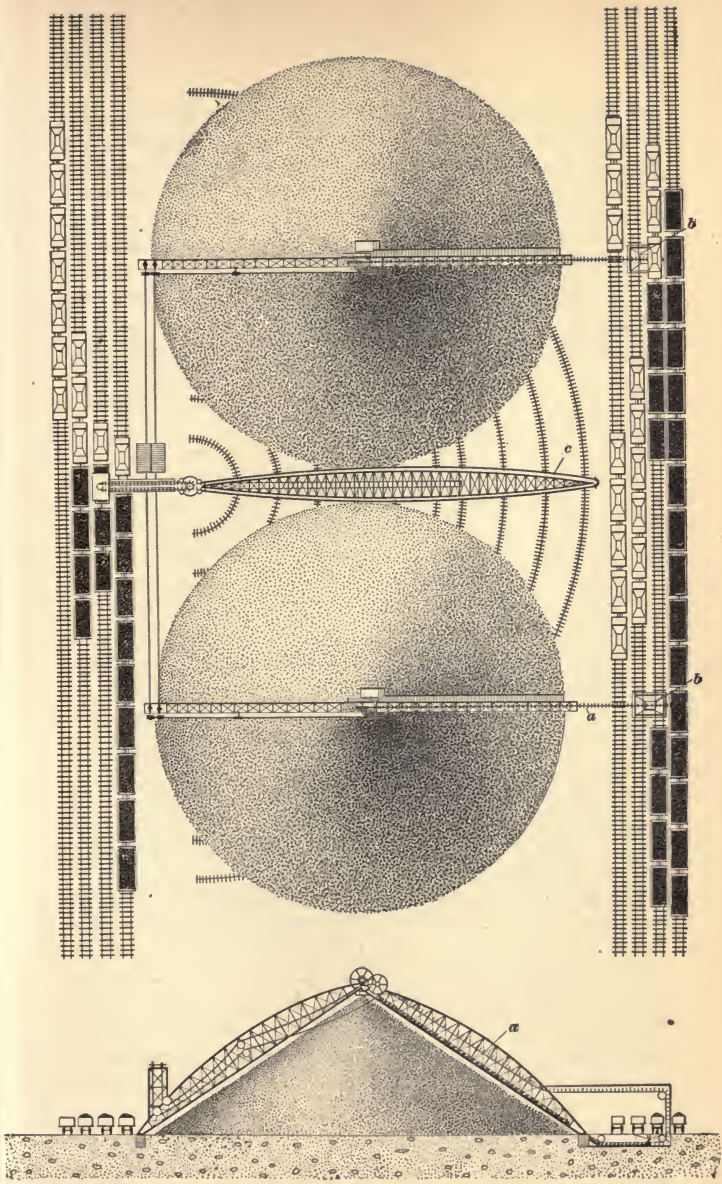

FIG. 46

the two frames may be moved independently of each other, and the front frame regulated to suit the unloading from the hatch of the vessel, and the back one to suit the conditions at the stock pile. The trolley carrying the bucket is operated from an engine room placed either on the front or back frame and either near the ground or elevated so that the engineer may have a full view of the plant. The coal is unloaded from the storage pile into the cars shown by means of the bucket used in stocking it, or tunnels may be used, as shown in Fig. 44.

190. The Dodge system of coal storage is designed to stock the coal in conical piles, outdoors. The system is arranged in units of two piles each, as shown in Fig. 46. The coal is stacked by means of trimming machines, of which each unit has two, one for each pile. This trimming machine consists of a truss arranged as shown and carrying a flight conveyer *a* on one leg. This conveyer is fed with coal from a bin *b*, into which it is dumped from cars, or unloaded from boats by any of the methods already described.

The *trimmer* builds the coal into conical piles, beginning the delivery just above the ground line, and gradually advancing the delivery point, keeping it slightly above the apex of the growing pile, so that after the coal drops from the car or bucket into the track hopper there is no further drop exceeding a few inches. The truss of the trimmer spans the space on which the pile is to be formed and the legs are inclined at about the natural angle of repose of coal.

The *reloading* is accomplished by a horizontal conveyer *c*, shown enlarged in Fig. 47, which is open at one side and which is run on circular tracks and is pivoted at one end so that it is kept along the edge of the coal pile. The conveyer *a* delivers the coal to an inclined conveyer *b*, Fig. 47, which carries it to a reloading tower, from which it falls into cars either with or without first being screened as may be desired.

For large capacities, the dumping tracks are arranged on one side of the plant and the reloading tracks at the other,

so that trimming and reloading can be carried on at the same time without interference of the cars. Each unit is designed to stock 100,000 tons of coal, that is, each pile

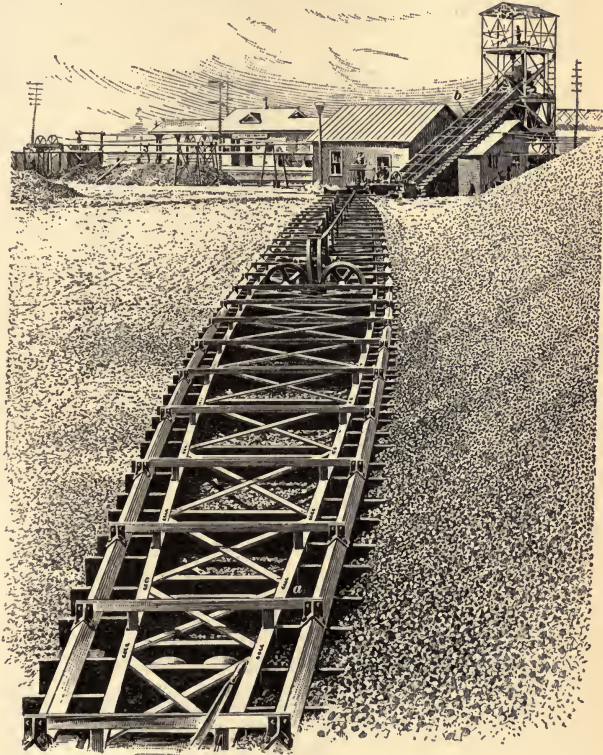

FIG. 47

contains 50,000 tons and the capacity of each unit is 8,000 to 9,000 tons per day of 10 hours either loaded or unloaded or both when arranged so that both operations can be carried on simultaneously.

This system is particularly applicable to anthracite, as it permits the stocking of the different sizes in different piles.

191. A system for storing bituminous coal is shown in Fig. 48. A locomotive crane *a* provided with a long boom *b*

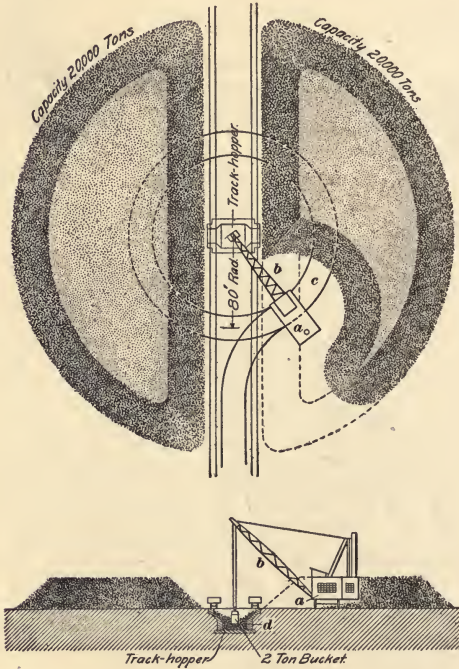

FIG. 48

runs on a circular track *c* around a central hopper *d* into which coal is dumped from the cars. From this hopper, it is lifted by a clam-shell bucket and delivered to the pile. In reloading, the crane takes coal from the pile and delivers it directly into cars or carts. This system has a capacity

of from 40 to 90 tons per hour. The capacity of such piles of different sizes is given in Table XXX.

TABLE XXX
DODGE BITUMINOUS-COAL STORAGE

Diameter of Pile Feet	Total Capacity of Piles, in Tons, for Depths of					
	30 Feet	25 Feet	20 Feet	17½ Feet	15 Feet	12 Feet
425	63,900	56,700	44,800	38,300	31,400	23,500
412	59,000	52,400	41,200	35,200	29,100	21,500
400	54,700	48,700	38,200	32,500	26,800	19,700
387	50,000	44,600	35,300	29,800	24,600	17,700
375	46,000	41,200	32,300	27,300	22,400	16,300
362	41,800	37,400	29,400	24,900	20,400	14,600
350	37,700	34,200	27,000	22,700	18,400	13,100
337	34,100	30,900	24,100	20,400	16,500	11,600
325	30,600	27,900	21,800	18,300	14,900	10,300
312	27,200	24,800	19,300	16,300	13,000	
300	24,000	22,200	17,300	14,300	11,000	
287	21,000	19,600	15,200	12,500	9,900	
275	18,300	17,200	13,200	10,900		
262	15,500	14,800	11,400			
250	13,200	12,700	10,000			
237	10,900	10,600				

192. In the Dodge revolving bridge system, Fig. 49, a light truss bridge is supported at one end on a pivoted structure that contains the operating mechanism, and at the other on a leg that is carried by wheels running on a circular track. A clam-shell bucket travels along a rail suspended from the bridge and transfers coal from the cars to the pile or vice versa, every part of the storage area being reached by the bucket whether the pile is full or empty. This system is used for storage of from 40,000 to 100,000 tons in a single unit, the units being generally rectangular in form.

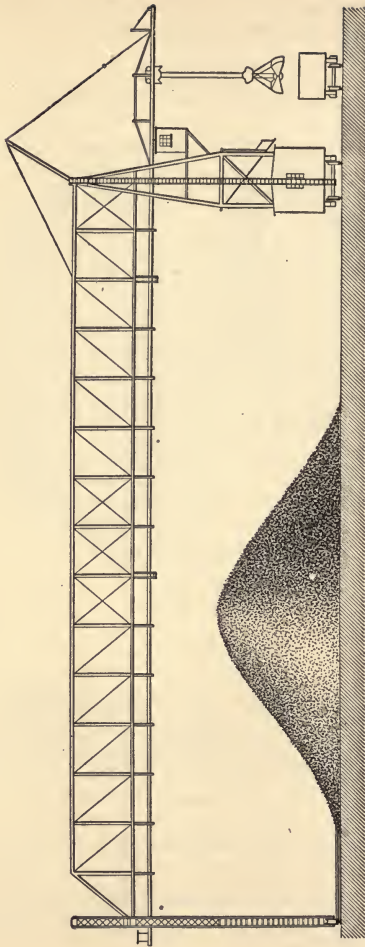

FIG. 49

193. Determining Horizontal Pressure Against Retaining Walls.—The horizontal pressure exerted, by any material, against retaining walls depends on the weight per cubic foot of the material, the depth of the material below

TABLE XXXI
HORIZONTAL PRESSURE EXERTED BY ANTHRACITE
AGAINST VERTICAL RETAINING WALLS PER
FOOT OF LENGTH

Depth, in Feet	Horizontal Surface		Sloping Surface		Depth, in Feet	Horizontal Surface		Sloping Surface	
	Total Pressure Pounds	Pressure Pounds Lowest Foot	Total Pressure Pounds	Pressure Pounds Lowest Foot		Total Pressure Pounds	Pressure Pounds Lowest Foot	Total Pressure Pounds	Pressure Pounds Lowest Foot
1	9.78	9.78	14.22	14.22	26	6,611.1	498.78	9,612.8	725.21
2	39.12	29.34	56.88	42.66	27	7,129.5	518.35	10,366.0	753.67
3	88.02	48.90	127.98	71.10	28	7,667.6	537.90	11,149.0	782.10
4	156.48	68.46	227.52	99.54	29	8,225.0	557.46	11,988.0	810.54
5	244.50	88.02	355.50	127.98	30	8,802.0	577.01	12,797.0	839.00
6	352.08	107.58	511.92	156.42	31	9,398.5	596.59	13,665.0	867.41
7	479.22	127.14	696.78	184.86	32	10,015.0	616.14	14,561.0	895.86
8	625.92	146.70	910.08	213.30	33	10,650.0	635.70	15,486.0	924.30
9	792.18	166.26	1,151.82	241.74	34	11,306.0	655.26	16,439.0	952.70
10	978.00	185.82	1,422.30	270.18	35	11,980.0	674.81	17,420.0	981.19
11	1,183.38	205.38	1,720.62	298.62	36	12,675.0	694.39	18,429.0	1,009.60
12	1,408.32	224.94	2,047.68	327.06	37	13,389.0	713.94	19,467.0	1,038.10
13	1,652.82	244.50	2,403.18	355.50	38	14,123.0	733.50	20,533.0	1,066.50
14	1,916.88	264.06	2,787.12	383.94	39	14,875.0	753.07	21,629.0	1,095.00
15	2,200.50	283.62	3,199.50	412.38	40	15,648.0	772.63	22,752.0	1,123.40
16	2,503.68	303.18	3,640.32	440.82	41	16,440.0	792.20	23,904.0	1,151.80
17	2,826.42	322.74	4,109.56	469.26	42	17,252.0	811.74	25,084.0	1,180.30
18	3,168.72	342.30	4,607.28	497.70	43	18,083.0	830.73	26,293.0	1,208.70
19	3,530.58	361.86	5,133.42	526.14	44	18,934.0	850.86	27,530.0	1,237.20
20	3,912.00	381.42	5,688.00	554.58	45	19,804.0	870.41	28,793.0	1,265.60
21	4,313.00	400.98	6,271.00	583.26	46	20,695.0	889.99	30,090.0	1,294.00
22	4,733.50	420.54	6,882.50	611.46	47	21,605.0	909.54	31,412.0	1,322.30
23	5,173.70	440.10	7,522.50	639.90	48	22,533.0	929.10	32,763.0	1,350.90
24	5,633.30	459.67	8,190.70	668.35	49	23,482.0	948.66	34,143.0	1,379.40
25	6,112.60	479.22	8,887.50	696.79	50	24,450.0	968.21	35,550.0	1,407.90

NOTE.—Weight of anthracite is taken as 52 pounds per cubic foot in calculating this table.

the top of the wall, or the line marking the height of the coal on the wall, and the surface of the pile, whether level or sloping. The accompanying formulas and tables of pressures

TABLE XXXII

HORIZONTAL PRESSURE EXERTED BY BITUMINOUS COAL
AGAINST VERTICAL RETAINING WALLS PER
FOOT OF LENGTH

Depth, in Feet	Horizontal Surface		Sloping Surface		Depth, in Feet	Horizontal Surface		Sloping Surface	
	Total Pressure Pounds	Pressure Pounds Lowest Foot	Total Pressure Pounds	Pressure Pounds Lowest Foot		Total Pressure Pounds	Pressure Pounds Lowest Foot	Total Pressure Pounds	Pressure Pounds Lowest Foot
1	6.4	6.4	10	10	26	4,305	325	6,760	510
2	25.0	19.0	40	30	27	4,641	338	7,290	530
3	57.0	32.0	90	50	28	4,993	350	7,840	550
4	102.0	45.0	160	70	29	5,358	363	8,410	570
5	159.0	57.0	250	90	30	5,733	376	9,000	590
6	229.0	70.0	360	110	31	6,122	389	9,610	610
7	312.0	83.0	490	130	32	6,523	401	10,240	630
8	407.0	96.0	640	150	33	6,935	414	10,890	650
9	516.0	108.0	810	170	34	7,362	427	11,560	670
10	637.0	121.0	1,000	190	35	7,778	440	12,250	690
11	770.0	134.0	1,210	210	36	8,253	452	12,960	710
12	917.0	146.0	1,440	230	37	8,754	465	13,690	730
13	1,076.0	159.0	1,690	250	38	9,193	478	14,440	750
14	1,248.0	172.0	1,960	270	39	9,682	490	15,210	770
15	1,433.0	185.0	2,250	290	40	10,192	503	16,000	790
16	1,630.0	197.0	2,560	310	41	10,669	516	16,810	810
17	1,840.0	210.0	2,890	330	42	11,236	529	17,640	830
18	2,063.0	223.0	3,240	350	43	11,797	541	18,490	850
19	2,298.0	236.0	3,610	370	44	12,331	554	19,360	870
20	2,548.0	248.0	4,000	390	45	12,968	567	20,250	890
21	2,809.0	261.0	4,410	410	46	13,478	580	21,160	910
22	3,083.0	274.0	4,840	430	47	14,100	592	22,090	930
23	3,369.0	287.0	5,290	450	48	14,679	605	23,040	950
24	3,669.0	299.0	5,760	470	49	15,275	618	24,010	970
25	3,981.0	312.0	6,250	490	50	15,925	631	25,000	990

NOTE.—Weight of coal is taken as 50 pounds per cubic foot in calculating this table.

for anthracite and bituminous coal are published through the courtesy of the Link-Belt Engineering Company:

For anthracite, let d represent the depth, in feet; then with surface of the pile horizontal:

$$\text{Total pressure in pounds on wall per foot of length} \\ = 9.78d^2 \quad (1)$$

$$\text{Pressure on wall on lowest foot of depth} \\ = 9.78(2d - 1) \quad (2)$$

With surface of pile sloping:

$$\text{Total pressure in pounds on wall per foot of length} \\ = 14.22d^2 \quad (3)$$

$$\text{Pressure on wall on lowest foot of depth} \\ = 14.22(2d - 1) \quad (4)$$

Angle of repose = 27° .

Table XXXI gives these pressures in pounds for anthracite for every foot of depth up to 50 feet.

For bituminous coal, let d represent the depth, in feet, then with surface of pile horizontal:

$$\text{Total pressure in pounds on wall per foot of length} \\ = 6.37d^2 \quad (5)$$

$$\text{Pressure on wall on lowest foot of depth} \\ = 6.37(2d - 1) \quad (6)$$

With surface of pile sloping:

$$\text{Total pressure in pounds on wall per foot of length} \\ = 10d^2 \quad (7)$$

$$\text{Pressure on wall on lowest foot of depth} \\ = 10(2d - 1) \quad (8)$$

Angle of repose = 35° .

Table XXXII gives these pressures in pounds for bituminous coal for every foot of depth up to 50 feet.



A SERIES OF QUESTIONS AND EXAMPLES

RELATING TO THE SUBJECTS
TREATED OF IN THIS VOLUME

It will be noticed that the Examination Questions contained in the following pages are divided into sections corresponding to the sections of the text of the preceding pages, so that each section has a headline which is the same as the headline of the section to which the questions refer. No attempt should be made to answer any questions or to work any examples until the corresponding part of the text has been carefully studied.



PROPERTIES OF GASES

EXAMINATION QUESTIONS

(1) (a) What is matter? (b) What are the names of the three principal divisions of matter?

(2) Explain what is meant by the mass and the volume of a body.

(3) Calculate the weight of a cubic yard of bituminous coal when the specific gravity of the coal is 1.3.

Ans. 2,193.75 lb.

(4) (a) What is heat? (b) Explain the action of heat on the volume of a body.

(5) Find the absolute temperature corresponding to the following ordinary temperatures: (a) 32° F.; (b) -10° C.; (c) 212° F.

(6) What is the mechanical equivalent of 12,000 B. T. U.?

Ans. 9,336,000 ft.-lb.

(7) What is the relation between the volume and temperature of gases or air when the pressure remains constant?

(8) Calculate the expanded volume of the upcast current in a furnace shaft where the temperature of the air, after passing the furnace, is 400° F.; the quantity of air passing into the mine measured on the intake airway is 50,000 cubic feet per minute at a temperature of 32° F. In making this calculation, call the pressure constant, thus ignoring the

the estimated volume of gas given off in this mine per minute? (b) What is the percentage of gas in the return air-current?

$$\text{Ans. } \begin{cases} (a) & 2,500 \text{ cu. ft. per min.} \\ (b) & 1.53+ \text{ per cent.} \end{cases}$$

NOTE.—First calculate the volume of the air for the new temperature and pressure, then subtract this volume from the volume passing out of the mine. It will be more convenient to express both pressures in pounds per square foot.

(18) (a) What is spontaneous combustion? (b) How is spontaneous combustion caused in coal?

(19) Explain how the force of gravity may assist the diffusion of gases into the mine air.

(20) Name the gases most commonly occluded in coal seams.

(21) Which of the common mine gases transpires most rapidly from the coal?

(22) (a) What is a feeder or blower? (b) Explain how a gas feeder may operate to produce an outburst of gas.

(23) (a) What is a gob fire? (b) Describe the condition under which gob fires occur most frequently.

(24) Describe, briefly, the different methods of treating gob fires.

(25) When it is necessary to isolate a mine fire in order to extinguish it, where should the work of building stoppings be commenced?



MINE GASES

EXAMINATION QUESTIONS

(1) Name the most common mine gases, giving their symbols and specific gravities.

(2) Which of the common mine gases is the most deadly and dangerous, and why?

(3) What is firedamp?

(4) Describe the effect of pure marsh gas on the flame of a lamp, and explain how the addition of air to this gas in different proportions changes the gas with respect to its effect on the flame.

(5) Explain briefly the effect of the more important mine gases on firedamp.

(6) What is afterdamp, and how is the character of the afterdamp produced by the explosion of a body of firedamp affected by the relative proportions of the air and marsh gas in the firedamp mixture?

(7) Name the inflammable mine gases.

(8) Name the principal causes of the ignition of gases in mines.

(9) (a) Explain what is meant by an explosive condition of the mine air. (b) What determines the maximum explosive point of an inflammable gas? (c) Explain the meaning of the expression "explosive range."

(10) Which of the common mine gases has the widest explosive range?

(11) (a) Is an atmosphere in which lights are extinguished necessarily dangerous to life? (b) Is an atmosphere in which lights continue to burn always safe?

(12) When carbon dioxide is added to air, (a) what percentage of this gas is necessary in the mixture to extinguish the flame of a candle? (b) what percentage is fatal to human life?

(13) What effect does coal dust suspended in the air have on the flame of a blast or an explosion, and on what does this effect depend?

(14) (a) What is a mine explosion? (b) Name the types of mine explosions.

(15) On what does the effect of a gas explosion depend?

(16) What are the factors determining the character of a dust explosion?

(17) Explain why an explosion usually travels against the air-current.

(18) Explain how the work of rescue is conducted in case of a mine explosion.

(19) What precaution should be adopted in the working of a mine to reduce the liability of an explosion?

(20) Explain the principle of the safety lamp.

(21) Name the more common types of safety lamps, and state, briefly, the conditions or the work to which each is particularly adapted.

(22) Explain the principal features of the Ashworth-Hepplewhite-Gray safety lamp.

(23) Explain the principal features of the Wolf safety lamp.

(24) What are the principal forms of locks for safety lamps?

(25) Explain the manner of testing for gas with the common Davy lamp by observing the height of the flame cap.

MINE VENTILATION

(PART 1)

EXAMINATION QUESTIONS

(1) What are the principal means employed to control the direction and amount of the air-currents passing through a mine?

(2) (a) What is the purpose of a mine door or curtain in connection with the ventilation of a mine? (b) How should a mine door be built and how should it be hung?

(3) (a) Explain the use of a regulator in connection with mine ventilation. (b) What two kinds of regulators are there? (c) What effect has a regulator on the mine resistance of the airway on which it is used?

(4) (a) What is an air crossing? (b) What are the disadvantages of using an undercast?

(5) What form of airway will give the most air with the same power and why?

(6) (a) What is the sectional area of an airway? (b) What is the rubbing surface of an airway? (c) What are similar airways?

(7) Find the perimeter, sectional area, and rubbing surface of an airway 7 feet high, 9 feet wide, and 1,000 feet long.

Ans. { Perimeter, 32 ft.
Area, 63 sq. ft.
Rubbing surface, 32,000 sq. ft.

(8) Explain the essential difference between the blowing or plenum system of ventilation and the exhaust system.

(22) What velocity will 15 horsepower produce in an airway 7 ft. \times 8 ft., and 3,000 feet long? Ans. 650 +

(23) A 7' \times 10' airway is passing 35,000 cubic feet of air each minute, and it is desired to reduce this quantity to 21,000 cubic feet each minute by means of a regulator. The water-gauge reading taken on the regulator being $\frac{3}{4}$ inch, what must be the area of the opening in the regulator?

Ans. 9.2 sq. ft.

(24) If two ventilators producing the same power are used on the same airway, will they produce twice as much air as one ventilator? If not, how much more than one ventilator will the two ventilators produce? Ans. 1.26 times, nearly.

(25) If the airways of a mine are increased to double their length, other conditions remaining the same, in what proportion would you have to increase the ventilating pressure to maintain the same velocity of the air current?

(26) In order to obtain double the quantity of air in the same airway, in what proportion must the ventilating pressure be increased?

(27) In question 26, in what proportion would the power have to be increased to obtain the same result?

(28) If you had the choice of the three following intake airways, which would you prefer and why, all the airways being of the same length: the first airway is 8 ft. \times 8 ft. in section, the second 6 ft. \times 10 ft., and the third 5 ft. \times 10 ft?

(29) A square airway has a sectional area of 64 square feet, and has passing through it 15,000 cubic feet of air per minute. What must be the sectional area of a similar airway of equal length to pass 20,000 cubic feet per minute, the power remaining the same? Ans. 90.25 sq. ft.

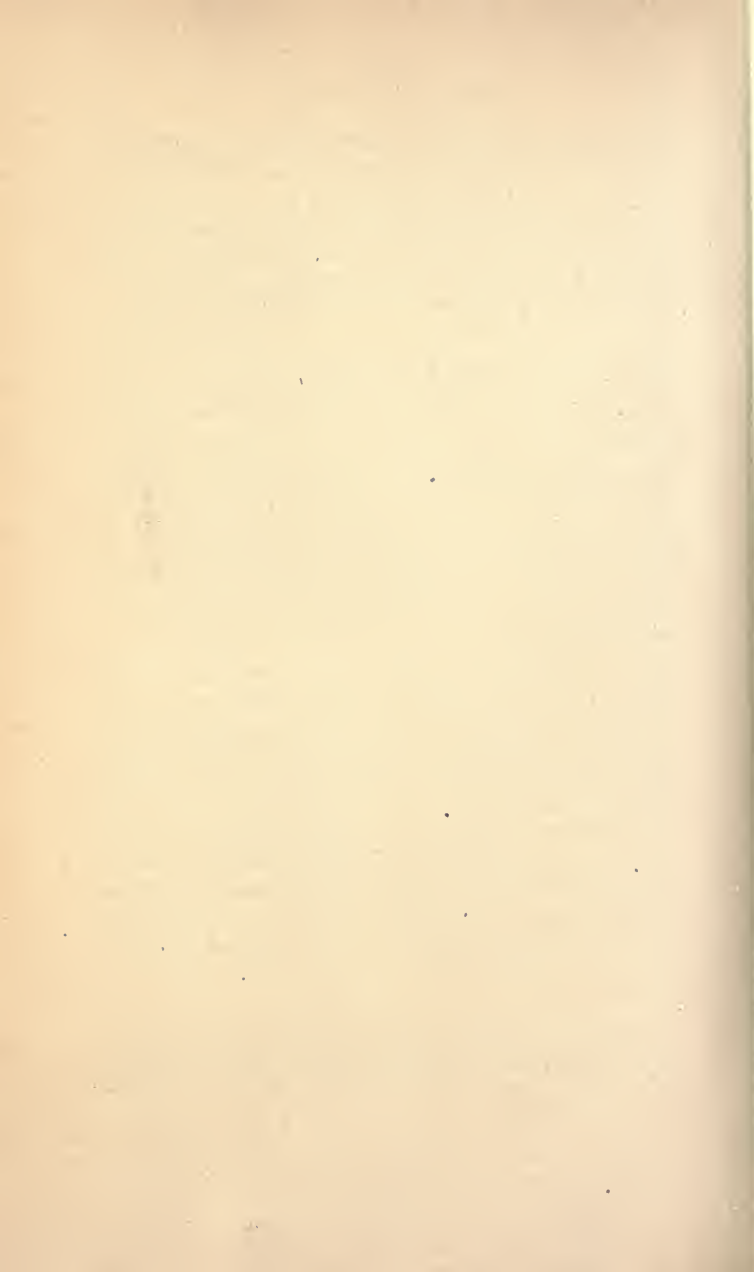

MINE VENTILATION

(PART 2)

EXAMINATION QUESTIONS

(1) What is meant by splitting the air in mine ventilation, and what particular advantage is gained by splitting?

(2) What effect does splitting the air-current in a mine have on the ventilating pressure?

(3) When the power on the air at the mouth of a mine remains unchanged and a split is made in the mine at a distance from the opening, why is not the power on the air at the point of split the same after the split is made as it was before dividing the air?

(4) When is the limit of splitting the air reached in any section of a mine?

(5) Name the chief advantages of splitting the air-current in a mine.

(6) What is meant by the natural division of the air-current in mine ventilation?

(7) Calculate the natural division of an air-current of 25,000 cubic feet between the following airways: *A*, 6 ft. \times 8 ft. and 2,000 feet long; *B*, 8 ft. \times 12 ft. and 3,000 feet long; *C*, 6 ft. \times 10 ft. and 4,000 feet long.

Ans. $\left\{ \begin{array}{l} A, 6,483 \text{ cu. ft.} \\ B, 12,526 \text{ cu. ft.} \\ C, 5,991 \text{ cu. ft.} \end{array} \right.$

(8) Find the horsepower required to pass 160,000 cubic feet of air per minute in four equal splits. The size of all

the airways is 8 ft. \times 10 ft., and the length of each split, including the return, is 3,000 feet. Ans. 32.728 H. P.

(9) Find the unit of ventilating pressure that will be required to circulate 50,000 cubic feet of air per minute in two equal splits, each split being 6 ft. \times 8 ft. and 6,000 feet long, including the return. Ans. 19 lb. per sq. ft.

(10) (a) Find the unit of ventilating pressure that will circulate 150,000 cubic feet of air per minute in the following three unequal splits, starting from the same point in the mine: *A*, 8 ft. \times 10 ft. and 3,000 feet long; *B*, 6 ft. \times 12 ft. and 4,000 feet long; *C*, 8 ft. \times 8 ft. and 2,000 feet long. (b) What is the horsepower on the air at the point where the air-current is divided? Ans. $\left\{ \begin{array}{l} (a) \text{ 13.326 lb. per sq. ft.} \\ (b) \text{ 60.57 H. P.} \end{array} \right.$

(11) Suppose that 50,000 cubic feet of air per minute passes through an airway 10 ft. \times 10 ft. and 10,000 feet long, and that a change is made by dividing the current into three splits of the following dimensions: *A*, 6 ft. \times 6 ft. and 4,000 feet long; *B*, 5 ft. \times 6 ft. and 3,000 feet long; *C*, 5 ft. \times 5 ft. and 4,000 feet long. (a) What quantity will pass through each of the splits that are now substituted for the original airway, assuming that the total quantity remains the same? (b) What horsepower is required to pass the given quantity of air in a single current? (c) What horsepower will circulate the given quantity in the three splits?

Ans. $\left\{ \begin{array}{l} (a) \left\{ \begin{array}{l} A, 19,597 \text{ cu. ft. per min.} \\ B, 17,980 \text{ cu. ft. per min.} \\ C, 12,423 \text{ cu. ft. per min.} \end{array} \right. \\ (b) \text{ 30.3 H. P.} \\ (c) \text{ 23.94 H. P.} \end{array} \right.$

(12) A slope mine is ventilated by means of an air-shaft, which forms the upcast shaft for sections *A* and *B*. The main intake for the entire mine is the haulage slope. At the foot of the slope, the entire intake current is conducted through a single main airway for a distance of 1,500 feet to a point where it is divided into two currents, each current ventilating a separate section of the mine after which they

pass out through a common upcast shaft. The sizes of the slope, airways, and shaft are as follows: Haulage slope, 6 ft. \times 12 ft. and 2,000 feet long; main intake airway, 10 ft. \times 12 ft. and 1,500 feet long; split *A*, 8 ft. \times 12 ft. and 6,000 feet long; split *B*, 8 ft. \times 10 ft. and 4,000 feet long; upcast shaft, 10 ft. \times 10 ft. and 500 feet deep. (a) Find the unit of ventilating pressure that will circulate 100,000 cubic feet of air in this mine. (b) Find the total horsepower producing the circulation in this mine.

Ans. $\left\{ \begin{array}{l} (a) \text{ 64 lb. per sq. ft.} \\ (b) \text{ 194 H. P.} \end{array} \right.$

(13) Explain briefly the essential factors that determine the efficient ventilation of a mine.

(14) Name one of the principal features in the ventilation of inclined seams.

(15) What is an air column in mine ventilation?

(16) What is meant by the term motive column as used in mine ventilation?

(17) A certain mine is ventilated by two shafts, each being 600 feet deep; the average temperature of the furnace shaft is 380° F., while that of the downcast shaft is 40° F. (a) What is the height of the motive column, in terms of the downcast air? (b) What pressure and water gauge does this column represent?

Ans. $\left\{ \begin{array}{l} (a) \text{ 243 ft.} \\ (b) \text{ 19.352 lb. per sq. ft., or 3.72 in. water gauge.} \end{array} \right.$

(18) Which are the most difficult to ventilate, rise or dip workings and why?

(19) In furnace ventilation, what determines the weight of coal burned per hour, and how is this weight of coal calculated?

(20) In a mine ventilated by a furnace, a current of 60,000 cubic feet of air is passing; the depth of the furnace shaft is 200 feet. Other conditions remaining unchanged, what quantity of air will be circulated in this mine if a stack 40 feet in height is erected over the mouth of the upcast or furnace shaft?

Ans. 65,700 cu. ft. per min.



MINE VENTILATION

(PART 3)

EXAMINATION QUESTIONS

(1) (a) Into what two general classes may ventilating fans be divided with respect to their principle of action? (b) Into what two classes may centrifugal fans be divided with respect to the manner of discharging the air from the fan?

(2) What points should be mentioned in describing a centrifugal fan?

(3) Explain the principle of the action of the centrifugal fan.

(4) Explain in what way an exhaust fan differs from a blower fan with respect to its connection with the mine.

(5) (a) Explain what is meant by the fan housing and what is its purpose. (b) Where should the expansion of the fan casing begin, and why should the fan casing expand uniformly around the fan?

(6) Explain briefly how the spiral of a fan is laid out.

(7) Mention some of the chief causes of vibration in a centrifugal fan and state what means may be taken to reduce or prevent such vibration.

(8) Explain briefly how the air-current in a mine ventilated by a centrifugal fan can be reversed.

(9) Describe, in a few words, the general features of the Nasmyth fan.

(10) How does the Guibal fan differ in its principal features from the Nasmyth fan?

(11) (a) What are the chief characteristics of the Waddle fan? (b) How does the Schiele fan differ from the Waddle fan?

(12) (a) Calculate the diameter of the central orifice or intake opening of a single-intake fan designed to pass 150,000 cubic feet of air per minute. (b) Find the inner diameter for a double-intake fan that will pass the same quantity of air.

(13) (a) What forms the basis for calculating the size of the intake opening of a fan? (b) Explain what consideration determines the breadth of a fan with respect to the diameter of its intake opening.

(14) (a) Find the volume of a fan whose outer and inner diameters are 16 feet and 10 feet, respectively, and whose breadth is 4 feet 6 inches. (b) Assuming the weight of 1 cubic foot of air within the fan to be .083 pound, find the weight of the revolved air and its centrifugal force when the fan is making 100 revolutions per minute. (c) Assuming a mine resistance of $pa = 800$ pounds and an efficiency of the ventilator of $K = .60$, find the acceleration due to the action of this fan at the given speed and the quantity of air that will be produced under these conditions.

$$\text{Ans.} \left\{ \begin{array}{l} (a) \ 551 + \text{ cu. ft.} \\ (b) \ \text{Weight} = 45.7 + \text{ lb.;} \\ \quad \text{Centrifugal force} = 1,023 \text{ lb.} \\ (c) \ \text{Acceleration} = 24.8 + \text{ ft. per sec.;} \\ \quad \text{Quantity} = 68,800 \text{ cu. ft. per min.} \end{array} \right.$$

(15) (a) Calculate the size of fan required to circulate 190,000 cubic feet of air against a pressure of 3.32 pounds per square foot, at a speed of 100 revolutions per minute, the area of the fan drift where the quantity and pressure are measured being as in question 14, $a = 120$ square feet, using the formula given in Art. 35 to calculate the outer diameter of the fan. (b) Calculate the size of a double-intake fan that will circulate 68,800 cubic feet of air per minute against a pressure of 6.67 pounds per square foot, at

a speed of 100 revolutions per minute, these being the conditions for the fan in question 14.

$$\text{Ans.} \left\{ \begin{array}{l} (a) \text{ Inner diameter } d = 10 \text{ ft.;} \\ \text{Outer diameter } D = 16 \text{ ft.;} \\ \text{Breadth} = 6 \text{ ft. 3 in.} \\ (b) \text{ } d = 6 \text{ ft.} \\ \text{ } b = 3 \text{ ft. 9 in.} \\ \text{ } D = 14 \text{ ft. 1 in.} \end{array} \right.$$

(16) Find the horsepower that will be required to operate the fan in question 14, assuming its efficiency to be, as stated, 60 per cent.

(17) Find the horsepower necessary to drive the fans in question 15 (a) and (b).

(18) If the velocity of the air in the fan drift where the pressure is measured is 30 feet per second and the water gauge produced by the fan is 2.4 inches, what static gauge would this fan produce at the same speed; or, in other words, what would be the water gauge produced by this fan at the same speed if the fan drift were closed tightly, so that no air could pass through the fan? Ans. 5.14+ in.

(19) (a) Theoretically, what should the term mechanical efficiency of a fan mean? (b) Why is not this its meaning in the usual method of making a fan test?

(20) (a) What observations are necessary to be taken in determining the mechanical efficiency of a fan? (b) Explain briefly the important points to be observed in making a test of the efficiency of a fan.



FUELS

EXAMINATION QUESTIONS

(1) What is meant by: (a) proximate analysis? (b) ultimate analysis?

(2) What is the amount of available hydrogen in a coal analyzing, moisture 10.34 per cent., carbon 74.37 per cent., hydrogen 2.58 per cent., oxygen 8.72 per cent., nitrogen 1.76 per cent., sulphur .73 per cent., ash 1.5 per cent.?

(3) What is the percentage of carbon and volatile matter in the combustible of a coal analyzing, moisture 3.5 per cent., fixed carbon 57.3 per cent., volatile matter 36.3 per cent., ash 2.9 per cent., sulphur 1.15 per cent.?

(4) What requirements should be fulfilled by a good steaming coal?

(5) Why does not the calorific power of a coal express correctly its heating value for steaming purposes?

(6) Under what conditions can a chemical analysis of coal be relied on as a check in determining the relative values of different coals for a given purpose?

(7) What items determine largely the market price of coal?

(8) (a) What causes lead to the spontaneous combustion of coal? (b) Under what conditions is spontaneous combustion most liable to occur?

(9) How is coal dust used as a fuel?

(10) Mention briefly the advantages and disadvantages of petroleum as a fuel.

(11) How is petroleum burned in a furnace under a boiler?

(12) What are the principal kinds of gases used as fuel?

(13) What are the principal chemical reactions that take place when a fuel containing carbon and hydrogen is burned in excess of air?

(14) Calculate the weight of air theoretically necessary for the complete combustion of 1 pound of coal whose analysis is, water .73 per cent., carbon 91.4 per cent., hydrogen 2.59 per cent., oxygen .08 per cent., nitrogen .21 per cent., sulphur .21 per cent., ash 3.04 per cent.

(15) Define the terms temperature of ignition and temperature of the fire.

(16) What will be the theoretical temperature of the fire, that of the atmosphere being 75° F., in burning a coal analyzing, moisture .69 per cent., carbon 81.15 per cent., hydrogen 5.21 per cent., oxygen 2.24 per cent., nitrogen 1.3 per cent., sulphur .68 per cent., ash 8.73 per cent.? The sulphur and ash need not be taken into account. The dry gases amount to 19.8 pounds per pound of combustible.

(17) How many pounds of air are supplied in burning 1 ton (2,000 pounds) of a coal analyzing 76 per cent. carbon, if the gases have the composition (by volume), carbon dioxide 11.5 per cent., carbon monoxide .9 per cent., oxygen 7.4 per cent., nitrogen 80.2 per cent.?

(18) Calculate, by Dulong's formula, the heating value of a coal having the composition, water .73 per cent., carbon 82.89 per cent., hydrogen 4.53 per cent., oxygen .4 per cent., nitrogen .64 per cent., sulphur .68 per cent., ash 10.13 per cent.

(19) Calculate, by Lord and Haas's formula, the heating value of a Pocahontas coal having the following proximate analysis: Moisture 1.5 per cent., volatile matter 21 per cent., fixed carbon 74.39 per cent., ash 3.11 per cent., sulphur .58 per cent.

(20) What will be the loss of heat due to hydrogen and moisture in burning 1 pound of a coal having the composition, moisture .69 per cent., carbon 81.15 per cent., hydrogen 5.21 per cent., oxygen 2.24 per cent., nitrogen 1.3 per cent., sulphur .68 per cent., ash 8.73 per cent., the temperature of the atmosphere being 70° F. and that of the gases 580° F.?

(21) What are the principal means of handling coal in large quantities?

(22) Why is it necessary to store coal?

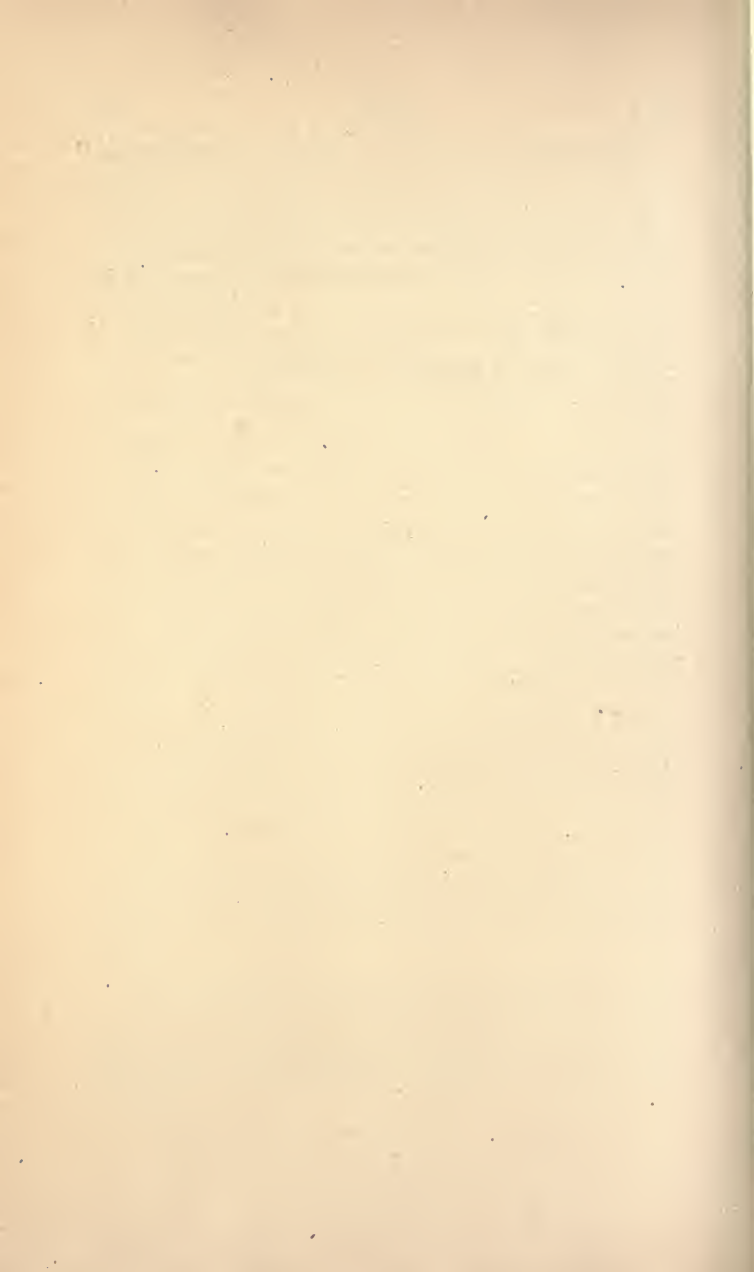

A KEY TO ALL THE QUESTIONS AND EXAMPLES

INCLUDED IN THE EXAMINATION QUESTIONS

It will be noticed that the Keys have been given the same section numbers as occur on the headlines of Examination Questions to which they refer. All article references refer to the Instruction Paper bearing the same section number as the Key in which it occurs, unless the title of some other Instruction Paper is given in connection with the article number.

To be of the greatest benefit, the Keys should be used sparingly. They should be used much in the same manner as a pupil would go to a teacher for instruction with regard to answering some example he was unable to solve. If used in this manner, the Keys will be of great help and assistance to the student, and will be a source of encouragement to him in studying the various papers composing the Course.

PROCEEDINGS OF THE

CONFERENCE

ON THE

TECHNIQUES OF THE

TECHNIQUES OF THE

TECHNIQUES OF THE

TECHNIQUES OF THE

PROPERTIES OF GASES

(1) (a) and (b) See Art. 1.

(2) See Art. 3.

(3) Substituting the given values in the formula given in Art. 8, we have for the weight of a cubic foot of this coal, $w = 62.5 \times 1.3 = 81.25$ lb. Then, since there is 27 cu. ft. in a cubic yard, the weight of a cubic yard of the coal is $w = 27 \times 81.25 = 2,193.75$ lb. Ans.

(4) (a) See Art. 22.

(b) The effect of heat is to drive the molecules of a body farther apart and thus cause an increase in the volume of the body.

(5) (a) $T = 460 + 32 = 492^\circ$ F., absolute. Ans.

(b) $T = 273 - 10 = 263^\circ$ C., absolute. Ans.

(c) $T = 460 + 212 = 672^\circ$ F., absolute. Ans.

(6) As explained in Art. 36, $12,000 \times 778 = 9,336,000$ ft.-lb. Ans.

(7) When the pressure of a gas remains constant, the volume increases or decreases in the same proportion as the absolute temperature increases or decreases.

(8) Applying the formula of Art. 52,

$$v_2 = v_1 \left(\frac{460 + t_2}{460 + t_1} \right) = 50,000 \left(\frac{460 + 400}{460 + 32} \right) = 87,400 \text{ cu. ft., nearly. Ans.}$$

(9) From Art. 57, $p = .4911 \times 24.435 = 12$ lb. per sq. in. Ans.

(10) See Art. 69.

(11) The symbols and molecular weights of the common mine gases are given in Table IX. The specific gravities of these gases are given in Table XII.

(12) The chemical symbol for carbon monoxide is *CO*. The atomic weights of the elements forming a molecule of this gas are

Carbon, <i>C</i>	12
Oxygen, <i>O</i>	16
Molecular weight, carbon monoxide	28

The percentage, by weight, of the oxygen in the gas is then $\frac{16}{28} \times 100 = 57\frac{1}{7}$ per cent. Ans.

(13) (a) The chemical equation expressing the reaction that takes place in the complete explosion of marsh gas in air, together with the molecular volume of each of the gases before and after explosion is (See Art. 88)

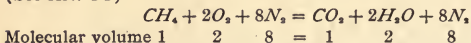

(b) It is readily observed that there are eleven volumes before and after explosion, and hence, no change of volume occurs in this case.

(14) Substituting the given values in the formula given in Art. 91, the weight of 1 cu. ft. of air under these conditions, $w = \frac{1.3273 \times 25}{460 + 300} = .0436+$ lb. Ans.

(15) By dividing the density of the gas referred to hydrogen by the density of air referred to hydrogen, namely 14.4. See Art. 93.

(16) See Art. 55. $\frac{26 \times 13.6}{12} = 29.47$ ft., nearly. Ans.

(17) (a) In this case, the volume of the return air-current is not only increased by the gases given off in the mine, but the air is expanded and its volume increased both by the increase of temperature and the decrease of pressure. The expanded volume due to these causes must first be calculated. When the reading of the barometer is 27.286 in., the atmospheric pressure is $27.286 \times .4911 = 13.400$ lb. per sq. in., or $144 \times 13.4 = 1,929.6$ lb. per sq. ft. The absolute pressure in the intake is the atmospheric pressure 1,929.6 lb. per sq. ft., while the absolute pressure on the return, when the fan is exhausting, is $1,929.6 - 14.56 = 1,915.04$, say 1,915 lb. per sq. ft. Applying formula 2,

Art. 64, $v_2 = v_1 \left(\frac{T_2 p_1}{T_1 p_2} \right) = 150,000 \left[\frac{(460 + 70) \times 1,929.6}{(460 + 40) \times 1,915} \right] = 160,200$ cu. ft. per min., nearly. Since the measurement of the return air has shown a volume of 162,700 cu. ft. per min., the volume of gas in this current may be assumed as $162,700 - 160,200 = 2,500$ cu. ft. per min. Ans.

(b) The percentage of gas in this current is then $\frac{2,500 \times 100}{162,700} = 1.53+$ per cent. Ans.

(18) (a) and (b) See Art. 106.

(19) When a gas lighter than air issues from the floor of the mine, the tendency of the gas to rise causes it to mix freely with the

air-current and thus increase the surface of contact of the gas with the air, which increases the rate of diffusion. See Art. 108.

(20) See Art. 111.

(21) The hydrocarbon gases, methane and ethylene gas, transpire more rapidly than the other mine gases (Table XV). See Art. 114.

(22) (a) See Art. 115.

(b) The extraction of the coal breaks the roof and in some cases crevices the coal, thus allowing the gas from a pocket or feeder to become distributed over a large area of the coal face or the rib of an entry or chamber. If the coal gives way under this great pressure, an outburst of gas is the result. See Art. 116.

(23) (a) Art. 117. A gob fire is a fire occurring in the waste material in the mine workings.

(b) Gob fires occur most frequently under moist conditions and where the ventilation is sluggish, and where the refuse is fine.

(24) A small fire that just started or is easily accessible should be loaded out before it can spread over a considerable area; no trace of it should be allowed to remain. The place should then be thoroughly ventilated (Art. 119). When gas feeders have been ignited and continue to burn under the waste or in any other inaccessible place, the flames should be extinguished, if possible, by exploding a small stick of dynamite near the place (Art. 120). Where the fire has spread over a considerable area, it may become necessary to seal off the portion of the workings affected by the fire so as to smother the same. This is accomplished by building air-tight stoppings in all the openings leading to this portion of the mine. The place must remain closed for a sufficient period of time for the fire to be completely extinguished (Art. 121). Culm is often used in anthracite mines to fill the places surrounding a fire so as to shut off the air and smother the fire. The culm is mixed with water and run into the mine after temporary stoppings have been erected at the mouths of all places to be filled (Art. 122). When all other methods have failed to extinguish the fire, a mine may be flooded, as a last resort (Art. 123).

(25) The work of building stoppings should be commenced at the return end of the district to be shut off, and should proceed in order toward the intake opening, which should be closed last. See Art. 121.



MINE GASES

(1) See Table I.

(2) Carbon monoxide; because the gas is very poisonous and in it the lamps continue to burn even more brightly than in air; the presence of the gas is, therefore, unsuspected by the miner. See Art. 3.

(3) Any explosive mixture of marsh gas and air. See Art. 12.

(4) Pure marsh gas will extinguish the flame of a lamp because this gas does not support combustion. The addition of air to the gas permits lamps to burn in the mixture. As the quantity of air is increased, the flame is more and more disturbed, and when the gas and air are mixed in the proportion of one volume of gas to five volumes of air, the mixture becomes slightly explosive. As the quantity of air is further increased, the explosiveness is increased, reaching a maximum when the proportion of gas to air is 1 : 9.66. Beyond this point, as the quantity of air is still increased, the explosive force is decreased until it ceases altogether when the proportion of gas and air is 1 : 13. When the proportion reaches 1 : 16, the flame is voluminous or enlarged and very much disturbed. Larger proportions of air than this are manifested by the formation of a pale-blue flame cap surmounting the flame of the lamp. The height of this flame cap decreases as the proportion of air is increased, and ceases to be visible when the proportion of gas and air is 1 : 40.

(5) The effect of carbon dioxide on firedamp is to decrease the explosiveness of the mixture. Likewise, the effect of nitrogen is to dilute the gases and weaken the explosive force of the mixture. When the firedamp is at its most explosive point, the addition of one-seventh of its volume of carbon dioxide or one-sixth of its volume of nitrogen will render the firedamp inexplorable. Carbon monoxide mixed with firedamp widens the explosive range of the gas. Olefiant gas renders the firedamp mixture more easily ignitable and increases its explosive force.

(6) Afterdamp is a mixture of gaseous products resulting from a mine explosion. When the firedamp is at its most explosive point, the afterdamp of the explosion consists of carbon dioxide, CO_2 , and water, H_2O , together with the nitrogen remaining from the air concerned in

the explosion. When the firedamp contains an insufficient quantity of air for the complete combustion of the marsh gas, the afterdamp produced by the explosion consists of carbon dioxide, CO_2 , carbon monoxide, CO , water, H_2O , and free hydrogen, H . See Art. 18.

(7) Marsh gas, CH_4 , carbon monoxide or whitedamp, CO , hydrogen sulphide, H_2S . See Art. 19.

(8) The flame of a naked lamp or match or a defective safety lamp, the flame resulting from blasting, the sparking or incandescence of electric wires, and mine fires. See Art. 22.

(9) (a) An explosive condition of the mine air exists when the air contains a certain proportion of inflammable gas.

(b) For each inflammable gas, there is a certain proportion of air required for its complete combustion, and this proportion determines the maximum explosive point for such gas.

(c) As the proportion of air required for the complete combustion of the gas is increased or decreased, the explosiveness of the mixture decreases and ceases altogether at points above and below the maximum explosive point, which points are called the explosive limits of the gas. These two limits determine the explosive range of the gas, and any proportion of air and gas lying within this range is explosive. See Art. 25.

(10) Carbon monoxide, CO , whose lower explosive limit is 1 : 13 and whose higher limit is 1 : 75, has the widest explosive range of any of the common mine gases. (See Table IV.) Hydrogen gas has a slightly greater range than this, but it does not occur commonly or abundantly as a mine gas.

(11) (a) Lights are often extinguished in an atmosphere that may be breathed for a considerable time without serious injury.

(b) Lights often continue to burn brightly in the presence of poisonous gases that will produce death in a short time. See Art. 26.

(12) (a) A candle is extinguished by an artificial atmosphere containing 14 per cent. of carbon dioxide. See Table VII.

(b) An atmosphere becomes fatal to life when it contains 18 per cent. of carbon dioxide. See Table V.

(13) A dry and dusty atmosphere lengthens the flame of a lamp or the flame of a blast. This effect is in proportion to the fineness and inflammability of the dust, the presence of small quantities of gas in the air, and the volume and intensity of the flame. See Art. 30.

(14) See Art. 31.

(15) The relative size of the workings and the body of gas exploded, the degree of explosiveness of the firedamp mixture and the temperature and velocity of the air in circulation. See Art. 32.

(16) The fineness and inflammability of the dust and its free suspension in the air, and the volume and intensity of the flame causing ignition. See Art. 33.

(17) The intake airway furnishes a plentiful supply of fresh air, which is necessary to support the flame. See Art. 38.

(18) See Art. 41.

(19) See Art. 45.

(20) See Art. 47.

(21) The Davy lamp is adapted to testing for gas because of its free admission of air through the gauze of the lamp. (See Art. 54.) The Clanny lamp is not a good lamp for testing for gas, but when bonneted is well adapted to general work in the mine. (See Arts. 56 and 57.) The bonneted Mueseler lamp is adapted to gaseous mines, owing to the sheet-iron conical chimney within the lamp increasing its security against explosion. This lamp, however, is easily extinguished when turned on one side. (See Arts. 60 and 61.) The Marsaut lamp is adapted to general work in strong air-currents, owing to the protection afforded in this lamp by the multiple gauze chimneys. See Art. 62.

(22) This lamp may be arranged to draw its air from above the lamp through the standards, which are hollow tubes. By this means, a thin layer of gas at the roof may be tested without tilting the lamp. The conical glass chimney assists the upward diffusion of the light, thus permitting a better inspection of the roof. The gauze is conical, but small in size. See Art. 65.

(23) See Art. 66.

(24) The simple screw pin is used in many lamps, but is unsafe because it is easily opened. (See Art. 70.) The common lead-plug lock cannot be opened without this being detected. (See Art. 71.) The spring lock of lamps of the protector type cannot be opened without extinguishing the light. (See Art. 72.) Magnetic locks can only be opened by the use of a strong magnet in the lamp room. See Art. 73.

(25) The flame of the lamp is first drawn down to a small glimmer. The lamp is raised slowly in an upright position into the body of gas and the flame carefully watched for the first appearance of a cap, the observer screening his eyes with his hand from the bright portion of the flame. The height of the cap is observed before the voluminous flame indicates the percentage of gas present. See Art. 86.

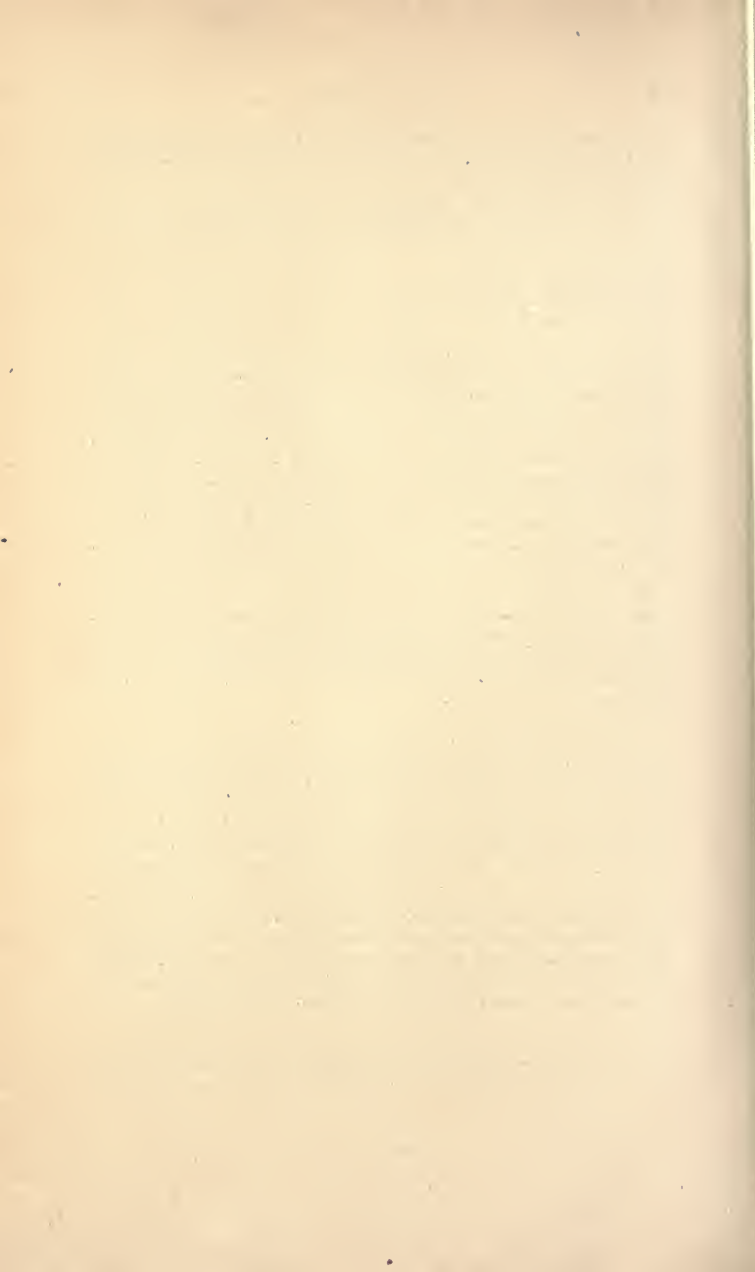

MINE VENTILATION

(PART 1)

(1) See Art. 2.

(2) (a) See Arts. 3 and 4.

(b) See Art. 3.

(3) (a) Its use is to regulate or control the amount of air passing through the airway. By the use of one or more regulators, the air is divided between the several districts of the mine in proportion to the requirements in each district. See Art. 5.

(b) See Art. 5.

(c) It has the same effect as increasing the length of the airway, and therefore increases the resistance of the airway. See Art. 42.

(4) (a) and (b) See Art. 8.

(5) The circular airway; because it has the smallest perimeter and therefore the smallest rubbing surface for the same sectional area of the airway. See Art. 10.

(6) (a) and (b) See Art. 9.

(c) See Art. 11.

(7) The perimeter is $o = 2(7 + 9) = 32$ ft. The sectional area is $a = 7 \times 9 = 63$ sq. ft. The rubbing surface is $s = 1,000 \times 32 = 32,000$ sq. ft. Ans. See Art. 9.

(8) See Art. 14.

(9) The power producing the circulation is the producing factor. The resisting factors are the rubbing surface and the unit of resistance. The resulting factors are the velocity, quantity, and pressure of the air and the work performed in moving the air-current. See Art. 15.

(10) See Art. 16.

(11) The sectional area of this airway is $a = 7 \times 7 = 49$ sq. ft. Substituting this and the given value, $v = 300$ in the formula given in Art. 16 for finding the quantity of air,

$$q = av = 49 \times 300 = 14,700 \text{ cu. ft. per min. Ans.}$$

(12) (a) The term mine resistance means the resistance offered by the airways of a mine to the passage of an air-current. See Art. 17.

(b) See Art. 17.

(13) (a) The term coefficient of friction is used to describe the unit of mine resistance, assuming this to be equal to the resistance, in pounds, offered by 1 sq. ft. of the rubbing surface of the airway to an air-current having a velocity of 1 ft. per min. See Art. 18.

(b) See Art. 19.

(14) The perimeter of this airway is $o = 2(7 + 8) = 30$ ft.; the rubbing surface is $s = lo = 3,000 \times 30 = 90,000$ sq. ft. Substituting this and the given value for the velocity of the air-current $v = 500$, in the formula given in Art. 20 for finding the resistance,

$$R = k s v^2 = .00000002 \times 90,000 \times 500^2 = 450 \text{ lb. Ans.}$$

(15) In this formula, p stands for the unit ventilating pressure, k for the coefficient of friction, s for the rubbing surface of the airway, v for the velocity of the air-current and a for the sectional area of the airway. The total pressure pa exerted on the sectional area of an airway overcomes the resistance ksv^2 offered by the airway to the passage of the air-current, and is therefore equal to the resistance. See Art. 20. The unit of ventilating pressure p or the pressure per square foot is therefore equal to the resistance divided by the sectional area of the airway, as expressed by the formula $p = \frac{ksv^2}{a}$. For example, the resistance offered by the airway in question 14 was found to be 450 lb.; the area of the airway is $a = 7 \times 8 = 56$ sq. ft. The unit of ventilating pressure in this case is then

$$p = \frac{R}{a} = \frac{ksv^2}{a} = \frac{450}{56} = 8.04 \text{ lb. per sq. ft. Ans. See Art. 22.}$$

(16) (a) See Art. 23.

(b) See Art. 26.

(17) The work performed each minute in producing this velocity in this airway is found by substituting values in formula 2 of Art. 24. The rubbing surface of this airway was found in question 14 to be $s = 90,000$ sq. ft. Then,

$$u = k s v^3 = .00000002 \times 90,000 \times 500^3 = 225,000 \text{ ft.-lb. per min.}$$

The horsepower producing the circulation is then found by substituting this value for the work, $u = 225,000$ in the formula in Art. 26,

$$h = \frac{225,000}{33,000} = 6.8 \text{ H. P.}$$

(18) (a) See Art. 28.

(b) See Art. 31.

(19) (a) and (b) See Art. 33.

(20) Since each inch of water-column represents a pressure of 5.2 lb. per sq. ft., as explained in Art. 33, the pressure per square foot in this airway is $p = 5.2 \times 1.5 = 7.8$ lb. The area of the airway is $a = 6 \times 7 = 42$ sq. ft. The total ventilating pressure in this case is, therefore, Art. 12,

$$P = p a = 7.8 \times 42 = 327.6 \text{ lb. Ans.}$$

(21) The rubbing surface of this airway was found in question 14 to be $s = 90,000$ sq. ft. Its area is $7 \times 8 = 56$ sq. ft. Substituting these values in formula 2 of Art. 38,

$$10 = \frac{.00000002 \times 90,000 \times q^2}{56^2} = \frac{.0018 q^2}{175,616}$$

$$175,616 \times 10 = .0018 q^2; \text{ or, } .0018 q^2 = 175,616 \times 10$$

$$q^2 = \frac{175,616 \times 10}{.0018} = 975,644,444+$$

$$q = \sqrt{975,644,444} = 31,235 \text{ cu. ft. per min. Ans.}$$

(22) This is the same airway as that given in question 14, and its rubbing surface is $s = 90,000$ sq. ft. Since 1 H. P. is 33,000 ft.-lb., Art. 26, the power producing the circulation in this case is $u = 33,000 \times 15 = 495,000$ ft.-lb. per min. Substituting these values in formula 2 of Art. 24,

$$495,000 = .00000002 \times 90,000 \times v^3 = .0018 v^3$$

$$.0018 v^3 = 495,000$$

$$v^3 = \frac{495,000}{.0018} = 275,000,000$$

$$v = \sqrt[3]{275,000,000} = 650+ \text{ ft. per min. Ans.}$$

(23) Substituting the given values in formula 2 of Art. 42, the area of the opening in the regulator is

$$a = .00038 \frac{21,000}{\sqrt{.75}} = 9.2 \text{ sq. ft. Ans.}$$

(24) No; two ventilators of equal power operating at the same time on a single airway will not produce double the quantity of air that one of these ventilators will produce working alone on the same airway, because the resistance due to the increased velocity of air increases more rapidly than the power, and to double the quantity of air in circulation will require $2^3 = 8$ times the power, as explained in Art. 43. In this case the power being double, the quantity will be increased in the ratio of $\sqrt[3]{2} = 1.26$, nearly. That is to say, if each ventilator when working alone will circulate 10,000 cu. ft. of air per min. in the given airway, together they will circulate 12,600 cu. ft. per min. in that airway.

(25) Other things being equal, the pressure producing a circulation is proportional to the length of the airways, or the pressure ratio

of the two airways is equal to their length ratio, as shown by formula 1 of Art. 51. Hence, to maintain the same velocity of the air in an airway when its length has been doubled the pressure must be doubled likewise.

(26) Other things being equal, the pressure producing a circulation is proportional to the square of the quantity of air, or the pressure ratio is equal to the square of the quantity ratio, as shown by formula 3 of Art. 51. Hence, to double the quantity of air in a mine or airway will require $2^2 = 4$ times the original pressure.

(27) Other things being equal, the power producing a circulation is proportional to the cube of the quantity of air, or the power ratio is equal to the cube of the quantity ratio. See Art. 48. Hence, to double the quantity of air in a mine or airway will require $2^3 = 8$ times the power. See also Art. 43.

(28) For the purposes of ventilation only, that airway is best that will pass the largest quantity of air with the least expenditure of power; that is to say, the ratio of the quantity of air in circulation to the cube root of the power producing the circulation should be a maximum, as explained in Art. 52. This ratio is expressed by transposing formula 1 in Art. 38 to read $\frac{q^3}{u} = \frac{a^2}{k s}$. Extracting the cube root of both members of this equation, and substituting for s its value $s = l o$, then $\frac{q}{\sqrt[3]{u}} = \frac{a}{\sqrt[3]{k l o}}$. The airway, therefore, that will give the greatest value for the expression $\frac{a}{\sqrt[3]{k l o}}$, or in this case, since k and l are both constant, the airway that will give the greatest value for $\frac{a}{\sqrt[3]{o}}$ will prove the best airway for the purposes of ventilation. The perimeters and areas and the values of this expression for each airway are as follows:

First airway:

$$o = 2(8 + 8) = 32 \text{ ft.}; a = 8 \times 8 = 64 \text{ sq. ft.}; \frac{a}{\sqrt[3]{o}} = \frac{64}{\sqrt[3]{32}} = 20.15;$$

Second airway:

$$o = 2(6 + 10) = 32 \text{ ft.}; a = 6 \times 10 = 60 \text{ sq. ft.}; \frac{a}{\sqrt[3]{o}} = \frac{60}{\sqrt[3]{32}} = 18.90;$$

Third airway:

$$o = 2(5 + 10) = 30 \text{ ft.}; a = 5 \times 10 = 50 \text{ sq. ft.}; \frac{a}{\sqrt[3]{o}} = \frac{50}{\sqrt[3]{30}} = 16.09.$$

These numbers represent the relative quantities that the same power will circulate in each of these airways. Thus, the power that will circulate 20,150 cu. ft. of air per min. in the first airway will circulate

18,900 cu. ft. per min. in the second airway and 16,090 cu. ft. per min. in the third airway.

(29) In this case, comparing the two airways, the quantity ratio is $\frac{q_1}{q_2} = \frac{15,000}{20,000} = \frac{3}{4}$, and calling the side of the second airway x , that of the first airway being $\sqrt{64} = 8$, the ratio of the sides is $\frac{d_2}{d_1} = \frac{x}{8}$. The length of the airways and the power being the same in each case their ratios will each be 1. Hence, substituting these values in the formula for the general power ratio in Art. 54,

$$1 = 1 \times \left(\frac{x}{8}\right)^5 \times \left(\frac{3}{4}\right)^5$$

Multiplying both sides of this equation by $\left(\frac{4}{3}\right)^5$,

$$\left(\frac{4}{3}\right)^5 = \left(\frac{x}{8}\right)^5 \times \left(\frac{3}{4}\right)^5 \times \left(\frac{4}{3}\right)^5 = \left(\frac{x}{8}\right)^5 \times \left(\frac{3}{4} \times \frac{4}{3}\right)^5$$

The last term reduces to 1 which gives

$$\left(\frac{4}{3}\right)^5 = \left(\frac{x}{8}\right)^5 \text{ or } \left(\frac{x}{8}\right)^5 = \left(\frac{4}{3}\right)^5 = \frac{64}{27}$$

Extracting the fifth root of both sides of this equation,

$$\frac{x}{8} = \sqrt[5]{\frac{64}{27}} = 1.188+$$

$$x = 8 \times 1.188 = 9.5+ \text{ ft.}$$

Since the airway is square, its area is then

$$a = x^2 = 9.5^2 = 90.25 \text{ sq. ft. Ans.}$$



MINE VENTILATION

(PART 2)

(1) The division of the air-current passing through a mine or airway into two or more currents is called splitting the air. By this means, a larger quantity of air is circulated by the same power in the same mine, or a smaller power is required to circulate the same quantity of air in the same mine. See Arts. 1 and 5.

(2) Splitting the air always causes a fall of pressure. See Art. 2.

(3) Because the splitting of the air reduces the ventilating pressure and permits a larger quantity of air to flow into and through the mine. The increase of the quantity of air passing through the main intake airway up to the point where the split is made causes an increased consumption of power in this main airway, and therefore reduces the power on the air at the point of split. See Art. 2.

(4) When the resulting velocity of the air-current is too low to sweep away the accumulating gases. See Art. 4.

(5) See Art. 5.

(6) The natural division of an air-current is such a division of the air as results when all the airways are left open to the free passage of the current, the airways being unobstructed by any regulator or other device for increasing the resistance of the airway and thus reducing the flow of air through the same. See Art. 8.

(7) The perimeters and areas of these airways are as follows:

$$A, \quad o = 2(6 + 8) = 28 \text{ ft.}; \quad a = 6 \times 8 = 48 \text{ sq. ft.}$$

$$B, \quad o = 2(8 + 12) = 40 \text{ ft.}; \quad a = 8 \times 12 = 96 \text{ sq. ft.}$$

$$C, \quad o = 2(6 + 10) = 32 \text{ ft.}; \quad a = 6 \times 10 = 60 \text{ sq. ft.}$$

The relative potential for the airways is then as follows:

$$A, \quad X_1 = a \sqrt{\frac{a}{lo}} = 48 \sqrt{\frac{48}{2,000 \times 28}}$$

$$B, \quad X_2 = a \sqrt{\frac{a}{lo}} = 96 \sqrt{\frac{96}{3,000 \times 40}}$$

$$C, \quad X_3 = a \sqrt{\frac{a}{lo}} = 60 \sqrt{\frac{60}{4,000 \times 32}}$$

Then, canceling those factors that are common to all these expressions and reducing,

$$A, \quad X_1 = 4\sqrt{\frac{4}{2 \times 7}} = 4\sqrt{\frac{2}{7}} = 2.138$$

$$B, \quad X_2 = 8\sqrt{\frac{8}{3 \times 10}} = \frac{16}{\sqrt{15}} = 4.131$$

$$C, \quad X_3 = 5\sqrt{\frac{5}{4 \times 8}} = 5\sqrt{\frac{5}{32}} = 1.976$$

$$\Sigma X = X_1 + X_2 + X_3 = 8.245$$

Finally, for the quantity of air passing in each respective airway,

$$A, \quad q_1 = 25,000 \times \frac{2.138}{8.245} = 6,483 \text{ cu. ft.}$$

$$B, \quad q_2 = 25,000 \times \frac{4.131}{8.245} = 12,526 \text{ cu. ft.}$$

$$C, \quad q_3 = 25,000 \times \frac{1.976}{8.245} = 5,991 \text{ cu. ft.}$$

Total quantity, 25,000 cu. ft.

(8) The quantity of air passing in each split is $160,000 \div 4 = 40,000$ cu. ft. per min. The perimeter and area of the airways are $o = 2(8 + 10) = 36$ ft., and $a = 8 \times 10 = 80$ sq. ft. Substituting these values in the formula for finding the horsepower, the power consumed in each split is (see Art. 11),

$$h = \frac{k \log q^3}{33,000 a^3} = \frac{.00000002 \times 3,000 \times 36 \times 40,000^3}{33,000 \times 80^3} = 8.182 \text{ H. P.}$$

The total power consumed in the four splits is then $4 \times 8.182 = 32.728$ H. P.

(9) The quantity of air passing in each split is $50,000 \div 2 = 25,000$ cu. ft. per min. The perimeter and area of the airways are $o = 2(6 + 8) = 28$ ft., and $a = 6 \times 8 = 48$ sq. ft. Substituting these values in the formula for finding the unit of ventilating pressure,

$$p = \frac{k \log q^3}{a^3} = \frac{.00000002 \times 6,000 \times 28 \times 25,000^3}{48^3} = 18.99, \text{ say } 19 \text{ lb. per sq. ft. Ans.}$$

(10) (a) The first step is to calculate the natural division of the air (see Art. 12). The perimeters and areas of these airways are as follows:

$$A, \quad o = 2(8 + 10) = 36 \text{ ft.}; \quad a = 8 \times 10 = 80 \text{ sq. ft.}$$

$$B, \quad o = 2(6 + 12) = 36 \text{ ft.}; \quad a = 6 \times 12 = 72 \text{ sq. ft.}$$

$$C, \quad o = 2(8 + 8) = 32 \text{ ft.}; \quad a = 8 \times 8 = 64 \text{ sq. ft.}$$

Then for the three airways,

$$A, \quad X_1 = a\sqrt{\frac{a}{lo}} = 80\sqrt{\frac{80}{3,000 \times 36}}$$

$$B, \quad X_2 = a \sqrt{\frac{a}{l o}} = 72 \sqrt{\frac{72}{4,000 \times 36}}$$

$$C, \quad X_3 = a \sqrt{\frac{a}{l o}} = 64 \sqrt{\frac{64}{2,000 \times 32}}$$

Canceling the factors common to all these expressions and reducing,

$$A, \quad X_1 = 10 \sqrt{\frac{10}{3 \times 9}} = \frac{10}{3} \sqrt{\frac{10}{3}} = 6.086$$

$$B, \quad X_2 = 9 \sqrt{\frac{9}{4 \times 9}} = \frac{9}{2} = 4.500$$

$$C, \quad X_3 = 8 \sqrt{\frac{8}{2 \times 8}} = \frac{8}{\sqrt{2}} = 5.657$$

$$\Sigma X = X_1 + X_2 + X_3 = 16.243$$

The quantity of air passing in each respective split is then as follows:

$$A, \quad q_1 = 150,000 \times \frac{6.086}{16.243} = 56,203 \text{ cu. ft.}$$

$$B, \quad q_2 = 150,000 \times \frac{4.500}{16.243} = 41,556 \text{ cu. ft.}$$

$$C, \quad q_3 = 150,000 \times \frac{5.657}{16.243} = 52,241 \text{ cu. ft.}$$

$$\text{Total quantity, } 150,000 \text{ cu. ft.}$$

The unit of ventilating pressure calculated for any one of these splits will be the pressure causing the circulation, since the pressure is assumed to be the same at the mouth of all the splits. Hence, substituting the values for split *A* in the formula for finding the unit of ventilating pressure,

$$p = \frac{k l o q^2}{a^3} = \frac{.00000002 \times 3,000 \times 36 \times 56,203^2}{80^3} = 13.326 \text{ lb. per sq. ft.}$$

Ans.

(*b*) The horsepower producing the circulation in all the splits is found by multiplying the unit of ventilating pressure at the point where the air is divided by the total quantity of air in circulation and dividing this result by 33,000; thus,

$$h = \frac{Q p}{33,000} = \frac{150,000 \times 13.326}{33,000} = 60.57 \text{ H. P. Ans.}$$

(11) (*a*) Applying the method illustrated in the answer to question 10

$$X_1 = \sqrt{\frac{a_1^3}{s_1}} = \sqrt{\frac{36^3}{96,000}} = .69714$$

$$X_2 = \sqrt{\frac{a_2^3}{s_2}} = \sqrt{\frac{30^3}{66,000}} = .63960$$

$$X_3 = \sqrt{\frac{a_3^3}{s_3}} = \sqrt{\frac{25^3}{80,000}} = .44194$$

$$\Sigma X = X_1 + X_2 + X_3 = 1.77868$$

$$\left. \begin{aligned} q_1 &= \frac{.69714}{1.77868} \times 50,000 = 19,597 \text{ cu. ft. per min. for 1st split.} \\ q_2 &= \frac{.63960}{1.77868} \times 50,000 = 17,980 \text{ cu. ft. per min. for 2d split.} \\ q_3 &= \frac{.44194}{1.77868} \times 50,000 = 12,423 \text{ cu. ft. per min. for 3d split.} \end{aligned} \right\} \text{Ans.}$$

50,000

(b) Applying the formula for the unit ventilating pressure,

$$p = \frac{k s q^2}{a^2} = \frac{.00000002 \times 400,000 \times 50,000^2}{100^2} = 20 \text{ lb. per sq. ft.}$$

$$\text{Therefore, } h = \frac{p q}{33,000} = \frac{20 \times 50,000}{33,000} = 30.3 \text{ H. P. Ans.}$$

$$(c) \hat{p}_1 = \frac{k s_1 q_1^2}{a_1^2} = \frac{.00000002 \times 96,000 \times 19,597^2}{36^2} = 15.8 \text{ lb. per sq. ft.}$$

$$\text{Therefore, } h = \frac{\hat{p} q}{33,000} = \frac{15.8 \times 50,000}{33,000} = 23.94 \text{ H. P. Ans.}$$

(12) (a) The first step is to calculate the perimeters and areas of the several splits, airways, and shaft in this mine. The perimeters and areas are as follows:

Haulage slope, $o = 2(6 + 12) = 36 \text{ ft.}; a = 6 \times 12 = 72 \text{ sq. ft.}$

Main airway, $o = 2(10 + 12) = 44 \text{ ft.}; a = 10 \times 12 = 120 \text{ sq. ft.}$

Split A, $o = 2(8 + 12) = 40 \text{ ft.}; a = 8 \times 12 = 96 \text{ sq. ft.}$

Split B, $o = 2(8 + 10) = 36 \text{ ft.}; a = 8 \times 10 = 80 \text{ sq. ft.}$

Upcast shaft, $o = 2(10 + 10) = 40 \text{ ft.}; a = 10 \times 10 = 100 \text{ sq. ft.}$

The relative pressure potentials in this case will be

$$\text{Haulage slope, } X_1 = a \sqrt{\frac{a}{lo}} = 72 \sqrt{\frac{72}{2,000 \times 36}} = 2.277$$

$$\text{Main airway, } X_2 = a \sqrt{\frac{a}{lo}} = 120 \sqrt{\frac{120}{1,500 \times 44}} = 5.117$$

$$\text{Split A, } X_3 = a \sqrt{\frac{a}{lo}} = 96 \sqrt{\frac{96}{6,000 \times 40}} = 1.920$$

$$\text{Split B, } X_4 = a \sqrt{\frac{a}{lo}} = 80 \sqrt{\frac{80}{4,000 \times 36}} = 1.886$$

$$\text{Upcast shaft, } X_5 = a \sqrt{\frac{a}{lo}} = 100 \sqrt{\frac{100}{500 \times 40}} = 7.071$$

The sum of the relative potentials for the two splits is $\Sigma X_p = X_3 + X_4 = 3.806$. To find the pressure producing the circulation in the mine, substitute the given values in the general equation for finding the pressure producing the circulation, Art. 14; thus,

$$p = .00000002 \times 100,000^2 \left(\frac{1}{2.277^2} + \frac{1}{5.117^2} + \frac{1}{3.806^2} + \frac{1}{7.071^2} \right) \\ = 64 \text{ lb. per sq. ft. Ans.}$$

(b) The horsepower producing the circulation in this mine is found by multiplying the unit of ventilating pressure obtained in (a) by the

total quantity of air passing in the main airway and dividing by 33,000; thus,

$$h = 100,000 \times \frac{64}{33,000} = 193.9, \text{ say } 194 \text{ H. P. Ans.}$$

(13) See Art. 15.

(14) It is important that the ventilation be so arranged wherever practicable that the air-current will tend to rise as it passes through the workings. See Art. 21.

(15) An air column in ventilation is a column of air having a base of one square unit, which is usually taken as 1 sq. ft., and a height equal to the height of the air considered. See Art. 25.

(16) See Art. 27.

(17) The motive column, in terms of the downcast air, is obtained by substituting the given values in formula 1 of Art. 27. Thus,

$$M = D \left(\frac{t_2 - t_1}{460 + t_2} \right) = 600 \left(\frac{380 - 40}{460 + 380} \right) = 600 \times \frac{340}{840} = 243 \text{ ft., nearly}$$

The pressure corresponding to this motive column is found by multiplying the height of the column by the weight of 1 cu. ft. of downcast air. The weight of 1 cu. ft. of this air having a temperature of 40 F°, assuming a barometric reading of 30 in. is

$w = \frac{1.3273 \times 30}{460 + 40} = .079638 \text{ lb.}$ The pressure due to the motive column is, therefore, $p = Mw = 243 \times .079638 = 19.352 \text{ lb. per sq. ft.}$ The water gauge corresponding to this pressure is then

$$i = \frac{p}{5.2} = \frac{19.352}{5.2} = 3.72 \text{ in. Ans.}$$

(18) In general, rise workings are the most difficult to ventilate because the current returning from the working face is generally warmer than that approaching the working face. The warmer air being lighter tends to rise, and the colder and heavier air to fall, which assists the ventilation of dip workings, but opposes the ventilation of rise workings. See Art. 33.

(19) See Art. 42.

(20) For the same conditions with respect to the temperature of the shaft and the circulation of air through the mine workings, the quantity ratio varies as the square root of the ratio of the depths of the shaft before and after the erection of the stack. See Art. 45. The shaft being 200 ft. deep and the stack 40 ft. high, the ratio of the depth after the erection of the stack to that of the shaft is $\frac{240}{200}$. Call-

ing the increased quantity of air in circulation x the quantity ratio is $\frac{x}{60,000}$; hence, $\frac{x}{60,000} = \sqrt{\frac{240}{200}} = \sqrt{\frac{6}{5}} = \sqrt{1.2}$. Then,

$$x = 60,000 \times \sqrt{1.2} = 60,000 \times 1.095 = 65,700 \text{ cu. ft. per min. Ans.}$$



MINE VENTILATION

(PART 3)

(1) (a) Disk or propeller fans and centrifugal fans. See Art. 6.

(b) Open running fans and closed running fans. See Art. 8.

(2) It is necessary to give the outer and the inner diameters and the width of the fan; also, the number, shape, and position of the fan blades. See Art. 8.

(3) See Art. 9.

(4) In the case of an exhaust fan, the intake opening of the fan is connected with the return airway of the mine and the mine air is thus drawn into the fan, from which it is discharged into the atmosphere. In the case of the blower fan, the discharge opening of the fan is connected with the intake airway of the mine while the intake orifice is open to the atmosphere. Air is thus drawn into the fan from the atmosphere and discharged into the mine. The direction of the air through the fan is the same in each case. See Art. 9.

(5) (a) The fan housing encloses the fan wheel and conducts the air from the mine to the fan when exhausting, or from the fan to the mine when blowing. See Art. 11.

(b) The expansion of the fan casing should begin at a point on the circumference of the fan wheel at a distance from the point of cut-off at least equal to the distance between two consecutive blade tips. From this point, the casing should expand uniformly so that the sectional area of the spiral passage encircling the fan will be uniform, and the velocity of the air will then be uniform all around the fan. See Art. 11.

(6) See Art. 12.

(7) The chief causes of vibration in a fan are lack of proportionment between the different parts of the fan, or the striking of the air-current against abrupt angles or surfaces, causing eddies to be set up in the air-current. Vibration is often caused by the rapid succession of

blows imparted to the air by the blades of the fan passing the edge of a straight cut-off. The several means taken to prevent this trouble are a careful proportionment of the different parts of the fan to the work to be performed; avoiding sharp angles and abrupt changes in the sectional area of the airways; also using a V-shaped cut-off or shutters in the fan. See Art. 14.

(8) See Art. 17.

(9) The Nasmyth fan is an open-running fan; it has straight radial blades supported on radial arms that are bolted to two cast-iron spiders mounted on the fan shaft, to which they are firmly keyed. See Art. 20.

(10) The Guibal fan is a closed-running fan; its blades are straight like the Nasmyth, but are not radial, being inclined backwards from the direction of motion. The chief feature of the Guibal fan is the frame that supports the blades; this consists of a series of pairs of double bars, one end of each bar supports a blade, while the other end forms a brace for one of the opposite blades. The spiral of the Guibal fan extends only one-quarter, and in more recent types of this fan one-half, around the circumference, the remainder of the circle fitting closely to the fan wheel. See Art. 21.

(11) (a) The Waddle fan is an open-running fan having tapered blades that are curved backwards from the direction of rotation. See Art. 22.

(b) The Schiele fan is a closed-running fan, the fan wheel being enclosed in a spiral casing. In most other respects, it resembles the Waddle fan except for the sheet-iron diaphragm that divides the fan practically into two single-inlet fans. See Art. 23.

(12) (a) Substituting the given value for Q in formula 1 of Art. 28, the diameter of the intake opening is

$$d = .03257 \sqrt{150,000} = 12.6 \text{ ft.}, \text{ or say } 12 \text{ ft. } 6 \text{ in. Ans.}$$

(b) Substituting the same value in formula 2 of Art. 28, the diameter of the central opening for a double-intake fan is

$$d = .023 \sqrt{150,000} = 8.9, \text{ say } 9 \text{ ft. Ans.}$$

(13) (a) The velocity of the air entering the fan. This is assumed as varying from 1,000 to 1,500 ft. per min., the average velocity for the purpose of calculation being taken as 1,200 ft. per min. See Art. 28.

(b) The deflection of the air entering the fan, or the change in its direction, causes a loss of velocity that is assumed to equal about 20 per cent., thus making the velocity of the air passing through the throat of the fan about eight-tenths of its velocity at the intake opening. On account of this loss of velocity, the area of the throat of the fan

must be increased in the same ratio as the velocity is decreased. See Art. 29.

(14) (a) Substituting the given values in the formula in Art. 30, the volume of this fan is

$$V = .7854 (16^2 - 10^2) 4.5 = 551 + \text{cu. ft. Ans.}$$

(b) The weight of the revolved air in this case is

$$W = .083 \times 551 = 45.7 + \text{lb. Ans.}$$

Now, finding the distance of the center of gravity of the air in one compartment of this fan by substituting the given values in formula 2 of Art. 31, assuming a uniform density of the air in the fan,

$$R_g = \frac{2}{3} \left(\frac{8^2 - 5^2}{8^2 - 5^2} \right) = 6.6 + \text{ft.}$$

The circumference of the circle described by this radius is

$$2 \pi R_g = 2 \times 3.1416 \times 6.6 = 41.47 \text{ ft.}$$

and the velocity of the center of gravity of the air in each compartment of the fan at a speed of 100 rev. per min. is

$$v_g = \frac{100 \times 41.47}{60} = 69.1 \text{ ft. per sec.}$$

Substituting these values in formula 1 of Art. 31, the centrifugal force due to the action of this fan is

$$F = \frac{45.7 \times 69.1^2}{32.16 \times 6.6} = 1,028 + \text{lb. Ans.}$$

(c) Substituting the values thus found and the given values in formula 2 of Art. 32, the acceleration due to the fan's action at the given speed is

$$f = \frac{.60 \times 1,028}{800} \times 32.16 = 24.795, \text{ say } 24.8 \text{ ft. per sec. Ans.}$$

Finally, assuming the sectional area in the fan drift where the quantity and pressure are measured is $a = 120$ sq. ft.; the unit of ventilating pressure corresponding to the given mine resistance is

$p = \frac{800}{120} = 6.67$ lb. per sq. ft. Substituting this and the other values found and given in the formula for finding the quantity of air delivered by the fan in Art. 33,

$$Q = 60 \left(\frac{.60 \times 1,028}{6.67} \times \frac{24.8}{2} \right) = 68,800 \text{ cu. ft. per min. Ans.}$$

NOTE.—This fan is an example of a poorly designed fan, as will be shown by the following example:

(15) (a) For a double-intake fan, the diameter of the intake opening and the width of the fan are, respectively,

$$d = .023 \sqrt{190,000} = 10.02, \text{ say } 10 \text{ ft. Ans.}$$

$$b = \frac{5}{8} d = \frac{5}{8} \times 10 = 6.25 \text{ ft., or } 6 \text{ ft. } 3 \text{ in. Ans.}$$

First find the value of $X = \sqrt{\frac{Q^2}{p}} = \sqrt{\frac{190,000^2}{3.32}} = 2,215 +$.

Assuming the value of the fan constant in this case to be $c = 4$, and substituting this and the given values in the formula given in Art. 35 for finding the ratio of the outer diameter to the inner diameter of the fan,

$$m = \sqrt[3]{\frac{\sqrt{120 \times 190,000}}{100^2} \left[4 + \left(\frac{3,000}{2,215} \right)^3 \right]} + 1 = 1.6$$

The outer diameter of the fan is then

$$D = m d = 1.6 \times 10 = 16 \text{ ft. Ans.}$$

NOTE.—It will be observed that this fan is the same size as that in question 14, except for its greater width; the fan in question 14 is 4.5 feet wide, while this fan is 6.25 feet wide.

(b) For a double-intake fan, the diameter of the intake opening and the width of the fan are, respectively,

$$d = .023 \sqrt{68,800} = 6.033, \text{ say } 6 \text{ ft. Ans.}$$

$$b = \frac{5}{8} d = \frac{5}{8} \times 6 = 3.75, \text{ or } 3 \text{ ft. } 9 \text{ in. Ans.}$$

The value of X in this case is $X = \sqrt[3]{\frac{Q^2}{p}} = \sqrt[3]{\frac{68,800^2}{6.67}} = 892+$.

Then, taking $c = 4$, and substituting this and the given values in the formula in Art. 35 for finding the ratio of the outer diameter to the inner diameter of the fan,

$$m = \sqrt[3]{\frac{\sqrt{120 \times 68,800}}{100^2} \left[4 + \left(\frac{3000}{892} \right)^3 \right]} + 1 = 2.356$$

The outer diameter of the fan is then

$$D = m d = 2.356 \times 6 = 14.13 \text{ ft., or say } 14 \text{ ft. } 2 \text{ in. Ans.}$$

NOTE.—This fan is about 2 ft. less in diameter and 9 in. narrower, but is calculated to do the same work at the same speed as that in question 14, which is thus seen to be too narrow with respect to its other dimensions.

(16) Substituting the given values in the formula for finding the horsepower in Art. 34,

$$H = \frac{Q p}{33,000 K} = \frac{68,800 \times 6.67}{33,000 \times .60} = 23.17 + \text{ H. P. Ans.}$$

(17) The fan in question 15 (a) is circulating 190,000 cu. ft. of air per min. against a pressure of 3.32 lb. per sq. ft. Except for its being wider, it has the same dimensions and is driven at the same speed as the fan in question 14. Assuming the efficiency of the fan to be 60 per cent. as stated, the horsepower required is

$$H = \frac{Q p}{33,000 K} = \frac{190,000 \times 3.32}{33,000 \times .60} = 31.85 + \text{ H. P. Ans.}$$

The fan in question 15 (b) is doing the same work as that in question 14. Though a smaller fan, a test would probably show its efficiency to be higher on account of its being better proportioned. The power required to drive the fan would be the same as that found in question 16 unless this power was decreased by a higher efficiency of the fan.

(18) Substituting the given values in the formula for finding the static pressure or water gauge due to a fan in Art. 45,

$$p_s = \frac{2g}{v} \times p = \frac{2 \times 32.16}{30} \times 2.4 = 5.14+ \text{ in. Ans.}$$

(19) (a) See Art. 46.

(b) Because it is usually impossible or impracticable to separately test the fan and the motor driving the fan.

(20) (a) and (b) See Art. 47.

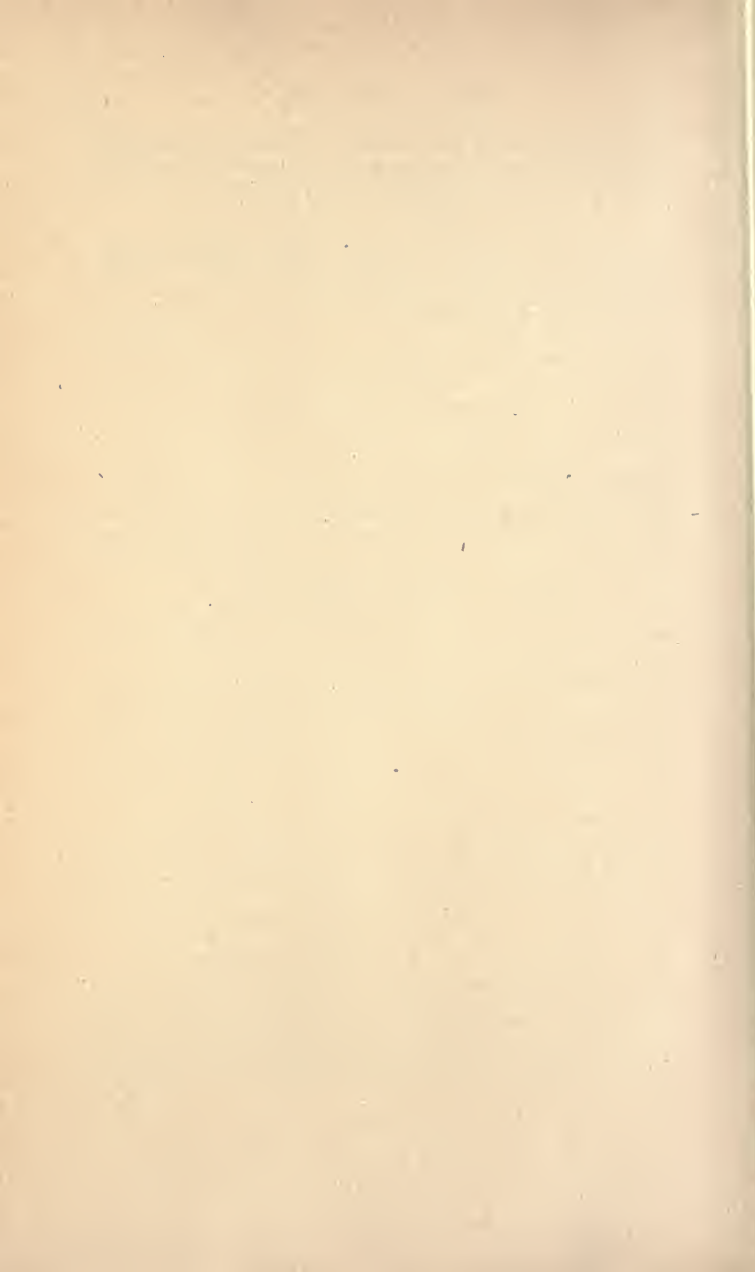

FUELS

(1) (a) An analysis in which the composition of a fuel is expressed in terms of moisture, volatile matter, fixed carbon, ash, and usually, in addition, sulphur and sometimes phosphorus, as determined by ultimate analysis.

(b) An analysis in which the elementary composition of a fuel is determined.

(2) Substituting in the formula, $h = H - \frac{O}{8}$, given in Art. 4, we have $h = 2.58 - \frac{8.72}{8} = 1.49$ per cent. Ans.

(3) The combustible matter in the coal is the fixed carbon plus the volatile matter, and is equal to $57.3 + 36.3 = 93.6$ per cent. of the coal; hence, the combustible analyzes,

$$\text{Fixed carbon, } \frac{57.3}{.936} = 61.2 \text{ per cent.}$$

$$\text{Volatile matter, } \frac{36.3}{.936} = 38.8 \text{ per cent. Ans.}$$

(4) A good steaming coal should kindle readily and burn quickly but steadily. It should contain only enough volatile matter to insure rapid combustion, and be low in ash and sulphur. It should not clinker and should not be so friable as to be too badly broken in handling.

(5) Because all coals cannot be burned with equal efficiency under all conditions.

(6) An actual test of the coals should be made in the furnace to be used, under the ordinary working conditions of the plant, and the coal selected that is best suited to the conditions. A proximate analysis of the coal selected will furnish a good guide for the selection of a coal for this particular plant.

(7) They are, the cost of the coal in the ground, or royalty to the owner; cost of mining and preparation at mine, including cost of repairs, interest on investment; freight rates; cost of handling, storing, selling, insurance, distribution to customers, and agents' and retailers'

profits; relative supply and demand and prejudice in favor of certain coals.

(8) (a) The generally accepted explanation is that there is an absorption of oxygen by the combustible matter, including the sulphur, producing a slow combustion that generates heat. If the heat thus produced cannot readily escape, the temperature may rise high enough to cause ignition or active combustion.

(b) It occurs most often on shipboard, where the coal is stored in warm and poorly ventilated bunkers, and in large stock piles. Very fine coal absorbs oxygen more readily than coarse, hence such coal is more liable to spontaneous combustion. Freshly mined coal absorbs oxygen more readily than coal that has been mined for some time, and hence is more liable to spontaneous ignition.

(9) The powdered coal is introduced into the combustion chamber of the furnace by means of a blast of air, the lining of the combustion chamber being first heated to a high temperature by means of an open fire. The distributing nozzle is so located that the dust is distributed throughout the entire space of the combustion chamber, where it is rapidly and completely burned.

(10) Its advantages are that it has a greater heating capacity than coal; is easily transported in pipes, tank cars, or tank vessels; the cost of handling is less than for coal; it may be burned without smoke and there are no ashes to be handled.

Its disadvantages are that its supply is limited, and in most localities its price is high as compared with that of coal.

(11) It is introduced into the firebox or combustion chamber by the use of burners so constructed that the oil is mixed with a jet of steam or compressed air and thus converted into a fine spray as it enters the combustion chamber.

(12) Natural gas, coal gas, water gas, producer gas, combined water gas and producer gas, blast-furnace gas and coke-oven gas.

(13) The carbon is completely burned to carbon dioxide and the hydrogen to water. With methane, CH_4 , the reaction is

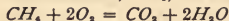

(14) In burning 1 lb. of carbon to carbon dioxide, $2\frac{3}{8}$ lb. of oxygen is required (Table XXV). In burning 1 lb. of hydrogen to water, 8 lb. of oxygen is required. In burning 1 lb. of sulphur to sulphur dioxide, 1 lb. of oxygen is required.

The amount of carbon to be burned is .914 lb., requiring $.914 \times 2\frac{3}{8} = 2.437$ lb. of oxygen.

The amount of available hydrogen is $2.59 - \frac{.08}{8} = 2.58$ per cent.
 $= .0258$ lb., requiring $.0258 \times 8 = .2064$ lb. of oxygen.

The amount of sulphur burned may be assumed as one-half of the whole, or .105 per cent. = .00105 lb., requiring .00105 lb. of oxygen.

As there are no other combustibles, the weight of oxygen theoretically required to burn the coal is:

	POUNDS
For the carbon	2.43700
For the hydrogen20640
For the sulphur00105
Total	2.64445

Since oxygen makes up only 23 per cent. of the air by weight, the weight of air theoretically required is $\frac{2.644}{.23} = 11.5$ lb. Ans.

(15) The temperature of ignition is the temperature at which a given body takes fire. The temperature of the fire is the temperature produced by the burning of a body.

(16) Applying the formula in Art. 133,

$$T = \frac{616 C + 2,220 H - 327 O - 44 W}{t + .02 W + .18 H}, \text{ we have}$$

$$T = \frac{616 \times 81.15 + 2,220 \times 5.21 - 327 \times 2.24 - 44 \times .69}{19.8 + .02 \times .69 + .18 \times 5.21} = 2929.5^\circ \text{ F.}$$

$$T + t = 2,929.5 + 75^\circ = 3,004.5^\circ \text{ F. Ans.}$$

(17) Applying formula in Art. 136, pounds of dry air per pound of carbon = $\frac{3.032 N}{CO_2 + CO}$, we have $\frac{3.032 \times 80.2}{11.5 + .9} = 19.6$ lb. of air per pound of carbon burned. Since the coal contains 76 per cent. of carbon, there are $2,000 \times .76 = 1,520$ lb. of carbon in 1 T. of coal. The total weight of air required will then be $1,520 \times 19.6 = 29,792$ lb. Ans.

(18) Substituting in Dulong's formula, Art. 138, heating value = $\frac{1}{100} \times \left[14,600 C + 62,000 \left(H - \frac{O}{8} \right) + 4,000 S \right]$, we have

$$\text{Heating value} = \frac{1}{100} [14,600 \times 82.89 + 62,000 \times 4.48 + 4,000 \times .68]$$

$$= \frac{1}{100} [1,210,194 + 277,760 + 2,720] = 14,906.7 \text{ B. T. U. Ans.}$$

(19) The value of K for a Pocahontas coal is given in Table XXIX as 15,829. Substituting in formula 1, Art. 140, we have

$$\frac{15,829 (100 - 3.11 - .58 - 1.5) + (.58 \times 4,050)}{100} = 15,030.96 \text{ B. T. U.}$$

Ans.

(20) Substituting in the formula in Art. 145, we have

$$(9 \times .0521 + .0069) \times [(212 - 70) + 965.8 + .48 (580 - 212)] = .4758$$

$$\times [142 + 965.8 + 176.64] = 611.14 \text{ B. T. U. Ans.}$$

(21) Self-filling buckets, flight conveyers, belts, continuous lines of metal buckets, chutes, and car-dumping machines.

(22) The reasons for storing coal are: at the points of consumption, to insure no interruption in supply from uncertain transportation, strikes and other causes; at the mines, to permit of the mines being run continuously when the demand for coal is small; and in cold climates; to take advantage of the cheaper transportation by water during a portion of the year.

INDEX

NOTE.—All items in this index refer first to the section and then to the page of the section. Thus "Advance of a mine explosion, §6, p27," means that advance of a mine explosion will be found on page 27 of section 6.

A

Absolute pressure, §5, p31.
temperature, §5, p17.
zero, §5, p17.

Adjustment of the mercurial barometer, §5, p30.

Advance of a mine explosion, §6, p27.

Affinity, §5, p1.

Afterdamp, §6, p11.

Air bridges, §13, p7.
columns, §14, p38.
columns, Average temperatures of, §14, p44.
columns, Density of, §14, p49.
courses, §13, p2.
crossings, §13, p7.
Density of, referred to hydrogen, §5, p52.
Effect of splitting the, §14, p2.
Explosive condition of mine, §6, p15.
Fuel burned in, §16, p72.
in mines, Condition of, §6, p15.
measurements, §13, p25.
Power on the, §13, p24.
Properties of, §16, p74.
Quantity of, delivered by fan, §15, p35.
Quantity of, in circulation, §13, p17.
Quantity of, produced by two or more ventilators, §13, p51.

Required, Quantity and velocity of, §14, p24.

Relation of velocity or quantity of, to power, §13, p55.

Relative humidity of, §16, p74.
required by law, Quantity of, §14, p25.

Shaft, §13, p2.

Splits, §14, p8.
supply, Estimation of, §16, p83.

To measure the velocity of, in an airway, §13, p25.

Weight of one cubic foot of, §5, p51.

-current, Calculation of work of producing an, §13, p23.

Air—(Continued)

-current, Natural division of the, §14, p9.
-current, Proportionate division of the, §14, p9.
-current, Reversing the, §15, p17.
-current, Velocity of, §13, p17.
-currents, Conducting, §13, p1.
-currents, How air columns produce, §14, p38.
-currents, How produced, §13, p13.
-currents, Production and control of, §13, p1.
-currents, Splitting, §14, p1.

Airway, Calculation of the resistance of an, §13, p20.
Perimeter of, §13, p9.
Relation between perimeter of, and power, §13, p54.
Relation between the length of an, and the power, §13, p54.
Rubbing surface of, §13, p11.
Sectional area of, §13, p10.
To measure the velocity of air in an, §13, p25.
Value of, §13, p18.

Airways, §13, p2.
Choice of, §13, p65.
Comparing similar, §13, p67.
Comparison of forms of, §13, p11.
Form and size of, §13, p9.
General power ratio for similar, §13, p67.
General ratio for similar, §13, p67.
Similar, §13, p13.
Single, or circulations, §13, p46.

Analysis of coal and coke, §16, p91.
Proximate, §16, pp4, 91.
Report of coal, §16, p97.
Selling coal by, §16, p30.
Ultimate, §16, pp4, 96.
Valuing coals by, §16, p28.

Anemometer, Biram, §13, p26.

- Anemometer—(Continued)
 Self-timing, §13, p27.
 Special, §13, p27.
 Use of the, §13, p29.
- Aneroid barometer, The, §5, p32.
- Animal oils, §6, p58.
- Approaching a body of gas, §6, p63.
- Area and power, Relation between, §13, p55.
- Arrest of an explosion, §6 p28.
- Artificial ventilation, §13, p14.
- Ash, §16, p3.
 Determination of, in coal §16, p93.
 in coal, §16, p18.
- Ashworth-Hepplewhite-Gray lamps, §6, p47.
- Atmosphere, Composition of, §5, p51.
 Dangerous, §6, p16.
 Extinctive character of an, §6, p18.
 Fatal, §6, p16.
 The, §5, p51.
- Atmospheres, §5, p31.
 Table of composition of fatal, §6, p17.
- Atmospheric pressure; §5, p28.
 Measurement of, §5, p29.
- Atomic weight, §5, p38.
- Atoms, §5, p1.
- Automatic railway, Hunt, §16, p103.
- Avogadro's law, §5, p45.
- B**
- Bagasse, §16, p10.
- Barometer, Adjustment of the mercurial, §5, p30.
 The aneroid, §5, p32.
 The mercurial, §5, p30.
- Beard-Mackie sight indicator, §6, p68.
- Beaume's hydrometer, §5, p11.
- Belt conveyer, Tripper for, §16, p107.
 conveyers, §16, p106.
- Belts for conveyers, §16, p106.
- Bench of retorts, Operating, §16, p61.
- Biram anemometer, §13, p26.
- Bituminous coal, To prevent spontaneous ignition of, §16, p35.
- Blackdamp, §6, p3.
- Blacksmith coals, §16, p17.
- Blades of fan, Number of, §15, p38.
 of fans, Curvature of, §15, p39.
 of fans, Inclination of, §15, p40.
 of fans, Secondary, §15, p39.
 Tapered fan, §15, p41.
- Blasting powder, Temperature of flame of, §6, p13.
- Blower fan, §15, p7.
- Blowers and feeders, §5, p53.
- Blowing system of ventilation, §13, p15.
- Blow-down fan, §15, p7.
- Bonneted Clanny Lamp, §6, p42.
- Bonneted—(Continued)
 Davy lamp, §6, p39.
 Marsaut lamp, §6, p47.
 Mueseler lamp, §6, p45.
- Box regulator, §13, p5.
- Brattices, §13, p6.
- Bridge tramway storage system, §16, p124
- Bridges, Air, §13, p7.
- Briqueting fuel, Machines for, §16, p39.
- Briquets, §16, p38.
- British thermal unit, §5, p18.
- Brown car-dumping machine, §16, p118.
- Bucket carriers, §16, p109.
 Clam-shell, §16, p98.
 conveyer, §16, p112.
 Drop-bottom, §16, p100.
 elevators, §16, p110.
 Orange-peel, §16, p99.
 Shovel, §16, p100.
- Buckets, Self-filling, §16, p98.
- Burner, Coal-dust, §16, p37.
- Burners, Flat-jet petroleum, §16, p47.
 oil, Injector, §16, p49.
- Burning of wood, §16, p10.
- C**
- Caking and non-caking coal, §16, p15.
- Calculation of change of volume of gas, §5 p49.
- Calculations in ventilation, §13, p34.
 Special ventilation, §13, p49.
- Calorie, French, §5, p18.
 Pound, §5, p18.
- Calorific value of fuels, §16, p90.
- Calorimeter, §16, p90.
 Mahler's bomb, §16, p90.
- Cannel coal, §16, p14.
- Canvas door, §13, p4.
- Capell fan, §15, p25.
- Car-dumping machine, Brown, §16, p118.
 machine, McMyler, §16, p120.
 machines, §16, p118.
- Carbon, §16, p1.
 dioxide, §6, p3.
 dioxide, Effect of, on firedamp, §6, p9.
 dioxide, Explanation of term, §5, p41.
 fixed, Determination of, in coal, §16, p93.
 fixed, and ash, Determination of, in coal, §16, p93.
 monoxide, §6, p2.
 monoxide, Effect of, on firedamp, §6, p9.
 monoxide, Explanation of term, §5, p41.
- Carbonic acid, Explanation of term, §5, p41.
 acid gas, §6, p3.
 acid gas, Effect of, on firedamp, §6, p9.
 oxide, §6, p2.
 oxide, Effect of, on firedamp, §6, p9

- Carbonic—(Continued)
 oxide, Explanation of term, §5, p41.
- Carbureted hydrogen, §6, p2.
- Carriers, Bucket, §16, p109.
- Casing, Expansion of fan, §15, p38.
- Celsius scale, §5, p14.
- Centigrade scale, §5, p14.
- Centrifugal fan, Principle of action of, §15, p6.
 fan, Static pressure due to a, §15, p44.
 fans, §15, p5.
 fans, Advantage of, §15, p52.
 fans, Types of, §15, p21.
 force developed by revolution of fan, §15, p32.
 force of fan, Work of, §15, p33.
- Change of pressures due to the change of volume, §5, p50.
 of volume of gases due to chemical changes, §5, p49.
- Charcoal, §16, p11.
 Uses of, §16, p11.
- Chemical compounds, §5, p41.
 equations, §5, p46.
 equations, Writing, §5, p47.
 formula, §5, p42.
 reactions, §5, p46.
 reactions, Heat of, §5, p53.
- Chemistry, §5, p38.
 of combustion, §16, p69.
 of gases, §5, p38.
- Chimney, Fan, §15, p12.
- Chokedamp, §6, p4.
- Chute, Adjustable, §16, p115.
- Chutes, §16, p115.
 Pitch of, §16, p115.
- Circulation of air, Factors of a, §13, p16.
 Quantity of air in, §13, p17.
- Circulations, §13, p46.
 Comparing different, §13, p52.
- Clam-shell bucket, §16, p98.
- Clanny lamp, §6, p41
 Bonneted, §6, p42.
- Closed-running fans, §15, p6.
- Clowes hydrogen lamp, §6, p50.
- Coal, §16, p13.
 Analysis of, §16, p91.
 analysis, Notes for, §16, p96.
 analysis, Report of, §16, p97.
 Ash in, §16, p18.
 Caking and non-caking, §16, p15.
 Cannel, §16, p14.
 Coking, §16, p15.
 Composition of, §16, p18.
 Determination of fixed carbon and ash in, §16, p93.
 Determination of moisture in, §16, p92.
 Determination of sulphur in, §16, p94.
- Coal—(Continued)
 Determination of volatile combustible matter in, §16, p93.
 dust as fuel, §16, p36.
 -dust burner, §16, p37.
 dust, Effect of, on firedamp, §6, p9.
 dust, Effect of, on flame of lamp, §6, p22.
 Free-burning, §16, p16.
 gas, §16, p6.
 gas, purified, Average composition of, §16, p63.
 Hard, §16, p14.
 Hoisting, conveying, and storing, §16, p97.
 Long-flaming and short-flaming, §16, p15.
 Market value of, §16, p31.
 Moisture in, §16, p18.
 Origin of, §16, p13.
 piles, Extinguishing fires in, §16, p35.
 piles, Fires in, §16, p35.
 sampling for analysis, §16, p92.
 Relation of heating value of, to composition of combustible, §16, p23.
- Sea, §16, p18.
- Selling, by analysis, §16, p30.
- Soft, §16, p14.
- Spontaneous ignition of, §16, p32.
- Storage, §16, p121.
 storage, Bridge tramway system of, §16, p124.
 storage, Dodge revolving system of, §16, p129.
 storage, Dodge system of, §16, p126.
 storage, Side-hill, §16, p122.
 storage, Trestle, §16, p123.
 Ultimate analysis of, §16, p96.
 Weathering of, §16, p31.
- Coals, Blacksmith, §16, p17.
 Classification of, §16, p14.
 Domestic, §16, p17.
 Gas, §16, pp17, 62.
 Relative practical values of steam, §16, p26.
 Steam, §16, p16.
 Valuation of, as fuel, §16, p23.
 Valuing of, by test and by analysis, §16, p28.
- Coefficient, §5, p40.
 of friction, Value of, §13, p19.
- Coefficients of expansion, §5, p25.
- Cohesion, §5, p1.
- Coke, §16, p40.
 Analysis of, §16, p91.
 Definition of, §16, p15.
- Coking coal, §16, p15.
- Column, Motive, §14, p40.
- Columns, Air, §14, p38.
 Density of air, §14, p49.
- Combined dust and gas explosion, §6, p25.

- Combustible elements, §16, p1.
 matter, Volatile, §16, p7.
 matter, volatile, Determination of, in coal, §16, p93.
 Relation of heating value of coal to composition of, §16, p23.
 substance, §5, p55.
- Combustion, §5, p54.
 Chemistry of, §16, p69.
 Dulong's formula for heat of, §16, p85.
 Heat of, §5, p54; §16, p85.
 Lord and Haas's formula for heat of, §16, p86.
 of fuel, §16, p69.
 Spontaneous, §5, p58.
- Comparing different circulations, §13, p52.
- Composition of a fuel, Methods of expressing the, §16, p4.
 of the atmosphere, §5, p51.
 percentage, §5, p44.
- Compound, Definition of, §5, p38.
 gas, Calculating heating value of a, §16, p87.
- Compounds, Chemical, §5, p41.
- Condition of air in mines, §6, p15.
- Conduction, §5, p13.
- Convection, §5, p13.
- Conveyer, Bucket, §16, p112.
- Conveyers, §16, p104.
 Belt, §16, p106.
 Flight, §16, p104.
- Conveying and hoisting systems, Combinations of, §16, p117.
 Coal, §16, p97.
- Cowl, Wind, §15, p3.
- Crane, Locomotive, §16, p100.
 Overhead, §16, p103.
- Cranes, §16, p100.
- Crossings, Air, §13, p7.
- Cubical expansion, §5, p25.
- Culm, Sealing off with, §5, p67.
- Curtain, §13, p4.
- D**
- Dangerous atmosphere, §6, p16.
- Davy lamp, §6, p37.
 lamp, Bonneted, §6, p39.
 lamp, Fire-boss, §6, p38.
 lamp, Jack, §6, p39.
 lamp, Testing for gas with, §6, p62.
 lamp, Tin-can, §6, p39.
- Decomposition, Heat absorbed by, §16, p88.
- Deflector, Howat, §6, p43.
- Density, §5, p2.
 and specific gravity of gases, §5, p52.
 of air columns, §14, p49.
 of air referred to oxygen, §5, p52.
 of any gas, Rule for finding, §5, p46.
- Density—(Continued)
 of mine gases, §5, p46.
- Derrick, Fixed steel, §16, p103.
- Determination of specific gravity of solids by a balance, §5, p6.
 of specific gravity of solids by a specific-gravity bottle and balance, §5, p7.
- Determining specific gravity, §5, p6.
 specific gravity by the hydrometer, §5, p9.
 specific gravity of liquids by balance, §5, p8.
 the specific gravity of gases, §5, p11.
- Diffusion of gases, §5, p59.
 Rate of, §5, p60.
- Dip and rise of workings, §14, p48.
- Disk fans, §15, p4.
- Division, Proportionate, §14, p20.
- Dodge revolving bridge system of storage, §16, p129.
 system of coal storage, §16, p126.
- Domestic coals, §16, p17.
- Door, Canvas, §13, p4.
 regulator, §13, p5.
- Doors, Explosion, §15, p20.
 Mine, §13, p3.
- Downcast shaft, §13, p2.
- Drift, Dumb, §14, p52.
 mine, Ventilation of a, §14, p26.
- Drop-bottom bucket, §16, p100.
- Dulong's formula, §16, p85.
- Dumb drift, §14, p52.
- Dust, coal, Effect of, on flame of lamp, §6 p22.
 explosion, §6, p23.
- Dynamite, Exploding, §5, p66
- E**
- Effect of rate of transpiration, §5, p63.
- Efficiency of fans, Manometrical, §15, p44.
 of fans, Mechanical, §15, p45.
 of mine furnace compared with fan, §15 p53.
- Electric lamps, Portable, §6, p77.
- Element, Definition of an, §5, p38.
- Elements, Combustible, §16, p1.
- Elevators, Bucket, §16, p110.
- Engines, Use of gas in gas, §16, p68.
- Entering a mine after an explosion, §6, p30.
- Equations, Chemical, §5, p46.
 Writing chemical, §5, p47.
- Equivalent orifice, §15, p51.
- Eschka mixture, §16, p96.
- Ethene, §6, p4.
- Ethylene, §6, p4.
 Effect of, on firedamp, §6, p9.
- Evan Thomas lamp, §6, p43.
- Exhaust fan, §15, p7.
 system of ventilation, §13, p15.

- Expansion, Coefficients of, §5, p25.
 Cubical, §5, p25.
 Formula for calculating, §5, p26.
 Linear, §5, p25.
 of bodies by heat, §5, p25.
 Surface, §5, p25.
- Exploding dynamite, §5, p66.
- Explosion, Advance of a mine, §6, p27.
 Arrest of an, §6, p28.
 doors, §15, p20.
 Dust, §6, p23.
 Gas, §6, p22.
 of combined gas and dust, §6, p25.
 of methane (marsh gas), Initial force of an, §5, p57.
 Recoil of an, §6, p28.
 Reducing the liability to, §6, p33.
 Transmission of flame of initial, §6, p26.
- Explosions, Entering a mine after, §6, p30.
 Mine, §6, p22.
 Phenomena of, §6, p26.
 Prevention of, §6, p33.
 Types of, §6, p22.
- Explosive condition of mine air, §6, p15.
 limits of firedamp, §96, p8.
- Expressing a molecule by symbols, §5, p42.
- Extinction of oil and gas flames, §6, p20.
- Extinctive character of an atmosphere, §6, p18.
- F
- Factors of a circulation of air, §13, p16.
- Fahrenheit scale, §5, p14.
- Fan blades, Support of, §15, p7.
 blades, Tapered, §15, p41.
 Blow-down, §15, p7.
 Blower, §15, p7.
 Breadth of, §15, p30.
 Calculation of water gauge due to action of, §15, p42.
 calculations, §15, p42.
 Capell, §15, p25.
 casing, Expansion of, §15, p28.
 casing or housing, §15, p9.
 Centrifugal force developed by revolution of, §15, p32.
 chimney, §15, p12.
 Connection of, with mine opening, §15, p16.
 construction, Details of, §15, p7.
 designs, §15, p28.
 Efficiency of mine furnace compared with, §15, p53.
 Exhaust, §15, p7.
 Force, §15, p7.
 Guibal, §15, p21.
 Mechanical efficiency of, §15, p45.
 Nasmyth, §15, p21.
- Fan—(Continued)
 Open-running, §15, p6.
 Outer diameter of, §15, p36.
 pit and foundation, §15, p14.
 Power required by, §15, p35.
 Propeller, §15, p4.
 Quantity of air delivered by, §15, p35.
 Robinson, §15, p27.
 Schiele, §15, p24.
 Shutter, §15, p13.
 Sirocco, §15, p27.
 Size of intaking opening of, §15, p29.
 Static pressure due to a centrifugal, §15, p44.
 Volume of, §15, p31.
 Waddle, §15, p23.
 Work of centrifugal force of, §15, p33.
- Fans, Advantages of centrifugal, §15, p52.
 Centrifugal, §15, p5.
 Closed-running, §15, p6.
 Curvature of blades of, §15, p39.
 Disk, §15, p4.
 Guide blades of, §15, p41.
 Inclination of blades of, §15, p40.
 Manometrical efficiency of, §15, p44.
 Number of blades of, §15, p28.
 Principal of action of centrifugal, §15, p6.
 Secondary blades of, §15, p39.
 Types of centrifugal, §15, p21.
 Ventilating, §15, p3.
- Fatal atmosphere, §6, p16.
- Feeders and blowers, §5, p53.
- Fire-boss Davy lamp, §6, p38.
- Fire, Extinguishing a coal-pile, §16, p35.
 grate surface, Area of, in a ventilating furnace, §14, p58.
 Temperature of, §16, p79.
 Temperature of the, the fuel containing hydrogen and water, §16, p82.
- Firedamp, §6, p7.
 Effect of other gases and dust on, §6, p9.
 Effect of pressure and temperature on, §6, p9.
 Explosive ranges of, §6, p8.
- Fires, Gob, §5, p65.
 in coal piles, §16, p35.
 Treatment of gob, §5, p65.
- Fixed carbon, §16, p7.
 carbon and ash, Determination of, in coal, §16, p93.
- Flame cap corresponding to different percentages of gas, Height of, §6, p64.
 of blasting powder, Temperature of, §6, p13.
 of burning gas, Temperature of, §6, p13.
 of lamp, Effect of coal dust on, §6, p22.
 Transmission of, of initial explosion, §6, p26.

- Flames, Extinction of oil and gas, §6 p20.
 Flashdamp, §6, p8.
 Flat seam, Ventilation of long-wall mine in, §14, p31.
 seams, Ventilation of slope or shaft mines in, §14, p28.
 Flight conveyers, §16, p104.
 Flooding a mine, §5, p67.
 Force, Centrifugal, developed by revolution of fan, §15, p32.
 fan, §15, p7.
 Initial, of an explosion of methane (marsh gas), §5, p57.
 of fan, Work of centrifugal, §15, p33.
 Forces, Natural, §5, p1.
 Form and size of airways, §13, p9.
 Forms of airways, Comparison of, §13, p11.
 of matter, §5, p12.
 Formula, Chemical, §5, p42.
 Dulong's, §16, p85.
 Lord and Haas's, §16, p86.
 Formulas, Elementary ventilation, §13, p35.
 for calculating expansion, §5, p26.
 Transposition of, §13, p36.
 Forter water-seal producer, §16, p58.
 Foundation, Fan, §15, p14.
 Free-burning coal, §16, p16.
 French calorie, §5, p18.
 Friction, Coefficient of, §13, p19.
 Value of coefficient of, §13, p19.
 Fuel, Advantages and disadvantages of petroleum as a, §16, p41.
 Ash in, §16, p3.
 burned in air, §16, p72.
 Coal dust as, §16, p36.
 Combustion of, §16, p69.
 containing hydrogen and water, Available heating value of, §16, p89.
 Distribution of gaseous, §16, p67.
 employed in making producer gas, §16, p58.
 Machines for briquetting, §16, p39.
 Methods of expressing the composition of, §16, p4.
 Practical values of, for different uses; §16, p25.
 Pressed, §16, p38.
 Uses of gaseous, §16, p67.
 Valuation of coals as, §16, p23.
 Value of wood as, §16, p9.
 Fuels, Calorific value of, §16, p90.
 Composition and classification of, §16, p1.
 Gaseous, §16, p52.
 Impurities in, §16, p3.
 Liquid, §16, p41.
 Moisture in, §16, p3.
 Properties of, §16, p1.
 Solid, §16, p8.
 Furnace, Area of fire-grate surface in a ventilating, §14, p58.
 Coal burned per hour in a ventilating, §14, p57.
 Construction of a mine, §14, p51.
 Efficiency of mine, compared with fan, §15, p53.
 Power of a mine, §14, p54.
 Pressure due to, §14, p53.
 ventilation, §14, p50.
 ventilation, Temperature of air in, §14, p55.
- G**
- Gas and dust explosion, Combined, §6, p25.
 Approaching a body of, §6, p63.
 Average composition of purified coal, §16, p63.
 Calculating the heating value of a compound, §16, p87.
 Calculation of change of volume of a, §5, p49.
 Change of pressure of, due to the change of volume, §5, p50.
 Coal, §16, p60.
 coals, §16, pp17, 62.
 engine, Use of gas in, §16, p68.
 explosion, §6, p22.
 flames, Extinction of, §6, p20.
 Fuel employed in making producer, §16, p58.
 Ignition of mine, by incandescent lamps, §6, p14.
 indicators, §6, p67.
 Lamps for testing for, §6, p37.
 Producer, §16, p56.
 purified water, Composition of, §16, p64.
 Rule for finding the density of any, §5, p46.
 Temperature of flame of burning, §6, p13.
 Testing for, §6, p62.
 Testing for, by the Shaw machine, §6, p72.
 -testing machine, Shaw, §6, p71.
 Use of, in gas engines, §16, p68.
 Water, §16, p63.
 water, Impurities in, §16, p64.
 Gaseous fuel, Distribution of, §16, p67.
 fuel, Uses of, §16, p67.
 fuels, §16, p52.
 mines, Ventilation of, §14, p35.
 Gases, §5, p12.
 Causes of ignition of mine, §6, p13.
 Change of volume of, due to chemical changes, §5, p49.
 Chemistry of, §5, p38.
 common to mines, §6, p1.
 Density and specific gravity of, §5, p52.
 Density of mine, §5, p46.

Gases—(Continued)

- Diffusion of, §5, p59.
 - Ignition of, §6, p12.
 - Inflammable mine, §6, p12.
 - in mines, Testing for, §6, p35.
 - Mixture of, §5, p36.
 - Mixtures of equal volumes of, having unequal pressures, §5, p36.
 - Mixtures of mine, §6, p7.
 - Mixtures of, of the same temperature and pressure, §5, p36.
 - Mixtures of two, having unequal volumes and pressures, §5, p37.
 - Occlusion of, §5, p60.
 - Physics of, §5, p1.
 - Pressure of occluded, §5, p61.
 - Properties of mine, §5, p59.
 - Temperature and pressure of, §5, p35.
 - Transpiration of, from coal, §5, p62.
 - Volume and pressure of, §5, p34.
 - Volume of, §5, p27.
 - Volume, temperature, and pressure of, §5, p34.
 - Weight and volume of, §16, p72.
- Gauge for safety lamp, §6, p57.
- Pressure, §5, p33.
 - Vacuum, §5, p32.
 - Water, §13, p31.
- Gay-Lussac's law, §5, p28.
- Geordie lamp, §6, p41.
- Gob fires, §5, p65.
- Guibal fan, §15, p21.
- Guide blades of fans, §15, p41.

II

- Heat, §5, p12.
- absorbed by decomposition, §16, p88.
 - Expansion of bodies by, §5, p25.
 - Latent, §5, p23
 - Mechanical equivalent of, §5, p18.
 - of chemical reactions, §5, p53.
 - of combustion, §16, p85; §5, p54.
 - of combustion, Dulong's formula for, §16, p85.
 - of combustion, Lord and Haas's formula for, §16, p86.
 - Quantity of, §5, p18
 - Sensible, §5, p19.
 - Sources of, §5, p13.
 - Specific, §5, p19.
 - Total, §5, p24.
 - Transmission of, §5, p13.
 - units, §5, p18.
- Heating value of a compound gas, Calculating the, §16, p87.
- value of coal, Relation of, to composition of combustible, §16, p23.

Heating—(Continued)

- value of fuel containing hydrogen and water, Available, §16, p89.
 - value of petroleum, §16, p41.
- Helmet, Vajen-Bader, §6, p32.
- Hoisting and conveying systems, Combinations of, §16, p117.
- coal, §16, p97.
- Horizontal pressure of coal against retaining walls, Determining, §16, p131.
- Horsepower, §13, p24.
- Houses, Safety-lamp, §6, p73.
- Howat deflector, §6, p43.
- Humidity of air, Relative, §16, p74.
- Hunt automatic railway, §16, p103.
- Hydrogen, §6, p6; §16, p2.
- Maximum theoretical temperature of the fire due to burning, in dry air, §16, p80.
 - sulphide, §6, p4.
- Hydrometer, Beaume's, §5, p11.
- Determining specific gravity by the, §5, p9.
 - Nicholson's, §5, p9.

I

- Incandescent lamps, Ignition of mine gas by, §6, p14.
- Indicator, Beard-Mackie sight, §6, p68.
- Liveing, §6, p68.
- Indicators for gas, §6, p67.
- Initial force of an explosion of methane (marsh gas), §5, p57.
- Ignition of coal, Spontaneous, §16, p32.
- of gases, Temperature of, §6, p12.
 - of mine gas by incandescent lamps, §6, p14.
 - of mine gases, Causes of, §6, p13.
 - Temperature of, §16, p78.
- Illuminating power of oils, §6, p60.
- power of safety lamps, Relative, §6, p61.
- Impurities in fuels, §16, p3.
- Inclined seams, Ventilation of, §14, p32.
- Inflammable mine gas, §6, p12.
- Intake, Definition of, §13, p2.

J

- Jack Davy lamp, §6, p39.

K

- Kent's method for determining moisture in coal, §16, p92.

L

- Lamp, Bonneted Clanny, §6, p42.
- Bonneted Davy, §6, p39.
 - Bonneted Marsaut, §6, p47.
 - Bonneted Mueseler, §6, p45.
 - Clanny, §6, p41.
 - Clowes hydrogen, §6, p50.

- Lamp—(Continued)
 Davy, §6, p37.
 Evan Thomas, §6, p43.
 gauge, §6, p57.
 Geordie, §6, p41.
 Jack Davy, §6, p39.
 Marsaut, §6, p46.
 Mueseler, §6, p44.
 Pieler, §6, p52.
 Pocket Davy, §6, p38.
 Principle of the safety, §6, p35.
 Stevenson, §6, p41.
 Stokes, §6, p51.
 Tin-can Davy, §6, p39.
 Wicks, §6, p56.
 Wolf, §6, p48.
- Lamps, Ashworth-Heppelewhite-Gray, §6, p47.
 for general use, Safety, §6, p37.
 for testing for gas, §6, p37.
 Portable electric, §6, p77.
 Special, §6, p47.
 Types of safety, §6, p36.
- Latent heat, §5, p23.
- Laughing gas, §6, p5.
- Lead-plug lock, §6, p53.
- Linear expansion, §5, p25.
- Liquid fuels, §16, p41.
- Liquids, §5, p12.
- Liveing indicator, §6, p68.
- Loading out, §5, p66.
- Lock, Lead-plug, §6, p53.
- Locks for safety lamps, §6, p52.
 Magnetic, §6, p54.
- Locomotive crane, §16, p100.
- Long-flaming and short-flaming coal, §16, p15.
- Long-wall mine in flat seam, Ventilation of a, §14, p31.
- Lord and Haas's formula, §16, p86.
- M**
- Machines, Car-dumping, §16, p118.
 for briqueting fuel, §16, p39.
- Magnetic locks, §6, p54.
- Mahler's bomb calorimeter, §16, p90.
- Manometrical efficiency of fans, §15, p44.
- Mariotte's law, §5, p34.
- Marsaut lamp, §6, p46.
 lamp, Bonneted, §6, p47.
- Marsh gas, §6, p2.
- Mass and volume, §5, p1.
- Masses, §5, p1.
- Matter, §5, p1.
 Forms of, §5, p12.
- McMyler car-dumping machine, §16, p120.
- Measurement of atmospheric pressure, §5, p29.
 of temperature, §5, p13.
- Measurements, Air, §13, p25.
- Mechanical efficiency of a ventilator, Effect of mine resistance on, §15, p49.
 efficiency of fans, §15, p45.
 equivalent of heat, §5, p18.
 mixtures, §5, p41.
 ventilation, §15, p1.
- Mercurial barometer, The, §5, p30.
- Methane, §6, p2.
 (marsh gas), Initial force of the explosion of, §5, p57.
- Mine air, Explosive condition of, §6, p15.
 doors, §13, p3.
 explosion, Advance of a, §6, p27.
 explosions, §6, p22.
 furnace, Construction of a, §14, p51.
 furnace, Efficiency of, compared with fans, §15, p53.
 furnace, Power of a, §14, p54.
 gas, Ignition of, by incandescent lamps, §6, p14.
 gases, Causes of ignition of, §6, p13.
 gases, Density of, §5, p46.
 gases, Inflammable, §6, p12.
 gases, Mixtures of, §6, p7.
 gases, Physical properties of, §5, p59.
 long-wall in flat seams, Ventilation of a, §14, p31.
 opening, Connection of fan with, §15, p16.
 resistance, Definition of, §13, p17.
 resistance, Effect of, on mechanical efficiency of a ventilator, §15, p49.
 ventilation, General principles of, §13, p1.
 ventilation, Influence of seasons on, §14, p45.
 Ventilation of a, §14, p24.
 Ventilation of a drift, §14, p26.
- Mineral oil, §6, p58.
- Mines, Condition of air in, §6, p15.
 Gases common to, §6, p1.
 Means for ventilating, §14, p37.
 slope, or shaft, Ventilation of, in flat seams, §14, p28.
 Ventilation of different types of, §14, p26.
 Ventilation of gaseous, §14, p35.
- Mixture of gases, §5, p36.
- Mixtures of mine gases, §6, p7.
 Mechanical, §5, p41.
 of equal volumes of gases having unequal pressures, §5, p36.
 of gases of the same temperature and pressure, §5, p36.
 of two gases having unequal volumes and pressures, §5, p37.
- Moisture, §16, p3.
 in coal, §16, p18.
 in coal, Determination of, §16, p92.

Molecular weight, §5, p43.
 Molecule, Expressing a, by symbols, §5, p42.
 Molecules, §5, p1.
 Motive column, §14, p40.
 Mueseler lamp, §6, p44.
 lamp, Bonneted, §6, p45.

N

Nasmyth fan, §15, p21.
 Natural forces, §5, p1.
 splitting, Calculations in, §14, p10.
 ventilation, §13, p14; §14, p37.
 Nicholson's hydrometer, §5, p9.
 Nitrogen, §6, p5.
 Effect of, on firedamp, §6, p9.
 Nitrous oxide, §6, p5.
 Non-caking coal, §16, p15.

O

Occluded gases, Pressure of, §5, p61.
 Occlusion of gases, §5, p60.
 Oil flames, Extinction of, §6, p20.
 Mineral, §6, p58.
 Oils, Animal, §6, p58.
 for safety lamps, §6, p57.
 Relative illuminating powers of, §6, p60.
 Vegetable, §6, p57.
 Olefiant gas, §6, p4.
 gas, Effect of, on firedamp, §6, p9.
 Open-running fans, §15, p6.
 Orange-peel bucket, §16, p99.
 Orifice, Equivalent, §15, p51.
 Outbursts, §5, p64.
 Overcasts, §13, p7.
 Overhead crane, §16, p103.
 Oxidation, §5, p54.
 Oxygen, §6, p6.

P

Partial vacuum, §5, p30.
 Peat, §16, p12.
 Composition of, §16, p12.
 Percentage composition, §5, p44.
 Perimeter of airway, Relation between, and
 power, §13, p54.
 Petroleum, §6, p58; §16, p41.
 as a fuel, Advantages and disadvantages
 of, §16, p41.
 Composition of, §16, p43.
 Heating value of, §16, p41.
 Method of burning, §16, p46.
 Uses of, §16, p46.
 Phenomena of explosions, §6, p26.
 Physical properties of mine gases, §5, p59.
 Physics of gases, §5, p1.
 Picker for wicks, §6, p56.
 Pieler lamp, §6, p52.

Pit, Fan, §15, p14.
 Pitch of chutes, §16, p115.
 Plenum system of ventilation, §13, p15.
 Pocket Davy lamp, §6, p38.
 Portable electric lamps, §6, p77.
 Pound calorie, §5, p18.
 Power, §13, p24.
 and work in producing an air-current, §13,
 p22.
 of a mine furnace, §14, p54.
 on the air, §13, p24.
 ratio for similar airways, General, §13,
 p67.
 ratio, General, §13, p56.
 Relation between area of airway and, §13,
 p55.
 Relation between perimeter of airway and,
 §13, p54.
 Relation between the length of an airway
 and the, §13, p54.
 Relation of velocity or quantity of air to,
 §13, p55.
 required by fan, §15, p35.
 Pressed fuel, or briquets, §16, p38.
 Pressure, §13, p60.
 Absolute, §5, p31.
 against retaining walls, Determining hori-
 zontal, §16, p131.
 and volume of gases, §5, p34.
 Atmospheric, §5, p28.
 Calculation of unit of ventilating, §13,
 p22.
 due to a furnace, §14, p53.
 Effect of, on firedamp, §6, p9.
 gauge, §5, p33.
 of occluded gases, §5, p61.
 ratio for similar airways, General, §13,
 p67.
 ratio, General, §13, p60.
 Static, due to a centrifugal fan, §15, p44.
 To measure the ventilating, §13, p31.
 Ventilating, §13, p14.
 Pressures, Change of, due to the change of
 volume, §5, p50.
 Preventions of explosions, §6, p33.
 Principle of the safety lamp, §6, p35.
 Problems, Practical ventilation, §13, p39.
 Producer, Forter water-seal, §16, p58.
 gas, §16, p56.
 gas, Fuel employed in making, §16, p58.
 Operation of the, §16, p60.
 reactions, §16, p59.
 Propeller fan, §15, p4.
 Properties of fuels, §16, p1.
 Proportionate division, §14, p20.
 splitting, §14, p20.
 Proximate analysis, §14, p91; §16, p4.

Q

- Quantity and velocity of air required, §14, p24.
 of air in circulation, §13, p17.
 of air required by law, §14, p25.
 of heat, §5, p18.

R

- Radiation, §5, p13.
 Railway, Hunt automatic, §16, 103.
 Rate of diffusion, §5, p60.
 Reactions, Chemical, §5, p46.
 Producer, §16, p59.
 Réaumur scale, §5, p15.
 Recoil of an explosion, §6, p28.
 Reduction, §5, p54.
 Regulator door, §13, p5.
 Regulators, §13, p4.
 Relative illuminating power of safety lamps, §6, p61.
 Repulsion, §5, p1.
 Rescue appliances and mine supplies, §6, p31.
 work, §6, p30.
 Resistance, Mine, §13, p17.
 of an airway, Calculation of the, §13, p20.
 Value of unit of, §13, p19.
 Retorts, Operating a bench of, §16, p61.
 Return, Definition of the, §13, p2.
 Reversing the air-current, §15, p17.
 Revolving bridge system of storage, Dodge §16, p129.
 Rise and dip of workings, §14, p48.
 Robinson fan, §15, p27.
 Rubbing surface of an airway, §13, p11.
 Rule for calculating total heat absorbed by any substance, §5, p24.
 for changing centigrade temperatures into corresponding Fahrenheit values, §5, p15.
 for changing centigrade temperatures into corresponding Réaumur values, §5, p16.
 for changing Fahrenheit temperatures into corresponding centigrade values, §5, p15.
 for changing Fahrenheit temperatures into corresponding Réaumur values, §5, p16.
 for changing Réaumur temperatures into corresponding centigrade values, §5, p16.
 for changing Réaumur temperatures into corresponding Fahrenheit values, §5, p15.
 for converting centigrade temperatures into absolute temperatures, §5, p18.
 for converting Fahrenheit temperatures into absolute temperatures, §5, p17.
 for finding density of any gas, §5, p46.
 for finding number of B. T. U. required to raise temperature of body a given number of degrees, §5, p20.
 for writing chemical equations, §5, p47.

- Rules for finding specific gravity of any substance, §5, p2.
 for finding the weight of a body when its volume is known, §5, p3.

S

- Safety-lamp details, §6, p52.
 lamp houses, §6, p73.
 lamp, Principle of, §6, p35.
 lamps, Locks for, §6, p52.
 lamps, Oils for, §6, p57.
 lamps, Relative illuminating power of, §6, p61.
 lamps, Types of, §6, p36.
 Sampling coal for analysis, §16, p92.
 Sawdust, §16, p10.
 Scales, Thermometer, §5, p14.
 Scaling, §14, p7.
 Schiele fan, §15, p24.
 Sea coal, §16, p18.
 Sealing off with culm, §5, p67.
 off with stoppings, §5, p66.
 Seams, Ventilation of a long-wall mine in flat, §14, p31.
 Ventilation of inclined, §14, p32.
 Ventilation of slope or shaft mines in flat, §14, p28.
 Seasons, Influence of, on mine ventilation, §14, p45.
 Secondary blades of fans, §15, p39.
 Self-filling buckets, §16, p98.
 Self-lighting device of safety lamp, §6, p49.
 Selling coal by analysis, §16, p30.
 Sensible heat, §5, p19.
 Shaft, Air, §13, p2.
 Downcast, §13, p2.
 mines in flat seams, Ventilation of, §14, p28.
 Upcast, §13, p2.
 Ventilation of a, during sinking, §14, p49.
 Shaw gas-testing machine, §6, p71.
 machine, Testing for gas by the, §6, p72.
 Short-flaming coals, §16, p15.
 Shovel bucket, §16, p100.
 Shutter, Fan, §15, p13.
 Side-hill storage, §16, p122.
 Sight indicator, Beard-Mackie, §6, p68.
 Similar airways, §13, p13.
 Sinking, Ventilation of a shaft during, §14, p49.
 Sirocco fan, §15, p27.
 Slope or shaft mines, Ventilation of, in flat seams, §14, p28.
 Solid fuels, §16, p8.
 Solids, §5, p12.
 Sources of heat, §5, p13.
 Special lamps, §6, p47.

- Specific gravity, §5, p2.
 gravity and density of gases, §5, p52.
 gravity, Determining, §5, p6.
 gravity, Determining, by hydrometer, §5, p9.
 gravity of gases, Determining the, §5, p11.
 gravity of liquids, Determining, by balance, §5, p8.
 gravity of solids, Determination of, by a balance, §5, p6.
 gravity of solids, Determination of, by a specific-gravity bottle and balance, §5, p7.
 gravity of various gases, Table of, §5, p5.
 gravity of various solids and liquids, Table of, §5, p4.
 gravity, Rules for finding, §5, p2.
- Specific heat, §5, p19.
- Split, Designation of, §14, p8.
 Main, §14, p9.
 of first degree, §14, p9.
 of second degree, §14, p9.
 of third degree, §14, p9.
 Primary, §14, p9.
 Secondary, §14, p9.
 Tertiary, §14, p9.
- Splits, Air, §14, p8.
 Equal, §14, p9.
 Free or open, §14, p9.
- Splitting air-currents, §14, p1.
 air, Limit of, §14, p7.
 Calculations in, §14, p10.
 natural, Calculations in, §14, p10.
 natural, Pressure and power required when splits are equal, §14, p14.
 natural, Pressure and power required when splits are unequal, §14, p15.
 natural, Total mine pressure and power required in, §14, p18.
 Proportionate, §14, p20.
 the air, Advantages of, §14, p7.
 the air, Effect of, §14, p2.
 the air, Requirements of law in regard to, §14, p8.
- Spontaneous combustion, §5, p58.
 ignition of coal, §16, p32.
 ignition, Precautions in storing bituminous coal to prevent, §16, p35.
- Stack, Effect of ventilating furnace, §14, p60.
- Steam coals, §16, p16.
 coals, Relative practical values of, §16, p26.
 jet, §15, p3.
- Stevenson lamp, §6, p41.
- Stinkdamp, §6, p4.
- Stokes lamp, §6, p51.
- Stopping, §13, p3.
 Stoppings, §13, p6.
 Sealing off with, §5, p66.
- Storage, Bridge tramway system of, §16, p124.
 Coal, §16, p121.
 Dodge revolving system of, §16, p129.
 Dodge system of coal, §16, p126.
 Side-hill, §16, p122.
 Trestle, §16, p123.
- Storing coal, §16, p97.
- Straw, §16, p10.
- Subscript, §5, p40.
- Sulphureted hydrogen, §6, p4.
- Sulphur, §16, p2.
 Determination of, in coal, §16, p94.
- Surface expansion, §5, p25.
- Symbols, §5, p38.
- Systems of ventilation, §13, p15.

T

- Table giving analyses and heating values of various gases, §16, p53.
 giving analyses of coke, §16, p40.
 giving analyses of natural, producer, and coke-oven gases, §16, p55.
 giving analyses of petroleum by fractional distillation, §16, p45.
 giving analyses of typical American gas coals, §16, p62.
 giving approximate heating value of coals, §16, p24.
 giving average values of K as determined for different coals by Lord and Haas, §16, p86.
 giving capacity of Dodge bituminous coal-storage piles, §16, p129.
 giving changes in chemical composition from wood to anthracite, §16, p13.
 giving chemical reactions and weights of oxygen involved in a combustion of hydrogen, carbon, and sulphur, §16, p76.
 giving classifications of coals as determined by percentages of fixed carbon, §16, p14.
 giving composition and calorific values of different varieties of wood, §16, p9.
 giving composition of extinctive atmospheres formed by a mixture of carbon dioxide and nitrogen, §6, p17.
 giving compositions of petroleum from different localities, §16, p44.
 giving elevations of temperature when burning carbon in various quantities of air, §16, p81.
 giving formulas and number of atoms in a molecule of various compounds, §5, p43.
 giving heating value of different coals, §16, p26.

Table—(Continued)

- giving heating values, of several constituents of a mixed fuel gas, §16, p56.
- giving height of flame caps, for lamps burning various fuels, in atmospheres containing different percentages of gas, §6, p65.
- giving horizontal pressure exerted by anthracite against vertical retaining walls, §16, p131.
- giving horizontal pressure exerted by bituminous coal against vertical retaining walls, §16, p132.
- giving proximate analysis and heating values of American coals, §16, p20.
- giving proximate analyses of anthracite of various sizes, §16, p19.
- giving proximate analyses of some American cannel coals, §16, p14.
- giving relative illuminating power of various oils, §6, p60.
- giving relative illuminating powers of safety lamps, §6, p61.
- giving relative practical values of coals, assuming different efficiencies of boiler results obtained from three coals under the same boiler, §16, p29.
- giving temperatures of ignition of charcoal prepared at various temperatures, §16, p79.
- giving temperatures of ignition of various fuels, §16, p78.
- giving temperatures of ignition of various gases, §6, p12.
- giving theoretical relative heating values of petroleum and coal, §16, p42.
- giving weights of air, water vapor, and saturated mixtures of air and water vapor, §16, p75.
- giving ultimate analyses of anthracite and bituminous coal, §16, p22.
- giving ultimate analyses of some foreign cannel coals, §16, p15.
- giving weight and volume of various gases, §16, p73.
- giving weight of coal equivalent to 1 cord of different woods, §16, p9.
- of approximate atomic weights, §5, p40:
- of coefficients of expansion, §5, p26.
- of coefficients of friction, §13, p20.
- of composition of atmosphere, §5, p51.
- of composition of fatal atmospheres, §6, p17.
- of densities and specific gravities of various gases, §5, p53.
- of densities of mine gases, §5, p47.
- of diffusion of gases, §5, p61.
- of elements, symbols, and atomic weights, §5, p39.

Table—(Continued)

- of explosive limits of gases, §6, p16.
- of explosive ranges of firedamp, §6, p8.
- of extinctive atmospheres, §6, p19.
- of heating values of various substances, §5, p56.
- of mine gases, §6, p1.
- of molecular weights of various gases, §5, p44.
- of relative velocities of transpiration of various gases, §5, p62.
- of specific gravity of various gases, §5, p5.
- of specific gravity of various solids and liquids, §5, p4.
- of specific heats of mine gases and vapors, §5, p22.
- of specific heats of some of the most common substances, §5, p21.
- showing comparative rubbing surfaces of airways of various shapes and sizes, §13, p12.
- Tan bark, Wet, §16, p10.
- Tapered fan blades, §15, p41.
- Temperature, §5, p13.
- Absolute, §5, p17.
- Actual, lower than theoretical, §16, p83.
- and pressure of gases, §5, p35.
- and volume of gases, §5, p27.
- Effect of, on firedamp, §6, p9.
- Measurement of, §5, p13.
- of a fire, §16, p79.
- of air in furnace ventilation, §14, p55.
- of flame of blasting powder, §6, p13.
- of flame of burning gas, §6, p13.
- of ignition, §16, p78.
- of ignition of gases, §6, p12.
- of the fire, maximum theoretical, due to burning oxygen and dry air, §16, p80.
- of the fire, the fuel containing hydrogen and water, §16, p82.
- of air columns, Average, §14, p44.
- Testing for gas, §6, p62.
- for gas by the Shaw machine, §6, p72.
- for gas, Lamps for, §6, p37.
- for gas with Davy lamp, §6, p62.
- for gases in the mines, §6, p35.
- Test, Valuing coals by, §16, p28.
- Thermometer scales, §5, p14.
- The, §5, p14.
- Tin-can Davy lamp, §6, p39.
- Total heat, §5, p24.
- Transmission of flame of initial explosion, §6, p26.
- of heat, §5, p13.
- Transpiration, Effect of rate of, §5, p63.
- of gases from coal, §5, p62.
- Transposition of formulas, §13, p36.

- Trestle storage, §16, p123.
 Tripper for belt conveyer, §16, p107.
 Trompe, §15, p1.
 Turf, §16, p12.
 Types of centrifugal fans, §15, p21.
 of explosions, §6, p22.
 of safety lamps, §6, p36.
- U**
- Ultimate analysis, §16, pp4, 96.
 analysis of coal, §16, p96.
 Undercasts, §13, p7.
 Unit of resistance, Value of, §13, p19.
 of ventilating pressure, Calculation of, §13, p22.
 Units, Heat, §5, p18.
 Upcast shaft, §13, p2.
- V**
- Vacuum gauge, §5, p32.
 Partial, §5, p31.
 The, §5, p31.
 system of ventilation, §13, p15.
 Vajen-Bader helmet, §6, p32.
 Valuations of coals as fuel, §16, p23.
 Value of an airway, §13, p18.
 Vegetable oils for safety lamps, §6, p57.
 Velocity of air-current, §13, p17.
 of air in an airway, To measure the, §13, p25.
 or quantity of air, Relation of, to power, §13, p55.
 Ventilating fans, §15, p3.
 furnace, Area of fire-grate surface in a, §14, p58.
 furnace, Coal burned per hour in, §14, p57.
 furnace stack, Effect of, §14, p60.
 mines, Means for, §14, p37.
 pressure, §13, p14.
 pressure, Calculation of unit of, §13, p22.
 pressure, To measure the, §13, p31.
 Ventilation, Artificial, §13, p14.
 Blowing system of, §13, p15.
 Calculations in, §13, p34.
 Elementary formulas of, §13, p35.
 Exhaust system of, §13, p15.
 Furnace, §14, p50.
 furnace, Temperature of air in, §14, p55.
 General principles of, §13, p16.
 General principles of mine, §13, p1.
 Influence of seasons on mine, §14, p45.
 Mechanical, §15, p1.
 Natural, §13, p14; §14, p37.
 of a drift mine, §14, p26.
 of a long-wall mine in flat seam, §14, p31.
 of a mine, §14, p24.
 of a shaft during sinking, §14, p49.
 of different types of mines, §14, p26
 of gaseous mines, §14, p35.
- Ventilation—(Continued)
 of inclined seams, §14, p32.
 of slope or shaft mines in flat seams, §14 p28.
 Plenum system of, §13, p15.
 Practical problems of, §13, p39.
 Special, calculation, §13, p49.
 Systems of, §13, p15.
 Vacuum system of, §13, p15.
 Volatile combustible matter, §16, p7.
 combustible matter, Determination of, in coal, §16, p93.
 Volume and pressure of gases, §5, p34.
 and temperature of gases, §5, p27.
 Mass and, §5, p1.
 of gases, §5, p27.
 of gases, Change of, due to chemical changes, §5, p49.
 of the gas, Calculation of the change of, §5, p49.
 temperature, and pressure of gases, §5, p34.
- W**
- Waddle fan, §15, p23.
 Water gas, §16, p63.
 gas, Blue, §16, p63.
 gas, Composition of purified, §16, p64.
 gas, Impurities in, §16, p64.
 gas, Uncarbureted, §16, p63.
 gauge, §13, p31.
 gauge, Calculation of, §13, p33.
 gauge due to the action of fans, Calculation of, §15, p42.
 Waterfall, or trompe, §15, p1.
 Weathering of coal, §16, p31.
 Weight, §5, p2.
 Atomic, §5, p38.
 of one cubic foot of air, §5, p51.
 Molecular, §5, p43.
 Whitedamp, §6, p2.
 Wick picker, §6, p56.
 tubes, §6, p56.
 Wicks, Lamp, §6, p56.
 Wolf safety lamp, §6, p48.
 Wood, §16, p8.
 Burning of, §16, p10.
 Composition of, §16, p8.
 Fuel value of, §16, p9.
 Work, §13, p22.
 of centrifugal force of fan, §15, p33.
 of producing an air-current, Calculation of §13, p23.
 Wind cowl, §15, p3.
 Workings, Rise and dip, §14, p48.
 Writing chemical equations, §5, p47.
- Z**
- Zero, Absolute, §5, p17.

UNIVERSITY OF CALIFORNIA LIBRARY
Los Angeles

This book is DUE on the last date stamped below.

Form L9-25m-9,'47(A5618)444

UNIVERSITY OF CALIFORNIA
LIBRARY

TN
301 International
I6lp Textbook
Engineering Company, Scranton, Pa.
Library

Properties of
gases, mine gases, mine
mine ventilation,

UC SOUTHERN REGIONAL LIBRARY FACILITY

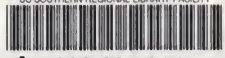

A 000 334 814 1



