

20TH CENTURY PRACTICAL BARN PLANS



OF THE
PUBLISHED

Digitized by the Internet Archive
in 2009 with funding from
NCSU Libraries





Radford's Practical Barn Plans

Being a Complete
Collection of Practical
Economical and Com-
mon-Sense Plans of
Barns, Out Buildings
and Stock Sheds :: :: ::

By WILLIAM A. RADFORD

*Editor-in-Chief of the "American Carpenter and Builder,"
and the "Cement World," President of "The Radford
Architectural Co.," Author of "The Steel Square
and Its Uses," and "Practical Carpentry" and
the Best Authority in the Country on all Mat-
ters Pertaining to the Building Industry*



Radford Architectural Company
CHICAGO, ILL.

Copyrighted, 1907,
BY
WILLIAM A. RADFORD, CHICAGO

PREFACE

Better farming methods require better buildings, not necessarily expensive ones, but buildings that are well planned and properly adapted to the work for which they are intended. A farm building should be first a property saver, second a labor saver. Farm buildings may be considered in a sense as a necessary expense, but on the other hand they should be considered in the light of an investment.

A farm barn is the farmer's factory. It is a building in which he converts raw materials into manufactured products. In a dairy stable he takes cheap feeds and manufacturers them into expensive cream and butter. In feeding stables and hog pens he manufacturers high priced breeding stock as well as good beef, mutton and pork out of grain and roughage.

It makes a great difference in the profits whether this barn factory is so constructed that the animals may be made comfortable enough to make the best possible use of the feeds given them. Profits are also seriously affected by the labor problem. Barns and stables may be so arranged as to conserve labor or to waste labor.

The object of this book is to present a great many up-to-date ideas in arranging and building in such a way as to enable farmers to take advantage of the experience of others. The author does not claim credit for the different plans and arrangements offered. He has gathered them from successful barn builders and architects in many different states and in Canada.

In selecting a plan the farmer himself must be the judge of what he needs. The kind of farm building best adapted to one

part of the country is not suitable for another. Two farms adjoining need different buildings because the kind of farming differs with individuals. One farmer makes a great mistake by blindly copying what another farmer uses to advantage. Every building requires careful study to fit it carefully into the environments of the farm and the peculiarities of the man.

It is not the aim or intention of this book to induce farmers to put unnecessary money in buildings. So far as possible utility has been combined with economy in construction. The profits in farming operations for the most part are gathered in a retail way. In this respect a farmer's business is different from commercial manufacturing concerns because the output cannot be multiplied indefinitely. There is a limit to the production of any kind of farm product; hence the necessity of economy in building. At the same time it pays to build well.

It will be noticed that in most cases there are plans of cheap structures, medium priced buildings and others that are thoroughly good. It does not follow that the more expensive buildings are better for the purpose than some of the cheaper ones. They are all well adapted to the uses for which they are intended. The cheaper ones will answer the purpose, but at the same time the better ones will prove more lasting and satisfactory if the farmer has the necessary means at hand to construct them. There is great satisfaction in having good buildings if the owner secures what he wants and gets the worth of his money.

In permanent structures the use of concrete is recommended wherever practic-

P R E F A C E

able because it is comparatively cheap and because it is lasting. The price of lumber has almost doubled in ten years, while cement is better and cheaper than ever before. A cement floor properly laid down is there for all time and cement walls harden with age until they become better than stone.

In building, by all means, secure the services of the best mechanics within reach. Their wages are a little higher but they seldom spoil material and the job is almost always more satisfactory in the end.

Judgment is necessary in buying mater-

ials; generally speaking the best is the cheapest, but it often happens that a good second grade answers the purpose just as well while affecting considerable saving in cash.

Farmers may save a great deal by getting ready weeks, or months, before building. Putting up even a small building runs into a great deal of work. Often the time required is more than twice as much as the estimates. By having everything on the ground confusion is avoided as well as the unnecessary expense of getting things together in a great hurry, often at an inconvenient season.

WILLIAM A. RADFORD,
Chicago, Ill.

RADFORD'S PRACTICAL BARN PLANS

Small Barn with Cement Floor—A 112

This barn is twenty-two feet wide by thirty-four feet long and has a cement floor cushioned with cinders the whole size of the building, but the standing stalls have a plank floor running lengthwise of the stall over the cement. These planks

if so desired, three or four inches thick, made of good stiff clay wet down and tamped level over the cement. Some horse-men prefer a cement bottom with a foot



WEST END.



EAST END

are not fastened except to two cross pieces—one under the manger is a two by four laid under the plank to give them the proper pitch. Another cross piece an inch thick is placed in the middle to strengthen

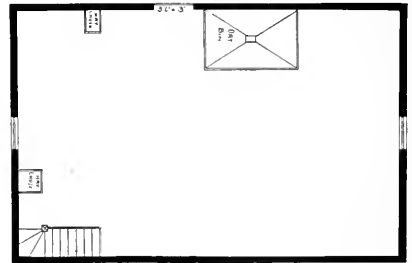

SECOND FLOOR

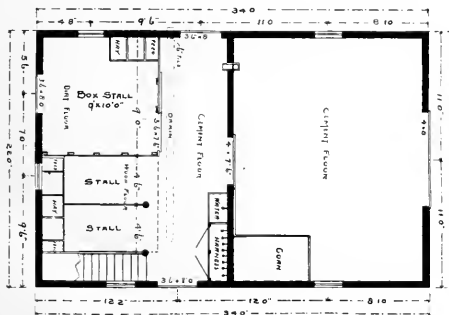

or two of straw; either way is good enough if the horses have the right kind of care.

The oat bin is in the hay loft and the corn bin may be put there too if the space

the plank, back of this the planks have free ends which facilitate drainage back to the gutter and makes it easy to remove the floor if the planks should split or wear out.

The box stall may have an earth floor,



SOUTH SIDE

on the carriage room floor is needed. By having the feed overhead and chutes for the different kinds of feed to the floor below, feeding is made easy.

Sliding doors usually are preferred for a horse barn, and a half door for ventilation is a good thing. A horse will stand for hours with his head out of such a door with evident satisfaction.

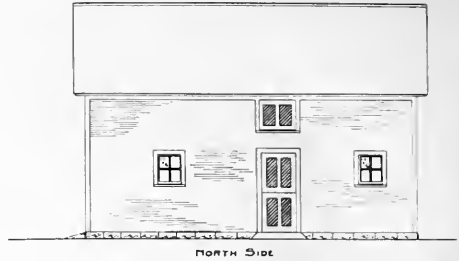

Open Front Poultry House—A110

The modification of the popular open front poultry house is given in this plan. It is suitable for two lots of hens of forty or fifty each, according to the size of the

construction of this house. Sills are four by six inches, and two by fours are used for rafters. Common lumber is used for boarding, which is covered on the outside

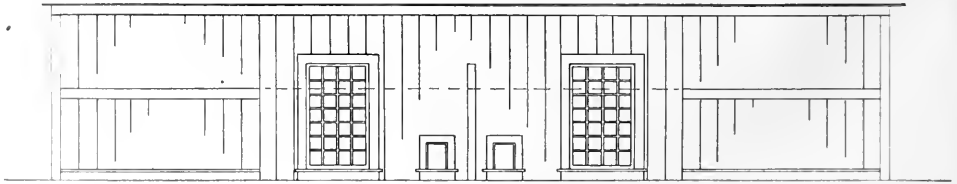

breed. The house is forty feet long and ten feet wide, divided into two compartments. Each compartment has a warm room and a scratching shed which is open to the south. This makes each room ten

feet square with a roof eight feet high in front and four feet at the back. No room is taken up in hallways or passageways but the doors entering the warm rooms open from the scratching sheds.

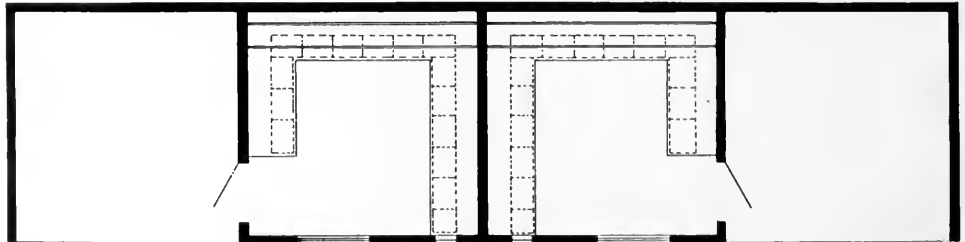

Very light material is used in the con-

struction of this house. Sills are four by six inches, and two by fours are used for rafters. Common lumber is used for boarding, which is covered on the outside

with building paper and the building paper is covered with thin matched sheathing. For the roof common sheathing boards are laid close together and covered with tarred paper and the paper covered with shingles. This makes a warm roof which is very essential in a poultry house.

Each of the closed pens has a window that reaches down to the sill. This window is wide enough and high enough to let in a great deal of sunshine, and this is

what the chickens need in winter. All inside surfaces are dressed to prevent lodgment of dust and hiding places for vermin. The whole bottom of the building is filled in several inches deep with grout mortar. In the warm rooms the floor joists are em-

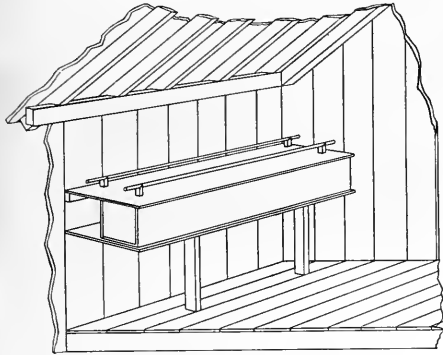

bedded in the soft mortar and a matched floor laid on. A floor like this is dry and easily cleaned and it is impossible for rats to work their way up through it. There is no wooden floor in the scratching sheds. The grout filling is supposed to be covered with straw a foot or so in depth. The hens will work in this straw even in the coldest

days, but of course it is a good plan to have a liberal supply of straw in the warm room for amusement night and morning.

For nest boxes the arrangement given in this plan is very satisfactory. It shows a roosting platform with a row of nests underneath. For leghorns or similar fowls twelve inches square and seven or eight inches high is large enough for the nest boxes, but for brahmas or cochins two or three inches larger each way are much better. To facilitate cleaning the dropping board and nest boxes lift off from the lower platform. The lower platform is hinged and may be dropped down or unhooked and the whole thing carried outdoors. It is very important to have roosting poles, dropping board and nest boxes loose. A great deal of trouble has come from vermin getting into these places without having facilities to eradicate them easily.

Hens seldom form the egg eating habit if the nests are dark. This is why the boxes open from the back under cover. The dropping board is not fastened to the nest boxes in any way. When gathering the eggs it may be lifted easily.

Convenient Horse Barn—A133

Men who keep good horses will appreciate this plan. The arrangement of the stalls is convenient and there is a good carriage room in which to keep vehicles away from the stable part and out of the dust. Every farmer who takes pride in his horses likes to have a nice rig to drive, and it is impossible to have it without conveniences for keeping it clean. With a good carriage room and a good harness room there is no excuse for dirty buggies or an unsightly harness.

A feature of this barn that should at-

tract especial attention is the tool room. It is nine by ten feet in a front corner of

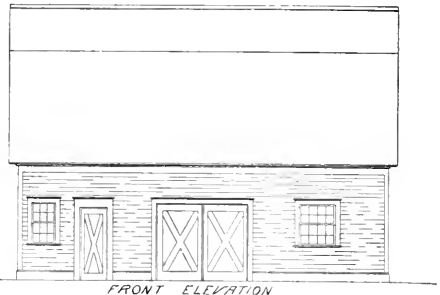

the building with two good windows for light. There is a general work bench with

is placed right because it may be shut off with two doors from the stable part, still

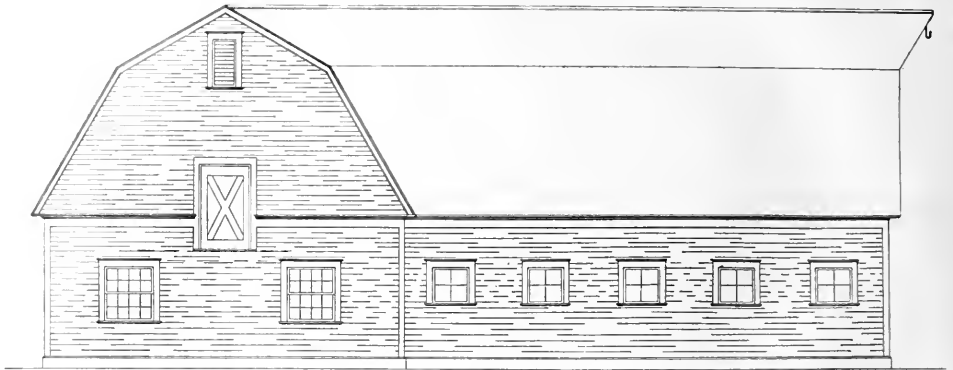

SIDE ELEVATION

a vise on one end and there are boxes to hold tools and supplies on the dark side of the room. The granary will be large enough or not according to the other

it is not so far away as to make feeding inconvenient.

There is room overhead for a good deal of hay and straw. The hay carrier will

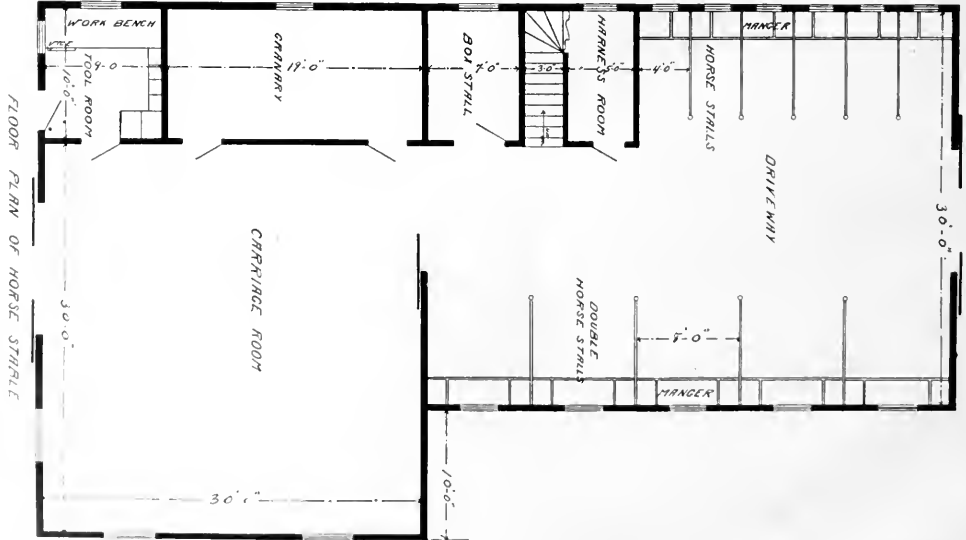

buildings on the farm. Where there is a large grain barn for threshing a smaller granary in the horse barn seems to answer every purpose. The granary in this plan

bring the stuff from the back end pretty well through to the front.

It would probably be advisable to put a cement floor in this building

Plan of an Ice House—A118

An ice house with a cold storage room is shown in plan (A118). The walls are built hollow with paper inside and out.

In the cold storage department there

For this reason a ventilator is built in the roof to encourage a circulation of air between the upper ceiling and the shingles. In this arrangement the cold storage de-

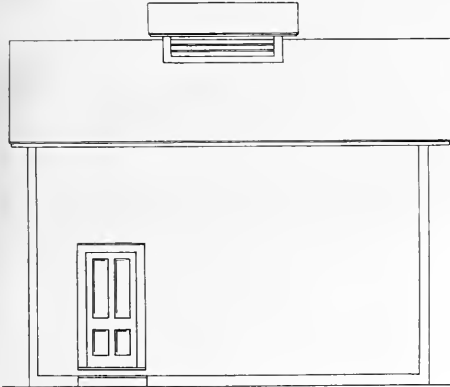

FRONT ELEVATION

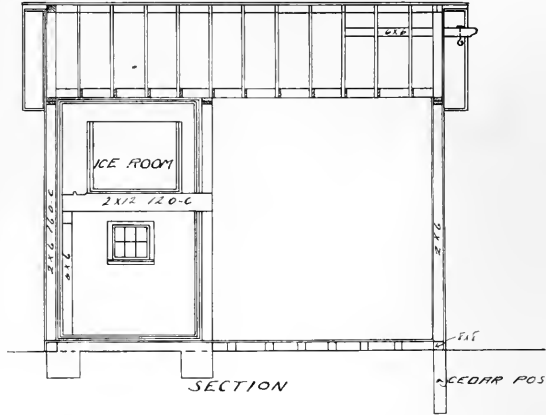

SECTION

are several thicknesses of paper in the inner wall to make the dead air space as tight as possible. If you have ever undertaken to make an absolutely dead air space you understand the difficulty, or the im-

partment is supplied with ice as needed by putting in a quantity, say once a week.

The construction of an ice house like this requires good workmanship. You will need the best mechanic in the neigh-

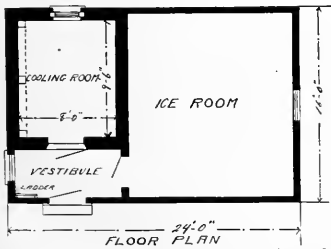

FLOOR PLAN

PLANS OF ICE HOUSE

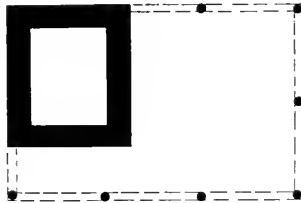

FOUNDATION PLAN

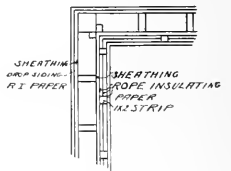

possibility of doing it. There is sure to be a crack somewhere to let the air through, but this plan probably comes as near to it as is necessary.

When an ice house is made as tight as this it is necessary to let the top air out.

borhood and it will pay to read up on cold storage before you start in. If it is made just right it will be a great comfort and satisfaction, but if it is not made right it will cause a great deal of trouble and be a continuous annoyance.

Housing of Dairy Cows—A100

The careful housing of dairy cows is receiving careful, systematic consideration as never before. Investigations have been conducted by men who are thoroughly conversant with the subject from a prac-

milk until he satisfies the inspector that he has mended his ways. This course was made necessary by the rapidly increasing volume of business which is conducted by such a cosmopolitan class of people; com-

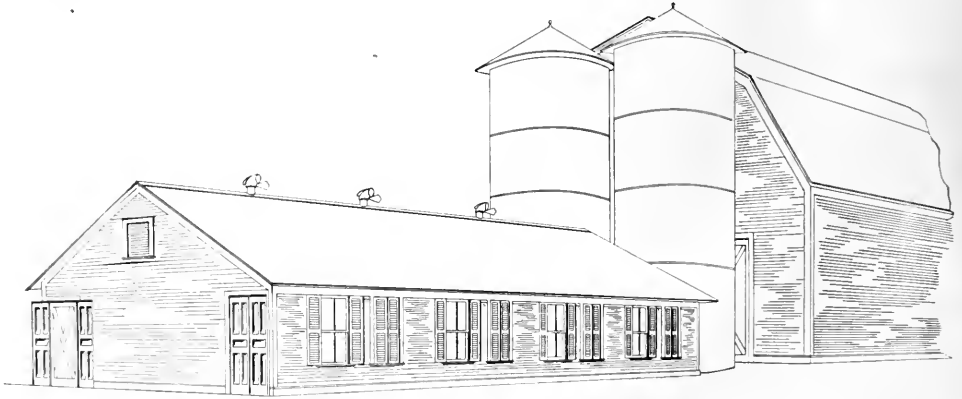

tical as well as scientific standpoint.

Government milk inspectors, backed by public opinion, have established a thorough system of inspection. City milk supply is now traced to its source, the cows

prising as it does, all grades of producers from the most progressive farmer down the line of small dairymen to the ignorant huckster. Cleanliness is required by inspectors first, last and all the time; thus,

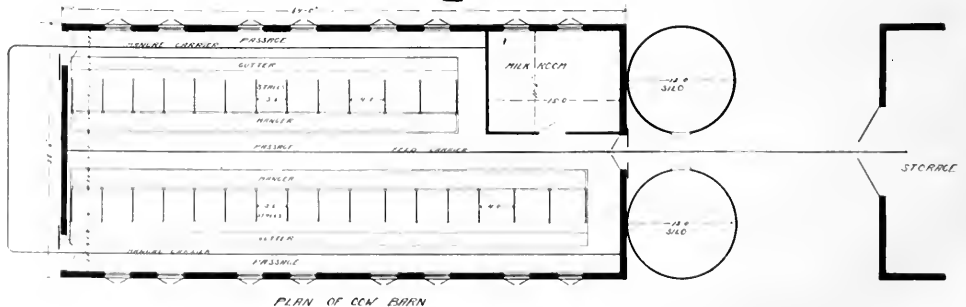

examined thoroughly for condition and health and the stable for cleanliness. If incompetency or indifference has led the dairyman to disobey the state sanitary requirements he is not permitted to ship his

making the right start, for cleanliness, leads to many virtues. A man who is particular about all utensils, his wagon, stable, cattle and himself, will not tolerate a poor stable or an unhealthy cow. He

may not understand the science of ferments or disease germs, but his milk supply will be good and wholesome, because he robs harmful bacteria of the dirt upon which they thrive.

In our northern climate, warmer stables have for years occupied the attention of

ability to grow or fatten. Too frequently cattle thus housed were attacked by bovine disease germs, which were materially assisted in their work of destruction by conditions so expensively though unintentionally provided. Stockmen thought the trouble was caused by too great a change

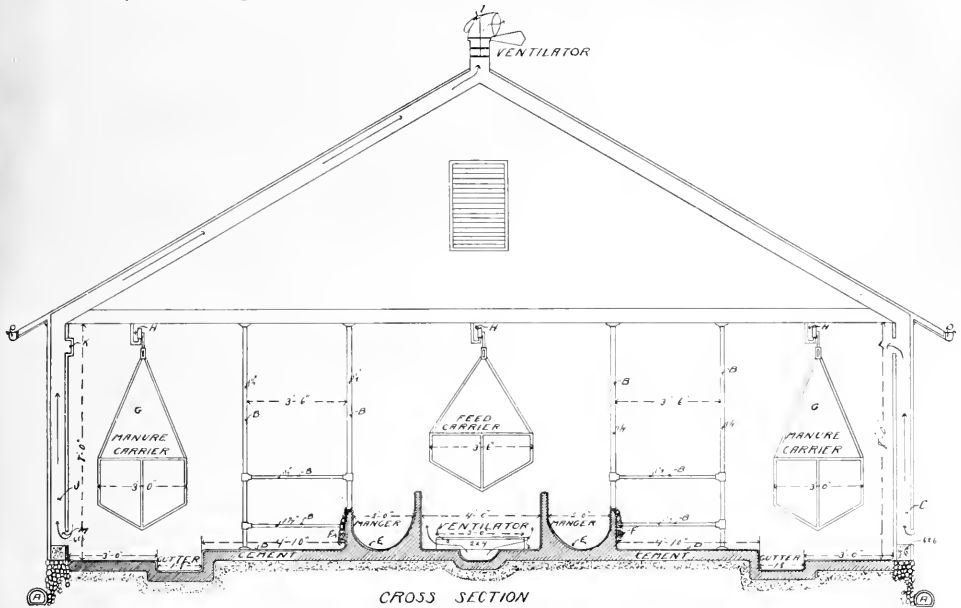

CROSS SECTION

our best farmers and stockmen. Bank barns were the outgrowth of a desire to provide comfortable stables that were both warmer and better. The convenience of having all stock under one roof, tucked carefully away from the cold, with plenty of feed overhead ready at all times to find its way to mangers and food racks by gravity, proved very alluring to ambitious farmers all over the country. But animals housed in these expensive dungeons were not happy and showed their discomfiture in watery eyes, lusterless hair, hot noses and hot, feverish breath, with fretful quarrelsome actions together with their in-

temperature by allowing the cattle to go out for an airing or for water each day; to remedy this, water buckets were added to the stable outfit and the stock confined in an abominable atmosphere for weeks at a time.

Atmospheric conditions affect animals differently. The heavy breeds of beef cattle are usually phlegmatic in disposition, paying little attention to ordinary disturbances; these suffered less in consequence, though it was noticed that they did not benefit from the quantity and quality of feed as they should. Milch cows of a highly nervous organization are more sus-

ceptible to incipient diseases caused by objectionable surroundings than any other domestic animal. Not until progressive scientific men spent much time and money in investigations and experiments was the trouble traced to its true source.

Analyzing stable atmosphere led to the detection of harmful bacteria in incredu-

same air over and over again, bacteria conditions are complete.

Bank barns are always damp and always dusty; owing to their construction they never admit sunlight in quantities sufficient to be of use. Sunlight is destructive to all forms of harmful bacteria; therefore a stable should admit the direct rays of the sun to every stall if possible.

An eastern model dairy stable combining all good qualities while eliminating objectionable features is shown in the accompanying plans. This stable may be built at a low cost, is warm in winter, cool in summer, and sanitary and hygienic at all times.

Location

The proper location for a dairy stable is the first consideration. Good air, good drainage, plenty of sunlight and an abundant water supply are all essential features. Fresh air and drainage may be secured by selecting an elevation; protection from cold winds by means of a tree belt or a high tight board fence. Sufficient water may be obtained in most any situation by a powerful windmill. There are other considerations such as convenience to the pasture fields and a short haul from the fields pasture, however, receives less consideration than it did a few years ago. North in which soiling crops are grown. The of parallel 42 there is an average of only six weeks of good pasture. Summer draughts sandwiched in between late spring and early fall frosts are responsible for this condition, so that a good many farmers in the east depend upon soiling crops a great deal more than they do on pasture. A runway consisting of at least a quarter of an acre for each cow is necessary, but the fields may be more profitably employed in raising cultivated crops. The question of drainage is a very important

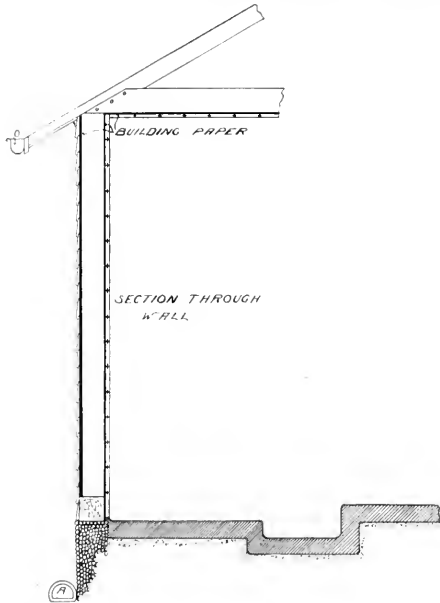

lous numbers. Scientists engaged in the work were slow to give out the result of their first investigations, thinking that the conditions under which they were working might be abnormal. Prospecting further and while endeavoring to learn the cause they found the conditions in these cellar stables particularly favorable to the propagation of stockmen's worst enemy. Harmful bacteria delight in a dusty atmosphere, especially when it is impregnated with moisture; when a share of the dampness comes from the moisture laden breath of animals that are obliged to breathe the

one. If the soil is naturally dry and slopes sufficient to carry off rain water no elaborate system of tiling will be necessary, but if there is any doubt it is better to be on the safe side.

Grading

In laying out a stable a great deal of after work may be saved by a careful survey of the grade. Manure should be removed from a dairy stable promptly every day and carted at once to the fields. By the use of a manure carrier and a spreader

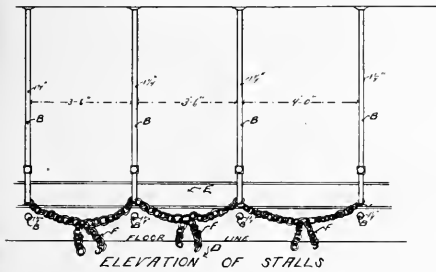

this way of managing is cheaper as well as better than the old fashioned way of piling in manure to be hauled away at some future time. In making the grade the stable floor may be placed high enough to run the manure carrier directly out over the spreader. Calculation must also be made for carrying off the water used in flushing the gutters and in washing the dairy utensils. The intake for ventilation is another consideration before commencing work. In order to lay out the ground right a general working drawing giving the floor plan and profile is necessary. Any one can work to such a plan by having a few simple instruments. An A level and a few stakes of different lengths comprises about all the tools necessary.

Excavation

The excavation for the walls may be just deep enough to go below frost. For con-

crete or cement walls make the trench just the width necessary to hold the wall material but after the trench is done make a rounded recess all around the edge near the bottom to hold a course of three inch tile. This answers the double purpose of carrying off surplus water and preventing rats from undermining the wall. Rats will dig down at the side of the wall until they come to an obstruction, they will follow the obstruction along close to the wall but never think of digging outward to get around it. The ends of the tile should terminate in the main drain just below the trap.

Walls

In some parts of the country stone is plentiful and farmers prefer to lay up a stone wall but generally speaking a concrete wall is cheaper and better. The materials may be put together on the ground and dumped into the trenches with unskilled labor. It is only necessary to look carefully to the leveling and finishing of the job. For this purpose a two inch plank staked carefully in position with the edges even with the top of the wall forms a guide both for leveling and for thickness. Openings in the plank may be left for doorways and boxes built around the size and shape to properly hold cement sills so that when the wall is finished the door sills will be complete and the whole thing will be in one piece.

The Floor

After the walls are finished the grading for the floor comes next in order. The profile shows the relative position of the intake for fresh air, the floor of the feeding alley, position of the cement mangers, inclines of the floor in which the cattle stand, the gutter and the walk behind the cows. Besides the cross section the mangers and gutters incline with the length of the sta-

ble. In order to locate all these points a good many grade stakes are necessary. They are set carefully to measurement and driven down until the tops come right for the grade. It is easier to do this work before the building is erected. One point to be remembered is that the wall should not extend much above the floor for the reason that dampness will collect on the inner side or warmer side of the wall especially in winter. Also the iron pipes designed to partition the stalls and support the ceiling should be imbedded in cement when it is fresh.

Superstructure

It is cheaper to build barns and stables low because lighter material may be used in their construction. A dairy stable should have a low ceiling to facilitate ventilation. Seven feet is high enough for a ceiling but eight feet looks better if the stable is long and where there are a good many cows together there is no objection to an eight foot ceiling. A good deal depends on the number of cows kept. A stable may be built on this plan to hold twenty-four cows or it may be made long enough to hold one hundred. The principle of ventilation depends on the circulation of air. Warm air is lighter than cold air and it naturally goes up. In order to ventilate a stable we must get animals enough into it to warm the air. There is little or no circulation in a cold room. For the ventilation to work right the temperature in a stable should not go below 55 degrees. This plan takes the air in at the center in front of the cows where the cows may breathe the clean fresh air from outside before it becomes contaminated. The hot breath of the cows goes to the ceiling, spreads in all directions to the sides of the room while it loads up with impurities and finally settles to the

floor at the sides of the stable where it is drawn off by the ventilators and sent out through the roof. In order for the ventilating system to work right the stable must be practically air tight around the sides and ceiling and the doors must fit well. There is a light sill six by six bedded in fresh cement mortar on top of the walls, two by six studding seven feet long toenailed into the sill and a two by six plate spiked on top of the studding. Building paper is nailed to the studding both inside and out. The inside is lined with matched ceiling without bead. This is to eliminate all cracks and joints as far as possible. There are no cracks and places for dust to lodge and all stable dust is bacteria laden. In like manner building paper is tacked to the ceiling joists and under the paper a light matched ceiling is nailed so that the whole room is smooth around and there are no projections or shelves of any kind to hold dust. The stall partitions are as light as possible for the same reason. Door and window frames are made flush on the inside and just a light four inch casing turned to cover the joint. It is better to use a great deal of care in laying the building paper around all such places to prevent air openings. It is not intended to use the loft over this stable for storage or any purpose but it is better to build the loft so that it may be swept occasionally to clear out the dust. A window is placed in each gable for the purpose of causing sufficient ventilation to keep the loft cool. The outside of the stable is boarded up with patent siding and a light box cornice makes the finish at the eaves. The ventilating system is shown in the cuts. It pays to put on an eave trough whether the water is wanted for use or not because the drip from the eaves will cause dampness and this should be avoided. Because the build-

ing is low a light roof is sufficient. Two by four rafters are heavy enough if well supported by cross collar beams.

The Silo

In this plan the silos are placed at the end of the stable. If the stable is long however it is better to put the silo in the middle. It will save steps at feeding time. It is better to have two small silos than one large one. From twelve to sixteen feet in diameter is big enough for any silo. The surface may then be fed off every day and the silage kept fresh at all times. The milk room is at the side of the silo. The floor and sides are built entirely of cement and the room has a light matched ceiling. It is provided with an open drain that connects with the main drain outside of the building. The milk room contains a separator, scales, Babcock tester and a shelf to hold the smaller utensils and a porcelain lined sink for washing dishes. Outside of the milk room is a rack to hold the cans where they are turned up side down every morning in the sun. Beyond the silos and milk room is the barn where the roughage is kept and the track from the stable runs across so the feed may be brought by an overhead track carrier. The silos are at the north end of the building. The manure is taken out through the south doors. The cows are also let in and out of the south doors. This style of stable should be built north and south so that the sun will shine in at all of the windows.

Silo Construction

The cheapest form of a silo is the round stave construction. It is about as good as any, too, when it is thoroughly well built from well seasoned lumber; in fact, it has been thoroughly demonstrated that the stave silo is a success. In New Jersey and Eastern Pennsylvania the stave silo

is almost universally used. They do not last as long as some others. Probably the average life of a stave silo is somewhere between five and ten years. But a farmer can tear down and rebuild because the material is comparatively cheap and there is not much of it. In some parts of the country there is a prejudice against this form of silo. Some claim that the silage is not so good, but it would be difficult to substantiate this claim. Of course, to keep silage properly in any kind of a silo it must be air tight. If a stave silo leaks at the joints the silage will suffer, but the same may be said of any make of silo.

Some of this prejudice comes from the dairy farmers who formerly had experience with stave silos which are constructed by putting rough planks together without beveling the edges, but the way staves are made now with bevels carefully cut to fit the circle and provided with heavy iron hoops, and plenty of them, there is probably no better construction. Some stave silos have round tongues and grooves. This is better than a plain straight bevel, but it is not absolutely necessary. The ends of the staves where they butt together are fitted with an iron tongue let into a saw cut in each end of the abutting staves.

A convenient height for a silo of this kind is thirty-two feet made from sixteen foot stuff, but some staves must be eight feet long in order to break joints. Most stave silos erected are bought from some manufacturer who has a patent on some little contrivance in connection with their manufacture, but any farmer can order the material and build his own silo if he wishes to do so. The mills will cut and bevel the staves and tongue and groove them to fit any circle desired, but it is necessary to understand all the little de-

tails and see that they are properly worked out. A good many of the patent silos have an iron framework to hold the doors. This is an advantage inasmuch as wood gets damp and swells, but any carpenter can bolt two timbers together in such a way as to make a good framework to hold the doors, and the saving in expense is considerable. The doors may be made loose

and calked around the edges with tow or the soft parts of corn stalks makes very good calking material. In fact, there are a great many different ways to manage if a person is determined to have a silo, but it is well to remember that the doors are a particular part. The framework must be solid and there must be ample space between the doors for the hoops.

Horse and Cattle Barn—A115

A medium sized barn to accommodate eight cows and six horses is given in plan (A115). The size on the ground is thirty two by forty-four, which is not very large

fifteen feet wide, is left for general purposes. It answers for a feed room, storage for a wagon or two and general barn purposes. The second floor covers the whole

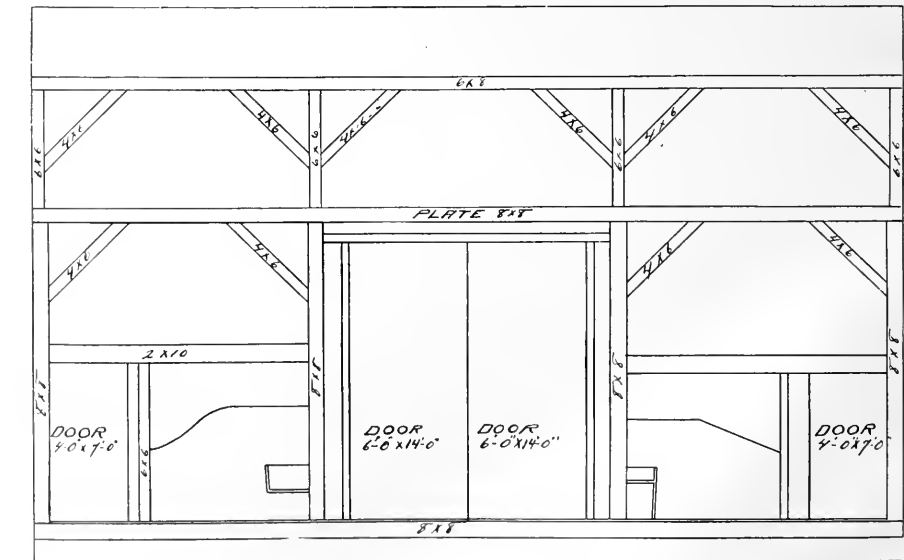

LONGITUDINAL SECTION

for a farm barn, but it is not intended to be a large one. The first floor is divided into three parts; the horses occupy one, the cows another and the middle section,

building with a couple of hay chutes to let down feed and straw to the horses and cattle. It hardly pays to work a horse fork in a barn of this size. The stuff may be

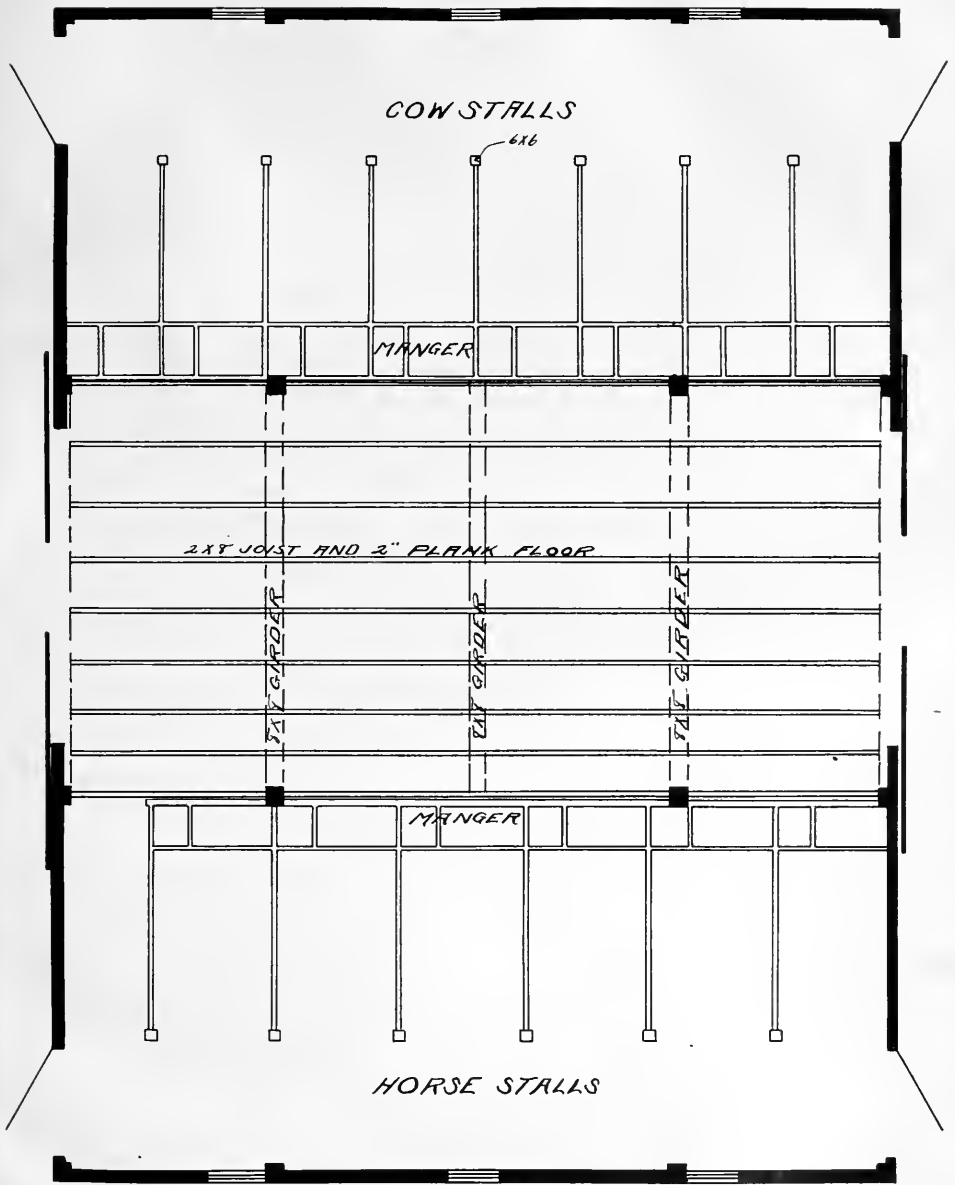

FLOOR PLAN OF HORSE AND CATTLE BARN

put in by hand from the outside through doors that open down to the floor. There is no waste space in this plan, every foot is made use of to the best advantage, and the barn will be found very useful on farms where a small number of cows and about the usual number of horses are kept. The plans show the construction in detail. It may be boarded up and down or covered with siding. May be made any length.

A good feature about this barn is that it can be added to without interfering with the general arrangement in any way.

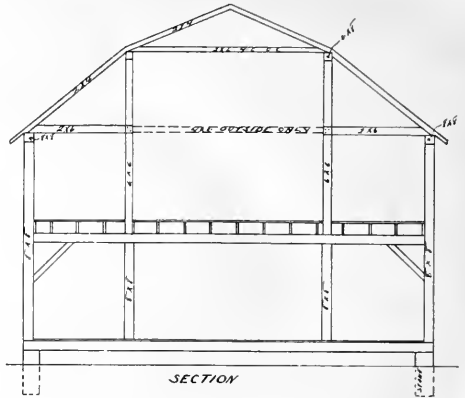

An A-shaped Poultry House—A152

An A shaped poultry house is given in plan (A152). This is the cheapest way to build a poultry house. You don't have to build a roof or if you build a roof you don't have to build sides. You can do either way you choose.

It is divided lengthwise with a curtain

pole and made flush on the curtain side. You attach the roller to the ridge pole so the curtain rolls up on the inside of the roller which brings it close to the woodwork.

The house shown in the plan is eight feet wide and sixteen feet long. One end

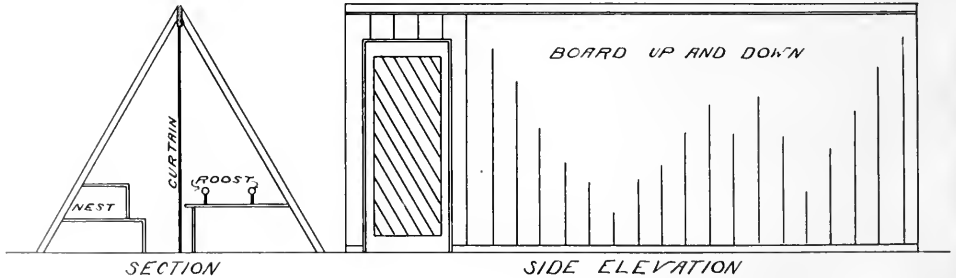

partition. This curtain is in four foot sections and it rolls up on heavy window shade rollers, so that it may be pulled down cold nights to make a warm roosting place. The material of the curtain is cheap cotton costing three or four cents per yard. The sections are divided by two by four posts reaching from the floor to the ridge

of this building is supposed to front the south. There is a small door in this end for the chickens to go in and out and the window is as big as possible. The entrance door is at the side and it should be near the south end. It is a bad plan to have doors, windows or any openings in the north end or north side of a poultry house.

A Dairy Bank Barn—A125

An old fashioned dairy barn is shown in plan (A125). There are a good many such barns still in use in Wisconsin. Those using them say they are satisfactory under certain conditions.

One good feature about this stable is the ventilation. To have good air in a cow stable it is absolutely necessary to have a system of ventilation. You can stable four or five cows together and depend on

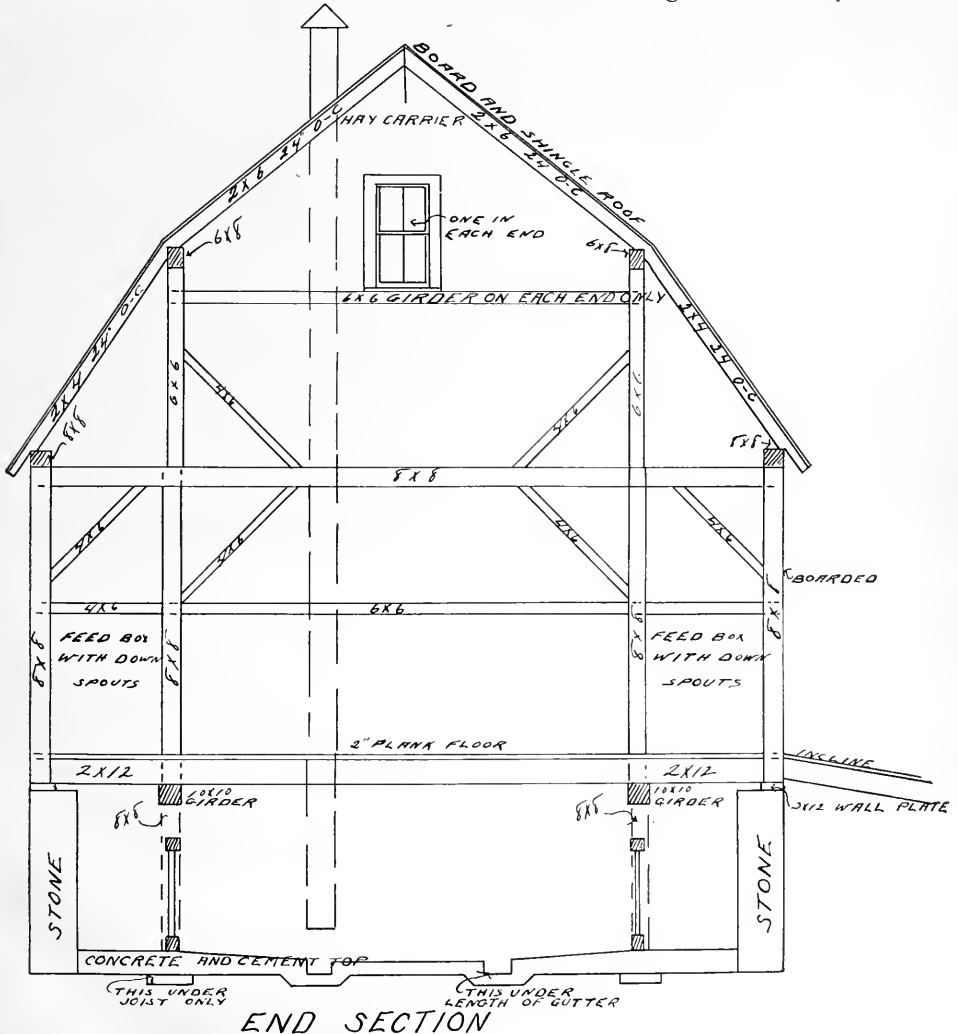

LONGITUDINAL SECTION

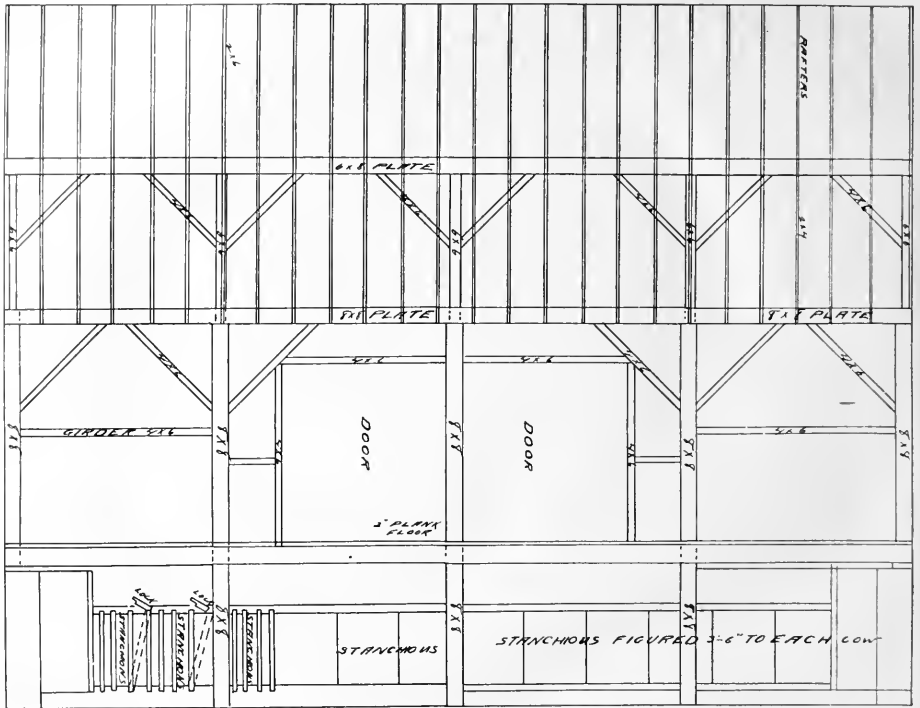

BARN AND COW STABLE
32 FT WIDE 50 FT LONG

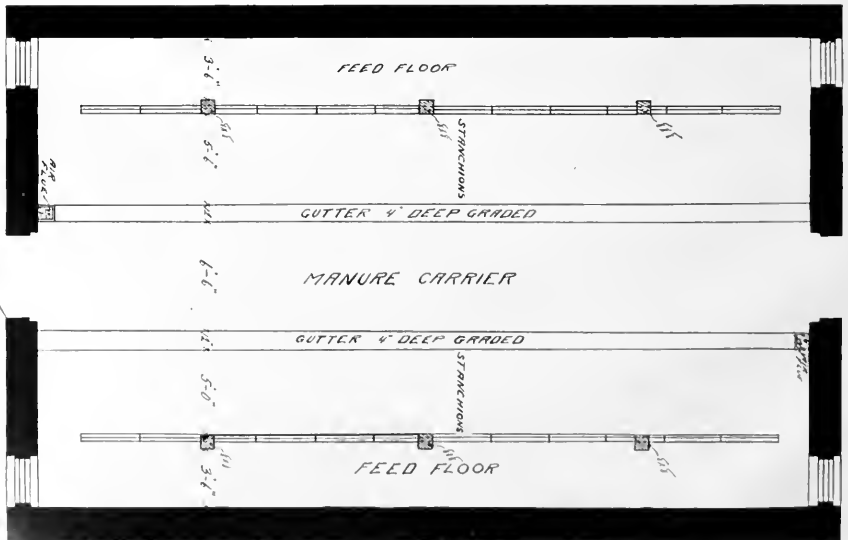

chance openings to provide them with oxygen, but you cannot depend on Providence to keep your cattle alive in a large stable unless you assist a little bit.

A good many dairy men prefer to have

the cows face outward. This is a matter of individual preference. Probably nine stables out of ten are made to face the cows in, but this is no dead open and shut reason why this stable should be built that way. One advantage of having the two manure gutters in the middle is that a cart may be driven through to remove the manure. If there is any other good reason I am not familiar with it. In these Wisconsin stables the old fashioned stanchions are used.

There is a large amount of storage overhead in a barn like this, and it is a convenient barn to do the work in except in the matter of feeding the cows. It takes more steps to get around to feed the cows when they face out. This barn is backed up to a bank, preferably on the north side, where the incline may be had easily to drive in on the main floor. The horse fork is worked from the center.

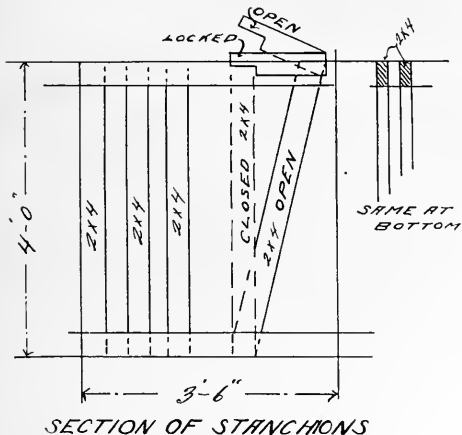

A Round Corn Crib—A142

So far as the size is concerned there is more room in a round corn crib than in any other shape made with the same amount of material. The building is easily constructed because it is all plain straight work and it is rat proof because it is set up two feet from the ground on cement posts.

The posts are made by digging holes in the ground three and one-half feet deep and about eight inches in diameter. Lengths of eight inch pipe made of galvanized iron are used to carry the cement two feet above the ground. Before commencing it is necessary to strike a common level at the surface of the ground so that when the pipes are all set up the tops of them will be the same height. The post above the ground and the post underground

should all be made at the same time so that the cement will unite into one solid post.

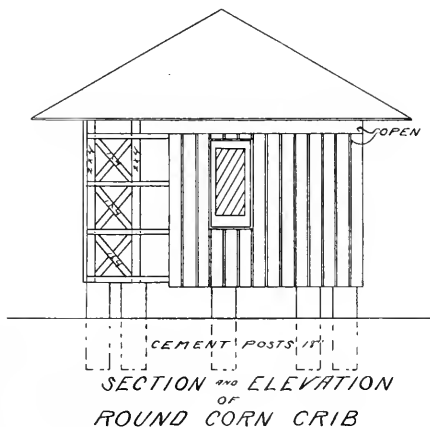

The floor plan shows the way the joists are laid and the circles represent the girts to which the 1x4 upright pieces are nailed. As the crib is sixteen feet in diameter it

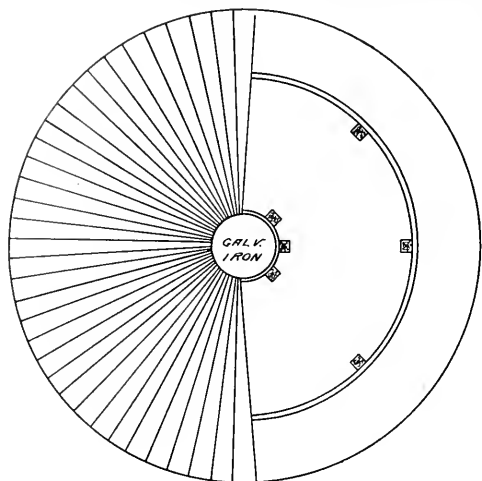

is necessary to have a ventilator in the middle. Ordinarily it is not advisable to have a body of corn more than six or seven feet in diameter. By making the inner circle three feet we have six and one half feet between the inner strips and the outer strips and as there is no floor over the joists in the center the air can pass up through the three foot ventilator easily.

The round girts may be made in two ways, either by using thin stuff and nailing one layer upon the other, breaking joints, or they may be ripped out of two inch planks. If ripped out of planks a single saw-cut through each piece of plank will shape the sections, cut as shown in the diagram. Use two inch plank ten inches wide cut to four foot lengths. Make segments enough to build up all the girts necessary by ripping the short planks lengthwise through the middle, then rip again on the curved line. The finished girts are about 4x4 3/4 inches. There is very little waste.

The roof is supported by a similar girt and this upper girt or plate is supported by extending some of the one by four pieces above the others as shown in the drawing. These extension strips may be doubled or two by fours used at these places. The

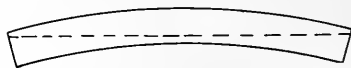
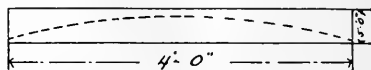

DETAILS OF ROUND CORN CRIB

crib is twelve feet high to the plate. An air space is left all around and this air space is big enough to shovel corn

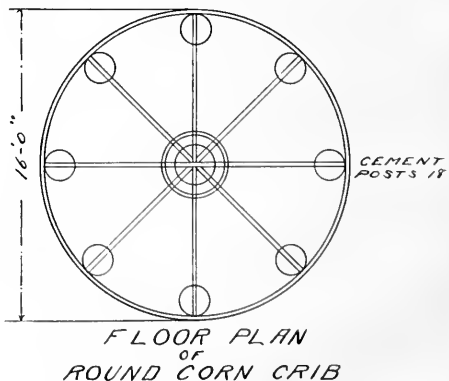

FLOOR PLAN
OF
ROUND CORN CRIB

through. Of course the corn is put in at the door and at the opposite window until the crib is pretty well filled.

The roof itself is a very simple affair. It is supported by the plate and the ven-

tilator shaft. The roof boards are 12 feet long and cut 11 inches at the wide end and 1 inch at the upper end or narrow end. These boards are nailed in place and the cracks battened. The center is easily filled

in with sheet of galvanized iron having a cut reaching from one edge to the center. Such a roof if kept painted will last a long time. It is very light, cheap and easily made.

A Small Barn with Stable—A117

A small barn with stable underneath is shown in plan (A117). The barn is thirty-two by thirty-six feet and contains stabling for eleven horses with convenient feed room in the basement.

The hay chute passes straight down from the loft to the feed room below and a corn chute is built diagonally across under the driveway floor to reach the feed room. The reason for this is that all feed rooms should be shut off from the stabling

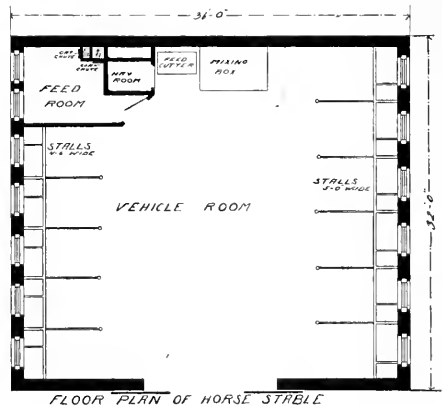
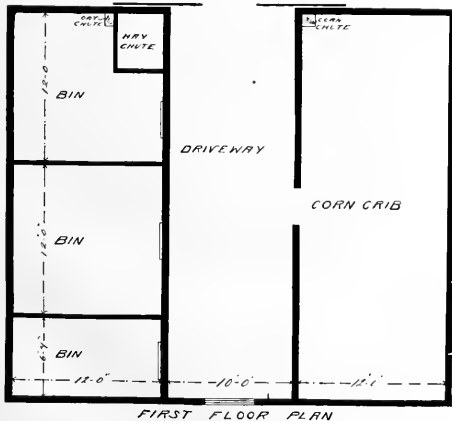
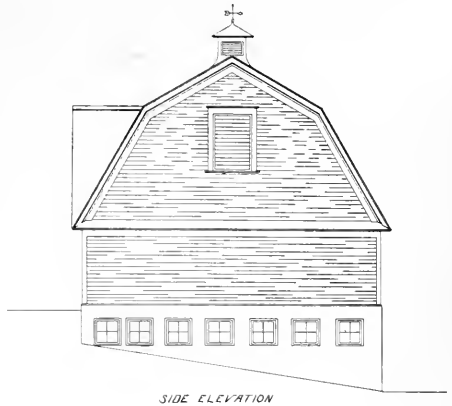
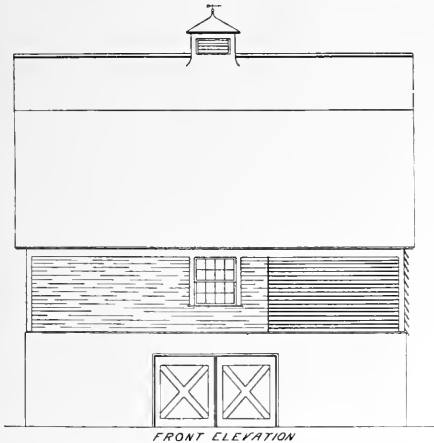

part with a good door. Most of us have had experiences with horses getting loose at night and eating more grain than was good for them. A corn chute twelve by twelve inches inside may be run on a slant work all right but it wouldn't do to make it much smaller than this.

The first floor above the stable is intended for granary bins on one side of the driveway and a corn crib on the other side. Some means of ventilating the crib part must be devised which can be done by leaving a three quarter inch space between the drop siding.

A Cheap Smoke House—A149

It is not necessary to do without a smoke house on a farm. A small building that will answer the purpose may be had with very little outlay. The plan (A149) shows

even dispense with the rafters, except the two end pairs, if you want to make a board roof. It is better however to make a good shingle roof, then you have something that will last as long as you want it. For boarding you just take sixteen foot boards and cut them in two in the middle. For the front and back use twelve foot lumber and the waste pieces work in for roof boards if shingles are used.

A smoke house like this is not tight enough to keep the meat in after being

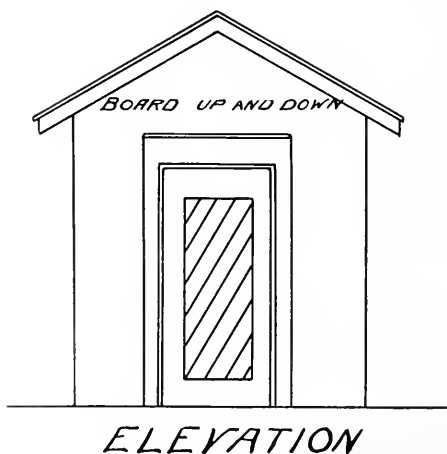

a little wooden smoke house eight by ten feet with sides eight feet high. It is big enough to hold as many hams and shoulders as farmers' families usually require with once filling, but it is an easy matter to fill the house the second time if you have the meat.

This little house requires no frame work at all. All you need is a four by four for sills and a two by four for plates and some more two by fours for rafters. You can

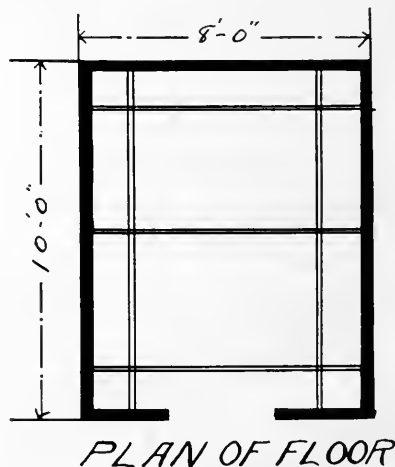

smoked. It is better to wrap it in paper, then roll it up in thin cotton and sew it up. You mustn't leave a place for a fly to crawl in. You must then hang the pack-

ages with strings, perfectly free. They must not touch each other and they must not touch anything else. They need a cool place but not damp.

A Granary—A107

Farmers have more use for granaries than formerly. There are two reasons for this, one is that more stock is kept on the farm and it is necessary to have grain the year round, another is that owing to a shortage of cars and speculation in grain,

the bins at threshing time and run through the fanning mill when taken to the warehouse for sale. By rigging the mill carefully a small proportion of the largest, heaviest grains may be retained for seed without adding anything to the cost. A

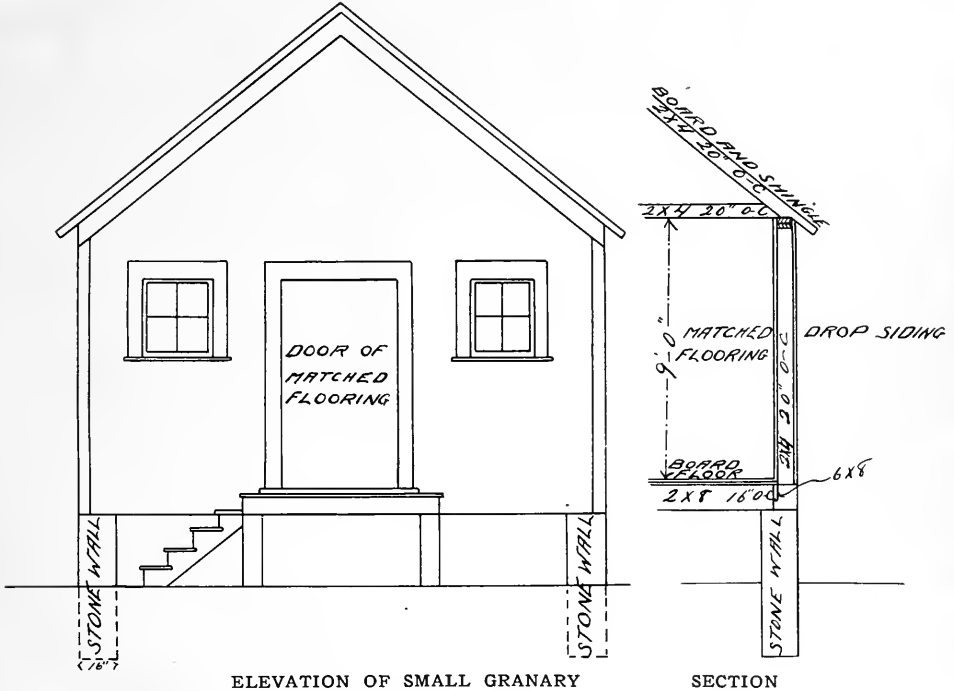

prices are not always satisfactory in the fall and it pays to hold grain to sell later.

Then, more attention is now being paid to seed. A grain house like this with a place for scales and a fanning mill is a very valuable addition to any farm. The different kinds of grain may be stored in

good mill that will select say one bushel out of ten of the kind of grain that you want to sow and do it while blowing the chaff out of the grain you are selling without interfering with the grade is a valuable mill, but there are just such fanning mills made and their cost is little if

any more than the common kind on the market.

In this scale room wires may be stretched for hanging the empty bags when not wanted. By sinking the scales in the floor each bag may be weighed as it is

It is difficult to arrange a plan of getting in and out conveniently without a platform. The door is too high to step up and if you have a kind of stair to reach it you might just as well have a good loading platform as a cheap shaky affair. A grain

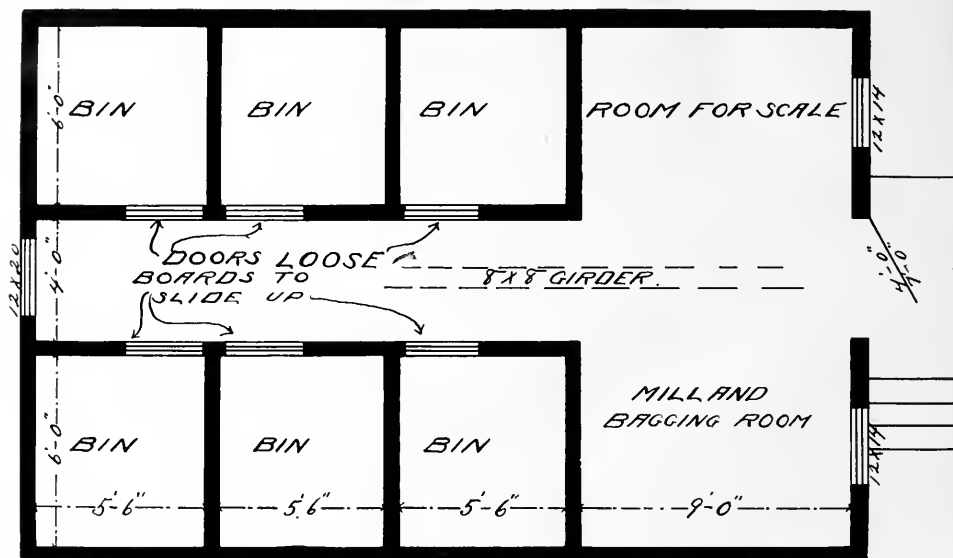

loaded. This is best done by having a two-wheeled bag truck and a counter weight on the scale beam so that the net weight may be written down each time without taking the time to calculate.

Great care should be taken in building a granary to have it rat proof. The wall of course must go below the frost and it is a good plan to put a three inch tile all around the bottom on the outside which answers for drainage as well as to keep the rats from burrowing under the wall. Some farmers object to a platform in front of the door just on account of rats, but if the door is made heavy and made to fit tight with a bit of hoop iron at the bottom, rats will not get in that way if the door is kept shut.

house should be set up well from the ground for two reasons, it should be the height of the wagon for easy loading and unloading and it should be high and dry because grain should be kept from all unnecessary moisture. There is moisture enough in the air in damp weather anyhow without taking chances on moisture from the ground.

The doors to the bins are made of loose boards dropped into grooves so that one board may be put in or taken out as required. A little extra expense put into the quality of the flooring is money well laid out. The floor should be free from shake and fairly free from knots, at least there should be no black knots.

A Balloon Roofed Barn—A143

A good sized barn with a basement stable, a good threshing floor and a large storage for fodder is shown in plan (A143). The wall may be made of stone or cement according to circumstances. Eight feet head room is enough for the cow stable but usually nine feet is better for a horse

this case there is a good deal of outside wall clear of the bank and the windows may be made large.

Balloon roofs are becoming quite popular in barn construction, but some of the first ones were not made strong enough and heavy winds wrecked them. This

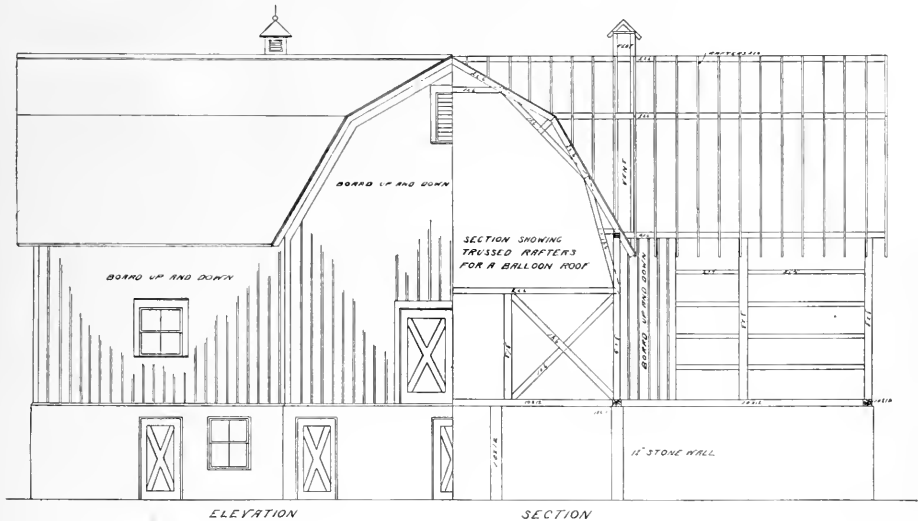

stable. This barn should front the south and the root house should be, if possible, in a bank on the north side and the feed alley is so arranged that a feed car may be run into the root house on a level.

It probably would be better to construct a board partition between the horse stable and the cow stable, but the calf and bull pens would be better without a partition because the air will circulate better and there will be more light in the cow stable.

One objection to a basement stable is the difficulty of lighting it properly. A good deal depends on the exposure. In

roof however is braced by the gables from every direction which makes the structure a strong one.

The threshing floor is open in the center to the roof but it may be floored over at the ends if so desired. The intention is to work the horse fork from this floor; to drive in with loads from the bank at the north and back out.

It is a good plan to leave sufficient opening to run the straw carrier or stacker up to the mows above. On most farms it would be desirable to have a stack in the yard but it is just as well to put some of

the straw back in the barn. A balloon roof works splendidly for this purpose. The stacker may be blown to blow the straw to the furthest end of any gable.

It will be noticed that two hay chutes are provided to carry the hay down to the feed alleys. Hay chutes are a great convenience but they are draughty things unless

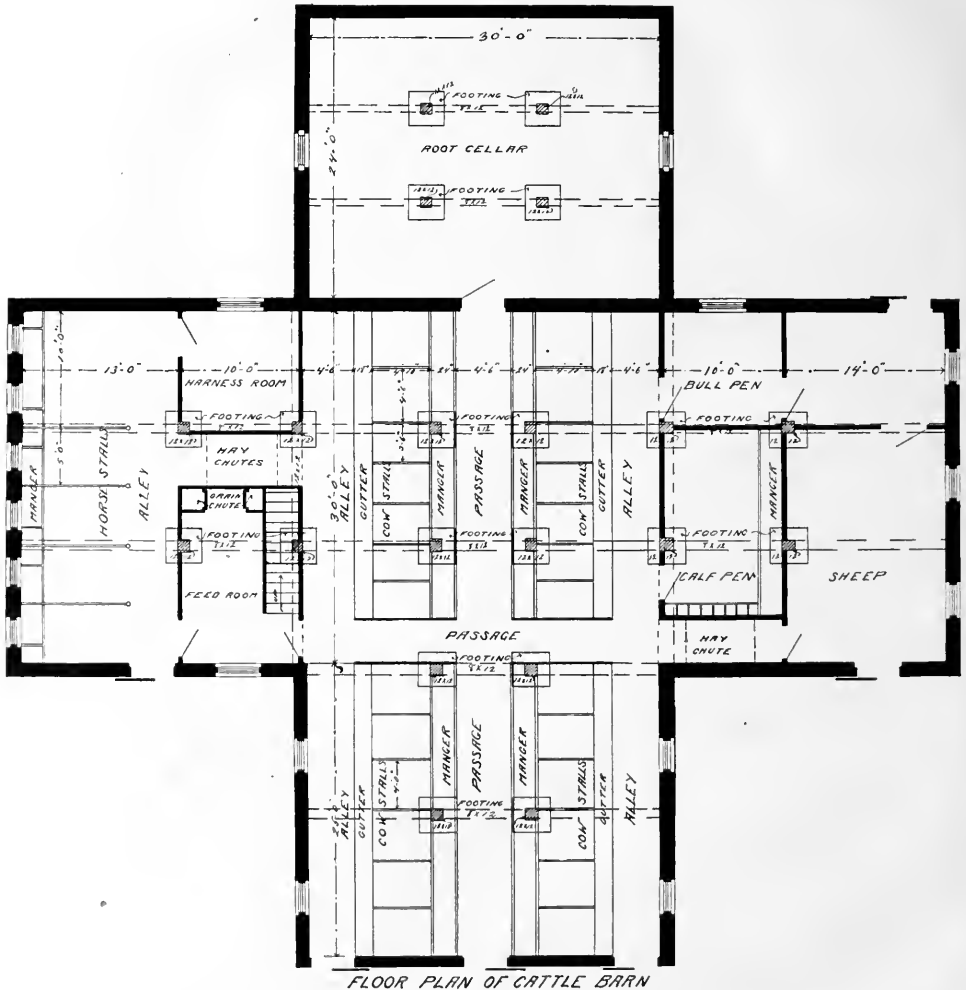

FLOOR PLAN OF CATTLE BARN

It is a good plan to pay careful attention to the ventilation of any stable. The air in a basement stable is seldom as good as it should be. There are two air shafts in this plan with openings near the floor.

doors are provided. In putting in the upper floor timbers and joists it is a good plan to make them continuous by building them up with two inch plank so as to tie the building together in both directions.

Remember in building this barn you have no upper ties and you must support the roof from the frame below, but this is eas-

any than the one shown in the plan. In that case it may be extended to cover the whole floor in the granary wing, which would

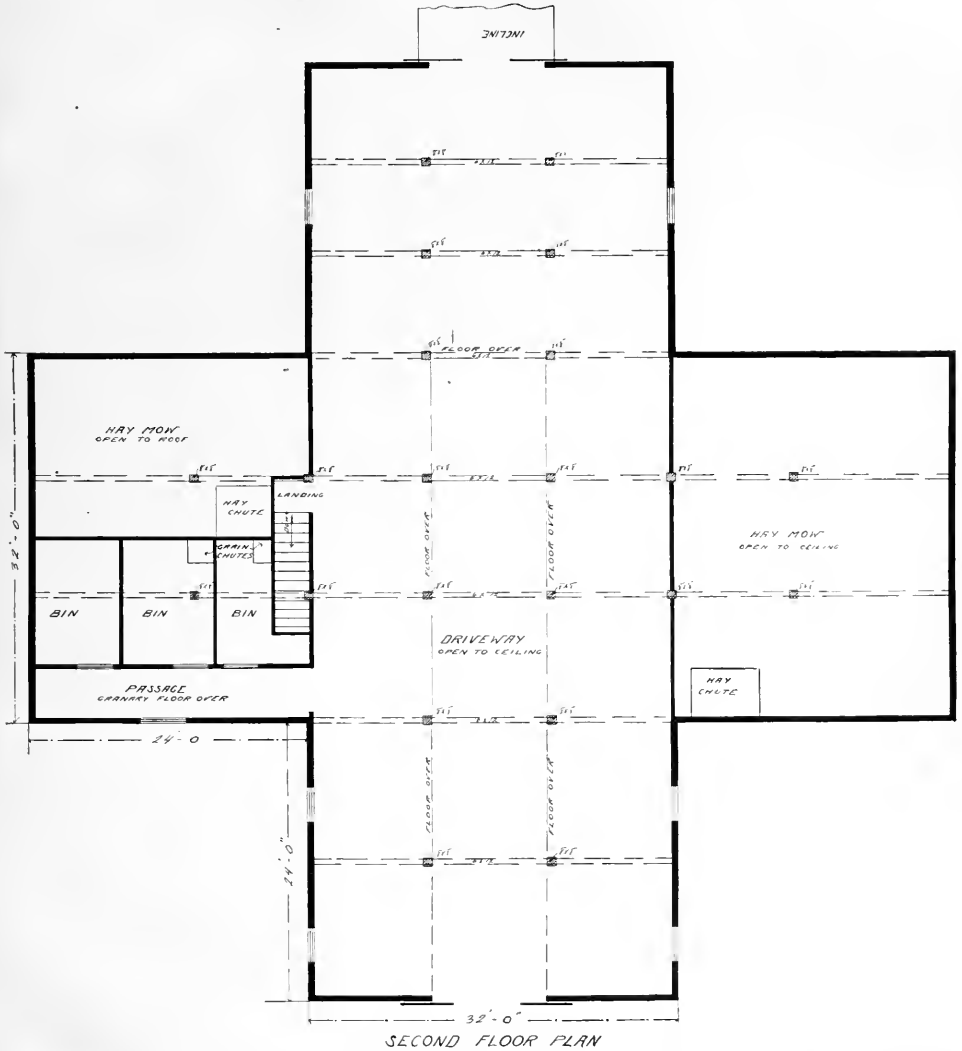

SECOND FLOOR PLAN

ily done because of the shape of the building.

Some farmers may need a larger gran-

make the granary about twenty-two by thirty feet and the hay shoot would pass down through it just the same.

A Double Corn Crib—A105

An old fashioned style double corn crib with a drive between and a roof to cover both cribs is shown in plan (A105). This

side opening from the center passage, but if the space is desirable for wagon storage the doors are built at the end as shown.

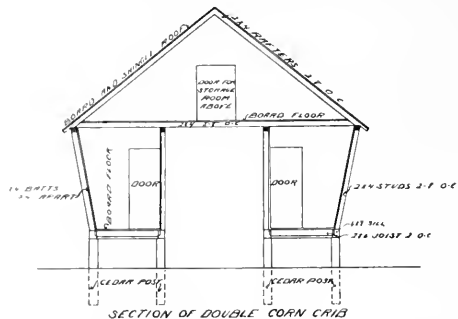

FLOOR PLAN OF DOUBLE CORN CRIB

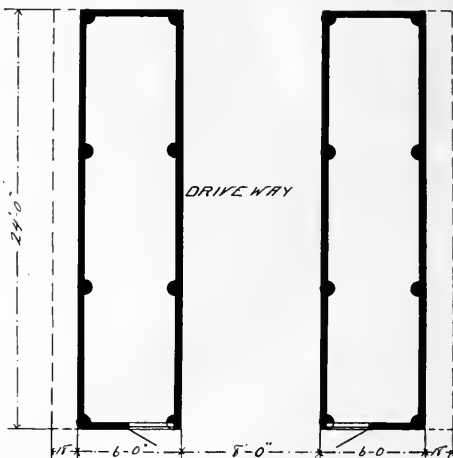

crib is set on cedar posts planted three and one-half feet in the ground and set up two and one-half feet above ground to be out of the way of mice and rats. The space between the two cribs makes a convenient place to store a couple of wagons. The doors being at the end, the center space is left free for this purpose. A good many cribs built on this plan have the doors in-

The storage room overhead will be found useful on any farm.

A Small Double Poultry House—A154

A small double poultry house is shown in plan (A154). It is twenty-four feet long and sixteen feet wide, giving a space of sixteen by twelve feet to each compartment. It is very simple and it is also cheap and durable. It may be built of matched stuff

with the smooth side turned in, or it may be constructed of rough lumber. Of course matched stuff is very much the best as it leaves no harbor for vermin and no lodgment for dust. In either case the building is covered outside with tarred paper. The

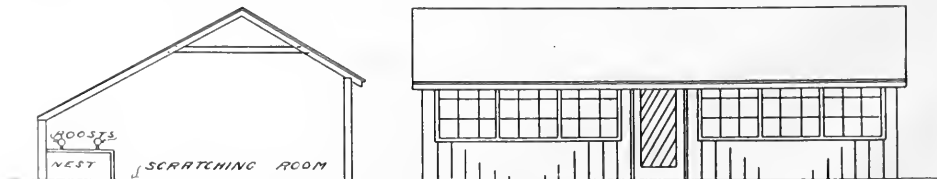

POULTRY HOUSE

paper is started, in strips, from the eaves in front, carried over the peak and clear down to the ground at the back.

Inside, the house is practically all one room, but a roost curtain may be hung with a roller to pull down at night or the cotton may be tacked on a hinged frame to let down at night, also one or more of

the windows may be left open and the spaces covered with cotton.

Against the back wall is the droppings board with the roosts above it and the nest boxes underneath. All this furnishing is made removable so far as possible for easy cleaning. The apron board in front of the nest boxes lifts out in sections.

Attractive Stables—A116

A very neat, attractive stable for a city or village is here given. A good stone wall is laid down below frost, or it may be carried a little deeper and the part under the carriage room excavated for a cellar, but

in this case a retaining wall would be necessary on the stable side because the box stalls are supposed to have an earth floor. Any way, you don't want horses over a cellar. The elevation is pleasing

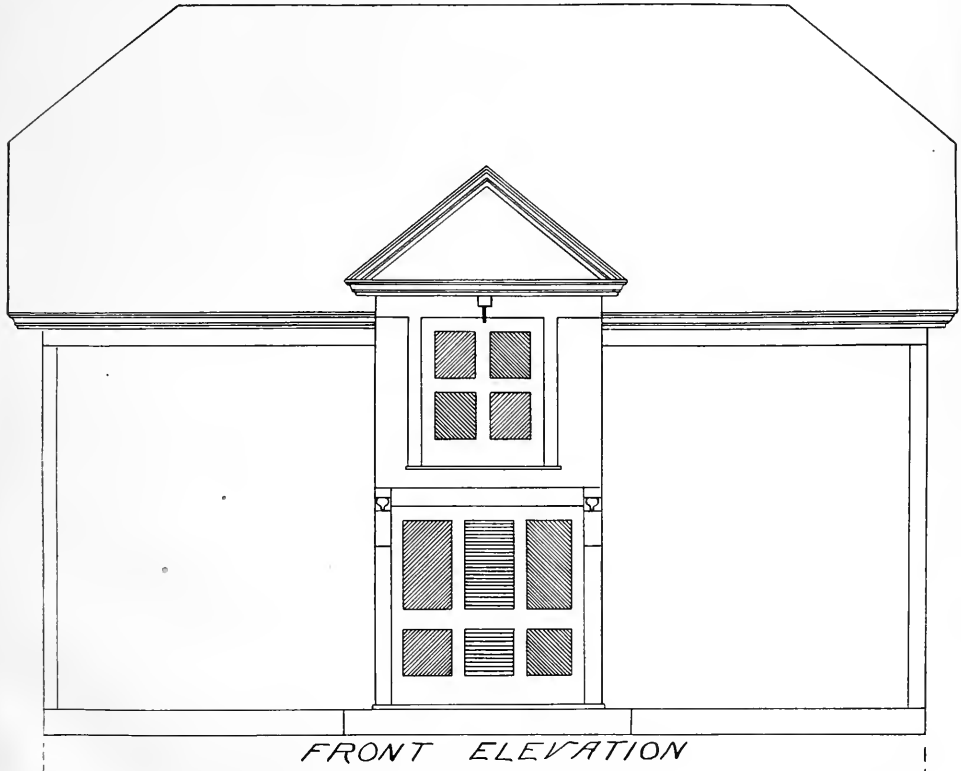

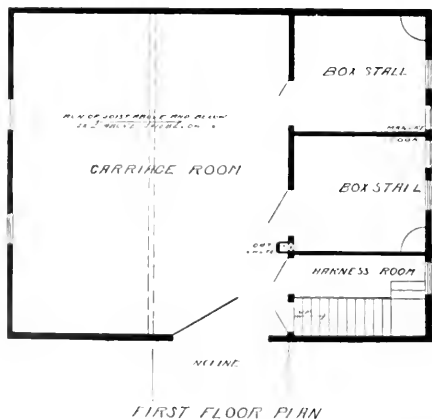
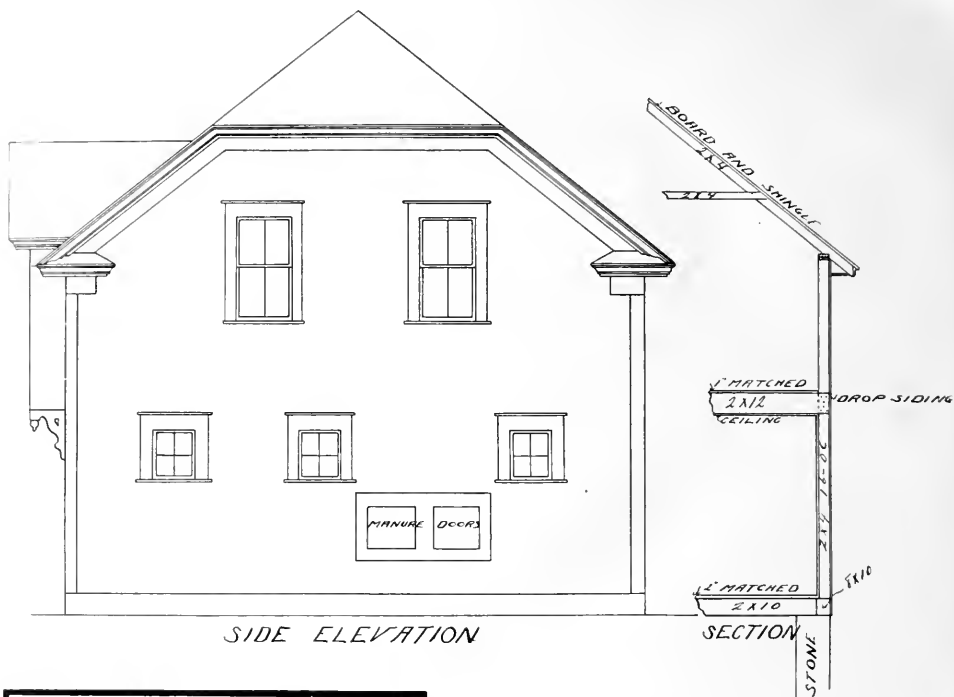

because it is not exactly plain, still there is no great additional expense in building a roof like this or in the little projection from the upper door in front. There is storage room above for hay, straw and

oats, and the upper door is wide enough and high enough to admit the supply easily. The doors to the box stalls should be made in halves so that the upper half may be opened and the lower half closed.

An Octagon Barn—A150

This is a cement silo with a barn built around it. The arrangement is a good one for feeding young cattle to make them grow, rather than to fatten steers for the market. The silo is sixteen feet in diameter and thirty-two feet high with a twelve inch cement wall and a pit that reaches three feet below the surface of the ground.

rods connect all the floor joists and all the rafters. This makes a circle of three quarter inch iron at the floor and again at the roof, but if the different sides of the building are well tied together there will be no getting away even if the iron rods are not used.

The octagon construction has been

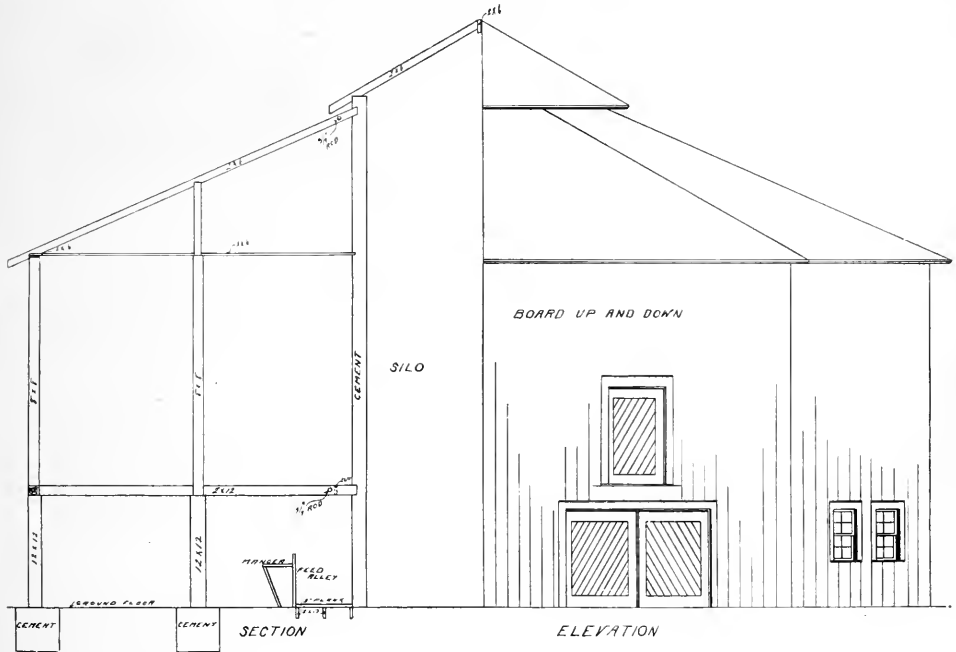

Three feet is deep enough to give a good solid foundation and it is deep enough when you come to pitch the last silage out of the bottom.

The frame-work of the barn is very light. The silo is used to support the middle and the barn really is braced from every direction. Every side is both a brace and a tie for the next side. To prevent any possible pulling away from the silo,

worked out in this plan in preference to a round barn because the construction is cheaper. The sills and other timbers are straight. The joists usually are cut square, at least there are not very many bevels and when a joist is beveled it is only on one end and the other end is cut square. It is the same with the rafters.

There is considerable room for straw and hay around the silo and it is easy to

make places next to the silo for putting both hay and straw down into the feed alley.

The mangers being next to the feed alley makes feeding as easy and convenient as it is possible to have it. Perhaps no other barn construction can offer such advantages at feeding time. The mangers hold hay, corn stalks or other roughage and the bottoms are tight for feeding corn

or ensilage. The feed room in front of the silo doors is boarded to the ceiling so that ensilage enough for a full feed may be piled up out of the way of the ensilage cart. A packing box with large castors may be used for a silage cart or it may be a well built cart with heavy iron wheels and with hinged sides to drop over to the manger.

There are four entrances for conveni-

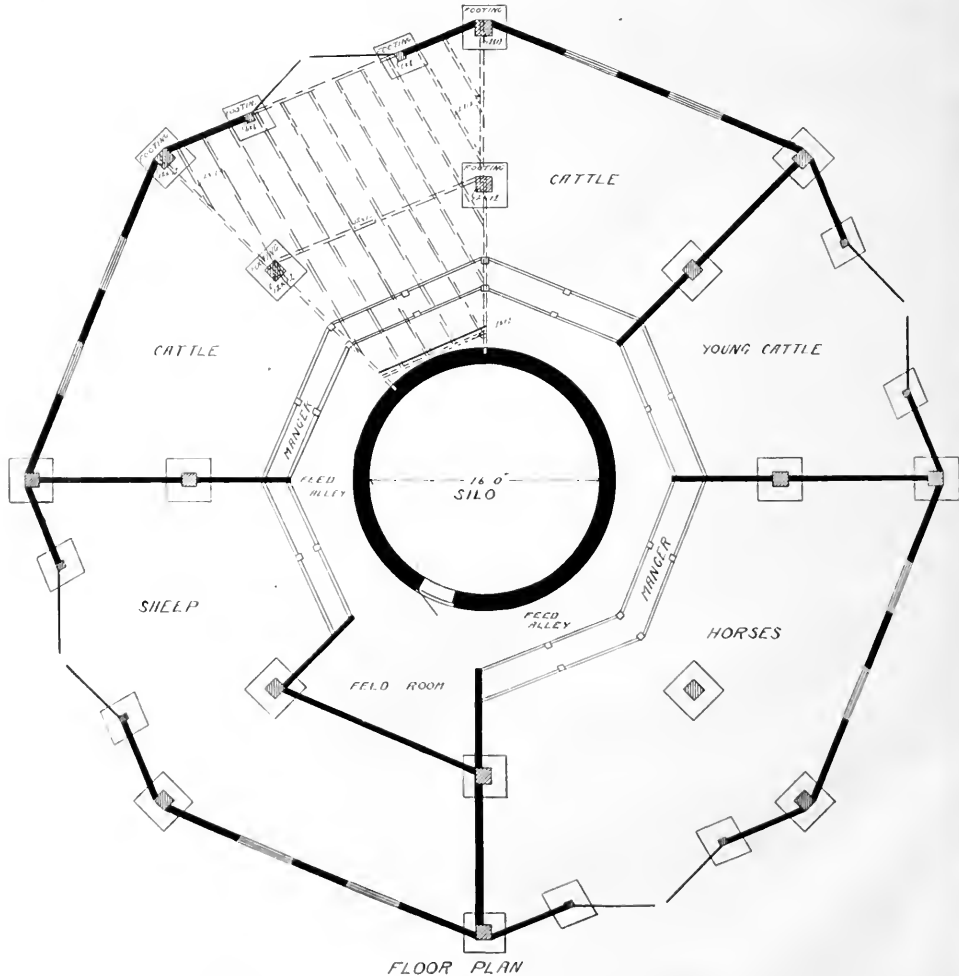

ence in getting out the manure and most of them will be used at times for letting stock in or out, especially if the barn is divided up in compartments for the different kinds of stock. Each post has a good cement footing as shown in the plan and the elevation shows the way the timbers run.

There is no floor in the bottom except

the ground as it is intended to let the straw and manure accumulate, but there is a good feed room floor as this is where the work is done three or four times a day. A silo surrounded like this must be filled with a carrier. A blast stack will not work well on an incline and it is not convenient to place the cutter close to the silo, but a good carrier works all right.

A Small Poultry House—A153

A little two story poultry house that looks like a plaything is shown in plan (A153), but this house is alright so far as it goes. It is especially valuable for a boy who would like to start in the poultry business but cannot afford a more expensive house. This little house is four feet wide and twelve feet long with a scratching

jamb to keep the cold from coming through the cracks.

The nest boxes and roosts are loose so they may be moved about for cleaning or taken out at any time and put back as needed. It is not intended that any one will find it necessary to go inside this little house. The work is all done through

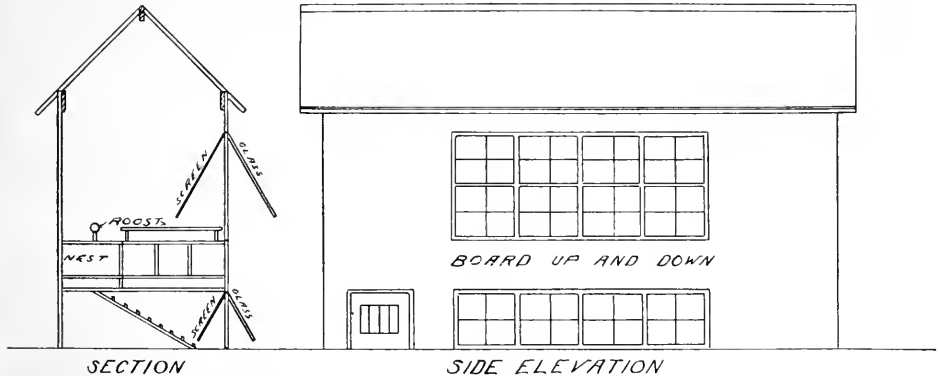

shed the full size on the ground under the floor. This space underneath is two feet high and the windows should extend well across the front side.

A runway for the chickens to get up and down the stairs is made by sawing off one wide floor board and hinging it in such a way as to let one end drop to the ground. When this is raised up it fits the opening in the floor and it should be fitted with

the windows. The inner screens may be rigged with cord and pulleys to hold them up and the outside windows may be held up by braces from the building. To gather the eggs, clean out the house, or for feeding, one of the windows is raised and the screen pulled back with a cord. The chickens may be driven down stairs or upstairs during the operation. The screen may be of wire or canvas, or both. Canvas

is the best because the window can be then left open and the chickens will get plenty of fresh air without a door. On farms

where considerable poultry is kept one of these little houses would be found useful occasionally to keep some breed separate.

Stable for Twenty-Four Cows—A 101

This plan provides stabling complete for twenty-four cows with calf pen, bull pen, two box stalls, a feed room and a wash room. This plan offers the advantage of a wide driveway through the center feed alley which is a great advantage in the summer time when green feed is used for soiling purposes and hauled directly on hay-racks from the fields to the cows in the stable.

There is an advantage in having a bull pen arranged in this manner. The door at the corner opens into the yard for exercise and the pen inside is made of one and one half inch gas pipe pickets placed five inches apart from centers. This gives

about three inches in the clear between the pickets. The object in this is to let the bull see everything that is going on in the stable. It makes a bull much more contented and he is less liable to become cross. A bull needs company just as much as any other animal. A great deal of trouble has come from shutting bulls up in tight pens where they become lonesome and morose. Box stalls are boarded to the ceiling and made as warm and as comfortable as possible.

The width of this stable is thirty-six feet, rather wider than usual but it allows ample room for the driveway in the center and a good passageway behind the cows

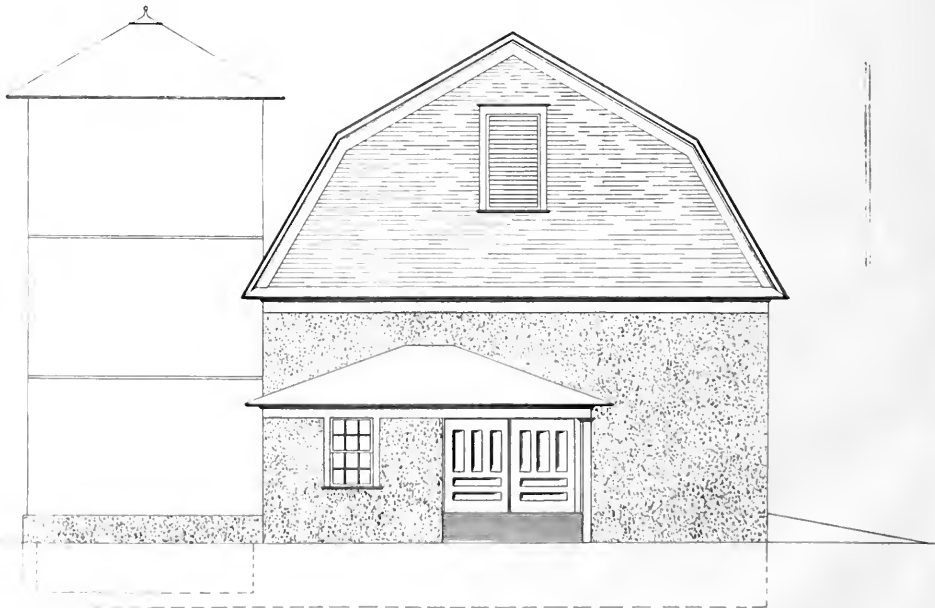

SIDE ELEVATION OF DAIRY BARN

besides giving room enough to place the feed room, box stalls and other pens on opposite sides of the driveway in one end

age with this stable is the number of windows. The windows extend from the ceiling to within three feet of the floor which

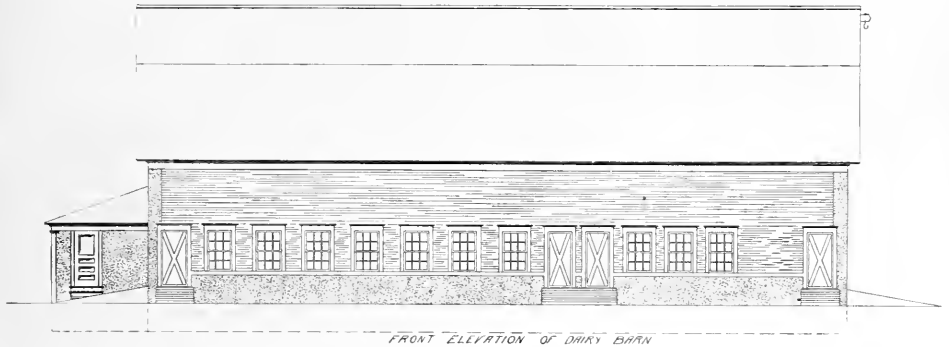

FRONT ELEVATION OF DAIRY BARN

of the stable. The length of the building is eighty-four feet, but of course it could be extended if more room is desired without altering the width or the general plan.

is a great advantage in admitting sunshine. The manger in this stable is placed two inches above the floor. It is two feet wide and six inches deep and the bottom

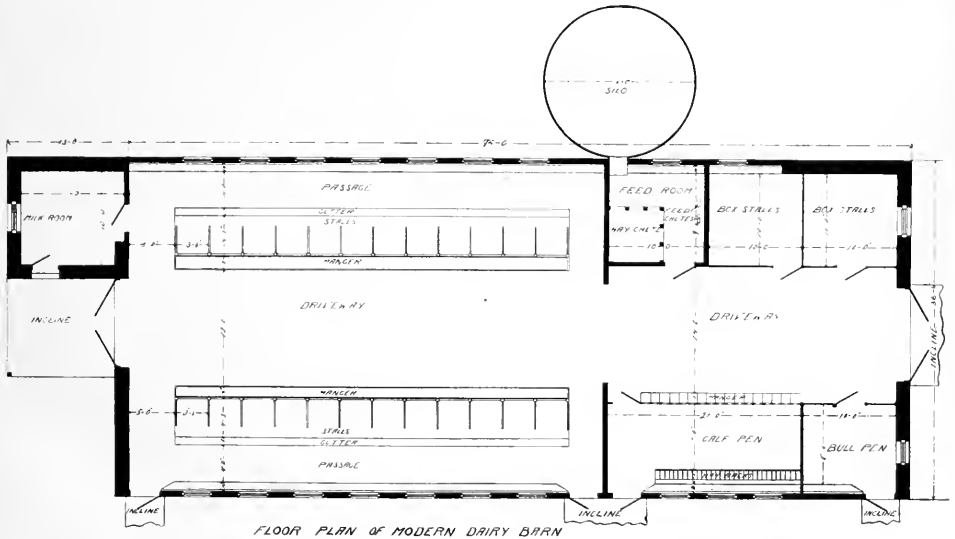

FLOOR PLAN OF MODERN DAIRY BARN

Placing the silo near the middle of the building saves carrying the silage more than fifty feet which is a great saving of steps at feeding time. One great advantage

is slightly rounded. Three feet six inches are allowed for the width of the stalls with a standing floor four feet ten inches. Of course both the length and width of the

stalls should be made to fit the cows. For an extra large Holstein a four foot stall with a five foot length may not be too much but four feet ten inches by three and one half feet is big enough for most cows and it is too much for some. A perfect cow stall has never been invented. If some dairyman wishes to be honored by posterity he should get busy and invent a cow stall that will be thoroughly satisfactory under all circumstances.

The calf pen in this plan meets the views of the best dairymen who have examined it. It is twenty-one by eleven feet with a manger in front for grain feeding and a hay-rack along the back wall. Individual stanchions are provided for use when feeding the calves grain or milk. It would be difficult to devise a better arrangement for calves and we all know that the calves of this year are the cows two years hence and the value of the cow depends on the quality of the calf and the feed and care given it.

A silo for twenty-eight sows should hold about one hundred and thirty tons. This amount will rather more than feed the cows during the winter but it is a good plan to have a little silage left over to help out the green feed in summer time. A silo

sixteen feet in diameter and thirty-two feet high is very satisfactory.

The milk room is not exactly separate but it is built on the front and there are two spring doors to shut out the odors of the stable. This building provides for storage over the stable with a feed chute in one corner of the feed room. There is a large door between this feed room and the alley for the purpose of preventing dust from flying out into the stable. This feed chute is large enough so that hay, straw or any roughage may be dropped into it from above in sufficient quantity at one time. The door may then be opened and the stuff forked out. There is also a small door opening from the chute into the feed room. This is for the purpose of mixing together feed with chopped stuff in case the owner puts a cutting box over head.

Because of the storage room above, the upper floor is made double thickness with two thicknesses of paper between, matched flooring is used and the first course nailed to the joists in the usual way, only that the dressed side is placed down. The two thicknesses of paper are then put on and the other floor laid over it and nailed over the joists, the workmen being guided by chalk lines on the paper.

An Implement Shed—A148

An implement shed sixteen feet wide by forty-eight feet long is given in plan (A148). This shed really is built in sixteen foot sections and may be carried to any length, but this size will hold the implements and machinery on an ordinary farm and leave room at one end for a work bench and repair shop.

The front is all doors so that any part of the shed may be opened and any implement removed without the work of getting it past some of the others. We have all

had experience in crowded quarters for farm machinery. We have been obliged to call all the male men together and occasionally invite the women to help get a grain drill out from behind harrows, plows, cultivators and other machinery. One reason why farm machinery is neglected is because farmers have no place to keep it. It is not repaired when it should be for the same reason. It is quite a job to do a simple piece of repair work if you haven't the tools or the room in which to

do it, but anybody can clean up machinery and oil or paint it if they have a comfortable place to work and the tools to work with.

The front part of this shed is built high-

feet high and the cross girts are the same height because it is sometimes necessary to move the machines lengthwise of the shed and the same head room is then needed. A truss is formed at each bent with

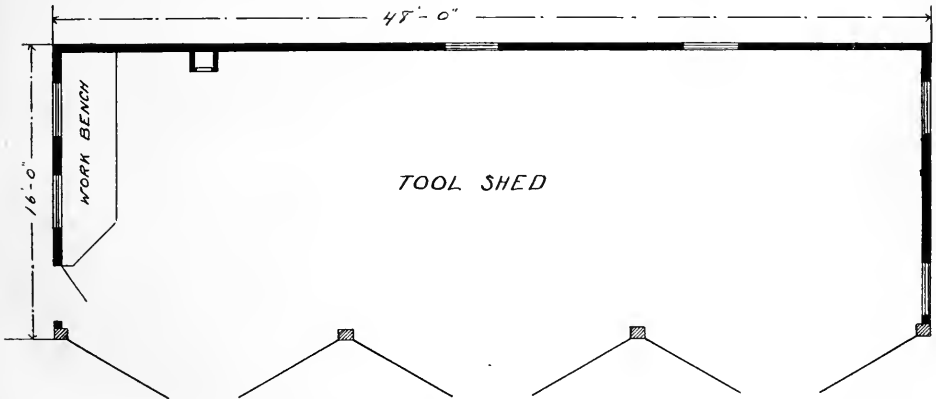
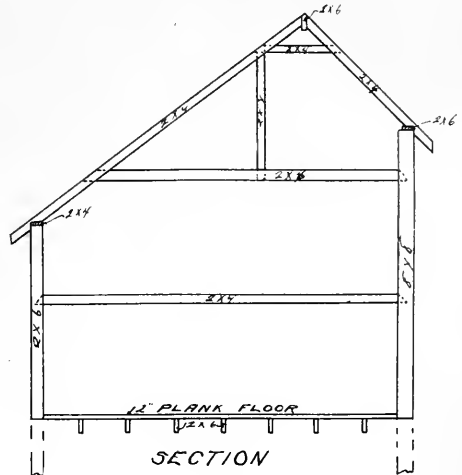
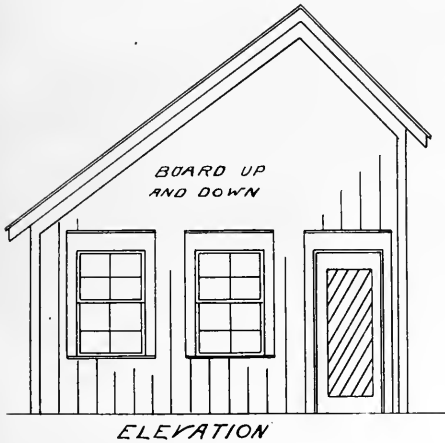

er than the back part in order to leave head room. If you want to get in with a binder with the reel on, or to house a threshing machine or traction engine you need about ten feet to the top of the doors, but you don't need so much height to the back end. The doors in this plan are ten

feet high and the cross girts are the same height because it is sometimes necessary to move the machines lengthwise of the shed and the same head room is then needed. A truss is formed at each bent with

the rafters to prevent the building from spreading. The two by four nailers shown in the detail drawing is intended for the end bents only. In the end of the shed most convenient a good solid bench should be rigged up and fitted with a good vise. At the back

of this bench there should be a long low window similar to those used in blacksmith shops all over the country. The bench should be heavy, solid and at least

three feet wide. There should be a good floor especially in the bench end of the building and it is a good plan to put up a chimney and have a stove there.

A Cyclone Barn—A 126

A style of barn that has been built extensively in the west is shown in this plan. The structure is made of light timbers, but they are thoroughly braced in every direction. So solid is the frame that one half of the barn may be built and the other side added as time will permit. The frame work of each side is built on the truss plan.

The roof in the center is built on the cantilever principle. Even the roof projections at the sides are built more to strengthen the structure than to add space to the mow room.

This is a kind of barn that farmers want who farm about one hundred and sixty acres of land and keep a variety of stock.

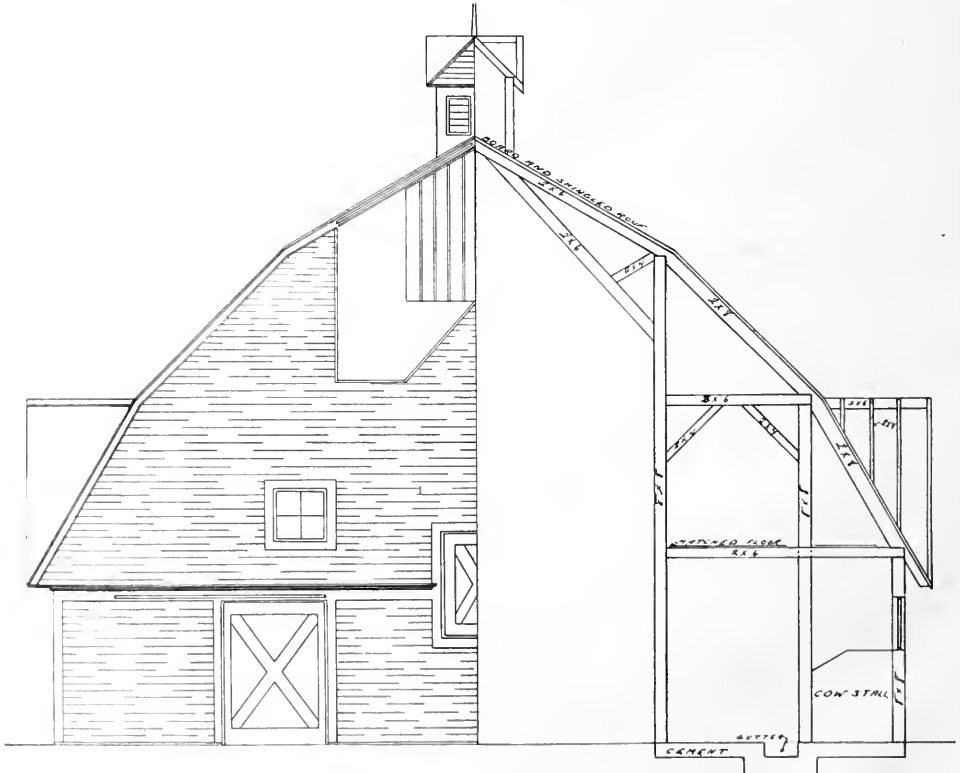

ELEVATION

SECTION

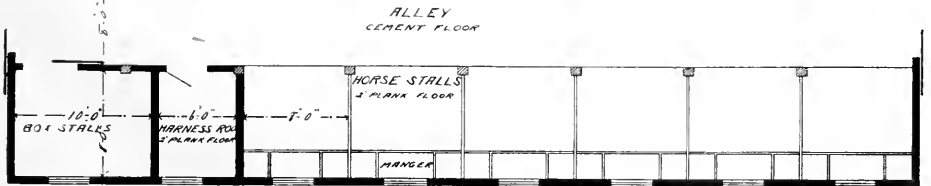
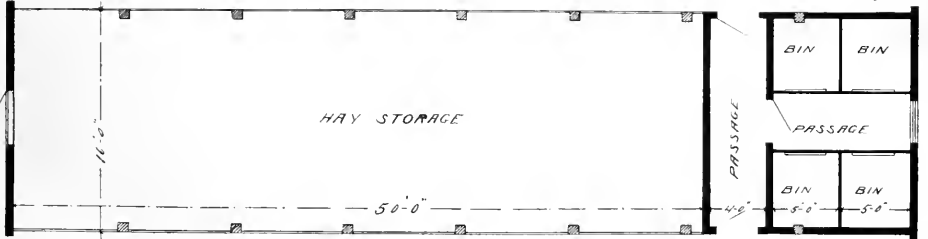
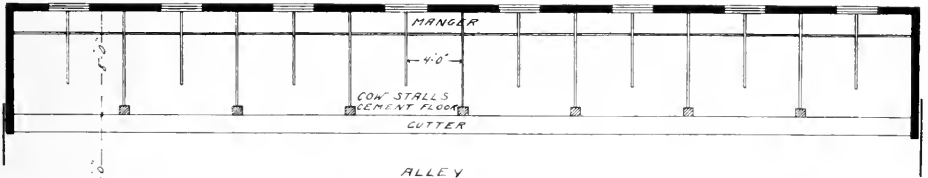
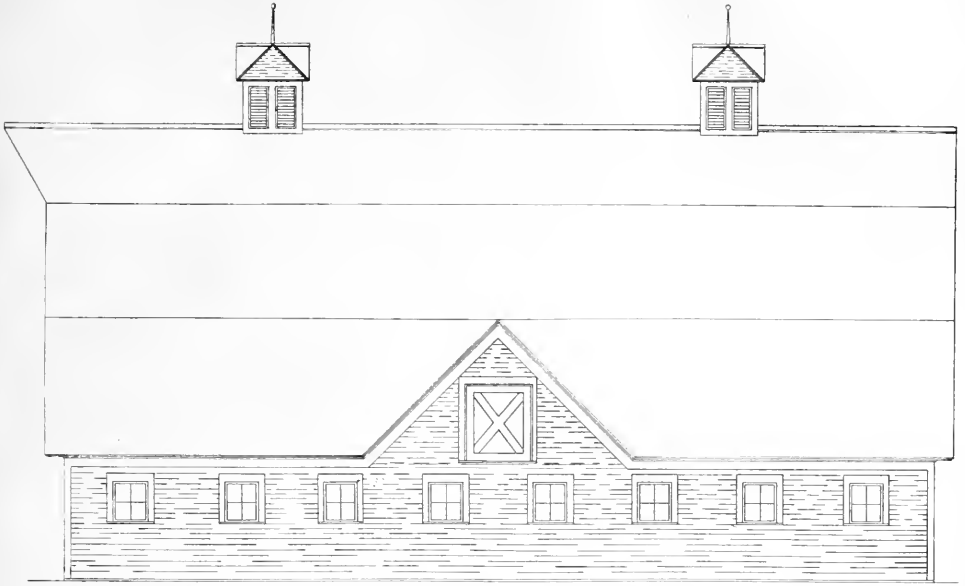

Everything necessary in a barn may be enclosed under one roof by following this plan. The cows are on one side and the horses on the other with hay storage in the center and a feed room convenient to both while it is easily shut off from either.

In making the cement floors it is better to make a solid floor including the alley and reaching to the outer walls on each side. This is really necessary on the cow stable side to have it right. It is better on the horse side, then lay a plank floor over the cement in the horse stalls.

This style of barn offers room for a great deal of storage and a convenient way to get rough stuff in. It is not so convenient to do threshing in a barn like this as some others but the barn is not intended to answer every purpose. It would be difficult to make one building just exactly right for everything. There are enough advantages in this building to satisfy most farmers. It is cheap considering the amount of room enclosed, and it is especially convenient in the arrangement for the winter.

Dairy Barn with Storage—A 136

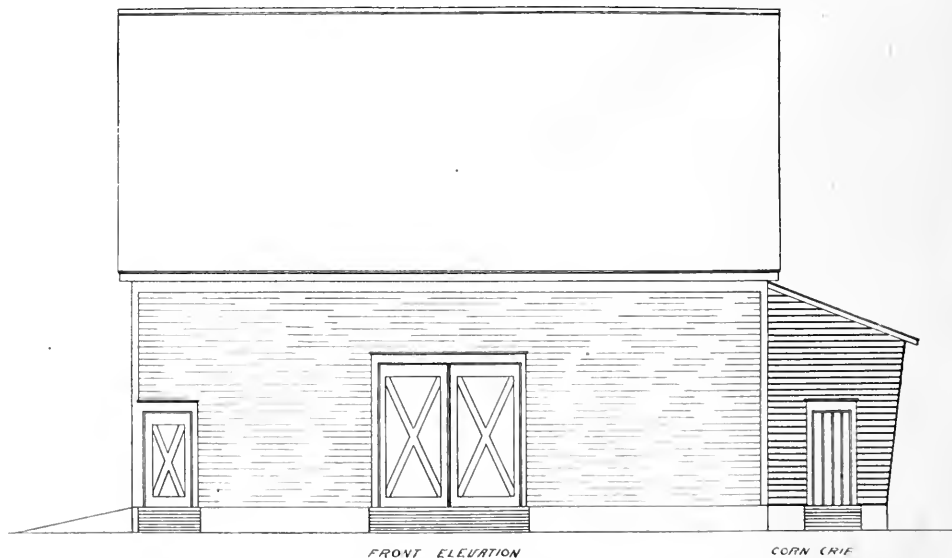

A great many dairymen object to having storage of any kind over a cow stable. There is more or less dust from the mows, and the dust is objectionable for several reasons. But it is impossible to keep cows profitably unless the rough feed and straw may be reached easily. Labor is so expen-

sive that even the steps necessary while feeding must be counted and reckoned in the cost. If there is no storage over the cows there must be storage near by. The silo in this plan is placed at the side about midway along the length of the stable for easy feeding. This position also makes

it easy to get the green cut stalks into the silo at filling time.

Not much corn is fed to dairy cows, but

very handy in the summer time if green feed is fed to the cows in the stable.

In the storage barn the hay mow



SIDE ELEVATION

the crib is not far away from either cows or horses. A dairy room ten by seventeen feet is built in the corner next to the stor-

reaches from the ground to the roof. For comfort in cold weather it is better to board up the side of this mow to the floor

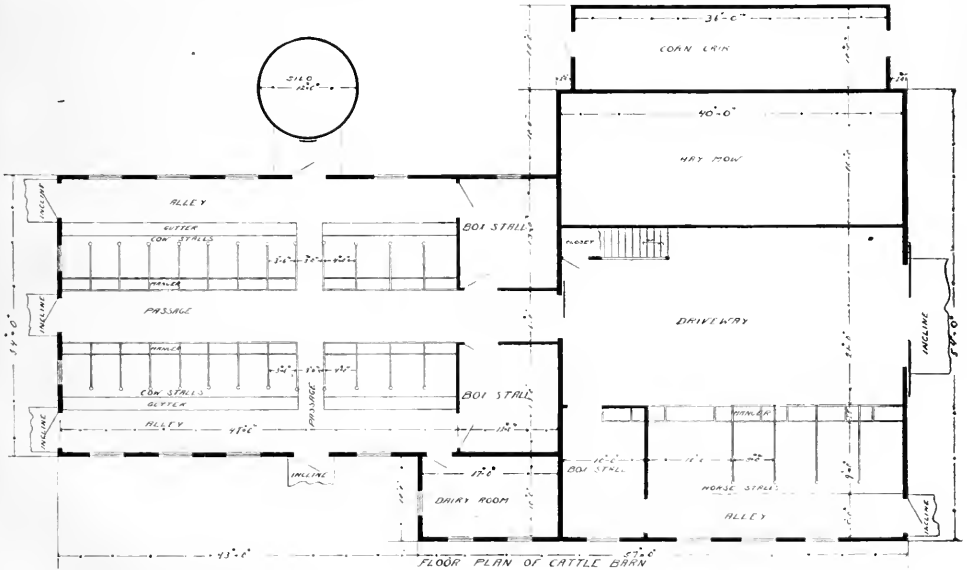

FLOOR PLAN OF CATTLE BARN

age barn easily accessible to the stable. It would not be necessary to have a door at the outer end of the feed alley, but it is

over the driveway. It is necessary to have an opening through the floor over the driveway to use a hay fork. The opening

may be boarded around and used as a chute to pitch hay down through for feeding, but such details must depend to a

great extent upon the kind of farming carried on and the other buildings on the farm.

Hog House and Corn Crib—A140

Hogs and corn may both be kept in the same house economically by building a house like the one shown in plan (A140). The building is set up from the ground about a foot on posts and pens are made in the usual way with an alley between.

each way from the center. There is about seven feet head room in the middle over the alley and the floor slopes to about five feet to the sides of the building. This is for two reasons, to get the corn down as low as possible and to divide it into two parts to prevent moulding. It is also nec-

The floor above to hold the corn slants

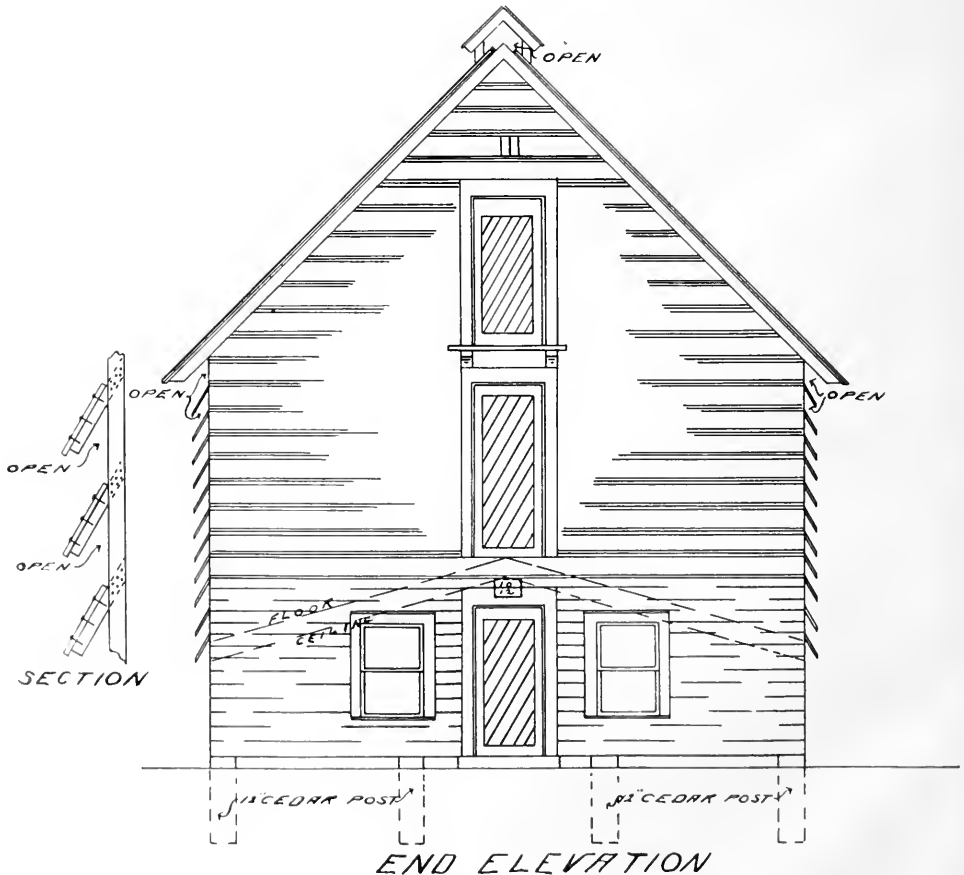

essary to put a slatted partition on both sides of the floor ridge if the house is filled full of corn. There are two windows in each end and the hog doors are hung with

Because of the shape of the corn floor it is necessary to support it well in the center which is done by running the alley partitions up to the floor joists above. This

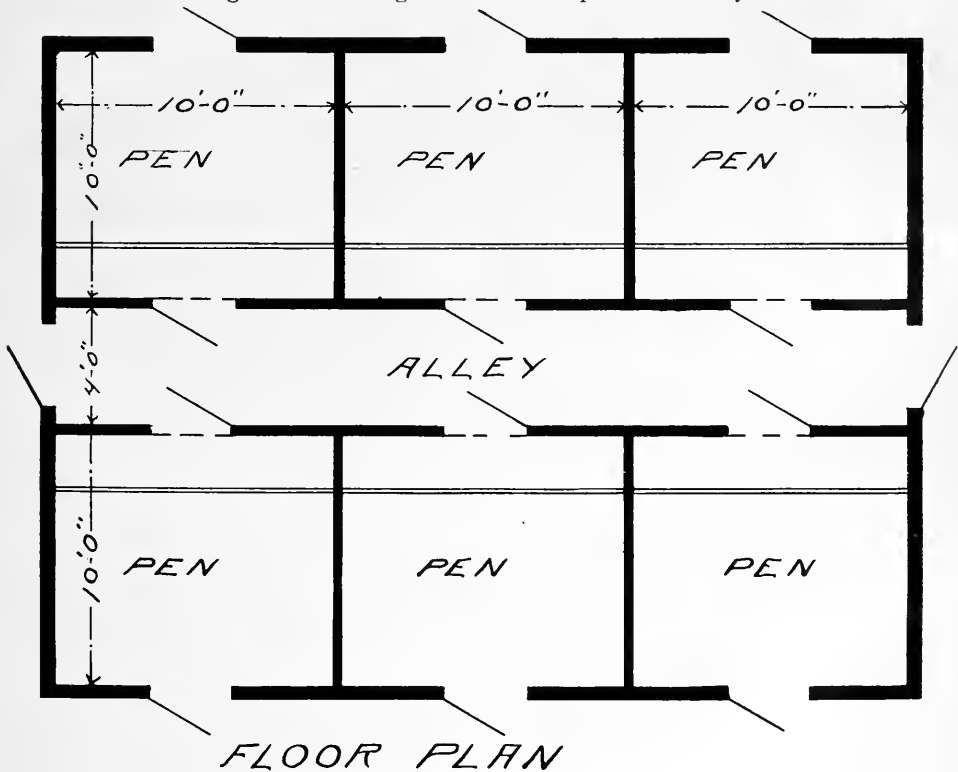

pins so they swing either way and the hogs open them going or coming. A pin at the bottom outside holds the door shut when it is desirable to keep the hogs confined

is very important because the weight of the corn will shove the sides of the building out if the floor is permitted to settle, an accident which frequently occurs.

A Small Double Poultry House—A151

A poultry house with an open scratching shed is shown in plan (A151). The house is thirty-four feet long by twelve in width. Poultry men differ about the width of a house constructed in this manner. Some prefer twelve feet because it is easier to get the sunlight clear to the back, as these

houses should always front the south. On the other hand men with considerable experience prefer houses sixteen or even twenty feet in width because they can house more fowls for practically the same amount of money.

There are many ways of building an

open scratching shed and poultry house, but this plan seems to contain about everything that is necessary. The door opening into the hen-house is just a frame covered with cotton which admits both light

poultry men more than anything else. Why a poultry house should gather dampness and have white frost on the inside when all the stables on the farm are comparatively dry has bothered more men

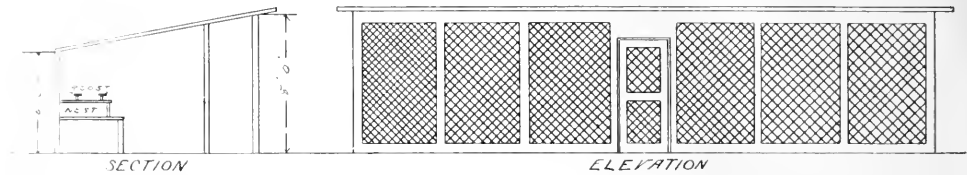

and air to the roosts and nest boxes. The outside wire netting may be covered with cotton or not according to the climate and the ideas of the owner.

than anything else in the poultry line. It is easier to build a satisfactory stable for any other domestic animal than it is for chickens unless we are satisfied with what is commonly termed a curtain front house. The phrase curtain front simply means that some of the openings are covered with thin cotton instead of glass. It seems to have solved the problem of how to make a chicken house light, airy and dry, but not all curtain front houses work alike. A great deal depends on the head room. A few hens have not body warmth enough to heat a great deal of space. You cannot have good ventilation without heat. The solution seems to be to build a comparatively small house with a low roof. Some poultry men build their curtain front houses as low as two feet at the back and only about six or seven feet high in the front.

The roofing is tarred paper and it starts

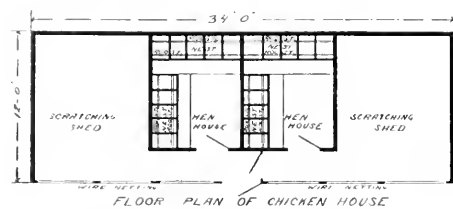

at the highest point in front, turns over the upper corner at the back and goes clear down to the ground. This makes a thoroughly wind proof and damp proof house.

It is a peculiar thing about the dampness in poultry houses. It is a comparatively simple question that has bothered

A Cement Block Smoke House—A 147

Every farm should have a smoke house, the better the house the more satisfactory will be the meat. The plans shown of (A147) is for a house constructed of cement blocks. It should be placed conveniently near the house on a raise of ground and a foundation started below the frost line. A trench should be dug, say $3\frac{1}{2}$ feet deep partly filled with concrete made of one part of Portland cement, two and one-half parts sand and five parts of broken

stone or gravel, ramming or puddling carefully. If plenty sand may be conveniently had, it would be a good plan to secure a block machine and have the blocks made on the ground. In making the concrete blocks, use a mixture of one part Portland cement, two and one-half parts sand and five parts of crushed stone or gravel. The use of crushed stone or coarse material for the back of the block saves a great deal of cement and at the

same time gives a much better block than where sand and cement alone are used. Blocks made of sand and cement alone and merely dampened are not concrete blocks, but on the contrary are simply sand

maple wood. Probably clean corn cobs come next. With a smoke house thoroughly well built to keep out flies and other insects the meat may be smoked in the spring and left in the smoke house all summer. By way of precaution a very little smoke may be started once or twice a month or some of the meat may be covered with paper and cloth. Very much depends on the house. If the house is too dry there will be too much evaporation and the meat will become dry; if the house is too damp it will be inclined to mould. If it is intended to keep the meat in the house after the smoking process is completed it will be necessary to fit the door very carefully. The frame must have a couple of ridges all around and cement worked in tight between these ridges to make tight joints. The ventilator on top must be fitted with a fine screen. Two screens would be better. A coarse galvanized screen on top and a fine screen inside at the bottom.

The plates and rafters must be laid in fresh cement mortar on top of the wall.



ELEVATION

blocks. The very term of concrete suggests coarse material and plenty of water. Great care should be taken in mixing the different aggregates and they should be mixed thoroughly dry and after they have been thoroughly mixed add water. After the blocks have been made they should be set aside to be cured, and while curing, they should be sprayed thoroughly from seven to ten days. This spraying should commence about twelve hours after the block has been made. Blocks should never be used in building until they are from twenty to thirty days old.

Farm cured meats are a great luxury if the hogs are properly grown on pasture. With a house like this and good pork to start with, a farmer can supply his table with good home-made bacon, hams and shoulders the year round.

The best smoke is made from green

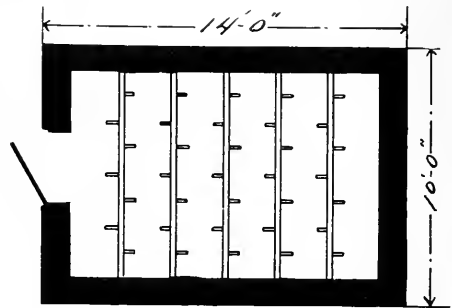

FLOOR PLAN

All spaces between rafters are filled in so as to prevent cracks or openings of any kind. Cross poles to support the meat are made of four by fours with half inch pegs inserted from the sides. The pegs are set at an angle of about thirty degrees. This

will permit hanging the pieces of meat in the old fashioned way of cutting a slit in the skin in the bone end. If strings are

preferred the same kind of peg may be used. Nails are not to be recommended for this purpose.

A Large Storage Barn—A139

A barn thirty-eight by fifty feet with stables underneath and a great deal of storage room above is shown in plan (A139). The

barn should face the South with higher ground at the north from which to build an incline to drive onto the first floor.

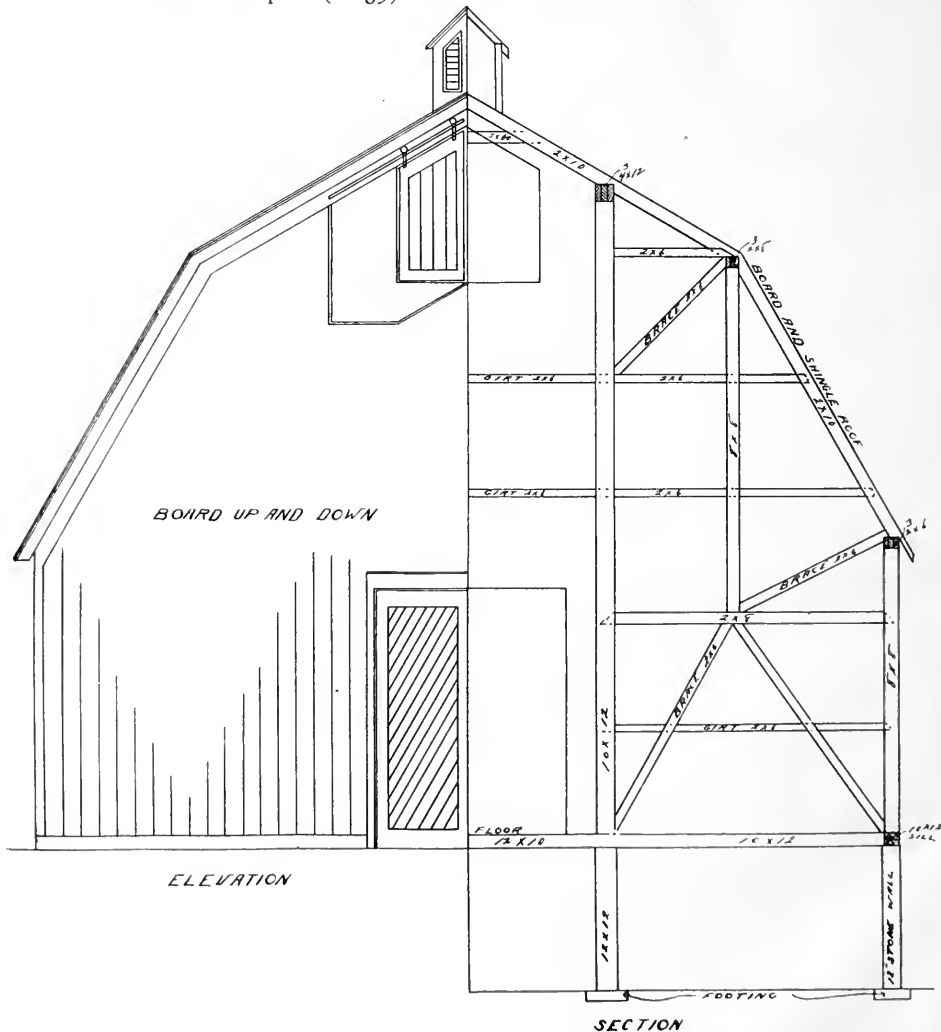

From this incline hay and grain is carried to the peak with a horse fork and distributed to the different mows.

A very strong frame is shown in this plan that is well braced from the different

bins connected with spouts from the granary on the threshing floor above. There is a good deal of storage room in this barn and it is an easy barn to do the work in. The hay from the hay chute drops on the

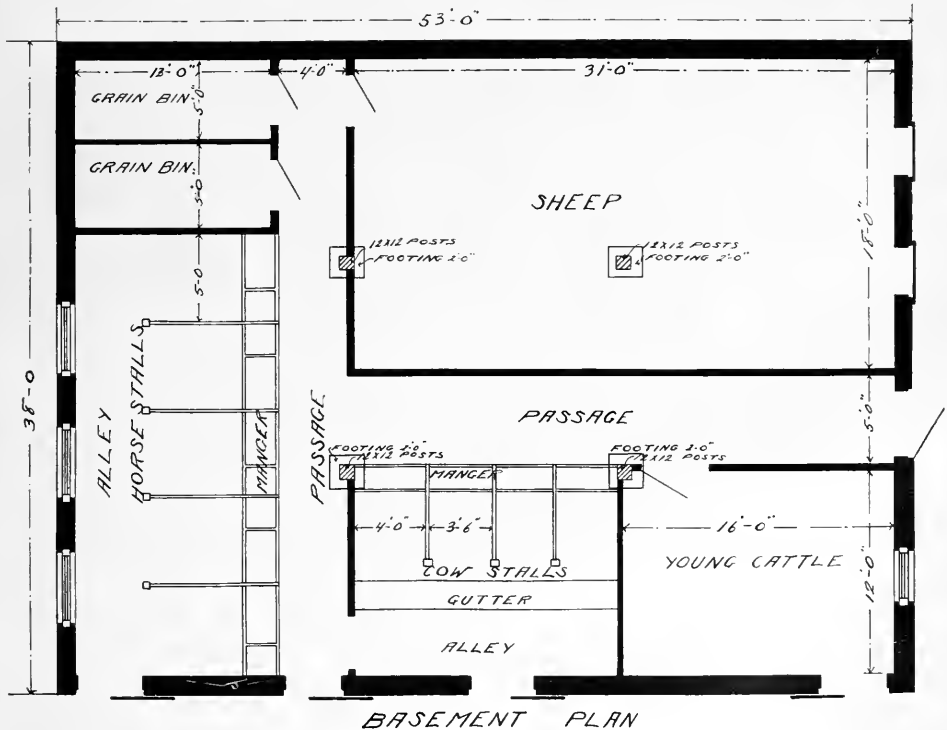

directions. It is intended to board up and down because this is a little cheaper than siding and it is quicker put on. When the stables are underneath and there is no necessity for a warmer construction up above the boarding up and down is about as good as anything.

The arrangement of the barn is intended for farms where not many cows are stabled. There is provision for horses, sheep and a few young cattle and there are grain

feed room floor and the chute may be carried as high as necessary through the mow above. The size of the barn is thirty-eight feet by fifty feet on the ground, but its principal size is in its height and shape of the roof. This is a frame construction that is especially well calculated to facilitate the use of a horse fork because it leaves a clear space through the center from one gable to the other. The diagonal braces tie the frame work together from every di-

rection so each side of the roof is an independent truss so thoroughly well constructed that one half of the barn would

This is a barn that would accommodate the stock kept on a small farm and house the crop under the same roof so conveni-



FIRST FLOOR PLAN

stand alone. The manner in which the timbers are put together is a study in truss work.

ently that one man could do all the chores, repair farm machinery, prepare his seed for spring and have a little leisure time.

A Small Chicken House—A119

A very neat little chicken house is shown in plan (A119). In size it is only 7x16 feet but it makes comfortable quarters for 15 or 20 hens. It is set on posts a foot or two from the ground to be out of the way of rats.

The floor is made warm by having it double boarded with a thickness of build-

ing paper between. The large windows of course face the south and the dust boxes are placed immediately in front of them because that is the way biddy likes to take a dust bath. She wants it directly in the sunlight if possible.

It is not necessary or desirable to go into a little house like this very often. It is

so small that the presence of an attendant frightens the hens and causes a disagreeable commotion. By proper management, however, they can usually be let out into

rear. The nest box cover, which also is the dropping board, is loose and may be easily taken out through the door for cleaning. The roosts also are loose and

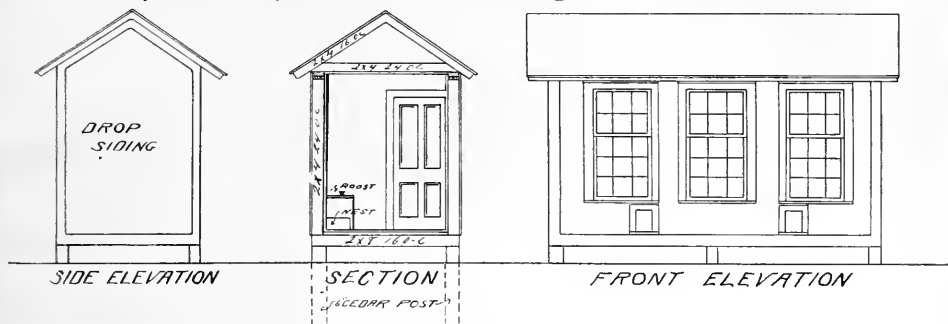

the yard when the presence of an attendant in the house becomes necessary. The

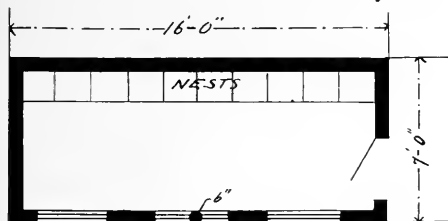

roosts are placed over the nest boxes and the entrance to the nest boxes is in the

may be removed easily.

This is just the kind of a house to start a boy in the poultry business. Boys take more interest in a small poultry house than they do in a house full size.

A little house like this is helped out very much by having a good yard in which considerable green stuff may be grown for the fowls to pick at. By planting a little grain and a variety of vegetables, the poultry will pick up a good deal of feed and the fowls will be more healthy because of it.

A Small Barn for Horses—A 156

This plan is a very neat arrangement for a city or village lot where two horses are kept together with the necessary carriages and harness equipment. The carriage room with rack for washing buggies is about as well arranged as it could be and the harness room being under the stairway occupies as little space as possible. Another nice arrangement about this barn is the location of the manure door. The stalls may be cleaned and the manure thrown out at the back as far away as possible from the carriage entrance and from the side entrance to the man's room.



Where horses are kept in town there is usually a lawn that requires attention and

more or less garden work to look after. For this reason it is often necessary to keep a man and it is desirable to have a room that he can occupy outside of the house. It is a good thing to have a man sleeping in the stable where valuable horses are kept so this arrangement works first rate for several reasons. It is hard to

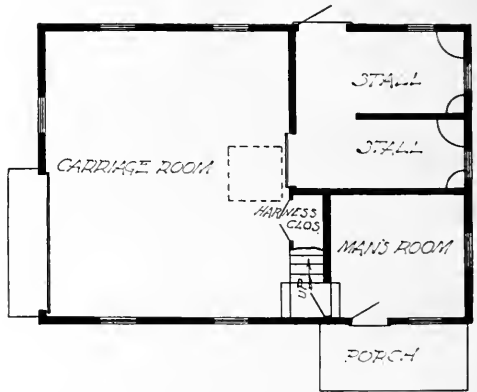
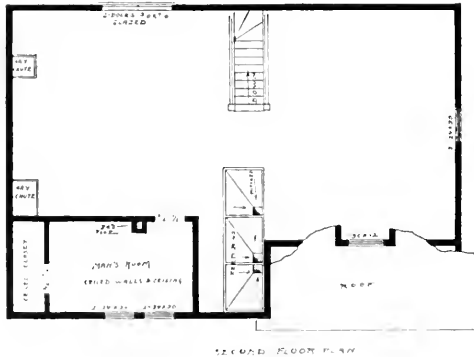
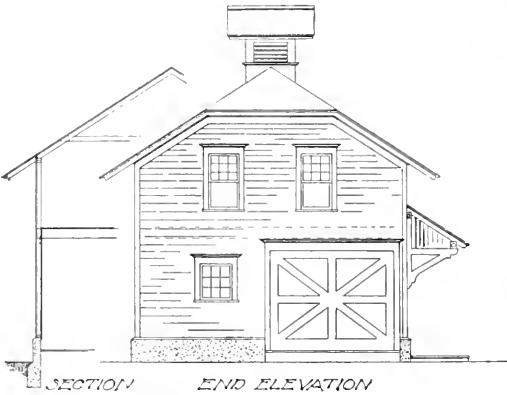

keep good men even in town unless they have comfortable accommodations. This building is thoroughly well constructed and the room arranged for the man is more comfortable than similar rooms in some houses.

A Small Stable—A124

A small cheap horse stable is shown in plan (A124). It sometimes happens that a separate stable for horses is necessary because of the manner in which the other buildings are constructed and occupied. This little stable will accommodate eight horses and there is room enough overhead to hold the straw for bedding, but it would be necessary to provide the feed from some near-by storage. It is not necessary to put a floor in this stable unless it be on the side where the open stalls are built.

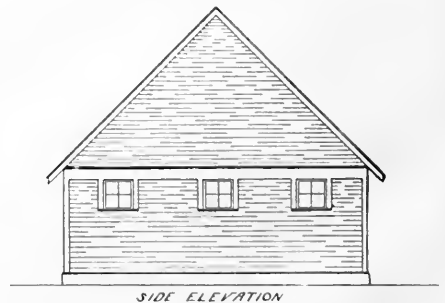

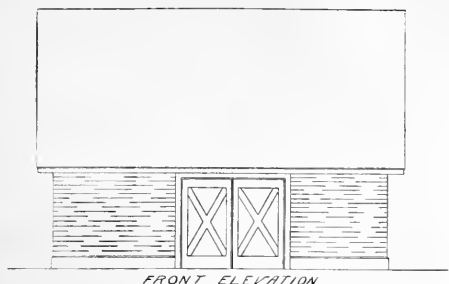

But a good many horse stalls have stiff clay pounded in and there are plenty of horse men who prefer such stable bottoms. They are all right if kept in good condition. As the material costs little or nothing a man can afford to put a little work on repairs occasionally.

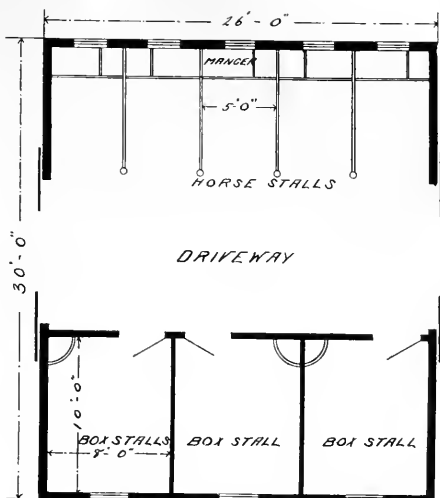

A Yankee Barn—A134

A style of barn that is often seen in New England is given in plan (A134). The horses and cows occupy part of the first floor, leaving a space in one corner that makes a convenient storage for farm tools. There is a driveway through this part of the barn and the door is large enough to get in with a hay-rack or a grain drill.

The upper part of the barn is used almost altogether for hay storage, the hay being lifted from the driveway by a horse-fork. It makes the stable much warmer to run the partitions in front of the cows and horses to the ceiling above. Unfortunately, too many farmers are careless about such things and their animals often suffer in large draughty stalls.

This barn is thirty-six feet wide by sixty feet long, not very large on the ground for a farm barn, but the shape of the roof helps out very much in the storage.

It is floored over with the exception of an opening over the driveway and as this

floor is only nine feet above the ground it leaves a very large loft.

There are a good many Yankee barns



without so many windows, but the windows are a great advantage. It is much easier and more pleasant to do work in a light barn and the animals do better. It is difficult to account for so many dark



SIDE ELEVATION

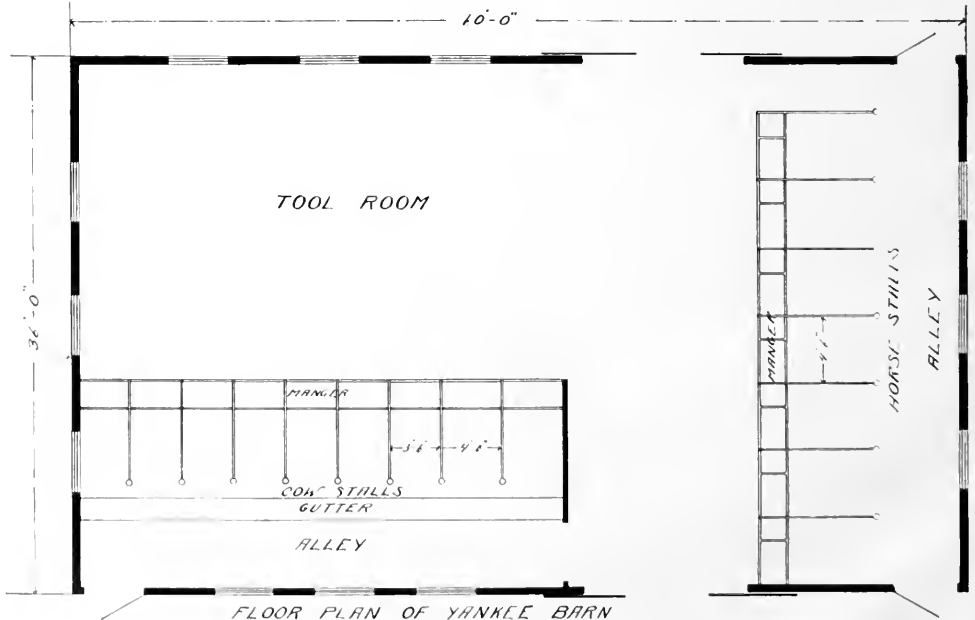

FLOOR PLAN OF YANKEE BARN

barns, except that the fashion was established when the country was new and window lights were a great deal more expensive than they are now. Glass and sash are just about as cheap as siding, there is no economy in building dark barns.

A Combined Barn and Covered Barnyard—A102

A great many dairymen like to have a covered barnyard for the cows to exercise in and some go so far as to keep the cows in this covered barnyard both night and

The plan, (A102), is designed for a bank sloping to the south. There is a good root cellar in the bank next to the building on the north side and the large roof surface is

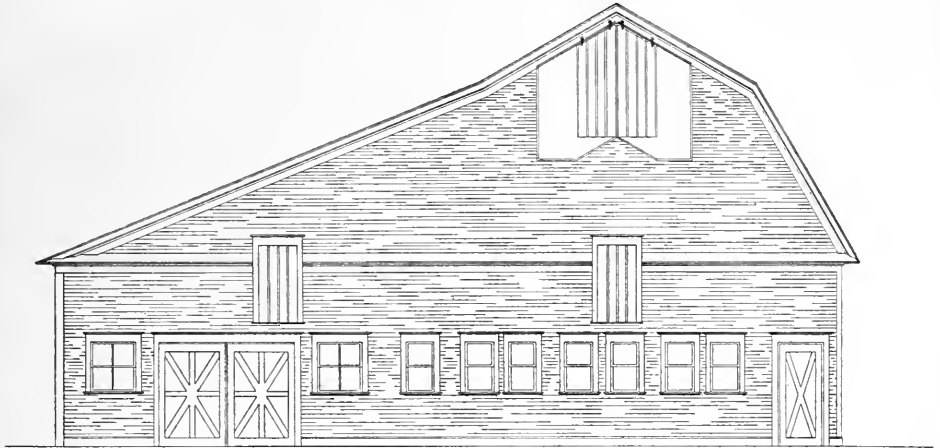

SIDE ELEVATION OF BARN AND YARD

day, just stabling them long enough to milk and feed grain and silage. In some parts of the country the covered barnyard is growing in favor.

utilized to furnish water for the cistern. A cistern filter is placed inside the building so it won't freeze. To have nice cistern water it is best to run it through a filter.

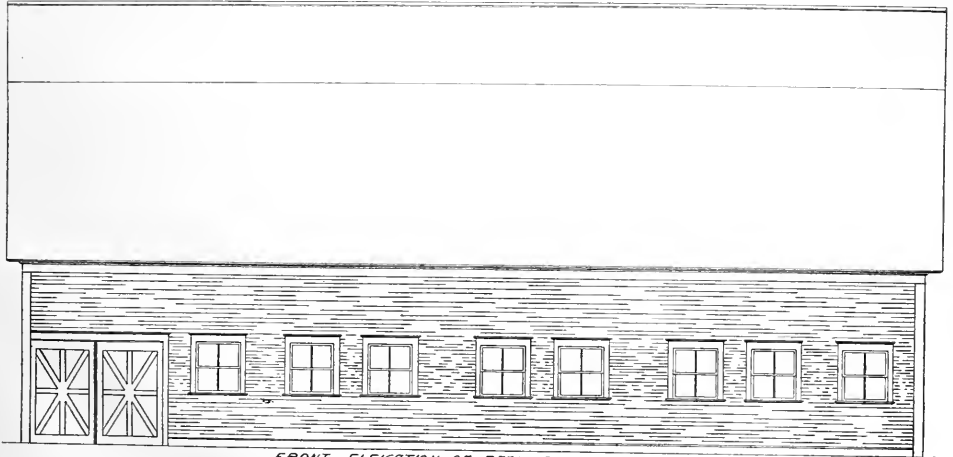

FRONT ELEVATION OF BARN AND YARD

The feed racks in the covered barnyard are made movable to facilitate driving through at cleaning time. Mild days in winter the manure spreader is brought in

to them with as little work as possible. With a cistern and a windmill the water tank is kept supplied all the time so the cows may run to it when they want to. The

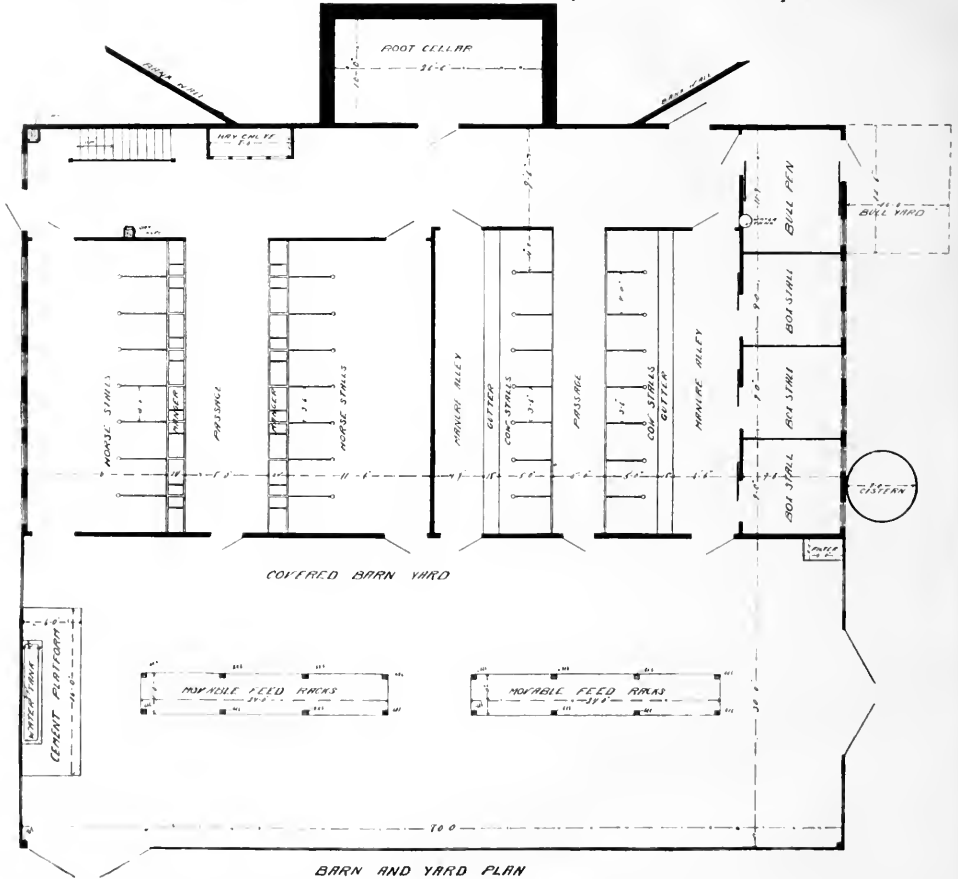

BARN AND YARD PLAN

at one door, loaded and taken out at the other. The racks are placed in the center under the feed shoots so the roughage from the storage above may be dropped in-

stable floor should be about two feet higher than the floor in the covered barnyard. This gives an eight foot ceiling for the stable and a ten foot ceiling in the yard.

A Single Corn Crib—A106

Sometimes a single corn crib is preferable to a double one. The corn keeps better in a single crib because the air circu-

lates all around. Sometimes corn will mould in the center, even in a good crib that is properly constructed and not too

wide. Sometimes farmers bore the floor full of holes to help the ventilation but this lets

ered over, and it is doubtful if they help very much. A better plan is to have the sides carefully constructed and to have the

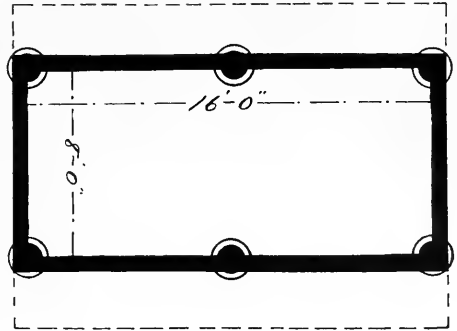
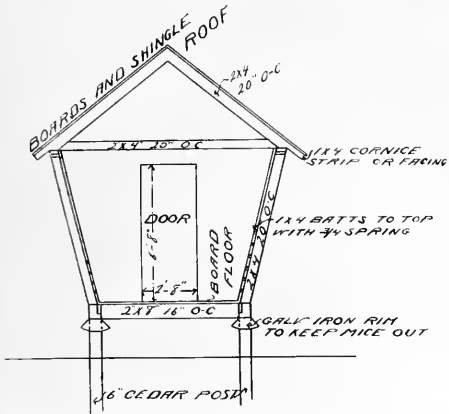

the shelled corn through and as dirt settles to the bottom the holes get easily cov-

corn in a good condition when it is put in crib. A crib built after this plan may be any length but the posts should be not more than eight feet apart.

A Horse Shed—A 121

On farms where a number of brood mares are kept and colts of all ages coming along, it is much better to have a separate shed for winter feeding for the colts than to let them run at large among the cattle. One colt might not do much damage in the general barnyard, but colts are mischievous and one teaches another.

A light shed may be built on this plan, which is fifteen by thirty-four feet, at very

little expense. It should front on the stack yard and face the south if possible. For economy it is placed on cedar posts let in the ground below frost, but it should be thoroughly banked up in the fall to keep out the cold winds. In banking up a shed like this set a board all around the outside to keep the earth away from the building proper. Fit the board nicely so there are no chinks to let in the cold draft.

HORSE SHED

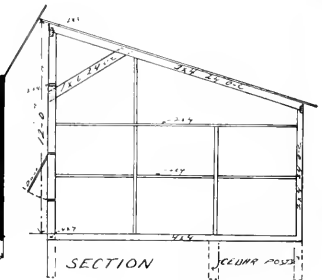
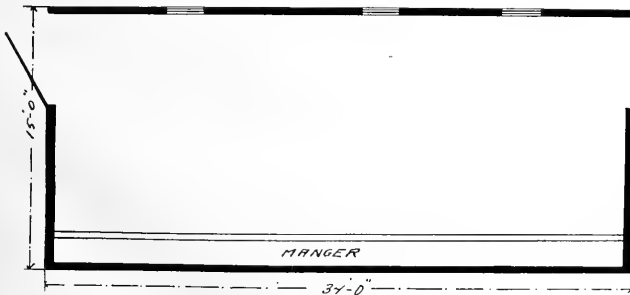

A Model Cow Barn—A158

The size of this cow stable is thirty-eight feet six by one hundred and forty-two feet and it has a capacity for housing fifty-two cows. It was designed very carefully to provide every comfort for a herd of thoroughbred Guerneys.

The mangers are also connected with the sewer so that the cows may be watered in the manger and the surplus water immediately drawn off.

A space of two feet high between the studding of the outer walls is filled in with

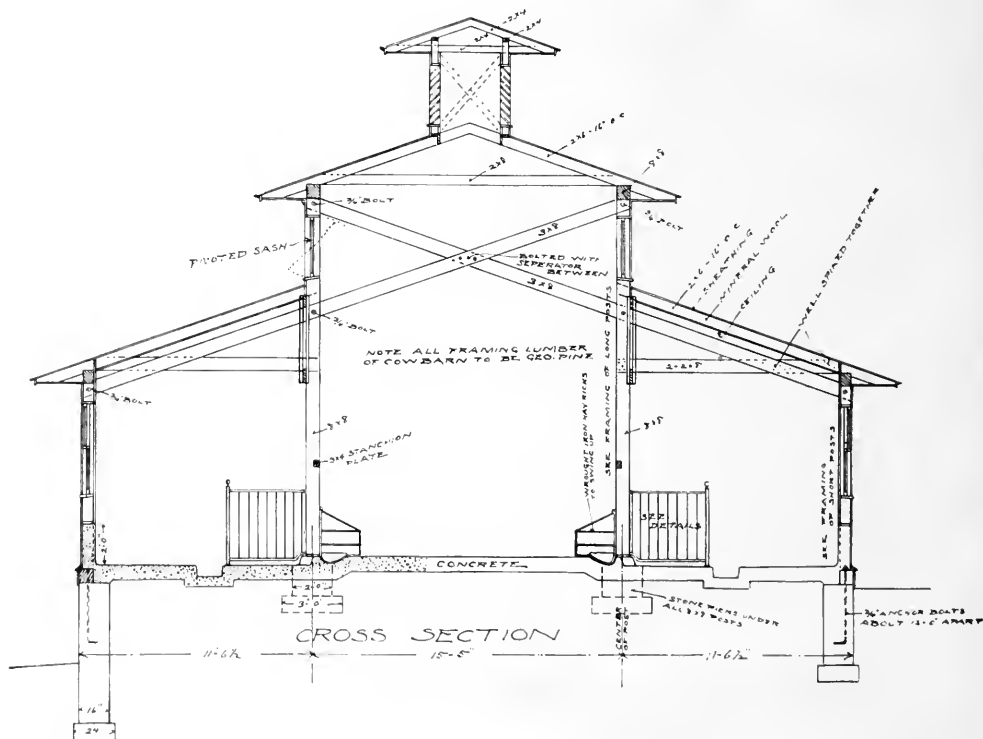

The entire floor is made of concrete, including manger and manure drains which carry the liquid manure back to the manure pits. They are also connected with the sewer drain so that the wash water from flooding the floors can be carried away to a safe distance.

concrete and troweled smooth with a curve at the floor line to leave no chance for the collection of filth to favor the breeding of disease germs. Gas piping is used for stalls set firmly in the cement. Each stall is finished with individual wrought iron hay racks made to swing up.

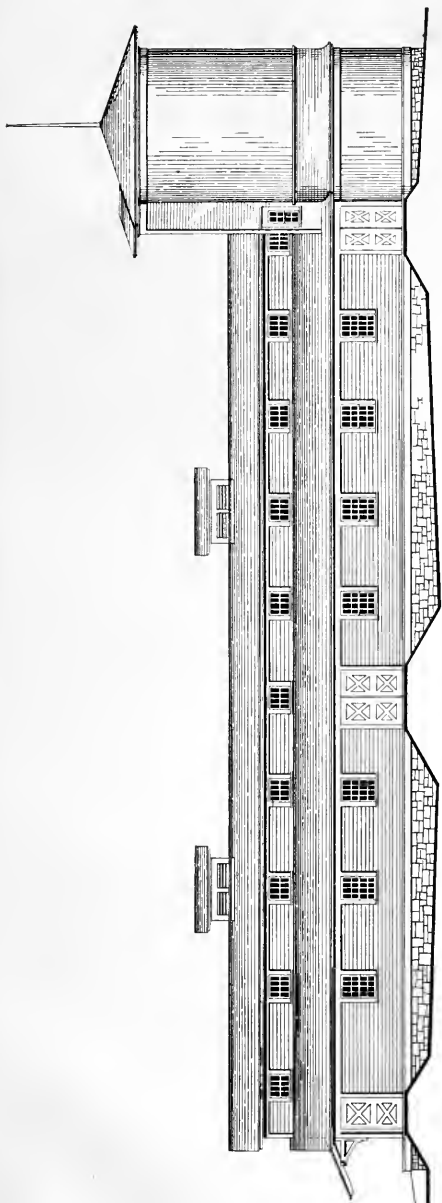

SIDE ELEVATION

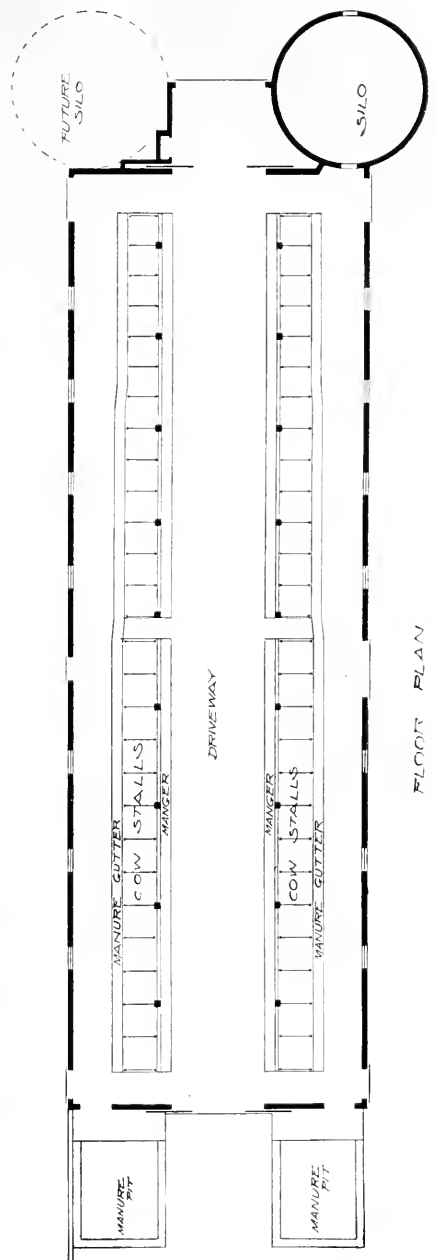

FLOOR PLAN

There is a cement top to the concrete floors which is finished rough enough to prevent slipping and to hold the bedding. Cows in this stable face towards the cen-

ter and the center aisle is wide enough to drive through with a wagon and hay-rack for hauling loose hay and fodder. The silos are located at the end, the silage be-

ing loaded into cars and wheeled through the feed alley to the mangers. Light and ventilation were main features in the construction of this stable.

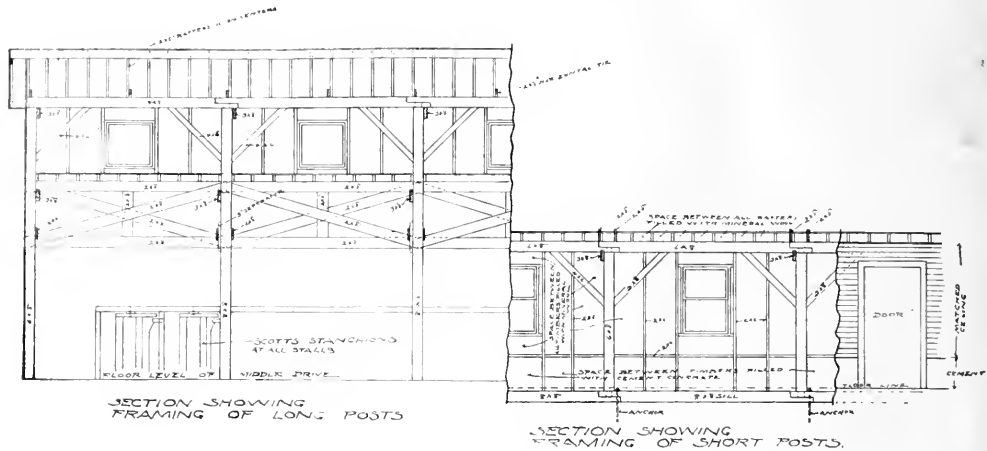

ter and the center aisle is wide enough to drive through with a wagon and hay-rack for hauling loose hay and fodder. The silos are located at the end, the silage be-

Careful calculations were made to secure plenty of fresh air for each animal as the sanitary conditions with such a valuable herd of animals is an important feature.

A Cow Barn for Forty Cows—A159

A cow barn for the accommodation of forty cows having a feed alley of sufficient width to accommodate a wagon with a load of soiling feeds is shown in this plan. This is the quickest and cheapest way of distributing feeds to the mangers along both sides of the feed alley.

The mangers as well as the whole floor surface are built of concrete with the mangers elevated only three inches above the floor level. As cows naturally feed from the ground it is only right that the mangers should be very low down. The side of the manger nearest the cow is made almost perpendicular to prevent feed from working over amongst the bedding. But

the feed alley floor is elevated and that side of the manger is rounded up to it which makes it easy to keep the feed in the mangers and easy to kick it back when the cows shove it out, as they do while feeding.

A water faucet is placed at each end of the mangers for the purpose of watering the cows. For disposing of the water left in the manger a drain in the center with an overflow is provided. The middle posts extend from the back of the mangers and run to the roof and these are spaced to allow three stanchions between the posts.

A gutter sixteen inches wide and from five to eight inches deep is run diagonally

SECTION THROUGH WALL

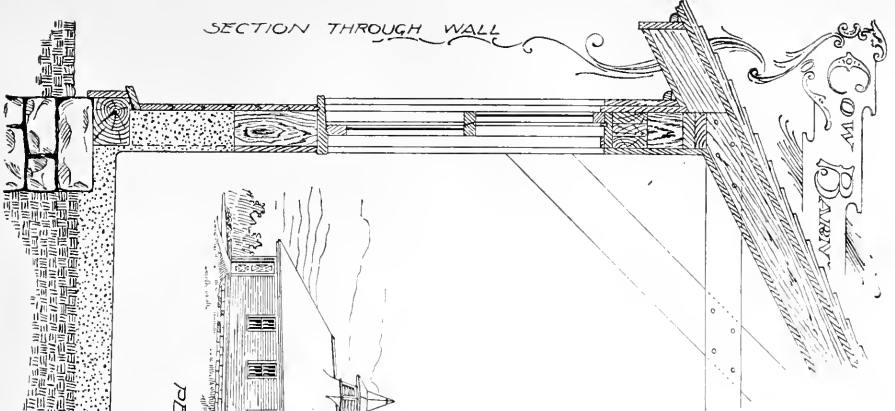

PERSPECTIVE VIEW

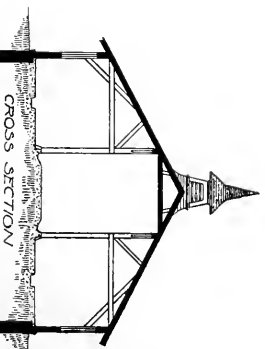
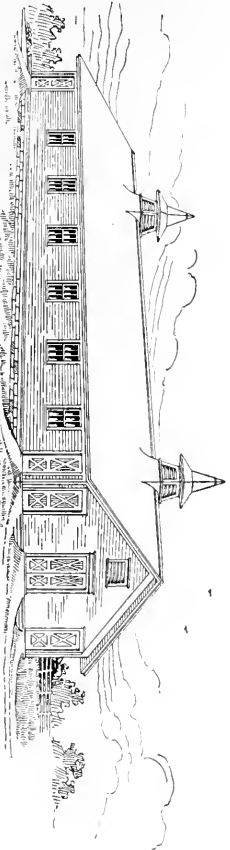

CROSS SECTION

FLOOR PLAN

EXTERIOR DIMENSIONS
LENGTH 89 FT. WIDTH 52 FT.

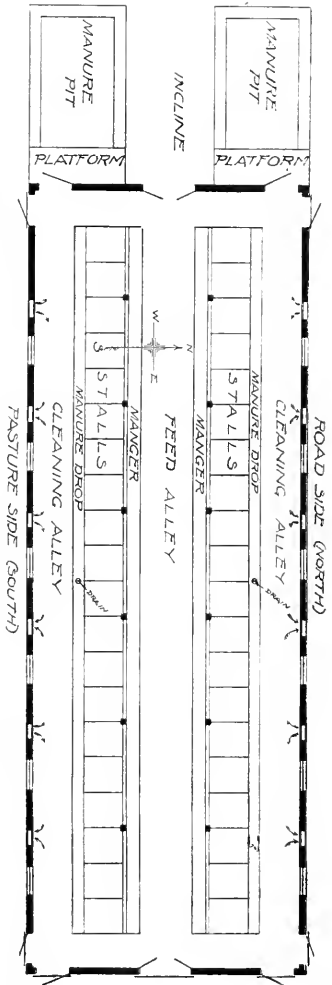

behind the cows, starting at five feet four from the mangers at one end and finishing up at the other end five feet ten, thus making different length stalls to accommodate longer or shorter cows.

The floor of the stalls is given a slight slope from the manger back to the gutter and the surface of the floor is left rough to prevent the cows from slipping and to hold the bedding in place. There is sufficient room back of the alley to run a truck or wheelbarrow to facilitate cleaning out the manure. The liquids of course run to the lowest point in the center of the gutters where they are connected with a bell trap drain, whence they are carried to a catch-basin directly opposite the drain outside of the building. From this catch-basin the liquids are pumped into the distributing manure cart.

All side walls are filled in solid between

the timbers with cement concrete to a height of two feet above the floor and then finished with smooth cement plaster which makes a perfectly sanitary finish and permits the entire barn floor to be washed with a hose and flooded with water without injuring any woodwork.

Warmth and ventilation are secured by fitting the size of stable to the number of animals and there are windows enough to admit abundant sunshine which is nature's best disinfectant. Ventilators and fresh air shafts in the walls supply a continuous stream of fresh air which can be controlled by slides. The foul air enters the shafts near the floor and rises in the walls to the triangular vent duct under the ridge of the roof and from this duct the air is exhausted through the slat ventilator towers. About 1,800 cubic feet of air space is provided for each animal.

An Elevated Chicken House—A165

This plan elevates the poultry house about fourteen inches above the ground for the purpose of preventing rats from making nests under the floor. It is high enough up so that cats and dogs can have

free access underneath and this space also offers a shady protection for fowls in the summer time. At the approach of cold weather in the fall this space is boarded up and manure is banked against the

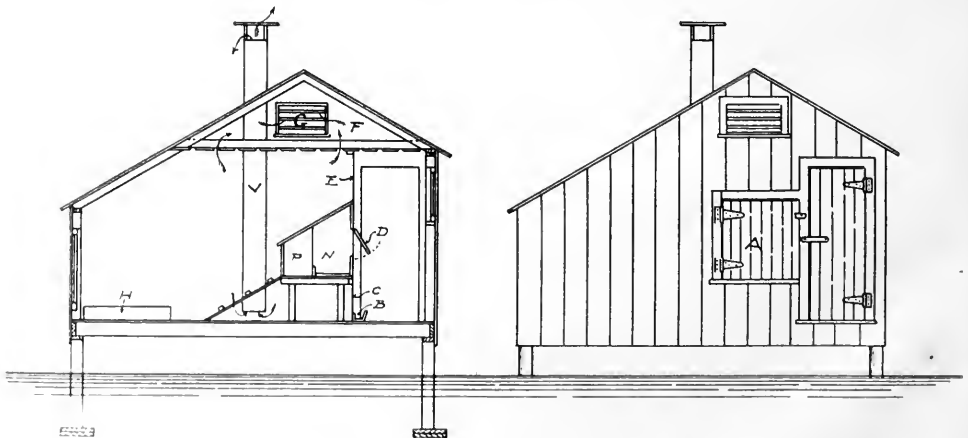

boarding to keep out the cold. If horse manure is used considerable heat may be generated.

As the building is not very heavy the sills are made of two pieces of two by six,

floor and this wall is made tight to keep out the cold. A partition three and one-half feet from the north side of the house forms an alley and the nests are placed against this partition so the eggs may be

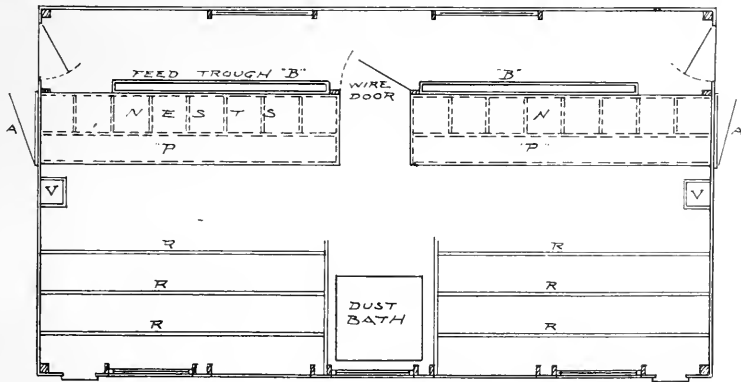
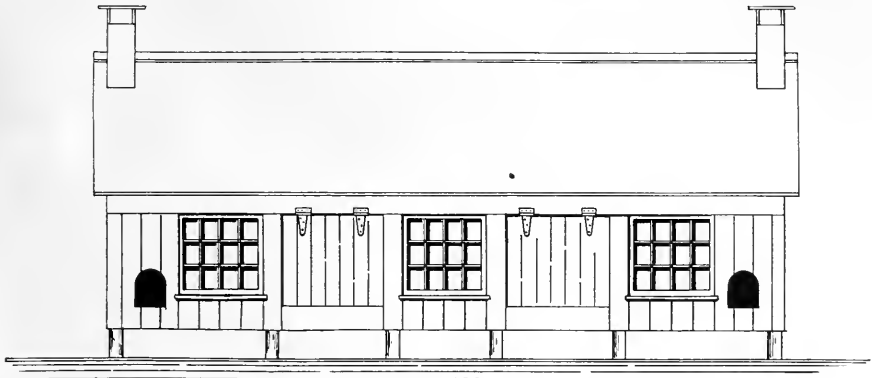

one laid flat on the supporting cedar posts and the other turned edgewise as shown in the drawing.

The south end of the building is only four feet high above the floor and the windows are placed well down. This has the advantage in the winter time of letting the sun shine on the floor where the chickens can make the best use of it.

The north wall is six feet high above the

gathered without going into the henhouse proper. The nest boxes are placed high enough above the floor so the fowls may use the space under them for scratching. The nest boxes are easily removed for cleaning and they are covered with a steep slanting roof to prevent the hens from roosting on them.

The ceiling in this house is an important feature. It is made by nailing one by six

boards on the lower side of the ceiling joists about two inches apart. In winter the space above this slatted floor is filled in with straw for the purpose of having good ventilation without creating a draft. In the summer time the straw is removed and the place thoroughly cleaned.

For further ventilation there is a vent stack in each end of the building which

comes down to within a few inches of the floor. These ventilators pass out through the roof and extend above the highest point and are capped to keep out the rain. There is also a slide near the bottom to regulate the amount of air. If heavy fowls are kept in this house good ladders should be provided to help them up and down or they may get bumble foot.

Barn for a Small Farm—A160

This is a small barn for a small farm where four or five horses are kept besides a few milch cows and a little other stock. This barn was designed for 10 cows, five horses and about fifty fowls and there is

and other forage. This same opening answers for passing feed down to the mangers from the feed lofts.

There are windows all around this barn for light and ventilation; a provision that

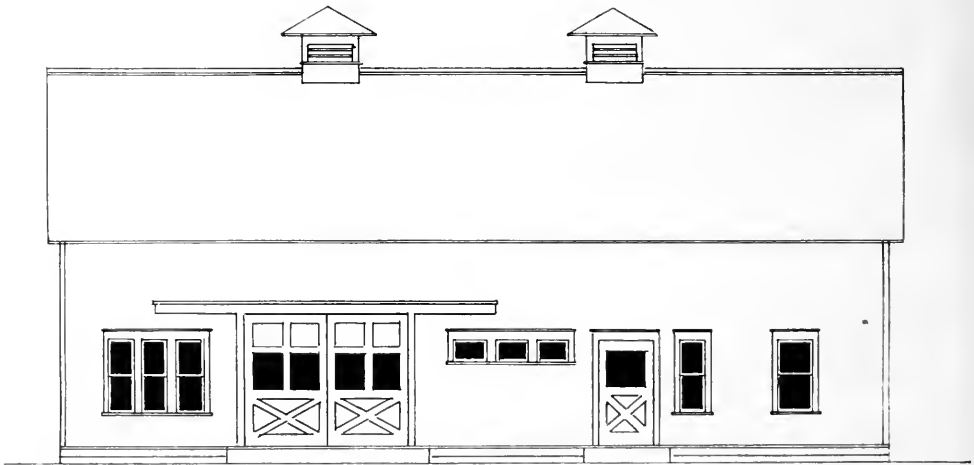

room for a couple of breeding sows. In every stable a box stall or two comes in handy. A box stall is almost an absolute necessity sometime during the year either for sick animals because some special attention is required.

The entire upper part is floored and there is an opening over the storage and implement room to pitch up hay, straw

is too often left out when farm barn plans are made. It is not necessary to shut a barn all up dark, and it is not advisable to do so. Windows do not cost much more than siding and the sun and light let in is a great advantage to stock.

The floor of this stable should be of concrete with the upper layer an inch thick composed of one part Portland cement

and two parts clear soft sand but in making a floor like this it should be remembered that hard smooth cement is slippery and dangerous. The passage way may be marked off in diamonds with a regular tool

driveway is of superior quality the cement top layer should be more than an inch in thickness, perhaps two inches in the center tapering to an inch at the sides next to the stalls.

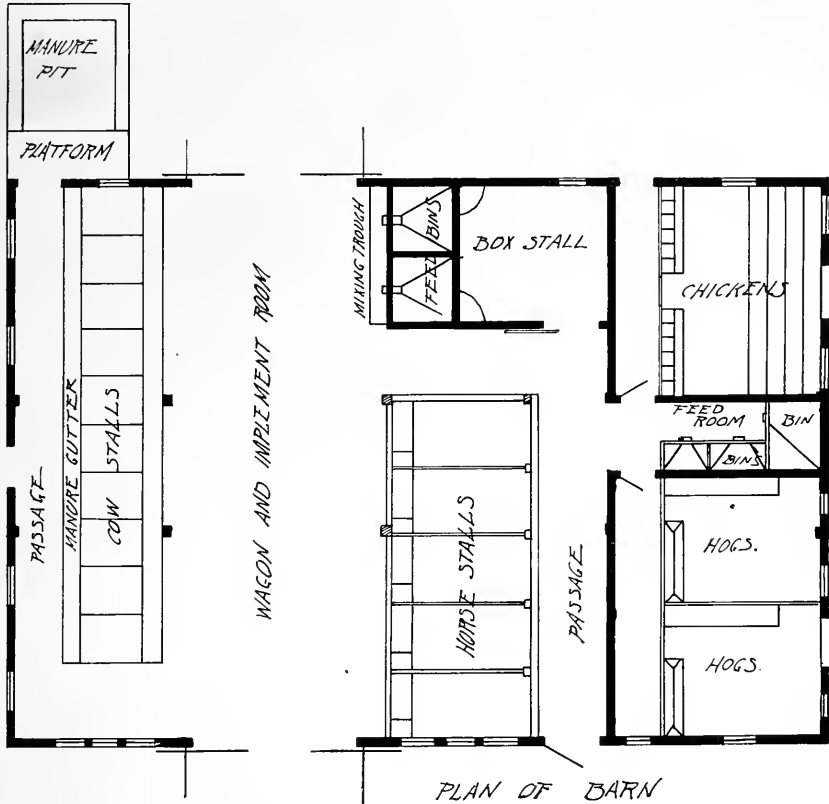

which presses into the soft cement about one-half inch deep, but if the work is done on the farm and the usual mason's implements are not at hand, a smooth rake handle may be used by imbedding it in the soft cement half its thickness. The handle should not be more than three-fourths or seven-eighths of an inch in diameter.

Unless the concrete foundation in this

In laying a concrete floor in any building it is necessary to run a wall around the outside and this wall should extend below frost. If the ground is inclined to dampness, it is better to run a three inch or four inch drain tile all around the wall along the bottom and the outlet of this tile should be carried away from the building eight or ten feet and terminate in a drain.

A Plain Horse Barn—A161

A plain straight-away horse barn with ten single stalls, five box stalls, feed room, harness room and vehicle room with a wash platform in the center is given in this plan. There is a driveway through the center wide enough to admit a load of

teen horses and it will hold feed enough to supply them for a long time. The building is thirty-seven feet wide by sixty-eight

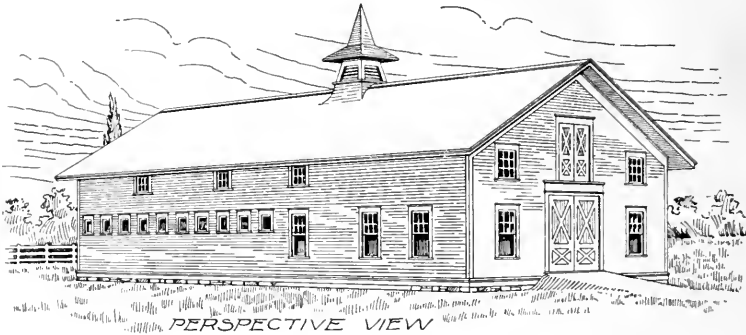

PERSPECTIVE VIEW

wash platform in the center is given in this plan. There is a driveway through the center wide enough to admit a load of

feet long. It is set on a stone foundation with two rows of stone piers supporting the floor joists and posts which run to purlin plates.

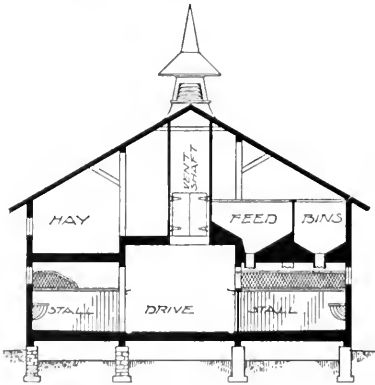

CROSS SECTION

There is a large vent shaft running from the stable ceiling to and through the hay mow with doors for throwing down hay or fodder as well as for ventilation. Grain in sacks can be hoisted up this ventilator shaft and conveniently dumped into feed bins which have hopper bottoms and spouts leading to the mixing room below.



FRONT ELEVATION

hay or a load of straw, if so desired, but there are doors opening outside in the gable to pitch in hay and straw, either by hand or horse fork, so it would not be necessary ordinarily to drive inside with a bulky load, but a good passageway between horse stalls is a great convenience anyway.

This barn will easily accommodate fif-

In the driveway at one side of the mixing room door is a water supply pipe and watering trough with a hose connection

length of the stall room on each side of the driveway. The first thickness of these stall floors is laid in hot tar, then two thicknesses of tar roofing felt is put on be-

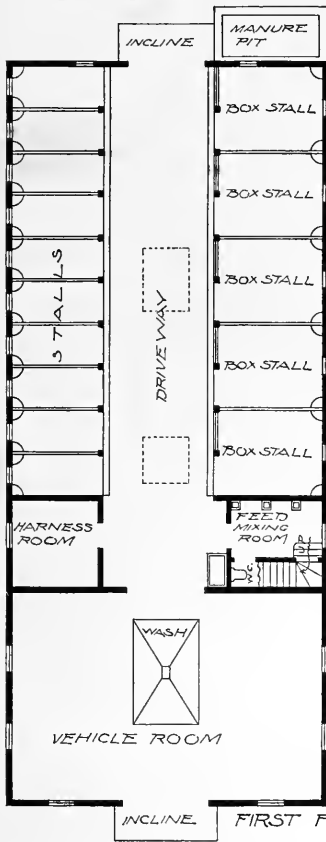

FIRST FLOOR PLAN

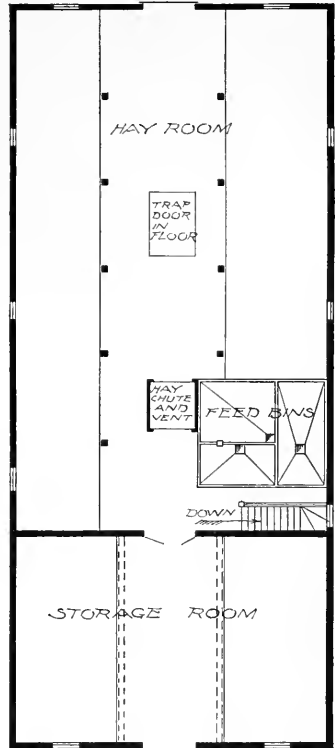

SECOND FLOOR PLAN

to supply water to the wash room on the floor of the vehicle room.

The stalls are floored with a double thickness of oak flooring one and three-quarter inches thick slightly sloping to cast iron gutters which run the entire

ing well mopped over with tar, and this covered with the upper thickness of oak one and three-quarter inch flooring. Each stall has a hay chute from above together with a feed box and salt box and each stall has a window for light and ventilation.

A Barn for Dairy Cows—A162

This cow barn is forty feet wide by eighty-one feet long and will accommodate twenty-four cows. There is a feed

room, wash room for washing utensils and an office. Along one side a silo is placed near the mixing room and conven-

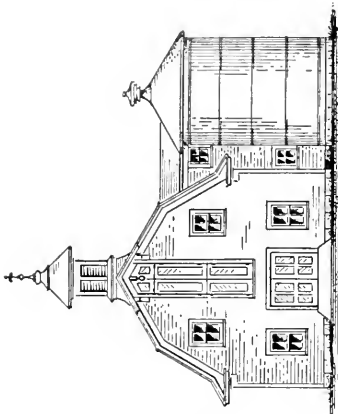

FRONT ELEVATION.

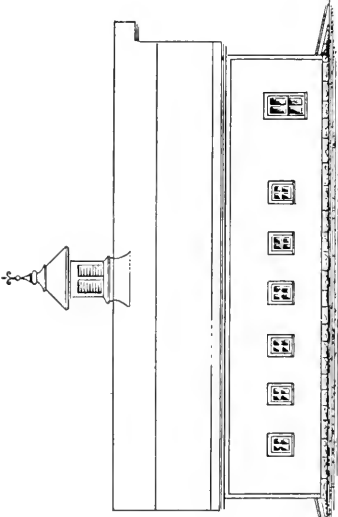

SIDE ELEVATION.

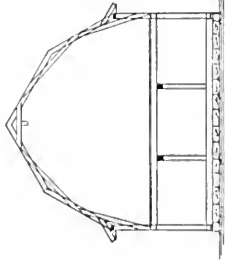

END SECTION.

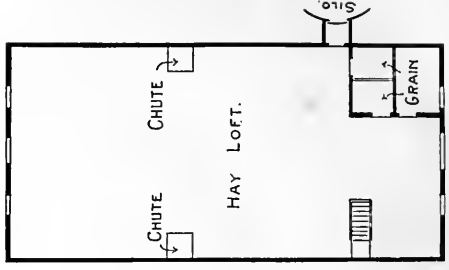

LOFT PLAN.

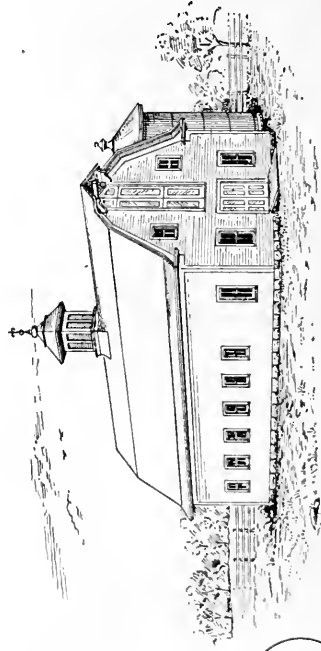

A. BARN FOR DAIRY COWS.

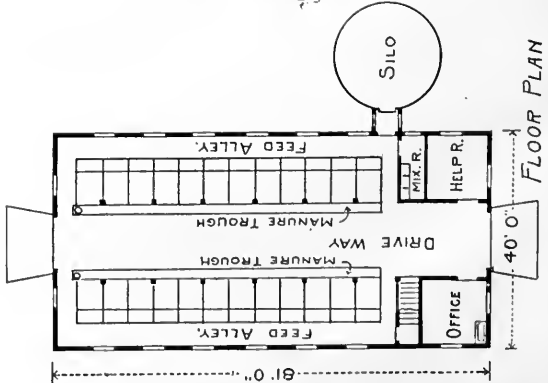

FLOOR PLAN

ient to the feed alleys which in this stable are at the sides.

The manure gutters and floor for cleaning is in the center so that in this stable the cows face outward. This arrangement makes it easier to remove the manure and the plan is liked by some dairymen.

The balloon roof construction makes it possible to store a great deal of feed over head. It leaves a clear space for the horse fork which works freely from one end of the building to the other. Roofs like this are comparatively new. The first ones built were not strong enough to stand heavy winds and some of them blew down, but there has been no such trouble recently. If properly braced each side forms a truss and the two trusses meet together at the peak.

There are hay chutes at the sides for putting down hay and bedding and there is a stairway at the side of the office for convenience in getting up and down.

To help out in feeding time there should be a silage carrier to run from the silo down the different alleys to distribute the feed. If a farmer wants to know the number of miles traveled about the stable it is only necessary to figure the number of trips and steps taken each feeding time, then multiply this by the number of feeds during the winter. If every dairyman would do this the location of some silos would be changed. The amount of travel will surprise those who have never thought about it. This is one reason for placing the silo at the side.

The manure alley in the center is wide enough to drive the manure spreader right through, loading it in the meantime so it is not necessary to have a pile of manure outside of the stable. Manure is worth a great deal more when it is drawn immediately from the stable to the field. This barn looks well and it is a good practical barn.

Small Carriage House—A132

Plan A132 is a small carriage house which may be built at very little expense. It often happens that a man wants to keep a horse for his own driving when he don't care to put a great deal of expense on the

stable. It is a mistake in such cases to build a cheap looking affair because a man is never satisfied with it and it injures a person's property. It is just as easy to build an attractive stable, one that is well

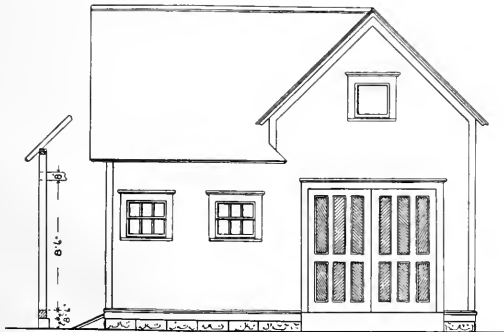

FRONT ELEVATION

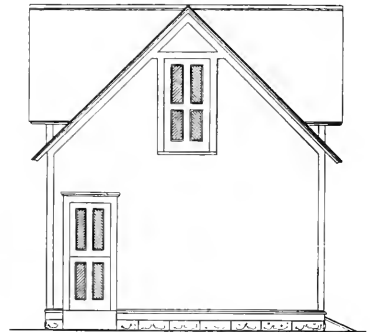

SIDE ELEVATION

proportioned and well designed because if rightly laid out it costs but little more than a poor looking affair that has a cheap appearance. It is all right to build cheap if nobody finds it out, but we often see mis-

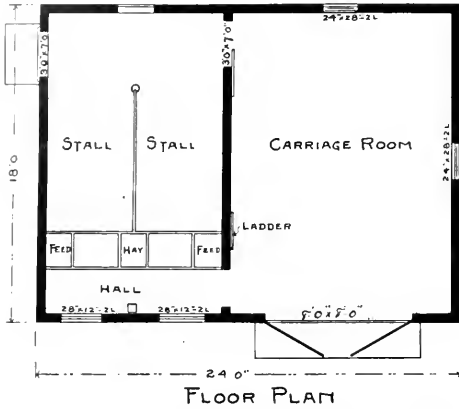

erable structures that give away the owner's ambition.

Here is a stable that costs very little to build but you never would know it, especially if it is neatly painted and nicely kept both inside and outside as it should be.

Small Barn for a Village Lot—AIII

This is just a little affair, only eighteen by twenty feet, but it is big enough to hold four horses and leave room for a wagon on the storage floor. There is also loft enough to mow away three or four tons of hay. It is not necessary to make a very deep foundation for a little barn like this. If the ground is leveled and three or four courses of brick laid around under the sills the building will set all right probably for a good many years. Many small barns are just blockted up on stones placed at the corners and one or two places along the sides but this is objectionable because it makes a harbor underneath for vermin. The foundation

There is sometimes more genuine satisfaction in a cheap building well cared for than in an expensive structure that is permitted to go to seed.

The size of this barn is eighteen by

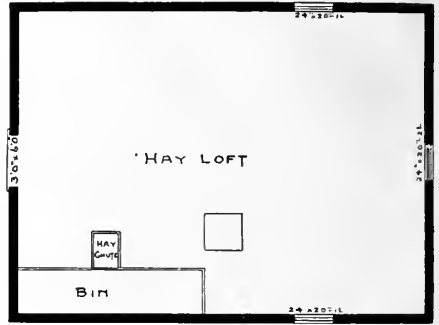

twenty-four feet. Its attractive appearance is due more to the shape of the roof than to the general design or to any other one feature. All village barns should be placed carefully on the lot to look well and so they will not annoy the neighbors.



should have some air but air enough will penetrate through the chinks between the bricks if they are laid without mortar.

great winter addition to the looks of a stable. Grape vines usually do well if suspended by wires from the eaves, but grape

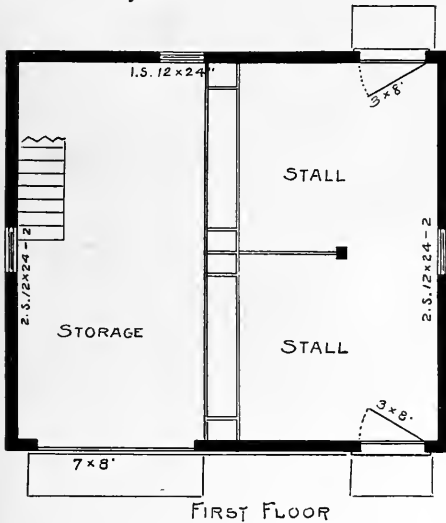

The construction of this little barn is about as plain and simple as it could be and still have it look right when finished. Nobody likes a cheap looking building, but no one objects to a good looking building if they get it cheap. The problem is how to build what will be satisfactory in a few years' time. Sometimes an inexpensive building may be shaded with trees or screened by vines in such a way as to give it a presentable appearance even in winter. An evergreen or two planted along the side, if there is plenty of room, makes a

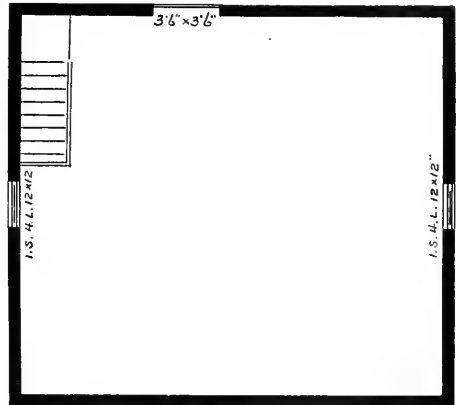
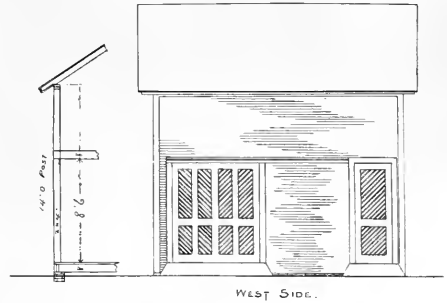

vines should never be tacked close to the side of a building, they need air on all sides.

A Cheap Hog House—A122

The cheapest kind of a hog house is shown in plan (A132.) It is only seven feet six inches wide, but it may be any length. This house is thirty-one feet six inches long because this length is covered by two sixteen foot joists. Even on well regulated hog farms where there is a good

solid hog house this shed affair will be found useful to hold the overflow. It often happens that shoats in fall are kept in a muddy feed lot or sold too soon for lack of just such shelter as this to hold them while being finished. Beginners in the hog business could not do better than

to build a little cheap hog house like this to start with.

The seven and one-half foot width permits of roofing the shed with sixteen foot boards cut in two in the middle. Each six-

teen foot section will make two pens nearly eight feet square which will hold from five to seven or eight pigs according to size. The posts are just set into the ground and the floor raised about a foot to keep it dry. Four two by six joists run lengthwise

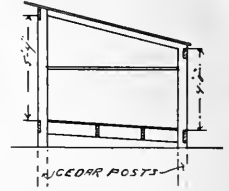
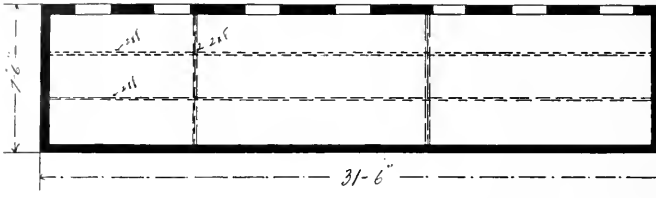

PLAN AND SECTION OF HOG HOUSE

teen foot section will make two pens nearly eight feet square which will hold from five to seven or eight pigs according to size. The posts are just set into the ground and the floor raised about a foot to keep it dry. Four two by six joists run lengthwise

is closed by a hinged board which drops down on the inside. This precaution is necessary because a cold draft on the floor is a very bad thing for hogs. This little hog house don't run into very much money but it is a very useful, practical affair.

A Small Carriage House—A131

A small carriage house with stable room for two horses or a horse and a cow is a very convenient thing when a person has a good sized lot in the city or village. A

cow appreciates comfort and will give enough more milk to pay for it. Of course a cow in a horse stall needs plenty of bedding, but where only one cow is kept it is easy enough to furnish all the litter necessary.

There are a good many designs for small carriage houses, some of which are decidedly homely. A good many of the fancy buildings are too expensive. Here is a



horse stall makes a splendid stall for a cow, better than what is ordinarily designed for a cow stall because there is more room and it gives more comfort. A

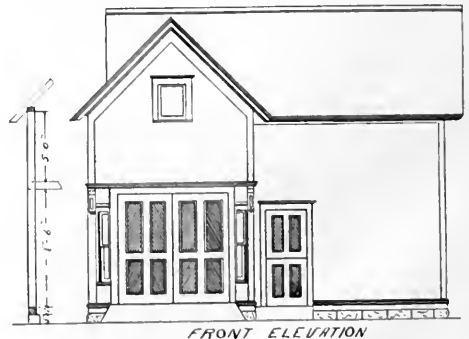

comparatively cheap structure, but it is all right for looks and it is a convenient stable to do work in. There is a hay chute

corner of the mangers for grain and other feeds.

A carriage house like this may have a

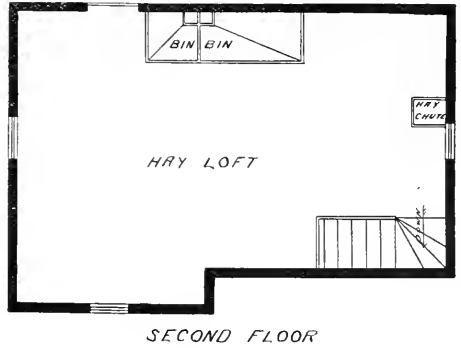
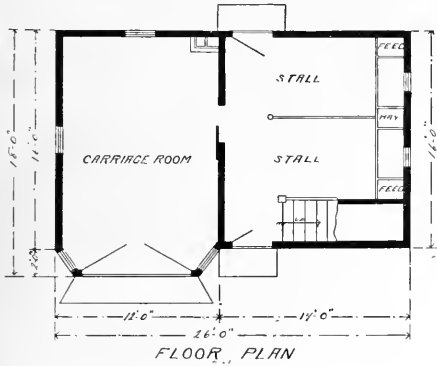

which reaches from the loft to the manger below with openings for both stalls, which is a very convenient arrangement and is worth a good deal just to keep the hay dust and chaff out of the horse's mane and fore top. It also leaves the feed boxes in the

plank floor or the floor may be left out entirely and the ground leveled up with cinders except the stalls and the very best stall floor is made of stiff clay pounded in wet. Some of the most successful horsemen prefer a clay bottom stall.

Cheap Cattle Shed—A123

Some kind of a cattle shed is necessary in connection with every feed lot. Plan (A123) shows a cattle shed ninety feet long and ten feet six inches wide. It is built of two by fours for framing, covered with boards twelve feet and sixteen feet long which cut to advantage without waste except at the ends.

a current of air from the north, but this feed manger arrangement seems to get

There is a low-down manger which runs the full length of the shed against the back wall. The front side of the manger is bedded in the ground which together with a little banking on the outside prevents the cold winds from blowing under. Some feeders fail to realize the importance of this precaution. The north wind seems much colder when it forces through a small opening. There is something about the bottom of a shed that seems to invite

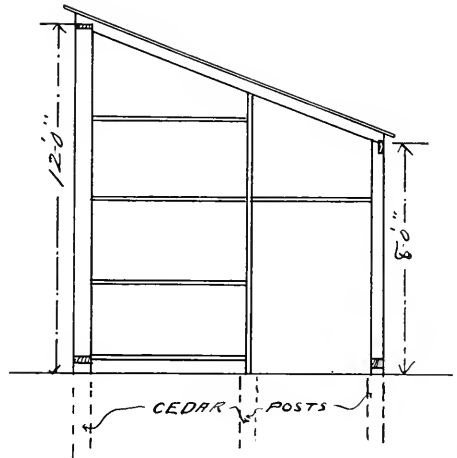

the better of. Mangers should be low for another reason. For thousands of years cattle have been accustomed to feed from the ground. While in pastures they keep

The shed is supported by short cedar posts which are set well into the ground, the tops of them being cut almost even with the surface. The doors are made

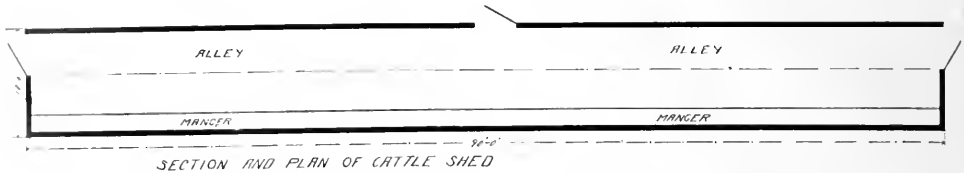

their heads down nearly all of the time, but for some unaccountable reason they are expected to hold their heads two or three feet high when being fed artificially.

wide enough and high enough to get in easily with a manure spreader, and there are no posts or partitions in the way so that it is easy to clean out the manure.

Ice House Design—A162

An ice house to hold two hundred tons of ice is given in this plan. This ice house was built on a large dairy farm near a good sized village. Some seasons the farmer sells considerable ice to the village at paying prices.

The building is twenty feet wide by thirty feet long and sixteen feet high to the eaves. When completely filled it would hold about two hundred and twenty-five tons.

The exterior is finished with drop siding and a stained shingle roof. Next to the siding is a layer of building paper, inside of this and nailed to the outside row of two by four studding is matched ceiling of good quality. Then comes a dead air space four inches thick. Next is a layer of hair felt seven-eighths of an inch thick nailed to the inner edges of the four-inch studding; inside the hair felt is another matched ceiling of narrow pine sheathing, then another row of two by four studding lined on the inside again with another boarding of matched pine sheathing, then an inch of block mineral wool, and this is protected on the inside with another board-

ing of matched soft pine sheathing nailed to furring strips. All this work is very carefully done to prevent so far as possible the slightest air connection between the different spaces. It is recognized that a dead air space is the best possible non-conductor of heat or cold.

There are six doors and they are just as carefully made as the siding. The detail drawing shows how they are fitted. Inside of the doors the opening is further closed and sealed by a double thickness of loose inch boards, which fit into the grooves and are laid to break joints. These boards are put in place as the filling proceeds and are taken out one at a time as the ice lowers in summer.

The ceiling over the ice is just as carefully constructed as other parts of the building and the space over the ceiling is kept cool by a ventilator in each gable end and another ventilator in the roof.

All these details are very important but they are not more important than the covering for the ice, which should be of saw dust if it is possible to get it.

An interesting feature of this house is

DESIGN OF AN ICE HOUSE HAVING A CAPACITY OF 200 TONS

FRONT ELEVATION

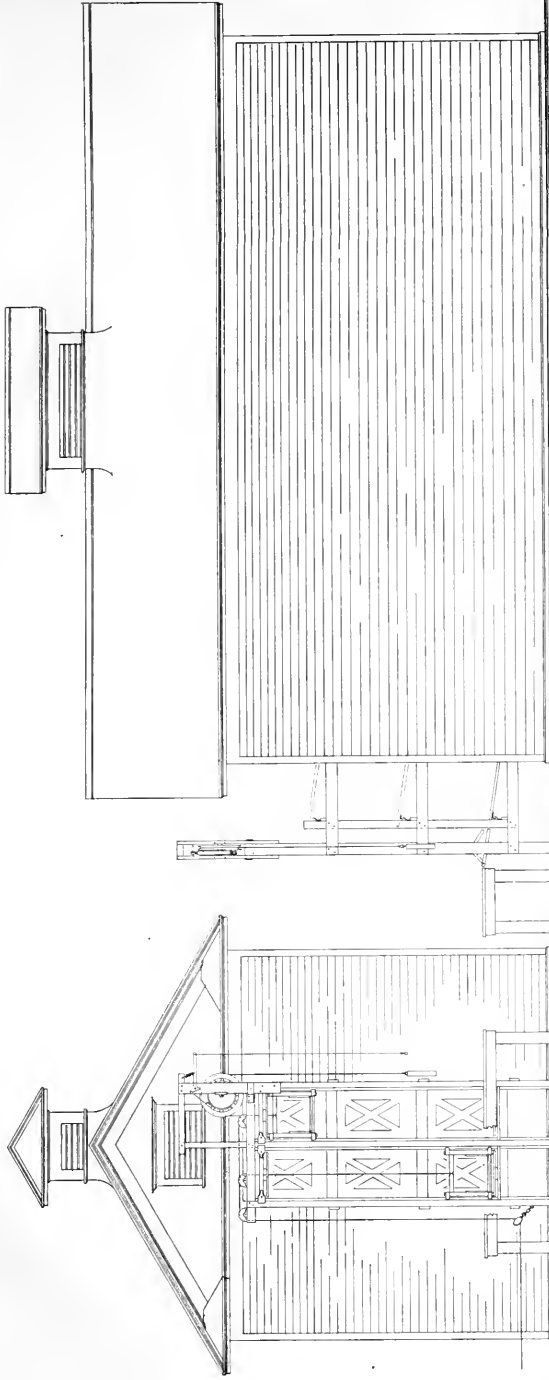

SIDE ELEVATION

DETAIL SHOWING CONSTRUCTION OF WALLS

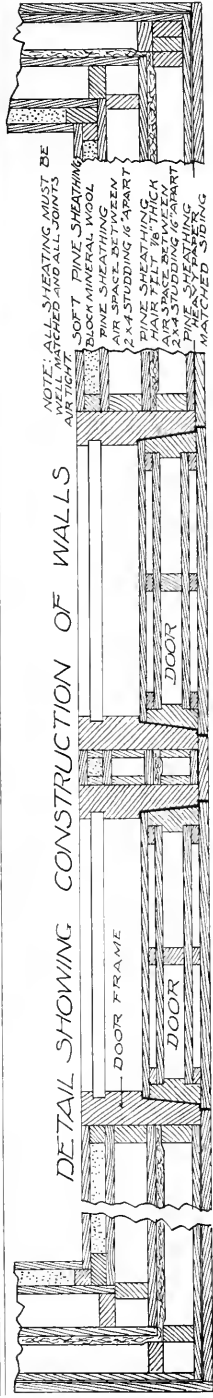

the simple elevator to be used in filling. It is a double gig elevator so arranged that one gig goes up as the horse walks in one direction, and as the horse walks

in the other direction the first gig lowers and the second one goes up. Perhaps this is the quickest arrangement made for the purpose, considering its simplicity.

A Large Bank Barn—A166

A bank barn is very desirable where a suitable location can be found but some bank barns are very inconvenient and others are damp and musty because the barn is not built right. It is not absolutely necessary to build a bank barn just because there is a hill on the farm. It is much better to pick out a plan which is suitable for

the location than to blindly follow the lead of some other farmer. A barn that is all right on one farm may be all wrong on the next farm, so much depends on the use made of it, the kind of farming and the lay of the land.

This bank barn is 30 feet wide by 70 feet long with a basement full size. The

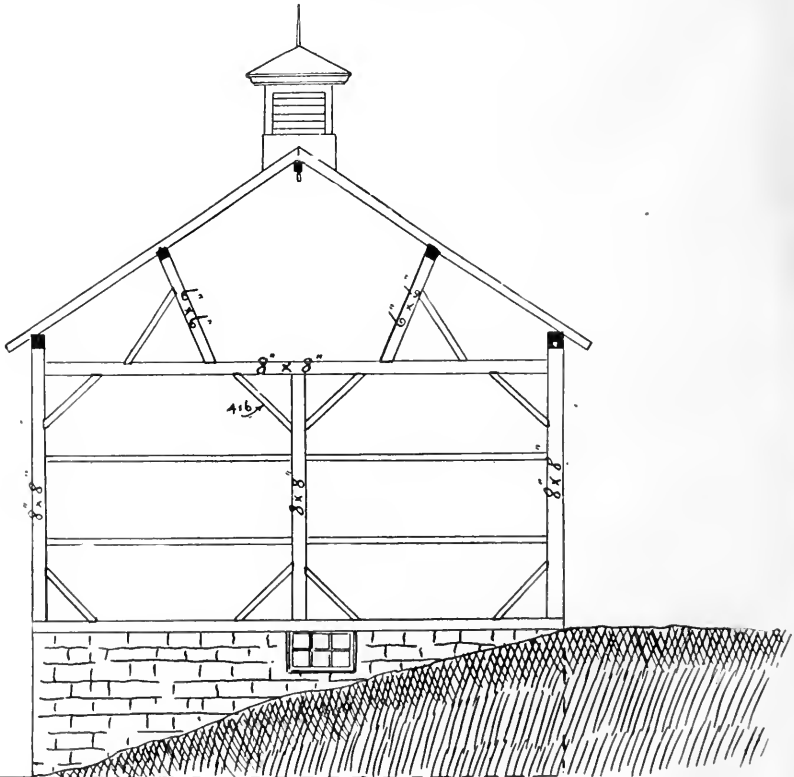

FRAMING AT END

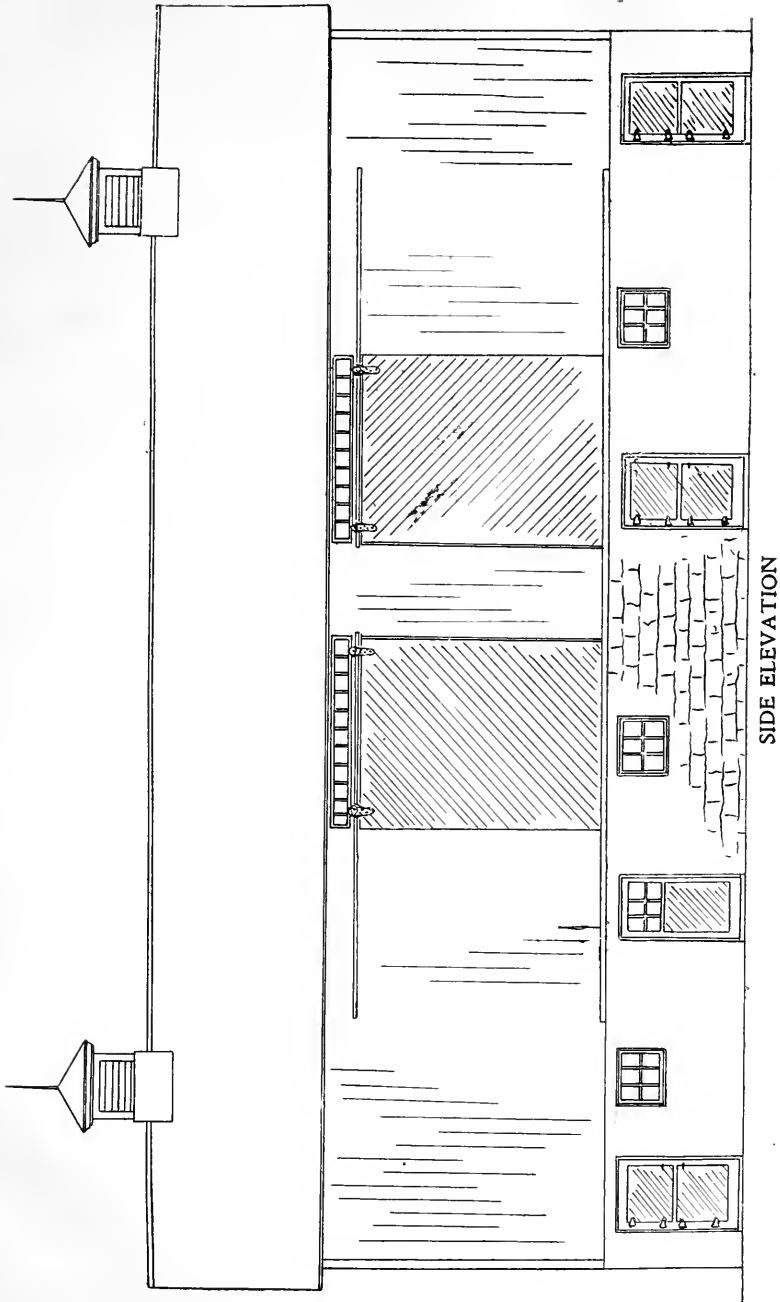

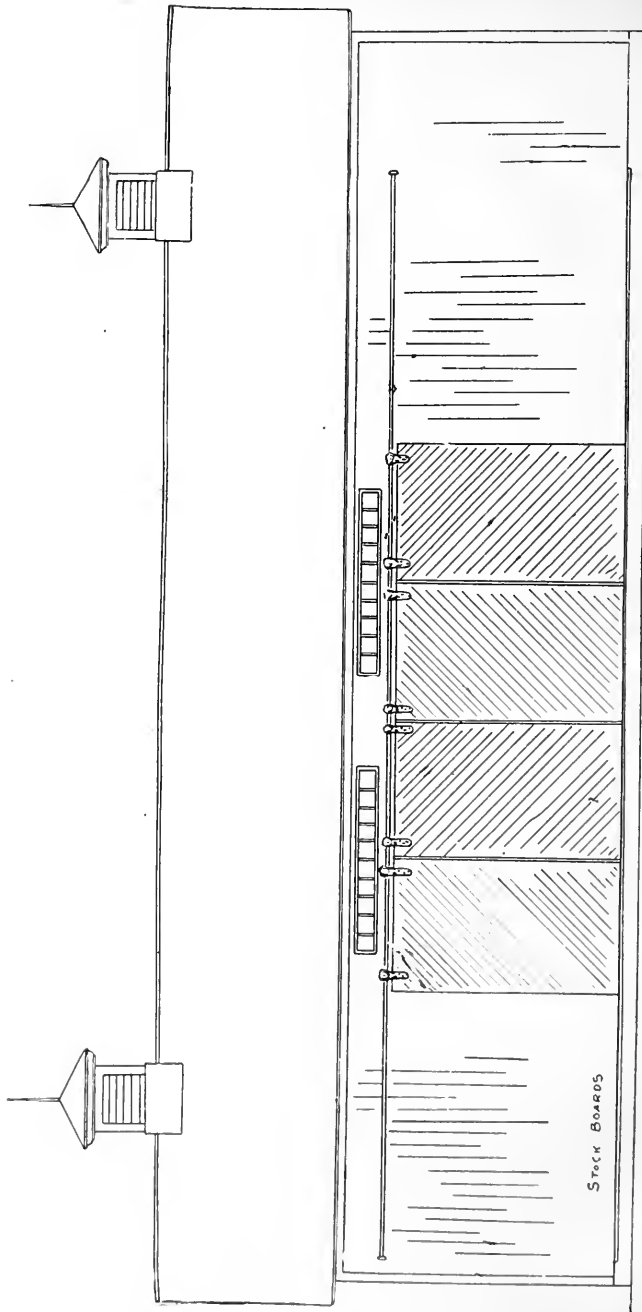

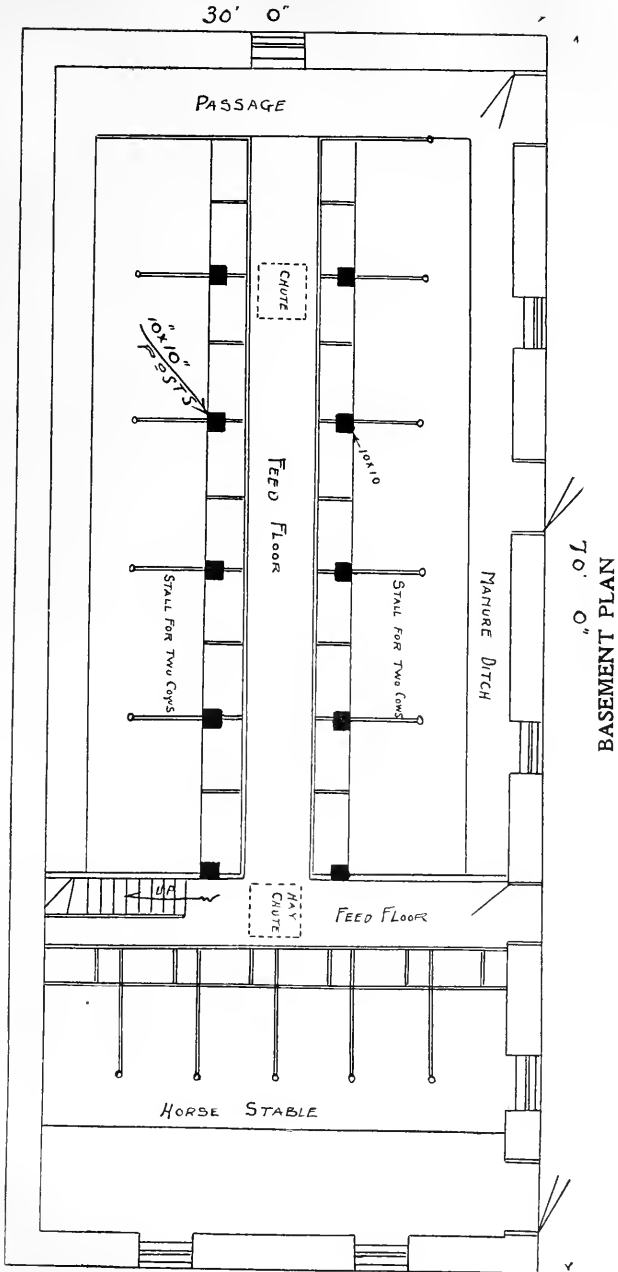

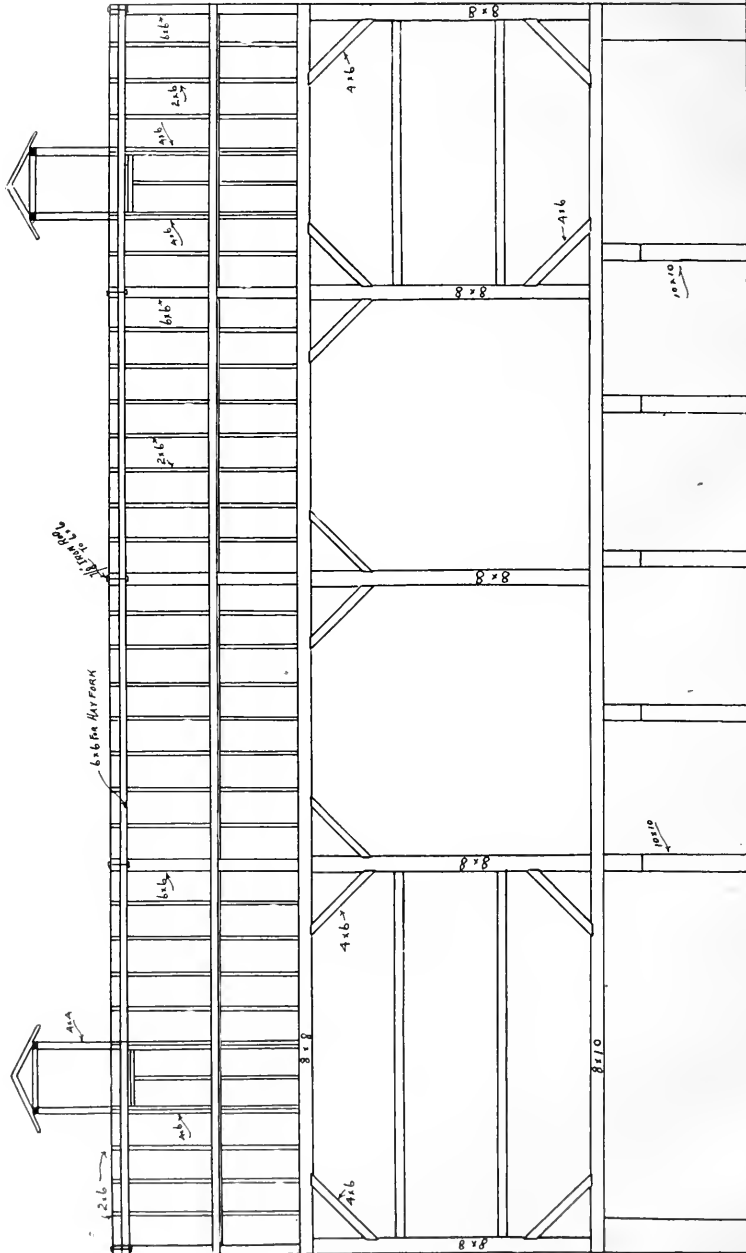

LONGITUDINAL SECTION

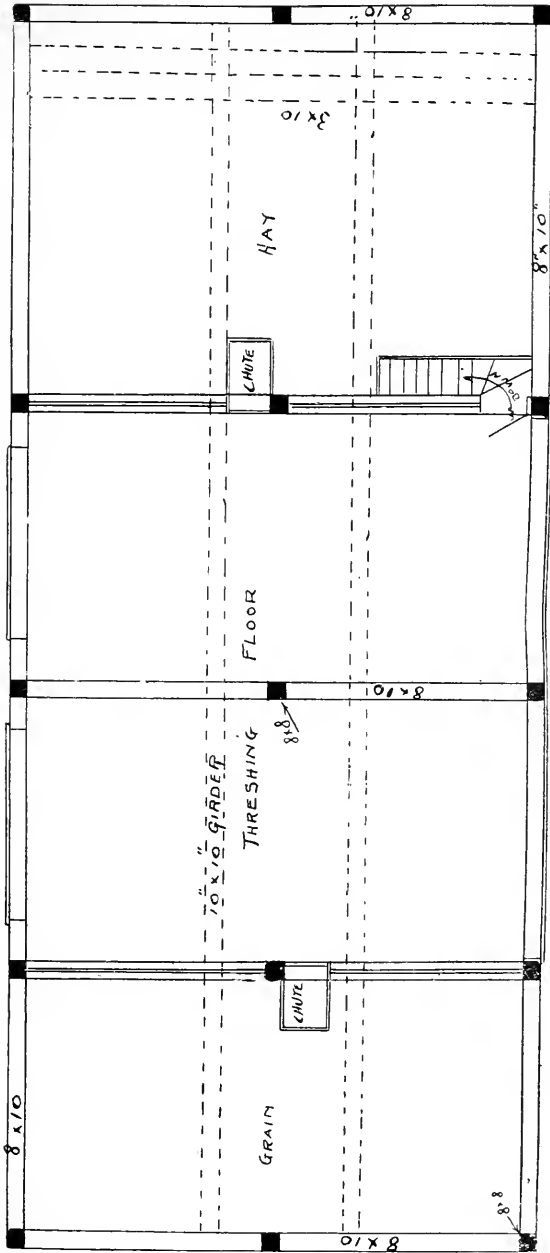

FLOOR PLAN

walls of the basement are of stone and the upper structure is heavy frame work braced in such a way that a horse fork could be used in the peak with a track clear from obstruction extending from one gable to the other.

There is no objection to making this wall of cement or concrete if stone is scarce or if for any other reason a farmer prefers cement construction. This barn is placed side ways to the bank and has two bridges leading to what is commonly termed a double threshing floor on a level with the ground on the upper side. There are two doors on the opposite or south side of the barn but they are designed merely as openings for light and air as occasion requires and to run the carriers out when threshing. It is intended to build the straw stack in the yard on this lower side of the barn.

The basement is partitioned off into stables for six horses and twenty head of cattle as shown in the basement plan.

In building a barn like this it is necessary to use heavy timbers over the stable

and to support them with good solid posts with good stone foundation or thoroughly well constructed cement footings solid enough to prevent settling. A good many such barns give considerable trouble in this respect but not necessarily so because it is easy to make them right in the first place.

In all stock barns, but especially where stock is kept in the basement, ventilation is of prime importance. This barn has two ventilators extending through the roof at the peak.

For convenience in feeding there are two chutes running down from the hay mow to the feed alleys on the stable floor. The double threshing floor leaves considerable room for storage of farm implements which is very important on most farms. Where the land slants like this the barn yard usually is dry but probably a little tile draining helps every yard. We seldom see a barn yard dry enough in the fall and spring. It is well to consider all these side issues when selecting the site to build on.

Stable and Granary—A130

A cheap little stable and granary with considerable loft room may be built after plan (A130). It is twenty-one by thirty-four feet, including the implement shed at the end. This little barn is intended for a small farm where a little grain is grown and fed to horses that are used partly for farm work and partly perhaps for teaming for hire.

There is an eight foot ceiling over the stable and over the grain bins and a ten foot ceiling over the machinery room, because a stable is warmer with a low ceiling and eight feet is not high enough to accommodate all kinds of farm machinery.

On some small farms this shed room

would not be necessary for storage purposes, but it would be very handy to drive loads in at night for safe keeping. The opposite doors make it very handy to drive through, which is much better than being obliged to back out with a heavy load. The grain bins are also filled from this shed by drawing the sacks directly from the threshing machine and dumping through the openings shown in the plan. Each opening is three feet square and is closed with a swinging sash fitted with four lights of glass.

This little barn is quite different from the ordinary, but it is not necessary to build a barn just exactly like some other

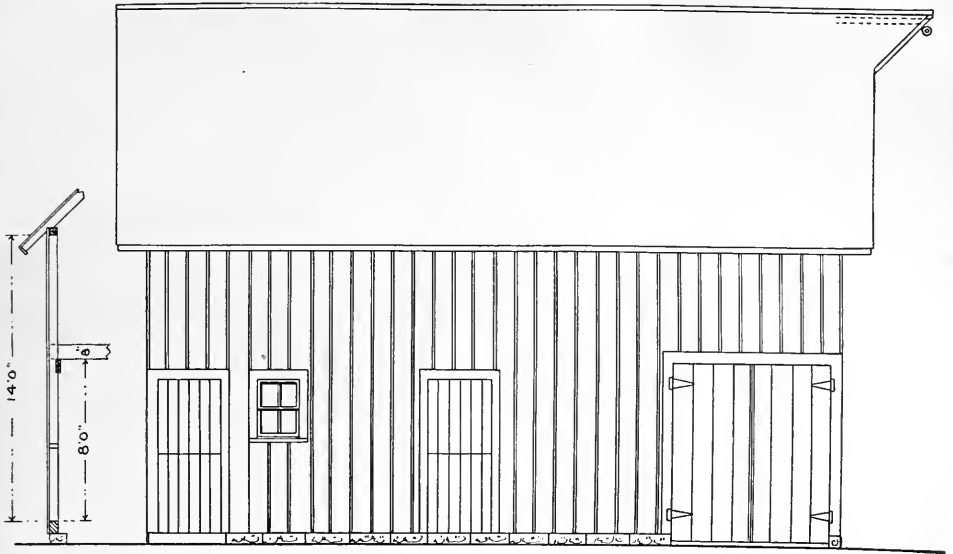

FRONT ELEVATION.

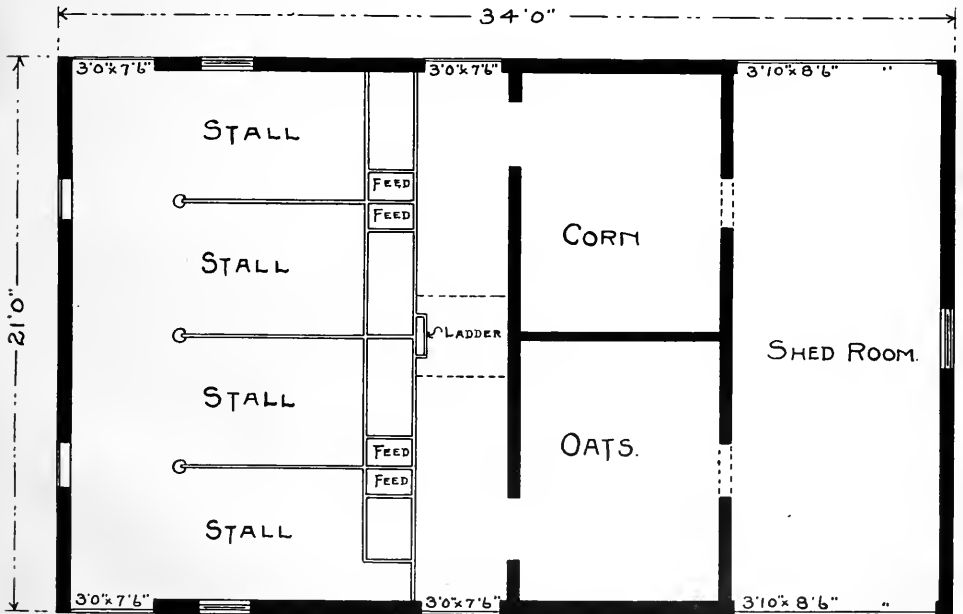

FLOOR PLAN.

Small Barn with Ell Shed—A163

A small barn with an ell shed attached is shown in this design. The barn proper which is 28 feet wide by 56 feet long is intended to accommodate five head of horses in about one-third of the floor space leaving the other part for a driveway with storage for grain, hay and farming implements. The whole of the second floor is given over to storage for hay or grain in the sheaf.

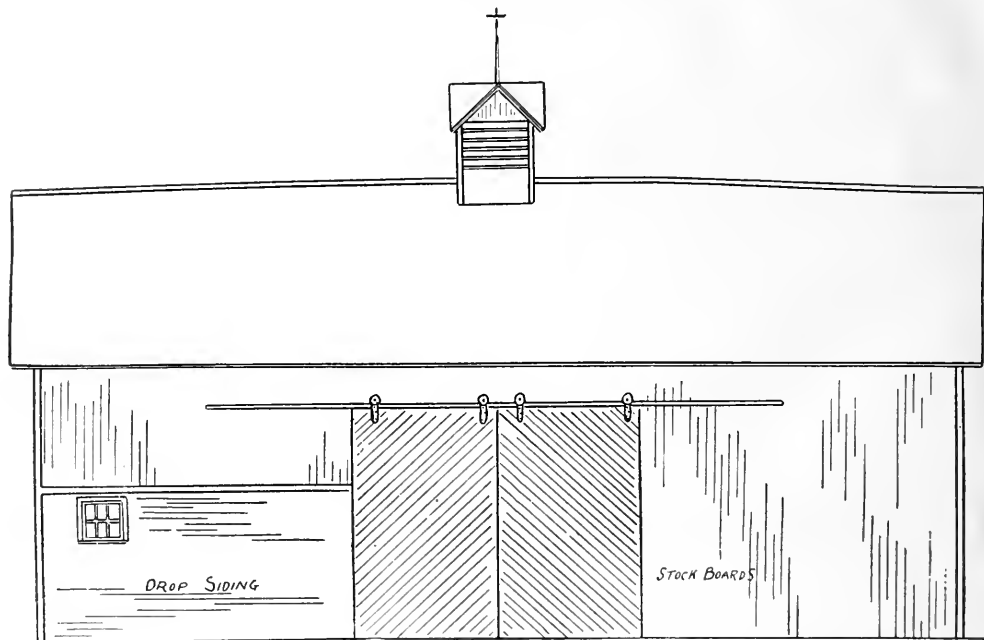

SIDE ELEVATION

A hay bay extends from the ground to the roof in one end of the building but a floor extends over the stable and the greater part of the threshing floor. The thresh-

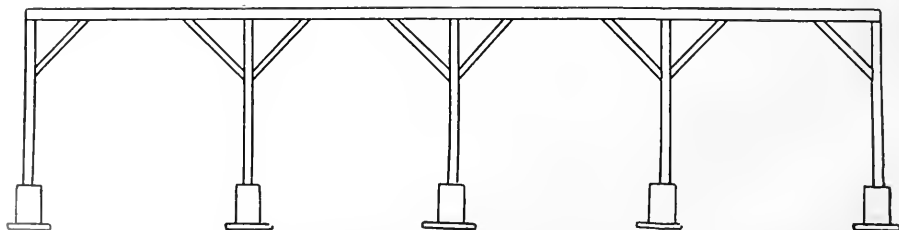

CONSTRUCTION OF SHED

ing floor section may be partitioned off from the horse stable to make the stable warmer.

The shed forms an L running across the

north and west sides of the barn yard leaving the south side open to the sun. This arrangement breaks the north and the west wind and provides a comfortable barn yard for winter.

Stalls for 12 cows are built in the north shed by putting two cows in each stall. This shed has a cement floor built like a sidewalk and the floor extends out under the projecting roof which comes over a few feet into the yard forming a protection against rain and snow.

It is something that every barn yard should have because there are times where the yard is wet and muddy in spite of every precaution. A wide roof dripping into a barn yard is objectionable but the drip from this little short roof is insignificant.

The other part of the shed is open to the weather on the east side looking towards the barn, an arrangement that makes about as comfortable a barn yard as is pos-

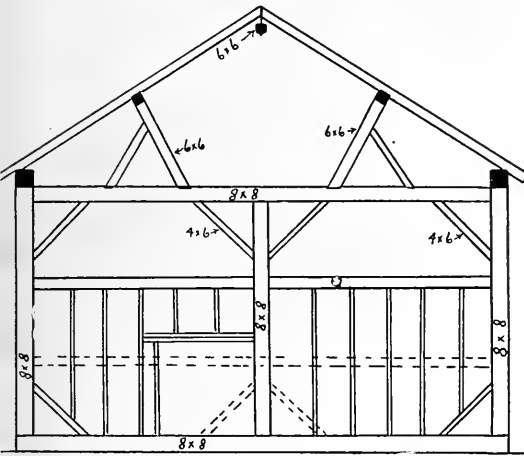

TRANSVERSE SECTION

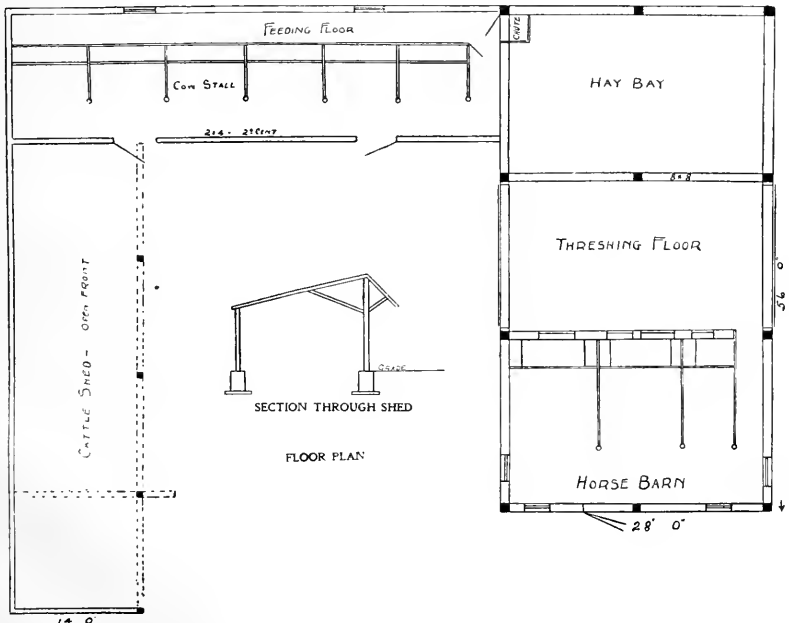

sible to obtain without roofing the whole thing.

This little barn with shed attachment is not expensive but is more convenient than some larger structures. The cost is within the reach of any farmer although

he may not have more than 20 acres of land. A transverse section is shown giving a good idea of how the building is framed. It is a strong frame that is easily put together and there is no waste of timber.

Inexpensive Poultry House—A170

A cheap little poultry house is shown in this design. It is ten feet square on the ground, the front is eight feet and the rear five feet high. Where only from ten to twenty hens are kept this little house will be found very useful. The only openings are a door in the east side, the large

down shade roller, so that it may be pulled down over the opening on cold days and rolled up when the sun shines warm. Such a curtain should be thin enough to let the air through freely. It is a splendid ventilator for a poultry house because it lets the air in and out gently without any

DESIGN FOR AN INEXPENSIVE CITY POULTRY HOUSE

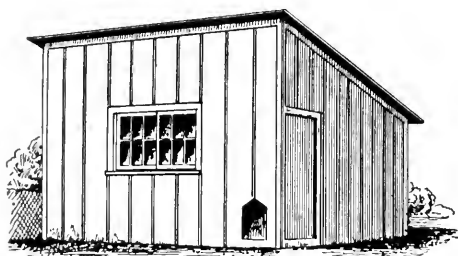

PERSPECTIVE VIEW

window on the south side and the little door to permit poultry to pass in and out.

A little house like this can be built if so desired without so much as a frame, except two by fours at the top and bottom to nail the boards to and another piece of two by four for the door and window frames. The window frame consists of a two by four at the bottom and another two by four at the top, spaced to hold the sashes in such a way as to permit them to pass back to leave the opening free. It is a good plan to have a wire netting over the window outside and a muslin curtain inside. A curtain may roll up on a win-

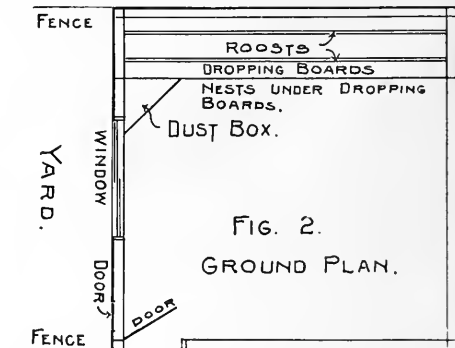

draft. Some poultry houses are built without glass, thin muslin being depended on for both light and air. Such houses are usually dry and it is well known that a poultry house must be dry or the fowls won't do well.

A poultry house like this must have a good floor. One of the greatest annoyances in poultry keeping is to have rats burrow underneath. Rats prefer a poultry house to any other building because there is always feed around that they can get and there is always water. Rats like eggs too, and they have been known to sample young chickens, but it is easy to

block them out of a poultry house by making a concrete floor. Concrete for this purpose may be pretty much all sand and gravel. Most any kind of a composition will answer the purpose. A little lime and

a little cement, or lime without cement, or cement without lime mixed up with water in most any proportion will do the business. It should be pounded in and come up about even with the sill.

A Tower Tank House—A145

Where a water pressure is wanted it is often a good plan to put the water tank in the windmill tower. In plan (A145) the tank is shown in the dotted lines. It is placed ten feet above the ground and the tank itself is fourteen feet high by ten feet in diameter at the bottom.

In placing a tank like this it is necessary to carry a three inch pipe through the tank and pass the pump shaft through this pipe. The pipe is screwed into a flange at the bottom and the flange is bolted to the bottom of the tank to make it thoroughly water tight. The pipe must be steadied at the top and the shaft must have a bearing, both, above the tank and below it so it won't scrape on the pipe. The well and pump of course are directly under the tank in the center of the tower.

The outside boarding is made double and lined with paper to be warm in winter.

There is generally some drip from a tank placed like this for which reason the room below is seldom made use of for any purpose, but a few farmers have utilized this room for a bath room. They make a cement bottom with a drain to carry off the surplus water and put in a shower bath connected with a pipe from the tank. A shower bath is the most convenient and probably the most healthful of any kind of a bath. At any rate it is easily kept clean.

There is no reason why a farmer or his men should be denied the privilege of getting a bath when they want it. There are bath rooms in almost all city houses and

there should be bathing conveniences on every farm. By placing a stove in this room under the tank it could be made com-

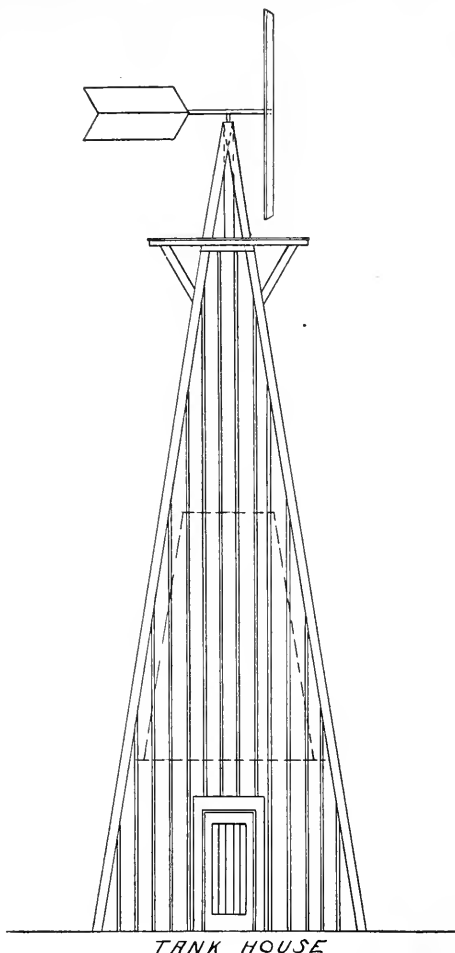

fortable in winter as well as summer, and a stove with a water heater attached to the tank would give a water pressure so that the shower could be made any temperature desired.

The height of this tower is forty feet

to the wind mill. Of course the height of a wind mill tower must depend upon its location. If the tower is built on high ground it is not necessary to go up so high unless the wind mill is surrounded by high buildings or trees.

Small Carriage House—A135

The little barn, eighteen by twenty-four feet, as shown in the plans and elevations is a very appropriate design and can be used

barn in building a stairway, as the upright ladder placed against one of the partitions answers the purpose very well. To keep the cold from blowing down through the opening a light door with a pulley, cord and counter weight may be made to shut over the opening.

If there is a boy in the family he will find a way to rig up a work bench in the front corner of the carriage room between the door and the first window. It is easy

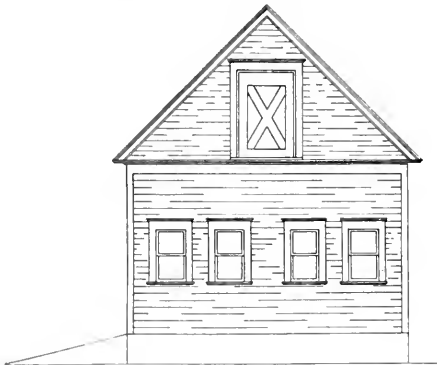

SIDE ELEVATION

in either village or city. It is not expensive, in fact, it is probably as cheap as any satisfactory structure could be. It is better not to take up room in such a small

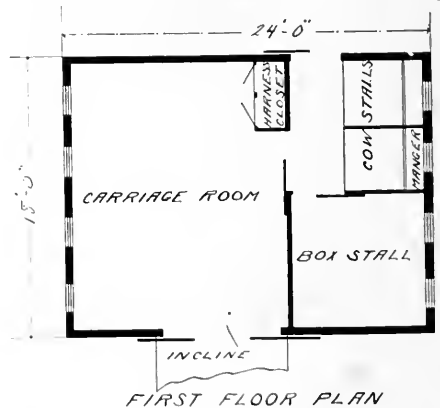

FIRST FLOOR PLAN



FRONT ELEVATION

to encourage boys to work with tools, especially since the graded schools have taken up manual training. The schools have added tone to the work, boys don't consider it labor now, it is part of their education and it is an important part, too. Truth may be taught in a more thorough manner through mechanics than by any other means. The principle of learning a thing by doing it is just as valuable now as it was in Froebel's time.

As a general thing a boy's work with tools is not very valuable when judged from a mechanical standpoint or from the amount of money that the finished product would bring, but it very often has a great educational value to a boy that is little appreciated by the older members of the family. The fundamental principles of mechanics permeate all nature. Animals are built on the best mechanical principles.

A Neat Carriage House—A114

A very neat carriage house is shown in plan (A114). It is intended to house two horses and have room enough for a couple of carriages. The building is supported

There is a very close connection between mechanics and nature. Mechanics point the way to the connecting link between natural phenomena and commercial success. Mechanics and mathematics also are very closely related, but the natural live boy loves the one and hates the other. No woman wants a boy tinkering in the house, but he can spend many happy hours in the barn without disturbing anyone.

a good deal. Generally a pleasing effect may be obtained by a curved driveway where it is kept neatly trimmed at the sides. If the driveway is gently rounded and the edges kept about two inches lower than the sod it is easy to maintain a clean track and a well defined edge without putting a whole lot of unnecessary work on it. The lawn mower will trim the grass and a spade used once a month will keep the edge of the drive in good shape.

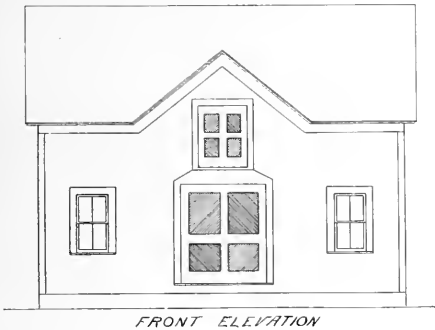

by a stone wall three feet in the ground and one foot above ground to keep the floor well up, but the height of course must depend on the nature of the ground and location in reference to the street and driveway. It is not desirable to approach the main doorway by a very steep bridge because it is often necessary to run carriages out and in by hand. Of course if it is necessary to set the floor up the driveway may be raised accordingly, this however very often runs into considerable expense.

The way a driveway approaches the stable affects the appearance of the stable

The floor of this carriage house is made

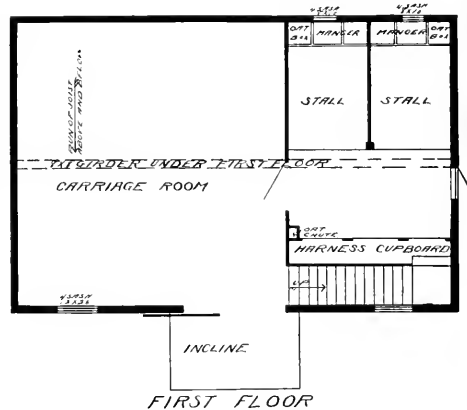

solid by running a heavy girder lengthwise of the building through the center. Joists are carried from the sills to meet the girder. The floor is double, the first layer be-

ing an inch thick dressed on one side to make the boards even in thickness, is laid diagonally. On top of this is laid a layer of felt roofing topped with tar, both under-

in the length of the stall. These planks are nailed to one cross piece in the middle and another cross piece a little thicker under the manger, but the nailing is not very

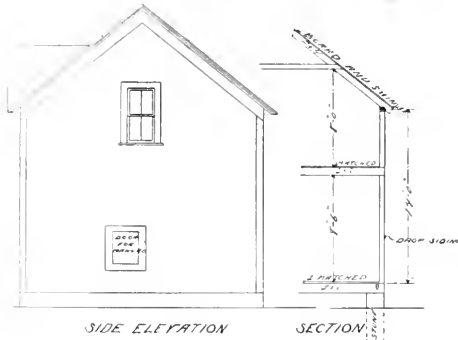

SECOND FLOOR

neath and on top. The upper floor is one and three-eighths matched hard pine.

In the stalls two inch planks are laid lengthwise, having an incline of two inches

solid because stable planks soon wear through and it is necessary to turn them end for end, sometimes within a year.

Hay and Grain Barn—A167

A long barn designed to hold a good deal of hay and grain is shown in this illustration. It is a timber frame covered with eight inch drop siding and shingles.

The track for the hay fork is suspended from the peak by seven-eighth inch iron

rods and the track extends the whole length of the building and projects several feet at each end. This arrangement makes it convenient to fill the barn from either end or from both ends as occasion requires. There is a driveway crosswise

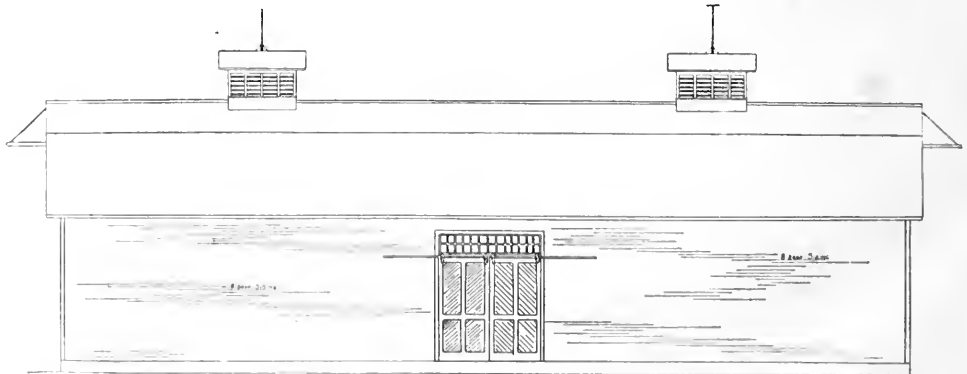

SIDE ELEVATION

through the barn at the center. This driveway is floored with a two inch plank floor, but it is not necessary to floor the other

farmers prefer to have it convenient to the fields because it is never used for housing stock unless it be sheep and they

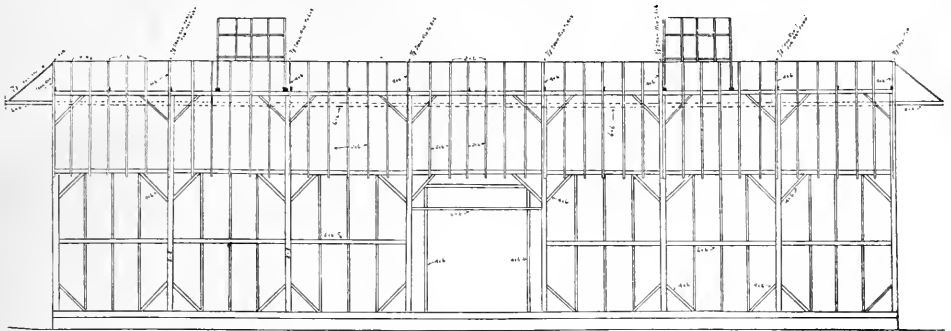

LONGITUDINAL SECTION

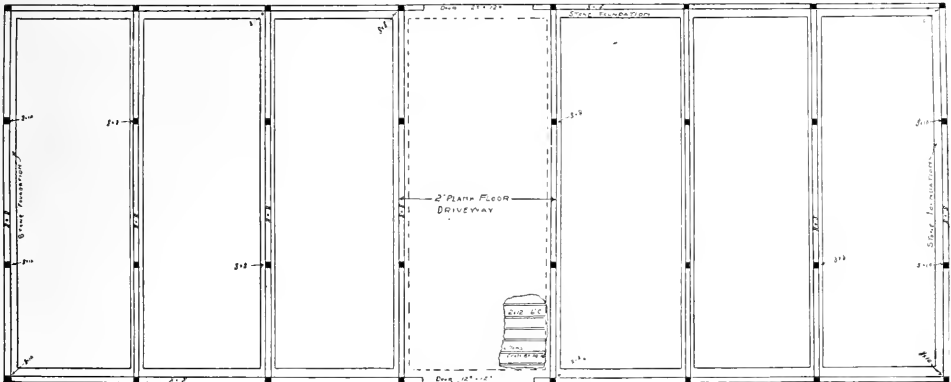

FLOOR PLAN

part of the building except with round poles to keep the hay and grain sheaves off the ground. Such a barn is intended more for storage on large farms where considerable grain is harvested and hay cut either to feed or for sale.

It is not necessary to have such a barn near the other farm buildings. Many

don't require quite such frequent attention as other animals.

The cross center floor is intended for threshing, but there is no provision for storing threshed grain. It is supposed that there is a granary near the house and other buildings and it is better to haul the grain from the machine.

A Double Corn Crib—A120

A double corn crib with a storage room overhead and a driveway in the center is shown in this illustration. A peculiar

feature of this plan is the siding which is split from two by fours with a band saw in such a way as to get three pieces of sid-

ing from one strip. After the siding is ripped out it is run through a sticker to give the curve as shown in the the detail drawing. This is an extra protection

strong enough to hold the corn by being well nailed with wire nails on the outside of the studding which is placed twenty-four inches apart. It is impossible to get

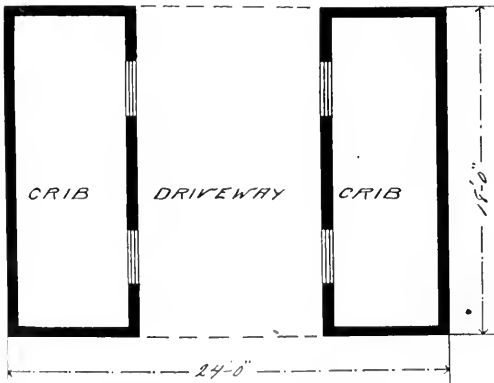
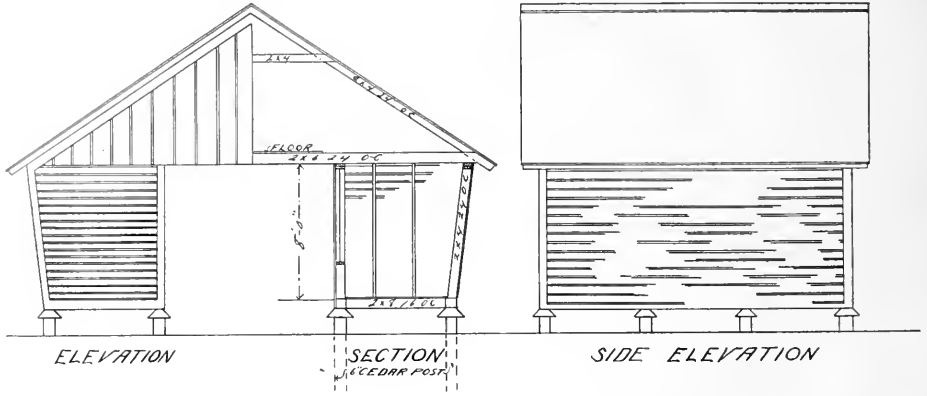

PLAN OF CORN CRIB.



DETAIL OF SIDING

against beating storms and it is supposed to encourage a draft of fresh air up through each opening for the benefit of the corn. The strips are nearly an inch thick on the lower edge making them

corn enough into a crib of this height to break the slats or shove them out. Corn cribs should not be more than six feet wide because corn will mould in a crib that is too wide.

The driveway in the center of a crib like this is very useful. There is room for a wagon or two and there may be pegs to hang a great many farm implements such as neck-yokes, extra whiffle-trees, chains and hand tools of all kinds. The loft overhead makes good storage for lumber and there is no better place for seed corn than to hang it by wires from the collar beams. The tin pans turned up-side-down over the tops of the cedar posts will

bother the rats most of the time, although they sometimes find a way to get in. Probably carelessness in leaning something against the crib helps them up in the majority of cases. Rats and mice are often carried into the crib with the corn. They are sharp enough to get into a bushel crate and stay there until they are carried inside. In this way a farmer often populates his own corn crib with rats or mice without intending to.

A Small Wagon Shed—A108

A wagon shed twenty feet wide and forty feet long like the one in the plan illustrated is a useful building on every farm. One thing is important about a

apart, and will, of course, build a doorway accordingly.

Implement sheds like all other buildings should be designed for what is to be required of them. An implement shed is a necessity on every farm, but some farmers want to house threshing machines and traction engines, while others want a shed to hold mowers, plows, cultivators, a wagon or two, and perhaps a few barrels and other truck. A large building, of course, would answer for everything, but it is not necessary to build bigger than a man wants.

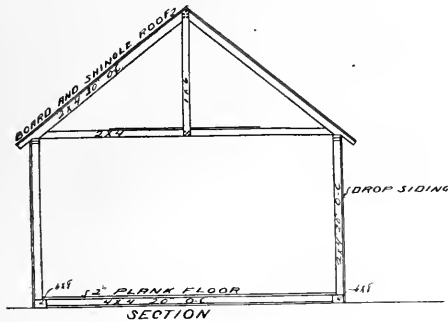

wagon shed, and that is to have the entrance wide enough to get things in and out easily and quickly. This double door gives an opening ten feet wide, which is very good for small implements, but some binders require about sixteen. The door entering an implement shed must be high enough to let in the highest implements used on the farm, and there must be no cross timbers inside lower than the top of the door. A binder with a reel on takes considerable room.

The farmer building the shed will know whether he wants to house a binder under full sail or whether he wants to take it

A good many tool houses are built with-

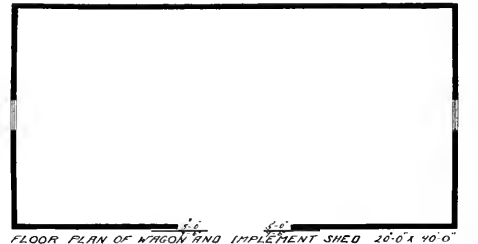

out floors, but the extra cost of the floor is more than offset by the dryness and freedom from rust on the machinery. Wagons and machinery require repairing, which is easily done in a building like this when you have a good floor to work on.

Odd days in winter may be profitably spent in such a building with a few carpenter's tools, a paint brush and an assortment of paints and oils.

Two Small Ice Houses—A103, A104

There are two requisites in all ice houses that must be considered. The first and most important is drainage. There is a constant drip from ice during warm

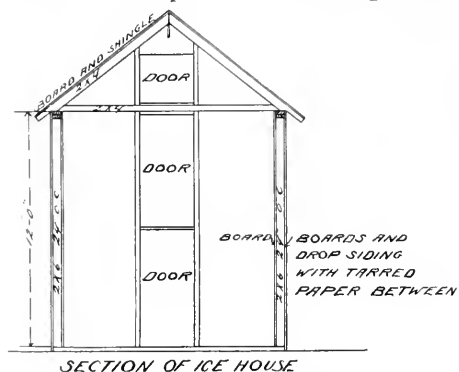

weather, and if this is permitted to accumulate it will melt the ice very fast, but if carried away as fast as it comes it can do no harm. The second is the roof. You must have a roof tight enough to keep the ice dry on top. This is because the dripping of the water through a leaky roof will bore holes through the sawdust and let the air down to the ice.

Sawdust is the best covering to keep ice, but marsh hay is a close second. The reason why marsh hay is better than tame hay or straw is because the shell of the stalk is tougher and thinner; when it gets damp it mats down closely and keeps the air from the ice.

No matter what kind of a house you may have, you will find it necessary to pay some attention to the ice during the spring and summer. In the best of houses ice melts and settles. As it settles, cracks are made in the sawdust which must be immediately filled or serious loss will re-

sult. In the spring the ice house should be entered at least once a week and the sawdust tamped down all around the edges until it is solid. A foot of solid sawdust all around the ice will keep it splendidly.

Experienced builders of ice houses seem to favor cheap floors. Poles or rails covered with straw from four to six inches deep and this straw covered with a foot of sawdust before putting in the ice makes about as good a bottom as you can have. Very expensive ice house floors have been discarded in favor of this cheap affair.

Another point to consider in building an ice house is to have plenty of head

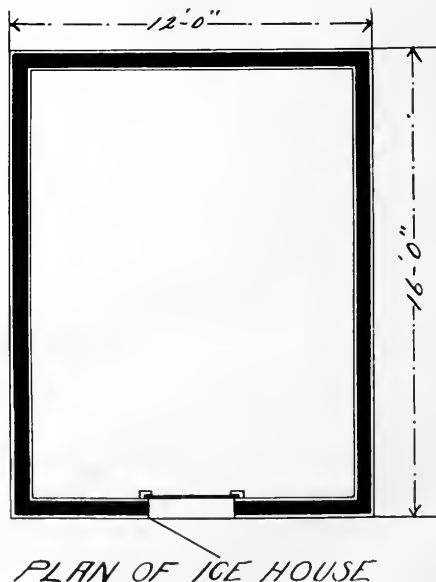

room. The best form of a block of ice is square and as high as it is wide. A couple of feet extra in height is a very good pre-

caution. A house twelve feet square and twelve feet high to the eaves leaves room for a block of ice ten feet square and twelve feet high if you lay the ice up to

the plan illustrated there are three doors outside and the inside of the door opening is laid in with loose boards which may be put in as the filling progresses and taken

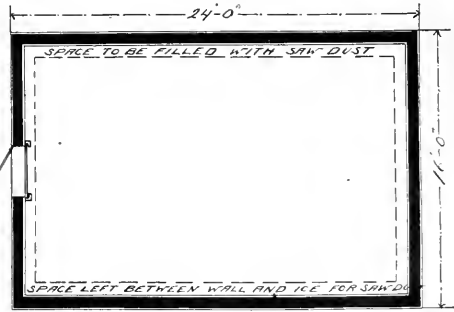
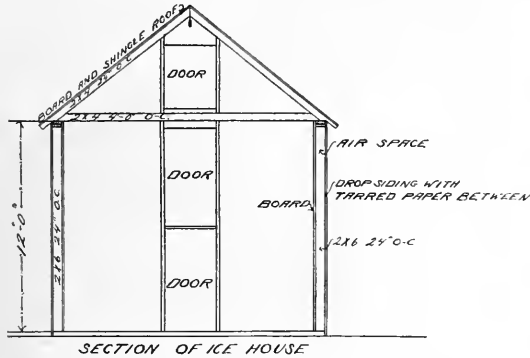

the plates. If you expect to do this, you can not have any cross beams except in the front and rear. There is very little side pressure on an ice house, so the construction can be made strong enough without cross beams in the center.

out again one at a time as needed to get at the ice. A single pulley in the peak and another one hooked in the sill at the bottom answers very well for a hoisting tackle. The ice may be lifted straight up from the sled or pulled up an incline. The thickness of the ice and the size of the blocks will have to govern the filling.

The door openings in all cases should reach from the ground to the peak. In

Small Livery Barn—A138

For a village or small city this plan offers a comparatively cheap building that may be used to advantage by a man who

hostler wants to sleep in the stable and this room, ten by fifteen feet, is sufficient for such purposes.

The problem in all livery stables is how to take care of the different rigs. There are cutters and sleighs to be taken care of

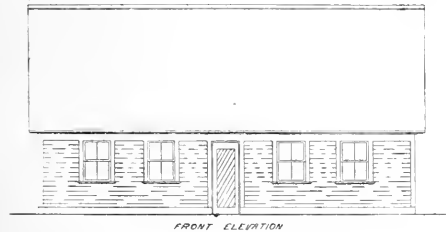

keeps four or five horses for hire. Usually in such cases it is not necessary to have a great deal of feed storage room because the hay is baled and sometimes the straw comes in bales. A good harness room is necessary and it often happens that the

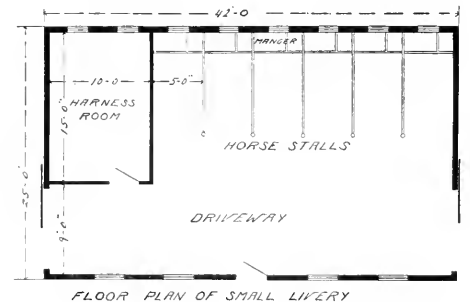

nine or ten months in the year, when they are not in use, and there are wagons in the way almost all the time. Storage room is

Too often public stables are littered around outside of the building with old trash that should be sold for junk or burned up. Such conditions are more noticeable in the smaller places. But pride in keeping up one's property is just as valuable and just as necessary in a village as in the city. Perhaps liverymen and blacksmiths are a little more careless in this respect than any other class of citizens. Why this should be so is a mystery. It costs nothing to be neat and neatness attracts trade in these lines as well as others. From general observation it would seem that a place for everything and everything in its place is a suggestion which applies to liverymen and blacksmiths all over the country.

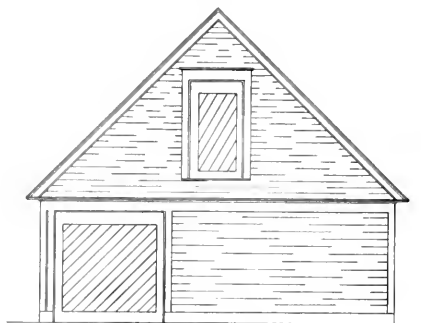

SIDE ELEVATION

expensive and sometimes ground room is an object.

Convenient Horse Barn--A129

Plan (A129) shows how to build a small convenient horse barn twenty-one by thirty-two feet in size. A building like this is very convenient on farms where it seems

best to keep the horses by themselves. There are a good many farmers who object to stabling horses in the same building with other animals. Besides it often is

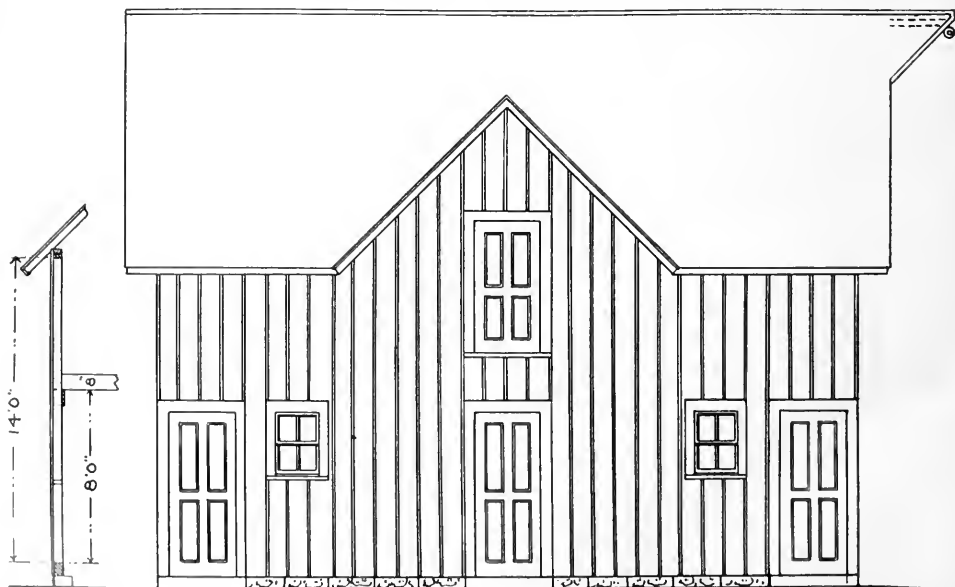

more convenient to have a small horse barn near the house and in case of fire there is a further advantage in having the

about three inches higher than the floor behind the horses an incline will be secured sufficient to keep the feed room dry

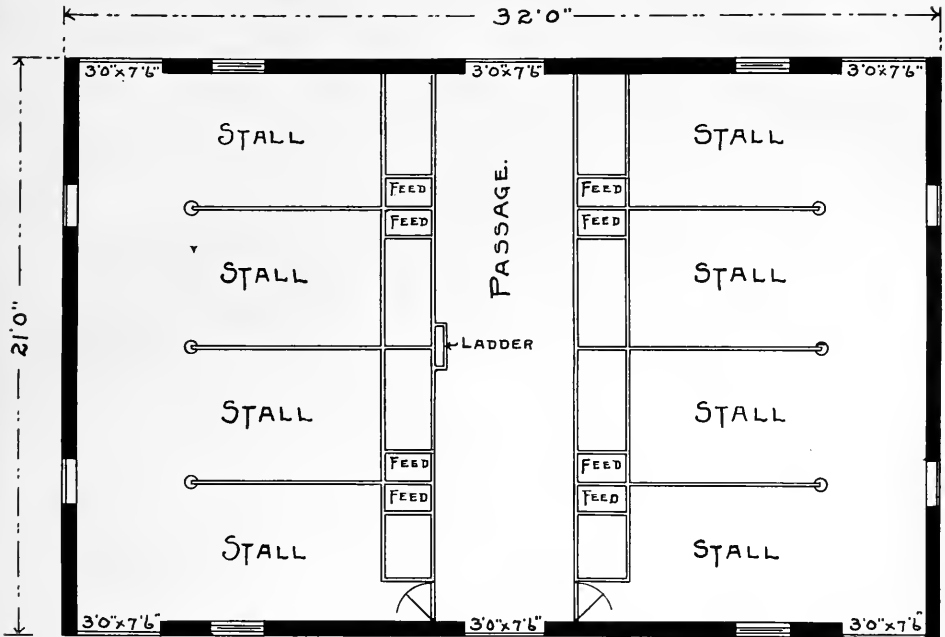

FLOOR PLAN.

buildings separated. The old English plan was to scatter farm buildings far enough to prevent a general conflagration in case one should take fire, but labor cut less of a figure then.

This little barn should have a cement floor with foundation walls going below frost. By making the feed passageway

as well as the floor under the horses. Most horsemen prefer to cover a cement floor with planks where the horses stand. This may be done in every stall or in some of the stalls while others are left with the cement floor. The planks should be two inches thick with tongue and groove matching laid at a slight incline.

Cattle Shed--A155

Sheds on three sides of a hollow square is an old style way of building feeding sheds. It is probably the best way now except that it is more difficult to economize labor with this construction than it is with a straight away proposition where you can run a railway and a feed truck the whole

length of the shed. The hollow square proposition has the advantage of warmth because it is protected from the east, west and north winds. Yards like this are always built opening towards the south.

In this plan there are convenient gates to drive in when bringing roughage or

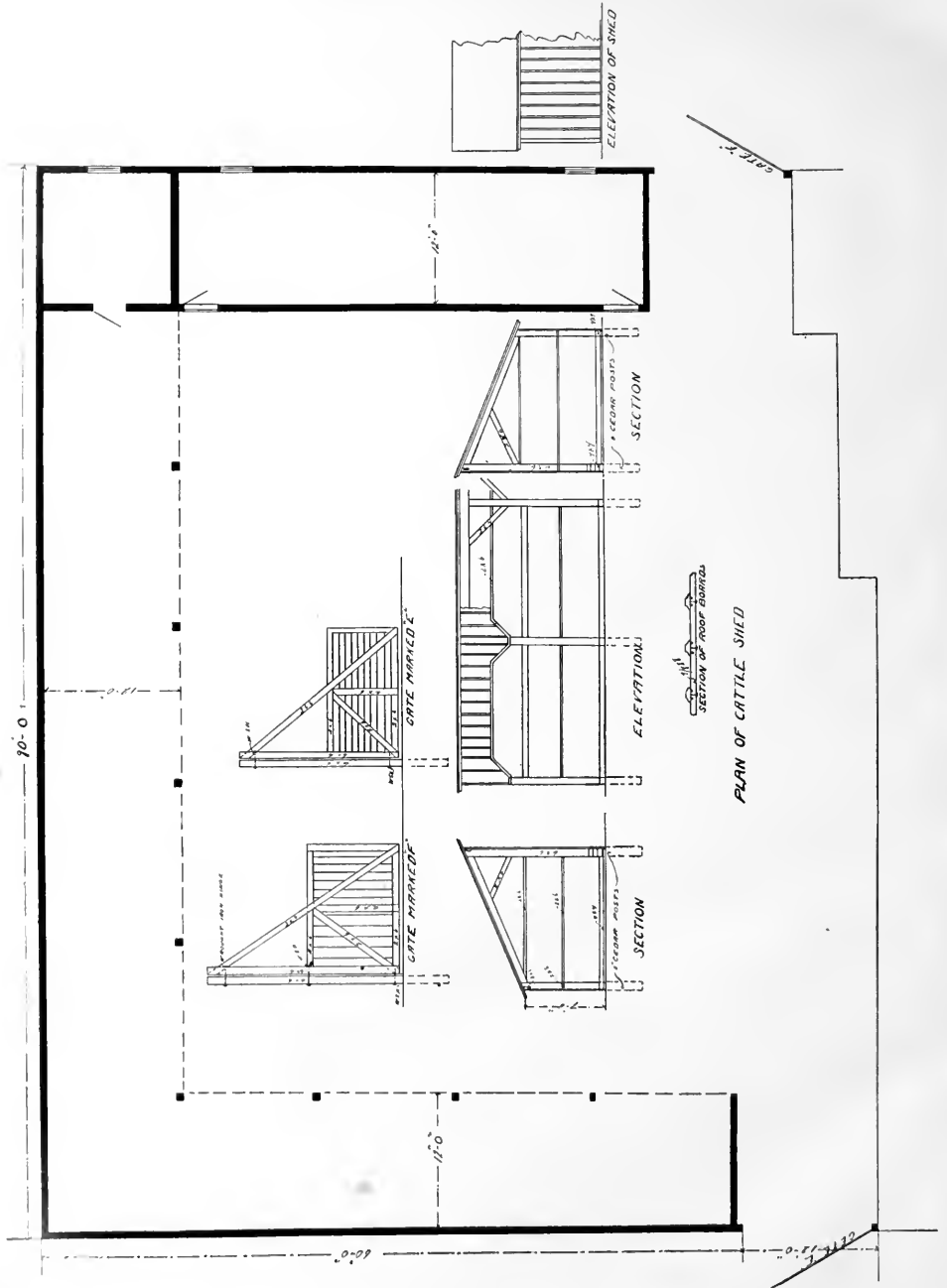

other feed to the cattle. The gates to look well should be made right and left and they should have automatic device to fasten them quickly. Animals confined in a yard in the winter time are crazy to get out. They learn how to slip up alongside of a wagon and crowd through the gate when the driver is engaged with his team. This is a source of annoyance that can hardly be avoided, but good gates that swing easily and fasten quickly help a good deal.

It is customary to drive around with a rack load of feed and dump a little in each feed rack as often as necessary. Sometimes a self-feeder for corn in the ear is placed in the middle of the yard and this helps a good deal in saving labor and the labor problem is worrying feeders more every year. There are feed carriers that may be hung from an overhead track to pass around through a shed like this, but usually the cars do not hold enough to effect much of a saving.

A Hog House—A109

In building a hog house it is necessary to consider convenience in getting the hogs in and out, to provide means for loading them into wagons and a place for heating water and to do the work of killing.

tain pens. That is the time when the alley door will be appreciated. Another good thing about this hog house is the swinging front of the pens which swings back over the trough and prevents interference when putting in the feed. The

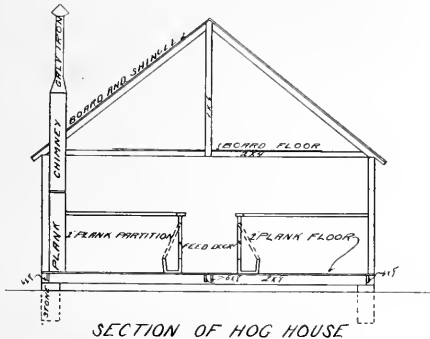

This plan offers an opportunity to back a wagon up to the rear door for loading and a room in the front end away from the pens is arranged for a feed room and slaughter house.

Provision is made for moving hogs from one pen to another by having cleats in the alley for holding sliding doors.

Hogs thrive better when animals of the same size are penned together. Some grow faster than others and it is sometimes desirable to select out one or two from cer-

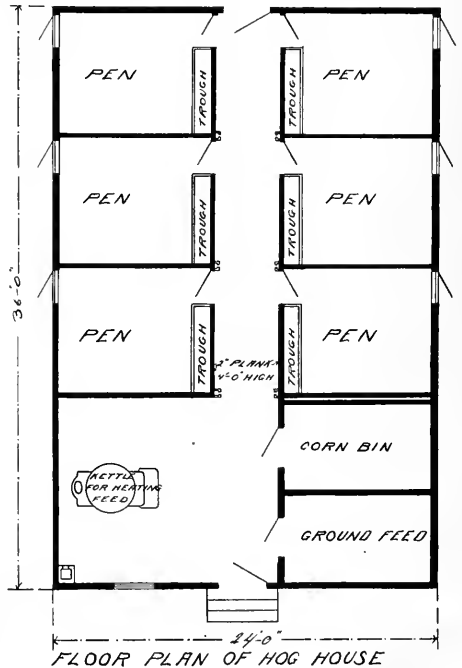

partitions next to the feed room run to the ceiling but the partitions between the pens are only four feet high.

There is no cornice to the roof. The openings above the plates between the raf-

ters are left for ventilation. This hog house will accommodate about forty hogs. From six to eight in a pen are enough, if more are housed together they pile up and smother each other.

Carriage House and Stable--A127

The illustration on this page shows a carriage house and stable twenty by thirty feet on the ground and fourteen feet high to the plates. The ceiling is eight foot six inches which is about as low as

ing things. No carpenter likes to have such remarks made about him.

The internal arrangement of this stable is different from most small carriage houses. There is a box stall about nine

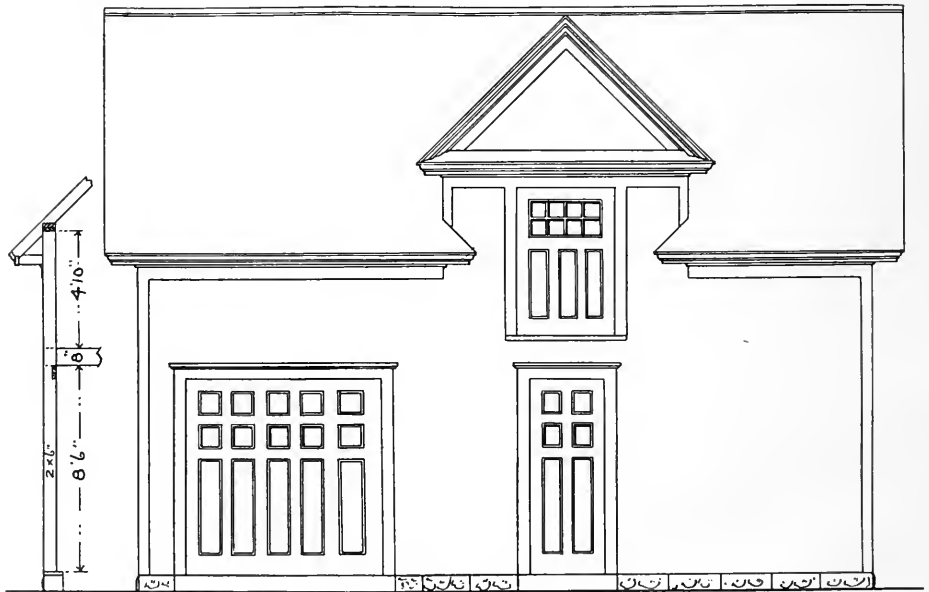

FRONT ELEVATION.

you can have a ceiling in a carriage house because you must have room enough for a top buggy. For this reason the doorway must be about the same height. We all have had experience in catching a buggy-top on the lintel of a low doorway. It seems to be the proper occasion for say-

feet square. It is difficult to plan a decent sized box stall in a small stable. They run into room too fast. Nothing looks so comfortable for a good horse as a roomy box stall. If the horses had their say about it there would be more box stalls, but it really requires about three

times as much room to stable horses this way. No man begrudges the room, but most men don't like to put up money enough to enclose it properly.

The ideal arrangement for stabling a horse is a big box stall with a good sized window for light and a door cut in half

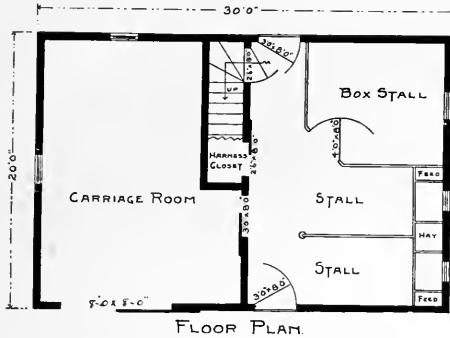

so that the upper part may be left open during the day time to let the horse look out. A box stall shut up tight is a prison for a horse; they like to see things as well as other folks.

Some box stalls are fitted with rubbing boards. These consist of planks about two inches thick turned edgewise to the horse and fastened to the sides of the stall just low enough down so the horse can't rub his tail. A box stall needs no floor and there should be no feed rack or manger. A box on the ground to feed oats

in is all the manger necessary. The hay should be put in at frequent intervals in small quantities placed lightly on the floor or bedding against the side of the stall. This way of feeding has often cured horses of chronic indigestion.

In building a stable it is a great deal better to find out all these little details and build accordingly. There are several reasons why box stalls are better than standing stalls with mangers. A horse loves his freedom. To understand this it is only necessary to watch a horse when you take the bridle or halter off.

One great defect in horse stalls as you ordinarily see them is lack of ventilation. It is quite common to see the inner walls of a stable in winter white with frost. The frost wouldn't be there if the stable was dry as it should be. It is not necessary to put in an elaborate system of ventilating pipes in a small stable. The windows and doors are sufficient if they are managed right. The breath of one or two horses is easily taken care of, but even in small stables such things often are neglected.

In this barn the carriage room is closed off from the stable, which is right. The odor from the stable is a damage to the carriages and to the rugs. The stable should be warmer than the carriage room, so the door works right from both sides.

Practical Poultry House--A168

A single section of a two-pen poultry house fourteen by twenty-four feet is given in this plan. The house of course may be any length by adding any number of twenty-four foot sections. It is placed so that the windows look to the south to gather all the sunlight possible.

A passageway on the north side, where

the roof is high to make head room, is partitioned off and the work of feeding is done along this passage. A door lifts up in front of the roosts from this passageway to facilitate cleaning. It is not necessary to enter the scratching room very often because most of the attention may be given from the alleyway. With the ex-

ception of the space occupied by the dust boxes the whole floor, except this passage-

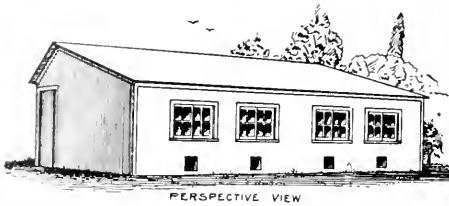

commodate from twenty to thirty birds according to the size.

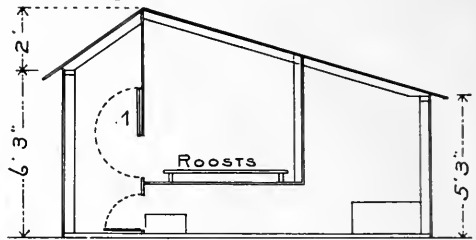

way, is given over to scratching purposes as the roosts and dropping boards are ele-

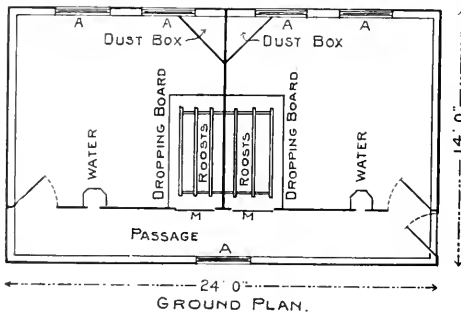

vated so the chickens can work under them. A section of this house will ac-

Poultry men argue by the hour about the necessity of an alleyway. There are many different opinions. Some think an alleyway is worth all the room it takes up just to prevent annoying the fowls, when feeding in and out from amongst them. Other poultry men think that chickens ought to be tame enough to pay very little attention to the feeder when he goes about his work, but it is generally noticeable that a hen makes quite a fuss when she thinks she is about to be cornered. This applies to hens that are ordinarily tame as well as those that are ordinarily wild.

Cheap Grain Building—A128

A cheap building to hold grain and corn is shown in this design. It is a low building with studding only ten feet long, but that is about as high as a person cares to pitch corn or threshed grain. Just ordinary one by four pine strips spaced to $\frac{3}{4}$ inch are nailed on the outside of two by four studding to make the corn crib, but the wheat and oat bins of course are made tight all around and a little extra work is put on the floor.

There is considerable side pressure in a wheat bin which must be guarded against by using a few extra braces, but heavy timbers are unnecessary in a bin the size

of this one. This building may be floored overhead for storage, or the bins may be left open to the roof. By leaving the space open the building will be lighted sufficient by the small window in each gable.

It is not intended to floor the driveway unless it is needed when using a fanning mill to clean grain, but the building would be all the better for having a good solid floor the full size. This plan provides for a building thirty by forty feet. Thirty feet is wide enough for convenience either in building or for use afterwards, but of course it may be any length.



FRONT ELEVATION.

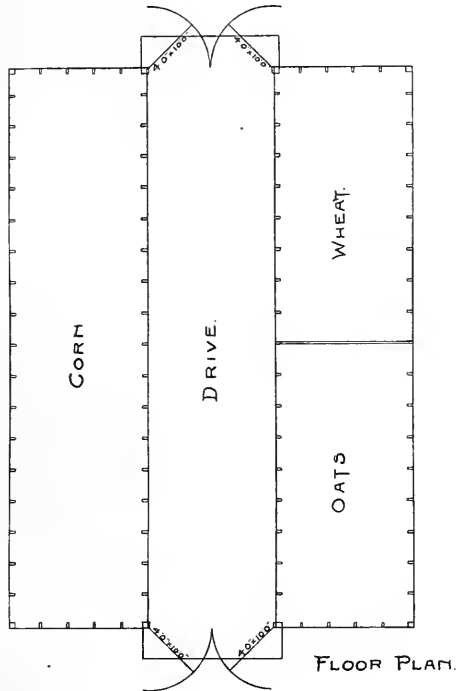

FLOOR PLAN.

Barn for Small Farm—A 169

A neat little barn that is well proportioned and suitable for a farm of twenty or thirty acres is given in these illustrations. There is a threshing floor in the middle with wide double doors in the north side as well as in the south side mak-

warmer in a stable with a low ceiling and if there is plenty of chance for the air to get in and out again they have good ventilation.

It seems difficult for some livestock men to understand this phenomenon. The rea-

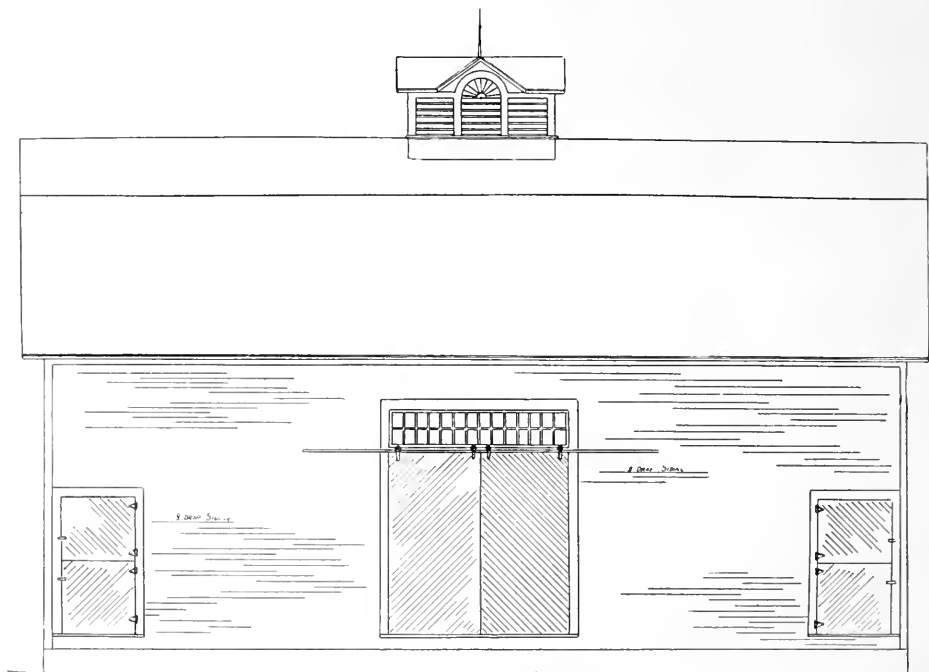

SIDE ELEVATION

ing a good liberal passageway through the center of the barn.

On one side of the driveway is a granary and stabling for three horses with a nine foot ceiling. A third of the barn on the other side of the driveway is made into a cow stable making seven good roomy stalls. The cow stable side has a ceiling seven feet high. Cows don't get their heads up as high as horses do and they don't need such a high ceiling. Cows keep

son is the air circulates more freely when it is warm. The body heat of seven cows in this stable with a low ceiling will warm the air sufficiently to keep it in circulation. If there are openings where the fresh air can get in, the foul air will find its way out and there will be a constant change.

Both the cow stable and horse stable are boarded up in front, but barn boarding usually is not very tight. Unless matched stuff is used there is a little opening be-

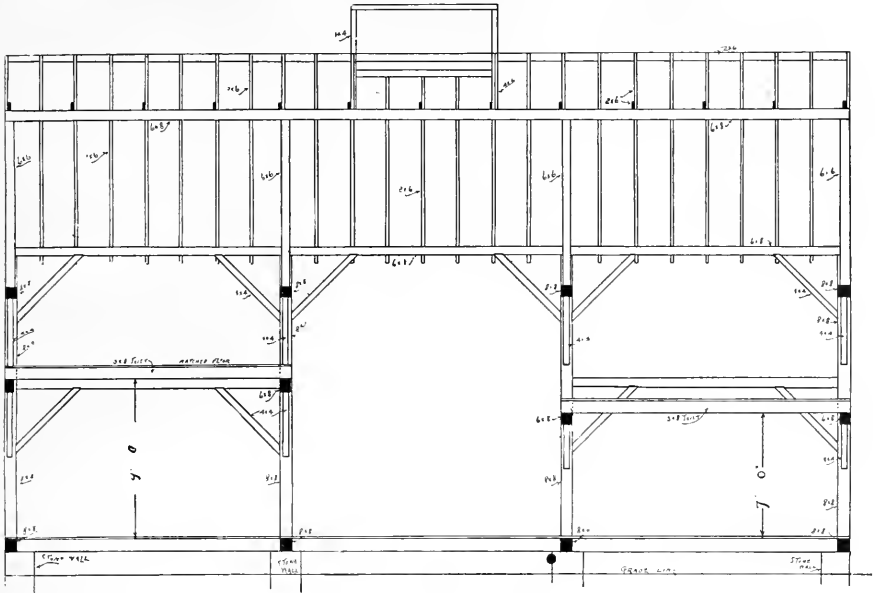

LONGITUDINAL SECTION

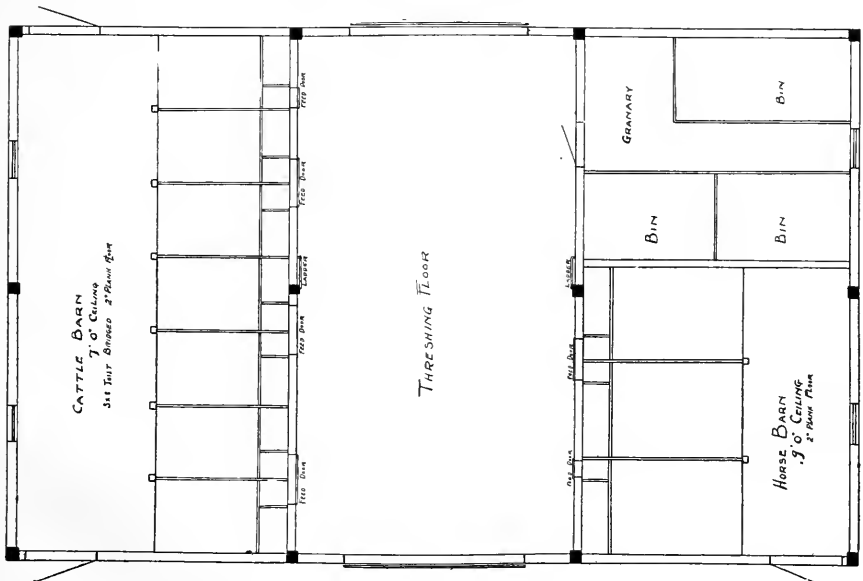

FLOOR PLAN

tween the boards that allow for the escape of a good deal of bad air. There usually is considerable space around the doors. There are feed doors in front of the stable so the fodder may be put in from the barn floor.

It is hardly necessary to use a horse fork in a barn of this size. The flooring overhead does not cover the whole of the threshing floor so that hay and grain in the sheaf is forked up by hand. It will be noticed by referring to the transverse and longitudinal sections that the timber is very carefully planned for size and length in proportion to the building. Every stick is necessary but there is not a piece too many.

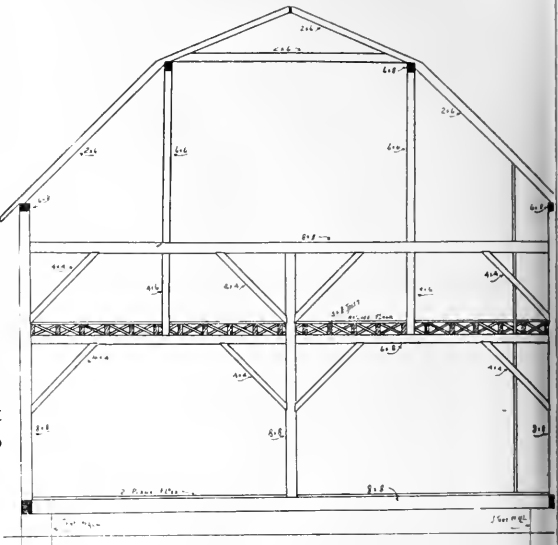

A Rat Proof Granary—A141

A dry floor and one that is rat proof is made by excavating for the foundation of the granary about six inches deep. Then pound in three or four inches of cinders and lay the sills and joists on the cinders.

After the building is up and enclosed make cement concrete by mixing one part cement, three parts sand and four parts

gravel or broken stone. Fill in with this concrete to the tops of the joists, then while the concrete is soft put down the matched floor, nailing it right into the soft concrete. As soon as the floor is finished shut the building up tight and bank around the outside to keep the air away from the concrete so it will dry slowly.

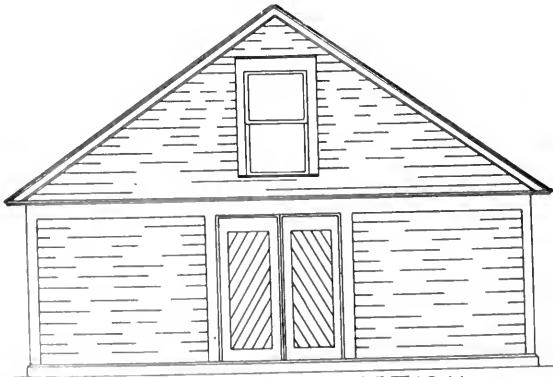

END ELEVATION

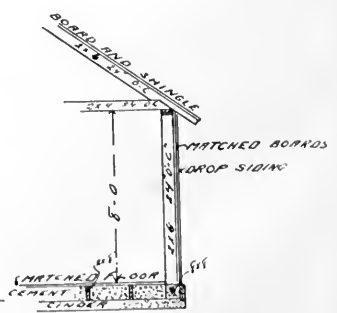

SECTION

The matched boarding is put on the outside of the studding and the siding nailed over that. This is for the purpose of leaving the inside exposed so that a cat or dog could easily reach a rat if it should get inside. Hollow walls make harbors for rats but this construction leaves them no protection.

There is a window in the back end of the alley and another one over the door in front. The doors are made heavy and swing out. They close against heavy jams so that rats and mice have very little encouragement to get in at the door. The scales are let in the floor flush. Provision must be made for this before the concrete is put in.

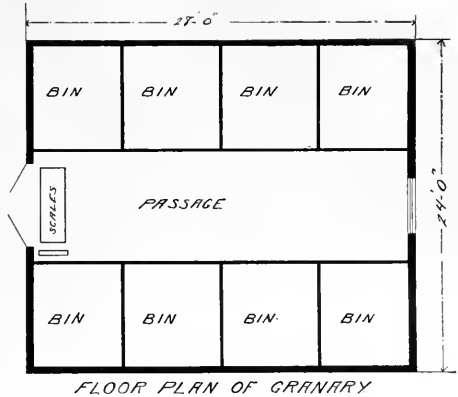

A Tank House—A144

Every farm should have a wind-mill and every wind-mill should have a tank house connected with pipes in such a way as to keep a continuous supply of water

a tank inside six feet high, four feet wide and twelve feet long. In the winter time a space between the sides of the tank and the sides of the building may be filled in

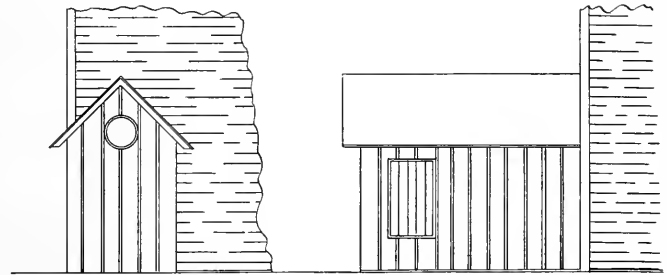
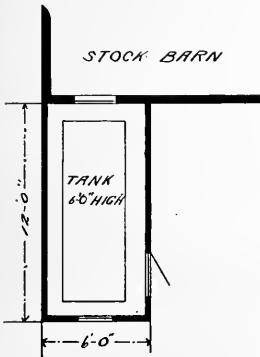

PLAN OF TANK HOUSE

for the stock. Tank houses are wet things and it is better not to have one inside of a barn. A tank house is necessary to shade the tank so the sun won't spoil it, to shade the water in summer to keep it cool and to protect it from frost in winter.

Plan (A144) shows a snug little house, tightly built with paper in the walls and

with manure to keep water from freezing.

Pipes from the bottom of the tank to the watering troughs are connected with valves either underground or in boxes that are covered with manure. The valves have long stems so they may be turned from outside the building, or by opening the little door and reaching in.

A Small Barn—A113

A small barn with two double stalls and one single stall with standing room for another horse is offered in this plan. The

makes a harbor for rats. It is better to have it boarded up. The stable doors in this plan, both at the north side and at

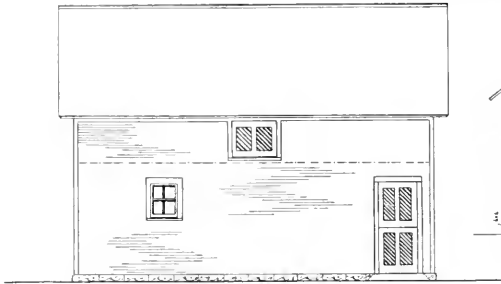

North Side



South Side

barn is twenty-six feet wide and thirty-two feet long, one half of which is partitioned off for a stable and the other half

the south side, are cut in two so the upper half may be opened for air and ventilation and the lower one remain shut to keep the animals from going out and in. The plan is as simple as possible to make a barn and still have it look well. It is large enough to be of some use and it has quite a loft for hay. A cheap little barn like this answers the purpose as well as a more expensive one.



West End

is kept for carriage room and storage. There is no foundation under this barn except stone or brick corners and center supports, but it is a good plan to put a board around under the sill and bury the lower edge in the ground.

A barn that is open underneath

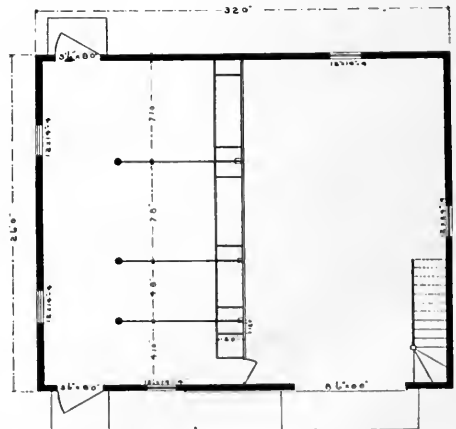

FLOOR PLAN

A Stave Silo—A157

The cheapest way to make a satisfactory silo is to build it of two inch staves with a cement foundation and pit. Stave silos don't last forever, probably their average usefulness is somewhere between five and

when not filled. The best stave silos will go to pieces if the hoops are not kept tight when the silo is empty.

The most convenient height to make a stave silo is thirty-two feet above the wall. This gives an opportunity to use sixteen foot stuff to advantage. In building a silo sixteen feet in diameter it is only necessary to use two lengths of staves, a short length, eight feet, and a long length, sixteen feet, in order to break joints at dif-

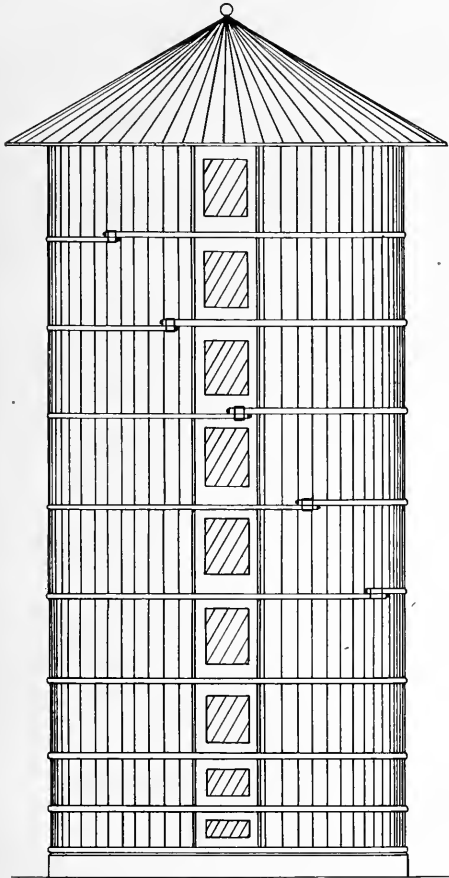

ELEVATION OF SILO

ten years. It will vary according to the material used in the construction, the care with which they are built and the protection they receive afterward, especially

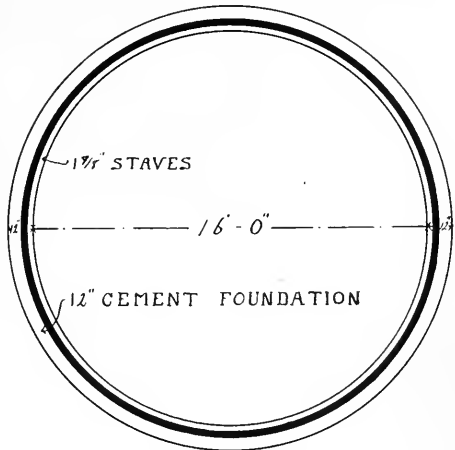

PLAN OF SILO

ferent heights. If larger silos are built it is a good plan to use enough four foot and twelve foot lengths of staves so that you have only one joint to two solid staves on one level. Where only two lengths are used as in this plan the joints and solid staves come alternately, but even this makes a very strong structure when the hoops are pulled up tight as they should be at all times.

The staves should not be wider than eight inches. The edges should be straight

and true, the bevel carefully made on a sticker and turned up with a hand pointer by a competent workman. The bevel is very important. Where the edges of the

venient to use staves all of the same width. They may be from six to nine inches wide, but they must come in pairs or sets of three of the same width together. Where staves are used of different widths the system of numbering shown in the draw-

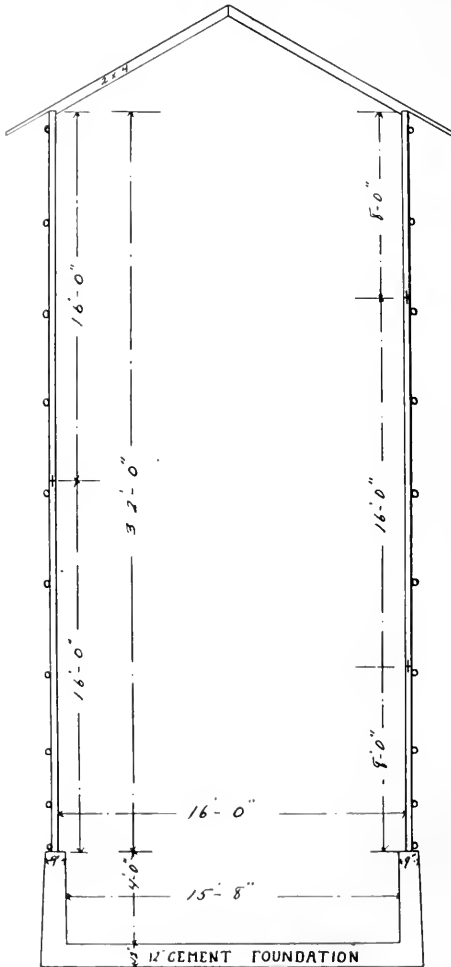

CROSS SECTION OF SILO

staves come together the joint should be perfect from inside to outside and from top to bottom of the silo.

It very often happens that it is not con-



ing will be found very useful. Staves are all cut to size and length and numbered, they can then be loaded on a wagon and hauled to the building site and laid out on the ground in proper order. There will be about seventy-five eight inch staves in a silo sixteen feet in diameter. The door frame takes up about three feet of the



14 1 7/8" x 8" STAVES

IN A SILO 16'-0" INSIDE DIAMETER

circle. In making the door frame ladder use the best material you can get and have it framed square and solid with good jambs well fitted for the inside door panel to shut against. It is almost impossible to make a silo door tight enough.

The doors in this plan are built like refrigerator doors. They are put on and

BAND



IRON TONGUE

held in place by lag screws turned into the timber. The outside boarding of the doors is double to make a firm hold for the lag screws. It is a slower job to put the doors on when they are fastened this way, but it is only necessary to change them twice a year.

A hoop passes around the silo between each door. These hoops are made in sec-

tions, each length about sixteen feet six inches long, as this allows for the lap and the take up of the threads at the yokes.

hole a foot thick at the bottom and nine inches at the top and five feet high. A twelve inch bottom is put in at the same



DOOR SECTION

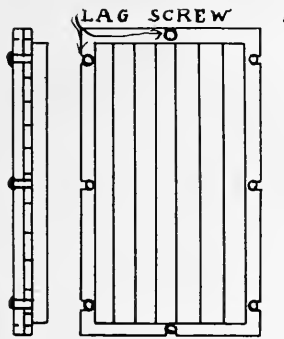

SIDE AND BACK ELEVATION OF DOOR

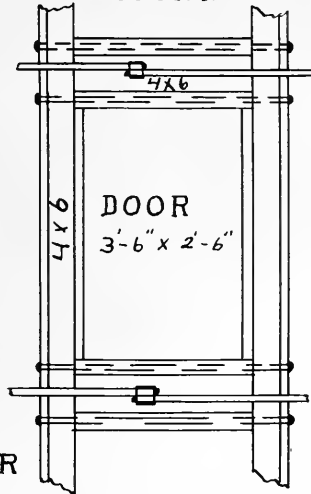

FRONT ELEVATION OF DOOR

ELEVATION OF DOOR FRAME

There is a cast iron yoke at each meeting of the hoops as shown in the detail drawing.

time so that the pit when finished is four feet deep and fifteen feet eight inches in diameter in the clear. The walls are nine

2B 2B	1 1	2T 2T
4B 4B	3 3	4T 4T
6B 6B	5 5	6T 6T
8B 8B	7 7	8T 8T
9B 9B	9 9	9T 9T

STAVES NUMBERED AND LETTERED

The bottom of the silo is made of cement. A round hole is dug seventeen feet eight inches in diameter. A cement wall is built around the outside of this

inches thick on top.

In starting the woodwork, first set up the ladder door frame on the center of the cement wall. Make it plumb and stay-

lath it in place and put on plenty of braces so it can't move. Then set up the staves starting at one side of the ladder with number one. Set the staves on end on the center of the wall or a little outside of the center. This is important because when you commence to tighten the hoops the staves must draw in and you want about two inches of wall on the inside after the staves are drawn tight. You shouldn't have more than two inches because you don't want a shelf at the top of the wall to prevent the silage from settling.

It will be noticed that the hoops are placed much closer together at the bottom than they are further up. It seems more difficult to keep a silo tight at the bottom, there is more pressure on it. When the sides are up and the hoops made tight the bottom should be finished all

around both inside and out with rings of cement where the wooden staves meet the cement wall. Make this joint water tight if you possibly can. Very often the juice from the corn will fill the pit and run over. Keep the liquid in if you possibly can.

The roof of the silo should be light and removable. You can't fill a silo full unless you have boards to set up to reach a few feet above the top. It will settle sometimes as much as ten feet. It is an advantage to take the top all off and to have boards six or eight feet long set up around the top temporarily and fill to the top of these extra boards. It will settle enough then. Where the ends of the staves meet make a saw-cut an inch deep. Have pieces of two inch hoop iron cut just long enough to reach the width of the staves and use them for iron tongues to match the ends of the staves together.

An English Barn—A99

Small artistic stables are more common in England than they are in the United States, possibly because the country is older and the people have had more time to develop an artistic taste in such matters. An English gentleman likes to keep his cob and cart. He wants a good smart turn-out that presents a respectable if not a dashing appearance; then he likes to have things in keeping at home, so he maintains a very neat carriage house and stable.

Some of these carriage houses are older than the proprietor but you would never know it to look at them. They are kept in such repair and they nestle amongst the hedges and trees in such a pretty homelike way that you never think about their age or intrinsic value. You get the impression at once that they are proper and proper goes a long way in England.

You don't wonder that they have very neat stables just the right size and that they appear modestly retiring away to the back end of the pretty garden. It just seems to come natural. Their great, great grandfather or their double great uncle did the same thing long before they were born so all they have to do is to follow precedent.

The English carriage house of today was built after hundreds of years of experimenting until the location of every plank, the size and direction of every door and window was determined without any further question in regard to the possibility of the slightest improvement. It is put back on the lot in the furthest corner from the house. The approach to it is through an arched or pillared opening in a beautifully well kept hedge. The driveway is not straight. English gardeners

keep just as far away from straight lines as they possibly can. Somebody discovered in the time of King Alfred that curved paths and roadways in gardens were proper. Some of the old enthusiasts went a step too far and got them crooked. This

was frowned upon for a century or two until succeeding generations pulled some of the kinks out by injecting a few liberal doses of English conservatism so that now after a good many generations the driveway from the lane through the back



SIDE ELEVATION

DESIGN FOR A
SMALL BARN

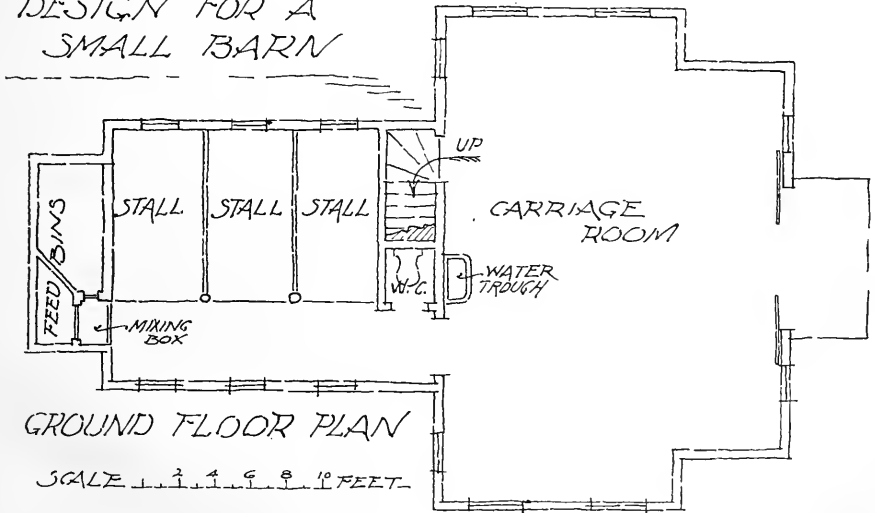

GROUND FLOOR PLAN

SCALE 1 2 3 4 5 6 7 8 9 10 FEET

of the lot to the stable is gently curved. The stable also is partially screened from view by hedges, vines and trees: This is proper in England, it is good sense in any other country.

The difficulty of doing things just right in the United States is that we are in too much of a hurry to get satisfactory results. We get ready to build a stable one day and have the material on the ground before breakfast the next morning. We haven't decided where to put the thing so we go out with the carpenter harboring the idea that his time is going on and that while we detain him he is not engaged in sawing or hammering. For economy sake we must decide instantly. The street line is guessed at and the barn placed just a little inside. After it is up and the workmen have gone there is plenty of time to think it over and regret not having done some things differently, but the barn is up now, it has cost a little more than we counted on, they always do cost more than we expect, and we always expect they

will when we start in, but at any rate we haven't any time or money now to change things or even level off the ground properly. We haven't figured on a curved driveway, that is all nonsense, but we lay down some planks to keep us out of the mud. The finish is not satisfactory to ourselves or anybody else, but we have a barn and we have secured it in characteristic American hustle fashion so we ought to be satisfied.

The plan (A99) shows the general arrangement. There is a room partitioned off in the gable upstairs for the man. A stairway going up from the carriage room lands in this upper room. The feed bins at the back of the stalls connect with the storage bin on the upper floor by means of spouts as indicated. There is a carriage room that is large enough to look well and to accommodate a number of vehicles. Instead of having a harness room there are pegs for harness in a corner of the carriage room and the harness is covered with curtains hung to a wire overhead.

A Duck House—A98

A house designed for the housing of thoroughbred ducks is given in plan (A98). It is built up from the ground on cedar posts set on blocks to prevent settling. The idea is to have a damp proof house with the best possible ventilation.

The building is sixteen by thirty feet and contains one general room with a passage, which is also a storeroom for feed, along one side and across one end. All the principal construction details are fully shown in the detail drawings.

The house is built principally of two by fours as it is not very large and heavier timber is unnecessary. The especial features are the filling of mineral wool in the partitions for warmth and a slatted ceiling

with straw overhead for ventilation without drafts and without letting in an unnecessary amount of cold air.

This style of building is somewhat expensive but it is very satisfactory when finished. It is usually considered that any kind of an old shed will do for ducks. In most cases any kind of an old shed is made to answer the purpose, but there is money in the better breeds and to get results it is necessary to keep even ducks with some idea of comfort. Some of the improved varieties bring fancy prices for eggs and young breeding stock, but like other thoroughbred animals fancy ducks need a little more attention than little old scrubs that most of us were accustomed to.

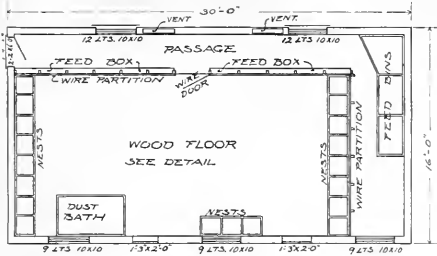

FLOOR PLAN

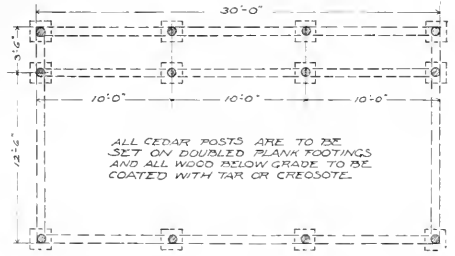

FOUNDATION PLAN

ALL CEDAR POSTS ARE TO BE SET ON DOUBLED PLANK FOOTINGS AND ALL WOOD BELOW GRADE TO BE COATED WITH TAR OR CREOSOTE.

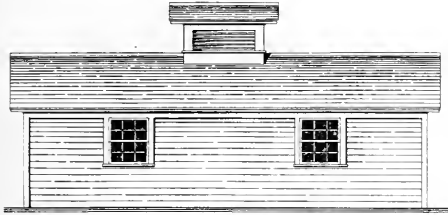

NORTH ELEVATION

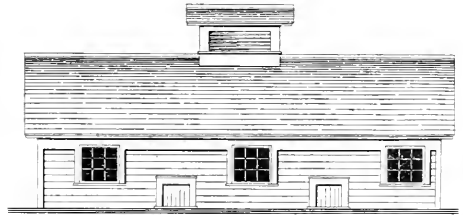

SOUTH ELEVATION

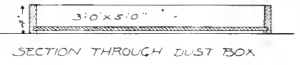
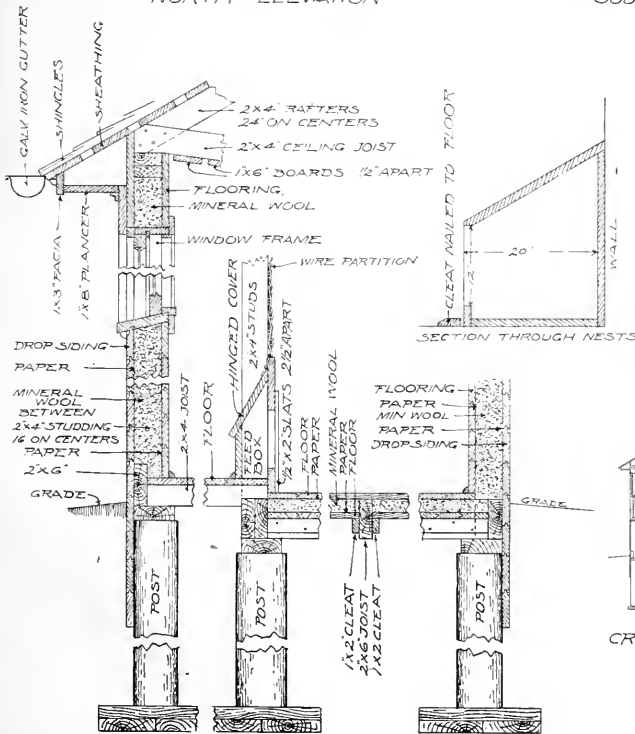

SECTION THROUGH DUST BOX

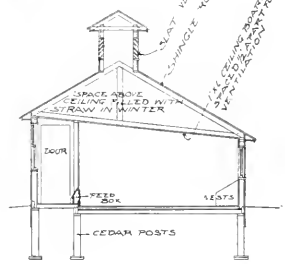

CROSS SECTION

Feed Lots for Beef Cattle—A184

Where cattle are fed in large numbers it pays and pays well to fit up properly for the business. In the corn belt, buying thrifty young cattle and finishing them for the market, is a splendid business in the hands of men who understand how to

of cattle in such a way as to make the animals comfortable and to economize labor.

Plan (A1234) has received very careful attention in this respect. The storage barn and silos are set on a ridge of ground sloping preferably to the southwest. The feed

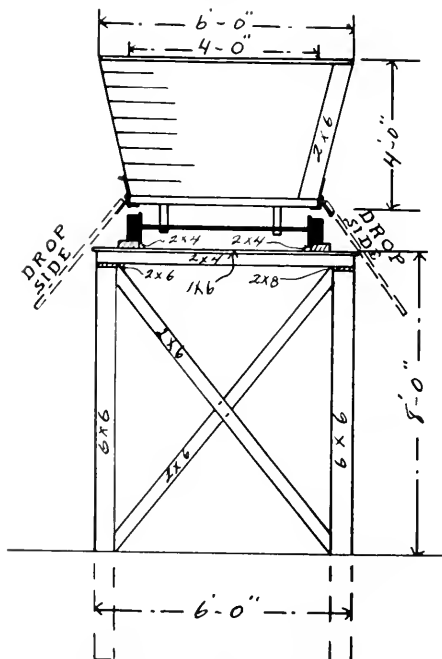

CROSS SECTION
OF CAR

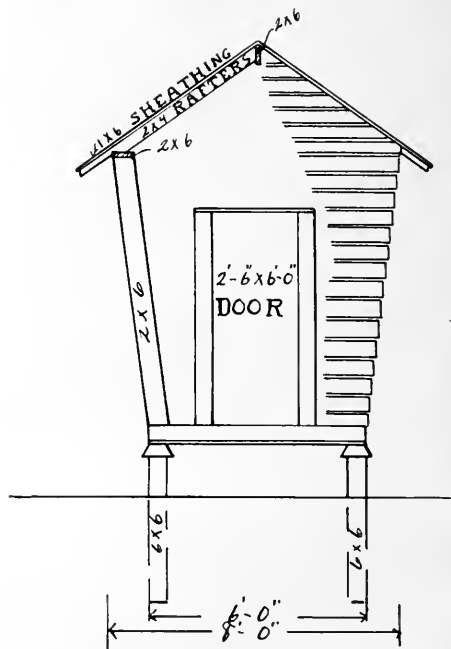

CROSS SECTION
OF CORN CRIB

buy, how to feed and how to sell. The old fashioned way of putting a fence around a mud-hole and confining a bunch of cattle in the mire for weeks or months at a time ceased to be profitable long ago, but unfortunately some men haven't found it out. Considerable engineering ability is required to plan and construct feed lots for the accommodation of large numbers

lots, thirty-two by seventy-two feet in size, including the shed, are fenced off one after another as many as needed. Two yards only are shown in the drawings because no matter how many you have each pair of two would be a repetition of this pair. The lots might be extended a quarter of a mile holding the same order.

It works better if the ground is about

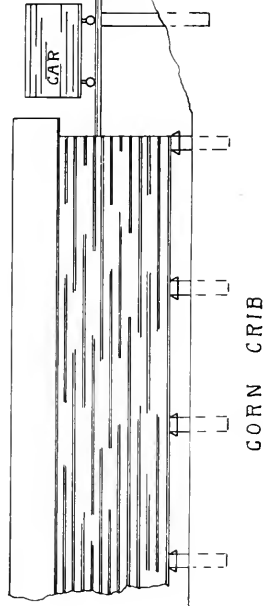
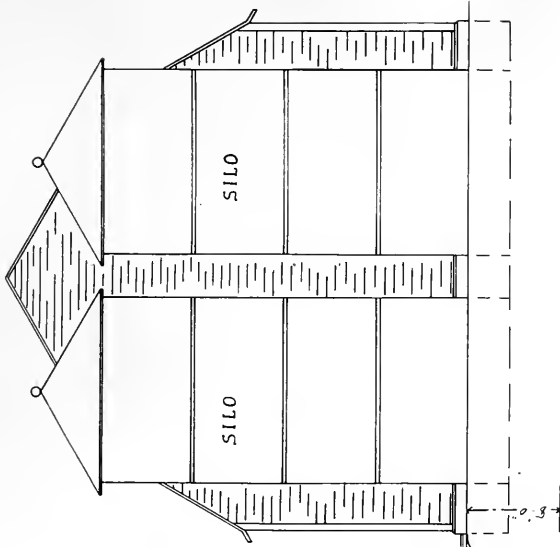
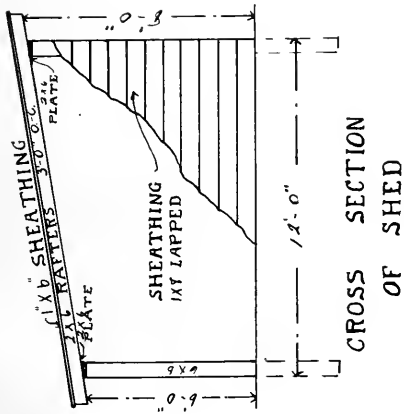

eight feet lower for the feed lots than it is for the storage barn and silos as this gives a chance to run the track from the floor of the storage barn over the heads of the cattle high enough to leave a passageway under for a pair of horses and a manure spreader. Eight feet in the clear is little enough and it is high enough because straw as well as feed will be brought to each lot by a car on the overhead track. The car is made large for this purpose, being four feet wide at the bottom, six feet wide at the top, four feet high and eight feet long. When filled with silage it will

enough to hold something. He runs a chute from the silo to the car which saves forking the silage up from the floor until the silo is nearly empty. The sides of the car are hinged so they drop down over the feeding racks in the yards. He loads the car quickly and easily and a good deal of the stuff unloads itself. The track is made in sixteen foot sections, as the yards are thirty-two feet wide the tracks have one support in the middle of the yard. The other supports form part of the fences between the yards.

In laying out the yards the problem of

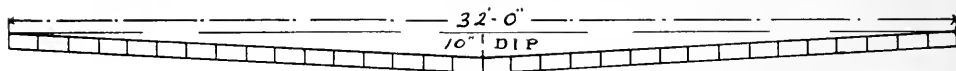

6" CINDERS

DETAIL OF BRICK PAVEMENT

make quite a load, but one man can move it if the wheels are large and kept well oiled and if the track is level and true. Some feeding yards have an inclined track, but this is not necessary, in fact it is objectionable because the car will never stay where you want it and it is uphill work getting it back to be refilled. Make the track absolutely dead level and perfectly straight. Two by fours plated on top with two inch band iron that has been hammered straight and true will answer very well but the two by fours must be well supported and thoroughly spiked in place. In building the track remember that you are trying to save time and labor at every feeding period for a number of years to come. You want the track so true and the car wheels to fit so perfectly that the car will run along without much friction after getting it started.

One man with a rig like this that works right should feed a large bunch of cattle because he can take advantage of his work. In the first place he has got a car big

drainage must be worked out first. It is impossible to have the yards dry unless ample provision is made for taking care of the rainfall. A drain tile is marked on the plan leading from the corner of the storage barn and running across the ends of the feeding pens down the whole length of the alley to an outlet in the field beyond. The brick pavement in each feed lot slopes to the center to lead the water to the tile drain underneath which connects with the trunk line of tile near the fence in the alley. This main drain increases in size to accommodate the extra drainage as it proceeds past the different pens.

An open shed twelve by thirty-two feet occupies one end of each yard. This shed is not paved but is kept well bedded. All the rest of the yard is paved with brick laid flat on a cinder bed.

An additional drain tile runs from each water tank to the trunk tile line to take care of any overflow from the tank. In some locations another tile drain will be

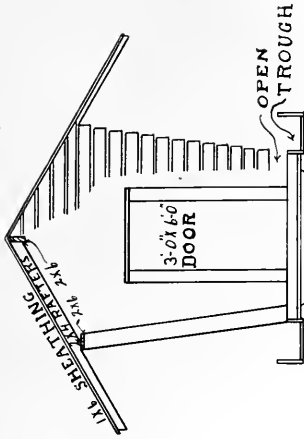

CROSS SECTION OF
CORN CRIB FEEDER

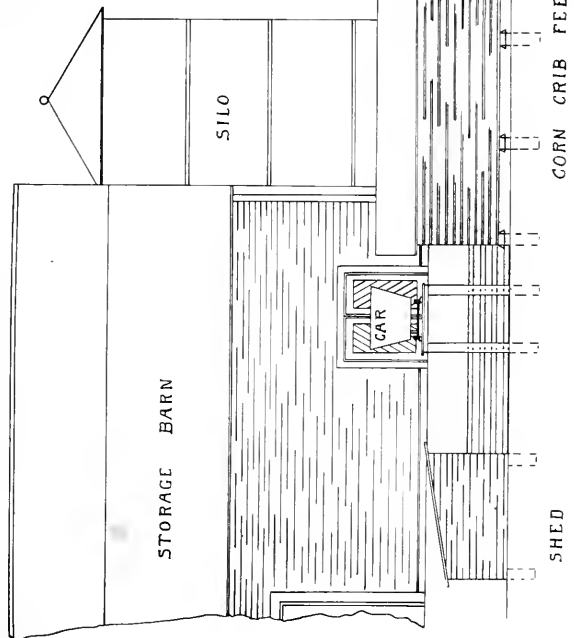
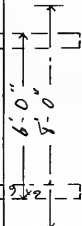

WEST SIDE ELEVATION

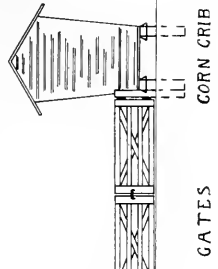

necessary at the back of the shed because the ground must be kept dry.

Water Supply.

Good fresh water in sufficient quantity to supply the needs of the cattle in these feed lots is quite a problem in itself. The water must be good and there must be plenty of it. It must also be supplied under pressure and carried to each water tank in pipes placed under ground below frost. There must be a valve placed in each pipe running to each water tank so constructed that it won't freeze. The stems from these valves should be extended up to the overhead track so a man can walk from one end of the feeding yards to the other and regulate the water easily and quickly.

Generally the water must be supplied by a windmill and a reservoir of some kind. A cement basin in a nearby hillside is perhaps the most satisfactory because when once made it is permanent. The source must be sufficient to supply it and the windmill or other power which does the pumping must be powerful enough to do the work at all times. You cannot afford to take chances on a water famine with several hundreds of feeding cattle on your hands.

Storage barn.

In the plan not much attention is paid to the storage barn except that it shows the most convenient location. Every feeder must plan storage to suit his way of doing business. If he has a large farm on which he grows alfalfa, grain and other crops that make large quantities of roughage he must provide an extensive storage barn with appliances to get the stuff in and out again when needed for feeding.

Generally speaking, the barn should be large and high. The capacity of a storage barn is increased by additional height at a very rapid ratio because all kinds of loose fodder packs very close in the bottom and lies very loose at the top. A deep bay may

be filled to the peak with hay at haying time and settle sufficiently to hold a large quantity of sheaf wheat a few weeks later, but a shallow mow don't hold much at any time. It don't have the weight sufficient to pack it.

There will, of course, be a good solid floor over the car track and there will be chutes or openings to let the hay down directly into the car and there will be a ladder to let a man down into the car to tramp it full. The same horse fork that is used to put the fodder in will move the stuff from the other parts of the barn to this floor as it is needed.

Brick Pavement.

There is only one way to have a feeding lot clean and that is to pave it. There are different kinds of pavements more or less virtuous but the cheapest satisfactory bottom for a feeding yard is brick laid on a foundation of sand and cinders. The cinders help drainage and prevent the bricks heaving with the frost. It is easier to lay the bricks level and smooth if an inch or two of sharp sand is scattered over the top of the cinders. The sand holds the bricks in place and a little sand does not prevent the water from getting away.

A great deal depends on the foundation. The ground should be graded with the proper slope to the center gutter. It is not necessary to have an opening in the bricks, the cracks between the bricks are sufficient, but a line of tile should be carefully laid underneath deep enough to be out of the way of frost. Frost does not penetrate deep in a feeding yard under a brick pavement. During some winters the ground won't freeze. There is more or less litter scattered about that prevents hard freezing. Probably if the tile starts a foot below the brick at the shed end and deepens to two and one-half feet where it joins the rump tile in the alley the drain will give no trouble.

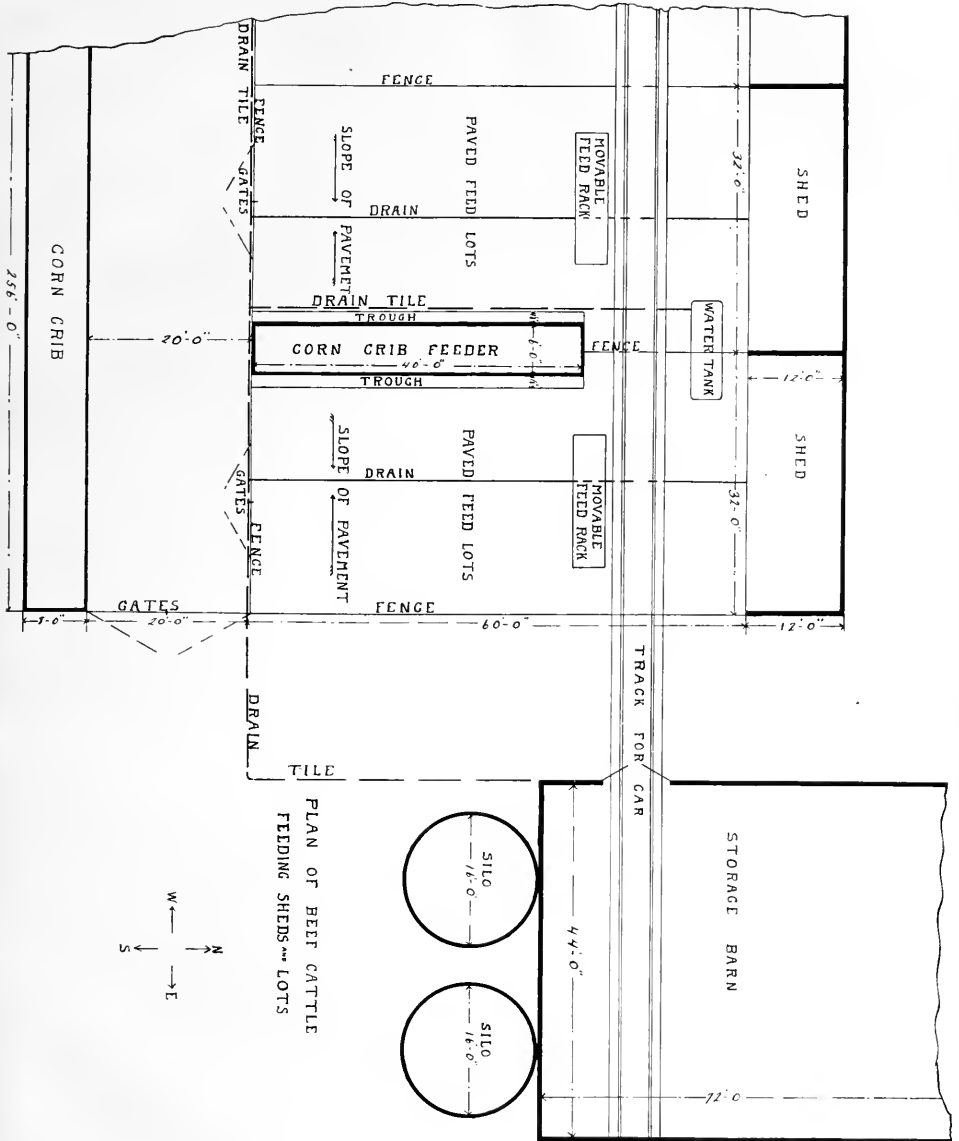

Lay the tile first smoothly and evenly and cover the joints with pieces of broken tile, then fill in with coarse cinders using no earth over the tile. Tile in a mud-bottom barn yard seldom works satisfactorily because the tramping of the cattle packs the mud so that the water can't get through. A mud-bottom yard has never been drained and the chances are that such a yard never will be drained in a satisfactory manner.

Commence laying the brick in the center over the tile and work both ways to the fences. The herring bone style of laying brick gives the best satisfaction. No two brick tip alike when laid like this. Of course you want every brick to lay flat and level, but you don't always get just what you want. If good hard burned bricks are laid flat, herring bone style on a good foundation you will have more comfort and satisfaction than you ever had in a feeding lot before. If you have lots of money to use and don't care for expense then put in a cement pavement and build it just the same as sidewalks are built. You will then have a yard that will last a life time, but it won't be as dry as the brick because the water must all run to the end or center outlet on top of the pavement before it can get away.

The Shed.

A continuous shed is designed to run the whole length of the feeding plant without a break. The shed is twelve feet wide and eight feet high in front and six feet six inches high at the back. The shed faces the south and the front is left open to admit sunshine. The construction is light and cheap as shown in the detail drawing. There are no partitions except the fences between pens which run to the back of the shed, in fact the fence posts and shed posts are the same.

Two by six rafters fourteen feet long are

used for the roof. These are covered with sheathing boards, dressed one side, and on this is stretched a good quality of felt roofing. The north side is banked with cinders to prevent the cold winds from blowing under and the ground floor of the shed slopes to the brick pavement. A liberal supply of straw for bedding is kept in the shed and this is carefully shaken up every day.

Feeders now-a-days appreciate the importance of making animals comfortable. It takes a good deal of feed to supply the heat dissipated by animals lying on the cold ground. Straw is cheaper than corn.

Beef cattle don't require much protection against the cold. Their thick winter hair and hides are sufficient if they are kept dry and well fed. Cattle will gain a little faster on the same amount of feed if kept warmly stabled, but they must have fresh air and the extra expense of individual attention when handling them in a stable more than eats up the additional profits from the extra gains made. A feeding rack well up above the ground along the back of the shed is a good thing at times in rainy weather; it induces the cattle to stay inside. It is better to put the feeding racks on the ground when you use them regularly every day, but ground space in the shed is limited and such racks will be used occasionally only. For this reason it is not desirable to take up any more ground space than necessary for this purpose.

Corn Crib.

On the south side of the alley way is a corn crib six feet wide at the bottom, eight feet wide at the top, ten feet high above the foundation wosts and as long as necessary to have an opening in the bricks necessary. This crib is intended for storage purposes to hold corn enough to last all winter. There is a door in the end

and doors along the alley side thirty-two feet apart, each door being opposite the door of a feeder crib. A temporary bridge reaches from one door to the other so the carrying may be done with a wheelbarrow or car running on a track. As the bridge is intended to be moved from feeder crib to the next a wheelbarrow would be handier than a car because it is lighter and may be easily moved.

Feeder Cribs.

Between each two pens is a feeder crib six feet wide at the bottom, eight feet wide at the top and eight feet high. These cribs are forty feet long extending back from the alley fence. This gives forty lineal feet of corn trough for each feeding yard. These feeding troughs are made by extending two by four floor cross joists two feet beyond the sills at each side. The floor in the crib is laid on top of these cross joists and the feeder boxes are made by boarding on the under side and across the ends. This makes the floor of the feeder trough about five inches lower than the floor of the crib which permits the corn to work out easily and in case of a driving storm the water does not run in from the feed troughs to wet the crib floor.

Some little experimenting is necessary to get the opening the right size. A smaller opening answers when the trough is lower than the corn floor. A narrow strip may be nailed in the opening at the top if it is found too large.

The roofs of these feeder cribs are made by using sixteen foot boards full length. The projection keeps the feeder troughs dry and provides a little shelter for the animals when feeding. For the comfort of the cattle it is a good plan to run eave troughs the whole length of these roofs. The water could be carried to the water tanks or the drain in the alley.

At corn harvest time these feeder cribs

of course would be filled first with the earliest and best seasoned corn to feed first. The later and poorer quality of corn would be housed in the main storage crib.

It is not every feeder of beef cattle who approves of self feeder cribs, but if they don't like to have the animals help themselves the same cribs and the same troughs will be just as useful, so that the man who really loves to work may dig the corn out, load it in a basket and carry it around to the side of the crib and distribute it along the troughs. It will pay some men to do this, men who are built that way. Each man must work in his own harness.

Silos.

For some unaccountable reason beef men have entertained a prejudice against silos. But not every man who feeds cattle without their assistance objects to silos. In many cases they have more corn stalks than they can feed without trying to save the last vestige of the corn crop and they think the animals can cut the feed and mow it away cheaper than it can be done by machinery, but the fact remains that nearly one-half of the feeding value of the corn crop is in the stalks and leaves of the corn plant. If cut just at the right time, when the sap is all in the stalk, cut up fine and packed away in an airtight silo the stalks lose very little of their feeding value. They may be kept a year and the last silage from the bottom comes out as fresh and apparently as palatable as the first. Cattle will even leave pasture in the summer time to eat left over silage. If we ask the animals what they think of it their actions are strongly in the affirmative. We must study these things in detail to thoroughly understand our business.

Looking at the silo problem from the broadest side it certainly would pay to put some of the crop in silos. The stalks from eight or ten acres will fill a sixteen by thir-

ty-two foot silo so that most feeders would only have an opportunity to cut off one side of the corn crop and they would still have a large quantity of stalks to go to waste.

The silos in the plan are made of two by eight pine planks dressed both sides, the edges beveled and put together like a tub. They are hooped with three-quarter inch round iron hoops drawn up with nuts against the shoulders of cast iron plates

as shown in the detail drawing on another page.

This feeding plant is designed to save labor and to utilize feed to the best possible advantage. It would be difficult to build a large plant any cheaper and have it satisfactory. It would also be difficult to build, on any other plan, a thoroughly practical plant that could be extended indefinitely as the business grows without altering or rebuilding.

An Ohio Barn—A146

A style of barn that is very much used in Ohio is shown in plan (A146). A peculiarity of this style of barn is what is commonly termed a double threshing floor. In some of the larger ones the threshing machine is set first on one side and then on the other for convenience in getting

the grain to the machine. The bridge from the bank to the second floor must be stronger than common barn bridges because it spans the space between the barn and the bank and it leaves a runway for cattle along the bank side of the building. In this plan the cows have no stalls but



are stabled in an enclosed shed with a feeding rack the whole length of the side so arranged that it may be filled from the mow above. Several removable racks for feeding grain may be placed anywhere in this shed and a water trough with an everlasting supply of good pure water will hardly freeze in here.

may all have different quarters and be kept separate very much to the advantage of the stock and at a great saving in time. The dampness which is a bad feature of most bank barns is obviated in this plan because there is a circulation of air all around.

One of these barns was built on a hilly

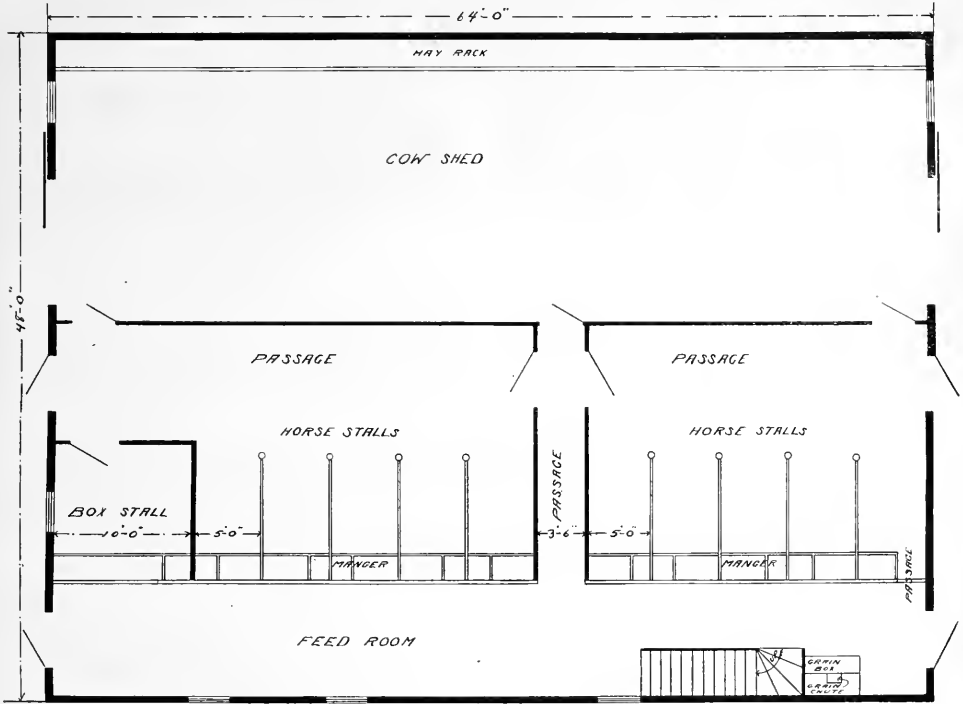

FIRST FLOOR PLAN

There are many points of convenience about a barn built after this plan, one of which is the facility for getting all around it. Gates, fences and retaining walls for the bank offer opportunities for stock pens in almost every corner without interfering with the barn proper. The entrance to the barn being overhead the whole ground space around the barn is left free to handle stock. Horses, cows, sheep and hogs

farm in southern Ohio on a site some distance from the house and about twenty feet higher, in fact the house was on one hill and the barn on another with a small ravine separating them. Two round wooden water tanks were placed near the top of the barn and these tanks were kept supplied by means of a hydraulic ram working from a running spring of pure clear water back among the hills.

To facilitate cleaning the tanks one at a time, they were connected at the bottom with a short pipe. In this pipe were two globe valves and between the valves was the outlet pipe to the house and to the stock watering troughs.

The pipe that brought the supply from

longer they were inclined to become slimy.

About seventy-five head of cattle and horses were kept on the farm besides other stock and their thrift was due in great measure to the unlimited supply of good water within easy reach at all times where they could drink out of cement troughs

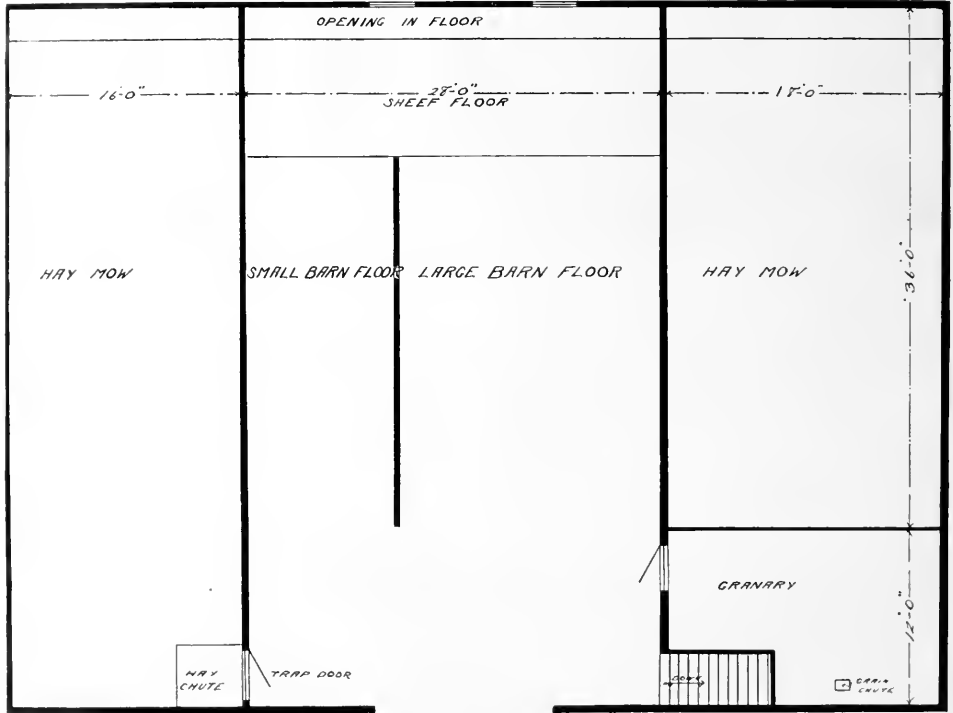

the spring entered the tops of both tanks in a similar way. Two valves in the cross pipe permitted to water to flow into either tank or both tanks as desired.

This arrangement of feed and outlet pipes made provision for emptying and cleaning either tank at any time without interfering with the water supply because the other tank could be continued in use. In practice it was found desirable to clean both tanks twice each year because if left

and cast iron buckets in convenient places about the stable and nearby pasture lots.

Besides supplying the stock an inch pipe was carried under ground to the house, which was in this way supplied with hot and cold running water in the kitchen sink and bath room. There was also an outside hose tap for sprinkling the lawn and watering the flower beds. Another hose cock in the carriage house supplied a hose brush for washing buggies.

It might be noted that help stayed along a farm of his own. Farm hands are quick on the farm year after year. One man grew up on the place from a chore-boy to appreciate modern improvements. Farmers who plan right can keep help and and only left to get married and work on make money from their work.

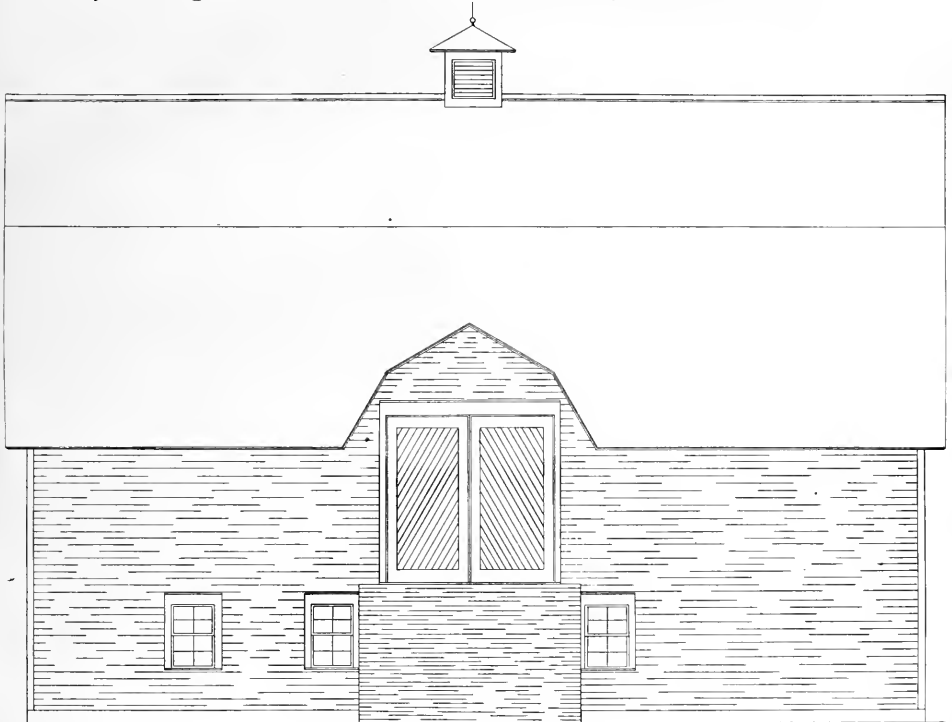

SIDE ELEVATION OF BARN BARN

Well Planned Horse Barn—A171

We are herewith illustrating a horse barn and in addition to a few words about its utility we will explain its construction, which, we trust, will be of interest to the readers. To make this article more comprehensive to those interested in barn construction we show an exact reproduction of the architectural plans after which the building was erected.

This building is designed to accommodate fourteen horses, having ten single stalls and four box stalls, and all the nec-

essary feed bins, harness room, wash room, grain room, carriage room, storage rooms, etc.

The carriage room, which is 30 by 36 feet clear span without posts, is on the east end and has an entrance of large double sliding doors, and also a large sliding door to the horse stable. The carriage room floor contains a carriage wash near its center and overhead is a large trap door, so any vehicles which are out of use can be hoisted up to the floor above for storage.

The carriage room also has direct doors to the harness washing room. The harness room is equipped with dust proof cases for the harness, blankets, etc., and the washing room contains a sink with soft water

supply and all the necessary fixtures required for the washing and repairing of the harness.

The stable room contains a watering trough, a store room for tools, shovels, etc., and a grain room for the mixing of

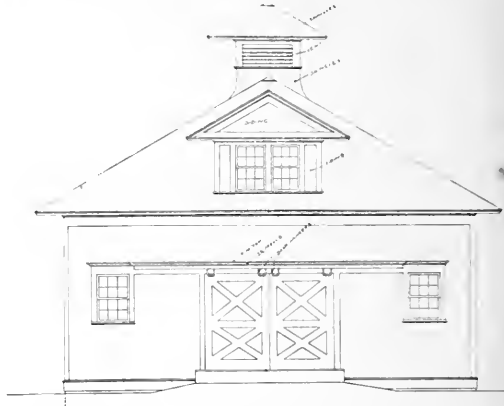
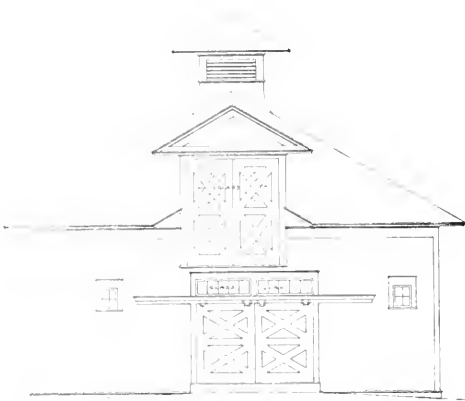

swinging out. This provides each animal with fresh air and a direct draft upon the animal is avoided by these windows being placed up near the ceiling, also being covered with a wire screen for protection. All stalls have cast iron feed boxes, salt

feed, and which has small grain bins which are connected with spouts from the larger bins on the upper floor.

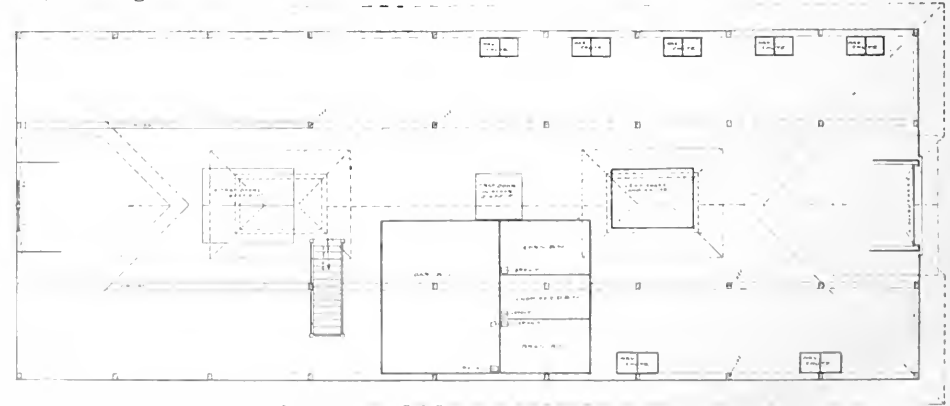

boxes and wrought iron hay racks connected directly with hay chutes from the hay room above. All stall floors are slightly sloped to the back and there connected with a cast iron drain trough running the

feed, and which has small grain bins which are connected with spouts from the larger bins on the upper floor.

The box stalls have sliding doors with a wire grill in the top half, and the parti-

full length of and on each side of the driveway.

In the ceiling of this driveway is a large trap door for throwing down hay and bedding, and also for the hoisting of hay from

of hay, bedding, grain and feed, and the room above the carriage room is partitioned off into a dust-proof room for the storage of vehicles, etc.

This building is built on a foundation of

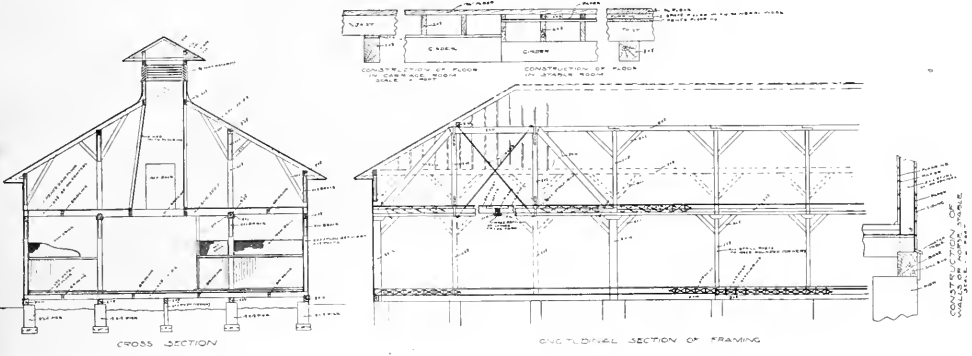

the hay wagon in stormy weather.

One of the roof ventilators has a shaft running down to the ceiling of the horse stable for ventilation, and is at this ceiling provided with trap doors by which the

stone piers, so as to admit a free circulation of air under the floor and to prevent the floor from becoming cold in the horse stable. It is built, as will be seen in the detail above the longitudinal section, by

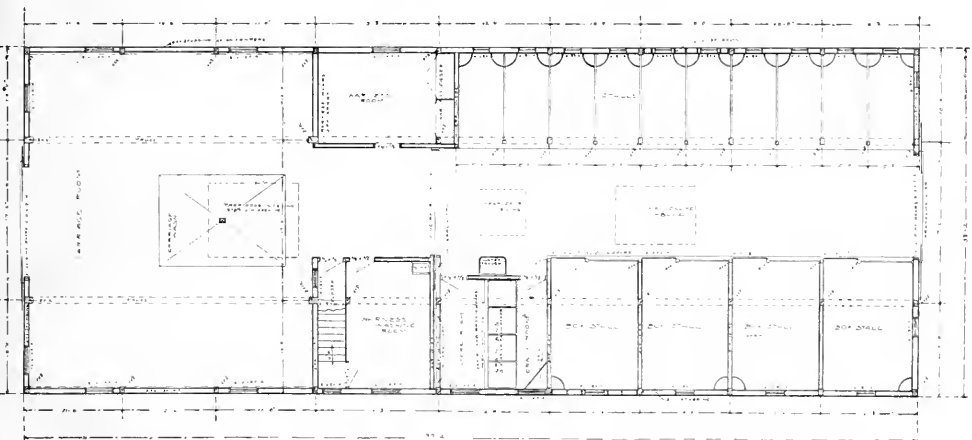

flow of air can be regulated as desired, and this shaft at the same time serving for a hay and bedding chute.

The second story is used for the storage

first resting the joists upon the sills, then floored with a matched floor 1 inch thick, which is covered with a heavy building paper, then 2 by 2 inch strips are nailed

one over each joist. The space between these strips is filled with mineral wool, then this entire surface is floored with a strong floor $1\frac{3}{4}$ inches thick, and on this

6 inch braces. The outside walls are formed by filling in between these bents with 2 by 6 inch studding spaced 2 feet on centers and well spiked to the floor joist, sills

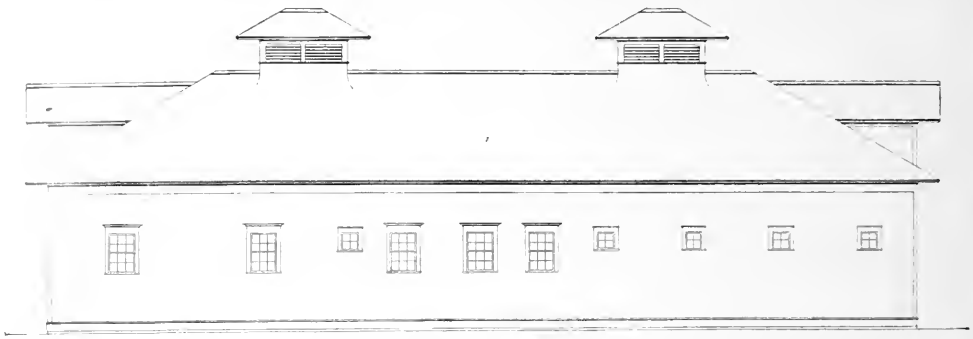

FIGURE 1. ELEVATION OF HORSE BARN

are laid strips of various thickness to receive and form a pitch to the stall floors. On the sills over each stone pier is set a 6 by 8 inch post for the support of the second story floor and roof. These posts run up to the plate, which is a 6 by 8 inch timber, and at the second story joist level there is a 6 by 8 inch timber notched in between these posts for the bearing plate of the second floor joist. All these timbers are braced at all intersections with 4 by

and plates. The inside surface of these studding are covered with heavy building paper, then ceiled with matched flooring, and the outside surface of studding is also covered with paper and then sided with drop siding. The roof is of cedar shingles dipped in moss-green creosote stain, which in contrast with the white painted walls, makes a very artistic effect. The interior of the carriage room is finished with yellow pine beaded ceiling.

A Servicable Barn—A172

We are here illustrating a small barn, which is twenty feet by thirty-two feet, and contains a carriage room thirteen feet by nineteen feet, which has large double doors in front that will admit the largest size carriage, a wide single door to the horse stable, and a stairway leading to the upper floor, which is for the storage of hay, feed, etc., and will admit the installation of a man's room if it is desired.

This barn contains two single stalls and a box stall. Each stall has a direct window, which is high enough from the floor to avoid too much draft on the horses

and is protected by a wire mesh guard.

This barn has been designed for utility and is practical in every way. The arrangement is convenient, and it is of a neat appearance on the outside. If painted a stone grey, with all trimmings and cornice work painted pure white, it would be a credit to any neighborhood.

The carriage room has a cement floor, which is slightly pitched from all directions down to the center, where it is provided with a floor drain. This will admit the carriages to be washed any place in the room without injury to the floor and

the side walls, which are wainscoted with Portland cement to a height of two feet six inches.

All the walls of the first story and ceiling are finished with clear southern yellow pine, beaded ceiling, with two coats of

when laid the boards will fit tightly together at the bottom and leaving about an eighth of an inch crack on the top surface, which is then filled with hot tar. This construction makes a very durable and sanitary floor. The entire stall floor is

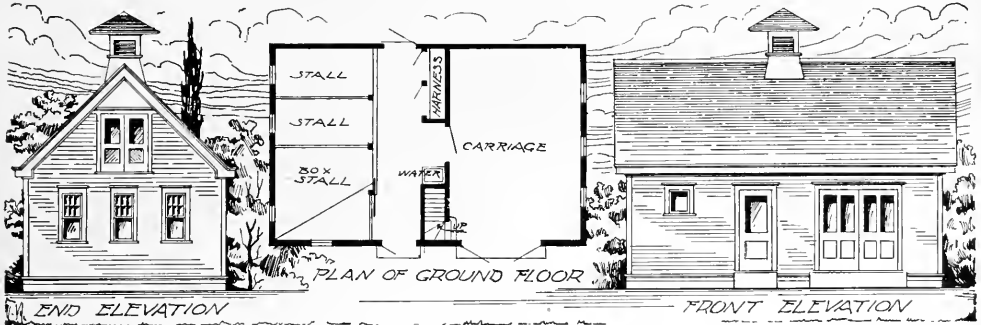

hard oil. This makes a very pretty effect for a stable and it is at the same time very serviceable. The stall floors are of double thickness one and three-quarter inch floors. The first floor is tongued and grooved, tightly laid, and then covered with hot tar. The upper floor is then laid and has slightly beveled edges, so that

pitched slightly to the rear to a cast iron gutter with perforated cover and connected with the catch basin and sewer. The second floor has ample storage room for a winter's supply of hay and feed for three horses and is of strong construction. The roof is of shingles and the ventilator gives the building a complete appearance.

A Canadian Barn—A183

We are here illustrating a large stock and dairy barn which has been designed for a large Canadian farm and has many good features worth noting, both from the builder's and the dairyman's point of view.

The shape of the building was developed with the view of giving the best shelter to the stock. From the points of the compass, as shown on the floor plan, it will be seen that the wings of the cow barn and the young stock barn are so situated as to keep the north wind off the stock when it is let out for exercise during the winter months, and at the same time giv-

ing them all the sunshine. The building is also arranged to be convenient from the paddocks, pastures, etc., allowing the stock to approach their respective stalls without having to be driven across unnecessary driveways or through a series of gates.

The building is built of wood, on a foundation of concrete, which is put in place by excavating the trenches the exact width and depth of the wall and then the concrete is dumped and tamped into the trench, thus avoiding the work and expense of planking for concrete forms below grade. Above grade the concrete is tamped between planks well fastened in

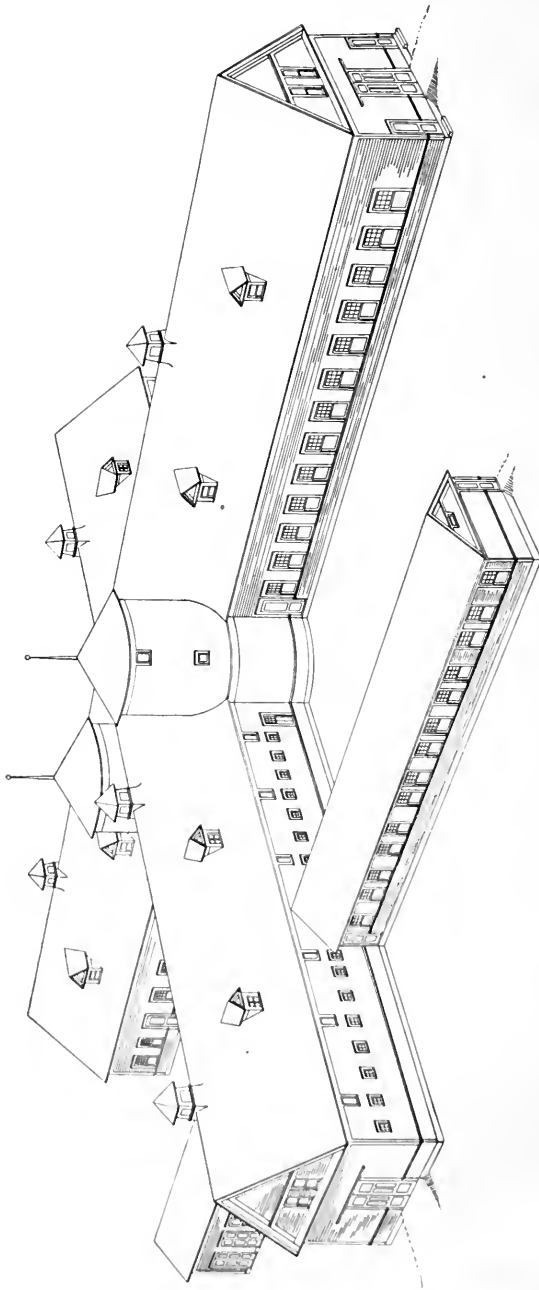

NURSE BIDDINGS

RAVON AND APPOINTMENT HEDD

NURS BIDDINGS

8 NURSE STALLS

7 NURSE STALLS

10 NURSE STALLS

7 NURSE STALLS

NURSE BIDDINGS



COMB

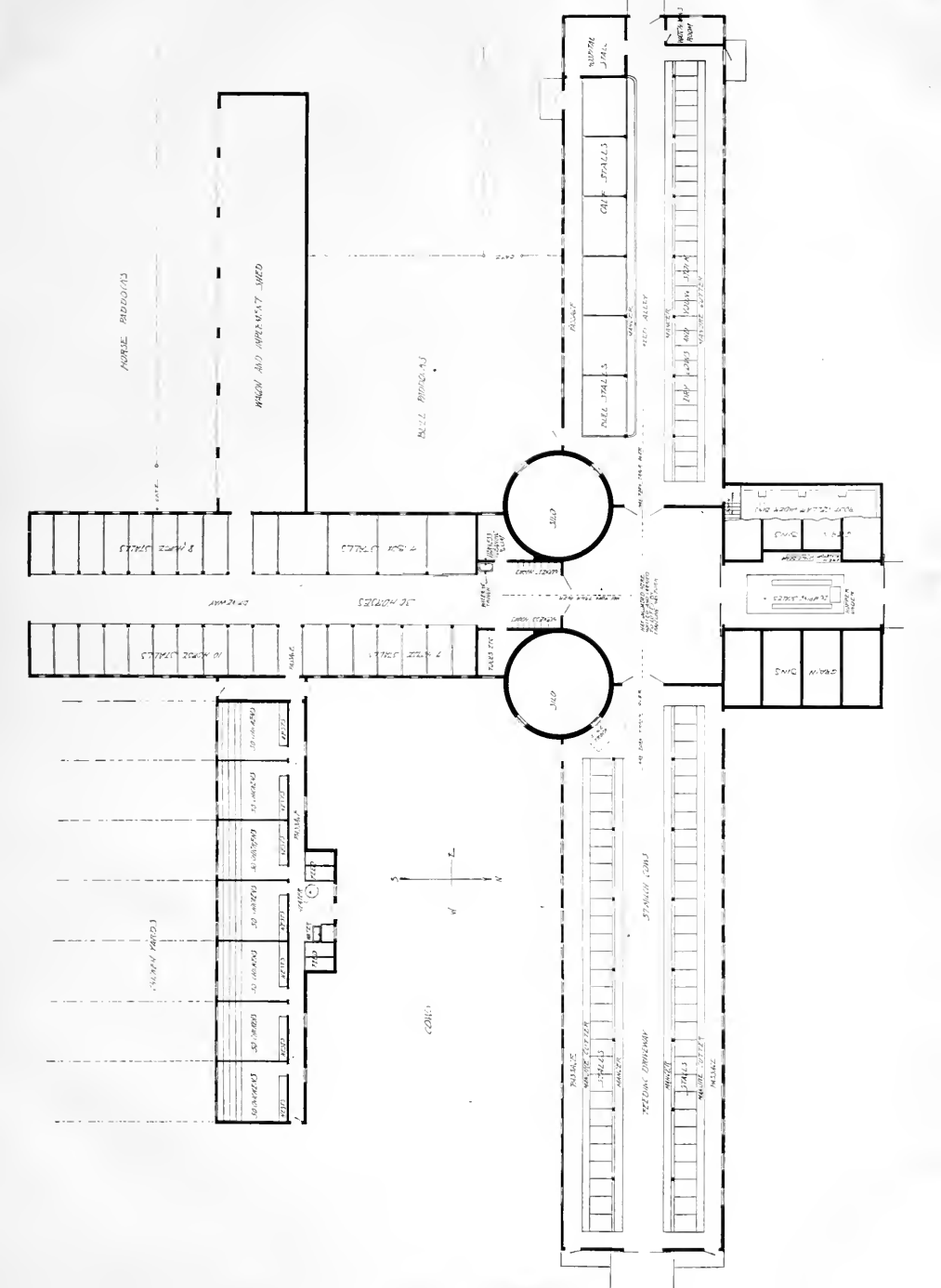
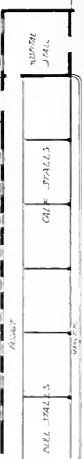

place in the usual manner. The concrete wall extends up to the floor level where the wood construction begins. The space between the studding from the floor up to the window sill level is also filled with concrete after the walls have been sided with drop siding over a layer of thick tar paper. After the concrete between the studding has become hard metal lath are put in place on the interior face of studding and over the concrete, which is then plastered with cement mortar, making a

elevator boot for loading grain into the bins.

This granary being located near the center of the barn is very convenient for feeding the stock and adds to the exterior appearance of the building. The basement of the granary is used for the storage of roots for the stock and can be equipped with a kettle for boiling and mixing foods, etc.

The cow barn contains 57 cow stalls and arranged with a feed alley running

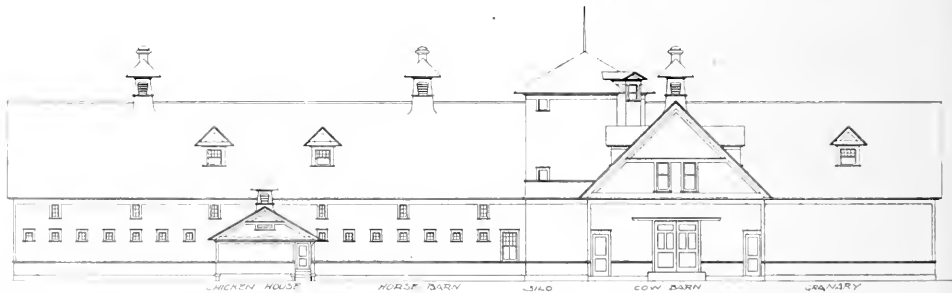

cement wainscoting around the walls, which makes a perfectly sanitary barn. The concrete filled walls help greatly to keep the barn warm in winter and cool in summer, as well as to stiffen the structure against heavy winds.

The granary is located at the center of the north side and contains eight large hopper bottom bins for the storage of grain and feed. The bottom of each bin is connected with a spout leading to an elevator boot in the basement, which elevates the grain to a revolving head so that the grain can readily be transferred from one bin to another or onto a truck or wagons. Some of the bins also have spouts which wagon-bed height above the floor for feeding purposes. The main driveway of the barn goes through this granary and contains a combination dumping scales with a hopper under the floor spouted to the

through the entire length with the mangers on either side, so the cattle can be conveniently fed from a truck or a trolley track system suspended from the ceiling. The cows stand facing each other and the mangers are continuous, constructed out of concrete which forms part of the cement floor. The stall floors are of concrete covered with plank, which can be taken up and cleaned or renewed when desired. The manure gutters have sufficient fall to drain all liquids to one outlet in the center which is connected with a catch-basin, and also contains gate valves so arranged that while scrubbing the water can be switched into a sewer. The passages back of the cows are of good width for milking and bedding the stock and trucking out manure to platforms built at the end of each passage outside of the building. The ventilation is well taken care of by ducts

in the walls which carry the air to the ventilators on the roof.

The young stock barn is located to the west of the cow barn and contains six box stalls for bulls and calves. These stalls are constructed from heavy wrought iron gas pipe, having three-inch pipes for corner posts and for top or header rail, and 1½-inch pipe spaced 6 inches apart for the stall partitions; these pipes are set upright with the bottom ends well bedded in the concrete floor and the upper ends screwed into the 3-inch header. The gates are also of pipe construction and have self-closing locks and hinges.

There are 28 single stalls with swinging stanchions for calves, one-year-olds, and dry stock similar in arrangement to the stalls of the milk cows only not so wide, as no milking room is necessary.

The wing also contains a hospital stall which is isolated from all others by solid walls and has all side walls, floor and ceiling finished with cement which is impervious to moisture and can be readily disinfected. Opposite the hospital stall is a watchman's room for a man who can attend any sick stock during the night.

The silos are centrally located for convenience in feeding and filling, as the silage cutter can be located in the central feeding room and thus be operated in all kinds of weather during the ensilage season. The silos are constructed of studding spaced 12 inches on centers, sheathed on the inside with two thicknesses of 1½-inch by 6 inch sheathing bent around horizontal and then veneered on the inside with hard, vitreous paving brick laid in cement mortar, each brick being tightly pressed against the sheathing so that the silage pressure can not force it out of place. The exterior of each silo is finished to match the balance of the building. The silos have a concrete foundation which is

flush on the inside with the face of brick lining, and being excavated down to the footing increases its capacity by about 50 tons. The floors are of concrete, dished to the center, and connected with a deep seal trap and drain.

South of the silos is the horse barn, which contains 17 single stalls on one side and 9 single and 4 box stalls on the other side, giving it a capacity of thirty horses. Each stall has an outside window for light and ventilation. These windows are about seven feet from the floor to avoid draft on the animals, and protected by a wire mesh guard. The stall partitions are of wood to a height of 5 feet 6 inches, above which there are wire mesh guards, giving a good circulation of air and light. The stall floors are of double thickness of 1¾ inch by 6 inch flooring with several thicknesses of roofing felt laid in hot tar between. All stall floors are slightly sloped down towards the driveway and have cast iron gutters with perforated cast iron covers and connected with catch-basin and sewer.

East of the horse barn is the chicken house, having a capacity of 350 fowls, divided into seven compartments of 50 each, so arranged that the chickens get the south sun and protected from the cold north winds.

East of the horse barn is the shed for wagons and farming implements with a door into the horse stable, so the team can be taken directly from the stable into the shed and hitched up without having to go through a barn yard.

There are many other conveniences about this building, but we must refrain in this article for lack of space. Suffice it, therefore, to conclude in stating that the building is so constructed that any department of the same can at any future time be extended or added to.

A Cement Rough Cast Barn—A182

A carriage house and stable plastered on the outside with cement mortar with a rough cast finish is shown in plan (No. A182). There are locations where a basement for laundry purposes under the house is not desirable. This plan for a carriage house with a laundry attachment was designed especially to meet such cases. In New Orleans, La., such carriage houses

barns are provided in this building, but it is a little more elaborate than ordinary. The box stalls are especially large and roomy, there is a larger feed room than is customary and the harness room is a little larger than we usually find in a small or medium sized stable. But the especial features about the building are the rooms for servants with an entrance separate

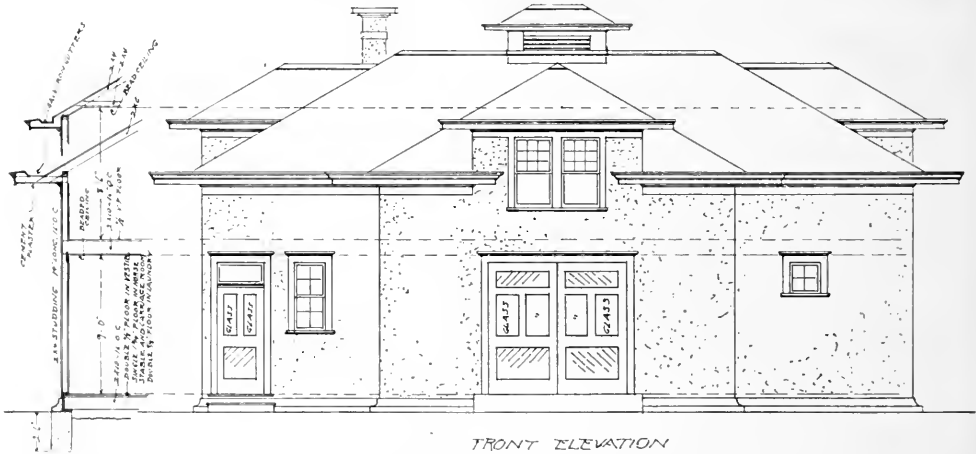

FRONT ELEVATION

are quite common. There is a great deal of made ground and the sewers are not deep enough to permit much underground building, so that basement laundries are not common. To meet just such conditions stables with laundry rooms just seem to fill the bill, especially when they are well designed and built to suit individual needs.

This building is substantial in appearance and the manner of construction is very satisfactory for a warm climate. The outside cement work when properly put on with metal lath is very durable. It looks well and is not expensive.

The usual conveniences found in small

from the carriage house, and the laundry with its hot water heating apparatus, which not only furnishes hot water for washing and for stable use, but to warm the stables and the servants' rooms in winter. This laundry room is also large enough to hold the clothes lines in stormy weather, and there are plenty of windows for light.

Laundry work is a problem in the south as well as in the north. Those who get along with the least friction usually have the best possible conveniences for doing the work. Large light laundry rooms supplied with plenty of hot water and furnished with good machinery and tubs that

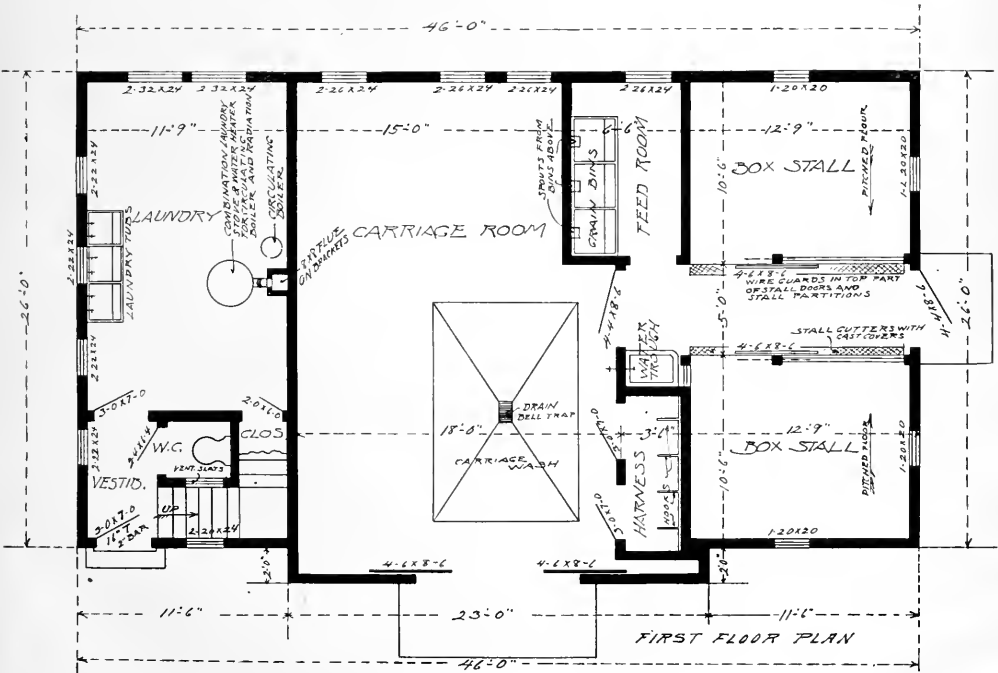
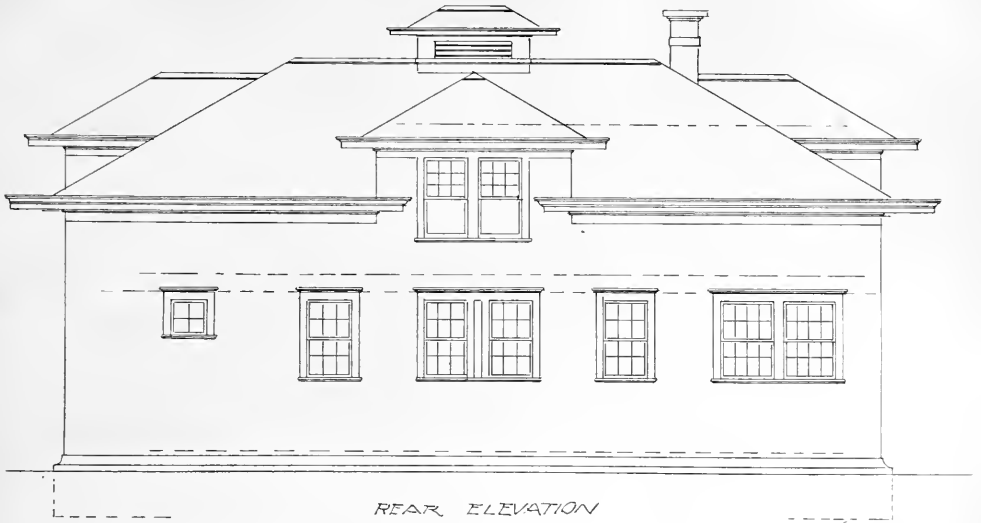

are rightly placed and fitted with the necessary faucets, waste pipes, etc., offer more inducements to do good work and less occasion for complaints than ordinary.

There are many advantages in having

For a pretentious property a stable building of this size and design looks well. The building is large enough to match up well with a good big residence and the design and style of the roof shows character



LEFT SIDE ELEVATION

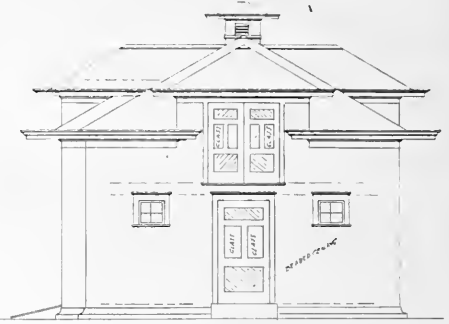

RIGHT SIDE ELEVATION

the laundry room away from the house. It avoids confusion in the house on wash days and the odors of dirty steam and soapy water are done away with.

enough for a house, in fact many costly houses are built with roofs that are less attractive than this one. A carriage house like this is not complete without a good

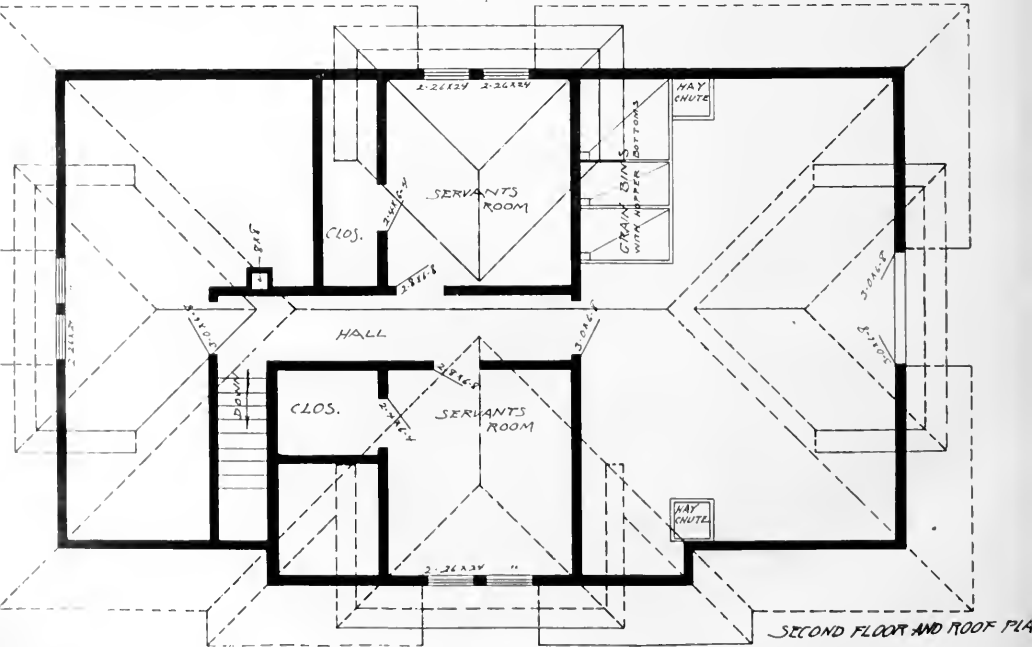

SECOND FLOOR AND ROOF PLAN

wide drive leading to it. This design requires a smooth pavement in front of the building one-third wider than the building itself. It should have a pretentious approach to give it proper setting. Some-

times an inferior building can be given a royal appearance by an elaborate entrance. A driveway to the stable is part of the entrance. In this plan the inside is right, the outside looks well.

Hexagonal Poultry House—A174

The house shown is in the shape of a hexagon and makes a very handsome and convenient house, and is just the thing for the city lot, where space is limited. The

In nearly all the plans given it is designed that the ground floor shall be of earth, which is, in most cases, the most satisfactory floor material, and should be used whenever practicable. Cement floors

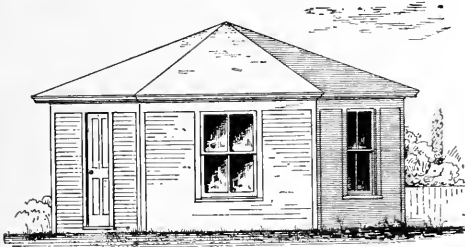

ELEVATION.

ground or floor plan will show you the interior arrangement. The size of this house is ten feet six inches, and each of the sides is six feet three-quarters inch in length. The corner posts are six feet long and the center of the house nine feet from floor to peak of roof. The house should be built with one window facing directly south and the other facing south-east, thus allowing an abundance of sunlight to enter the building in the morning, when it is most needed.

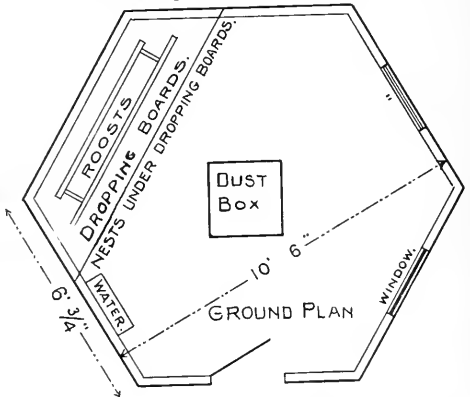

are also good, however; where they are used the poultry house will generally present a more attractive appearance and can be kept cleaner, with less labor, than a house having earth or wooden floors. Wooden floors should not be used if they can be avoided.

A Pretentious Stock Barn—A179

This pretentious stock barn is very complete and of an elastic pattern, so designed that its capacity can be increased by building on to the gable ends and extending them out any distance that may be required without affecting the general arrangement or exterior architectural pro-

portions in the least. The two wings to the right and left of the silo contain the young stock and horses respectively and face the south. These two wings form a sort of court around the silo, admitting the sun, but obstructing the severe storms and giving shelter to the stock. The silo

is well situated with reference to feeding, being in the middle of the cow barn. The cows stand back to back, which is of great advantage in cleaning out the gutters, as all the dirt can be handled from the center driveway and carried to the manure pits

two by six studding covered with tar paper and drop siding on the outside and tar paper and matched sheathing on the inside.

The lower story has two rows of posts which support the upper floor and also

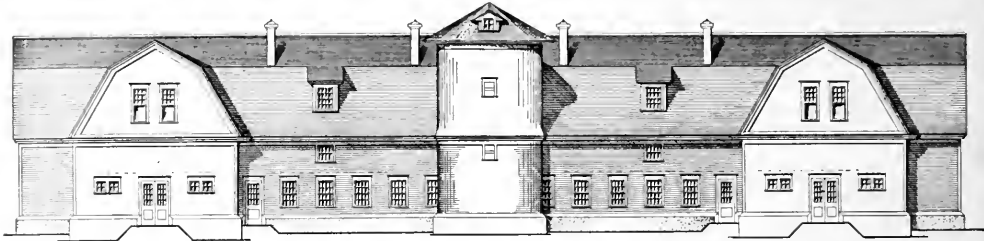

SOUTH ELEVATION OF STOCK BARN

to the right. To the left hand or west end of the cow barn is a large room for implements, wagons, harness cases and stairways to upper floor which contains grain bins, storage rooms for light machines, vehicles, etc., and sufficient hay and feed room for all stock.

serve to hold the stanchions and stall partitions. The upper story is of a single span, braced roof which allows the free use of a trolley hay fork the full length of the building.

The roof is of green stained shingles, of Dutch colonial architecture, and not

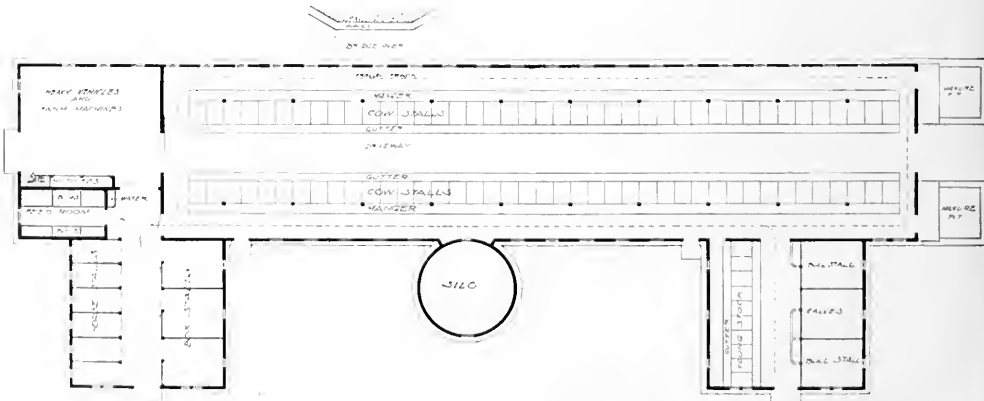

This building has a concrete foundation with the concrete walls extending about 2 feet above the cement floor level in the stock rooms. This prevents any moisture from getting to the framework and also makes a very sanitary and durable building. The frame walls are constructed of

only of a very appropriate design, but its shape adds greatly to the storage capacity of hay, grain, etc.

There is an embankment driveway on the north side which admits hay wagons into the upper floor for the unloading of hay, grain, etc. This silo is of frame con-

struction lined on the inside with paving brick, making it absolutely air tight and almost frost proof. There is a trolley track feed carrier hung to the ceiling of

the lower story, which simplifies the feeding. The building, as the cut shows it, will accommodate 100 head of cattle and nine horses.

A Gothic Barn—A181

If the house has a steep roof the barn should have a similar roof to be in keeping. We often see a house of one style and the other buildings nearby built on entirely different lines. If the house is

There is too little originality in building. It is much easier to follow the local trend than it is to think out a plan that is suitable for individual needs. In offering this barn plan it is with the idea that there



FRONT ELEVATION

SIDE ELEVATION

DESIGN FOR A SMALL BARN WITH FOUR STALLS

new and the other buildings old there is some excuse for such incongruity, but in most cases the house is built first and the barn is added to the lot some years afterwards. In the meantime some architectural fad has taken possession of the neighborhood and every building erected must bear the marks of the new fashion.

are many locations where the style of building and the shape of the roof will match the house and other surroundings better than any other plan.

A roof like this is not economical to build if the owner is influenced especially by dollars and cents, but there is a style about it that shows up well for the amount

of money it costs. There is a great deal in appearance. When we have things right we have something to appreciate for a long time to come. If the house has a steep roof we can not tolerate a barn with a main roof that is, say one-third pitch and a lean-to that is even less.

If the mischief has been done conditions may be somewhat improved by moving the barn well back out of the way and hav-

ing; they may be aggravated by the perfume or the noise of the chickens when they want to sleep in the morning.

A good many folks don't like neighbors and it is generally for some such reason, but neighbors are necessary and the neighbors sometimes build barns and they don't always keep them nicely. It requires a level-headed man to lay out a lot to the best advantage and put up buildings in

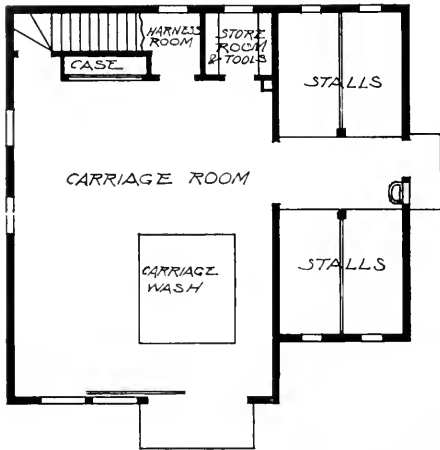

FIRST FLOOR PLAN

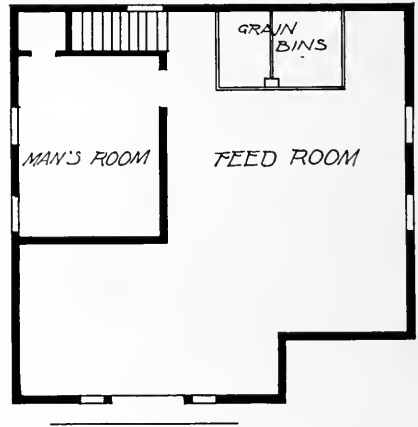

SECOND FLOOR

ing it covered with vines or screened in some way so it is not obtrusive. But there is something wrong with a man who will build a gothic house and a barn with a flat roof on the same lot. His ideas have been dwarfed in some direction. His property shows it because it does not balance up right.

A lot with its buildings must be one homogeneous whole or it shows at once that it has not been arranged rightly. A village stable may be made an ornament to the property or a damage to the owner and an eyesore in the neighborhood. Neighbors often say unkind things about the owner of the barn on the next lot. Not always on account of the looks of the

such a way that no one can find fault with them.

There is something about the arrangement of this barn inside that will appeal to every orderly person. The stalls are right for convenience both in handling the horses and for cleaning the stable. The carriage room is quite large and convenient with two store rooms, one for general garden tools with a place for a small work bench on one side, a necessity in almost any village lot where a man is kept to do the chores. The other storeroom is intended for harness. There is also a case which comes in very handy to keep the smaller things and those that are valuable. The glass doors slide past each

other and may be easily locked shut. It is a good plan to have some little cupboard like this that may be locked when occasion requires it. In almost every stable medicines are kept, and they should be out of the way of children. It is a splendid precaution to keep medicine bottles locked up. A great many accidents have come just from carelessness in this respect.

Every village stable that is large enough should have a room for the man; it may

not be necessary at all times, but the time will probably come when this room will be found very useful. In this case it is built in one of the large gables where the roof is steep enough to lath and plaster right on the rafters. It is a case of building a roof and a side at the same time and it makes a saving in expense in one way or the other. You either don't pay for the roof or you don't pay for the side of the room.

A Model Dairy Building—A180

We are here illustrating a dairy building which is very complete and answers all the requirements for a country dairy. It has waterworks, power and electric light plant of sufficient capacity to supply heat, water, light and power for the various purposes required on a large dairy and stock farm. The building consists of three

foundations, above which it is of the regular balloon frame construction. The walls are of two-inch by six-inch studding sheathed on the outside with matched sheathing, then papered and covered with drop siding. The space between the studding of the dairy and wash rooms from the floor to the window sills is filled with

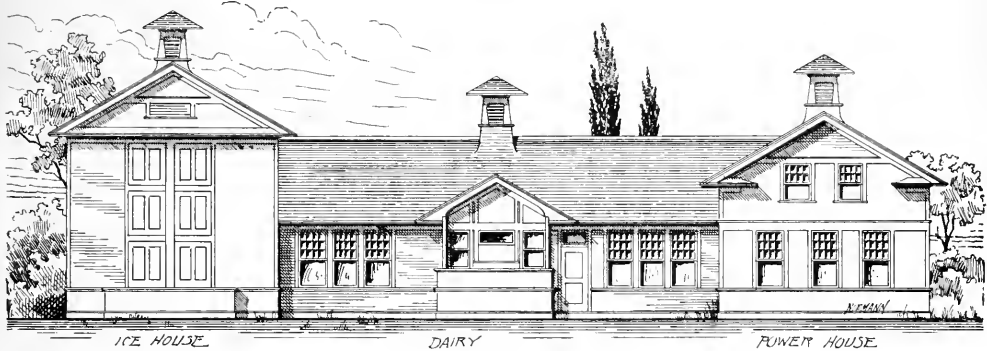

parts; the left hand wing is the ice storage house and also contains two cold storage rooms for butter, cream, milk, etc.; the central part is the dairy containing the churn room, bottling room, washing room, etc., and the right wing is the power and pumping station.

This building is built on a concrete

concrete and then cemented on the inside forming a cement wainscoting as well as strengthening the building. Above this cement work the side walls and ceiling are ceiled with beaded yellow pine ceiling. The roof is of moss green stained shingles and has large ventilators, which makes it hygienic and adds to the appearance.

The ice house is insulated with several thicknesses of hair felt, air spaces and matched sheathing and insulating, water-proof paper.

The power house has a basement which

contains the boilers, which are sunk below the ground level in order to admit steam pipes to be run underground to the other farm buildings for heating purposes. The pumps and dynamo are run by an engine.

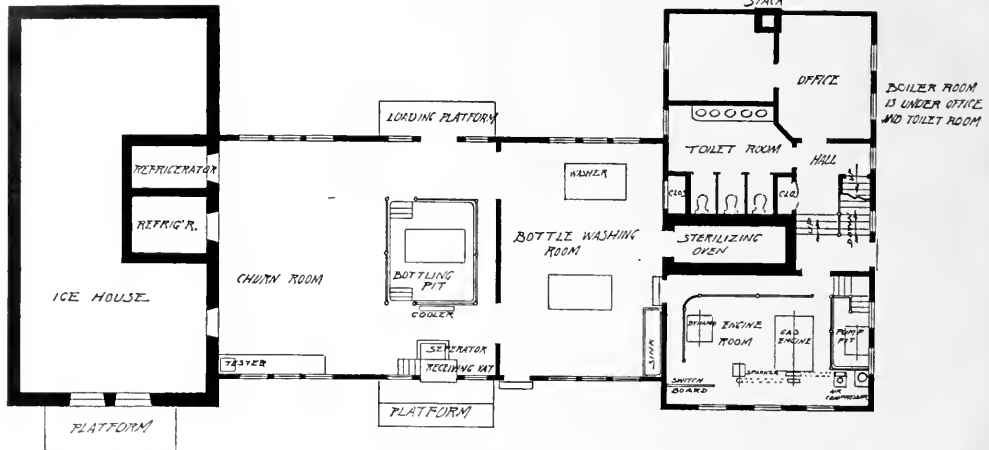

GROUND FLOOR PLAN OF DAIRY

A Practical Silo—A175

We are indebted for the following plans of farm buildings to G. W. Ashby, Architect, who is recognized as one of the leading architects along this line in the country.

We illustrate the construction of silos, which are built of concrete, wood and brick so as to unite strength and durability to an artistic outline.

The accompanying illustrations show the exterior during the course of construction showing the arrangement of the studding, hoops and doors.

The foundation walls are constructed out of concrete two feet in thickness and running down below the frost line, where they rest on a ten-inch by thirty-two-inch concrete footing course to avoid settling. This concrete work is composed of one part Portland cement, three parts sand

and four parts crushed stone, and is reinforced with a five-eighths-inch iron hoop to prevent the walls from spreading. There are anchor bolts bedded in the concrete with which the wooden sill is bolted solid on to the concrete foundation.

The area inside the foundation is excavated down to the footing course in order to increase the capacity, and has a concrete floor slightly pitched to the center.

Frost may not do great damage to the silage as far as its food qualities are concerned, but if frozen into a solid mass it is very difficult to handle and should therefore be to some extent protected against heavy frost. Hence wood construction with dead air spaces between the studding and heavy building paper between the

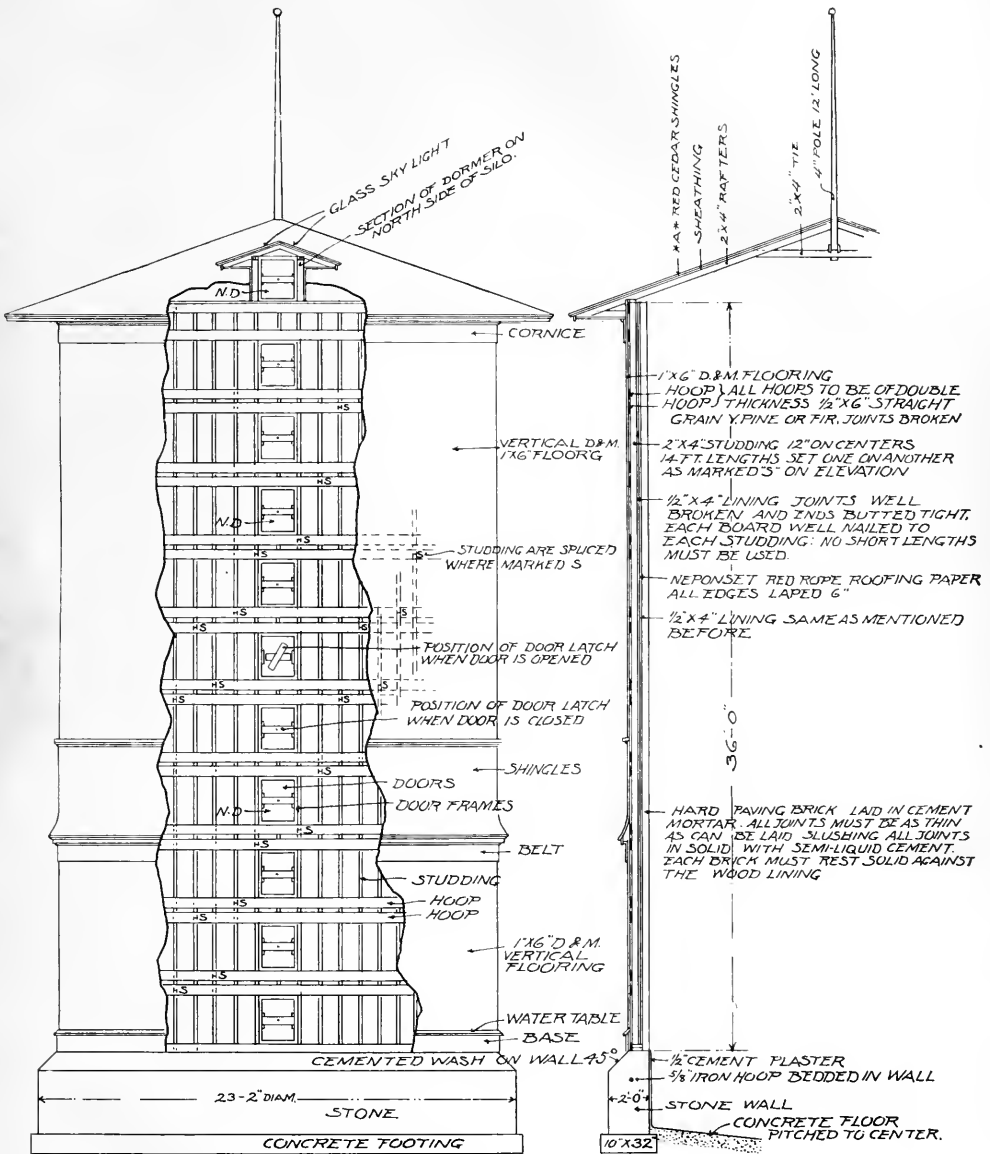

ELEVATION OF SILO SHOWING DOORS ON EAST SIDE (FACING INTERIOR OF COW BARN) ALSO CONSTRUCT DOORS ON NORTH SIDE AS MARKED "N.D."

sheathing has been selected as the most practical construction.

Silage is very heavy and creates a great pressure against the walls, similar to water in a tank, and to prevent this pressure from bulging out the walls the silo has been built in the shape of a cylinder. The sheathing boards on the inside and outside surface of the studding have been resawed to one-half-inch thickness out of one-and-one-eighth-inch boards so that it can without difficulty be bent around the wall and securely nailed in place, thus breaking the joints as to form a continuous series of hoops.

To properly preserve the silage it is necessary to exclude the air, hence the walls must be perfectly air tight. This is frequently accomplished by lathing and plastering the interior surface of the silo with cement mortar, which makes a very hard and air tight surface. However, experi-

ence has proven that the acids in the silage are very detrimental to the cement causing it to chalk and crumble away so that it becomes necessary to re-coat the surface with cement every few years. For this reason, in place of cement plastering, the inside surface has been veneered with vitreous paving brick, which do not absorb moisture and are proof against the action of acid. These bricks are laid tight against the sheathing surface so the pressure cannot change their position and laid in a thin bed of cement mortar not exposing any more mortar to the surface than is necessary to properly bond the brick together.

The exterior surface is composed of dressed and matched narrow flooring vertically to the outer hoops. About ten feet above the ground there is a shingled belt for exterior effect. The roof is of shingles and has a wide projecting cornice.

A Model Chicken House—A173

This building is 68 feet long and 16 feet wide, built on a post foundation, which is enclosed with planking covered with galvanized wire cloth to a depth of about two feet below the ground, to check the tunneling of rats, etc.

Almost every lover of poultry has his own ideas as to how the model chicken house should be arranged and constructed, and every chicken house that is not thus constructed may meet with his severe criticism. We will, therefore, not lay stress on any one particular feature of this building but will say that several different ideas have been used which may be explained as follows:

Rooms Nos. 1 and 2 (see floor plan) are used together; room 1 being the scratching room which is used in stormy and winter weather for exercise, and room No. 2 is the feed, nest and roost room.

The roosts are placed above the nests which have a cover, or roof, pitched so the chickens cannot roost on the nest, but are compelled to get on the roost above. The nests are open in front, having a passage for the chickens, running the full length of each section. The nest sections are removable through doors opposite each section, so they can be easily cleaned and aired; they set on a rack which elevates them about twenty inches above the floor, so the chickens can walk below them where the feed troughs are located, as shown in the section through room No. 2.

Room No. 3 is a feed room, 5 feet wide, which contains feed bins for grain, meal, etc. To the right (east) of this feed room are rooms 4, 5 and 6. In this scheme, the nest room, 4, is separated from the roost room, 6, one being to the west and the other to the east of the scratching rooms.

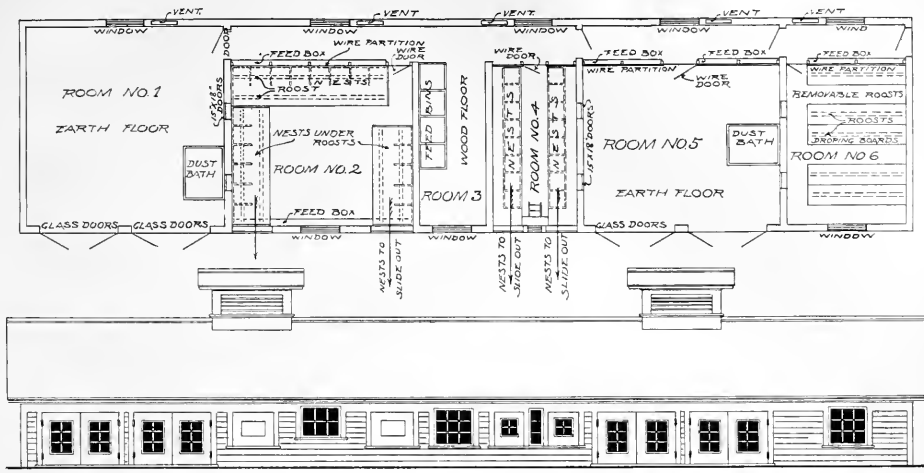

SOUTH SIDE ELEVATION

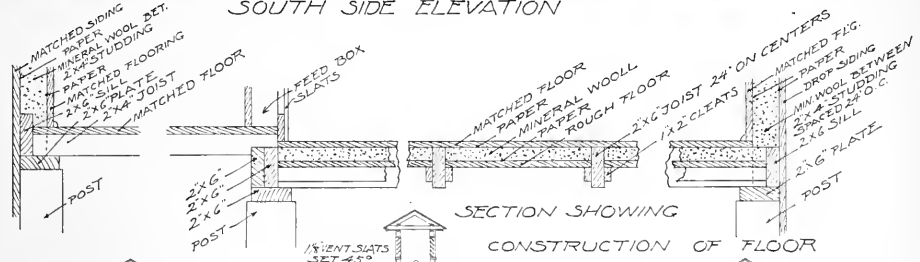

SECTION SHOWING CONSTRUCTION OF FLOOR

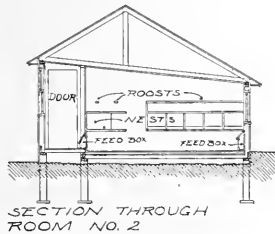

SECTION THROUGH ROOM NO. 2

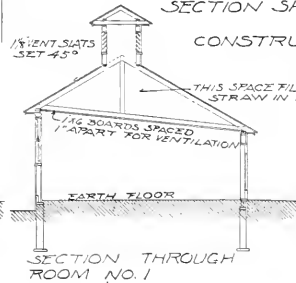

SECTION THROUGH ROOM NO. 1

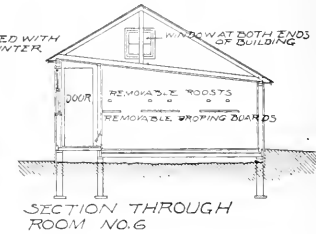

SECTION THROUGH ROOM NO. 6

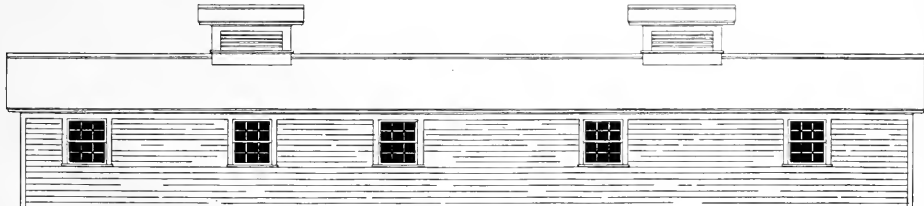

NORTH SIDE ELEVATION

DESIGN OF CHICKEN HOUSE

This may have several advantages over the idea of room 1 and 2 where the chickens roost and lay in the same room, but it also has some disadvantages, one of which is that a larger building is required for the same number of fowls.

The nests of room 4 are so constructed that each nest can be taken out separately, or each entire section can be taken out through doors the same as in room 2. In place of the chicken being in view while on the nest, in room 4 the opening of the nests face the wall, having a dark passage for the chickens. By being out of view they are not frightened while the eggs are being gathered, which is done through a small round hand-hole through the back of the nest. This is covered by a small wooden shutter loosely screwed on over the hand-hole so it will always hang closed. Feed boxes are similar to those in room 2, are located along the hallway.

Rooms 1 and 5 have earth floors and boxes filled with dust, for dust baths. All other floors are constructed double, with two inches of mineral wool between them for warmth, as shown in the section. All side walls of the building have heavy building paper both inside and outside of the studding, and the space between is also filled with mineral wool.

The space between the ceiling and roof is filled with straw during the winter months, and the ceiling boards are spaced half an inch apart to allow a free circulation of air through the ceiling and straw. This is brought about by having windows at each end of the building, which are controlled by cords. All windows on the north have storm sash for winter. Ventilation shafts are built in the north wall, with side shutters for admitting fresh air and exhausting foul air in winter, when all windows are kept closed.

Power House for a Farm—A177

The power house here shown gives shelter to the various mechanisms which furnishes the power, light, water and heat to the different buildings of the farm and thus becomes one of the most important buildings. Its engine room is equipped with a powerful Westinghouse, three cylinder, gas engine which supplies power for pumping water and generating electricity for light and power for the various small machines such as cream separator, churn, ensilage cutter, grain elevator, ice hoist and for many other purposes about the farm.

The various electric circuits are controlled by a modern marble switchboard, from which the wires run up to the ventilator on the roof of the building and from thence to the different buildings, supplying them with incandescent light and power.

The pumping apparatus supplies water from a deep driven well to two large pneumatic pressure storage tanks. The soft water supply is pumped from large cis-





terns with a total capacity of 700 barrels into another pneumatic storage tank; the three tanks supply the various buildings with cold, hard and soft water, having a pressure of about 80 pounds per square inch and a capacity of 27,000 gallons.

The boiler room is of fireproof construc-

tion, having stone walls and a ceiling of book tile laid on steel T bars, bedded in cement; this ceiling also forms the roof which is of asphalt and gravel. The boiler room is built partly below ground so that the steam return pipes from the various buildings will slope back to the boilers.

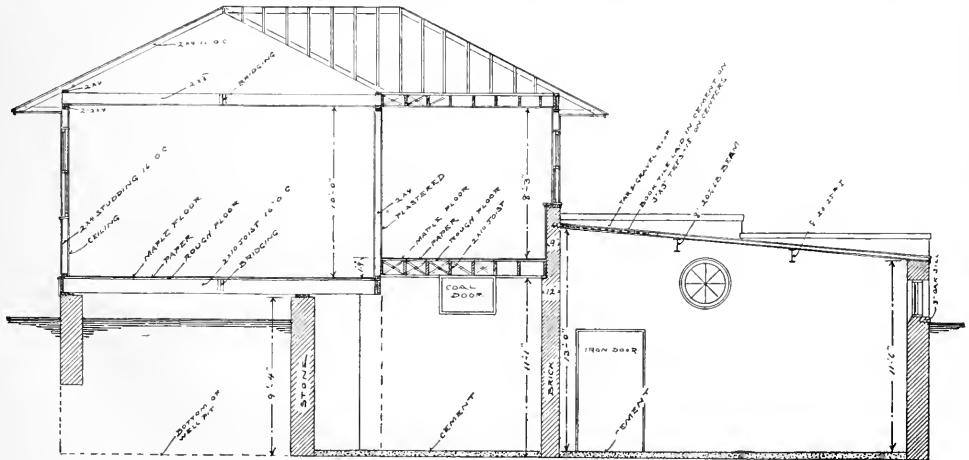

Both boilers are of the high pressure, fire-box type; the large one is of sufficient capacity to heat all the buildings in the coldest weather and the smaller to furnish

tain hard and soft water, hot and cold water and steam supply and return pipes. Between the boiler room and engine room is the toilet and wash room for the em-

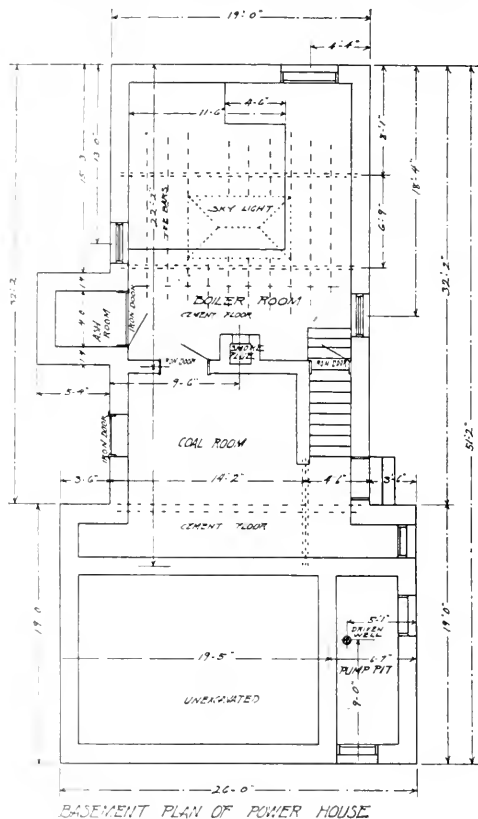

high pressure steam at all times for the sterilizing oven, creamery, laundry and other purposes.

This building is connected to the other buildings with a network of pipes run through underground conduits which con-

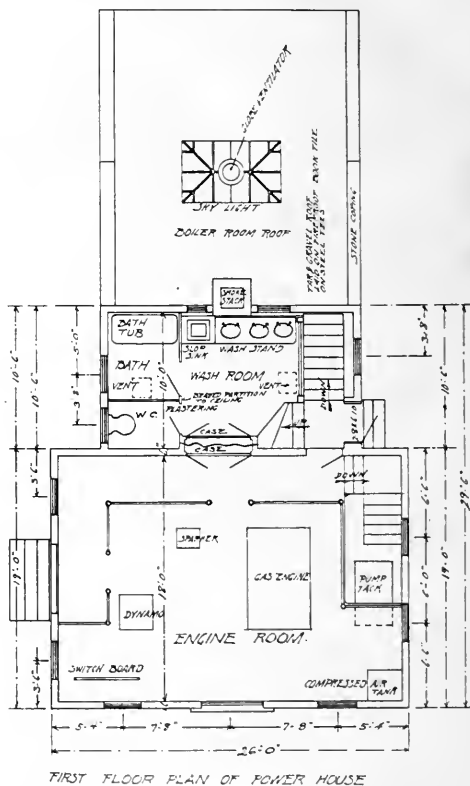

ployees of the farm. Under this wash room and under part of the engine room is a large basement for coal and fuel. The exterior of this building is very pretty and from an architectural point of view it is in-harmony with the other buildings.

Model Dairy Barn--A176

We illustrate herewith a dairy building which is located directly west of the cow barn and so arranged that the milk can be

brought from the west door of the cow barn directly to the receiving vat in the dairy building. The milk cans are unload-

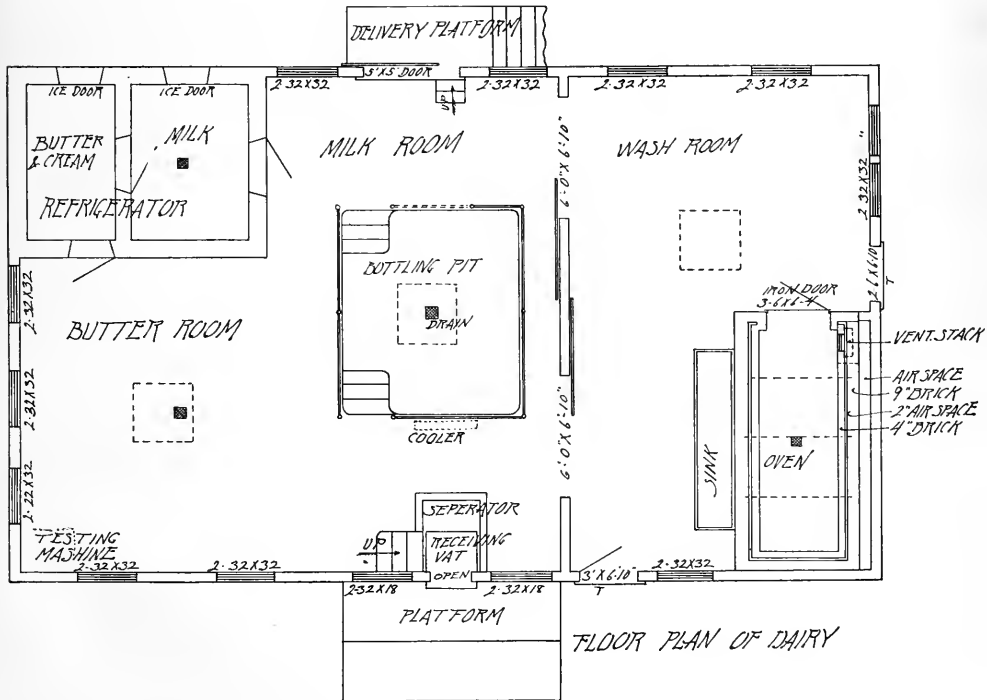
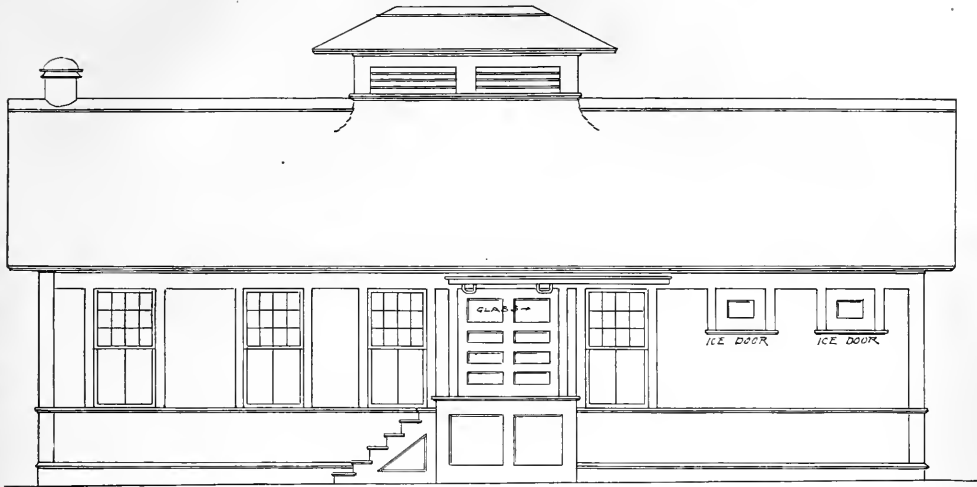

Manual Training on the Farm—A178

Manual training is learning a thing by doing it. The teaching of manual training does not necessarily mean that every student should become a mechanic, but it

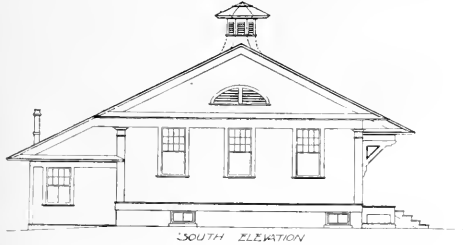

is founded on the principle of truth, and truth is taught in a more direct and forceful manner by the aid of mechanics than by any other process. In a course of instruction the students imbibe a knowledge of the principles of mechanics as a natural sequence, and by this means a practical knowledge of the problems of life are absorbed in a manner well calculated to develop the mind along the practical channels.



Every farmer and every business man is the better off for having had a mechanical training. When a boy is told to make a box four inches long, three inches wide and two inches deep the problem seems simple, but when the work is complete and he shows the instructor a box of different dimensions it is of no use for him to con-

tend that he has followed the instructions, because the measurements show the mistake beyond controversy; no argument applies, it is the acknowledgement of an untruth in concrete form and the lesson is driven home.

This building contains the office of the farm superintendent, the blacksmith shop, and a room eighteen by thirty-five feet fitted up with the necessary parapher-

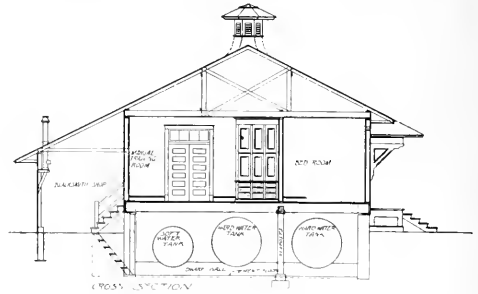

nalía for teaching the elements of mechanics. The blacksmith shop and working shop furnish practical appliances for working out the theories developed and set forth by drawings, which are made to scale in the manual training room proper. A tool case in one corner provides for the proper keeping of the necessary hand and machine tools to carry out the mechanical development of the plans.

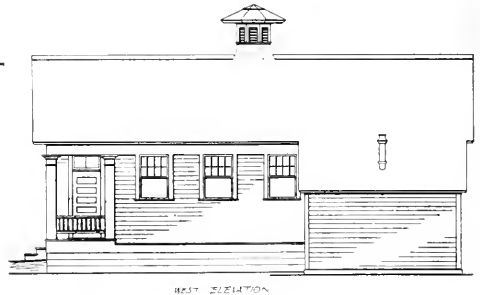

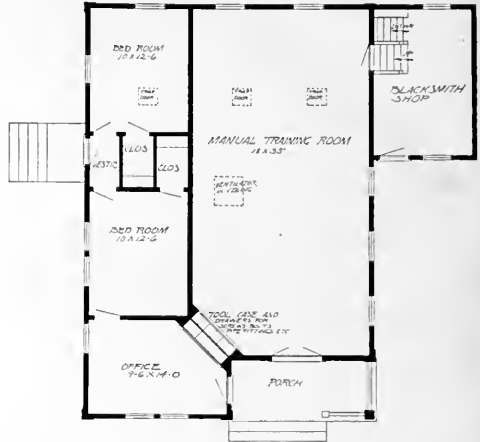
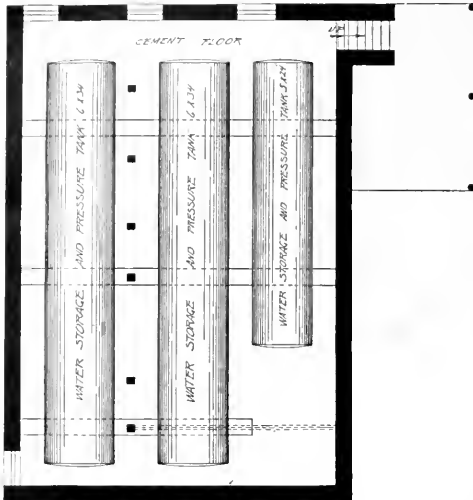

The motto "a place for every tool, and every tool in its place" is rigidly enforced, thereby demonstrating the value of system and order. The basement of this building contains the high pressure water

supply tanks that hold the hard water, and the cistern water required for use on the farm. The tanks are supplied by pumps in the power house and from these tanks pipes are run to the other buildings, water tanks, etc.



INDEX

A.	PAGE	E.	PAGE
An A-Shaped Poultry House	18	Elevated Chicken House, A	62
Attractive Stable	31	English Barn, An	112
		Excavation	13
B.		F.	
Balloon Roofed Barn, A	27	Feeder Cribs	123
Barn for Dairy Cows, A	67		
Barn for a Small Farm	64		
C.		G.	
Canadian Barn, A	131	Gothic Barn, A	141
Carriage House and Stable	100	Granary, A	141
Cattle Shed	97		
Cement Block Smoke House, A.....	46		
Cement Rough Cast Barn, A.....	136		
Cheap Cattle Shed	73		
Cheap Grain Building	102		
Cheap Hog House, A	71		
Cheap Smoke House, A	24		
Combined Barn and Covered Barn- Yard	55		
Convenient Horse Barn	7		
Convenient Horse Barn	96		
Corn Crib	122		
Cow Barn for Forty Cows, A	60		
Cyclone Barn, A	40		
		H.	
		Hay and Grain Barn	90
		Hexagonal Poultry House	139
		Hog House, A	99
		Hog House and Corn Crib	44
		Horse and Cattle Barn	16
		Horse Shed, A	57
		Housing of Dairy Cows	11
		I.	
		Ice House Design	74
		Implement Shed, An	38
		Inexpensive Poultry House	86
		L.	
		Large Bank Barn, A	76
		Large Storage Barn, A.....	48

INDEX—Continued.

	PAGE		PAGE
M.		S.	
Manual Training on the Farm.....	153	Serviceable Barn, A	130
Model Chicken House, A	146	Silo Construction	15
Model Cow Barn	58	Silos	123
Model Dairy Barn, A	150	Single Corn Crib	56
Model Dairy Building, A	143	Small Barn	108
		Small Barn for a Village Lot.....	70
N.		Small Barn for Horses	51
Neat Carriage House, A	89	Small Barn with Cement Floor.....	5
		Small Barn with Ell Shed	84
		Small Barn with Stable, A	23
		Small Carriage House	69
		Small Carriage House	88
		Small Carriage House	72
		Small Chicken House	50
O.		Small Double Poultry House, A	30
Octagon Barn, An	33	Small Double Poultry House, A	45
Ohio Barn, An	124	Small Livery Barn	95
Open Front Poultry House	6	Small Poultry House	35
		Small Stable	52
		Small Wagon Shed	93
P.		Single Corn Crib	56
Plain Horse Barn, A	66	Stable for 24 Cows	36
Plan of an Ice House	9	Stable and Granary	82
Power House for a Farm	148	Stave Silo, A	109
Practical Poultry House	101		
Practical Silo, A	144	T.	
Preface	3	Tank House, A	107
Pretentious Stock Barn	139	Tower Tank House, A	87
		Two Small Ice Houses	94
R.			
Rat Proof Granary, A	106	Y.	
Round Corn Crib, A	21	Yankee Barn, A	53

Radford American Homes

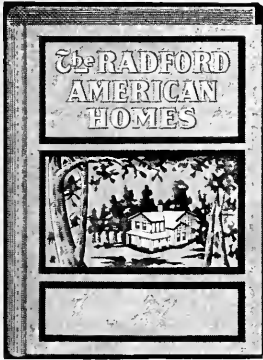

Edited by William A. Radford, president of the Radford Architectural Company.

ONE HUNDRED IDEAL HOMES

Fully illustrated, are contained in this splendid work. There are shown in detail the perspective views and floor plans, accompanied by full description of up-to-date houses, such as people wish to build to-day.

ORIGINAL, PRACTICAL AND ATTRACTIVE HOMES

are the only ones described. Every plan is designed by a licensed architect who has been at the head of his profession in his particular class of work.

ECONOMICAL CONSTRUCTION AND SAVING

of many dollars for the home builder and contractor has been the keynote of our effort in this special book. It has been our effort to provide and devise plans that will give the most satisfaction and comfort for the least possible expenditure. In no case has any useless expense been put upon the building to carry out some pet idea. Every plan shown is guaranteed to work out to the best advantage in every respect, and every bit of space has been utilized to the best advantage.

SPECIAL EDITION

We have gone to work at great expense and obtained what we think the finest set of designs and plans for houses to be built at a reasonable cost that has ever been offered to the public.

REMEMBER, when buying this book you are buying what you cannot obtain from anyone else, and a book that our reputation and business standing guarantees to be superior to any book of a similar nature ever offered.

OF EVERY BEAUTIFUL HOUSE

in this book we show perspective views, floor plans and full description. Each book is printed on the very best quality of heavy plate paper. The book is bound in buckram cloth with attractive cover design. 256 pages. Size, 6¼x8 inches.

Price \$1.00 postpaid.

RADFORD ARCHITECTURAL CO.
CHICAGO—NEW YORK.

Practical Carpentry

A Complete Up-to-Date Explanation of Modern Carpentry. Two Volumes

Edited under the personal supervision of William A. Radford, editor-in-chief of "The American Carpenter and Builder," and author of "The Steel Square and Its Uses," assisted by Alfred W. Woods, the world's greatest expert on the steel square, and William Reuther, the leading authority on carpentry, joinery and building.

NEW SPECIAL EDITION

This work "Practical Carpentry," is absolutely new, being completed only January 1, 1907. It was written especially for us, at an enormous expense, and can be obtained from no one else. It is written in simple, plain, every day language so that it can be easily understood. It will not bewilder the working man with long mathematical formulas or abstract theories.

IT IS THE MOST COMPLETE

most accurate, most up-to-date and most practical work upon this subject. It contains the best and quickest methods for laying roofs, rafters, stairs, floors, hopper bevels, mitering, coping, splayed work, circular work, and, in fact, for forming all kinds of joinery and carpenter work.

SPECIAL CHAPTERS

are devoted to building construction, which takes the carpenter from foundation to roof, with complete illustrations of each detail, such as foundation, windows, cornices, doors, roofs, porch work, etc. There are also special chapters devoted to good and faulty construction and all kinds of framing.

400 SPECIAL ILLUSTRATIONS

There are over 400 illustrations, many of them cover an entire page, and they illustrate completely and instructively the text. They show the detail and actual construction down to the minutest point. They enable the reader to understand the text easily and to follow the work in hand without difficulty.

REMEMBER, this work is the latest one published on this extensive subject (issued January 1, 1907). This edition cannot be obtained from anyone else but ourselves. It was made for us at our order. Each volume measures 6x9 inches, and is bound in cloth with cover design attractively stamped. Contains more than 300 pages in each volume. Printed on an excellent quality of paper. **Each volume contains 50 modern house plans.**

Price \$1.00 per volume, postpaid.

RADFORD ARCHITECTURAL CO.
CHICAGO—NEW YORK.

The Steel Square and Its Uses

Two Volumes

Edited under the personal supervision of William A. Radford, editor-in-chief of "The American Carpenter and Builder," and author of "Practical Carpentry," assisted by Alfred W. Woods, the world's greatest expert on the steel square, and William Reuther, the leading authority on carpentry, joinery and building. In addition to containing all the matter that has appeared in the original Fred T. Hodgson's Steel Square books, revised and brought up to date, it contains several hundred pages of absolutely new matter that has never before been printed or placed in the hands of the practical carpenter.

JUST PUBLISHED.

This very valuable and practical work is published for the first time. It is up to the minute, being issued January 1, 1907. This splendid edition was made especially for us, and cannot be obtained from anyone else. It is not a rehash and compilation of material taken from other and out of date works on this subject, but is a brand new book from cover to cover, written in simple, plain, every day language so that it can be easily understood and followed. Information of value that has appeared in former works, appears in this work, together with a vast amount of new, practical, everyday information, such as is necessary for every progressive and successful carpenter to know.

THIS UP TO DATE AND PRACTICAL WORK

on the application of the steel square, treats of the laying out of rafters, finding the lengths of jacks, securing bevels, laying out hopper bevels, treating of the steel square as a calculating machine, and showing how to measure solids, surfaces and distances.

SPECIAL CHAPTERS

are devoted to that part of stair building to which the steel square can be applied. Other chapters treat of heavy timber framing, showing how the square is used for laying out mortises, tenons, shoulders, etc.

PRACTICAL AND INSTRUCTIVE ILLUSTRATIONS

to the number of more than 300 are scattered through this work. These illustrations are not technical mathematical designs, nor geometrical problems, but are the thoroughly practical illustrations of a thoroughly practical text, bringing to the attention of the carpenter such points of interest and information as he needs in his everyday business. While the text and descriptive matter are so accurate and easy of comprehension that they could be understood without even the assistance of the illustrations, nevertheless the book has been thoroughly and profusely illustrated with diagrams and drawings.

REMEMBER, this work is absolutely up-to-date, (being issued January 1, 1907), and you cannot obtain this book from anyone else but ourselves. Each volume measures 6x9 inches, and contains over 300 pages, being the largest books on the steel square ever published. They are bound in cloth with attractive cover designs, handsomely stamped. Printed on the best quality of paper. **Each volume contains 50 modern house plans.**

Price \$1.00 per volume, postpaid.

RADFORD ARCHITECTURAL CO.

CHICAGO—NEW YORK.









